

Autodesk Navisworks Simulate 2010

User Guide

The Autodesk logo is displayed in white text on a black rectangular background. The word "Autodesk" is written in a bold, sans-serif font and is oriented vertically, reading from bottom to top.

March 2009

© 2009 Autodesk, Inc. All Rights Reserved. Except as otherwise permitted by Autodesk, Inc., this publication, or parts thereof, may not be reproduced in any form, by any method, for any purpose.

Certain materials included in this publication are reprinted with the permission of the copyright holder.

Trademarks

The following are registered trademarks or trademarks of Autodesk, Inc., in the USA and other countries: 3DEC (design/logo), 3December, 3December.com, 3ds Max, ADI, Alias, Alias (swirl design/logo), AliasStudio, AliasWavefront (design/logo), ATC, AUGI, AutoCAD, AutoCAD Learning Assistance, AutoCAD LT, AutoCAD Simulator, AutoCAD SQL Extension, AutoCAD SQL Interface, Autodesk, Autodesk Envision, Autodesk Insight, Autodesk Intent, Autodesk Inventor, Autodesk Map, Autodesk MapGuide, Autodesk Streamline, AutoLISP, AutoSnap, AutoSketch, AutoTrack, Backdraft, Built with ObjectARX (logo), Burn, Buzzsaw, CAiCE, Can You Imagine, Character Studio, Cinestream, Civil 3D, Cleaner, Cleaner Central, ClearScale, Colour Warper, Combustion, Communication Specification, Constructware, Content Explorer, Create>what's>Next> (design/logo), Dancing Baby (image), DesignCenter, Design Doctor, Designer's Toolkit, DesignKids, DesignProf, DesignServer, DesignStudio, DesignStudio (design/logo), Design Web Format, Discreet, DWF, DWG, DWG (logo), DWG Extreme, DWG TrueConvert, DWG TrueView, DXF, Ecotect, Exposure, Extending the Design Team, Face Robot, FBX, Filmbox, Fire, Flame, Flint, FMDesktop, Freewheel, Frost, GDX Driver, Gmax, Green Building Studio, Heads-up Design, Heidi, HumanIK, IDEA Server, i-drop, ImageModeler, iMOUT, Incinerator, Inferno, Inventor, Inventor LT, Kaydara, Kaydara (design/logo), Kynapse, Kynogon, LandXplorer, LocationLogic, Lustre, Matchmover, Maya, Mechanical Desktop, Moonbox, MotionBuilder, Movimento, Mudbox, NavisWorks, ObjectARX, ObjectDBX, Open Reality, Opticore, Opticore Opus, PolarSnap, PortfolioWall, Powered with Autodesk Technology, Productstream, ProjectPoint, ProMaterials, RasterDWG, Reactor, RealDWG, Real-time Roto, REALVIZ, Recognize, Render Queue, Retimer, Reveal, Revit, Showcase, ShowMotion, SketchBook, Smoke, Softimage, SoftimageXSI (design/logo), SteeringWheels, Stitcher, Stone, StudioTools, Topobase, Toxik, TrustedDWG, ViewCube, Visual, Visual Construction, Visual Drainage, Visual Landscape, Visual Survey, Visual Toolbox, Visual LISP, Voice Reality, Volo, Vtour, Wire, Wiretap, WiretapCentral, XSI, and XSI (design/logo).

The following are registered trademarks or trademarks of Autodesk Canada Co. in the USA and/or Canada and other countries: Backburner, Multi-Master Editing, River, and Sparks.

The following are registered trademarks or trademarks of MoldflowCorp. in the USA and/or other countries: Moldflow, MPA, MPA (design/logo), Moldflow Plastics Advisers, MPI, MPI (design/logo), Moldflow Plastics Insight, MPX, MPX (design/logo), Moldflow Plastics Xpert.

LightWorks, the LightWorks logo, LWA and LWA-Enabled are registered trademarks of LightWork Design Ltd. The LWA-Enabled logo, Interactive Image Regeneration, IIR, A-Cubed, Feature-Following Anti-Aliasing and FFAA are all trademarks of LightWork Design Ltd. All other trademarks, images and logos remain the property of their respective owners. Copyright of LightWork Design Ltd. 1990-2007, 2008.

This software is based in part on the work of the Independent JPEG Group.

Contains a modified version of Open CASCADE libraries. See the license file "OpenCascadeLicense.txt" in the Navisworks installation directory. Source code is available from download.autodesk.com/us/navisworks/OpenCascade.zip.

Disclaimer

THIS PUBLICATION AND THE INFORMATION CONTAINED HEREIN IS MADE AVAILABLE BY AUTODESK, INC. "AS IS." AUTODESK, INC. DISCLAIMS ALL WARRANTIES, EITHER EXPRESS OR IMPLIED, INCLUDING BUT NOT LIMITED TO ANY IMPLIED WARRANTIES OF MERCHANTABILITY OR FITNESS FOR A PARTICULAR PURPOSE REGARDING THESE MATERIALS.

Contents

	Welcome to Autodesk Navisworks Simulate 2010	1
Chapter 1	What Is New in This Release?	3
Chapter 2	How to Get Assistance	7
	Use Communication Center	7
	Overview of Communication Center	7
	Specify Communication Center Settings	8
	Use the Help System	9
	Find Information in Help	9
	Use Searches	10
	How Help Topics Are Organized	11
	Print Help Topics	11
	Show and Hide the Contents Pane	12
	Get More Help	12
	Learn the Product	12
	Access Subscription Center	13
	About Subscription Center	14
	Manage Files with Autodesk Vault	14
	View the Product Readme	15
	Join the Customer Involvement Program	15
Chapter 3	Installation	17
	Quick Start to Stand-Alone Installation	17
	Prepare for Installation	17
	System Requirements for Stand-Alone Installation	17
	Understand Administrative Permission Requirements	19
	Locate Your Autodesk Navisworks Serial Number and Product Key	19
	Avoid Data Loss During Installation	19
	Choose a Language	19
	Configure Button	20
	Install Multiple or Bundled Products	20
	Install and Run Autodesk Navisworks Simulate 2010	21
	Install Autodesk Navisworks	21
	Launch Autodesk Navisworks	25
	How to Launch Autodesk Navisworks in Another Language	25
	Add or Remove Features	26
	Reinstall or Repair Autodesk Navisworks Simulate 2010	26
	Uninstall Autodesk Autodesk Navisworks Simulate 2010	27
	Move to Autodesk Navisworks from a Previous Release	27

Install Autodesk Navisworks for Multiple Users	28
Quick Start to Network Administration and Deployment	28
Deployment Preparation	28
Set Up Network Tools and Your License Server	31
Distribute the Program	33
Distribute an Autodesk Navisworks Product	33
Set Up a Deployment	34
Preliminary Tasks for a Network Deployment	34
Configure Button	35
Your Deployment Choices	36
Choose a Language	40
Create a Deployment	41
Final Review and Complete Setup	44
Modify a Deployment (optional)	44
Point Users to the Administrative Image	44
Uninstall an Autodesk Product	45
Installation Troubleshooting	45
General Installation Issues	45
How can I check my graphics card driver to see if it needs to be updated?	45
When performing a Typical installation, what gets installed?	46
Why should I specify the Project Folder and Site Folder?	46
How do I share the Autodesk Navisworks settings on a site and project basis?	46
Where are my product manuals?	47
How do I register and activate Autodesk Navisworks?	47
Deployment Issues	48
Is there a checklist I can refer to when performing a deployment?	48
Where should deployments be located?	48
Where can I check if service packs are available for my software?	48
How do I choose between 32-bit and 64-bit deployments?	48
What are information channels?	48
Licensing Issues	49
What is the difference between a stand-alone license and a network license?	49
What is the benefit to using a network licensed version of the software?	49
What is Internet Explorer used for?	49
Networking Issues	49
Where do I find my server name?	49
If I choose to create a log file, what kind of information does the log file contain?	50
What is an administrative image (MSI) file?	50
What is the impact of selecting all products to be included in the administrative image?	50
Uninstall and Maintenance Issues	50
When adding or removing features, how can I tell what features get installed by default?	50
Is it possible to change the installation folder when adding or removing features?	50
When should I reinstall the product instead of a repair?	50
Do I need my original disk to reinstall my software?	51
When I uninstall my software, what files are left on my system?	51
Chapter 4 Quick Start	53
Start and Quit Autodesk Navisworks	53
Automatically Save and Recover Navisworks Files	53
Command Line Options	55
The User Interface	57
Parts of Autodesk Navisworks Interface	57
Menu Bar	57
Toolbars	61
Scene Area	68
Dockable Windows	70
Status Bar	71
Undo/Redo Commands	72
Autodesk Navisworks Workspaces	72
Default Keyboard Shortcuts	74
Customize the Toolbars	76
Autodesk Navisworks Options	78
Environment Options	81
Location Options	82

Display Units	82
Profiles	83
Search Directories	84
Get a Whole-Project View	85
Chapter 5 Work with Files	87
Native File Formats	87
Compatible CAD Applications	88
Supported CAD File Formats	90
Supported Laser Scan File Formats	91
Use File Readers	91
3DS File Reader	91
ASCII Laser Scan File Reader	92
Bentley AutoPLANT File Reader	92
CIS2 File Reader	93
DWG/DXF/SAT File Reader	95
DWF File Reader	97
DGN File Reader	98
Faro Scan File Reader	99
IFC File Reader	99
IGES File Reader	99
Inventor File Reader	100
JTOpen File Reader	100
Leica Scan File Reader	101
MAN File Reader	102
PDS File Reader	103
Riegl Scan File Reader	103
RVM File Reader	103
SketchUp SKP File Reader	104
STEP File Reader	104
STL File Reader	105
VRML File Reader	105
Z+F Scan File Reader	106
Use File Exporters	106
AutoCAD File Exporter	106
Revit File Exporter	111
MicroStation File Exporter	112
Viz and Max File Exporter	114
ArchiCAD File Exporter	115
Manage Files	117
Open Files	117
Create Files	117
Save and Rename Files	117
Complex Models	120
Refresh Files	122
Merge Files	122
Email Files	123
Receive 3D Mail	123
Chapter 6 Explore Your Model	125
View Scene Statistics	125
Navigate a Scene	125
Orientation in 3D Space	126
Navigation Modes	127
SteeringWheels	133
Camera	150
ViewCube	152
Navigation Aids	159
View All	161
View Selected	161
Focus	162
Hold	162

	Control the Realism of Your Navigation	162
	Gravity	162
	Crouching	163
	Collision	163
	Third Person View	164
	Head-Up Display	165
Chapter 7	Control Model Appearance and Render Quality	167
	Control Model Appearance	167
	Select Render Mode	167
	Add Lighting	168
	Select Background Effect	170
	Adjust Displaying of Primitives	172
	Control Render Quality	174
	Use Culling	174
	Control Rendering of Objects	176
	Adjust Presenter Materials	177
	Stereo Rendering	178
Chapter 8	Review Your Model	179
	Select Objects	179
	Interactive Geometry Selection	179
	Set Selection Resolution	183
	Set Highlighting Method	184
	Hide Objects	185
	Find Objects	186
	Find Items Window	186
	Quick Find	190
	Create and Use Sets of Objects	190
	Selection Sets Window	191
	Create and Manage Selection and Search Sets	192
	Compare Objects	194
	Object Properties	195
	Properties Window	195
	Custom Properties	196
	External Database Links	198
	Manipulate Object Attributes	205
	Transform Objects	205
	Change Color and Transparency	209
	Snapping	209
	Reset to Original Values	210
	Measure Tools	211
	Measure Tools Window	211
	Measuring	212
	Comments and Redlines	216
	Add Comments and Redlines	216
	Review Comments and Redline Tags	223
	Links	226
	Link Categories	227
	Display Links	227
	Customize Links	228
	Add Links	230
	Find and Follow Links	231
	Manage Links	232
	Smart Tags	233
	SwitchBack to AutoCAD and MicroStation	234
Chapter 9	Use Viewpoints and Sectioning Modes	237
	Create and Modify Viewpoints	237
	Overview of Viewpoints	237
	Saved Viewpoints Window	237
	Save Viewpoints	240
	Recall Viewpoints	241

	Organize Viewpoints	241
	Edit Viewpoints	241
	Default Viewpoint Options	242
	Share Viewpoints	244
	Sectioning	244
	Enable Section Planes	245
	Position and Use Section Planes	245
	Link Section Planes	248
	Enable and Use Section Boxes	248
Chapter 10	Record and Play Animations	251
	Create and Edit Viewpoint Animations	251
	Play Animations	254
	Share Animations	254
Chapter 11	Work Within a Team	255
	Collaborate Toolbar	255
	Collaboration Session	255
Chapter 12	Share Data	259
	Print	259
	Print Preview	259
	Print Setup	259
	Print Current Viewpoint	260
	Import Files	260
	PDS Tag Files	260
	PDS Display Set Files	261
	Viewpoints Files	261
	Search Criteria Files	262
	Search Set Files	262
	Export Files	263
	Piranesi EPix Format	263
	PDS Tag Files	264
	Autodesk DWF Format	264
	Google Earth KML Format	264
	TimeLiner CSV	266
	Export Images and Animations	266
	Viewpoints Files	268
	Current Search Criteria	268
	Search Set Files	269
	Viewpoints Report	269
Chapter 13	Animate Objects	271
	Overview of the Animator Tool	272
	Animator Window	272
	The Animator Toolbar	272
	The Animator Tree View	273
	The Animator Timeline View	275
	The Manual Entry Bar	277
	Scripter Window	278
	The Scripter Tree View	278
	The Events View	279
	The Actions View	280
	The Properties View	281
	Create Object Animations	285
	Work with Animation Scenes	286
	Work with Animation Sets	288
	Add Animation Sets	288
	Update Animation Sets	288
	Manipulate Geometry Objects	289
	Work with Cameras	291
	Work with Section Plane Sets	292

Work with Keyframes	292
Capture Keyframes	293
Edit Keyframes	293
Play Animation Scenes	293
Add Interactivity	294
Work with Animation Scripts	294
Work with Events	296
Work with Actions	297
Enable Scripting	298
Chapter 14 Create Photorealistic Visualizations	299
Overview of the Presenter Tool	299
Presenter Window	299
Use the Presenter Archives	300
Photo-Realistic Scene Rendering	301
Use Presenter Materials	303
Materials Tab	303
Apply and Remove Presenter Materials	303
Organize and Manage Materials	305
Edit Presenter Materials	306
Advanced Materials	309
Use Presenter Lights	310
Lighting Tab	310
Add and Position Lights	311
Organize and Manage Lights	312
Edit Lights	313
Shadow Casting	315
Advanced Lighting	315
Soft Shadows	316
Physically Accurate Lights	316
Volumetric Lights	316
Image-based Lighting	317
Use Presenter RPCs	318
RPC Tab	318
Use Presenter Rendering Effects	321
Effects Tab	321
Background Effects	321
Foreground Effects	325
Use Presenter Rendering Styles	325
Rendering Tab	325
Rendering Styles	326
Predefined Rendering Styles	327
Auto Exposure	327
Use Presenter Texture Space	328
Use Presenter Rules	329
Rules Tab	329
Predefined Rules	330
Custom Rules	331
The Presenter Rules Example	332
Chapter 15 Simulate Construction Scheduling	335
Overview of TimeLiner Tool	335
TimeLiner Window	335
Tasks Tab	336
Links Tab	339
Configure Tab	340
Rules Tab	341
Simulate Tab	342
Select Link Dialog Box	343
Field Selector Dialog Box	343
Simulation Settings Dialog Box	346
Overlay Text Dialog Box	349
Get Started	350

TimeLiner Tasks	353
Create Tasks	354
Edit Tasks	355
Attach Tasks to Geometry	356
Attach Tasks Manually	357
Use Rules to Attach Tasks	358
Validate Project Schedule	359
Link to External Project Files	360
Supported Scheduling Software	360
CSV Support	362
Add and Manage Links	362
Add Links	362
Edit Links	363
Delete Links	363
Build Tasks from Links	364
Synchronize Tasks with Project Changes	364
4D Simulation	364
Play Simulations	364
Configure Simulations	365
Simulation Playback	365
Simulation Appearance	365
Export	366
Add Animation	366
Overview	367
Add Animation to an Entire Schedule	367
Add Animation to Tasks	369
Add Scripts to Tasks	370

Chapter 16 Autodesk Navisworks Reference 371

File Options Dialog Box	371
Culling Tab	371
Orientation Tab	372
Speed Tab	372
Head Light Tab	373
Scene Lights Tab	373
DataTools Tab	373
File Units and Transform Dialog Box	373
New Link Dialog Box	374
Edit Link Dialog Box	374
Edit Viewpoint Dialog Box	374
Options Editor	375
General Node	376
Undo Page	376
Locations Page	376
Environment Page	376
Communication Center Page	376
Auto-Save Page	377
Model Node	377
Performance Page	377
NWD Page	379
NWC Page	379
Interface Node	380
Display Units Page	380
Selection Page	380
Measure Page	381
Snapping Page	381
Viewpoint Defaults Page	381
Hyperlinks Page	382
Smart Tags Page	385
Developer Page	385
Display Page	385
SpaceBall Page	386
ViewCube Page	386
SteeringWheels	387

File Readers Node	389
3DS Page	389
ASCII Laser Page	389
CIS2 Page	390
DGN Page	390
DWF Page	391
DWG/DXF/SAT Page	392
Faro Page	394
IFC Page	394
IGES Page	395
Inventor Page	395
JTOpen Page	395
Leica Page	395
MAN Page	396
PDS Page	396
Riegl Page	397
RVM Page	397
SKP Page	398
STEP Page	399
STL Page	399
VRML Page	399
Z + F Page	400
File Exporters Node	401
DWG Page	401
Revit Page	402
DGN Page	403
Viz/Max Page	404
Tools Node	405
Presenter Page	405
TimeLiner Page	406
Scripter Page	406
Animator Page	407
Default Collision Dialog Box	407
Collision Dialog Box	407
Convert Object Properties Dialog Box	408
Culling Options Dialog Box	408
Customize Dialog Box	409
Toolbars Tab	409
Commands Tab	409
Options Tab	410
Customize Keyboard Dialog Box	410
Edit Key Frame Dialog Box	411
Publish Dialog Box	412
Background Settings Dialog Box	413
QTVR Object Movie Settings Dialog Box	414
Export Rendered Image Dialog Box	414
Image Export Dialog Box	415
Animation Export Dialog Box	416
Glossary	419
Index	423

Welcome to Autodesk Navisworks Simulate 2010

Autodesk Navisworks Simulate 2010 software provides dynamic 4D schedules and real-time visualization that enables design and construction professionals to share and combine output for clear, descriptive content that helps demonstrate design intent and validate decisions. Entire projects can be replicated with dynamic, photorealistic views and 4D construction schedules to demonstrate options and predict consequences. Project models can be published in NWD and 3D DWF™ formats for free viewing.

What Is New in This Release?

1

Autodesk Navisworks Simulate 2010 contains many new features and enhancements.

Installation

The installation screen provides links to the installation options, deployment options, installation tools and utilities, documentation and language settings. When installing the product you can select to install either the 32-bit or 64-bit version. You also have the option of selecting the DWG file readers that require installation, plus the exporter plugins that you require.

NOTE If you are installing the product on a 32-bit operating system the 64-bit install options are inaccessible.

User Interface

Changes to the Autodesk Navisworks Simulate 2010 interface more closely align the product with Autodesk standard interface and navigation toolsets.

- **ViewCube.** The ViewCube is an on-screen widget, shaped like a cube, that rotates as you orbit your 3D scene and provides you with feedback about your current camera viewing angle in relation to the model world. See “[ViewCube](#)” on page 152.



- **SteeringWheels.** SteeringWheels are task-based floating tool palettes that travel with the cursor to minimize tool access time. SteeringWheels provide access to different navigation tools grouped into various wheels depending on the navigation task and user skill level. See “[SteeringWheels](#)” on page 133.



- Button menus. In Autodesk Navisworks, some toolbar buttons exist in mutually-exclusive groups of which only one at a time can be selected. These buttons are now grouped under drop-down menus to improve accessibility and decrease screen clutter.
- Artificial horizon. You can now place your model against a fixed artificial horizon so that it appears more realistic and does not float in mid air. The background of the 3D scene is split across the horizontal plane giving the effect of a sky and the ground. The resulting artificial horizon gives you an indication of your orientation in the 3D world. See “[Select Background Effect](#)” on page 170.

TimeLiner

Changes to the TimeLiner tool support improved integration with third-party planning tools, and make adding and editing dates more intuitive.

- Copy and paste TimeLiner dates.
- Import and export support for the CSV file format.
- Attach a selection to multiple TimeLiner tasks.

See “[Overview of TimeLiner Tool](#)” on page 335.

Measurement

Numerous improvements to the measurement tools allow greater accuracy when calculating dimensions and distances between objects in your Autodesk Navisworks model.

- Measure Shortest Distance. When measuring the distance between two objects, Autodesk Navisworks can now calculate and display the shortest distance between the selected objects.

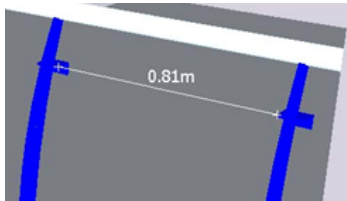

- Measure distance between center lines of parametric objects.

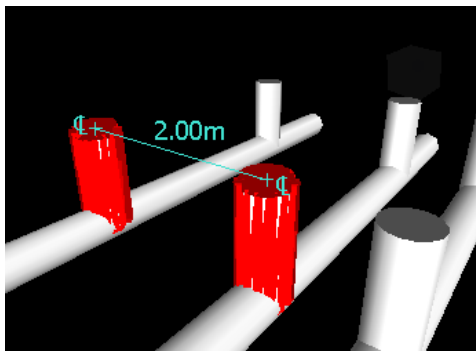

- When measuring distances you now have the option of converting measurements into redlines. The end markers, lines, and dimension labels of your current measurement are converted into a redline and stored in the current viewpoint.
- When measuring an angle, Autodesk Navisworks now displays a measurement arc.

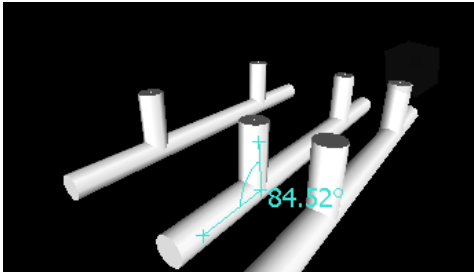

- When measuring an area, Autodesk Navisworks now displays a dotted line to indicate the closure path for the area.

See [“Measuring”](#) on page 212.

Sectioning

Improved support for quick and accurate analysis of models using the sectioning toolset.

- Create a user-defined section box to display only geometry within the defined section box.
- Align section planes to specific faces of an object or line.

See [“Sectioning”](#) on page 244.

Auto-Save

You now have the option of automatically saving your work at regular intervals.

See [“Automatically Save and Recover Files”](#) on page 53.

Communication Center

The Communication Center  allows the Autodesk Navisworks and Autodesk team to notify you of product-related updates and announcements.

See [“Use Communication Center”](#) on page 7.

File Format Support

- Support for JT file format, supporting most geometry types and object attributes. See [“JTOpen File Reader”](#) on page 100.
- Support for CIMSteel Integration Standards (CIS/2). See [“CIS2 File Reader”](#) on page 93.

Miscellaneous Enhancements

- Autodesk Navisworks Simulate 2010 is available for full 64-bit installation.
- Manual override option allows you to specify the distance of Near and Far Clipping Planes. See [“Use Culling”](#) on page 174.
- When entering invalid values in the Options Editor, you are notified of the error.
- You can now configure site and project folders at install time, making deployment across an organization easier. See [“Select the Project and Site Folder Paths \(optional\)”](#) on page 40.
- Upgrades to the Autodesk Navisworks rendering engine (LADS) provide improved support for PNG transparencies and improved rendering consistency.
- Improved Revit support for: shared coordinates, rebars, True North, views, and viewpoints exported from Revit 9 and later.

How to Get Assistance

2

There are various ways to find information about how to use this program, and multiple resources are available.

Use Communication Center

Communication Center provides up-to-date product information, software updates, product support announcements, and other product-related announcements.

Overview of Communication Center

Communication Center provides up-to-date product information, software updates, product support announcements, and other product-related announcements.

Communication Center is an interactive feature that must be connected to the Internet in order to deliver content and information.

Each time Communication Center is connected, it sends your information to Autodesk so that you receive the correct information. All information is sent anonymously to Autodesk to maintain your privacy.

The following information is sent to Autodesk:

- Product name (in which you are using Communication Center)
- Product release number
- Product language
- Country/region (specified in the Communication Center settings)
- Your subscription contract number (if you're a subscription customer)

Autodesk compiles statistics using the information sent from Communication Center to monitor how it is being used and how it can be improved. Autodesk maintains information provided by or collected from you in accordance with the company's published privacy policy, which is available on <http://www.autodesk.com/privacy>.

Whenever new information is available, Communication Center notifies you by displaying a balloon message below the Communication Center button on the InfoCenter box.

Communication Center provides the following kinds of announcements:

- **Product Support Information.** Get breaking news from the Product Support team at Autodesk, including when Live Update maintenance patches are released.
- **Subscription Announcements.** Receive subscription announcements and subscription program news, as well as links to e-Learning Lessons, if you are an Autodesk subscription member (available in countries/regions where Autodesk subscriptions are offered).
For more information about Autodesk Subscription, see “[Access Subscription Center](#)” on page 13.
- **Articles and Tips.** Be notified when new articles and tips are available on Autodesk websites.
- **Live Update Maintenance Patches.** Receive automatic notifications whenever new maintenance patches are released from Autodesk.
- **Featured Technologies and Content.** Learn more about third-party developer applications and content.

You can customize the items that display on the Communication Center panel. For more information, see “[Specify Communication Center Settings](#)” on page 8.

To open Communication Center

- Click the Communication Center  button on the Standard toolbar in the upper right-side of the application.

 **Menu:** Help ► Communication Center

To receive new information notifications

- Click the link in the balloon message below the notification  icon on the Status bar.

To turn off Balloon Notifications

- Right-click the notification  icon on the Status bar, and click Disable Balloon Notifications.

Specify Communication Center Settings

You can specify Communication Center settings in the Options Editor.

In the Options Editor, you can specify the following settings:

- **General.** Your current locations, how often to check for new online content, and maximum age of the displayed articles.
- **Autodesk Channels.** Channels to display in the Communication Center panel as well as the number of articles to display for each channel.
- **Balloon Notification.** Notifications for new product information, software updates, and product support announcements. Also, you can customize the display time of the balloon.

To specify general settings for Communication Center

- 1 Open the Communication Center panel, and click Options.
- 2 In the Options Editor, expand the General node, and click the Communication Center option.
- 3 On the Communication Center page, select the country in which you are working. This is used for tailoring location-specific Communication Center content.
- 4 Use the Check for New Online Content drop-down list to specify the desired frequency. By default, Communication Center checks for new content every 4 hours.
- 5 To remove old content, select the Hide Old Content check box, and use the After box to set the number of days after which old content is hidden. The default value is 14 days.

- 6 Click OK.

To specify the channels to display in the Communication Center panel

- 1 Open the Communication Center panel, and click Options.
- 2 In the Options Editor, expand the General node, expand the Communication Center node, and click the Autodesk Channels option.
- 3 On the Autodesk Channels page, select the Subscribed check boxes for all channels you want to display.
- 4 Click OK.

To specify balloon notification settings

- 1 Open the Communication Center panel, and click Options.
- 2 In the Options Editor, expand the General node, expand the Communication Center node, and click the Balloon Notifications option.
- 3 On the Balloon Notifications page, use the Enable Balloon Notifications check box to turn balloon notification on/off.
- 4 In the Display Duration box, enter the number of seconds to set the length of time for balloon notifications to display.
The default value for the balloon display time is 5 seconds.
- 5 Click OK.

Use the Help System

You can get much more benefit from the Help system when you learn how to use it efficiently.

The Help system contains complete information about using this program. In the Help window, you use the left pane to locate information. The tabs above the left pane give you several ways for finding the topics you want to view. The right pane displays the topics you select.

Find Information in Help

The tabs on the left side of the Help window provide different methods for finding information.

To locate a specific word or phrase in the current topic, click in the topic text and press the CTRL+F keys.

Contents Tab

- Presents an overview of the available documentation in a list of topics and subtopics.
- Allows you to browse by selecting and expanding topics.
- Provides a structure so you can always see where you are in Help and quickly jump to other topics.

Index Tab

- Displays an alphabetical list of keywords related to the topics listed on the Contents tab.
- Accesses information quickly when you already know the name of a feature, command, or operation, or when you know what action you want the program to perform.

Search Tab

- Provides a keyword search of all the topics listed on the Contents tab.
- Accepts the Boolean operators AND (+), OR, NOT (-), and NEAR.
- Accepts the wild cards *, ?, and ~.

- Allows you to perform a search for a phrase when the phrase is enclosed in double quotes.
- Displays a ranked list of topics that contain the word or words entered in the keyword field.
- Arranges the results alphabetically by title or by location if you click on the Title and Location column headings.

Use Searches

Use the Search tab to find relevant topics based on keywords that you enter.

The basic search rules are as follows:

- Type your keywords in uppercase or lowercase characters; searches are not case-sensitive.
- Search for any combination of letters (a-z) and numbers (0-9).
- Do not use punctuation marks such as a period, colon, semicolon, comma, hyphen, and single quotation marks; they are ignored during a search.
- Group the elements of your search using double quotation marks or parentheses to set each element apart.

Use Wild Card Characters

You can use the following wild card characters in any keyword:

Symbol	Description
*	Replaces one or more characters when used at the beginning, middle, or end of a word. For example, <i>"*lish"</i> , <i>"p*lish"</i> , and <i>"pub*"</i> will all find <i>"publish"</i> . Also, <i>"anno*"</i> will find <i>"annotative"</i> , <i>"annotation"</i> , <i>"annoupdate"</i> , <i>"annoreset"</i> , and so on.
?	Replaces a single character. For example, <i>"cop?"</i> will find <i>"copy"</i> , but not <i>"copy-base"</i> .
~	Expands the tense of the word at the beginning or end of a word. For example, <i>"plotting~"</i> will find <i>"plots"</i> , <i>"plotted"</i> , and so on. Also, <i>"~plot"</i> will find <i>"preplot"</i> , <i>"replot"</i> , and so on.

Search for Phrases

When searching for a phrase, use double quotation marks (" ") to enclose words that must appear next to each other in the specified sequence. For example, enter **"specifying units of measurement"** to find only topics with all those words in that order. If you don't use the quotation marks around that text, Help finds all topics containing any one of the listed words, that is, all topics containing "specifying", all topics containing "units", all topics containing "of", and all topics containing "measurement".

TIP If you can't find the information you need through a search, try using the Contents tab.

Use Boolean Operators

With the AND, OR, NOT, and NEAR operators, you can precisely define your search by creating a relationship between search terms. The following table shows how you can use each of these operators. If no operator is

specified, AND is used. For example, the query spacing border printing is equivalent to spacing AND border AND printing.

Search for	Example	Results
Both terms in the same topic	"tree view" AND "palette"	Topics containing both the words "tree view" and "palette"
Either term in a topic	viewpoint OR animation	Topics containing either the word "viewpoint" or the word "animation" or both
The first term without the second term	nwd NOT nwc	Topics containing the word "NWD," but not the word "NWC"
Both terms in the same topic, close together	user NEAR menu	Topics containing the word "user" within eight words of the word "menu"

NOTE The |, &, and ! characters do not work as Boolean operators. You must use AND (also +), OR, and NOT (also -).

How Help Topics Are Organized

Most topics in this Help system have three tabs above the right pane of the Help window. The tabs display different types of information.

- **Concept tab.** Describes a feature or function. When you click the Concept tab, the Help Contents list in the left pane of the Help window expands and highlights the current topic. The Contents tab displays the structure of the Help on that topic. You can easily display nearby topics by clicking them in the list.
- **Procedure tab.** Provides step-by-step instructions for common procedures related to the current topic. After displaying a procedure, you can click the Procedure tab to redisplay the current list of procedures.
- **Quick Reference tab.** Lists reference information related to the current topic.

When you click a different tab, the topic remains the same. Only the type of information displayed—concept, procedures, or quick reference links—is different.

Concept Tab Organization

In a Concept tab, there are two types of information that may be displayed: *navigation text* and *destination text*. Navigation text displays links with short descriptions. The purpose of navigation text is to guide you step-by-step to the information that you need. The links on navigation pages lead to additional navigation pages deeper in the Help structure until you come to a destination page. Each link is designed to provide you with more detailed information.

Procedure Tab and Quick Reference Tab Organization

As you navigate deeper into the Help structure on the Contents tab, the corresponding information on the Procedure tab and on the Quick Reference tab becomes more specific, and the number of entries displayed on each of these two tabs decreases.

Print Help Topics

The quickest way to print the current topic is to right-click within the topic and click Print.

The Print button on the Help toolbar provides these print options:

- Print the selected topic (recommended)
- Print the selected heading and all subtopics

NOTE When you select the second option, you may get numerous printed pages, depending on how many subtopics the currently selected topic contains.

To print a Help topic

- 1 Display the topic you want to print.
- 2 Right-click in the topic pane. Click Print.
- 3 In the Print dialog box, click Print.

To print a selected heading and all subtopics

- 1 Display the topic you want to print and make sure that the Contents tab is displayed.
- 2 On the Help toolbar, click Print.
- 3 In the Print Topics dialog box, click Print the Selected Heading and All Subtopics.
- 4 Click OK.

Show and Hide the Contents Pane

Use the Hide button on the Help toolbar to shrink the Help window to a compact size by hiding the pane that contains the Contents, Index, and Search tabs.

The compact window size is best for displaying procedures while you work.



Use the Show button to expand the Help window to display the pane that contains Contents, Index, and Search tabs. The expanded window size is best for locating and displaying conceptual and reference information.



Get More Help

You can access several additional sources of help.

- **On the Standard toolbar, use Communication Center.** Display the Communication Center panel for product updates and announcements.
- **Press F1.** Displays context-sensitive reference information.
- **Click the Help button in many dialog boxes.** Displays reference information for the dialog box.
- **View the product README.** Displays late-breaking information about this product.

Other resources help you get information about Autodesk products and assistance with your questions about this program.

- **Autodesk website.** Access <http://www.autodesk.com>.
- **Local support.** Check with your dealer or Autodesk country/region office.

Learn the Product

Training programs and products from Autodesk help you learn the key technical features and improve your productivity. For the latest information about Autodesk training, visit <http://www.autodesk.com/training> or contact your local Autodesk office.

Autodesk Authorized Training Centers

The Autodesk® Authorized Training Center (ATC®) network delivers Autodesk-authorized, instructor-led training to design professionals who use Autodesk software. Autodesk Authorized Training Centers use experienced and knowledgeable instructors. More than 1,200 ATC sites are available worldwide to meet your needs for discipline-specific, locally based training.

To find a training center near you, contact your local Autodesk office or visit <http://www.autodesk.com/atc>.

Autodesk Official Training Courseware

Autodesk Official Training Courseware (AOTC) is technical training material developed by Autodesk. Designed for traditional 1/2-day to 5-day, instructor-led classroom training and used by Authorized Training Centers and other Autodesk partners, AOTC is well-suited for self-paced, stand-alone learning. The manuals cover key concepts and software functionality with hands-on, step-by-step, real-world exercises. You can purchase AOTC from your local reseller or distributor, or you can order it online from the Autodesk Store at <http://www.autodesk.com/aotc>.

e-Learning

Autodesk e-Learning for Autodesk Subscription customers features interactive lessons organized into product catalogs. Each lesson is 20-40 minutes in length and features hands-on exercises, with an option to use a simulation of the product or the actual application. You can also use an online evaluation tool that identifies gaps in skills, determines what lessons will be most helpful, and gauges learning progress.

If you are a member of Autodesk subscription, you can access e-Learning and other subscription services from within your Autodesk product.

For more information about how to access e-Learning in the product, see “[Access Subscription Center](#)” on page 13.

For more information about Autodesk subscription resources, visit <http://www.autodesk.com/subscriptioncenter>.

Autodesk Developer Network

The Autodesk Developer (ADN) program for ADN members provides support for full-time, professional developers who want to build software based on Autodesk products. As an ADN member, you will receive the business, software, support, and training you need to be successful. If you are a developer, visit <http://www.autodesk.com/adn>.

Autodesk Consulting

Autodesk Consulting provides services that help set up processes and provide critical training that will help increase productivity so you can capitalize on the power of your products. For more information on general consulting, systems integration, or custom training services, visit <http://www.autodesk.com/consulting>.

Partner Products and Services

Autodesk works together with thousands of software partners around the world. These partners provide products and services that enhance Autodesk products for design professionals. Visit the Partner Products & Services page at <http://www.autodesk.com/partnerproducts> for a list of resources available for your Autodesk product and your industry.

Access Subscription Center

The Subscription Center is available to subscription members from within the product.

If you are a subscription member, you can access subscription services by clicking the Communication Center



button on the Standard toolbar, and then clicking a Subscription Center link. To learn more about Autodesk subscription membership, visit <http://www.autodesk.com/subscriptioncenter>.

About Subscription Center

With Autodesk Subscription, you get the latest releases of Autodesk software, incremental product enhancements, personalized web support from Autodesk technical experts, and self-paced e-Learning. Subscription services are available to subscription members only.

By clicking the Communication Center  button on the Standard toolbar, members have access to the following options (under Subscription Center):

- **Subscription status.** Checks your subscription status.
- **Create support request.** Provides direct one-to-one communication with Autodesk support technicians. You receive fast, complete answers to your installation, configuration, and troubleshooting questions.
- **View support requests.** Tracks and manage your questions and responses through Autodesk's state-of-the-art support system.
- **Edit Subscription Center profile.** Sets up and maintains your subscription account.
- **View e-Learning catalog.** Features interactive lessons organized into product catalogs.
- **e-Learning Lessons.** (For subscription members only.) Each lesson is 15-30 minutes and features hands-on exercises, with an option to use a simulation instead of the software application. You can use an online evaluation tool that identifies gaps in skills, determines what lessons will be most helpful, and gauges learning progress.

Subscription Resources and Privacy

Subscription resources provide interactive product features over the Internet. Each time you access subscription resources (such as e-Learning or Create Support Request) from Communication Center in an Autodesk product, product information (such as the serial number, version, language, and the subscription contract ID) is sent to Autodesk for verification that your product is on subscription.

Autodesk compiles statistics using the information sent to subscription resources to monitor how they are being used and how they can be improved. Autodesk maintains the information provided by or collected from you in accordance with Autodesk's published privacy policy, which is available at <http://www.autodesk.com/privacy>.

To access the Subscription Center in the program

- 1 Click the Communication Center  button on the Standard toolbar.
- 2 On the Communication Center panel, under Subscription Center, click the subscription resource you want to access.

NOTE Subscription Center is not available to all product users. If subscription resources are not available in your product, your product is not entitled to subscription benefits.

Manage Files with Autodesk Vault

If you are a subscription customer, you have access to Autodesk Vault, a file management tool that provides a repository where documents and files are stored and managed.

Autodesk Vault gives you more power to manage files and track changes. Versioned copies of master files are maintained, allowing you to easily revert to earlier versions of files. You can check files out for editing and later check them back in. The master copy is never directly edited.

Autodesk Vault consists of two required components: the Autodesk Data Management Server and the Vault Client. Optionally, you can also install the Vault Office Add-in.

For information about using the Vault, refer to the Vault Help system.

TIP The main components for the Autodesk Vault can be downloaded from the Autodesk Subscription site.

View the Product Readme

You can find late-breaking information about this software in the Readme.

It is suggested that you read through the Autodesk Navisworks Readme for information about recommended hardware, updated installation instructions, and known software problems.

Join the Customer Involvement Program

You are invited to participate in helping guide the direction of Autodesk design software.

If you participate in the Customer Involvement Program (CIP), specific information about how you use AutoCAD is forwarded to Autodesk. This information includes what features you use the most, problems that you encounter, and other information helpful to the future direction of the product.

Here is a list of the information that is automatically sent to Autodesk:

- Name and version of the Autodesk product
- Number of minutes you are running the software
- Number of sessions that end due to stability issues
- Menu actions triggered
- Error conditions encountered, fatal, and non-fatal
- Import/export actions (including file extension used)
- Scene statistics after a load or import (number of objects, faces, vertices etc.)
- Operating system name and version
- System configuration information such as processor, amount of memory, and graphics card
- Other Autodesk products installed
- Plug-in (DLLS) installed with Autodesk Navisworks
- IP address, used to identify your country or region

What the Customer Involvement Program Cannot Do

The Customer Involvement Program is committed to protecting your privacy. It *cannot* do any of the following:

- Collect any drawing or design data
- Collect any identity information such as name, address, or phone number
- Send you email or contact you in any other way

For additional information, click the links in the Customer Involvement Program dialog box.

Why You Should Consider Participating

The Customer Involvement Program involves you directly in telling Autodesk

- The commands and features that Autodesk should focus on
- The commands and features that are hardly ever used
- The most common problem areas
- The hardware typically used with Autodesk Navisworks

NOTE You can start or stop your participation in this program at any time. Access to the controls is available from the Autodesk Navisworks Help menu. In network installations, your system administrator can choose whether to make the CIP program available or not.

To turn the CIP on or off

- 1 Click Help ► Customer Involvement Program.
- 2 In the Customer Involvement Program dialog box, click a level of participation, and then click OK.

Installation

3

This chapter provides information about installing and activating Autodesk Navisworks on a workstation, as well as deploying Autodesk Navisworks from a network location.

Quick Start to Stand-Alone Installation

This section provides step-by-step instructions about how to prepare, and then install Autodesk Navisworks.

If you have never installed the product before, you should familiarize yourself with the entire installation process and options before beginning.

For information about installing network-licensed or multi-seat stand-alone versions of the program, see [“Install Autodesk Navisworks for Multiple Users”](#) on page 28.

Prepare for Installation

To prepare for installation, you should review the system requirements, understand administrative permission requirements, locate your Autodesk Navisworks Simulate 2010 serial number and product key, and close all running applications.

Complete these tasks, and you are ready to begin installing Autodesk Navisworks Simulate 2010.

System Requirements for Stand-Alone Installation

The first task you need to complete is to make sure that your computer meets the minimum system requirements. If your system does not meet these requirements, problems can occur, both within Autodesk Navisworks and at the operating system level.

Whether your Windows operating system is the 32-bit or the 64-bit version, the version is automatically detected during installation.

NOTE Both the 32-bit version and 64-bit version of Autodesk Navisworks Simulate 2010 can be installed on a 64-bit version of Windows, but the 64-bit version of Autodesk Navisworks Simulate 2010 cannot be installed on a 32-bit version of Windows.

See the following table for hardware and software requirements.

Hardware and software requirements	
Hardware/Software	Requirement
Operating system	32-Bit Windows® XP® Professional, SP 2 or SP 3; Windows XP Home, SP 2 or SP 3; Windows Vista Ultimate, SP 1; Windows Vista Enterprise, SP 1; Windows Vista Business, SP 1; Windows Vista Home Premium, SP 1; Windows Vista Home Basic, SP 1
	64-Bit Windows® XP® Professional, SP 1; Windows Vista Enterprise, SP 1; Windows Vista Business, SP 1; Windows Vista Ultimate, SP 1; Windows Vista Home Premium, SP 1
Web browser	32-Bit Microsoft® Internet Explorer 6.0, SP 1 or later
	64-Bit Internet Explorer 7.0 or later
Processor	32-Bit AMD® Athlon®, 3.0 GHz or faster (minimum); Intel® Pentium® IV, 3.0 GHz or faster (recommended)
	64-Bit AMD or Intel EM64T
RAM	32-Bit 512 MB (minimum) 2 GB or greater (recommended)
	64-Bit 2 GB
Graphics card	128 MB, 1024 x 768 VGA, True Color (minimum); 256 MB or greater - 1280 x 1024 32-bit color video display adapter, True Color (recommended)
Hard disk	Installation 800 MB
Pointing device	MS-Mouse compliant
DVD-ROM	Any speed (for installation only)

Hardware and software requirements

Optional hardware	Open GL [®] -compatible 3D video card; Printer or plotter; Modem or access to an Internet connection; Network interface card
-------------------	--

Understand Administrative Permission Requirements

To install Autodesk Navisworks, you must have administrator permissions.

You do not need to have domain administrative permissions. See your system administrator for information about administrative permissions.

To run Autodesk Navisworks, you do not need administrator permissions. You can run the program as a limited user.

Locate Your Autodesk Navisworks Serial Number and Product Key

When you install Autodesk Navisworks, you are prompted for your serial number and product key in the Product and User Information page.

The serial number must contain a three-digit prefix followed by an eight-digit number. The product key consists of five digits.

The serial number and product key are located on the outside of the product packaging, or in the email you received if you downloaded your product. Make sure to have these available before you install the program so that you don't have to stop in the middle of the installation.

Make sure to have this number available before you activate the program so that you don't have to stop in the middle of the installation.

The information you enter is permanently retained with the product. Because you can't change this information later without uninstalling, take care when entering the information. To review this product information later, click Help ► About.

NOTE If you have lost your serial number or product key, contact your local Autodesk office for assistance.

Avoid Data Loss During Installation

The Autodesk Navisworks installation process may stop if some applications (such as Microsoft[®] Outlook[®] or virus-checking programs) are running.

Close all running applications to avoid possible data loss.

Choose a Language

You can select a different language for installation instructions, and a language for individual product installations in the same install process.

When you start the installation process, the installer automatically determines your operating system language. If a supported language is detected, your install pages are displayed in that language. If you want to change that language, you select a different one from the Installer Language list on the first page of the Installation wizard.

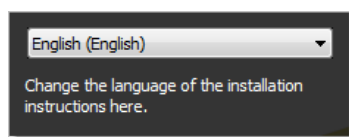

NOTE Some products may not have multi-language support at the time of product release. Additional language support may be available later. Check <http://autodesk.com/servicesandsupport> for the availability of additional language packs.

Using Language Packs

Language packs (.msi) support use of different languages in each Autodesk Navisworks product, including exporters. Pack names start with NAVFREE_, NAVREV_, NAVSIM_, NAVMAN_, and exporters_ respectively.

NOTE You must install at least one language pack for each product.

It is possible to add additional language packs to Autodesk Navisworks products later. You can manually install the required language packs by double-clicking on the language pack .msi file.

Language packs are located on the installation DVD and unpacked downloaded media under the x86 folder for 32-bit products and under the x64 folder for 64-bit products.

- Language packs for specific products are included in the NAVFREE, NAVREV, NAVSIM, NAVMAN, and NWEXPORT subfolders of x86 and x64 folders.
- Language packs for specific languages are included in the en-US (English), de-DE (German), es-ES (Spanish), fr-FR (French), it-IT (Italian), ja-JP (Japanese), ko-KR (Korean), pt-BR (Brazilian Portuguese), ru-RU (Russian) and zh-CN (Chinese PRC) subfolders of the product folders.

So, for example, to install the 32-bit French language pack for Autodesk Navisworks Simulate, double-click `x86/NAVSIM/fr-FR/NAVSIM_LP.msi`.

Configure Button

During the installation process, you choose either a typical installation (install the product with default settings), or a customized installation. If you choose to customize, you start that process in the Review - Configure - Install dialog box. Select the appropriate product from the drop-down list, and click the Configure button.

After you click the Configure button, the following dialog boxes and options are displayed:

- **Select the License Type** - *Stand-Alone license* or *Network license*. If you choose Network license, you also need to select the license server model - Single, Distributed, or Redundant.
- **Project and Site Folders** - These settings can be shared across an entire project site, or across a specific project group depending on the required level of granularity. Refer to [“Why should I specify the Project Folder and Site Folder?”](#) on page 46.
- **Select the Installation Type** - *Typical* or *Custom*. If you choose a Typical installation (default settings), the product installs the most common application features. To see which features are included in a Typical installation, refer to [“When performing a Typical installation, what gets installed?”](#) on page 46. If you choose Custom, you select specific features to install.
- **Include a Service Pack** - If a service pack is available for your installation, you can include it.

When you have completed your choices, click the Configuration Complete button. This takes you back to the Review - Configure - Create dialog box, where you can review your selections and complete the installation process.

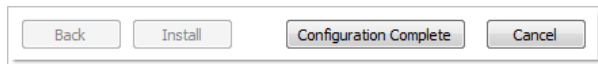

If you do not wish to make configuration changes on the Review - Configure - Install page, click Install.

Install Multiple or Bundled Products

Some Autodesk packages are comprised of multiple products or are part of *multi-product bundles*.

The Installation wizard for packages that are comprised of multiple products gives you the option to choose which products you want to install.

In the Installation wizard, for packages containing multiple products, you can choose which products and languages you want to install. During the install process, you are informed whether a copy of the software is already installed. You are also warned if your system does not meet the minimum system requirements for the product. Each product name is displayed on its own tabbed panel; you can configure them individually.

If you purchased a package that is a multi-product bundle, such as an educational or institutional package, you may have a package that includes several Autodesk products. For these bundled packages, an Installer disc contains information for all the products in the package. The Installer disc helps you install all of the products.

Install and Run Autodesk Navisworks Simulate 2010

To use the product, you must install the product, register and activate it, and then launch it.

You must have administrative permissions to install Autodesk Navisworks.

This section provides instructions for installing and activating Autodesk Navisworks for an individual user on a stand-alone computer.

For information about installing network-licensed or multi-seat stand-alone versions of the program, see “[Install Autodesk Navisworks for Multiple Users](#)” on page 28.

When you have successfully installed Autodesk Navisworks Simulate 2010, you are ready to register your product and start using the program. To register the product, start Autodesk Navisworks Simulate 2010 and follow the on-screen instructions. For more information, see “[How do I register and activate Autodesk Navisworks?](#)” on page 47

NOTE Autodesk does not recommend or support the distribution of an Autodesk product using imaging software.

Install Autodesk Navisworks

The Autodesk Navisworks Installation wizard contains all installation-related material in one place.

From the Installation wizard, you can access user documentation, change the installer language, select a language-specific product, install supplemental tools, view support solutions, and learn about deploying your product on a network.

NOTE Autodesk Navisworks Simulate 2010 ships on a single DVD. Insert the Autodesk Navisworks DVD in your DVD drive to start the installation process. Follow the prompts to complete the installation. As long as the DVD is in the drive, you can access documentation by clicking the documentation link.

- Review installation documentation before you install. It is recommended that you take the time to familiarize yourself with the complete installation process before you install Autodesk Navisworks. You can access PDF versions of the licensing manuals and CHM versions of the installation manuals from the product's Installation wizard by selecting the Read this Documentation selection, or the Documentation link at the bottom, left pane of the install pages. You can also access PDFs from the product disc. For late-breaking information, it is also recommended that you review the product *Readme*.

NOTE To view or print PDF (.pdf) files, Adobe® Reader must be installed on your computer. If you do not have Adobe Reader, you can download the latest version at <http://www.adobe.com>.

- Install Autodesk Navisworks Simulate 2010. From the Installation wizard, click Install Products. Follow the on-screen instructions to complete the installation.

Install Autodesk Navisworks Using Default Values

This is the fastest means of installing Autodesk Navisworks on your system.

Only default values are used which means it is a typical installation being installed to C:\Program Files\Autodesk\Navisworks Simulate 2010.

To install Autodesk Navisworks using default values on a stand-alone computer

- 1 Insert the Autodesk Navisworks Simulate 2010 DVD into your computer's DVD drive.
The Autodesk Navisworks Simulate 2010 Installation wizard launches in the language that best matches the settings on your computer.
If the Installation wizard does not start automatically, double-click `Setup.exe` at the root of the Autodesk Navisworks DVD.
- 2 In the Installation wizard, select a language for the install instructions or accept the default language. Click Install Products.

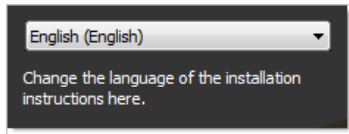

- 3 Select the products and the languages for the products you want to install:
 - On a 64-bit version of Windows, you can install both 32-bit and 64-bit versions of Autodesk Navisworks, 64-bit version of Autodesk Navisworks Freedom, and both 32-bit and 64-bit versions of exporter plugins.
 - On a 32-bit version of Windows, you can install 32-bit version of Autodesk Navisworks, 32-bit version of Autodesk Navisworks Freedom, and 32-bit version of exporter plugins.

Click Next.

In order to choose a language for an individual product, you first must click the Select Language for Individual Products check box, then select the language from the drop-down list. In some cases, additional languages may not be available for the products you choose to install.

- 4 Review the Autodesk software license agreement for your country or region. You must accept this agreement to proceed with the installation. Choose your country or region, click I Accept, and then click Next.

NOTE If you do not agree to the terms of the license and want to terminate the installation, click Cancel.

- 5 On the Product and User Information page, enter your serial number, product key, and user information. Review the *Privacy Policy* from the link at the bottom of the dialog box. After reviewing, click Next.

IMPORTANT The information you enter here is permanent and is displayed in the Autodesk Navisworks Simulate 2010 window (accessed by Help ► About) on your computer. Because you can't change this information later without uninstalling the product, make sure you enter the correct information now.

- 6 On the Review - Configure - Install page, click Install to begin installing.

The wizard does the following:

- Uses a Typical installation, which installs the most common application features. To see which features are included in a Typical installation, refer to “[Typically Installed Features](#)” on page 46.
- Installs Autodesk Navisworks to the default install path of `C:\Program Files\Autodesk\Navisworks Simulate 2010`.
- Installs the products you selected in Step 3.

NOTE By default, the Installation wizard automatically enables the exporter plugins for all 3rd party products already installed on your PC.

7 On the Installation Complete page, choose from the following:

- View the installation log file - to view the installation log file.
- View the Autodesk Navisworks Simulate 2010 Readme - to open the *Readme* file with the information that was not available when the Autodesk Navisworks Simulate 2010 documentation was prepared.
- View the Autodesk Navisworks Freedom 2010 Readme - to open the *Readme* file with the information that was not available when the Autodesk Navisworks Freedom 2010 documentation was prepared.

NOTE If you do not want to view the *Readme* files now, clear the check boxes.

8 Click Finish.

Install Autodesk Navisworks Using Configured Values

With this installation method, you can fine-tune exactly what gets installed by using the Configure option.

You can alter the installation type, the install path, the license type, and specify the location of the Project and Site folders.

To install Autodesk Navisworks using configured values on a stand-alone computer

- 1 Insert the Autodesk Navisworks Simulate 2010 DVD into your computer's DVD drive.
The Autodesk Navisworks Simulate 2010 Installation wizard launches in the language that best matches the settings on your computer.
If the Installation wizard does not start automatically, double-click `Setup.exe` at the root of the Autodesk Navisworks DVD.
- 2 In the Installation wizard, select a language for the install instructions or accept the default language. Click Install Products.
- 3 Select the products and the languages for the products you want to install:
 - On a 64-bit version of Windows, you can install both 32-bit and 64-bit versions of Autodesk Navisworks, 64-bit version of Autodesk Navisworks Freedom, and both 32-bit and 64-bit versions of exporter plugins.
 - On a 32-bit version of Windows, you can install 32-bit version of Autodesk Navisworks, 32-bit version of Autodesk Navisworks Freedom, and 32-bit version of exporter plugins.

Click Next.

In order to choose a language for an individual product, you first must click the Select Language for Individual Products check box, then select the language from the drop-down list. In some cases, additional languages may not be available for the products you choose to install.

- 4 Review the Autodesk software license agreement for your country or region. You must accept this agreement to proceed with the installation. Choose your country or region, click I Accept, and then click Next.

NOTE If you do not agree to the terms of the license and want to terminate the installation, click Cancel.

- 5 On the Products and User Information page, enter your serial number, product key, and user information. Review the *Privacy Policy* from the link at the bottom of the dialog box. After reviewing, click Next.

IMPORTANT The information you enter here is permanent and is displayed in the Autodesk Navisworks Simulate 2010 window (accessed by Help ► About) on your computer. Because you can't change this information later without uninstalling the product, make sure you enter the correct information now.

- 6 On the Review - Configure - Install page, click Configure to make configuration changes. Each of the products you selected in Step 3 has its own tab:
- For each of the selected products you can change the license type, installation type, installation path, and the project and site folder paths.
 - For Navisworks exporter plugins, you can change which plugins are installed.

NOTE At any time you can click Next and then Configuration Complete to return to the Review-Configure-Install page.

- 7 To configure a product installation:
- a On the Select License Type page, you can choose to install a Stand-Alone License or Network license. Click Next.
 - b On the Project and Site Folder Paths page, you can specify:
 - Project Folder - use the Browse button to select the directory that contains the product settings specific to a project group.
 - Site Folder - use the Browse button to select the directory that contains the product settings standard across the entire project site.
 - c On the Select the Installation Type page, you can choose to make the following configuration changes:
 - Typical - installs the most common application features.
 - Custom - installs only the application features that you select from the Select Features To Install list:

ActiveX Lite Control	Contains Navisworks ActiveX Lite control.
API	Contains the Component Object Model interface for customizing and extending the Navisworks functionality.
Example NWD files	Contains various feature sample files.
PDF Manual	Contains the Autodesk Navisworks User Guide in PDF format.
Product	Contains full set of Autodesk Navisworks files.
Sample RPCs	Contains several Rich Photorealistic Content files.

- Product Install Path - use the Browse button to select the drive and location where product will be installed. Click Next.
- 8 To configure Navisworks exporter plugins, click the product tab. The Select the Installation Type page, shows a list of all exporter plugins:
-  - indicates plugins with the 3rd party software already installed on your PC.

-  - indicates plugins for the 3rd party software, which is either not installed on your PC or has not been detected by the Installation wizard.

Select the check boxes next to all required plugins. If the 3rd party software has not been detected by the wizard, you can manually enable the plugins for it. Selecting the check box automatically opens the dialog box, which enables you to browse for the correct software installation directory.

- 9 Click another product tab to configure another product, or click Next and then Configuration Complete to return to the Review-Configure-Install page. Then, click Install.

NOTE If you want a copy of your configuration summary information, click the Copy to Clipboard button.

- 10 On the Installation Complete page, choose from the following:

- View the installation log file - to view the installation log file.
- View the Autodesk Navisworks Simulate 2010 Readme - to open the *Readme* file with the information that was not available when the Autodesk Navisworks Simulate 2010 documentation was prepared.
- View the Autodesk Navisworks Freedom 2010 Readme - to open the *Readme* file with the information that was not available when the Autodesk Navisworks Freedom 2010 documentation was prepared.

NOTE If you do not want to view the *Readme* files now, clear the check boxes.

- 11 Click Finish.

Launch Autodesk Navisworks

Assuming that you've followed all of the previous steps outlined in this Quick Start section, you can launch Autodesk Navisworks and start taking advantage of its new and updated features.

You can start Autodesk Navisworks in the following ways:

- Desktop shortcut icon. When you install Autodesk Navisworks, a shortcut icon is placed on your desktop. Double-click the Autodesk Navisworks icon to start the program.
- Start menu. On the Start menu, click All Programs (or Programs) ► Autodesk ► Navisworks Simulate 2010 ► Autodesk Navisworks Simulate 2010.
- Location where Autodesk Navisworks is installed. If you have administrative permissions, you can run Autodesk Navisworks in the location where you installed it. If you are a limited-rights user, you must run Autodesk Navisworks from the Start menu or from the desktop shortcut icon. If you want to create a custom shortcut, make sure that the Start In directory for the shortcut points to a directory where you have write permissions.

NOTE When the product is started, by default, it uses the language that best matches the settings on your computer. You can also launch Autodesk Navisworks in another of the supported languages.

How to Launch Autodesk Navisworks in Another Language

To run Autodesk Navisworks in another of the installed languages, you need to add one of the language selector arguments to the desktop shortcut.

To run Autodesk Navisworks in another language

- 1 Right-click the Autodesk Navisworks desktop shortcut, and click Properties on the shortcut menu to open the Autodesk Navisworks Properties dialog box.
- 2 On the Shortcut tab, enter a space in the Target field after `.. \roamer.exe`, and then enter one of the following arguments:
 - lang en-US for English localization
 - lang de-DE for German localization

- lang es-ES for Spanish localization
- lang fr-FR for French localization
- lang it-IT for Italian localization
- lang ja-JP for Japanese localization
- lang ko-KR for Korean localization
- lang pt-BR for Brazilian Portuguese localization
- lang ru-RU for Russian localization
- lang zh-CN for Chinese (PRC) localization

- 3 Click OK to save the changes.

Add or Remove Features

You can add or remove Autodesk Navisworks Simulate 2010 features at any time. For example, you may have chosen a Custom installation option when you first installed Autodesk Navisworks, but now you want to add features that you did not install originally. Or you may no longer need to use all of the features that were installed originally.

You can add or remove features by using the Add or Remove Programs dialog box.

To add or remove features

- 1 In the Control Panel, double-click Add or Remove Programs.
- 2 In the Add or Remove Programs dialog box, click Autodesk Navisworks Simulate 2010, and then click Change/Remove in Windows XP or Uninstall/Change in Vista.
The Autodesk Navisworks Simulate 2010 Installation wizard re-opens in Maintenance Mode.
- 3 Click Add or Remove Features. On the Add/Remove Features page, select a feature to install or uninstall. The icons to the left of the selections give you an indication of the action that will be taken.



Indicates a feature that was marked for installation will be in a typical installation.



Indicates a feature that is not currently scheduled for installation.



Indicates a feature that was not originally marked for installation, but was added to the installed feature list.



Indicates an installed feature that is chosen for removal.

NOTE If you need to revert to the Autodesk Navisworks Simulate 2010 features that you selected in your original installation, click Cancel.

Click Next.

- 4 On the Update Autodesk Navisworks Simulate 2010 Installation page, click Next.
- 5 On the Update Complete page, you are informed when the updates have been performed. Click Finish.

Reinstall or Repair Autodesk Navisworks Simulate 2010

If you accidentally delete or alter files that are required by Autodesk Navisworks Simulate 2010, Autodesk Navisworks might not perform correctly, and you might receive error messages when you try to execute a command or find a file. You can attempt to fix this problem by reinstalling or repairing Autodesk Navisworks Simulate 2010.

The reinstallation or repair uses the features that were part of the installation type you chose when you initially installed the program.

To reinstall or repair Autodesk Navisworks Simulate 2010

- 1 In the Control Panel, double-click Add or Remove Programs.
- 2 In the Add or Remove Programs dialog box, click Autodesk Navisworks Simulate 2010, and then click Change/Remove in Windows XP or Uninstall/Change in Vista.
The Autodesk Navisworks Simulate 2010 Installation wizard re-opens in Maintenance Mode.
- 3 Click Repair Autodesk Navisworks Simulate 2010.
- 4 On the Select Repair or Reinstall page, click one of the following, and then click Next.
 - Repair My Autodesk Navisworks Simulate 2010 Installation. This option replaces all registry entries that Autodesk Navisworks initially installed and restores Autodesk Navisworks Simulate 2010 to its default state.
 - Reinstall My Autodesk Navisworks Simulate 2010 Installation. This option repairs the registry and reinstalls all files from the original installation. Use this option if the Repair My Autodesk Navisworks Simulate 2010 Installation option does not solve the problem.
- 5 On the Repair Autodesk Navisworks Simulate 2010 page, click Next to start the process.
- 6 On the Repair Complete page, you are informed when the repairs have been performed. Click Finish.

Uninstall Autodesk Autodesk Navisworks Simulate 2010

When you uninstall Autodesk Navisworks Simulate 2010, all components are removed. This means that even if you've previously added or removed components, or if you've reinstalled or repaired Autodesk Navisworks Simulate 2010, the uninstall removes all Autodesk Navisworks installation files from your system.

To uninstall Autodesk Navisworks Simulate 2010

- 1 In the Control Panel, double-click Add or Remove Programs.
- 2 In the Add or Remove Programs dialog box, click Autodesk Navisworks Simulate 2010, and then click Change/Remove in Windows XP or Uninstall/Change in Vista.
The Autodesk Navisworks Simulate 2010 Installation wizard re-opens in Maintenance Mode.
- 3 Click Uninstall.
- 4 On the Autodesk Navisworks Simulate 2010 page, click Next to remove Autodesk Navisworks from the system.
- 5 When informed that the product has been successfully uninstalled, click Finish.

NOTE Even though Autodesk Navisworks Simulate 2010 is removed from your system, the software license remains. If you reinstall Autodesk Navisworks Simulate 2010 at some future time, you will not have to register and re-activate the program.

Move to Autodesk Navisworks from a Previous Release

If you have a previous version of Autodesk Navisworks installed on your system, you can install Autodesk Navisworks Simulate 2010 and keep other versions of the program on the same system. This is called a *side-by-side* installation.

If you've purchased an *upgrade* version of Autodesk Navisworks Simulate 2010, you are required to uninstall the previous version within 120 days of installing Autodesk Navisworks Simulate 2010. See your license agreement for more information.

Install Autodesk Navisworks for Multiple Users

This section provides step-by-step instructions for installing network-licensed or multi-seat stand-alone versions of the Autodesk Navisworks Simulate 2010.

Quick Start to Network Administration and Deployment

Network deployment of this program requires careful planning and execution.

If you are not familiar with network administration and deployment, you should familiarize yourself with the following topics before you attempt to deploy and administer the program over a network.

Deployment Preparation

To prepare for a deployment, you should take the time to review the following requirements and options.

System Requirements for a Deployment

This section contains the system requirements for the location of the administrative image that you create, the network license server, and the client workstation.

Before you begin installing the program on a network, make sure that your servers and client workstations meet the minimum recommended hardware and software requirements for a deployment.

Whether the Windows operating system is the 32-bit or the 64-bit version is automatically detected when installing Autodesk Navisworks. You can choose which versions of Navisworks will be installed.

NOTE Both the 32-bit version and 64-bit version of Autodesk Navisworks Simulate 2010 can be installed on a 64-bit version of Windows, but the 64-bit version of Autodesk Navisworks Simulate 2010 cannot be installed on a 32-bit version of Windows.

See the following tables for administrative image, license server, and client workstation system requirements.

Hardware and software requirements for the location of the administrative image

Hardware/Software	Requirement
Hard disk	1.5 GB (recommended)

Hardware and software requirements for the network license server

Hardware/Software	Requirement
Operating system	Windows Vista 32-bit
	Windows XP 32-bit
	Windows 2003 Server Edition
Computer/processor	AMD® Athlon®, 3.0 GHz or faster (minimum)
	Intel® Pentium® IV, 3.0 GHz or faster (recommended)
Network interface card	Compatible with existing Ethernet network infrastructure

Hardware and software requirements for the network license server

Communication protocol TCP/IP

Hardware and software requirements for client machine

Hardware/Software Requirement

Operating system

32-Bit

Windows®XP® Professional, SP 2 or SP 3; Windows XP Home, and Professional, SP 2 or SP 3; Windows Vista Ultimate, SP 1; Windows Vista Enterprise, SP 1; Windows Vista Business SP 1; Windows Vista Home Premium, SP 1; Windows Vista Home Basic, SP 1

64-Bit

Windows Vista Enterprise, SP 1; Windows Vista Business, SP 1; Windows Vista Ultimate, SP 1; Windows Vista Home Premium, SP 1; Windows XP Professional, SP 1

Web browser

32-Bit

Internet Explorer 6.0, SP 1 (or later)

64-Bit

Internet Explorer 7.0 or later

Processor

32-Bit

AMD® Athlon®, 3.0 GHz or faster (minimum); Intel® Pentium® IV, 3.0 GHz or faster (recommended)

64-Bit

AMD 64 or Intel EM64T

Memory (RAM)

32-Bit

512 MB (minimum); 2 GB or greater (recommended)

64-Bit

2 GB

Graphics card

128 MB, 1024 x 768 VGA, True Color (minimum)

256 MB or greater - 1280 x 1024 32-bit color video display adapter, True Color (recommended)

Hard disk

Installation 800 MB

Hardware and software requirements for client machine

Pointing device	MS-Mouse compliant
DVD-ROM	Any speed (for installation only)
Optional hardware	Open Open GL [®] -compatible 3D video card
	Printer or plotter
	Modem or access to an Internet connection
	Network interface card

Choose an Installation Type

When you set up your deployment, you need to choose the type of installation to deploy.

In the Autodesk Navisworks Simulate 2010 Deployment wizard, you specify one of the following installation types:

- **Network License installation.** With this type of installation, you install the program to workstations with the files and registry entries that allow the program to communicate with the Network License Manager. You also define the configuration of the Network License Manager so that the licenses can be accessed. Workstations running the program based on a network installation do not require individual activation. Licensing of this program is managed by at least one license server.
The main advantage is that you can install Autodesk Navisworks Simulate 2010 on more systems than the number of licenses you have purchased (for example, purchasing 25 licenses but installing on 40 workstations). At any one time, Autodesk Navisworks Simulate 2010 runs on the maximum number of systems for which you have licenses. This means you get a true floating license.
- **Multi-Seat Stand-Alone installation (Stand-Alone option).** Choose this type of installation for stand-alone installations where a single serial number and product key are used for multiple seats. Multi-seat stand-alone installations do not rely upon a Network License Manager to manage product licenses; however, you can still use the Autodesk Navisworks Simulate 2010 Installation wizard to create administrative images and create deployments. Registration and activation is more automated for multi-seat stand-alone installations. After the first activation using the multi-seat stand-alone serial number, activation occurs automatically for all workstations based on this deployment, as long as your systems are connected to the Internet.
- **Stand-Alone installation (Stand-Alone option).** Choose this type of installation for stand-alone installations where a single serial number and product key are used for a single seat. Like a multi-seat stand-alone installation, you do not use the Network License Manager to manage product licensing, but installation, registration, and activation occurs on each workstation.

If you choose one of the Stand-Alone installation types, you can proceed to the section [“Distribute the Program”](#) on page 33.

Choose a License Server Model

If you chose the Network License option, you need to decide which license server model to use to distribute the product licenses.

TIP If you are deploying a stand-alone or multi-seat stand-alone installation type, you do not use a license server model. Proceed to the section [“Distribute the Program”](#) on page 33.

For the network installation, use one of the following license server models:

- Single license server model. The Network License Manager is installed on a single server, so license management and activity is restricted to this server. A single license file represents the total number of licenses available on the server.
- Distributed license server model. Licenses are distributed across more than one server. A unique license file is required for each server. To create a distributed license server, you must run the Network License Manager on each server that is part of the distributed server pool.
- Redundant license server model. You use three servers to authenticate a single license file. One server acts as the master, while the other two provide backup if the master server fails. With this configuration, licenses continue to be monitored and issued as long as at least two servers are still functional. The license file on all three servers is the same. You must install the Network License Manager on each server.

Each of these license server models is described in detail in the *Network Licensing Guide*. It is strongly recommended that you read that guide before you deploy the program. You can find the *Network Licensing Guide* by clicking the Documentation link at the lower left corner of the Autodesk Navisworks Simulate 2010 Deployment wizard.

Set Up Network Tools and Your License Server

If you are planning to have users run the program using network licenses, you need to use the Network License Manager.

The Network License Manager helps you configure and manage license servers.

Install the Network License Manager

The Network License Manager is used to configure and manage the license servers.

To install your Network License Manager

- 1 In the Autodesk Navisworks Simulate 2010 Installation wizard, click Install Tools and Utilities.
- 2 On the Select the Products to Install page, select Autodesk Network License Manager and click Next.
- 3 Review the Autodesk software license agreement for your country or region. You must accept this agreement to proceed with the installation. Choose your country or region, click I Accept, and then click Next.

NOTE If you do not agree to the terms of the license and want to terminate the installation, click Cancel.

- 4 On the Review - Configure - Install page, review your product selection and the current settings. If you don't want to make any changes, click Install. If you want to change the install type or installation path, click Configure.
- 5 On the Select the Installation Type page, accept the default installation path (C:\Program Files\Autodesk Network License Manager\) or Browse to specify a different path. If you enter a path that does not exist, a new folder is created using the name and location you provide. Click Next.

WARNING Do not install the Network License Manager on a remote drive. When you install the Network License Manager files, you must provide a path to a local drive. You must specify the drive letter; the universal naming convention (UNC) is not supported.

- 6 On the Configuration Complete page, click Configuration Complete to return to the confirmation page.
- 7 On the Review - Configure - Install page, click Install.
- 8 When the Installation Complete page displays, click Finish.

To Activate a Network License Through Autodesk.com

If your product does not include the Network License Activation Utility, you can activate your license by going to <https://registeronce.autodesk.com>, and following the on-screen instructions.

Configure Your License Server

You configure a license server so that you can manage the Autodesk Navisworks product licenses.

You can configure the license server with the *lmtools.exe* utility.

You should be logged in with Administrator rights when working with the LMTOOLS utility.

To configure your license server

- 1 Do one of the following:
 - Click Start menu ► All Programs (or Programs) ► Autodesk ► Network License Manager ► LMTOOLS.
 - (Windows Vista) Double-click the LMTOOLS icon on the desktop.
- 2 In the Lmtools program, on the Service/License File tab, select the Configure Using Services option.
- 3 Click the Config Services tab.
- 4 In the Service Name list, select the service name you want to use to manage licenses.

By default, the service name is *FLEXnet Service 1*. If FLEXnet® is managing other software on your computer in addition to Autodesk, you can change the service name to avoid confusion, for example, you can rename *FLEXnet Service 1* to *Autodesk Server1*.

NOTE If you have more than one software vendor using FLEXnet for license management, the Service Name list contains more than one option. Make sure that only one Autodesk service is listed.

- 5 In the Path to Lmgrd.exe File field, enter the path to the Network License Manager daemon (*lmgrd.exe*), or click Browse to locate the file.

By default, this daemon is installed in the *C:\Program Files\Autodesk Network License Manager* folder.
- 6 In the Path to the License File box, enter the path to your license file, or click Browse to locate the file.
- 7 In the Path to the Debug Log File box, enter a path to create a debug log, or click Browse to locate an existing log file.

It is recommended that you save to the *\Program Files\Autodesk Network License Manager* folder. The log file must have a *.log* file extension. For new log files, you must enter the *.log* extension manually.
- 8 To run *lmgrd.exe* as a service, select Use Services.
- 9 To automatically start *lmgrd.exe* when the system starts, select Start Server at Power Up.
- 10 Click Save Service to save the new configuration under the service name you selected in step 4. Click Yes when prompted if you would like to save the settings to the service.
- 11 Click the Start/Stop/Reread tab and do one of the following:
 - If a service has not yet been defined for Autodesk, click Start Server to start the license server.
 - If a service for Autodesk is already defined and running, click ReRead License File to refresh the Network License Manager with any changes made to the license file or Options file.

The license server starts running and is ready to respond to client requests.
- 12 Close *lmtools.exe*.

Distribute the Program

Once you have fully prepared for creating a deployment, you are ready to set up and distribute Autodesk Navisworks by using the Deployment wizard and choosing a deployment method.

Create a Network Share

A network share is an installation folder that you make available to users' computers on a network. You point users to this location to install the program. Create a network share that will be used by the Autodesk Navisworks Deployment wizard during the creation of a client deployment.

A *shared folder* is required for network license and multi-seat stand-alone methods of installation.

It is recommended that you name the network share folder *Deployments* on the desktop of the system where you want deployments stored. You can then add subfolders inside the shared *Deployments* folder that clearly convey the name of product you plan to deploy. This is also beneficial if you plan to deploy multiple products.

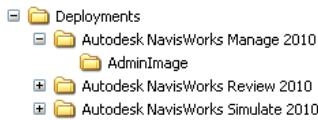

Any subfolders that are placed inside a shared folder are automatically shared.

TIP You must have Full Control permissions set for your shared folder when you are creating your deployment images. Read permissions are necessary to access the network share and administrative permissions on the workstation where the program is deployed.

To create your network share

- 1 On the desktop of a network server, create a folder named *Deployments*.
- 2 Right-click the *Deployments* folder and click Share and Security (or Sharing).
- 3 In the *[folder name]* Properties dialog box, Sharing tab, select Share This Folder.
- 4 Specify a Share Name, such as *Deployments*, if necessary.
- 5 Click the Permissions button. In the Permissions dialog box make sure Full Control is active. Click OK.
In Vista, right-click the *Deployments* folder and then click Share. In the Properties dialog box select Sharing and then Advanced Sharing to share the folder. Click the Permissions button to make sure Full Control is active. Click OK.
These steps are important when creating your deployment images.
- 6 Click OK or Close to close the Properties dialog box.
- 7 For each product you plan to install, create a subfolder in the *Deployments* folder. Name each folder with the pertinent product name.

Minimize the Chances of Installation Failure

The Navisworks installation process may stop if some applications, such as Microsoft Outlook or virus checking programs, are running when you are creating a deployment. Close all running applications and temporarily disable virus checking utilities.

Distribute an Autodesk Navisworks Product

You can choose from several methods of distributing an Autodesk program. Network sharing is the default method.

- **Network Share.** Users launch the program with the shortcut icon that you created with the Deployment wizard. The program is installed on users' local computers, and a product icon appears on their desktop.

NOTE Users must have Read permissions to access the network share and administrative permissions on the workstation where this program is installed.

- **Scripting.** A script executes a command or a set of commands. Scripts are similar to batch files but are more flexible. Installation scripts are most useful for stand-alone installation of programs on computers that are connected to a network. Scripts are also useful for installing service packs, extensions, and object enablers on a network.
- **Group Policy Objects (GPOs).** With group policy objects, this program can be advertised to any Windows XP or Windows Vista computer that is part of a Windows 2003 Server Active Directory environment. Autodesk products are designed to be installed on a computer so that any user who logs on to the computer can run the software. If you attempt to assign this program for a specific user rather than a computer, you may encounter problems when a second specified user tries to install or uninstall a copy of the program.
- **Microsoft SystemCenter Configuration Manager (SCCM).** You can deploy Autodesk software using Microsoft® System Center Configuration Manager (SCCM). When you use SCCM to deploy Autodesk software, you set up the source directory using the Deployment wizard. The Deployment wizard creates an administrative image that is used by SCCM to distribute the Autodesk software to the target systems. The location where you perform the administrative installation becomes the location of the package source directory.
- **Imaging Software.** You can use imaging software, such as Norton Ghost, to create a master image to distribute Autodesk products. Once created, the master image is then replicated to other computers throughout your facility. Care needs to be taken since the use of imaging software can result in conflicts with the product licensing, incomplete installations, and problems with activation.

Set Up a Deployment

The deployment process provides you with numerous options for creating, and customizing your deployments, so you should set aside ample time to complete the process in one sitting.

To be successful it is recommended that you review the following checklist and information before you begin. The deployment process is initiated from the Deployment wizard. Once a deployment is created, users then access the deployment to install products to their computers.

Preliminary Tasks for a Network Deployment

The deployment checklist gives you a quick summary of the type of information you should be familiar with before begin. When you have completed these tasks, you are ready to create a deployment.

Deployment Checklist

- | | |
|--------------------------|--|
| <input type="checkbox"/> | You have reviewed the system requirements. You must make sure that your network, servers, and client workstations meet the system requirements. |
| <input type="checkbox"/> | You understand the type of license you've purchased. If you plan a network license deployment, you should also be familiar with the type of license server model you want to use and the license server names. |
| <input type="checkbox"/> | You have installed and activated any supporting tools and utilities. |
| <input type="checkbox"/> | You have located your product serial number and product key. The serial number and product key are located on the outside of the product packaging, or in the email you received if you downloaded your product. |
-

Deployment Checklist

- You know how you're going to personalize the programs during registration. Using consistent registration data is very important.

- You have identified the location (such as a shared folder) where deployments will reside for each program you plan to deploy.

- You have closed all other programs and disabled anti-virus software.

- You have decided what languages you will include in your administrative image, and what languages you will use for your deployment package.

- You have determined if your deployment plan involves using imaging software to distribute your programs to client workstations.

- You have specified whether you want to create log files that contain deployment and installation data, run silent mode, and participate in the Customer Involvement Program.

- You know which type of installation you'll perform - typical or custom.

- You have chosen the installation folder option.

- You have decided if you want to include centralized product settings with your deployment, such as global options, workspaces, datatools, avatars, Clash Detective rules, Presenter archives, custom Clash Detective tests, object animation scripts, and so on.

- You have set up access and participation in features like the Customer Involvement Program.

Configure Button

During the deployment process, you can create a deployment that uses the default settings, or you can create a customized deployment. To customize, you begin in the Review - Configure - Create Deployments dialog box. Select the appropriate product from the drop-down list, and click the Configure button.

The following options are available after you click the Configure button. See [“Your Deployment Choices”](#) on page 36 for more details about deployment options.

- Select the License Type - Stand-alone or Network license
- Select the Installation Type - Typical or Custom
- Select the Project and Site Folder Paths
- Select Installation Folder

When you finish selecting options for your customization, click the Configuration Complete button. The Review - Configure - Create Deployments dialog box is displayed again, and you can review your selections. Once you have confirmed your selections, click Create Deployment.

NOTE To get a copy of your settings, select the Copy to Clipboard button.



If you do not wish to make configuration changes on the Review - Configure - Create Deployments page, click Create Deployment.

Your Deployment Choices

When you create a deployment, you will make several choices during the process to create various client deployment images and deployment types. The following sections outline your choices in more detail.

Enter Product and User Information

The Product and User Information page is used to personalize the program for your environment.

The information you enter is permanently retained with the product and is displayed in the Help menu on all workstations. Because you can't change this information later without uninstalling, take care when entering the information.

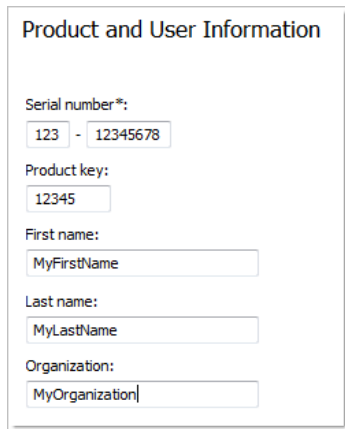
A screenshot of a web form titled 'Product and User Information'. The form contains several input fields: 'Serial number*' with a value of '123 - 12345678', 'Product key' with a value of '12345', 'First name' with a value of 'MyFirstName', 'Last name' with a value of 'MyLastName', and 'Organization' with a value of 'MyOrganization|'. Each field is a simple text box with a light gray border.

You must also enter the product serial number and product key in order to run the product. The product serial number and product key are located on the product packaging, or in the electronic fulfillment messaging. The serial number must contain a three-digit prefix followed by an eight-digit number. The product key consists of five digits.

Your client's can review this product information later, by clicking Help ► About.

To enter your serial number and personal information

- 1 When creating a deployment, on the Product and User Information page, enter your product serial number and the required personalization data.

NOTE Although it is required that you enter information in each box on this page, you can enter any information that you want to convey to users who install the deployment.

- 2 Click Next.

Specify Log File Locations

The program has two types of log files with which you can monitor information about deployments and installations.

- **Network log.** The network log file keeps a record of all workstations that run the deployment. On the General Deployment Settings page of the deployment process, you choose whether or not to create a network log

file. The log lists the user name, workstation name, and the status of the installation. Refer to this file for status information and details about problems that users encountered during installation (for example, low disc space or inadequate permissions).

The network log is named with the same name you chose for your deployment. You can specify where the log file is created by entering either a valid UNC (universal naming convention) path or hard-coded path on your network, for example `\\MyComputer\Autodesk\<Autodesk product>`. Users should use their actual computer name in place of `MyComputer`.

NOTE The folder where the network log resides must be a shared folder where users who install the program have Change permissions. Otherwise, successes or failures for user installations cannot be written to the log file.

- **Client log.** The client log contains detailed installation information for each workstation. This information may be useful in diagnosing installation problems. The client log is located in the `%Temp%` directory of each client workstation.

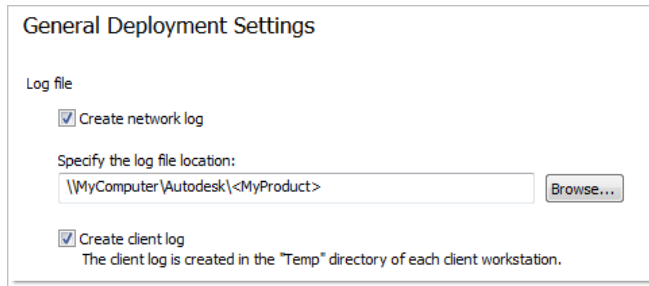

To specify a log file location

- 1 While creating a deployment, on the General Deployment Settings page, select the check box next to the Create Network Log box. Enter the name of the folder where you want the network log to be located.
- 2 If you want to create a client log, select the Create Client Log option.
- 3 Click Next.

What Is Silent Mode?

When silent mode is active and a user initiates the deployment, the installation proceeds without any explicit user input.

No dialog boxes are presented that require interaction from the user. This includes all error and warning dialog boxes. Check the log file for errors that may occur in the event of installation problems.

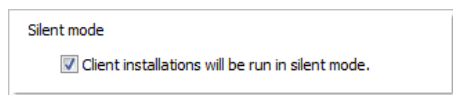

Customer Involvement Program (CIP)

If you choose to have your clients participate in the Customer Involvement Program, Autodesk Navisworks Simulate 2010 will automatically send Autodesk information about system configuration, what features you use most, any problems that you encounter, and other information helpful to the future direction of the product.

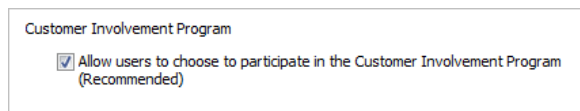

Select a License Type (optional)

When you set up your deployment, you choose the type of installation to deploy based on the type of software license you purchased: stand-alone or network. You also select the network license server model you want to use to distribute product licenses.

IMPORTANT Depending on the type of option you choose on the configuration page, network or stand-alone license, note that you must use the same type of installation for all those products in your deployment session. If you select products that do not support the type of license you purchased, you will not be able to activate those products.

Specify the license type to use during deployment

- Stand-Alone license (a single serial number for a single seat). For a stand-alone license, you install, register, and activate the program on each workstation.
- Network license. With this type of installation, you install the program to workstations with the files and registry entries that allow the program to communicate with the Network License Manager. You also define the configuration of the Network License Manager so that the licenses can be accessed. Workstations running the program based on a network installation do not require individual activation. Licensing of this program is managed by at least one license server.

Specify the license server model during deployment

If you choose the Network license option, you need to decide which license server model to use to distribute your product licenses - single, distributed or redundant license server model.

If you are deploying a stand-alone or multi-seat stand-alone installation type, you do not use a license server model. For more information on server models, see [“Choose a License Server Model”](#) on page 30.

To deploy a stand-alone license

- 1 While creating a deployment, on the Select the License Type page, select Stand-alone license.



The screenshot shows a dialog box titled "Select the License Type". It contains two radio button options: "Stand-alone license" and "Network license". The "Stand-alone license" option is selected, indicated by a filled blue circle next to it.

- 2 Click Next.

To deploy a network license using a single license server model

- 1 While creating a deployment, on the Select the License Type page, select the Network License option.
- 2 Select Single License Server as the license server model you want to use with the Network License Manager. If you have already used the Network License Manager to create a license server model, you must select the same license server model in this step. If you have not yet used the Network License Manager to create a license server model, make sure that you select the same settings in the Network License Manager that you choose here.
- 3 Enter the server name of the server that will run the Network License Manager, or click the Browse button to locate the server. Click Next.

For more information about license server models and setting up your license server, see [“Choose a License Server Model”](#) on page 30 or [“Configure Your License Server”](#) on page 32

To deploy a network license using a distributed license server model

- 1 While creating a deployment, on the Select the License Type page, select the Network License option.
- 2 Select Distributed License Server as the license server model you want to use with the Network License Manager.

If you have already used the Network License Manager to create a license server model, you must select the same license server model in this step. If you have not yet used the Network License Manager to create a license server model, make sure that you select the same settings in the Network License Manager that you choose here.

- 3 Enter the name of one of the servers that will run the Network License Manager, or click the Browse button to locate the server. Click Add to add the server to the Server Pool. Once all the servers are added to the Server Pool list, use the Move Up and Move Down buttons to arrange the servers in the order you want them to be searched by a user's workstation. You must enter at least two servers. Click Next.

For more information about license server models and setting up your license server, see [“Choose a License Server Model”](#) on page 30 or [“Configure Your License Server”](#) on page 32

To deploy a network license using a redundant license server model

- 1 While creating a deployment, on the Select the License Type page, select the Network License option.
- 2 Select Redundant License Server as the license server model you want to use with the Network License Manager.
If you have already used the Network License Manager to create a license server model, you must select the same license server model in this step. If you have not yet used the Network License Manager to create a license server model, make sure that you select the same settings in the Network License Manager that you choose here.
- 3 In the First Server Name field, enter a server name of one server that will run the Network License Manager, or click the Browse button to locate the server. Enter the server names for the remaining two servers that you will use in the redundant server pool. Click Next.

NOTE If you are not sure how to obtain the server host name, see Plan Your License Server Configuration in the *Network Licensing Guide*, located on the Documentation link of the Installation wizard.

For more information about license server models and setting up your license server, see [“Choose a License Server Model”](#) on page 30 or [“Configure Your License Server”](#) on page 32

Select the Installation Type and Location (optional)

As part of making your deployment choices, you can select the type of installation that users receive when they install the program, choose which optional features are included, and specify a product location.

- **Typical.** Installs the most common application features. This option is recommended for most users.
- **Custom.** Installs only the application features that you select.

To deploy a typical installation, and specify a product location

- 1 During the deployment, on the Select the Installation Type page, select Typical as the type of installation that you want.
- 2 Enter the path on the client workstation where you want to install the program, for example *C:\Program Files\<Autodesk product>*.
The Disc Space Requirements chart lets you review available drives and disc space.
- 3 Click Next.

To deploy a custom installation, choose optional features, and specify a product location

- 1 During the deployment, on the Select the Installation Type page, select the Custom option as the type of installation that you want.
- 2 From the Select Features to Install list, select the features that you want to install.

Your choices are as follows:

ActiveX Lite Control	Contains Navisworks ActiveX Lite control.
API	Contains the Component Object Model interface for customizing and extending the Navisworks functionality.
Example NWD files	Contains various feature sample files.
PDF Manual	Contains the Autodesk Navisworks User Guide in PDF format.
Autodesk Navisworks Simulate 2010	Contains full set of Navisworks files.
Sample RPCs	Contains several Rich Photorealistic Content files.

If, after making feature changes, you decide you want the original selections, click the Restore Defaults button on the Select the Installation Type page.

- 3 Enter the path on the client workstation where you want to install the program, for example C:\Program Files\<Autodesk product>.

The Disc Space Requirements chart lets you review available drives and disc space.

Select the Project and Site Folder Paths (optional)

When you set up your deployment, you can share various Autodesk Navisworks settings across entire project site, or across a specific project group depending on the required level of granularity.

See also:

- [“How do I share the Autodesk Navisworks settings on a site and project basis?”](#) on page 46

To select the Project and Site folder paths

- 1 On the Project and Site Folder Paths page, Project Folder box, click the Browse button to select the directory that contains the Autodesk Navisworks settings specific to a project group.
- 2 In the Site Folder box, click the Browse button to select the directory that contains the Autodesk Navisworks settings standard across the entire project site.

Choose a Language

You can select a different language for deployment instructions, and a language for product installations in the same deployment process.

For example, if you need to provide Autodesk Navisworks to users in one or more languages different than your own, you can download language packs from the installer that will allow you to deploy the product in the languages you need to support.

NOTE Language packs can only be included in an administrative image during the creation of the deployment and not during modification.

When you start the deployment process, the installer automatically determines your operating system language. If a supported language is detected, your deployment pages are displayed in that language. If you want to change that language, you can choose a different one from the installer language list on the opening page of the Installation wizard.

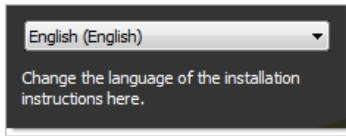

NOTE Some products may not have multi-language support at the time of product release. Additional language support may be available later. Check <http://autodesk.com/servicesandsupport> for the availability of additional language packs.

Using Language Packs

Language packs (.msi) support use of different languages in each Autodesk Navisworks product, including exporters. Pack names start with NAVFREE_, NAVREV_, NAVSIM_, NAVMAN_, and exporters_ respectively.

NOTE You can only select one language pack for each product for deployment.

It is possible to manually add additional language packs to Autodesk Navisworks products later by double-clicking on the language pack .msi file. Alternatively, you can set up and run scripts to install additional language packs.

Language packs are located on the installation DVD and unpacked downloaded media under the x86 folder for 32-bit products and under the x64 folder for 64-bit products.

- Language packs for specific products are included in the NAVFREE, NAVREV, NAVSIM, NAVMAN, and NWEXPORT subfolders of x86 and x64 folders.
- Language packs for specific languages are included in the en-US (English), de-DE (German), es-ES (Spanish), fr-FR (French), it-IT (Italian), ja-JP (Japanese), ko-KR (Korean), pt-BR (Brazilian Portuguese), ru-RU (Russian) and zh-CN (Chinese PRC) subfolders of the product folders.

Create a Deployment

A deployment contains a Microsoft Transform (MST) file that modifies the default behavior of the installation program.

As you begin a deployment, you need to select the location of your Administrative image, a deployment name, and if your target systems are 32 or 64-bit operating systems.

Create a Deployment Using Default Values

This is the fastest means of creating client deployment images.

To create a default deployment

- 1 In the Deployment wizard, click Create Deployments.
- 2 On the Begin Deployment page, specify the following: administrative image location, deployment name, and if your target system is 32 or 64-bit.
 - In the Administrative Image field, enter the path to your existing shared network location, or use the Browse button to navigate to that location. This area is where you create and store your administrative image. Users install the program from this location.

NOTE If you do not know how to create a network share, see [“Create a Network Share”](#) on page 33.

- In the Deployment Name field, enter the new deployment's name. The name you enter here is the name of the shortcut users will access to install the product.
- Under This is to be a:, select either 32-bit or 64-bit for your target operating system. This selection does not identify the system your deployment was created on; it identifies your target system.

Click Next.

- 3 On the Select the Products to Include in the Deployment page, select the products you want to include, the languages to include in your administrative image, and the language of your deployment:
 - a For a 64-bit version of Windows, you can install both 32-bit and 64-bit versions of Autodesk Navisworks, 64-bit version of Autodesk Navisworks Freedom, and both 32-bit and 64-bit versions of exporter plugins.
 - b On a 32-bit version of Windows, you can install 32-bit version of Autodesk Navisworks, 32-bit version of Autodesk Navisworks Freedom, and 32-bit version of exporter plugins.

After making your choices, click Next.

- 4 Review the Autodesk software license agreement for your country or region. You must accept this agreement to proceed with the deployment. Choose your country or region, click I Accept, and then click Next.

NOTE If you do not agree to the terms of the license and want to terminate the installation, click Cancel.

- 5 On the Product and User Information page, enter your serial number, product key, and user information. Review the Privacy Policy, and then click Next.

NOTE The information you enter here is permanent and is displayed in the Help menu on users' computers. Because you can't change this information later without uninstalling the product, make sure you enter the information carefully.

- 6 On the General Deployment Settings page, choose whether or not you want to create network log and/or a client log, if you want to run the client installation in silent mode, and if you want users to participate in the Customer Involvement Program.

- When you choose to create a network log file, you also have to specify where the log file is created by entering either a valid UNC (universal naming convention) path or hard-coded path on your network. The network log file is optional.

NOTE The folder where the network log resides must be a shared folder where users who install the program have Change permissions. Otherwise, successes or failures for user installations cannot be written to the log file.

- Choose whether you want a client log file created.
- If you want to prevent users from changing installation settings when they install, select Silent mode.
- If you choose participation in the Customer Involvement Program, Autodesk sends helpful information about the product.

For more information regarding log files, refer to [“Specify Log File Locations”](#) on page 36.

Click Next.

- 7 On the Review - Configure - Create Deployments page, click Create Deployment.

By clicking Create Deployment, an administrative image is created in your shared folder using the deployment options listed in the Current Settings field. If you would like a summary of your deployment settings, click the Copy to Clipboard button.

- 8 On the Deployment Complete page, click Finish.

Create a Deployment Using Configured or Customized Values

If you plan on altering your deployment by removing features or restricting access to online resources you can create a configured or customized deployment.

To create a custom deployment

- 1 In the Deployment wizard, click Create Deployments.

- 2 On the Begin Deployment page, specify the following: administrative image location, deployment name, and if your target system is 32 or 64-bit.
 - In the Administrative Image field, enter the path to your existing shared network location, or use the Browse button to navigate to that location. This area is where you create and store your administrative image. Users install the program from this location.

NOTE If you do not know how to create a network share, see [“Create a Network Share”](#) on page 33.

- In the Deployment Name field, enter the new deployment's name. The name you enter here is the name of the shortcut users will access to install the product.
- Under This is to be a:, select either 32-bit or 64-bit for your target operating system. This selection does not identify the system your deployment was created on; it identifies your target system.

Click Next.

- 3 On the Select the Products to Include in the Deployment page, select the products you want to include, the languages to include in your administrative image, and the language of your deployment:
 - a For a 64-bit version of Windows, you can install both 32-bit and 64-bit versions of Navisworks, 64-bit version of Autodesk Navisworks Freedom, and both 32-bit and 64-bit versions of exporter plugins.
 - b On a 32-bit version of Windows, you can install 32-bit version of Navisworks, 32-bit version of Autodesk Navisworks Freedom, and 32-bit version of exporter plugins.

After making your choices, click Next.

- 4 Review the Autodesk software license agreement for your country or region. You must accept this agreement to proceed with the deployment. Choose your country or region, click I Accept, and then click Next.

NOTE If you do not agree to the terms of the license and want to terminate the installation, click Cancel.

- 5 On the Product and User Information page, enter your serial number, product key, and user information. Review the Privacy Policy, and then click Next.

NOTE The information you enter here is permanent and is displayed in the Help menu on users' computers. Because you can't change this information later without uninstalling the product, make sure you enter the information carefully.

- 6 On the General Deployment Settings page, choose whether or not you want to create network log and/or a client log, if you want to run the client installation in silent mode, and if you want users to participate in the Customer Involvement Program.
 - When you choose to create a network log file, you also have to specify where the log file is created by entering either a valid UNC (universal naming convention) path or hard-coded path on your network. The network log file is optional.

NOTE The folder where the network log resides must be a shared folder where users who install the program have Change permissions. Otherwise, successes or failures for user installations cannot be written to the log file.

- Choose whether you want a client log file created.
- If you want to prevent users from changing installation settings when they install, select Silent mode.
- If you choose participation in the Customer Involvement Program, Autodesk sends helpful information about the product.

For more information regarding log files, refer to [“Specify Log File Locations”](#) on page 36.

Click Next.

- 7 On the Review - Configure - Create Deployments page, click the Configure button to make changes to the administrative image. Each of the products you selected to install, has its own configuration tab:
 - For Autodesk Navisworks Freedom 2010 you can [change the installation path](#).
 - For Autodesk Navisworks Manage 2010, you can change the [license type](#), [installation type](#), [installation path](#), and the [project and site folder paths](#).
 - For Navisworks exporter plugins, currently you cannot change which plugins are installed. By default, the exporter plugins for all 3rd party products installed on a client PC will be automatically enabled.Make your selections, and then click Next.
- 8 On the Configuration Complete page, select a different product tab to configure another product, or click Configuration Complete to review your choices.
- 9 On the Review-Configure-Create Deployments page, click Create Deployment. If you want a summary of your deployment settings, click the Copy to Clipboard button.
- 10 On the Deployment Complete page, click Finish.

Final Review and Complete Setup

To complete your deployment setup, confirm the settings you selected.

You have created an Autodesk product deployment with precise options that are specific to your group of users. You can now use this deployment to install the program.

To confirm and complete the setup of a network deployment

- 1 On the Review - Configure - Create Deployments page, scroll the list of current settings and verify your installation selections.
- 2 Click the Configure button, if you need to change any selections.
- 3 Click the Copy to Clipboard button, if you want a copy of the installation information.
- 4 Click Create Deployment.
- 5 On the Deployment Complete page, click Finish.

Modify a Deployment (optional)

After a deployment is created, it may be necessary to modify the deployment for some client workstations.

You can apply a patch or select various custom files that are not part of the base administrative image. You can also perform modifications such as changing the installation directory from drive C to drive D.

To modify a deployment

- 1 Open the shared network folder where you originally chose to place your product deployment.
- 2 In the Tools folder, double-click the Create and Modify a Deployment shortcut.
This re-opens the Deployment wizard.
- 3 Click through the deployment pages and make the necessary changes.
- 4 After all the modifications have been made, click Create Deployment.

Point Users to the Administrative Image

When you have completed the deployment process, you are ready to have users install the newly created or modified deployment.

You need to notify your users of the shortcut that was created in the administrative image. The shortcut is the same name that you chose when you [created a deployment](#).

To point users to the administrative image

- The simplest method of notifying users how to install the deployment is to email them with instructions about using the shortcut. At a minimum, the instructions need to include the location of the deployment and instructions about double-clicking the shortcut to the deployment.

Uninstall an Autodesk Product

When you uninstall an Autodesk product, all components are removed in the process.

This means that even if you have previously added or removed components, or if you have reinstalled or repaired an Autodesk product, uninstalling removes all Autodesk product installation files from your system.

To uninstall the program

- 1 Do one of the following:
 - (Windows XP) Click Start menu ► Settings ► Control Panel ► Add or Remove Programs.
 - (Windows Vista) Click Start menu ► Control Panel ► Programs and Features ► Uninstall or change a program.
- 2 In the Add/Remove Programs window, select Autodesk Navisworks Simulate 2010, and then click Change/Remove or Uninstall/Change.
- 3 Click Uninstall.
- 4 On the Uninstall Autodesk Navisworks Simulate 2010 page, click Next to remove Autodesk Navisworks from the system.
- 5 When informed that the product has been successfully uninstalled, click Finish.

NOTE Even though Autodesk Navisworks is removed from your system, the software license remains. If you reinstall Autodesk Navisworks at some future time, you will not have to register and re-activate the program.

Installation Troubleshooting

This section provides solutions to installation issues and answers to commonly asked questions that may arise while installing your products.

Additional troubleshooting information and support is also available at <http://autodesk.com/support>.

General Installation Issues

This section provides solutions to installation issues and answers to commonly asked questions that may arise while installing your products.

How can I check my graphics card driver to see if it needs to be updated?

It is recommended that you verify and update your graphics card driver to optimize your program. Use the following procedure to identify your current graphics card driver.

To identify your graphics card driver

- 1 Start Autodesk Navisworks Simulate 2010.
- 2 Click Help ► System Info.
The Autodesk Navisworks Simulate 2010 information dialog box opens.

- 3 Review the information about your system including the graphics card driver and driver version, and click OK to close the dialog.

When performing a Typical installation, what gets installed?

A Typical installation includes the following features:

Autodesk Navisworks Simulate 2010	Contains full set of Autodesk Navisworks Simulate 2010 files
API	Contains the Component Object Model interface for customizing and extending the Autodesk Navisworks functionality
Sample RPC's	Contains several Rich Photorealistic Content files for the Presenter tool
Example NWD files	Contains various feature sample files
PDF manual	Contains the Autodesk Navisworks Simulate 2010 user guide in PDF format

Why should I specify the Project Folder and Site Folder?

You can share global Autodesk Navisworks settings, workspaces, datatools, avatars, Clash Detective rules, Presenter archives, custom Clash Detective tests, object animation scripts, and so on, with other users.

These settings can be shared across an entire project site, or across a specific project group depending on the required level of granularity.

Autodesk Navisworks examines the current user profile and the all users profile on the local machine, and then checks the settings in the Project Directory and the Site Directory. The files in the Project Directory take precedence.

How do I share the Autodesk Navisworks settings on a site and project basis?

To install Autodesk Navisworks with the pre-configured settings, such as a site-wide set of global options or project-specific set of workspaces, you need to:

- 1 Configure and export required settings (such as workspaces, global options, clash tests and so on) in an XML file format.

When you configure global options, you can lock some of the options to prevent users from editing them later on local machines.

TIP If you want to create a locked global options file, run the stand-alone Options Editor from the command line by typing `"drive:pathname\OptionsEditor.exe" -l`. The Options Editor opens with the locking facility.

- 2 Set up the Site and Project directory structure.

Typically, you need to place the Site and Project directories on a central server, so that they can be used for centralized access by Autodesk Navisworks users.

The Site and Project Directories should contain the following subfolders:

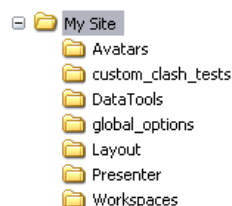

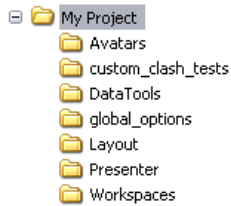

- 3 Place the exported settings inside the appropriate subfolders.

The centralized workspace files should go into the *Workspaces* subfolder, the centralized global options files should go into the *global_options* subfolder, and so on.

Where are my product manuals?

All documentation created for Autodesk products are built in two different formats: PDF and CHM.

- CHM files are made available during installation; click the Documentation link in the Installation wizard. To access CHM files after the product is installed, use the Help system in the product.
- PDF files are available after the product is installed; they are located in the `Autodesk\Autodesk Navisworks 2010\<locale>\Manuals` folder.

CHM files are installed to the `\Autodesk\Autodesk Navisworks 2010\<locale>` folder.

How do I register and activate Autodesk Navisworks?

The first time you start Autodesk Navisworks Simulate 2010, the Product Activation wizard is displayed. You can either activate Autodesk Navisworks at that time or run Autodesk Navisworks and activate it later.

Until you register and enter a valid activation code for Autodesk Navisworks Simulate 2010, you are operating the program in trial mode and the Product Activation wizard is displayed for 30 days from the first time that you run the program. If after 30 days of running Autodesk Navisworks Simulate 2010 in trial mode you have not registered and provided a valid activation code, your only option is to register and activate Autodesk Navisworks Simulate 2010. You will not be able to run in trial mode after the 30 days expires. Once you register and activate Autodesk Navisworks Simulate 2010, the Product Activation wizard is no longer displayed.

TIP The fastest and most reliable way to register and activate your product is by using the Internet. Simply enter your registration information and send it to Autodesk over the Internet. Once you submit your information, registration and activation occur almost instantly.

To register and activate Autodesk Navisworks Simulate 2010

- 1 Click Start menu ► All Programs (or Programs) ► Autodesk ► Autodesk Navisworks Simulate 2010 ► Autodesk Navisworks Simulate 2010.
- 2 In the Autodesk Navisworks Simulate 2010 Product Activation wizard, select Activate the Product, and then click Next.
This starts the Register Today process.
- 3 Click Register and Activate (Get an Activation Code).
- 4 Click Next and follow the on-screen instructions.

If you do not have Internet access, or if you want to use another method of registration, you can register and activate Autodesk Navisworks Simulate 2010 in one of the following ways:

- Email. Create an email message with your registration information and send it to Autodesk.
- Fax or Post/Mail. Enter your registration information, and fax or mail the information to Autodesk.

Deployment Issues

This section outlines common issues and their solutions with regards to software deployments.

Is there a checklist I can refer to when performing a deployment?

The *Installation* chapter contains a complete section that describes preliminary actions and the entire deployment process. See “[Preliminary Tasks for a Network Deployment](#)” on page 34.

Where should deployments be located?

Shared folders are required for both network license and multi-seat stand-alone methods of installation.

The shared folder (*network share*) is created before you run the Installation wizard and is where product deployments are stored. It is recommended that you name the network share folder *Deployments* on the desktop of the system where you want deployments stored. You can then add subfolders inside the shared *Deployments* folder that clearly convey the names of products you plan to deploy. For example:

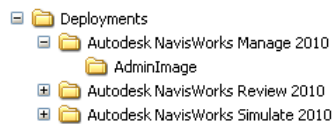

Any subfolders that are placed inside a shared folder are automatically shared.

NOTE You must have Full Control permissions set for your shared folder when you are creating your deployment images. Read permissions are necessary to access the network share and administrative permissions on the workstation where the program is deployed.

Where can I check if service packs are available for my software?

To find out if a patch or Service Pack is available for your product, visit the Autodesk Product Support page at <http://support.autodesk.com>.

How do I choose between 32-bit and 64-bit deployments?

You have a choice of selecting 32-bit or 64-bit deployment. This choice controls which operating system the deployment is targeted at, NOT what sort of products to include in the deployment.

- Selecting 32-bit deployment gives you a choice of 32-bit products, and will **only** install on 32-bit operating systems.
- Selecting 64-bit deployment gives you a choice of 32-bit and 64-bit products, and will **only** install on 64-bit operating systems.

So, for example, if you want to install 32-bit products on a 64-bit operating system, you need to choose 64-bit deployment.

NOTE You can make either type of deployment from either type of operating system.

What are information channels?

The Communication Center allows you to receive announcements from various information channels. Through information channels, you can receive the following:

- Product Support information, including maintenance patch notifications.

- Subscription Center announcements and subscription program news, as well as links to e-Learning Lessons, if you are an Autodesk subscription member.
- Notifications of new articles and tips posted on Autodesk websites.

Licensing Issues

This section outlines common issues and their solutions with regards to software licenses and licensing your products.

What is the difference between a stand-alone license and a network license?

Stand-alone licensed products are registered and activated to an individual workstation.

While the software can be installed on multiple systems in your facility, the license only allows one system to be operational. The Portable License Utility can be used if a license needs to be transferred to another system. If you need to run more systems, you need to purchase more stand-alone licensed products, or consider converting to network licenses.

Network licensed products rely on the Network License Manager to keep track of software licenses.

The software can be installed and run on multiple systems, up to the maximum number of licenses you've purchased. The Network License Manager "checks out" licenses until they are all in use. No further systems can run the program until a license is "checked in." If you need to run more systems, you can purchase additional licenses for the Network License Manager to maintain.

What is the benefit to using a network licensed version of the software?

Network licensed products are recommended for large drafting/design facilities, classrooms, and lab environments.

The main advantage is that you can install products on more systems than the number of licenses you have purchased (for example, purchasing 25 licenses but installing on 40 workstations). At any one time, products will run on the maximum number of systems for which you have licenses. This means you get a true floating license. If software needs to be run on more systems, additional licenses can be purchased.

Registration and activation occurs only once and the licenses are maintained on your Network License Server.

What is Internet Explorer used for?

After installing your product, you can operate in *trial mode* for a given number of days. Whenever you launch the program, you are prompted to activate the software.

When you choose to activate the software, Internet Explorer makes this process much faster.

Once you entered your registration data and submit it to Autodesk, an activation code is returned and you are not prompted again during startup.

Networking Issues

This section outlines common issues and their solutions with regards to performing a network installation or configuring your network license servers.

Where do I find my server name?

When installing a network licensed product, you must specify the name of the server that will run the Network License Manager.

If you don't know the server name, you can quickly find it by opening a Windows command prompt on the system that will be the Network License Manager. At the prompt, enter `ipconfig /all` and note the Host Name entry.

If I choose to create a log file, what kind of information does the log file contain?

There are two types of log files that can be generated that monitor information about deployments and installations.

- The Network log file keeps a record of all workstations that run the deployment. The log lists the user name, workstation name, and the status of the installation. Refer to this file for status information and details about problems that users may have encountered during installation.
- The Client log file contains detailed installation information for each workstation. This information may be useful in diagnosing installation problems. The client log is located in the `\Temp` directory of each client workstation.

What is an administrative image (MSI) file?

An *administrative image* is a collection of shared file resources created during the deployment process and is used by deployments to install the program to networked workstations. An *.msi* file is a Microsoft Installer file.

What is the impact of selecting all products to be included in the administrative image?

If you elect to include all products in your deployment, the administrative image will be larger.

You should select all products only when you create multiple deployments from this image and prefer not to use the installation disk. If there are products you rarely or never use, and you do not expect to create additional deployments, you should only select a subset of products.

You can still create a deployment at a later date, and include additional products, but you need to create a new administrative image. You need the installation media to do so.

Uninstall and Maintenance Issues

This section outlines common issues and their solutions with regards to adding and removing features, reinstalling or repairing your installation, and uninstalling products.

When adding or removing features, how can I tell what features get installed by default?

To quickly see what gets installed during a typical, default installation, click the Restore Defaults button on the Add/Remove Features page.

Is it possible to change the installation folder when adding or removing features?

Once your product is installed, you cannot change the installation path from the Add/Remove Features page. Changing the path while adding features results in program corruption, so it is not an option.

When should I reinstall the product instead of a repair?

You should reinstall your product if you accidentally delete or alter files that are required by the program. Missing or altered files adversely affect the performance of your product and cause error messages when you try to execute a command or find a file.

If an attempt to repair an installation fails, reinstalling is the next best option.

Do I need my original disk to reinstall my software?

When performing a reinstall of the product, you do not need to have the original DVD on hand.

Installation data is cached locally on your drive and that data is reused when reinstalling.

When I uninstall my software, what files are left on my system?

If you uninstall the product, some files remain on your system such as files you created or edited.

Your license file also stays on your workstation when you uninstall your product. If you reinstall on the same workstation, the license information remains valid and you do not have to reactivate the product.

Quick Start

4

This chapter helps you get up-to-speed with the Autodesk Navisworks interface.

Start and Quit Autodesk Navisworks

Once you've [installed](#) Autodesk Navisworks Simulate 2010, you can start it from the Windows desktop or from the command line.

To start Autodesk Navisworks, do one of the following from the Windows desktop:

- Double-click the Autodesk Navisworks icon, or
- Go to Start ► All Programs (or Programs) ► Autodesk ► Navisworks Simulate 2010 ► Autodesk Navisworks Simulate 2010.

Autodesk Navisworks starts in the language that best matches the settings on your computer. You can also start Autodesk Navisworks in [another of the installed languages](#).

NOTE You can add command line switches to specify different startup routines for the program. See "[Command Line Options](#)" on page 55.

To quit Autodesk Navisworks, on the File menu, click Exit.

If the model has been changed since opening it, Autodesk Navisworks asks you whether you want to save any changes. Respond appropriately and Autodesk Navisworks will close.

Automatically Save and Recover Navisworks Files

Power cuts, system and software failures can cause Autodesk Navisworks to close before you can save changes to your file.

Autodesk Navisworks can automatically save backup versions of a file you are working on, enabling you to recover your work if Autodesk Navisworks closes abnormally.

Auto-saved files have an .nwf format, and named as *<FileName>.AutoSave<x>* where **<FileName>** is the name of the current Navisworks file, and **<x>** is a number that increments with each auto-save. So, for example, if you work with a file called *Enviro-Dome.nwd*, the first auto-saved file is called

Enviro-Dome.Autosave0.nwf, the second auto-saved file is called *Enviro-Dome.Autosave1.nwf* and so on.

You can control a number of auto-save options, such as how often Navisworks saves your work, the location of backup files, and the maximum number of backup files you want to keep.

To customize the auto-save options

- 1 Click Tools ► Global Options.
- 2 In the Options Editor, expand the General node, and click Auto-Save.

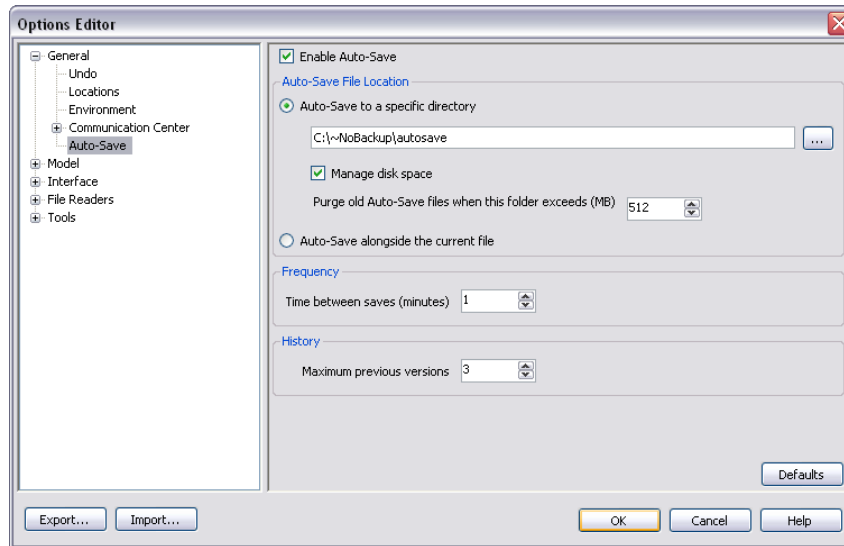

- 3 Adjust the auto-save options, as required. For example, if you want Navisworks to save a backup file every 20 minutes from a significant file change, enter **20** into the Time Between Saves (minutes) box.
- 4 Click OK.

To recover your work

- 1 Start Autodesk Navisworks. You are automatically prompted to reload the last file you were working on.
- 2 Click Yes to open the most recent saved version of the file.

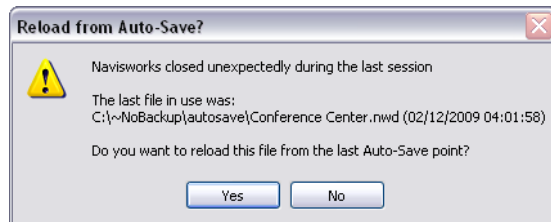

NOTE Click No, if you don't want to recover your work, or if you want to manually load a different backup file.

To manually load a backup file into Navisworks

- 1 Start Autodesk Navisworks. If you are prompted to reload the last file you were working on, click No.
- 2 Click File ► Open.
- 3 In the Open dialog box, browse to the folder that contains the backup files. By default, it's *<USERPROFILE>\Application Data\<PRODUCTFOLDER>\AutoSave*.
- 4 Click Open.
- 5 When you are prompted to save a file with a different name, click Save As.

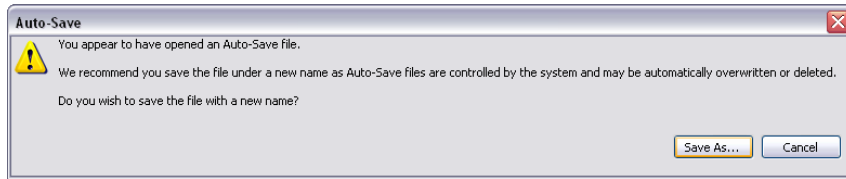

- 6 In the Save As dialog box, enter a new file name, and browse to the desired location.
- 7 Click Save.

Command Line Options

Command line switches can specify different startup routines for Navisworks.

You can use command line switches to specify several options when you start the program. For example, you can run Autodesk Navisworks in another language, perform additional memory checks, load and append files, output error reports. With command line switches, you can also set up several program icons, each with different start-up options.

Command line switches are parameters you can add to the *roamer.exe* command line associated with a Microsoft® Windows® shortcut icon or the Windows Run dialog box. You can include several switches within a single command line. Valid switches are listed in the following table.

Command Line Switch	Argument	Description
-dump	[file_name.dmp]	Outputs an error report to the specified file. You must provide the file name and file path within quotation marks.
-lang	en-US = English de-DE = German es-ES = Spanish fr-FR = French it-IT = Italian ja-JP = Japanese ko-KR = Korean pt-BR = Brazilian Portuguese ru-RU = Russian zh-CN = Chinese (PRC)	Launches Autodesk Navisworks in the specified language. It is possible to run Autodesk Navisworks in a language other than the default locale (for example, you can run a Japanese version of Autodesk Navisworks with English default locale).
-log	[filename.txt]	Outputs log to the specified file. You must provide the full file path within quotation marks. For example, "C:\temp\log.txt"
-memcheck		Runs Autodesk Navisworks with additional checks for memory errors.

Command Line Switch	Argument	Description
-nwc	[outputfile.nwc] [inputfile]	Autodesk Navisworks converts an input file into the NWC format in the background, and places it into the specified directory. You must provide the full file paths within quotation marks. For example, "C:\temp\a.dwg"
-nwd	[outputfile.nwd] [input file]	Autodesk Navisworks converts an input file into the NWD format in the background, and places it into the specified directory. You must provide the full file paths within quotation marks. For example, "C:\temp\b.dwg"
-options	[filename.xml]	Starts Autodesk Navisworks, and imports the global options from the specified global options file. You must provide the full file path within quotation marks. For example, "C:\temp\my_global_options.xml"
-regserver		Registers roamer.exe with COM.

The syntax for using command line switches is:

"drive:pathname\roamer.exe" [switches] ["file1"] ["file2"] ["fileN"], where [switches] are the valid command line switches in any order, and [file1]...[fileN] are the files to be loaded and appended together, if required. You must provide the full file paths within quotation marks.

For example, the following entry starts the program from a folder named *Autodesk Navisworks* in *Russian* language, loads the global options file *options.xml*, and creates a log file *log.txt*.

```
"C:\Autodesk Navisworks\roamer.exe" -options "C:\temp\options.xml" -lang ru-ru -log
"C:\temp\file.log"
```

To start the program with a command line switch

- 1 Right-click the program icon on the Windows desktop. Click Properties.
- 2 In the Autodesk Navisworks Properties dialog box, Shortcut tab, in the Target box, edit the parameters for the switch using the following syntax:
"drive:pathname\roamer.exe" [switches] ["file1"] ["file2"] ["fileN"], where [switches] are the valid command line switches in any order, and [file1]...[fileN] are the files to be loaded and appended together, if required. You must provide the full file paths within quotation marks.
For example, enter: "D:\Autodesk Navisworks\roamer.exe" -log "D:\temp\nw_log.txt" "D:\temp\a.nwd" "D:\temp\b.dwg".
- 3 Click OK.

The User Interface

The Autodesk Navisworks interface contains a number of traditional Windows elements, such as toolbars, dockable windows, dialog boxes and shortcut menus in which you complete tasks.

Parts of Autodesk Navisworks Interface

This section briefly describes the main interface components.

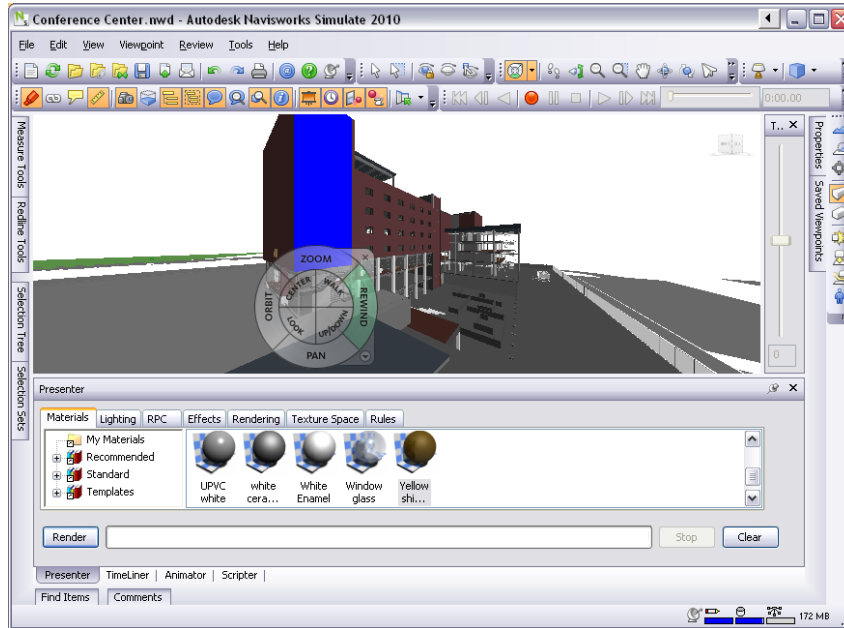

The Autodesk Navisworks interface is intuitive and easy to learn and use. You can adjust the application interface to match the way you work. For example, you can hide toolbars that you rarely use, so they do not clutter the interface. You can add and remove buttons from toolbars. You can also create your own toolbars.

Menu Bar

The Menu bar contains all commands available in Autodesk Navisworks, grouped together by similar or 'like' functionality.

For example, all commands related to review functionality are located under the Review menu, all commands related to user assistance are located under the Help menu and so on.

When a menu has a right-pointing arrow, such as Navigation Mode ▾, there is a submenu associated with that choice.

When a menu item is followed by a series of dots, such as Edit Current Viewpoint..., there is a dialog box associated with that choice.

Quick Reference

File Menu

This menu contains commands for managing files.

Option	Description
New	Resets the program, and closes the currently open Navisworks file.
Refresh	Refreshes your scene with the latest versions of currently loaded model files.

Option	Description
Open	Displays the Open dialog box.
Open URL	Displays the Open URL dialog box.
Append	Displays the Append dialog box.
Merge	Displays the Merge dialog box.
Save	Saves the currently open Navisworks file.
Save As	Displays the Save As dialog box.
Publish	Displays the Publish dialog box.
Print	Displays the Print dialog box.
Print Preview	Enables print preview mode.
Print Setup	Displays the Print Setup dialog box.
Delete	Deletes the selected files. You can only delete appended files.
Send	Saves the currently open Navisworks file, accesses your email program, and adds the saved file as an email attachment.
Import	Displays the Import dialog box, and enables you to import Intergraph PDS review data, and various Navisworks data.
Export	Displays the Export dialog box, and enables you to export data from Navisworks.
Recent Files	Displays shortcuts to the most recently opened files.
Exit	Exits the program.

Edit Menu

This menu contains commands for locating, selecting and editing geometry in your model.

Option	Description
Undo	Reverses the last performed operation.
Redo	Reverses the last operation performed by the Undo command.
Select	Gives you access to selection functionality.
Quick Find	Displays the Quick Find dialog box.
Quick Find Next	Repeats the previously run quick find search.
Find Items	Toggles the Find Items control bar.

Option	Description
Find Comments	Toggles the Find Comments dialog box.
Hidden	Toggles hidden mode for selected items.
Required	Toggles required mode for selected items.
Unselected Hidden	Toggles hidden mode for unselected items.
Override Item	Enables you to override color, transparency, and transform for selected items.
Reset Item	Enables you to reset selected items back to their original state.
Reset All	Enables you to reset all overridden items back to their original state.
Sort	Enables you to sort the items in the Selection Tree alphabetically.
File Units an Transform	Displays the File Units and Transform dialog box.

View Menu

This menu contains commands that control the Navisworks interface.

Option	Description
Control Bars	Enables you to toggle the display of control bars.
Workspaces	Enables you to control workspaces.
Scene View	Enable you to control the views in the Scene Area.
Head-Up Display	Enables you to control the Head-Up Display elements.
SteeringWheels	Enables you to control the SteeringWheels.
Stereo	Puts the video output into stereo mode.
Stereo Options	Displays the Stereo Options dialog box.
Scene Statistics	Displays useful scene statistics.

Viewpoint Menu

This menu contains a set of commands that affect the current viewpoint, including model appearance, navigation and sectioning.

Option	Description
Saved Viewpoints	Enables you to use saved viewpoints.
Look From	Enables you to look from a preset viewpoint.

Option	Description
Set Viewpoint Up	Sets the viewpoint up vector to align with the selected orientation.
Rendering	Enables you to select rendering mode.
Lighting	Enables you to select lighting mode.
Display	Enables you to display primitives.
Navigation Mode	Enables you to select navigation mode.
Navigation Tools	Enables you to control the camera during interactive navigation.
Sectioning	Enables you to create a limited volume of your model.
Edit Current Viewpoint	Displays the Edit Viewpoint dialog box for the current viewpoint.

Review Menu

This menu contains commands for reviewing and markup.

Option	Description
Comments	Enables you to add and manage comments.
Redline	Enables you to add and manage annotations.
Measure	Enables you to use the measure tools.
Hyperlinks	Enables you to add and manage hyperlinks.
Tags	Enables you to locate review tags.
SwitchBack	Sends the current view of the currently loaded file back to AutoCAD or MicroStation-based program.
Renumber Comment IDs	Renumbers all comment IDs, making them unique to the scene.
Renumber Tag IDs	Renumbers all tag IDs, making them unique to the scene.

Tools Menu

This menu contains commands for advanced model analysis and reviewing, and also commands for customizing Autodesk Navisworks.

Option	Description
Presenter	Toggles the Presenter tool window.
TimeLiner	Toggles the TimeLiner tool window.
DataTools	Displays the DataTools dialog box.

Option	Description
Animator	Toggles the Animator tool window.
Scripter	Toggles the Scripter tool window.
Compare	Displays the Compare dialog box.
Redline	Toggles the Redline Tools tool window.
Hyperlinks	Toggles the display of hyperlinks.
Smart Tags	Toggles the display of smart tags.
Measure	Toggles the Measure Tools tool window.
Animation	Enables you to control animation playback, and record viewpoint animations.
Background	Enables you to select a background color for the Scene Area.
File Options	Displays the File Options dialog box.
Customize	Displays the Customize dialog box.
Global Options	Displays the Options Editor.

Help Menu

This menu provides access to the Autodesk Navisworks online reference system.

Option	Description
Help Topics	Opens the Help system.
Communication Center	Opens the Communication Center dockable window.
What's This	Opens the context-sensitive help.
Navisworks on the Web	Displays the Autodesk Navisworks product page.
Customer Involvement Program	Displays the Customer Involvement dialog box.
System Info	Displays detailed information about your system.
About Autodesk Navisworks Simulate 2010	Displays copyright and license information about your copy of Autodesk Navisworks, and enables you to access the Product Information dialog box.

Toolbars

Autodesk Navisworks toolbars provide quick access to frequently used commands.

Every button on a toolbar includes a tooltip, which describes the function the button activates. Placing the mouse over a button displays a brief instruction on how to use this feature in the Status bar.

You can rearrange, open and close toolbars:

- To move a toolbar, click the dotted line at the edge of the toolbar, and drag it to a different location.
- To open or close toolbars, right-click an empty area next to the last toolbar on the screen, and choose from the list of available toolbars on the shortcut menu.

In addition to rearranging the existing Autodesk Navisworks toolbars, you can customize their appearance and content, and create your own toolbars.

NOTE To quickly personalize a toolbar, click the Toolbar Options  button on the right, and click Add or Remove Buttons on the shortcut menu.

When a Autodesk Navisworks toolbar button has a down-pointing arrow, such as , a submenu toolbar is associated with that choice. Click the triangle to open the menu, and select a specific option. As you move through the menu, additional help is displayed in the Status bar. When the option is selected, it becomes the current command and is displayed as a button in the toolbar. To repeat the command, click the button in the toolbar. To choose a different command, click the triangle again.

Some toolbar buttons enable you to choose a program mode. For example, to look around your model, you need to be in look around mode. To rotate the model, you need to be in examine mode and so on. Autodesk Navisworks remains in the selected mode until instructed otherwise. To identify the mode you are in, look at the buttons. If a button is highlighted and has a dark blue boarder around it, the corresponding mode is currently active.



To leave the mode, either click the same button again or choose a different mode.

Some buttons are used to toggle the display of dialog boxes, and dockable windows (for example, the Presenter window, the Animator window etc.). Again, if a button is highlighted and has a dark blue boarder around it, it means that the corresponding display element is currently open.

As you open more toolbars on the screen, or resize the Autodesk Navisworks window, the toolbars may get overlapped with each other to reduce the screen clutter. When this happens, some buttons will be hidden under the overlaps. To quickly access the entire set of commands on a toolbar, click the chevron  button at the right end of the toolbar. The remaining commands available for that toolbar will appear.

Quick Reference



In this section, you will find a complete list of Navisworks toolbars and associated buttons.











NOTE The actual toolbar content can differ from this reference depending on the workspace you use.

Standard Toolbar



This toolbar provides quick access to file management commands. It also enables you to undo/redo your actions, and open the Help system.





Button	Description
	Resets the program, and closes the currently open Navisworks file.
	Refreshes your scene with the latest versions of currently loaded model files.
	Displays the Open dialog box.

Button	Description
	Displays the Open URL dialog box.
	Displays the Merge dialog box.
	Saves the currently open Navisworks file.
	Displays the Publish dialog box.
	Saves the currently open Navisworks file, accesses your email program, and adds the saved file as an email attachment.
	Reverses the last performed operation.
	Reverses the last operation performed by the Undo command.
	Displays the Print dialog box.
	Displays copyright and license information about your copy of Autodesk Navisworks.
	Opens the Help system.
	Opens the Communication Center.

Selection Tools Toolbar



This toolbar provides access to the selection commands, plus enables you to hide geometry objects.









Button	Description
	Turns on select mode.
	Turns on select box mode.
	Toggles required mode for selected items.
	Toggles hidden mode for selected items.
	Toggles hidden mode for unselected items.

Navigation Mode Toolbar



This toolbar includes nine modes and six SteeringWheels for interactive navigation around your 3D models.







Button	Description
	Selects the wheel.

Button	Description
	Turns on walk mode.
	Turns on look around mode.
	Turns on zoom mode.
	Turns on zoom box mode.
	Turns on pan mode.
	Turns on orbit mode.
	Turns on examine mode.
	Turns on fly mode.
	Turns on turntable mode.

Rendering Style Toolbar





This toolbar controls the model appearance in Navisworks.

















Button	Description
	Selects lighting mode.
	Selects rendering mode.
	Toggles the rendering of surfaces.
	Toggles the rendering of lines.
	Toggles the rendering of points.
	Toggles the rendering of snap points.
	Toggles the rendering of 3D text.

Workspace Toolbar



This toolbar gives you quick access to the Navisworks review and analysis tools.



Button	Description
	Toggles the Redline Tools tool window.
	Toggles the display of hyperlinks.

Button	Description
	Toggles the display of smart tags.
	Toggles the Measure Tools tool window.
	Toggles the Viewpoints control bar.
	Toggles the Sectioning toolbar.
	Toggles the Plan Thumbnail control bar.
	Toggles the Section Thumbnail control bar.
	Toggles the Selection Tree control bar.
	Toggles the Selection Sets control bar.
	Toggles the Comments control bar.
	Toggles the Find Comments dialog box.
	Toggles the Find Items control bar.
	Toggles the Properties control bar.
	Toggles the Presenter tool window.
	Toggles the TimeLiner tool window.
	Toggles the Animator tool window.
	Toggles the Scripter tool window.
	Controls workspaces.

Model Views Toolbar









This toolbar controls the views in the Scene Area.

Button	Description
	Splits your active scene view vertically.
	Splits your active scene view horizontally.
	Adds title bars to all custom scene views.

Sectioning Toolbar











This toolbar enables you to create a limited volume of your model.

Button	Description
	Enables you to link two opposing section planes together.
	Displays the Set Sectioning Box Size dialog box.
	Restricts the section distance to the bounding box limits of the objects selected in the Scene Area
	Displays the Sectioning Plane dialog box.
	Enables/disables the current section plane or box.
	Deletes the current section plane.
	Enables you to choose the alignment method.

Animation Toolbar



This toolbar allows you to record viewpoint animations, play back object and viewpoint animations, and toggle the scripting functionality.



Button	Description
	Rewinds the current animation back to the beginning.
	Steps back a single animation frame or keyframe.
	Plays the current animation backwards.
	Records the viewpoint animation.
	Pauses the animation.
	Stops playing the current animation, and rewinds it back to the beginning.
	Plays the currently selected animation.
	Steps one frame or keyframe forwards.
	Fast forwards the current animation to the end.

Button	Description
	Toggles the Scripter engine on and off in the Navisworks file.

Collaborate Bar Toolbar









This toolbar enables you to participate in design review sessions across a Local Area Network (LAN).

Button	Description
	Starts Windows™ NetMeeting.
	Enables you to rtake control of the session, and become the 'driver'.
	Refreshes Navisworks data on all attendees machines.

Object Manipulation Toolbar





This toolbar enables you to edit geometry in your model.











Button	Description
	Toggles the display of the translation gizmo.
	Toggles the display of the rotation gizmo.
	Toggles the display of the scale gizmo.
	Enables you to apply color override.
	Enables you to apply transparency override.
	Enables/disables snapping.

Navigation Tools Toolbar



This toolbar enables you to control the camera during interactive navigation.

Button	Description
	Dollies and pans the camera so that the entire model is in the Scene View.
	Zooms the camera so that the selected item fills the Scene View.
	Puts the Scene View into focus mode.

Button	Description
	Holds the selected items. As you move around the model, these objects will move with you.
	Uses a perspective camera.
	Uses an orthographic camera.
	Toggles collision.
	Toggles gravity.
	Toggles crouching.
	Toggles third person view.
	Aligns the current viewpoint with the X axis.
	Aligns the current viewpoint with the Y axis.
	Aligns the current viewpoint with the Z axis.
	Straightens the camera.

Scene Area

This is the area where you view and interact with your 3D models.

When you start Navisworks, the Scene Area contains only one scene view, but you can add more scene views, if needed. Custom scene views are named "ViewX" where 'X' is the next available number.

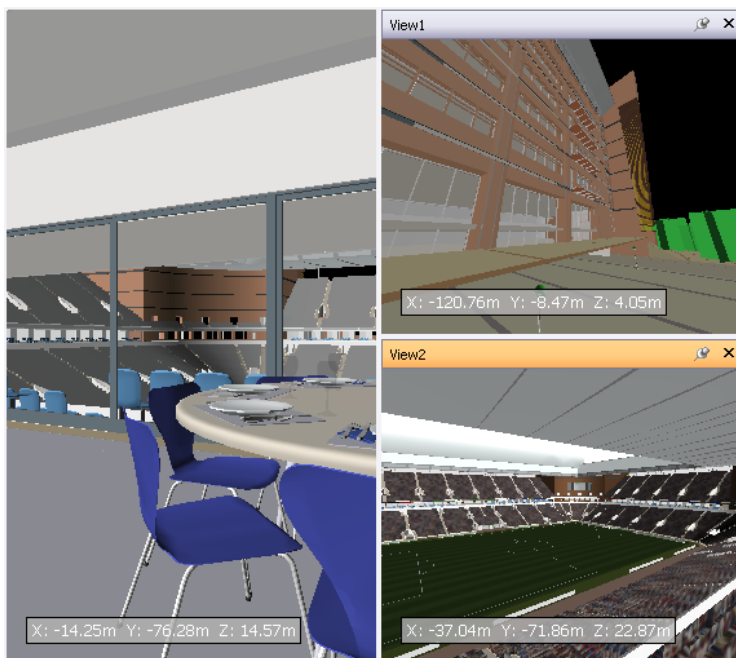

Looking at several views of your model simultaneously is useful when you compare lighting and rendering styles, animate different parts of your model, and so on.

Only one scene view can be active at a time. A scene view becomes active as you work in it. If you left-click a scene view, the scene view is activated and whatever you click is selected, or, if you click an empty area, everything is deselected. Right-clicking a scene view activates it, and opens a shortcut menu.

Each scene view remembers the navigation mode being used. The recording and playback of animations only occurs in the currently active view.

Each scene view can be resized. To resize scene views, move the cursor over the scene view intersection and drag the splitter bar .

You can make custom scene views dockable. Dockable scene views have title bars, and can be moved, docked, tiled, and auto hidden the same way as [dockable windows](#). If you want to use several custom scene views, but don't want to have any splits in the Scene Area, you can move them elsewhere. For instance, you can tile your scene views on the Viewpoints control bar.

NOTE You cannot undock the default scene view.

Full Screen Mode

In full screen mode your current scene view takes up the full screen, and no interface controls are shown.

To interact with the model in the scene view, use the keyboard shortcuts and the shortcut menu.



TIP If you use two monitors, your default scene view is automatically placed on the primary display, and the interface can be placed on the secondary display to control the interaction.

Scene View Content

Navisworks enables you to change the size of content displayed in a scene view. This can be of particular use if you are composing a scene for image or animation export. By setting the content size to the same proportions as your intended output, you can visualize exactly how it will look.

To create a custom scene view

- To split your active scene view horizontally, click View ► Scene View ► Split Horizontal.
- To split your active scene view vertically, click View ► Scene View ► Split Vertical.

 **Toolbar:** Model Views ► Split Horizontal  and Model Views ► Split Vertical 

To make custom scene views dockable

- Click View ► Scene View ► Toggle Title Bars.
All of your custom scene views now have title bars.

 **Toolbar:** Model Views ► Toggle Title Bars 

To delete a custom scene view

- 1 If your scene view is not dockable, click View ► Scene View ► Toggle Title Bars.
- 2 Click  to close the scene view.

NOTE You cannot delete the default scene view.

To toggle full screen mode

- Click View ► Scene View ► Full Screen.

 **Command entry:** F11

Shortcut menu: Viewpoint ► Full Screen

To resize the content of the active scene view

- 1 Click View ► Scene View ► Window Size.
- 2 In the Window Size dialog box, Type drop-down list, select the sizing type.

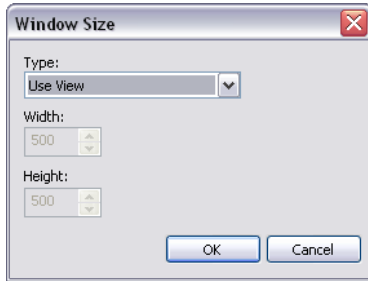

- **Use View** - makes the content fill the currently active scene view.
 - **Explicit** - defines the exact width and height for the content.
 - **Use Aspect Ratio** - uses the aspect ratio of the current scene view to automatically calculate the width of the content when the height is entered, or the height of the content when the width is entered.
- 3 If you selected the Explicit option, enter the width and height for your content in pixels.
If you selected the Use Aspect Ratio, enter the width or height for your content in pixels.
 - 4 Click OK.

Dockable Windows

Most Navisworks features are accessible from the dockable windows.

There are two types of dockable windows:

- Control bars
- Tool windows

To display a control bar, click View ► Control Bars on the Menu bar, and then choose from the list of available control bars.

To display a tool window, click Tools on the Menu bar, and then choose from the list of available tool windows.

Alternatively, click the desired button on the Workspace toolbar.

Both types of windows can be moved and resized, and either floated in the Scene Area or docked. A docked window shares one or more edges with adjacent windows and toolbars. If a shared edge is moved, the windows change shape to compensate. You can also float windows anywhere on the screen, if necessary.

To undock and relocate a window, click and drag the title bars at the top or side of the window.

To prevent a window from automatically docking while you drag it, hold down the CTRL key.

NOTE You can quickly dock and undock a window by double-clicking the window's title bar.

Use the Docking Tool

When you drag a dockable window from its current location towards a new destination on the interface, a docking tool appears.

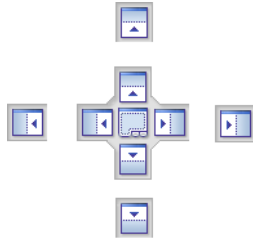

The docking stickers point towards the four edges of the interface.



When the window you are dragging is close to the place where you want it to dock, move the mouse over the corresponding area of the docking tool. You will see an outline of the window appear on the interface. To dock the window there, release the mouse button.

Tile Windows

You can tile dockable windows on the interface. To do this, drag a window you want to tile over the window where you want it to be placed. When a rectangular outline appears, release the mouse button.

Auto Hide Windows

You can auto hide dockable windows; this keeps the windows active while maximizing the amount of available screen space. If auto-hide is active, the body of the window disappears when you move the cursor out of it, leaving only the title bar visible. Move the cursor over the title bar to display the entire window again.

To switch auto-hide on, click  on the title bar. To switch auto-hide off, click  on the title bar.

The Shortcut Menu

Right-clicking a dockable window displays a shortcut menu of available commands. If you right-click a single item, or select one or more items and right-click, this menu contains commands related to the items. If you right-click an area that contains no items or data, the menu contains commands related to the dockable window, if appropriate.

Status Bar

The Status bar appears at the bottom of the Autodesk Navisworks screen. As this is not a toolbar, it cannot be customized or moved around.

The left-hand corner of the Status bar is used to display short instructions on how to use the Autodesk Navisworks features.

In the right-hand corner of the Status bar there are four performance indicators that give you constant feedback as to how well Autodesk Navisworks is performing on your machine, and the notification icon.



Notification Icon

Notification icon indicates whether any new information is available. Balloon notifications appear over this icon whenever new Communication Center content is available. You can right-click this icon to turn off the notifications, or to customize the Communication Center options.

Pencil Progress Bar

The progress bar under the left hand icon (pencil) indicates how much of the current view is drawn, that is how much drop-out there is in the current viewpoint. When the progress bar is at 100%, the scene is completely drawn, with no drop-out. The icon changes color when a redraw is in progress. Whilst the scene is being drawn, the pencil will change to yellow. If there is too much data to handle and your machine cannot process this quickly enough for Autodesk Navisworks, then the pencil changes to red, indicating a bottleneck.

Disk Progress Bar

The progress bar under the central icon (disk) indicates how much of the current model is loaded from disk, that is how much is loaded into memory. When the progress bar is at 100%, the entire model, including geometry

and property information, is loaded into memory. The icon changes color when a file load is in progress. Whilst data is being read, the disk changes to yellow. If there is too much data to handle and your machine cannot process this quickly enough for Autodesk Navisworks, then the disk changes to red, indicating a bottleneck.

Web Server Progress Bar

The progress bar under the right hand icon (web server) indicates how much of the current model is downloaded, that is how much has been downloaded from a web server. When the progress bar is at 100%, the entire model has been downloaded. The icon changes color when a file load is in progress. Whilst data is being downloaded, the web server changes to yellow. If there is too much data to handle and your machine cannot process this quickly enough for Autodesk Navisworks, then the web server changes to red, indicating a bottleneck.

Memory Bar

The field to the right of the icons reports the amount of memory currently being used by Autodesk Navisworks. This is reported in Megabytes (MB).

Undo/Redo Commands

You can undo or redo your actions in Autodesk Navisworks.

The default settings are adequate for regular Autodesk Navisworks usage, but you can [adjust](#) the amount of space allocated to the undo/redo buffer, if necessary.

The Edit ► Undo and Edit ► Redo menu items state what type of action you can undo/redo.

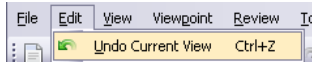

To undo an action

- Click Edit ► Undo on the Menu bar.



 **Command entry:** CTRL + Z

 **Toolbar:** Standard ► Undo 

To redo an action

- Click Edit ► Redo on the Menu bar.

 **Command entry:** CTRL+Y

 **Toolbar:** Standard ► Redo 

Autodesk Navisworks Workspaces

Workspaces are sets of toolbars and dockable windows that are grouped and organized so that you can work in a custom, task-oriented design review environment.



Each workspace contains sets of toolbars and dockable windows with the tools required to perform a certain job, making it easy to switch between design review layouts as necessary. For example, 'file aggregation', 'project review', 'object animation' and 'interference detection' workspaces could be set up, saved and used as appropriate.

The workspaces can also be shared with other users. You could, for example, create separate workspaces for occasional and power Navisworks users, or setup your own corporate standard.

Autodesk Navisworks comes with several pre-configured workspaces:

- **Safe Mode** - selects the design review layout with the minimum features.
- **Extended** - selects the design review layout recommended for advanced users.
- **Default** - selects the design review layout recommended for users new to the program.
- **Classic** - selects the design review layout used in Navisworks v5 and earlier.

You can use these workspaces as-is or modify them in accordance to your requirements. When you first start Navisworks, the default workspace is used. You can choose a different workspace at any time by clicking View ► Workspaces, and then selecting the required workspace from the list.

 **Toolbar:** Workspace ► Workspaces 

To save current layout to a new workspace

- 1 Set up your design review layout. For example, you can close all toolbars except the Standard, Selection Tools, Navigation Mode, and Workspace.
- 2 On the View menu, click Workspaces ► Save Workspace.
- 3 In the Save Current Workspace dialog box, enter a name for the new workspace. You can also select the name of an existing workspace to overwrite it with your modified configuration.

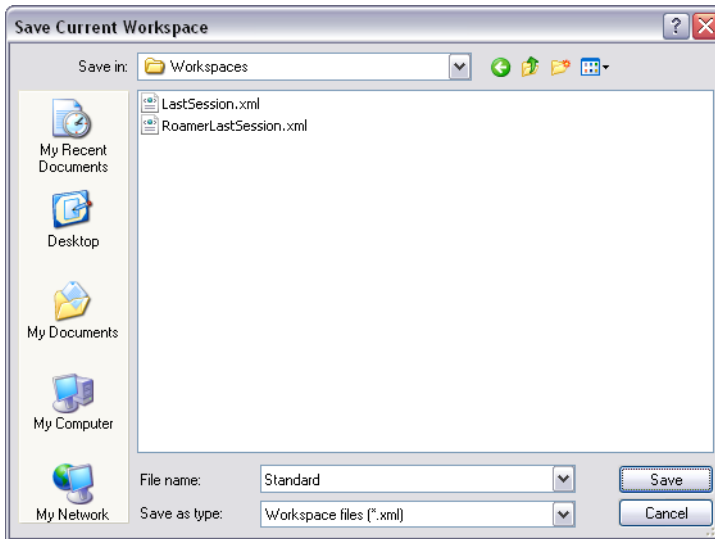

- 4 Click Save.

To load a saved workspace into Navisworks

- 1 On the View menu, click Workspaces ► Load Workspace.
- 2 In the Load Workspace dialog box, browse to the folder containing the desired workspace, and select it.

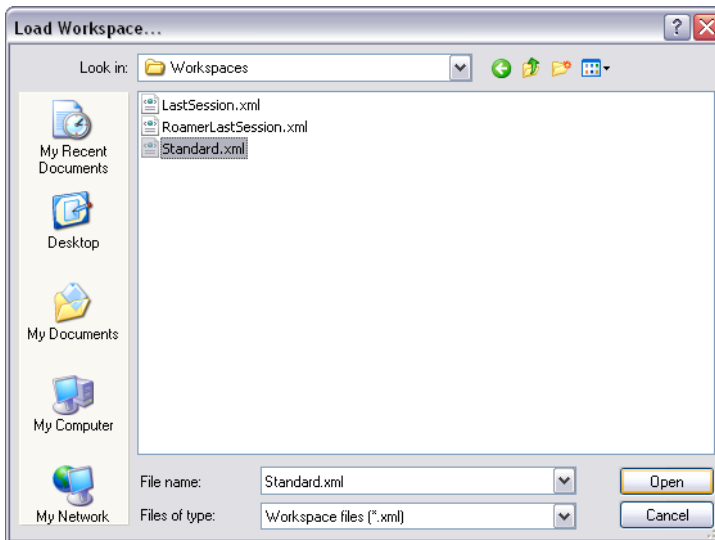

- 3 Click Open.

Default Keyboard Shortcuts

Keyboard shortcuts are keyboard alternatives you can use to initiate commands normally accessed with the mouse.

For example, to open the Selection Tree, you can press CTRL + F12, to open the Find Comments dialog box, you can press SHIFT + F4, and so on. Keyboard shortcuts offer a means to let you work faster and more efficiently. Some dialog boxes or dockable windows can be closed with the same command used to open it.

Many keyboard shortcuts are already set for most commonly used actions. You can modify the default shortcuts or add new shortcuts, if necessary.

Quick Reference

Default Keyboard Shortcut	Description
ALT + F4	Closes the currently active dockable window when it is undocked, or exits the application if the main application window is active.
ALT + F6	Switches between the dockable windows when they are undocked.
CTRL + 0	Turns on turntable mode.
CTRL + 1	Turns on select mode.
CTRL + 2	Turns on walk mode.
CTRL + 3	Turns on look around mode.
CTRL + 4	Turns on zoom mode.
CTRL + 5	Turns on zoom box mode.
CTRL + 6	Turns on pan mode.
CTRL + 7	Turns on orbit mode.
CTRL + 8	Turns on examine mode.
CTRL + 9	Turns on fly mode.
CTRL + A	Displays the Append dialog box.
CTRL + D	Toggles collision mode. You must be in appropriate navigation mode (that is, Walk or Fly) for this keyboard shortcut to work.
CTRL + F	Displays the Quick Find dialog box.
CTRL + G	Toggles gravity mode.
CTRL + H	Toggles hidden mode for selected items.
CTRL + M	Displays the Merge dialog box.
CTRL + N	Resets the program, and closes the currently open Navisworks file.

Default Keyboard Shortcut	Description
CTRL + O	Displays the Open dialog box.
CTRL + P	Displays the Print dialog box.
CTRL + R	Toggles required mode for selected items.
CTRL + S	Saves the currently open Navisworks file.
CTRL + T	Toggles third person mode.
CTRL + Y	Reverses the last operation performed by the Undo command.
CTRL + Z	Reverses the last performed operation.
CTRL + F1	Opens the Help system.
CTRL + F7	Toggles the Camera Tilt control bar.
CTRL + F8	Toggles the Sectioning toolbar.
CTRL + F9	Toggles the Plan Thumbnail control bar.
CTRL + F10	Toggles the Section Thumbnail control bar.
CTRL + F11	Toggles the Viewpoints control bar.
CTRL + F12	Toggles the Selection Tree control bar.
CTRL + HOME	Dollies and pans the camera so that the entire model is in view.
CTRL + SHIFT + N	Takes you to the next redline tag.
CTRL + SHIFT + P	Takes you to the previous redline tag.
HOME	Enables view selected mode. This keyboard shortcut only applies to the Scene Area windows. This means it will only work when this window has focus.
ESC	Deselects everything.
F1	Opens the Help system.
F2	Renames the selected item, when appropriate.
F3	Repeats the previously run quick find search.
F5	Refreshes your scene with the latest versions of currently loaded model files.
F11	Toggles full screen mode.
Shift + W	Opens the last used SteeringWheel.

Default Keyboard Shortcut	Description
SHIFT + F1	Enables you to get context-sensitive help.
SHIFT + F2	Toggles the Selection Sets control bar.
SHIFT + F3	Toggles the Find Items control bar.
SHIFT + F4	Toggles the Find Comments dialog box.
SHIFT + F6	Toggles the Comments control bar.
SHIFT + F7	Toggles the Properties control bar.
SHIFT + F10	Opens a shortcut menu for the active dockable window.

Customize the Toolbars

You can customize the appearance and contents of the Autodesk Navisworks toolbars by using the Customize dialog box.

To add a custom toolbar

- 1 Click Tools ► Customize.
- 2 In the Customize dialog box, Toolbars tab, click the New button.
- 3 Enter a name for the toolbar in the Toolbar Name box. By default, new toolbars are named "Custom X" where 'X' is the next available number added to the list.



- 4 Click OK.
The new toolbar appears in the toolbar area.
- 5 Close the Customize dialog box.

To rename a custom toolbar

- 1 Click Tools ► Customize.
- 2 In the Customize dialog box, Toolbars tab, click your toolbar.
- 3 Click Rename.

NOTE You can only rename custom toolbars.

- 4 Enter the new name for your toolbar.

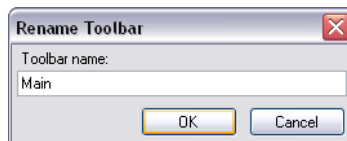

- 5 Click OK.
- 6 Close the Customize dialog box.

To delete a custom toolbar

- 1 Click Tools ► Customize.
- 2 In the Customize dialog box, Toolbars tab, click the toolbar you don't need.
- 3 Click Delete.

NOTE You can only delete custom toolbars.

- 4 Close the Customize dialog box.

To add commands

- 1 Click Tools ► Customize. This opens the Customize dialog box.
- 2 There are several ways to add commands to a toolbar or a menu:
 - In the Customize dialog box, Commands tab, click the desired category, and drag the command from the commands list on to the toolbar. If the command has a default icon assigned to it (it is shown next to the command in the command list), the icon will appear as a button on your toolbar. If no icon is assigned to the command, the name of the command will appear as a button on the toolbar. For menus, the command will appear exactly as it is shown in the command list.

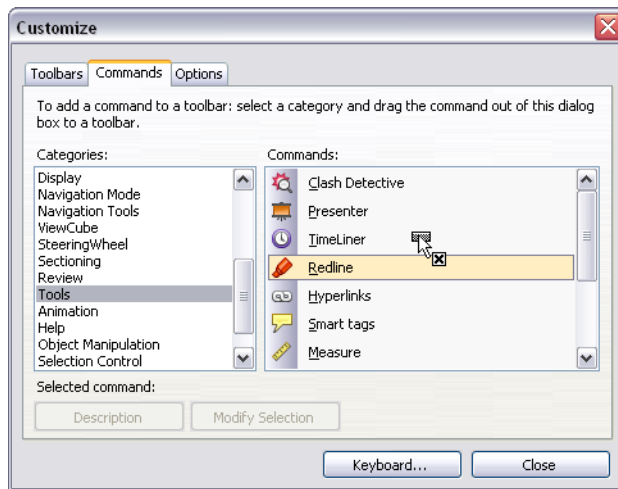

- Drag the command from another menu or toolbar onto your toolbar or menu. This moves the command from its original location into a new place.
 - Hold CTRL and drag the command from another menu or toolbar onto your toolbar or menu. This creates a copy of the command, and does not remove the command from its original location.
- 3 If you want to edit the command's appearance, right-click it on the toolbar or menu, and use options on the shortcut menu.
 - 4 Close the Customize dialog box.

To delete commands

- 1 Click Tools ► Customize. This opens the Customize dialog box.
- 2 Drag the command away from the menu or toolbar, until a cursor displays a small cross.



- 3 Release the left mouse button to delete the command.
- 4 Close the Customize dialog box.

To customize keyboard shortcuts

- 1 Click Tools ► Customize.
- 2 In the Customize dialog box, click the Keyboard button.
- 3 In the Customize Keyboard dialog box, use the Categories and Commands lists to find desired command.
- 4 Click the command, and choose a shortcut in the Select a New Shortcut drop-down list.

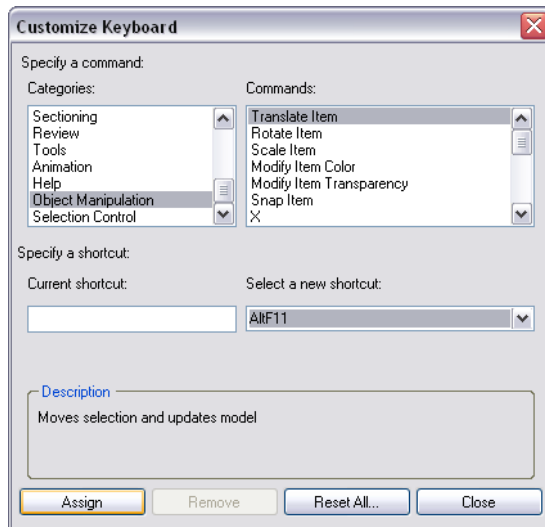

- 5 Click Assign.

NOTE Clicking Remove removes the shortcut assignment for the selected command, and clicking Reset All restores the default shortcut assignments.

- 6 Close the dialog boxes.

Autodesk Navisworks Options

There are two types of options: File Options and Global Options.

File Options

For each Autodesk Navisworks file (.NWF and .NWD), you can adjust the model appearance and the speed of navigation around it. File options are stored with Autodesk Navisworks files (.nwf or .nwd), and reloaded each time you open these files.

The File Options dialog box is used to customize various file options, and can be accessed from the Tools menu.

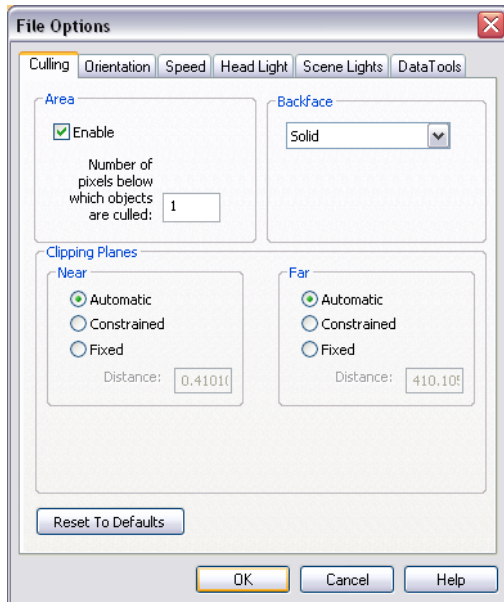

Global Options

Global options, on the other hand, are set for all Autodesk Navisworks sessions. The Options Editor can be accessed from the Tools menu, or it can be launched as a separate application. To do this, click Start ► Programs ► Autodesk ► Navisworks Simulate 2010 ► Options Editor. The options are grouped together, and presented in a tree structure, making it quicker to find and change them.

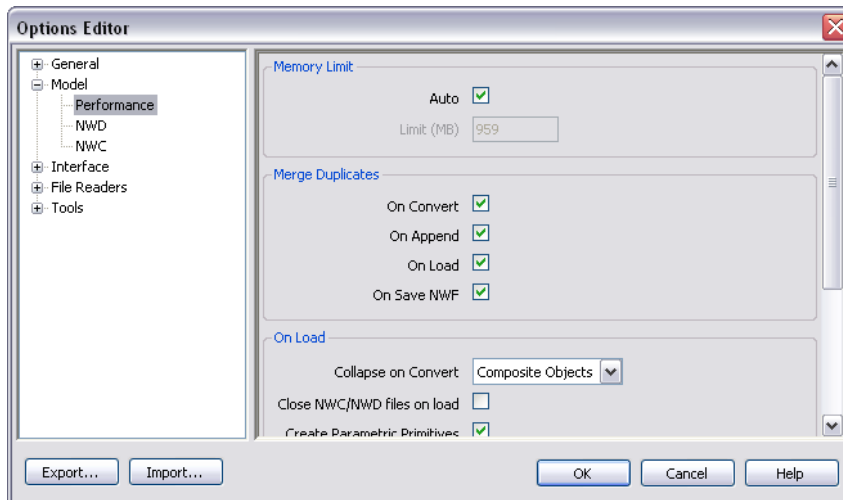

Global options can be exported and imported, making it quick and easy for project managers, or systems administrators, to ensure the Autodesk Navisworks settings on all machines are identical.

To configure file options

- 1 Click Tools ► File Options.
- 2 Use the File Options dialog box to customize various file settings.
- 3 Click OK to save the changes.

See also:

- [“File Options Dialog Box”](#) on page 371

To configure global options

- 1 Click Tools ► Global Options.

- 2 In the Options Editor, expand the desired node, and click the option you want to configure.
- 3 Click OK to save the changes.

See also:

- [“Options Editor”](#) on page 375

To export global options

- 1 Click Tools ► Global Options.
- 2 In the Options Editor, click the Export button.
- 3 In the Select Options to Export dialog box, select the check boxes for all options you want to be exported (or 'serialized'). If an option cannot be exported, it is greyed out.

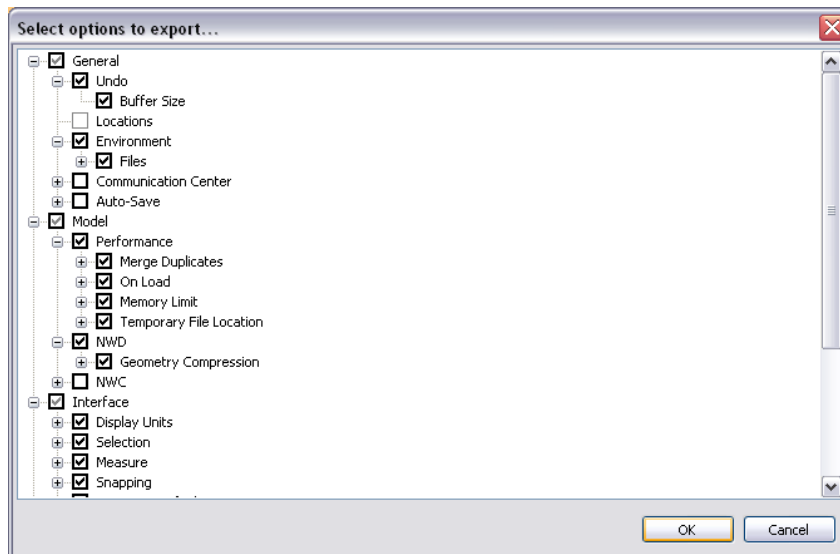

TIP To quickly select/deselect all options for a given category, use the top-level check boxes. For example, selecting the General check box, instantly selects all options under this node.

- 4 Click OK to export the selected settings.
- 5 In the Save As dialog box, enter a name for the settings file. You can also select the name of an existing settings file to overwrite it with your modified configuration.

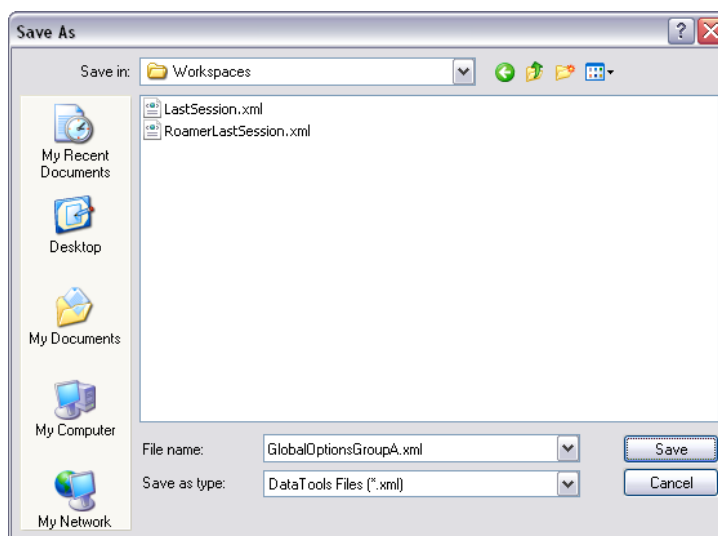

- 6 Click Save.
- 7 Click OK to close the Options Editor.

To import global options

- 1 Click Tools ► Global Options.
- 2 In the Options Editor, click the Import button.
- 3 In the Open dialog box, browse to the folder containing the settings file, select it, and click Open.

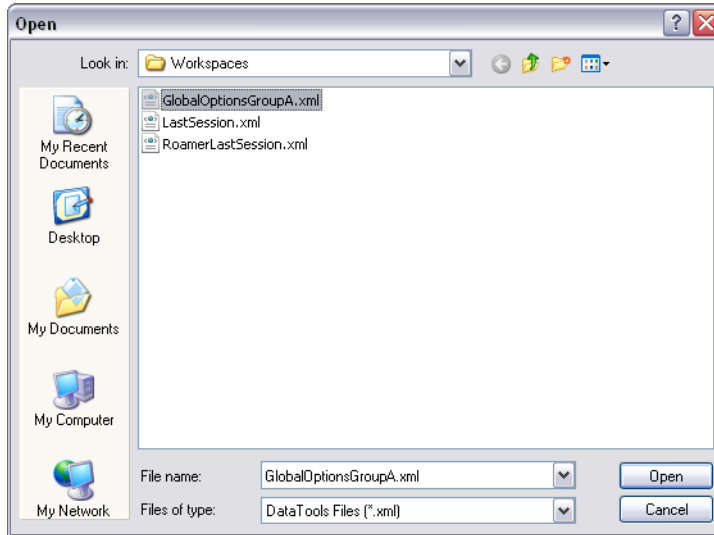

- 4 Click OK to close the Options Editor.

Environment Options

You can adjust the number of recent file shortcuts stored by Autodesk Navisworks.

To configure environment options

- 1 Click Tools ► Global Options.
- 2 In the Options Editor, expand the General node, and click the Environment option.
- 3 On the Environment page, enter the desired number into the Maximum Recently Used Files box. By default, shortcuts to the four most recently opened files can be displayed.

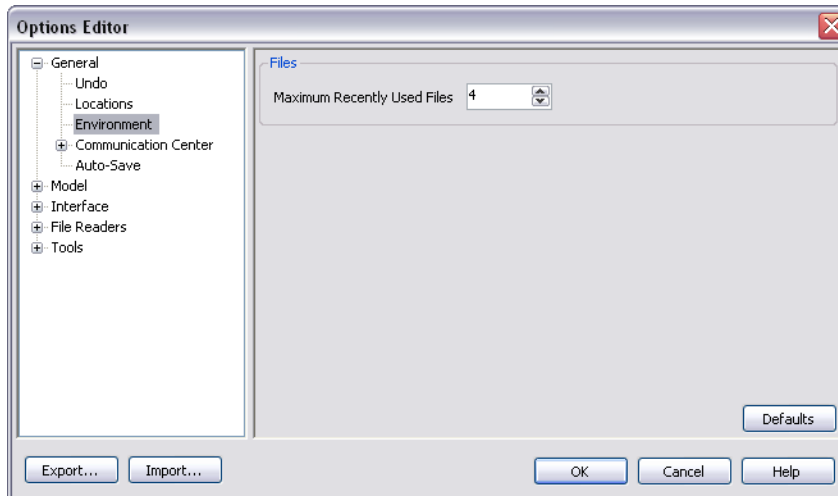

- 4 Click OK.

Location Options

These options enable centralized sharing of global Autodesk Navisworks settings, workspaces, datatools, avatars, Clash Detective rules, Presenter archives, custom Clash Detective tests, object animation scripts, and so on, with other users.

The settings can be shared across an entire project site, or across a specific project group depending on the required level of granularity.

To configure location options

- 1 Click Tools ► Global Options.
- 2 Expand the General node in the Options Editor, and click the Locations option.

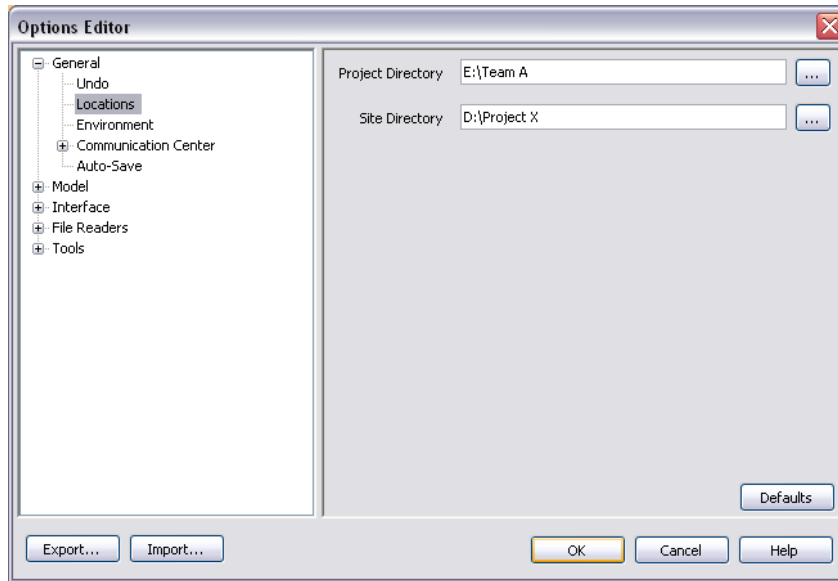

- 3 In the Project Directory box, browse to the directory that contains the Autodesk Navisworks settings specific to your project group.
- 4 In the Site Directory box, browse to the directory that contains the Autodesk Navisworks settings standard across the entire project site.
- 5 Click OK.

NOTE When you run Autodesk Navisworks for the first time, the settings are picked up from the installation directory. Subsequently, Autodesk Navisworks examines the current user profile and the all users profile on the local machine, and then checks the settings in the Project Directory and the Site Directory. The files in the Project Directory take precedence.

Display Units

Display units determine the scale of your model in Navisworks.

Display units are used to measure geometry in your scene, align appended models, set tolerances for clash detection, set texture sizes and so on.

When you open CAD and laser scan files, Autodesk Navisworks reads the file units directly from the files. If this is not possible (for example, the file is unitless), Autodesk Navisworks uses the default file units configured for that file type in the Global Options whenever possible. Loaded files are scaled appropriately to the configured display units.

It is possible to rescale the file units, if they are found to be incorrect for the scene.

To customize display units

- 1 Click Tools ► Global Options.
- 2 Expand the Interface node in the Options Editor, and click the Display Units option.

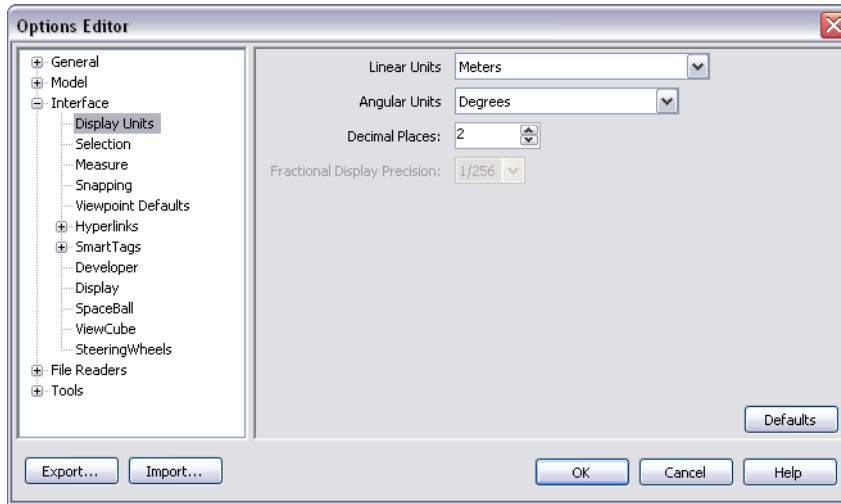

- 3 Select the Linear Units from the drop-down list. Be sure to choose the exact format required.
- 4 Select the Angular Units from the drop-down list.
- 5 Enter the number of decimal places you want to see throughout the interface for your units in the Decimal Places box. If the unit chosen is a fractional unit, rather than a decimal unit, then you have the choice of what level of fraction to display the units from the Fractional Display Precision drop-down list.
- 6 Click OK.

Profiles

Autodesk Navisworks can be adjusted to your level of CAD technical knowledge.

By default, a standard profile is used. If necessary, you can use a developer profile to display additional object properties.

To use a developer profile

- 1 Click Tools ► Global Options.
- 2 Expand the Interface node, and click the Developer option.

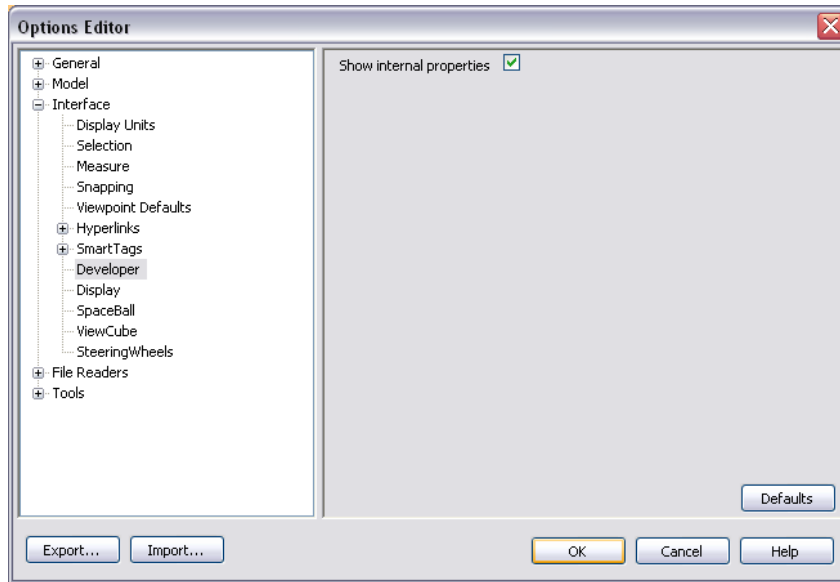

- 3 Select the Show Internal Properties check box to add additional object properties to the Properties control bar.
- 4 Click OK.

Search Directories

Autodesk Navisworks searches for a variety of configuration files in subdirectories of three standard directories. These files can be overridden on a per user, all users or per installation basis. The search directories are:

- *Application Data\Autodesk Navisworks Simulate 2010* within the current user profile. For example, *C:\Documents and Settings\user\Application Data\Autodesk Navisworks Simulate 2010* where **user** is the name of the current user.
- *Application Data\Autodesk Navisworks Simulate 2010* within the all users default profile. For example, *C:\Documents and Settings\All Users\Application Data\Autodesk Navisworks Simulate 2010*.
- Within the Navisworks install directory. For example, *C:\Program Files\Autodesk Navisworks Simulate 2010*.

Get a Whole-Project View

Work with Files

5

In Autodesk Navisworks you can open files originated from a variety of CAD applications.

You can combine these files together, and create a single Autodesk Navisworks file with a whole-project view of your model. This file brings together geometry and data created by multi-disciplinary teams, and enables you to explore and review complex models in real-time.

Native File Formats

Autodesk Navisworks has three native file formats: NWD, NWF, and NWC.

NWD File Format

An NWD file contains all model geometry together with review markups. You can think of an NWD file as a snapshot of the current state of the model.

NWD files are very small, as they compress the CAD data by up to 80% of the original size.

NWF File Format

An NWF file contains links to the original native files (as listed on the Selection Tree) together with review markups. No model geometry is saved with this file format; this makes an NWF considerably smaller in size than an NWD.

NWC File Format (Cache Files)

By default, when you open or append any native CAD or laser scan files in Autodesk Navisworks, a cache file is created in the same directory and with the same name as the original file, but with an .nwc extension.

NWC files are smaller than the original files, and speed up your access to commonly used files. When you next open file or append file in Autodesk Navisworks, the data is read from the corresponding cache file if it is newer than the original file. If the cache file is older, which means the original file has changed, Autodesk Navisworks converts the updated file, and creates a new cache file for it.

See also:

- [“NWC File Options”](#) on page 379

Compatible CAD Applications

The table below is provided as a quick reference only, and does not contain an exhaustive list of compatible CAD applications. For additional information, please refer to the Features and Specifications section on our website <http://www.autodesk.com/naivworks>.

Application	File Formats
Autodesk AutoCAD	DWG, DXF, 3DS
Autodesk ADT/AutoCAD Architecture	DWG, DXF, 3DS
Autodesk Building Systems/AutoCAD MEP	DWG, DXF, 3DS
Autodesk Inventor	IPT, IAM, IPJ, IGES, STEP
Autodesk AutoCAD Civil 3D	DWG, DXF, 3DS
Autodesk MDT	DWG, DXF, 3DS, VRML
Autodesk Revit	DWG, DXF, DGN
Autodesk Revit Building/Revit Architecture	DWG, DXF, DGN
Autodesk Revit Structure	DWG, DXF, DGN, CIS/2
Autodesk Revit Systems/Revit MEP	DWG, DXF, DGN
Autodesk 3DS MAX	DWG, DXF, 3DS, IGES
Autodesk VIZ	DWG, DXF, 3DS
Autodesk Maya	DXF, IGES, VRML
Bentley AutoPLANT	DGN, DWG, DXF
Bentley MicroStation SE	DGN, DWG, DXF, IGES, VRML
Bentley MicroStation J	DGN, DWG, DXF, IGES, STEP, VRML
Bentley MicroStation	DGN, DWG, DXF, IGES, STEP, VRML
Bentley Triforma J	DGN, DWG, DXF, IGES, STEP, VRML
Bentley Triforma	DGN, DWG, DXF, IGES, STEP, VRML
Graphisoft ArchiCAD	DWG, DXF, DGN, IFC
Graphisoft Constructor	DWG, DXF, DGN
AceCad StruCad	DXF
auto.des.sys form.z	DWG, DXF, 3DS, IGES, STL, VRML
AEC CADPIPE	DWG, DXF, 3DS
AVEVA PDMS	RVM

Application	File Formats
CADopia IntelliCAD	DWG, DXF
CEA Technology Plant-4D	DWG, DGN
COADE CADWorx Plant	DWG, DXF, 3DS
COADE CADWorx Pipe	DWG, DXF, 3DS
COADE CADWorx Steel	DWG, DXF, 3DS
COINS BSLink	DWG, DXF, 3DS
COINS Framing	DWG, DXF, 3DS
CSC 3D+	DWG
Dassault Systemes CATIA	DXF, IGES, STEP
Google SketchUp	SKP, DWG, 3DS
Hannappel Software GmbH elcoCAD R4	DWG, DXF, 3DS
Integrapp PDS	DRI, DRV, DWG, DXF, DGN, IGES, STEP
Informatix MicroGDS	MAN
ITandFactory CADISON	DWG, DXF, 3DS
ITandFactory TRICAD MS	VRML
Kiwi Software GmbH ProSteel 3D	DWG, DXF, 3DS
Kubotek USA CADKEY	DWG, DXF, IGES, STEP
M.A.P. CAD-Duct	DWG, DXF, 3DS
McNeel North America Rhino	DWG, DXF, 3DS, IGES, STEP
Mensch und Maschine RoCAD	DWG, DXF, 3DS
MultiSUITE MultiSTEEL	DWG, DXF, 3DS
Nemetschek Allplan	DWG, DXF, DGN, IFC
PROCAD 3DSMART	DWG, DXF, 3DS
PTC Pro/ENGINEER	IGES, STEP, VRML
PTC CADD5 5	IGES, STEP
QuickPen PipeDesigner 3D	DWG, DXF, 3DS
QuickPen DuctDesigner 3D	DWG, DXF, 3DS
RAM International CADstudio	DWG, DXF, 3DS
SolidWorks	DWG, DXF, IGES, STEP, VRML

Application	File Formats
Tekla Structures	DGN, VRML, CIS/2
Tekla Xsteel	DGN
think3 thinkdesign	DWG, DXF, IGES, STEP
UGS I-deas	DXF, IGES, STEP
UGS Solid Edge	IGES, STEP
UGS NX (Unigraphics)	DXF, IGES, STEP
UGS Factory CAD	DWG, DXF, 3DS
UHP Process Piping FabPro Pipe	DWG, DXF, 3DS
UHP Process Piping x-plant	DWG, DXF, 3DS

Supported CAD File Formats

See the following table for the native CAD file formats you can open in Autodesk Navisworks without having the CAD applications installed on your machine.

Format	Extension
Autodesk Navisworks	.nwd, .nwf, .nwc
AutoCAD	.dwg, .dxf
ACIS SAT	.sat
CIS/2	.stp, .step
DWF	.dwf
IFC	.ifc
IGES	.igs, .iges
Informatix MicroGDS	.man, .cv7
Inventor	.ipt, .iam, .ipj
JTOpen	.jt
MicroStation (SE, J, V8, XM)	.dgn, .prp, .prw
PDS Design Review	.dri
RVM	.rvm
SketchUp	.skp
STEP	.stp, .step
STL	.stl
VRML	.vrl, .wrz

Format	Extension
3D Studio	.3ds, .prjv

IMPORTANT The DWG/DXF/SAT file formats are supported when you run the 64-bit version of Autodesk Navisworks on a 64-bit version of Windows, or when you run the 32-bit version of Autodesk Navisworks on a 32-bit version of Windows. They are not supported when you run the 32-bit Autodesk Navisworks on a 64-bit version of Windows.

Supported Laser Scan File Formats

See the following table for the laser scan file formats you can open in Autodesk Navisworks.

Format	Extension
ASCII Laser File	.asc, .txt
Faro	.fls, .fws, .iQscan, .iQmod, .iQwsp
Leica	.pts, .ptx
Riegl	.3dd
Z+F	.zfc, .zfs

NOTE Native Trimble file format is NOT supported. To open your file in Autodesk Navisworks, convert it into ASCII laser file format first.

Use File Readers

Autodesk Navisworks provides file readers to support a variety of CAD file formats and laser scan file formats.

When you open a CAD file in Autodesk Navisworks, an appropriate file reader is automatically used. If necessary, you can adjust the default file reader settings to improve the conversion quality.

3DS File Reader

3DS is a common file format supported by many CAD applications.

The Autodesk Navisworks file reader reads all 2D and 3D geometry, as well as texture maps. The hierarchy defined by the keyframe data from keyframe 0 is preserved, including instancing. Entities are positioned based on keyframe 0.

Supported Entities

- All 2D and 3D geometry
- Cameras
- Groups
- Texture maps in the formats: 8-bit color-mapped, 16-bit and 24-bit true color, uncompressed or Run Length Encoded .tga, .bmp, .jpg, .lwi (LightWork Image).

NOTE Textures from 3DS files come through as Presenter materials, though you should bear in mind that 3DS files contain file names in the 8.3 DOS format only and that various formats are not yet supported in Presenter.

- Colors (from material color, not wireframe color - ambient, diffuse, shininess, transparency and self illumination).

Unsupported Entities

- Keyframes (objects are currently taken from keyframe 0)
- Texture maps in the formats: gray-scale .tga, .tif, .gif, .png.
- Other maps (e.g. opacity maps, reflections etc.)
- Wireframe meshes
- Lines, splines
- Points
- Background images

See also:

- [“3DS File Reader Options”](#) on page 389

ASCII Laser Scan File Reader

Most scanner software support exporting the point data in an ASCII text file. Providing that the data is saved in the correct format, this data can be read by Autodesk Navisworks.

Supported formats for ASCII laser scan data are listed below. The data must be separated using one of the following characters: comma, tab or space. The character used to signify a decimal must be a point (period).

- X, Y, Z
- X, Y, Z, Intensity
- X, Y, Z, Red, Green, Blue
- X, Y, Z, Intensity, Red, Green, Blue

Intensity, Red, Green, and Blue values are integers in the range 0-255. Intensities are not gamma corrected.

Supported Entities

- Points

Unsupported Entities

- No other entities are supported.

See also:

- [“ASCII Laser Scan File Reader Options”](#) on page 389

Bentley AutoPLANT File Reader

Bentley AutoPLANT is based on AutoCAD and as such uses the DWG file format to store model geometry. Any settings related to the DWG file format also affect files from AutoPLANT.

AutoPLANT Object Properties can be stored in external database MDB files. By default, Autodesk Navisworks also supports these files through the DataTools functionality, and looks for Equipment, Nozzle and Piping datatools links.

See also:

- [“DWG/DXF/SAT File Reader Options”](#) on page 392

CIS2 File Reader

The CIS2 file reader supports CIMSteel Integration Standards (CIS/2) adopted by the American Institute of Steel Construction (AISC) as their format for data exchange between steel related CAD software.

Supported Entities

- Assembly_design
- Assembly_design_child
- Assembly_manufacturing
- Analysis_model_3d
- Part_derived
- Part_prismatic_simple
- Part_sheet_bounded_complex
- Part_sheet_bounded_simple
- Section_profile_compound
- Section_profile_derived
- Section_profile_edge_defined
- Section_profile_angle
- Section_profile_channel
- Section_profile_circle
- Section_profile_circle_hollow
- Section_profile_i_type
- Section_profile_i_type_asymmetric
- Section_profile_i_type_rail
- Section_profile_rectangle
- Section_profile_rectangle_hollow
- Section_profile_t_type
- feature_volume_prismatic_chamfer
- feature_volume_prismatic_flange_notch
- feature_volume_prismatic_flange_chamfer
- feature_volume_prismatic_notch
- feature_volume_prismatic_skewed_end
- Element_curve_simple
- Element_node_connectivity
- Element_eccentricity
- Located_joint_system
- Design_joint_system
- Joint_system_mechanical
- Fastener_mechanism

- Fastener_simple_bolt
- Fastener_simple_shear_connector

Unsupported Entities

- Part_complex
- Part_prismatic_complex
- Part_sheet_profiled
- Section_profile_centreline
- feature_cutting_plane
- feature_edge_chamfer
- feature_surface
- feature_thread
- feature_volume_complex
- feature_volume_curved
- feature_volume_hole
- Element_volume
- Element_surface
- Element_point
- Element_curve_complex
- Element_with_material
- Joint_system_amorphous
- Joint_system_chemical
- Joint_system_welded
- Weld_mechanism
- Joint_system_complex
- Fastener_simple_nut
- Fastener_simple_washer
- Fastener_simple_stud
- Fastener_simple_pin
- Fastener_simple_nail
- Fastener_simple_screw
- Fastener_simple_countersunk
- Fastener_simple_curve
- Fastener_simple_complex

Supported Basic Section Profile Types

The file reader supports the following basic section profile types:

- I-Beam

- Tee
- Angle
- Channel
- Circle
- Rectangle
- Double Angle
- Joist

Supported AISC Section Profile Types

The reader supports all AISC defined section profile types and maps them to the basic section profile types:

- I-Beam: HP, M, S, W
- Tee: MT, ST, WT
- Angle: L, LP
- Channel: C, MC
- Circle: HSRO, P, PX, PXX, RB
- Rectangle: HSRE, HSSQ, SB, TS
- Double Angle: DL, DLL, DLS

See also:

- [“CIS2 File Reader Options”](#) on page 390

DWG/DXF/SAT File Reader

The DWG/DXF/SAT file reader uses Autodesk's ObjectDBX™ technology and so is guaranteed to read all object geometry and information for those third party applications that utilize the ObjectDBX Framework.

The structure of the drawing is preserved including xrefs, blocks, inserts, AutoCAD color index, layers, views and active viewpoint. Entities are colored using the AutoCAD Color Index (ACI), so will match those in an AutoCAD 'shaded' view.

NOTE The file reader supports files from all products based on AutoCAD 2010 and earlier.

IMPORTANT The DWG/DXF/SAT file reader is not supported when you run the 32-bit Autodesk Navisworks on a 64-bit version of Windows.

Supported Entities

- All 2D and 3D geometry, including arcs, lines, polylines with non-zero thickness, ACIS objects (regions and solids), polygon and polyface meshes, 3D faces and surfaces.
- Points and snap points.
- Lines, polylines, circles, arcs with zero thickness.
- Named views
- Layers
- Colors
- Blocks, inserts and multiple inserts

- Groups
- External references (xrefs)
- Hyperlinks
- Text or multi-line text
- Entity handles
- Attributes
- Textures
- File properties

Unsupported Entities

- Lights
- Splines
- Multi-lines
- Linetypes
- Dimensions and leaders
- Raster bitmaps
- Construction lines (xlines and rays)
- Hatching

See also:

- [“DWG/DXF/SAT File Reader Options”](#) on page 392

Overview of Object Enablers

Object Enablers (OEs) can be thought of as a ‘translator’ for custom objects. Applications based on the AutoCAD® platform, (including Autodesk products like AutoCAD® Architecture, and non-Autodesk products like Bentley AutoPlant) generate custom objects that are saved into the DWG file format. These custom objects are typically found in content libraries that are built into these applications.

Many applications have the ability to read DWG files; however, outside of the authoring application any custom objects cannot be interpreted. As a result, DWG file readers display such custom objects incorrectly, as proxy graphics (wireframe geometry), unless the required OE is installed on the machine reading the DWG file.

NOTE Autodesk Navisworks contains versions of RealDWG™ for 2004, 2005, 2006, 2007, 2008, 2009, and 2010. This means you can use OE between 2004 and 2010 with Navisworks. You cannot use any OEs older than 2004. However, OEs are backwards compatible, and you can install a later OE to support reading of older versions of DWG files.

To check if an OE is required

- 1 In Autodesk Navisworks, open a DWG file.
- 2 If you can only see wireframe geometry, click View ► Scene Statistics. The Scene Statistics dialog box contains the report listing any missing, or failed to load OEs. You need to install all missing OEs to open the file correctly in Autodesk Navisworks.

NOTE Occasionally, an OE is already installed, but does not support non-AutoCAD-based applications, like Autodesk Navisworks. In such cases, the OE is reported as missing in the Scene Statistics dialog box.

To install and use an OE with Navisworks

- 1 Obtain the required OE, and run the installer.
- 2 On the OE Setup page, select the check box for the relevant Autodesk Navisworks products.

NOTE Some OEs have dependencies on other OEs, and, therefore, must be installed in a specific order. For example, the AutoCAD MEP 2009 OE has a dependency on the AutoCAD Architecture 2009 OE. As a result, the AutoCAD MEP 2009 OE must be installed after the AutoCAD Architecture OE.

- 3 Click Install. When the OE is installed, click Finish.
- 4 Run Autodesk Navisworks.
- 5 Click Tools ► Global Options.
- 6 In the Options Editor, expand the File Readers node, and click DWG/DXF/SAT.
- 7 Ensure the value in the DWG Loader Version field is the same as the version of the installed OE, and close the dialog box. For example, if you've installed OE for AutoCAD Architecture 2007, you must set the DWG Loader Version to '2007'.

When you open a DWG file in Autodesk Navisworks, the file reader uses the configured OE.

How do I know if I need to use an Object Enabler with Autodesk Navisworks 2010?

When a DWG file is opened in Autodesk Navisworks 2010, and the objects are displayed as wireframe geometry, it usually means that an Object Enabler is missing.

Additionally, the Scene Statistics dialog box reports any missing or failed to load OEs.

Where do I obtain Object Enablers from?

The recommended way to obtain OEs is to request them from the persons authoring the DWG file. This ensures that the correct version of OE is used.

TIP You can also download many OEs from the vendor websites for the authoring applications. For example, you can download Autodesk OEs from <http://www.autodesk.com/oe>.

What do I do when Object Enablers are not reported as missing but I can only see wireframe geometry?

- 1 Click Tools ► Global Options.
- 2 In the Options Editor, expand the File Readers node, and click DWG/DXF/SAT.
- 3 Select 'Shaded' in the Render Type field.
- 4 Ensure the Use ADT Standard Configuration check box is selected.
- 5 Click OK to save the changes and close the dialog box.
- 6 Click File ► New, and then open the DWG file again.

DWF File Reader

Autodesk DWF was specifically developed by Autodesk as a file format for architects, engineers, and GIS professionals to share design data. The DWF file reader reads all 3D geometry, as well as textures and properties.

Supported Entities

- All 3D geometry
- Texture maps
- Texture coordinates
- Colors (per-vertex, per-face)
- Property fields
- Categories

Unsupported Entities

- 2D lines/plot sections
- Thumbnails
- Marked-up sketches
- More than one 3D section per file (any others are ignored)
- NURBS surfaces
- Cameras

See also:

- [“DWF File Reader Options”](#) on page 391

DGN File Reader

Autodesk Navisworks can read 3D DGN and PRP files from Bentley's MicroStation, but does not support CEL files or 2D DGNfiles. Referenced files and instances of cells are respected, and the Selection Tree reflects this file structure.

NOTE The file reader supports files from MicroStation 95, SE and /J. It does not support MicroStation Modeller and any versions of MicroStation before 95.

Supported Entities

- All 2D and 3D geometry including shapes, complex shapes, meshes, cones, surfaces, B-spline boundaries, solids, SmartSolids and Feature Solids, lines, arcs and ellipses.
- Splines and B-spline curves
- Lights
- Levels
- Cells, shared cells, and their instancing
- Colors and ambient, diffuse, and shininess properties of materials from .pal and .mat palette and material files
- Texture maps
- Referenced files including aliases
- Dynamic drawing of parametric models when loading/exporting DGN and PRP files.
- 3D text used for notes and labels is now converted and displayed by default.
- Family, part and texture information from TriForma, and PDS object information from DRV files.
- Family, part and texture information from TriForma, and PDS object information from DRV files

Unsupported Entities

- Raster bitmaps
- Dimensions and leaders

See also:

- [“DGN File Reader Options”](#) on page 390

Faro Scan File Reader

The file reader supports files from all Faro™ scanners. Combined iQscan files must be located in a folder called 'Scans' in the same directory as the associated iQmod and iQwsp workspace files.

See also:

- [“Faro Scan File Reader Options”](#) on page 394

IFC File Reader

The file reader supports stand-alone IFC files.

Supported Entities

- Faceted BReps
- Extruded area solids
- Geometric sets
- Face-based and surface-based models
- Simple, trimmed, and composite curves
- Simple surfaces
- Simple parametric, arbitrary and derived profiles
- Boolean clipping results and element-level voiding and projection CSG operations
- Basic styled and mapped items
- Property sets, including simple and complex properties

Unsupported Entities

- Voided BReps
- Bounded half-space solids
- Complex parametric profiles
- BSpline curves
- Curve styles
- Swept surfaces
- Textures and complex lighting
- Loading of server-based IFC models

See also:

- [“IFC File Reader Options”](#) on page 394

IGES File Reader

The file reader uses the Open CASCADE libraries to read and tessellate IGS and IGES files up to and including IGES 5.3.

Supported Entities

- Groups

- Colors
- Planes
- Parametric spline, ruled, B-spline, offset, bounded, trimmed and plane surfaces and surfaces of revolution.
- Tabulated cylinders
- Solids and manifold solids
- Shells
- Faces

Unsupported Entities

- Points
- Lines
- Circular or conic arcs
- Composite, parametric spline, B-spline, or offset curves
- Boundaries
- Attributes

See also:

- [“IGES File Reader Options”](#) on page 395

Inventor File Reader

The file reader supports IPT (part), IAM (assembly) and IPJ (project) file formats. IDW (drawing) file format cannot be read.

The reader supports files from Autodesk Inventor 2010™ and earlier. Later versions should also work, but haven't been tested. Autodesk Inventor 5™ (or higher) or Autodesk Inventor Design Tracking 5™ (or higher) must be installed. Autodesk Inventor Design Tracking™ can be downloaded from <http://support.autodesk.com>.

See also:

- [“Inventor File Reader Options”](#) on page 395

JTOpen File Reader

The file reader supports 3D JT data format developed by Siemens PLM Software (formerly UGS Corp.).

Supported Entities

- Tri-strip set shape
- Polyline set shape
- Box primitive shape
- Cylinder primitive shape
- Sphere primitive shape
- Models with vertex-based color and normal
- General JT B-Rep

- Geometric transform attribute
- Material attribute
- XT B-Rep segment
- Properties

Unsupported Entities

- Point set shape
- Polygon set shape
- Wire harness set shape
- Pyramid primitive shape
- Tri-prism primitive shape
- PMI manager meta data
- Models with facet-based or primitive-based color and normal
- Texture
- HSV color model
- B-Rep CAD tag
- Line style attribute
- Point style attribute
- Shader effects attribute
- Vertex shader attribute
- Fragment shader attribute
- Infinite light attribute
- Point light attribute
- Wireframe segment
- LOD

See also:

- [“JTOpen File Reader Options”](#) on page 395

Leica Scan File Reader

The file reader supports files from all Leica™ HDS scanners.

Supported Entities

- Points

Unsupported Entities

- No other entities are supported

See also:

- [“Leica File Reader Options”](#) on page 395

MAN File Reader

The file reader supports MAN files from Informatix's MicroGDS™ version 6.0 or later. MicroGDS™ projects are not supported. The workaround is to export the desired project window with a .man extension.

In Autodesk Navisworks, MicroGDS renderer materials are shown in their flat-shaded colors in shaded mode. In full render mode, or with Presenter rendering, the full shaders are used. Only the standard LightWorks shaders are available. The shaders which are unique to MicroGDS are not available inside Autodesk Navisworks, and are converted as follows:

- Height band color shader is treated as plain grey
- Wrapped random color shader is treated as a plain color using the flat-shaded color from MicroGDS
- Wrapped stencil transparency is ignored
- Undulate, wrapped brick, wrapped grid and wrapped ripple displacement shaders are ignored
- Object axis texture space is equivalent to the Autodesk Navisworks box texture space
- Auto axis and object XY axis texture spaces are treated as the Autodesk Navisworks box texture space
- Grid background is treated as a plain background using the background color, that is grid lines are not shown
- Foreground and environment shaders are ignored

NOTE All other shaders, as of MicroGDS 7.2, are correctly imported into Autodesk Navisworks.

MicroGDS materials are specified in millimeters, and are converted into metres to make Autodesk Navisworks materials, dividing distance parameters by 1000.

Windows with Perspective Views are converted as viewpoints.

Supported Entities

- Clump primitives
- Line primitives.

NOTE The color of line primitives is determined by the first phase in which they appear in the Principal window of the MAN file. If they are not included in the Principal window, the color is determined by their style.

- Light styles.

NOTE Projector lights are treated as a spot light without the transparent image.

- Material styles, both plain and most LightWorks Renderer materials.

NOTE For materials using wrapped images, you must specify the texture paths.

- Layers.

NOTE All layers are read, and made visible according to their status in the Principal window of the MAN file.

- Instances
- Object data structure

Unsupported Entities

- Text primitives
- Photo primitives

See also:

- [“MAN File Reader Options”](#) on page 396

PDS File Reader

The file reader supports DRI files from the PDS Design Review package.

See also:

- [“PDS File Reader Options”](#) on page 396

Riegl Scan File Reader

The file reader supports files from all Riegl™ LMS scanners.

Supported Entities

- Points
- Triangles

Unsupported Entities

- No other entities are supported

See also:

- [“Riegl File Reader Options”](#) on page 397

RVM File Reader

The file reader supports the following file formats:

- Binary and ASCII RVM files exported from AVEVA's PDMS™ product
- Dump Attributes and Datal (also called 'OUTPUT') attribute files, with the .att, .attrib, and .txt file extensions.
- RVS files

Supported Entities

- All geometry
- Attributes stored on groups
- Textures (via RVS file)
- Cameras and camera tracks (via RVS file)
- Clip planes (via RVS file)
- Signs (via RVS file)
- Tags (via RVS file)
- Labels (via RVS file)
- Translucency (via RVS file)
- PDMS origin points

Unsupported Entities

- Attributes stored on primitives
- Lights

- Object Animation
- Smooth Animation
- Groups
- Autotags

See also:

- [“RVM File Reader Options”](#) on page 397

SketchUp SKP File Reader

The file reader supports native SKP file format.

Supported Entities

- Geometry
- Materials (face front material only)
- Transparency
- Groups
- Components
- Layers
- Imported images
- Transparency

Unsupported Entities

- Text
- Dimensions
- Section planes

See also:

- [“SketchUp SKP File Reader Options”](#) on page 398

STEP File Reader

The file reader uses the Open CASCADE libraries to read and tessellate STP and STEP files up to and including AP214 CC2 and AP203.

Supported Entities

- Assemblies
- Colors
- Planes
- B-spline and rational B-spline, Bezier, conical, cylindrical, offset, rectangular trimmed, linear extrusion, bounded, manifold, spherical, toroidal, uniform and quasi-uniform, surfaces.
- Shells
- Advanced and faceted boundary representations (BReps)

Unsupported Entities

- Points
- PCurves, B-spline, rational B-spline, Bezier, trimmed, uniform or quasi-uniform curves.
- Circles or ellipses
- Hyperbola

See also:

- [“STEP File Reader Options”](#) on page 399

STL File Reader

The file reader only supports binary STL files. ASCII versions are not supported.

Supported Entities

- Triangles

Unsupported Entities

- No other entities are supported

See also:

- [“STL File Reader Options”](#) on page 399

VRML File Reader

The file reader supports files in both VRML1 and VRML2 file formats.

Supported Entities

- All 3D geometry including cuboids, cylinders, cones, spheres, elevation grids, extrusions, face and line sets, and points.
- All grouping nodes, but with the following limitations:
 - VRML2 Billboard nodes - children are loaded but no billboarding takes place.
 - VRML2 Collision nodes - children are loaded but no specification of collision detection occurs.
 - VRML1 WWWAnchor and VRML2 Anchor nodes - children are loaded but clicking objects does not load any referenced VRML world.
 - VRML1 and VRML2 LOD nodes - the most detailed (that is, first) child is always loaded.

Unsupported Entities

- All ROUTE definitions
- All sensor nodes
- All interpolator nodes
- Textures specified within the VRML file (VRML2 PixelTexture nodes and the image component of VRML1 Texture2 nodes).
- VRML2 Script nodes
- VRML2 MovieTexture nodes

- VRML2 Fog nodes
- VRML2 AudioClip and Sound nodes
- All text-related nodes (VRML1 ASCII Text, VRML2 Text, and FontStyle nodes).

See also:

- [“VRML File Reader Options”](#) on page 399

Z+F Scan File Reader

The file reader supports files from all Z+F™ IMAGER scanners.

Supported Entities

- Points

Unsupported Entities

- No other entities are supported

See also:

- [“Z+F File Reader Options”](#) on page 400

Use File Exporters

Autodesk Navisworks provides file exporters to create native Navisworks files directly in CAD applications.

Currently, you can export NWC files from AutoCAD, MicroStation, Revit, ArchiCAD, and Viz/Max applications.

You can use file exporters:

- If Autodesk Navisworks cannot read the native CAD file format. Currently, the following native file formats are not supported: VIZ, MAX, ArchiCAD, Revit.
- If Autodesk Navisworks has converted the native CAD file, but some geometry is missing, for example, and you want to improve the file quality.

AutoCAD File Exporter

Autodesk Navisworks comes with ARX plugins for any AutoCAD™ based product, such as Architectural Desktop™, and enables you to export files into NWC file format.

The file exporter is available for any AutoCAD-based product between AutoCAD 2004 and 2010 releases.

NOTE If you installed the Autodesk Navisworks software with exporter plugins, and you install any AutoCAD-based software after Autodesk Navisworks is installed, you need to update your exporter plugins installation with the appropriate ARX plugins before you can use them.

See also:

- [“DWG File Exporter Options”](#) on page 401

Add the ARX Plugin

You can either add the ARX plugin to Exporter Plugins installation, or load it manually in AutoCAD-based software.

To add the ARX plugin to Exporter Plugins installation

- 1 In the Control Panel, double-click Add or Remove Programs.
- 2 In the Add or Remove Programs dialog box, click Autodesk Navisworks Simulate 2010 Exporter Plugins, and then click Change/Remove in Windows XP or Uninstall/Change in Vista.
- 3 In the Installation wizard, click Add or Remove Features.
- 4 On the Select Exporters to Install page, the Export From Other Applications node, select the check box next to the required plugin.
- 5 Click Next.
- 6 On the Update Autodesk Navisworks Simulate 2010 Exporter Plugins page, click Next.
- 7 On the Update Complete page, you are informed when the updates have been performed. Click Finish.

To load the ARX plugin in an AutoCAD-based application

- 1 Type **ARX** at the command line.
- 2 Press Return.
- 3 Type the letter **L** (for 'Load') at the command line.
- 4 Press Return.
- 5 In the Select ARX/DBX File dialog box, browse to the ARX plugin.

NOTE For AutoCAD 20xx based applications, the plugin is located under *C:\Program Files\Common Files\Autodesk Shared\Navisworks\2010\NWExport20xx\nwexport20xx.arx*. So, for example, for AutoCAD 2004 based applications, the plugin is located under *C:\Program Files\Common Files\Autodesk Shared\Autodesk Navisworks\2010\NWExport2004\nwexport2004.arx*, and so on.

- 6 Click OK to load the ARX plugin.

Use the ARX Plugin

You can export files from AutoCAD-based applications either from the command line, or by using the Navisworks menu.

Before you can use the Navisworks menu, you need to load it first. By default, the Navisworks menu is added to the menu browser. In some programs, it can also be added to the menu bar.

To use the command line to export files

- 1 To export an NWC file, type **NWCOUT** at the command line.
- 2 Press Return.
- 3 In the Save As dialog box, enter the name for the Navisworks file, and browse to the desired storage location.
- 4 Click OK to export the file, or Cancel to return to the application without exporting it.

To load the Autodesk Navisworks export menu

- 1 At the command line, type **MENULOAD**.
- 2 Press Return.
- 3 In the Load/Unload Customizations dialog box, click Browse.
- 4 In the Select Customization File dialog box, change the Files of Type to Legacy Menu Template (*.mnu), and browse to the Autodesk Navisworks menu file.

NOTE For AutoCAD 20xx based applications, this file is located under *C:\Program Files\Common Files\Autodesk Shared\Navisworks\2010\NWExport20xx\lwnw_export.mnu*. So, for example, for AutoCAD 2004 based applications, this file is located under *C:\Program Files\Common Files\Autodesk Shared\Navisworks\2010\NWExport2004\lwnw_export.mnu*, and so on.

- 5 Click Open.
- 6 In the Load/Unload Customizations dialog box, click Load.
The loaded menu is shown in the Loaded Customization Groups.
- 7 Click Close.

To use Navisworks menu to export files

- 1 Click the menu browser button located at the top-left corner of the application window.
- 2 To export an NWC file, click **Navisworks Cache** on the Navisworks menu.
- 3 In the Save As dialog box, enter the name for the Navisworks file, and browse to the desired storage location.
- 4 Click OK to export the file, or Cancel to return to the application without exporting it.

To adjust the options for the DWG file exporter

- 1 Click the menu browser button located at the top-left corner of the application window.
- 2 Click **Navisworks Export Option** on the Navisworks menu.
- 3 Expand the File Exporters node in the Options Editor, and click the DWG page. Use the options on this page to adjust the settings for future exports of NWC files from AutoCAD-based applications.
- 4 Click OK to save the changes.

 **Command entry:** NWOPT

CAD Preview

The ARX plugin also enables you to walk through your model in real time inside a dockable Navigator window directly in the AutoCAD interface.

You can easily import and export viewpoints between Navigator and AutoCAD, and explore the models that you are building.

NOTE The Navisworks Navigator is provided for products based on AutoCAD 2004™ and above.

To navigate AutoCAD models in real time











- 1 Type **NWNAVIGATOR** at the command line.
- 2 Use the Navigator window to explore your model.





Quick Reference

Buttons

The Navigator toolbar contains the following buttons.

Button	Description
	Synchronizes the model in the Navigator window with the AutoCAD model. The Navigator window is not updated automat-

Button	Description
	ically. Click this button every time you want to navigate around the latest model.
	Changes the current AutoCAD view to the view in the Navigator window.
	Changes the view in the Navigator window to the current AutoCAD view.
	Selects walk mode and enables you to walk through the model on a horizontal plane.
	Selects look around mode and enables you to look around the model from the current camera position.
	Selects zoom mode. Dragging the left mouse button up and down or using the UP and DOWN ARROW keys zooms in and out respectively.
	Selects zoom-to-a-box mode. Dragging a box with the left mouse button over the model fills the view with the contents of the box. Holding down the SHIFT or CTRL keys or spinning the mouse wheel, temporarily switches this mode to zoom mode.
	Selects pan mode. Dragging the left mouse pans the model up, down, left and right. Holding down the SHIFT or CTRL keys or spinning the mouse wheel, temporarily switches this mode to zoom mode.
	Selects orbit mode. Dragging the left mouse button or using the UP, DOWN, LEFT ARROW, and RIGHT ARROW keys rotates the camera around the model. Holding down the SHIFT key or spinning the mouse wheel, temporarily switches this mode to zoom mode. Holding down the CTRL key temporarily pans the camera.
	Selects examine mode. Dragging the left mouse button or using the UP, DOWN, LEFT ARROW, and RIGHT ARROW keys rotates the model about. Holding down the SHIFT key or spinning the mouse wheel, temporarily switches this mode to zoom mode. Holding down the CTRL key temporarily switches this mode to pan mode.
	Selects fly mode. Holding down the left mouse button moves the camera forward. As in a flight simulator, the left mouse button banks left/right when dragged left or right and tilts up/down when dragged up or down. The UP and DOWN cursor keys zoom in and out respectively, and the

Button	Description
	LEFT ARROW and RIGHT ARROW keys spin the camera left and right respectively. Holding down the SHIFT key speeds up this movement. Holding down the CTRL key rotates the camera around its viewing axis, while still moving forward.
	Selects turntable mode. Dragging the left mouse button left and right, or using the LEFT ARROW and RIGHT ARROW keys spins the turntable left and right respectively. Holding down the SHIFT key or spinning the mouse wheel, temporarily switches this mode to zoom mode. Holding down the CTRL key temporarily switches this mode to pan mode.
	Shows all model. Clicking this button dollyes and pans the camera so that the entire model is displayed.
	Selects perspective camera view.
	Selects orthographic camera view.
	Opens the Help system.

The Shortcut Menu

Right-clicking in the Navigator window opens a shortcut menu.

Focus on Item Focuses the camera on the selected item. The point you click becomes the focal point for examine, orbit, and turntable navigation modes.

Speed

Frame Rate Specifies the number of frames per second (FPS) that are rendered in the Navigator window.

The default setting is 6. You can set the frame rate from 1 through 20 frames per second. Reducing the value reduces drop-out, but can cause jerky movement during navigation. Increasing the value ensures a smoother navigation, but increases drop-out.

Hardware Acceleration Select this option to utilize any available OpenGL hardware acceleration on your video card.

NOTE If your video card does not support OpenGL hardware acceleration, this option is not available.

Viewpoint

Rendering Selects rendering mode for your model. Choose from:

- **Shaded** - renders the model with smooth shading and without textures. This is the default option.
- **Wireframe** - renders the model in wireframe; all triangle edges are visible in this mode.
- **Hidden Line** - renders the model in hidden line; this is equivalent to rendering model as shaded and wireframe at the same time. The output is low quality as all the facet edges in the model are visible.

Lighting Selects lighting mode for your model. Choose from:

- **No Lights** - turns off lighting. The model is shaded with flat rendering.

- **Head Light** - uses a single directional light located at the camera that always points in the same direction as the camera. This is the default option.
- **Scene Lights** - uses any lights defined in the model, or two default opposing lights, if none are available.

Navigation Mode Selects navigation mode. The options available here are the same as on the Navigator toolbar, with one exception. The Select option enables you to select items in your model. You can select multiple items by holding down the CTRL key while selecting items.

Navigation Tools Select View All to display the entire model.

Perspective Camera Selects perspective camera view.

Orthographic Camera Selects orthographic camera view.

Options

Culling Options Opens the [Culling Options dialog box](#).

Close Files on Open Indicates whether NWC file created for the model is closed once it has been loaded into memory.

Selecting this option unlocks NWC files for editing by other users.

Max Image Texture Size Specifies the maximum size for texture images in pixels.

The higher the value, the higher the load on your graphics card, as more MB in memory is required to render textures.

Revit File Exporter

Autodesk Navisworks cannot read native Revit files directly. Use the file exporter to save your files in NWC format, which can be open in Navisworks.

See also:

- [“Revit File Exporter Options”](#) on page 402

To export NWC files from Revit

- 1 In Revit, click Tools ► External Tools ► Navisworks 2010.

NOTE This option is not available in Demo/Viewer mode. If you are not in demo mode, but do not have access to the Navisworks menu, check if editing view is set to normal, and the modify tool is selected (Edit ► Modify).

- 2 In the Export Scene As dialog box, enter the name for the Navisworks file, and browse to the desired storage location.
- 3 Click Save to export the file, or Cancel to return to the application without exporting it.

To adjust the options for the Revit file exporter

- 1 In Revit, click Tools ► External Tools ► Navisworks 2010.
- 2 In the Export Scene As dialog box, click the Navisworks Settings button.
- 3 Expand the File Exporters node in the Options Editor, and click the Revit page. Use the options on this page to adjust the settings for future exports of NWC files from Revit.
- 4 Click OK to save the changes and return to the Export Scene As dialog box.
- 5 Click Cancel to close the dialog box.

MicroStation File Exporter

Autodesk Navisworks comes with MDL plugins for MicroStation™ 95, SE, /J and v8 , and enables you to export files into NWC file format.

NOTE If you installed the Autodesk Navisworks software with exporter plugins, and you install MicroStation software after Autodesk Navisworks is installed, you need to update your exporter plugins installation with the appropriate ARX plugins before you can use them.

See also:

- [“DGN File Exporter Options”](#) on page 403

To add the MDL plugin to Autodesk Navisworks Exporter Plugins installation

- 1 In the Control Panel, double-click Add or Remove Programs.
- 2 In the Add or Remove Programs dialog box, click Autodesk Navisworks Simulate 2010 Exporter Plugins, and then click Change/Remove in Windows XP or Uninstall/Change in Vista.
- 3 In the Installation wizard, click Add or Remove Features.
- 4 On the Select Exporters to Install page, the Export From Other Applications node, select the check box next to the required plugin.
- 5 Click Next.
- 6 On the Update Autodesk Navisworks Simulate 2010 Exporter Plugins page, click Next.
- 7 On the Update Complete page, you are informed when the updates have been performed. Click Finish.

Load the MDL Plugin

Before you can use the MDL plugin, you need to load it first.

You can either do it for the current session only, or you can add the plugin to your default configuration, in which case, it is loaded for all future sessions.

To load the MDL plugin for the current session only

- 1 Click Utilities ► Key-In.
- 2 In the Key-In dialog box, type **mdl load nwexport7**.
- 3 Press Return.

To load the MDL plugin for all future sessions

- 1 Click Workspace ► Configuration.
- 2 In the Configuration dialog box, Category field, click Design Applications.
- 3 Click NWEXPORT7 in the Available Applications field.
- 4 Click the Add button.
- 5 Click OK, and confirm that you want to add NWEXPORT MDL plugin to your default configuration.

Export Files from the Key-In Command Line

You can export files from the key-in command line individually or in batches.

You can also add the commands to the Key-In menu to speed up the process.

To use the key-in command line to export files

- 1 Click Utilities ► Key-In to open the Key-In dialog box.
- 2 To export an NWC file, type **nwcout**.

NOTE To export the current design file quickly, you can use the **batchnwcout** command. The exporter replaces the design file extension (usually .dgn) with .nwc when exporting the file. When you use this commands, you are not prompted to overwrite any existing files, and no export dialog box is shown.

- 3 In the Export Navisworks file dialog box, browse to the desired storage location.
The exporter automatically provides a filename, and a view number, which you can modify, if necessary. The chosen view number determines the initial model view in Navisworks.
- 4 Click OK to export the file.

To add Navisworks export commands to the Key-In menu

- 1 Click Workspace ► Customize.
- 2 In the Customize dialog box, the Menu Bar tab, expand the Utilities option in the Edit Menu Bar field.
- 3 Click the Key-In option, and click the Insert button.
- 4 In the Insert Menu Item dialog box, enter the Label, for example, 'Export Navisworks Cache File'.
- 5 In the Key-In field, type the appropriate command, for example, 'nwcout'.
- 6 Click OK.
- 7 Add as many menu items as necessary, and click Save.
The added options are now available from the Utilities ► Key-In menu.

Export Files from the Command Line

You can also export files from the command line by using the msbatch.bat file. This is useful when you want to set up an automated script for file export.

NOTE To export a file from the command line, you must first add the MicroStation program directory to the Path environment variable.

The format of the command line exporter is

```
msbatch nwexport7 [-f] FILE [OUTPUT]
```

FILE is the name of the MicroStation file you want to export. This is the only required option. The **OUTPUT** argument enables you to specify the name of the output file.

By default, the exporter only converts files that have been changed since the last time you exported them. This is useful for speeding up exporting a large number of files. If you want to force the exporter to convert all files, use the **-f** option.

NOTE If the exporter encounters any problems, it produces an error log in a file called **nwdout.err**.

To modify the Path environment variable

- 1 In the Control Panel, double-click System.
- 2 In the System Properties dialog box, Advanced tab, click the Environment Variables button.
- 3 In the Environment Variables dialog box, double-click Path under System Variables.
- 4 In the Edit System Variable dialog box, add the path to the MicroStation application to the Variable Value field.

NOTE Paths must be separated with a semicolon (;).

- 5 Click OK to save the changes and close the dialog boxes.

To use the command line to export files

- 1 On the Start menu, click Run in Windows XP or press Windows + R on the keyboard in Vista.
- 2 Enter the file export command with appropriate arguments, for example **msbatch nwexport7 file**.
- 3 Press Enter.
- 4 In the MicroStation Manager dialog box, select the files you want to export, file extension (.nwc), and storage location.
- 5 Click OK.

Customize the DGN File Exporter Options

The file exporter only exports from 3D DGN files - 2D files are not supported.

Navisworks colors are derived from either MicroStation cell colors or MicroStation materials, depending on the chosen export options. The appearance of objects in Publisher matches the appearance of a MicroStation shaded render.

To adjust the options for the DGN file exporter

- 1 Click Utilities ► Key-In to open the Key-In dialog box.
- 2 Type **nwopt**, and press Enter.
- 3 Expand the File Exporters node in the Options Editor, and click the DGN page. Use the options on this page to adjust the settings for future exports of NWC files from MicroStation.
- 4 Click OK to save the changes.

Viz and Max File Exporter

Autodesk Navisworks cannot read native Viz/Max files directly. Use the file exporter to save your files in NWC format, which can be open in Navisworks.

The file exporter is available for Viz versions 4 to 2008 and Max versions from 5 to 2010.

NOTE If you installed the Autodesk Navisworks software with exporter plugins, and you install Viz or Max software after Autodesk Navisworks is installed, you need to update your exporter plugins installation with the appropriate ARX plugins before you can use them.

See also:

- [“Viz/Max File Exporter Options”](#) on page 404

Export NWC files from Viz or Max

- 1 Click File ► Export.
- 2 In the Select File to Export dialog box, select Navisworks 7 Cache (*.NWC) in the Save as Type field.
- 3 Enter the name for the Navisworks file, and browse to the desired storage location.
- 4 Click Save to export the file, or Cancel to return to the application without exporting it.

NOTE Any textures applied to the Viz or Max model are saved in a directory with the same name as the exported file, but with a **_presenter_maps** suffix. All textures are converted into .bmp files and saved into this directory for use with Navisworks.

Add the Navisworks utility menu

- 1 Click the More button on the Utilities panel.
- 2 In the Utilities dialog box, select Navisworks 2010 option, and click OK.

Customize the 3DS file exporter options

- 1 Click the Options Editor button on the Navisworks menu on the Utilities panel.
- 2 Expand the File Exporters node in the Options Editor, and click the Viz/Max page. Use the options on this page to adjust the settings for future exports of NWC files from Viz and Max applications.

ArchiCAD File Exporter

Autodesk Navisworks cannot read native ArchiCAD files directly. Use the file exporter to save your files in NWC format, which can be open in Navisworks.

The file exporter is available for ArchiCAD v8 through to v12.

The export add-on for ArchiCAD is available from both the 2D and 3D windows. All standard ArchiCAD elements and library parts can be exported provided they have a 3D representation, and any others are ignored. The file exporter saves both standard materials and custom GDL script materials.

NOTE Only visible layers are exported.

ArchiCAD cutaway plane settings does not set the Navisworks section plane; it is used to export items that are physically reduced by the plane.

Supported Entities

- Global Unique Identifiers (GUIDs)
- Custom parameters for library parts defined by GDL scripts
- Storeys
- Library part instances
- Cameras
- Hotlinks
- Sun attributes
- Materials

Unsupported Entities

- Section planes
- Points
- Lines
- Textures

Export from 2D window

- 1 Click File ► Save As.

- 2 In the Save As dialog box, select Navisworks 7 (*.nwc) in the Save As Type field.
- 3 Enter the name for the Navisworks file, and browse to the desired storage location.
- 4 Click Save to begin the export process.
- 5 In the Export dialog box adjust the file exporter options:
 - **Export GUIDs** - select this check box to attach a Globally Unique Identifier as a property to each item in the model. In Navisworks, GUIDs are used by the Clash Detective to track clashes.
 - **Enable Library Part Instancing** - select this check box to make instances of library parts rather than creating new items. This is only possible when multiple library part elements within the ArchiCAD model have exactly the same properties. Instancing these parts means a smaller NWC file, and shorter export times.

NOTE In sectioned models, when this check box is selected all instances show the same sectioning as the original item (usually, the first library part in the file). If you get some unexpected effects, clear this check box.

 - **Export Library Part Parameters** - select this check box to save library part parameters (including the user-defined custom parameters) as item properties in Navisworks.
 - **Export Current Story Only** - select this check box to export the current story only. Clear this check box to export the whole model. The default view is determined from the bounding box of the model.
- 6 Click OK.

Export from 3D window

- 1 Click File ► Save As.
- 2 In the Save As dialog box, select Navisworks 7 (*.nwc) in the Save As Type field.
- 3 Enter the name for the Navisworks file, and browse to the desired storage location.
- 4 Click Save to begin the export process.
- 5 In the Export dialog box adjust the file exporter options:
 - **Export GUIDs** - select this check box to attach a Globally Unique Identifier as a property to each item in the model. In Navisworks, GUIDs are used by the Clash Detective to track clashes.
 - **Enable Library Part Instancing** - select this check box to make instances of library parts rather than creating new items. This is only possible when multiple library part elements within the ArchiCAD model have exactly the same properties. Instancing these parts means a smaller NWC file, and shorter export times.

NOTE In sectioned models, when this check box is selected all instances show the same sectioning as the original item (usually, the first library part in the file). If you get some unexpected effects, clear this check box.

 - **Export Library Part Parameters** - select this check box to save library part parameters (including the user-defined custom parameters) as item properties in Navisworks.
 - **Export Current Story Only** - this option is not used; everything contained within the view is exported. When saving from the 3D window, the view becomes the default Navisworks view (including window settings, such as cutaway planes).
- 6 Click OK.

Manage Files

Open Files

To open files in Autodesk Navisworks, you can either use a standard Open dialog box or drag and drop files directly to the Selection Tree control bar.

NOTE If the chosen file is a CAD or laser scan file, Autodesk Navisworks automatically uses an appropriate file reader to open it, provided this file format is supported.

Autodesk Navisworks keeps a list of recently opened files (by default, up to 4 files are shown). You can open any of these files by clicking Files ► Recent Files. If you want to modify the size of this list, use the Options Editor.

You can use the SHIFT and CTRL keys to open several files at the same time. This automatically creates a new 'Untitled' Navisworks file with the selected files appended together.

For NWD files, it is possible to publish them to a web server, and then open them directly from within Navisworks. You can start navigating the model even before the file has been fully downloaded. 10 - 50% is usually sufficient for this. The greater the hierarchical structure of the model, the closer to 50% download is required. Similarly, the lesser the hierarchical structure of the model, the sooner you can begin the navigation.

To open a file

- 1 Click File ► Open.
- 2 In the Open dialog box, use the Files of Type box to select the appropriate file type, and navigate to the folder where your file is located.
- 3 Select the file, and click Open.

 **Toolbar:** Standard ► Open 

 **Command entry:** CTRL + O

To open NWD files located on a web server

- 1 Click File ► Open URL.
- 2 Enter the file address, and click OK.

Create Files

When you start Autodesk Navisworks, a new 'Untitled' Navisworks file is automatically created for you. The new file uses default settings defined in the Options Editor, and in the File Options dialog box. You can customize these settings, as necessary.

If you have a Navisworks file already open, and want to close it and create another file, click File ► New.

 **Toolbar:** Standard ► New 

Save and Rename Files

When you save a Navisworks file, you have a choice between an NWD and NWF file formats.

As a rule of thumb, use an NWF file format to save the scene you created by bringing all model files together, and an NWD file format when you simply want a snapshot of your current work.

Both formats store the review markups, but NWD file stores the file geometry, while NWF file stores the links to original files. This makes NWF files considerably smaller in size. Also when you open an NWF file, Autodesk Navisworks automatically reloads all modified referenced files, which means the geometry is always up-to-date, even for the most complex models.

On the other hand, whenever you need to share the scene you created and review markups with others, it is best to distribute a published NWD file, which includes additional features such as password protection and file expiration date. The published files can be viewed in both Autodesk Navisworks Simulate 2010 and Autodesk Navisworks Freedom 2010 (a free viewer).

IMPORTANT When you publish an NWD file, you cannot include any RPCs added to your scene.

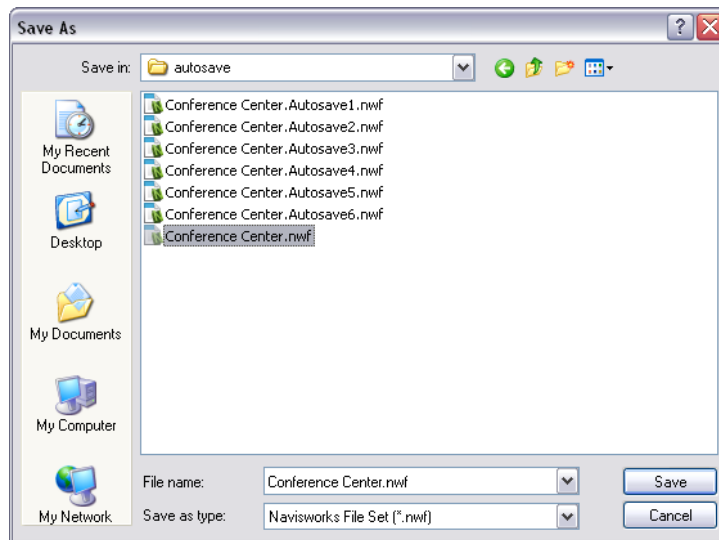

To save a file

- 1 Click File ► Save. If your file has been saved previously, Navisworks overwrites the file with the new data.
- 2 If your file has not been previously saved, the Save As dialog box opens.



Enter the file name, use the Files of Type box to select one of the native Navisworks formats (NWF or NWD), select the location for the file, and click Save.

TIP If you need to open your file with an earlier version of Autodesk Navisworks, save it as that version type.

 **Toolbar:** Standard ► Save 

 **Command entry:** CTRL + S

To rename a file

- 1 Click File ► Save As.
- 2 In the Save As dialog box, enter the new name for your file.

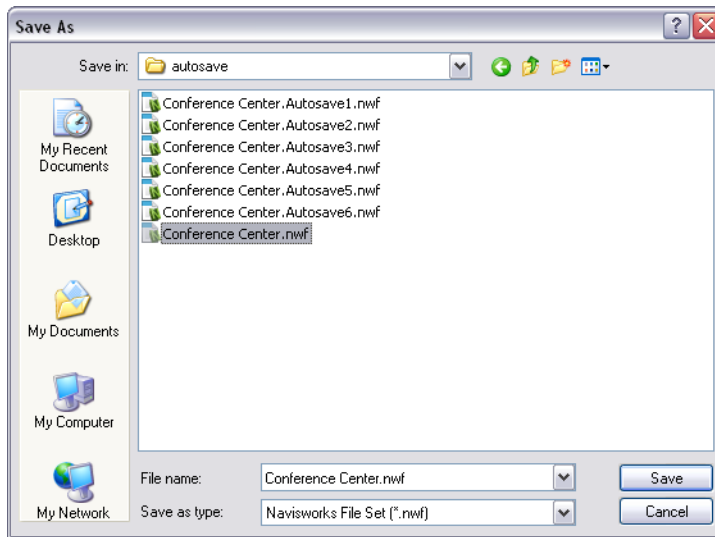

- 3 Click Save.

To publish an NWD file

- 1 Open the file that you want to publish (NWD or NWF).
- 2 Click File ► Publish.
- 3 Use the Publish dialog box to enter the document information, and specify the required document protection.

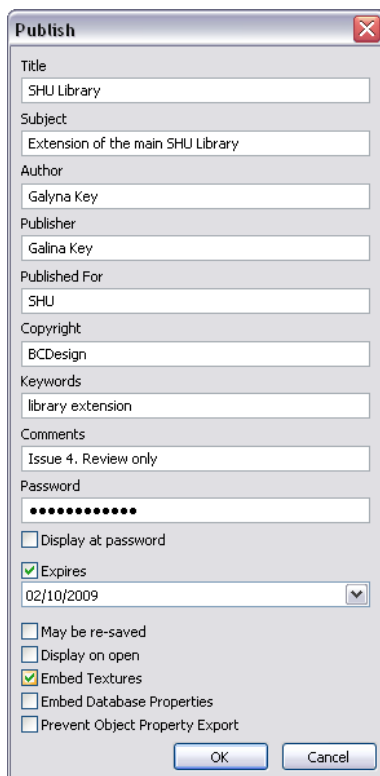

- 4 Click OK.
- 5 In the Save As dialog box, enter the file name, and specify the file location.
- 6 Click Save. Your file is now published.

 **Toolbar:** Standard ► Publish

Complex Models

You can use Navisworks files to build complex models.

When you bring files from different sources into the same scene, Autodesk Navisworks automatically aligns rotation and origin of models, and rescales the units in each file to match [display units](#).

If the rotation, origin, or file units are incorrect for the scene, you can manually adjust them for each of the opened files.

Append Files

To add more models to an existing scene, you need to append model files.



NOTE If you try to drag and drop files directly to the Selection Tree control bar or to use the Open dialog box, you will create a new Navisworks file instead.

To append model files

- 1 Open a Navisworks file.
- 2 Click File ► Append.
- 3 In the Append dialog box, use the Files of Type box to select the appropriate file type, and navigate to the folder where the files you want to add is located.
- 4 Select the required files, and click Open.

TIP To select multiple files, use SHIFT and CTRL keys.

 **Command entry:** CTRL + A

 **Toolbar:** Standard ► Append 

Delete Files

You can delete files appended to your Navisworks file.

NOTE You cannot delete any files from a published NWD file.

To delete a file

- 1 Open a Navisworks file.
- 2 Right-click the file you want to delete in the Selection Tree.
- 3 Click Delete.
- 4 Click Yes to confirm your command.

NOTE The Undo command is not available; therefore, if you make a mistake, you will need to append your file back manually.

 **Menu:** File ► Delete

Adjust File Units and Transform

For each appended file, you can change the file units, and modify the model's rotation, origin, and scale.

It is recommended to adjust file units first, before attempting to fix the problems with model alignment.

To change file units in a loaded file

- 1 Click the desired file in the Selection Tree.
- 2 Click Edit ► File Units and Transform.
- 3 In the File Units and Transform dialog box, select the required format in the Units drop-down list.

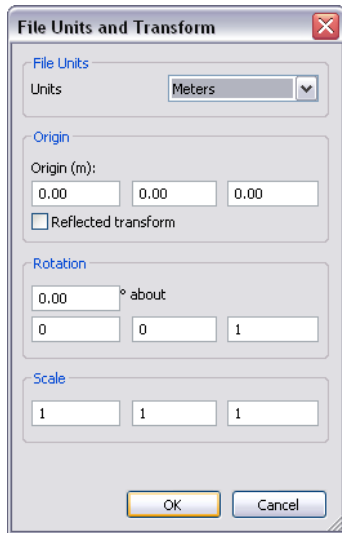

- 4 Click OK.

To change a file transform in a loaded file

- 1 Click the desired file in the Selection Tree.
- 2 Click Edit ► File Units and Transform.
- 3 To move the model's location, in the File Units and Transform dialog box, the Origin area, enter values for the X, Y and Z axis.
If you use a negative scale, select the Reflected Transform check box.
- 4 To change the model's rotation, in the File Units and Transform dialog box, the Rotation area, enter an angle of rotation, and selecting the axis to rotate about (by typing a value greater than 0). This will rotate the model about its origin point.
- 5 To change the model's scale, in the File Units and Transform dialog box, the Scale area, enter values for the X, Y and Z axis. To proportionally scale an object, ensure the X, Y, and Z values are equal.
Entering a negative value flips the model inside out.



6 Click OK.

Refresh Files

When working in Autodesk Navisworks, it is possible that others may be working on the CAD files you are currently reviewing. For example, if you are coordinating various disciplines on a project, then you may have an NWF file referencing numerous design files. During the iterative stages of the project, any member of the design team could potentially be modifying their CAD files.

To ensure the data you are reviewing is current, Autodesk Navisworks provides a refresh function to reopen the files that have been modified on the disk since commencing the review session.

To refresh currently open files

➤ Click File ➤ Refresh.

 **Toolbar:** Standard ➤ Refresh 

Merge Files

Autodesk Navisworks is a collaborative solution, and although users may be reviewing the model in different ways, their resultant files can be merged into a single Navisworks file, with any duplicate geometry and markup automatically removed.

When merging multiple NWF files that each comprise the same referenced files, Autodesk Navisworks only loads a single set of the combined models, along with all review markup (such as tags, viewpoints or comments) from each NWF file. Any duplicate geometry or markup is removed when merged.

Merging Timeliner Data

For files that contain TimeLiner data, merging is done as follows:



- if two TimeLiner data sets are identical, all duplicate data is removed.
- if two TimeLiner data sets contain the same Primary link, then the data set with the most recent link (that is, the newest file date) is chosen over the other. If the Primary links are different, then the data set with the highest number of tasks will be used, and links are re-attached wherever possible.
- if two TimeLiner data sets are completely unrelated, no data merging is performed.

To merge files

- 1 Click File ➤ New.
- 2 Open the first of the files with the review markup.
- 3 Click File ➤ Merge.
- 4 In the Merge dialog box, use the Files of Type box to select the appropriate file type (NWD or NWF), and navigate to the folder where your files you want to merge are located.
- 5 Select the required files, and click Open.

TIP To select multiple files, use SHIFT and CTRL keys.

 **Command entry:** CTRL + M

 **Toolbar:** Standard ➤ Merge 



Email Files

You can send and receive Navisworks files by email.

To send an open Autodesk Navisworks file, click File ► Send.

Autodesk Navisworks saves your file first, and then opens the available mail software and attaches your file to a blank email message.

You can email both NWD and NWF files, although the size of an NWD file will be considerably larger.

 **Toolbar:** Standard ► Send 

Receive 3D Mail

To open a received file, save the attachment on your disk, and then double-click it.

If it's an NWF file, Autodesk Navisworks searches for the referenced files first using the absolute path that the sender originally saved the file with. This is useful if a team is on a local network and the files can be found using the Universal Naming Convention (UNC).

TIP A team not sharing a server can organize a project using the same file hierarchy and drive letter, and Autodesk Navisworks can find the files this way.

If Autodesk Navisworks is unable to find the referenced files, then you need to save the attached NWF file in a directory where all referenced files are located. Autodesk Navisworks can then search for the files relative to the master NWF location.

TIP

You can use the same method to move a whole sub-directory from your projects directory to a completely new location. Save the master NWF file in this new place, and Autodesk Navisworks will be able to search for the referenced files from there.

Explore Your Model

6

Autodesk Navisworks Simulate 2010 enables you to walk through a scene in real time.

View Scene Statistics

Scene statistics display information about the current scene.

Scene statistics list all files contributing to the scene, and the different graphic elements that make up the scene, along with which of these have been processed or ignored when loaded.

Other useful statistics are the bounding box of the entire scene and the total number of primitives (triangles, lines, points) in the scene.

Quick Reference

To view scene statistics

- Click View ► Scene Statistics.

Navigate a Scene

In Autodesk Navisworks, you have a variety of options for navigating your scene.

You can directly manipulate your position in 3D space with nine navigation modes on the Navigation Modes toolbar. You can also use SteeringWheels that travel with the cursor, and can save you time by combining many of the common navigation tools into a single interface.

You can change the orientation and view of your model by using the preset views available from the Viewpoint ► Navigation Tools menu. Alternatively, you can use the ViewCube, a 3D navigational tool that enables you to reorient the view of a model by clicking predefined areas on the cube. For example, clicking the front of the ViewCube turns the view until the camera is facing the front of the scene. You can also click the ViewCube and drag it to rotate the view freely.

You can use the options on the Navigation Tools toolbar to control the realism of your navigation. So, for example, you can walk down stairs or follow terrain, crouch under objects, use an avatar to represent yourself within the 3D model.

Animating Navigation

As you navigate in Autodesk Navisworks, you can record viewpoint animations, and then play them back. For more information, see [“Record and Play Animations”](#) on page 251.

Orientation in 3D Space

Although Autodesk Navisworks uses the X, Y, Z coordinate system, there is no hard-and-fast rule as to which way each of these particular axes actually 'points'.

Autodesk Navisworks reads the data necessary to map which way is 'up' and which way is 'north' directly from the files loaded into your scene. If this is not possible, by default, Z is treated as 'up' and Y is treated as 'north'.

It is possible to change the 'up' and 'north' directions for the entire model (world orientation), and the 'up' direction for the current viewpoint (viewpoint up vector).

NOTE Changing the viewpoint up vector affects navigation in modes that rely on the 'up' direction of the current viewpoint, such as walk, turntable, and orbit. It also has an impact on section views.

To align the viewpoint up vector to the current view

- Click Viewpoint ➤ Set Viewpoint Up ➤ Set Up.

To align the viewpoint up vector to one of the preset axes

- 1 Click Viewpoint ➤ Set Viewpoint Up.
- 2 Click one of the preset axis. Choose from:
 - Set Up + X
 - Set Up - X
 - Set Up + Y
 - Set Up - Y
 - Set Up + Z
 - Set Up -Z

To change the world orientation

- 1 Click Tools ➤ File Options.
- 2 In the File Options dialog box, Orientation tab, enter the required values to adjust the model orientation.

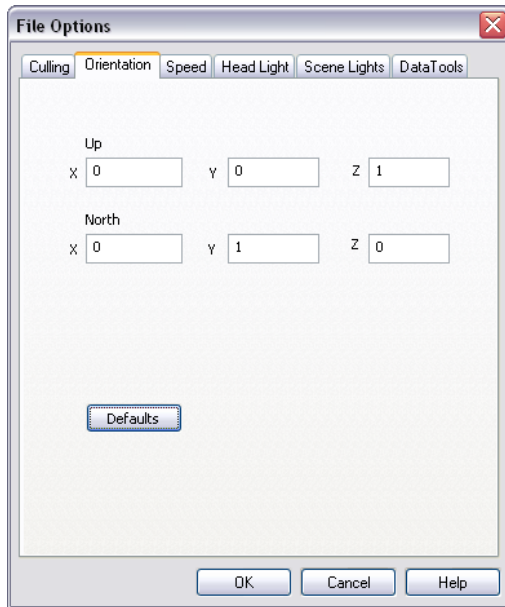

- 3 Click OK.

Navigation Modes

There are nine navigation modes available from the Navigation Mode toolbar to control how you move around the Scene Area- six camera-centric modes and three model-centric modes.



In a camera-centric mode, the camera moves within the scene, whereas in a model-centric mode, model moves inside the scene. For example, orbit and examine modes essentially do the same thing, except that orbit mode moves the camera around the focal point and examine mode moves the model around the focal point.

NOTE Navigation modes and [SteeringWheels](#) are mutually exclusive, so activating navigation mode deactivates the current SteeringWheel menu.

Movement in each mode is based on the keyboard arrow keys, the Shift and Control keys, and mouse drags. The mouse wheel is also supported, allowing quick and easy zooming or tilting, depending on the current navigation mode.









TIP Dragging with the left mouse button while holding down the Control key performs the same actions as dragging with the middle mouse button, which is useful if you only have a two-button mouse.

The Shift and Control keys modify the movement, for example holding down Shift in walk mode speeds up movement, and holding down Control in this mode, glides the camera left/right and up/down.

NOTE Gliding the camera is opposite to panning the model. Gliding is a camera-centric motion and panning is a model-centric motion.

Quick Reference

Mode	Description
	Walk. Enables you to walk through the model on a horizontal plane ensuring that "up" is always "up".

Mode	Description
	Look Around. Enables you to look around the model from the current camera position and gives the effect that you are moving your head around.
	Zoom. Enables you to zoom into and out of the model. Cursor up zooms in and cursor down zooms out.
	Zoom to a Box. Enables you to drag a box so that the contents of the box fill the view.
	Pan. Enables you to pan the model rather than the camera.
	Orbit. Enables you to orbit the camera around the model, ensuring that “up” is always “up”. The camera always orbits around the focal point of the model.
	Examine. Enables you to rotate the model about.
	Fly. Enables you to fly around the model like in a flight simulator.
	Turntable. Enables you to spin the model around the up vector. This navigation mode behaves as though the model is sitting on a turntable, ensuring that “up” is always “up”.

Walk Mode

In walk mode, you can navigate through a model as if you were walking through it. In this mode, the up direction is always maintained.

Once you start walk mode, the cursor changes to the walk cursor. To walk through the model, you drag in the direction in which you want to move in.



To use walk mode to move through the model

- 1 Click Walk  on the Navigation Mode toolbar.
- 2 To move, hold down the left mouse button as you drag in the direction you want to walk, or use the cursor keys. The camera spins left and right, and moves forwards and backwards.

NOTE Holding down the SHIFT key speeds up this movement.

- 3 To glide, hold down the CTRL key as you drag the mouse. The camera glides left and right and up and down.

As walk mode is camera-centric, this mode differs from the normal pan mode in that the camera is moved rather than the model.

- 4 To tilt the camera up and down, spin the mouse wheel.

 **Menu:** Viewpoint ► Navigation Mode ► Walk

 **Command entry:** CTRL + 2

Look Around Mode

In look around mode, you can rotate the current view vertically and horizontally. When rotating the view, your line of sight rotates about the current eye position, like turning your head.





To look around a view

- 1 Click Look Around  on the Navigation Mode toolbar.
- 2 To look around, drag the left mouse button, or use the cursor keys. The camera looks left, right, up or down.

NOTE Holding down the SHIFT key speeds up this movement.

- 3 To rotate the camera around its viewing axis, hold down the CTRL key.

 **Menu:** Viewpoint ► Navigation Mode ► Look Around

 **Command entry:** CTRL + 3

Zoom Mode

In zoom mode, you can zoom into and out of the model.



To zoom the view

- 1 Click Zoom  on the Navigation Mode toolbar.
- 2 Drag the left mouse button up and down, or use the up and down cursor keys, to zoom in and out respectively.

 **Menu:** Viewpoint ► Navigation Mode ► Zoom

 **Command entry:** CTRL + 4

Zoom Box Mode

In zoom box mode, you can zoom in to an area of the model by dragging a rectangular box around the area you want to fit in the Scene Area.



To zoom in to an area of the model by specifying box

- 1 Click Zoom Box  on the Navigation Mode toolbar.
- 2 Drag a box with the left mouse button over the Scene Area to fill the view with the contents of the box.

NOTE Holding down the Shift or Control keys, or spinning the mouse wheel, temporarily enables normal zoom mode.

 **Menu:** Viewpoint ► Navigation Mode ► Zoom Box

 **Command entry:** CTRL + 5

Pan Mode

In pan mode, you can move the model, rather than the camera. For example, dragging upward moves the model up while dragging downward moves the model down.



To pan a model

- 1 Click Pan  on the Navigation Mode toolbar.
- 2 Drag the left mouse button to pan the model up, down, left and right.

NOTE Holding down the SHIFT or CTRL keys, or spinning the mouse wheel, temporarily enables normal zoom mode.

 **Menu:** Viewpoint ► Navigation Mode ► Pan

 **Command entry:** CTRL + 6

Orbit Mode

In orbit mode, the camera moves around the focal point of the model. In this mode, the up direction is always maintained.



To orbit a model

- 1 Click Orbit  on the Navigation Mode toolbar.
- 2 To rotate the camera around the model, drag the left mouse button, or using the cursor keys.

NOTE Holding down the SHIFT key, or spinning the mouse wheel, temporarily enables normal zoom mode.

- 3 To glide the camera, hold down the CTRL key as you drag the mouse. The camera glides left and right and up and down.

As orbit mode is camera-centric, this mode differs from normal pan mode in that the camera is moved rather than the model.

 **Menu:** Viewpoint ► Navigation Mode ► Orbit

 **Command entry:** CTRL + 7

Examine Mode

In examine mode, you can rotate the model around the focal point.



To examine a model

- 1 Click Examine  on the Navigation Mode toolbar.
- 2 To rotate the model around the focal point, drag the left mouse button, or using the cursor keys. If the mouse is moving when you let go of the button, the model keeps spinning. Clicking on the model stops this.

NOTE Holding down the Shift key, or spinning the mouse wheel, temporarily enables normal zoom mode. Holding down the CTRL key, temporarily enables normal pan mode.

 **Menu:** Viewpoint ► Navigation Mode ► Examine

 **Command entry:** CTRL + 8

Fly Mode

In fly mode, you can move around the model like in a flight simulator.



To use fly mode to move through the model

- 1 Click Fly  on the Navigation Mode toolbar.
- 2 Hold down the left mouse button to move the camera forward. As in a flight simulator, the left mouse button banks left/right when dragged left or right and tilts up/down when dragged up or down.

NOTE Holding down the SHIFT key speeds up this movement.

- 3 Use the up and down cursor keys to zoom the camera in and out respectively; use the left and right cursor keys to spin the camera left and right respectively.

NOTE Holding down the CTRL key rotates the camera around its viewing axis, while still moving forward.

 **Menu:** Viewpoint ► Navigation Mode ► Fly

 **Command entry:** CTRL + 9

Turntable Mode

In turntable mode, you can spin the model around the up vector as though the model is sitting on a turntable. In this mode, the up direction is always maintained.





To spin model on a turntable

- 1 Click Turntable  on the Navigation Mode toolbar.
- 2 Drag the left mouse button left and right, or use the left and right cursor keys, to spin the turntable left and right respectively.

NOTE Holding down the SHIFT key or spinning the mouse wheel, temporarily enables normal zoom mode. Holding down the CTRL key, temporarily enables normal pan mode.

- 3 To tilt the the turntable up and down, spin the mouse wheel, or use the up and down cursor keys.

 **Menu:** Viewpoint ► Navigation Mode ► Turntable

 **Command entry:** CTRL + 0

SteeringWheels

SteeringWheels™ are tracking menus that follow your cursor, and from which you can access different 3D navigation tools from a single tool.

Overview of SteeringWheels

SteeringWheels, also known as wheels, can save you time by combining many of the common navigation tools into a single interface. Wheels are specific to the context from which a model is being viewed.



NOTE SteeringWheels and [navigation modes](#) are mutually exclusive, so activating a SteeringWheel deactivates the currently selected navigation mode.

First Contact Balloon

At startup, the SteeringWheel is pinned. When you move the cursor over the SteeringWheel, the First Contact balloon is displayed. The First Contact balloon serves as an introduction to the purpose of the wheels and how you can use them.

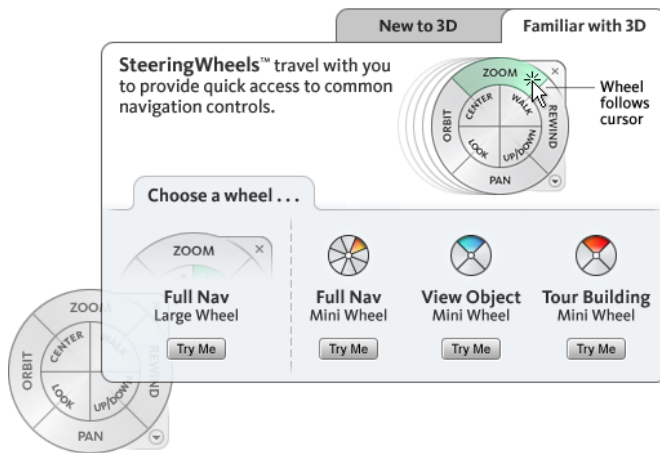

Display and Use Wheels

Pressing and dragging on a wedge of a wheel is the primary mode of interaction. After a wheel is displayed, click one of the wedges and hold down the button on the pointing device to activate the navigation tool. Drag to reorient the current view. Releasing the button returns you to the wheel.

Control the Appearance of Wheels

You can control the appearance of the wheels by switching between the different styles of wheels that are available, or by adjusting the size and opacity. Wheels are available in two different styles: big and mini. The

big wheel is larger than the cursor, and labels are shown on the wheel wedges. The mini wheel is about the same size as the cursor, and labels are not displayed on the wheel wedges.



Big Full Navigation Wheel



Mini Full Navigation Wheel

The size of a wheel controls how large or small the wedges and labels appear on the wheel; the opacity level controls the visibility of the objects in the model behind the wheel.

Control Tooltips for Wheels and Messages for Tools

Tooltips are displayed for each button on a wheel as the cursor is moved over them. The tooltips appear below the wheel and identify what action will be performed if the wedge or button is clicked.

Similar to tooltips, tool messages and cursor text are displayed when you use one of the navigation tools from a wheel. Tool messages are displayed when a navigation tool is active; they provide basic instructions about using the tool. Tool cursor text displays the name of the active navigation tool near the cursor. Disabling tool messages and cursor text only affects the messages that are displayed when using the mini wheels or the big Full Navigation wheel.

To display a wheel

- 1 Click View ► SteeringWheels.
- 2 Click the wheel you want to display, for example Full Navigation Wheel.

 **Toolbar:** Navigation Mode ► SteeringWheels 

To close a wheel

Use one of the following methods to close a wheel:

- Press *SHIFT+W*
- Click the Close button.
- Right-click the wheel, and click Close Wheel.

To change the size of a wheel

- 1 Display a wheel.
- 2 Right-click the wheel, and click SteeringWheels Options.
- 3 In the Options Editor, the SteeringWheels page under the Interface node, select an option from the Size drop-down list in the Big Wheels or Mini Wheels area.
- 4 Click OK.

To change the opacity of a wheel

- 1 Display a wheel.
- 2 Right-click the wheel, and click SteeringWheels Options.
- 3 In the Options Editor, the SteeringWheels page under the Interface node, select an option from the Opacity drop-down list in the Big Wheels or Mini Wheels area.

- 4 Click OK.

To control the startup placement of a wheel

- 1 Display a wheel.
- 2 Right-click the wheel, and click SteeringWheels Options.
- 3 In the Options Editor, the SteeringWheels page under the Interface node, select the Always Show the Pinned Wheel on Startup check box.
When this option is selected, the wheel is pinned to the window at startup. When this check box is clear, the wheel follows the position of the cursor at startup.
- 4 Click OK.

To enable tooltips for wheels

- 1 Display a wheel.
- 2 Right-click the wheel, and click SteeringWheels Options.
- 3 In the Options Editor, the SteeringWheels page under the Interface node, select the Show Tooltips check box.
Tooltips are displayed for each wedge and button on a wheel when the cursor moves over the wheel.
- 4 Click OK.

To enable tool messages for wheels

- 1 Display a wheel.
- 2 Right-click the wheel, and click SteeringWheels Options.
- 3 In the Options Editor, the SteeringWheels page under the Interface node, select the Show Tool Messages check box.
Messages are displayed when you use the navigation tools.
- 4 Click OK.

To enable tool cursor text for wheels

- 1 Display a wheel.
- 2 Right-click the wheel, and click SteeringWheels Options.
- 3 In the Options Editor, the SteeringWheels page under the Interface node, select the Show Tool Cursor Text check box.
The name of the active tool is displayed near the cursor when the tool is in use.
- 4 Click OK.

Wheel Menu

From the Wheel menu, you can switch between different wheels and change the behavior of some of the navigation tools on the current wheel.

Use the Wheel menu to switch between the big and mini wheels that are available, go to the Home view, change the preferences of the current wheel, and control the behavior of the orbit, look, and walk 3D navigation tools. The menu items available on the Wheel menu are dependent on the current wheel and program.

To display the Wheel menu

- Click the down arrow in the lower-right corner of the wheel or right-click on the wheel.

Quick Reference

The Wheel menu has the following options:

- **View Object Wheel.** Displays the big View Object wheel.
- **Tour Building Wheel.** Displays the big Tour Building wheel.
- **Full Navigation Wheel.** Displays the big Full Navigation wheel.
- **Advanced Wheels.** Displays the mini View Object, Tour Building, or Full Navigation wheel.
- **Go Home.** Goes to the Home view saved with the model.

NOTE This is the Home view as set using the ViewCube.

- **Fit to Window.** Resizes and centers the current view to display all objects in the Scene Area. This is equivalent to clicking View All  on the Navigation Tools toolbar.
- **Restore Original Center.** Restores the center point of the view to the extents of the model.
- **Level Camera.** Orients the camera such that it is level with the 'ground'. That is to say, resets the camera 'up' vector to the world up vector as set in File Options ► Orientation, and sets the roll of the camera to 0.
- **Increase Walk Speed.** Increases the walk speed for the Walk tool to double its current setting in the Options Editor.

NOTE This does not affect the viewpoint linear speed for Navisworks walk navigation mode. The navigation tool used by SteeringWheels and Navisworks navigation modes are independent.

- **Decrease Walk Speed.** Decreases the walk speed for the Walk tool to half its current setting in the Options Editor.

NOTE This does not affect the viewpoint linear speed for Navisworks walk navigation mode. The navigation tool used by SteeringWheels and Navisworks navigation modes are independent.

- **SteeringWheels Options.** Displays the Options Editor where you can adjust the appearance and behavior of SteeringWheels.
- **Help.** Launches the online Help system and displays the topic for SteeringWheels.
- **Close Wheel.** Closes the wheel.

View Object Wheels

With the View Object wheels (big and mini), you can view individual objects or features in a model. The big View Object wheel is optimized for new 3D users while the mini View Object wheel is optimized for experienced 3D users.

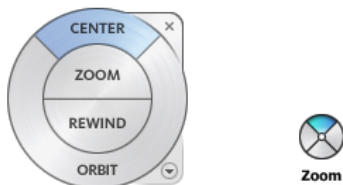

Big View Object Wheel

The big View Object wheel wedges have the following options:

- **Center.** Specifies a point on a model to adjust the center of the current view or change the target point used for some of the navigation tools.
- **Zoom.** Adjusts the magnification of the current view.
- **Rewind.** Restores the most recent view orientation. You can move backward or forward by clicking and dragging left or right.
- **Orbit.** Rotates the current view around a fixed pivot point.

Mini View Object Wheel

The mini View Object wheel wedges have the following options:

- **Zoom (Top wedge).** Adjusts the magnification of the current view.
- **Rewind (Right wedge).** Restores the most recent view. You can move backward or forward by clicking and dragging left or right.
- **Pan (Bottom wedge).** Repositions the current view by panning.
- **Orbit (Left wedge).** Rotates the current view around a fixed pivot point.

NOTE When the mini wheel is displayed, you can press and hold the middle mouse button to pan, scroll the wheel button to zoom in and out, and hold the SHIFT key while pressing and holding the middle mouse button to orbit the model.

To switch to the mini View Object wheel

- Right-click the wheel, and click Advanced Wheels ► Mini View Object Wheel.

☒ **Menu:** View ► SteeringWheels ► Mini View Object Wheel

☒ **Toolbar:** Navigation Mode ► Mini View Object Wheel 

To switch to the big View Object wheel

- Right-click the wheel, and click View Object Wheel.

☒ **Menu:** View ► SteeringWheels ► View Object Wheel

☒ **Toolbar:** Navigation Mode ► View Object Wheel 

Tour Building Wheels

With the Tour Building wheels (big and mini), you can move through a model, such as a building, an assembly line, ship, or oil rig. You can also walk through and navigate around a model. The big Tour Building wheel is optimized for new 3D users while the mini Tour Building wheel is optimized for experienced 3D users.



Big Tour Building Wheel

The big Tour Building wheel wedges have the following options:

- **Forward.** Adjusts the distance between the current point of view and the defined pivot point of the model. Clicking once moves forward half the distance as far as the object you clicked.
- **Look.** Swivels the current view.
- **Rewind.** Restores the most recent view. You can move backward or forward by clicking and dragging left or right.
- **Up/DownTool.** Slides the current view of a model along the Z axis of the model.

Mini Tour Building Wheel

The mini Tour Building wheel wedges have the following options:

- **Walk (Top wedge).** Simulates walking through a model.
- **Rewind (Right wedge).** Restores the most recent view. You can move backward or forward by clicking and dragging left or right.
- **Up/Down (Bottom wedge).** Slides the current view of a model along the Z axis of the model.
- **Look (Left wedge).** Swivels the current view.

NOTE When the mini wheel is displayed, you can press and hold the middle mouse button to pan, scroll the wheel button to zoom in and out, and hold the SHIFT key while pressing and holding the middle mouse button to orbit the model.

To switch to the mini Tour Building wheel

- Right-click the wheel, and click Advanced Wheels ► Mini Tour Building Wheel.

☒ **Menu:** View ► SteeringWheels ► Mini Tour Building Wheel

☒ **Toolbar:** Navigation Mode ► Mini Tour Building Wheel 

To switch to the big Tour Building wheel

- Right-click the wheel, and click Tour Building Wheel.

☒ **Menu:** View ► SteeringWheels ► Tour Building Wheel

☒ **Toolbar:** Navigation Mode ► Tour Building Wheel 

Full Navigation Wheels

The Full Navigation wheels (big and mini) combine the 3D navigation tools found on the View Object and Tour Building wheels. You can view individual objects, and walk through and around a model. The big and mini Full Navigation wheels are optimized for experienced 3D users.



NOTE When one of the Full Navigation wheels is displayed, you can press and hold the middle mouse button to pan, scroll the wheel button to zoom in and out, and hold the SHIFT key while pressing and holding the middle mouse button to orbit the model.

Big Full Navigation Wheel

The big Full Navigation wheel wedges have the following options:

- **Zoom.** Adjusts the magnification of the current view.
- **Rewind.** Restores the most recent view. You can move backward or forward by clicking and dragging left or right.
- **Pan.** Repositions the current view by panning.
- **Orbit.** Rotates the current view around a fixed pivot point.
- **Center.** Specifies a point on a model to adjust the center of the current view or change the target point used for some of the navigation tools.
- **Walk.** Simulates walking through a model.
- **Look.** Swivels the current view.
- **Up/Down.** Slides the current view of a model along the Z axis of the model.

Mini Full Navigation Wheel

The mini Full Navigation wheel wedges have the following options:

- **Zoom (Top wedge).** Adjusts the magnification of the current view.
- **Walk (Upper right wedge).** Simulates walking through a model.
- **Rewind (Right wedge).** Restores the most recent view. You can move backward or forward by clicking and dragging left or right.
- **Up/Down (Lower right wedge).** Slides the current view of a model along the Z axis of the model.
- **Pan (Bottom wedge).** Repositions the current view by panning.
- **Look (Lower left wedge).** Swivels the current view.
- **Orbit (Left wedge).** Rotates the current view around a fixed pivot point.
- **Center (Upper left wedge).** Specifies a point on a model to adjust the center of the current view or change the target point used for some of the navigation tools.

To switch to the mini Full Navigation wheel

- Right-click the wheel, and click Advanced Wheels ► Mini Full Navigation Wheel.

 **Menu:** View ► SteeringWheels ► Mini Full Navigation Wheel

 **Toolbar:** Navigation Mode ► Mini Full Navigation Wheel 

To switch to the big Full Navigation wheel

- Right-click the wheel, and click Full Navigation Wheel.

 **Menu:** View ► SteeringWheels ► Full Navigation Wheel

 **Toolbar:** Navigation Mode ► Full Navigation Wheel 

Navigation Tools

Each wheel is divided into different wedges. Each wedge contains a navigation tool that you can use to reorient the current view of a model. Which navigation tools are available depends on which wheel is active.

Control Navigation Realism

You can use [collision](#), [gravity](#), and [crouching](#) with the Walk tool. This allows you, for example, to walk up and down stairs and walk under low objects.

You can also use the [third person view](#) with SteeringWheels to enhance your navigation experience. However, the avatar is only shown when you use the Walk tool, and the Pan tool to prevent cluttering of the screen.

Center Tool

With the Center tool, you can define the center of the current view of a model. To define the center, you drag the cursor over your model. A sphere is displayed in addition to the cursor. The sphere indicates that the point below the cursor in the model will be the center of the current view when you release the mouse button, the model is centered on the sphere.

NOTE If a center point on a model cannot be identified, then a prohibited icon (a circle with a diagonal line) is displayed instead of the sphere.



The point defined by the Center tool provides a focal point for the Zoom tool and a pivot point for the Orbit tool.

NOTE If you want to zoom from the Full Navigation wheels from your defined center point, hold down *CTRL* before zooming.

To specify a point on a model as the center of a view

- 1 Display one of the Full Navigation wheels or the big View Object wheel.
- 2 Click and hold down the Center wedge.
- 3 Drag the cursor to the desired location of the model.
- 4 Release the button on your pointing device when the sphere is displayed.
The model is panned until the sphere is centered.

To specify the target point for the Zoom and Orbit tools

- 1 Display one of the Full Navigation wheels or the big View Object wheel.
- 2 Click and hold down the Center wedge.
- 3 Drag the cursor over the desired location of the model.
- 4 Release the button on your pointing device when the sphere is displayed.
The model is panned until the sphere is centered.
- 5 Use the Zoom or Orbit tool to reorient the view of the model.
If you are using one of the Full Navigation wheels, hold down the *CTRL* key before using the Zoom tool.

Forward Tool

You use the Forward tool to change the magnification of the model by increasing or decreasing the distance between the current point of view and the pivot point. The distance that you can move forward or backward is limited by the position of the pivot point.

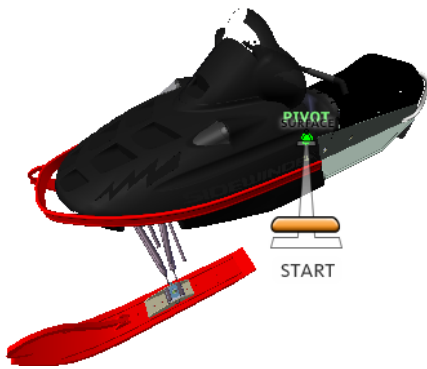

NOTE In orthographic views, the Forward tool is limited to the distance between the current position and the pivot point. In perspective views, it is not limited, so you can move the cursor through the pivot point.

To adjust the distance between the current point of view and the pivot point you use the Drag Distance indicator. The Drag Distance indicator has two marks on it that show the start and destination distances from the current point of view. The current traveled distance is shown by the orange position indicator. Slide the indicator forward or backwards to decrease or increase the distance towards the pivot point.

To reorient a view by moving towards or away from the model

- 1 Display the big Tour Building wheel.
- 2 Click and hold down the Forward wedge.
The Drag Distance indicator is displayed.

NOTE If you click the Forward wedge once, the model moves forward 50% of the distance between the current location and the pivot point.

- 3 Drag the cursor up or down to change the distance from which you view the model.
- 4 Release the button on your pointing device to return to the wheel.

Look Tool

With the Look tool, you can rotate the current view vertically and horizontally. When rotating the view, your line of sight rotates about the current eye position, like turning your head. The Look tool can be compared to you standing in a fixed location, and looking up or down while turning your head left or right.

When using the Look tool, you adjust the view of the model by dragging the cursor. As you drag, the cursor changes to the Look cursor and the model rotates around the location of the current view.



In addition to using the Look tool to look around a model, you can also use the tool to pan the current view to a specific face on the model. Press and hold the *SHIFT* key before selecting the Look tool on one of the Full Navigation wheels.

Walking Through a Model

When using the Look tool from the big Full Navigation wheel, you can walk through a model by using the arrow keys on the keyboard. To adjust the walk speed, use the Options Editor.

Invert Vertical Axis

When you drag the cursor upward, the target point of the view raises; dragging the cursor downward lowers the target point of the view. To invert the vertical axis for the Look tool, use the Options Editor.

To look around a view with the Look tool

- 1 Display one of the Full Navigation wheels or the mini Tour Building wheel.
- 2 Click and hold down the Look wedge.
The cursor changes to the Look cursor.
- 3 Drag the pointing device to change the direction in which you are looking.
- 4 Release the button on your pointing device to return to the wheel.

To look at a face in the model with the Look tool

- 1 Display one of the Full Navigation wheels.
- 2 Press and hold down the *SHIFT* key.
- 3 Click and hold down the Look wedge.
The cursor changes to the Look At cursor.
- 4 Drag over the objects in the model until the face highlights that you want to look at.
- 5 Release the button on your pointing device to return to the wheel.

To look around and walk through a model with the Look tool

- 1 Display the big Full Navigation wheel.
- 2 Click and hold down the Look wedge.
The cursor changes to the Look cursor.
- 3 Drag to change the direction in which you are looking.
- 4 While holding down the button on your pointing device, press the arrow keys to walk in the model.
- 5 Release the button on your pointing device to return to the wheel.
- 6 Click Close to exit the wheel.

To invert the vertical axis for the Look tool

- 1 Display a wheel.
- 2 Right-click the wheel, and click SteeringWheels Options.
- 3 In the Options Editor, the SteeringWheels page under the Interface node, select the Invert Vertical Axis check box.
Dragging downward and upward lowers and raises the target point of the current view.
- 4 Click OK.

Orbit Tool

You use the Orbit tool to change the orientation of a model. The cursor changes to the Orbit cursor. As you drag the cursor, the model rotates around a pivot point while the view remains fixed.



Specify the Pivot Point

The pivot point is the base point used when rotating the model with the Orbit tool. You can specify the pivot point in the following ways:

- **Default pivot point.** When you first open a model, the target point of the current view is used as the pivot point for orbiting the model.
- **Select objects.** You can select objects before the Orbit tool is used to calculate the pivot point. The pivot point is calculated based on the center of the extents of the selected objects.
- **Center tool.** You can specify a point on the model to use as the pivot point for orbiting with the *Center tool*.
- **CTRL+Click and drag.** Press and hold down the *CTRL* key before clicking the Orbit wedge or while the Orbit tool is active; then drag to the point on the model you want to use as the pivot point. This option is only available when using the big and mini Full Navigation wheels or the mini View Object wheel.

NOTE While the Orbit tool is active, you can be press and hold the *CTRL* key at anytime to move the pivot point used by the Orbit tool.

Maintain Up Direction

You can control how the model orbits around the pivot point by choosing to maintain the up direction of the model. When the up direction is maintained, orbiting is constrained along the *XY* axis and in the *Z* direction. If you drag horizontally, the camera moves parallel to the *XY* plane. If you drag vertically, the camera moves along the *Z* axis.

If the up direction is not maintained, you can roll the model using the roll ring which is centered around the pivot point. Use the properties dialog box for the SteeringWheels to control whether the up direction is maintained or not for the Orbit tool.



To orbit a model with the Orbit tool

- 1 Display one of the View Object or Full Navigation wheels.
- 2 Click and hold down the Orbit wedge.
The cursor changes to the Orbit cursor.
- 3 Drag to rotate the model.

NOTE Use the Center tool to re-center the model in the current view, if you are using one of the Full Navigation or View Object wheels.

- 4 Release the button on your pointing device to return to the wheel.

To orbit around an object with the Orbit tool

- 1 Press ESC to make sure no commands are active and to clear any previously selected objects.
- 2 Select the objects in the model for which you want to define the pivot point.
- 3 Display one of the View Object or Full Navigation wheels.
- 4 Click and hold down the Orbit wedge.
The cursor changes to the Orbit cursor.
- 5 Drag to rotate the model.
- 6 Release the button on your pointing device to return to the wheel.

To turn on selection sensitivity for the Orbit tool

- 1 Display one of the View Object or Full Navigation wheels.
- 2 Right-click the wheel, and click SteeringWheels Options.
- 3 In the Options Editor, the SteeringWheels page under the Interface node, select the Enable Selection Sensitivity check box.
- 4 Click OK.
The extents of any objects that are selected before the wheel is displayed are used to define the pivot point for the Orbit tool. If no objects are selected, the pivot point used by the Orbit is the one defined by the Center tool.

To maintain the up direction for the Orbit tool

- 1 Display the mini View Object wheel or one of the Full Navigation wheels.
- 2 Right-click the wheel, and click SteeringWheels Options.
- 3 In the Options Editor, the SteeringWheels page under the Interface node, select the Keep Scene Upright check box.
- 4 Click OK.
Orbiting the model is constrained along the XY plane and Z directions.

To roll the model around the pivot point with the Orbit tool

- 1 Display the mini View Object Wheel or one of the Full Navigation wheels.
- 2 Right-click the wheel, and click SteeringWheels Options.
- 3 In the Options Editor, the SteeringWheels page under the Interface node, clear the Keep Scene Upright check box.
- 4 Click OK.

- 5 Click and hold the Orbit wedge.
The cursor changes to the Orbit cursor.
- 6 Press and hold the *SHIFT* key to display the roll ring. Drag to roll the model.
- 7 Release the button on your pointing device to return to the wheel.

To start the Orbit tool with the middle mouse button

- 1 Display one of the wheels other than the big View Object or Tour Building wheels.
- 2 Press and hold down the *SHIFT* key.
- 3 Press and hold down the scroll wheel or middle button on your pointing device and drag to orbit the model.
- 4 Release the button on your pointing device to return to the wheel.

Pan Tool

When the pan tool is active, the Pan cursor (a four-sided arrow) is displayed. Dragging the pointing device moves the model in the same direction. For example, dragging upward moves the model up while dragging downward moves the model down.



TIP If the cursor reaches the edge of the screen, you can continue panning by dragging further to force it to wrap around the screen.

To pan the view with the Pan tool

- 1 Display one of the Full Navigation wheels, or the mini View Object wheel.
- 2 Click and hold the Pan wedge.
The cursor changes to the Pan cursor.
- 3 Drag to reposition the model.
- 4 Release the button on your pointing device to return to the wheel.

To start the Pan tool with the middle mouse button

- 1 Display one of the Full Navigation wheels, or the mini View Object wheel.
- 2 Press and hold down the scroll wheel or middle button.
The cursor changes to the Pan cursor.
- 3 Drag to reposition the model.
- 4 Release the wheel or button on your pointing device to return to the wheel.

Rewind Tool

As you use the navigation tools to reorient the view of a model, the previous view is saved to the navigation history. The navigation history holds a representation of the previous views of the model along with a thumbnail. A separate navigation history is maintained for each window; it is not maintained after the window is closed. Rewind navigation history is view-specific.

With the Rewind tool, you can retrieve previous views from the navigation history. From the navigation history, you can restore a previous view or scroll through all of the saved views.

When you hold down the button on the pointing device over the Rewind tool on the wheel, the Rewind History panel is displayed. You can scroll through the navigation history. To restore one of the previous views in the navigation history, drag the bracket to the left in the Rewind History panel.

NOTE Rewind history is not saved between sessions.



To restore the previous view

- 1 Display a wheel.
- 2 Click the Rewind wedge.

To restore a previous view with the Rewind History panel

- 1 Display a wheel.
- 2 Click and hold the Rewind wedge.
The Rewind History panel is displayed.
- 3 While holding down the button on your pointing device, drag to the left or to the right to restore a previous view.
Dragging to the left restores an older previous view. Dragging to the right restores a view that is newer than the one you are currently viewing. You must have previously used the Rewind tool to see views available on the right. The current position in the navigation history is indicated by the orange box that is dragged along the Rewind History panel.

Up/Down Tool

Unlike the Pan tool, you use the UP/Down tool to adjust the height of the current viewpoint along the model's Z axis. To adjust the vertical elevation of the current view, you drag up or down. As you drag, the current elevation and the allowed range of motion is displayed on a graphical element called the Vertical Distance indicator.

The Vertical Distance indicator has two marks that show the highest (Top) and lowest (Bottom) elevation the view can have. While changing the elevation with the Vertical Distance indicator, the current elevation is shown by the bright orange indicator, while the previous elevation is shown by the dim orange indicator.



To change the elevation of a view

- 1 Display one of the Full Navigation wheels or the Tour Building wheels.
- 2 Click and hold down the Up/Down wedge.
The Vertical Distance indicator is displayed.
- 3 Drag up or down to change the elevation of the view.
- 4 Release the button on your pointing device to return to the wheel.

Walk Tool

With the Walk tool, you can navigate through a model as if you were walking through it. Once you start the Walk tool, the Center Circle icon is displayed near the center of the view and the cursor changes to display a series of arrows. To walk through the model, you drag in the direction in which you want to move in.



Constrain the Walk Angle

When walking through a model, you can constrain the movement angle to the world up vector. If the Constrain Walk Angle option is enabled, you can freely walk around while maintaining a constant camera viewpoint elevation; if the walk angle is not constrained, you will “fly” in the direction you are looking. Use the Options Editor to constrain the movement angle to the world up vector for the Walk tool.

Movement Speed

As you walk or “fly” through a model, you can control the movement speed. Movement speed is controlled by the distance in which the cursor is moved from the Center Circle icon and the current movement speed setting. You can adjust the movement speed setting permanently and temporarily as you use the Walk tool. To permanently adjust the movement speed, use the Options Editor or the < and > keys when the Walk tool is active. To temporarily increase movement speed, press and hold the + (plus) key while using the Walk tool.

Change the Elevation

As you use the Walk tool, you can adjust the camera elevation by holding down the *SHIFT* key. This temporarily activates the Up/Down tool. With the Up/Down tool active, drag up or down to adjust the elevation of the camera. You can also use the *UP ARROW* and *DOWN ARROW* keys as you walk to adjust the height of the view.

To use the Walk tool to move through the model

- 1 Display one of the Full Navigation wheels or the mini Tour Building wheel.
- 2 Click and hold down the Walk wedge.
The cursor changes to the Walk cursor and the Center Circle icon is displayed.
- 3 Drag in the direction you want to walk.

NOTE While walking, press and hold down the + (plus) key to temporarily increase your movement speed.

- 4 Release the button on your pointing device to return to the wheel.

To change the movement speed for the Walk tool

- 1 Display a wheel.
- 2 Right-click the wheel, and click SteeringWheels Options.
- 3 In the Options Editor, the SteeringWheels page under the Interface node, use the Walk Speed slider.
Dragging the slider to the left decreases the walking speed; dragging the slider to the right increases the walking speed.
- 4 Click OK.

To constraint the Walk tool to the world up vector

- 1 Display a wheel.
- 2 Right-click the wheel, and click SteeringWheels Options.
- 3 In the Options Editor, the SteeringWheels page under the Interface node, select the Constrain Walk Angle check box.
- 4 Click OK.
Movement when walking is done parallel to the world up of the model.

To adjust the height of the current view from the Walk tool

- 1 Display one of the Full Navigation wheels or the mini Tour Building wheel.
- 2 Click and hold down the Walk wedge.
The cursor changes to the Walk cursor and the Center Circle icon is displayed.
- 3 Do one of the following:
 - Press and hold down the *SHIFT* key to enable the Up/Down tool; drag up or down.
 - Press and hold down the *UP ARROW* or *DOWN ARROW* key.
- 4 Release the button on your pointing device to return to the wheel.

Zoom Tool

You use the Zoom tool to change the zoom magnification of a model.



NOTE When you start the Zoom tool from the Full Navigation wheel, incremental zooming must be enabled in the Options Editor in order to use *CTRL*+click and *SHIFT*+click.

Zoom Constraints

When changing the magnification of a model with the Zoom tool, you cannot zoom in any further than the focus point or out past the extents of the model. The direction you can zoom in and out is controlled by the center point set by the Center tool.

NOTE Unlike the Zoom tool on the big View Object wheel, the Zoom tool on the mini View Object wheel and the Full Navigation wheels are not constrained.

To zoom the view with a single click

NOTE You must enable incremental zoom when using the Full Navigation wheels, or a mini View Object wheel. For the big View Object wheel, the incremental zoom is always enabled.

- 1 Do the following to make sure the Enable Single-Click Incremental Zoom In option is selected:
 - a Display the Full Navigation Wheel.
 - b Right-click the wheel, and click SteeringWheel Options.
 - c In the Options Editor, the SteeringWheels page under the Interface node, select the Enable Single-Click Incremental Zoom In check box.
 - d Click OK.
- 2 Display a wheel that has the Zoom tool.
- 3 Click the Zoom wedge.

The magnification of the model is increased and you are zoomed in closer to the model. If you hold down the *SHIFT* key while clicking the Zoom wedge, the model is zoomed out; you can hold down the *CTRL* key to zoom in.

To zoom a view in and out by dragging

- 1 Display one of the Full Navigation wheels, or one of the View Object wheels.
- 2 Click and hold down the Zoom wedge.

The cursor changes to the Zoom cursor.
- 3 Drag vertically to zoom in or out.
- 4 Release the button on your pointing device to return to the wheel.

To zoom in to an area of the model by specifying window

- 1 Display one of the Full Navigation wheels or the mini View Object wheel.
- 2 Press and hold down the *SHIFT* key.
- 3 Click and hold down the Zoom wedge.

The cursor changes to the Zoom cursor.

- 4 Drag the pointing device to define the opposite corner of the window that defines the area in which you want to zoom.

NOTE Holding down the *CTRL* key while defining the second point of the window determines if the first point of the window is used as the corner or center of the window being dragged. When the *CTRL* key is held down, the first point defines the center of the window.

- 5 Release the button on your pointing device to return to the wheel.

To zoom in and out by scrolling the mouse wheel when a SteeringWheel is displayed

- 1 Display one of the wheels other than the big Tour Building wheel.
- 2 Scroll the wheel forward or backward to zoom in or out.
- 3 Release the button on your pointing device to return to the wheel.

Quick Reference

You use the Zoom tool to change the zoom magnification of a model. The following mouse click and key combinations are available to control how the Zoom tool behaves:

- **Click.** If you click the Zoom tool on a wheel, the current view is zoomed in by a factor of 25 percent. If you are using the Full Navigation wheel, incremental zoom must be enabled in the Options Editor.
- **SHIFT+click.** If you hold down the *SHIFT* key before you click the Zoom tool on a wheel, the current view is zoomed in by a factor of 25 percent. Zooming is performed from the current pivot point, and not the location of the cursor.
- **CTRL+click.** If you hold down the *CTRL* key before you click the Zoom tool on a wheel, the current view is zoomed in by a factor of 25 percent. Zooming is performed from the current pivot point, and not the location of the cursor.
- **Click and drag.** If you click the Zoom tool and hold down the button on your pointing device, you can adjust the magnification of the model by dragging up and down.
- **CTRL+click and drag.** When using the Full Navigation wheels or the mini View Object wheel, you can control the target point used by the Zoom tool. By holding down the *CTRL* key, the Zoom tool uses the location of the previous pivot point defined by the Zoom, Orbit, or Center tool.
- **SHIFT+click and drag.** When using the Full Navigation wheels or the mini View Object wheel, you can zoom in to an area of the model by dragging a rectangular window around the area you want to fit in the window. Hold down the *SHIFT* key and then click and drag a window around the area in which you want to zoom.

NOTE If you hold down the *CTRL* key along with the *SHIFT* key, you can zoom in to an area of a model using a center-based window instead of one defined by opposite corners.

- **Mouse wheel.** When a wheel is displayed, scroll the mouse wheel up or down to zoom the view of the model in or out.

NOTE When you use the Zoom tool from the Full Navigation wheel or the View Object wheel, the point in the view where you click to zoom becomes the Center point for future Orbit operations until you either use the Zoom tool again or use the Center tool. If you press *CTRL* before you click the Zoom wedge, the Center point does not change.

Camera

Autodesk Navisworks offers you a number of prefixed options to control the camera position and orientation during navigation.

Camera Projection

You can choose to use a perspective camera or an orthographic camera during navigation.

NOTE Orthographic cameras are not available with walk and fly navigation modes.

To use a perspective camera

- Click Perspective  on the Navigation Tools toolbar.

 **Menu:** Viewpoint ➤ Navigation Tools ➤ Perspective

To use an orthographic camera

- Click Orthographic  on the Navigation Tools toolbar.

 **Menu:** Viewpoint ➤ Navigation Tools ➤ Orthographic

Camera Tilt

You can adjust the tilt angle of the camera during navigation by using the slider on the Camera Tilt control bar.



The tilt angle is indicated in the scene's units below (negative) or above (positive) horizontal (0) at the base of the control bar.

This is particularly useful in walk mode to look up and down. If your mouse has a wheel, you can use it to adjust the tilt angle.

To toggle the Camera Tilt control bar

- Click View ➤ Control Bars ➤ Camera Tilt.

 **Command entry:** CTRL + F7

Straighten Camera

You can straighten the camera to align with the viewpoint up vector.

When the camera position is close to the viewpoint up vector (within 13 degrees), you can use this function to snap the camera to the appropriate axis.

TIP The same effect can be achieved by typing 0 at the base of the Camera Tilt control bar.

To straighten camera

- Click Viewpoint ➤ Navigation Tools ➤ Straighten.

Predefined Camera Views

In Autodesk Navisworks, you can align a camera to one of the axis, or select one of six predefined face views to instantly change the camera's position and orientation in the scene.

When you align the camera position along one of the axis:

- Aligning with X axis toggles between front and back face views.
- Aligning with Y axis toggles between left and right face views.
- Aligning with Z axis toggles between top and bottom face views.

NOTE In previous versions of Autodesk Navisworks, the front face view was fixed and linked to the 'up' direction of the current viewpoint by default. In Autodesk Navisworks Simulate 2010 you can customize the location of the front face by using the ViewCube. This change is global, and affects all viewpoints.

To align with X-axis

➤ Click Align X  on the Navigation Tools toolbar.

 **Menu:** Viewpoint ➤ Navigation Tools ➤ Align X

To align with Y-axis

➤ Click Align Y  on the Navigation Tools toolbar.

 **Menu:** Viewpoint ➤ Navigation Tools ➤ Align Y

To align with Z-axis

➤ Click Align Z  on the Navigation Tools toolbar.

 **Menu:** Viewpoint ➤ Navigation Tools ➤ Align Z

To look from a preset face view

- 1 Click Viewpoint ➤ Look From.
- 2 Click one of the face views. Choose from:
 - Top
 - Bottom
 - Front
 - Back
 - Left
 - Right

ViewCube

Autodesk® ViewCube® navigation tool provides visual feedback of the current orientation of a model. You can use the ViewCube tool to adjust the viewpoint of your model.

Overview of the ViewCube

The ViewCube tool is a persistent, clickable, and draggable interface that you use to switch between views of your model.

When you display the ViewCube, it is shown in the top- right corner of the Scene Area over the model in an inactive state. While the ViewCube tool is inactive, it provides visual feedback about the current viewpoint of the model as view changes occur. When the cursor is positioned over the ViewCube tool, it becomes active; you can switch to one of the available preset views, roll the current view, or change to the Home view of the model.



Control the Appearance of the ViewCube

The ViewCube tool is displayed in one of two states: inactive and active. When the ViewCube tool is inactive, it appears partially transparent by default so that it does not obscure the view of the model. When active, it is opaque and may obscure the view of the objects in the current view of the model.

In addition to controlling the opacity level of the ViewCube when it is inactive, you can also control its size, and the display of the compass. The settings used to control the appearance of the ViewCube are located in the Options Editor.

Use the Compass

The compass is displayed below the ViewCube tool and indicates which direction North is defined for the model. You can click a cardinal direction letter on the compass to rotate the model, or you can click and drag one of the cardinal direction letters or the compass ring to interactively rotate the model around the center of the view.

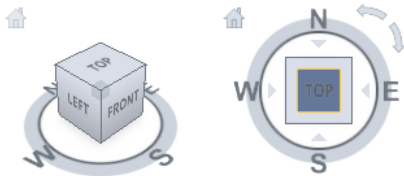

To display or hide the ViewCube

- Click View ► Head-Up Display ► ViewCube.

To control the size of the ViewCube

- 1 Right-click the ViewCube tool, and click ViewCube Options.
- 2 In the Options Editor, the ViewCube page under the Interface node, select an option from the Size drop-down list.

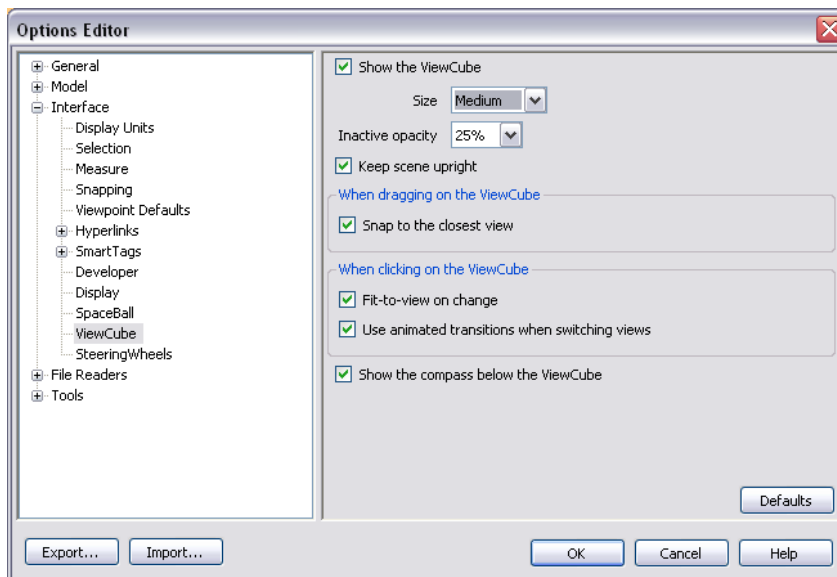

- 3 Click OK.

To control the inactive opacity of the ViewCube

- 1 Right-click the ViewCube tool, and click ViewCube Options.
- 2 In the Options Editor, the ViewCube page under the Interface node, select an option from the Inactive Opacity drop-down list.

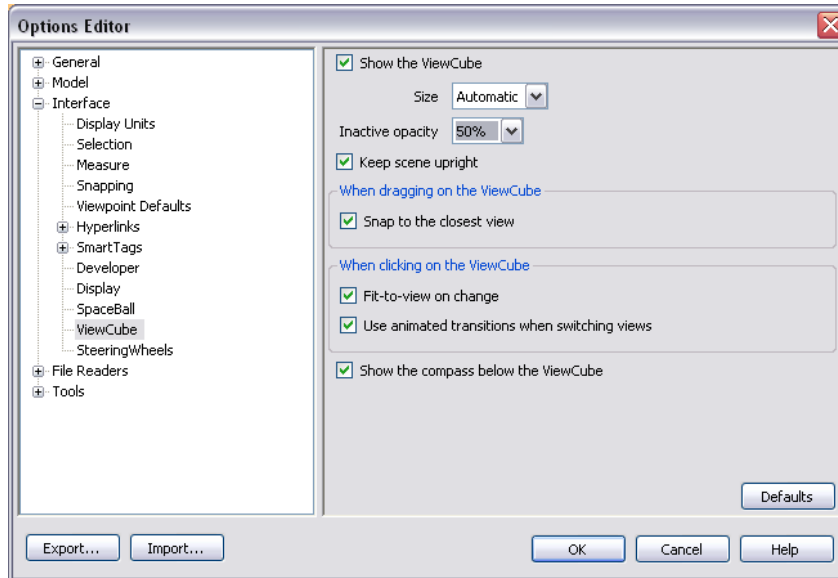

- 3 Click OK.

To display the compass for the ViewCube

- 1 Right-click the ViewCube tool, and click ViewCube Options.
- 2 In the Options Editor, the ViewCube page under the Interface node, select Show Compass Below the ViewCube.
- 3 Click OK.
The compass is displayed below the ViewCube tool and indicates the direction of North for the model.

ViewCube Menu

Use the ViewCube menu to restore and define the Home view of a model, switch between view projection modes, and change the interactive behavior and appearance of the ViewCube tool.

To display the ViewCube menu

To display the ViewCube menu, do one of the following:

- Right-click on the compass, Home icon, or the main area of the ViewCube tool.
- Click the context menu button located below the ViewCube tool.

Quick Reference

The ViewCube menu has the following options:

- **Home.** Restores the Home view saved with the model.
- **Orthographic.** Switches the current view to orthographic projection.

- **Perspective.** Switches the current view to perspective projection.
- **Lock to Selection.** Uses the selected objects to define the center of the view when a view orientation change occurs with the ViewCube tool.

NOTE If you click Home on the ViewCube tool, the view returns to the Home view even if Lock to Current Selection is selected.

- **Set Current View as Home.** Defines the Home view of the model based on the current view.
- **Set Current View as Front.** Defines the Front view of the model based on the current view.
- **Reset Front.** Resets the Front view of the model to its default orientation.
- **ViewCube Options.** Displays the Options Editor where you can adjust the appearance and behavior of the ViewCube tool.
- **Help.** Launches the online Help system and displays the topic for the ViewCube tool.

Reorient the Current View

ViewCube is used to reorient the current view of a model. You can reorient the view of a model with the ViewCube tool by clicking pre-defined areas to set a preset view current, click and drag to freely change the view angle of the model, and define and restore the Home view.

TIP When the cursor is over one of the clickable areas of the ViewCube tool, the cursor changes to an arrow with a small cube to indicate that it is over the ViewCube tool.

You use the other twenty defined areas to access angled views of a model. Clicking one of the corners on the ViewCube tool reorients the current view of the model to a three-quarter view, based on a viewpoint defined by three sides of the model. Clicking one of the edges reorients the view of the model to a half view based on two sides of the model.



You can also click and drag the ViewCube tool to reorient the view of a model to a custom viewpoint other than one of the twenty-six predefined viewpoints. As you drag, the cursor changes to indicate that you are reorienting the current view of the model. If you drag the ViewCube tool close to one of the preset orientations and it is set to snap to the closest view, the ViewCube tool rotates to the closest preset orientation.

The outline of the ViewCube tool helps you identify the form of orientation it is in: freeform or constrained. When the ViewCube tool is in freeform orientation, not orientated to one of the twenty-six predefined views, its outline is displayed as dashed. The ViewCube tool is outlined in a solid continuous line when it is constrained to one of the predefined views.

Roll a Face View

When you view a model from one of the face views, two roll arrow buttons are displayed near the ViewCube tool. Use the roll arrows to rotate the current view 90 degrees clockwise or counterclockwise around the center of the view.

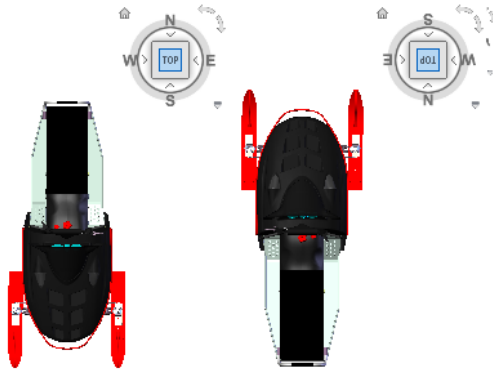

Switch to an Adjacent Face

When the ViewCube tool is active while viewing a model from one of the face views, four orthogonal triangles are displayed near the ViewCube tool. You use these triangles to switch to one of the adjacent face views.



Front View

You can define the Front view of a model to define the direction of the face views on the ViewCube tool. Along with the Front view, the up direction of a model is also used to define the direction of the face views on the ViewCube tool.

NOTE Front view is a global setting and will be the same for viewpoints.

To reorient the current view to a preset orientation

- Click one of the faces, edges, or corners on the ViewCube tool.

To view an adjacent face

NOTE Make sure a face view is current.

- Click one of the triangles displayed near the edges of the ViewCube tool.



To interactively reorient the view

- Click the ViewCube tool, hold down the left mouse button, and drag in the direction that you want to orbit the model.

To use animated transitions when reorienting a view to a preset orientation

- 1 Right-click the ViewCube tool, and click ViewCube Options.
- 2 In the Options Editor, the ViewCube page under the Interface node, select Use Animated Transitions When Switching Views.

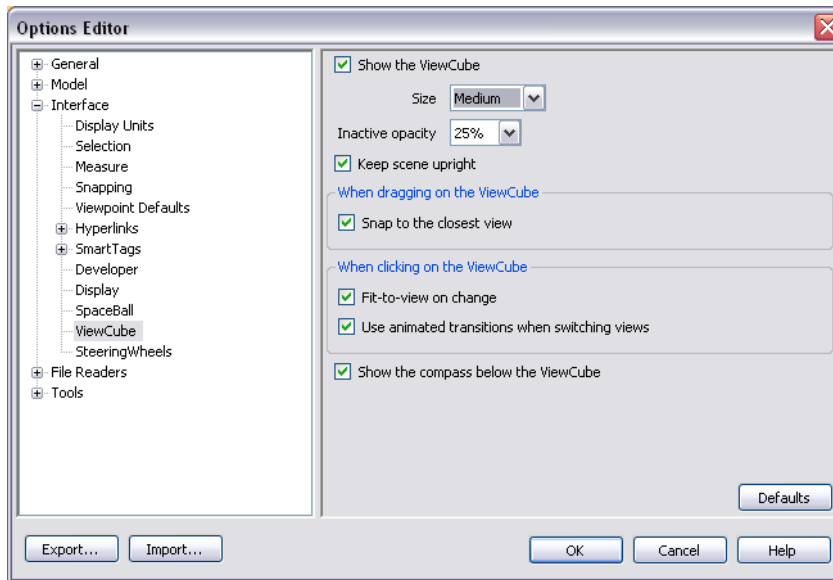

- 3 Click OK.

To automatically fit the model after a view orientation

- 1 Right-click the ViewCube tool, and click ViewCube Options.
- 2 In the Options Editor, the ViewCube page under the Interface node, select Fit-to-View on Change.

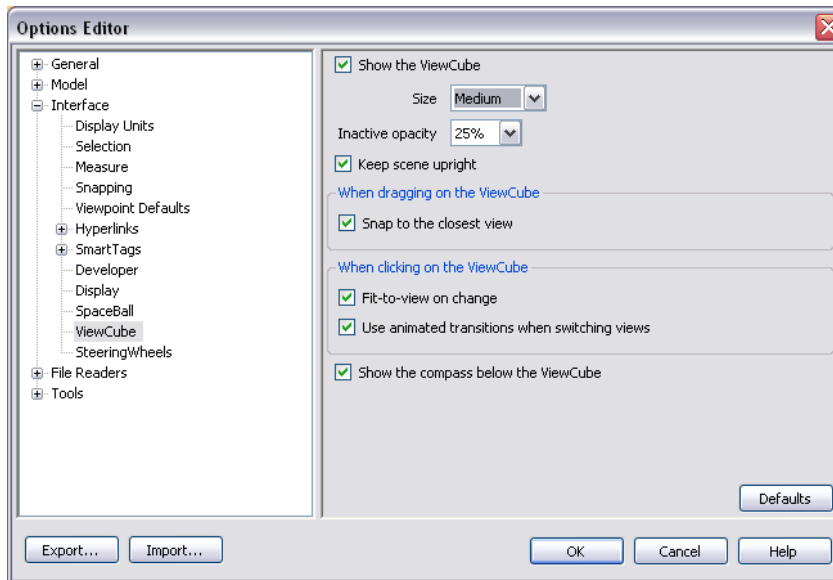

- 3 Click OK.

To roll a face view

NOTE Make sure a face view is displayed.

- Click one of the roll arrows displayed above and to the right of the ViewCube tool.

The left roll arrow rotates the view 90 degrees counterclockwise; the right roll arrow rotates the view 90 degrees clockwise.

To define the front view

- Right-click the ViewCube tool, and click Set Current View as Front.

To restore the Front view

- Right-click the ViewCube tool, and click Reset Front.

Set the View Projection Mode

The ViewCube tool supports two different view projections: perspective and orthographic. Orthographic projection is also referred to as parallel projection. Perspective projected views are calculated based on the distance from a theoretical camera and target point. The shorter the distance between the camera and the target point, the more distorted the perspective effect appears; greater distances produce less distorted affects on the model. Orthographic projected views display all the points of a model being projected parallel to the screen.

Orthographic projection mode makes it easier to work with a model due to all the edges of the model appearing as the same size, regardless of the distance from the camera. Orthographic projection mode though, is not how you commonly see objects in the real world. Objects in the real world are seen in perspective projection. So when you want to generate a rendering or hidden line view of a model, using perspective projection will give the model a more realistic look.

The following illustration shows the same model viewed from the same viewing direction, but with different view projections.



Orthographic

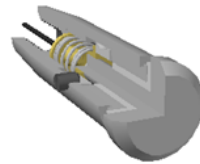

Perspective

To change the view projection mode

- Right-click the ViewCube tool, and click one of the following options:
 - Orthographic
 - Perspective

Home View

The Home view is a special view stored with a model that makes it easy to return to a known or familiar view. You can define any view of the model as the Home view. The saved Home view can be applied to the current view by clicking the Home button above the ViewCube tool or from the ViewCube menu.

To define the Home view

- Right-click the ViewCube tool, and click Set Current View as Home.

To reorient the model to the Home view

- Click the Home button () located near the ViewCube tool.

Examine Individual Objects with ViewCube

You can lock the ViewCube tool to a set of selected objects. Locking a selection of objects to the ViewCube tool defines the center of the current view and the distance from center for the view based on the selected objects.

Selecting and deselecting objects after Lock to Selection is turned on has no effect on the center or distance from the center of the view when a view orientation changes. You cannot zoom to the extents of a model when Lock to Selection is on, even if the ViewCube tool is set to zoom to extents after each view orientation change.

To lock to the current selection

- Right-click the ViewCube tool, and click Lock to Selection.
If Lock to Selection is checked when a view orientation change occurs, the selected objects are used to calculate the center of the view and the view zooms to the extents of the selected objects. When cleared, the selected objects are used to calculate the center of the view and the view zooms to the extents of the model.

To examine an individual object with ViewCube

- 1 In the model, select one or more objects to define the centerpoint of the view.
- 2 Click one of the preset locations on the ViewCube tool, or click and drag the ViewCube tool to reorient the view of the model.
The ViewCube tool reorients the view of the model based on the centerpoint of the selected objects.

Navigation Aids

SpaceBall

NOTE The term SpaceBall is used as a generic term for all 3D motion controllers from 3Dconnexion™, including the SpaceBall, SpaceMouse and SpaceTraveler.

A SpaceBall can be used as an alternative to the mouse to move around the Scene Area.

The behavior of the SpaceBall corresponds to the currently selected [navigation mode](#). This enables you to navigate with the SpaceBall whilst performing other operations with the mouse.

If no mode is selected on the Navigation Mode toolbar or if the selected mode is not a valid mode for the SpaceBall, then a default navigation mode will be used.

The speed of navigation is sensitive to the amount of force applied to the SpaceBall. You can adjust the SpaceBall settings by using the Control Panel for the device which is supplied by the SpaceBall manufacturer with the installation.

The default navigation mode and the speed of translation and rotation can be adjusted in the [Options Editor](#).

Thumbnail Views

Thumbnails are useful to get an overall view of where you are in the whole scene and to quickly move the camera to a location in a large model.

There are two types of thumbnail views available in Autodesk Navisworks:

- Section thumbnail
- Plan thumbnail

The thumbnails show a fixed view of the model. By default, the section thumbnail shows the view from the front of the model and the plan thumbnail shows a top view of the model.

Thumbnail views are displayed inside the control bars. A triangular marker represents your current viewpoint. This marker moves as you navigate, showing the direction of your view. The marker may also be dragged by holding the left mouse button over it and dragging to move the camera in the Scene Area.

NOTE The marker changes to a small dot when the thumbnail view is in the same plane as the camera view.

To use the Plan Thumbnail

- 1 Click View ► Control Bars ► Plan Thumbnail.

The Plan View control bar opens with the thumbnail view of the model.

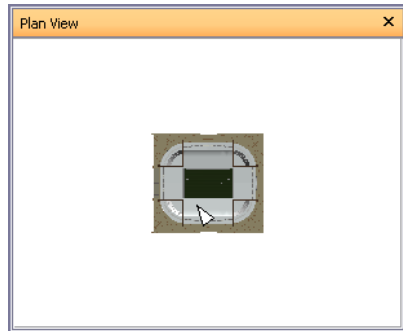

- 2 Drag the triangular marker on the thumbnail into a new location. The camera in the Scene Area changes its position to match the position of the marker in the thumbnail.
Alternatively, navigate to a different location in the Scene Area. The triangular marker in the thumbnail changes its position to match the camera position in the Scene Area.
- 3 To manipulate a thumbnail view, right-click anywhere in the Plan View control bar. Use the shortcut menu to adjust the view as desired.

 **Command entry:** CTRL + F9

To use the Section Thumbnail

- 1 Click View ► Control Bars ► Section Thumbnail.

The Section View control bar opens with the thumbnail view of the model.

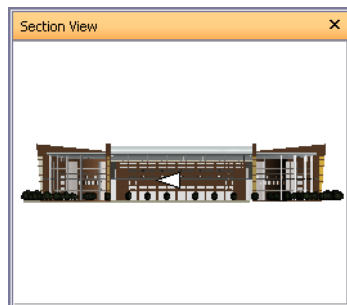

- 2 Drag the triangular marker on the thumbnail into a new location. The camera in the Scene Area changes its position to match the position of the marker in the thumbnail.
Alternatively, navigate to a different location in the Scene Area. The triangular marker in the thumbnail changes its position to match the camera position in the Scene Area.
- 3 To manipulate a thumbnail view, right-click anywhere in the Section View control bar. Use the shortcut menu to adjust the view as desired.

 **Command entry:** CTRL + F10

Quick Reference

Right-clicking the Section View or the Plan View control bar opens the shortcut menu with the following options.

Option	Description
Look From	Enables you to set the thumbnail view to one of the preset viewpoints. Choose from: Top, Bottom, Front, Back, Left, Right, or Current Viewpoint. Selecting the Current Viewpoint option sets view in the thumbnail to the active navigation viewpoint.
Update Current Viewpoint	Sets the active navigation viewpoint to the view in the thumbnail.
Edit Viewpoint	Opens the Edit Viewpoint dialog box, and enables you to modify the settings for the thumbnail viewpoint.
Lock Aspect Ratio	Instructs Autodesk Navisworks to match aspect ratio of the thumbnail to that of the current viewpoint in the Scene Area. The matching is done even when you resize the control bar with the thumbnail. This will usually give gray strips either to the top and bottom, or to either side of the thumbnail view.
Refresh	Redraws the thumbnail based on the current setting. Thumbnail drawing uses software OpenGL and so can take a couple of seconds for large models.
Help	Opens context-sensitive help.

View All

Makes the complete model fit into the Scene Area.

Using this function dollies and pans the camera so that the entire model is shown in the current view, which is very useful if you get lost inside a model or lose it completely.

Occasionally, you may get a blank view. This is usually because there are items that are very small in comparison to the main model, or items that are located a long way away from the main model. In these cases, right-click an item in the Selection Tree and click View Selected to find your way back to the model before trying to figure out which items are "lost".

To view everything

- Click View All  on the Navigation Tools toolbar.

 **Menu:** Viewpoint ➤ Navigation Tools ➤ View All

Shortcut menu: Scene ➤ View All

View Selected

Zooms the camera so that the selected items fill the Scene Area.

To view selected items

- Click View Selected  on the Navigation Tools toolbar.

 **Menu:** Viewpoint ➤ Navigation Tools ➤ View Selected

Shortcut menu: Scene ➤ View Selected

Focus

You can put the Scene View into focus mode until the next click.

When you are in focus mode, clicking on an item swivels the camera so that the point clicked is in the center of the view. This point becomes the focal point for examine, orbit, and turntable [navigation modes](#).

To focus

- Click Focus  on the Navigation Tools toolbar.

 **Menu:** Viewpoint ➤ Navigation Tools ➤ Focus



Shortcut menu: Scene ➤ Focus

Hold

When you navigate around a model in Autodesk Navisworks, it is possible to "pick up" or hold selected items and move around with them in the model.

For example you may be viewing a plan for a factory and would like to see different configurations of machine layouts.

To hold and release objects

- 1 Select the objects you want to hold either in the Scene Area or in the Selection Tree.
- 2 Click Hold  on the Navigation Tools toolbar.
The selected objects are now held and will move with you through the model when you use navigation modes, such as walk, pan and so on.
- 3 To release the held objects, click Hold  on the Navigation Tools toolbar again.
- 4 If you want to reset the objects to their original position, click Edit ➤ Reset All ➤ Reset Transforms.

 **Menu:** Viewpoint ➤ Navigation Tools ➤ Hold

Control the Realism of Your Navigation

Gravity

NOTE This function only works in connection with collision.

Where collision gives you mass, gravity gives you weight. As such, you (as the collision volume) will be pulled downwards whilst walking through the scene.

NOTE Gravity can only be used in walk navigation mode, and with the Walk tool for SteeringWheels.

This allows you to walk down stairs, for example, or follow terrain.

To toggle gravity

- In walk navigation mode, click Gravity  on the Navigation Tools toolbar.

 **Menu:** Viewpoint ➤ Navigation Tools ➤ Gravity

 **Command entry:** CTRL + G

Crouching

NOTE This function only works in connection with collision.

When walking or flying around the model with collision activated, you may encounter object that are too low to walk under, a low pipe for example. This function enables you to crouch under any such objects.

With crouching activated, you will automatically crouch under any objects that you cannot walk under at your specified height, thereby not impeding your navigation around the model.

TIP To temporarily crouch under a low object, hold down the Space bar to allow navigation to proceed.

To toggle crouching

- In walk or fly navigation mode, click Crouch  on the Navigation Tools toolbar.

 **Menu:** Viewpoint ➤ Navigation Tools ➤ Crouch

Collision

This function defines you as a collision volume - a 3D object that can navigate around and interact with the model, obeying certain physical rules that confine you within the model itself. In other words, you have a mass and as such, cannot pass through other objects, points or lines in the scene.

You can walk over, or climb over objects in the scene that are up to half the height of the collision volume, thus allowing you to walk up stairs, for example.

The collision volume, in its basic form, is a sphere (with radius = r), that can be extruded to give it height (with height = $h \geq r$). See diagram below:

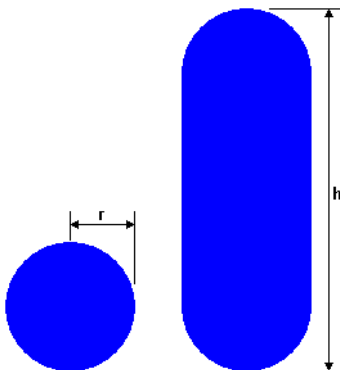

The dimensions of the collision volume can be customized for the current viewpoint or as a global option.

NOTE Collision can only be used in walk and fly navigation modes, and with the Walk tool for SteeringWheels.

When collision is turned on, rendering prioritization is changed so that objects around the camera or avatar are displayed with much higher detail than normal. The size of the region of high detail is based on collision volume radius and speed of movement (needing to see what is about to be walked into).

To toggle collision

- In walk or fly navigation mode, click Collision  on the Navigation Tools toolbar.

 **Menu:** Viewpoint ➤ Navigation Tools ➤ Collision

 **Command entry:** CTRL + D

Third Person View

This function allows you to navigate scene from a third person perspective.

When third person is activated, you will be able to see an avatar which is a representation of yourself within the 3D model. Whilst navigating you will be controlling the avatar's interaction with the current scene.

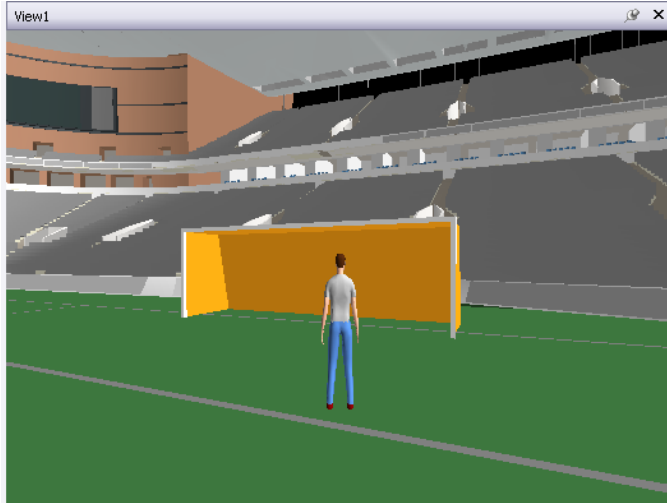

Using third person in connection with collision and gravity makes this a very powerful function, allowing you to visualize exactly how a person would interact with the intended design.

NOTE When you use third person with SteeringWheels, the avatar is only shown with the Walk and Pan tools, to prevent the screen clatter.

You can customize settings, such as avatar selection, dimension, and positioning, for the current viewpoint or as a global option.

When third person view is turned on, rendering prioritization is changed so that objects around the camera or avatar are displayed with much higher detail than normal. The size of the region of high detail is based on collision volume radius, speed of movement (needing to see what is about to be walked into) and the distance of the camera behind the avatar (in order to see what the avatar is interacting with).

To toggle third person view

- Click Third Person  on the Navigation Tools toolbar.

 **Menu:** Viewpoint ➤ Navigation Tools ➤ Third Person

 **Command entry:** CTRL + T

To add and use a custom avatar

IMPORTANT Autodesk does not recommend or support usage of the custom avatars.

- 1 Open the file you want to use as your avatar (.dwg, .skp etc.) in Autodesk Navisworks.
- 2 Click File ➤ Save As.
- 3 In the Save As dialog box, select .nwd in the Save as Type box.

- 4 Browse to the Autodesk Navisworks installation directory, for example: `C:\Program Files\Autodesk\Navisworks Simulate 2010\avatars\my_new_folder_name`.
- 5 Type in the new name for your avatar file, and click Save.
- 6 Restart Autodesk Navisworks, and open any file.
- 7 Click Tools ► Global Options.
- 8 In the Options Editor, expand the Interface node, and click the Viewpoint Defaults option.
- 9 Click the Settings button.
- 10 In the Default Collision dialog box, select the Enable check box in the Third Person area.
- 11 Select your avatar in the Avatar drop-down list.
- 12 Click OK to return to the Options Editor.
- 13 You can also change the size of the avatar by changing the Height and the Radius values in the Viewer area.
- 14 Click OK.
- 15 Restart Autodesk Navisworks.

Head-Up Display

Head-up display elements are on-screen displays that provide information about your location and orientation in the 3D world.

In Autodesk Navisworks, you can use the following head-up display (HUD) elements:

- **XYZ Axes** - shows the X, Y, Z orientation of the camera (or the avatar's eye if the avatar is visible). The XYZ Axes indicator is located at the bottom-left of the Scene Area.

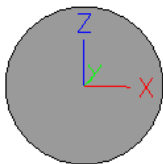

- **Position Readout** - shows the absolute X, Y, Z position of the camera (or the avatar's eye position if the avatar is visible). The Position Readout is located at the bottom-left of the Scene Area.

X: -50.51m Y: -57.92m Z: 10.97m

- **ViewCube** - provides visual feedback about the current camera viewing angle in relation to the model world. The ViewCube is located at the top-right of the Scene Area.

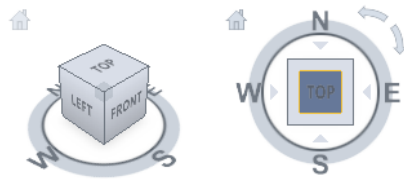

To toggle XYZ Axes

- Click View ► Head-Up Display ► XYZ Axes.

To toggle Position Readout

- Click View ► Head-Up Display ► Position Readout.

To toggle ViewCube

➤ Click View ➤ Head-Up Display ➤ ViewCube.

Control Model Appearance and Render Quality

7

You can control both the appearance of the model in the Scene Area and the quality of rendering in real time.

Control Model Appearance

You can use the Rendering Styles toolbar to control how your model is displayed in the Scene Area.



You have a choice of one of four interactive lighting modes (full lights, scene lights, head light, or no lights), four rendering modes (full render, shaded render, wireframe or hidden line) and you can individually turn each of the five primitive types (surfaces, lines, points, snap points and text) on and off.

Select Render Mode

Rendering shades the scene's geometry using the lighting you've set up, and the materials and environmental settings (such as background) you've applied.

In Autodesk Navisworks, you can use four render modes to control how the items are rendered in the Scene Area. The spheres below demonstrate the effect that the render modes have on model appearance. In order from the left, these are full render, shaded, wireframe and hidden line.

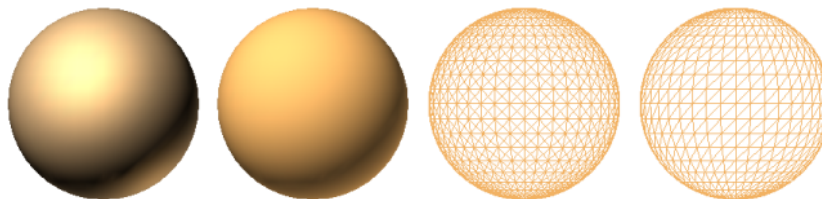



Full Render

In full render mode, the model is rendered with smooth shading including any materials that have been applied using the Presenter tool, or have been brought through from the native CAD file.

NOTE Autodesk Navisworks does not convert all native CAD file's textures. For more details, see ["Use File Readers"](#) on page 91 and ["Use File Exporters"](#) on page 106.

To select full render mode

- Click Full Render  on the Rendering Style toolbar.

 **Menu:** Viewpoint ► Rendering ► Full Render

Shaded

In shaded mode, the model is rendered with smooth shading and without textures.

To select shaded mode

- Click Shaded  on the Rendering Style toolbar.

 **Menu:** Viewpoint ► Rendering ► Shaded

Wireframe

In wireframe mode, the model is rendered in wireframe. As Autodesk Navisworks uses triangles to represent surfaces and solids, all triangle edges are visible in this mode.

To select wireframe mode

- Click Wireframe  on the Rendering Style toolbar.

 **Menu:** Viewpoint ► Rendering ► Wireframe

Hidden Line

In hidden line mode, the model is rendered in wireframe, but only the outline and facet edges of surfaces that are visible to the camera are displayed.

NOTE Unlike wireframe mode, where surfaces are rendered transparent, hidden line mode renders surfaces opaque.

To select hidden line mode

- Click Hidden Line  on the Rendering Style toolbar.

 **Menu:** Viewpoint ► Rendering ► Hidden Line

Add Lighting

In Autodesk Navisworks, you can use four lighting modes to control how the 3D scene is lit.

The spheres below demonstrate the effect the lighting styles have on them. In order from the left, these are full lights, scene lights, head light and no lights.

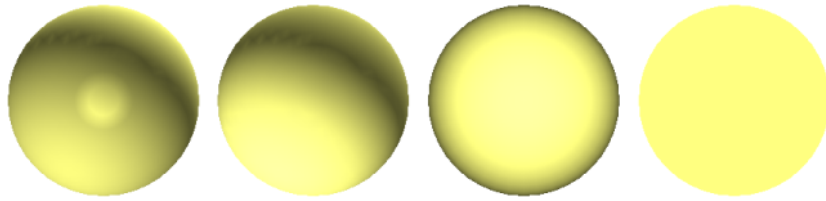

No Lights

This mode switches off all lights. The scene is shaded with flat rendering.

To turn off all lights

- Click No Lights  on the Rendering Style toolbar.

 **Menu:** Viewpoint ► Lighting ► No Lights

Head Light

This mode uses a single directional light located at the camera that always points in the same direction as the camera.

You can customize the head light properties in the File Options dialog box.

To use head light mode

- Click Head Light on the Rendering Style toolbar.

 **Menu:** Viewpoint ► Lighting ► Head Light

To adjust head light intensity

- 1 Click Tools ► File Options.
- 2 In the File Options dialog box, click the Headlight tab.

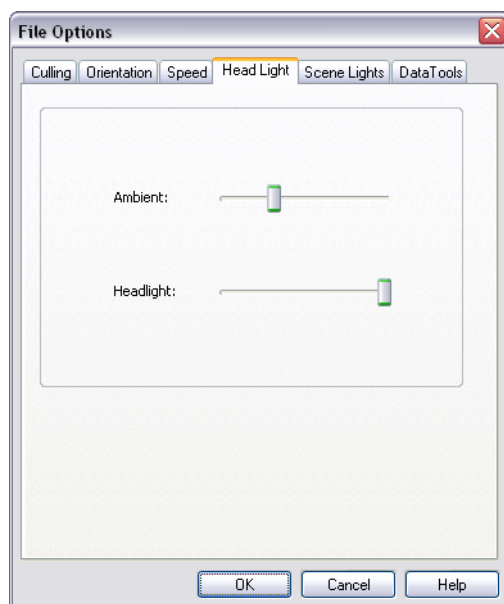

- 3 Move the Ambient slider to adjust the brightness of the scene, and the Headlight slider to adjust the brightness of the directional light.

TIP Turning on head light mode before following this procedure lets you instantly see the effect your changes have on the scene rendering.

- 4 Click OK.

Scene Lights

This mode uses the lights that have been brought through from the native CAD file. If no lights are available, two default opposing lights are used instead.

You can customize the intensity of scene lights in the File Options dialog box.

To use lights defined with the model

- Click Scene Lights  on the Rendering Style toolbar.

 **Menu:** Viewpoint ► Lighting ► Scene Lights

To adjust scene lights intensity

- 1 Click Tools ► File Options.
- 2 In the File Options dialog box, click the Scene Lights tab.
- 3 Move the Ambient slider to adjust the brightness of the scene.

TIP Turning on scene lights mode before following this procedure lets you instantly see the effect your changes have on the scene rendering.

- 4 Click OK.

Full Lights

This mode uses lights that have been defined with the Presenter tool.

To use lights defined with the Presenter tool

- Click Full Lights  on the Rendering Style toolbar.

 **Menu:** Viewpoint ► Lighting ► Full Lights

Select Background Effect

In Autodesk Navisworks, you can choose a background effect to use in the Scene Area.

Currently, the following options are available:

- **Plain** - the background of the 3D scene is filled with the selected color. This is the default background style.



Plain background

- **Graduated** - the background of the 3D scene is filled with a smooth gradient between the two selected colors.



Graduated background

- **Horizon** - the background of the 3D scene is split across the horizontal plane giving the effect of a sky and the ground. The resulting artificial horizon gives you an indication of your orientation in the 3D world. By default, the artificial horizon respects the world up vector as set in File Options ► Orientation.

NOTE The artificial horizon is a background effect, and does not include a physical ground plane. So, for example, if you navigate 'under the ground' and look up, you will not see the back of a ground plane, instead you will see the model from beneath, and a background filled with the sky color.



Horizon background

To set a plain background

- 1 Click Tools ► Background.
- 2 In the Background Settings dialog box, select Plain in the Mode drop-down list.
- 3 Select the required color from the Color palette.
- 4 Review the new background effect in the preview box, and click OK.

To set a graduated background

- 1 Click Tools ► Background.
- 2 In the Background Settings dialog box, select Graduated in the Mode drop-down list.
- 3 Select the first color from the Top Color palette.

- 4 Select the second color from the Bottom Color palette.
- 5 Review the new background effect in the preview box, and click OK.

To set an artificial horizon background

- 1 Click Tools ► Background.
- 2 In the Background Settings dialog box, select Horizon in the Mode drop-down list.
- 3 To set a graduated sky color, use the Sky Color and Horizon Sky Color palettes.
- 4 To set a graduated ground color, use the Horizon Ground Color and Ground Color palettes.
- 5 Review the new background effect in the preview box, and click OK.

Adjust Displaying of Primitives

You can enable and disable the drawing of surfaces, lines, points, snap points, and 3D text in the Scene Area.

Points are ‘real’ points in the model, whereas snap points mark locations on other primitives, for example the center of a circle, and are useful for snapping to when measuring.

Surfaces

Surfaces are the triangles that make up the 2D and 3D items in the scene. You can toggle the rendering of surfaces in the model.

To toggle the rendering of surfaces

- Click Surfaces  on the Rendering Style toolbar.

 **Menu:** Viewpoint ► Display ► Surfaces

Lines

You can toggle the rendering of lines in the model. You can also change the width of the drawn lines by using the Options Editor.

To toggle the rendering of lines

- Click Lines  on the Rendering Style toolbar.

 **Menu:** Viewpoint ► Display ► Lines

To change the line width

- 1 Click Tools ► Global Options.
- 2 In the Options Editor, expand the Interface node, and click the Display options.
- 3 On the Display page, Primitives area, enter a number between 1 and 9 in the Line Size box. This sets the width in pixels for lines drawn in the Scene Area.
- 4 Click OK.

Points

Points are real points in the model, for example, the points in a point cloud in a laser scan file. You can toggle the rendering of points in the model. You can also change the size of drawn points by using the Options Editor.

To toggle the rendering of points

- Click Points  on the Rendering Style toolbar.

 **Menu:** Viewpoint ► Display ► Points

To change the size of points

- 1 Click Tools ► Global Options.
- 2 In the Options Editor, expand the Interface node, and click the Display option.
- 3 On the Display page, Primitives area, enter a number between 1 and 9 in the Point Size box.
This sets the size in pixels for points drawn in the Scene Area.
- 4 Click OK.

Snap Points

Snap points are implied points in the model, for example, the center point of a sphere or end points of a pipe. You can toggle the rendering of snap point in the model. You can also change the size of the drawn snap points by using the Options Editor.

To toggle the rendering of snap points

- Click Snap Points  on the Rendering Style toolbar.

To change the size of snap points

- 1 Click Tools ► Global Options.
- 2 In the Options Editor, expand the Interface node, and click the Display option.
- 3 On the Display page, Primitives area, enter a number between 1 and 9 in the Snap Size box.
This sets the size in pixels of snap points drawn in the Scene Area.
- 4 Click OK.

Text

You can toggle the rendering of 3D text in the model.

To toggle the rendering of 3D text

- Click Text on the Rendering Style toolbar.

 **Menu:** Viewpoint ► Display ► Text

Control Render Quality

Use Culling

Culling lets you navigate and manipulate large and complex scenes at interactive rates by intelligently hiding less-important objects as you work.

In Autodesk Navisworks, you can use the following methods of culling objects:

- **Area** - the objects' size in pixels determines whether the objects are rendered or not. By default, any objects smaller than 1x1 pixels in size are discarded.
- **Backface** - by default, only the front face of every polygon is drawn in Autodesk Navisworks. Sometimes, during the conversion process the front and back face of polygons get mixed, in which case, you need to adjust the Backface option.
- **Near and Far Clipping Planes** (frustum culling) - objects closer to the camera than the near clipping plane or beyond the far clipping plane are not drawn. You can let Autodesk Navisworks automatically constrain the location of the clipping planes, or you can constrain their location manually.

To set area culling

- 1 Click Tools ► File Options.
- 2 In the File Options dialog box, Culling tab, select the Enable check box in the Area section.
- 3 Enter a value for the screen area in pixels below which geometry objects are culled. For example, setting this value to 100 pixels means that any object within the model that would be drawn less than 10x10 pixels in size are discarded.
- 4 Click OK.

To turn on backface culling for all objects

- 1 Click Tools ► File Options.
- 2 In the File Options dialog box, Culling tab, select On in the Backface area.
- 3 Click OK.

To turn off backface culling for all objects

- 1 Click Tools ► File Options.
- 2 In the File Options dialog box, Culling tab, select Off in the Backface area.
- 3 Click OK.

To turn on backface culling only for solid objects

- 1 Click Tools ► File Options.
- 2 In the File Options dialog box, Culling tab, select Solid in the Backface area.
- 3 Click OK.

To constrain the position of the clipping planes automatically

- 1 Click Tools ► File Options.
- 2 In the File Options dialog box, click the Culling tab.
- 3 Select Automatic for the Near clipping plane.
- 4 Select Automatic for the Far clipping plane.

- 5 Click OK.

Autodesk Navisworks automatically controls the position of near and far clipping planes to give you the best view of the model.

To constrain the position of the clipping planes manually

- 1 Click Tools ► File Options.
- 2 In the File Options dialog box, click the Culling tab.
- 3 Select Constrained for the Near clipping plane, and enter the desired value in the Distance box.
- 4 Select Constrained for the Far clipping plane, and enter the desired value in the Distance box.
- 5 Click OK.

Autodesk Navisworks uses the provided values unless doing so affects the system performance (for example, makes the whole model invisible), in which case it adjusts the position of the clipping planes as necessary.

To fix the position of the clipping planes

- 1 Click Tools ► File Options.
- 2 In the File Options dialog box, click the Culling tab.
- 3 Select Fixed for the Near clipping plane, and enter the desired value in the Distance box.
- 4 Select Fixed for the Far clipping plane, and enter the desired value in the Distance box.
- 5 Click OK.

IMPORTANT Autodesk Navisworks uses the provided values even if doing so affects the system performance (for example, makes the whole model invisible).

Make Objects Required

Although Autodesk Navisworks intelligently prioritizes objects for culling in the scene, sometimes it drops out geometry that needs to remain visible while navigating.

You can make sure the objects are always rendered during interactive navigation by making them required.

To make objects required

- 1 Select geometry items that you want to remain visible during navigation in the Selection Tree.
- 2 Click Required  on the Selection Tools toolbar.
In the Selection Tree, the object appear red when required.

TIP Clicking Required  again makes the selected objects unrequired.

 **Menu:** Edit ► Required

 **Command entry:** CTRL + R

Shortcut menu:  Required

To make all objects unrequired

- Click Edit ► Reset All ► Unrequire All.

Shortcut menu: Scene ► Reset All ► Unrequire All

Control Rendering of Objects

Adjust Scene Rendering During Navigation

Your models can range in size from small models to complex supermodels. As you navigate a scene in real time, Autodesk Navisworks automatically calculates which items to render first, based on the size of items, distance from the camera, and the specified frame rate. This customizable frame rate is guaranteed by default, but can be turned off, if necessary. Items that Autodesk Navisworks does not have time to render are dropped out. These dropped items are rendered when navigation stops.

The amount of drop-out depends on several factors, such as your hardware performance (graphics card and driver), the size of the Scene Area, and the size of the model. When working with truly large supermodels in Autodesk Navisworks, you will require a sufficient amount of RAM to load and review the data.

Autodesk Navisworks employs JetStream technology which optimizes the usage of the available RAM. Before running out of memory, Autodesk Navisworks pages unnecessary data to the hard disk, freeing up space for loading to continue. JetStream technology also enables you to start navigating the supermodel, before it has been completely loaded into memory. Autodesk Navisworks is large address aware, and utilizes any additional memory assignment following the 3GB switch available on Windows XP systems.

TIP You can reduce the amount of drop-out during navigation by reducing frame rate, or switching off the Guarantee Frame Rate option.

To set the target frame rate

- 1 Click Tools ► File Options.
- 2 In the File Options dialog box, Speed tab, select the number of frames per second to be applied to the rendered display of the model.
- 3 Click OK.

To set the level of detail

- 1 Click Tools ► Global Options.
- 2 In the Options Editor, expand the Interface node, and click the Display option.
- 3 On the Display page, Detail area, select the Guarantee Frame Rate check box to maintain the target frame rate during navigation. If this check box is clear, the complete model is rendered during navigation, no matter how long it takes.
- 4 Select the Fill in Detail check box to render a complete model when navigation stops. If this check box is clear, the items dropped out during navigation are not filled in when it stops.
- 5 Select the Batch Fill check box if you want the dropped out items to be rendered in chunks rather than gradually.

NOTE This check box is clear by default, as gradual rendering gives better results for most video cards.

- 6 Click OK.

To render transparent items

NOTE If your video card supports hardware accelerated OpenGL, you can turn on the rendering of transparent items during interactive navigation. By default, transparent items are only drawn when interaction has ceased to prevent problems with display performance.

- 1 Click Tools ► Global Options.
- 2 In the Options Editor, expand the Interface node, and click the Display option.
- 3 On the Display page, Transparency area, select the Interactive Transparency check box.

- 4 Click OK.

To render parametric primitives

NOTE Modifying this option requires a restart of Autodesk Navisworks to take effect.

- 1 Click Tools ► Global Options.
- 2 In the Options Editor, expand the Interface node, and click the Display option.
- 3 On the Display page, Primitives area, select the Enable Parametric Primitives check box. The level of detail changes during navigation depending on the distance from the camera.
If you want to use the default representations of primitives, clear this check box. The level of detail stays the same during navigation.
Click OK.

Accelerate Display Performance

If your video card supports OpenGL, you can improve the graphical performance by turning on hardware acceleration and occlusion culling.

Using the hardware acceleration usually gives you better and faster rendering. However, some graphics cards may not function well in this mode in which case switching this option off is recommended.

Occlusion culling can significantly improve performance in situations when much of the model is not visible. For example, when you walk down the corridor of a building, the walls occlude most geometry outside the corridor. Other rooms are only visible through doorways or windows. Turning on occlusion culling dramatically reduces the rendering load in such cases.

To use hardware acceleration

NOTE If your video card does not support OpenGL hardware acceleration, this option is not available.

- 1 Click Tools ► Global Options.
- 2 In the Options Editor, expand the Interface node, and click the Display option.
- 3 On the Display page, Acceleration area, select the Hardware Acceleration check box. This allows Autodesk Navisworks to utilize any available OpenGL hardware acceleration on your video card.

NOTE If your video card drivers do not function well with Autodesk Navisworks, clear this check box.

- 4 Click OK.

To use occlusion culling

- 1 Click Tools ► Global Options.
- 2 In the Options Editor, expand the Interface node, and click the Display option.
- 3 On the Display page, Acceleration area, select the Occlusion Culling check box.
- 4 Click OK.

NOTE Occlusion culling can only be used on a machine with an OpenGL 1.5 compliant graphics card.

Adjust Presenter Materials

You can adjust the appearance of Presenter materials in the Scene Area to get optimum performance from your graphics card when navigating around heavily textured scenes.

See also:

- [“Presenter Page”](#) on page 405

Stereo Rendering

Stereoscopic viewing in Autodesk Navisworks allows the viewing of the 3D model through stereo-enabled hardware, including active and passive stereo viewing glasses in conjunction with both CRT screens and dedicated projectors.

IMPORTANT Using stereo rendering requires the host computer have an OpenGL graphics card with stereo support. Additionally, some drivers require stereo to be explicitly enabled in the driver and may require lower color or resolution settings before the stereo rendering becomes available.

When the video output is in stereo mode, the view looks blurred without the correct glasses being worn. If the camera is in orthographic mode, it needs to be set to perspective for the effect to work correctly.

NOTE As the view for each eye has to be rendered separately it is not possible to support incremental filling in of detail in stereo mode. The detail appears when rendering is complete. Progress can be seen using the bar in the status area, and it is still possible to interrupt and start interacting again at any time.

In focal point-based navigation modes (such as examine, orbit, and turntable) the model is positioned so that parts closer than the focal point appear in front of the screen, with the rest behind. In other navigation modes (such as walk and fly), the focal point is set so that any avatar will be level with the screen. Objects between you and the avatar will appear in front of the screen. You can adjust the out of screen effect in the Stereo Options dialog box.

To enable stereo rendering

- Click View ► Stereo.

NOTE This option is only available if you have the required hardware, and the correct driver and display settings.

To adjust the stereo effects

- 1 Click View ► Stereo Options.
- 2 In the Stereo Options dialog box, move the Magnitude slider to vary the strength of the effect.
- 3 To adjust the out of screen effect, select the Enable check box, and then move the slider to control how much of the scene appears out of the screen during navigation.
- 4 If you need to swap the left and right eyes over, select the Swap Eyes check box. This can be useful when moving from CRT to a large screen projector and back.
- 5 Click OK.

Review Your Model

8

Select Objects

With large models it is potentially a very time-consuming process to select items of interest. Autodesk Navisworks makes this a much simpler task by providing a range of functions for quickly selecting geometry both interactively and by searching the model manually and automatically.

Interactive Geometry Selection

In Autodesk Navisworks, there is a concept of an active selection set (the currently selected items, or the current selection) and saved selections sets. Selecting and finding items makes them part of the current selection, so you can hide them or override their colors. At any time, the current selection can be saved and named for retrieval in later sessions.

Selecting items makes them part of the current selection, so you can hide them or override their colors.

You can use several methods to interactively select items into the current selection. You can use the tabs in the Selection Tree, select items directly in the Scene Area with select and select box modes, and you can select other items with similar properties to an existing selection using the selection commands.

NOTE Right-clicking any item in the Selection Tree or Scene Area opens a shortcut menu.

You can also customize the level at which you select items ([selection resolution](#)), and modify the highlighting method for the items selected in the Scene Area.

Selection Tree Window

The Selection Tree is a dockable window, which displays a variety of hierarchical views of the structure of the model, as defined by the CAD application in which the model was created.

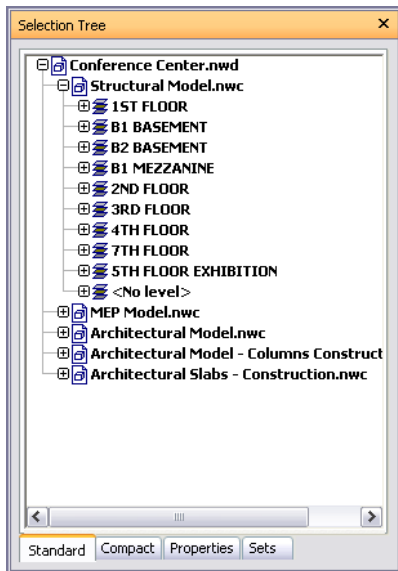

Autodesk Navisworks uses this hierarchical structure to identify object-specific paths (from the file name down to a particular object).

By default there are four tabs:

- **Standard.** Displays the default tree hierarchy, including all instancing. The contents of this tab can be sorted alphabetically.
- **Compact.** Displays a simplified version of the hierarchy on the Standard tab, omitting various items. You can customize the level of complexity of this tree in the Options Editor.
- **Properties.** Displays the hierarchy based on the items' properties. This enables simple manual searching of the model by item property.
- **Sets.** Displays a list of selection and search sets. If no selection and search sets have been created, this tab is not shown.

NOTE The list of the items on the Sets tab is exactly the same as the list on the Selection Sets dockable window.

- **Sets.** Displays a list of selection and search sets. If no selection and search sets have been created, this tab is not shown.

Additional customized Selection Tree tabs can be added by using the Autodesk Navisworks API.

Naming of items reflects the names from the original CAD application, wherever possible. There are different tree icons representing the types of geometry making up the structure of the model. Each of these item types can be marked as hidden (gray), unhidden (dark blue) or required (red).

NOTE If a group is marked as hidden or required, then all instances of that group are marked as hidden or required. If you want to operate on a single occurrence of an item, then you should mark the instanced group (the level above, or the “parent”, in the hierarchy) hidden or required.

To toggle the Selection Tree

- Click Selection Tree  on the Workspace toolbar.

 **Menu:** View ► Control Bars ► Selection Tree

 **Command entry:** CTRL + F12

To use the Selection Tree to select objects

- 1 Open the Selection Tree, and click the Standard tab.

- 2 Click an object in the Selection tree to select the corresponding geometry in the Scene Area.

NOTE When you select an item in the tree, individual geometry or a group of geometry is selected in the Scene Area depending on chosen selection resolution.

- 3 To select several items at the same time, use the SHIFT and CTRL keys. CTRL allows multiple selection item by item, and SHIFT allows multiple selection between the first and last items selected.
- 4 To remove selection from an object in the Selection Tree press ESC.

To change the sort order on the Standard tab







- 1 Open the Selection Tree, and click the Standard tab.
- 2 Right-click any item in the tree and click Scene ► Sort. The contents of the tab is now ordered alphabetically.



NOTE You cannot use the Undo  option to reverse this action.

To customize the contents of the Compact tab

- 1 Click Tools ► Global Options.
- 2 In the Options Editor, expand the Interface node, and click the Selection option.
- 3 On the Selection page, select the required level of detail in the Compact Tree box. Choose from the following options:
 - **Models** - the tree is restricted to displaying model files only.
 - **Layers** - the tree can be expanded down to the layer level.
 - **Objects** - can be expanded down to the objects level, but without the levels of instancing shown on the Standard tab.
- 4 Click OK.

Quick Reference

Icon	Description
	A model, such as a drawing file or design file.
	A layer or level.
	A group, such as a block definition from AutoCAD or cell definition from MicroStation.
	An instanced group, such as an inserted block from AutoCAD or cell from MicroStation. If in the imported file the instance was unnamed, Autodesk Navisworks names the instance to match its child's name.
	An item of geometry, such as a polygon.
	An instanced item of geometry, such as an instance from 3D Studio.

Icon	Description
	A composite object. A single CAD object that is represented in Autodesk Navisworks by a group of geometry items.
	Saved selection set.
	Saved search set.

Selection Modes

There are two selection modes available from the Selection Tools toolbar to control how you select geometry.



As standard, selection modes are mutually exclusive to [navigation modes](#), and [SteeringWheels](#), so that when you are selecting you cannot navigate and vice versa.

NOTE When using a SpaceBall in conjunction with the standard mouse control, the SpaceBall can be configured for navigation and the mouse for selecting. See “[SpaceBall](#)” on page 159 for more information.

Selecting geometry in the Scene Area automatically selects the corresponding objects in the Selection Tree.

Holding the SHIFT key whilst selecting items in the Scene Area cycles through the selection resolution, allowing you to get more specific with your selections.

You can use the Options Editor to customize the distance from an item you have to be for it to be selected (pick radius). This is useful when you select lines and points.

Select Mode

In select mode, you can click an item in the Scene Area to select it. Once a single item is selected, its properties are shown in the Properties window.

Select Box Mode

In select box mode, you can select multiple items in the model by dragging a rectangular box around the area you want to make your current selection.

To use select mode to select geometry

- 1 Click  on the Selection Tools toolbar.
- 2 Click an item in the Scene Area to select it.
- 3 To select multiple geometry, press and hold down the CTRL key while clicking items in the scene.
- 4 To remove items from the current selection, hold down the CTRL key while clicking them again. Alternatively, press the ESC key to to remove all items from the current selection.

 **Menu:** Edit ► Select ► Select

 **Command entry:** CTRL + 1

To use select box mode to select geometry

- 1 Click  on the Selection Tools toolbar.
- 2 Drag a box with the left mouse button over the Scene Area to select all items within the box.

TIP Holding down the SHIFT key while dragging the box selects all items within and that intersect the box.

- 3 To select multiple geometry, press and hold down the CTRL key while dragging a box in the scene.

- 4 To remove items from the current selection, press the ESC key.

To set the pick radius

- 1 Click Tools ► Global Options.
- 2 In the Options Editor, expand the Interface node, and click the Selection option.
- 3 On the Selection page, enter the radius in pixels that an item has to be within in order to be selected. The valid values are between 1 and 9.
- 4 Click OK.

Selection Commands

Selection commands enable you to quickly alter the current selection using logic. You can select multiple items based on the currently selected items' properties, or quickly invert the set, select everything or nothing.

To select items with selection commands

- 1 Click Edit ► Select.
- 2 Click the required selection command.

Quick Reference

The selection commands are as follows:

- **Select All.** Selects all items contained within the model.
- **Select None.** Deselects everything in the model.
- **Invert Selection.** Currently selected items become deselected and vice versa.
- **Selection Sets.** Provides you with options to save and recall selection and search sets.
- **Select Multiple Instances.** Selects all instances (sometimes called insertions) of the currently selected geometry group that occur in the model.
- **Select Same Name.** Selects all items in the model that have the same name as the currently selected item.
- **Select Same Type.** Selects all items in the model that have the same type as the currently selected item.
- **Select Same <Property>.** Selects all items with the same property as the currently selected item. This property can be any searchable property currently attached to the item, for example material or hyperlink.

NOTE Using the **Select Same <Property>** command works by comparing items' properties. If you have multiple items selected when you perform a selection command of same name or type and so on, all the types, names and properties of the items in the current selection are compared with all items' properties in the scene. The items with properties matching any properties of the currently selected items are selected.

Set Selection Resolution

When you click an item in the Scene View, Autodesk Navisworks doesn't know what level of item to start selecting at - do you mean the whole model, or the layer, or the instance, or group, or just the geometry? The default selection resolution specifies a starting point for the object path in the Selection Tree so that Autodesk Navisworks can locate and select the item.

You can customize the default selection resolution in the Options Editor. Or you can use a quicker way, by right-clicking any item in the Selection Tree and clicking Set Selection Resolution to X, where X is one of the available selection resolutions.

If you find you have selected the wrong level of item, you can interactively cycle through the selection resolution, without having to go to the Options Editor or the Selection Tree. You can do this by holding down the SHIFT key when clicking an item. This selects an item one level more specific each time you click the item until the resolution gets to "geometry", at which point it reverts back to "model". Clicking on a different item reverts the selection resolution back to default (as set in the Options Editor).

To set the default selection resolution

- 1 Click Tools ► Global Options.
- 2 In the Options Editor, expand the Interface node, and click the Selection option.
- 3 On the Selection page, select the required starting point for the object path in the Resolution box.
- 4 Click OK.

Quick Reference

The available options for selection resolution are as follows:

- **Model.** Makes the object path start at the model node; as a result, all objects in the model are selected.
- **Layer.** Makes the object path start at the layer node; as a result all objects within a layer are selected.
- **First Object.** Makes the object path start at the highest level of objects below the layer node, if applicable.
- **Last Object.** Makes the object path start at the lowest level of objects in the Selection Tree. Autodesk Navisworks looks for composite objects first, and if none are found, the geometry level is used instead. This is the default option.
- **Last Unique.** Makes the object path start at the first unique level of objects (not multiple-instanced) in the Selection Tree.
- **Geometry.** Makes the object path start from the geometry level in the Selection Tree.

Set Highlighting Method

You can use the Options Editor to customize color and method of highlighting geometry selected in the Scene Area.

There are three types of highlighting:

- Shaded

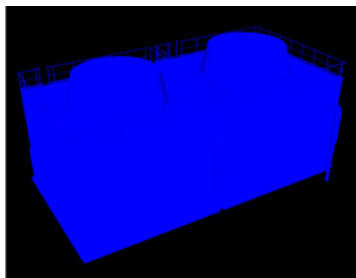

- Wireframe

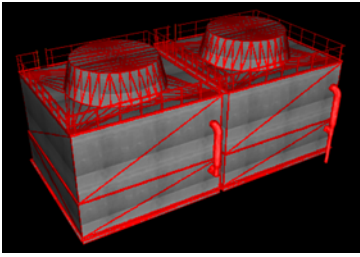

■ Tinted

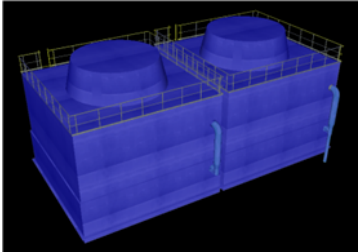

To toggle highlighting of selected objects

- 1 Click Tools ► Global Options.
- 2 In the Options Editor, expand the Interface node, and click the Selection option.
- 3 On the Selection page, Highlight area, select the Enabled check box, if you want the selected items to be highlighted in the Scene Area. Clear this check box, if you don't want any highlighting.
- 4 Click OK.

To customize the way objects are highlighted

- 1 Click Tools ► Global Options.
- 2 In the Options Editor, expand the Interface node, and click the Selection option.
- 3 Make sure the Enabled check box is selected.
- 4 Use the Method drop-down list to select the type of highlighting you want (Shaded, Wireframe or Tinted).
- 5 Click the Color palette to select the highlight color.
- 6 If you selected Tinted in the Method box, use the slider to adjust the Tint Level.
- 7 Click OK.

Hide Objects

Autodesk Navisworks provides tools that can be used to hide and display objects or groups of objects. Hidden objects are not drawn in the Scene Area.

Hide Selected Objects

You can hide the objects in the current selection so that they are not drawn in the Scene Area. This is useful when you want to remove specific parts of the model. For example, when you walk down the corridor of building, you may want to hide a wall that occlude your view of the next room.

Hide Unselected Objects

You can hide all items except those currently selected so that they are not drawn in the Scene Area. This is useful when you only want to see specific parts of the model.

NOTE In the Selection Tree, the items appear gray when marked as hidden.

To make selected objects hidden

- 1 In the Scene Area, select all items you want to hide.
- 2 Click Hidden  on the Selection Tools toolbar.
The selected objects are now invisible.

TIP Clicking Hidden  again displays the invisible objects.

 **Menu:** Edit ► Hidden

 **Command entry:** CTRL + H

Shortcut menu:  Hidden

To make unselected items hidden

- 1 In the Scene Area, select all items you want to review.
- 2 Click Unselected Hidden  on the Selection Tools toolbar.
Only the selected geometry remains visible.

TIP Clicking Unselected Hidden  again displays the invisible objects.

 **Menu:** Edit ► Unselected Hidden

Shortcut menu:  Unselected Hidden

To reveal all hidden objects

- Click Edit ► Reset All ► Unhide All.

Shortcut menu: Scene ► Reset All ► Unhide All

Find Objects

Finding is a quick and powerful way of selecting items into the current selection based on items' properties.

You can use the Find Items window to set up and run a search, which can then be saved and re-run in later sessions or shared with other users.

You can also use Quick Find, which is a faster way of searching. It simply looks for the specified string in all property names and values attached to items in the scene.

Find Items Window

The Find Items window is a floating window that enables you to search for items having a common property or combination of properties.

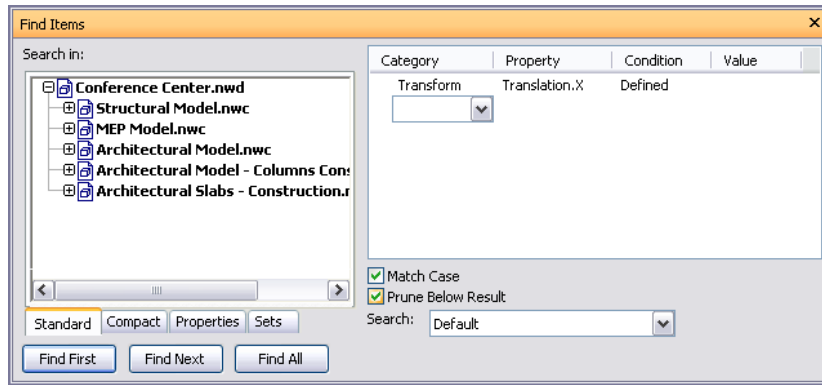

The left pane contains the Find Selection Tree with several tabs at the bottom, and enables you to select the level of item to start searching at; this can be a file, a layer, an instance, a selection set, and so on.

The tabs are the same as on the Selection Tree window:

- **Standard.** Displays the default tree hierarchy, including all instancing.
- **Compact.** Displays a simplified version of the tree hierarchy.
- **Properties.** Displays the hierarchy based on the items' properties.
- **Sets.** Displays a list of selection and search sets. If no selection and search sets have been created, this tab is not shown.

NOTE The list of the items on the Sets tab is exactly the same as the list on the Selection Sets window.

The right pane enables you to add the search statements (or conditions). And the buttons enable you to find the qualifying items in your scene.

Defining Search Statements

A search statement contains a property (a combination of category name and property name), a condition operator, and a value to be tested against the selected property. For example, you can search for Material that Contains Chrome.

By default, all items that match your statement criteria are found (for example, all objects that use chrome material). You can also negate a statement, in which case, all items that do not match your statement criteria are found instead (for example, all objects that do not use chrome material).

Each category and property name has two parts - a user string which is shown in the Autodesk Navisworks interface, and an internal string which is not shown, and is mainly used by the API. By default, the items are matched on both parts, but you can instruct Autodesk Navisworks to match only on one part, if necessary. For example, you can ignore user names in searches, and match items on their internal names only. This can be useful when you plan on sharing your saved searches with other users who may be running localized versions of Autodesk Navisworks.

The statements that do not use default settings are identified by this icon: ✱. It appears, for example, when you negate a statement, or choose to ignore the upper and lower cases in property values.

Combining Search Statements

Search statements are read from left to right. By default, all statements are ANDed. For example: "A AND B", "A AND B AND C".

You can arrange your statements into groups. For example, "(A AND B) OR (C AND D)". ORed statements are identified by a plus icon: +. All statements preceding the ORed statement are ANDed, and all statements following the ORed statement are ANDed. So to create two groups in the previous example, you need to mark statement C as ORed.

There are no parentheses to visually show you the way the statements are read. Simple statements such as "A OR B" will not be misinterpreted. For complex searches, the order and groupings of the statements is more

important, especially if you choose to negate some statements. For example, "(A AND B) OR (C AND NOT D)". When search conditions are evaluated, NOT is applied before AND, and AND is applied before OR.

To toggle the Find Items window

- Click Find Items  on the Workspace toolbar.

 **Menu:** View ► Control Bars ► Find Items

 **Command entry:** SHIFT + F3

To find objects

- 1 Open the Find Items window.
- 2 On the Find Selection Tree, click the items where you want to start searching from. For example, if you want to search the whole model, click the Standard tab, press and hold CTRL, and click all files that comprise the model. If you want to limit your search to a selection set, click the Sets tab, and click the required set.
- 3 Define a search statement:
 - a Click the Category column, and select the property category name from the drop-down list, for example, 'Item'.
 - b In the Property column, select the property name from the drop-down list, for example, 'Material'.
 - c In the Condition column, select the condition operator, for example, 'Contains'.
 - d In the Value column, type in the property value to search for, for example, 'Chrome'.
 - e If you want to make your search statement case-insensitive, right-click it, and click Ignore String Value Case.
- 4 Define more search statements, if required.

By default, all statements are ANDed. This means that they all need to be true for an item to be selected. You can make a statement use OR logic, by right-clicking it and clicking Or Condition. If you are using two statements, and marked the second one as ORed, this means that an item will be selected if either of these statements is true.
- 5 Click the Find All button. The search results are highlighted in the Scene Area and the Selection Tree.

To save current search

- 1 Open the Selection Sets window.
- 2 Right-click anywhere in the window, and click Add Current Search.
- 3 Type a name for your search set, and press ENTER.

 **Menu:** Edit ► Select ► Selection Sets ► Add Current Search

To export a current search

- 1 Click File ► Export ► Current Search XML.
- 2 In the Export dialog box, browse to the desired folder.
- 3 Enter a name for your file, and click Save.

To import a saved search

- 1 Click File ► Import Search XML.
- 2 In the Import dialog box, brose to the folder containing the file with the save search criteria, and select it.
- 3 Click Open.

Quick Reference

Search Options

Category Selects the category name. Only the categories that are contained in the scene are available in the drop-down list.

Property Selects the property name. Only the properties in the scene within the category chosen are available in the drop-down list.

Condition Selects a condition operator for your search. You can use the following operators depending on the property you are searching for:

- **=**. Equals; can be used to evaluate any type of property. To qualify for the search, a property must match the specified value exactly.
- **Not Equals** . Can be used to evaluate any type of property.
- **<** - Greater Than; can be used to evaluate numerical property types only.
- **<=** - Greater Than or Equals; can be used to evaluate numerical property types only.
- **>** - Less Than; can be used to evaluate numerical property types only.
- **>=** - Less Than or Equals; can be used to evaluate numerical property types only.
- **Contains**. To qualify for the search, a property must contain the specified value (for example, series of letters within a string).
- **Wildcard**. Enables you to use wildcards in the Value field to allow matching against any character (?) or an arbitrary sequence of characters (*).
- **Defined**. To qualify for the search, a property must have some value defined.
- **Undefined**. To qualify for the search, a property must not have any defined value.

Value You can either type in a value freely in this box, or choose a pre-defined value from the drop-down list which shows all values in the scene available within the category and property you defined earlier. If you used Wildcard as the condition operator, you can type a value with wildcards. To match one single unspecified character use the symbol ? (question mark). To match any number of unspecified characters, use the symbol * (asterisk). For example, "b??k" will match "brick" and "block"; "b*k" will match "bench kiosk", "brick", and "block"; and "*b*k*" will match "bench kiosk", "brick" and "block" and also "Coarse bricks" and "block 2".

This box is not available if you used Defined or Undefined as the condition operator.

Match Case Select this check box to respect the upper and lower case letters of the values tested during the search. This affects all statements in your search. It's also possible to set case sensitivity for individual search statements by using the Search Conditions shortcut menu.

Prune Below Result Select this check box if you want to stop searching a branch of the Find Selection Tree as soon as the first qualifying object is found.

Search Specifies the type of the search to run. Choose from:

- **Default**. Searches all items selected in the Find Selection Tree, along with the paths below these items, for qualifying objects.
- **Below Selected Paths**. Only searches below the items selected in the Find Selection Tree for qualifying objects.
- **Selected Paths Only**. Only searches within the items selected in the Find Selection Tree for qualifying items.

Find Selection Tree Shortcut Menu

Select Changes the selection you made in the Scene Area to the current selection in the Find Selection Tree.

Import Current Selection Changes the selection in the Find Selection Tree to your current selection the Scene Area.

Search Conditions Shortcut Menu

Ignore String Value Case Makes the selected search statement case-insensitive (for example, both 'Chrome' and 'chrome' materials are treated as qualifying).

Ignore Category User Name Instructs Autodesk Navisworks to use internal category names and ignore the user category names for the selected search statement.

Ignore Category Internal Name Instructs Autodesk Navisworks to use user category names and ignore the internal category names for the selected search statement.

Ignore Property User Name Instructs Autodesk Navisworks to use internal property names and ignore the user property names for the selected search statement.

Ignore Property Internal Name Instructs Autodesk Navisworks to use user property names and ignore the internal category names for the selected search statement.

Or Condition Chooses OR condition for the selected search statement.

Negate Condition Negates the selected search statement, so that all items that do not match the statement criteria are found.

Delete Condition Deletes the selected search statement.

Delete All Conditions Deletes all search statements.

Buttons

Find First Finds the first qualifying item, and selects it in the Scene Area and the Selection Tree.

Find Next Finds the next qualifying item, and selects it in the Scene Area and the Selection Tree.

Find All Finds all qualifying items, and highlights them in the Scene Area and the Selection Tree.

TIP Click Unselected Hidden  on the Selection Tools toolbar to display only the search results in the Scene Area.

Quick Find

To locate and select the objects quickly, use the Quick Find feature.

To quickly find items

- 1 Click Edit ► Quick Find.
- 2 In the Quick Find dialog box, type in the text to search for in all item's properties. This can be a word or a few words. The search is not case-sensitive.
- 3 Click Find Next. Autodesk Navisworks finds and selects the first item in the Selection Tree that matches the entered text, selects it in the Scene Area, and stops the search.
- 4 To repeat the search, click Edit ► Quick Find Next. If there are any more items that match the entered text, Autodesk Navisworks selects the next one in the Selection Tree, selects it in the Scene Area, and stops the search.

 **Command entry:** To use Quick Find: CTRL + F. To Find Next: F3

Create and Use Sets of Objects

In Autodesk Navisworks, you can create and use sets of like objects. This makes it easier to review and analyze your model.

Selection Sets

Selection sets are static groups of items, and are useful for saving a group of objects that you want to regularly perform some action on, such as hiding them, changing transparency and so on. They simply store a group of

items for later retrieval. There is no intelligence behind this set - if the model changes at all, the same items are selected (assuming they are still available in the model) when recalling the selection set.



Search Sets

Search sets are dynamic groups of items, and work in a similar way to selection sets, except that they save search criteria instead of the results of a selection, so that you can re-run the search at a later date as and when the model changes. Search sets are much more powerful and can save you time, especially if your CAD files are continuing to be updated and revised. It is also possible to export search sets, and share them with other users.

Selection Sets Window

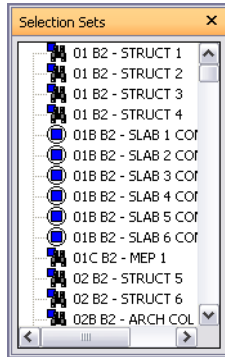
The Selection Sets is a dockable window, which displays both selection sets and search sets available in your Navisworks file.



The selection sets are identified by this icon: , and the search sets are identified by this icon: .

NOTE The list of the items on the Selection Sets window is exactly the same as the list on the Sets tab of the Selection Tree.

You can customize the names of selection and search sets, and add comments. You can also show the selection and search sets as [links](#) in the Scene Area. These links are created automatically by Navisworks. Clicking on a link restores the geometry within the corresponding selection or search set to the active selection, and highlights it in the Scene Area and on the Selection Tree.

You can use the Selection Set shortcut menu to create and manage selection and search sets in the Navisworks file.

To toggle the Selection Sets window

■ Click Selection Sets  on the Workspace toolbar.

 **Menu:** View ► Control Bars ► Selection Sets

 **Command entry:** SHIFT + F2

To use the Selection Sets window to select objects

- 1 Open the Selection Sets window.
- 2 Click the desired set in the list. The geometry in this set is selected in the Scene Area and in the Selection Tree.

NOTE If you clicked on a search set, the search is performed on the current model, looking for all geometry that meets the search criteria, including any additional geometry that could have been added to the file.

 **Menu:** Edit ► Select ► Selection Sets ► <Saved Set>

To change the sort order on the Selection Sets window

- 1 Open the Selection Sets window.
- 2 Right-click any item in the list, and click Sort. The contents of the tab is now ordered alphabetically.

Quick Reference

The Selection Set shortcut menu has the following options:

- **New Folder.** Creates a folder above the selected item.
- **Add Current Selection.** Saves the current selection as a new selection set in the list. This set contains all currently selected geometry.
- **Add Current Search.** Saves the current search as a search set in the list. This set contains the current search criteria.
- **Make Visible.** If the geometry in the selected search or selection set is hidden, you can use this option to make it visible.
- **Add Copy.** Creates a copy of the search or selection set highlighted in the list. The copy has the same name as the original set, but with a **(X)** suffix, where **X** is the next available number.
- **Add Comment.** Opens the Add Comment dialog box for the selected item.
- **Edit Comment.** Opens the **Edit Comment** dialog box for the selected item.
- **Update.** Updates the selected search set with the current search criteria, or updates the selected selection set with the currently selected geometry.
- **Delete.** Deletes the selected search or selection set.
- **Rename.** Renames the selected search or selection set. By default, new selection sets are named **Selection SetX**, and search sets are named **Search SetX**, where **X** is the next available number added to the list.
- **Sort.** Orders the contents of the Search Sets window alphabetically.
- **Help.** Launches the online Help system and displays the topic for selection and search sets.

Create and Manage Selection and Search Sets

You can add, move and delete selection and search sets, and organize them into folders.

Search and selection sets can be updated. You can modify your current selection in the Scene Area, or the current search criteria, and change the contents of your set to reflect this.

You can also export search sets and reuse them. For example, if models contain the same components, such as steel structure, ventilation ductwork, and so on, you can define generic search sets, export them as an XML file, and share with other users.

To save a selection set

- 1 Open the Selection Sets window.
- 2 Select all the items that you want to save in the Scene Area or on the Selection Tree.
- 3 Right-click the Selection Sets window, and click Add Current Selection.
- 4 Type a name for your selection set, and press ENTER.

 **Menu:** Edit ► Select ► Selection Sets ► Add Current Selection

To save a search set

- 1 Open the Find Items window, and set up the desired search criteria.

- 2 Click the Find All button to run the search. All items that satisfy your criteria are now selected in the Scene Area and the Selection Tree.
- 3 Open the Selection Sets window, right-click, and click Add Current Search.
- 4 Type a name for your search set, and press ENTER

 **Menu:** Edit ► Select ► Selection Sets ► Add Current Search

To rename a search or selection set

- 1 Open the Selection Sets window.
- 2 Right-click the desired search or selection set, and click Rename.
- 3 Type a new name for your set, and press ENTER.

 **Command entry:** F2

To delete a search or selection set

- 1 Open the Selection Sets window.
- 2 Right-click the search or selection set you want to remove, and click Delete.

To organize selection and search sets into folders

- 1 Open the Selection Sets window.
- 2 Right-click, and click New Folder on the shortcut menu. The folder is added to the list.
If, when you right-click, the item selected is a folder, then the new folder is created inside it, otherwise it is added above the selected item. You can have as many folders as you like.
- 3 Type a name for your folder, and press ENTER.

TIP Use names that can help you to identify your sets in future.

- 4 Click the set that you want to add to your new folder. Hold down the left mouse button and drag the mouse to the folder name. Release the mouse button to drop the set into the folder.

TIP You can also drag the folders themselves, together with their contents.

To update a selection set

- 1 Select the desired geometry in the Scene Area or on the Selection Tree.
- 2 Open the Selection Sets window.
- 3 Right-click the selection set you want to modify, and click Update.

To update a search set

- 1 Open the Find Items window, and run a new search.
- 2 Open the Selection Sets window.
- 3 Right-click the search set you want to modify, and click Update.

To export search sets

- 1 Click File ► Export ► Search Sets XML.
- 2 In the Export dialog box, browse to the desired folder.
- 3 Enter a name for your file, and click Save.

To import search sets

- 1 Click File ► Import ► Search Sets XML.
- 2 In the Import dialog box, brose to the folder containing the file with the search sets, and select it.
- 3 Click Open.

Compare Objects

You can look for differences between any two selected items in the scene. These items can be files, layers, instances, groups, or just geometry.

You can also use this feature to investigate the differences between two versions of the same model.

During the comparison, Autodesk Navisworks starts at the level of each item, and recursively travels down each path on the Selection Tree, comparing each item it comes across in terms of the criteria you requested.

When the comparison is finished, the results can be highlighted in the Scene Area. The following color-coding is used by default:

- **White.** Matching items.
- **Red.** Items with differences.
- **Yellow.** The first item contains things not found in the second item.
- **Cyan.** The second item contains things not found in the first item.

You can save the comparison results as selection sets with automatic comments describing the found differences in more detail.

To compare two versions of the model

- 1 Open the first file that you want to compare in Autodesk Navisworks.
- 2 Click File ► Append, locate the second file, and click Open.
- 3 Hold down CTRL key, and select both files.
- 4 Click Tools ► Compare.
- 5 In the Compare dialog box, the Find Differences In area, select the check boxes for all required options.

NOTE The Overridden Material and Overridden Transform check boxes relate to changing the color and transparency in Autodesk Navisworks, and changing a file's origin, scale or rotation since loading into Autodesk Navisworks, respectively. These check boxes are clear by default. All the other criteria relate to properties of items from the original CAD model.

- 6 In the Results area, select the check boxes to control how the comparison results are displayed:
 - **Save as Selection Sets.** Saves the items that you are comparing as a selection set. You can then use this set for later comparisons between the same items.
 - **Save Each Difference As Set.** Saves the resulting differences found in the comparison between the two items as a selection set for later analysis. The selection set will also have a comment attached detailing the differences in more depth.
 - **Remove Old Results.** Removes any selection sets resulting from a previous comparison, in order to reduce confusion when looking at the results.
 - **Hide Matches.** Hides all items that turn out to be the same in the comparison, when the comparison finishes.
 - **Highlight Results.** Highlights each resulting difference with a color override, when the comparison finishes. You can reset the colors back by clicking Edit ► Reset All ► Colors and Transparencies.

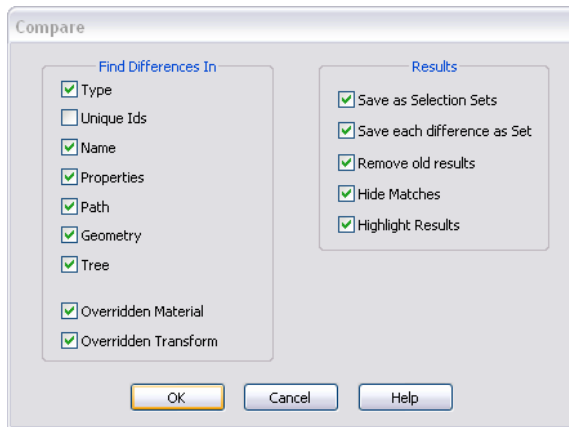

7 Click OK.

To compare two items in the model

- 1 Select exactly two items in the scene.
- 2 Click Tools ► Compare.
- 3 Use the Compare dialog box to set up the comparison search.
- 4 Click OK.

Object Properties

Autodesk Navisworks supports the conversion of object properties for many file formats. For more details on supported/unsupported entities, see “[Use File Readers](#)” on page 91.

Properties Window

Once brought into Autodesk Navisworks, the object properties can be examined in the Properties window.

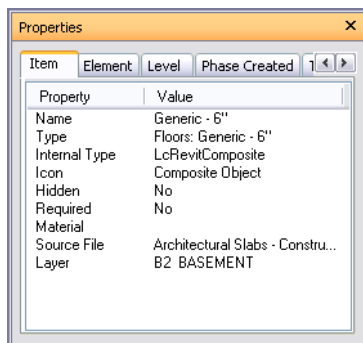

This is a floating window, which has a dedicated tab for each property category associated with the currently selected object.

Internal file properties, such as transform and geometry properties, are not shown by default. The Options Editor enables you to switch this on.

You can use the Properties shortcut menu to create and manage custom object properties, and [links](#).

You can also bring more object properties into Autodesk Navisworks from external databases, and show on the database-specific tabs in the Properties window.

To toggle the Properties window

- Click Properties  on the Workspace toolbar.

 **Menu:** View ► Control Bars ► Properties

 **Command entry:** SHIFT + F7

To examine object's properties

- 1 Select the object of interest in the Selection Tree, or in the Scene Area.
- 2 Open the Properties window, and use the tabs to navigate between the available property categories.

NOTE If more than one object is selected, the Properties window only shows the number of selected items, and doesn't show any property information.

To add tabs with internal properties to the Properties window

- 1 Click Tools ► Global Options.
- 2 In the Options Editor, expand the Interface node, and click the Developer option.
- 3 On the Developer page, select the Show Internal Properties check box.
- 4 Click OK.

Quick Reference

The Properties shortcut menu has the following options:

- **Copy Value** Copies the selected value.
- **Copy Row** Copies the selected row.
- **Copy All** Copies all on the tab.
- **Edit Hyperlinks.** Opens the Edit Hyperlinks dialog box.
- **Add New User Data Tab.** Adds a custom property tab to the Properties window.
- **Delete New User Data Tab.** Deletes the currently selected custom property tab from the Properties window.
- **Insert New Property.** Adds a custom property.
- **Delete Property.** Deletes the currently selected custom property.
- **Edit Property Value.** Enables you to edit the value for all property types except Boolean.
- **Set Value.** Enables you to edit the value for Boolean property type.
- **Rename Property.** Renames the currently selected custom property.
- **Rename Tab.** Renames the currently selected custom property tab on the Properties window.

Custom Properties

Property information brought into Autodesk Navisworks from a CAD application cannot be edited, with the exception of color, transparency and links. You can, however, add your own custom information to any item in the model scene.

To add a custom property tab

- 1 Open the Properties window.

- 2 Select the object of interest in the Scene Area or on the Selection Tree.
- 3 Right-click the Properties window, and click Add New User Data Tab. The new property category is added for the currently selected object. By default, the tab is called User Data.

To rename a custom property tab

- 1 Open the Properties window.
- 2 Click the custom tab you want to rename.
- 3 Right-click the properties area, and click Rename Tab.
- 4 Enter a new name for the tab in the box provided.
- 5 Click OK.

To delete a custom property tab

- 1 Open the Properties window.
- 2 Click the custom tab you want to delete.
- 3 Right-click the properties area, and click Delete User Data Tab.

To add a custom property

- 1 Open the Properties window.
- 2 Click the custom tab where you want to add a property.
- 3 Right-click the properties area, click Insert New Property, and click the property type you want to add. Choose:
 - **String** - if the property value is a string
 - **Boolean** - if the property value is Yes or No
 - **Float** - if the property value is a decimal value, for example: 1.234
 - **Integer** - if the property value is a positive whole number (1, 2, 3,...), a negative whole number (-1, -2, -3,...), or zero (0)
- 4 Enter the name for the property in the Property box, and press ENTER.
- 5 Double-click the Value box, enter the value associated with your property into the box provided, and click OK.

NOTE For Boolean properties, double-clicking the Value box toggles between Yes and No values.

To edit a custom property

- 1 Open the Properties window.
- 2 Click the custom tab where the property you want to edit is located.
- 3 To rename the property, right-click it, click Rename Property, and enter the new name in the box provided. Click OK.
- 4 To edit the property value, right-click it, click Edit Property Value, and enter the new value in the box provided. Click OK.

NOTE For Boolean properties, click Set Value on the shortcut menu, and choose Yes or No.

To delete a custom property

- 1 Open the Properties window.

- 2 Click the custom tab where the property you want to delete is located.
- 3 Right-click the property, and click Delete Property.

External Database Links

Databases are commonly used to store large amount of data, such as equipment specifications, catalogue data, and maintenance manuals.

You can connect to external databases directly from your Navisworks files, and create links between objects in the scene and fields in the database tables to bring through extra properties.

Any database with a suitable ODBC driver is supported, but the properties for the objects in the model must include unique identifiers to the data in the database. For example, for AutoCAD-based files, entity handles can be used.

You can have as many database links as you want, but they all should have unique names. To use a database link, you need to activate it first.

Database links can be saved inside Navisworks files (NWF and NWD). You can also save database links globally, making them persistent across all Autodesk Navisworks sessions. The global connection information is saved on the local machine. If the associated database is available on loading the NWF/NWD file, the link automatically establishes itself when an object is selected. On selecting an object, if the database is available, and there is data associated with the object, Autodesk Navisworks adds an appropriate database tab to the Properties window, and displays the appropriate data.

NOTE To be able to display the data, you need to configure the connection details. You may need a database administrator to do this, as a knowledge of the database being connected to is required. You can use Navisworks tags in connection strings and SQL statements.

Data linked from a database connection can be extracted and embedded as static data within the published NWD file. It also can also be included in object searches, and can be used with the Clash Detective tool as part of the clash criteria.

You can export database links, and share them with other users.

To add a database link

- 1 If you want to add a database link to the Navisworks file:
 - a Click Tools ► File Options.
 - b In the File Options dialog box, DataTools tab, click the New button.

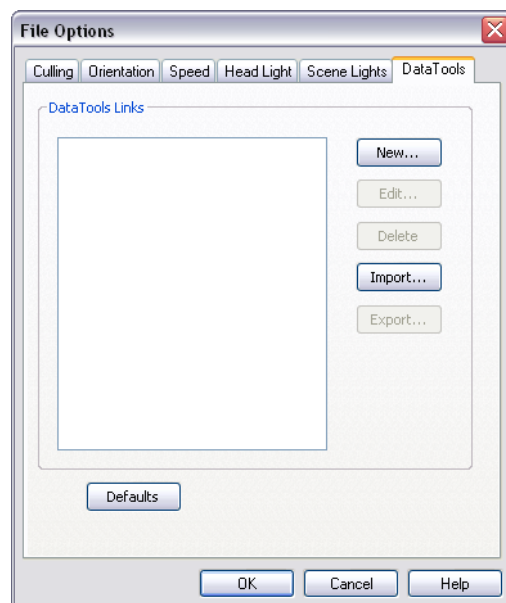

- 2 If you want to add a database link globally:
 - a Click Tools ► DataTools.
 - b In the DataTools dialog box, click the New button.

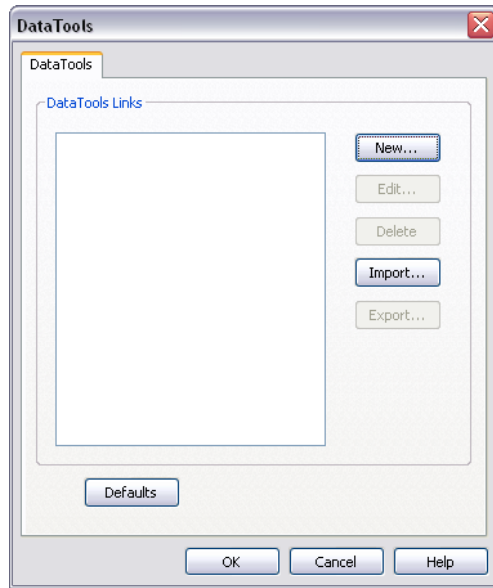

- 3 In the New Link dialog box, enter a Name for the new link, for example, 'Service Information'. This is the name of the tab that will appear on the Properties window.

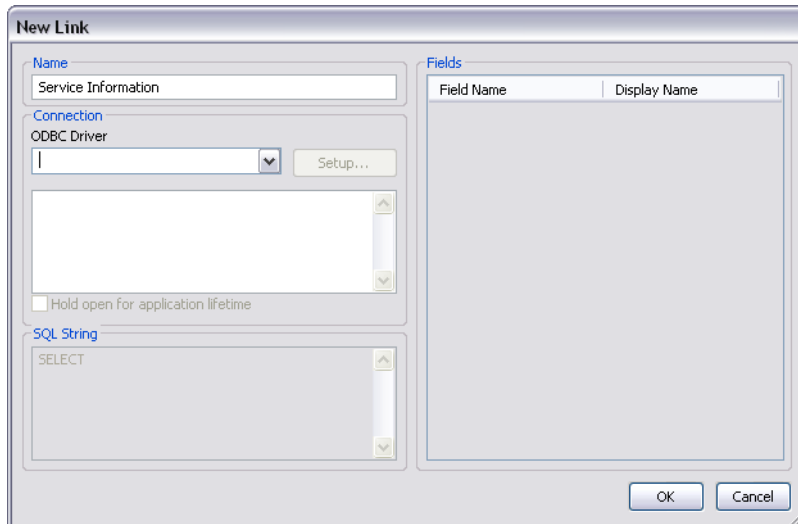

You are now ready to configure the database link.

- 4 Click OK to save the link and return to the previous dialog box.

To configure a database link

- 1 To configure a file-based database link:
 - a Click Tools ► File Options.
 - b In the File Options dialog box, DataTools tab, click the link you want to configure in the DataTools Links area, and click the Edit button.

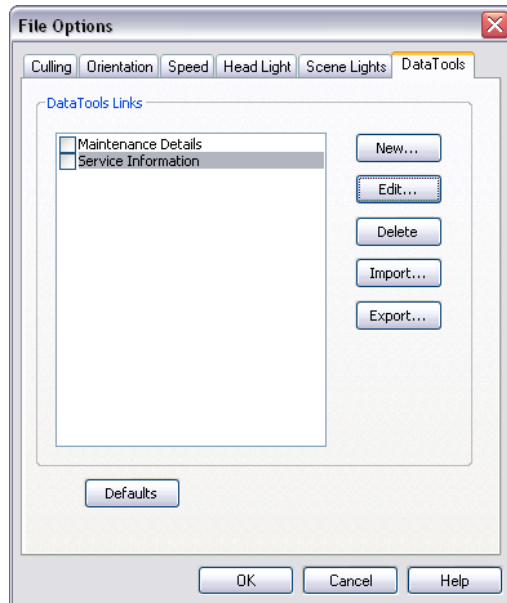

NOTE If you haven't added any links yet, click the New button, and follow the procedure for adding database links first.

2 To configure a global database link:

- a Click Tools ► DataTools
- b In the DataTools dialog box, click the link you want to configure in the DataTools Links area, and click the Edit button.

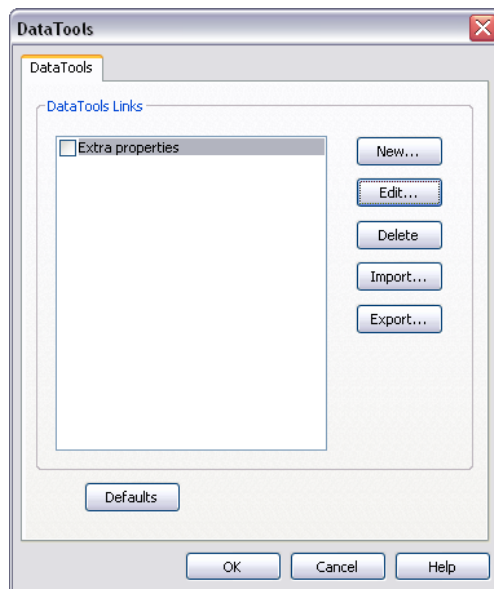

NOTE If you haven't added any links yet, click the New button, and follow the procedure for adding database links first.

3 Configure the ODBC Driver:

- a In the Edit Link dialog box, select the appropriate ODBC Driver to define the type of the database to link to, for example 'Microsoft Access Driver (*.mdb).

- b Click the Setup button. The driver wizard opens, and guides you through the setup options. If you have difficulties setting up your connection details, contact your database administrator. When you finish, the box underneath will show the connection string. This string can be modified, if necessary. For example, if you want to select a database with a certain name (say, test.mdb) that is always next to the model file (as in the resultant NWD/NWF not the original), type in:

```
DBQ=%pushpath(%poppath(%currentpath), "test.mdb"); DRIVER={Microsoft Access Driver (*.mdb)};
```

If you want to select a database with the same name as the original model file (say, AutoPlant), type in: DBQ=%join(%removeext(%removepath(%sourcepath)), ".mdb"); DRIVER={Microsoft Access Driver (*.mdb)};

- 4 Select the Hold Open for Application Lifetime check box, if you want to keep the database link open until you exit Autodesk Navisworks.
- 5 Specify which table in the database to query:

In the SQL String field, click after SELECT, and enter the selection statement, for example: SELECT * FROM tblBoilerData WHERE "NWUniqueID" = %prop("Entity Handle", "Value");

This statement instructs Autodesk Navisworks to select all columns from the tblBoilerData table, whilst requiring that the column called NWUniqueID matches a category/property pair called Entity Handle/Value.

- 6 Select which columns you want to display as link categories on the Properties window:
 - a Double-click the Fields Name field, and type the exact name of the database column, for example: "Part-time".
 - b Press ENTER.

The Display Name is automatically completed for you, but you can click it, and enter a different name, if you want. The text entered here is the category name shown on the link tab of the Properties window.
 - c Repeat the above process to list all required categories in the Fields area of the dialog box.

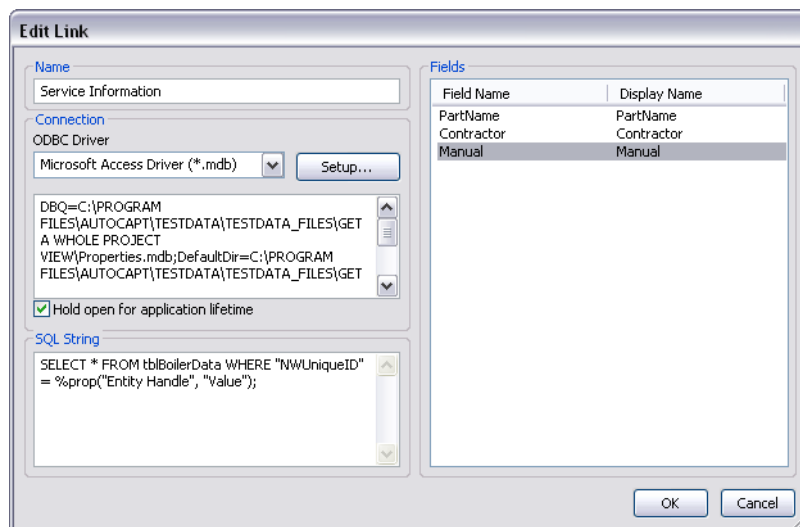

- 7 Click OK.

IMPORTANT The model is not linked to the external data source until you have activated the database link.

To delete a database link

- 1 To delete a file-based database link:
 - a Click Tools ► File Options.
 - b In the File Options dialog box, DataTools tab, click the link you want to remove in the DataTools Links area, and click the Delete button.

- 2 To delete a global database link:
 - Click Tools ► DataTools.
- 3 In the DataTools dialog box, click the link you want to remove in the DataTools Links area, and click the Delete button.
- 4 Click OK.

To activate a database link

- 1 To activate a file-based database link:
 - a Click Tools ► File Options.
 - b In the File Options dialog box, DataTools tab, select the check boxes for all links you want to activate in the DataTools Links area.
- 2 To activate a global database link:
 - a Click Tools ► DataTools.
 - b In the DataTools dialog box, select the check boxes for all links you want to activate in the DataTools Links area.
- 3 Click OK.

IMPORTANT You cannot activate links with insufficient or invalid configuration information.

To export a database link

- 1 Click Tools ► File Options.
- 2 In the File Options dialog box, DataTools tab, click the link you want to export in the DataTools Links area, and click the Export button.

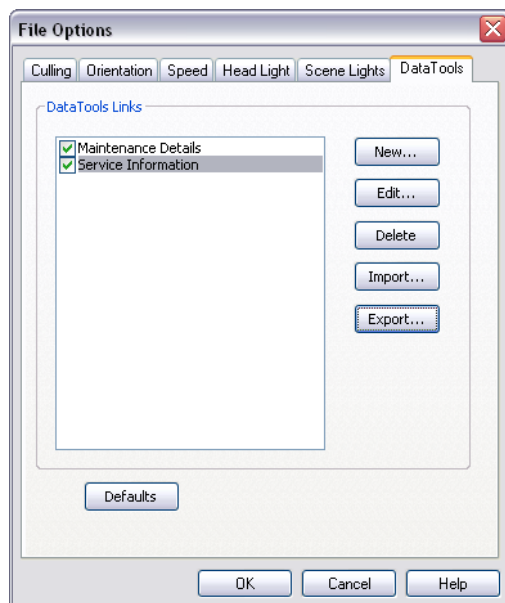

- 3 In the Save As dialog box, browse to the desired folder, and enter a name for the datatools file. You can also select the name of an existing datatools file to overwrite it with your modified configuration.

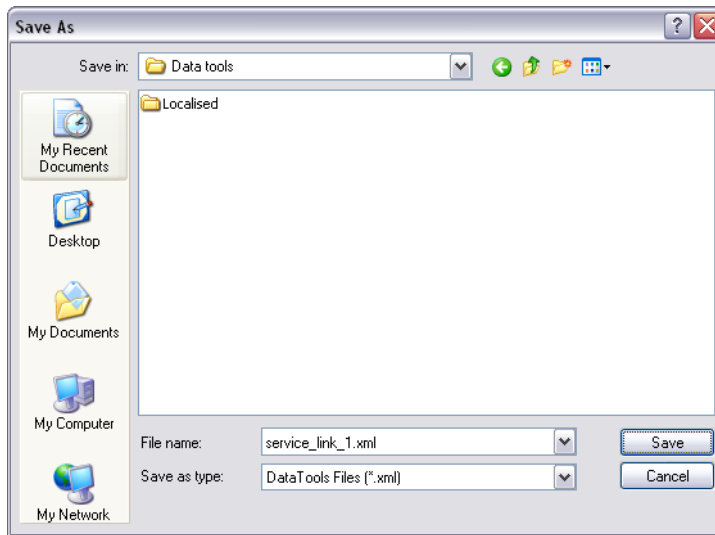

- 4 Click Save.
- 5 Click OK to close the File Options dialog box.

To import a database link

- 1 Click Tools ► File Options.
- 2 In the File Options dialog box, DataTools tab, click the Import button.

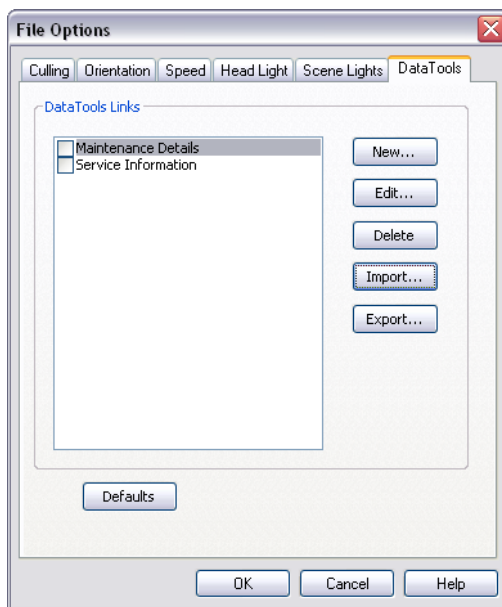

- 3 In the Open dialog box, browse to the folder containing the required datatools file, select it, and click Open.

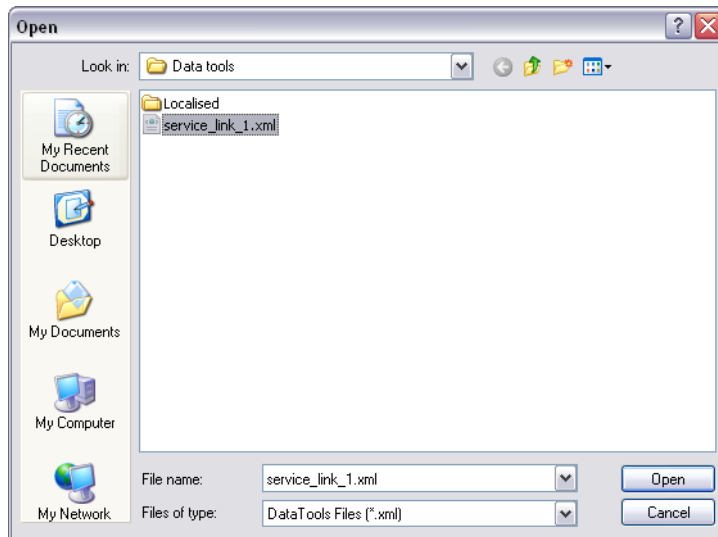

- 4 Click OK to close the File Options dialog box.

Quick Reference

You can use the following Navisworks tags with SQL queries:

Property Tags

%prop("category","property") Property of the currently selected object. Category is the name of the tab in the property windows (for example, Item or Entity Handle) and property is the name of the property in that tab (for example, Value or Layer).

%intprop("category","property") Property of the currently selected object. This is the same as the previous tag except instead of using the publicly visible category and property name use the internal Navisworks names. The benefit of using internal names is that they are not language dependent. This is advanced tag suitable for users familiar with the Autodesk Navisworks API.

File and Path Tags

%sourcepath This tag represents the full path and filename that the currently selected object comes from. Even when a collection of model files have been combined into a single NWD file this tag still remembers the path and filename of the original model file.

%currentpath This tag represents the full path and filename of the currently loaded model. If you currently have an NWF or NWD loaded that contains many other models it will just return the path and filename of the top level NWF/NWD.

File and Path Manipulation Tags

%removeext("text") If the provided text includes a filename with an extension, this tag removes the extension.

%removepath("text") If the provided text includes a path and filename, this tag remove the paths and just returns the filename.

%poppath("text") If the provided text includes a path, this tag removes the top level. If it the text also includes a filename, it counts as the top level and is removed. For example, `%poppath("c:\temp")` becomes `c:\` and `%poppath(c:\temp\readme.txt)` becomes `c:\temp`.

%pushpath("text1","text2") If `text1` is a path and `text2` is a file or folder name, then `text2` is added onto the path in `text1`. For example, `%pushpath("c:\test","model.nwd")` becomes `c:\test\model.nwd`.

String Manipulation Tags

%join("text","text") This tag simply joins the two pieces of text together. For example, `%join("c:\","model.nwd")` returns `c:\model.nwd`.

Query Examples

The examples below illustrate how tags could be used with SQL queries.

- Selecting all columns from table `Test` whilst requiring that the column called `Entity Handle` matches a category/property pair called `Entity Handle/Value` and the column called `File Name` matches the original filename of the drawing:

```
SELECT * FROM Test WHERE "Entity Handle" = %prop("Entity Handle","Value") AND "File Name" = $removeext(%removepath(%sourcepath));
```

Here the path and the extension of the file name are being stripped, so a file like `c:\model\3rdFloorDucts.dwg` would come out as `3rdFloorDucts`.

- Selecting two columns from table `Test` whilst requiring that the column called `Entity Handle` matches a category/property pair called `Entity Handle/Value`:

```
SELECT Name,Part FROM Test WHERE "Entity Handle" = %prop("Entity Handle","Value");
```

- Selecting all columns from table `Test` whilst requiring that the column called `Value` is within a certain range given by two category/property pairs:

```
SELECT * FROM Test WHERE Value BETWEEN %prop("Pressure","Minimum") AND %prop("Pressure","Maximum");
```

NOTE Tags must not contain white space between the brackets (unless enclosed by quote marks), so `%prop("EntityHandle","Value")` works, but `%prop("EntityHandle", "Value")` does not.

Manipulate Object Attributes

In Autodesk Navisworks, you can manipulate objects' transforms (translation, rotation, and scale), and also change color and transparency of objects. All object manipulation is carried out in the Scene Area.

Any changes that you make to object attributes are considered to be global, (as if they'd been changed in the original CAD model), and can be saved with Navisworks files. You have an option of resetting object attributes back to the state they were in when imported from the original CAD files.

Manipulating Object Attributes During Object Animation

You can temporarily modify position, rotation, size, color and transparency of geometry objects for animation purposes. These changes are not global, and can only be saved (or captured) as animation keyframes.

Transform Objects

To transform objects, you can use three visual manipulation tools, or gizmos, available from the Object Manipulation toolbar. You can also transform objects numerically.

To get a clearer view of objects as you manipulate them, you can use the Options Editor to adjust the way in which the current selection is highlighted. For more information, see "[Set Highlighting Method](#)" on page 184.

Using Gizmos

Each gizmo displays three colored axes at the correct angles relevant to the current camera position. Gizmos act like 3D objects in that the axis rotate with the viewpoint. However, they are overlaid over the top of the 3D scene, and can't be obscured by other objects. When you hover over a grabable part of the gizmo, the cursor changes to a hand  icon.

Translation Gizmo

Rotation Gizmo

Scale Gizmo

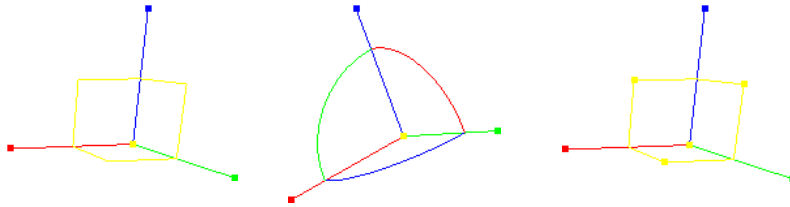



When you use gizmos, you can adjust snapping to control the precision of your operations.

Using Measure Tools to Transform Objects

You can use the [Measure Tools](#) functionality to move and rotate the currently selected objects.

To move an object with the translation gizmo

- 1 Select the object you want to move in the Scene Area.
- 2 Click Translate Item  on the Object Manipulation toolbar.
- 3 Use the translation gizmo to adjust the position of the currently selected object:
 - To move all currently selected objects, place the mouse over the square at the end of the desired axis. When the cursor changes to , drag the square on the screen to increase/decrease the translation along that axis.
 - To move the objects along several axes at the same time, drag the square frame between the desired axes. Dragging the yellow square in the middle of the translation gizmo enables you to snap this center point to other geometry in the model.
 - To move the translation gizmo itself rather than the selected objects, hold down the CTRL key while dragging the square at the end of the desired axis.
 - To snap the translation gizmo to other objects, hold down the CTRL key while dragging the yellow square in the middle of the gizmo.
 - For the point-to-point translation, hold down the CTRL key, and use the center square to drag the gizmo to the start point. Then, with CTRL released, drag the square again to move the objects to the end point.

To move an object numerically

- 1 Select the object you want to move in the Scene Area.
- 2 Click Translate Item  on the Object Manipulation toolbar.
- 3 On the Object Manipulation toolbar, type in numerical values into the manual entry boxes to move the object by the amount entered:
 - X, Y, Z represent translation distance in the current model unit.
 - cX, cY, cZ represent the translation center point.

To move an object by overriding its transform

- 1 Select the object you want to move in the Scene Area.
- 2 Click Edit ► Override Item ► Override Transform.
- 3 In the Override Transform dialog box, enter the XYZ values of the transform to be applied to the currently selected object. For example, a transform of (0, 0, 1) repositions an object by one unit in the Z direction.

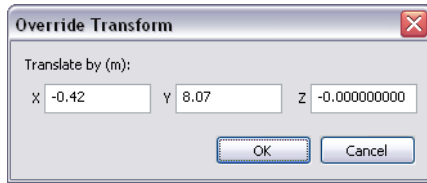

- 4 Click OK.

To move an object with a measure tool



- 1 Select the object you want to move.
- 2 Open the Measure Tools window, and click Point Line .
- 3 Click the selected object to create the first point. This is the start point from which the repositioning will be calculated.
- 4 Click the second point in the scene. This is the point where the object will be moved to. There is now a line connecting the start point and the end point in the Scene Area.
- 5 If you want to be able to move the object several times, create more points in the scene.

NOTE You can only select a point on another object in the scene. Selecting a point in 'space' is not a valid option. To reposition an object into 'space', you can either use a translation gizmo or, if you know the distance by which the object is to be moved, by overriding its transform.

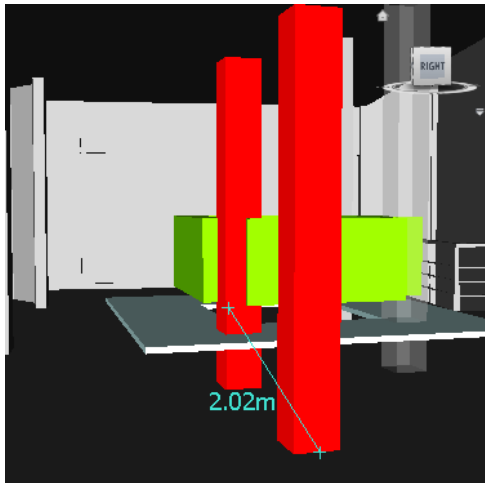
- 6 Click Transform Objects  to move the object to the second point. If you have multiple points in the scene, each time you click Transform Objects the selected object is moved to the next point.



To rotate an object with the rotation gizmo

- 1 Select the object you want to rotate in the Scene Area.
- 2 Click Rotate Item  on the Object Manipulation toolbar.
- 3 Use the rotation gizmo to rotate the currently selected object:
 - Before you can rotate the currently selected objects, you need to position the origin (center point) of the rotation. To do this, place the mouse over the square at the end of the desired axis. When the cursor changes to , drag the square on the screen to increase/decrease the translation along that axis. This will move the rotation gizmo itself. Dragging the yellow square in the middle of the rotation gizmo enables you to move it around, and snap it to points on other geometry objects.

- Once the rotation gizmo is positioned correctly, place the mouse over one of the curves in the middle, and drag it on the screen to rotate the selected objects. The curves are color-coded, and match the color of the axis used to rotate the object around. So, for example, dragging the blue curve between the X and Y axes, rotates the objects around the blue Z axis.
- To rotate the orientation of the rotation gizmo to an arbitrary position, hold down the CTRL key while dragging one of the three curves in the middle.
- To snap the gizmo to other objects, hold the CTRL key while dragging the yellow square in the middle of the gizmo.

To rotate an object numerically

- 1 Select the object you want to rotate in the Scene Area.
- 2 Click Rotate Item  on the Object Manipulation toolbar.
- 3 On the Object Manipulation toolbar, type in numerical values into the manual entry boxes to move the object by the amount entered:
 - X, Y, Z represent degrees of rotation in the current model unit.
 - cX, cY, cZ represent the rotation center point.

To rotate an object with a measure tool

- 1 Select the object you want to move.
- 2 Open the Measure Tools window, and click Measure Angle .
- 3 To rotate the object, click three points on the selected object to determine how the object is to be rotated (refer to the diagram below).

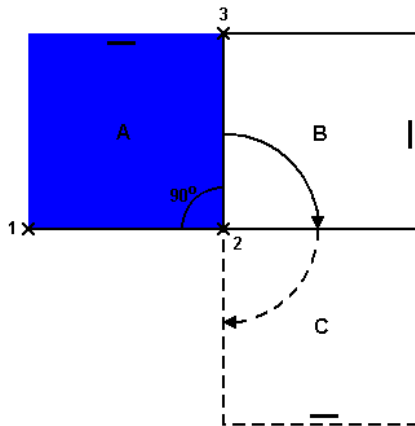

This diagram illustrates how the selected object (position A) is rotated. Lines from the first to the second point (1 to 2) and from the second to third point (2 to 3) define the angle by which the object is rotated (for example, 90 degrees). The second point (2) is used as the rotation center point.

- 4 Click Transform Objects . This rotates the selected object from position A into position B (as shown in the previous diagram). Clicking this button again, rotates the object from position B into position C.

To resize an object with the scale gizmo

- 1 Select the object you want to resize in the Scene Area.
- 2 Click Scale Item  on the Object Manipulation toolbar.

- 3 Use the scale gizmo to resize the currently selected object:
 - To resize all currently selected objects, place the mouse over one of seven squares. When the cursor changes to , drag the square on the screen to modify the size of the objects. Typically, dragging a square up or right increases the size, dragging it down or left decreases the size.
 - To resize the objects across a single axis only, use colored squares at the end of the axes. To resize the objects across two axes at the same time, use yellow squares in the middle of the axes. Finally, to resize the objects across all three axes at the same time, use the square in the center of the gizmo.
 - You can modify the center of scaling. To do this, place the mouse over the square in the middle of the gizmo, and hold down the CTRL key while dragging the square on the screen.

To resize an object numerically

- 1 Select the object you want to resize in the Scene Area.
- 2 Click Scale Item  on the Object Manipulation toolbar.
- 3 On the Object Manipulation toolbar, type in numerical values into the manual entry boxes to move the object by the amount entered:
 - X, Y, Z represent a scaling factor (1 being the current size, 0.5 half, 2 being double, and so on).
 - cX, cY, cZ represent the scaling center point.

Change Color and Transparency

You can apply custom colors and transparencies to geometry in the scene.

For example, when you are dealing with models with unsupported materials and textures, all geometry is displayed in its wireframe color. You can change (or overridden) the color and transparency of objects in the scene for more realistic presentation.

You can also choose to use Presenter tool to apply texture materials to objects in the scene to obtain even better results.

NOTE Any materials applied with the Presenter tool supersede any color and transparency changes.

To change color

- 1 Select the object you want to modify in the Scene Area.
- 2 Click Modify Item Color  on the Object Manipulation toolbar, and choose the desired color.

 **Menu:** Edit ► Override Item ► Override Color

To change transparency

- 1 Select the object you want to modify in the Scene Area.
- 2 Click Modify Item Transparency  on the Object Manipulation toolbar.
- 3 Use the slider to adjust how transparent or opaque the selected object is.



 **Menu:** Edit ► Override Item ► Override Transparency

Snapping

Snapping gives you control when measuring, moving, rotating, and scaling objects in Autodesk Navisworks.

Points and snap points are automatically snapped to. You can set the cursor to snap to the nearest vertex, edge, or line when you pick geometry. You can also adjust the snapping angle and the snapping tolerance that are used when you rotate geometry.

Different cursors feed back what is being snapped to:

Cursor	Description
	No snap, but a point on a surface is found.
	A vertex, point, snap point or line end is found to snap to.
	An edge is found to snap to.

Geometry in Autodesk Navisworks is tessellated with triangles, and therefore, the cursor snaps to edges that may appear to be in the middle of a face. Consider viewing the model in hidden line mode  to clarify which vertex or edge the cursor is snapping to.

To customize snap settings

- 1 Click Tools ► Global Options.
- 2 In the Options Editor, expand the Interface node, and click the Snapping option.
- 3 On the Snapping page, Picking area, select the check boxes for all required snaps, and enter the snapping Tolerance. The smaller the value, the closer the cursor must be to a feature in the model before it snaps to it.
- 4 In the Rotation area, enter the multiplier for the snapping angle into the Angles box, and the snapping tolerance into the Angle Sensitivity box. The smaller the value, the closer to the snapping angle the cursor must be for snap to take effect.
- 5 Click OK.

Reset to Original Values

In Autodesk Navisworks, you can reset object attributes back to the values in the original CAD files.

To restore original colors and transparencies for an object or a group of objects in your scene

NOTE You cannot restore colors separately from transparencies.

- 1 Select the required objects in the Scene Area.
- 2 Click Edit ► Reset Item ► Colors and Transparencies.

To reset colors and transparencies for all objects in your scene

NOTE You cannot restore colors separately from transparencies.

- Click Edit ► Reset All ► Colors and Transparencies.

To reset transform for an object or a group of objects in your scene

- 1 Select the required objects in the Scene Area.
- 2 Click Edit ► Reset Item ► Reset Transforms.

To reset transform for all objects in your scene

- Click Edit ► Reset All ► Reset Transforms.

Measure Tools

Measure tools enable you to measure between points on items in the model. All measurements are made in [display units](#).

Using measure tools is mutually exclusive to using [navigation modes](#) and [SteeringWheels](#), so that when you are measuring you cannot navigate and vice versa.

Measure Tools Window

The Measure Tools window is a dockable window, which contains a number of buttons at the top enabling you to select the type of measurement you want to do.

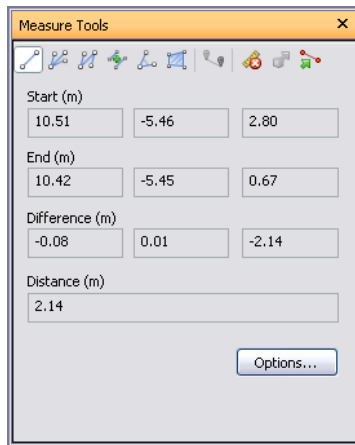





For all measurements, the X, Y, and Z coordinates of the Start point and End point are displayed in the text boxes underneath the buttons, together with the Difference and the absolute Distance. If you use accumulative measure, such as Point Line or Accumulate, Distance shows the accumulated distance for all points registered in the measurement.







To toggle the Measure Tools window

- Click Measure  on the Workspace toolbar.

 **Menu:** Tools ► Measure

Quick Reference

Button	Description
	Measures the distance between two points.
	Measures the distance between a base point and various other points.
	Measures a total distance between multiple points along a route.
	Calculates the sum total of several point-to-point measurements.

Button	Description
	Calculates an angle between two lines.
	Calculates an area on a plane.
	Measures the shortest distance between two selected objects.
	Clears all measuring lines in the Scene Area.
	Enables you to move or rotate an object.
	Converts the endpoint markers, the lines, and any displayed measurement values into redlines.

Measuring

You can use measuring tools to make linear, angular, and area measurements, and to automatically measure the shortest distance between two selected objects.

NOTE When you measure, you must click on a point on an item to register a point - clicking on the background will not register anything. You can reset a measure command at any time by right-clicking instead of left-clicking in the Scene Area. This starts the measure command again with no points registered, just as if you had chosen a new measurement type.

Endpoints of standard measuring lines are represented as small cross symbols in the Scene Area, and all lines being measured by a simple line between registered points.

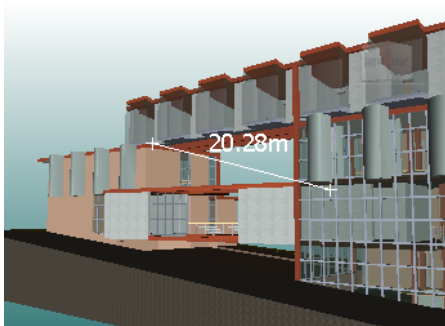

Endpoints of measuring lines that are snapped to center lines are represented as cross symbols with additional CL markers.

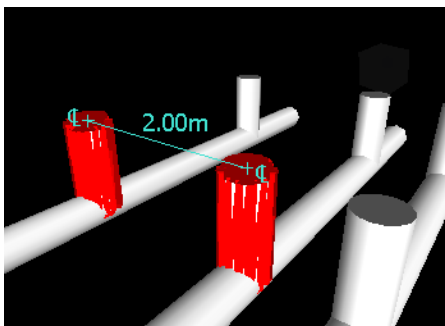

You can change the color and thickness of measuring lines, and toggle the display of dimension label in the Scene Area.

Dimension Labels

For distance-based measurements, the dimension label is drawn for each line segment. For accumulative measurements, the dimension label shows the totals, and is drawn for the last line segment. The text is positioned relative to the center point of the line.

For angular measurements, an arc indicator is shown inside the angle, with the centre of the text positioned on the invisible line bisecting the angle. If an angle is too acute, the label is drawn outside the angle. This label is fixed, and does not resize when you zoom in or out, unless the measuring lines become too short on screen to accommodate the arc, in which case it will be adjusted.

The Options Editor enables you to toggle the dimension labels on and off.

For area measurements, the dimension label is positioned at the centre of the area being measured.

Converting Measurements to Redlines

You can convert measurements to redlines. The measurement itself is cleared when it is converted to a redline, and the redline takes the color and line thickness that is currently set for redlining.

NOTE When you convert measurements to redlines, the lines and text are stored in the current viewpoint.

To change the thickness and color of measuring lines

- 1 Open the Measure Tools window, and click Options.
- 2 In the Options Editor, the Measure page under the Interface node, enter the desired number into the Line Thickness box.
- 3 Select the required color from the Color palette. By default, measuring lines are white.
- 4 Click OK.

To toggle the dimension labels

- 1 Open the Measure Tools window, and click Options.
- 2 In the Options Editor, the Measure page under the Interface node, select the Show Measurement Values in Scene View check box.
- 3 Click OK.

To measure a distance between two points

- 1 Open the Measure Tools window, and click Point to Point  .
- 2 Click the start and end point of the distance to be measured in the Scene Area.
The Distance box, and the optional dimension label display the measured distance.

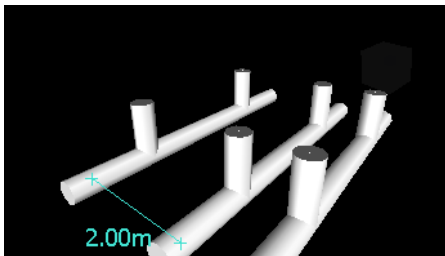

 **Menu:** Review ► Measure ► Point to Point

To keep the same start point as you measure a distance between two points

- 1 Open the Measure Tools window, and click Point to Multiple Points  .

- 2 Click the start point, and the first end point to be measured. A measuring line is displayed between two points.
- 3 Click to register the next end point to be measured.
- 4 Repeat this to measure additional end points if required. The Distance box, and the optional dimension label always display the last measured distance. Your start point stays the same throughout.

TIP If you want to change the start point, right-click in the Scene Area, and select a new start point.

 **Menu:** Review ► Measure ► Point to Multiple Points

To measure a total distance along a route

- 1 Open the Measure Tools window, and click Point Line  .
- 2 Click the start and the second point to be measured.
- 3 Click the next point along the route.
- 4 Repeat this to measure the entire route. The Distance box, and the optional dimension label display the total distance along the selected route.

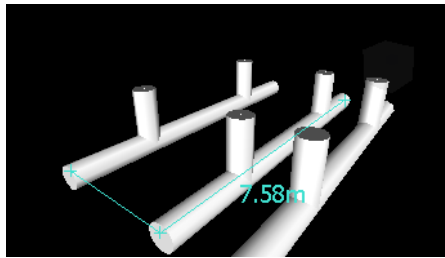

TIP If you want to change the start point, right-click in the Scene Area, and select a new start point.

 **Menu:** Review ► Measure ► Point Line

To calculate an angle between two lines

- 1 Open the Measure Tools window, and click Angle  .
- 2 Click a point on the first line.
- 3 Click the first line at the point where it intersects the second line.
- 4 Click a point on the second line. The Angle box and the optional dimension label display the calculated angle between the two lines.

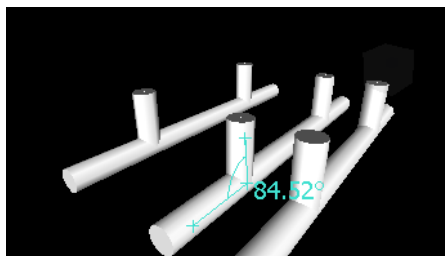

 **Menu:** Review ► Measure ► Measure Angle

To calculate the sum total of several point-to-point measurements

- 1 Open the Measure Tools window, and click Accumulate  .

- 2 Click the start and end points of the first distance to be measured.
- 3 Click the start and end points of the next distance to be measured.
- 4 Repeat to measure more distances if necessary. The Distance box, and the optional dimension label display the sum of all point-to-point measurements.

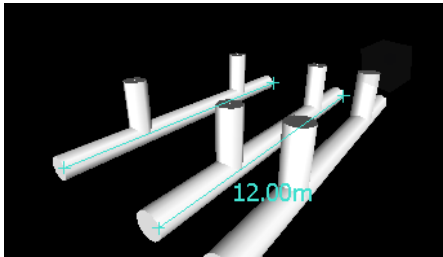

 **Menu:** Review ► Measure ► Accumulate

To calculate an area on a plane

- 1 Open the Measure Tools window, and click Measure Area .
- 2 Click to register a series of points to describe the perimeter of the area you want to calculate. The Area box, and the optional dimension label display the area of the perimeter described since the first point, as projected onto the plane of the viewpoint.

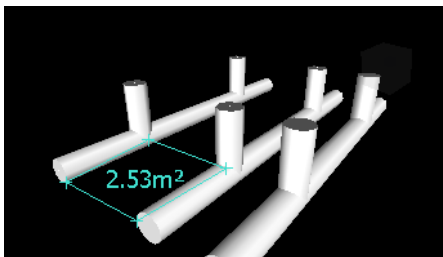

NOTE For your calculation to be accurate, all added points must be on the same plane.

 **Menu:** Review ► Measure ► Measure Area

To measure the shortest distance between two objects

- 1 Press and hold the CTRL key and select two objects in the Scene Area.
- 2 Open the Measure Tools window, and click Measure Shortest Distance .
The Distance box, and the optional dimension label display the shortest distance between the selected objects.

 **Menu:** Review ► Measure ► Measure Shortest Distance

To measure the shortest distance between two parametric objects

- 1 Press and hold the CTRL key and select two parametric objects in the Scene Area.
- 2 Open the Measure Tools window, and click Options.
- 3 In the Options Editor, the Measure page under the Interface node, select the Use Center Lines check box, and click OK.
- 4 In the Measure Tools window, click Measure Shortest Distance .
The Distance box, and the optional dimension label display the shortest distance between the center lines of the selected parametric objects.

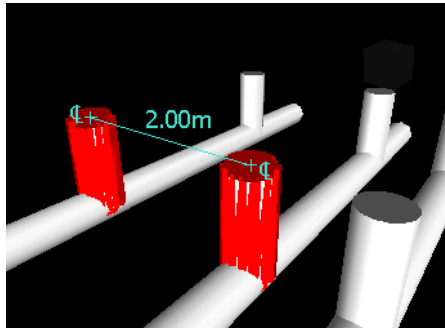

 **Menu:** Review ► Measure ► Measure Shortest Distance

To clear measuring lines

- Open the Measure Tools window, and click Clear .

 **Menu:** Review ► Measure ► Clear

To convert measurements into redlines

- 1 Open the Measure Tools window, and take the desired measurements, for example, distance between two points.
- 2 Click Convert to Redline  in the Measure Tools window.

The end markers, lines, and dimension label (if any) of your current measurement are now converted to a redline, and stored in the current viewpoint.

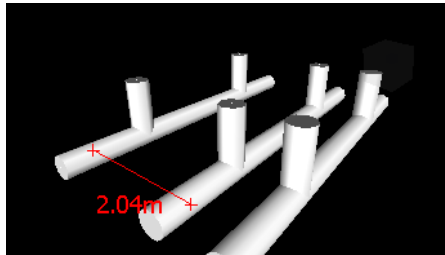

Comments and Redlines

Add Comments and Redlines

You can add comments to viewpoints, viewpoint animations, selection and search sets, clash results, and timeliner tasks.

Redline tools enable you to add review annotations to viewpoints, and clash detection results.

Using redline tools is mutually exclusive to using [navigation modes](#) and [SteeringWheels](#), so that when you are redlining you cannot navigate and vice versa.

Redline Tags

Redline tags combine the features of redlining, viewpoints and comments into a single, easy to use review tool. This allows you to tag anything you want to identify in the model scene. A viewpoint is automatically created for you, and you can add a comment and status to the tag.

For example, during a review session, you locate an item in the scene that is incorrectly sized or positioned. You can tag this item, stating the problem, save your review results as an NWF file, and pass the file to the design team. The design team can search the file, for any tags of status 'new', and locate your review comments. Once

any necessary modifications are made to the drawing files, these can be reloaded into the *.nwf file, and the tag status can be changed accordingly. You can review this latest version of the NWF file, ensure all tags have been resolved and finally 'approve' them.

Comments Window

The Comments window is a dockable window that enables you to view and manage comments.

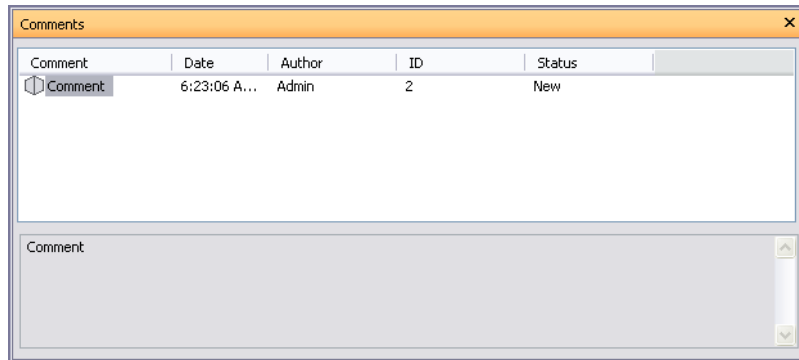

The Comments window shows the name, time and date, author, ID, status, and subject (or first line) of each comment. There are different icons helping you to identify the source of each comment at a glance.

The Comment shortcut menu has the following options:

- **Add Comment.** Opens the Add Comment dialog box.
- **Edit Comment.** Opens the Edit Comment dialog box for the selected item.
- **Delete Comment.** Deletes the selected comment.
- **Help.** Launches the online Help system and displays the topic for comments.

You can add as many comments as you wish to a source, either from the Comments window, or from the source itself.

TIP To add a comment to a specific object in the Scene Area, use redline tags.

To toggle the Comments window

- Click Comments  on the Workspace toolbar.

 **Menu:** View ► Control Bars ► Comments

To add a comment to a viewpoint

- 1 Open the Viewpoints window.
- 2 Right-click the desired viewpoint, and click Add Comment.
- 3 In the Comments window, type in your comment. By default, it is assigned New status.
- 4 Click OK.

To add a comment to a viewpoint animation

- 1 Open the Viewpoints window.
- 2 Right-click the desired viewpoint animation, and click Add Comment.
- 3 In the Comments window, type in your comment. By default, it is assigned New status.
- 4 Click OK.

To add a comment to a selection or search set

- 1 Open the Selection Sets window.
- 2 Right-click the desired selection or search set, and click Add Comment.
- 3 In the Comments window, type in your comment. By default, it is assigned New status.
- 4 Click OK.











To add a comment to a TimeLiner task

- 1 Open the TimeLiner window, and click the Tasks tab.
- 2 Right-click the desired task, and click Add Comment.
- 3 In the Comments window, type in your comment. By default, it is assigned New status.
- 4 Click OK.

To view comments

- 1 Open the Comments window.
- 2 Go to the source of your comments. For example, open the Saved Viewpoints window.
- 3 As you click the source items, for example, viewpoints, the associated comments are displayed in the Comments window.

Quick Reference

Icon	Description
	Selection set
	Search set
	Viewpoint (orthographic camera)
	Viewpoint (perspective camera)
	Viewpoint animation
	Viewpoint animation cut
	Redline tag
	Timeliner task (no attached items)
	Timeliner task (with attached items)
	Timeliner task (synchronized link)
	Timeliner task (old or broken link)

Redline Tools Window

The Redline Tools window is a dockable window with a number of buttons at the top enabling you to mark up viewpoints with redline annotations.

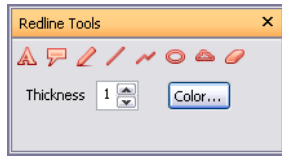

The Thickness and Color controls enable you to modify the redline settings. These changes do not affect already drawn redlines. Also, thickness only applies to lines; it does not affect redline text, which has a default size and weight and cannot be modified.

All redlines (with an exception of redline tags) can only be added to a saved viewpoint or to a clash result which has a saved viewpoint. If you don't have any saved viewpoints, adding a redline tag will automatically create and save a viewpoint for you.

You can also convert measurements to redlines. For more information, see [“Measuring”](#) on page 212.

To toggle the Redline Tools window

■ Click Redline  on the Workspace toolbar.

 **Menu:** Tools ► Redline

To add a redline tag

- 1 Open the Redline Tools window, and click Tag .
- 2 In the Scene Area, click the object you want to tag.
- 3 Click the area where you want the tag label to be located. The redline tag is now added, and both points are rejoined by a leader line.

If the current viewpoint is not already saved, then it will be saved automatically and named 'Tag View X', where X is the tag ID.

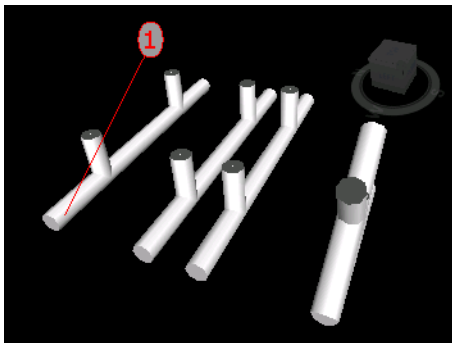

- 4 In the Add Comments dialog box, enter the text to be associated with the tag, set the tag Status from the drop-down list, and click OK.

 **Menu:** Review ► Redline ► Tag

To add text

- 1 Open the Viewpoints window, and click the viewpoint that you want to review.
- 2 Open the Redline Tools window, and click Text .
- 3 In the Scene Area, click the location where you want to place the text.

- 4 Enter your annotation into the box provided, and click OK. The redline is added to the selected viewpoint.

NOTE Text can only be added in a single line with this redline tool. To display text on multiple lines, write each line individually.



- 5 If you want to move the annotation, right-click the redline, and click Move. Clicking a different location in the Scene Area moves the text there.
- 6 If you want to edit the annotation, right-click the redline, and click Edit.

 **Menu:** Review > Redline > Text

To draw freehand

- 1 Open the Viewpoints window, and click the viewpoint that you want to review.
- 2 Open the Redline Tools window, and click Freehand .
- 3 Drag the mouse to draw in the viewpoint.

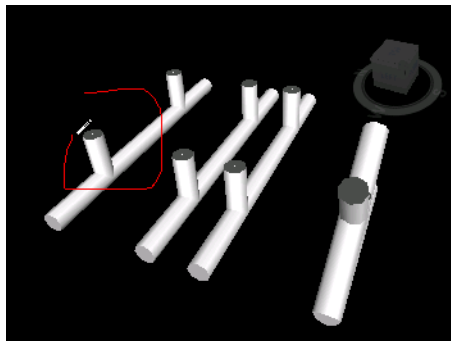

 **Menu:** Review > Redline > Freehand

To draw a line

- 1 Open the Viewpoints window, and click the viewpoint that you want to review.
- 2 Open the Redline Tools window, and click Line .
- 3 Click in the viewpoint at line start and end points.

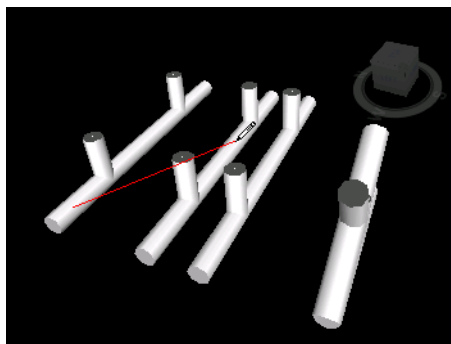

 **Menu:** Review > Redline > Line

To draw a string of lines

- 1 Open the Viewpoints window, and click the viewpoint that you want to review.
- 2 Open the Redline Tools window, and click Line String .
- 3 Click in the viewpoint to begin. Each time you click, a new point is added to the line string. When the string is complete, click the right mouse button to end the line, and you can then start a new line string.

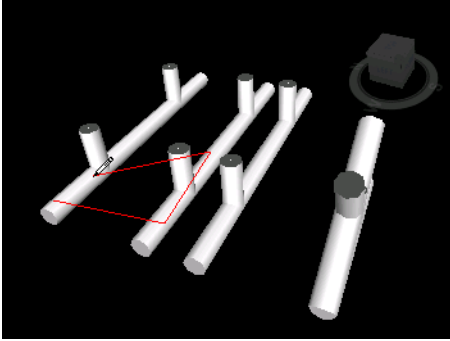

 **Menu:** Review > Redline > Line String

To draw an ellipse

- 1 Open the Viewpoints window, and click the viewpoint that you want to review.
- 2 Open the Redline Tools window, and click Ellipse .
- 3 Click and drag a box in the viewpoint to outline the ellipse.
- 4 Release the mouse to place the ellipse in the viewpoint.

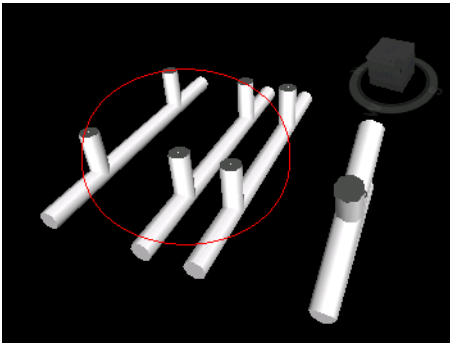

 **Menu:** Review > Redline > Ellipse

To draw a cloud

- 1 Open the Viewpoints window, and click the viewpoint that you want to review.
- 2 Open the Redline Tools window, and click Cloud .
- 3 Click in the viewpoint to begin drawing the arcs of the cloud. Each time you click, a new point is added. Clicking clockwise draws regular arcs, clicking counterclockwise, draws inverted arcs.
- 4 To automatically close the cloud, right-click.

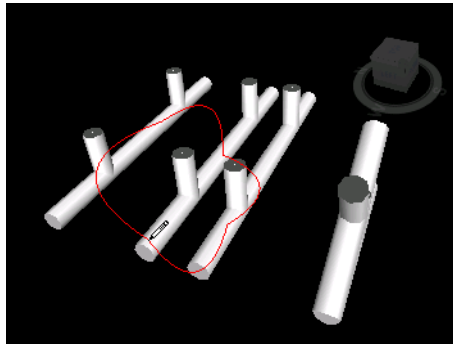

Menu: Review > Redline > Cloud

To erase redlines

- 1 Open the Viewpoints window, and click the viewpoint that you want to review.
- 2 Open the Redline Tools window, and click Erase .
- 3 Drag a box over the redline you want to delete, and release the mouse.

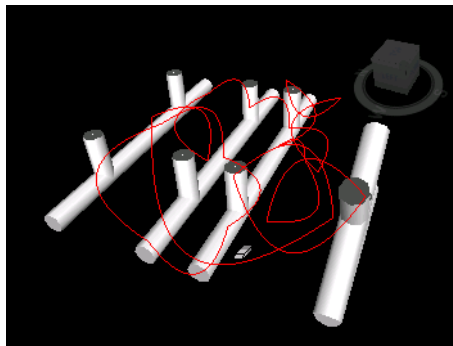









Menu: Review > Redline > Erase

To view redlines

- 1 Open the Viewpoints window.
- 2 Click the desired viewpoint. All attached redlines (if any) are displayed in the Scene Area.

Quick Reference

Button	Description
	Adds text to a viewpoint.
	Adds a redline tag to a viewpoint.
	Enables you to draw freehand in a viewpoint.
	Draws a line in a viewpoint.
	Draws a string of lines in a view point.
	Draws an ellipse in a viewpoint.

Button	Description
	Draws a cloud in a viewpoint.
	Erases redlines.

Review Comments and Redline Tags

You can use the Find Comments window to set up and run a search for redline tags and comments. You can also use a quick find feature to locate redline tags.

During a review session, you can edit text, change status assigned to comments and redline tags, and delete comments and tags. You can also renumber tag and comments IDs, if necessary.

Find Comments Window

The Find Comments window is a floating window that enables you to search for comments and redline tags based on the comment data (text, author, ID, status), comment modification date, and the source of comment.

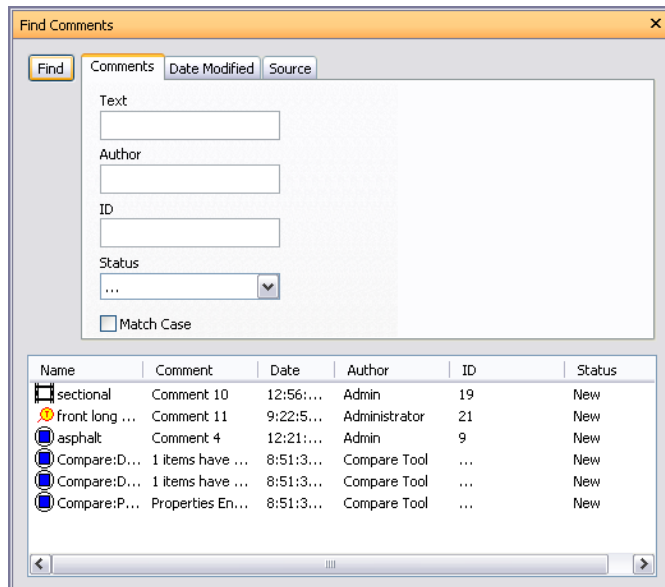

Three tabs on the top enables you to set up the search criteria. Pressing the Find button runs the search. Any found results are displayed in a multi-column table at the bottom of the window. You can use the scroll bars at the right and at the bottom of the tab to move through the comments. There are different icons helping you to identify the source of each comment at a glance. These icons are the same as the ones used in the Comments window.

Selecting a comment in the list also selects the source of the comment. For example, selecting a comment which originated from a saved viewpoint selects that viewpoint.

You can change the sort order of the items in the list by clicking a column head.

If new comments are added, or any of the existing comments are modified, the results list is cleared.

To toggle the Find Comments window

- Click Find Comments  on the Workspace toolbar.

 **Menu:** Edit ► Find Comments or Review ► Comments ► Find Comments

 **Command entry:** SHIFT + F4

To find comments

- 1 Open the Find Comments window.
- 2 Set up the search criteria:
 - a Use the Comments tab if you want to search for a specific text, author, ID, or status.
 - b Use the Date Modified tab to only search for comments created within the specified timeframe.
 - c Use the Source tab to only search for comments attached to the selected sources.
- 3 Click Find.

To find redline tags

- 1 Open the Find Comments window.
- 2 Click the Source tab, select the Redline Tags check box, and clear the rest of the check boxes.
- 3 Use the Comments and Date Modified tabs to restrict your search further, if required.
- 4 Click Find.

Quick Reference

Comments Tab

Use this tab to restrict your search based on the comment data. If the boxes on this tab are left empty, the search returns all comments within the criteria set on the Date Modified and Source tabs.

Text The exact text to search for in all comments. This can be a word or a few words. So for, example, typing *redline*, and running a search, returns only the comments that contain a single “redline” word.

If you don’t know the exact content of the comment, you can use the wildcards. To match one single unspecified character use the symbol ? (question mark). To match any number of unspecified characters either before or after the text, use the symbol * (asterisk). For example, if you want to find all comments that contain some text before and after the word *redline*, type **redline** in the Text box.

Author The exact author name to search for in all comments. Use the wildcards if you don’t know the exact author name.

ID The exact comment ID to search for. You can only use numbers here.

Status Selects the comment status to search for.

Match Case Select this check box if you want the search to respect lower and upper case characters in the search.

Date Modified Tab

Use this tab to specify a date range within which the comments must have been made.

All Comments The search returns all comments. This is the default option.

Between Select this radio button if you want to search for all comments modified between the specified dates.

During the Previous Months Select this radio button to locate all comments modified in the last X number of months.

During the Previous Days Select this radio button to locate all comments modified in the last X number of days.

Source Tab

Use this tab to restrict the search by the source that the comment is attached to. By default all check boxes are selected.

Clash Detective Select this check box if you want to find the comments attached to Clash Detective results. Clearing this check box excludes the comments related to clashes from the search results.

TimeLiner Select this check box if you want to find the comments attached to TimeLiner tasks. Clearing this check box excludes the comments related to TimeLiner from the search results.

Viewpoints Select this check box if you want to find the comments attached to viewpoints. Clearing this check box excludes the comments related to viewpoints from the search results.

Redline Tags Select this check box if you want to find the comments attached to redline tags. Clearing this check box excludes the comments related to redline tags from the search results.

Selection Sets Select this check box if you want to find the comments attached to selection and search sets. Clearing this check box excludes the comments related to selection and search sets from the search results.

Find Redline Tags

You can search for redline tags the same way as you search for comments. You can also use a quick find functionality specifically designed to work with redline tags.

To find redline tag

- 1 Click Review ► Tags ► Find Tag by ID.
- 2 In the Find Tag dialog enter the tag ID.

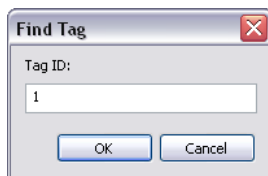

- 3 Click OK. You are automatically taken to the appropriate viewpoint.

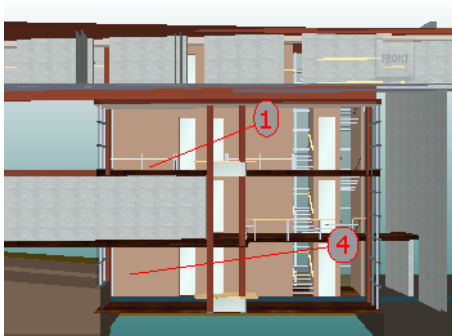

To navigate through redline tags

- 1 Open the Comments window.
- 2 Click Review ► First Tag. The tag comment is shown in the Comments window, and the Scene View displays the viewpoint with the first redline tag.
- 3 To navigate through the tags in your scene:
 - Click Review ► Tags ► Next Tag to find the tag following the current tag.
 - Click Review ► Tags ► Previous Tag to find the tag preceding the current tag.
 - Click Review ► Tags ► Last Tag to find the last tag in the scene.
- 4 Click Review ► Tags ► Current Tag to select the current tag.

Edit Comments and Redlines

Once a comment is saved, you can edit it either from the Comments window, or from the source itself. Editing redline tags is the same as editing comments.

To change content and status of a comment or redline tag

- 1 View the comment or redline tag you want to edit in the Comments window.
- 2 Right-click the comment or tag, and click Edit Comment.
- 3 Modify the comment text as necessary.
- 4 Use the Status box to change the status.
- 5 Click OK.

 **Menu:** Review ► Comments ► Edit Comment

To delete a comment or redline tag

- 1 View the comment or redline tag you want to delete in the Comments window.
- 2 Right-click the comment or tag, and click Delete Comment.

 **Menu:** Review ► Comments ► Delete Comment

Manage IDs

When you add a redline tag or comment to your scene, it is automatically assigned a unique ID. If, however, you are appending or merging multiple Navisworks files together, then there is a possibility for the same ID to be used more than once. Consider the following example. Three users reviewed and added comments and redlines to same model file, each saving their work as an NWF file. If you merge the resulting NWF files together, only one copy of the geometry would be loaded and any tag viewpoints of the same name would be suffixed with the .nwf filename in brackets. All tag ID's, however, would be retained. In such cases, you can renumber all the IDs, making them unique to the scene once again.

NOTE There may be a situation, where two sessions are merged that contain identically numbered tags and corresponding viewpoints (Tag Views). In this situation, when you renumber tag IDs, Autodesk Navisworks will also attempt, wherever possible, to rename the associated Tag Views in line with the new tag numbers.

To renumber comment IDs

- Click Review ► Renumber Comment IDs.

To renumber tag IDs

- Click Review ► Renumber Tag IDs.

Links

There are several sources of links in Autodesk Navisworks: original links that have been converted from the native CAD files, links that have been added by Autodesk Navisworks users, and links that have been automatically generated by the program (for example, selection set links, viewpoint links, TimeLiner task links and so on).

The links converted from the native CAD files, and the links added by Autodesk Navisworks users are treated as object properties. This means, you can examine them in the Properties window.

You can also use the Find Items window to search for them.

All links are saved with Autodesk Navisworks files so that as the model changes, the links remain there for you and others to view.

Link Categories

There are two types of links: standard and user-defined.

Standard links are split into the following categories:

- Hyperlink
- Tag
- Viewpoints
- TimeLiner
- Selection sets
- Redline tags

By default, all links except tags, are drawn as icons in the Scene Area. Tags are drawn as text.

User-defined links enable you to customize the link categories to suit your workflow. By default, user-defined links are drawn as icons in the Scene Area.

You can use the Options Editor to toggle the display of each of the link categories, and also to control their appearance.

When you add a link, you can assign a user-defined category, hyperlinks category, or tag category to it. The rest of the categories are automatically assigned by Autodesk Navisworks when it generates corresponding links.

Display Links

You can switch links in the Scene Area on and off. You can also toggle the display of each of the link categories.

When links are switched on, you can reduce the screen clutter by restricting a number of links can be shown in the Scene Area, hiding colliding icons, and using culling. Finally, as some standard link categories can have comments associated with them, you can choose to only draw links with attached comments.

To toggle the display of links

- Click Hyperlinks  on the Workspace toolbar.

 **Menu:** Tools ► Hyperlinks

To control the display of standard links

- 1 Click Tools ► Global Options.
- 2 In the Options Editor, expand the Interface node, expand the Hyperlinks node, and click the Standard Categories option.
- 3 On the Standard Categories page, select the Visible check box to display the corresponding link category. Clearing the check box hides the corresponding link category in the Scene Area.
By default, all standard link categories are visible.
- 4 Click OK.

To control the display of user-defined links

- 1 Click Tools ► Global Options.
- 2 In the Options Editor, expand the Interface node, expand the Hyperlinks node, and click the User-Defined Categories option.
- 3 On the User-Defined Categories page, select the Visible check box to display the corresponding link category. Clearing the check box hides the corresponding link category in the Scene Area.

By default, all user-defined link categories are visible.

NOTE If no user-defined categories have been added, this page is empty.

- 4 Click OK.

To reduce the screen clutter

- 1 Click Tools ► Global Options.
- 2 In the Options Editor, expand the Interface node, and click the Hyperlinks option.
- 3 On the Hyperlinks page, enter the number of links into the Max Icons box. By default, up to 25 links can be visible.
- 4 To hide links that appear overlapped in the Scene Area, select the Hide Colliding Icons check box.
- 5 In the Cull Radius box enter the desired value. Only the links located within the specified distance from the camera are drawn in the Scene Area. The default value of 0 means that all links are drawn.
- 6 Click OK.

To hide links without comments

- 1 Click Tools ► Global Options.
- 2 In the Options Editor, expand the Interface node, expand the Hyperlinks node, and click the Standard Categories option.
- 3 On the Standard Categories page, select the Hide Icons Without Comments check box for all required link categories.
By default, links without comments are also displayed.
- 4 Click OK.

Customize Links

You can customize the default appearance of links in Autodesk Navisworks. In particular, you can draw them in 3D, and you can add leader lines (arrows) pointing to the attachment point on the items. You can also choose how to represent each link category (as an icon or as text).

Attachment Points

By default, links are attached to the default center of the item's bounding box.

You can override this with more convenient attachment points. If you add more than one attachment point, the link is displayed attached to the closest attachment point to the camera during navigation. This allows you to set up links so that they are always available for following when drawn in 3D mode during navigation, and do not disappear behind objects.

To draw links in 3D mode

NOTE In 3D mode links can become hidden by other objects in the scene when you are navigating.

- 1 Click Tools ► Global Options.
- 2 In the Options Editor, expand the Interface node, and click the Hyperlinks option.
- 3 On the Hyperlinks page, select the In 3D check box.
Links now float in 3D space just in front of their attachment points to the items.
- 4 Click OK.

To show leader lines

- 1 Click Tools ► Global Options.
- 2 In the Options Editor, expand the Interface node, and click the Hyperlinks option.
- 3 On the Hyperlinks page, Enter the X- and Y- distance in Leader Offset for the number of pixels to the right and up that these leader lines will use. The default angle is 0. The recommended angle is 45.
Links in the Scene Area have now leader lines pointing to the attachment point on the items.

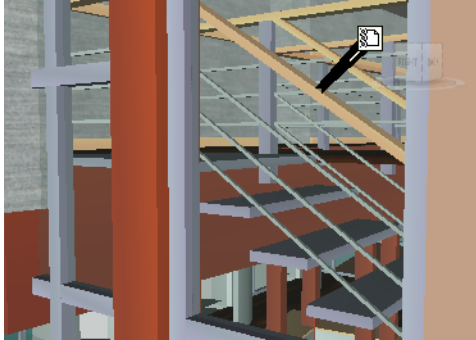

- 4 Click OK.

To customize appearance of standard links

- 1 Click Tools ► Global Options.
- 2 In the Options Editor, expand the Interface node, expand the Hyperlinks node, and click the Standard Categories option.
- 3 On the Standard Categories page, use the Icon Type box to specify how you want a link to be drawn for each of the available categories. You can choose between an icon and text.
By default, tag links are shown as text, and the rest of the link categories are shown as icons.
- 4 Click OK.

To customize appearance of user-defined links

- 1 Click Tools ► Global Options.
- 2 In the Options Editor, expand the Interface node, expand the Hyperlinks node, and click the User-Defined Categories option.
- 3 On the User-Defined Categories page, use the Icon Type box to specify how you want a link to be drawn for each of the available categories. You can choose between an icon and text. By default, links with user-defined categories are shown as icons.









NOTE If no user-defined categories have been added, this page is empty.

- 4 Click OK.

Quick Reference

The table below shows the icons that can be used to represent different link categories in the Scene Area.

Icon	Description
	Represents links that have hyperlink, tag, or any user-defined category (and points to a web address).

Icon	Description
	Represents links that have hyperlink, tag, or any user-defined category (and points to an external file).
	Represent links with TimeLiner category (task with attached items).
	Represent links with TimeLiner category (task with valid links).
	Represent links with TimeLiner category (tasks with broken links).
	Represents links with viewpoints category (perspective camera mode).
	Represents links with viewpoints category (orthographic camera mode).
	Represents links with redline tags category.
	Represents links with selection sets category (selection sets).
	Represents links with selection sets category (search sets).

Add Links

You can add links that point to various data sources, such as spreadsheets, webpages, scripts, graphics, audio and video files and so on. An object can have multiple links attached to it, although, only one link, called default, is shown in the Scene Area. The default link is the link that you add first, but you can mark a different link as default, if necessary.

To add a link to an object

- 1 In the Scene Area, select the desired geometry item.
- 2 Click Review ► Hyperlinks ► Add Hyperlink.
- 3 In the Add Hyperlink dialog box, enter the name for the link in the Name box.
- 4 In the Link to File or URL box, type in the full path to the required data source or the URL address. You can also browse  to the folder containing the desired external file.
- 5 Choose the category for your link from the Category drop-down list. By default, your link has hyperlink category.

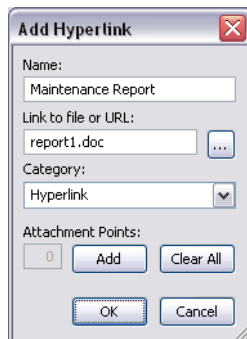

TIP To create a custom category type, type its name directly into the Category box. When you save your hyperlink, the corresponding user-defined category is automatically created.

- 6 **Optional:** By default, your link is attached to the default center of the item's bounding box. If you want to attach your link to a specific point on the selected item, click the Add button. A cross-hair cursor appears in the Scene Area, allowing you to select a point on the item where the link will be attached to.

NOTE If you made a mistake, clicking the Clear All button deletes all attachment points associated with this link and reverts to the link being attached to the center of the item's bounding box.

- 7 Click OK.

To add several links to the same object

- 1 In the Scene Area, select the desired geometry item.
- 2 Right-click and click Hyperlinks ► Add Hyperlinks.
- 3 Use the Add Hyperlinks dialog box to add the first link. This is the default link, and it's the only link that will be visible in the Scene Area. You can choose a different default link later, if necessary.
- 4 Right-click the object again, and repeat the previous steps to add all required links.

Find and Follow Links

Links are an extremely useful review tool to allow you to access non-graphical information through the graphical interface of Autodesk Navisworks.

The links converted from the native CAD files, and the links added by Autodesk Navisworks users are treated as object properties. This means, you can examine them in the Properties window.

You can also use the Find Items window to search for them.

To follow a default link

- 1 Make sure links are switched on. If not, click Hyperlinks  on the Workspace toolbar.
- 2 Click the desired link in the Scene Area to open the attached data source.

Shortcut menu: Follow Link

To follow one of the non-default links

- 1 Make sure links are switched on. If not, click Hyperlinks  on the Workspace toolbar.
- 2 Right-click the default link, and click the Select Item Containing Hyperlink option. This option is only available for multiple hyperlinks attached to the same item.
- 3 Click Review ► Hyperlinks, and click the link that you want to follow.

To follow a default link from the Properties window

NOTE You can use this procedure to follow links from original CAD files, or links that you have added yourself.

- 1 In the Scene Area, select the object with a link.
- 2 Open the Properties window, right-click any tab, and click Follow Default Hyperlink.

To find links

- 1 Click Find Items  on the Workspace toolbar.

- 2 In the Find Items window, click the Standard tab, press and hold CTRL, and click all files that comprise the model.
- 3 Click the Category column, and select Hyperlinks from the drop-down list.
- 4 In the Property column, select the property name from the drop-down list, for example, 'Category'.
- 5 In the Condition column, select the condition operator, for example, '='.
- 6 In the Value column, type in the property value to search for, for example, 'Hyperlink'.
- 7 Click the Find All button. The search results are highlighted in the Scene Area and the Selection Tree.

Manage Links

You can edit original links that have been converted from the native CAD files. If you do this, then save the changes in an .nwf file, then change the hyperlink in the original CAD file, and reopen the .nwf file in Autodesk Navisworks, then your edit 'overrides' will remain. If you haven't edited the hyperlinks in Autodesk Navisworks, however, the updated links from the CAD file will appear.

You can reset all links on an object to those that were originally converted from the CAD file. You can also reset all links on all objects in the scene to their original state.

NOTE You cannot edit automatically generated links, such as the links that point to clash results, TimeLiner tasks and so on.

You can delete any links that have been added to your file by Autodesk Navisworks users, and the links that have been converted from original CAD files. You cannot delete automatically generated links, but you can turn them off, so they don't clutter the Scene Area.

To edit a link

- 1 In the Scene Area, right-click the link you want to edit, and click Edit Hyperlink.
- 2 In the Edit Hyperlinks dialog box, click the link you want to change, and click the Edit button.

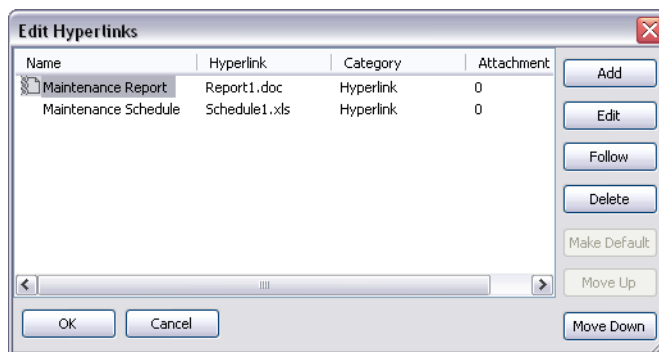

- 3 Use the Edit Hyperlink dialog box to modify the link details, and click OK.

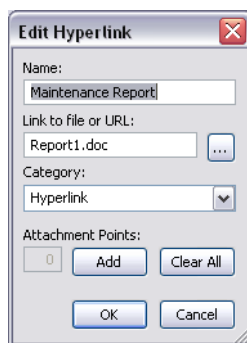

- 4 Click OK to close the Edit Hyperlinks dialog box.

To change the default link

- 1 In the Scene Area, right-click the default link, and click Edit Hyperlink.
- 2 In the Edit Hyperlink dialog box, select the link that you want to be shown in the Scene Area, and click the Make Default button.

NOTE You can also move links up and down the list using the Move Up and Move Down buttons, or by dragging them to their new position in the list. The link at the top of the list is the default link.

- 3 Click OK.

To delete a link

- 1 In the Scene Area, right-click the default link, and click Edit Hyperlink.
- 2 In the Edit Hyperlinks dialog box, click the link you want to delete, and click the Delete button.
- 3 Click OK.

 **Menu:** Review ► Hyperlinks ► Edit Hyperlinks

To reset all links for an object

IMPORTANT Resetting links for an object also removes any links manually added to it by Navisworks users. If you made a mistake, use the Undo  button on the Standard toolbar.

- 1 In the Scene Area, select the object with the links that you want to reset to their original state.
- 2 Click Edit ► Reset Item ► Reset Hyperlinks.

To reset all links in a scene

IMPORTANT Resetting links in a scene also removes all links manually added to it by Navisworks users. If you made a mistake, use the Undo  button on the Standard toolbar.

- Click Edit ► Reset All ► Reset Hyperlinks

Smart Tags

Smart tags display property information in a tooltip style window as you move your cursor over objects in the Scene Area. You don't need to select objects first. The smart tags disappear after a few seconds.

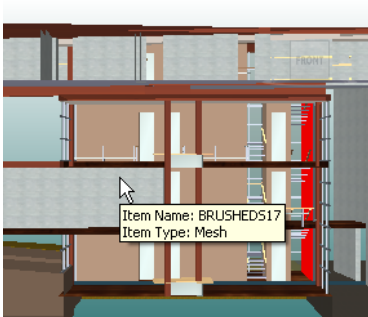

By default, smart tags show the name and type of the object, but you can use the Options Editor to define which properties are shown. Each definition that you configure enables you to display an additional category/property combination in smart tags. You can choose whether to hide category names in smart tags or not.



NOTE When you move your mouse over an object that doesn't have the requested property, Autodesk Navisworks searches up the selection tree for a parent object that contains that information, and displays it instead, thus maximising the useful information you get.

To toggle the display of smart tags

- Click Smart Tags on the Workspace toolbar.



 **Menu:** Tools ► Smart Tags

To add a smart tag definition

- 1 Click Tools ► Global Options.
- 2 In the Options Editor, expand the Interface node, expand the SmartTags node, and click the Definitions option.
- 3 On the Definitions page, click Grid View  to display smart tag definitions as table rows.
- 4 Click Add Element . A new row is added to the top of the table.
- 5 Click the Category column, and select the property category from the drop-down list, for example 'Item.' The options available depend on the property categories in your model.
- 6 Click the Property column, and select the property name from the drop-down list, for example, 'Material'. The options available depend on the selected property category.
- 7 Click OK.

NOTE You can add as many definitions to your smart tags as you like.

To delete a smart tag definition

- 1 Click Tools ► Global Options.
- 2 In the Options Editor, expand the Interface node, expand the SmartTags node, and click the Definitions option.
- 3 On the Definitions page, click Grid View  to display smart tag definitions as table rows.
- 4 Click the Category or Property for the definition that you want to delete.
- 5 Click Remove Element .
- 6 Click OK.

To hide category names

- 1 Click Tools ► Global Options.
- 2 In the Options Editor, expand the Interface node, and click the SmartTags option.
- 3 Select the Hide Category check box.
- 4 Click OK.

SwitchBack to AutoCAD and MicroStation

You can use the SwitchBack functionality to send the current view of the currently loaded file back to AutoCAD (version 2004 or later) or MicroStation-based CAD products (/J and v8).

IMPORTANT The native CAD package must be installed on the same machine as Autodesk Navisworks for SwitchBack to work.

To use SwitchBack with AutoCAD

- 1 For AutoCAD (version 2004 or later) or products based on it, first open the product in the usual manner, and type: `nwload` in the command line to load the `nwexport` plugin.

NOTE If SwitchBack needs to be available every time AutoCAD is run, `nwexport` can be added to the set of startup applications in AutoCAD.

- 2 Once the CAD package is running, and `nwexport` has been started, return to Autodesk Navisworks.
- 3 Click Tools ► Global Options.
- 4 In the Options Editor, expand the File Readers node, and click the DWG/DXF/SAT option.
- 5 On the DWG/DXF/SAT page, check that the Convert Entity Handles option is selected.
- 6 Select an object in the Scene Area, and click Review ► SwitchBack.

The current Autodesk Navisworks camera view is taken back to the CAD package, and the same object is selected. Selection of objects is done by entity handle.

NOTE If a Clash Detective tool is available, you can click the SwitchBack button on the Results tab.

- 7 Make the changes in AutoCAD, then save the changes.
- 8 Return to Autodesk Navisworks, and click Refresh  on the Standard toolbar to view the modified object.

NOTE Some objects cannot be selected in AutoCAD (for example, blocks) which may mean that running SwitchBack may be unsuccessful with a given selected object. If this is the case, try selecting further up the object tree and trying again.

Shortcut menu: SwitchBack

To use SwitchBack with MicroStation

- 1 For MicroStation (*/J* and v8) or products based on it, open the product in the usual manner.
- 2 Click Utilities ► Key In.
- 3 In the Key-In dialog box, type `mdl load nwexport6` to load the `nwexport` plugin.

NOTE If SwitchBack needs to be available every time MicroStation is run, `nwexport6` can be added to the list of MDL plugins in MicroStation.

- 4 Once the MicroStation package is running, and `nwexport` has been started, return to Autodesk Navisworks.
- 5 Select an object in the Scene Area, and click Review ► SwitchBack.

The current Autodesk Navisworks camera view is taken back to first visible view in MicroStation, and the same object is selected. Selection of objects is done by element ID (MicroStation v8) or DMRS value (MicroStation */J*).

NOTE If a Clash Detective tool is available, you can click the SwitchBack button on the Results tab.

- 6 If you want to override the view used by SwitchBack, use the `nwview <view number> key-in` where view number is the visible window in MicroStation. This view setting is not saved between sessions.
- 7 Make the changes in MicroStation, then save the changes.
- 8 Return to 2010, and click Refresh  on the Standard toolbar to view the modified object.

Shortcut menu: SwitchBack

Use Viewpoints and Sectioning Modes

9

Viewpoints are an important feature of Autodesk Navisworks. They not only allow you to save and return to views of the model which are of importance, but they can also be used for design review audit trails, and for setting up animations of the model.

Create and Modify Viewpoints

Overview of Viewpoints

Viewpoints contain more than just the camera information - each viewpoint can also contain redlines and comments. In fact, you can use viewpoints as a design review audit trail. They can be used as hyperlinks in the Scene Area to click on and zoom to the viewpoint, which will also bring up the redline and comments associated with it. The viewpoints, redlines and comments are all saved into an .nwf file from Autodesk Navisworks, and are independent of the model geometry. So, if the native CAD files are changing, the saved viewpoints remain the same, appearing as an overlay on top of the base layer of model geometry. This enables you to see how the design has evolved. See [“Review Your Model”](#) on page 179 for more information on hyperlinks, comments and redlines and [“Native File Formats”](#) on page 87 for more information on the .nwf file format.

Viewpoints also retain the section planes active at the time of viewpoint creation, which can be useful in animating sliding sections. See [“Sectioning”](#) on page 244 for more information on sections. Viewpoints can optionally retain saved attributes too, so that on returning to a viewpoint, overridden colors, transparencies and hidden items are reinstated. This can be used to great effect to create animations where items appear and disappear from the scene in time. See [“Default Viewpoint Options”](#) on page 242 for more information on options, and [“Record and Play Animations”](#) on page 251 for more information on viewpoint animations.

Saved Viewpoints Window

The Saved Viewpoints window is a floating window that enables you to create and manage different views of your model so that you

can jump to preset viewpoints without having to navigate each time to reach an item.

The Saved Viewpoints window is a floating window that enables you to jump to preset viewpoints without having to navigate each time to reach an item.

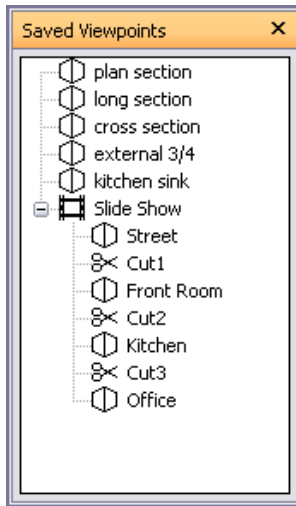

Viewpoint animations are also saved with the viewpoints, as they are simply a list of viewpoints treated as keyframes. In fact, viewpoint animations can be made by simply dragging preset viewpoints onto an empty viewpoint animation. You can organize your viewpoints and viewpoint animations using folders.

Icons are used to represent different elements:



represents a folder which may contain all other elements (including other folders).



represents a viewpoint saved in orthographic mode.



represents a viewpoint saved in perspective mode.



represents a viewpoint animation clip.



represents a cut inserted into a viewpoint animation clip.

You can select more than one viewpoint by either holding down the Control key and left-clicking, or by left-clicking the first item, and then clicking the last item while holding down the Shift key.

You can drag viewpoints around the Saved Viewpoints window, and reorganize them into folders or animations.

There are no buttons on this window, and commands are actioned through shortcut menus.

Through these menus, you can save and update viewpoints, create and manage viewpoint animations, and create folders to organize these viewpoints and viewpoint animations. You can also drag and drop viewpoints or viewpoint animations onto viewpoint animations or folders. Holding down the Control key during this operation will copy the element being dragged. This allows fairly complex hierarchies of viewpoint animations and folders to be easily composed.

Viewpoints, folders and viewpoint animations can all be renamed by slow clicking (clicking and pausing without moving the mouse) the element, or clicking it and pressing F2.

To toggle the Saved Viewpoints window

- Click Saved Viewpoints  on the Workspace toolbar.

 **Menu:** View ► Control Bars ► Saved Viewpoints

 **Command entry:** CTRL + F11

Quick Reference

You get a different shortcut menu, depending on what element you right-click in the Saved Viewpoints window. All shortcut menus share the Sort option, which sorts the contents of the window alphabetically, including folders and their contents.

IMPORTANT Any changes that you make cannot be saved, and will apply for the duration of your Autodesk Navisworks session.

Blank Space

Save Viewpoint Saves the current viewpoint, and adds it to the Saved Viewpoints window.

New Folder Adds a folder to the Saved Viewpoints window.

Add Animation Adds a new empty viewpoint animation, ready for dragging viewpoints onto.

Add Cut Adds an animation cut. Cuts are used as pauses in the viewpoint animations, and are 1 second long by default.

Sort Sorts the contents of the Saved Viewpoints window alphabetically.

Help Opens the Help system.

Saved Viewpoint

Save Viewpoint Creates a copy of the selected viewpoint in the Saved Viewpoints window.

New Folder Adds a folder above the selected viewpoint.

Add Animation Adds a new empty viewpoint animation above the selected viewpoint.

Add Cut Adds an animation cut above the selected viewpoint. Cuts are used as pauses in the viewpoint animations, and are 1 second long by default.

Add Copy Creates a copy of the selected viewpoint in the Saved Viewpoints window. The copy is named the same as the selected viewpoint, but includes the version number in brackets. For example, View1(1), View1(2) and so on.

Add Comment Adds a comment regarding the selected viewpoint. See “[Comments and Redlines](#)” on page 216 for more information on comments.

Edit Comment When available, opens the Edit Comment dialog box.

Edit Opens the Edit Viewpoint dialog box, and enables you to manually edit the viewpoint’s attributes.

Update Makes the selected viewpoint the same as the current viewpoint in the Scene Area.

Transform Opens the Transform dialog box. It enables you to transform the camera position.

Delete Deletes the selected viewpoint from the Saved Viewpoints window.

Rename Enables you to rename the selected viewpoint.

Sort Sorts the contents of the Saved Viewpoints window alphabetically.

Help Opens the Help system.

Viewpoint Animation

Save Viewpoint Saves the current viewpoint, and adds it as the last keyframe in the selected viewpoint animation.

New Folder Adds a folder as the last keyframe in the selected viewpoint animation.

Add Animation Adds a new empty viewpoint animation as the last keyframe in the selected viewpoint animation.

Add Cut Adds an animation cut to the end of viewpoint animation. Cuts are used as pauses in the viewpoint animations, and are 1 second long by default. You can drag the created cut into a different position.

Add Copy Creates a copy of the selected viewpoint animation in the Saved Viewpoints window. The copy is named the same as the selected viewpoint animation, but includes the version number in brackets. For example, View1(1), View1(2) and so on.

Add Comment Adds a comment regarding the selected viewpoint animation. See “[Comments and Redlines](#)” on page 216 for more information on comments.

Edit Comment When available, opens the Edit Comment dialog box.

Edit Opens the Edit Animation dialog box, and enables you to set the duration of the selected viewpoint animation, the type of smoothing, and whether it loops or not.

NOTE Clicking Edit over an animation keyframe, opens the Edit Viewpoint dialog box; and clicking Edit over an animation cut, opens the Edit Animation Cut dialog box.

Update Updates all keyframes in the viewpoint animation with the current render style, lighting, and navigation mode.

NOTE Clicking Update over a single keyframe will only update that frame with the current modes.

Delete Deletes the selected viewpoint animation from the Saved Viewpoints window.

NOTE Clicking Delete over a keyframe or a cut, removes the keyframe or cut from the viewpoint animation.

Rename Enables you to rename the selected viewpoint animation, keyframe, or cut.

Sort Sorts the contents of the Saved Viewpoints window alphabetically.

Help Opens the Help system.

Folder

Save Viewpoint Saves the current viewpoint, and adds it to the selected folder.

New Folder Adds a subfolder to the selected folder.

Add Animation Adds a new empty viewpoint animation to the selected folder.

Add Cut Adds an animation cut to the selected folder. Cuts are used as pauses in the viewpoint animations, and are 1 second long by default. You can drag the created cut into a different position.

Add Copy Creates a copy of the selected folder in the Saved Viewpoints window. The copy is named the same as the selected folder, but includes the version number in brackets. For example, View1(1), View1(2) and so on.

Add Comment Adds a comment regarding the selected folder. See “[Comments and Redlines](#)” on page 216 for more information on comments.

Edit Comment When available, opens the Edit Comment dialog box.

Update Updates all viewpoints in the folder with the current render style, lighting and navigation mode. Choosing Update for a single viewpoint will only update that viewpoint with the current modes.

Delete Removes the selected folder and all of its contents from the Saved Viewpoints window.

Rename Enables you to rename the selected folder.

Sort Sorts the contents of the Saved Viewpoints window alphabetically.

Help Opens the Help system.

Save Viewpoints

New viewpoints are named "ViewX" where 'X' is the next available number added to the list. This new viewpoint takes all the attributes of the current viewpoint in the Scene Area.

To save a viewpoint

- 1 If the Saved Viewpoints window is not displayed, click Saved Viewpoints  on the Workspace toolbar.

- 2 Right-click an empty space in the Saved Viewpoints window, and click Save Viewpoint.
- 3 Type a new name for your viewpoint, and press Enter.

 **Toolbar:** Viewpoint ► Saved Viewpoints ► Save Viewpoint

Recall Viewpoints

You can return to any of previously saved viewpoints. On recalling viewpoints the navigation mode that was active when the viewpoint was created will be re-selected. Any redlines and comments associated with the viewpoint will also be reinstated.

To recall a viewpoint from the menu

- Click Viewpoint ► Saved Viewpoints, and choose the saved viewpoint from the list.
It is now displayed in the Scene Area.

NOTE Up to 19 viewpoints can be shown on the Viewpoint menu. Also, if a viewpoint is located inside a folder, it will not be shown on this menu.

To recall a viewpoint from the Saved Viewpoints window

- 1 If the Saved Viewpoints window is not displayed, click Saved Viewpoints  on the Workspace toolbar.
- 2 Click the desired viewpoint in the list. It is now displayed in the Scene Area.

Organize Viewpoints

Viewpoints can be organized into folders, if necessary.

IMPORTANT The viewpoints stored inside folders cannot be recalled by using the Viewpoint ► Saved Viewpoints menu.

To organize viewpoints into folders

- 1 If the Saved Viewpoints window is not displayed, click Saved Viewpoints  on the Workspace toolbar.
- 2 Right-click an empty space in the Saved Viewpoints window, and click New Folder.
- 3 Type in a new name, and press Enter.

TIP Use names that can help you identify your viewpoints in future.

- 4 Drag the required viewpoints into your new folder.

Edit Viewpoints

You can edit any viewpoints attributes, including camera position, field of view, speed of motion and saved attributes. All entries are measured in [Display Units](#).

To edit a viewpoint

- 1 If the Saved Viewpoints window is not displayed, click Saved Viewpoints  on the Workspace toolbar.
- 2 Right-click the viewpoint you want to modify, and click Edit.

- 3 Use the **Edit Viewpoint dialog box** to adjust the viewpoint's attributes.



- 4 Click OK.

To delete a viewpoint

- 1 If the Saved Viewpoints window is not displayed, click Saved Viewpoints  on the Workspace toolbar.
- 2 Right-click the viewpoint you want to remove, and click Delete.

Default Viewpoint Options

Two view attributes can be saved with a viewpoint:

- Hide/Required - whether items are hidden or required.
- Override Materials - the color and transparency of items.

You can set a viewpoint to save either attribute by **editing** the viewpoint. To update changes to overridden material or hide/required, use the Update option on the viewpoints shortcut menu. Be careful, though, as this also updates the point of view as well, which may disrupt any redline information stored with the viewpoint.

By default these attributes are not stored with new saved viewpoints. If you do wish them to be saved by default, then this can be set in the Options Editor.

Default collision settings can also be saved with a viewpoint, including whether collision, gravity, crouching, and third person view are enabled.

You can set a viewpoint to save any of these settings by editing the viewpoint, in the same way as the view attributes.

By default, all of the collision settings are disabled. If you want to save your preferred collision setting defaults, use the Options Editor.

NOTE When you modify the default viewpoint settings, your changes do not affect the currently opened Autodesk Navisworks file. They are used as soon as you open a new Autodesk Navisworks file, or start a new Autodesk Navisworks session.

To set the default view attributes

- 1 Click Tools ► Global Options.

- 2 In the Options Editor, expand the Interface node, and click the Viewpoint Defaults option.

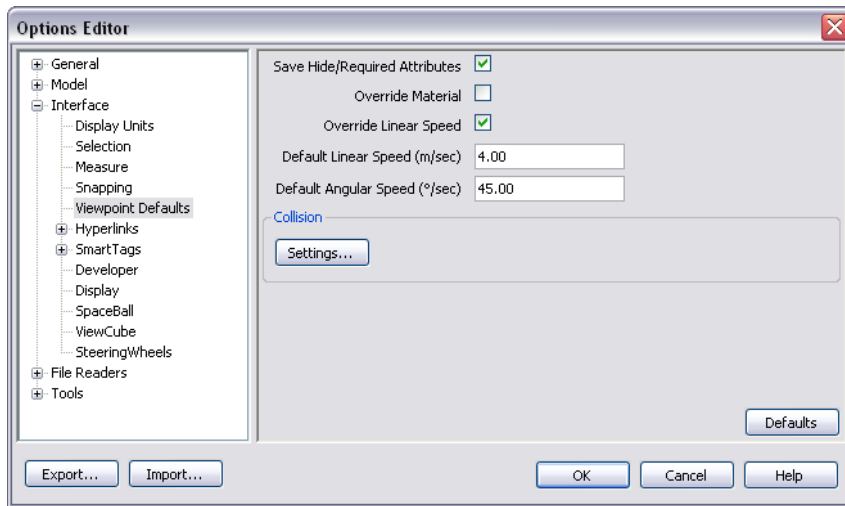

- 3 Select the Save Hide/Required Attributes check box if you want to save the hidden and required items with the viewpoints you save. This means that when returning to those viewpoints, the items that were hidden when the viewpoint was saved will be hidden again and those that were drawn will be drawn again. By default, this check box is clear, as it requires a relatively large amount of memory to save this state information with each viewpoint.
See “[Hide Objects](#)” on page 185 for more information on hidden items, and “[Make Objects Required](#)” on page 175 for more information on making items required.
- 4 Select the Override Material check box if you want to save the material overrides with the viewpoints you save. This means that when returning to those viewpoints, the material overrides set when the viewpoint was saved will be reinstated. By default, this check box is clear as it requires a relatively large amount of memory to save this state information with each viewpoint.
See “[Manipulate Object Attributes](#)” on page 205 for more information on overriding materials.
- 5 Select the Override Model Linear Speed check box to be able to set a specific speed to navigate on loading a model. Without this selected, the linear navigation speed is directly related to the size of the model loaded.
- 6 The Default Angular Speed can be set to any number of degrees per second. This affects the speed at which the camera turns.
- 7 Click OK.

To set the default collision options

- 1 Click Tools ► Global Options.
- 2 In the Options Editor, expand the Interface node, and click the Viewpoint Defaults option.
- 3 On the Viewpoint Defaults page, click the Settings button.
- 4 In the [Default Collision dialog box](#), select the default options you want Autodesk Navisworks to initialize with.

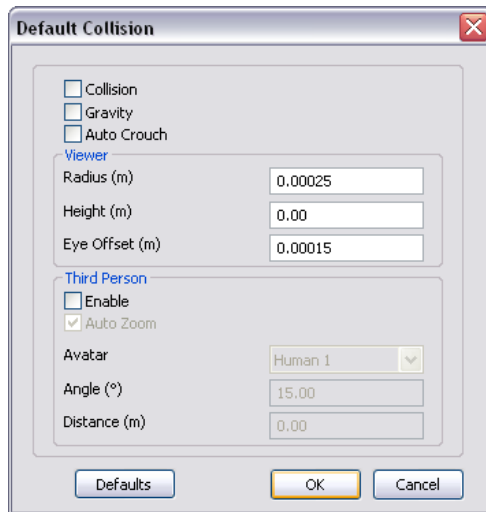

- 5 Click OK to return to the Options Editor.
- 6 Click OK to save the changes.

Share Viewpoints

You can export saved viewpoints from Autodesk Navisworks into an .xml file, and share them with other users. For more information, see “[Export Viewpoints](#)” on page 268 and “[Import Viewpoints](#)” on page 261.

Sectioning

There are two sectioning modes available from the Sectioning toolbar: planes and box.



Planes mode allows you to make up to six sectional cuts in any plane while still being able to navigate around the scene, enabling you to see inside models without hiding any item.

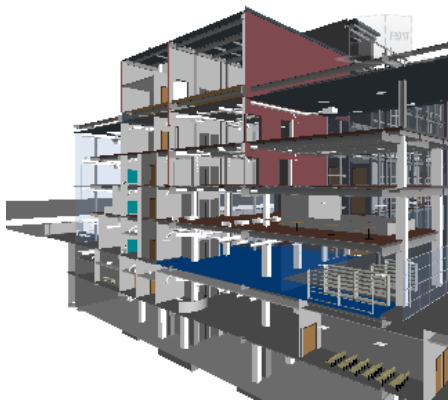

Section planes are stored inside viewpoints and so can also be used within viewpoint animations and object animations to show a dynamically sectioned model. See “[Saved Viewpoints Window](#)” on page 237 for more information on viewpoints, and “[Record and Play Animations](#)” on page 251 for more information on animations.

Slices can also be created using two opposing section planes and linking them. In this way you can move a slice through the scene in real time and can again link this to viewpoint animations, object animations, and viewpoints.

Box mode enables you to define a section box to focus your review on specific and limited areas of the model. As you move the box around, only the geometry within the defined section box is displayed in the Scene Area.

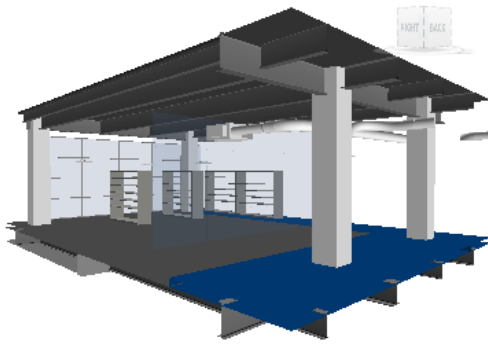

To open the Sectioning toolbar

- Right-click anywhere in the toolbar area of the screen, and click Sectioning on the shortcut menu.

 **Toolbar:** Workspace ➤ Sectioning 

Enable Section Planes

To view cross-sectional cuts of your model, you can enable up to six section planes. Only one plane is active at a time, but it is possible to link two section planes together to form slices.

The section plane that is active is numbered in the drop-down box on the Sectioning toolbar.

To enable a section plane

- 1 Select the Planes mode on the Sectioning toolbar.
- 2 Select the plane you want to enable in the drop-down box. In this box, there will always be one more than the number of enabled section planes in the scene, up to a maximum of 6.
- 3 Click the Enable/Disable  button.

Position and Use Section Planes

Once you have enabled at least one section plane, you can align it, and then use the slider to control how the section plane moves through the model.

Each section plane remembers its settings (alignment, slider position, step size and so on).



If you have more than one section plane enabled, you can delete the currently active plane using the Delete









button. The next enabled plane will then become the active plane.

Alignment Modes

By default, section planes are aligned to the top of your model. This means using the section plane enables you to view top-down into your model. You can use the Sectioning toolbar to select a different mode of alignment:

- Align Top  - aligns section plane with top of model. This is the default option.
- Align Bottom  - aligns section plane with bottom of model.

- Align Front  - aligns section plane with front of model.
- Align Back  - aligns section plane with back of model.
- Align Left  - aligns section plane with left of model.
- Align Right  - aligns section plane with right of model.
- Align To Line  - enables you to pick a line, and place the section plane 'on' that line, at the point where you clicked, and aligned so that its normal is on the line itself, facing towards the camera.
- Align To Surface  - enables you to pick a surface, and place the section plane 'on' that surface, with its normal aligned to the normal of the triangle picked.
- Align To View  - aligns section plane with camera view plane.

Slider Behavior

The slider behavior depends on the selected mode of section alignment. By default, the range of slider represents the entire extents of the model in the selected direction. For example, for section planes aligned to top, moving the slider moves the plane from the very top to the very bottom of the model; for section planes aligned to bottom, moving the slider moves the plane from the very bottom to the very top of the mode, and so on.

It is possible to restrict the range of the slider movement, and set a finer resolution for sectioning large models.

The Set Range  button enables you to limit the range of the section planes to the bounding box limits of the currently selected items. Clicking this button with nothing selected resets the range back to default.

You can also control the Step Size of the slider; it dictates the incremental value by which the slider moves when you single-click rather than drag on it.

If the Step Size is not enabled, the slider will move at percentage intervals when you single-click on it.

To align a section plane to one of the pre-fixed directions

- 1 On the Sectioning toolbar, select the plane you want to align in the drop-down box.

- 2 If it's not already enabled, click  .

- 3 Select one of the six pre-fixed directions from the alignment button menu, for example, Align Right  .
Autodesk Navisworks updates the position and alignment of the section plane.

To align a section plane to line

- 1 On the Sectioning toolbar, select the plane you want to align in the drop-down box.

- 2 If it's not already enabled, click  .

- 3 Select Align To Line  from the alignment button menu.

The cursor changes to a target  .

- 4 In the Scene Area, click somewhere on the line you want to align to.

Autodesk Navisworks updates the position and alignment of the section plane, so that it is placed at the point you clicked.

To align a section plane to surface

- 1 On the Sectioning toolbar, select the plane you want to align in the drop-down box.

- 2 If it's not already enabled, click .

- 3 Select Align To Surface  from the alignment button menu.

The cursor changes to a crosshair .

- 4 In the Scene Area, click somewhere on an object you want to align to.

Autodesk Navisworks updates the position and alignment of the section plane so that it is placed 'on' the surface of the selected object.

To align a section plane to view

- 1 On the Sectioning toolbar, select the plane you want to align in the drop-down box.

- 2 If it's not already enabled, click .

To set the slider step size

- 1 On the Sectioning toolbar, select the required section plane in the drop-down box.

- 2 If it's not already enabled, click .

- 3 Click the Step Size  button.

- 4 In the Sectioning Plane dialog box, select the Enable check box, enter the desired value into the text box below, and click OK.

To move a section plane through the model

- 1 On the Sectioning toolbar, select the required section plane in the drop-down box.

- 2 If it's not already enabled, click .

- 3 If necessary, change the alignment of the section plane, and set up the slider step size.

- 4 Move the slider to interactively position the section plane to the required location. Clicking the slider causes it to move incrementally. The distance shown in the edit box is the distance from the 'base point' that is set by the alignment. So if you chose 'Top' alignment, it is the distance from the top of the model, if you chose 'Left' alignment, it's the distance from the left, and so on. You can type the distance value directly into the edit box (instead of using the slider).

TIP You can also use the cursor keys and mouse wheel for simple sliding of the section plane through the model.

- 5 If you want to restrict the range of the section plane movement to specific items, select them in the Scene Area, and click the Set Range  button.

Link Section Planes

In Autodesk Navisworks, you can link any two section planes together, so they move as one. Doing this enables you to quickly slice your model in real time. The slices can be used in viewpoints, viewpoint animations, and object animations.

In practice, you should only link parallel planes together, such as top and bottom, left and right, front and back. This is because linking together section planes that are at right angles to each other, and then moving them will have no visible effect on the model.

Also, you may have unpredictable results if you try to link section planes that are aligned to lines, surfaces, or view.

To link two parallel planes together

- 1 Begin by setting up two parallel section planes, for example, the first one aligned to Top, and the second one aligned to Bottom. You can use the slider to adjust the position of each of the planes (that is how far you want them separated in the slice).
- 2 Click the Link button.
- 3 Move the slider. Now when you move one of the section planes, the other one moves with it, effectively, creating a slice through the model.

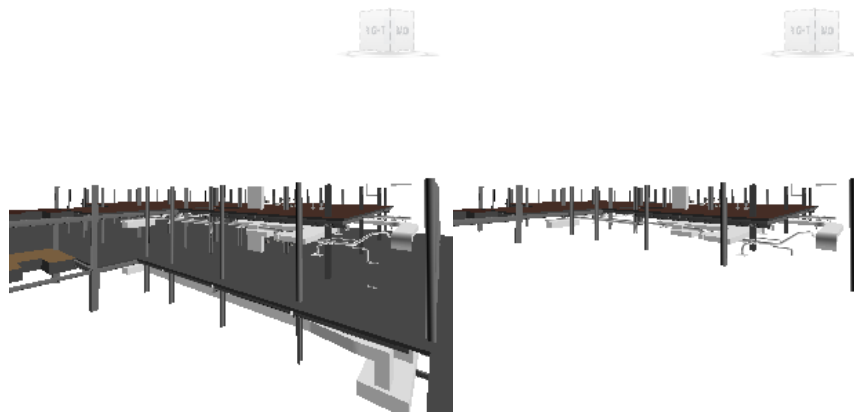

NOTE You can click the Record  button on the Animation toolbar, and record a viewpoint animation showing the model as it is sliced. You can also save the configured slice as a viewpoint, and return to it later.

Enable and Use Section Boxes

You can define a section box to focus your review on specific and limited areas of the model. Once you've set the box size, you can use the X, Y, Z boxes on the Sectioning toolbar to move the box around the model. By default, the range of box movement covers the entire extents of the model.

It is possible to restrict the range of the box movement, and set a finer resolution for sectioning large models.



The Set Range  button enables you to limit the range of the section box to the bounding box limits of the currently selected items. Clicking this button with nothing selected resets the range back to default.

You can also specify the Step Size used to control the X, Y, Z boxes; it dictates the incremental value by which the box moves when you single-click on the up/down arrows next to each box.

If the Step Size is not enabled, the box will move at percentage intervals when you single-click on the up/down arrows.

Once defined, the box remembers its settings.

To enable and use a section box

- 1 Select the Box mode on the Sectioning toolbar.
- 2 Click the Enable/Disable  button.
- 3 Click the Set Box Size  button.
- 4 In the Set Box Size dialog box, enter the X, Y, Z values to define the box, and click OK.

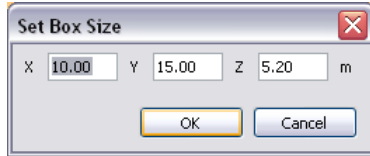

Autodesk Navisworks creates the sectioning box in the center of the model.

- 5 Click the Step Size  button.
- 6 In the Sectioning Plane dialog box, select the Enable check box, enter the desired value into the text box below, and click OK.
- 7 Use the X, Y, and Z numeric steppers to move the sectioning box around the model.

TIP If you want to restrict the range of the box movement to specific items, select them in the Scene Area, and click the Set Range  button.

Record and Play Animations

10

In Autodesk Navisworks there are two types of animation: viewpoint animation and object animation.

Viewpoint Animation

Viewpoint animation is a quick and efficient way of recording both your movement through the model and views of the model. There are two ways to produce a viewpoint animation in Autodesk Navisworks:

- By recording interactive navigation
- By creating animated transitions between saved views

You can also create slide show animations, which are, essentially, viewpoint transitions with a number of cuts (pauses) added between viewpoints.

Object Animation

In addition to viewpoint animation, you can also animate and interact with 3D geometry in your model. Although the ability to record animations and produce scripts necessary to interact with animated objects is limited to users with access to the Animator and Scripter functionality, any user can actually play them back once they have been recorded.

See “[Animate Objects](#)” on page 271 for step-by-step instructions on how to record animations and scripts.

Create and Edit Viewpoint Animations

There are two ways to create viewpoint animations in Autodesk Navisworks. You can either simply record your real-time walk through, or you can assemble specific viewpoints for Autodesk Navisworks to interpolate into a viewpoint animation later.

Viewpoint animation is controlled through the Tools ► Animation menu, the Saved Viewpoints dockable window, and the Animation toolbar.

It is worth remembering that you can hide items in viewpoints, override colors and transparencies and set multiple section planes and these will all be respected by a viewpoint animation. This way you can easily create powerful viewpoint animations.



Once a viewpoint animation is recorded, you can edit it to set the duration, the type of smoothing and whether it loops or not.

There is also nothing to stop you copying viewpoint animations (hold down the CTRL key when dragging an animation on the Saved Viewpoints window), dragging frames off the animation into a blank space on the Saved Viewpoints window to remove them from the viewpoint animation, editing individual frames attributes, inserting cuts or dragging other viewpoints or viewpoint animations onto the existing one, to continue developing your animations.

Animation Cuts (Pauses)

Cuts in a viewpoint animation are simply points where the camera pauses for a while. They are inserted automatically when you click Pause during the interactive recording of a viewpoint animation, or you can insert them manually into an existing viewpoint animation.

To create a viewpoint animation in real time

- 1 If the Animation toolbar is not displayed, right-click anywhere in the toolbar area of the screen, and click Animation on the shortcut menu.
- 2 Click the Record button  on the Animation toolbar.
- 3 Navigate around in the Scene Area while Autodesk Navisworks records your movement. You can even move the section planes through the model during your navigation, and this will be recorded into the viewpoint animation too.
- 4 At any point during the navigation, you can click the Pause button . This will pause the recording while you maneuver into a new position. Click the Pause button again to continue recording the viewpoint animation. The resulting viewpoint animation will contain a “cut” on page 252 for the duration of the pause.
- 5 When finished, click the Stop button .
- 6 If the Saved Viewpoints window is not displayed, click View ► Control Bars ► Saved Viewpoints. This is where your new viewpoint animation called "AnimationX", where 'X' is the latest available number, is added to. The name will be editable at this point if you want to name it yourself. This viewpoint animation will also become the current active animation in the Available Animations drop-down box on the Animation toolbar.

While the above method is useful for creating quick viewpoint animations on the fly, sometimes you need more control over the viewpoint camera. To do this in Autodesk Navisworks, you need to set up several viewpoints and add them to an empty viewpoint animation. When playing back the animation, Autodesk Navisworks will then interpolate between these viewpoints.

To create an animation frame by frame

- 1 If the Saved Viewpoints window is not already displayed, click View ► Control Bars ► Saved Viewpoints.
- 2 Right-click the Saved Viewpoints window, and click Add Animation on the shortcut menu.
A new viewpoint animation called "AnimationX", where 'X' is the latest available number, will be added to the Saved Viewpoints window. The name will be editable at this point if you want to name it yourself. There will be no plus sign next to the viewpoint animation, showing that the viewpoint animation is indeed empty.
- 3 Create the viewpoints where you want the camera to move through during the animation and save these on the Saved Viewpoints window. They will become the frames for the animation. The more frames you have, the smoother and more predictable the viewpoint animation will be. See “[Save Viewpoints](#)” on page 240 for more information on creating viewpoints.
- 4 When you have all required viewpoints, simply drag them onto the empty viewpoint animation you just created. You can drag them on one-by-one, or you can select multiple viewpoints using the CTRL and SHIFT keyboard keys and drag several on at once. If you drop them onto the viewpoint animation icon itself, then

the viewpoints will become frames at the end of the animation, but you can drop the viewpoints anywhere on the expanded animation to put them where you wish.

- 5 At this point, you can use the Animation Position slider on the Animation toolbar to move backward and forward through the viewpoint animation to see how it looks.
- 6 You can edit any of the viewpoints inside the viewpoint animation (see “[Edit Viewpoints](#)” on page 241 for details on this), or you can add more viewpoints, delete them, move them around, add cuts, and [edit the animation itself](#) until you are happy with the viewpoint animation.
- 7 Once you have several viewpoint animations, you can drag and drop them onto a master viewpoint animation to compose more complex combinations of animations, just like dragging and dropping viewpoints onto an animation as a frame.

To edit a viewpoint animation

- 1 If the Saved Viewpoints window is not already displayed, click View ► Control Bars ► Saved Viewpoints.
- 2 Right-click the viewpoint animation you want to modify on the Saved Viewpoints window, and click Edit on the shortcut menu.
- 3 In the Edit Animation dialog box, type in the duration in seconds in the Duration box.

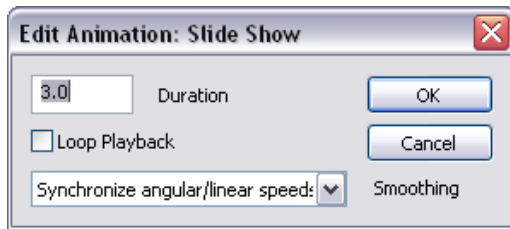

- 4 If you want the viewpoint animation to play back continuously, select the Loop Playback check box.
- 5 From the Smoothing drop-down list, select the type of smoothing you want the viewpoint animation to use.
None means that the camera will move from one frame to the next without any attempt at smoothing out the corners.
The speed of movement between frames of an animation is dictated by the angular and linear speeds of the individual frames and so choosing Synchronize Angular/Linear Speeds will smooth the differences between the speeds of each frame in the animation, resulting in a less jerky animation.
- 6 Click OK.

To insert cuts (pauses) into a viewpoint animation

- 1 If the Saved Viewpoints window is not already displayed, click View ► Control Bars ► Saved Viewpoints.
- 2 Right-click the animation frame below where you want to insert the cut, and click Add Cut on the shortcut menu.
- 3 Type in the name of the cut, or press Enter to accept the default name, which will be "CutX", where 'X' is the next available number.
- 4 The default duration of a cut is 1 second. To alter the duration of this pause, right-click the cut, and click Edit on the shortcut menu.
- 5 In the Edit Animation Cut dialog box, type in the duration of the pause in seconds.

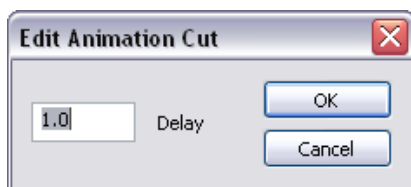

6 Click OK.

Play Animations

You can play back both pre-recorded object animation and viewpoint animation in the Scene Area.

The viewpoint animations play in real time; this means that the Autodesk Navisworks engine is still attempting to maintain the guaranteed frame rate so some drop-out may still occur, just as in real-time navigation.

To play back an animation

- 1 If the Saved Viewpoints window is not already displayed, click View ► Control Bars ► Saved Viewpoints.
- 2 Select the animation you want to play back from either the Saved Viewpoints window, or from the Available Animations drop-down list on the Animation toolbar.
- 3 You can use the Animation Position slider to quickly move forwards and backwards through the animation. Full left is at the beginning and full right is at the end. The text box next to the slider shows the point in time (in seconds) through the animation that the camera is. You can type a number into this box to set the camera at a certain point in the animation and play back from that point.
- 4 For viewpoint animations, you may notice that the frame in the animation in the Saved Viewpoints window is highlighted when the animation is playing. You can click on any frame to set the camera to that point in time in the viewpoint animation and continue playing back from there.
- 5 Use the VCR buttons on the “[Animation Toolbar](#)” on page 66 to step and play forwards and backwards through the animation.

To enable scripting

- To enable animation scripts in your file, click the Toggle Scripts  button on the Animation toolbar. You can now interact with your model. For example, if there is a script to open a door on pressing a specific key on the keyboard, pressing this key will open the door.

Share Animations

You can export the animations to .avi files for playback with Windows Media Player™.

For more information, see “[Export Images and Animations](#)” on page 266.

Work Within a Team

11

Autodesk Navisworks Simulate 2010 enables multiple users to participate in a single design review session across a Local Area Network (LAN). This utilizes the shared program features of Windows NetMeeting, available to all Windows users.

Collaborate Toolbar

The Collaborate toolbar contains the collaboration tools necessary to run collaboration sessions.



If the Collaborate toolbar is not displayed, right-click anywhere in the toolbar area of the screen, and click Collaborate Bar on the shortcut menu.

Collaboration Session

All meeting participants require access to a Autodesk Navisworks .nwf or .nwd file, in a shared location. One of the participants will 'host' the meeting and place a call to invite the others to join the meeting. Any of the participants who have joined the meeting can take control and drive the session. All navigation performed by the driver will be displayed in the Scene Area on each of the participants' machines. Any viewpoints or redlines (for example) added during the session can be updated on all participants' machines at the click of a button.

NOTE If a collaborative review session, as outlined here, is not conducted in single room, then additional teleconferencing provisions could be necessary. This may be using the NetMeeting Whiteboard, or your own telephone system.

To start a collaboration session

- 1 Open the Autodesk Navisworks file that you want to collaborate on from a shared directory.
- 2 Click the Collaborate  button on the Collaborate toolbar. This initializes Windows NetMeeting.

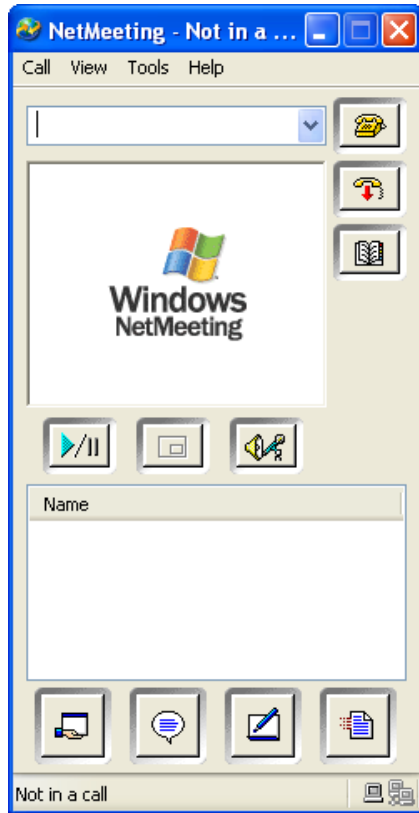

NOTE The first time Windows NetMeeting initializes, a Setup wizard will take you through the setup process. You will need to enter your name and email address. When using NetMeeting on a LAN you do not need to log onto a directory server, as these will not be available to you.

To place a call, inviting attendees to join

- 1 Having initialized Windows NetMeeting, click the Call  button in the NetMeeting dialog box.
- 2 In the Place a Call dialog box, enter the machine name or IP address of the machine you wish to join the meeting into the To box.

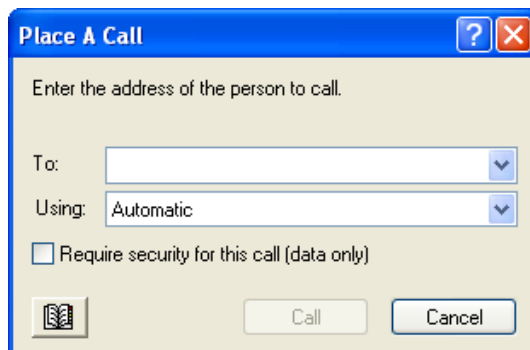

- 3 Click the Call button to send the invite.
Once the person receiving the invite accepts this, both their name and yours will be listed in the NetMeeting dialog box.
- 4 Repeat this procedure to invite all required participants.

To accept an invitation

- 1 When you are invited to join a meeting, the Incoming Call dialog box is displayed.

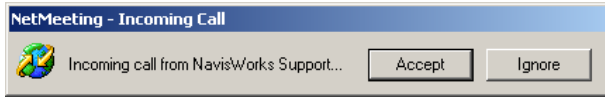

- 2 Click the Accept button to join the meeting, or Ignore to decline the invitation.

NOTE Once you have accepted a call, you will need to click the Collaborate  button on the Collaborate toolbar to start your own collaboration session.

To become the driver

During a collaboration meeting, anyone in the call can take control of the session and become the 'driver'. The driver will control navigation of the shared model on all machines in the call.

- 1 Click the Drive  button on the Collaborate toolbar.
- 2 Upon clicking the drive button, all other users in the call will receive a message advising that you are requesting control. They will have to answer Yes to this message if you are to drive Autodesk Navisworks on their machine.

To refresh all attendees machines

Although real-time navigation in Autodesk Navisworks can be performed on all machines in a call by one user, it is not possible for review data such as saved viewpoints, comments and redlines, to be automatically updated on all users' machines. This information can, however, be updated on their machines by refreshing the model. This refresh process can be performed on one users machine and refresh all machines in the call.

- Click the Refresh  button on the Collaborate toolbar.

Share Data

12

Print

You can print a hard copy of the current viewpoint to any printer or plotter.

Print Preview

Before you print out a copy of the model you are working on, you may wish to see how it will appear.

To preview model before printing

- 1 Click File ► Print Preview.
- 2 Use the Zoom In and Zoom Out buttons to do just that with the preview image.
- 3 Click Print.
- 4 In the Print dialog box, click OK.

Print Setup

This option enables you to the set up paper size and orientation options.

To change the print setup

- 1 Click File ► Print Setup.
- 2 In the Print Setup dialog box, make changes as required to the paper and orientation.
- 3 Click the Properties button if you want to change printer-specific settings.
- 4 Return to the Print dialog box, and click OK to print the image.

Print Current Viewpoint

When the print option is selected, Autodesk Navisworks prints the current viewpoint scaled to fit and centered on the page.

NOTE If you would prefer to export an image for printing, see [“Export an Image”](#) on page 266 for more information.

To print the current viewpoint

- 1 Click File ► Print.
- 2 Check the printer settings are as required, and click OK.

NOTE The maximum image size is 2048x2048 pixels.

The Properties button controls printer-specific ink and paper settings.

 **Toolbar:** Standard ► Print

Import Files

The import option inputs Intergraph PDS review data, including: PDS Tags (.tag) and PDS Display Sets (.dst). It is also possible to import various data that has been exported from previous Autodesk Navisworks sessions.

PDS Tag Files

Tag information from Intergraph PDS contains a unique ID, saved viewpoint and corresponding comments. Tag information created in Autodesk Navisworks may also be exported to be used in Intergraph PDS. See [“PDS Tag Files”](#) on page 264.

To import a PDS tag file

- 1 Click File ► Import ► PDS Tags.
- 2 Use the Import dialog box to locate the desired .tag file.

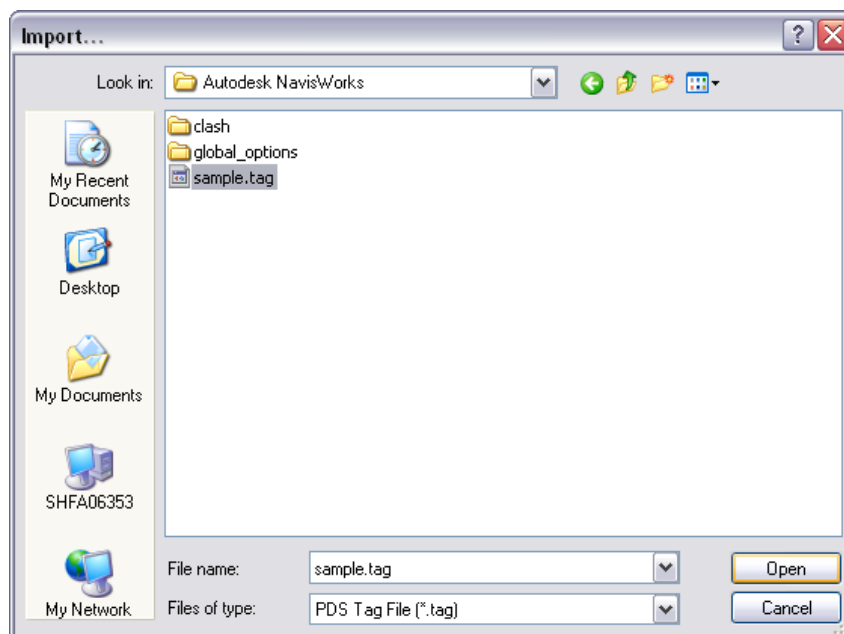

- 3 Click Open to import the PDS data.

PDS Display Set Files

Display sets from Intergraph PDS contain detailed criteria, defining item selections. When imported into Autodesk Navisworks, .dst files create Search Sets in the Selection Sets window.

See also:

- [“Selection Sets Window”](#) on page 191

To import PDS display sets

- 1 Click File ► Import ► PDS Display Sets.
- 2 Use the Import dialog box to locate the desired .dst file.

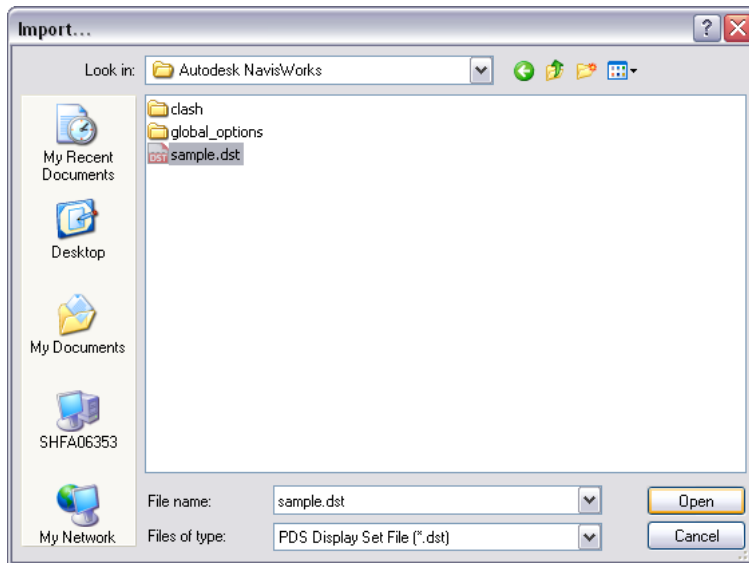

- 3 Click Open to import the PDS display sets.

Viewpoints Files

Viewpoints can be imported into Autodesk Navisworks via an .xml file, enabling you to bring viewpoints into the current scene from another model file. For example, if you are working on different versions of the same model, you can save viewpoints in one version of the file, export them and then import them into the other version. See [“Save Viewpoints”](#) on page 240 for more information on saving viewpoints, and [“Export Viewpoints Files”](#) on page 268 for more information on exporting viewpoints to an .xml file.

To import viewpoints and associated data

- 1 Click File ► Import ► Viewpoints XML.
- 2 In the Import dialog box, locate the desired viewpoints .xml file.

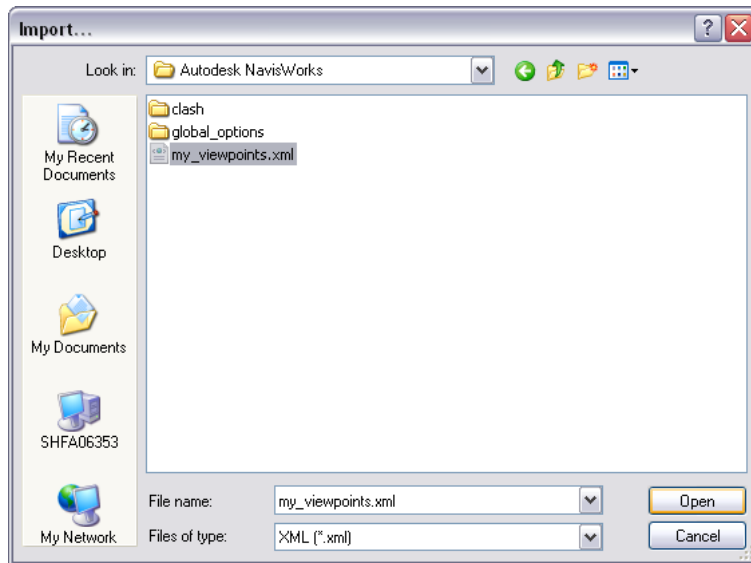

- 3 Click Open.

Search Criteria Files

Search criteria can be imported into Autodesk Navisworks. This will populate the Find Items window. The search can then be run on the current model, finding any items that match the specific criteria. See “[Find Items Window](#)” on page 186 for more information on searching the model for items based on their properties.

To import saved search criteria

- 1 Click File ► Import ► Search XML.
- 2 In the Import dialog box, locate the desired search .xml file.

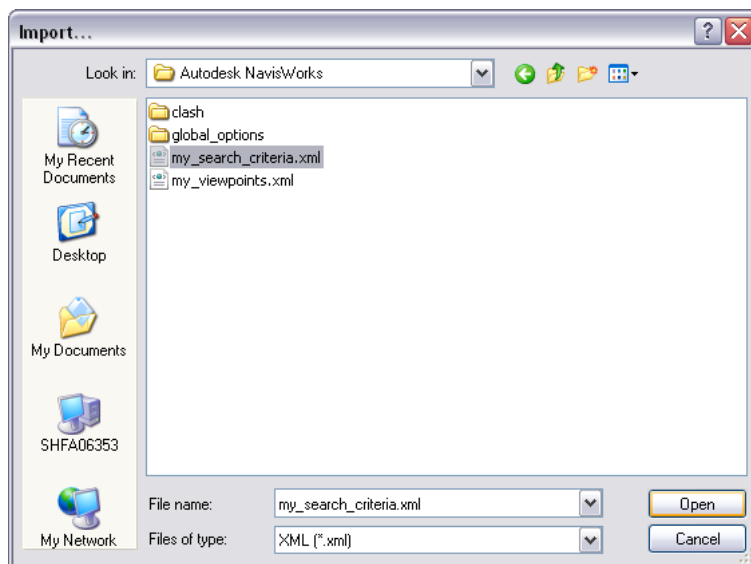

- 3 Click Open.

Search Set Files

Search sets can be imported into Autodesk Navisworks. This will populate the Selection Sets window with pre-defined search sets. Selecting an imported Search Set will define the current Find Items criteria and search

the current model accordingly. See “[Find Items Window](#)” on page 186 for more information on searching the model for items based on their properties.

To import saved search sets

- 1 Click File ► Import ► Search Sets XML.
- 2 In the Import dialog box, locate the desired search sets .xml file.

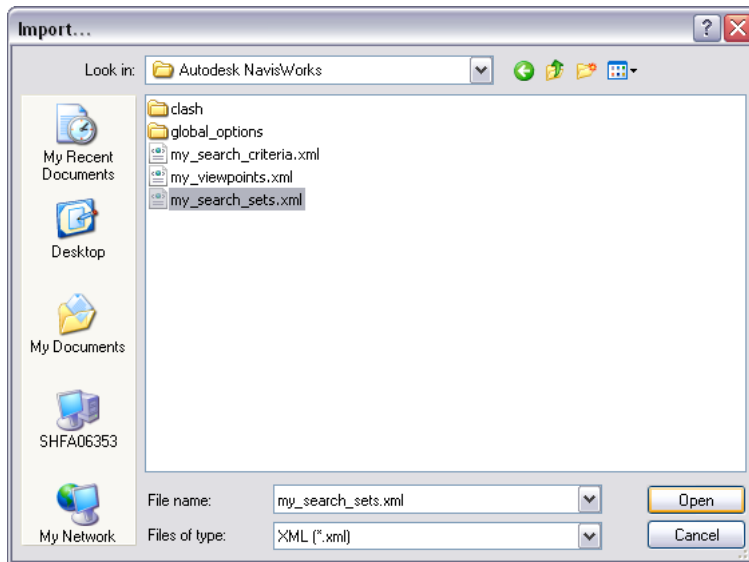

- 3 Click Open.

Export Files

Piranesi EPix Format

To export an .epx file for rendering in Informatix's Piranesi

- 1 File ► Export ► Piranesi EPix
- 2 In the Piranesi EPix dialog box, click the Browse button to locate a destination and enter a new filename to export, if you want to change from the existing filename and location.
- 3 Select the sizing options for the file to be exported:
 - **Type** - sets the size of the exported image as follows:
 - Explicit. Gives you full control of the width and height (the dimensions are in pixels).
 - Use Aspect Ratio. Enables you to specify the height. The width is automatically calculated from the aspect ratio of your current view.
 - Use View. Uses the width and height of your current view.
 - **Width** - enables you to enter the width in pixels, when available.
 - **Height** - enables you to enter the height in pixels, when available.
- 4 Select the desired value in the Anti-Aliasing box. This option applies to OpenGL renderer only. Anti-aliasing is used to smooth the edges of the exported images. The higher the number, the smoother the image, but the longer they take to export. 4x is adequate for most situations.
- 5 Click Save.

PDS Tag Files

To export PDS tags

- 1 Click File ► Export ► PDS Tags.
- 2 In the Export dialog box, enter a new filename and location, if you want to change from those suggested.
- 3 Click Save.

Autodesk DWF Format

Autodesk DWF files can be exported from Autodesk Navisworks. The file exporter creates a .dwf file containing:

- All geometry
- All materials
- Per-vertex colors
- Properties (where available)

To export a DWF file

- 1 Click File ► Export ► Autodesk DWF.
- 2 In the Export dialog box, enter a new filename and location, if you want to change from those suggested.
- 3 Click Save.

Google Earth KML Format

Google Earth KML files can be exported from Autodesk Navisworks. The exporter creates a compressed KML file with the extension .kmz and supports the export of:

- Triangles
- Lines
- Materials (color and flat transparency only)
- Viewpoints (adjustments may occur due to Google Earth limitations)
- Model Hierarchy
- Hyperlinks (currently only URLs work correctly in Google Earth)

To export to Google Earth KML files

- 1 Click File ► Export ► Google Earth KML
- 2 In the KML Options dialog box, select the Export Model Relative to Terrain Height check box to put Google Earth in a mode where all heights are measured from the surface of the ground. When this is check box is clear all heights are measured from sea-level.

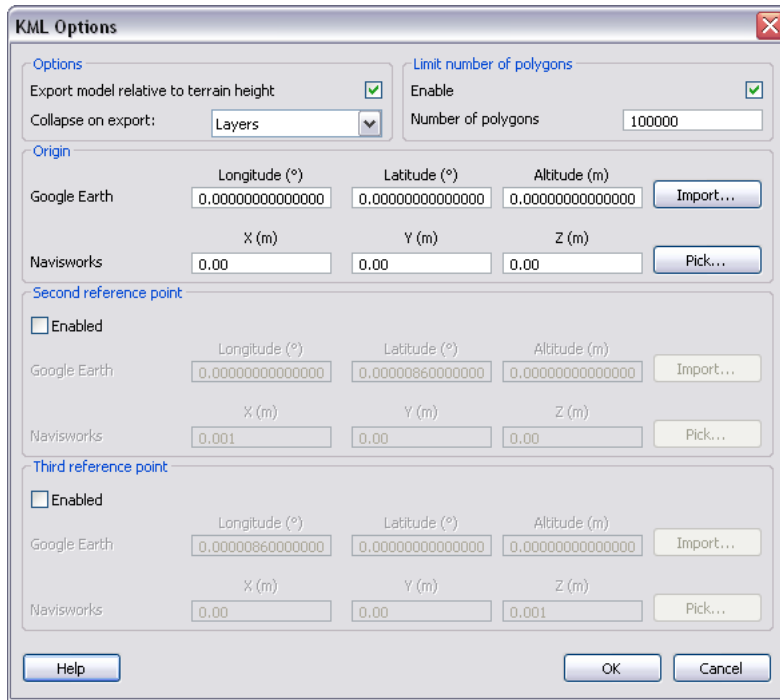

NOTE When positioning a model relative to sea level, the height of the Google Earth reference points must also be measured relative to sea level. When positioning a model relative to the ground, the Google Earth reference points must be measured relative to the ground.

Google Earth always places new placemarks at an altitude of zero, irrespective of whether that is relative or absolute.

- 3 The Collapse on Export drop-down list allows different levels of collapsing parts of the model hierarchy in the exported file. Choose from:
 - None - ensures the whole hierarchy is exported
 - All Objects - collapses everything into one node
 - Files - collapses each file into one node
 - Layers - collapses each layer into one node
- 4 Select the Enable check box in the Limit Number of Polygons area to restrict the amount of geometry exported into the output file. Geometry is selected on the basis of taking the most obvious objects in preference to the fine detail. If the exported file is too large for Google Earth to display, try enabling this and reducing the number of polygons. Clicking View ► Scene Statistics in Autodesk Navisworks shows the number of triangles and/or lines in the current project. By setting a polygon limit you are choosing to export only some of these items.
- 5 The Origin position values are the first pair of reference points on the Google Earth surface, and must always be defined. The Autodesk Navisworks reference point will always be positioned to exactly overlay the Google Earth reference point.

Second and Third reference points can be used, and if enabled then the position and orientation of the model can be more accurately defined.
- 6 Use the Import buttons to read-in saved placemark locations from KML files exported from Google Earth. The Origin Import button differs slightly from the other two; if the KML file contains multiple placemarks, this button will offer the user the choice of importing second and third reference points if available. The other two buttons will only import a single reference point.
- 7 The Pick buttons allow the reference point locations to be selected in the Scene Area.

These points must be visible in the Scene Area prior to exporting, as once the KML Options dialog box is open you will not be able to navigate before picking.

TIP You can use View ► Scene View ► Split Vertical or Split Horizontal to split the Scene Area into separate views of each reference point.

- 8 Click OK.
- 9 In the Export dialog box, enter a new filename and location, if you want to change from those suggested.
- 10 Click Save.

TimeLiner CSV

You can export CSV data from TimeLiner. The columns exported, and their order, will be precisely as in the TimeLiner Task View.

NOTE When exporting a CSV from TimeLiner, the hierarchy of tasks is not represented. All available tasks are exported without any hierarchical structure. This means that collapsing/expanding task nodes in the TimeLiner grid does not affect whether or not tasks are output to CSV.

To export CSV data from TimeLiner

- 1 Click File ► Export ► TimeLiner CSV Export.
- 2 In the Export dialog box, enter a new filename and location, if you want to change from those suggested.
- 3 Click Save.

NOTE Exported CSV files always have headers at row 1, which contains the TimeLiner column names.

Export Images and Animations

Export an Image

To export an image as a bitmap, .png, or .jpeg file

- 1 Display the view you want to export in the Scene Area, and click File ► Export ► Image.
- 2 In the Image Export dialog box, select the Format of the image you want to export.

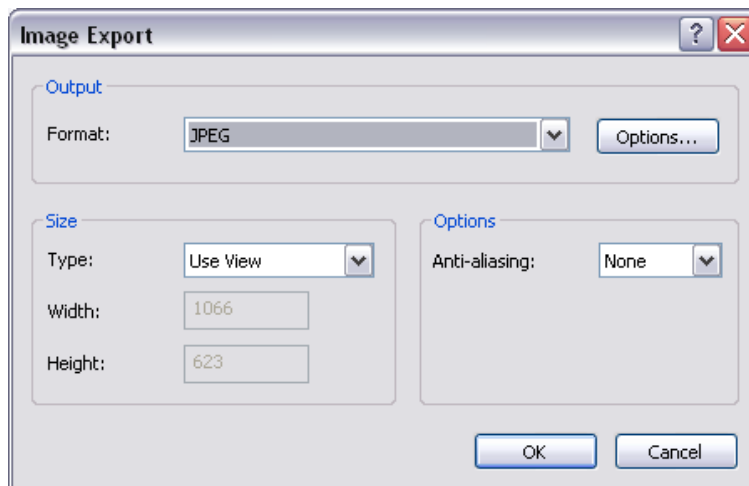

- 3 Use the Size and Options area to set the image size. See [“Image Export Dialog Box”](#) on page 415.
For .png file format, click the Options button, and use the PNG Options dialog box to specify the Interlacing and Compression settings.

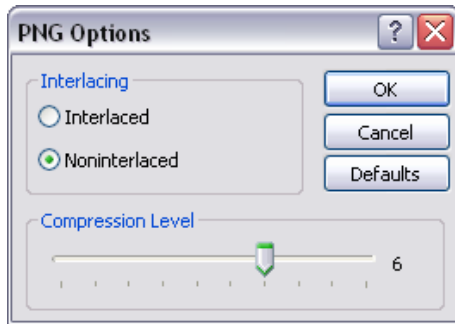

For .jpeg file format, click the Options button, and use the JPEG Options dialog box to specify the Compression and Smoothing settings.

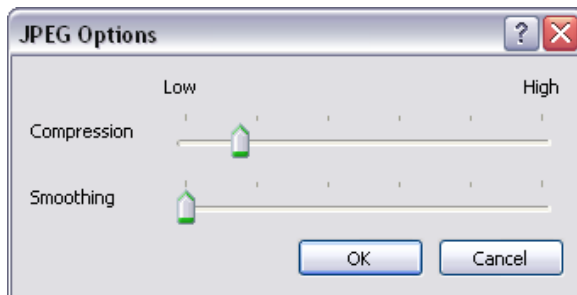

- 4 Click OK.
- 5 In the Save As dialog box, enter a new filename and location, if you want to change from those suggested.
- 6 Click Save.

Export a Rendered Image

Scenes rendered in Presenter can be exported out as images, so they can be used in presentations, on websites, in print, and so on. For more information, see [“Photo-Realistic Scene Rendering”](#) on page 301.

Export an Animation

To export an animation to an .avi file, or a sequence of image files

- 1 Click File ► Export ► Animation.
The Animation Export dialog box opens.

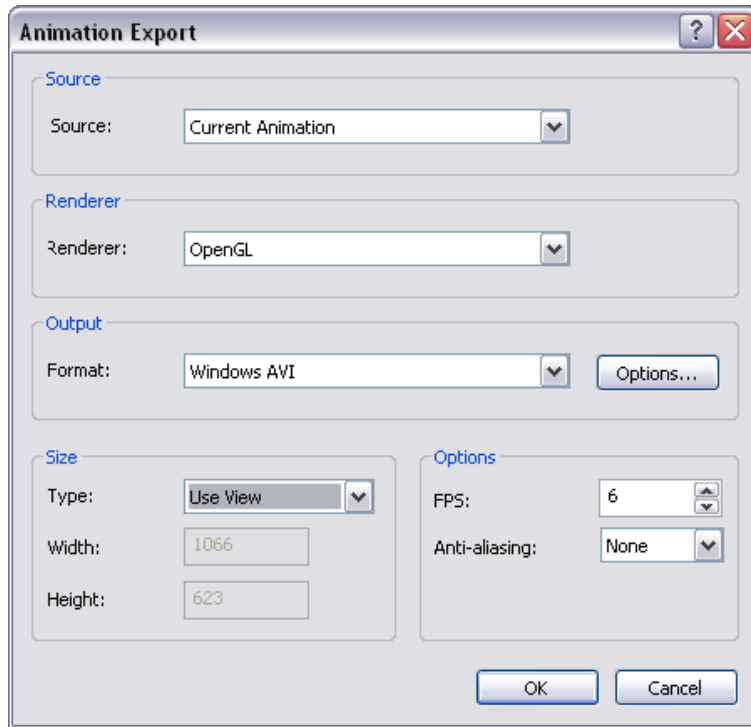

- 2 To export the currently selected viewpoint animation, select Current Animation in the Source box.
To export the currently selected object animation, select Current Animator Scene in the Source box.
To export a TimeLiner sequence, select TimeLiner Simulation in the Source box.
- 3 Set up the rest of the boxes in the Animation Export dialog box, and click OK. For more information, see [“Animation Export Dialog Box”](#) on page 416.
- 4 In the Save As dialog box, enter a new filename and location, if you want to change from those suggested.
- 5 Click Save.

Viewpoints Files

Viewpoints can be exported from Autodesk Navisworks to an .xml file.

These viewpoints contain all associated data, including camera positions, sections, hidden items and material overrides, redlines, comments, tags and collision detection settings.

Once the viewpoint data is exported to this text-based file format, it can either be imported into other Autodesk Navisworks sessions, or it can be accessed and used in other applications. For example, you may want to set up the same viewpoints in your CAD application.

To export viewpoints

- 1 Click File ► Export ► Viewpoints XML.
- 2 In the Export dialog box, enter a new filename and location, if you want to change from those suggested.
- 3 Click Save.

Current Search Criteria

The search criteria specified in the Find Items window can be exported to an .xml file. This can then be imported into other Autodesk Navisworks sessions. For example, if you have specified a complicated search criteria, containing various logic statements, that relates to all projects you work on, then this feature allows you to specify it once and use it on all projects.

For more information, see [“Find Items Window”](#) on page 186.

To export current search criteria

- 1 Click File ► Export ► Current Search XML.
- 2 In the Export dialog box, enter a new filename and location, if you want to change from those suggested.
- 3 Click Save.

Search Set Files

Saved search sets can be exported from Autodesk Navisworks as an .xml file. These can then be imported into other Autodesk Navisworks sessions and re-used. For example, if you have a number of generic searches that you perform on all of your projects, this feature allows you to specify the searches once and use them on all projects.

For more information see, [“Create and Manage Selection and Search Sets”](#) on page 192.

To export search sets

- 1 Click File ► Export ► Search Sets XML.
- 2 In the Export dialog box, enter a new filename and location, if you want to change from those suggested.
- 3 Click Save.

Viewpoints Report

An .html file can be exported containing a JPEG of all of the saved viewpoints and associated data, including camera position and comments.

NOTE To customize the appearance or layout of the html file, you will need to edit the `viewpoints_report_lang.xml` file, where **lang** is a code representing your language. The installed file is located in the stylesheets subdirectory of the Autodesk Navisworks install directory. You can copy the edited file to the stylesheets subdirectory of any of the Autodesk Navisworks search directories. For more information, see [“Search Directories”](#) on page 84.

Animate Objects

13

In Autodesk Navisworks Simulate 2010 you can animate your model and interact with it. For example, you could animate how a crane moves around a site, or how a car is assembled or dismantled, and so on. With a few mouse clicks, you can also create interaction scripts, which link your animations to specific events, such as 'On Key Press' or 'On Collision'. So, for example, a conveyor belt will move when you press a button on your keyboard, the doors will open as you approach them in your model.

Scope

Autodesk Navisworks Simulate 2010 supports both object animation and object interaction as follows:

- Animation specified by keyframes with linear interpolation between keyframes (similar to viewpoints animation).
- Camera, section plane, object animation.
- Multiple independently moving objects independently started.
- Multiple animations of the same object in the same scene (for example, moving a crane, and then lifting its arm).
- Simple scripts (for example, to open and close a specified door).
- Linking to TimeLiner to trigger off independent animations as tasks start.
- Linking to TimeLiner with different TimeLiner tasks play to specific points in an animation (e.g. have one animation that moves crane between all points on a site, any task can trigger animation to move from current point to desired point).
- Linking to Clash Detective to run clash tests at specific steps through an animation to check for animated versus animated or animated versus static object clashes.

The following is not currently supported in Autodesk Navisworks Simulate 2010:

- Animation specified by anything other than objects, for example spline or path.
- Animation of lights.
- Moving a whole object and then creating an independent trigger to move part of object (e.g. move whole crane and have button that triggers arm moving at any point).
- Opening/closing of multiple doors without having to create a separate script and animation for each door. Currently there are no cut-and-paste capabilities in scripting.

- Linking to TimeLiner to have different TimeLiner tasks trigger animations that depend on each other (e.g. one task moves crane to a specific point, another task moves arm of crane).
- Real-time collision checking where you turn it on, play an animation and have animation stop when moving object first hits something.



Overview of the Animator Tool

The Animator and Scriptor windows are the two dockable windows that are used to create and edit object animation in Autodesk Navisworks Simulate 2010.

Animator Window

Use the Animator window to create animated objects in your model.





 **Menu:** Tools ► Animator











 **Toolbar:** Workspace ► Animator 

The Animator Toolbar

The Animator toolbar is located at the top of the Animator window.

Use this toolbar to create, edit and play animations.

Control	Purpose
	Puts Animator into translation mode. The translation gizmo is displayed in the Scene Area, and enables you to modify the position of the geometry objects. This mode remains active until you select a different object manipulation mode from the toolbar.
	Puts Animator into rotation mode. The rotation gizmo is displayed in the Scene Area, and enables you to modify the rotation of the geometry objects. This mode remains active until you select a different object manipulation mode from the toolbar.
	Puts Animator into scale mode. The scaling gizmo is displayed in the Scene Area, and enables you to modify the size of the geometry objects. This mode remains active until you select a different object manipulation mode from the toolbar.
	Puts Animator into color mode. A color palette is shown in the Manual Entry bar, and enables you to modify the color of the geometry objects.
	Puts Animator into transparency mode. A transparency slider is shown in the Manual Entry bar, and enables you to modify the transparency of the geometry objects.

Control	Purpose
	Takes a snapshot of the current change to the model as a new keyframe in the timeline view.
	Enables/disables snapping. Snapping only comes into effect when moving objects by dragging the gizmos in the Scene Area, and has no effect on numerical entry or keyboard control.
<input type="text" value="Scene 1"/>	Selects the active scene.
<input type="text" value="0:10.00"/>	Controls the current position of the time slider in the timeline view.
	Rewinds the animation back to the beginning.
	Steps one second backwards.
	Plays the animation backwards from the end point to the start, and then stops. This does not alter the direction that the animated elements face.
	Pauses the animation at the point you press it at. To continue playing from where you paused, click Play again.
	Stops the animation playing and rewinds it back to the beginning.
	Plays the animation forward from the starting point to the end, then stops.
	Steps one second forwards.
	Fast forwards the animation to the end.

The Animator Tree View

The Animator tree view lists all scenes and scene components in a hierarchical list view.

Use it to create and manage animation scenes.

Hierarchical List

You can use the Animator tree view to create and manage your animation scenes. The scene trees display the scene components such as animation sets, cameras, and section planes in a hierarchical structure.

To work with an item in the tree view, you must first select it.

Selecting a scene component in the tree view selects all the elements contained within that component in the Scene Area. For example, selecting an animation set in the tree view automatically selects all geometry objects contained within that animation set.





You can quickly copy and move items in the tree view by dragging them. To do this, click the item you want to copy or move, hold down the right mouse button, and drag the item to the desired location. When the cursor changes to a black arrow, release the mouse button to display a shortcut menu. Click Copy Here or Move Here, as appropriate.

Shortcut Menu

You can display a shortcut menu for any item in the tree by right-clicking the item. The following commands are available on the shortcut menu whenever they are applicable:

Command	Purpose
Add Scene	Adds a new scene to the tree view.
Add Camera	Adds a new camera to the tree view.
Add Animation Set	Adds an animation set to the tree view.
Update Animation Set	Updates the selected animation set.
Add Section Plane	Adds a new section plane to the tree view.
Add Folder	Adds a folder to the tree view. Folders can hold scene components and other folders.
Add Scene Folder	Adds a scene folder to the tree view. Scene folders can hold scenes and other scene folders. When you add a scene folder, if you do this while having an empty scene folder selected, Navisworks creates the new scene folder at the very top of the tree, otherwise it creates it beneath your current selection.
Loop	Selects loop mode for scenes and scene animations. The animation plays forward to the end, then restarts again from the beginning, looping indefinitely.
Ping-Pong	Selects ping-pong mode for scenes and scene animations. The animation plays forward to the end, and then plays backwards to the beginning. Unless loop mode is also selected, this will only happen once.
Infinite	Selects infinite mode; it only applies to scenes, and will make the scene play indefinitely (that is until the Stop  button is pressed).
Cut	Cuts the selected item in the tree to clipboard.
Copy	Copies the selected item in the tree to clipboard.
Paste	Pastes the item from clipboard into the new location.
Delete	Deletes the selected item from the tree.

Icons

Icon	Purpose
	Opens a shortcut menu that enables you to add new items to the tree view with commands such as Add Scene, Add Camera and so on.
	Deletes the currently selected item in the tree view. NOTE If you made a mistake, use the  button on the Standard toolbar to restore the deleted item.
	Moves the currently selected item up in the tree view.
	Moves the currently selected item down in the tree view.

Check Boxes

Use the check boxes in the scene view to control whether the corresponding item is active, whether it loops, ping-pongs, and if it should run infinitely.

Active Select this check box to make the animation in the scene active. Only active animations will play.

NOTE To make a scene active, you need to select it in the Scene Picker on the Animator toolbar.

Loop This check box is available for scenes and scene animations. It enables you to control the playback mode. Select this check box to use loop mode. When the animation reaches the end, it will reset back to the start and run again.

P.P. This check box is available for scenes and scene animations. It enables you to control the playback mode. Select this check box to use ping-pong mode. When the animation reaches the end, it will run backwards until it reaches the start. Unless loop mode is also selected, this will only happen once.

Infinite This check box is only available for scenes. Select this check box to make the scene play indefinitely (that is, until the Stop  button is pressed). If this check box is clear, the scene will play until its end point is reached.

NOTE When a scene is set to infinite, it can not also loop or ping-pong; so if you select this check box, the Loop and P.P. check boxes are not available for your scene.

The Animator Timeline View



The timeline view shows the timelines with keyframes for animation sets, cameras, and section planes in your scenes.

Use it to visualize and edit the animations.

Timescale Bar

At the top of the timeline view is the timescale bar in seconds. All timelines start at 0.

Right-clicking the timescale bar opens a shortcut menu.

Use the  and  icons at the bottom of the tree view to zoom in and out on the timescale bar.

The default timescale shows around 10 seconds of animation on a standard screen resolution, zooming in and out has an effect of doubling or halving the visible area. So, for example, zooming in shows around 5 seconds of animation, and zooming out shows around 20 seconds.

TIP You can also zoom in and out with mouse wheel while hovering over the timeline.

Another way of changing the timescale is to use the Zoom box. For example, type in '1/4', and press Enter to quarter the visible area. The value you enter is halved when you zoom in, and doubled when you zoom out. You can return to the default timescale by clearing the box, and pressing Enter.

Keyframes

The keyframes are shown as black diamonds in the timelines.

You can change the time when a keyframe occurs by dragging the black diamond left or right in the timeline view. As you drag a keyframe, it changes the color from black to a lighter grey.

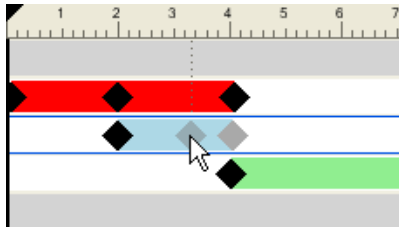

Left-clicking a keyframe moves the time slider to that position.

Right-clicking a keyframe opens a shortcut menu.

Animation Bars

The colored animation bars are used to visualise the keyframes in a timeline, and cannot be edited. Each animation type is shown in a different color, and the animation bars for the scenes are grey. Typically, the animation bar ends with the last keyframe. If an animation bar carries on in a faded color after the last keyframe, this indicates that the animation will play indefinitely (e.g., loop animation).

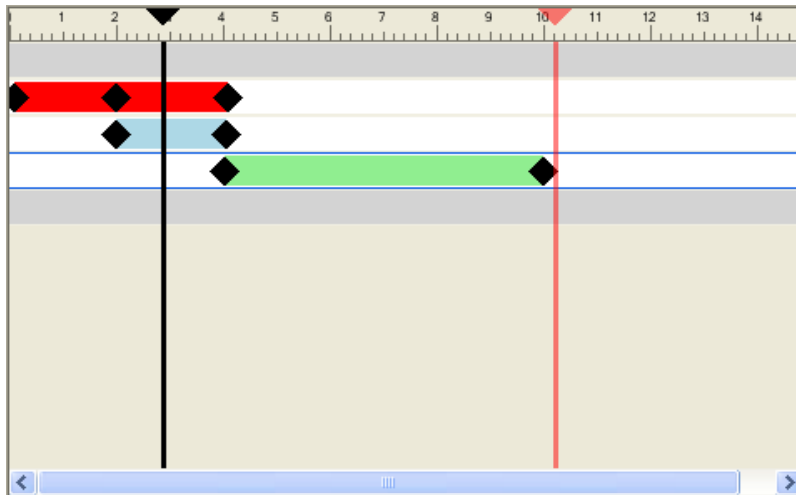

Sliders

You can use two sliders in the timeline view:

Time Slider The black vertical line is the time slider, representing the current position in the playback. This can be adjusted by either using the VCR controls on the toolbar or by dragging the slider left or right in the timeline view, or by selecting a timeline in the timeline view and using the left and right cursor keys. As the time slider is moved, the model in the Scene Area updates to reflect movements caused by keyframes in the current scene as if the animation were playing back.

End Slider The red vertical line is the end slider, representing the end point of the current active scene. It is hidden if you selected the Infinite check box for the current scene in the tree view. By default, the end slider is set to the last keyframe in the scene and can't be moved. You can switch on manual control of the end slider in a scene by right-clicking it, and selecting the Manually Position Endbar option from the shortcut menu. To manually adjust the slider, drag it left or right. This end marker will be used as the animation end point when scenes are set to loop or ping-pong.

Shortcut Menu

Right-clicking the timescale bar opens a shortcut menu that allows you to adjust the sliders.

- **Move Time Here** - moves the time slider into the current cursor position.
- **Move Scene End Here** - moves the end slider into the current cursor position.

NOTE This option is not available until you select the Manually Position Endbar option.

- **Reset Endbar to the Scene End** - moves the end slider to its original position.
- **Manually Position Endbar** - switches on manual control of the end slider in a scene.

Right-clicking a keyframe opens the shortcut menu with the following options:

- **Edit** - enables you to edit the selected keyframe.
- **Go to Keyframe** - moves the black time slider to this keyframe.
- **Cut, Copy, Paste** - standard cut, copy, and paste commands. They only work inside the selected timeline.
- **Delete** - deletes the selected keyframe.
- **Interpolate** - determines whether Navisworks automatically interpolates between the current and the last keyframes. This is the default option. When disabled, there will be no gradual movement between the two keyframes; instead the animation will instantly jump to the position/view of the second keyframe when it's reached. Also, there will be no colored animation bar between the keyframes.

NOTE If you right-click an area on the animation bar without a keyframe in it, the shortcut menu will contain only the Paste option; to use it, you must have the keyframe data on the clipboard.

See also:

- [“Work with Keyframes”](#) on page 292

The Manual Entry Bar

The optional Manual Entry bar is located at the bottom of the Animator window, and enables you to manipulate geometry objects by typing in numerical values, instead of using gizmos in the Scene Area.

The contents of the bar change depending on the button last selected from the Animator toolbar.

You can toggle the Manual Entry bar on and off by using the [Options Editor](#).

Translate

X, Y, Z Enter the X, Y, and Z coordinate values to move the selected objects into this position.

Rotate

X, Y, Z Enter the degrees of rotation around X, Y, and Z axis to move the selected objects into this position.

cX, cY, cZ Enter the X, Y, and Z coordinate values to move the origin (or center point) of the rotation into this position.

oX, oY, oZ Enter the degrees of rotation around X, Y, and Z axis to modify the orientation of the rotation.

NOTE 0,0,0 represents world up.

Scale

X, Y, Z Enter the scaling factor around X, Y, and Z axis; 1 being the current size, 0.5 half, 2 being double and so on.

cX, cY, cZ Enter the X, Y, and Z coordinate values to move the origin (or center point) of the scaling into this position.

Color

Color This check box indicates whether or not clicking the **Capture Keyframe**  button will record color change in the keyframe.

Clearing this check box resets the color back to its original state.

By default, Navisworks clears this check box every time you create an animation set. Within one and the same animation set, once this check box is selected, it stays selected, until you manually clear it.

R, G, B Enter the Red, Green, and Blue values for the new color.



If you don't want to enter the R, G, B values manually, click this button, and select the desired color.

Transparency

Transparency This check box indicates whether or not clicking the **Capture Keyframe**  button will record transparency change in the keyframe.

Clearing this check box resets the transparency back to its original state.

By default, Navisworks clears this check box every time you create an animation set. Within one and the same animation set, once this check box is selected, it stays selected, until you manually clear it.

% Enter the value to adjust the transparency level (0 to 100%). A higher value makes the element more transparent; a lower value makes the element more opac.



If you don't want to enter the transparency value manually, use this slider to adjust the transparency level.



See also:

- [“Using Gizmos”](#) on page 205

Scripter Window

Use the Scripter window to add interactivity to animated objects in your model.

 **Menu:** Tools ► Scripter

 **Toolbar:** Workspace ► Scripter 

The Scripter Tree View

The Scripter tree view contains all scripts available in your Navisworks file in a hierarchical list view.

Use it to create and manage animation scripts.

NOTE Although you can organize the scripts into folders, this has no effect on the way scripts are executed in Navisworks.

Hierarchical List

You can use the Scripter tree view to create and manage your scripts.

To work with an item in the tree view, you must first select it.

Selecting a script in the tree view displays the associated events, actions and properties.





You can quickly copy and move items in the tree view by dragging them. To do this, click the item you want to copy or move, hold down the right mouse button, and drag the item to the desired location. When the cursor changes to a black arrow, release the mouse button to display a shortcut menu. Click Copy Here or Move Here, as appropriate.

Shortcut Menu

You can display a shortcut menu for any item in the tree by right-clicking the item. The following commands are available on the shortcut menu whenever they are applicable:

Command	Purpose
Add New Script	Adds a new script to the tree view.
Add New Folder	Adds a folder to the tree view. Folders can hold scripts and other folders.
Rename Item	Enables you to rename the currently selected item in the tree view.
Delete Item	Deletes the currently selected item in the tree view.
Activate	Selects the Active check box for the currently selected item in the tree view. Only active scripts will be executed.
Deactivate	Clears the Active check box for the currently selected item in the tree view. Only active scripts will be executed.

Icons

Icon	Purpose
	Adds new scripts to the tree view.
	Adds new folders to the tree view.
	Deletes the currently selected item in the tree view.
<hr/> NOTE If you made a mistake, click  on the Standard toolbar to restore the deleted item. <hr/>	

Check Boxes

Active Use this check box to specify which scripts you want to use. Only active scripts are executed.

If you organized your scripts into folders, you can quickly turn the scripts on and off by using the Active check box next to the top-level folder.









The Events View

The events view shows all events associated with the currently selected script.

Use the events view to define, manage, and test events.

Icons

Icon	Purpose
	Adds start events.

Icon	Purpose
	Adds timer events.
	Adds key press events.
	Add collision events.
	Adds hotspot events.
	Adds variable events.
	Adds animation events.
	Moves the currently selected event up in the events view.
	Moves the currently selected event down in the events view.
	Deletes the currently selected event in the events view.

Shortcut Menu

Right-click in the events view to display a shortcut menu. The following commands are available on the shortcut menu whenever they are applicable:











Command	Purpose
Add Event	Enables you to select an event to add.
Delete Event	Deletes the currently selected event.
Brackets	Enables you to select brackets. Choose from (,), and None .
Logic	Enables you to select logic operators. Choose from AND , and OR .
Test Logic	Tests the validity of your event condition.
Move Up	Moves the currently selected event up.
Move Down	Moves the currently selected event down.

The Actions View

The actions view shows the actions associated with the currently selected script.

Use it to define, manage, and test actions.

Icons

Icon	Purpose
	Adds play animation actions.
	Adds stop animation actions.
	Adds show viewpoint actions.
	Adds pause actions.
	Adds send message actions.
	Adds set variable actions.
	Adds store property actions.
	Adds load model actions.
	Moves the currently selected action up in the actions view.
	Moves the currently selected action down in the actions view.
	Deletes the currently selected action.

Shortcut Menu

Right-click in the actions view to display a shortcut menu. The following commands are available on the shortcut menu whenever they are applicable:

Command	Purpose
Add Action	Enables you to select an action to add.
Delete Action	Deletes the currently selected action.
Test Action	Executes the currently selected action.
Stop Action	Stops execution of the currently selected action.
Move Up	Moves the currently selected action up in the actions view.
Move Down	Moves the currently selected action down in the actions view.

The Properties View

The properties view shows the properties for the currently selected event or action.

Use it to configure the behavior of events and actions in your scripts.

Events Properties

Currently, there are seven event types in Navisworks. When an even is added, the properties view displays the properties for that event type. The event properties can be configured immediately, or at a later time.

On Start

You don't need to configure any properties for this event type.

On Timer

Interval Defines the length of time in seconds between timer triggering.

Regularity Specifies the event frequency. Choose from:

- **Once After** - an event happens once only. Use this option to create an event that starts after a certain length of time.
- **Continuous** - an event is continuously repeated at specified time intervals. You can use this, for example, to simulate cyclic work of a factory machine.

On Key Press

Key Click in this box, and press the key on the keyboard to link it to your event.

Trigger On Defines how the event is triggered. Choose from:

- **Key Up** - an event is triggered after you press the key, and let go (that is, when your finger releases the key).
- **Key Down** - an event is triggered the moment you press the key (that is, when your finger hits the key).
- **Key Pressed** - an event is triggered while the key is pressed. This option allows you to use a key press event together with Boolean operators. For example, you can AND this event to a timer event.

On Collision

Selection to Collide With Click the Set button, and use the shortcut menu to define the collision objects:

- **Clear** - clears your currently selected collision objects.
- **Set From Current Selection** - sets the collision objects to your current object selection in the Scene Area.

NOTE This option is not available until you make a selection in the Scene Area.

- **Set From Current Selection** - sets the collision objects to your current search set or selection set.

Show This is a read-only box, showing the number of geometry objects selected as collision objects.

Include the Effects of Gravity Select this check box if you want to include gravity in collision. If this option is used, hitting floor when walking across it, for example, will trigger your event.

On Hotspot

Hotspot Defines the hotspot type. Choose from:

- **Sphere** - simple sphere from a given point in space.
- **Sphere on Selection** - a sphere around a given selection. This option doesn't require you to define the given point in space. This hotspot will move as the selected objects move in the model.

Trigger When Defines how the event is triggered. Choose from:

- **Entering** - an event is triggered when you cross into the hotspot. This is useful for opening doors, for example.
- **Leaving** - an event is triggered when you leave the hotspot. This is useful for closing doors, for example.
- **In Range** - an event is triggered when you are inside the hotspot. This option allows you to use a hotspot event together with Boolean operators. For example, you can AND this event to a timer event.

Hotspot Type

Position The position of the hotspot point. If the chosen hotspot is Sphere on Selection, this field is not available.

Pick Enables you to pick the position of the hotspot point. If the chosen hotspot is Sphere on Selection, this button is not available. Click the button, and then pick a point for the hotspot in the Scene Area.

Selection Click the Set button, and use the shortcut menu to define the hotspot objects:

- **Clear** - clears the current selection.
- **Set From Current Selection** - the hotspot is set to your current object selection in the Scene Area.

NOTE This option is not available until you make a selection in the Scene Area.

- **Set From Current Selection Set** - the hotspot is set to your current search set or selection set.

NOTE If the chosen hotspot is Sphere, this button is not available.

Show This is a read-only field, which displays the number of geometry objects linked to the hotspot. If the chosen hotspot is Sphere, this field is not available.

Radius Radius of hotspot.

On Variable

Variable The alphanumeric name of the variable to be evaluated.

Value An operand to use. Enter a value to be tested against your variable. Alternatively, enter a name of another variable. Its value will be tested against the value in your variable.

The following rules apply:

- If you enter a number (for example 0, 400, 5.3), the value is treated as a numeric value. If it's got a decimal place, the floating-point formatting is preserved up to the user-defined decimal places.
- If you enter an alphanumeric string between single or double quote marks, such as "hello" or 'testing', the value is treated as a sting.
- If you enter an alphanumeric string without single or double quote marks, such as counter1 or testing, the value is treated as another variable. If this variable has never been used before, it's assigned a numerical value of 0.
- If you enter the word true or false without any quotes, the value is treated as a boolean (true = 1, false = 0).

Evaluation Operators used for variable comparison. You can use any of the following operators with numbers and boolean values. However, comparing strings is limited to the 'Equal To' and 'Not Equal To' operators only.

- Equal To
- Not Equal To
- Greater Than
- Less Than
- Greater Than or Equal To
- Less Than or Equal To

On Animation

Animation Selects the animation that triggers the event. If you don't have any object animation in your Navisworks file, this field is not available.

Trigger On Defines how the event is triggered. Choose from:

- **Starting** - an event is triggered when the animation starts.
- **Ending** - an event is triggered when the animation ends. This is useful for chaining animations together.

See also:

- [“Event Types”](#) on page 296

Actions Properties

Currently, there are eight action types in Navisworks. When an action is added, the properties view displays the properties for that action type. The action properties can be configured immediately, or at a later time.

Play Animation

Animation Selects the animation to play. If you don't have any object animation in your Navisworks file, this field is not available.

Pause at End Select this check box if you want the animation to stop at the end. When this check box is clear, the animation snaps back to the starting point when it ends.

Starting At Defines the starting position of the animation playback. Choose from:

- **Start** - the animation plays forwards from the beginning.
- **End** - the animation plays backwards from the end.
- **Current Position** - the animation plays from its current position, if the playback has already started. Otherwise, the animation plays forwards from the beginning.
- **Specified Time** - the animation plays from the segment defined in the Specific Start Time field.

Ending At Defines the finishing position of the animation playback. Choose from:

- **Start** - the playback ends at the beginning of the animation.
- **End** - the playback ends at the end of the animation.
- **Specified Time** - the playback ends at the segment defined in the Specific End Time field.

Specific Start Time The starting position of a playback segment.

Specific End Time The finishing position of a playback segment.

Stop Animation

Animation Selects the animation to stop. If you don't have any object animation in your Navisworks file, this field is not available.

Reset To Defines the playback position of the stopped animation. Choose from:

- **Default Position** - the animation is reset to its starting point.
- **Current Position** - the animation remains at the position it was stopped at.

Show Viewpoint

Viewpoint Selects the viewpoint or a viewpoint animation to show. If you don't have any viewpoints in your Navisworks file, this field is not available.

Pause

Delay Defines the amount of time delay before the next action in the script is run.

Send Message

Message Defines the message to send to a text file defined in the Options Editor.

You can output the Scripter variables in your message. To do this, use `%variable_name%` style.

Set Variable

Variable Name The alphanumeric name for the variable.

Value An operand to assign. The following rules apply:

- If you enter a number (for example 0, 400, 5.3), the value is treated as a numeric value. If it's got a decimal place, the floating-point formatting is preserved up to the user-defined decimal places.
- If you enter an alphanumeric string between single or double quote marks, such as "hello" or 'testing', the value is treated as a sting.
- If you enter the word true or false without any quotes, the value is treated as a boolean (true = 1, false = 0).

Modifier Assignment operators for your variable. You can use any of the following operators with numbers and boolean values. However, using strings is limited to the 'Set Equal To' operator only.

- Set Equal To
- Increment By
- Decrement By

Store Property

Selection to Get Property From Click the Set button, and use the shortcut menu to define the objects, which are used to get the property from:

- **Clear** - clears the current selection.
- **Set From Current Selection** - the objects are set to your current object selection in the Scene Area.

NOTE This option is not available until you make a selection in the Scene Area.

- **Set From Current Selection Set** - the objects are set to your current search set or selection set.

IMPORTANT If your selection contains a hierarchy of objects, the top-level object is automatically used to get the property from. So, for example, if you selected a group called "Wheel", which includes two subgroups called "Rim", and "Tyre", only the properties that relate to "Wheel" can be stored.

Variable to Set The name of the variable to receive the property.

Property to Store

Category The property category. The values in this drop-down box depend on the selected objects.

Property The property type. The values in this drop-down box depend on the chosen property category.

Load Model

File to Load The path to the Navisworks file that will be loaded to replace the current one.

You may find it useful when you present a selection of animated scenes contained in a range of different model files.

See also:

- ["Action Types"](#) on page 297

Create Object Animations

An animation is a prepared sequence of changes to the model. The changes you can make in Autodesk Navisworks Simulate 2010 are:

- Manipulating geometry objects by modifying their position, rotation, size, color, and transparency. This type of change is referred to as an animation set.
- Manipulating viewpoints by using different navigation modes (such as orbiting or flying), or by using existing viewpoint animations. This type of change is referred to as a camera.
- Manipulating section planes either by moving them, or by turning them on and off. This type of change is referred to as a section plane set.

Quick Reference

The Animator window is a floating window that enables you to add animations to your model.

 **Menu:** Tools ► Animator

 **Toolbar:** The Animator  button on the Workspace toolbar

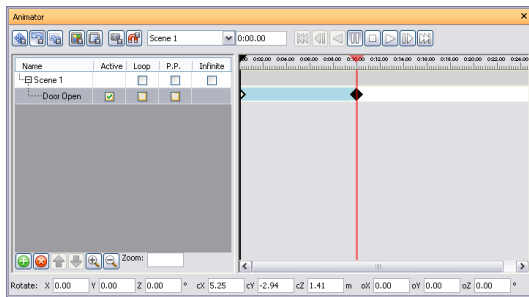

The Animator window contains the following components: [the toolbar](#), [the tree view](#), [the timeline view](#), and [the manual entry bar](#).

Work with Animation Scenes

Scenes act as containers for your object animations.

Each scene can contain the following components:

- One or more animation sets
- A single camera animation
- A single section plane set animation

The scenes and the scene components can be grouped into folders. This has no effect on playback, except that the contents of a folder can be easily switched on/off to save time.

There are two types of folders:

- **Scene folders** - to hold scenes and other scene folders.
- **Folders** - to hold scene components and other folders.

To add an animation scene

- 1 If the Animator window is not already open, select Tools ► Animator from the menu bar.
- 2 Right-click in the Animator tree view, and click Add Scene on the shortcut menu.
- 3 Click the default scene name, and type in a new name.

TIP Use names that can help you to identify your scenes in future.

Pointing device: Click  , and click Add Scene on the shortcut menu.

To delete an animation scene

- 1 If the Animator window is not already open, select Tools ► Animator from the menu bar.
- 2 Select the scene you want to delete, and click  .

NOTE Deleting a scene also deletes all of its components. If you made a mistake, use the  button on the Standard toolbar to restore the deleted scene.

To organize scenes into scene folders

- 1 If the Animator window is not already open, select Tools ► Animator from the menu bar.
- 2 Right-click in the Animator tree view, and click Add Scene Folder on the shortcut menu.
- 3 Click the default folder name, and type in a new name.

TIP Use names that can help you to identify your scenes in future.

- 4 Select the scene you want to add to your new folder. Hold down the left mouse button, and drag the mouse to the folder name. When the cursor changes to a black arrow, release the mouse button to drop the scene into the folder.

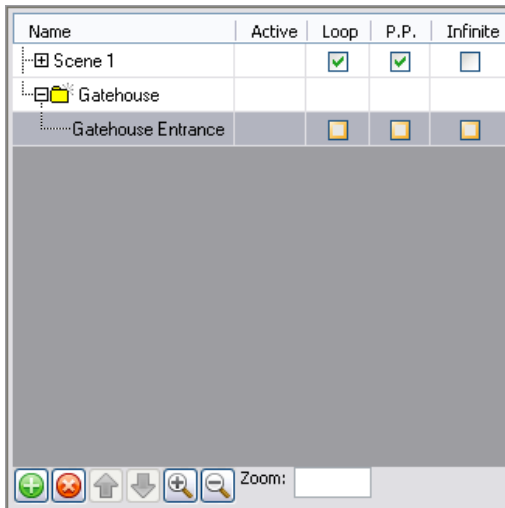

To organize scene components into folders

- 1 If the Animator window is not already open, select Tools ► Animator from the menu bar.
- 2 To add a subfolder to a scene, right-click it, and click Add Folder on the shortcut menu.
To add a subfolder to a scene component, right-click it, and click Add Folder on the shortcut menu.

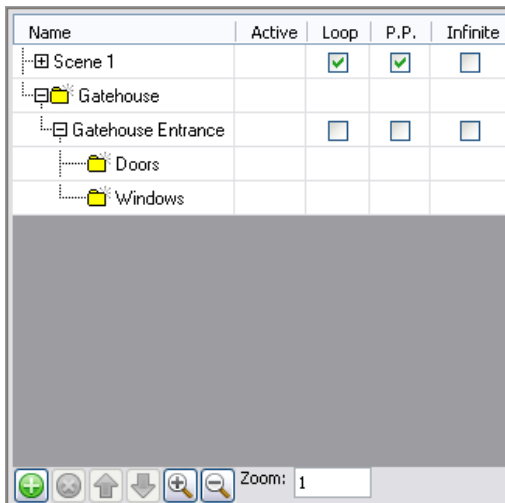

- 3 To move a subfolder, right-click it, and click Cut on the shortcut menu. Right-click the new location, and click Paste on the shortcut menu.
- 4 To rename a folder, click it, and type a new name.

TIP Use names that can help you to identify your scene components in future.

Work with Animation Sets

An animation set contains a list of geometry objects to be animated, and a list of keyframes that describe how it is to be animated.

Your scene can have as many animation sets as you want, and you can also have the same geometry objects in different animation sets within the same scene. The order of animation sets within a scene is important, and can be used to control the final object position when the same object is used in multiple animation sets.

Add Animation Sets

An animation set can be based on the current selection in the Scene Area, or on the current selection set or current search set.

When you add an animation set based on a selection set, the contents of the animation set is automatically updated if the contents of the source selection set change.

When you add an animation set based on a search set, the contents of the animation set is updated each time the model changes to include everything in the search set.

NOTE Any changes to search/selection sets during the animation playback are ignored.

If the model changes so that objects in a particular animation are missing, they are automatically removed from the animation set when the corresponding NWD or NWF file is resaved.

Finally, if the selection or search sets are deleted rather than being lost, the corresponding animation set becomes a static selection of objects based on what it last contained.

To add an animation set based on current selection

- 1 If the Animator window is not already open, select Tools ► Animator from the menu bar.
- 2 Select the desired geometry objects in the Scene Area, or from the Selection Tree.
- 3 Right-click the scene name, and click Add Animation Set ► From Current Selection on the shortcut menu.

To add an animation set based on current search set or selection set

- 1 If the Animator window is not already open, select Tools ► Animator from the menu bar.
- 2 Select the desired search set or selection set from the Selection Sets.
- 3 Right-click the scene name, and click Add Animation Set ► From Current Search/Selection Set on the shortcut menu.

Update Animation Sets

An animation set can be manually updated.

You can modify your current selection in the Scene Area, or the current selection set or current search set, and change the contents of your animation set to reflect this.

NOTE The keyframes are not affected by this operation.

To update an animation set based on current selection

- 1 If the Animator window is not already open, select Tools ► Animator from the menu bar.
- 2 Select the desired geometry objects in the Scene Area, or from the Selection Tree.
- 3 Right-click the scene name, and click Update Animation Set ► From Current Selection on the shortcut menu.

To update an animation set based on current search set or selection set

- 1 If the Animator window is not already open, select Tools ► Animator from the menu bar.
- 2 Select the desired search set or selection set from the Selection Sets control bar.
- 3 Right-click the scene name, and click Update Animation Set ► From Current Search/Selection Set on the shortcut menu.

Manipulate Geometry Objects

You can modify position, rotation, size, color and transparency of geometry objects in animation sets, and capture these changes in keyframes.

All object manipulation is carried out the in the Scene Area.

When you manipulate geometry objects by changing their position, rotation or size you can use snapping to control the precision of your operations in the Scene Area.

When you select animation sets in the Animator tree view, they are also highlighted in the Scene Area. To get a clearer view of an object as you animating it, you can use the Options Editor to adjust the way in which the current selection is highlighted.



See also:

- [“The Manual Entry Bar”](#) on page 277

To capture object movement

- 1 If the Animator window is not already open, select Tools ► Animator from the menu bar.
- 2 Select the desired animation set in the Animator tree view.
The corresponding geometry objects are highlighted in the Scene Area.

TIP To get a better view, change the way the objects are highlighted.



- 3 Click the Capture Keyframe  button on the Animator toolbar to create a keyframe with the initial object state.
- 4 In the timeline view, move the black time slider to the right to set the desired time.
- 5 Click the Translate Animation Set  button on the Animator toolbar.
- 6 Use the translation gizmo to change the position of the selected objects.
- 7 To capture the current object changes in a keyframe, click the Capture Keyframe  button on the Animator toolbar.

To capture object rotation

- 1 If the Animator window is not already open, select Tools ► Animator from the menu bar.
- 2 Select the desired animation set in the Animator tree view.

The corresponding geometry objects are highlighted in the Scene Area.



TIP To get a better view, change the way the objects are highlighted.

- 3 Click the Capture Keyframe  button on the Animator toolbar to create a keyframe with the initial object state.
- 4 In the timeline view, move the black time slider to the right to set the desired time.
- 5 Click the Rotate Animation Set  button on the Animator toolbar.
- 6 Use the rotation gizmo to rotate the selected objects.
- 7 To capture the current object changes in a keyframe, click the Capture Keyframe  button on the Animator toolbar.

To capture scaling changes

- 1 If the Animator window is not already open, select Tools ► Animator from the menu bar.
- 2 Select the desired animation set in the Animator tree view.
The corresponding geometry objects are highlighted in the Scene Area.



TIP To get a better view, change the way the objects are highlighted.

- 3 Click the Capture Keyframe  button on the Animator toolbar to create a keyframe with the initial object state.
- 4 In the timeline view, move the black time slider to the right to set the desired time.
- 5 Click the Scale Animation Set  button on the Animator toolbar.
- 6 Use the scale gizmo to resize the selected objects.
- 7 To capture the current object changes in a keyframe, click the Capture Keyframe  button on the Animator toolbar.

To capture color changes

- 1 If the Animator window is not already open, select Tools ► Animator from the menu bar.
- 2 Select the desired animation set in the Animator tree view.
The corresponding geometry objects are highlighted in the Scene Area.

TIP To get a better view, change the way the objects are highlighted.



- 3 Click the Capture Keyframe  button on the Animator toolbar to create a keyframe with the initial object state.
- 4 In the timeline view, move the black time slider to the right to set the desired time.
- 5 Click the Change Color  button on the Animator toolbar.
- 6 Press the Color button on the Manual Entry bar, and choose the desired color.

- 7 To capture the current object changes in a keyframe, click the Capture Keyframe  button on the Animator toolbar.

To capture transparency changes

- 1 If the Animator window is not already open, select Tools ► Animator from the menu bar.
- 2 Select the desired animation set in the Animator tree view.
The corresponding geometry objects are highlighted in the Scene Area.

TIP To get a better view, change the way the objects are highlighted.

- 3 Click the Capture Keyframe  button on the Animator toolbar to create a keyframe with the initial object state.
- 4 In the timeline view, move the black time slider to the right to set the desired time.
- 5 Click the Change Transparency  button on the Animator toolbar.
- 6 Use the Transparency slider on the Manual Entry bar to adjust how transparent or opaque the selected objects are.
- 7 To capture the current object changes in a keyframe, click the Capture Keyframe  button on the Animator toolbar.

Work with Cameras

A camera contains a list of viewpoints, and an optional list of keyframes to describe how the viewpoints move.

If no camera keyframes are defined, then the scene uses the current views in the Scene Area. If a single keyframe is defined, the camera moves to that viewpoint, and then remain static throughout the scene. Finally, if multiple keyframes are defined, the camera is animated accordingly.

You can add a blank camera, and then manipulate the viewpoints, or you can copy an existing viewpoint animation straight into your camera.

NOTE Each scene can only have one camera in it.

To add a blank camera



- 1 If the Animator window is not already open, select Tools ► Animator from the menu bar.
- 2 Right-click the desired scene name, and click Add Camera ► Blank Camera on the shortcut menu.
You are now ready to capture camera viewpoints.

To add a camera with existing viewpoint animation

- 1 If the Animator window is not already open, select Tools ► Animator from the menu bar.
- 2 Select the desired viewpoint animation from the Viewpoints control bar.
- 3 Right-click the desired scene name, and click Add Camera ► From Current Viewpoint Animation on the shortcut menu.
Autodesk Navisworks automatically adds all necessary keyframes to the timeline view.

To capture camera viewpoints

- 1 If the Animator window is not already open, select Tools ► Animator from the menu bar.

- 2 Select the desired camera in the Animator tree view.
- 3 Click the Capture Keyframe  button on the Animator toolbar to create a keyframe with the current viewpoint.
- 4 In the timeline view, move the black time slider to the right to set the desired time.
- 5 Use the buttons on the Navigation Mode toolbar to change your current viewpoint. Alternatively, select one of the saved viewpoints from the Viewpoints control bar.
- 6 To capture the current object changes in a keyframe, click the Capture Keyframe  button on the Animator toolbar.

Work with Section Plane Sets

A section plane set contains a list of sectional cuts, and a list of keyframes to describe how they move.

NOTE Each scene can only have one section plane set in it.





To add a section plane set

- 1 If the Animator window is not already open, select Tools ► Animator from the menu bar.
- 2 Right-click the desired scene name, and click Add Section Plane on the shortcut menu.
You are now ready to capture sectional cuts.

To capture sectional cuts

- 1 If the Animator window is not already open, select Tools ► Animator from the menu bar.
- 2 Select the desired section plane set in the Animator tree view.
- 3 Select the plane that you wish to manipulate from the drop-down list on the Sectioning toolbar.

NOTE Make sure it's not yet enabled.

- 4 Set the step size by clicking on the Step Size  button on the Sectioning toolbar.
- 5 Click the Capture Keyframe  button on the Animator toolbar to create a keyframe with the current section cut.
- 6 In the timeline view, move the black time slider to the right to set the desired time.
- 7 Switch the section plane on by clicking the Enable/Disable  button on the Sectioning toolbar.
- 8 Use the Sectioning toolbar to choose one of the seven planes that this section plane will cut.
For example, click the Align Right  button.
- 9 Move the slider on the Sectioning toolbar to adjust the depth of your section cut.
- 10 To capture the current plane changes in a keyframe, click the Capture Keyframe  button on the Animator toolbar.

Work with Keyframes

Keyframes are used to define position and properties of the changes made to the model.

See also:

- [“Edit Key Frame Dialog Box”](#) on page 411

Capture Keyframes

New keyframes are created by clicking the Capture Keyframe  button on the Animator toolbar. Every time you click this button, Autodesk Navisworks adds a keyframe of the currently selected animation set, camera, or section plane set at the current position of the black time slider.

Conceptually, keyframes represent relative translations, rotations and scaling operations from the previous keyframe or, in the case of the first keyframe, the model's starting position.

Keyframes are relative to each other and to the model's starting position. This means that if an object is moved in the scene (when, for example, a new version of the model is opened, or if movement tools are used in Navisworks), the animation is done relative to the new starting location rather than the animation's original start position.

The translation, scaling and rotation operations are cumulative. This means if a particular object is in two animation sets at the same time, both sets of operations are carried out. So if both are translating across the X axis, for example, the object will move twice as far.

If there is no keyframe at the start of the timeline for an animation set, camera, or section plane set, then the very start of the timeline acts like a hidden keyframe. So, for example, if you have a keyframe a few seconds in, and the frame has the Interpolate option enabled, then over those first few seconds objects would interpolate between their default starting position and those defined in the first keyframe.

Edit Keyframes

You can edit captured keyframes for animation sets, cameras, and section planes.

To edit a keyframe

- 1 If the Animator window is not already open, select Tools ► Animator from the menu bar.
- 2 Right-click the desired keyframe in the timeline view, and select Edit on the shortcut menu.
- 3 Use the Edit Key Frame dialog box to adjust the animation.
- 4 Click OK to save your changes or Cancel to exit the dialog box.

Play Animation Scenes

Animations created in Autodesk Navisworks Simulate 2010 can be played in all Navisworks 2010 products, including Freedom.

To play a scene in the Animator window

- 1 If the Animator window is not already open, select Tools ► Animator from the menu bar.
- 2 Select the scene you want to play in the Animator tree view.
- 3 Click the Play  button on the Animator toolbar.

To play a scene from the Animation toolbar

- 1 Select the scene you want to play in the Available Animations box on the Animation toolbar.
- 2 Click the Play  button on the Animation toolbar.

To adjust the scene playback

- 1 If the Animator window is not already open, select Tools ► Animator from the menu bar.
- 2 Select the desired scene in the Animator tree view.
- 3 Use the Loop, P.P., and Infinite check boxes to adjust the way the scene plays:
 - If you want the scene to play back continuously, select the Loop check box. When the animation reaches the end, it will reset back to the start and run again.
 - If you want the scene to play in ping-pong mode, select the P.P. check box. When the animation reaches the end, it will run backwards until it reaches the start. This will only happen once, unless you also select the Loop check box.

- If you want the scene to play indefinitely (that is, until the Stop  button is pressed), select the Infinite check box. If this check box is clear, the scene will play until its end point is reached.

NOTE Selecting this check box disables the Loop and P.P. check boxes.

- 4 If necessary, use the Active, Loop, and P.P. check boxes to adjust the playback of the individual scene components.

NOTE Only animations with the selected Active check box will play.

Add Interactivity

Quick Reference

The Scripter window is a floating window that enables you to add interactivity to object animations in your model.

 **Menu:** Tools ► Scripter

 **Toolbar:** The Scripter  button on the Workspace toolbar

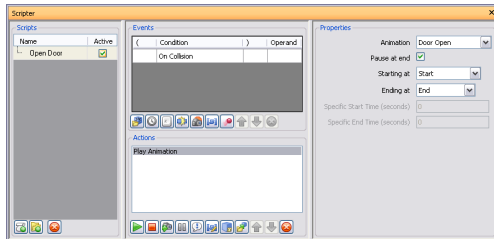

The Scripter window contains the following components: the [tree view](#), the [events view](#), the [actions view](#), and the [properties view](#).

NOTE If you can't use any of the controls in the Scripter window, it means that you are in interaction mode. To exit the mode, click the Toggle Scripts  button on the Animation toolbar.

Work with Animation Scripts

A script is a collection of actions that you want to happen when certain event conditions are met.

To add interactivity to your model, you need to create at least one animation script.

Each script can contain the following components:

- One or more events
- One or more actions

Your model can have as many scripts as you want, but only the active scripts are executed.

You can group the scripts into folders. This has no effect on their execution, except that the contents of a folder can be easily activated/deactivated to save time.

To add a script

- 1 If the Scripiter window is not already open, select Tools ► Scripiter from the menu bar.
- 2 Right-click in the script view, and click Add New Script on the shortcut menu.
- 3 Click the default script name, and type in a new name.

TIP Use names that can help you to identify your scripts in future.

Pointing device: Click  at the bottom of the tree view.

To delete a script

- 1 If the Scripiter window is not already open, select Tools ► Scripiter from the menu bar.
- 2 Select the script you want to delete in the tree view, and click .

NOTE If you made a mistake, click  on the Standard toolbar to restore the deleted script.

Shortcut menu: Right-click the script, and click Delete Item.

To organize scripts into folders

- 1 If the Scripiter window is not already open, select Tools ► Scripiter from the menu bar.
- 2 Right-click in the tree view, and click Add New Folder on the shortcut menu.
- 3 Click the default folder name, and type in a new name.

TIP Use names that can help you to identify your scripts in future.

- 4 Select a script you want to add to your new folder. Hold down the left mouse button, and drag the mouse to the folder name. When the cursor changes to a black arrow, release the mouse button to drop the script into the folder.

Alternatively, select the script, and hold down the right mouse button. Drag the mouse to the folder name. When the cursor changes to the black arrow, release the right mouse button, and click Move Here on the shortcut menu.

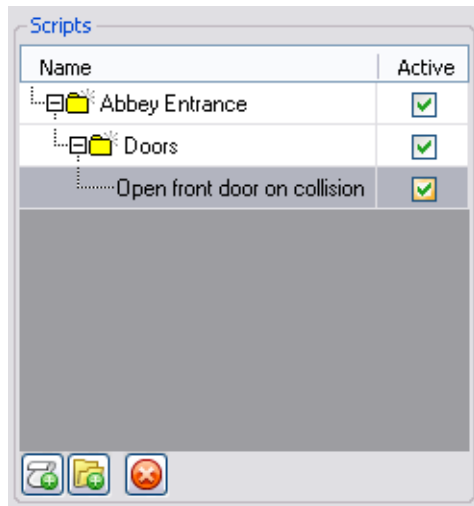

Work with Events

An event is the occurrence of an incident or a situation, such as a mouse click, key press or collision, which determines whether your script is run or not.

Your script can have more than one event in it. However, the way you combine all event conditions in the script becomes very important. That is you need to ensure the Boolean logic makes sense, the brackets are closed properly, and so on.

NOTE Until the combination of all event conditions in the script is satisfied, your script will not be executed.

Event Types

The following event types are available in Navisworks:

- **On Start** - event triggers a script as soon as scripting is enabled. If scripting is enabled when a file is loaded, then any start events in the file will be triggered immediately. This is useful for setting up the initial conditions of your script, such as giving initial values to variables, or moving the camera to a defined start point.
- **On Timer** - event triggers a script at predefined time intervals.
- **On Key Press** - event triggers a script with a specific button on the keyboard.
- **On Collision** - event triggers a script when the camera collides with a specific object.
- **On Hotspot** - event triggers a script when the camera is within a specific range of a hotspot.
- **On Variable** - event triggers a script when a variable meets a predefined criterion.
- **On Animation** - event triggers a script when a specific animation starts or stops.

Event Conditions

Events can be combined with a simple Boolean logic. To create an event condition you can use a combination of brackets and AND/OR operators.

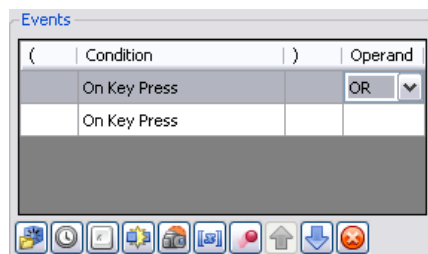

The brackets and logic operators can be added by right-clicking an event, and selecting the option from the shortcut menu. Alternatively, you can click in the corresponding field in the events view, and use the drop-down button to select the desired option.

NOTE If you have more than one event in your script, by default the AND operator will be used. This means the script only runs if all events have occurred.

To add an event

- 1 If the Scripiter window is not already open, select Tools ► Scripiter from the menu bar.
- 2 Select the desired script in the tree view.
- 3 Click the desired event icon at the bottom of the events view. For example, click  to create a start event.
- 4 Review the event properties in the properties view, and [adjust them as necessary](#).

To test event logic

- 1 If the Scripiter window is not already open, select Tools ► Scripiter from the menu bar.
- 2 Select the desired script in the tree view.
- 3 Right-click the events view, and click Test Logic on the shortcut menu.
Navisworks checks the event conditions in your script, and reports back any detected errors.

To delete an event

- 1 If the Scripiter window is not already open, select Tools ► Scripiter from the menu bar.
- 2 Select the desired script in the tree view.
- 3 Right-click the event you want to delete in the events view, and click Delete Event.

Work with Actions

An action is an activity, such as playing or stopping an animation, showing a viewpoint and so on, which is carried out when a script is triggered by an event or a combination of events.

Your script can have more than one action in it. Actions are executed one after another, so it is important to get the action sequence right.

NOTE Navisworks does not wait for the current action to be completed before moving on to the next action.

Action Types

The following action types are available in Navisworks:

- **Play Animation** - action specifies which animation to play back when a script is triggered.
- **Stop Animation** - action specifies which currently playing animation to stop when a script is triggered.
- **Show Viewpoint** - action specifies which viewpoint to use when a script is triggered.
- **Pause** - enables you to stop the script for a specified amount of time before the next action is run.
- **Send Message** - action writes a message in a text file when a script is triggered.
- **Set Variable** - action assigns, increases or decreases a variable value when a script is triggered.
- **Store Property** - action stores an object property in a variable when a script is triggered.
This can be useful if you need to trigger events based on embedded object properties or live data in a linked database.
- **Load Model** - action opens a specified file when a script is triggered.

You may find it useful if you want to present a selection of animated scenes contained in a range of different model files.

To add an action

- 1 If the Scripter window is not already open, select Tools ► Scripter from the menu bar.
- 2 Select the desired script in the tree view.
- 3 Click the desired action icon at the bottom of the actions view. For example, click  to add a play animation action.
- 4 Review the action properties in the properties view, and [adjust them as necessary](#).

To test an action

- 1 If the Scripter window is not already open, select Tools ► Scripter from the menu bar.
- 2 Select the desired script in the tree view.
- 3 Right-click the actions view, and click Test Action on the shortcut menu.
Navisworks executes the selected action.

To delete an action

- 1 If the Scripter window is not already open, select Tools ► Scripter from the menu bar.
- 2 Select the desired script in the tree view.
- 3 Right-click the action you want to delete in the actions view, and click Delete Action.

Enable Scripting

To enable animation scripts in your file, you need to click the Toggle Scripts  button on the Animation toolbar.

You can now interact with your model.

NOTE When the scripts are enabled, you can't create or edit scripts in the Scripter window. To disable scripting, click  again.

Create Photorealistic Visualizations

14

You can use the Presenter tool to apply texture materials, lighting, Rich Photorealistic Content (RPC), and background effects to your model.

Overview of the Presenter Tool

Presenter Window

The Presenter dockable window is used to set up materials and lights in your scene and render it with more realism and effects. You can also use it to edit pre-defined materials and apply them to items in the scene, add lights to the scene, and set up rules for applying the materials to other files in the same project set up with the same parameters. You can define and apply your materials and lights to a model and save the settings into an NWF file so that as the model is updated, the materials and lights remain the same.

Materials can also be brought through from CAD applications via the .3DS, .dwg and .dgn file formats, or by exporting from 3D Studio Viz or Max. See [“Work with Files”](#) on page 87 for more details on this.

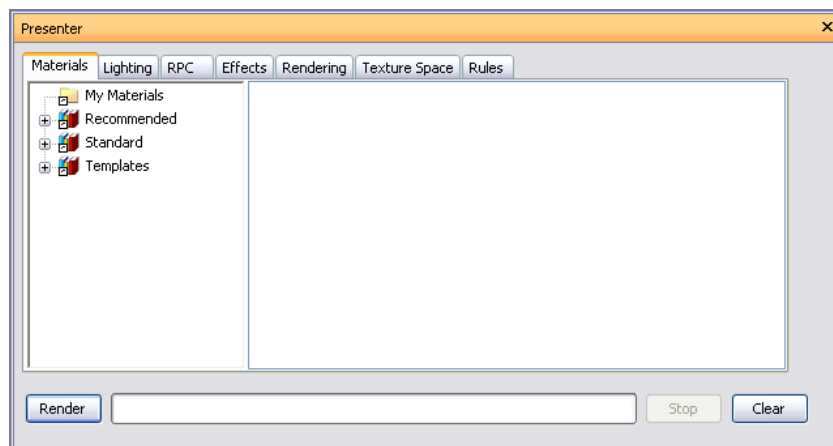

The Presenter window contains the following tabs:

- **Materials.** Includes a variety of materials, which can be selected and applied to individual or groups of model items. You can also

use this tab to create new materials, or customize existing materials.

- **Lighting.** Includes a variety of lighting options, which can be selected and applied to the model. You can also customize lighting options, if you want.
- **RPC.** Contains Rich Photorealistic Content (or RPC), which you can add from various sources, including websites. RPCs can include images of people, trees, cars and so on.
- **Effects.** Includes a variety of backgrounds and environments, which can be selected and applied to the model scene. Some existing backgrounds can be customized, or new backgrounds can be created. You can also add backgrounds and environments from other sources, such as websites.
- **Rendering.** Includes a variety of rendering styles, which can be selected and applied to the model. A render style affects the way a scene is rendered. You can also use this tab to create new render styles, or customize existing render styles.
- **Texture Space.** Defines the way in which a texture is applied to a model item, for example, applying a cylindrical texture space to a pipe will provide a more natural effect.
- **Rules.** Applies materials to models according to user-defined criteria. This can be used, for example, to speed up the application of materials to groups of items.

The Materials, Lighting, Effects, and Rendering tabs are divided into two panes. The left hand pane contains the [archives](#) and the right hand pane contains the palette, which defines what materials, lighting, effects and render styles are used in the scene. Archives are shown in a tree structure and are defined in the LightWorks Archive (.lwa) format.

Model Appearance

While Presenter can be used for photo-realistic renderings, it can also be used for OpenGL interactive rendering. Once you've set up the scene with Presenter, you can view the materials and lights in Autodesk Navisworks in real time.

For more information, see “[Control Model Appearance](#)” on page 167.

To toggle the Presenter window

- Click Presenter  on the Workspace toolbar.

 **Menu:** Tools ► Presenter

Use the Presenter Archives

There are three pre-defined archives that are installed with Presenter:

- The Recommended archives contain materials, lighting, effects and rendering styles that are recommended for most users. These include materials, lights and effects that can be seen during interactive navigation in Autodesk Navisworks and can be fully rendered with OpenGL. Of course, they will look better when rendered photorealistically.
- Additional materials, light studios, effects and render styles are available in the Standard archives. These include materials that cannot be fully reproduced using OpenGL and therefore will not be seen properly in interactive mode, or until a full photorealistic render is done.
- Any materials, lights, effects and render styles from any archive can be used as a template starter for your own definitions, but the Templates archives contains instances of each type of material, light, effect and render style, giving you quicker access.

TIP Additional .lwa archives can be downloaded from <http://www.lightworks-user.com/>, and added to the Materials, Lighting, Effects, and Rendering tabs.

Although materials, lights, effects and render styles cannot be edited in archives, once dragged into the scene's palette, they can be edited and saved with the scene in an NWF file, or published as an NWD file.

You can save your own edits to materials into an .nwp file format- see “[Organize and Manage Materials](#)” on page 305 for more information on how to do this.

The User Archives

The user archives allow you to save your own edited materials, lights, effects and render styles, for use in other scenes.

The User archives are accessible from each of the Materials, Lighting, Effects and Rendering tabs. On each of the tabs the archives are named My Materials, My Lighting, My Effects and My Render Styles, respectively.

To manage user archives

- 1 To save a material, light, effect or render style to a user archive for use in other scenes, drag that item from the scene's palette (right hand pane) onto the respective user archive.
- 2 To create a new sub-folder in a user archive, right-click the archive, and click New Directory on the shortcut menu. You can rename this new folder by right-clicking it, and clicking Rename on the shortcut menu. You can add as many nested sub-folders as you want.
- 3 To save a user archive to disk, right-click it, and click Save Archives on the shortcut menu. This saves any modified archives.

NOTE You will also be prompted to save any modified archives when you close Autodesk Navisworks.

- 4 To remove a material, light, effect or render style from the respective user archive, right-click the item to be removed, then click Delete on the shortcut menu.
- 5 To remove a sub-folder you've created from the respective user archive, right-click the folder to be removed, then click Delete on the shortcut menu.

NOTE You cannot delete any default user archive folders.

To add archives

- 1 To download an archive from the LightWorks-User web site, right-click any archive (in the left hand pane), and click Download Archive on the shortcut menu. Then follow the instructions given on the site.
- 2 To import a downloaded archive into Presenter, right-click any archive (in the left hand pane), and click Import Archive on the shortcut menu. Use the standard Open File dialog box to select the .lwa file to import.

To delete an added archive

- 1 To remove an archive that you have previously added, right-click the archive, then click Delete Archive on the shortcut menu.
- 2 Click Yes.

Photo-Realistic Scene Rendering

You can render directly in the Scene Area by clicking the Render button at the bottom of the Presenter window at any time.

You can export rendered scenes as images, and use them in presentations, on websites, in print, and so on. You can also export animated AVI presentations and instructional movies, in which the animated objects move in photo-realistically rendered scenes.

NOTE The larger the image size of the exported animation, the higher the resolution. However, this significantly increases render times. If you are creating high resolution images, it is best to use a separate machine to render.

Once you have set up and rendered a scene, you can additionally create animation in that scene. The rendering that you have set up will be applied to each frame of the animation.

To set up and render a scene

- 1 Click Tools ► Presenter to open the Presenter window.
- 2 Use the Materials tab to drag and drop materials onto items in the model.
You can use the pre-defined materials, or create your own from the templates in the Materials tab (see “[Use Presenter Materials](#)” on page 303 for more details).
Or
Use the Rules tab to set up rules which define project-wide material application (see “[Use Presenter Rules](#)” on page 329 for more details).
- 3 Use the Texture Space tab to more accurately map materials onto items in the scene (see “[Use Presenter Texture Space](#)” on page 328 for more details on this).
- 4 Use the Lighting tab to set up additional lighting (see “[Use Presenter Lights](#)” on page 310 for more details).
- 5 Use the Effects tab to add background and foreground effects to the scene (see “[Use Presenter Rendering Effects](#)” on page 321 for more details).
- 6 Use the Rendering tab to select a rendering style for the render (see “[Use Presenter Rendering Styles](#)” on page 325 for more details).
- 7 At any point, you can click on the Render button to start the rendering process in the Scene Area. The rendering process can be stopped at any point by clicking on the Stop button.
- 8 Click on the Clear button to clear the render in the Scene Area, and return to an OpenGL interactive view.

To print a rendered image

- 1 Apply materials and lighting effects to the required scene, and click the Render button.
- 2 When the scene is rendered, click File ► Export ► Rendered Image.
- 3 In the Export Rendered Image dialog box, select Printer from the Type drop-down list.
The Browse button and box are grayed out.
- 4 Click OK.
- 5 In the standard Print dialog box, select the desired printer, enter the print settings, and click OK.

To save a rendered image

- 1 Apply materials and lighting effects to the required scene, and click the Render button.
- 2 When the scene is rendered, click File ► Export ► Rendered Image.
- 3 In the Export Rendered Image dialog box, select the desired file type from the Type drop-down list. For more information, see “[Export Rendered Image Dialog Box](#)” on page 414
- 4 Browse to a location and enter the name of the file you want to render to.
- 5 Set the Size of the rendered file.

NOTE If you choose Use View as the Size of the image file, then Autodesk Navisworks will save any existing render in the Scene Area, without having to render again from scratch.

- 6 Click OK.

To export rendered animations

- 1 Apply materials and lighting effects to the required scene, and click the Render button.
- 2 When the scene is rendered, click File ► Export ► Animation.

The Animation Export dialog box opens.

- 3 To export a viewpoint animation, select Current Animation in the Source box.
To export a TimeLiner sequence, select TimeLiner Simulation in the Source box.
To export an object animation, select Current Animator Scene in the Source box.
- 4 Set up the rest of the boxes in the Animation Export dialog box, and click OK. For more information, see [“Animation Export Dialog Box”](#) on page 416.
- 5 In the Save As dialog box, enter a new filename and location, if you want to change from those suggested.
- 6 Click Save.

Use Presenter Materials

Materials Tab

Like the [Lighting](#), [Effects](#), and [Rendering](#) tabs, the Materials tab is divided into two panes. The left-hand pane describes the pre-defined [archives](#) of materials that are installed and the right-hand pane shows the current palette of materials that have been defined and are being used in the scene. The palette also shows a small thumbnail of the material as it will appear when rendered.

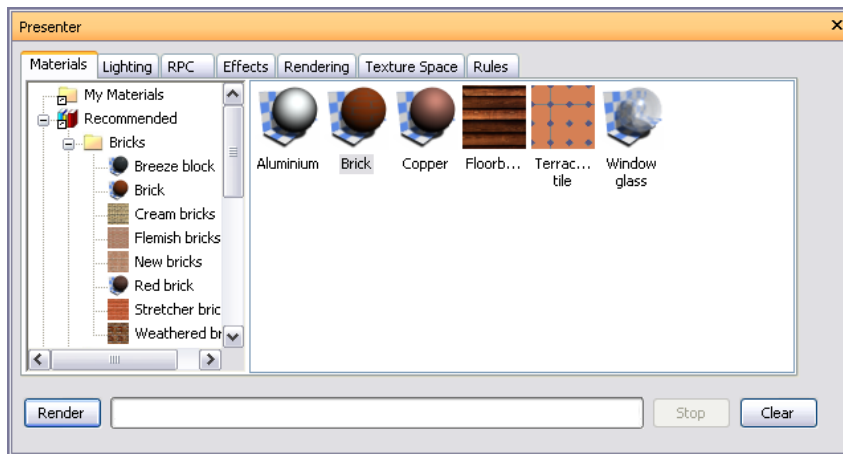

Apply and Remove Presenter Materials

Materials can be applied to items in the scene by dragging-and-dropping the material onto:

- An item in the Scene Area
- An item in the Selection Tree
- A selection or search set

If you drag the material from an archive then it will appear in the palette where it can be edited and saved with the scene if necessary.

Presenter uses Autodesk Navisworks selection resolution to decide which items to apply the material to when dragging from an archive or palette onto the main view. When hovering over any item in the main view, the proposed selection will turn the selection color (blue by default). When you drop the material onto the current selection, it will be applied to all the items selected. If you drop the material onto an item that is not currently selected, it will be applied to just that item. See [“Set Selection Resolution”](#) on page 183 for more information on selection resolution

You can also apply materials to items by selecting the items in the Autodesk Navisworks Selection Tree or Scene Area and then right-clicking the material in the palette and clicking Apply to Selected Items on the shortcut menu.

Rules can also be used to apply materials to items automatically based on their layer or color or selection set names, for example. See “Use Presenter Rules” on page 329 for more information on this.

You can remove materials assigned to geometry items either from the Presenter window, or directly in the Scene Area or Selection Tree.

Inheritance

Layers can have colors, just as geometry can. If a layer has a material, all its children in the Selection Tree inherit this material, until one of the children is assigned its own material, at which point, all *its* children in the Selection Tree inherit this material, and so on.

If you drag-and-drop materials onto layers, this works fine because only the layer picks up the material and although its children inherit the material, they do not have it explicitly assigned to them.

Therefore, right-clicking such a child will not allow you to remove the material because one was not explicitly assigned in the first place.

However, if you use a rule to assign a material to a certain color, then all objects in the scene will get this material explicitly assigned to them, including parent layers and child objects. If, with a selection resolution of something like Geometry (which is more specific than a resolution of Layer), you right-click a child object and click Remove Materials on the shortcut menu, then the material will be removed from the child object, but not from the parent layer and there won't be any apparent difference.

To remove the material, you will, therefore, have to remove it from the parent object; in the above situation this would be the layer.

To apply materials to model geometry

- 1 Select the geometry items directly in the Scene Area, or in the Selection Tree.
- 2 Open the Presenter window, and click the Materials tab.
- 3 Choose your material from an archive or palette, right-click this material and click the Apply to Selected Items option on the shortcut menu to assign the material to the current geometry selection.

NOTE Selected material will only be applied to the selected geometry item and not to every instance of the item, if, for example, it is a multiply instanced block or cell. To assign the material to all instances of a multiply instanced block or cell in the scene, you need to click the Apply to All Instances of Selection option on the shortcut menu.

TIP You can simply drag-and-drop a material from an archive or palette onto items in the Selection Tree or Scene Area to assign those materials to the items. The selection resolution determines which items will receive the materials.

To use Scene Area or Selection Tree to remove materials from model geometry

- 1 Right-click the item in the Scene Area, or in the Selection Tree.
- 2 Click Presenter ► Remove Material on the shortcut menu.

NOTE This item on the menu will only be available if the right-clicked item has any material assigned to it at that selection resolution in the Selection Tree.

To use the Presenter window to remove materials from model geometry

- 1 Open the Presenter window, and click the Materials tab.
- 2 In the material palette, right-click the material that you want to remove from items in the scene.
- 3 Click Remove From All Items on the shortcut menu to remove all assignments of the material from all geometry items.

If you have items selected in the Scene Area or Selection Tree, then you can click the Remove From Selected Items option on the shortcut menu to remove that material from only the items in the active selection set.

NOTE Deleting the material from the palette will automatically remove that material from any items in the Scene Area which it was applied to.

Organize and Manage Materials

Custom Folders

You can organize materials into custom folders for easy reference and management. By doing this, you are, effectively, customizing a user archive. For more information, see “[Use the Presenter Archives](#)” on page 300.

The Material Palette

The material palette is where you edit and manage your materials for your scene. Materials are taken from the archives into the palette where they are edited. You can then save the palette into a Autodesk Navisworks Palette file (.nwp) for use in other scenes too.

To add a custom folder

- 1 Open the Presenter window, and click the Materials tab.
- 2 Right-click the My Materials folder on the left pane, and click New Directory on the shortcut menu.
- 3 Expand the My Materials folder, right-click the new folder, and click Rename on the shortcut menu.
- 4 Type in the new name, for example 'GGK Project'.

To delete a custom folder

- 1 In the Presenter window, Materials tab, expand the My Materials folder on the left pane, and right-click the folder you want to delete.
- 2 Click Delete on the shortcut menu.

To copy materials into a custom folder

- 1 In the Presenter window, Materials tab, click a material on the right pane, and drag it to the desired location under the My Materials folder on the left pane until a cursor displays a small plus.
- 2 Release the left mouse button to drop the material into the folder.

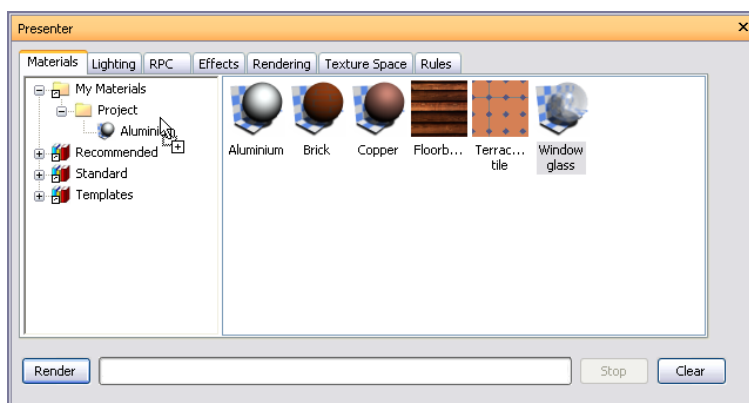

NOTE You can also copy materials between the folders on the left pane by either dragging and dropping them, or using the Copy and Paste options on the shortcut menu.

To manage palette materials

- 1 Right-click a material in the right-hand pane of the Materials tab (the palette).
 - 2 Click Delete on the shortcut menu to delete the material from the palette. This will also remove the material from all items in the scene.
 - 3 Click Copy to copy the material to the clipboard. Right-click an empty space in the palette and click Paste to paste a copy of the material with the same name suffixed with the next number in the list. This process is useful if you want to test small tweaks to a material.
 - 4 Click Rename to rename the material. You can also select the material and press **F2** to rename it.
 - 5 Click Regenerate Image to regenerate the thumbnail of the material in the palette with the current attributes.
 - 6 Click Select all instances to select the items in the scene which have this particular material assigned to them.
 - 7 Depending on whether items are selected in the scene and whether the material has been assigned to any items, there will also be a couple of Apply and Remove items on the shortcut menu. See “[Apply and Remove Presenter Materials](#)” on page 303 for more details.
 - 8 Click Clear Palette to delete all the materials from the palette and also from all items in the scene.
 - 9 Click Load Palette to load a previously saved palette of materials into the current scene. This will delete any materials currently in the palette. The standard File Open dialog box will appear, allowing you to browse to an NWP file.
 - 10 Click Append Palette to load a palette from an NWP file, while keeping all the existing materials in the current palette. Any materials that are duplicated will be renamed with the .nwp file as an extension.
 - 11 Click Merge Palette to merge a palette from an NWP file into the current scene. This is like appending, but instead of adding and renaming any duplicate materials, merging will overwrite existing materials of the same name.
 - 12 Click Save Palette As to save your current palette of materials into a Autodesk Navisworks Palette (.nwp) file. If you save the current scene using the usual File ► Save method into an .nwf or .nwd file, the palette will be saved too, but the independent .nwp file is useful if you want to transfer materials you've made in one scene into other scenes.
-
- NOTE** If you publish an .nwd file, using the File ► Publish command a _Presenter_Maps folder will be created along with the NWD file. This folder will contain any materials that are not contained in Presenter Runtime, which is used by both Autodesk Navisworks Simulate 2010 and Autodesk Navisworks Freedom 2010, to view materials.
-
- 13 Click Edit, or simply double-click a material to open the Material Editor dialog box, allowing you to edit its parameters. See “[Edit Presenter Materials](#)” on page 306 for more information.

Edit Presenter Materials

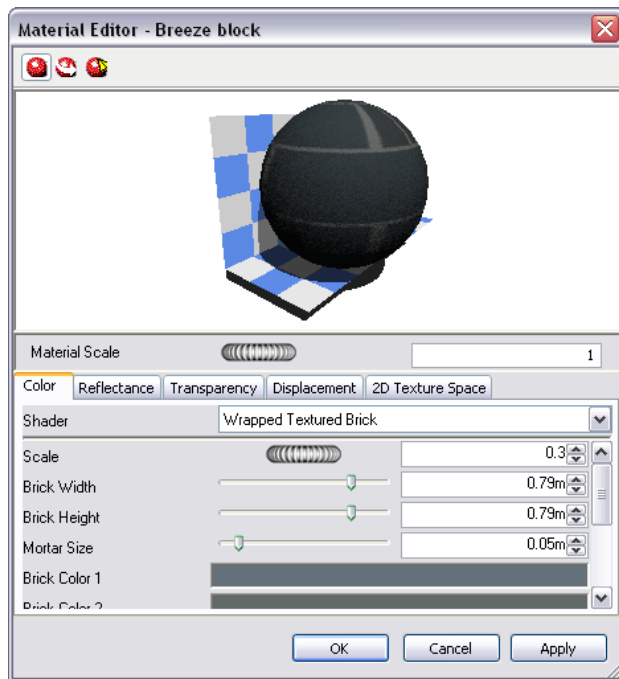

Installed archive materials cannot be edited whilst they are in the archives, but you can edit materials in the scene's palette. Edited materials will be saved with the Autodesk Navisworks model in an NWD or NWF file, or in an NWP palette file, or they can be added to your user archive, called My Materials.

To edit a material, double-click it in the palette, or right-click it and click Edit on the shortcut menu. The Material Editor dialog will appear, which will vary for different types of material. You can't add or remove parameters on a material - merely edit those existing, so it is important to use the right type of material template for the material you want to edit. The dialog box for the Breeze Block procedural texture is shown below and this will be used as an example of how to edit a material.



NOTE If the Presenter profile in the Options Editor (see “[Presenter Page](#)” on page 405 for more information) is set to Advanced, there are more tabs and parameters to edit in this dialog box. In particular, there are Reflectance, Transparency, Displacement, and 2D Texture Space tabs and at the top of each tab is a Shader type which allows you to completely change the type of material and all other parameters.

To edit the breeze block texture

- 1 Open the Presenter window, and click the Materials tab.
- 2 Double-click breeze block in the palette to open the Material Editor.
- 3 The three buttons at the top determine what sort of material preview you get:
 - Click the Standard Preview button  to get a software generated photorealistic preview of the material on the standard ball against checkered background, which is not interactive but will show how the material will look when rendered photorealistically.
 - Click the Active Preview button  to get an OpenGL interactive preview of the material on the standard ball against checkered background. This is updated interactively while you change the parameters and will resemble the quality of material shown in Autodesk Navisworks during navigation, but will not be as high a quality as the photorealistic render.
 - Click the Main Window Preview button  to close the preview window in the material editor and instead preview the material on the item in the scene in the Scene Area. This is updated interactively while you change the parameters and will be exactly the material shown in Autodesk Navisworks during navigation, but will not be as high a quality as the photorealistic render.
- 4 For a simple material, there is only a single Material tab on the Material Editor, whereas for a texture material, whether procedural (generated from an algorithm) or bitmap (generated from an image), there is an extra tab called Texture.
 - The Material tab contains simple parameters that affect the material's color, scale, shininess and so on. In the case of the breeze block, there are parameters for the overall scale of the material as well as a block's width and height, the blocks' color and mortar color, its roughness and reflectivity. For bitmap textures, you need to define the location of the image in the Image File Name box. On a glassy material, other factors would affect the transparency and refraction properties of the glass. Some of these factors will not be apparent in the interactive OpenGL window and will have to be rendered with the Render button to be seen.

- The Texture tab contains parameters that specifically affect a texture material's texture mapping properties, such as its rotation, offset (origin) and S- and T- (sometimes called U- and V-) scales. These parameter values are applied in relation to an origin point, (see “[Advanced Materials](#)” on page 309 for more information). There are S- and T- Reflect check boxes, which will show the reflection of the image in either (or both) of these axis. Finally there is an Offset Center check box, that repositions the origin to the center of the image (again, see “[Advanced Materials](#)” on page 309 for more information). When using the Main Window Preview, texture changes can be made instantly allowing interactive positioning of materials on an object.

- 5 At any time, click the Apply button to apply the parameter edits to the material in the scene.
- 6 Click OK to keep the changes made or Cancel to discard any changes made (since the last time you clicked Apply at least).

Create a texture using your own image

- 1 From the Templates material archive, double-click the Plain Texture material. This will add the material to the scene's palette, and open the Material Editor.

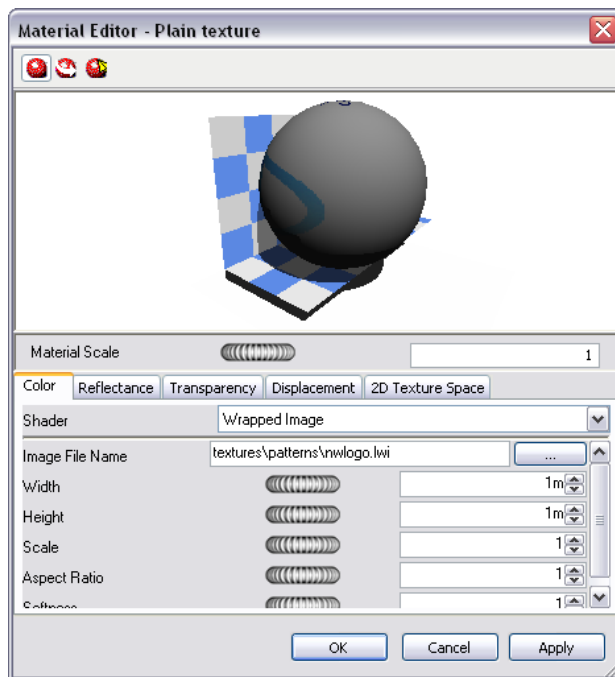

- 2 On the Material tab (or Color tab, if in Developer profile) click the Browse (...) button next to the Image File Name text box. The Open Image File dialog is displayed.

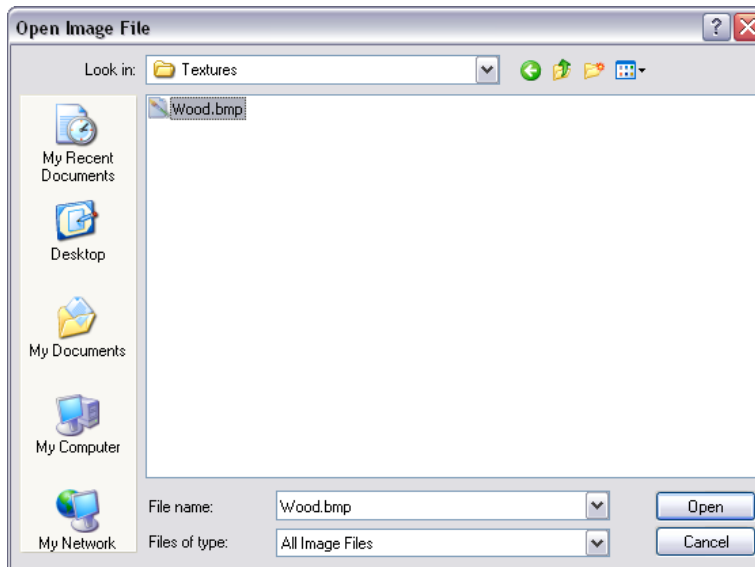

- 3 Browse to the location of and select your image file, then click Open.
- 4 You may then need to adjust some of the texture parameters of the new material, for example its scale, rotation, offset or reflection (if it's back to front). These may all be edited in the Texture tab. See "[Edit Presenter Materials](#)" on page 306 for more information.

Advanced Materials

Internally a material is defined by four shaders from different classes - Color, Transparency, Reflectance and Displacement. Each class of shader controls a different aspect of a material's behavior. There are many types of shader in each class, each type being defined by its own set of parameters.

- A **color** shader is used to define the color of a surface at any point in space. It may be as simple as a plain color which specifies all parts of the surface to have a uniform color, or it may define complex surface patterns such as marble or wood. Every material *must* have a color shader.
- A **transparency** shader is used to define how transparent or opaque a surface is, and thus how much light is able to pass through it. Transparency shaders range from a simple uniform transparency to more complex regular or irregular eroded patterns that would be more difficult to represent using modelling techniques. A material without a transparency shader is completely opaque.
- The behavior of a surface in the presence light is represented by a **reflectance** shader which defines how much light is reflected by the surface towards the viewer. Shaders of this class may be thought of as defining a surface's "finish", and are used to model properties such as matte, metal and plastic.
- Small surface perturbations can be supported by means of displacement shaders. Typically, a displacement shader will give an otherwise smooth surface an irregular or indented appearance. Displacement shaders are used to represent features that would be difficult, impossible, or inefficient if conventional modelling techniques were used. For example, rough metal castings and the regular indentations produced by pressed sheet metal can be simulated.

Normally, the Material Editor displays a selection of the most important parameters from all shaders within the material tab. If the user profile is set to Developer in the Options Editor (see "[Presenter Page](#)" on page 405), then all four shaders can be edited and changed individually.

Some shaders are described as "wrapped". These define a flat, two dimensional material, like wall paper. Wrapped materials need a texture space shader to define how they should be applied to (wrapped around) a three dimensional object. Materials that include a wrapped shader can also include a texture space shader. A special type of texture space shader, called a layout shader, can be used to transform (rotate, stretch, offset) the two dimensional material before it is applied to the three dimensional object. Transforms are based around an origin point, which by default, is the top left hand corner of the image (refer to the diagram below, where the image is inscribed in the red square, which is then repeated. The default origin is **Point 1**). Selecting the Offset Center

check box will reposition the origin to the center of the image (**Point 2**). Finally, in **Developer** profile, you can edit the Decal Mode, choosing from either Default or Normalized. Selecting Normalized will move the origin to the lower left corner of the image (Point 3, with the Offset Center option cleared). With both Normalized and Offset Center selected, the origin will be repositioned in the center of the repeated image, directly below (Point 4).

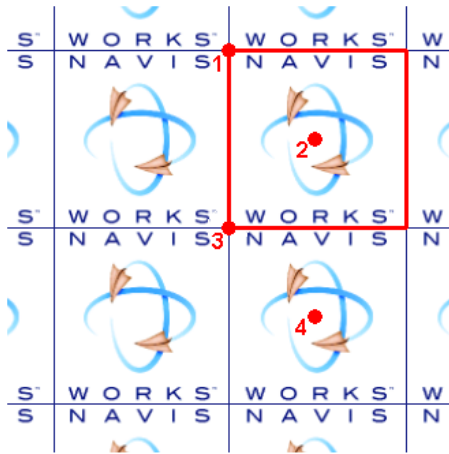

In Presenter, materials that include a wrapped shader also have a layout texture space shader associated with them. Normal texture space shaders are associated with objects.

NOTE A complete reference manual for all types of rendering styles is included with the Autodesk Navisworks API, (see `\API\COM\documentation\shaders.chm`). The Autodesk Navisworks API is included with Autodesk Navisworks Simulate 2010; it's an optional feature in the installer, and is installed by default into the API subfolder in the Autodesk Navisworks installation folder.

Use Presenter Lights

Lighting Tab

Like the [Materials](#), [Effects](#) and [Rendering](#) tabs, the Lighting tab is divided into two panes - the archive on the left and the palette on the right. The archive contains individual lights, as well as light studios. A light studio is a combination of lights that work well together. The palette contains all the lights that are active in the scene.

To apply a light to the scene, you drag it from an archive into the palette, at which point you can edit its parameters if required. The light is added to those already in the scene.

To apply a light studio to the scene, you drag it from an archive into the palette. All the lights in the light studio *replace* those already in the scene. Light Studios are applied to the scene intelligently. The light studio is oriented and scaled to match the scene to which it is being applied. You can also expand a light studio in the archive and drag the lights into the palette individually. If you do this the lights are *not* oriented or scaled to match the scene.

Each light in the palette has a check box, which can be used to turn the light on or off in the scene.

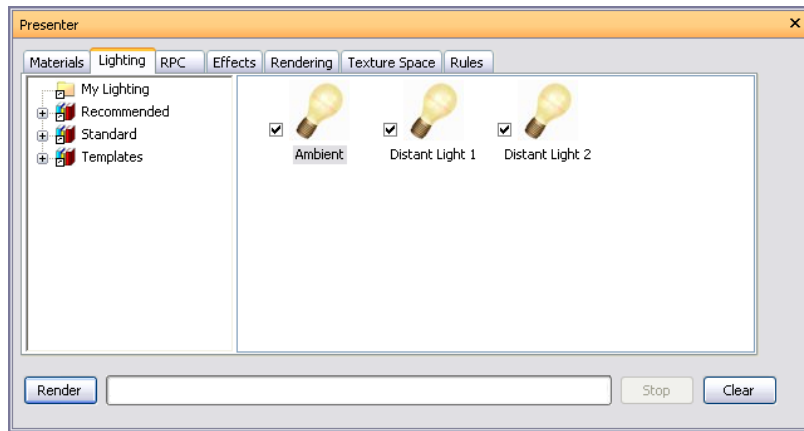

Add and Position Lights

Lights and light studios can be taken directly from the archives and applied to the model by simply dropping them into the palette. These can then be repositioned as you need.

The Recommended archive contains five lights (Ambient, Distant, Eye, Point and Spot), a Standard Light Studio, an Environment Light Studio, an Environment folder containing two Environment lights utilizing HDRI-based light sources (see “[Image-based Lighting](#)” on page 317 for more information), and an Exterior folder, that contains three light studios for different city locations around the World (Clear Sky, Overcast Sky and Sun Study).

If you are creating an external render of a building, for example, then you may find that one of the Environment light studios can give a very realistic effect, using Image-based lighting to light the model. Alternatively, Exterior light studios may give you the effect you require. These do use physically accurate lights however, which generally take longer to render the scene.

Alternatively, you may prefer to use the Standard Light Studio as a starting point and build up your lighting from there, adding combinations of the basic recommended lights to create the desired effect.

The Standard archive contains a Default Eye Light studio (which is effectively rendering with a head light); a folder of Exterior light studios which predominantly consist of studios that use a number of lights to replicate the effect of a Sky light. Not using physically accurate lights means you don't have to turn on Auto Exposure (see “[Auto Exposure](#)” on page 327) which can negatively impact on the basic recommended light settings; a folder of Interior light studios for use in internal scenes; a folder of Object light studios which are best suited to lighting smaller models, such as a vehicle or piece of machinery, for example; and a folder of Projector light studios, which can be used to project an image onto an object in the scene.

The Templates archive contains all of the basic light shaders that are available. These can then be edited (as can all lights) to create the exact lighting you require (see “[Edit Lights](#)” on page 313 for more information).

To add lights to the model

- 1 Open the Presenter window, and click the Lighting tab.
- 2 From one of the archives in the left-hand pane of the Lighting tab, choose the light you wish to add to the scene.
- 3 Drag the light and drop it into the palette (right-hand pane of the Lighting tab). This will automatically be added to the scene.

NOTE If you drag a light studio into the palette, this will replace any existing lights with those that make up the light studio.

As a general guide, the more lights there are in a scene, the longer it will take to render it photorealistically. For external rendered scenes, you may consider using the Standard Light Studio, (from the Recommended archive) as a starting point, then strategically add a couple of Point and Spot lights around the scene. Point lights are good to light up a dark area of the scene, whilst Spot lights can add an element of drama and enhance realism.

To position or reposition lights in the model

- 1 Open the Presenter window, and click the Lighting tab.
- 2 In the lighting palette, right-click the light you want to reposition, and click Edit on the shortcut menu.
- 3 Use the Light Editor to position the light as needed.

Point, distant, spot and projector lights have a Location parameter. Distant and spot lights additionally have a To parameter. You can type in X-, Y-, and Z- coordinates for these, or alternatively use the Pick button to interactively pick a point in the scene where the light and/or target is located. The light is represented by a 3D wireframe sun icon in the scene and the target by a wireframe sphere. The currently selected light is drawn in the selection color (see “[Selection Page](#)” on page 380 for more information).

NOTE Autodesk Navisworks does not allow you to pick a point in empty space so you must pick a point on the model.

- 4 Lights can be positioned interactively. The 3D wireframe sun icon, representing the light, has six bars extending out along the X- axis, Y- axis and Z- axis. Hover the mouse cursor over one of the bars. The cursor will change to a hand and the bars will extend further along that axis. Hold the left mouse button down to hold on to the light and move it in either direction, along the extended bar. Release the left mouse button to release the light in its new position. This can be performed for all three axis.
- 5 Lights can also be positioned in the current location of the camera, which can be anywhere in the scene. Navigate to the location where you wish the light to be positioned. Right-click the light in the palette (right-hand pane of the Lighting tab) and click Position as Camera on the shortcut menu.

NOTE Not only will this position the light in the same location as the camera, if the light has a To parameter, this will also be set to the focal (or Look At) point of the camera.

Organize and Manage Lights

Manage Folders

You can organize lights into custom folders for easy reference and management. By doing this, you are, effectively, customizing a user archive. For more information, see “[Use the Presenter Archives](#)” on page 300.

The Lighting Palette

The palette is where you edit and manage your lights for your scene. Lights are taken from the archives into the palette where they are edited.

To add a custom folder

- 1 Open the Presenter window, and click the Lighting tab.
- 2 Right-click the My Lighting folder on the left pane, and click New Directory on the shortcut menu.
- 3 Expand the My Lighting folder, right-click the new folder, and click Rename on the shortcut menu.
- 4 Type in the new name, for example 'GGK Project'.

To delete a custom folder

- 1 In the Presenter window, Lighting tab, expand the My Lighting folder on the left pane, and right-click the folder you want to delete.
- 2 Click Delete on the shortcut menu.

To copy lighting effects into a custom folder

- 1 In the Presenter window, Lighting tab, click a lighting effect on the right pane, and drag it to the desired location under the My Lighting folder on the left pane until a cursor displays a small plus.

- 2 Release the left mouse button to drop the lighting effect into the folder.

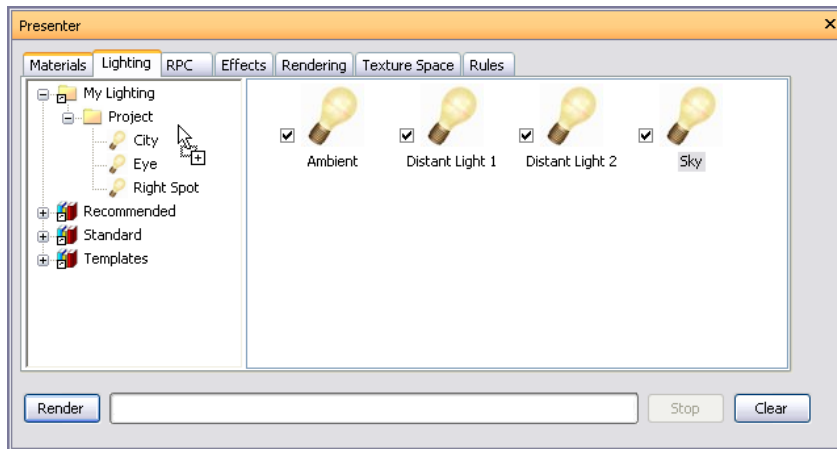

NOTE You can also copy lighting effects between the folders on the left pane by either dragging and dropping them, or using the Copy and Paste options on the shortcut menu.

To manage palette lights

- 1 Right-click a light in the right hand pane of the Lighting tab (the palette).
- 2 Click Delete to delete the light from the palette. This will also remove the light from the scene.
- 3 Click Copy to copy the light to the clipboard. Right-click an empty space in the palette and click Paste to paste a copy of the light with the same name suffixed with the next number in the list.
- 4 Click Rename to rename the light. You can also select the light and press F2 to rename it.
- 5 Click Clear Palette to delete all the lights from the palette and hence from the scene.
- 6 Click Edit or simply double-click a light to open the Light Editor dialog box, allowing you to edit its parameters. See “[Edit Lights](#)” on page 313 for more information.

Edit Lights

You can edit a light in the palette by double-clicking it, or right-clicking and choosing Edit on the shortcut menu.

There are six types of light visible in both OpenGL interactive renders and photorealistic renders:

- Ambient lights give a general background light to the scene and therefore only have intensity and color parameters.
- Eye lights are located at the viewpoint and also only have intensity and color parameters.
- Point lights have a location but shine in all directions. They also have an intensity and color and additionally can cast shadows (only available in a full photorealistic render).
- Distant lights are directional and so have a location and target. However, the location and target merely set up an axis down which the light shines, as these light types are infinitely far away and their beams are parallel. As well as intensity and color parameters, they can also cast shadows in a photorealistic render.
- Spot lights are also directional and therefore have a location and target, as well as intensity, color and shadow parameters. In addition, they also have parameters for affecting the light's fall off and cone angle, as these light types are not infinitely far away, so do spread their light over a cone and the intensity does diminish away from the light.
- Sun simulates the sun's light. The orientation of your model is defined by north and up directions. The position of the sun is specified as azimuth and altitude. If the sun's mode includes “Position”, you can input your location on earth, the time (using local time zone) and date and Presenter will calculate the sun's azimuth

and altitude for you. If the sun's mode includes "Intensity", Presenter will also calculate an accurate intensity for the sun based on position, time of year and atmospheric conditions.

There are an additional three types of light visible only in photorealistic renders:

- Projector lights are used to project an image onto surfaces. You can define the file of the image to be projected.
- Sky simulates the illumination from the sky (but not the direct contribution due to the sun itself). The orientation of your model is defined by north and up directions. The position of the sun is specified as "sun altitude" and "sun azimuth". Whilst the direct contribution of the sun is not included, its location will determine the appearance of the sky hemisphere. If the intensity is left at 0, Presenter will calculate an accurate intensity for you based on the sun's position.
- A Goniometric light is one which can emit widely varying amounts of light energy in different directions. One goniometric source could behave exactly like a point light, another could behave exactly like a spot light, and a third could look nothing like either of those. A goniometric light gets its intensity distribution function (how much light goes in any one direction) from an industry-standard file. Presenter supports CIE (*.cie), IESNA (*.ies), CIBSE (*.cib) and ILUMDAT (*.ldt) files.

NOTE A complete reference manual for all light types is included with the Autodesk Navisworks API (see \API\COM\documentation\shaders.chm). The Autodesk Navisworks API is included with Autodesk Navisworks Simulate 2010; it's an optional feature in the installer, and is installed by default into the API subfolder in the Autodesk Navisworks installation folder.

Each light type has its own parameters, and the editor for a Point Light is shown here:

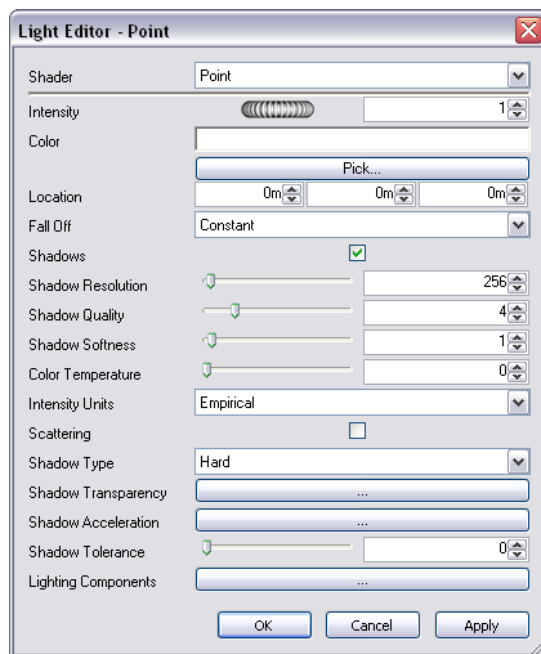

Point, distant, spot and projector lights have a Location parameter. Distant and spot lights additionally have a To parameter. See "[Add and Position Lights](#)" on page 311 for more information.

NOTE If the Presenter profile in the Options Editor (see "[Presenter Page](#)" on page 405 for more information) is set to Advanced, the dialog box will include a full list of available parameters and allow you to change the type of a light.

Point, distant, spot, sky, sun, projector and goniometric lights have the Shadows parameter. See "[Shadow Casting](#)" on page 315 for more information.

Editing parameters in the dialog will interactively alter the scene with those changes.

At any time, clicking the Apply button to apply the parameter edits to the light in the scene.

You can save an edited light for use in other scenes by simply dragging it onto the My Lighting user archive.

Shadow Casting

Selecting Shadows check box in the Light Editor of a light that supports shadows (point, distant, spot, sky, sun, projector and goniometric) results in the selected light casting shadows in the scene. Shadows will only be visible in photorealistic renders; unless you are using a Hardware accelerated OpenGL 1.5 compliant graphics card, in which case you can preview *interactive shadows*. See “[Presenter Page](#)” on page 405 for details on how to display interactive shadows and lighting.

NOTE Enabling shadows on lights should be given due consideration. If you turn on shadows on all lights, then you may find the effect very confusing and somewhat un-natural, especially if there are many lights in a small scene. This will also have an affect on performance, during navigation and general refreshing of the Scene Area. You may wish to consider only enabling shadows on a few strategically positioned lights, to create the effect you require.

In addition to choosing which *lights* in your model will cast shadows, you may also select which *geometry items* in the model should cast a shadow. Each item in the scene has its own shadow casting option.

To set shadow casting from the Scene Area

- Right-click an item in the Scene Area, click Presenter on the shortcut menu, and then click the shadow casting option you require.

The available shadow casting options available for a geometry item are:

- Off. Choose this to disable shadows. The selected item will not cast a shadow from any light source.
- On. Choose this to enable shadows. The selected item will cast a shadow from any light source that has shadows enabled.
- Inherit. Choose this to inherit the shadow casting option from the parent item. That is, the selected item will use the same option as the item directly above it in the Selection Tree path (see “[Selection Tree Window](#)” on page 179 for more information). For example, if you turn shadow casting On for a Group, and the geometry contained within that Layer is set to Inherit, then the geometry will also cast shadows, as it inherits the On option from its parent (the Group).

NOTE If all items in the scene are set to Inherit then the default setting is On.

NOTE The item selected will depend on your Selection Resolution setting. See for more information.

To set shadow casting from the Selection Tree

- Right-click an item in the Selection Tree, click Presenter on the shortcut menu, and then click the shadow casting option you require.

The available shadow casting options available for a geometry item are:

- Off. Choose this to disable shadows. The selected item will not cast a shadow from any light source.
- On. Choose this to enable shadows. The selected item will cast a shadow from any light source that has shadows enabled.
- Inherit. Choose this to inherit the shadow casting option from the parent item. That is, the selected item will use the same option as the item directly above it in the Selection Tree path (see “[Selection Tree Window](#)” on page 179 for more information). For example, if you turn shadow casting On for a Group, and the geometry contained within that Layer is set to Inherit, then the geometry will also cast shadows, as it inherits the On option from its parent (the Group).

NOTE If all items in the scene are set to Inherit then the default setting is On.

Advanced Lighting

You can use Presenter to apply advanced lighting effects.

Soft Shadows

Presenter includes shadows generated from pre-calculated shadow-maps for each shadow casting light source. The use of shadow maps enables rapid rendering of shadows with soft or graduated edges. The shadow resolution can be controlled to balance performance and image quality.

Soft shadows are only suitable for use with small models, and are disabled by default. For large models, the generation of the shadow maps can use excessive amounts of time and memory. Soft shadows generated for large models are often too vague and dispersed without using an excessively high resolution, which uses even more memory and time.

Physically Accurate Lights

By default, Presenter uses lights with unitless, or empirical intensities. These are physically meaningless and are just chosen to give a visually pleasing result. Presenter can also use physically accurate intensities. These are defined in real world units such as Candela, Lumen or Lux. However, once you start using lights with real world intensities, you start to produce images with a real world variation in luminance values.

By default, Presenter uses lights whose intensity remains constant as you move further from the light. In the real world intensity is reduced proportional to the inverse square of the distance from the light. Changing a light's "Fall Off" parameter to "Inverse Square Law" will more accurately model a light's fall off in intensity. However, once you start using lights with real world fall off, you start to produce images with a real world variation in luminance values.

In the real world, the human eye is capable of resolving images in extremely varied lighting conditions, ranging from bright sunshine reflecting off snow to a room lit only by a single candle. In computer graphics on the other hand, you need to produce an image on a display device which has a very limited range of luminance values. Therefore, it is necessary to compress the range of luminance values found in a real world scene into the displayable range in such a way as to produce a realistic looking image.

Photography, of course, has exactly the same problem. If a photographer (or camera) does not take into account the light levels in a scene before calculating the exposure of the shot, the likely result will be an image which is either over-exposed (everything is too bright) or under-exposed (everything is too dark). A professional photographer will also use different speeds of film for different lighting conditions. The aim is to produce an image on film that is representative of how that scene would have looked to a human observer.

Presenter includes the Auto Exposure option (see "[Auto Exposure](#)" on page 327). When enabled, Presenter will render the image twice. Once to sample the range of luminance values in the output image, then a second time to render the actual image with the luminance values adjusted to match the behavior of the human eye.

In general, when using physically accurate lights, the Auto Exposure option should be on.

Volumetric Lights

Volumetric lighting allows effects such as the scattering of light, by fog or smoke, in a scene. To use this effect, select the Scattering check box on each light. A Scattering Medium foreground effect must also be in use (see "[Foreground Effects](#)" on page 325 for more information).

NOTE You may need to adjust the Medium Density and Medium Ambient parameters of the Scattering Medium foreground effect to suit your model. If no volumetric effects are visible, the Medium Density is too low. If the rendered image is entirely white, the Medium Density is too high.

The default medium is plain white. Optionally, a density shader may be set to any solid (not wrapped) color shader, to create the effect of a non-uniform (inhomogeneous) medium. Examples of shaders that can be used are Blue Marble and Solid Clouds. A shader that has been designed explicitly for this purpose is the Turbulent shader.

The key points when using volumetric lighting are:

- Remember to turn the Scattering parameter of light sources on if you want to see their volumetric effects.
- Use Medium Density and Medium Color to define brightness and color of the lit medium.

- Use a solid color shader set as density shader for simulation of density variations in the medium.
- Decrease the Error Bound parameter, if image appears spotty outside shadow areas.
- Increase the Min LOD parameter, if areas with volumetric shadows appear spotty.
- For fast previews, set the Error Bound parameter high, and the Min LOD parameter small.
- For best results, set the Fall Off option to Inverse Square Law, and turn on Auto Exposure.

Image-based Lighting

Image-based lighting, simply put, is where an image is used to light a scene. In the real world, every object is lit not only by light sources like the sun, lamps etc., but also by everything around. Standing in the middle of a street, a person will be lit by the sun, the blue sky, the brown buildings and the grey floor. Emulating this form of lighting clearly has the potential to create incredibly realistic images.

Images used in this lighting method are a special kind of image, called a High Dynamic Range Image or HDRI. This type of image has the capability of lighting a scene with incredible accuracy. In Presenter, an HDRI is wrapped around the scene as a sphere, and color and brightness from the HDRI are cast onto the 3D model to light it.

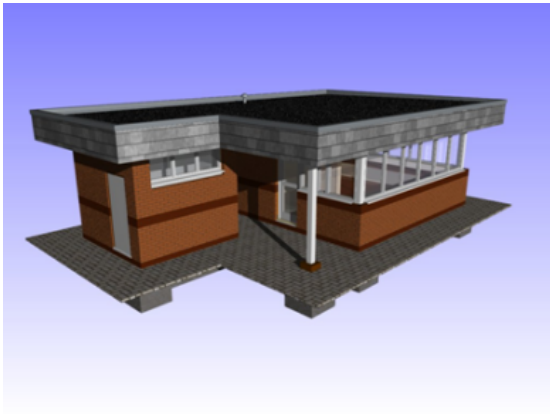

A model lit with normal lights

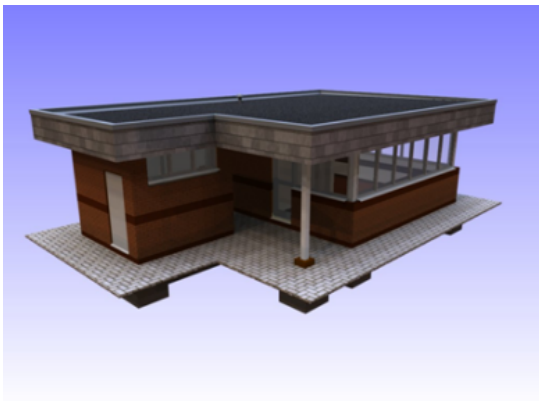

The same model lit with image-based lighting

You can see the difference this form of lighting can make to rendered images. And the enormous advantage here is that it is much easier to set up than traditional lighting.

To set up image-based lighting

- 1 Open the Presenter window, and click the Lighting tab.
- 2 Click the Recommended folder in the left-hand pane of the Lighting tab.

- 3 Drag the Environment Light Studio into the palette on the right.
This replaces all lights that were in the palette with an Ambient and an Environment light containing a High Dynamic Range Image.
- 4 Click the Render button to render the scene using the default image contained in this Environment light. This type of render can take slightly longer than traditional lighting methods, but the results are worth the extra time invested.
- 5 To use an alternative sample image, expand the Environment folder in the left-hand pane to view another two example environment lights; a Sky and a City. Drag the City light over to the right to replace the Environment light in the palette.

NOTE Before rendering, either delete the Environment light from the palette, or deselect the check box.

To manually insert a new HDRI

- 1 Open the Presenter window, and click the Lighting tab.
- 2 Right-click the Environment light in the palette, and click Edit on the shortcut menu.
- 3 In the Light Editor, click the Edit button in the Environment field.
- 4 In the Shader Editor, click the ... button in the File Name field, and browse to the required .hdr file.

NOTE For this to work correctly, this HDRI must be a Light Probe HDRI. Additional Light Probe HDRIs are available from a variety of places on the Internet, including *Dosch Design*.

Click on OK in both dialog boxes to set the new image to be the light source.

- 5 In Presenter, click Render to produce a newly lit rendered scene.

Use Presenter RPCs

RPC Tab

The RPC (Rich Photorealistic Content) support in Presenter enables the addition of photographic scenery into any 3D project. RPC files can be bought directly from *ArchVision*, and typically come in libraries of content ranging from trees and plants to people. They also come in a variety of types.

- 2D RPCs are single-direction 2D photographs that always face the camera, and are a single frame, looking the same from every angle, and not animating.
- 3D RPCs are objects that have a high number of frames allowing the camera to move around the object and see it from all angles.
- 2.5D RPCs are single-direction 2D photographs, but are animated. Animated RPCs will only animate visually when exported as a rendered animation.
- 3.5D RPCs include animation and views from all around the object.
- 3D+ RPCs, often called Smart Content, are not currently supported by Presenter.

This scene shows an example of some RPC people on and around a building.



The key benefit to using RPC content is that it only takes a short amount of time to fill a scene with realistic content, and it adds very little to the rendering time.

NOTE Whilst navigating through the scene, RPCs will always turn to face the camera. If the RPC is 3D or 3.5D right-clicking it in the Scene Area, and clicking Refresh on the shortcut menu will set it to the correct frame based on the current camera position. Rendering the scene using the Render button will always refresh all RPCs.

IMPORTANT When publishing a scene using the Publisher dialog box, any RPCs included in that scene are not published to the Presenter_maps directory or embedded in the NWD file. The size of the files and the fact that most are licensed currently prohibits this.

Like the [Materials](#), [Lighting](#) and [Rendering](#) tabs, the RPC tab is divided into two panes for archives and palette. This tab is where you set up RPCs (Rich Photorealistic Content).

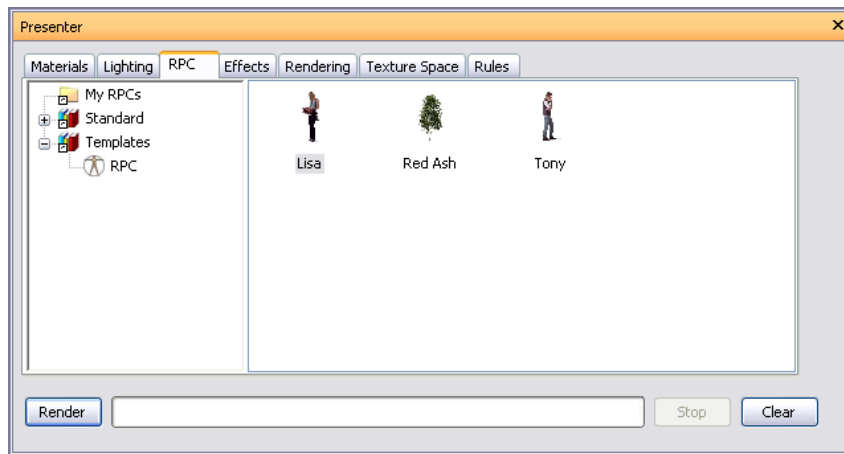

To add an RPC to a palette

- 1 Open the Presenter window, and click the RPC tab.
- 2 In the left pane, expand the Templates folder, and drag the RPC icon to the palette on the right.
- 3 Double-click the RPC icon in the palette.
- 4 In the RPC Editor, click the ... button in the File Name field.

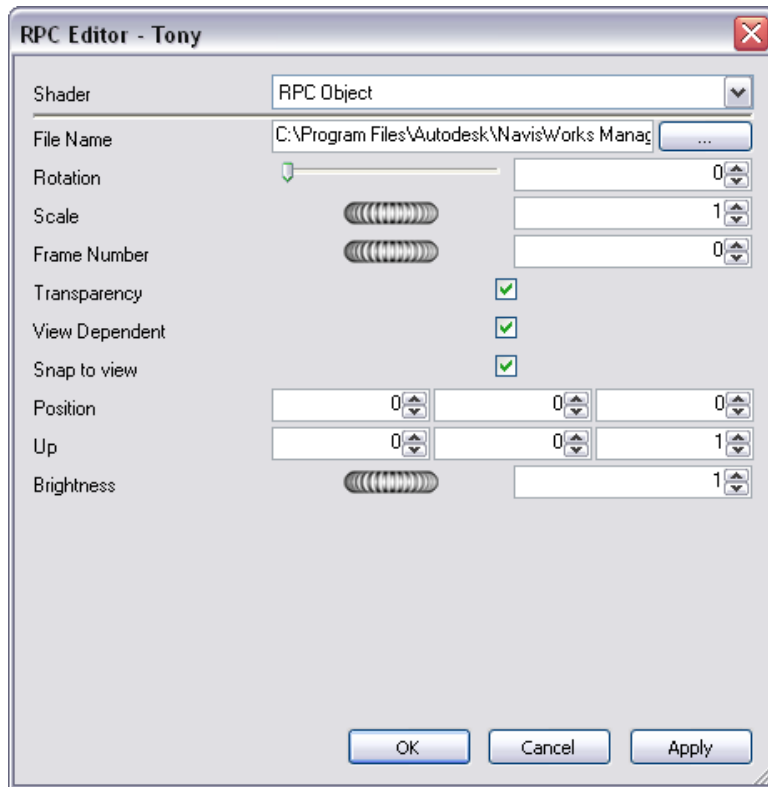

- 5 In the Open RPC File dialog box, locate the required RPC file, and click Open. Autodesk Navisworks has a small selection of free example RPC files in the resources area of the product CD. You can use them to make up a simple scene with some people, plants, and trees.
- 6 Make sure the settings in the RPC Editor are what is required, and click OK.

To add an RPC to a model

- 1 Open the Presenter window, and click the RPC tab.
- 2 To add an RPC to the model, either right-click desired RPC icon in the palette and select Add Instance which gives a target cursor with which to then click on a location in the Scene Area, or left-click and drag the RPC icon from the palette onto the required position in the Scene Area.
- 3 Click the Render button to see how the RPC effect looks in the scene.

To move an RPC

- Right-click the RPC you want to move in the Scene Area, and click the Pick Position option on the shortcut menu. This changes the cursor to a target for selection of an alternative location.

To edit an RPC

- 1 Open the Presenter window, and click the RPC tab.
- 2 Double-click the required RPC in the palette.
- 3 Use the RPC Editor to adjust the settings as necessary. For example, you can use the Rotation to set which direction people are facing, or you can change the Scale size.
- 4 Click OK.

To delete an RPC

- Right-click the RPC you want to delete in the Scene Area, and click Delete on the shortcut menu.

Use Presenter Rendering Effects

Effects Tab

Like the [Materials](#), [Lighting](#) and [Rendering](#) tabs, the Effects tab is divided into two panes for archives and palette. This tab is where you set up different background and foreground effects.

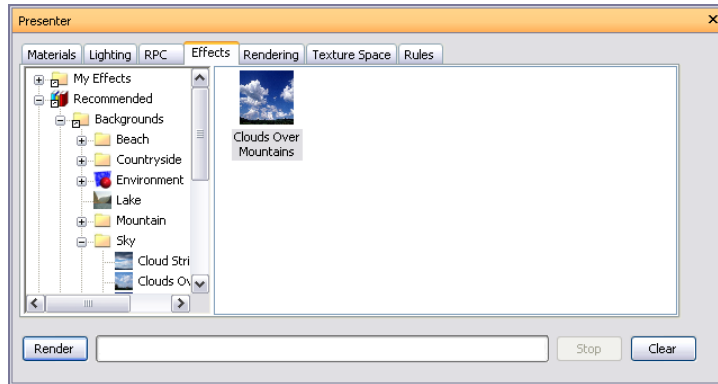

To set up an effect for the render, you simply drag a style from the archive to the palette. You can only have one of each type of effect at once in the palette: that is, one background and one foreground style.

NOTE A complete reference manual for all types of foregrounds, backgrounds and rendering styles is included with the Autodesk Navisworks API (see `\API\COM\documentation\shaders.chm`). The Autodesk Navisworks API is included with Autodesk Navisworks Simulate 2010; it's an optional feature in the installer, and is installed by default into the API subfolder in the Autodesk Navisworks installation folder.

Background Effects

Background effects affect the background of the image when rendered and include plain colors, graduated colors, procedural clouds and image files (tiled or scaled).

To set up a background for your render, simply drag your chosen background onto the palette on the right-hand side of the tab. Most backgrounds can be rendered interactively in OpenGL so you have a good preview of how the background will be fully rendered.

To edit your chosen background effect, simply double-click the effect in the palette. The Background Editor will appear. Each editor will be different for each type of background. The Scaled Image editor is shown here:

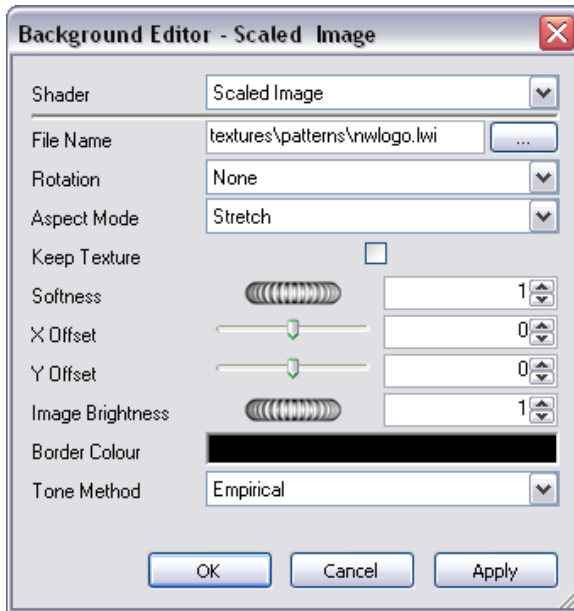

NOTE If the Presenter profile in the Options Editor (see “[Presenter Page](#)” on page 405 for more information) is set to Advanced, the dialog box will include the full list of parameters and allow you to change the type of background.

In the Background Editor, click the Browse button (...) next to the File Name field to display the Open Image File dialog box. From here, browse to an image file and click Open to use that image as the background.

Editing parameters in the Background Editor will interactively alter the scene with those changes.

At any time, click the Apply button to apply the parameter edits to the scene.

You can save an edited background for use in other scenes by simply dragging it into the Backgrounds folder inside the My Effects user archive.

Environment Background and Reflections

Environment backgrounds are a special kind of background that move with the model and allow reflections from reflective model parts.

Environment backgrounds not only make the scene look more realistic for static images of the model, but completely transform the realism effect in animations. This is because as in real life, by moving an object around in the background, the environment also changes. For example, looking up to the top of a building, the background will be the sky, whereas, an aerial view of the building will have the surrounding buildings or landscape as the background.



Another benefit of using environment backgrounds is that reflection properties of materials in the model are able to reflect the environment (for example, when looking up, towards the top of a glass-fronted building, the sky is reflected in the glass).



Environment backgrounds are images wrapped around the model. The recommended images to use are vertical cross maps. These images are automatically placed on the inside of a cube that then surrounds the scene. Due to the nature of the feature, edges and corners become indistinguishable. A wide variety of environment maps are available for purchase on the internet.

Setting up an environment background consists of two components: the background image, such as the sky over the desert, and the environment that holds the background image.

To add a background effect

- 1 Open the Presenter window, and click the Effects tab.
- 2 In the left-hand pane, expand the Recommended archive, and choose the desired background effect.
- 3 Drag your chosen background onto the palette on the right-hand side.
Most backgrounds can be rendered interactively in OpenGL so you have a good preview of how the background will be fully rendered.
- 4 Click the Render button to apply the background to the model.

To edit a background effect

- 1 Open the Presenter window, and click the Effects tab.
- 2 Double-click the required background in the palette.
- 3 Use the Background Editor to adjust the settings as necessary.
Each editor will be different for each type of background. The Scaled Image editor is shown here.

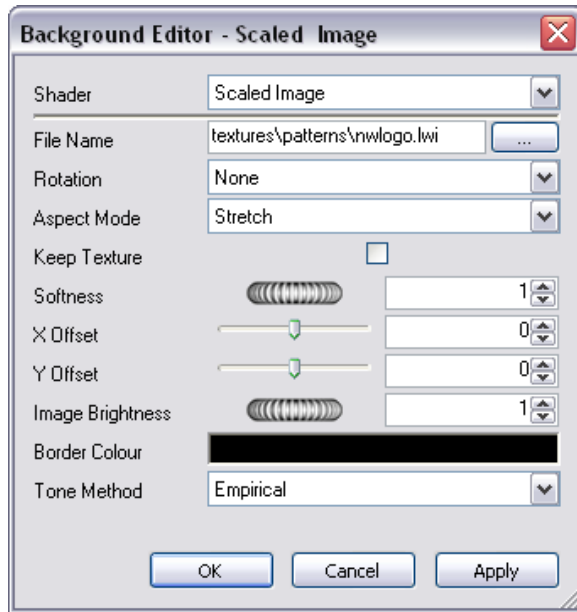

4 Click OK.

To add an environment background

- 1 Open the Presenter window, and click the Effects tab.
- 2 In the left-hand pane, expand the Recommended archive, open the Environments subfolder, and then open the Panorama folder.
- 3 Drag the Sky effect over to the palette on the right.
The background is not yet visible in the Scene Area.
- 4 Return to the Recommended archive, open the Backgrounds sub-folder, and drag the Environment effect over to the palette.

The background is now visible. This is because this type of background is made up of two parts, the Sky image and the background Environment shader that points at the image; the two elements link together automatically.

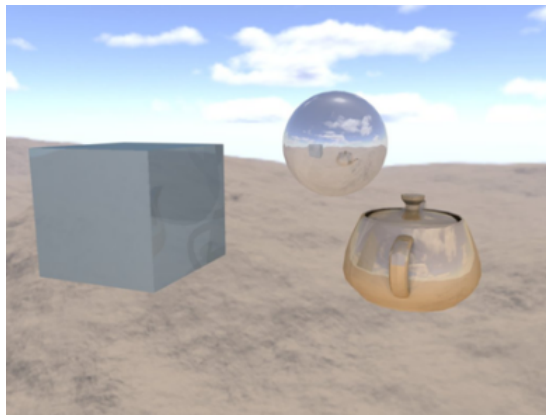

Once this is complete, moving around the model will see the background moving appropriately in real-time. With a modern graphics card, if there are reflective surfaces in the scene, setting the Presenter Hardware Shading in the Options Editor to Lighting will show the newly set up background reflected in all such surfaces (see “Presenter Page” on page 405).

TIP Pressing the Render button will show this background in the photorealistic output.

Foreground Effects

Foreground effects affect the foreground of the image when rendered, and include fog and snow effect. None of these effects are available as an interactive preview and can only be seen when a full render is done.

To set up a foreground for your render, simply drag your chosen foreground onto the palette on the right hand side of the tab.

To edit your chosen foreground effect, simply double-click the effect in the palette. The Foreground Editor dialog will appear. Each editor will be different for each foreground type. The Fog editor is shown here:

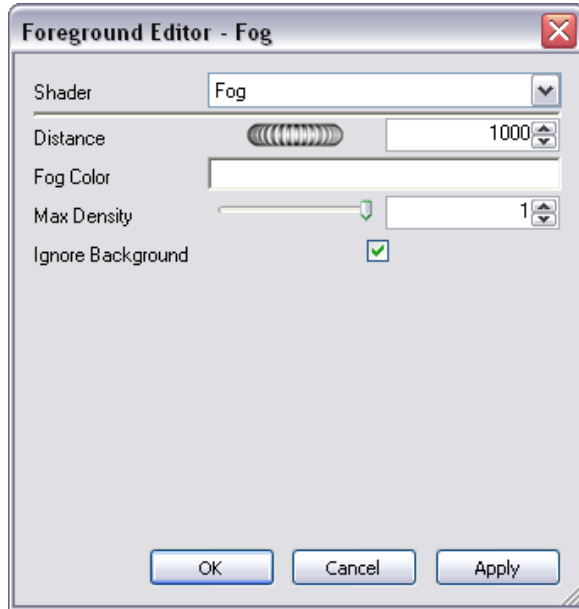

NOTE If the Presenter profile in the Options Editor (see "[Presenter Page](#)" on page 405 for more information) is set to Advanced, the dialog box will include the full list of parameters and allow you to change the type of foreground.

At any time, click the Apply button to apply the parameter edits to the scene.

You can save an edited foreground for use in other scenes by simply dragging it into the Foregrounds folder inside the My Effects user archive.

Use Presenter Rendering Styles

Rendering Tab

Like the [Materials](#), [Lighting](#) and [Effects](#) tabs, the Rendering tab is divided into two panes for archives and palette. This tab is where you select in which style and how you wish the scene to be rendered. Each archive has a number of different render styles to choose from.

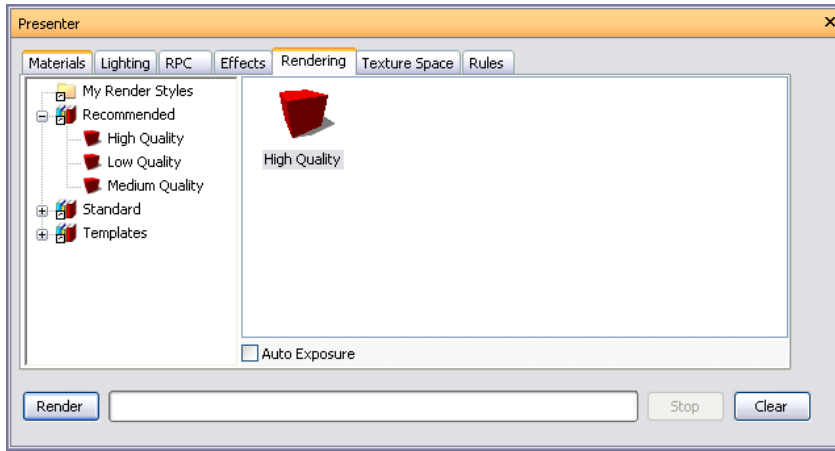

NOTE A complete reference manual for all types of rendering styles is included with the Autodesk Navisworks API, (see \API\COM\documentation\shaders.chm). The Autodesk Navisworks API is included with Autodesk Navisworks Simulate 2010; it's an optional feature in the installer, and is installed by default into the API subfolder in the Autodesk Navisworks installation folder.

Rendering Styles

Rendering styles affect the way that the scene is rendered when a full photorealistic render is done (by clicking on the Render button). None of these effects are available as an interactive preview.

To set up a rendering style, simply drag your chosen style onto the palette on the right-hand side of the tab.

To edit your chosen rendering style, simply double-click the style in the palette. The Render Editor dialog box will appear. Each editor will be different for each type of rendering style. The High Quality editor is shown here:

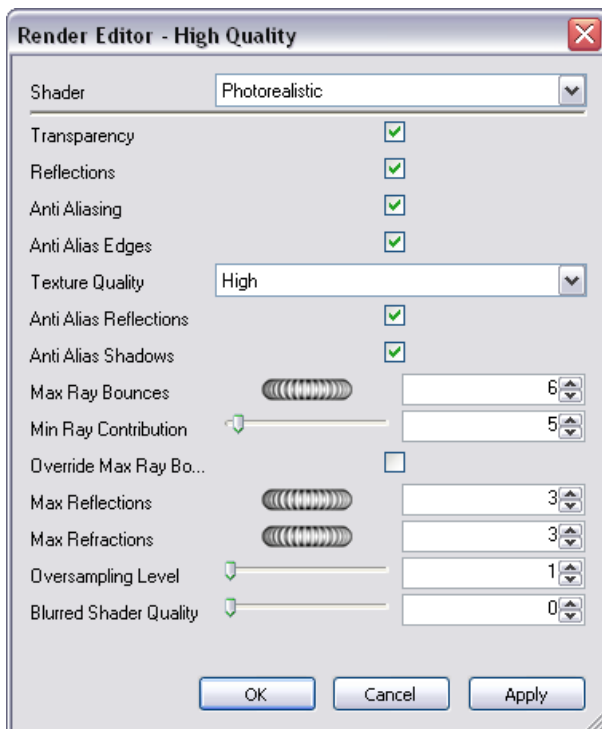

NOTE If the Presenter profile in the Options Editor (see "[Presenter Page](#)" on page 405 for more information) is set to Advanced, the dialog box will include the full list of parameters and allow you to change the type of foreground.

At any time, click the Apply button to apply the parameter edits to the scene.

You can save an edited rendering style for use in other scenes by simply dragging it onto the My Render Styles user archive.

Predefined Rendering Styles

The Recommended archive contains three predefined rendering styles:

- **High Quality.** Choose this rendering style for the highest quality rendered output. This includes all reflections and transparencies and anti aliasing on edges, reflections and shadows. Of the three recommended rendering styles, this will take the longest to render. This is also the rendering style used if no other is chosen. Use this style for the final export of your rendered output.
- **Low Quality.** Choose this rendering style for a quick, low quality render. This includes no reflections or anti aliasing. Use this style if you wish to quickly see the affects of materials and lighting you have applied to the scene.
- **Medium Quality.** Choose this rendering style for a medium quality render. This includes all reflections and transparencies and anti aliasing only on shadows. You may use this style for a final preview of the scene, prior to exporting your final rendered output.

The Standard archive contains twenty three rendering styles that simulate hand drawing and other non-photorealistic styles. These styles use a mixture of shaded, vector and image based rendering techniques. They are generally best suited to small models and small output images.

NOTE The Standard rendering styles require multiple stages to render a scene. These can therefore often take a considerable time to render.

The Templates archive contains five main types of rendering style, which can be used to define your own rendering styles:

- **Photorealistic (Raytrace).** This archive contains photorealistic rendering styles, including High Quality, Low Quality and Medium Quality as per the Recommended archive. These rendering styles are fastest and use least memory where large parts of the model are obscured from any particular viewpoint. For example, when inside a room within a building, the walls of the room will obscure the rest of the building from view.
- **Photorealistic (Scanline).** This archive contains photorealistic rendering styles, including High Quality, Low Quality and Medium Quality as per the Recommended archive. These rendering styles are fastest and use least memory where most of the model is visible from any particular viewpoint. For example, when rendering an overview of a plant and process model, the majority of the model can be seen as there are fewer walls, or similar, to obscure your view.
- **Simple Shaded.** This template is a simple shaded rendering style, where advanced features such as textures and transparency are not required.
- **Sketch.** This archive contains twelve basic sketch rendering styles.

NOTE Sketch rendering styles require multiple stages to render a scene. These can therefore often take a considerable time to render.

- **Vector.** This template is a vector rendering style, which will render the scene in wireframe.

Auto Exposure

Select the Auto Exposure check box to render the scene with balanced brightness and contrast. This is essential when using physically accurate lighting, such as a Sky or Sun light. If adding either of these lights to your scene, you will be prompted to turn Auto Exposure on, if it is not already.

Use Presenter Texture Space

Texture space describes the way in which a texture is applied to an item. For example, applying a cylindrical texture space to a pipe will cause textures on the pipe to be rendered more naturally. An item's texture space may have been assigned from the original CAD application and brought through from the native CAD file, or set up within Presenter with the options of Box, Plane, Cylinder, or Sphere. The Explicit option allows a user-defined texture space to be applied and will be available if the item had a texture space applied to it in the original CAD application. Each texture space option applies some imaginary bounding geometry around the item and "shrink-wraps" the texture as best it can to the geometry underneath this bounding geometry.

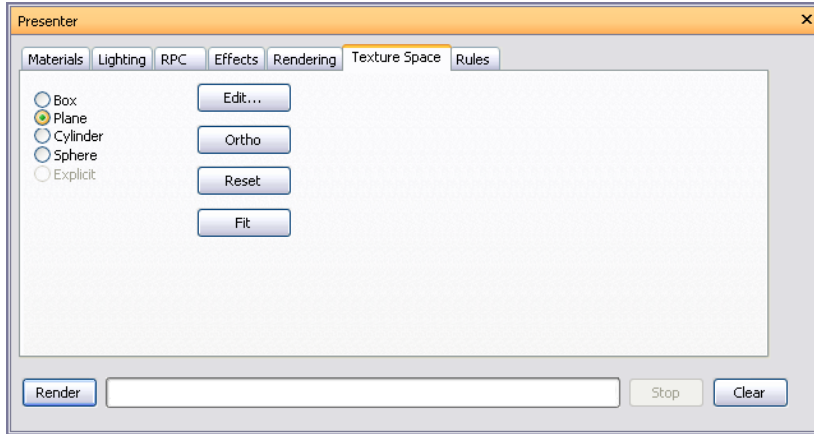

If you've applied a texture to an item, Presenter will attempt to work out the best fit from the four texture spaces available. If this isn't what you intended, then you can then edit the texture space.

To edit texture space

- 1 Select the item (see "[Interactive Geometry Selection](#)" on page 179 for more information) and go to the Texture Space tab in the Presenter window to choose another texture space.
Alternatively, right-click an item which has a texture applied to it and click a new texture space on the Presenter ► Texture Space shortcut menu.
- 2 You can fine-tune an item's texture space further by clicking the Edit button on the Texture Space tab of the Presenter window. The relevant Texture Space Editor will appear.

Either the plane texture space editor:

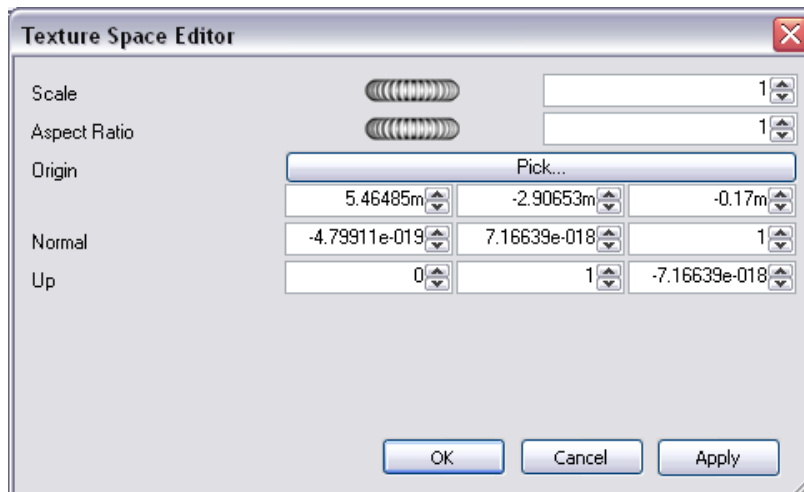

Or the cylindrical texture space editor:

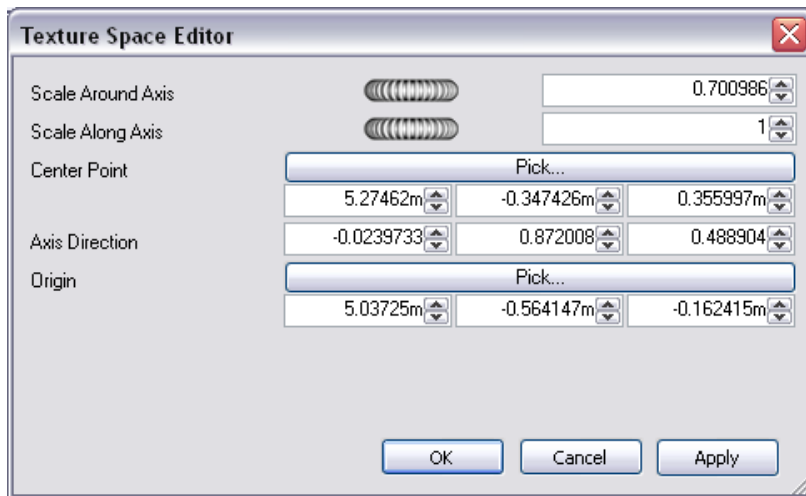

Or the spherical texture space editor:

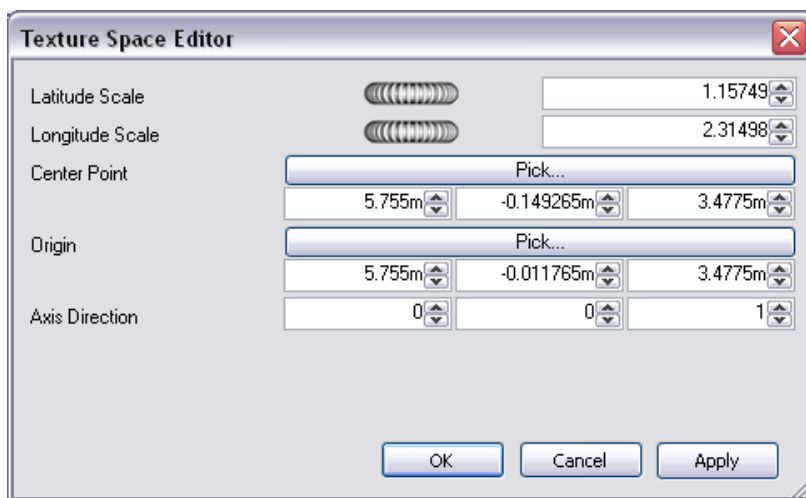

- 3 Edit each of the individual parameters and click Apply to see the results of the edit. Clicking the Pick button allows you to interactively pick a point in the model rather than individually typing in X-, Y-, and Z-coordinates.
- 4 Click OK.
- 5 Once edited, you can always reset a texture space to the Autodesk Navisworks-defined version by clicking the Reset button on the Texture Space tab.
- 6 Click the Ortho button if you want Autodesk Navisworks to align the texture space with the nearest axis.
- 7 Click the Fit button if you want Autodesk Navisworks to fit a single repeat of the texture to the item. This is of particular use when you are mapping an image to the exact size of the item it's being applied to.

Use Presenter Rules

Rules Tab

The Rules tab of the Presenter window allows you to apply materials to models according to certain user-defined criteria, rather than by dragging and dropping onto individual layers, groups or components. For example, all layers that are floors can be assigned a material called "floorboards", without having to manually drag-and-drop the material on to each floorboard. Each time the model is updated, the rules then just need re-applying, rather than manually re-applying them to all items.

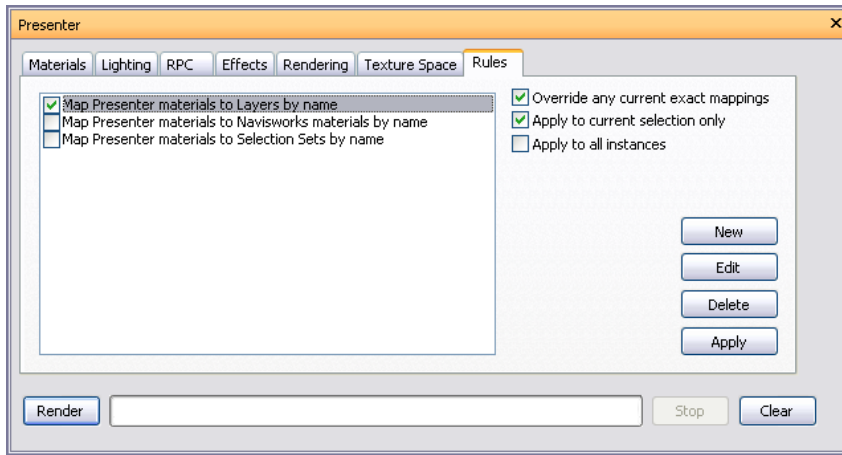

All materials can be saved in a Autodesk Navisworks “palette” (.nwp) file, which allows you to set up a palette of materials once for a project and re-apply them to a model as it evolves, or to another model in the same project that has been set up with the same layer names, colors, selection sets and/or properties.

See “[Organize and Manage Materials](#)” on page 305 for more information.

To apply Presenter rules

- 1 Open the Presenter window, and click the Rules tab.
- 2 Select the check boxes for all rules you want to apply. You can apply as many rules as you want, as all rules depend on material names.
- 3 Use three check boxes on the right-hand side of the Presenter window, Rules tab, to control how the selected rules applied to the scene:
 - Select the Override current mappings check box if you want to override any existing mappings from Presenter materials to items in the selection tree.
 - Select the Apply to current selection check box if you want to apply this rule only to the currently selected items in the scene. Be aware that this is the default setting, so if your rule seems not to have worked, check that you don't have this option checked with nothing selected in the scene.
 - Select the Apply to all instances check box if you want to apply this rule to all instances of any multiply-instanced item affected by the rule.
- 4 Click the Apply button.

Predefined Rules

You can apply as many rules at once, as all rules depend on material names. Rules can be defined using the Autodesk Navisworks API, but three predefined rules are:

- Layers by Name rule enables you to apply a material to named layers.
 - As an example, if a layer is called “Doors” and you rename a material to “Doors” (the spelling and case must be exactly the same as the layer's name) then all layers named “Doors” will appear with the properties of that material when you select the rule Layers by Name, and click the Apply button.
 - You can give multiple materials the name of different layers and apply this rule to all of the layers.
- Autodesk Navisworks Materials by Name rule enables you to apply a material to named Autodesk Navisworks materials. Autodesk Navisworks materials are *not* the same as Autodesk Navisworks Presenter materials - Autodesk Navisworks materials merely refers to the color and transparency of the item as it comes through from the original CAD file, whereas Presenter materials are those materials applied using the Presenter tool, or are more complex materials such as bitmaps converted from the original CAD file.
 - If a Presenter material has the same name as a Autodesk Navisworks material in the model (for example, "AutoCAD Color Index 7"), then all items with this original Autodesk Navisworks material name in the scene receive this Presenter material from the palette when you select the rule Autodesk Navisworks Materials by Name, and click Apply Rules.

- Selection Sets by Name rule enables you to apply a material to selection sets. See “[Create and Use Sets of Objects](#)” on page 190 for more information on setting up selection sets. If a material has the same name as a selection set in the model, then all items in this selection set receive this material from the palette when you select the rule Selection Sets by Name, and click Apply Rules.

Custom Rules

New custom rules may also be added and defined, using the Rules Editor.

To add custom Presenter rules

- 1 From the Rules tab of the Presenter window, click the New button. The Rules Editor dialog box is displayed.



- 2 Enter a new name for your rule in the Rule name box.

NOTE If you choose not to enter a name, upon selecting a rule template, the name of that template will be used.

- 3 From the Rule Templates list, choose a template from which your rule will be based upon.

NOTE The Layers by Name, Materials by Name, and Selection Sets by Name templates are those used for the predefined Presenter rules.

The Materials by Property template enables you to specify a property within the model scene. If a material has the same name as the specified property value in the model, then all items having that property will receive this material from the palette when you select the rule Materials by Property, and click Apply Rules.

- 4 In the Rule description box, click on each of the *underlined values* to define your custom rule. The customizable values available with the built in templates are:
 - Name. Use the name of the category or property as it is displayed in the interface (recommended). You can also choose Internal Name which is that accessed via the API (for advanced use only).
 - '<category>'. Choose from the available list, which category the property you wish to define is in. Only the categories that are contained in the scene are available in the drop down.

- '<property>'. Choose from the available list, which property you wish to define. Again, only the properties in the scene within the chosen category will be available.

5 Click OK.

The Presenter Rules Example

To follow this procedure, open the file called `gatehouse_pub.nwd` located under the `Examples\Gatehouse` folder in the Autodesk Navisworks installation directory.

Let's assume, you want to apply window glass material to all gatehouse items with material property of AutoCAD Color Index 9, and red brick material to all gatehouse items with material property of AutoCAD Color Index 32. The following procedure describes the necessary steps to achieve this, using the Presenter rules.

To apply materials with the custom Presenter rules

- 1 Open the Presenter window, and click the Rules tab.
- 2 Create a rule called 'Color Index 9', based on the materials by property template:
 - a From the Rules tab of the Presenter window, click the New button.
 - b Enter a name for the rule, Color Index 9.
 - c Choose the Materials by property template.
 - d Click on '<category>' and choose Material from the drop-down list.
 - e Click on '<property>' and choose Name from the drop-down list.
 - f Click OK to save the custom rule.



- 3 Create another rule called Color Index 32 using the same settings as before.
- 4 Set up the necessary materials:
 - a From the Recommended, Glass archive on the Materials tab, drag the Window Glass material into the palette (right-hand pane).
 - b Select the Window Glass material and press F2 and rename it to AutoCAD Color Index 9. Press Enter to save the new name.
 - c From the Recommended, Bricks archive on the Materials tab, drag the Red Brick material into the palette, and rename it to AutoCAD Color Index 32.

NOTE The name of the Presenter material must match the name of the material as it comes through from the original CAD file. You can view the material properties on the Properties control bar, or on the Properties tab of the Selection Tree.

- 5 Go to the Rules tab and select the check boxes for the Color Index 9 and Color Index 32 rules.
- 6 Ensure only the Override any current exact mappings check box is selected and then click the Apply button, to apply the rules.

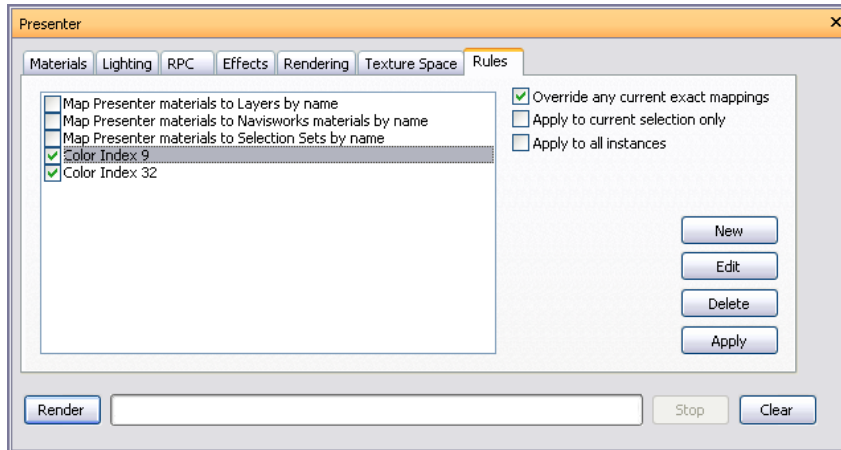

All items within the model scene that have the color index 9 and color index 32 properties should now have the corresponding Presenter materials applied to them.

Simulate Construction Scheduling

15

The TimeLiner tool enables you to link your 3D model to an external construction schedule for visual 4D planning.

Overview of TimeLiner Tool

The TimeLiner tool adds 4D schedule simulation to Autodesk Navisworks Simulate 2010. TimeLiner imports schedules from a variety of sources, allows you to connect objects in the model with tasks in the schedule and simulate the schedule showing the effects on the model, including planned against actual schedules. TimeLiner also allows the export of images and animations based on the results of the simulation. TimeLiner will automatically update the simulation if the model or schedule changes.

You can combine the functionality of TimeLiner with other Autodesk Navisworks tools:

- Linking TimeLiner and Object Animation together enables the triggering and scheduling of object movement based on start time and duration of project tasks, and can help you with workspace and process planning. For example, a TimeLiner sequence may indicate that when a particular site crane moves from its start point to its end point over the course of a particular afternoon, a workgroup working nearby causes an obstruction along its route. This potential obstruction problem can be resolved before going to site (e.g., the crane can be moved along a different route, the workgroup moved out of the way, or the project schedule altered). See “[Add Animation](#)” on page 366 for more information.

TimeLiner Window

The TimeLiner dockable window enables you to link items in the model to project tasks, and simulate project schedules.

To toggle the TimeLiner window

- Click TimeLiner  on the Workspace toolbar.

To set TimeLiner options

- 1 Click Tools ► Global Options.
- 2 Expand the Tools node in the Options Editor, and click the TimeLiner option.

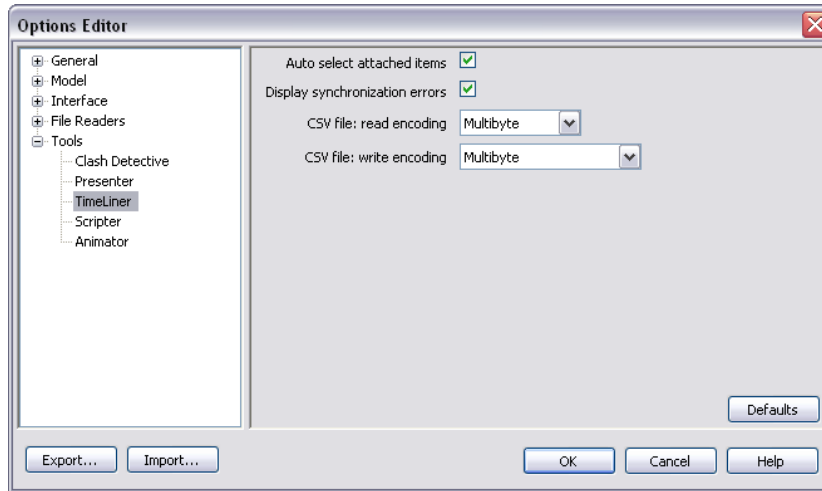

- 3 On the TimeLiner page, select the Auto Select Attached Items check box if you want TimeLiner to select any attached items in the Scene Area as you select each task in the TimeLiner window.
- 4 Select the Display Synchronization Errors check box if you want TimeLiner to inform you of errors when synchronizing tasks from external links.
- 5 Click OK.

Tasks Tab

The Tasks tab enables you to create and manage project tasks. It shows all of the tasks in your schedule, listed in a table format. You can use the scroll bars at the right and at the bottom of the tab to move through the task records.

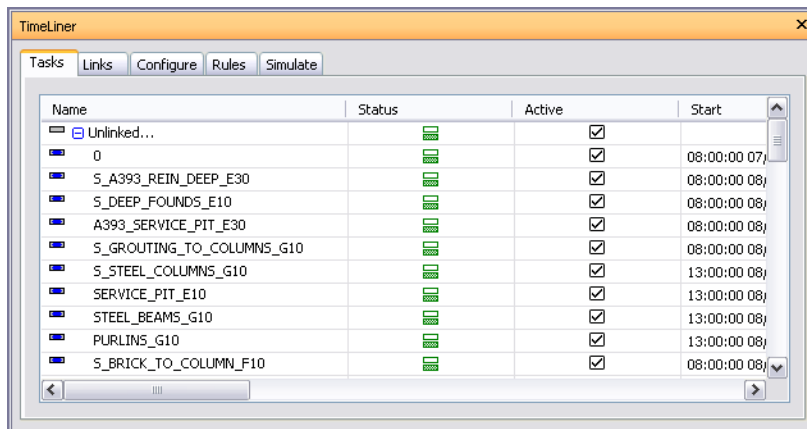

The Task View

The tasks are shown in a multi-column table, which provides some flexibility in how records are displayed. You can:

- Move or resize columns
- Sort column data in ascending or descending order

- Add new user columns to the default column set





TIP It is possible to move between entries in a manually editable task using the keyboard. Simply select a task that has been set to be manually editable, and use Tab and Shift-Tab keyboard keys to move forwards and backwards between fields. The keyboard can then be used to edit and set each entry where necessary.

The Task Hierarchy

Autodesk Navisworks TimeLiner supports a hierarchical task structure, as brought through from a link to your scheduling software, for example Microsoft Project™ see “[Links Tab](#)” on page 339 for more information). The hierarchy can be expanded or contracted by clicking on the plus or minus sign, respectively, to the left of the task.











The Task Icons

An icon is displayed to the left of each task name. These identify the current status of the task, with relation to attached items and links to external schedules:

-  Task with no attached items.
-  Task with attached items.
-  Task with link synchronized to external schedule.
-  Task with link synchronized to external schedule, including Task Type.
-  Task with link to external schedule that is either broken or old (unsynchronized).

The Status Icons

Each task has its own Status identified by an icon, representing planned against actual relationships. Each icon shows two bars. The top bar represents the Planned dates, and the bottom bar represents the Actual dates. If the Actual start and finish dates are the same as the Planned start and finish dates, the bars are displayed in green. Any variations between Planned and Actual dates are displayed in red. Missing Planned or Actual dates are shown in grey.

-  Actual start and end dates equal Planned start and end dates.
-  Actual end date before Planned start date.
-  Actual start date after Planned end date.
-  Actual start date before Planned start date and Actual end date after Planned end date.
-  Actual start date before Planned start date and Actual end date equals Planned end date.
-  Actual start date equals Planned start date and Actual end date after Planned end date.
-  Actual start date equals Planned start date and Actual end date before Planned end date.
-  Actual start date after Planned start date and Actual end date equals Planned end date.
-  Actual start date before Planned start date and Actual end date before Planned end date.
-  Actual start date after Planned start date and Actual end date after Planned end date.
-  Actual start and end dates only.



Planned start and end dates only.

The Active Check Box

The check box in the Active column enables you to turn a task on/off. If a task is turned off, then it will not appear in the [simulation](#). For hierarchical tasks, turning off the parent task will automatically turn off all child tasks.

The Shortcut Menus

Right-clicking any column header, opens a shortcut menu that enables you to create and manage custom columns, and change the sort order of tasks.

- Add User Column - enables you to insert a custom column into the tasks table. You can add as many custom columns as you want, but you can only have up to 10 different input types.
- Delete User Column - deletes the selected custom column from the tasks table.
- Rename User Column - renames the selected custom column. By default, the column has the same name as its input type. Changing the column name does not change the input type.
- Order - controls the tasks' sort order.

Right-clicking within the tasks area on the tab, opens a shortcut menu that enables you to work with tasks in your schedule.

- **Copy Date/Time** - copies date/time values in the selected field. This option is only available when you right-click one of the date fields (for example, Planned Start).

NOTE Currently, you cannot use the CTRL + C keyboard shortcut to copy date/time values.

- Paste Date/Time - pastes date/time values. To access this option you need to right-click one of the date fields. Also, this option is not available unless a valid date/time has been previously copied.

NOTE Currently, you cannot use the CTRL + V keyboard shortcut to copy date/time values.

- Add Task - adds a new task to the schedule.
 - Deletes Task - deletes the selected tasks from the schedule.
 - Detach Selection - detaches the currently selected items in the scene from the selected tasks.
 - Attach Selection - attaches the currently selected items in the scene to the selected tasks.
 - Append Selection - appends the currently selected items in the scene to the items already attached to the selected tasks.
-
- NOTE** See “[Select Objects](#)” on page 179 for more information on how to select items in Autodesk Navisworks.
-
- Attach Search - attaches all items selected by the current Search to the selected tasks. See “[Find Objects](#)” on page 186 for more information on searching.
 - Attach Named Search - attaches all items selected by the named search currently selected in the Selection Tree. For example, anything on the Sets or Properties tabs of the Selection Tree.
 - Attach Selection Set - attaches all items contained within a Selection Set, to the selected tasks. When you choose this option a list of all Selection and Search Sets saved in the current scene is displayed. Choose the Selection or Search Set you wish to attach to the tasks. See “[Create and Use Sets of Objects](#)” on page 190 for more information on using Selection and Search Sets.
 - Select Attached Items - selects all items attached to the selected tasks in the Scene Area and on the Selection Tree. The items will be highlighted based on the selection options you have defined. See “[Selection Page](#)” on page 380 for more information on selection options.
 - Relink - relinks the selected task with your scheduling software. You will only be able to relink the parent task, that is the task with the same name as the link. You will be prompted to choose the link to attach the task to, as you may have more than one link set up. Linked tasks are synchronized with the external schedule,

and you cannot edit start and end dates. See the “[Select Link Dialog Box](#)” on page 343 for more information on linking tasks.

- Unlink - breaks the link between the selected task and an external schedule, enabling you to manually edit start and end dates. You will only be able to unlink the parent task, i.e. the task with the same name as the link. However, your task is no longer synchronized with the external schedule.

NOTE For editing of dates, it is recommended to do this in the scheduling software and then Synchronize Tasks from Link.

- Check - validates the schedule, by identifying items that have not been included in any task, are duplicated in multiple tasks or, are in overlapping tasks.
- Tools - enables you to quickly create your own schedule, based on model layers, topmost items, or selection sets.
- Add Comment - adds a comment to the task. See “[Add Comments and Redlines](#)” on page 216 for more information.
- Rename - renames the task. When the text field becomes active, enter the new name then press Enter to save it.

You can use multi-selection (i.e. holding down Shift or Ctrl) to perform most commands on several tasks at once. For example, should you need to delete all tasks, select the first task, then hold down Shift and select the last task, then press Delete.

Links Tab

The Links tab enables you to import tasks from a third-party scheduling software, such as MS Project, Asta, and Primavera. It shows all of the links to external schedules in your project, listed in a table format.

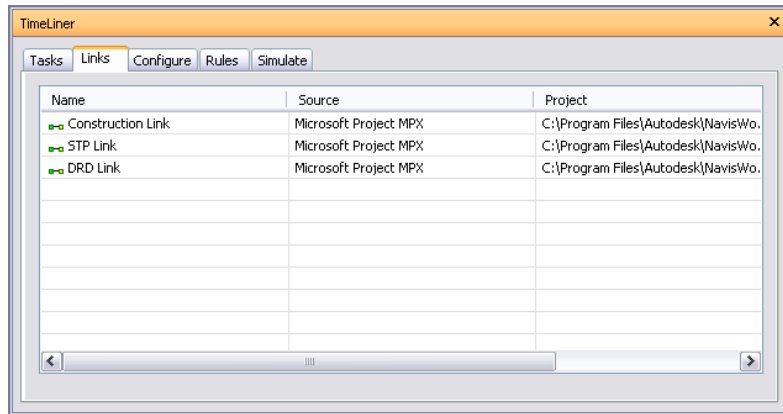

The Link View

The links are shown in a multi-column table. The columns show link name, source (for example, Microsoft Project™), project (e.g. my_schedule.mpp, and link status. Any further columns (there maybe none) identify the fields from the external schedule which specify the task type, unique id, start date and end date for each linked task.

You can move and resize columns, if necessary.

The Link Status

Synchronized All linked tasks have the same values as the external schedule.

Old Linked tasks have values that are out of date compared to the external schedule. You can [Synchronize Tasks with Project Changes](#) to update the tasks.

Status Not Available It's not possible to determine whether tasks are Synchronized or Old. This value only occurs for schedule sources that don't provide any way of determining when a schedule was last updated.

Broken The external schedule can not be accessed. The file may have been moved or deleted, or required software may be missing or not functioning correctly. TimeLiner will still function using the task values determined when the link was last synchronized.

The Shortcut Menus

Right-clicking within the links area on the tab opens a shortcut menu that enables you to add and manage links to external project files.

- Add Link - creates a new link to an external project file. Selecting this option will display a further menu, listing all project sources that may be connected to on the current machine. See “[Supported Scheduling Software](#)” on page 360 for more information on which sources are available.

- Delete Link - deletes the currently selected link.

NOTE Deleting the link to an external project file will not delete any tasks that have previously been rebuilt in the TimeLiner Tasks tab.

- Rebuild Task Hierarchy from Link - reads all of the tasks and associated data (as defined in the “[Field Selector Dialog Box](#)” on page 343) from the selected project file and adds these to the Tasks tab.

Choose this option also to synchronize with the selected project file when new tasks have been added to the project file. This will rebuild the task hierarchy in TimeLiner, containing all of the latest tasks and data.

- Synchronize Tasks from Link - updates all existing tasks in the Tasks tab, with the latest associated data from the selected project file (e.g. Start and End dates).

- Rebuild Task Hierarchy from All Links - reads all of the tasks and associated data (as defined in the [Field Selector Dialog Box](#)) from all project files listed in the Links tab and adds these to the Tasks tab.

Choose this option also to synchronize with all project files when new tasks have been added to the project files. This will rebuild the task hierarchy in TimeLiner, containing all of the latest tasks and data.

- Edit Link - enables you to edit the selected link. This will display the [Field Selector Dialog Box](#), from which you can define new fields or re-define existing ones.

- Rename - enables you to rename the link to something more appropriate. When the text field becomes highlighted, enter the new name, then press Enter to save it.

NOTE Tasks in the external schedule will be ignored if they do not include both start and end dates, with the start date being less than or equal to the end date.

Configure Tab

The Configure tab allows you to set up the task parameters, such as task types, appearance definitions for tasks, and the default model appearance at start of the simulation.

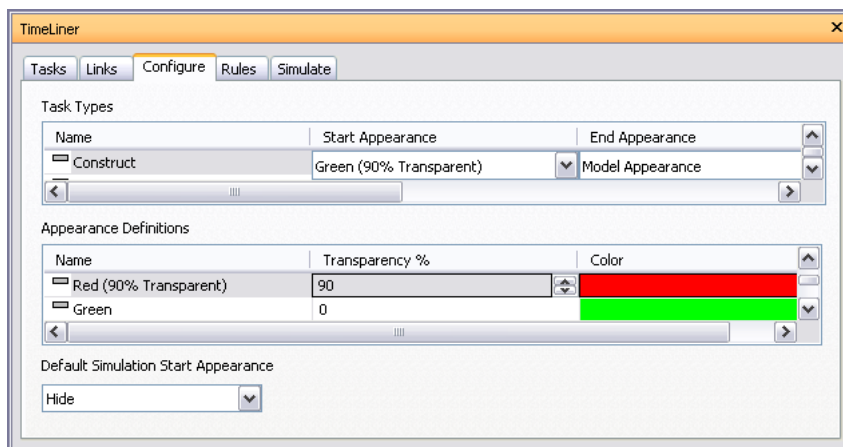

Task Types

The tasks types are shown in a multi-column table. You can move and resize table columns, if necessary.

TimeLiner comes with three predefined task types:

- Construct - for tasks where the attached items are to be constructed. By default, during a simulation, the objects are highlighted in green at the start of the task and are reset to [Model Appearance](#) at the end of the task.
- Demolish - for tasks where the attached items are to be demolished. By default, during a simulation, the objects are highlighted in red at the start of the task and are hidden at the end of the task.
- Temporary - for tasks where the attached items are only temporary. By default, during a simulation, the objects are highlighted in yellow at the start of the task and are hidden at the end of the task.

The Appearance Definition

You can customize the default task types, or create new ones, as necessary.

The appearance definitions are shown in a multi-column table. You can move and resize table columns, if necessary.

TimeLiner comes with a set of ten predefined Appearance Definitions that you can use to configure the task types. Appearances define a level of transparency and a color.

You can customize the default appearance definitions, or create new ones, as necessary.

The Shortcut Menus

Right-clicking in the Task Types table opens a shortcut menu that enables you to manage task types:

- Add - adds a new task type.
- Delete - deletes the selected task type.
- Rename - enables you to rename the selected task type.

Right-clicking in the Appearance Definitions table opens a shortcut menu that enables you to manage appearance definitions:

- Add - adds a new appearance definition.
- Delete - deletes the selected appearance definition.
- Rename - enables you to rename the selected appearance definition.

The Default Simulation Start Appearance

This drop-down box specifies a default appearance to apply to all objects in the model at the start of the simulation. The default is Hide, which is ideal for simulating most construction sequences.

Rules Tab

The Rules tab enables you to create and manage TimeLiner rules. It lists all currently available rules. These can be used to map tasks to items in the model. Each of the default rules can be edited and new rules may be added as necessary:

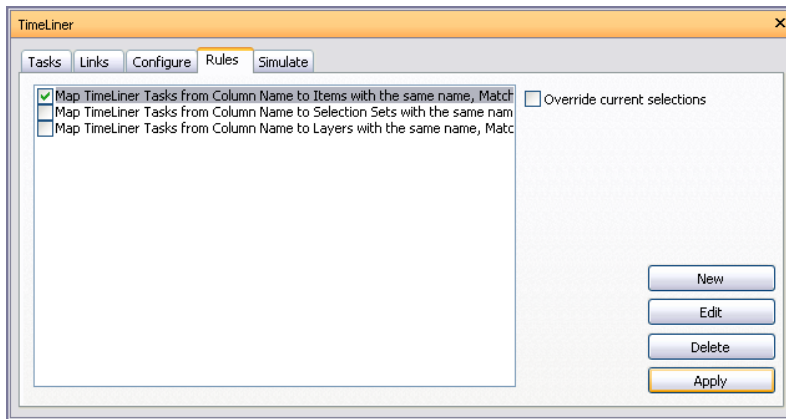

Simulate Tab

The Simulate tab enables you to simulate your TimeLiner sequence throughout the duration of the project schedule.

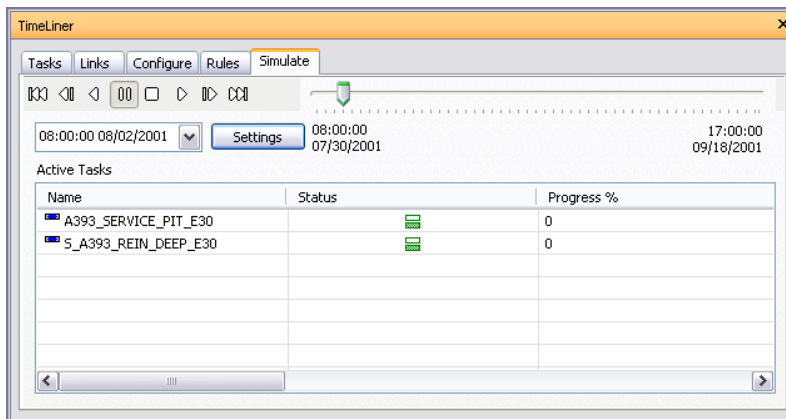



The Playback Controls

Use the standard VCR buttons to step and play forwards and backwards through the simulation:

Rewind  will rewind the simulation back to the beginning.

Step Back  will step back a single step size. See “[Simulation Settings Dialog Box](#)” on page 346 for more information.

Reverse Play  will play the simulation backwards.

Pause  will pause the simulation at the time you press it at. You can then look around and interrogate the model, or step forwards and backwards through the simulation. To continue playing from where you paused, just press Play again.

Stop  will stop the simulation playing and rewind back to the beginning.

Play  will play the simulation from the currently selected time.

Step Forwards  will step forwards a single step size.

Forward  will fast forward the simulation to the end.

You can use the Simulation Position slider to quickly move forwards and backwards through the simulation. Full left is at the beginning and full right is at the end.



The Date/Time box below the VCR buttons shows the point in time through the simulation. You can click on the drop-down icon to the right of the date to display a calendar, from which you can select a date to 'jump' to.

The Settings Button

The Settings button opens the “[Simulation Settings Dialog Box](#)” on page 346 that enables you to define how the schedule is simulated.

The Active Tasks

All Active Tasks are show in a multi-column table. You can move and resize table columns, if necessary.

You can view the current simulation time for each of the active tasks, and how close to completion they are (Progress is displayed as a percentage). The Status of each active task is also displayed as an icon. For simulations where Planned and Actual dates are available, the status provides a visual representation as to whether there is any variance between the planned and actual dates. See “[The Status Icons](#)” on page 337 for more information.

Select Link Dialog Box

When you relink a task to an external schedule you will be prompted to select which link to use, as your project may be linked to multiple schedules.

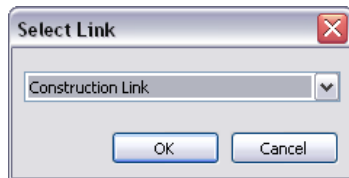

Field Selector Dialog Box

The Field Selector dialog box determines various options used when importing data from a link. The options available may be different for each type of link source.

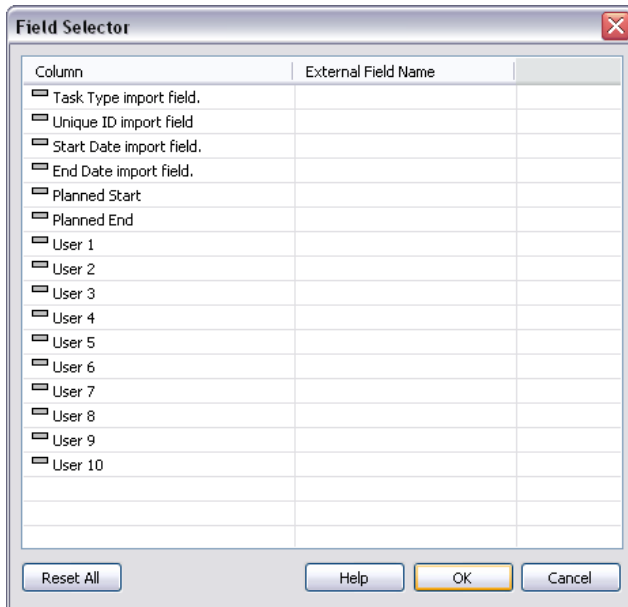

The Field Selector Dialog Box for importing data from an external scheduling software.

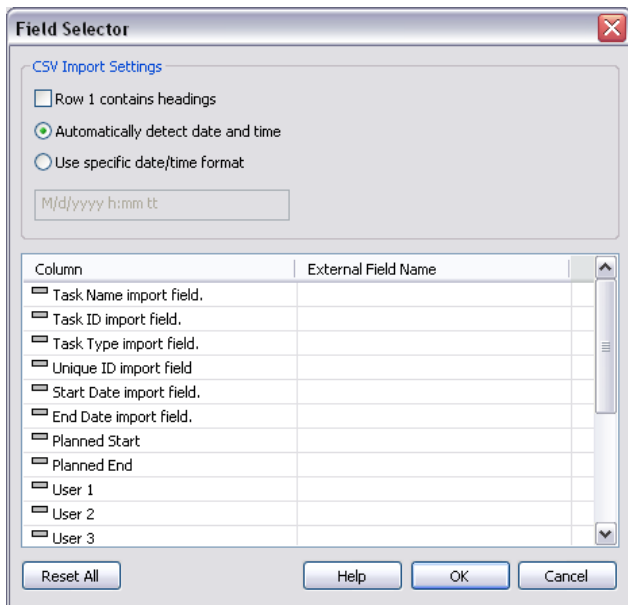

The Field Selector Dialog Box for importing CSV data

Options

CSV Import Settings

Row 1 Contains Headings Select the Row 1 Contains Headings check box if you want the first row of data in your .csv file to be treated as column headings. TimeLiner will use it to populate the External Field Name options in the grid.

If the first row of data in your .csv file does not contain column headings, clear this check box.

Automatically Detect Date/Time Format Select the Automatically Detect Date/Time Format option if you want TimeLiner to attempt to determine the date/time format used in your .csv file. First, TimeLiner applies a set of rules to try to establish the date/time format used in the document; if it is not possible, it uses the local settings on your system.

Use Specific Date/Time Format Select the Use Specific Date/Time Format option if you want to manually specify the date/time format that should be used. When this radio button is selected, you can enter the required format into the box provided. See the list of valid date/time codes below.

NOTE If one or more date/time-based columns are found to contain fields where the data cannot be mapped to a valid date/time value using the manually-specified format, TimeLiner will 'fall back' and attempt to use the automatic date/time format.

The Field-Mapping Grid

The field-mapping grid is a grid containing, in the left column, all the columns from the current TimeLiner schedule and, in the right column, a number of drop-down menus enabling you to map the incoming fields to the TimeLiner columns.

NOTE When you are importing data from a CSV file, the External Field Name column of the grid shows the data from the first row of the CSV file if Row 1 Contains Headings is selected. Otherwise, it defaults to Column A, Column B, and so on.

Task Name This field is shown and required when you import CSV data. If you do not map this field, you will receive an error message.

Task Type import field The field is used to automatically assign [Task Types](#) to each imported Task.

Unique ID import field The field is used to uniquely identify each imported Task. This allows synchronization to work even if major changes are made to the external schedule in the scheduling software. The default behavior is to use the most appropriate field for each source. Some sources do not have a well defined unique id, in which case you may need to choose a field manually.

Start Date import field Some project sources support multiple start dates for different purposes. The default behavior is to use the most appropriate available date for each source. This field may be used to define an Actual Start date, should it be different to that selected by default.

End Date import field Some project sources support multiple end dates for different purposes. The default behavior is to use the most appropriate available date for each source. This field may be used to specifically define an Actual End date, should it be different to that selected by default.

Planned Start The field is used to identify a planned start date. This allows planned against actual comparisons to be made and simulated.

Planned End The field is used to identify a planned end date. This allows planned against actual comparisons to be made and simulated.

User 1 to 10 Ten user fields are available to link any custom data fields from the project source.

Reset All button Use this button to clear all column mapping and also reset CSV import settings to their defaults, if appropriate.

Valid Date/Time Codes

d, %d The day of the month. Single-digit days will NOT have a leading zero.

dd The day of the month. Single-digit days will have a leading zero.

ddd The abbreviated day name.

dddd The full day name.

M, %M The numeric month. Single-digit months will NOT have a leading zero.

MM The numeric month. Single-digit month names will have a leading zero.

MMM The abbreviated month name.

MMMM The full month name.

y, %y The year without the century. If less than 10, it will NOT have a leading zero.

yy The year without the century. If less than 10, it will have a leading zero.

yyyy The year in four digits, including the century.

h, %h The hour in 12-hour clock format. Single digit hours will NOT have a leading zero.

hh The hour in 12-hour clock format. Single digit hours will have a leading zero.

H The hour in 24-hour clock format. Single digit hours will NOT have a leading zero.

HH The hour in 24-hour clock format. Single digit hour will have a leading zero.

m, %m The minute. Single-digit minutes will NOT have a leading zero.

mm The minute. Single-digit minutes will have a leading zero.

s, %s The second. Single-digit seconds will NOT have a leading zero.

ss The second. Single-digit seconds will have a leading zero.

t, %t The first character of the AM/PM designator, if any.

tt The AM/PM designator, if any.

z The GMT time zone offset ("+" or "-" followed by the hour only). Single-digit hours will NOT have a leading zero.

zz The time zone offset. Single digit hours will have a leading zero.

zzz The full time zone offset in hours and minutes. Single digit hours and minutes will have leading zeros. For example, "-8:00".

Simulation Settings Dialog Box

The Settings button on the Simulate tab provides access to the Simulation Settings dialog box.

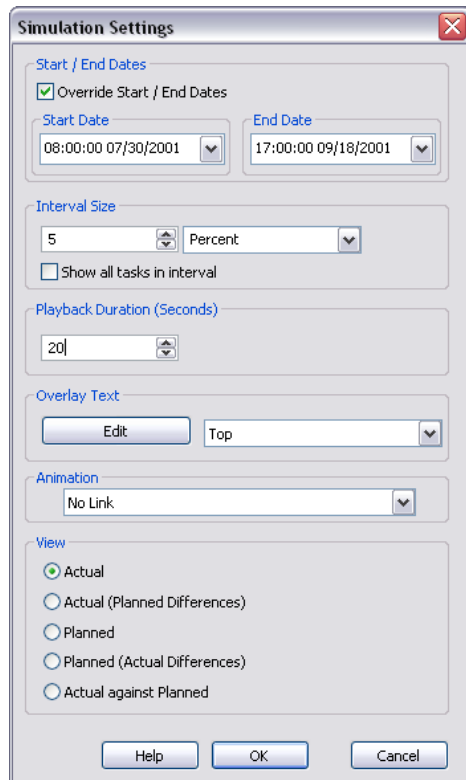

It is possible to override the Start and End dates that the simulation runs between. Selecting the Override Start/End dates check box enables the date boxes and allows you to choose the start and end dates. By doing this, you can simulate a small sub-section of the overall project. The dates will be shown on the Simulate tab. These dates will also be used when exporting animations.

You can define the Interval Size to use when stepping through the simulation using the playback controls. The interval size can be set either as a percentage of the overall simulation duration or to an absolute number of days or weeks, and so on.

Use the drop-down list to select the interval unit, then use the Up and Down arrow buttons to increase or decrease the interval size.

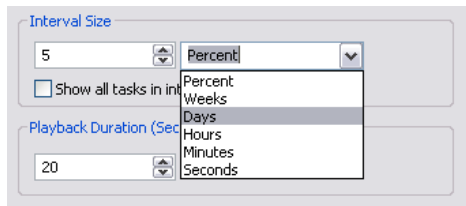

It is also possible to highlight all the tasks that are being worked on during the interval. By selecting the Show All Tasks in Interval check box, and, for example, setting the Interval Size to 5 Days, all tasks being worked on during those 5 days will be set to their Start Appearance in the Scene Area, including those that begin and end within the bounds of the interval. The Simulation slider will show this by drawing a blue line under the slider. If this check box is clear, tasks that begin and end within the bounds of the interval will not be highlighted in this manner, and will need to overlap with the current date in order to be highlighted in the Scene Area.

You can define the overall Playback Duration for the complete simulation (the time needed to play it through from start to finish). Use the Up and Down arrow buttons to increase or decrease the duration (in seconds). You may also enter a duration directly into this field.

You can define whether the current simulation date should be overlaid in the Scene Area, and if so whether it should appear at the top or bottom of the screen. From the drop-down, choose from None (to display no overlay text), Top (to display the text at the top of the window), or Bottom (to display the text at the bottom of the window).

You can Edit the information displayed in the overlay text using the [Overlay Text Dialog Box](#). This dialog box also makes it possible to alter the Font Type, Style and Size by clicking on the contained Font button.

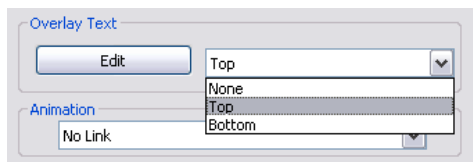

You can add animation to an entire schedule, so that during the TimeLiner sequence playback, Autodesk Navisworks will also play the specified viewpoint animation or camera.

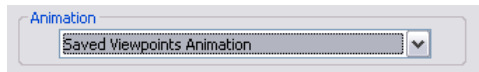

The following options can be selected in the Animation field:

- **No Link** - no viewpoint animation or camera animation will be played.
- **Saved Viewpoints Animation** - links your schedule to the currently selected viewpoint or viewpoint animation.
- **Scene X - > Camera** - links your schedule to a camera animation in the selected animation scene.

You can pre-record suitable animations for use with the TimeLiner simulation (see [“Record and Play Animations”](#) on page 251). Using animation also affects the [Animation Export](#).

Views. Each view will playback the schedule depicting Planned and Actual relationships:

- **Actual**. Choose this view to simulate the Actual schedule only (that is, only use the Actual Start and Actual End dates).
- **Actual (Planned Differences)**. Choose this view to simulate the Actual schedule against the Planned schedule. This view will only highlight the items attached to the task over the Actual date range (that is, between Actual Start and Actual End. See diagram below for graphical representation). For time periods where the Actual dates are within the Planned dates (on schedule), the items attached to the task will be displayed in the Task Type Start Appearance. For time periods where the Actual dates are early, or late in comparison to the Planned dates (there is a variance), then the items attached to the task will be displayed in the Task Type Early or Late Appearance, respectively.

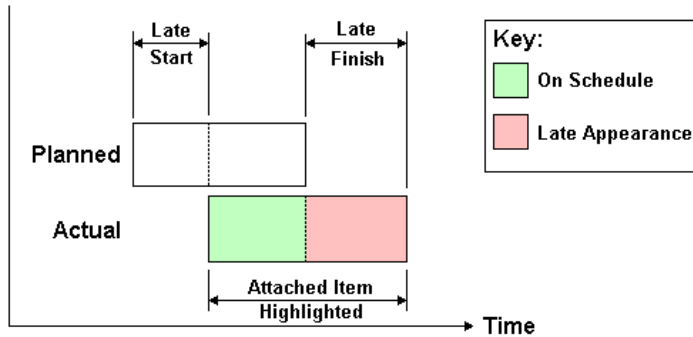
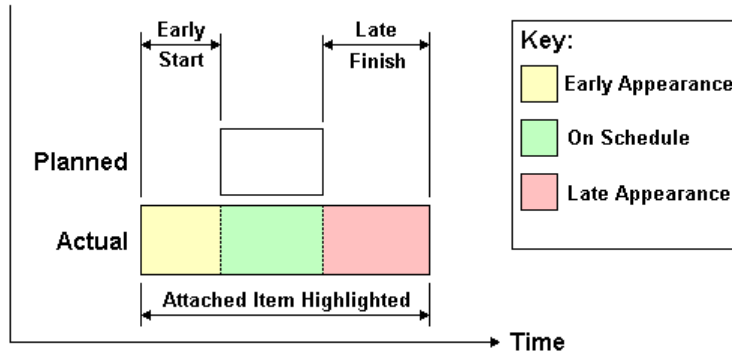

- Planned. Choose this view to simulate the Planned schedule only (that is, only use the Planned Start and Planned End dates).
- Planned (Actual Differences). Choose this view to simulate the Actual schedule against the Planned schedule. This view will only highlight the items attached to the task over the Planned date range (that is, between Planned Start and Planned End. See diagram below for graphical representation). For time periods where the Actual dates are within the Planned dates (on schedule), the items attached to the task will be displayed in the Task Type Start Appearance. For time periods where the Actual dates are early, or late in comparison to the Planned dates (there is a variance), then the items attached to the task will be displayed in the Task Type Early or Late Appearance, respectively.

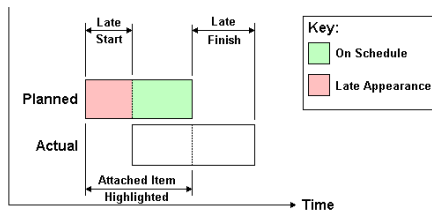
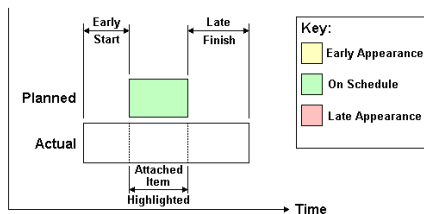

- Actual against Planned. Choose this view to simulate the Actual schedule against the Planned schedule. This will highlight the items attached to the task over the entire Planned and Actual date range (that is, between the earliest of Actual and Planned Start dates and the latest of Actual and Planned End dates. See diagrams below for graphical representation). For time periods where the Actual dates are within the Planned dates (on schedule), the items attached to the task will be displayed in the Task Type Start Appearance. For time periods where the Actual dates are early, or late in comparison to the Planned dates (there is a variance), then the items attached to the task will be displayed in the Task Type Early or Late Appearance, respectively.

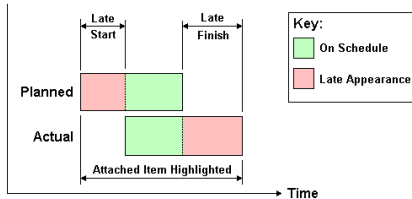
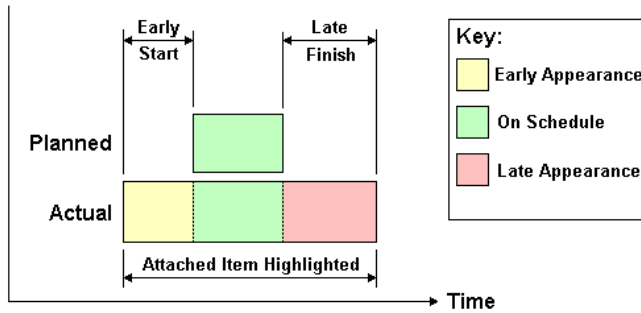

Overlay Text Dialog Box

You have the option to define the text overlaid in the Scene Area during simulation, by clicking Edit in the [Simulation Settings Dialog Box](#).

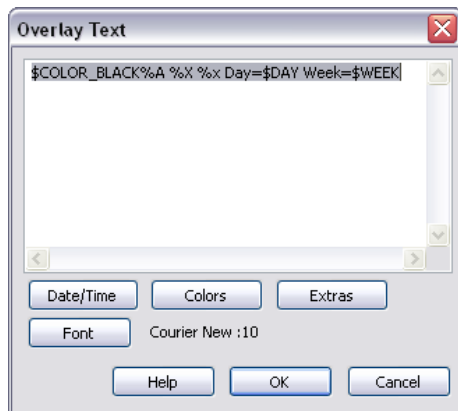

By default the date and time are displayed using the format specified in Control Panel ► Regional Settings. You can specify the exact format to use by entering text into the text box. Most text will appear as entered, except that words prefixed with a % or \$ character act as keywords and are replaced with various values. The Date/Time and Extras buttons can be used to select and insert all possible keywords. The Colors button can be used to define the color of the overlay text.

The Font button brings up the standard Microsoft Windows font picker dialog box. Once the correct font, font style and point size have been selected, press OK to return to the Overlay Text dialog box. The current font selection is shown next to the Font button, and during the TimeLiner simulation, all text on the overlay will be shown using this font.

Date/Time Keywords

%a Abbreviated weekday name.

%A Full weekday name.

%b Abbreviated month name.

%B Full month name.

%c Date and time representation appropriate for locale.

%d Day of month as decimal number (01 - 31).

%H Hour in 24-hour format (00 - 23).
%I Hour in 12-hour format (01 - 12).
%j Day of year as decimal number (001 - 366).
%m Month as decimal number (01 - 12).
%M Minute as decimal number (00 - 59).
%p Current locale's A.M./P.M. indicator for 12-hour clock.
%S Second as decimal number (00 - 59).
%U Week of year as decimal number, with Sunday as first day of week (00 - 53).
%w Weekday as decimal number (0 - 6; Sunday is 0).
%W Week of year as decimal number, with Monday as first day of week (00 - 53).
%x Date representation for current locale.
%X Time representation for current locale.
%y Year without century, as decimal number (00 - 99).
%Y Year with century, as decimal number.
%z Time-zone abbreviation; no characters if time zone is unknown.
%Z Time-zone name; no characters if time zone is unknown.

Color Keywords

\$COLOR_RED Sets the overlay display text color to be red.
\$COLOR_BLUE Sets the overlay display text color to be blue.
\$COLOR_GREEN Sets the overlay display text color to be green.
\$COLOR_WHITE Sets the overlay display text color to be white.
\$COLOR_BLACK Sets the overlay display text color to be black.
\$RGBr,g,b\$RGB Sets the overlay display text to any color specified using explicit rgb values between 0 and 255. For example, **\$RGB127,127,127\$RGB** sets the color to grey.

Extra Keywords

\$TASKS Adds the name of each currently active task to the overlay display text. Each task is displayed on a new line.
\$DAY Days since start of first task in project (starting from 1).
\$WEEK Weeks since start of first task in project (starting from 1).
Ctrl+Enter Type Ctrl+Enter to insert a new line into the overlay display text.
%% Percent sign.

Get Started

To get started

- 1 Load a model into Autodesk Navisworks in the usual way (see “[Open Files](#)” on page 117 for more information), and then click Tools ► TimeLiner.

NOTE Although the ability to create 4D simulations is limited to users with access to the TimeLiner functionality, any user can actually play 4D simulations back once they have been set up.

- 2 Create some tasks, each having a name, start and end date and a task type. You can [add tasks manually](#). Alternatively, right-click within the task area on the **Tasks** tab to open the [shortcut menu](#), and create an initial set of tasks based on layer, item, or selection set names. TimeLiner defines some default task types for you (Construct, Demolish and Temporary), or you can define your own task types on the [Configure Tab](#).

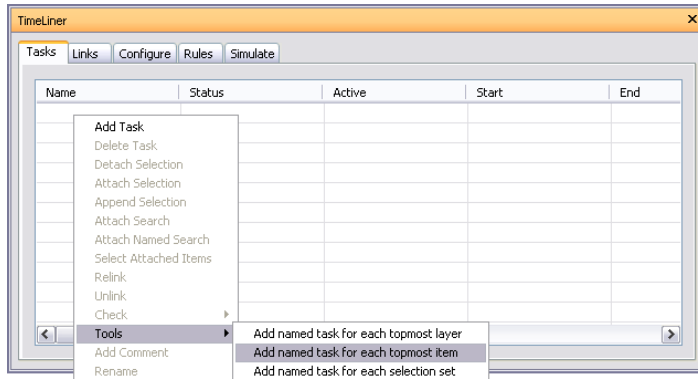

You can use the [Links Tab](#) to import tasks from an external source, such as Microsoft Project™. You can choose a field from the external schedule to define the types of the imported tasks, or you can set task types by hand. Linked fields cannot be edited directly in TimeLiner. You can, of course, update the schedule externally and synchronize the tasks in TimeLiner with those from the external source.

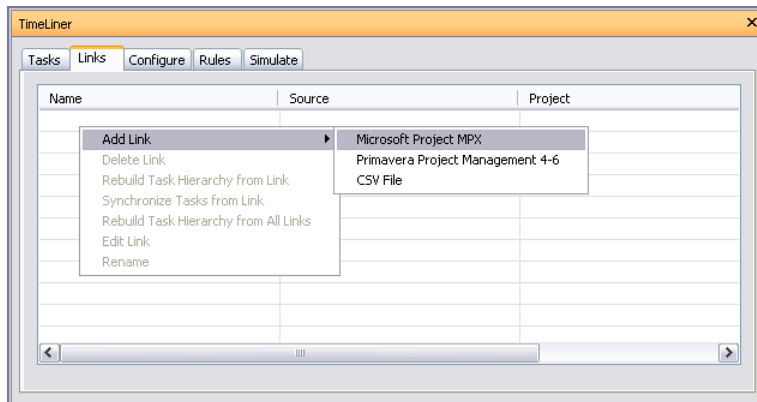

- 3 Attach objects in the model to tasks.

If you used the shortcut menu on the **Tasks Tab** to create an initial set of tasks based on layer, item or selection set names, then the corresponding layers, items or selection sets will already be attached for you. If you need to manually [Attach Tasks to Geometry](#), you can use the shortcut menu to attach selections, searches or selection sets.

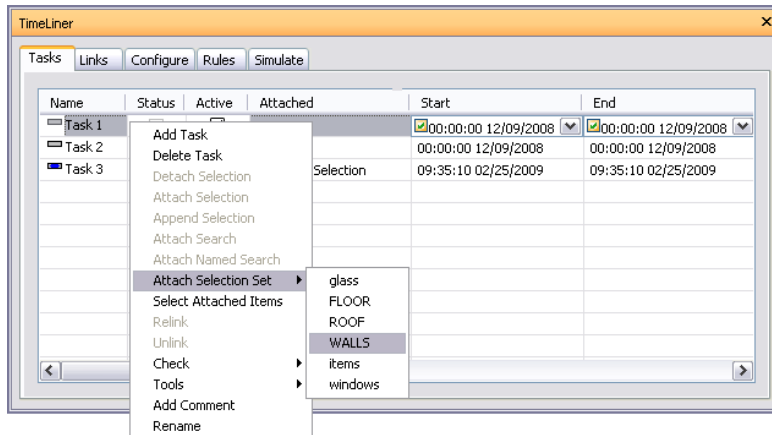

Alternatively, you can [Use Rules to Attach Tasks](#) automatically.

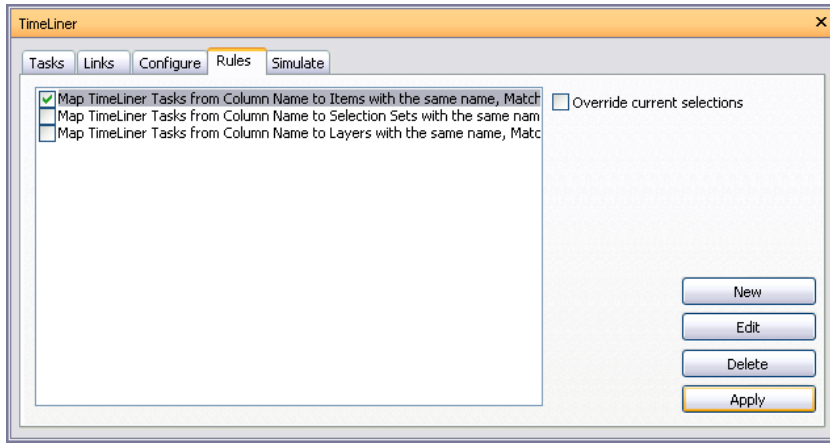

- 4 **Simulate your schedule.** You can visualize your model at any date in your schedule with the currently active tasks highlighted. Run through the entire schedule using familiar VCR controls. You can [Add Animation](#) to your construction schedules, and enhance the quality of simulations.

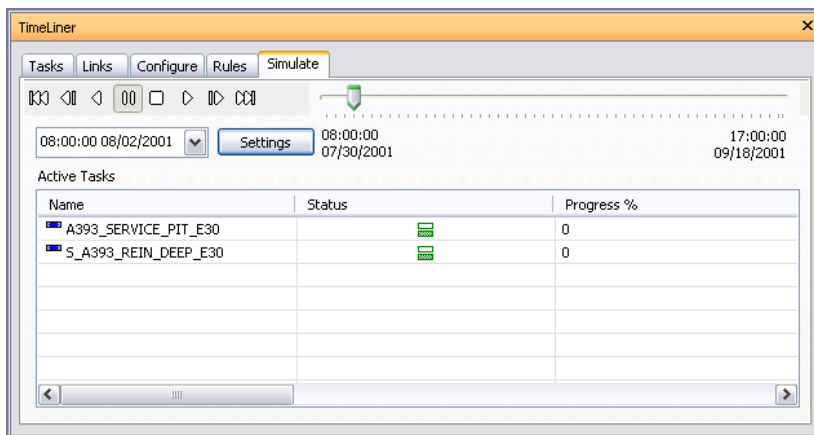

- 5 **Adjust the way your simulation plays.** You can use the Configure tab to create new task types and edit old ones. The task type defines what happens at the start and end of each task of that type. You can hide attached objects, change their appearance or reset them to the appearance specified in the model.

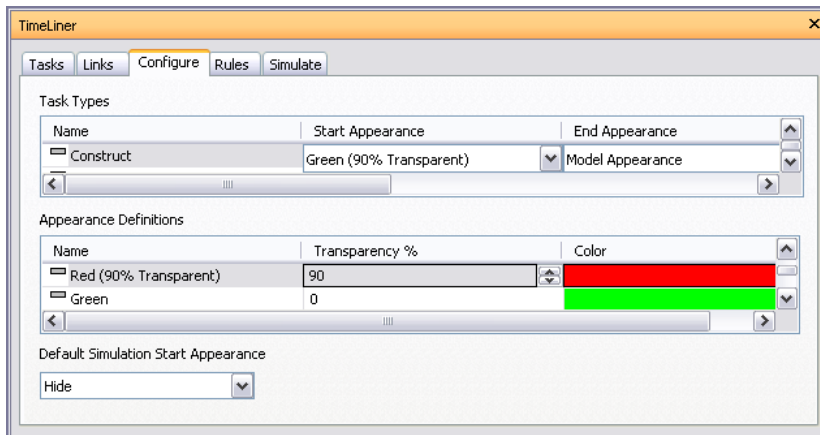

- 6 Create image and AVI files. [Export](#) the current simulation view as an image, or the entire simulation as an AVI.
- 7 Keep up to date with changes in your project. Save your project as a Autodesk Navisworks .nwf file. Open the .nwf and [Synchronize Tasks with Project Changes](#).

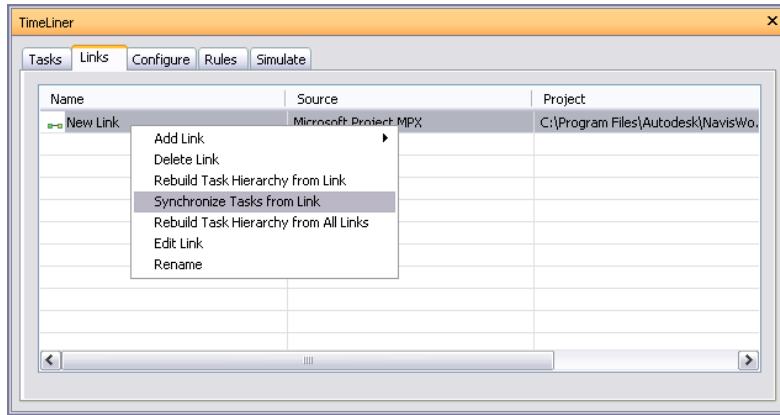

TimeLiner Tasks

The Tasks tab can be used to create and edit tasks, to attach tasks to geometry items, and to validate your project schedule.

You can adjust the Task View.

You can also add new user columns to the default column set. This is useful when you create links to external project files that contain more fields than TimeLiner.

To move a column

- 1 Open the TimeLiner window, and click the Tasks tab.
- 2 Position the mouse over the header of the column you want to move, and press the left mouse button.
- 3 Drag the column header to the desired location, and release the left mouse button.

To resize a column

- 1 Open the TimeLiner window, and click the Tasks tab.
- 2 Select the grid line at the right border of the column header of the column you want to resize.
- 3 Drag to the right to enlarge the column, or to the left to shrink it.

To specify sort order

- 1 Right-click the header of the column you want to use, and click Sort to open the shortcut menu.
- 2 Select Ascending or Descending to specify a sort order.

Ascending order sorts the column starting with the smallest value and ending with the largest value (for example: a-z, 0-9, Monday-Friday). Descending order sorts the column starting with the largest value and ending with the smallest value.

NOTE If sorting is selected on the Status column, activities will be sorted from early through to late start for ascending, and vice-versa for descending.

- 3 By default, Autodesk Navisworks preserves the task hierarchy during the sorting process, that is tasks are sorted first by container, then by container contents. If you want to turn this option off, right-click any column header, and click Sort ► Maintain Hierarchy. The tasks and containers will be treated as unrelated items.

NOTE You can only sort by one column at a time. Instead of using the shortcut menu to change the sort order, you can click the heading of the desired column. This alternates the sort order between ascending and descending.

To add a user column

- 1 In the TimeLiner window, the Tasks tab, right-click any column header and click Add User Column on the shortcut menu.
- 2 Click one of the ten available user fields, for example User 1.
The custom user column has been added to TimeLiner. By default, it's got the same name as the option you clicked on the shortcut menu.
- 3 Right-click the added column, click Rename User Column, and type in a new name, for example 'Cost'.

NOTE To populate this column with data, you must map the user field (in this case, User 1) to the corresponding data field in each of the linked project files. For more information, see “[Field Selector Dialog Box](#)” on page 343.

To delete a user column

- 1 In the TimeLiner window, the Tasks tab, right-click the header of the column you want to delete.
- 2 Click Delete User Column on the shortcut menu.

Create Tasks

In TimeLiner tasks can be created in one of the following ways:

- **Manually**, one at a time.
- **Automatically**, based on object structure in the Selection Tree, or the selection and search sets.
- **Automatically**, built from links to external project files.

TIP Unlike manual tasks, which need to be attached to geometry in your model, automatic tasks will be attached to the corresponding geometry as soon as they are created.

To add a task manually

- 1 Load your model into Autodesk Navisworks (see Opening Files if you need help).
- 2 Click Tools ► TimeLiner, and click the Tasks tab in the TimeLiner window.
- 3 Right-click anywhere in the task view, and click Add Task on the shortcut menu.
- 4 Enter the name for your task, and press Enter. The task is now added to your schedule.

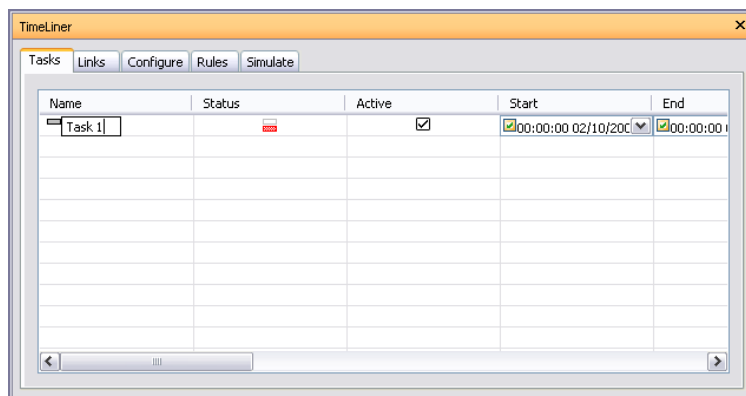

NOTE Added tasks are automatically assigned the Actual Start and End date (the current system date is used by default), which be modified. You can also assign the Planned Start and End dates to your tasks, if necessary.

To add tasks based on the Selection Tree Structure

- 1 If the TimeLiner window is not already open, click Tools ► TimeLiner.
- 2 In the TimeLiner window, the Tasks tab, right-click in the Task View, and click Tools on the shortcut menu.
- 3 Click Add Named Task for Each Topmost Layer if you want to create tasks with the same names as each topmost layer in the Selection Tree.
Click Add Named Task for Each Topmost Item if you want to create tasks with the same names as each topmost item in the Selection Tree. This can be a layer, a group, block or cell, or geometry, depending on how the model is constructed.

NOTE Actual Start and End dates will be automatically created, starting from the current system date and incrementing by one day for each subsequent end and start date. Planned Start and End dates will also be automatically created and these will be the same as the Actual dates. Finally, the Task Type will be set to Construct.

To add tasks based on search or selection sets

- 1 If the TimeLiner window is not already open, click Tools ► TimeLiner.
- 2 In the TimeLiner window, the Tasks tab, right-click in the Task View, and click Tools on the shortcut menu.
- 3 Click Add Named Task for Each Selection Set to create tasks with the same names as each selection and search set in the Selection Sets dockable window.

NOTE Actual Start and End dates will be automatically created, starting from the current system date and incrementing by one day for each subsequent end and start date. Planned Start and End dates will also be automatically created and these will be the same as the Actual dates. Finally, the Task Type will be set to Construct.

Edit Tasks

When you work with tasks created from links, you may not be able to edit certain task parameters. For obvious reasons, you will not be able to change the task name, or date and time unless you unlink the tasks. However, unlinked tasks are no longer synchronized with the external schedule; therefore, to edit linked tasks, modify the external project file, and then either synchronize or rebuild your tasks in TimeLiner.

To change the task name

- 1 In the TimeLiner window, the Tasks tab, double-click the name of the task you want to modify.
- 2 Type in the new name for the task, and press Enter.

To change the task date and time

- 1 In the TimeLiner window, the Tasks tab, click the task you want to modify.
- 2 Modify the task's date:
Clicking the drop-down button in the Start and End field opens the calendar, and lets you set the Actual Start/End dates.
Clicking the drop-down button in the Planned Start and Planned End field opens the calendar, and lets you set the Planned Start / End dates.

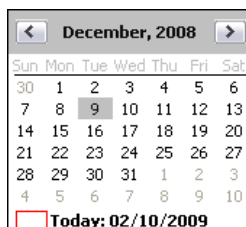

Use the left and right arrow buttons at the top of the calendar to move backwards and forwards a month, respectively, then click on the day you require.

- 3 To change the start or end time, click the time unit you want to modify (hours, minutes or seconds), and enter the value. You can use the left and right arrow keys to move between the units in the time field.

07:35:39 23/02/2008 

NOTE When you edit a date/time field, the check box appears on the left. Select it to use the new value. Clearing the check box resets the field to its default value.

To copy and paste date/time values

- 1 In the TimeLiner window, the Tasks tab, right-click the date field you want to copy, for example Planned Start.
- 2 Click Copy Date/Time.
- 3 Right-click in a different date field, and click Paste Date/Time.

NOTE Currently, you cannot use the keyboard shortcuts CTRL + C and CTRL + V to copy and paste date/time values.

To set or modify the task type

- 1 In the TimeLiner window, the Tasks tab, click the task you want to modify.
- 2 From the Task Type drop-down list, select the type of task you wish this task to be. By default, you can choose from:
 - Construct
 - Demolish
 - Temporary

The task type defines how the items attached to the task will be displayed during simulation. For example, a default construction sequence would start with all items hidden, as the task starts the attached items will be displayed in transparent green, then as the task ends the attached items will be displayed as they are in the normal model display (this may be with materials applied if previously set up in the Presenter tool). Task types themselves can be defined and new types created on the [Configure Tab](#).

NOTE If you want all tasks to have the same task type, click the Task Type field for the first task, then press Shift, and click the Task Type field for the last task. The task type you select for the last field will be used for all tasks in the range.

To delete a task

- 1 If the TimeLiner window is not already open, click Tools ► TimeLiner.
- 2 In the TimeLiner window, the Task tab, right-click the task you want to delete, and click Delete Task on the shortcut menu.

NOTE Deleting the root-level task deletes all tasks in the hierarchy. If you made a mistake, use the  button on the Standard toolbar to restore the deleted item.

Attach Tasks to Geometry

Each task needs to be attached to items in the model before 4D simulation can work. You can create and attach tasks at the same time, or you can create all tasks first, and then attach them, either separately, or in rule-defined batches.

Tasks can be attached to the current selection in the Scene Area, or any of the selection sets, or any of the search sets. You can view the type of attachments in the Attached column. By default, this column is located after Task Type, but you can move it, for example, in front of the Start column.

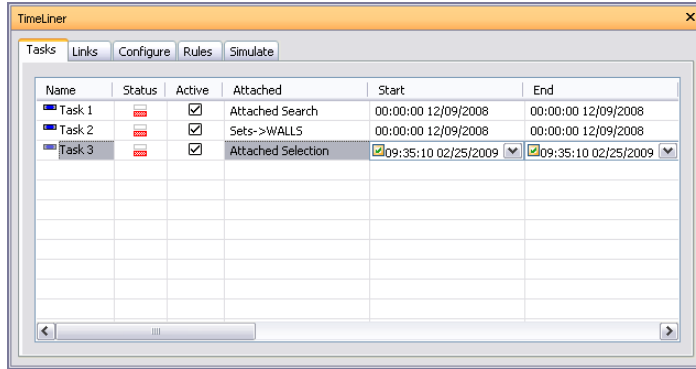

Attach Tasks Manually

To attach a task to a current selection

- 1 If the TimeLiner window is not already open, click Tools ► TimeLiner.
- 2 Select the desired geometry objects in the Scene Area, or on the Selection Tree.
- 3 In the TimeLiner window, the Tasks tab, right-click the required task, and click Attach Selection on the shortcut menu.

The task icon has changed indicating that this task now contains attached items. Look under the Attached column to get information on the attachment type.

NOTE If you need to add additional items to an already attached task, click the Append Selection option on the shortcut menu, otherwise any previous task attachments will be overridden.

To attach a task to a selection set or a search set

- 1 If the TimeLiner window is not already open, click Tools ► TimeLiner.
- 2 In the TimeLiner window, the Tasks tab, right-click the required task, click Attach Selection Set, and click the required selection set or a search set.

The task icon has changed indicating that this task now contains attached items. Look under the Attached column to get information on the attachment type.

To attach a task to a current search

- 1 If the TimeLiner window is not already open, click Tools ► TimeLiner.
- 2 Run the desired search from the Find Items dockable window.
- 3 In the TimeLiner window, the Tasks tab, right-click the required task, and click Attach Search.

The task icon has changed indicating that this task now contains attached items. Look under the Attached column to get information on the attachment type.

To attach multiple tasks to a selection set or a search set

- 1 If the TimeLiner window is not already open, click Tools ► TimeLiner.
- 2 In the TimeLiner window, the Tasks tab, hold the CTRL or SHIFT key to select all required tasks.
- 3 Right-click the task selection, click Attach Selection Set, and click the required selection set or a search set.

The task icons have changed indicating that the selected tasks now contain attached items. Look under the Attached column to get information on the attachment type.

To attach multiple tasks to a current selection

- 1 If the TimeLiner window is not already open, click Tools ► TimeLiner.
- 2 Select the desired geometry objects in the Scene Area, or on the Selection Tree.
- 3 In the TimeLiner window, the Tasks tab, hold the CTRL or SHIFT key to select all required tasks.
- 4 Right-click the task selection, and click Attach Selection on the shortcut menu.

The task icons have changed indicating that the selected tasks now contain attached items. Look under the Attached column to get information on the attachment type.

NOTE If you need to add additional items to already attached tasks, click the Append Selection option on the shortcut menu, otherwise any previous task attachments will be overridden.

Use Rules to Attach Tasks

Attaching tasks manually could take a long time. It is a good practice to either use task names, which correspond to Selection Tree layers, or create selection and search sets that correspond to the task names. If this is the case, then you can apply predefined and custom-made rules to instantly attach tasks to objects in the model.

Predefined Rules

- **Items By Task Name.** Choose this rule to attach each geometry item in the model to each task with the same name in the specified column. The default is to use the Task Name column.
- **Selection Sets By Task Name.** Choose this rule to attach each Selection and Search Set in the model to each task with the same name in the specified column. The default is to use the Task Name column.
- **Layers By Task Name.** Choose this rule to attach each layer in the model to each task with the same name in the specified column. The default is to use the Task Name column.
- **Attach Items to Task by Category/Property.** Choose this rule to attach each item in the model with the defined property, to each task with the same name in the specified column. The default is to use the Task Name column; however, you will also need to define the <category> and <property> values.

To add custom TimeLiner rules

- 1 From the Rules tab of the TimeLiner window, click the New button.
The Rules Editor dialog is displayed.

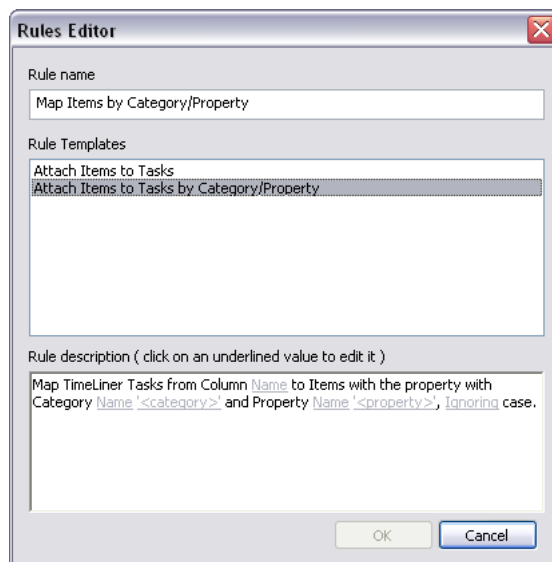

- 2 Enter a new name for your rule in the Rule name box.

NOTE If you choose not to enter a name, upon selecting a rule template the name of that template will be used.

- 3 From the Rule templates list, choose a template from which your rule will be based upon.

NOTE The Attach Items to Tasks template is the one used for the first three pre-defined TimeLiner rules, that is, Items, Selection Sets and Layers By Task Name.

The Attach Items to Tasks by Category/Property template enables you to specify a property within the model scene. If a task has the same name as the specified property value in the model, then all items having that property will be attached to that task when you check the rule Attach Items to Tasks by Category/Property, and click Apply Rules.

- 4 In the Rule description box, click on each of the underlined values to define your custom rule. The customizable values available with the built in templates are:
 - **Column Name.** Choose which column in the [Tasks Tab](#) you want to compare Item names to. The default is the Task Name, though you may also choose one of the ten User columns, identified in the [Field Selector Dialog Box](#).
 - **Items.** Choose what you would like the value in the Column Name to be compared to in the model scene. The default is Item name, though you may also choose either Selection Sets or Layers.
 - **Matching.** Use case sensitivity and therefore only match names that are exactly the same. You may also choose Ignoring to ignore case sensitivity.
 - **Category/Property Name.** Use the name of the category or property as it is displayed in the interface (recommended). You can also choose Internal Name which is that accessed via the API (for advanced use only).
 - **'<category>'**. Choose from the available list, which category the property you wish to define is in. Only the categories that are contained in the scene are available in the drop down.
 - **'<property>'**. Choose from the available list, which property you wish to define. Again, only the properties in the scene within the chosen category will be available.
- 5 Click OK to add the new TimeLiner rule, or Cancel to return to the TimeLiner window.

To apply TimeLiner rules

- 1 Open the TimeLiner window, and click the Rules tab.
- 2 Select the check boxes for all rules you want to apply. The rules will be applied in order.
- 3 If Override current selections check box is selected, then when the rules are applied they will replace any existing attached items. Otherwise, and the rules will attach items to the relevant tasks without attached items.
- 4 Click the Apply button.

NOTE To validate tasks in your schedule, click the Tasks tab, right-click in the Task View, and use the Check shortcut menu.

Validate Project Schedule

You can check the validity of your schedule, by identifying items that have not been included in any task, are duplicated in multiple tasks or, are in overlapping tasks. This is especially useful, when you use rules to attach tasks.

An item may remain unattached for a number of reasons. For example, a task in the project scheduling file is omitted, or the geometry item has not been included in a selection or search set.

To check a schedule

- 1 If the TimeLiner window is not already open, click Tools ► TimeLiner.
- 2 In the TimeLiner window, the Tasks tab, right-click the tasks view, and click Check.
- 3 Select one of the available options:
 - Find uncontained items. Choose this to select any items in the scene that are not attached to a task, or are not contained within any other item attached to a task.

NOTE A Contained item is the child of another item. For example, if you select a Group, Block or Cell which is comprised of various pieces of geometry, then that geometry is contained within the Group, Block or Cell. A Group, Block or Cell may therefore be attached to a task and although the child geometry is not directly attached itself, it is contained within an item that is attached.

- Find contained items. Choose this to select any items in the scene that are either attached to a task or contained within any other items attached to a task.
- Find attached items. Choose this to select any items in the scene that are directly attached to a task.
- Find items attached to multiple tasks. Choose this to select any items in the scene that are directly attached to more than one task.
- Find items contained in multiple tasks. Choose this to select any items in the scene that are either attached to, or contained within any other item that is attached to more than one task.
- Find items attached to overlapping tasks. Choose this to select any items in the scene that are attached to more than one task, where the task durations overlap.
- Find items contained in overlapping tasks. Choose this to select any items in the scene that are either attached to, or contained within any other item that is attached to more than one task, where the task durations overlap.

The check results are highlighted on the Selection Tree and in the Scene Area.

Link to External Project Files

One of TimeLiner most powerful features is its integration with project scheduling software. A list of tasks including their start and end dates/times can be imported from a project file directly into TimeLiner.

Supported Scheduling Software

Autodesk Navisworks TimeLiner supports a variety of scheduling software.

NOTE Some of these may only function if the relevant scheduling software is installed.

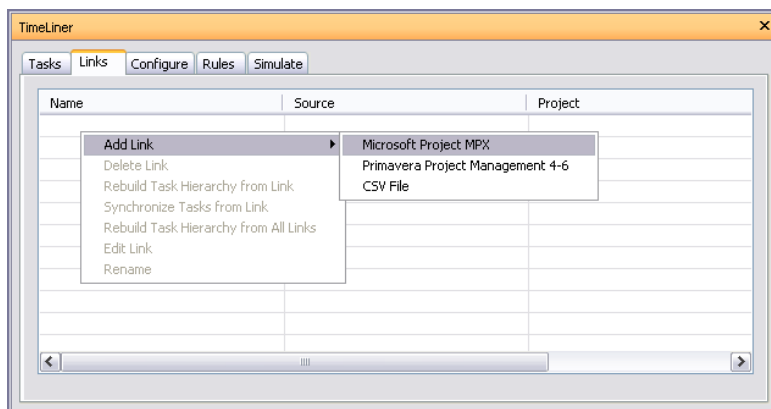

NOTE Autodesk Navisworks TimeLiner supports multiple sources of external schedules using a COM interface. Anyone can develop support for a new schedule source - the type library that defines the interface is included with TimeLiner.

Microsoft Project 2000

This Link requires Microsoft Project 2000™ to be installed.

Microsoft Project

This Link requires Microsoft Project 2002™ to be installed.

Microsoft Project MPX

TimeLiner can read Microsoft Project™ .mpx files directly, without needing a copy of Microsoft Project™ (or any other scheduling software) installed. Primavera SurtTrak™, Primavera Project Planner and Asta Power Project™ can all export .mpx files.

NOTE Primavera SurTrak™ exports its unique id in the text10 field of the .mpx file, rather than the unique id field. When linking to an .mpx file exported from SureTrak be sure to specify the text10 field as the unique id field in the [Field Selector Dialog Box](#).

Primavera Project Planner

This Link requires Primavera Project Planner™ to be installed. The Link status will be displayed as "Status not available".

NOTE TimeLiner will ask for a user name and password to link to Primavera Project Planner. If these are unknown, there is a possibility that these can be retrieved from the P3 shortcut. To locate this information, right-click on the shortcut used to run P3, and select Properties. The Properties dialog box will show the target command line which will look something like

```
"C:\Program Files\P3\P3.exe /U:Bob"
```

Here, the user name is set as "Bob", and for the purposes of the TimeLiner tool, the password will be the same.

Primavera Project Management 4 and 5

This Link requires a number of elements to be installed alongside Autodesk Navisworks:

- Primavera Project Manager 4 and 5 product
- ActiveX Data Objects 2.1
- Primavera Software Development Kit (available on the Primavera CDs)

PPM 4 and 5 are database driven, and as such require the Software Development Kit to be installed in order to set up the ODBC data source link. This can be installed and setup from the Project Management CD by taking the following steps:

- 1 Insert Project Management CD, enter the Product Key and accept the License Agreement.
- 2 Make sure Primavera Applications or Components is selected, and click Next.
- 3 Select Other Components, and click Next.
- 4 Select Software Development Kit, and click Next.
- 5 Continue through clicking Next until the install starts.
- 6 Once installation is complete, click OK to start the Database Configuration wizard.
- 7 Adjust settings in the Software Development Kit Setup dialog box where appropriate, and click OK.
- 8 Click Yes for a log file, followed by Finish to complete.

On connecting to PPM 4 and 5 within TimeLiner, a logon dialog box allows the source link to be selected (a warning occurs if none are present). The user name and password are not stored in the Autodesk Navisworks file, and will be prompted for each time.

Once connected, a dialog box allows the user to select which project to open. A check box determines if all sub-projects are opened.

By default, TimeLiner brings through Start, End, Planned Start, and Planned End as Start, Finish, BL Start and BL Finish respectively.

Other Primavera dates can be selected through the generic [Field Selector Dialog Box](#), including Project Activity Codes, Global Activity Codes, and User Defined Fields.

The TimeLiner hierarchy supports the WBS structure for Project / Activity hierarchy.

NOTE Due to the nature of the Primavera Project Manager 4 and 5 products using the SDK for data access, linking with TimeLiner can take a longer period of time than other formats.

Asta Power Project

This Link requires Asta Power Project™ to be installed.

CSV Support

The TimeLiner tool now support schedules in CSV/Excel formats. You need to use commas (",") when saving a CSV file, otherwise you will have problems importing it into TimeLiner.

NOTE If your software product uses other separators than commas (","), try adjusting the software settings. You may also want to check your OS setting for the regional list separator.

Add and Manage Links

In this section you will learn how to create, delete and edit links.

Add Links

To import data from an external project schedule

- 1 If the TimeLiner window is not already open, click Tools ► TimeLiner.
- 2 In the TimeLiner window click the Links tab.
- 3 Right-click in the Link View, click Add Link, and choose the required option from a list of the project sources that may be connected to on the current PC.

NOTE For more information on which sources are typically available, see "[Supported Scheduling Software](#)" on page 360.

- 4 Use the standard Open dialog box to browse to and open the desired project file.
TimeLiner creates the link to the selected file in accordance with the predefined parameters configured for the corresponding data source using a COM interface.
Depending on the data source, the [Field Selector Dialog Box](#) may be displayed. You can use it to override some of the predefined data import options.
- 5 By default, your link is called New Link (x), where x is the latest available number. To make your link more descriptive, right-click it, click Rename on the shortcut menu, and enter a new name.

To import CSV data

- 1 If the TimeLiner window is not already open, click Tools ► TimeLiner.
- 2 In the TimeLiner window click the Links tab.
- 3 Right-click in the Link View, click Add Link, and click CSV File.

- 4 Use the standard Open dialog box to locate the desired project file in .csv format, and click Open.
- 5 In the [Field Selector Dialog Box](#), use the CSV Import Settings area to specify how your data should be imported into TimeLiner.

NOTE The CSV import settings, including field mappings, are remembered by the system and pre-populated when the dialog box opens. If you are linking to a different CSV file than was previously used, TimeLiner will attempt to map any columns to similarly-named columns in the CSV file.

- Select the Row 1 Contains Headings check box if you want the first row of data in your .csv file to be treated as column headings. TimeLiner will use it to populate the External Field Name options in the grid.
If the first row of data in your .csv file does not contain column headings, clear this check box.
- Select the Automatically Detect Date and Time option if you want TimeLiner to attempt to determine the date/time format used in your .csv file. First, TimeLiner applies a set of rules to try to establish the date/time format used in the document; if it is not possible, it uses the local settings on your system. Select the Use Specific Date/Time Format option if you want to manually specify the date/time format that should be used. When this radio button is selected, you can enter the required format into the box provided. For the list of valid codes, see [Field Selector Dialog Box](#).

NOTE If one or more date/time-based columns are found to contain fields where the data cannot be mapped to a valid date/time value using the manually-specified format, TimeLiner will 'fall back' and attempt to use the automatic date/time format.

- 6 By default, your link is called New Link (x), where x is the latest available number. To make your link more descriptive, right-click it, click Rename on the shortcut menu, and enter a new name.

You are now ready to [Build Tasks from Links](#).

Edit Links

To edit a link

- 1 If the TimeLiner window is not already open, click Tools ► TimeLiner.
- 2 In the TimeLiner window, the Links tab, right-click the link you want to modify, and click Edit Link on the shortcut menu.

The [Field Selector Dialog Box](#) opens.

Typically, this dialog box is used to customize the column mapping between the TimeLiner link and the external project file. For example, if the external file includes Baseline Start and End dates you may want to map them to the Start Date and End Date columns in TimeLiner. Also, if you have added any [user columns](#) to TimeLiner, for each link, you must map the data in the external file to the required user columns in TimeLiner, otherwise the user columns will be empty.

- 3 Click OK.

NOTE For each link, you must either rebuild the task hierarchy or synchronize tasks to apply the changes.

Delete Links

To delete a link

- 1 If the TimeLiner window is not already open, click Tools ► TimeLiner.
- 2 In the TimeLiner window, the Links tab, right-click the link you want to delete, and click Delete Link on the shortcut menu.

This only deletes the link, not the tasks built from this link. These tasks become automatically Unlinked.

NOTE If you made a mistake, use the  button on the Standard toolbar to restore the deleted item.

Build Tasks from Links

To build tasks from a link

- 1 If the TimeLiner window is not already open, click Tools ► TimeLiner.
- 2 In the TimeLiner window, the Links tab, right-click the link you want to use, and click Rebuild Task Hierarchy from Link on the shortcut menu.
This will import all of the tasks from the project file into TimeLiner.
- 3 Click the Tasks tab to view the created tasks. The task table is populated in accordance with predefined settings for the data source. You can make any necessary overrides in the [Field Selector Dialog Box](#).

NOTE Although the tasks have now been imported into TimeLiner, you still need to [Attach Tasks to Geometry](#) before you can run a 4D simulation. The fastest way to attach linked tasks is by applying rules (see “[Use Rules to Attach Tasks](#)” on page 358).

Synchronize Tasks with Project Changes

One of the benefits of linking the model to an external project schedule is that any changes to the schedule can be easily updated in TimeLiner.

To synchronize tasks

- 1 Make changes to the project in the scheduling software, and save it.
- 2 Load your model into Autodesk Navisworks (see [Open Files](#) if you need help).
- 3 Click Tools ► TimeLiner, and click the Links tab in the TimeLiner window.
- 4 Right-click the link to the modified project file, and click one of the following options:
 - Rebuild Task Hierarchy from Link. Choose this to re-import all tasks and associated data from the selected project file, and rebuild the task hierarchy on the Tasks tab.
 - Synchronize Tasks from Link. Choose this to update all existing tasks in the Tasks tab, with the latest associated data from the selected project file (for example, Start and End dates).

Alternatively, right-click anywhere in the link view, and click Rebuild Task Hierarchy from All Links.

This enables you to re-import all tasks and associated data from all linked project files, and rebuild the task hierarchy on the Tasks tab.

4D Simulation

In this section, you will learn how to play 4D simulations, and how to customize the simulation playback and appearance.

Play Simulations

To play a simulation

- 1 If the TimeLiner window is not already open, click Tools ► TimeLiner.
- 2 On the Tasks tab select the Active check box for all tasks that you want to include in the simulation.
- 3 Be sure the active tasks are assigned the correct [Task Types](#).

4 Be sure the active tasks are [attached](#) to geometry objects, and click the Simulate tab.

5 Click the Play  button.

The TimeLiner window displays the tasks as they are carried out, and the Scene Area shows the sections of the model added or removed over time, in accordance with the task types.

NOTE When the Simulate tab is in use, by default the current simulation date is overlaid in the Scene Area. You can customize the displayed information by using the [Overlay Text Dialog Box](#).

Configure Simulations

You can adjust both the simulation playback parameters, and the simulation appearance.

Simulation Playback

By default, the playback duration of the simulation is set to 20 seconds, regardless of the duration of the tasks. You can adjust the simulation duration, and a number of other playback options to increase the effectiveness of your simulation.

To adjust a simulation playback

- 1 If the TimeLiner window is not already open, click Tools ► TimeLiner.
- 2 Click the Simulation tab, and click the Settings button.
- 3 When the [Simulation Settings Dialog Box](#) opens, modify the playback settings, and click OK.

Simulation Appearance

Each task has a task type associated with it, which specifies how the items attached to the task are treated (and displayed) at the start and end of the task during simulation. The available options are:

- None - the items attached to the task will not change.
- Hide - the items attached to the task will be hidden.
- Model Appearance - the items attached to the task will be displayed as they are defined in the model. This may be the original CAD colors or, if you have applied color and transparency overrides in Autodesk Navisworks or materials in Presenter, then these will be displayed.
- Appearance Definitions - enables you to choose from the list of Appearance Definitions, including ten predefined appearances and any custom appearances you have added.

To add a task type definition

- 1 If the TimeLiner window is not already open, click Tools ► TimeLiner.
- 2 Click the Configure tab, right-click in the Task Types area, and click Add on the shortcut menu.
- 3 A new task type is added to the bottom of the list; it will be highlighted, enabling you to enter a new name for it.
- 4 Use the drop-down buttons to the right of each of the Appearance field to assign the desired object behavior. You can customize the following properties:
 - Start Appearance - how the items will look at the start of the task, for example Transparent Green.
 - End Appearance - how the items will look when the task is completed, for example Hidden.

- Early Appearance - how the items will look if the task is started before the planned time, for example Transparent Yellow.
- Late Appearance - how the items will look if the task is started after the planned time, for example Transparent Red.
- Simulation Start Appearance - how the items should be displayed at the start of a simulation.

NOTE As a minimum, you need to define the Simulation Start Appearance; this assigns a unique start appearance to your task type. If you do not configure this field, the start appearance set in Default Simulation Start Appearance will be used instead.

To delete a task type definition

- 1 If the TimeLiner window is not already open, click Tools ► TimeLiner.
- 2 Click the Configure tab, right-click the task type definition, and click Delete on the shortcut menu.

To add an appearance definition

- 1 If the TimeLiner window is not already open, click Tools ► TimeLiner.
- 2 Click the Configure tab, right-click in the Appearance Definition area, and click Add on the shortcut menu.
- 3 A new appearance definition is added to the bottom of the list; it will be highlighted, enabling you to enter a new name for it.
- 4 In the Transparency % field, use the Up and Down controls to set the transparency level, between 0% and 100% (where 0% is opaque and 100% is fully transparent).
- 5 In the Color field, click on the color to open the color selector. From here, either select one of the basic colors available, or click Define Custom Colors to define your own color choice.

To delete an appearance definition

- 1 If the TimeLiner window is not already open, click Tools ► TimeLiner.
- 2 Click the Configure tab, right-click the appearance definition, and click Delete on the shortcut menu.

To change the default simulation start appearance

- 1 If the TimeLiner window is not already open, click Tools ► TimeLiner, and click the Configure tab.
- 2 In the Default Simulation Start Appearance drop-down list, select the appearance option, which you want to use to start your simulations.

Export

You can export a static image at any time during a simulation by using one of the standard Autodesk Navisworks image exports, whilst the Simulation tab is active. See [“Export an Image”](#) on page 266 for more information.

You also have an option to export an animation of an entire TimeLiner simulation. See [“Export an Animation”](#) on page 267 for more information.

Add Animation

In this section, you will learn how to add animation to the TimeLiner schedules.

Overview

You can link object and viewpoint animations to your construction schedules, and enhance the quality of simulations. For instance, you can start your simulation with a camera showing an overview of the whole project, and then, as the tasks are simulated, zoom into specific areas for a detailed view of the model. You can also play animation scenes as the tasks are simulated. For example, you can animate the arrival and depletion of the material stock piles together with the vehicle movements, and monitor the vehicular access to site.

You can add animation to an entire schedule, to individual tasks within a schedule, or combine these methods together to achieve the desired effect.

To record animation, see “[Create and Edit Viewpoint Animations](#)” on page 251 and “[Create Object Animations](#)” on page 285.

It is also possible to add scripts to the tasks in your schedule. By doing this, you gain control over the animation properties. For example, you may be able to play different animation segments as the tasks are simulated, or play animations backwards and so on.

To record scripts, see “[Add Interactivity](#)” on page 294.

Add Animation to an Entire Schedule

The animation that you can add to an entire schedule is restricted to viewpoints, viewpoint animations, and cameras.

Added viewpoint and camera animation will be automatically scaled to match the playback duration.

Once you’ve added an animation to your schedule, you can [simulate](#) it.

To add a current viewpoint or a viewpoint animation

- 1 If the TimeLiner window is not already open, click Tools ► TimeLiner.
- 2 Select the required viewpoint or viewpoint animation on the Viewpoints dockable window
- 3 In the TimeLiner window, click the Simulation tab, and click the Settings button.
- 4 In the Simulation Settings dialog box, click the drop-down arrow in the Animation field, and select Saved Viewpoints Animation.

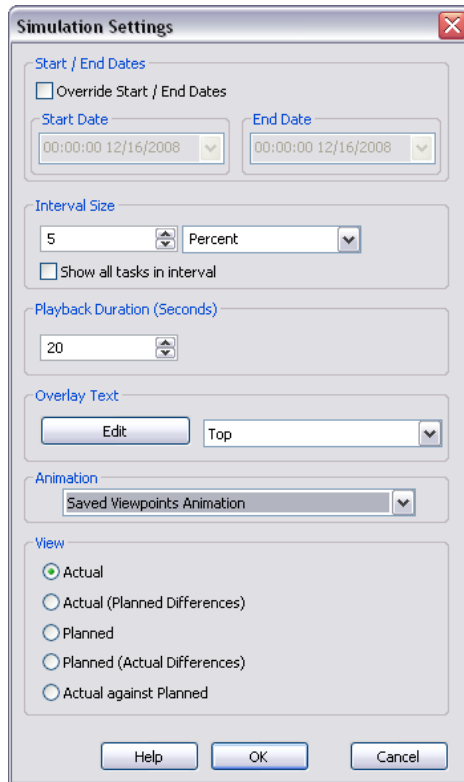

5 Click OK.

To add a camera animation

- 1 If the TimeLiner window is not already open, click Tools ► TimeLiner.
- 2 Click the Simulation tab, and click the Settings button.
- 3 In the Simulation Settings dialog box, click the drop-down arrow in the Animation field, and select the desired camera animation, for example Scene1 ► Camera.

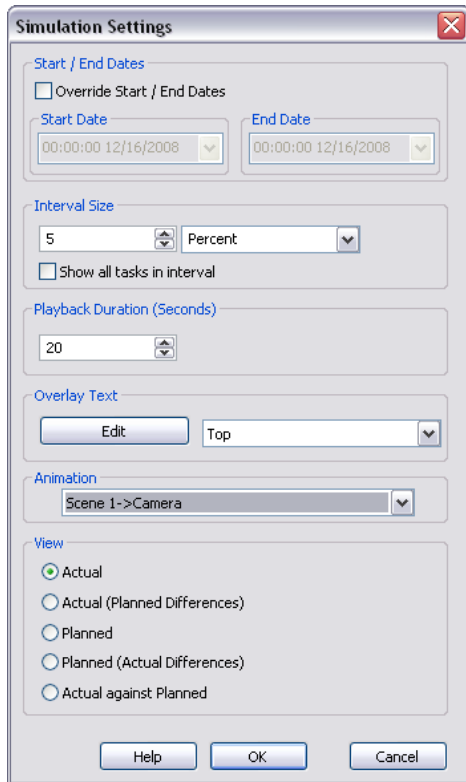

- 4 Click OK.

Add Animation to Tasks

The animation that you can add to individual tasks in TimeLiner is restricted to scenes and animation sets from the scenes.

By default, any added animation is scaled to fit the task duration. You also got an option of playing an animation at its normal (recorded) speed, by matching its start or end point with the task.

NOTE Animation key-frames may contain transparency and color overrides. During the TimeLiner simulation, the transparency and color override data from Animator are ignored.

Once you've added animation to your tasks, you can [simulate](#) your schedule.

To add an animation scene or an animation set

- 1 If the TimeLiner window is not already open, click Tools ► TimeLiner.
- 2 On the Tasks tab, click the task you want to add an animation to, and use the horizontal scroll bar to locate the Animation column.
If you prefer, you can move the animation columns in front of the Start Date column as shown below.

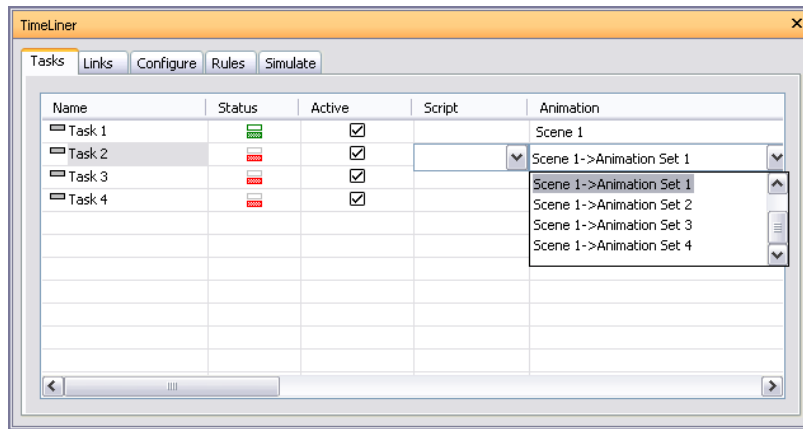

- 3 Click the drop-down arrow in the Animation field, and select a scene or an animation set from a scene. When you select a scene, all animation sets recorded for this scene will be used.
- 4 Click the drop-down arrow in the Animation Behavior field, and select how the animation will play during this task:
 - Scale - the duration of the animation is matched to the duration of the task. This is the default setting.
 - Match Start - the animation starts when the task starts. If the animation runs past the end of the TimeLiner simulation, the end of the animation will be clipped.
 - Match End - the animation starts early enough so that it ends just when the task end. If the animation starts before the beginning of the TimeLiner simulation, the start of the animation will be clipped.

Add Scripts to Tasks

When you add scripts to TimeLiner tasks, the script events are ignored, and the script actions are run regardless of the events.

Using scripts enables you to control how the animation will play (forwards, backwards, a segment at a time and so on). You can also use scripts to change the camera viewpoints for individual tasks, or play several animations at the same time.

NOTE Before you [simulate](#) your schedule, be sure to enable animation scripts in your file, by clicking the Toggle Scripts



button on the Animation toolbar.

To add a script

- 1 If the TimeLiner window is not already open, click Tools ► TimeLiner.
- 2 On the Tasks tab, click the task you want to add a script to, and use the horizontal scroll bar to locate the Script column.
- 3 Click the drop-down arrow in the Script field, and select the desired script to run with this task.

Autodesk Navisworks

Reference

16

File Options Dialog Box

Use this dialog box to control the appearance of the model and the speed of navigation around it, and also to create and configure links to external databases.

When you modify any of the options in this dialog box, your changes are saved in the currently opened Autodesk Navisworks file, and apply to this file only.

 **Menu:** Tools ► File Options.

Culling Tab

Use this tab to adjust geometry culling in the opened Autodesk Navisworks file.

Area

Enable Specifies whether area culling is used.

Number of Pixels Below Which Objects are Culled Specifies a value for the screen area in pixels below which objects are culled. For example, setting the value to 100 pixels means that any object within the model that would be drawn less than 10x10 pixels in size are discarded.

Clipping Planes

Near

Automatic Select this radio button to make Autodesk Navisworks automatically control the near clip plane position to give you the best view of the model. The Distance box becomes unavailable.

Constrained Select this radio button to constrain the near clipping plane to the value set in the Distance box.

Autodesk Navisworks uses the provided value unless doing so affects performance (for example, makes the whole model invisible), in which case it adjusts the near clip plane position as necessary.

Fixed Select this radio button to set the near clipping plane to the value provided in the Distance box.

Distance Specifies the farthest distance between the camera and the near clipping plane position in constrained mode.

Specifies the exact distance between the camera and the near clipping plane position in fixed mode.

NOTE Nothing is drawn between the camera and the near clipping plane; when you override automatic mode, make this value small enough to display your data. Also, overriding automatic mode with values under 1 can produce unpredictable results.

Far

Automatic Select this radio button to make Autodesk Navisworks automatically control the far clipping plane position to give you the best view of the model. The Distance box becomes unavailable.

Constrained Select this radio button to constrain the far clipping plane to the value set in the Distance box. Autodesk Navisworks uses the provided value unless doing so affects performance (for example, makes the whole model invisible), in which case it adjusts the far clip plane position as necessary.

Fixed Select this radio button to set the far clipping plane to the value provided in the Distance box.

Distance Specifies the closest distance between the camera and the far clipping plane position in constrained mode.

Specifies the exact distance between the camera and the far clipping plane position in fixed mode.

NOTE Nothing is drawn beyond this plane; when you override automatic mode, make this value large enough to include your data. Additionally, using the ratio of the far clipping plane to near clipping plane in excess of 10000 can produce unwanted effects.

Backface

Turns on backface culling for all objects. Select from the following options:

- **On** - turns on backface culling for all objects.
 - **Off** - turns off backface culling
 - **Solid** - turns on backface culling for solid objects only. This is the default option.
-

TIP If you can see through some objects, or some object parts are missing, turn off backface culling.

TIP If you want to restore the default values, click the Defaults button.

Orientation Tab

Use this tab to adjust the real-world orientation of your model.

Up

X, Y, Z Specify the X, Y, and Z coordinate values. By default, Autodesk Navisworks takes the positive Z-axis as Up.

North

X, Y, Z Specify the X, Y, and Z coordinate values. By default, Autodesk Navisworks takes the positive Y-axis as North.

TIP If you want to restore the default values, click the Defaults button.

Speed Tab

Use this tab to adjust the frame rate speed to reduce the amount of drop-out during navigation.

TIP If this does not improve navigation, try switching off the Guarantee Frame Rate option.

Frame Rate Specifies the number of frames per second (FPS) that are rendered in the Scene View.

The default setting is 6. You can set the frame rate from 1 through 60 frames per second. Reducing the value reduces drop-out, but can cause jerky movement during navigation. Increasing the value ensures a smoother navigation, but increases drop-out.

TIP If you want to restore the default values, click the Defaults button.

Head Light Tab

Use this tab to change the intensity of the scene's ambient light and headlight for Head Light mode.

Ambient Use the slider to control the overall brightness of the scene.

Headlight Use the slider to control the brightness of the light located at the camera.

NOTE To see the effect your changes have on the model in the Scene View, apply Head Light mode.

Scene Lights Tab

Use this tab to change the intensity of the scene's ambient light for Scene Lights mode.

Ambient Use the slider to control the overall brightness of the scene.

NOTE To see the effect your changes have on the model in the Scene View, apply Scene Lights mode.

DataTools Tab

Use this tab to create and manage links between the opened Autodesk Navisworks file and external databases.

DataTools Links Displays all database links in Autodesk Navisworks file. Select the check box next to the link to activate it.

IMPORTANT You cannot activate links with insufficient or invalid configuration information.

Buttons

New Opens the [New Link dialog box](#) where you can specify the link parameters.

Edit Opens the [Edit Link dialog box](#) where you can modify the parameters for the selected database link.

Delete Deletes the selected database link.

Import Lets you select and open previously saved datatools files.

Export Saves the selected database link as a datatools file.

NOTE If you want to restore the default values, click the Defaults button.

File Units and Transform Dialog Box

Use this dialog box to adjust the file units and file transforms for the file selected in the Selection Tree.

NOTE You can only adjust file units and transforms for one file at a time.

 **Menu:** Edit ► File Units and Transform

Shortcut menu: File Units and Transform

File Units

Units Lets you choose the units for the loaded file.

Origin

Origin Enter the X, Y, and Z coordinate values to move the file geometry into this position.

Reflected Transform Select this check box if you use a negative scale for your transform.

Rotation

Enter the rotation angle.

Select the rotation axis by entering values greater than 0. The file geometry rotates about its origin point.

Scale

Enter the scaling factor around X, Y, and Z axis for the file geometry; 1 being the current size, 0.5 half, 2 being double and so on. To scale proportionally, ensure the X, Y and Z scale values are equal. Entering negative values flips the file geometry inside out.

New Link Dialog Box

Use this dialog box to add a database link to the opened Autodesk Navisworks file.

Pointing device: File Options dialog box ► DataTools tab ► New button

Name Specifies the name of the database link. This name appears as a tab on the Properties control bar. Each link name must be unique.

Connection

ODBC Driver Defines the type of database for the link. Use the drop-down list to select the appropriate ODBC Driver.

Setup Opens the Database Setup wizard. Use it to enter the connection options. If you have problems setting up your connection details, contact your database administrator.

When you finish, the box underneath shows the connection string.

Hold Open for Application Lifetime Specifies whether the database link is open until you exit Autodesk Navisworks.

SQL String Defines which table in the database to query. If you are not familiar with SQL, you may need to ask your database administrator to set the SQL statement for you.

Fields

Defines which columns to display as link categories on the Properties control bar.

Field Name Specifies the name of the column in the selected database table. You must enter the exact name

Display Name Specifies the link category name shown on the Properties control bar. This name is automatically completed for you, but you can modify it, if necessary.

Edit Link Dialog Box

Use this dialog box to modify the selected database link.

For information about the settings on this dialog box, see the [“New Link dialog box”](#) on page 374.

Pointing device: File Options dialog box ► DataTools tab ► Edit button

Edit Viewpoint Dialog Box

Use this dialog box to edit viewpoint attributes.

 **Menu:** Viewpoint ► Edit Current Viewpoint

Camera

Position Enter the X, Y, and Z coordinate values to move the camera into this position.

Look At Enter the X, Y, and Z coordinate values to change the focal point for the camera.

Vertical Field of View, Horizontal Field of View Defines the area of the scene that can be viewed through the camera. You can adjust the values for both vertical and horizontal angles of view. If the display units are set to degrees, then these numbers should be between 0.1 and 90; and if in radians, between 0.002 and 3.124.

A larger value produces a wider angle of view and a smaller value produces a narrower, or more tightly focused, angle of view.

NOTE When you modify the Vertical Field of View, the Horizontal Field of View is automatically adjusted, and vice versa to match the aspect ratio in Autodesk Navisworks.

Roll Rotates the camera around its front-to-back axis. A positive value rotates the camera anticlockwise, and a negative value rotates it clockwise.

NOTE This value is not editable where the viewpoint up vector stays upright (that is, in walk, orbit and turntable modes).

Motion

Linear Speed The speed of motion in a straight line for the viewpoint. The minimum value is 0 and the maximum is based on the size of the scene's bounding box.

Angular Speed The speed at which the camera turns.

Saved Attributes

This area applies to saved viewpoints only. If you are editing a current viewpoint, this area is not greyed out.

Hide/Required Select this check box to save hidden/required markup information about objects in your model with the viewpoint. When you use a viewpoint again, the hidden/required markups set when the viewpoint was saved are reapplied.

NOTE Saving the state information with each viewpoint requires a relatively large amount of memory.

Override Material Select this check box to save material override information with the viewpoint. When you use a viewpoint again, the material overrides set when the viewpoint was saved are reapplied.

NOTE Saving the state information with each viewpoint requires a relatively large amount of memory.

Collision

Settings Opens the [Collision dialog box](#).

Options Editor

Use the Options Editor to adjust program settings for Autodesk Navisworks sessions.

The settings that you set up in the Options Editor are persistent across all Autodesk Navisworks sessions. You also share the modified settings with other members of your team.

The options are presented in a hierarchical tree structure. Clicking  expands the nodes, clicking  collapses the nodes.

 **Menu:** Tools ► Global Options

Shortcut menu: Global Options

Buttons

Export Displays the Select Options to Export dialog box, where you can select the global options you want to export (or 'serialize'). If an option cannot be exported, it is grayed out.

Import Displays the Open dialog box, where you can browse to the file with the required global option settings.

OK Saves the changes, and closes the Options Editor.

Cancel Discards the changes, and closes the Options Editor.

Help Displays the context-sensitive help.

General Node

Use the settings in this node to adjust the buffer size, file locations, number of recent file shortcuts you want Autodesk Navisworks to store, and the auto-save options.

TIP If you want to restore the default values, click the Defaults button.

Undo Page

Use the settings on this page to adjust the buffer size.

Buffer Size (kB) Specifies the amount of space Autodesk Navisworks allocates for saving undo/redo actions.

Locations Page

Use the options on this page to share global Autodesk Navisworks settings, workspaces, datatools, avatars, Clash Detective rules, Presenter archives, custom Clash Detective tests, object animation scripts, and so on, with other users.

The settings can be shared across an entire project site, or across a specific project group depending on the required level of granularity.

When you run Autodesk Navisworks for the first time, the settings are picked up from the installation directory. Subsequently, Autodesk Navisworks examines the current user profile and the all users profile on the local machine, and then checks the settings in the Project Directory and the Site Directory. The files in the Project Directory take precedence.

Project Directory Click  to open the Browse for Folder dialog box, and locate the directory that contains the Autodesk Navisworks settings specific to a project group.

Site Directory Click  to open the Browse for Folder dialog box, and locate the directory that contains the Autodesk Navisworks settings standard across the entire project site.

Environment Page

Use the settings on this page to adjust the number of recent file shortcuts stored by Autodesk Navisworks.

Maximum Recently Used Files Specifies how many file shortcuts Autodesk Navisworks can remember. By default, shortcuts to the four most recently opened files can be displayed.

Communication Center Page

Use the settings on this page to adjust the settings for Communication Center.

Please Indicate the Country/Region Nearest to Your Current Location Set the country in which Autodesk Navisworks users work. This is used for tailoring location-specific Communication Center content.

Check for New Online Content Specifies how often Communication Center checks for new content.

Content Filtering

Hide Old Content Indicates whether old content in Communication Center is hidden from view.

After Sets the number of days after which content is considered to be old.

Autodesk Channels Page

Use the settings on this page to select which channels you want to display in the Communication Center list.

By default, all available channels are selected. You cannot add or remove channels from the grid, and you cannot edit data in the grid.

Balloon Notifications Page

Use the settings on this page to adjust balloon notifications.

Enable Balloon Notifications Indicates whether balloon notifications are turned on.

Display Duration Sets the length of time (in seconds) the balloon notifications are shown in the Status bar before automatically disappearing.

Auto-Save Page

Use the setting on this page to adjust the auto-save options.

Enable Auto-Save Indicates whether Autodesk Navisworks automatically saves Navisworks files. By default, this check box is selected.

Clear this check box if you do not want to save Navisworks files automatically.

Auto-Save File Location Specifies how the backup files are saved. Select from the following options:

- Auto-Save to a Specific Directory - this is the default option.

Directory

The default directory for auto-save is: <USERPROFILE>\ Application Data \<PRODUCTFOLDER>\AutoSave



Click  to open the Browse for Folder dialog box, and select the desired location for auto-save.

Manage Disk Space

Indicates whether the size of the disk space restricts the creation of backup files. This check box is selected by default.

Purge Old Auto-Save Files When This Folder Exceeds (MB)

Active when the Manage Disk Space check box is selected. Specifies the maximum directory size for backup files. The default value is 512 MB. When the size of the auto-save folder exceeds the specified value, Autodesk Navisworks deletes the oldest backup file (based on the date modified).

- Auto-Save Alongside the Current File

Frequency

Time Between Saves (minutes) Defines the time interval between auto-saves of significant file changes.

By default, a backup file is saved every 15 minutes following a significant change to a Navisworks file.

History

Maximum Previous Versions Determines how many backup files are stored. By default, it's three files. When the number of auto-saved files exceeds the specified value, Autodesk Navisworks deletes the oldest backup file (based on the date modified).

Model Node

Use the settings in this node to optimize Autodesk Navisworks performance, and customize parameters for NWD and NWC files.

TIP If you want to restore the default values, click the Defaults button.

Performance Page

Use the options on this page to optimize Autodesk Navisworks performance.

Memory Limit

Auto Indicates whether Autodesk Navisworks automatically determines the maximum memory that can be used. Selecting this check box sets the memory limit to the lowest of your available physical memory or address space, less that required for your operating system.

Limit (MB) Specifies the maximum memory that Autodesk Navisworks can use.

Merge Duplicates

These options improve performance by multiply instancing matching items. Rather than storing every item in memory, if any items are the same, Autodesk Navisworks can store one instance of them and 'copy' that instance into other positions. This is of particular benefit on larger models, where there are significant numbers of these duplicate geometries.

On Convert Select this check box to merge duplicates when a CAD file is converted into the Autodesk Navisworks format.

On Append Select this check box to merge duplicates when a new file is appended to the currently opened Autodesk Navisworks file.

On Load Select this check box to merge duplicates when a file is loaded into Autodesk Navisworks.

On Save NWF Select this check box to merge duplicates when the current scene is saved in the NWF file format.

On Load

Collapse on Convert Collapses the tree structure on the Selection Tree to the specified level when native CAD files are converted into Autodesk Navisworks. Select from the following options:

- **None** - the tree is fully expanded.
- **Composite Objects** - the tree is collapsed up to the level of composite objects.
- **All Objects** - the tree is collapsed up to the level of objects.
- **Layers** - the tree is collapsed up to the level of layers.
- **Files** - the tree is collapsed up to the level of files.

This enables performance to be prioritized over structure/properties and has the added benefit of improving streaming by cutting down the logical structure.

NOTE Although Autodesk Navisworks tries to collapse items to the fewest number possible, it may be necessary to prevent collapsing in some cases to preserve model fidelity. For example, if an item has properties or materials unique to itself, then collapsing would endanger this information, and therefore it will not be collapsed.

Close NWC/NWD files on Load Indicates whether NWC and NWD files are closed once they've been loaded into memory.

When you open NWC/NWD files, Autodesk Navisworks locks them for editing. By selecting this check box, you instruct Autodesk Navisworks to close NWC or NWD files as soon as they've been loaded into memory. This means that the files can be opened and edited by other users while you are viewing them.

Create Parametric Primitives Select this check box to enable creation of parametric models (models described by formulae not vertices).

Using this option allows you to get better looking visuals, faster rendering, smaller memory footprint (especially, when loading DGN and RVM files with significant amounts of parametric data that no longer need to be converted into vertices in Autodesk Navisworks).

NOTE Modifying this option takes effect when you next load or refresh file.

Create Presenter Materials Select this check box to enable creation of Presenter materials when NWC files are loaded.

Clearing this check box turns off creation of Presenter materials. Use this option if you've only got Autodesk Navisworks Review installed.

Temporary File Location

Auto Indicates whether Autodesk Navisworks automatically selects your user Temp folder.

Location Click  to open the Browse for Folder dialog box, and select the desired Temp folder.

NWD Page

Use the options on this page to enable and disable geometry compression and select whether the precision of certain options is reduced when saving or publishing NWD files.

Geometry Compression

Enable Select this check box to enable geometry compression when NWD files are saved.

Geometry compression results in less memory being required and therefore smaller NWD files.

Reduce Precision

Coordinates Select this check box to reduce the precision of coordinates.

Precision Specifies the precision value for coordinates. The larger the value, the less precise coordinates are.

Normals Select this check box to reduce the precision of normals.

Colors Select this check box to reduce the precision of colors.

Texture Coordinates Select this check box to reduce the precision of texture coordinates.

See also:

- [“Native File Formats”](#) on page 87

NWC Page

Use the options on this page to manage reading and writing of cache files (NWC).

By default, when Autodesk Navisworks opens a native CAD file (for example, AutoCAD or MicroStation), it first checks in the same directory whether there is a cache file present with the same name as the CAD file but with an .nwc extension. If there is, and this cache file is newer than the native CAD file, then Autodesk Navisworks opens this file instead as it has already been converted to Autodesk Navisworks format and, therefore, opens much quicker. If, however, there is no cache file present, or the cache file is older than the native CAD file, then Autodesk Navisworks has to open the CAD file and convert it. By default, it writes a cache file in the same directory and with the same name as the CAD file, but with the .nwc extension, for speeding up the opening of this file in future.

Caching

Read Cache Select this check box to use cache files when Autodesk Navisworks opens native CAD files.

Clear this check box if you don't want to use cache files. This ensures that Autodesk Navisworks converts native CAD files each time they are opened.

Write Cache Select this check box to save cache files when native CAD files are converted. Generally, cache files are much smaller than original CAD files, therefore, selecting this option does not take up too much disk space.

Clear this check box if you don't want to save cache files.

Geometry Compression

Enable Select this check box to enable geometry compression when NWC files are saved.

Geometry compression results in less memory being required and therefore smaller NWC files.

Reduce Precision

Coordinates Select this check box to reduce the precision of coordinates.

Precision Specifies the precision value for coordinates. The larger the value, the less precise coordinates are.

Normals Select this check box to reduce the precision of normals.

Colors Select this check box to reduce the precision of colors.

Texture Coordinates Select this check box to reduce the precision of texture coordinates.

See also:

- [“Native File Formats”](#) on page 87

Interface Node

Use the settings in this node to customize Autodesk Navisworks interface.

TIP If you want to restore the default values, click the Defaults button.

Display Units Page

Use this page to customize the units used by Autodesk Navisworks.

Linear Units Use the drop-down list to select the desired linear value. Meters are used by default.

Angular Units Use the drop-down list to select the desired angular value. Degrees are used by default.

Decimal Places Specifies the number of decimal places used by units.

Fractional Display Precision Specifies the level of fraction used by units. This box is enabled for fractional units only.

Selection Page

Use the options on this page to configure the way geometry objects are selected, and highlighted.

Pick Radius Specifies the radius, in pixels, that an item has to be within in order for it to be selected.

Resolution Specifies the level of selection used by default.

When you click in the Scene View, Autodesk Navisworks requires a starting point for the object path in the Selection Tree box to identify the selected item. You can choose one of the following options:

- **Model** - the object path starts at the model node; as a result, all objects in the model are selected.
- **Layer** - the object path starts at the layer node; as a result all objects within a layer are selected.
- **First Object** - the object path starts at the highest level of objects below the layer node, if applicable.
- **Last Object** - the object path starts at the lowest level of objects in the Selection Tree. Autodesk Navisworks looks for composite objects first, and if none are found, the geometry level is used instead. This is the default option.
- **Last Unique** - the object path starts at the first unique level of objects (not multiple-instanced) in the Selection Tree.
- **Geometry** - the object path starts from the geometry level in the Selection Tree.

Compact Tree Specifies the level of detail shown on the Compact tab of the Selection Tree.

Use one of the following options:

- **Models** - the tree is restricted to displaying model files only.
- **Layers** - the tree can be expanded down to the layer level.
- **Objects** - can be expanded down to the objects level, but without the levels of instancing shown on the Standard tab.

Highlight

Enabled Indicates whether Autodesk Navisworks highlights the selected items in the Scene View.

Clear this check box if you don't want to highlight selected items.

Method Specifies how the objects are highlighted. Select one of the following options:

- Shaded
- Wireframe
- Tinted

Color Click  to specify the highlight color.

Tint Level (%) Use the slider to adjust the tint level.

Measure Page

Use the options on this page to adjust the appearance and style of the measure lines.

Line Thickness Specifies the thickness of the measure lines.

Color Click  to specify the color of the measure lines.

In 3D Select this check box to draw the measure lines in 3D.

If the measure lines become obscured by other geometry, clear this check box to draw the lines in 2D over the top of geometry.

Show Measurement Values in Scene View Select this check box if you want to display the dimension labels in the Scene Area.

Use Center Lines When this check box is selected, the shortest distance measurements snap to the center lines of parametric objects.

When this check box is clear, the surface of the parametric objects is used for the shortest distance measurement instead.

NOTE Changing this option does not affect any measurement currently in place. To see any changes, clear the measurement, and start again.

Snapping Page

Use the options on this page to adjust the cursor snapping.

Picking

Snap to Vertex Select this check box to snap the cursor to the nearest vertex.

Snap to Edge Select this check box to snap the cursor to the nearest triangle edge.

Snap to Line Vertex Select this check box to snap the cursor to the nearest line end.

Tolerance Defines the snapping tolerance. The smaller the value, the closer the cursor must be to a feature in the model before it snaps to it.

Rotation

Angles Specifies the multiplier for the snapping angle.

Angle Sensitivity Defines the snapping tolerance. The value you enter here determines how close to the snapping angle the cursor must be for snap to take effect.

Viewpoint Defaults Page

Use the options on this page to define attributes that are saved with viewpoints when you create them.

When you modify default viewpoint settings, your changes do not affect the currently opened Autodesk Navisworks file. They are used as soon as you open a new Autodesk Navisworks file, or start a new Autodesk Navisworks session.

Save Hide/Required Attributes Select this check box to save viewpoints with hidden/required markup information about objects in your model. When you use a viewpoint again, the hidden/required markups set when the viewpoint was saved are reapplied.

By default, this check box is clear, as saving the state information with each viewpoint requires a relatively large amount of memory.

Override Material Select this check box to save viewpoints with material override information. When you use a viewpoint again, the material overrides set when the viewpoint was saved are reapplied.

By default, this check box is clear, as saving the state information with each viewpoint requires a relatively large amount of memory.

Override Linear Speed By default, the linear navigation speed is directly related to the size of your model. Select this check box, if you want to set a specific navigation speed manually.

Default Linear Speed Specifies the default linear speed value.

Default Angular Speed Specifies the default speed at which the camera turns.

Collision

Settings Opens the [Default Collision dialog box](#) where you can adjust the collision, gravity, crouching and third person view settings.

Hyperlinks Page

Use the options on this page to customize the way hyperlinks are displayed in the Scene View.

TIP If you want to restore the default values, click the Defaults button.

In 3D Indicates whether the hyperlink icons are drawn in 3D in the Scene View.

Select this box if you want the hyperlink items to float in 3D space just in front of their attachment points to the geometry.

If the hyperlink items become obscured by other geometry, clear this check box to draw the hyperlink icons in 2D over the top of geometry.

Max Icons Specifies the maximum number of icons to draw in the Scene View.

Hide Colliding Icons Select this check box to hide the hyperlink icons that appear overlapped in the Scene View.

Cull Radius Specifies how close to the camera hyperlinks have to be before they are drawn in the Scene View. Any hyperlinks further away than this distance are not drawn. The default value of 0 means that all hyperlinks are drawn.

X Leader Offset, Y Leader Offset Hyperlinks can be drawn with leader lines (arrows) pointing to the attachment point on the geometry that the hyperlink is attached to. Enter the X- and Y- values to specify the number of pixels to the right and up that these leader lines use.



Standard Categories Page

Use the settings on this page to switch the displaying of hyperlinks based on their categories.

Hyperlink

Icon Type Specifies how to display this hyperlink category.

Select one of the following options:

- **Icon** - hyperlinks are represented by default icons  and  in the Scene View.



- **Text** - hyperlinks are represented by text boxes with hyperlink descriptions in the Scene View.

Visible Select this check box to display this hyperlink category in the Scene View.

Tag

Icon Type Specifies how to display this hyperlink category.

Select one of the following options:

- **Icon** - hyperlinks are represented by default icons  and  in the Scene View.
- **Text** - hyperlinks are represented by text boxes with hyperlink descriptions in the Scene View.

Visible Select this check box to display this hyperlink category in the Scene View.

TimeLiner

Icon Type Specifies how to display this hyperlink category.

Select one of the following options:

- **Icon** - hyperlinks are represented by default icons in the Scene View:

 - hyperlinks to manually created tasks

 - hyperlinks to tasks with valid links

 - hyperlinks to tasks with broken links

- **Text** - hyperlinks are represented by text boxes with hyperlink descriptions in the Scene View.

Visible Select this check box to display this hyperlink category in the Scene View.

Hide Icons without Comments Select this check box to display only the hyperlinks that have comments in the Scene View.

Viewpoints

Icon Type Specifies how to display this hyperlink category.

Select one of the following options:

- **Icon** - hyperlinks are represented by default icons in the Scene View:

 - hyperlinks to viewpoints saved in perspective mode

 - hyperlinks to viewpoints saved in orthographic mode

- **Text** - hyperlinks are represented by text boxes with hyperlink descriptions in the Scene View.

Visible Select this check box to display this hyperlink category in the Scene View.

Hide Icons without Comments Select this check box to display only the hyperlinks that have comments in the Scene View.

Redline Tags

Icon Type Specifies how to display this hyperlink category.

Select one of the following options:

- **Icon** - hyperlinks are represented by default icons  in the Scene View.
- **Text** - hyperlinks are represented by text boxes with hyperlink descriptions in the Scene View.



Visible Select this check box to display this hyperlink category in the Scene View.

Hide Icons without Comments Select this check box to display only the hyperlinks that have comments in the Scene View.

Selection Sets

Icon Type Specifies how to display this hyperlink category.

Select one of the following options:

- **Icon** - hyperlinks are represented by default icons in the Scene View:
 -  - hyperlinks to selection sets
 -  - hyperlinks to search sets
- **Text** - hyperlinks are represented by text boxes with hyperlink descriptions in the Scene View.

Visible Select this check box to display this hyperlink category in the Scene View.

Hide Icons without Comments Select this check box to display only the hyperlinks that have attached comments in the Scene View.

User-Defined Categories Page

Use this page to view custom hyperlink categories.



The padlock  icon indicates that you cannot add or remove categories directly from here.

Buttons

Grid View Click  to display custom hyperlink categories in a tabular format.



List View Click  to display custom hyperlink categories in a list format (the same way as the standard hyperlink categories are shown).

Records View Click  to display hyperlink categories as records.

Previous and Next Element Use  and  to navigate between hyperlink categories. If you clicked the Records View button, this is the only way to move between the records.

Visible Select this check box to display the corresponding hyperlink category in the Scene View.

Icon Type Select one of the following options:

- **Icon** - hyperlinks are represented by default icons  and  in the Scene View.
- **Text** - hyperlinks are represented by text boxes with hyperlink descriptions in the Scene View.

Smart Tags Page

Use the options on this page to customize the way smart tags are displayed in the Scene View.

TIP If you want to restore the default values, click the Defaults button.

Hide Category Clear this check box to include category names in the smart tag tooltips. If you don't want to see category names in the smart tag tooltips, select this check box.

Definitions Page

Use the options on this page to set up the smart tag categories.

Buttons



Add Element Click  to add a smart tag definition.

Remove Element Click  to delete the selected smart tag definitions.

Grid View Click  to display smart tag definitions in a tabular format.

List View Click  to display smart tag definitions in a list format.

Records View Click  to display smart tag definitions as records.

Previous and Next Element Use  and  to navigate between smart tag definitions. If you clicked the Records View button, this is the only way to move between the records.

Category Specifies the smart tag category that you want to customize.

Property Specifies the property that is displayed in the tooltips for the selected category.

Developer Page

Use the options on this page to adjust the display of object properties.

Show Internal Properties Indicates whether additional object properties are displayed in Autodesk Navisworks. Select this check box if you want to get access to the Geometry tab and the Transform tab in the Properties control bar.

Display Page

Use the options on this page to adjust the display performance.

Acceleration

Hardware Acceleration Select this check box to utilize any available OpenGL hardware acceleration on your video card.

If your video card drivers do not function well with Autodesk Navisworks, clear this check box.

NOTE If your video card does not support OpenGL hardware acceleration, this check box is not available.

Occlusion Culling Select this check box to enable occlusion culling. This means that Autodesk Navisworks only draws visible objects and ignores any objects located behind other objects.

Selecting this check box improves the display performance when much of the model is not visible. For example, when you're walking down the corridor of a building.

IMPORTANT Occlusion culling can only be used on a machine with an OpenGL 1.5 compliant graphics card.

Transparency

Interactive Transparency Select this check box to render transparent items dynamically during interactive navigation.

By default, this check box is clear, therefore, transparent items are only drawn when interaction has stopped.

NOTE If your video card does not support hardware accelerated OpenGL, selecting this check box can affect display performance.

Detail

Guarantee Frame Rate Indicates whether the Autodesk Navisworks engine maintains the frame rate specified on the [Speed tab](#) of the File Options dialog box.

By default, this check box is selected, and the target rate is maintained while moving. When movement stops the complete model is rendered.

If this check box is clear, the complete model is always rendered during navigation, no matter how long it takes.

Fill In Detail Indicates whether Autodesk Navisworks fills in any discarded detail when navigation has stopped.

Batch Fill Select this check box to render detail in chunks (batches) rather than gradually.

NOTE This check box is clear by default, as gradual rendering gives better results for most video cards.

Primitives

Point Size Enter a number from 1 through 9 to set the size (in pixels) of points drawn in the Scene View.

Line Size Enter a number from 1 through 9 to set the width (in pixels) of lines drawn in the Scene View.

Snap Size Enter a number from 1 through 9 to set the size (in pixels) of snap points drawn in the Scene View.

Enable Parametric Primitives Indicates whether Autodesk Navisworks dynamically renders parametric primitives during interactive navigation.

Selecting this check box means the level of detail changes during navigation depending on the distance from the camera.

Clear this check box to use the default representations of primitives; the level of detail stays the same during navigation.

SpaceBall Page

Use the options on this page to customize the SpaceBall behavior.

These options are offered in addition to the adjustments that can be made using the Control Panel for the device which is supplied by the SpaceBall manufacturer with the installation.

Scale Translation By Enter the value that is used to adjust the speed of translation.

Scale Rotation By Enter the value that is used to adjust the speed of rotation.

Navigation Mode Use the drop-down list to specify a default navigation mode for the SpaceBall. It is used when no valid navigation mode is currently selected.

ViewCube Page

Use the options on this page to customize the ViewCube behavior.

Show the ViewCube Indicates whether or not the ViewCube is displayed in the top-right corner of the Scene Area.

TIP You can also toggle the ViewCube by clicking **View** ► **Head-Up Display** ► **ViewCube**.

Size Specifies the size of the ViewCube. You can choose from the following options:

- Automatic
- Tiny
- Small
- Medium
- Large

NOTE In automatic mode, the size of the ViewCube is relative to the size of the Scene Area, and ranges between medium and tiny.

Inactive Opacity When the ViewCube is inactive, that is your cursor is distant from the ViewCube, it appears transparent. To control the opacity level, choose from the following options:

- 0%
- 25%
- 50%
- 75%
- 100%

Keep Scene Upright Indicates whether the upside-down orientations of the scene is allowed when you use the ViewCube.

When this check box is selected, dragging the ViewCube produces a turntable effect.

When Dragging on the ViewCube

While being dragged, the ViewCube and the scene rotate in an arcball like fashion, unless the Keep Scene Upright check box is selected.

Snap to the Closest View Indicates whether the ViewCube snaps to one of the fixed views when it is angularly close to one of the fixed views.

When Clicking on the ViewCube

Fit-to-View on Change When this check box is selected, clicking the ViewCube rotates around the center of the scene and zooms out to fit the scene into the Scene Area. When dragging the ViewCube, prior to the drag, the view changes to look at the scene center (but does not zoom) and continues to use that as the pivot point while dragging.

If this check box is clear, clicking or dragging the ViewCube rotates around the current pivot point and does not zoom in or out.

Use Animated Transitions When Switching Views If this check box is selected, an animated transition displays when you click on a section of the ViewCube to help you visualize the spatial relationship between the current viewpoint and the selected viewpoint.

NOTE When navigating about 3D scenes that contain vast amounts of geometry, the application frame rate may drop and make it difficult for the system to smoothly animate a viewpoint transition.

Show the Compass Below the ViewCube Indicates whether the compass is displayed below the ViewCube tool.

SteeringWheels

Use the options on this page to customize the SteeringWheels menus.

Big Wheels

Size Specifies the size of big wheels. You can choose from the following options:

- Small (64x64)

- Normal (128x128)
- Large (256x256).

Normal is the default option.

Opacity Controls the opacity level of big wheels. The default value is 50%. You can choose from the following options:

- 25% (mostly transparent)
- 50%
- 75%
- 90% (mostly opaque)

Mini Wheels

Size Specifies the size of mini wheels. You can choose from the following options:

- Small (16x16)
- Normal (32x32)
- Large (64x64).
- Extra Large (256x256)

Normal is the default option.

Opacity Controls the opacity level of mini wheels. The default value is 50%. You can choose from the following options:

- 25% (mostly transparent)
- 50%
- 75%
- 90% (mostly opaque)

Always Show the Pinned Wheel on Startup When this check box is selected, the ‘pinned’ SteeringWheel and the First Contact dialog box are always shown when Autodesk Navisworks is started.

On-Screen Messages

Show Tool Messages Toggles the display of tooltips for navigation tools. When this check box is selected, the tooltips are shown below the cursor as you use the tools.

NOTE This setting is always on for View Object and Tour Building wheels, and cannot be turned off.

Show Tooltips Toggles the display of wheel tooltips. When this check box is selected, the tooltips are shown when you hover over wedges on the wheels.

NOTE This setting is always on for View Object and Tour Building wheels, and cannot be turned off.

Show Tool Cursor Text Toggles the display of tool label below the cursor.

NOTE This setting is always on for View Object and Tour Building wheels, and cannot be turned off.

Look Tool

Invert Vertical Axis Selecting this check box swaps the up-down axis for the Look tool; that is pushing the mouse forward looks down, and pulling the mouse backward looks up.

Walk Tool

Constrain Walk Angle Selecting this check box makes the Walk Tool respect the world up vector (as set in File Options ► Orientation). As a result, using the Walk tool causes the camera to snap to the current up vector.

When this check box is clear, the Walk tool disregards the world up vector, and the camera is walked with its current up orientation unaffected.

Walk Speed Sets the speed of the Walk tool from 0.1 (very slow) to 10 (very fast).

Zoom Tool

Enable Single-Click Incremental Zoom In When this check box is selected, single clicking over the Zoom wedge increases the magnification of the model. When this check box is clear, nothing happens when you single click over the Zoom wedge.

Orbit Tool

Keep Scene Upright When this check box is selected, the Orbit tool behaves similarly to orbit navigation mode, with orbiting constrained along the XY axis and in the Z direction.

When this check box is clear, the Orbit tool behaves similarly to examine navigation mode, and you can roll the model around the pivot point.

Enable Selection Sensitivity When this check box is selected, the objects selected before the Orbit tool are used to calculate the pivot point to use for orbiting. The pivot point is calculated based on the center of the extents of the selected objects.

File Readers Node

Use the settings in this node to configure the file readers required to open native CAD and scanning applications file formats in Autodesk Navisworks.

TIP If you want to restore the default values, click the Defaults button.

3DS Page

Use this page to adjust the options for the 3DS file reader.

Convert Hidden Select this check box if you want Autodesk Navisworks to convert hidden entities in 3DS files. They are automatically marked as hidden by Autodesk Navisworks.

When this check box is clear, the file reader ignores hidden items.

Bitmap File Search Paths The paths of texture map files are not stored with the texture maps in the model. Enter the required paths into this box, separating them with semi-columns.

Default Units Specifies the type of units Autodesk Navisworks uses when opening 3DS files.

TIP If the chosen units type turns out to be wrong, you can rescale the model by using the File Units and Transform option.

See also:

- [“3DS File Reader”](#) on page 91

ASCII Laser Page

Use this page to adjust the options for the ASCII laser scan file reader.

Sample Rate Specifies the frequency of points extracted from the input file.

Increasing the sample rate, reduces the number of points extracted. This has the effect of reducing the image resolution, but increasing the speed with which the file is loaded.

Use Point Intensity Values Select the check box to extract intensity values from the input file.

When this check box is clear, the file reader ignores intensity values.

Use Point Color Values Select the check box to extract color values from the input file.

When this check box is clear, the file reader ignores color values.

See also:

- [“ASCII Laser Scan File Reader”](#) on page 92

CIS2 Page

Use this page to adjust the options for the CIS2 file reader.

Convert Features Indicates whether features are converted.

NOTE Converting a large number of features may have a negative impact on the loading performance.

Convert Unknown Section into Rectangle Select this check box to convert unknown sections profiles into rectangles with estimated parameters, but the scale may not be appropriate.

When this check box is clear, the file reader ignores unknown sections profiles.

Faceting Factor Enter the required value to control the level of faceting that takes place.

The faceting factor must be greater or equal to 0, where 0 results in the faceting factor being turned off. The default value is 1. To get twice the number of facets, double this value. To get half as many facets, halve this value. Larger faceting factors result in more polygons to a model and larger Autodesk Navisworks files.

Max Facet Deviation This setting controls the greatest distance between the edge of a facet and the actual geometry. If this distance is greater than the Max Facet Deviation value, Autodesk Navisworks adds more facets. If the Max Facet Deviation is set to 0, then this function is ignored.

DGN Page

Use this page to adjust the options for the 3D DGN and PROP file reader.

Faceting Factor Enter the required value to control the level of faceting that takes place.

The faceting factor must be greater or equal to 0, where 0 results in the faceting factor being turned off. The default value is 1. To get twice the number of facets, double this value. To get half as many facets, halve this value. Larger faceting factors result in more polygons to a model and larger Autodesk Navisworks files.

Max Facet Deviation This setting controls the greatest distance between the edge of a facet and the actual geometry.

If this distance is greater than the **Max Facet Deviation** value, Autodesk Navisworks adds more facets.

If the **Max Facet Deviation** is set to 0, then this function is ignored.

Convert Hidden Items Select this check box to convert hidden entities in DGN files. They are automatically marked as hidden by Autodesk Navisworks.

When this check box is clear, the file reader ignores hidden items.

Show Hidden Items Select this check box, if you want to display all entities in converted DGN files, irrespective of whether they are hidden or not.

NOTE To use this option, you must select the Convert Hidden Items check box.

Convert Lines and Arcs Select this check box to convert lines, splines, curves, arcs, circles, or ellipses in DGN files.

Merge Lines and Arcs Select this check box if you want to reduce the complexity of the model in the Selection Tree by interpreting adjoining lines with the same color, level, and parent as a single item.

Clear this check box if you want to leave these elements as separate items in Autodesk Navisworks.

Convert Text Select this check box to convert text into smart tags in Autodesk Navisworks.

When this check box is clear, the file reader ignores text in DGN files.

Shape Merge Threshold Specifies the number of vertices for MicroStation shapes.

If the number of vertices is less than or equal to the **Shape Merge Threshold** value, Autodesk Navisworks merges all shapes on the same level or in the same cell and with the same color into a "Shape Set".

Convert References Select this check box to convert reference files in DGN files.

When this check box is clear, the file reader ignores reference files.

Ignore Unres. References Select this check box to ignore unresolved reference files in DGN files.

If this check box is clear, the file reader attempts to convert all reference files, and presents you with a dialog box to find any unresolved reference files at a run time.

Use Level Symbology Select this check box to enable the level symbology from MicroStation. This makes items in Autodesk Navisworks take their color from level rather than use the default element color in MicroStation.

Align Global Origins Indicates whether Autodesk Navisworks aligns global origins in referenced DGN files to the origin of the master DGN file.

When DGN files are appended together with this check box selected, their global origins are positioned in the same place.

Use Materials Indicates whether MicroStation's materials are exported and assigned to elements.

Select this check box to assign the same textures, diffuse, ambient, and specular colors to the elements as in the MicroStation scene.

Clear this check box to assign the same colors to the elements as in the MicroStation scene.

Material Search Paths Enter a semi-colon separated list of paths to the MicroStation palette (.pal) and material (.mat) files. These paths are used by the file reader to convert MicroStation materials.

Convert PDS Data Select this check box to read object information from Intergraph's Plant Design System™ while converting the DGN files.

PDS information is read from Intergraph's DRV files. The file reader looks for a DRV file with the same base name as the DGN file in the same directory.

When this check box is clear, the file reader ignores PDS data.

Convert TriCAD Data Select this check box to read object information from Triplan's TriCAD™ while converting DGN files.

When this check box is clear, the file reader ignores TriCAD data.

Convert TriForma Data Select this check box to read object information from Bentley's TriForma™ while converting DGN files.

When this check box is clear, the file reader ignores Tri-Forma data.

TriForma Dataset Search Paths Enter a semi-colon separated list of paths that the file reader uses to locate TriForma data set files. You must include the paths to user-defined datasets.

View Number Enter the required value to selects a specific view for loading. The file reader uses the level visibility of this view when converting items.

For example, enter 0 to use the first active view.

See also:

- [“DGN File Reader”](#) on page 98

DWF Page

Use this page to adjust the options for the DWF file reader.

Faceting Factor Enter the required value to control the level of faceting that takes place.

The faceting factor must be greater or equal to 0, where 0 results in the faceting factor being turned off. The default value is 1. To get twice the number of facets, double the value. To get half as many facets, halve the value. Larger faceting factors result in more polygons to a model and larger Autodesk Navisworks files.

Max Facet Deviation This setting controls the greatest distance between the edge of a facet and the actual geometry.

If this distance is greater than the **Max Facet Deviation** value, Autodesk Navisworks adds more facets.
If the **Max Facet Deviation** is set to 0, then this function is ignored.

Extract Textures Select this check box to extract textures and environment maps associated with the file.

NOTE Environment maps are not set in the scene by default, and must be configured in Presenter manually.

When this check box is clear, the file reader ignores maps and textures.

See also:

- [“DWF File Reader”](#) on page 97

DWG/DXF/SAT Page

Use this page to adjust the options for the DWG/ DXF/SAT file reader.

Faceting Factor Enter the required value to control the level of faceting that takes place.

The faceting factor must be greater or equal to 0, where 0 results in the faceting factor being turned off. The default value is 1. To get twice the number of facets, double the value. To get half as many facets, halve the value. Larger faceting factors result in more polygons to a model and larger Autodesk Navisworks files.

Max Facet Deviation This setting controls the greatest distance between the edge of a facet and the actual geometry.

If this distance is greater than the **Max Facet Deviation** value, Autodesk Navisworks adds more facets.

If the **Max Facet Deviation** is set to 0, then this function is ignored.

Split by Color Compound objects can be split into parts based on their color. Select this check box if you want to use this functionality.

For example, a window object from Architectural Desktop can be split into a frame and a pane. If this check box is clear, you can only select the window object as a whole, whereas if you select this check box, you can select the individual pane and frame.

NOTE Autodesk Navisworks names parts of compound objects after their color.

Default Decimal Units Selects the types of units Autodesk Navisworks uses to open DWG and DXF files that were created with decimal drawing units.

NOTE DWG and DXF files do not specify the units they were created in. To adjust the units in Autodesk Navisworks, use the File Units and Transform option.

Merge 3D Faces Indicates whether the file reader interprets adjoining faces with the same color, layer, and parent as a single item in the Selection Tree.

Clear this check box to keep the entities as separate items in the Selection Tree.

Merge Lines Indicates whether the file reader interprets joining lines with the same color, layer, and parent as a single item in the Selection Tree.

Clear this check box to keep the entities as separate items in the Selection Tree.

Convert Off Select this check box to convert layers that are switched off in DWG and DXF files. They are automatically marked as hidden in Autodesk Navisworks.

When this check box is clear, the file reader ignores switched off layers.

Convert Frozen Select this check box to convert layers that are frozen in DWG and DXF files. They are automatically marked as hidden in Autodesk Navisworks.

When this check box is clear, the file reader ignores frozen layers.

Convert Entity Handles Select this check box to convert entity handles, and attach them to object properties in Autodesk Navisworks.

When this check box is clear, the file reader ignores entity handles.

Convert Groups Select this check box to retain groups in DWG and DXF files; this adds another selection level to the Selection Tree.

When this check box is clear, the file reader ignores groups.

Convert XRefs Select this check box to convert any external reference files contained within the DWG file automatically.

Clear this check box if you want to append files in Autodesk Navisworks later yourself.

Merge XRef Layers Select this check box to merge the layers in external reference files with layers in the main DWG file in the Selection Tree.

Clear this check box to keep the external reference files separate from the main DWG file in the Selection Tree.

Convert Views Select this check box to convert the named views into Autodesk Navisworks viewpoints.

When this check box is clear, the file reader ignores views.

Convert Points Select this check box to convert points in DWG and DXF files.

When this check box is clear, the file reader ignores points.

Convert Lines Select this check box to convert lines and arcs in DWG and DXF files.

When this check box is clear, the file reader ignores lines.

Convert Snap Points Select this check box to convert snap points in DWG and DXF files.

When this check box is clear, the file reader ignores snap points.

Convert Text Select this check box to convert text in DWG and DXF files.

When this check box is clear, the file reader ignores text.

DWG Loader Version Specifies which version of ObjectDBX to use when loading AutoCAD files. This option enables you to select support for the correct version of object enablers that can be used within the file.

NOTE When you modify this setting, restart Autodesk Navisworks to apply the changes. This is because once any particular version of ObjectDBX is loaded during reading of a DWG or DXF file, the version in use does not change until the program is restarted.

Load Material Definitions Select this check box to extract material definitions from DWG files.

When this check box is clear, the file reader ignores material definitions.

Use ADT Standard Configuration Select this check box to convert geometry and materials in DWG files using the Standard display configuration.

Clear this check box to convert geometry and materials accordingly to whether they are displayed in the currently saved display configuration.

Convert Hidden ADT Spaces Indicates whether space objects that lack any visible 3D geometry in DWG files are converted (for example, objects that lack floor or ceiling thicknesses).

Selecting this check box results in corresponding hidden objects appearing in Autodesk Navisworks.

NOTE This option does not affect the normal behavior of space objects that have visible 3D geometry in DWG files.

Material Search Paths Autodesk Navisworks automatically searches the default Autodesk material paths.

Use this box to specify additional paths to texture files used in Autodesk Architectural Desktop materials. Separate the paths with semi-columns.

Render Type Specifies the render style used for objects when loading DWG files.

Selecting **Automatic** means Autodesk Navisworks uses the render style saved in DWG files.

If geometry is not correctly displayed, adjust the render style with one of the following options: **Rendered**, **Shaded**, or **Wireframe**.

Buttons

Defaults Restores the default values.

Advanced Opens the “[Convert Object Properties dialog box](#)” on page 408 where you can select third-party applications to read object information from.

See also:

- [“DWG/DXF/SAT File Reader”](#) on page 95

Faro Page

Use this page to adjust the options for the Faro Scan file reader.

Point Colors Specifies how points are extracted from the input file.

Select from the following options:

- **None** - the points come through as white.
- **Intensity** - the points use the intensity values stored in the file.
- **Color** - the points use the color values stored in the file.

NOTE If the selected option is not available, then the file reader defaults to the values used in the file. For example, if you set Point Colors to **Color**, but only intensities are available in the file, then the file reader uses the intensities.

See also:

- [“Faro Scan File Reader”](#) on page 99

IFC Page

Use this page to adjust the options for the IFC file reader.

Convert Bounding Boxes Select this check box to bring through and visualize bounding boxes.

When this check box is clear, the file reader ignores bounding boxes.

Convert Spaces Select this check box to bring through and visualize spaces.

When this check box is clear, the file reader ignores spaces.

Faceting Factor Enter the required value to control the level of faceting that takes place.

The faceting factor must be greater or equal to 0, where 0 results in the faceting factor being turned off. The default value is 1. When you double the value, you get twice the number of facets. When you halve the value you get half as many facets. Larger faceting factors result in more polygons to a model and larger Autodesk Navisworks files.

Max Facet Deviation This setting controls the greatest distance between the edge of a facet and the actual geometry.

If this distance is greater than the **Max Facet Deviation** value, Autodesk Navisworks adds more facets.

If the **Max Facet Deviation** is set to 0, then this function is ignored.

Representation Detail Specifies the level of visual representation of IFC elements.

IFC elements can have multiple visual representations, such as bounding boxes (simplest), lines, styled lines, polygons, and styled polygons (most complex). Loading and showing all of these representations can lead to cluttered visuals and memory overheads.

Select from the following options:

- **Highest Only** - to load and show the most complex level of detail available while ignoring simpler ones.
- **Show Highest** - to load all representations, but only show the highest level of detail available.
- **Show All** - to load and show everything available.

Show Spatial Hierarchy Select this check box to show IFC model as a tree structure in the Selection Tree.

Clear this check box to show IFC model as a simple list of elements in the Selection Tree.

Use Property-Based Colors Select this check box to convert and use property-based colors.

TIP If an IFC file is predominantly black when loaded, clear this check box to revert back to using IFC-standard colors.

See also:

- [“IFC File Reader”](#) on page 99

IGES Page

Use this page to adjust the options for the IGES file reader.

Faceting Factor Enter the required value to control the level of faceting that takes place.

The faceting factor must be greater or equal to 0, where 0 results in the faceting factor being turned off. The default value is 1. To get twice the number of facets, double the value. To get half as many facets, halve the value. Larger faceting factors result in more polygons to a model and larger Autodesk Navisworks files.

Max Facet Deviation This setting controls the greatest distance between the edge of a facet and the actual geometry.

If this distance is greater than the **Max Facet Deviation** value, Autodesk Navisworks adds more facets.

If the **Max Facet Deviation** is set to 0, then this function is ignored.

See also:

- [“IGES File Reader”](#) on page 99

Inventor Page

Use this page to adjust the options for the Inventor file reader.

Active Project Specifies the path of the current Inventor project.

See also:

- [“Inventor File Reader”](#) on page 100

JTOpen Page

Use this page to adjust the options for the JTOpen file reader.

Faceting Factor Enter the required value to control the level of faceting that takes place.

The faceting factor must be greater or equal to 0, where 0 results in the faceting factor being turned off. The default value is 1. To get twice the number of facets, double this value. To get half as many facets, halve this value. Larger faceting factors result in more polygons to a model and larger Autodesk Navisworks files.

Max Facet Deviation This setting controls the greatest distance between the edge of a facet and the actual geometry.

If this distance is greater than the **Max Facet Deviation** value, Autodesk Navisworks adds more facets.

If the **Max Facet Deviation** is set to 0, then this function is ignored.

Retriangulate JT Brep Models Select this check box to use BREP entities to create geometry.

Clear this check box to use tri-strips to create geometry.

See also:

- [“JTOpen File Reader”](#) on page 100

Leica Page

Use this page to adjust the options for the Leica Scan file reader.

Sample Rate Specifies the frequency of points extracted from the input file.

Increasing the sample rate, reduces the number of points extracted. As a result, the image resolution is reduced, and the file is converted faster.

Point Colors Specifies how points are extracted from the input file.

Select from the following options:

- **None** - the points come through as white.
- **Raw Intensity** - the points use the intensity values stored in the file.
- **Color** - the points use the color values stored in the file.
- **Color-Mapped Intensity** - the points use a spectrum of RGB colors.
- **Gamma Correction Intensity** - the points use gamma-corrected raw intensity values stored in the file.

Gamma Correction Level Specifies a gamma correction value used to adjust the normalized point intensity values obtained from the file, and results in lighter or darker images depending on the setting.

A gamma correction value in the range between 0.1 and 0.99 adjusts the weighting of intensity values at the lower end of the intensity range, so that the image appears lighter.

A gamma correction level above 1.0 has the effect of darkening the image.

NOTE A gamma correction of 1 means no changes.

See also:

- [“Leica Scan File Reader”](#) on page 101

MAN Page

Use this page to adjust the options for the MAN file reader.

Include Line-Geometry Select this check box to convert MicroGDS line-primitives.

When this check box is clear, the file reader ignores line-geometry.

Set Facet Circle Specifies the number of facets for arcs.

Enter the number of straight line segments required to facet a whole circle. This option corresponds to the MicroGDS Set Facet preference.

Texture Path Specifies the path to the folder containing images used in MicroGDS Materials. This path is used as the base for relative paths for materials that use image files.

This option corresponds to the MicroGDS Renderer Textures preference.

Define Presenter Materials Select this check box to define MicroGDS material-styles as Presenter materials in Autodesk Navisworks.

When this check box is clear, the file reader ignores MicroGDS material-styles.

See also:

- [“MAN File Reader”](#) on page 102

PDS Page

Use this page to adjust the options for the PDS file reader.

Load Tags Select this check box if you want Autodesk Navisworks to read associated TAG files together with the DRI file.

When this check box is clear, the file reader ignores TAG files.

Load Display Sets Select this check box if you want Autodesk Navisworks to read associated Display Set DST files with the DRI file.

When this check box is clear, the file reader ignores Display Set DST files.

Input Files Selects the input file type.

Select from the following options:

- **DGN Files** - to convert the original DGN files.
- **NWC Files** - to open the NWC cache versions of the files.
This option is useful if you routinely perform a batch conversion of the DGN files into NWC files, and would like to open the NWC files when reading a DRI file.

See also:

- [“PDS File Reader”](#) on page 103

Riegl Page

Use this page to adjust the options for the Riegl Scan file reader.

Use Point Color Values Select this check box to extract color values from the input file.

When this check box is clear, the file reader ignores color values.

Use Point Intensity Values Select this check box to extract intensity values from the input file.

When this check box is clear, the file reader ignores intensity values.

Triangulate Point Data Select this check box to extract triangles from the input file.

Selecting this check box slows down the speed of file conversion.

Apply Scanner Transformation Select this check box to display the image in local coordinates relative to the scanner.

Clear this check box to display the image in global coordinates. Use this option when the file contains more than one frame.

See also:

- [“Riegl Scan File Reader”](#) on page 103

RVM Page

Use this page to adjust the options for the RVM file reader.

Faceting Factor Enter the required value to control the level of faceting that takes place.

The faceting factor must be greater or equal to 0, where 0 results in the faceting factor being turned off. The default value is 1. When you double the value, you get twice the number of facets. When you halve the value you get half as many facets. Larger faceting factors result in more polygons to a model and larger Autodesk Navisworks files.

Max Facet Deviation This setting controls the greatest distance between the edge of a facet and the actual geometry.

If this distance is greater than the **Max Facet Deviation** value, Autodesk Navisworks adds more facets.

If the **Max Facet Deviation** is set to 0, then this function is ignored.

Convert Attributes Select this check box to convert attribute files. All files located by the file reader are considered in the same order they were found. Attributes are matched to elements in the scene by name. Any attributes that were not found are counted, and the number reported in the scene statistics.

When this check box is clear, the file reader ignores attribute files.

Search All Attribute Files Controls the way the file reader locates attribute files. The file extensions are specified in the Attribute File Extensions box.

When this check box is clear (the default option), the file reader checks the directory where the RVM file is located for an attribute file with the same name. If it cannot find an attribute file, then it looks in a subdirectory with the same name as the RVM file for all files with the specified file extensions.

When this check box is selected, the file reader first uses the default search method. If it cannot find any attribute files, it returns to the directory where the RVM reader is located, and looks for all files with the specified file extensions.

Attribute File Extensions Specifies the file extensions that the file reader uses to recognize attribute files. The default extensions are *.ATT, *.ATTRIB, and *.TXT. Separate the values in the list with semi-colons.

Generate Texture Coordinates Select this check box to create texture coordinates for each point in the model. When this check box is clear, the file reader ignores texture coordinates.

Keep Empty Groups Select this check box to convert groups that do not contain any geometry. Use this option when, for example, these groups contain attributes.

When this check box is clear, the file reader ignores empty groups. This is the default option.

Load RVS File Select this check box to read an RVS file at the same time as the corresponding RVM file. This is the default option.

NOTE To work correctly, the RVS file must have the same name, and path as the associated RVM file, but with an .rvs extension.

When this check box is clear, the file reader ignores RVS files.

RVS Transparencies as Materials Select this check box to attach transparent materials to the objects. Use this option, for example, when large objects in the scene are permanently transparent, and you want to convert them as such.

When this check box is clear (the default option), the file reader ignores RVS transparency settings. Use this option, for example, when you want to override transparency settings in the RVS file.

NOTE You can also override object transparency directly in Autodesk Navisworks.

Convert Origins Select this check box to convert component origin points into Autodesk Navisworks snap points.

When this check box is clear, origin points are discarded.

Convert Zero-Thickness Solids Select this check box to convert 3D solids with a zero thickness into 2D geometry. When this check box is clear, 3D solids with a zero thickness are discarded.

See also:

- [“RVM File Reader”](#) on page 103

SKP Page

Use this page to adjust the options for the SketchUp SKP file reader.

Convert Hidden Items Select this check box to convert hidden entities in SKP files. They are automatically marked as hidden in Autodesk Navisworks.

When this check box is clear, the file reader ignores hidden items.

Merge Faces Indicates whether the file reader interprets adjoining faces with the same color, layer, and parent as a single item in the Selection Tree.

Clear this check box to keep the faces as separate items in the Selection Tree.

Merge Lines Indicates whether the file reader interprets joining lines with the same color, layer, and parent as a single item in the Selection Tree.

Clear this check box to keep the lines as separate items in the Selection Tree.

See also:

- [“SketchUp SKP File Reader”](#) on page 104

STEP Page

Use this page to adjust the options for the STEP file reader.

Faceting Factor Enter the required value to control the level of faceting that takes place.

The faceting factor must be greater or equal to 0, where 0 results in the faceting factor being turned off. The default value is 1. To get twice the number of facets, double the value. To get half as many facets, halve the value. Larger faceting factors result in more polygons to a model and larger Autodesk Navisworks files.

Max Facet Deviation This setting controls the greatest distance between the edge of a facet and the actual geometry.

If this distance is greater than the **Max Facet Deviation** value, Autodesk Navisworks adds more facets.

If the **Max Facet Deviation** is set to 0, then this function is ignored.

See also:

- [“STEP File Reader”](#) on page 104

STL Page

Use this page to adjust the options for the STL file reader.

Default Units Specifies the type of units Autodesk Navisworks uses when opening STL files.

TIP If the chosen units type turns out to be wrong, you can rescale the model by using the File Units and Transform option.

Override Normals Normals control how objects appears when lit. By default, this check box is clear, and the file reader uses the data provided in the STL file, giving the most accurate visible results.

Select this check box if you want Autodesk Navisworks to ignore the normals, and generate the lighting data instead, for example when the supplied model contains invalid lighting data.

NOTE Using this option is less accurate than using real lighting data in STL files.

See also:

- [“STL File Reader”](#) on page 105

VRML Page

Use this page to adjust the options for the VRML file reader.

Default Units Specifies the type of units Autodesk Navisworks uses when opening VRML world files.

Faceting Factor Enter the required value to control the level of faceting that takes place.

The faceting factor must be greater or equal to 0, where 0 results in the faceting factor being turned off. The default value is 1. When you double the value, you get twice the number of facets. When you halve the value you get half as many facets. Larger faceting factors result in more polygons to a model and larger Autodesk Navisworks files.

Max Facet Deviation This setting controls the greatest distance between the edge of a facet and the actual geometry.

If this distance is greater than the **Max Facet Deviation** value, Autodesk Navisworks adds more facets.

If the **Max Facet Deviation** is set to 0, then this function is ignored.

Override Normals Normals control how objects appears when lit. By default, this check box is clear, and the file reader uses the data provided in the VRML file, giving the most accurate visible results.

Select this check box if you want Autodesk Navisworks to ignore the normals, and generate the lighting data instead, for example when the supplied model contains invalid lighting data.

NOTE Using this option is less accurate than using real lighting data in VRML files.

Override Orientation By default, this check box is clear, and the file reader processes the geometry information in order indicated in VRML files, which can be clockwise or counter-clockwise.

When this check box is selected, the file reader ignores the order in VRML files, and processes the geometry information counter-clockwise. This option is useful, if your model, when viewed in Autodesk Navisworks, has holes or black areas in it.

Override Switch Statements By default, this check box is clear. This means, the file reader uses the default behavior of the switch statements in VRML files.

For switch statements that are used in VRML scripting, related geometry is only converted if the corresponding switch is turned on. As a result, you can get a mostly empty model in Autodesk Navisworks.

When this check box is selected, the file reader processes all switch statements, and brings through extra geometry.

NOTE Overriding Switch Statements can result, for example, in creating duplicate geometry if the switch statement contains several ways to represent the same object.

See also:

- [“VRML File Reader”](#) on page 105

Z + F Page

Use this page to adjust the options for the Z+F Scan file reader.

Sample Rate Specifies the frequency of points extracted from the input file.

Increasing the sample rate, reduces the number of points extracted. As a result, the image resolution is reduced, and the file is converted faster.

Remove Spurious Points Select this check box to ignore spurious points in the input file.

When this check box is clear, the file reader extracts spurious points.

Point Intensity Specifies how points are extracted from the input file.

Select from the following options:

- **None** - the points come through as white.
- **Raw Intensity** - the points use the intensity values stored in the file.
- **Color-Mapped Intensity** - the points use a spectrum of RGB colors.
- **Gamma Correction Intensity** - the points use gamma-corrected raw intensity values stored in the file.

Gamma Correction Level Specifies a gamma correction value used to adjust the normalized point intensity values obtained from the file, and results in lighter or darker images depending on the setting.

A gamma correction value in the range between 0.1 and 0.99 adjusts the weighting of intensity values at the lower end of the intensity range, so that the image appears lighter.

A gamma correction level above 1.0 has the effect of darkening the image.

NOTE A gamma correction of 1 means no changes.

See also:

- [“Z+F Scan File Reader”](#) on page 106

File Exporters Node

Use the settings in this node to configure the file exporters required to export native Navisworks files directly from CAD applications.

TIP If you want to restore the default values, click the Defaults button.

DWG Page

Use this page to adjust the options for the DWG file exporter.

Convert Entity Handles Select this check box to convert entity handles, and attach them to object properties in Autodesk Navisworks.

When this check box is clear, the file exporter ignores entity handles.

Convert Frozen Select this check box to convert layers that are frozen in DWG and DXF files. They are automatically marked as hidden in Autodesk Navisworks.

When this check box is clear, the file exporter ignores frozen layers.

Convert Groups Select this check box to retain groups in DWG and DXF files; this adds another selection level to the Selection Tree.

When this check box is clear, the file exporter ignores groups.

Convert Hidden ADT Spaces Indicates whether space objects that lack any visible 3D geometry in DWG files are converted (for example, objects that lack floor or ceiling thicknesses).

Selecting this check box results in corresponding hidden objects appearing in Autodesk Navisworks.

NOTE This option does not affect the normal behavior of space objects that have visible 3D geometry in DWG files.

Convert Lines Select this check box to convert lines and arcs in DWG and DXF files.

When this check box is clear, the file exporter ignores lines.

Convert Off Select this check box to convert layers that are switched off in DWG and DXF files. They are automatically marked as hidden in Autodesk Navisworks.

When this check box is clear, the file exporter ignores switched off layers.

Convert Points Select this check box to convert points in DWG and DXF files.

When this check box is clear, the file exporter ignores points.

Convert Snap Points Select this check box to convert snap points in DWG and DXF files.

When this check box is clear, the file exporter ignores snap points.

Convert Text Select this check box to convert text in DWG and DXF files.

When this check box is clear, the file exporter ignores text.

Convert Views Select this check box to convert the named views into Autodesk Navisworks viewpoints.

When this check box is clear, the file exporter ignores views.

Convert XRefs Select this check box to convert any external reference files contained within the DWG file automatically.

Clear this check box if you want to append files in Autodesk Navisworks later yourself.

Default Decimal Units Selects the types of units Autodesk Navisworks uses to open DWG and DXF files that were created with decimal drawing units.

NOTE DWG and DXF files do not specify the units they were created in. To adjust the units in Autodesk Navisworks, use the File Units and Transform option.

Default Font Specifies default font used to display converted text in Autodesk Navisworks.

DWG Loader Version Specifies which version of ObjectDBX to use when loading AutoCAD files.

Faceting Factor Enter the required value to control the level of faceting that takes place.

The faceting factor must be greater or equal to 0, where 0 results in the faceting factor being turned off. The default value is 1. To get twice the number of facets, double the value. To get half as many facets, halve the value. Larger faceting factors result in more polygons to a model and larger Autodesk Navisworks files.

Load Material Definitions Select this check box to extract material definitions from DWG files.

When this check box is clear, the file exporter ignores material definitions.

Material Search Paths Autodesk Navisworks automatically searches the default Autodesk material paths.

Use this box to specify additional paths to texture files used in Autodesk Architectural Desktop materials. Separate the paths with semi-columns.

Max Facet Deviation This setting controls the greatest distance between the edge of a facet and the actual geometry.

If this distance is greater than the **Max Facet Deviation** value, Autodesk Navisworks adds more facets.

If the **Max Facet Deviation** is set to 0, then this function is ignored.

Merge 3D Faces Indicates whether the file exporter interprets adjoining faces with the same color, layer, and parent as a single item in the Selection Tree.

Clear this check box to keep the entities as separate items in the Selection Tree.

Merge Lines Indicates whether the file exporter interprets joining lines with the same color, layer, and parent as a single item in the Selection Tree.

Clear this check box to keep the entities as separate items in the Selection Tree.

Merge XRef Layers Select this check box to merge the layers in external reference files with layers in the main DWG file in the Selection Tree.

Clear this check box to keep the external reference files separate from the main DWG file in the Selection Tree.

Render Type Specifies the render style used for objects when loading DWG files.

Selecting **Automatic** means Autodesk Navisworks uses the render style saved in DWG files.

If geometry is not correctly displayed, adjust the render style with one of the following options: **Rendered**, **Shaded**, or **Wireframe**.

Split by Color Compound objects can be split into parts based on their color. Select this check box if you want to use this functionality.

For example, a window object from Architectural Desktop can be split into a frame and a pane. If this check box is clear, you can only select the window object as a whole, whereas if you select this check box, you can select the individual pane and frame.

NOTE Autodesk Navisworks names parts of compound objects after their color.

Use ADT Standard Configuration Select this check box to convert geometry and materials in DWG files using the Standard display configuration.

Clear this check box to convert geometry and materials accordingly to whether they are displayed in the currently saved display configuration.

See also:

- [“AutoCAD File Exporter”](#) on page 106

Revit Page

This page enables you to adjust the NWC export options for the Revit file exporter.

Convert Element Ids Select this check box to export the ID numbers for each Revit element.

When this check box is clear, the file exporter ignores IDs.

Convert Element Parameters Specifies how Revit parameters are read. Select from the following options:

- **None** - the file exporter does not convert parameters.
- **Elements** - the file exporter converts parameters for all found elements.

- **All** - the file exporter converts parameters for all found elements, including the referenced elements. As a result, extra property tabs are available in Autodesk Navisworks.

Export Specifies how geometry is exported. Select from the following options:

- **Entire Project** - all geometry in the project is exported.
- **Current View** - everything that is currently visible is exported.
- **Selection** - only the currently selected geometry is exported.

Try and Find Missing Materials When this check box is selected (the default option), the file exporter looks for a match for the materials missing from the export.

NOTE If any inappropriate materials are applied to the model geometry as a result, clear this check box to fix the problem.

World Units Selects the type of units Autodesk Navisworks uses to open the exported NWC files.

NOTE To adjust the units in Autodesk Navisworks, use the File Units and Transform option.

See also:

- [“Revit File Exporter”](#) on page 111

DGN Page

Use this page to adjust the options for the 3D DGN file exporter.

Align Global Origins Indicates whether Autodesk Navisworks aligns global origins in referenced DGN files to the origin of the master DGN file.

When DGN files are appended together with this check box selected, their global origins are positioned in the same place.

Convert Hidden Items Select this check box to convert hidden entities in DGN files. They are automatically marked as hidden by Autodesk Navisworks.

When this check box is clear, the file exporter ignores hidden items.

Convert Lines and Arcs Select this check box to convert lines, splines, curves, arcs, circles, or ellipses in DGN files.

Convert PDS Data Select this check box to read object information from Intergraph's Plant Design System™ while converting the DGN files.

PDS information is read from Intergraph's DRV files. The file exporter looks for a DRV file with the same base name as the DGN file in the same directory.

When this check box is clear, the file exporter ignores PDS data.

Convert References Select this check box to convert reference files in DGN files.

When this check box is clear, the file exporter ignores reference files.

Convert Text Select this check box to convert text into smart tags in Autodesk Navisworks.

When this check box is clear, the file exporter ignores text in DGN files.

Convert TriCAD Data Select this check box to read object information from Triplan's TriCAD™ while converting DGN files.

When this check box is clear, the file exporter ignores TriCAD data.

Convert TriForma Data Select this check box to read object information from Bentley's TriForma™ while converting DGN files.

When this check box is clear, the file exporter ignores Tri-Forma data.

Default Font Specifies default font used to display converted text in Autodesk Navisworks.

Faceting Factor Enter the required value to control the level of faceting that takes place.

The faceting factor must be greater or equal to 0, where 0 results in the faceting factor being turned off. The default value is 1. To get twice the number of facets, double this value. To get half as many facets, halve this value. Larger faceting factors result in more polygons to a model and larger Autodesk Navisworks files.

Ignore Unres. References Select this check box to ignore unresolved reference files in DGN files.

If this check box is clear, the file exporter attempts to convert all reference files, and presents you with a dialog box to find any unresolved reference files at a run time.

Material Search Paths Enter a semi-colon separated list of paths to the MicroStation palette (.pal) and material (.mat) files. These paths are used by the file exporter to convert MicroStation materials.

Max Facet Deviation This setting controls the greatest distance between the edge of a facet and the actual geometry.

If this distance is greater than the **Max Facet Deviation** value, Autodesk Navisworks adds more facets.

If the **Max Facet Deviation** is set to 0, then this function is ignored.

Merge Lines and Arcs Select this check box if you want to reduce the complexity of the model in the Selection Tree by interpreting adjoining lines with the same color, level, and parent as a single item.

Clear this check box if you want to leave these elements as separate items in Autodesk Navisworks.

Shape Merge Threshold Specifies the number of vertices for MicroStation shapes.

If the number of vertices is less than or equal to the **Shape Merge Threshold** value, Autodesk Navisworks merges all shapes on the same level or in the same cell and with the same color into a 'Shape Set'.

Show Hidden Items Select this check box, if you want to display all entities in converted DGN files, irrespective of whether they are hidden or not.

NOTE To use this option, you must select the Convert Hidden Items check box.

TriForma Dataset Search Paths Enter a semi-colon separated list of paths that the file reader uses to locate TriForma data set files. You must include the paths to user-defined datasets.

Use Level Symbology Select this check box to enable the level symbology from MicroStation. This makes items in Autodesk Navisworks take their color from level rather than use the default element color in MicroStation.

Use Materials Indicates whether MicroStation's materials are exported and assigned to elements.

Select this check box to assign the same textures, diffuse, ambient, and specular colors to the elements as in the MicroStation scene.

Clear this check box to assign the same colors to the elements as in the MicroStation scene.

View Number Enter the required value to select a specific view for loading. The file exporter uses the level visibility of this view when converting items.

For example, enter 0 to use the first active view.

See also:

■ [“MicroStation File Exporter”](#) on page 112

Viz/Max Page

Use this page to adjust the options for the 3DS file exporter.

Convert Hidden Items Select this check box to convert hidden entities in 3DS files. They are automatically marked as hidden by Autodesk Navisworks.

When this check box is clear, the file exporter ignores hidden items.

Convert User Properties Select this check box to attach any user properties you have defined in Viz or Max to the converted Navisworks items.

When this check box is clear, the file exporter ignores user properties.

Pre-Render Scene By default, this check box is clear.

Select this check box if the exported file misses some texture maps. This forces Viz/Max to do an internal render, and cache all texture maps. As a result, all texture maps are exported with the model.

See also:

- [“Viz and Max File Exporter”](#) on page 114

Tools Node

Use the settings in this node to adjust the options for Presenter, TimeLiner, Scripter, and Animator.

Presenter Page

Use this page to adjust the Presenter options.

Profile You can adjust Presenter to your level of knowledge.

Select from the following options:

- **Basic** - gives you access to the basic Presenter features, with a limited editing functionality. This is the default option.
- **Standard** - gives you access to some of the advanced Presenter features.
- **Advanced** - gives you access to the advanced Presenter features, such as extra materials, lights, render styles.

Smoothed Textures Select this check box if you want textures to look smooth; this takes longer to render.

When this check box is clear, the textures render faster, but appear pixelated.

Filtered Textures Select this check box to turn on mipmapping. Using this option improves the appearance of textures in the distance.

Interactive Materials Indicates whether the applied Presenter materials are shown during navigation. By default, this check box is selected.

When this check box is clear, textures are not displayed during navigation. Using this option reduces the load on graphics cards, and gives less drop-out in heavily textured scenes. The materials reappear automatically when navigation stops, provided Autodesk Navisworks uses full render mode.

Interactive Lighting Indicates whether the applied Presenter lights are shown during navigation. By default, this check box is selected.

When this check box is clear, lights are not displayed during navigation. Using this option reduces the load on graphics cards, and gives less drop-out in heavily lit scenes. The lights reappear automatically when navigation stops, provided Autodesk Navisworks uses full lights mode.

Max Texture Size This option affects the visual details of the textures applied to geometry. Enter the desired value in pixels. For example, a value of 128 means the maximum texture size of 128 pixels x 128 pixels.

The higher the value, the higher the load on your graphics card, as more MB in memory is required to render textures.

Max Image Texture Size Specifies the maximum size for texture images in pixels. For example, a value of 256 means the maximum texture size of 256 pixels x 256 pixels.

The higher the value, the higher the load on your graphics card, as more MB in memory is required to render textures.

Max Background Texture Specifies the maximum size for background textures in pixels. For example, a value of 256 means the maximum texture size of 256 pixels x 256 pixels.

The higher the value, the higher the load on your graphics card, as more MB in memory is required to render textures.

Blend Transparent Textures Select this check box to use partially transparent objects. This option improves overall quality, but takes longer to render.

When this check box is clear, items with transparency of more than 50% are treated as completely transparent, and are not rendered.

Use Texture Anti-Aliasing Indicates whether antialiasing is used for procedural textures. Selecting this check box improves quality, but takes longer to render.

A procedural texture is a mathematically-generated image that represents natural elements such as wood, marble, granite, metal, stone, and so on. In Presenter, procedural textures have ball-style preview icons.

Hardware Shading Selects the hardware-accelerated shading.

NOTE This option can only be used on machines with OpenGL 1.5 compliant graphics cards.

Choose from the following options:

- **Off** - turns off hardware-accelerated shading.
- **Lighting** - only lights are shown.
- **Passive Shadows** - both lights and shadows are turned off during navigation, and automatically reappear when navigation stops.
- **Interactive Shadows** - both lights and shadows are shown during navigation.

Hardware Bump Maps Select this check box to display bump map textures during navigation. To use this option, enable **Hardware Shading** first.

NOTE This option can only be used on machines with OpenGL 1.5 compliant graphics cards.

Hardware Marble Select this check box to display hardware-rendered marble materials during navigation. To use this option, enable **Hardware Shading** first.

NOTE This option can only be used on machines with OpenGL 1.5 compliant graphics cards.

TimeLiner Page

Use the settings in this node to customize the TimeLiner options.

Auto Select Attached Items Indicates whether selecting tasks in the TimeLiner window automatically selects attached objects in the Scene View. This check box is selected by default.

Display Synchronization Errors Indicates whether error messages are displayed when you synchronize tasks from external links in TimeLiner. This check box is selected by default.

Scripter Page

Use the settings in this node to customize the Scripter options.

Message Level Selects the contents of the message file.

Choose from the following options:

- **User** - the message file only contains user messages (that is, messages generated by message actions in scripts).
- **Debug** - the message file contains both user messages and debug messages (that is, messages generated internally by Scripter). Debugging enables you to see what is going on in more complex scripts.

Path to Message File Use this box to enter the location of the message file. If a message file doesn't exist yet, Autodesk Navisworks attempts to create one for you.

NOTE You can't use variables in the file path.

Animator Page

Use the settings in this node to customize the Animator options.

Display Manual Entry Indicates whether the Manual Entry bar is shown in the Animator window. By default, this check box is selected.

Default Collision Dialog Box

Use this dialog box to specify and save your preferred collision settings.

By default, collision, gravity, crouching, and third person view are switched off. When you modify default collision settings, your changes do not affect the currently opened Autodesk Navisworks file. They are used as soon as you open a new Autodesk Navisworks file, or start a new Autodesk Navisworks session.

TIP If you want to restore the default values, click the Defaults button.

Pointing device: Global Options dialog box ► Interface node ► Viewpoint Defaults option ► Settings button

Collision Select this check box to define a viewer as a collision volume in walk and fly modes. As a result, a viewer acquires some mass, and cannot pass through other objects, points, or lines in the Scene View.

NOTE Selecting this check box changes the rendering prioritization so that objects around the viewer are displayed with much higher detail than normal. The size of the region of high detail is based on collision volume radius and speed of movement.

Gravity Select this check box to give a viewer some weight in walk mode. This option works in conjunction with Collision.

Auto Crouch Select this check box to enable a viewer crouch under objects that are too low to pass under in walk mode. This option works in conjunction with Collision.

Viewer

Radius Specifies the radius of the collision volume.

Height Specifies the height of the collision volume.

Eye Offset Specifies the distance below the top of the collision volume, where the camera will focus upon if Auto Zoom check box is selected.

Third Person

Enable Select this check box to use third person view. In third person view, an avatar is shown in the Scene View to represent the viewer.

Selecting this check box changes rendering prioritization so that objects around the avatar are displayed with much higher detail than normal. The size of the region of high detail is based on collision volume radius, speed of movement, and the distance of the camera behind the avatar.

Auto Zoom Select this check box to automatically switch from third person view to first person view whenever the line of vision becomes obscured by an item.

Avatar Specifies the avatar that is used in third person view.

Angle Specifies the angle at which the camera looks at the avatar.

For example, zero degrees positions the camera directly behind the avatar; 15 degrees makes the camera look down on the avatar at a 15 degree angle.

Distance Specifies the distance between the camera and the avatar.

Collision Dialog Box

Use this dialog box to adjust the collision settings for the selected viewpoint.

By default, collision, gravity, crouching, and third person view are switched off.

TIP If you want to restore the default values, click the Defaults button.

Pointing device: Edit Viewpoint dialog box ► Settings button

Collision Select this check box to define a viewer as a collision volume in walk and fly modes. As a result, a viewer acquires some mass, and cannot pass through other objects, points, or lines in the Scene View.

NOTE Selecting this check box changes the rendering prioritization so that objects around the viewer are displayed with much higher detail than normal. The size of the region of high detail is based on collision volume radius and speed of movement.

Gravity Select this check box to give a viewer some weight in walk mode. This option works in conjunction with Collision.

Auto Crouch Select this check box to enable a viewer crouch under objects that are too low to pass under in walk mode. This option works in conjunction with Collision.

Viewer

Radius Specifies the radius of the collision volume.

Height Specifies the height of the collision volume.

Eye Offset Specifies the distance below the top of the collision volume, where the camera will focus upon if Auto Zoom check box is selected.

Third Person

Enable Select this check box to use third person view. In third person view, an avatar is shown in the Scene View to represent the viewer.

Selecting this check box changes rendering prioritization so that objects around the avatar are displayed with much higher detail than normal. The size of the region of high detail is based on collision volume radius, speed of movement, and the distance of the camera behind the avatar.

Auto Zoom Select this check box to automatically switch from third person view to first person view whenever the line of vision becomes obscured by an item.

Avatar Specifies the avatar that is used in third person view.

Angle Specifies the angle at which the camera looks at the avatar.

For example, zero degrees positions the camera directly behind the avatar; 15 degrees makes the camera look down on the avatar at a 15 degree angle.

Distance Specifies the distance between the camera and the avatar.

Convert Object Properties Dialog Box

Use this dialog box to select third-party applications for the DWG and DXF file reader to read object information from.

The DWG and DXF file reader can convert object information from a number of third-party applications that are built on AutoCAD.

Pointing device: Global Options ► File Readers node ► DWG/DXF/SAT option ► Advanced button

Select the check boxes for all required applications.

Culling Options Dialog Box

This dialog box is shown when you access the culling options from the Navigator window. It enables you to adjust geometry culling when you navigate a model in an AutoCAD application.

Area

Enable Specifies whether area culling is used.

Number of Pixels Below Which Objects are Culled Specifies a value for the screen area in pixels below which objects are culled. For example, setting the value to 100 pixels means that any object within the model that would be drawn less than 10x10 pixels in size are discarded.

Backface

Turns on backface culling for all objects. Select from the following options:

- **On** - turns on backface culling for all objects.
- **Off** - turns off backface culling.
- **Solid** - turns on backface culling for solid objects only. This is the default option.

Near Clip Plane

Furthest Distance Specifies the farthest distance between the camera and the near clip plane position.

Automatically Generated Specifies whether Autodesk Navisworks automatically controls the near clip plane position to give you the best view of the model.

Far Clip Plane

Closest Distance Specifies the closest distance between the camera and the far clip plane position.

Automatically Generated Specifies whether Autodesk Navisworks automatically controls the far clip plane position to give you the best view of the model.

TIP If you want to restore the default values, click the Defaults button.

Customize Dialog Box

Use this dialog box to customize the appearance and contents of the Navisworks toolbars.

 **Menu:** Tools ► Customize

Shortcut menu: Customize

Buttons

Keyboard Opens the Customize Keyboard dialog box and enables you to customize keyboard shortcuts.

Toolbars Tab

Use this tab to specify which toolbars should appear and which should be hidden, and to add and manage your own toolbars.

Toolbars Select the check box to display the corresponding toolbar. Clear the check box to hide the corresponding toolbar.

Buttons

New Creates a new custom toolbar. By default, new toolbars are named "Custom X" where 'X' is the next available number added to the list.

Rename Enables you to rename a custom toolbar.

Delete Enables you to delete a custom toolbar.

Commands Tab

Use this tab to add and remove commands from the Menu bar and the toolbars.

NOTE You cannot add and remove commands from shortcut menus.

Categories Contains the groups of commands that can be customized.

Commands Contains all available commands for the selected category.

Selected Command

Description Activates when you've dropped the command onto a toolbar or a menu. Clicking this button gives you more information about the command.

Modify Selection Activates when you've dropped the command onto a toolbar or a menu. Clicking this button enables you to edit the command's appearance.

- **Reset** - resets the selected command to its default appearance.
- **Delete** - deletes the selected command.
- **Name** - specifies the name of the command. Place **&** (ampersand) in front of a letter you want to use as a keyboard shortcut. Pressing ALT together with this letter activates the command.
- **Default Style** - uses the default style for the command.
- **Text Only** - the command is shown as text (as it's entered in the Name box).
- **Image and Text** - the command is show as both text and image.
- **Begin a Group** - adds a separator to the left of the command if it's added to a toolbar, or above the command, if it's added to a menu.

Options Tab

Use this tab to personalize appearance of toolbars and menus, and to customize keyboard shortcuts.

Personalized Menus and Toolbars

Always Show Full Menus Indicates whether the Menu bar contains all commands. By default, this check box is selected.

If you want to show only basic and frequently used commands on short versions of the menus, clear this check box.

Show Full Menus After a Short Delay Activates when the Always Show Full Menus check box is clear. Select this check box if you want to show all commands on the menu after a brief delay when you rest the mouse pointer on an open menu.

Reset Menu and Toolbar Usage Data Resets any changes you've made to the appearance of toolbars and menus to default settings.

Other

Large Icons Toggles the size of the toolbar buttons. This does not affect icons used on the menus.

List Font Names in Their Font Toggles the way the font names are shown in font lists.

Show ScreenTips on Toolbars Toggles the display of tooltips when the mouse is over a toolbar button.

Show Shortcut Keys in ScreenTips Activates when the Show ScreenTips on Toolbars check box is selected. Toggles the display of shortcut keys in tooltips.

Menu Animations Defines the way menus are animated.

Customize Keyboard Dialog Box

Use this dialog box to assign keyboard shortcuts to the Navisworks commands.

Pointing device: Customize dialog box ► Keyboard button

Specify a Command

Categories Contains the groups of commands that can be customized.

Commands Contains all available commands for the selected category.

Specify a Shortcut

Current Shortcut Displays the current keyboard shortcut for the selected command, if assigned.

Select a New Shortcut Select the shortcut you want to assign to the selected command from the drop-down list of valid shortcuts.

Currently Assigned To

Displays the command a shortcut is assigned to if the shortcut you've entered is already assigned.

Description

A description of the selected command, if defined.

Buttons

Assign Activates when you select a value from the Select a New Shortcut drop-down list. When you click Assign, it transfers the shortcut information to the Current Shortcut box.

Remove Removes the shortcut selected in the Current Shortcut box.

Reset All Resets any changes you've made to the shortcuts to the default settings.

Pointing device: Click the Keyboard button in the Customize dialog box.

Edit Key Frame Dialog Box

Use the Edit Key Frame dialog box to edit keyframes for animation sets, cameras, and section planes.

The fields in this dialog box are context-sensitive, depend on the animation type, and enable you to edit the animation operations the selected keyframe represents.

Pointing device: Double-click a keyframe

Shortcut menu: Right-click a keyframe. Click Edit.

Edit Key Frame - Animation Set

All values are relative to the previous keyframe, or, if it is the first keyframe, relative to the model's starting position.

Time Enables you to reposition the time of this keyframe. The value is the number of seconds since the start of the scene; it is not relative to the last keyframe.

Translate Enter the X, Y, and Z coordinate values to move the selected objects into this position.

Center Enter the X, Y, and Z coordinate values to move the center point of the rotation or scale into this position.

Rotate Enter the degrees of rotation around X, Y, and Z axis to move the selected objects into this position.

Orientation Enter the degrees of rotation around X, Y, and Z axis to modify the orientation of the rotation.

NOTE 0,0,0 represents world up.

Scale Enter the scaling factor around X, Y, and Z axis; 1 being the current size, 0.5 half, 2 being double and so on.

Color This check box indicates whether the color change is recorded in the keyframe.

R, G, B Enter the Red, Green, and Blue values for the new color.



If you don't want to enter the R, G, B values manually, click this button, and select the desired color.

Transparency This check box indicates whether the transparency change is recorded in the keyframe.

% Enter the value to adjust the transparency level (0 to 100%). A higher value makes the element more transparent; a lower value makes the element more opac.



If you don't want to enter the transparency value manually, use this slider to adjust the transparency level.

Interpolate Determines whether Navisworks automatically interpolates between the current and the last keyframes. This is the default option. When disabled, there is no gradual movement between the two keyframes; instead the animation instantly jumps to the position/view of the second keyframe when it's reached. Also, there will be no colored animation bar between the keyframes.

Edit Key Frame - Camera

Time Enables you to reposition the time of this keyframe. The value is the number of seconds since the start of the scene; it is not relative to the last keyframe.

Position Enter the X, Y, and Z coordinate values to move the camera into this position.

Look At Enter the X, Y, and Z coordinate values to change the focal point for the camera.

Vertical Field of View, Horizontal Field of View Defines the area of the scene that can be viewed through the camera. You can adjust the values for both vertical and horizontal angles of view. A larger value produces a wider angle of view and a smaller value produces a narrower, or more tightly focused, angle of view.

NOTE When you modify the Vertical Field of View, the Horizontal Field of View is automatically adjusted, and vice versa to match the aspect ratio in Navisworks.

Roll Rotates the camera around its front-to-back axis. A positive value rotates the camera anticlockwise, and a negative value rotates it clockwise.

Interpolate Determines whether Navisworks automatically interpolates between the current and the last keyframes. This is the default option. When disabled, there is no gradual movement between the two keyframes; instead the animation instantly jumps to the position/view of the second keyframe when it's reached. Also, there will be no colored animation bar between the keyframes.

Edit Key Frame - Section Plane

Time Enables you to reposition the time of this keyframe. The value is the number of seconds since the start of the scene; it is not relative to the last keyframe.

Section Planes A list of current section planes.



Adds a section plane to the Section Planes list.



Deletes the section plane selected in the Section Planes list.

Distance The distance of the selected section plane across the model.

Plane Selects the vector that represents the angle of the section plane. The drop-down list contains a range of pre-defined values. If you select the Define Custom option, you can manually define the 'up' vector for the plane.

Enabled Indicates whether the selected section plane is active or not.

Interpolate Determines whether Navisworks automatically interpolates between the current and the last keyframes. This is the default option. When disabled, there is no gradual movement between the two keyframes; instead the animation instantly jumps to the position/view of the second keyframe when it's reached. Also, there will be no colored animation bar between the keyframes.

Publish Dialog Box

Use this dialog box to adjust security settings for a published NWD file.

Menu: File ► Publish

Toolbar: Standard ► Publish

Title Displays the document title. The title doesn't have to be the same as the file name.

Subject Displays the document subject.

Author Displays the author of the document.

Publisher Displays the publisher of the document.

Published For Displays the party the document is published for.

Copyright Displays copyright information.

Keywords List of keywords that can be used to search for this document.

Comments Displays additional information about the document.

Password You can limit access to an NWD file by entering a password into this box. You are asked to confirm the password later, when you click OK in this dialog box.

Now anybody who wants to open this NWD file must type in the password you specified.

IMPORTANT If you forget your password, you cannot recover it from the published NWD file.

Display at password This check box indicates whether the Publish dialog box is shown to users who are trying to open password-protected NWD files.

Selecting this check box gives the users a read-only access to document properties, and enables them to find out the details of the person they can request a password from.

Clear this check box if you don't want to provide the document information to users.

Expires Select this check box to set an expiration date for the published file. This activates the Calendar box, where you can pick the required date. After the selected date is passed, the file cannot be opened.

NOTE Evaluation copies of Autodesk Navisworks Simulate 2010 can publish NWD files, however, these files have the same expiry date as the evaluation software. To remove the expiry date from an NWD file created by an evaluation copy, you must re-publish the file with a full Autodesk Navisworks Simulate 2010 license.

May be Re-saved This check box controls whether users can republish this file as an NWD.

If this check box is clear, the review changes made to the published file can only be saved as an NWF file.

Display on Open This check box indicates whether the Publish dialog box is shown to the users as soon as they open the file.

If the file is password-protected, the dialog box is shown after the users have entered the correct password.

Embed Textures Select this check box if you want to embed all textures into the published file. This enables you to password-protect textures, including any custom or imported textures.

By default, this check box is clear, and textures are saved separately.

Embed Database Properties Select this check box if you want to embed all properties accessed via external databases in the published file.

By default, this check box is clear, and only the database links are stored in the published file.

Prevent Object Property Export Select this check box if you don't want to include object properties that come from native CAD packages in the published file. This enables you to protect intellectual property.

Background Settings Dialog Box

Use this dialog box to choose a background effect to use in the Scene Area.

 **Menu:** Tools ► Background

Mode Selects the type of background effect. Choose from:

- Plain
- Graduated
- Horizon

Color Sets the color for a plain background.

Top Color Sets the top color in a graduated background.

Bottom Color Sets the bottom color in the graduated background.

Sky Color Sets the sky color (top) in a horizon background.

Horizon Sky Color Sets the sky color (bottom) in a horizon background.

Horizon Ground Color Sets the ground color (top) in a horizon background.

Ground Color Sets the ground color (bottom) in a horizon background.

QTVR Object Movie Settings Dialog Box

Use this dialog box to specify the number of pan frames and number of tilt frames that are used to export the QuickTime VR object movie.

Pointing device: Export Rendered Image ► QTVR Object Movie Type ► OK button

Pan Settings

Pan Min and Pan Max Define how far the model can be revolved (as though on a turntable).

Pan Initial Defines where you view the model from at the start (again, as though on a turntable, 0 or 360 would be the same point at the opposite side and 180 would be where the camera is now).

Pan Frame No. The number of frames to be used to revolve the model from the Pan Min position to the Pan Max position.

Tilt Settings

Tilt Min and Tilt Max Define how far the model can be tilted (backwards and forwards from its current position).

Tilt Initial Defines where you view the model from at the start (assuming you are looking at the model straight, -90 would be from the bottom and 90 from the top).

Tilt Frame No. The number of frames to be used to tilt the model from the Tilt Min position to Tilt Max position.

Export Rendered Image Dialog Box

Use this dialog box to export a rendered scene into one of the file types supported by Autodesk Navisworks.

 **Menu:** File ► Export ► Rendered Image

Type Use the drop-down list to select one of the file types supported by Autodesk Navisworks.

Choose from:

- Targa
- TIFF
- JPEG
- Windows Bitmap
- EPix
- PostScript
- LWI
- HDR (High Dynamic Range Image)
- OpenEXR (High Dynamic Range Image)

NOTE The QTVR Panoramic Movie will effectively export 32 images, rotating about the current camera position to form a 360 degree panorama. Best results are achieved when the camera has zero tilt and is located in a position that has a 360 degree panoramic view, for example, in the center of a room.

■ QuickTime VR Object Movie

NOTE The QTVR Object Movie will effectively export an extensive number of images, (based on number of pan frames x number of tilt frames, see “[QTVR Object Movie Settings Dialog Box](#)” on page 414) pivoting the model about its center point. Best results are achieved when the model is relatively small or compact.

Browse Opens the Save As dialog box, and enables you to specify the location, and the name of the file you want to render to.

Size

Type Use the drop-down list to specify how to set the size of the exported image.

Choose from:

- **Explicit.** Gives you full control of the width and height (the dimensions are in pixels).
- **Use Aspect Ratio.** Enables you to specify the height. The width is automatically calculated from the aspect ratio of your current view.
- **Use View.** Uses the width and height of your current view.
- **Use Printer Page.** Sizes the image to the page setup size of the default printer.

Width Enables you to enter the width in pixels, when available.

Height Enables you to enter the height in pixels, when available.

Image Export Dialog Box

Use this dialog box to export the current viewpoint into one of the file types supported by Autodesk Navisworks.

 **Menu:** File ► Export ► Image

Type Use the drop-down list to select one of the image types supported by Autodesk Navisworks.

Choose from:

- **JPEG**
- **Windows Bitmap**
- **PNG**

Options Enables you to specify the options for .png and .jpg file formats. For PNG images, you can select the Interlacing and Compression levels, and for the JPEG images you can select Compression and Smoothing levels.

Size

Type Use the drop-down list to specify how to set the size of the exported image.

Choose from:

- **Explicit.** Gives you full control of the width and height (the dimensions are in pixels).
- **Use Aspect Ratio.** Enables you to specify the height. The width is automatically calculated from the aspect ratio of your current view.
- **Use View.** Uses the width and height of your current view.

Width Enables you to enter the width in pixels, when available.

Height Enables you to enter the height in pixels, when available.

Options

Anti-Aliasing This option applies to OpenGL renderer only. Anit-aliasing is used to smooth the edges of the exported images. Select the appropriate value from the drop-down list. The higher the number, the smoother the image, but the longer they take to export. 4x is adequate for most situations.

Animation Export Dialog Box

Use this dialog box to export an animation to an AVI file or a sequence of image files.

 **Menu:** File ► Export ► Animation

Source

Source Selects the source from which to export the animation. Choose from:

- **Current Animation.** The currently selected viewpoint animation.
- **TimeLiner Simulation.** The currently selected TimeLiner sequence.
- **Current Animator Scene.** The currently selected object animation.

Renderer

Renderer Selects the animation renderer. Choose from:

- **OpenGL.** Quickly renders your animation; this option is also ideal for previewing animations.
- **Presenter.** Use this option when you require the highest rendering quality.

Output

Format Select the output format. Choose from:

- **Windows AVI.** Exports animation as a commonly readable AVI file. Use the Options button to select the video compressor from the drop-down list, and adjust the output settings.

NOTE If a video compressor is not available on your computer, the Configure button may be greyed out.

- **JPEG.** Exports a sequence of static images, which are taken from individual frames in the animation. Use the Options button to select Compression and Smoothing levels.
- **PNG.** Exports a sequence of static images, taken from individual frames in the animation. Use the Options button to select Interlacing and Compression levels.
- **Windows Bitmap.** Exports a sequence of static images, which are taken from individual frames in the animation. There are no Options for this format.

Options Enables you to configure the options for the selected output format.

Size

Type Use the drop-down list to specify how to set the size of the exported animation.

TIP For animations, a much lower resolution can be used than for static images, for example, 640x480.

Choose from:

- **Explicit.** Gives you full control of the width and height (the dimensions are in pixels).
- **Use Aspect Ratio.** Enables you to specify the height. The width is automatically calculated from the aspect ratio of your current view.
- **Use View.** Uses the width and height of your current view.

Width Enables you to enter the width in pixels, when available.

Height Enables you to enter the height in pixels, when available.

NOTE There is a maximum size of 2048 x 2048 pixels, for Autodesk Navisworks OpenGL output.

Options

FPS Specifies the number of frames per second; this setting is relevant for AVI files.

NOTE The higher the FPS, the smoother the animation will be. However, using a high FPS will considerably increase the rendering time. It is, usually, acceptable to use between 10 to 15 FPS.

Anti-Aliasing This option applies to OpenGL renderer only. Anti-aliasing is used to smooth the edges of the exported images. Select the appropriate value from the drop-down list. The higher the number, the smoother the image, but the longer they take to export. **4x** is adequate for most situations.

Glossary

Glossary of technical terms relating to Autodesk Navisworks Simulate 2010.

Display Terminology

average frame rate This shows the current measured frame rate, averaged over the last second.

average frame time This shows the time taken to render the last frame.

average triangle rate This shows the rate at which triangles are being rendered and is a measure of how well your graphics card is working.

culling Culling is a process for determining items *not* to draw during the render of a scene. Autodesk Navisworks does a level of prioritized culling with the **drop-out** method of rendering interactive scenes, but you have a certain level of control over other aspects of culling such as backface, near and far planes.

drop-out In order to maintain interactivity and guarantee a user-defined **frame rate**, Autodesk Navisworks only renders what it can in the fraction of a second it has. The remainder is "dropped out", or not rendered.

Autodesk Navisworks prioritizes what is rendered and what is dropped out based on size of the item's bounding box, distance from viewer and size on screen, so only the less significant items in the scene are dropped out.

Once navigation has ceased, the scene continues rendering until all items are visible.

frame rate The frame rate is the number of frames per second (FPS) that are rendered in the main navigation window. Autodesk Navisworks guarantees a user-defined frame rate in order to maintain interactivity.

Export Terminology

These are terms specific to Autodesk Navisworks that are used in relation to exporting.

codec Codec stands for "COmpression-DECompression" and is a program that compresses and decompresses animations when creating and playing back .avi files. Codecs are installed independently of Autodesk Navisworks and are available when installed on your Windows™ system and the same codec that was used to create an .avi file is required to play it back.

File Terminology

cache files (.nwc) When any native CAD file is opened or appended, Autodesk Navisworks creates a cache file (.nwc) if the write cache option is set. When the file is next opened or appended, Autodesk Navisworks will read data from the corresponding cache file rather than re-converting the original data if the cache is newer than the original file. If the original file is altered, Autodesk Navisworks will re-create the cache file when it is next loaded. Cache files speed up access to commonly used files. They are particularly useful for models made up of many files of which only a few are changed between viewing sessions. Cache files can also be exported from some CAD applications where a native file reader is not available with Autodesk Navisworks. Cache options can be edited in the Options Editor (Tools ► Global Options ► Model node).

external references External references (sometimes called reference files or "XRefs") are shown in Autodesk Navisworks Selection Tree as an inserted group. Autodesk Navisworks looks for the externally referenced files in the same place as AutoCAD or MicroStation would.

If the Unresolved XRef dialog box is shown, then this link has somehow been broken and the referenced files need to be relocated to where AutoCAD or MicroStation would expect them to be.

If these XRefs are not important for the current session, then you can Ignore the reference and the file will load without that XRef inserted. Similarly, Ignore All will load the file without any unresolved XRefs.

You can also customize the options for the DWG/DXF/SAT and DGN file readers in the Options Editor (Tools ► Global Options ► File Readers node) to set whether external references are loaded or not. This gives you more control over file appending into Autodesk Navisworks.

faceting factor During an export from a CAD package to .nwc format, or while Autodesk Navisworks is reading a native CAD file, decisions must be made as how a curved surface is reduced to flat facets. For most applications and file formats, you have control over the level of faceting that takes place.

All items, no matter what their size, will use the same faceting factor and so have the same number of sides to curved entities. Therefore, you need to experiment a little with different values to account for the size that these items will appear on screen.

The faceting factor must be greater or equal to 0, where 0 results in the faceting factor being turned off. The default value is 1, if you double the value you get twice the number of facets, if you halve the value you get half as many facets. Larger faceting factors will result in more polygons to a model and larger Autodesk Navisworks files. There is little point having a large faceting factor if these curved entities are golf balls viewed from 200 yards!

For AutoCAD exports, the faceting factor is set from the NWCOPT command. MicroStation's faceting factor is set from Options, which is available from the NWCOUT export dialog. To set the faceting factor on reading CAD files go to the Options Editor (click Tools ► Global Options, expand the File Readers node, and choose the relevant file reader page).

max facet deviation Maximum facet deviation is used in conjunction with faceting factor to ensure that larger objects, with too large a deviation from the original, have additional facets added. If a difference greater than the entered value is found in a model it adds more facets. The values are measured in the model units.

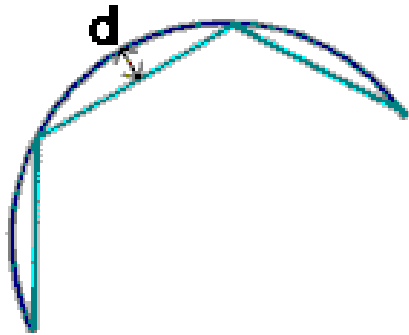

Where d is greater than the maximum faceting deviation value, more facets are added to the object.

If the max faceting deviation is set to 0, then this function is ignored and just the faceting factor is used.

published data files (.nwd) Published NWD files are useful when wanting to take a snapshot of the model at a certain time. All the geometry and review information is saved into the .nwd file and cannot then be changed. Published NWD files can also contain information about the file, as well as being able to be password protected and time-bombed for security. These files are also very small, compressing the CAD data by up to 80% of the original size.

Published NWD files are useful when issuing models for viewing by others with the Autodesk Navisworks Freedom 2010 free viewer, as well as being appendable themselves into Autodesk Navisworks to build up a larger scene.

review files (.nwf) Review files are useful when using the native CAD files appended into Autodesk Navisworks. They store the location of the appended files, along with any design reviews made in Autodesk Navisworks, such as comments, redlines, viewpoints, animations and so on.

If a group of files is appended into a Autodesk Navisworks scene, and saved as an NWF file, then on re-opening this .nwf file later, once the original CAD files have been changed, the updated CAD files will be loaded into the scene for review.

shape merge threshold MicroStation shapes are polygons that can have 3 or more vertices. They're often used to model more complex objects which can waste memory. So, Autodesk Navisworks merges all shapes on the same level or in the same cell and with the same color into a "Shape Set" if these shapes have less than or equal to the number of vertices given by the *Shape Merge Threshold*.

Selection Terminology

These are terms specific to Autodesk Navisworks that are used in relation to selecting items.

composite objects A composite object is a group of geometry that is considered a single object in the selection tree. For example, a window object might be made up of a frame and a pane. If a composite object, the window object would be both the frame and the pane and be selected all at once.

instances An instance is a single object, which is referred to several times within a model, for example a tree. This has the advantage of cutting down on file size by not unnecessarily repeating an object.

item name The original CAD or Autodesk Navisworks assigned identifier. Any item can have a name and this name will usually come from the original CAD package that the model was created in.

item type Every item in Autodesk Navisworks has a type. Examples of types are reference files, layers, instances (sometimes called inserts) and groups. Every CAD package also has a number of geometry types, for example, polygons, 3D Solids and so on.

selection resolution The selection resolution is the level in the selection tree you start selecting at. You can cycle through items in the tree by holding down the shift key during a selection.

user name and internal name Each category and property name has two parts - a user visible string which is localized and an internal string which isn't and is mainly used by the API. By default when matching names in the Smart Tags and Find Items dialog boxes, both parts must be the same, but you can use the flags to match only on one part. You might use Ignore User Name if you wanted to match something irrespective of which localized version was being used.

Viewpoint Terminology

angular speed The speed that the camera moves when turning right and left in any navigation mode.

anti-aliasing Anti-aliasing improves image quality by softening the jagged edge appearance of sharp lines. 2x to 64x refers to the extra number of frames that are required for the anti-aliasing process. The greater the number of frames, the finer the effect, (with the consequent increase in rendering time).

aspect ratio Aspect ratio is the proportion of X-axis to Y-axis size. For example, in exporting a bitmap of a viewpoint, maintaining the aspect ratio would keep the proportion of the view even if the number of pixels was different.

camera-centric Navigation modes in which the camera is moved around the model.

field of view The field of view of a camera is the angle that the camera can see. A large field of view will fit more into the view, but will look distorted and a small field of view will tend to make the view more flat, tending towards an orthographic view. There are two fields of view in Autodesk Navisworks - vertical and horizontal. Editing one will change the other and the two are related by the viewpoint's [aspect ratio](#).

focal point The focal point is the position in 3D space that the camera will rotate around or zoom into in examine, orbit, turntable and zoom modes.

model centric Navigation modes in which the model is moved in front of the camera.

roll The roll of the camera is its angle around the viewing axis. This cannot be edited in a navigation mode where the world up vector stays upright (walk, orbit and turntable).

saved attributes Each viewpoint can optionally save the state of its hidden and "required" items, as well as any material (color and transparency) overrides. Then, on recalling the viewpoint, those same items are re-hidden, re-made required, and the materials reinstated. This can be useful in the creation of animations when dragging on viewpoints onto an empty animation.

tilt angle This is indicated in the scene's units below (negative) or above (positive) horizontal (0) at the base of the tilt bar.

viewpoint up vector The direction that Autodesk Navisworks considers "up" is called the "viewpoint up vector". This is maintained in the walk, orbit and turntable modes. This may be also referred to as 'world up vector'.

Index

3D space 126
4D 364

A

ADN 13
align viewpoint 126
animation
 action types 297
 actions 297
 add sets 288
 capture 289
 create 285
 create scenes 286
 cut 252
 cuts 252
 delete scenes 286
 edit 251
 enable scripts 254, 298
 event conditions 296
 event types 296
 events 296
 object 251
 organize scenes 286
 play 254, 285
 record 251
 scope 271
 scripts 294
 sets 288
 share 254
 update sets 288
 viewpoint 251
Animation Export 416
Animation toolbar 66
Animator toolbar 272
annotations 216
append model 120
ARX plugin 106
Auto-Save 53
Autodesk Developer Network 13
AVI 254

B

background effects 170
Background Settings 413
backup 53

C

CAD preview 108
cameras 151
 align 152
 blank camera 291
 capture viewpoints 291
 from current viewpoint 291
 orthographic 151
 perspective 151
 straighten 151

 tilt 151
CIP (Customer Involvement Program) 15
close toolbars 61
collaborate
 drive 255
 refresh 255
 session 255
 start 255
 Windows NetMeeting 255
Collaborate Bar toolbar 67
collision 163
Collision 407
 auto crouch 407
 gravity 407
 third person 407
 viewer 407
color 209
command line 55
comments 216
 clash result 216
 edit 226
 find 223
 IDs 226
 review 223
 search set 216
 selection set 216
 status 226
 TimeLiner task 216
 view 216
 viewpoint 216
 viewpoint animation 216
Communication Center 7
 settings 8
 Subscription Center 13
compare
 items 194
 models 194
compatible CAD applications 88
configuration files 84
Convert Object Properties 408
create 117
crouching 163
culling 174
 area 174
 backface 174
 near and far clipping planes 174
 require objects 175
Culling Options 408
 area 408
 backface 409
 far clip plane 409
 near clip plane 409
custom properties 196
custom scene views 69
Customer Involvement Program 15
Customize 409
 commands 409
 keyboard shortcuts 410
 options 410
 toolbars 409

customize keyboard 76
customize toolbars 76
cuts 252

D

database links 198
Default Collision 407
 auto crouch 407
 gravity 407
 third person 407
 viewer 407
delete files 120
Display Units 82
dockable windows 70

E

edit
 comments 226
 redlines 226
edit animations 251
Edit Key Frame 411
Edit Link 374
Edit menu 58
Edit Viewpoint 374
email 123
enable scripts 254
enhancements 3
exit 53
export
 animations 266
 DWF 264
 image 366
 images 266
 KLM 264
 PDS tags 264
 Piranesi EPix 263
 search criteria 268
 search sets 269
 simulation 366
 TimeLiner CSV 266
 viewpoints 268
 viewpoints report 269
Export Image 415
Export Rendered Image 414

F

field selector 343
field selector codes 345
field selector options 344
file exporters 106
 ArchiCAD 115
 AutoCAD 106
 DGN 114
 Max 114
 MicroStation 112
 Revit 111
 Viz 114
file formats
 NWC 87
 NWD 87
 NWF 87

 supported CAD 90
 supported laser scan 91
File menu 57
File Options 78, 371
 culling 371
 DataTools 371
 head light 371
 orientation 371
 scene lights 371
 speed 371
file readers 91
 3DS 91
 ASCII laser scan 92
 Bentley AutoPLANT 92
 CIS2 93
 DGN 98
 DWF 97
 DWG/DXF/SAT 95
 Faro Scan 99
 IFC 99
 IGES 99
 Inventor 100
 JTOpen 100
 Leica Scan 101
 MAN 102
 PDS 103
 Riegl 103
 RVM 103
 SketchUp SKP 104
 STEP 104
 STL 105
 VRML 105
 Z+F Scan 106
file units 120
File Units and Transform 373
 file units 373
 origin 373
 rotation 373
 scale 373
find 186
 comments 223
 links 231
 redline tags 225
First Contact balloon 133
fly 131
focal point 131
frame rate 371
frustum culling 174
Full Navigation Wheels 133
full screen mode 69

G

gizmos 205
Global Options 78
 Developer 83
 Display Units 82
 Environment 81
 export 79
 import 79
 Location 82
graduated background 170
gravity 162

H

- hardware acceleration 177
- head-up display 165
- Help 9
 - access more information 12
 - concepts 11
 - print 11
 - procedures 11
 - quick reference 11
 - search 10
 - training 12
- Help menu 61
- hide objects 185
- highlighting 184
- horizon background 170
- HUD 165
- hyperlinks 226

I

- import
 - PDS display sets 261
 - PDS tags 260
 - search criteria 262
 - search sets 262
 - viewpoints 261
- installation 17, 21
 - deployment 28
 - deployment issues 48
 - general issues 45
 - languages 19
 - licensing issues 49
 - maintenance issues 50
 - multiple users 28
 - networking issues 49
 - side-by-side 27
 - stand-alone 17
 - troubleshooting 45

K

- keyboard shortcuts 74
- keyframes 293

L

- launch 53
- lighting 168
 - full lights 170
 - head light 169
 - no lights 169
 - scene lights 170
- links 226
 - add 230
 - attachment points 228
 - categories 227
 - control display 227
 - customize 228
 - default 232
 - delete 232
 - edit 232
 - external database 198
 - find 231

- follow 231
- reset 232
- section plane 248
- standard 227
- user-defined 227
- load backup 53
- Locations 82
- look around 129

M

- markups 216
- MDL plugin 112
- measure
 - angle between two lines 212
 - area 212
 - clear measuring lines 212
 - cumulative distance 212
 - distance between two points 212
 - point to multiple points 212
 - shortest distance 212
 - shortest distance between parametric objects 212
 - total distance along path 212
- measurements
 - convert to redlines 213
 - dimension labels 213
 - formatting 212
- Menu bar 57
- menus 57
 - Edit 58
 - File 57
 - Help 61
 - Review 60
 - Tools 60
 - View 59
 - Viewpoint 59
- merge
 - files 122
 - TimeLiner data 122
- Model Views toolbar 65
- move objects 205
- move toolbars 61
- multiple-user installation 28

N

- navigation 125
- Navigation Mode toolbar 63
- navigation modes 127
 - Examine 131
 - Fly 131
 - Look Around 129
 - Orbit 130
 - Pan 130
 - Turntable 132
 - Walk 128
 - Zoom 129
 - Zoom Box 130
- Navigation Tools toolbar 67
- NetMeeting 255
- network deployment 28
- Network License Activation 31
- Network License Manager 31
- network licenses 31

- network share 33
- new 117
- new features 3
- New Link 374
 - connection 374
 - fields 374
- notification icon 71
- notifications 7
- NWC 87
- NWD 87
- NWF 87

O

- object attributes 205
 - during animation 205
 - move 205
 - resize 205
 - rotate 205
- object attributes
 - color 209
 - snapping 209
 - transparency 209
- Object Enablers 96
- Object Manipulation toolbar 67
- open 117
- open toolbars 61
- Options Editor 375
 - file exporters 375
 - file readers 375
 - general 375
 - interface 375
 - model 375
 - tools 375
- orbit 130
- orientation 126
- overlay text 349
 - color keywords 350
 - date and time keywords 349
 - extra keywords 350

P

- pan 130
- pauses 252
- pick radius 182
- plain background 170
- Presenter 299
 - advanced lighting 315
 - advanced materials 309
 - archives 300
 - background effects 321
 - custom rules 331
 - edit materials 306
 - effects 321
 - foreground effects 325
 - lighting 310
 - materials 303
 - position lights 311
 - predefined rendering styles 327
 - predefined rules 330
 - rendering styles 326
 - shadows 315
 - texture space 328

- user archives 301
- Presenter materials 177
- preview 259
- primitives 172
 - lines 172
 - points 173
 - snap points 173
 - surfaces 172
 - text 173
- print 259
 - current viewpoint 260
 - preview 259
 - setup 259
- product news 7
- progress bar
 - disk 71
 - memory 72
 - pencil 71
 - web server 72
- Project Directory 82
- properties
 - custom 196
- publish 117
- Publish 412

Q

- QTVR Object Movie Settings 414
 - pan settings 414
 - tilt settings 414
- Quick Find 190
- quit 53

R

- Readme 15
- receive files 123
- recently used files 81
- record animations 251
- recover 53
- redlines
 - cloud 219
 - color 219
 - edit 226
 - erase 219
 - find tags 225
 - freehand 219
 - line 219
 - line string 219
 - review 223
 - status 226
 - tag 219
 - tag IDs 226
 - tags 216
 - text 219
 - thickness 219
 - view 219
- Redo 72
- refresh files 122
- rename 117
- rendering 167, 301
 - accelerate 177
 - control 176
 - full 168

- hidden line 168
- shaded 168
- stereo 178
- wireframe 168
- Rendering Style toolbar 64
- reset 210
- resize objects 205
- restore 210
- review 216
- Review menu 60
- Rich Photorealistic Content 318
- rotate objects 205
- RPC (Rich Photorealistic Content) 318

S

- save 117
 - automatically 53
 - search sets 192
 - selection sets 192
 - viewpoints 240
- Scene Area 68
- scene statistics 125
- scene views 68
 - content 69
 - custom 69
 - resize 68
- search directories 84
- search sets 191
 - delete 192
 - export 192
 - import 192
 - rename 192
 - save 192
 - update 192
- section plane sets 292
- section planes
 - align 245
 - disable 245
 - enable 245
 - link 248
 - move 245
 - slider step size 245
- sectioning 244
 - box attributes 248
 - boxes 248
 - planes 245
- Sectioning toolbar 66
- select link 343
- selection 179
 - commands 183
 - pick radius 182
 - resolution 183
 - sets 190
- selection sets
 - delete 192
 - rename 192
 - save 192
 - update 192
- Selection Tools toolbar 63
- Selection Tree 179
 - sort 179
- send 123

- share 123
 - animations 254
 - export files 263
 - import files 260
 - print 259
 - viewpoints 244
- shortcuts 74
- Show Internal Properties 83
- side-by-side installation 27
- simulation
 - 4D 364
- simulation settings 346
- Site Directory 82
- smart tags 233
 - control display 233
 - definition 233
 - hide category name 233
- snapping 209
- SpaceBall 159
- stand-alone installation 17
- Standard toolbar 62
- start 53
- status 226
- Status bar 71
- SteeringWheels 133
- stereo 178
- straighten 151
- Subscription Center 14
- SwitchBack
 - AutoCAD 234
 - MicroStation 234
- switches 55
- system requirements
 - network deployment 28
 - stand-alone installation 17

T

- tag IDs 226
- thumbnails 159
- tilt 151
- TimeLiner 335
 - active tasks 343
 - animation 366
 - animation to schedule 367
 - animation to tasks 369
 - attach tasks 356
 - configure 340
 - external project files 360
 - links 339, 362
 - rules 341
 - scripts to tasks 370
 - simulate 342
 - simulation playback 342
 - synchronize tasks with schedule 364
 - task types 340
 - tasks 336, 353
 - validate schedule 359
- Toolbar Options 61
- toolbars 61
 - Animation 66
 - Animator 272
 - Collaborate Bar 67, 255
 - customize 76

- delete 76
- Model Views 65
- Navigation Mode 63
- Navigation Tools 67
- new 76
- Object Manipulation 67
- Rendering Style 64
- Sectioning 66
- Selection Tools 63
- Standard 62
- Workspace 64
- Tools menu 60
- tooltips 133
- Tour Building Wheels 133
- transform 120
- transparency 209
- turntable 132

U

- UI 57
- Undo 72
- unhide objects 185
- updates 7
- upgrade 27
- user interface 57

V

- view
 - fit model to Scene Area 161
 - fit selection to Scene Area 161
 - hold items 162
 - set focal point 162
 - third person perspective 164
- View menu 59
- View Object Wheels 133
- ViewCube 153
 - appearance 153
 - compass 153
 - lock to selection 159
- Viewpoint menu 59
- viewpoints 237
 - default collision options 242

- default view attributes 242
- delete 241
- edit 241
- export 244
- folders 241
- organize 241
- save 240
- use 241

W

- walk 128
- wheels 133
- window
 - Animator 272
 - Comments 217
 - Edit Viewpoint 241
 - Find Comments 223
 - Find Items 186
 - Measure Tools 211
 - Presenter 299
 - Properties 195
 - Redline Tools 219
 - Saved Viewpoints 237
 - Scripter 272
 - Selection Sets 191
 - TimeLiner 335
- windows
 - auto-hide 70
 - dock 70
 - tile 70
 - undock 70
- Workspace toolbar 64
- workspaces 72
 - create 72
 - load 72
 - save 72
 - shared 72
- world orientation 126

Z

- zoom 129
- zoom area 130