

AutoCAD® Map 3D 2011

User's Guide

The Autodesk logo is displayed in white text on a black rectangular background. The text is oriented vertically, reading from bottom to top.

April 2010

© 2010 Autodesk, Inc. All Rights Reserved. Except as otherwise permitted by Autodesk, Inc., this publication, or parts thereof, may not be reproduced in any form, by any method, for any purpose.

Certain materials included in this publication are reprinted with the permission of the copyright holder.

Trademarks

The following are registered trademarks or trademarks of Autodesk, Inc., and/or its subsidiaries and/or affiliates in the USA and other countries: 3DEC (design/logo), 3December, 3December.com, 3ds Max, Algor, Alias, Alias (swirl design/logo), AliasStudio, AliasWavefront (design/logo), ATC, AUGI, AutoCAD, AutoCAD Learning Assistance, AutoCAD LT, AutoCAD Simulator, AutoCAD SQL Extension, AutoCAD SQL Interface, Autodesk, Autodesk Envision, Autodesk Intent, Autodesk Inventor, Autodesk Map, Autodesk MapGuide, Autodesk Streamline, AutoLISP, AutoSnap, AutoSketch, AutoTrack, Backburner, Backdraft, Built with ObjectARX (logo), Burn, Buzzsaw, CAiCE, Civil 3D, Cleaner, Cleaner Central, ClearScale, Colour Warper, Combustion, Communication Specification, Constructware, Content Explorer, Dancing Baby (image), DesignCenter, Design Doctor, Designer's Toolkit, DesignKids, DesignProf, DesignServer, DesignStudio, Design Web Format, Discreet, DWF, DWG, DWG (logo), DWG Extreme, DWG TrueConvert, DWG TrueView, DXF, Ecotect, Exposure, Extending the Design Team, Face Robot, FBX, Fempro, Fire, Flame, Flare, Flint, FMDesktop, Freewheel, GDX Driver, Green Building Studio, Heads-up Design, Heidi, HumanIK, IDEA Server, i-drop, ImageModeler, iMOUT, Incinerator, Inferno, Inventor, Inventor LT, Kaydara, Kaydara (design/logo), Kynapse, Kynogon, LandXplorer, Lustre, MatchMover, Maya, Mechanical Desktop, Moldflow, Moonbox, MotionBuilder, Movimento, MPA, MPA (design/logo), Moldflow Plastics Advisers, MPI, Moldflow Plastics Insight, MPX, MPX (design/logo), Moldflow Plastics Xpert, Mudbox, Multi-Master Editing, Navisworks, ObjectARX, ObjectDBX, Open Reality, Opticore, Opticore Opus, Pipeplus, PolarSnap, PortfolioWall, Powered with Autodesk Technology, Productstream, ProjectPoint, ProMaterials, RasterDWG, RealDWG, Real-time Roto, Recognize, Render Queue, Retimer, Reveal, Revit, Showcase, ShowMotion, SketchBook, Smoke, Softimage, SoftimageXSI (design/logo), Sparks, SteeringWheels, Stitcher, Stone, StudioTools, ToolClip, Topobase, Toxik, TrustedDWG, ViewCube, Visual, Visual LISP, Volo, Vtour, Wire, Wiretap, WiretapCentral, XSI, and XSI (design/logo).

All other brand names, product names or trademarks belong to their respective holders.

Disclaimer

THIS PUBLICATION AND THE INFORMATION CONTAINED HEREIN IS MADE AVAILABLE BY AUTODESK, INC. "AS IS." AUTODESK, INC. DISCLAIMS ALL WARRANTIES, EITHER EXPRESS OR IMPLIED, INCLUDING BUT NOT LIMITED TO ANY IMPLIED WARRANTIES OF MERCHANTABILITY OR FITNESS FOR A PARTICULAR PURPOSE REGARDING THESE MATERIALS.

Published by:
Autodesk, Inc.
111 McInnis Parkway
San Rafael, CA 94903, USA

Contents

Chapter 1	Getting Started Guide	1
	Overview of AutoCAD Map 3D Concepts	1
	The AutoCAD Map 3D Window	2
	Map Files and Data Sources	3
	Map Files and Display Maps	7
	Geospatial Features and Drawing Objects	9
	Overview of AutoCAD Map 3D Features	10
	Create and Assign Geographic Coordinate Systems	11
	Combine Geospatial Features and Drawing Objects	12
	Create and Edit Features and Drawing Objects	19
	Search and Filter Data	24
	View and Edit Attribute Data	27
	Use Metadata	30
	Organize Data	31
	Style Data	34
	Theme and Analyze Data	37
	Manage Data	43
	Share and Publish Data	46
	Customize Your Working Environment	49
	Extend Functionality Using Open Source and API	51
	Finding Information	51
	Watching Videos	51
	Using InfoCenter	55
	Using the Help	57

	Watching the Welcome Screen Videos	57
	Navigating the User's Guide	57
	Using the Tutorials	58
	Getting Help with AutoCAD	58
	New in This Release	59
	Using Other Sources of Information	59
	Participating in Autodesk Training	60
	Printing This Documentation	61
	AutoCAD Map 3D Sample Data and Templates	62
	Sample Real-World Data	63
	Templates for Maps and Map Books	66
	Symbols for Water, Gas, Electric, and Emergency Response	69
	Symbols for General Use	70
	North Arrows, Scale Bars, and Other Map Elements	71
	Geospatial Data Available for Purchase	72
	Tutorial Sample Files	73
	AutoCAD Samples	73
	User's Guide	75
Chapter 2	Setting Up	77
	Overview of Setting Up	77
	Setting Up AutoCAD Map 3D	80
	Overview of Setting Up AutoCAD Map 3D	81
	Setting Up Users and Assigning Rights	82
	Customizing Your Work Environment	84
	Creating New Coordinate Systems	89
	Setting Up Object Classification	116
	Setting Up for Digitizing	130
	Setting Up Your Map File	139
	Overview of Setting Up Your Map File	139
	Logging Into AutoCAD Map 3D	141
	Assigning Coordinate Systems	142
	Attaching Drawings	154
	Setting Up a Query Library	173
	Setting Up Annotation Templates	185
	Setting Up Object Data	198
	Using Data from Feature Sources	204
	Setting Up Data Sources for Drawings	204
	Setting Options	216
	Overview of Setting Options	217
	Setting Task Pane Options	220
	Setting Drawing Options	223
	Setting Multi-user Options	226
	Setting System Options	228

	Setting Coordinate System Options	230
	Setting Coordinate Tracker Options	232
	Setting Coordinate Geometry Options	233
	Setting Data Source Options for Drawings	235
	Setting Data View Options	237
	Setting Geospatial Feature Editing Options	239
	Setting Metadata Options	241
	Setting InfoCenter Options	242
	Associating Database Versions with File Extensions	242
	Setting Query Options (DWG)	244
	Using Associative Hatch	246
	Saving Option Settings	248
	Setting Raster Image Options	249
	Customizing and Automating Import and Export	260
	Setting Up and Running Workflows	274
	Overview of Workflows	275
	Running Workflows	278
	Editing or Creating Workflows	281
	Changing the Workflow Designer Display	289
Chapter 3	Bringing In Data	291
	Overview of Bringing In Data	291
	Before You Bring In Data	296
	Creating a Map	296
	Organizing Layers in Your Map	300
	Bringing in GIS Features	303
	Overview of Bringing In GIS Features	305
	Filtering Features When You Add Them to a Map	309
	Changing Coordinate Systems	311
	Bringing In Features from Oracle	312
	Bringing In Features from ArcSDE	316
	Bringing In Features from SQL Server	323
	Bringing In Features from SQL Server Spatial	326
	Bringing In Features From SQLite	330
	Bringing In Features from MySQL	332
	Bringing In Features from SHP	335
	Bringing In Features from SDF	337
	Bringing in Features from PostgreSQL/PostGIS	340
	Accessing Data from ODBC	342
	Bringing In Features from WFS	346
	Repairing Broken Feature Connections	349
	Bringing In Drawing Data From DWG Files	350
	Overview of Bringing in Drawing Data From DWG Files	351
	Bringing In Drawing Objects from AutoCAD Layers	355
	Bringing In Drawing Objects by Object Class	356
	Bringing In Drawing Objects by Location	358

Bringing In Drawing Objects by Property	361
Bringing In Drawing Objects Based on Attached Data	363
Bringing In Drawing Objects Based on Topology	367
Combining Conditions	368
Bringing in Survey Data	370
Bringing in LandXML Data	371
Bringing in ASCII Point Data	372
Bringing in LiDAR Data	374
Bringing in Point Cloud Data	375
Converting Data From Other Formats to Drawing Objects	377
Overview of Converting Geospatial Data to Drawing Objects	378
Styling Drawing Data Converted From a Geospatial Data Store	384
Supported Import Formats	387
Specifying an Area to Import	417
Specifying an AutoCAD Layer During Import	419
Assigning an Object Class During Import	421
Performing a Coordinate Conversion During Import	423
Importing Attribute Data	425
Specifying How to Import Points	427
Importing Polygons	429
Creating Centroids for Polygons	431
Importing Objects with Links to an External Database	433
Displaying Attribute Data as Text	435
Adding Rasters and Surfaces	437
Overview of Adding Rasters and Surfaces	437
Adding Raster-Based Surfaces to Your Map	441
Adding 2D Rasters	443
Adding an Image from a WMS (Web Map Service)	445
Making an Image Transparent	449
Specifying Image Insertion Point	451
Using Other Raster Image Formats	453
Joining Data to GIS Features	507
Overview of Joins	507
Creating a Join	509
Modifying or Removing Joins	514
Editing Joined Data	515
Using Joins with Calculated Properties	518
Sharing Joined Data with Others	519
Adding Attributes to Drawing Objects	521
Storing Attribute Data in the Drawing (Object Data)	521
Overview of Linking Database Records to Objects	522
Creating a Link Template	525
Opening a Linked Database Table	527
Manually Linking Database Records to Objects	528

	Automatically Linking Database Records to Objects	530
	Converting Object Data to Database Links	533
	Editing Database Links	536
	Editing a Link Template	538
	Using Open Source FDO Providers	540
	Bringing In AutoCAD Civil 3D Data	543
Chapter 4	Managing Data	547
	Overview of Managing Data	547
	About Geospatial Feature Classes, Data Stores, and Schemas	551
	Overview of Geospatial Data	551
	Working with FDO Schemas	553
	Working with Oracle Data	554
	Working with SQL Server Data	559
	Working with SQL Server Spatial Data	561
	Working with SQLite Data	565
	Working with MySQL Data	567
	Working with SDF Data	569
	Working with SHP Data	572
	Working with PostgreSQL/PostGIS Data	574
	Working with ODBC Data	576
	Working with ESRI ArcSDE Data	579
	Working with WFS Data	581
	Working with Feature Sources	582
	Overview of Working with Feature Sources	582
	Setting Up Database Users	584
	Creating a Data Store	586
	Creating FDO-Enabled SQL Server Spatial Data Stores	590
	Deleting a Feature Source	593
	Working with Schemas	593
	Overview of Working with Schemas	594
	Creating a Schema	596
	Setting Up Constraints in the Schema Editor	599
	Exposing a Native Database View in a Schema	603
	Importing and Exporting a Schema	606
	Viewing a Schema	608
	Editing a Schema	610
	Deleting Schemas	613
	Undoing Schema Changes	614
	Migrating Data	615
	Overview of Migrating Data	616
	Migrating GIS Data (Bulk Copy)	617
	Understanding How Bulk Copy Converts Data Types	623
	Fixing Geometry Issues After a Bulk Copy	625
	Reviewing the Bulk Copy Log Information	626
	Migrating DWG Data to GIS	628

Chapter 5	Visualization and Styling	631
	Overview of Visualization and Styling	631
	Controlling the Display of Your Map	633
	Overview of the Display Manager	634
	Controlling Display Order	636
	Setting Map Scale	638
	Creating Multiple Display Maps	638
	Styling Features	639
	Overview of Styling Features	640
	Defining Scale Ranges	643
	Styling Point Features	645
	Styling Line Features	648
	Styling Area Features	650
	Labeling Features	651
	Saving and Loading Styled Feature Layers	651
	Styling Drawing Layers	652
	Overview of Styling Drawing Layers	652
	Styling a Drawing Layer	657
	Creating a Style	658
	Combining Styles	661
	Modifying a Style	662
	Saving a Display Style in the Library	664
	Referencing a Library Style	666
	Creating and Modifying a Display Manager Scale Threshold	667
	Viewing Styles at All Scale Thresholds	669
	Styling Raster Images	671
	Overview of Styling Raster Images	671
	Changing Brightness, Color, or Transparency for Raster Images	672
	Viewing Raster Images	674
	Styling Point Clouds	675
Chapter 6	Creating and Editing Data	681
	Overview of Creating and Editing Data	681
	Working with Features	683
	Overview of Working with Features	684
	Creating New Features	686
	Checking In Features	693
	Checking Out Features	695
	Canceling Checkout	697
	Updating Edits Automatically	698
	Editing Features	701
	Working Offline	721
	Managing Versions	723

Working with Drawing Objects	727
Overview of Working with Drawing Objects	727
Editing Data in Attached Drawings	729
Cleaning Up Drawing Data	765
Creating, Editing, and Managing Topologies	820
Using Map Editing Tools	926
Working with Polygon Objects	954
Adding and Deleting Annotation	980
Using Object Classification	981
Working with Survey Data	996
Overview of Working with Survey Data	997
Working with Survey Data Stores	999
Working with Projects	1001
Working with Surveys	1002
Working with Point Groups	1004
Working with Survey Points	1005
Creating Surfaces From Survey Data	1009
Working With Point Cloud Data	1012
Overview of Point Clouds	1012
Overview of LiDAR Data	1012
Overview of Point Cloud Files and Objects	1013
Managing LiDAR Data	1015
Using LiDAR Data to Create a Point Cloud Data Store	1019
Creating Surfaces From Point Cloud Data	1021
Filtering Point Cloud Data	1024
Entering Coordinate Geometry	1026
Overview of Coordinate Geometry Commands	1027
Using Angle and Distance to Specify a Point	1032
Using Bearing and Distance to Specify a Point	1034
Using Bearings from Two Points to Specify a Point	1036
Using Deflection and Distance to Specify a Point	1037
Using Distances from Two Points to Specify a Point	1040
Using Azimuth and Distance to Specify a Point	1042
Using Distance and Offset from a Line to Specify a Point	1044
Creating an Inverse Report	1045
Working with Attribute Data and Object Data	1047
Viewing External Data Sources for Drawing Object Data	1047
Entering and Editing Object Data	1061
Digitizing Objects	1073
Overview of Digitizing Maps	1073
Overview of Digitizing Objects	1079
Digitizing Using MAPDIGITIZE	1081
Attaching Object Data As You Digitize	1082
Linking Database (SQL) Records as You Digitize	1084

Chapter 7 Annotating Maps 1089

Overview of Annotating Maps	1089
Adding Labels	1091
Adding Labels to Features	1091
Allowing Labels to Obscure Points	1096
Displaying Fixed Labels at Point Locations	1098
Annotating Drawing Objects	1100
Overview of Annotation	1100
Attaching Annotation to Objects	1103
Refreshing Annotation	1105
Updating Annotation	1106
Deleting Annotation from Drawings	1108
Working with Text Layers	1109
Creating Text Layers	1109
Styling a Text Layer	1111
Adding Text to a Text Layer	1113
Editing an Instance on a Text Layer	1115
Adding a Legend	1116
Annotating with AutoCAD Text Objects	1119

Chapter 8 Analyzing Data 1121

Overview of Analyzing Data	1121
Getting Information About Features and Objects	1124
Getting Information about Features	1125
Getting Information About Drawing Objects	1143
Measuring and Tracking Coordinates	1147
Overview of Measuring and Tracking	1148
Tracking Coordinates	1149
Measuring Geodetic Distance	1152
Measuring Coordinate Geometry	1153
Creating Themes	1162
Overview of Creating Themes	1163
Theming Features	1165
Theming Drawing Data	1176
Analyzing Raster-Based Surfaces	1186
Overview of Analyzing Raster-Based Surfaces	1187
Adding and Modifying Contour Lines	1189
Draping Map Data Over 3D Surfaces	1192
Viewing Surfaces in 3D	1194
Using Hillshading and Vertical Exaggeration	1199
Theming Surfaces to Analyze Height, Slope, and Aspect	1202
Changing Colors in a Themed Surface	1204
Finding and Selecting Data	1206
Finding and Selecting Features	1206
Finding and Querying Drawing Objects	1218
Analyzing Feature Classes	1301
Overview of Analyzing Feature Classes	1302

	Buffering Features in Your Map	1306
	Overlaying Two Feature Sources	1309
	Analyzing Drawing Topologies	1318
	Overview of Analyzing Drawing Topologies	1319
	Performing a Shortest Path Trace	1324
	Performing a Best Route Analysis	1328
	Performing a Flood Trace	1333
	Overlaying Two Topologies	1336
	Dissolving a Composite Topology	1342
	Buffering a Topology	1345
	Querying a Topology	1348
	Saving a Temporary Topology	1354
Chapter 9	Publishing and Sharing Maps	1357
	Overview of Publishing and Sharing	1357
	Publishing Maps	1360
	Overview of Publishing Maps	1360
	Adding a Reference Grid to a Map	1362
	Publishing a Map to a Plotter	1363
	Publishing to DWF	1364
	Publishing to PDF	1373
	Publishing to a Web Page	1373
	Using eTransmit	1376
	Publishing to MapGuide	1376
	Viewing Publish to MapGuide Results	1379
	Publishing Map Books	1381
	Converting and Exporting	1403
	Overview of Converting and Exporting	1405
	Supported Objects	1411
	Supported Formats	1412
	Exporting To Autodesk SDF (Spatial Data File)	1413
	Exporting DWG Data to SDF2 Format	1417
	Exporting To ESRI Arc/INFO Coverages	1419
	Exporting to ESRI ArcSDE	1422
	Exporting to ESRI SHP	1424
	Exporting To Geographic Markup Language (GML)	1429
	Exporting To MapInfo MIF/MID	1431
	Exporting To MapInfo TAB	1433
	Exporting To MicroStation Design (DGN) Versions 7 and 8	1435
	Exporting to Multiple Classes	1439
	Exporting To Shape Multiclass	1443
	Exporting To SQLite	1447
	Exporting To VML (Vector Markup Language)	1449
	Exporting Point Cloud Data	1451
	Mapping Drawing Attributes to Feature Class Properties	1452
	Exporting Text Enclosed in a Polyline	1455

Exporting Polygons from a Polygon Topology	1457
Saving Drawing Objects to a DXF File	1458
Exporting Maps to DWG Format	1459
Exporting DWG Data to an FDO Data Store	1461
Exporting DWG Data to an Image Format	1465
Moving DWG Data to a Spatial Data Store and Back Again	1465
Saving or Exporting a Display Manager Layer	1469
Exporting Survey Points to a LandXML File	1471
Exporting and Printing Attribute Data	1472
Overview of Exporting Attribute Data	1472
Exporting from the Data Table	1473
Printing from the Data View	1474
Creating a Drawing Object Report (DWG)	1477
Chapter 10 Working with Metadata	1481
Overview of Working with Metadata	1481
Setting Metadata Options	1484
Creating and Viewing Metadata	1486
Working with Metadata Style Sheets	1488
Working with Metadata Templates	1490
Overview of Metadata Templates	1490
Using Metadata Templates	1491
Previewing Metadata Templates	1493
Setting a Default Metadata Template	1494
Deactivating Metadata Templates	1495
Exporting Metadata Templates	1496
Removing Metadata Templates	1497
Editing Metadata	1498
Overview of Editing Metadata	1498
Updating Metadata	1503
Copying and Pasting Metadata	1504
Adding and Deleting Records in the Metadata Editor	1504
Working with Compound Metadata Elements	1505
Using the Record Navigator	1506
Auditing Metadata	1509
Sharing Metadata	1510
Overview of Sharing Metadata	1510
Importing Metadata	1510
Exporting Metadata	1512
Publishing and Printing Metadata	1514
Reference Guide	1517
Chapter 11 Command Reference	1519

	Mapping Commands	1519
	Discontinued Commands	1533
	Wildcard Characters	1537
	Improving Performance	1538
Chapter 12	Expression Evaluator	1541
	Functions	1541
	Arithmetic Functions	1541
	String-Handling Functions	1543
	Equality and Conditional Functions	1543
	Symbol-Handling Functions	1544
	Conversion Functions	1544
	Other Functions	1545
	Variables	1546
	Dot Variables	1546
	Object Data Variables	1549
	Block Attribute Variables	1549
	SQL Variables and Expressions	1549
	Object Classification Variables	1551
	AutoLISP Variables	1551
	EED Expressions	1551
	Using Color in Expressions	1552
	Tips and Suggestions for the Expression Evaluator	1553
Chapter 13	Expression Builder	1555
	Using the Expression Builder	1555
	Dialog Boxes	1557
Chapter 14	Analyzing Data Dialog Boxes	1559
	Create Buffer dialog box	1559
	Buffer Warning dialog box	1560
	Generate Contour dialog box	1561
	Hillshade Settings dialog box	1562
	Overlay Analysis dialog box	1563
Chapter 15	Annotation Dialog Boxes	1569
	Annotation Delete dialog box	1569
	Annotation Refresh dialog box	1569
	Annotation Text dialog box	1570
	Annotation Update dialog box	1571
	Define Annotation Template dialog box	1572
	Edit Expression dialog box	1574

	Insert Annotation dialog box	1574
	New Annotation Template Name dialog box	1576
Chapter 16	Autodesk MapGuide Dialog Boxes	1577
	Publish to MapGuide dialog box	1577
	Publish to MapGuide Results dialog box	1578
	Define New Object Data Field dialog box	1578
	New Layer dialog box	1579
	Autodesk MapGuide Export dialog box	1580
	Autodesk MapGuide Import dialog box	1582
Chapter 17	Cleaning Up Maps Dialog Boxes	1585
	Cleanup Methods Page	1585
	Error Markers Page	1587
	Select Actions Page	1588
	Drawing Cleanup	1591
	Drawing Cleanup Errors dialog box	1593
	Select Objects Page	1595
Chapter 18	Coordinate Systems Dialog Boxes	1597
	MAPDIST	1597
	Assign Global Coordinate System dialog box	1598
	Select Drawings to Assign Coordinate System dialog box	1599
	Coordinate Tracker Options Dialog Box	1600
	Track Coordinates Dialog Box	1601
	Create Reference System Dialog Box	1602
Chapter 19	Data Connect Dialog Boxes	1603
	Create a Join / Edit a Join dialog box	1603
	Create Data Store dialog box	1604
	Edit Spatial Contexts	1605
	Feature Information dialog box	1606
	Feature Source Scope	1606
	Feature Source Administration dialog box	1606
	Feature Source Connection dialog box	1607
	Manage Layer Data dialog box	1607
	Save Features dialog box	1608
	Select Coordinate System dialog box	1609
	User Credentials dialog box	1610
	View/Create Query Statement dialog box	1610
Chapter 20	Data Table Dialog Box	1613
	Data Table dialog box	1613

Chapter 21	Digitizing Dialog Boxes	1615
	MAPDIGITIZE (Digitize command)	1615
	Data to Attach dialog box	1616
	Digitize Setup dialog box	1617
	Link Template Data Entry dialog box	1619
	Link Template Key Column Entry dialog box	1620
Chapter 22	Display Manager Dialog Boxes	1621
	MAPDISPLAYLIBRARY (Display Library command)	1621
	MAPDISPLAYMANAGER (Display Manager command)	1621
	Alter Block Insertion dialog box	1622
	Alter Line Format dialog box	1622
	Alter Linetype dialog box	1623
	Alter Lineweight dialog box	1624
	Alter Plotstyle dialog box	1624
	Copy Scale dialog box	1624
	Define Hatch dialog box	1625
	Define Text dialog box	1626
	Edit Text Instance dialog box	1627
	Import Old Theme dialog box	1628
	New Scale dialog box	1629
	Range of Values dialog box	1629
	Select Display Element dialog box	1631
	Source Drawing Scope dialog box	1633
	Style Band dialog box	1633
	Style Label dialog box	1634
	Style Line dialog box	1636
	Style Point dialog box	1637
	Style Polygon dialog box	1639
	Style Text Layer dialog box	1640
	Thematic Mapping dialog box	1642
	Thematic Values dialog box	1644
	Theme dialog box	1645
Chapter 23	Editing Maps Dialog Boxes	1647
	ADEFILLPOLYG (Fill Closed Polyline command)	1647
	ADERSHEET (Rubber Sheet command)	1648
	ADETRANSFORM (Transform command)	1649
	MAPCOGO	1651
	MAPFEATUREMERGE	1651
	MAPFEATURESPLIT	1652
	MAPIGNORESPLITMERGERULES	1653
	MAPLINESTRINGCREATE	1654
	MAPLINESTRINGEDIT	1655

	MAPMULTILINESTRINGCREATE	1656
	MAPMULTILINESTRINGEDIT	1658
	MAPMULTIPOINTCREATE	1659
	MAPMULTIPOINTEDIT	1659
	MAPMULTIPOLYGONCREATE	1660
	MAPMULTIPOLYGONEDIT	1662
	MAPPOINTCREATE	1663
	MAPPOLYGONCREATE	1663
	MAPPOLYGONEDIT	1665
	Break Objects at Boundary dialog box	1666
	COGO Input dialog box	1668
	Split and Merge Rules dialog box	1669
	Trim Objects At Boundary dialog box	1672
Chapter 24	External Databases Dialog Boxes	1675
	Associate Database Versions dialog box	1675
	Column dialog box	1676
	Column Values dialog box	1678
	Configure Data Source dialog box	1679
	Connect Data Source dialog box	1679
	Convert Object Data to Database Links dialog box	1680
	Define Link Template dialog box (MAPOD2ASE)	1682
	Define Link Template dialog box (MAPDEFINELT)	1683
	Source dialog box	1684
	Disconnect Data Source dialog box	1684
	Header/Footer dialog box	1685
	Link Template Properties dialog box	1686
	Page Setup dialog box	1686
	Select Database Version dialog box	1688
	Select Existing Link Template dialog box	1689
	Select Link Template dialog box	1690
	Select Link Templates dialog box	1690
	Select Query dialog box	1691
	Select Table dialog box (MAPBROWSETBL)	1691
	Sort dialog box	1692
	Table Filter dialog box	1693
	Table Filter History dialog box	1696
	Table Properties dialog box	1696
	Zoom Scale dialog box	1697
Chapter 25	Import Export Dialog Boxes	1699
	Attribute Data dialog box	1699
	Block Mapping dialog box	1701
	Conflict Resolution dialog box	1701
	Coordinate System Translation dialog box	1703

Define Link Template dialog box (MAPIMPORT4)	1704
Export dialog box	1704
Export to LandXML dialog box	1709
Object Class Attribute Mapping dialog box	1710
Import dialog box	1711
Import Data Options dialog box (MAPIMPORT4)	1715
Import ASCII Points dialog box	1716
LandXML Coordinate System dialog box	1717
Layer Mapping dialog box (MAPIMPORT4)	1718
Layer Mapping dialog box (Import)	1719
Link Template to Export dialog box	1720
Map Data Elements to Block Name dialog box (MAPIMPORT4)	1720
Map Data Elements to Layers dialog box (MAPIMPORT4)	1721
Map Data Elements to SQL dialog box (MAPIMPORT4)	1722
Map Export dialog box	1723
Map Export Options dialog box	1725
New Property Data Type dialog box	1726
Feature Class Property Mapping dialog box	1727
Property Value Mapping	1728
Select Attributes dialog box	1729
Map Import dialog box	1729
New Layer dialog box	1730
Object Data Table dialog box (Export)	1730
Object Data Table dialog box (Import)	1731
Object Data/External Database Mapping dialog box	1732
Point Mapping dialog box	1733
Design File Input Settings	1734
Design File Output Settings	1736
Chapter 26 Managing Data Dialog Boxes	1739
Schema Editor	1739
Bulk Copy	1744
Create Data Store Dialog Box	1747
Manage Versions dialog box	1748
Resolve Feature Conflicts dialog box	1750
Chapter 27 Metadata Dialog Boxes	1751
Metadata Viewer	1751
Metadata Editor	1754
Attribute Editor	1756
Metadata Options dialog box	1756
Import Metadata Options dialog box	1757
Export Metadata dialog box	1757
Create Metadata Template dialog box	1758
Compound Element Metadata Editors	1758

Chapter 28	Object Classification Dialog Boxes	1779
	MAPSELECTCLASSIFIED (Select Classified Objects command)	1779
	MAPSELECTUNCLASSIFIED (Select Unclassified Objects command)	1780
	MAPSELECTUNDEFINED (Select Undefined Objects command)	1780
	Attach Object Class Definition File dialog box	1781
	Classified Property List dialog box	1782
	Classify dialog box	1782
	Classify Objects dialog box	1783
	Color Range Editor dialog box	1783
	Define Object Classification dialog box	1785
	Layer Range Editor dialog box	1789
	Linetype Range Editor dialog box	1789
	Lineweight Range Editor dialog box	1790
	New Object Class Definition File dialog box	1790
	New Property dialog box	1791
	Plotstyle Range Editor dialog box	1792
Chapter 29	Object Data Dialog Boxes	1793
	Attach Object Data dialog box	1793
	Attach/Detach Object Data dialog box	1794
	Edit Object Data dialog box	1795
	Rename Table dialog box	1797
	Select Link Template Key dialog box	1797
Chapter 31	Polygon Object Dialog Boxes	1817
	MAPPOLYLINETOPOLYGON (Convert Polylines to Polygons command)	1817
	MAPUSEMPOLYGON	1818
	MAPMPEDIT (Edit Polygon command)	1818
	MPSPLIT (Split Polygon command)	1821
	Create Polygons From Topology dialog box	1823
	Polygon Fill Properties dialog box	1824
Chapter 32	Printing and Publishing Dialog Boxes	1827
	Create Map Book/Edit Map Book dialog box	1827
	Identify Map Book Template Placeholders dialog box	1829
	Map Book Properties dialog box	1830
	Tile Properties dialog box	1831
	Select Plot Set to Convert dialog box	1831
	Map Information dialog box	1832
	Plot Map Set dialog boxes	1833

Chapter 33	Query Dialog Boxes	1835
	Alternate Font dialog box	1835
	Change Category dialog box	1835
	Data Condition dialog box	1836
	Define New Category dialog box	1838
	Define Query dialog box	1838
	Define Range Table dialog box	1842
	Define Text dialog box	1846
	Hatch Options dialog box	1847
	Load Internal Query dialog box	1848
	Location Condition dialog box	1849
	New Range Table dialog box	1852
	Output Report Options dialog box	1852
	Property Condition dialog box	1855
	Query Library Administration dialog box	1858
	Rename Category dialog box	1860
	Rename Range Table dialog box	1860
	Run Library Query dialog box	1861
	Save Current Query dialog box	1862
	Set Property Alterations dialog box	1863
	SQL Condition History dialog box	1866
	SQL Link Condition dialog box	1866
	Type SQL Condition dialog box	1870
Chapter 34	Raster Image Dialog Boxes	1873
	MAPIFRAME (Image Frame command)	1873
	Image Correlation dialog box	1873
	Image Information dialog box	1875
	Image Management dialog box	1875
	Image Management Layout dialog box	1877
	Image Select dialog box	1877
	Insert Image dialog box	1878
	Raster Extension Options dialog box	1879
	Transparency Color dialog box	1883
Chapter 35	Saving Objects Dialog Boxes	1885
	ADEREMOBS (Remove Objects from Save Set command)	1885
	ADESELOBS (Select Objects for Save Back command)	1886
	ADESHOWOBS (Show Objects in Save Set command)	1887
	Save Objects to Source Drawings dialog box	1887
	Who Has It Information dialog box	1889
Chapter 36	Survey Dialog Boxes	1891
	New Data Store dialog box	1891

	Project Properties dialog box	1892
	Survey Properties dialog box	1893
	Point Group Properties dialog box	1894
	Field Note Editor	1894
	Create Surface dialog box	1895
	Source Data dialog box	1897
	Point Cloud Manager	1897
	Surface Manager	1898
	Filter Point Cloud dialog box	1900
	Grid Parameters dialog box	1901
	Point Cloud Style dialog box	1902
Chapter 37	Setting Map Options Dialog Boxes	1905
	MAPABOUT (About AutoCAD Map 3D command)	1905
	MAPAUTOCHECKOUT	1905
	MAPDOCKWSPACE (Dock Task Pane command)	1906
	MAPEDITSETAUTO	1906
	MAPFEATUREEDITTOOLS	1906
	MAPWSFOCUS	1907
	MAPWSPACE (Task Pane command)	1908
	MAPWSREFRESH	1908
	AutoCAD Map Options dialog box	1908
	Coordinate Geometry Setup dialog box	1917
	Define/Modify Drawing Set dialog box	1918
	Drawing Maintenance dialog box	1920
	Drawing Set Display Filter dialog box	1922
	Drawing Settings dialog box	1923
	Drawing Statistics dialog box	1926
	Drive Alias Administration dialog box	1928
	Feature Editing Options dialog box	1929
	Generate Object Data Index dialog box	1931
	Index Maintenance dialog box	1931
	Remove Object Data Index dialog box	1933
	Select Alias dialog box	1933
	Undefined Alias Referenced dialog box	1934
	User Administration dialog box	1934
	User Information dialog box	1936
	User Login dialog box	1937
Chapter 38	Topology Dialog Boxes	1939
	MAPEDITDIR (Edit Direction command)	1939
	MAPEDITRES1 (Edit Direct Resistance command)	1939
	MAPEDITRES2 (Edit Reverse Resistance command)	1940
	MAPLINKADD (Add Topology Link command)	1941
	MAPLINKDEL (Delete Topology Link command)	1942

MAPLINKEDIT (Edit Topology Link command)	1943
MAPLINKREV (Reverse Direction of Topology Link command)	1943
MAPLINKUPD (Update Topology Link command)	1944
MAPNODADD (Add Topology Node command)	1944
MAPNODDEL (Delete Topology Node command)	1945
MAPNODEEDIT (Edit Topology Node command)	1946
MAPNODINS (Insert Topology Node command)	1947
MAPNODUPD (Update Topology Node command)	1948
MAPPOLYADD (Add Topology Polygon command)	1948
MAPPOLYDEL (Delete Topology Polygon command)	1949
MAPPOLYUPD (Update Topology Polygon command)	1949
AutoCAD Map Confirmation dialog box - MAPTOPOADMIN	
Delete	1950
AutoCAD Map Confirmation dialog box - MAPTOPOEDIT	1951
AutoCAD Map Confirmation dialog box - MAPTOPOADMIN	
Rename	1951
Centroid Objects dialog box	1952
Create Closed Polylines dialog box	1953
Create Network Topology - Create New Nodes dialog box	1955
Create Network Topology - Select Links dialog box	1956
Create Network Topology - Select Nodes dialog box	1957
Create Node Topology - Select Nodes dialog box	1959
Create Polygon Topology - Create New Centroids dialog box	1960
Create Polygon Topology - Create New Nodes dialog box	1961
Create Polygon Topology - Select Centroids dialog box	1962
Create Polygon Topology - Select Links dialog box	1964
Create Polygon Topology - Select Nodes dialog box	1965
Create Polygon Topology - Set Error Markers dialog box	1967
Create Topology - Select Topology dialog box	1969
Create Topology Warning dialog box	1971
Delete Topology dialog box	1971
Edit Direct Resistance dialog box	1972
Edit Direction dialog box	1972
Edit Reverse Resistance dialog box	1973
Edit Topology dialog box	1973
Link Objects dialog box	1975
Load Topology Conflict dialog box	1976
Load Topology dialog box	1976
Load Topology From Source Drawing dialog box	1978
Network Topology Analysis - Choose Locations dialog box	1978
Network Topology Analysis - Output dialog box	1980
Network Topology Analysis - Resistance and Direction dialog	
box	1981
Network Topology Analysis - Select Method dialog box	1983
Node Objects dialog box - Network and Polygon Topologies)	1985
Node Objects dialog box (Node topology)	1987

	Rename Topology dialog box	1988
	Select Data dialog box - Topology Overlay	1989
	Topology Buffer - Create New Centroids and Nodes dialog box	1990
	Topology Buffer - New Topology dialog box	1991
	Topology Buffer - Set Buffer Distance dialog box	1992
	Topology Dissolve - Create New Centroids and Nodes dialog box	1994
	Topology Dissolve - Create Nodes dialog box	1995
	Topology Dissolve - New Topology dialog box	1996
	Topology Dissolve - Object Data dialog box	1997
	Topology Dissolve - Set Parameter dialog box	1998
	Topology Overlay Analysis - Analysis Type dialog box	1999
	Topology Overlay Analysis - Create New Centroids and Nodes dialog box	2002
	Topology Overlay Analysis - Create Nodes dialog box	2003
	Topology Overlay Analysis - Output Topology dialog box	2004
	Topology Overlay Analysis - Output Attributes dialog box	2006
	Topology Overlay Analysis - Select Overlay Topology dialog box	2007
	Topology Query dialog box	2008
	Topology Query Result dialog box	2010
	Topology Selection dialog box	2011
	Topology Statistics dialog box	2011
Chapter 39	Viewing Dialog Boxes	2013
	Quick View Drawings dialog box	2013
	Zoom Drawing Extents dialog box	2014
	Define Document View dialog box	2015
	Define Key View dialog box	2017
	Document View dialog box	2019
	Key View dialog box	2019
Chapter 40	Workflow Designer	2021
	MAPWORKFLOWOPEN	2021
	MAPWORKFLOWRUN	2021
	Workflow Designer	2022
	Workflow Activity Input dialog boxes	2025
	Add Feature Layer	2028
	Add Group	2029
	Add Map	2030
	Change Feature Layer Properties	2030
	Change Feature Layer Symbol	2031
	Change Group Properties	2033
	Connect To Data Store	2034
	Create Buffer Layer	2036
	Display Feature Attributes	2037
	Highlight Features/Remove Highlighting	2038

List Current Connections	2039
List Feature Classes	2039
List Feature Layer Properties	2040
Load Layer File	2040
Perform Overlay	2041
Remove Connection	2043
Remove Feature Layer	2044
Remove Group	2044
Remove Map	2045
Rename Map	2045
Run AutoCAD Command	2046
Run Workflow	2047
Save Layer File	2048
Select Features	2049
Switch Map	2050
Zoom To Extents	2050
Chapter 41 Programming Interfaces	2053
Glossary	2055
Index	2081

Getting Started Guide

1

This section provides the following:

- An introduction to the main concepts and features of AutoCAD Map 3D
- A description of resources for learning more about the program
- An overview of the available sample data and templates

For a tutorial that provides a tour of the application and leads you through the basic steps of creating a map, see *Introducing AutoCAD Map 3D 2011*.

For a general overview of working with geospatial data, see *Best Practices for Managing Geospatial Data*.

Overview of AutoCAD Map 3D Concepts

AutoCAD Map 3D is the leading engineering solution for creating and managing spatial data. AutoCAD Map 3D bridges the gap between Computer Aided Design (CAD) and Geographic Information Systems (GIS). AutoCAD Map 3D provides direct access to the leading data formats used in design and GIS. Use AutoCAD® tools to maintain a broad variety of geospatial information. Integrate GIS functions in your design processes in a single environment for more efficient workflows. The results are better designs, increased productivity, and better data quality.

The AutoCAD Map 3D Window

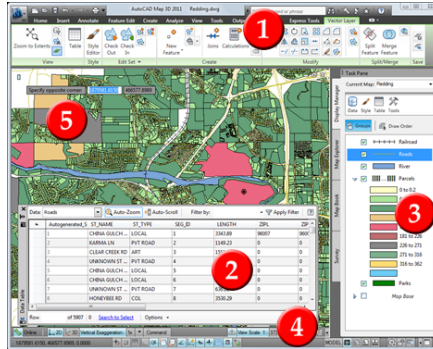

The main elements of the AutoCAD Map 3D product window

- 1 The Ribbon. The commands for your mapping tasks.
- 2 Data Table and Data View. Display attribute data in a table format. Use the [Data Table](#) (page 2059) for viewing spatial data and attribute data for geospatial features; use the Data View for viewing attribute data linked to drawing objects.
- 3 The Task Pane. Use the [Task Pane](#) (page 2076) tabs for the following:
 - Managing maps and map data
 - Displaying and styling data layers
 - Bringing in and managing survey data
 - Publishing multi-page map books
- 4 Status Bars. Check the current cursor location, change exaggeration and scale settings, switch between 2D and 3D, and use common tools.
- 5 Dynamic input. Launch commands and respond to prompts at the cursor location. For experienced AutoCAD users, the command interface allows for efficient editing using keyboard entry.

Tell me more



Procedures

- [To switch between Tool-based, Task-based, and Map Classic workspaces](#) (page 86)
- [To access the Data Table](#) (page 1127)
- [To use the Data View](#) (page 1047)
- [To set Task Pane options](#) (page 221)
- To add an item to the status bar
- To use dynamic input



Tutorial

- [Lesson 2: Take a Quick Tour of AutoCAD Map 3D](#)



Workflow

- [Set Up Your Work Environment](#)



Related topics

- [Customizing Your Work Environment](#) (page 84)
 - [Workspaces](#)
 - [Setting Options](#) (page 216)
-

Map Files and Data Sources

What is a map?

An AutoCAD Map 3D map file is a window onto your information. It has links to all the data and images you include in your map:

- Standard AutoCAD objects
- Spatial data from a database or file
- Raster images
- Attribute data

You can use multiple sources in a single map file. For example, attach a DWG file to your map file, query in some of its layers, and add them as Display Manager layers. Then, connect to a SHP file that becomes another layer in

your display map, or add features from a geospatial database. The map file remembers all the connections and which objects you added to the map file.



This map contains a photo raster image, building data stored in a SHP file, and parcel data stored in a DWG file.

What is the Display Manager?

You coordinate the data in your map using the Display Manager.

Each set of data is a Display Manager layer. For example, a raster layer can display an aerial photograph of a city. An SDF layer can display an SDF file representing parcels within the city. A drawing layer can display objects from the current drawing or from an attached drawing file.

Display Manager layers are not the same as AutoCAD layers.

In the Display Manager, you can style each layer separately, change the order of the layers, and view and plot the result. You can specify line styles, color, and weights; fill colors and styles; labels; and more.

What is in a map file?

Each AutoCAD Map 3D map file contains the information for connecting to the data sources, drawings, raster images, and attribute data for its contents.

It also stores queries, object data, styling information, printing layouts, and any customized settings.

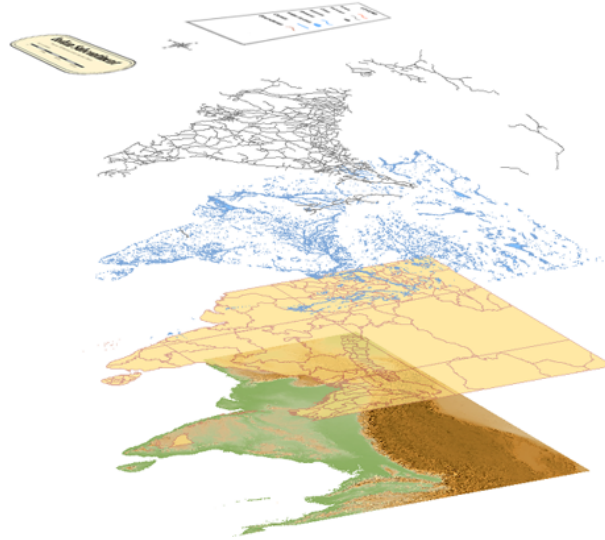

Each data set is a layer in the map.

Whenever you open a map file, all this information is immediately available to you.

What is a data source?

A data source is any source of information that can be used in a map. It can be any of the following:

- A spatial database created with Oracle, SQL Server, or another relational database management system
- A file-based spatial data store, such as Autodesk SDF or ESRI SHP
- An AutoCAD drawing file
- A spreadsheet or other ODBC source that contains attribute data
- A raster image, such as a TIFF or DEM file

The relationship between the sources and the map file is dynamic. If the data in the source file changes, those changes are updated in your map file. When you change the objects in your map file, you can save those changes back to their original sources.

What can you do with a finished map?

You can share maps even with viewers who do not have access to AutoCAD Map 3D. For example, you can share maps in the following ways:

- Print maps
- Save maps as DWFs (which can be viewed with Autodesk Design Review, available from the Autodesk web site)
- Publish maps to MapGuide
- Convert all the data to AutoCAD DWG data
- Post maps on the web

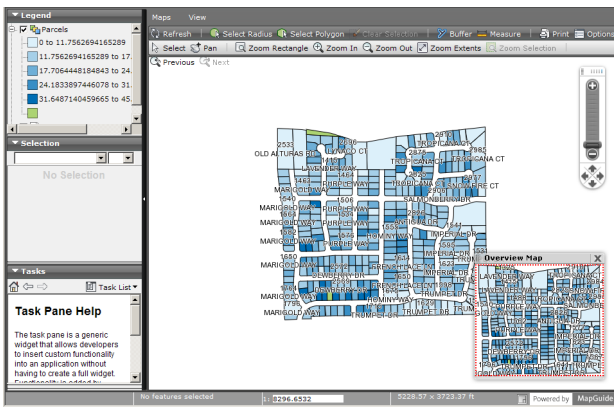

Publish to a MapGuide server to share a map on the web.

AutoCAD cannot read some information in an AutoCAD Map 3D file, such as links to external spatial data. To share a map with an AutoCAD user, convert all the data in your map to DWG format, including data from spatial data stores.

Tell me more



Video

- [Show me how to publish a map to a MapGuide server.](#)



Procedures

- [To access data through FDO](#) (page 308)
- [To bring drawing objects into your map](#) (page 354)
- [To create a map with styled feature layers](#) (page 641)

- [To create a map with styled drawing layers](#) (page 654)
- [To publish your map](#) (page 1361)

 Tutorial

- Lesson 3: Get Started

 Workflow

- Create a Map Start to Finish

 GIS Skills

- *Bring in data from multiple image files to a single layer.*
- *Publish a completed map to a MapGuide server.*

 Related topics

- [Overview of the Display Manager](#) (page 634)
 - [Overview of Publishing and Sharing](#) (page 1357)
 - [Converting and Exporting](#) (page 1403)
-

Map Files and Display Maps

A *map file* is a drawing that connects to all the sources for your map: geospatial features, drawing objects, raster images, and attribute data.

Each map file can contain multiple *display maps* (for printing or for online distribution), in which you can selectively hide or show items in your map. Maps exist only as conceptual structures, and are not separate entities or files.

You can apply styles to the items in a display map, based on data, layers, and other criteria. Changes that you make to the appearance of items in a map do not affect the actual data in your map file.

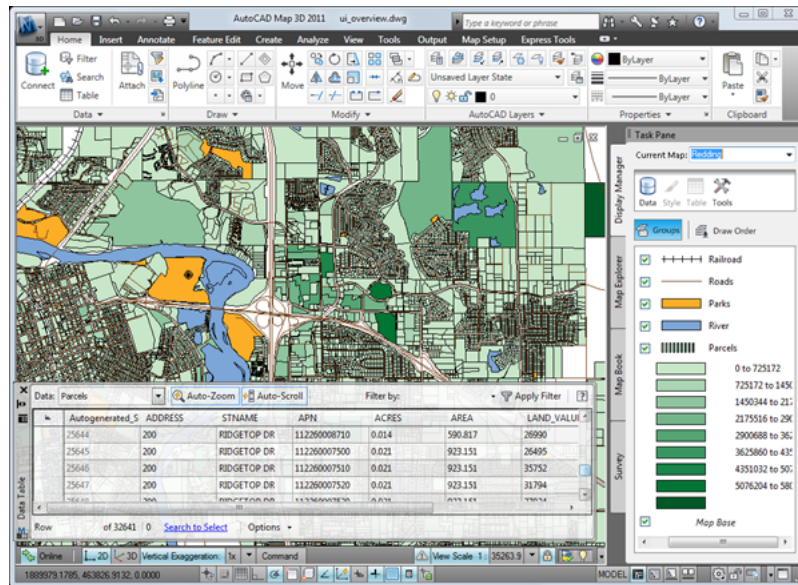

This map has Display Manager layers for railroads, roads, parks, the river, and parcels. Each is styled differently. For an introduction to the parts of the AutoCAD Map 3D window, see Lesson 2: Take a Quick Tour of AutoCAD Map 3D.

Tell me more



Video

- [Show me how to theme a parcels layer.](#)



Procedures

- [To create multiple display maps](#) (page 639)
- [To create a map with styled feature layers](#) (page 641)
- [To create a map with styled drawing layers](#) (page 654)



Tutorial

- [Lesson 3: Get Started](#)



Workflow

- [Use Themes to Reveal Patterns in Data](#)



GIS Skills

- [Choose the right type of theme to suit your data.](#)



Related topics

■ [Overview of the Display Manager](#) (page 634)

■ [Creating Multiple Display Maps](#) (page 638)

Geospatial Features and Drawing Objects

Use AutoCAD Map 3D to work with both CAD objects and geospatial features. You can combine them in your map, edit either type of data, and move data from one format to the other.

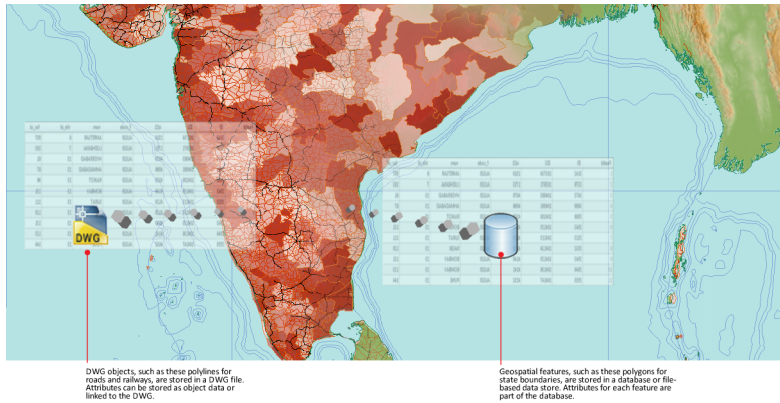

Combine data from drawing files and geospatial data stores.

Geospatial Features

A feature is the spatial description of a real-world entity such as a road or a utility pole. Features are stored in a spatial database or in file formats such as Oracle, ArcSDE, SDF, or SHP. The spatial database or file is referred to as a feature source.

Using Open Source FDO Data Access Technology, AutoCAD Map 3D natively accesses spatial data. To work with features, connect to the database or file and then select the sets of features (feature classes) to include in your map.

Drawing Objects

A drawing object is any object in a DWG file, such as a line, circle, or closed polyline.

Create and store drawing objects in the current map, or attach a DWG file to the current map and query in its objects. AutoCAD Map 3D remembers the

original location of the objects and saves edited objects back to their original file.

Tell me more



- [Show me how to bring in objects from a set of attached DWG files.](#)
 - [Show me how to bring in features from a feature class.](#)
 - [Show me how to bring in data from AutoCAD Civil 3D.](#)
-



- [To access data through FDO](#) (page 308)
 - [To bring drawing objects into your map](#) (page 354)
-



- [Tutorial: Building a Map](#)
-



- [Create a Map Start to Finish](#)
-



- [Bring in data from multiple image files to a single layer.](#)
 - [Bring in a subset of features using a query.](#)
-



- [Overview of Bringing In Data](#) (page 291)
 - [Overview of Creating and Editing Data](#) (page 681)
-

Overview of AutoCAD Map 3D Features

AutoCAD Map 3D is built on the latest release of AutoCAD® software and is enhanced with a suite of geospatial tools. It has all the features and functionality of AutoCAD, which is automatically installed with AutoCAD Map 3D.

Create and Assign Geographic Coordinate Systems

Work with more than 4,000 real-world coordinate systems or define your own custom coordinate system. Use tools such as transform, rubber sheeting, and track coordinates to georeference your AutoCAD design data accurately.

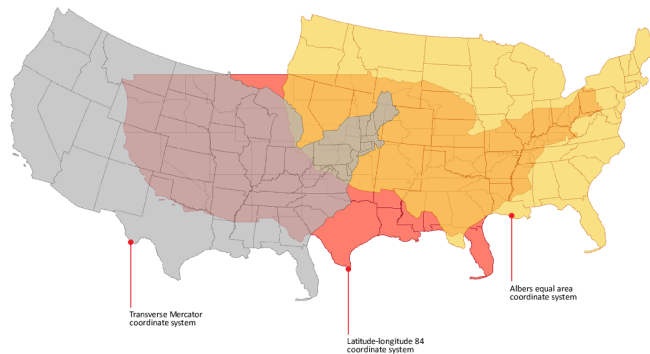

Coordinate systems determine how your map is projected in two dimensions.

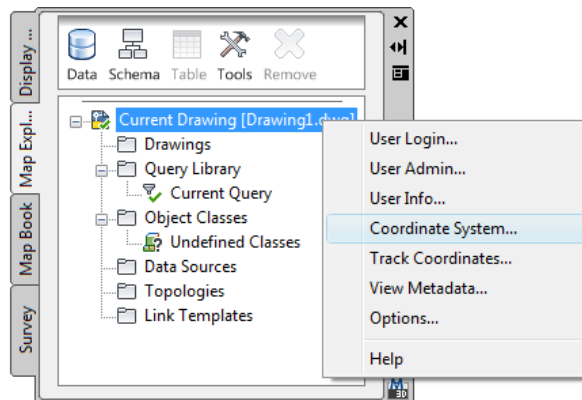

Assign a coordinate system to the drawing to locate it in real space.

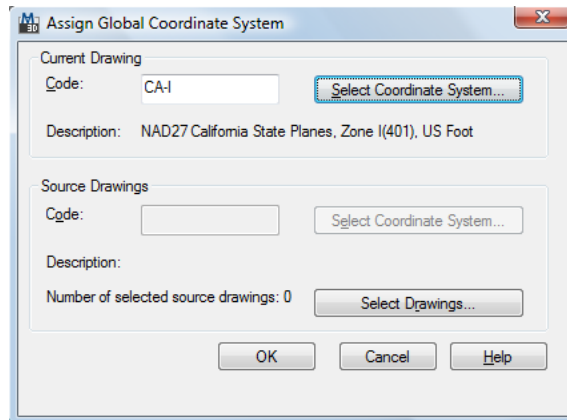

You can enter or select the appropriate coordinate system for the map.

Tell me more



Video

- *Show me how to set a map to the coordinate system of the data.*



Procedures

- [To assign coordinate systems](#) (page ?)



Tutorial

- Exercise 1: Create a map



Workflow

- Work with Coordinate Systems



GIS Skills

- *Reproject incoming data to a new coordinate system.*



Related topics

- [Overview of Coordinate Systems](#) (page 143)

Combine Geospatial Features and Drawing Objects

AutoCAD Map 3D software integrates computer-aided design (CAD) and geographic information system (GIS) data. After working with the data, you

can maintain it in a DWG™ file, convert it to an external file, or move it into a spatial database.

DWG Data

Maps are saved in DWG format. Open an AutoCAD drawing directly, or attach drawings and query in just the objects you want.

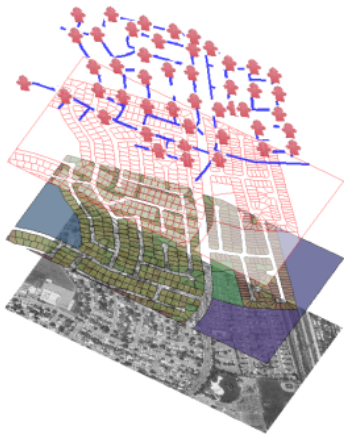

- Combine feature data from a spatial database with objects from CAD drawings, raw geometry from a spreadsheet, and raster images.
- Features and objects are automatically transformed to the coordinate system used in the map.

Spatial Data

Connect to the data to include.

- Directly access and edit spatial data in files and databases.
- Without data translations, data integrity is ensured.
- Connect to publicly available web services such as Web Map Services (WMS) and Web Feature Services (WFS).

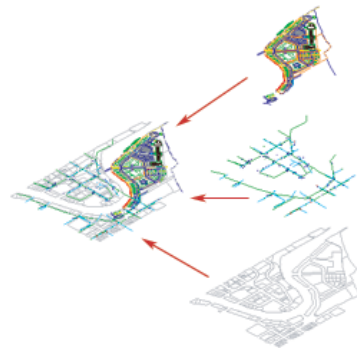

Raster Images

Add aerial photos, contour maps, and DEM surfaces.

- Georeferenced images are displayed in the correct location.
- Surface rasters are draped over your elevations.

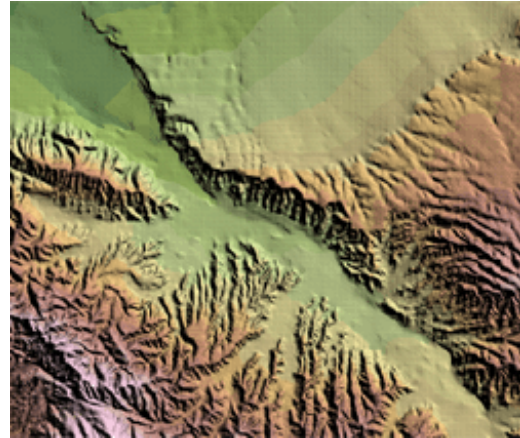

Connect to the data from the Task pane.

- Select the data source.
- Select the feature classes to add to your map.
- Each feature class you add becomes a layer in the Display Manager.

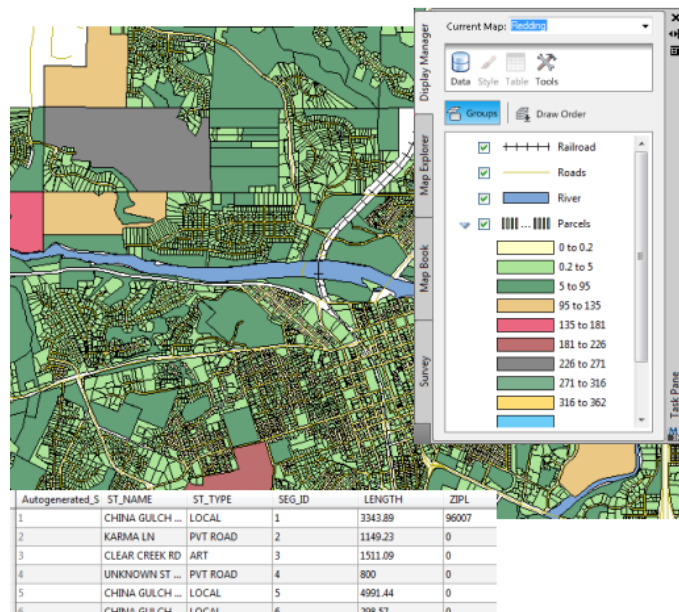

The layers in **Display Manager (page 2060)** represent the data sources to which this map is connected. The **Data Table (page 2059)** lets you edit the information for individual items in a layer.

Import Data

You can import data, rather than connecting to it. Importing breaks the connection to the source and adds a “snapshot” of the data to your map. If the data changes after that, you will not see any changes in your map unless you import the data again. There is no way to update imported data in its source. Similarly, when you export data, you export the current data only. The connection to the live data is lost.

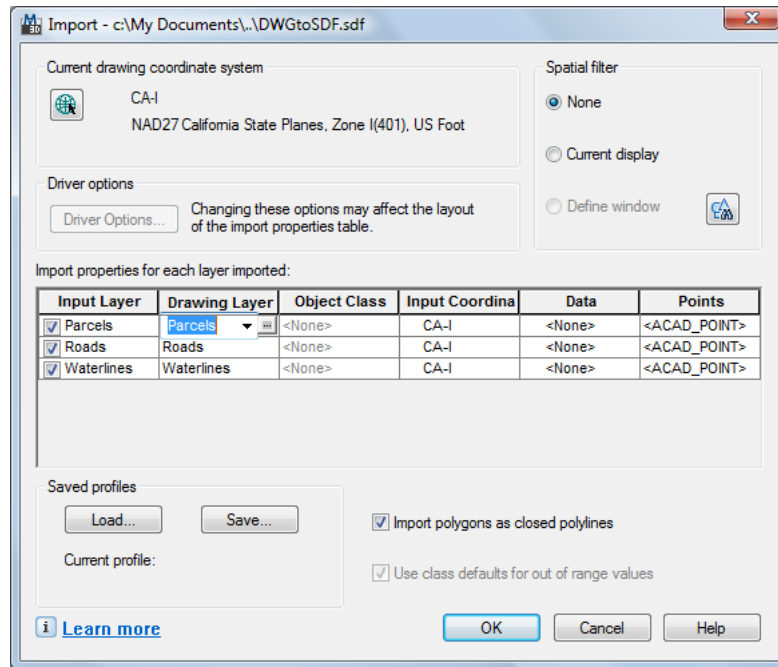

When you import data, you can structure it in your map. Assign data to layers or object classes. Add attribute data to object data tables. Assign a coordinate system. Specify that points come in as points, text, or blocks.

You can read, write, and convert data between standard formats. For a list of supported formats, see the following topics:

- [Bringing in GIS Features](#) (page 303)
- [Supported Import Formats](#) (page 387)
- [Supported Export Formats](#) (page 1412)

Integrate Database Information

Join CAD objects to commonly used databases using link templates. Join geospatial data to ODBC data stores and databases using joins.

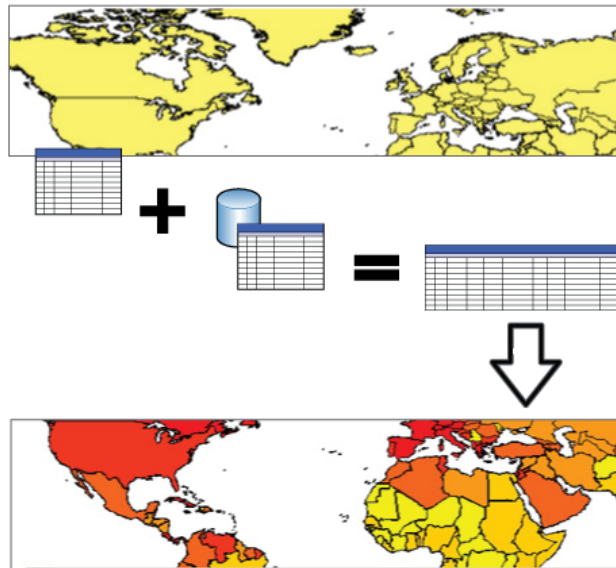

When you join a database to a feature layer, the properties from both data stores are available to that layer for theming and other purposes.

Add Survey Data

Bring in points you exported from Autodesk Civil 3D (LandXML) or ASCII data from a GPS device.

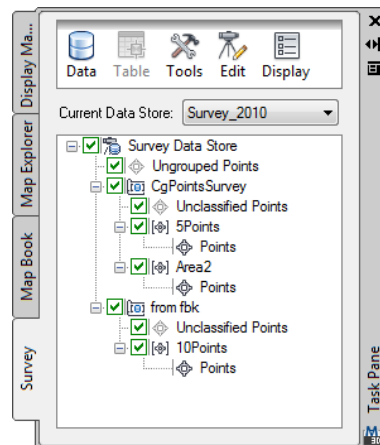

Use the Survey tab to import and organize survey data

Add Point Cloud Data

Bring in [point cloud](#) (page 2071) data from [LiDAR](#) (page 2066) Aerial Survey (.LAS) files or ASCII (.XYZ) files.

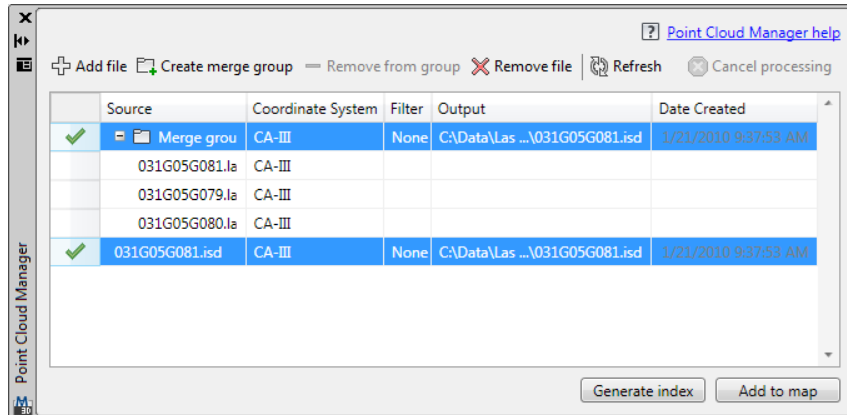

Use the Point Cloud Manager to bring in point cloud data

Tell me more



Procedures

- [To access data through FDO](#) (page 308)
- [To bring drawing objects into your map](#) (page 354)
- [To add a raster image to the map](#) (page 440)
- [To import data from other formats](#) (page 381)
- [To bring LandXML data into a Survey Data Store](#) (page 371)
- [To bring ASCII point data into a Survey Data Store](#) (page 373)
- [To bring LiDAR data into your map](#) (page 374)



Tutorial

- [Tutorial: Building a Map](#)



Workflow

- [Create a Feature Map](#)
- [Create a CAD Map](#)



GIS Skills

- *Bring in data from multiple image files to a single layer.*
- *Access data published on a public web server.*
- *Bring in point data from a Microsoft Access database.*
- *Bring in a subset of features using a query.*



Related topics

- [Bringing in GIS Features](#) (page 303)
- [Bringing In Drawing Data From DWG Files](#) (page 350)
- [Converting Data From Other Formats to Drawing Objects](#) (page 377)
- [Joining Data to GIS Features](#) (page 507)
- [Adding Attributes to Drawing Objects](#) (page 521)
- [Adding Rasters and Surfaces](#) (page 437)
- [Bringing in Survey Data](#) (page 370)
- [Bringing in LiDAR Data](#) (page 374)

Create and Edit Features and Drawing Objects

When you connect to a feature source, your map is a window onto the data. Your edits are made directly to the source. The data remains in its source location. Any changes you make appear in the source. Any changes in the source are immediately reflected in your map.

When you edit objects from attached drawings, AutoCAD Map 3D tracks the original location of each object and saves them back to their original source.

Use AutoCAD Tools to Edit All Data

Use the full set of AutoCAD editing tools and commands to add or change map objects. It does not matter what the object source is. Editing does not convert the data. AutoCAD Map 3D includes all the AutoCAD editing tools as well as tools designed for creating maps, such as using coordinate geometry to specify a point. View and style with the ease of GIS, edit with the power of CAD.

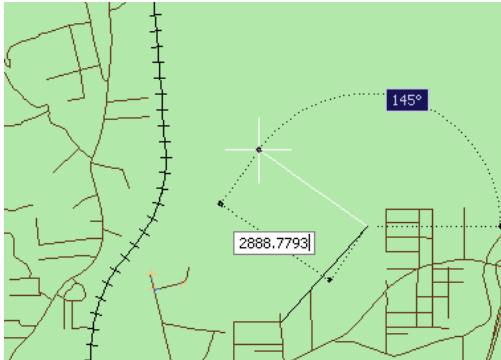

Use the powerful, high-precision AutoCAD tools to edit a feature, then save your changes back to the data source.

Lock Data for Secure Editing

For geospatial features, you can choose how to save your changes. Set an option to save changes to the original source automatically, or work offline and update the feature source when you finish editing. Check out a feature to lock it for other users (if the feature source supports this option). Check it back in to make it available again.

For drawing objects, you can lock the source drawings so no one else can use them. You can use save set options to control whether your changes are saved back to the original drawings or affect the current map only.

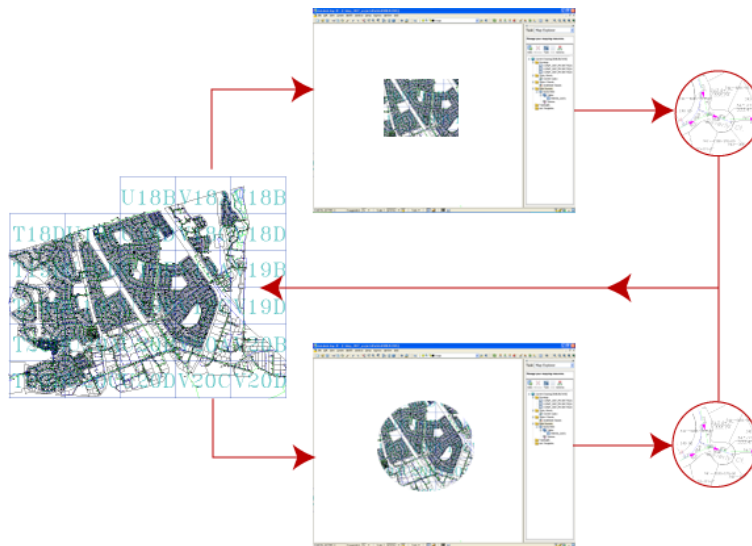

Drawing objects selected for editing in a save set (the red circle in the illustration) are locked so others cannot edit them.

Spatial Data Type	Locking Capability
Oracle and ArcSDE	Individual features are locked when you check them out.
Attached drawings (DWG)	Individual objects are locked when you query them into the map.

Clean Up Drawings

Using Drawing Cleanup tools, you can automate the correction of common drafting and digitizing errors. Delete duplicates, correct undershoots and dangling objects, and more.

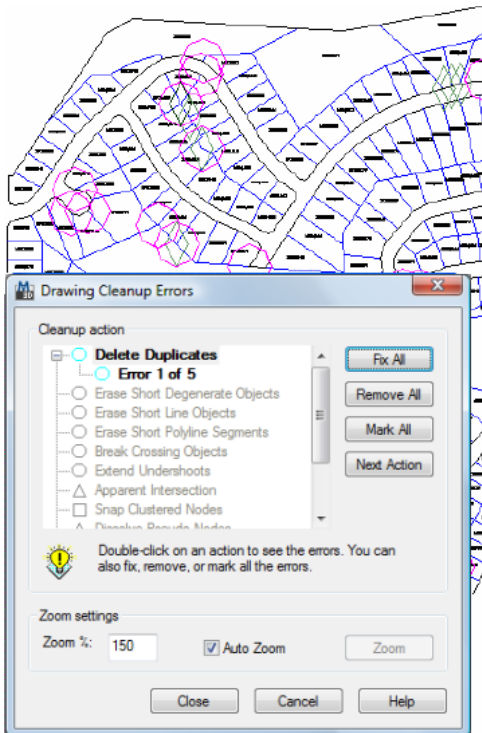

Review, mark, and correct errors interactively.

Use Coordinate Geometry Commands

Create and measure simple coordinate geometry (COGO) for lines, curves, closed polylines, and polygons. When drawing plats and existing conditions, input geometry in terms of bearing, direction, deflection, and azimuth angle.

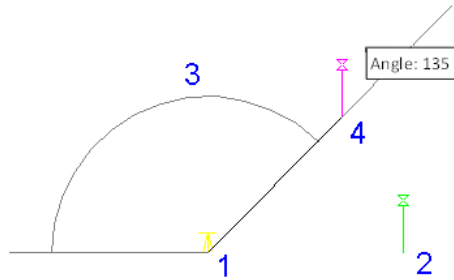

Use the Deflection And Distance COGO command to specify a point by supplying a deflection angle and a distance from another point.

Use the COGO Input dialog box to enter coordinates manually or select them in the drawing or in the Data Table. The Inverse Report option gives you information about the relationship between existing points.

Tell me more



Video

- [Show me how multi-user editing of drawing files works.](#)
- [Show me how to edit features stored in a database or data store.](#)
- [Show me how to create new features from existing AutoCAD objects.](#)



Procedures

- [To work with features](#) (page 683)
- [To work with drawing objects](#) (page 727)
- [To clean up drawing data](#) (page 765)
- [To enter coordinate geometry](#) (page 1026)



Tutorial

- [Tutorial: Building a Map](#)



Workflow

- [Create and Edit Data](#)



GIS Skills

- [Edit DWG files in a multi-user environment.](#)
- [Edit feature geometry directly in a SHP file using CAD tools.](#)

- *Create new features from existing AutoCAD objects.*



Related topics

- [Working with Features](#) (page 683)
- [Working with Drawing Objects](#) (page 727)
- [Overview of Sharing Attached Drawings](#) (page 730)
- [Cleaning Up Drawing Data](#) (page 765)
- [Overview of Coordinate Geometry Commands](#) (page 1027)

Search and Filter Data

Using DWG query functionality, multiple users can access, search, and edit the same sets of DWG files or base maps simultaneously.

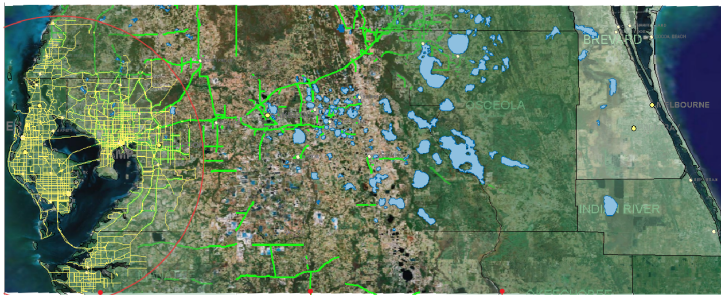

Use a property filter and a location filter to view the condition of roads in a circular area.

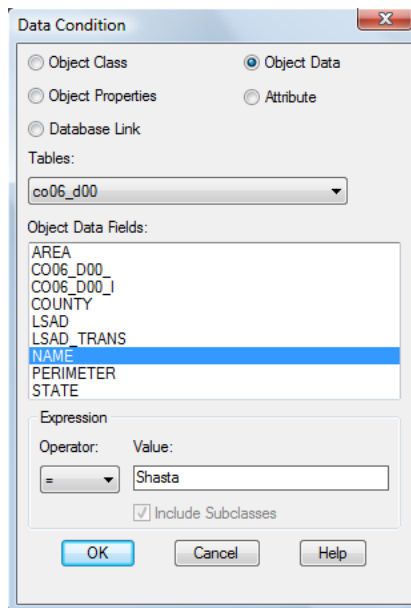

Use queries to filter data as you add it to your map. You can also filter data after you add it to your map. For example, use a query to select a subset of data.

Use geospatial and DWG queries to find a feature or object based on its location, its properties, or attribute data linked to it from another source.

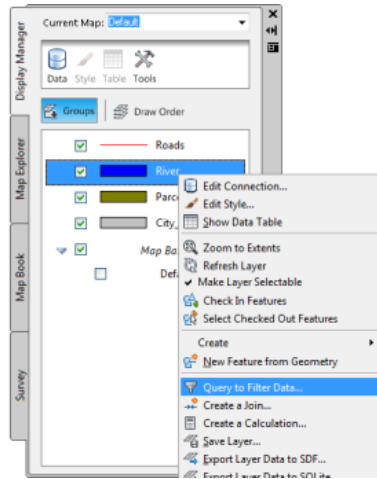

Apply a query to any feature layer in the Display Manager.

Tell me more



Video

- [Show me how to run a query on a set of attached DWG files.](#)
- [Show me how to run a query on a feature class.](#)



Procedures

- [To filter feature data when you add it to a map](#) (page 310)
- [To find and filter features](#) (page 1209)
- [To filter drawing data when you add it to your map](#) (page 354)
- [To find and select drawing objects](#) (page 1219)



Tutorial

- Lesson 5: Find and Edit Features



Workflow

- Find and Edit Objects in Attached Drawings
- Edit Features in a Geospatial Feature Source



GIS Skills

- *Bring in a subset of features using a query.*



Related topics

- [Filtering Features When You Add Them to a Map](#) (page 309)
- [Overview of Bringing in Drawing Data From DWG Files](#) (page 351)
- [Finding and Selecting Features](#) (page 1206)
- [Finding and Querying Drawing Objects](#) (page 1218)

View and Edit Attribute Data

Attribute data is non-geometry data about a drawing object or feature. For example, a drawing of parcels can have attribute data that lists the owner and improvements for each parcel.

For drawing objects, you can do the following:

- Import attribute data.
- Attach drawing objects with links to external data.
- Link database entries to the data already associated with drawing objects.
- Create and manage attribute data within AutoCAD Map 3D using Data View.
- Use attribute data as the basis of queries.
- Display attribute data on your map as text.
- View attribute data linked to drawing objects using the Data View.

For geospatial feature data, you can do the following:

- Join an attribute data store to an existing feature class.
- Create and manage attribute data within AutoCAD Map 3D.
- Use attribute data as the basis of queries.

- Display attribute data on your map as text.
- View and edit attribute data for features using the Data Table.

Data Table

Use the Data Table to highlight data for specific features in your map. AutoCAD Map 3D maintains the link between spatial data and attribute data; when you update the attribute data, the updates are dynamically reflected in your drawing.

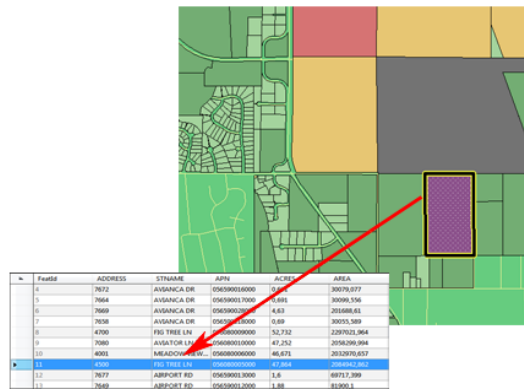

The Data Table displays geometry and attribute data for a feature. You can search and theme features based on any data in the feature source.

Data View

To link attribute data to drawing objects, attach the database to the current map. Then use a link template to connect the data to the objects.

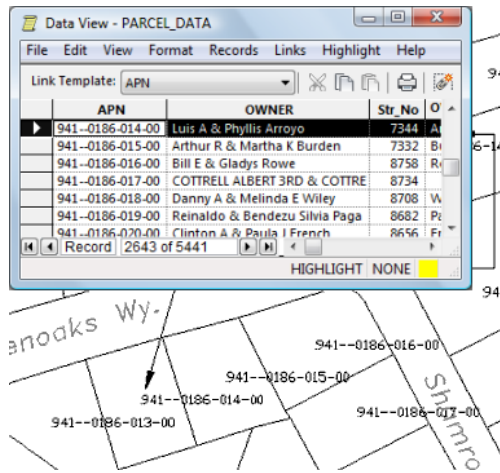

Link attribute data to drawing objects, then highlight objects in your map by selecting the linked data in the table.

Tell me more



Video

- [Show me how to view the contents of an SDF file.](#)



Procedures

- [To display the Data Table](#)
- [To use the Data View](#)



Tutorial

- [Data Table and Data View](#)



Workflow

- [Attach Attribute Data to Drawing Objects](#)
- [Add Attribute Data Based on Constraints](#)
- [Join Attribute Data to a Geospatial Feature](#)



GIS Skills

- [Convert styled DWG objects to features.](#)



Related topics

- [Viewing Data for a Selected Layer, Join, Unfiltered Feature Class, or Non-Spatial Data Table](#) (page 1134)
- [Setting Up Data Sources for Drawings](#) (page 204)

- [Adding Attributes to Drawing Objects](#) (page 521)
-

Use Metadata

View, create, and edit metadata (the who, what, when, where, why, and how) about your spatial information.

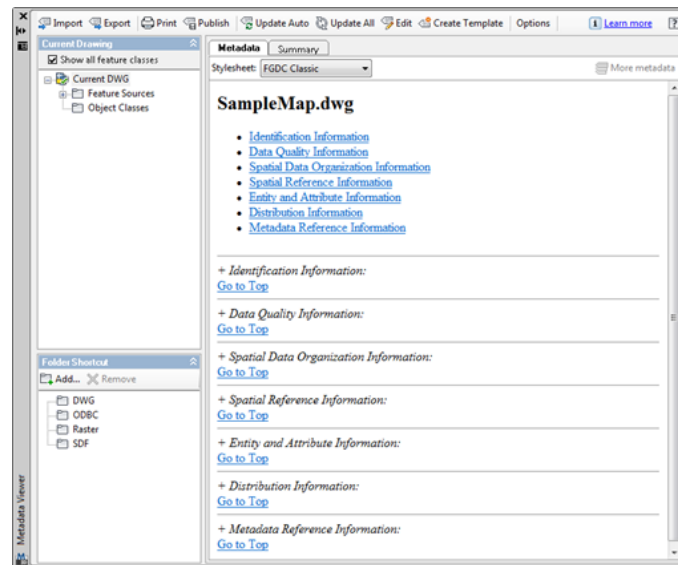

View and edit metadata.

Publish metadata in standard formats including International Organization for Standardization (ISO) (19115 and 19139) and Federal Geographic Data Committee (FGDC). Share your data with other people in your organization or externally with contractors and regulatory agencies.

Tell me more



Video

- [Show me how to view and interpret metadata.](#)
 - [Show me how to create and edit metadata.](#)
-



Procedure

- [To work with metadata](#) (page 1487)
-



Tutorial

- Lesson 6: Generate Metadata for a Classified Drawing
-



Workflow

- Create a Feature Map
 - Create a CAD Map
-



GIS Skill

- *View and interpret metadata.*
 - *Create metadata for your map.*
-



Related topics

- [Creating and Viewing Metadata](#) (page 1486)
 - [Overview of Sharing Metadata](#) (page 1510)
-

Organize Data

Organize objects in your drawing by the real-world features that they represent (for example, roads, parcels, cables, or water pipes).

Object Classification for Drawing Objects

When you create an object using object classification, the object automatically takes its properties and values from its object class. Classification maintains consistency and establishes standards in your drawing.

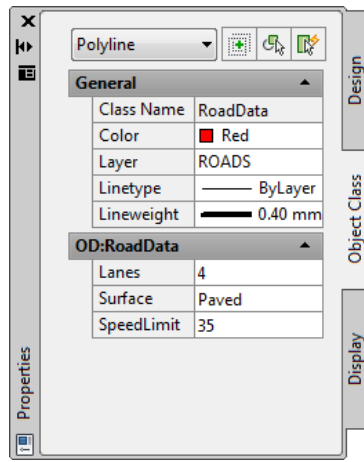

The Object Class tab of the Properties palette displays the properties associated with the class of the selected object.

If you are an AutoCAD Map 3D subscriber, you can download free industry-specific toolkits. These toolkits fast-track the classification process.

To enroll in or visit the Subscription Center, click  in the InfoCenter area at the top right of the application window.

Feature Classes for Geospatial Data

FDO features use schemas to define their feature classes and feature properties. A schema is a set of feature classes. Each feature class has properties that describe its members.

You can do the following with feature classes:

- Define schemas (databases and files)
- Create a data store and add a schema to it
- Load data models with XML Metadata Interchange (XMI) from industry standard modeling programs
- Edit a schema (for spatial data formats that support editing)

Logical Property

Name: Lanes

Type: Data

Description: The number of lanes for this road

System generated: Yes No

Data Attributes

Identifier	False
Data Type	Single
Default Value	
Read only	False
Nullable	True
Constraint Type	Range
Minimum Value	1
Min Value Included	True
Maximum Value	5
Max Value Included	True

Max Value Included
The maximum value is included in the constraint range.

Use the Schema Editor to create or edit properties in a feature class.

Tell me more



Video

- [Show me how to append a feature class to an SDF file.](#)



Procedure

- [To set up object classification](#) (page 118)
- [To use object classification](#) (page 981)
- [To work with feature schemas](#) (page 595)
- [To enroll as a subscriber or visit the Subscription Center](#) (page 56)



Tutorial

- [Tutorial: Classifying Drawing Objects](#)



Workflow

- [Set Up Your DWG Data](#)
- [Move CAD Data to GIS](#)



GIS Skills

- [Edit a schema \(SDF\)](#)



Related topics

- [Overview of Setting Up Object Classification](#) (page 117)
- [Overview of Object Classification](#) (page 981)
- [Overview of Working with Schemas](#) (page 594)

Style Data

Use styles to change the appearance of objects and features in your map.

- Assign visual properties to object groups, or to objects that match certain criteria.
- Create complex styles, such as roads with a thick black line with a double yellow stripe down the middle. Use specific colors and line types for different features.
- Call out details with attribute-driven labels that provide text along a curve and segment-stitching functionality.
- Blend data using transparency.
- Save and reuse styles in any project, saving time and streamlining map production.
- Save display layer definitions (which include styling information and pointers to the data source) for reuse.
- Export styles to share with others.
- Use special formatting options for raster images to show hillshade, contours, and more.

Style Drawing Objects and Features

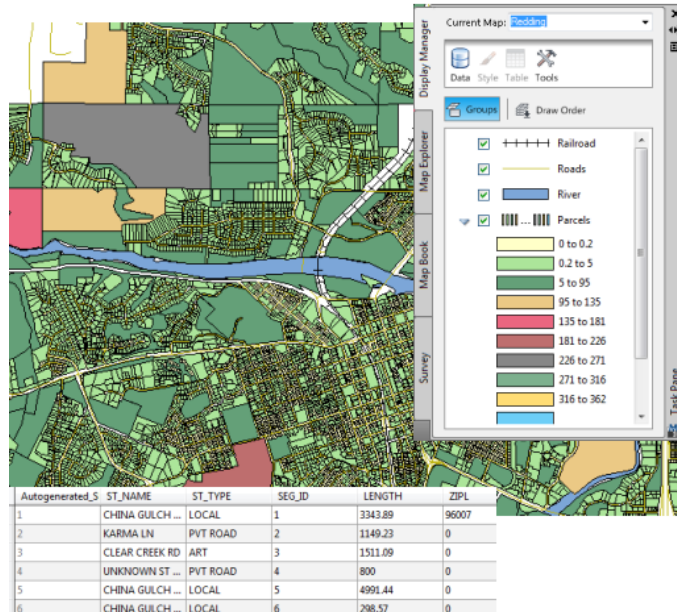

Style layers in **Display Manager (page 2060)** to change the appearance of your map.

Style Surfaces

Visualize and analyze large-scale topographic information—digital elevation models (DEM) and ESRI GRID files.

- Show elevation, slope, and aspect.
- Create contours.
- Perform sunlight studies with hill shading.
- Drape aerial photographs and vector data on topography data.
- Publish the results to 3D DWF files for viewing in free Autodesk® Design Review software. No experience with AutoCAD Map 3D is required.

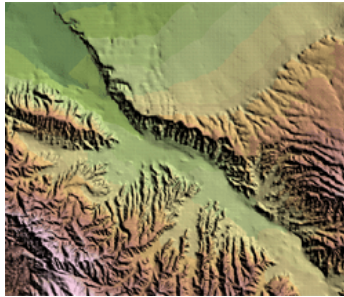

Style raster surfaces to show elevation.

Styling Point Cloud Data

Style [point cloud](#) (page 2071) data by classification, elevation, LiDAR intensity, and RGB values.

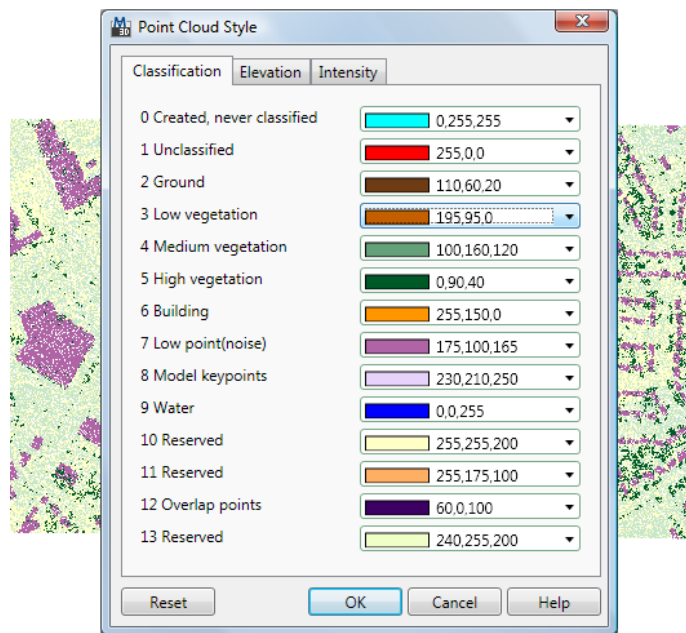

Style point clouds by classification

Tell me more



Video



Procedure

- [To apply styles to points](#) (page 646)
 - [To apply styles to areas](#) (page 650)
 - [To apply styles to lines](#) (page 649)
 - [To style point data by classification](#)In the Display Manager, right-click the point cloud layer or gr... (page 677)
-



Tutorial

- Lesson 2: Style Map Features
-



Workflow

- Style and Label a Linear Feature
-



GIS Skills

- *Hide and show features as you zoom in and out.*
 - *Replace points in the map with symbols.*
 - *Set transparency for parcels or other features.*
-



Related topics

- [Styling Features](#) (page 639)
 - [Styling Drawing Layers](#) (page 652)
 - [Creating Themes](#) (page 1162)
 - [Overview of Styling Raster Images](#) (page 672)
 - [Styling Point Clouds](#) (page 675)
-

Theme and Analyze Data

Answer questions about your data and make decisions.

- Sort, filter, and edit information about map items in a tabular format.
- Temporarily join data from external data stores to features in your map and use that data to theme the features.

- Locate specific coordinate points and measure the geodetic distance between points.
- Visually communicate relative values and scale with themed displays.
- Create contour maps to help you analyze 3D terrain.
- Use raster-based theming to analyze elevation, slope, and aspect, drape map data over surfaces and view the data in 3D, and more.
- Create buffer zones based on feature properties and select objects based on their proximity to a buffer. Save the buffer as its own feature class, for future reuse.
- Overlay two geospatial layers to compare their data. Save the resulting data as a separate layer, which you can join to attribute data or theme.

Theme Data

Use color themes to show the elevation of terrain or illustrate the population density of counties.



The colors give the viewer an immediate sense of the population distribution in California

Create themes by varying the style based on an attribute of the feature; for example, change the color of parcels based on their size.

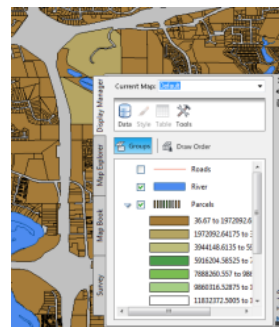

Analyze Surfaces

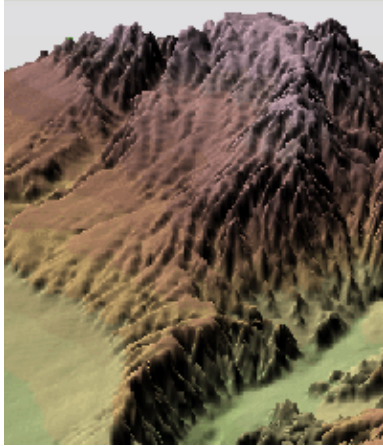

Create contour maps and analyze geospatial data by exaggerating elevations or looking at maps in different light conditions.

Create Buffers

Use buffers to analyze features by proximity.

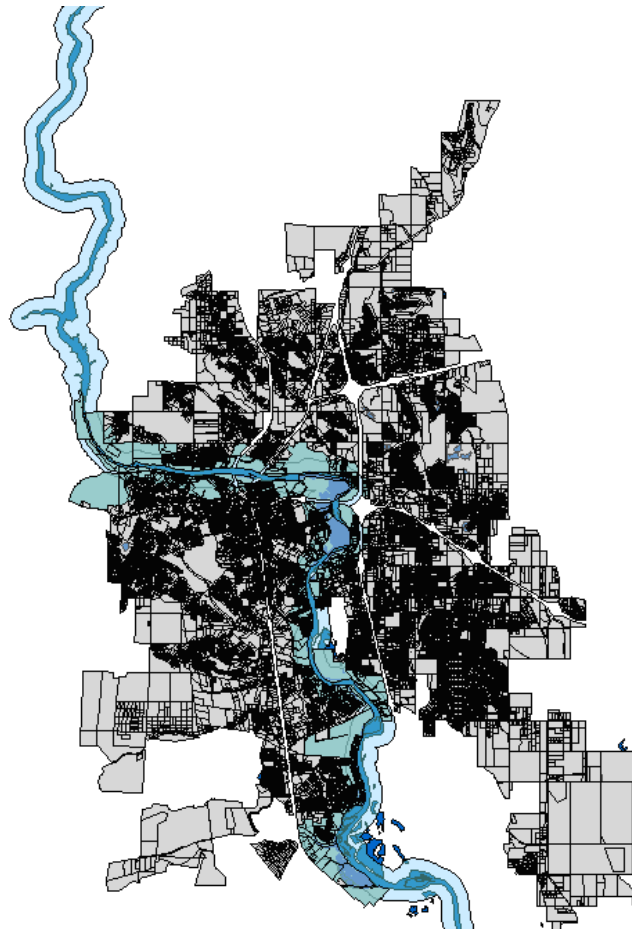

The buffer in this map defines an area within 1000 feet of the river. You can use the buffer to see which parcels lie within the flood zone.

Overlay Two Feature Layers

Use overlays to compare two feature classes or layers.

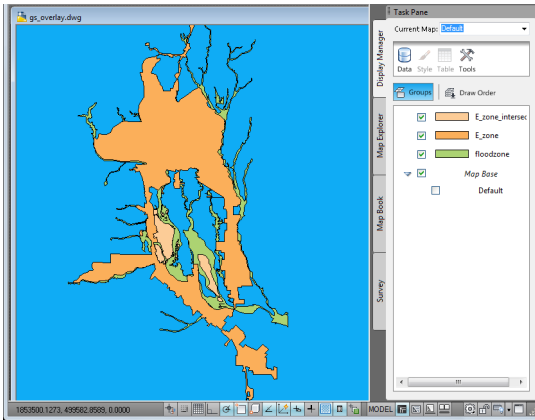

This map overlays two layers (a flood zone and an enterprise zone). You can use the overlay to see where the two intersect. That area becomes a new layer, which you can style and save out to a file and use as a separate data store.

Tell me more



Video

- *Show me how to color surfaces based on elevation.*
- *Show me how to theme a parcels layer.*
- *Show me how to create a buffer zone around a parcel.*
- *Show me how to join attribute data to features.*



Procedures

- [To get information about features and objects](#) (page 1125)
- [To find, filter, and query data](#) (page 1206)
- [To measure and track coordinates](#) (page 1147)
- [To create themes](#) (page 1163)
- [To analyze raster-based surfaces](#) (page 1186)
- [To create a buffer](#) (page 1308)
- [To perform an Overlay operation](#) (page 1316)



Tutorial

- Tutorial: Analyzing Data



Workflow

- Analyze Data
- Analyze Data with Overlays



GIS Skills

- *Join attribute data to features.*
- *Color a surface by elevation and adjust hill shading.*
- *Change the elevation ranges for a surface.*
- *Analyze the slope and aspect of a site.*
- *Select features by location using a buffer.*



Related topics

- [Getting Information about Features](#) (page 1125)
- [Getting Information About Drawing Objects](#) (page 1143)
- [Joining Data to GIS Features](#) (page 507)
- [Measuring and Tracking Coordinates](#) (page 1147)
- [Adding and Modifying Contour Lines](#) (page 1189)
- [Creating Themes](#) (page 1162)
- [Analyzing Raster-Based Surfaces](#) (page 1186)
- [Buffering Features in Your Map](#) (page 1306)
- [Overlaying Two Feature Sources](#) (page 1309)

Manage Data

AutoCAD Map 3D acts as a hub for managing large amounts of spatial data.

- Use Schema Editor to create new schemas.
- Add and delete features and properties in existing schemas.
- Use Data Connect to create a data store from within AutoCAD Map 3D.
- Export DWG data to [Oracle format](#), [ESRI ArcSDE format](#) (page 1461), or [Autodesk SDF](#) (page 44).
- Export your entire map to DWG format.
- Use Bulk Copy to copy data from one data store to another.

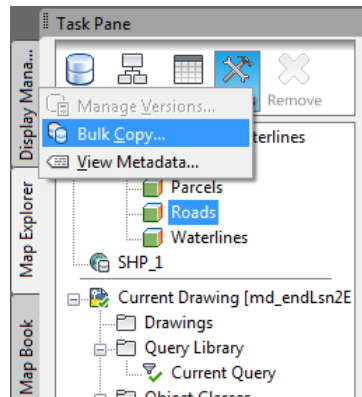

Use Bulk Copy to convert data from one geospatial format to another.

The Spatial Data File (SDF)

The spatial data file (SDF) format lets you store geometry and attribute information in a file-based geospatial format.

SDF can hold more information and has faster performance than DWG. SDF supports rich geometry, multiple tables, and spatial indexing.

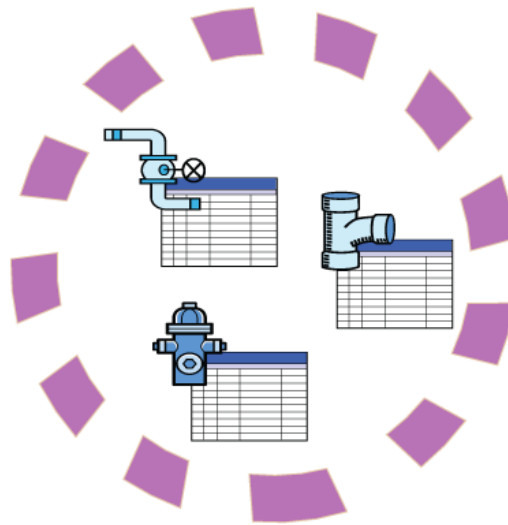

The circle represents an SDF file with a single schema that defines three feature classes: valves, pipes, and hydrants.

- Use Data Connect to connect directly to an SDF file. Any edits you make are made to the SDF file.
- If you import data from SDF, the imported data becomes drawing objects in your map and the live connection to the SDF file is broken. Importing is one way to convert the data from SDF to DWG.
- You can copy data to SDF format from other geospatial formats, and from SDF to those formats, using Bulk Copy.

Tell me more



Video

- *Show me how to create an SDF file and import a schema.*
- *Show me how to copy data from one data store to another.*
- *Show me how to append a feature class to an SDF file.*
- *Show me how to limit what can be entered in a field.*



Procedure

- [To create a data store for a file-based data provider](#) (page 589)

- [To create a schema](#) (page 598)
- [Other ways to move data into SDF format](#) (page 1417)
- [To copy data from one feature source to another](#) (page 621)
- [To import data from other formats](#) (page 381)



Tutorial

- [Tutorial: Managing Data From Different Sources](#)



Workflow

- [Manage Data](#)



GIS Skill

- [Create a GIS data store \(SDF\) to be populated from various sources](#)
- [Bulk copy data from a SHP file to an SDF file](#)
- [Edit a schema \(SDF\)](#)
- [Limit what can be entered in a field](#)



Related topics

- [About Geospatial Feature Classes, Data Stores, and Schemas](#) (page 551)
- [Overview of Geospatial Data](#) (page 551)
- [Importing Autodesk SDF \(Spatial Data Files\)](#) (page 387)
- [Working with Schemas](#) (page 593)
- [Exporting DWG Data to an FDO Data Store](#) (page 1461)
- [Bringing In Features from SDF](#) (page 337)
- [Migrating Data](#) (page 615)
- [Overview of Converting Geospatial Data to Drawing Objects](#) (page 378)
- [Overview of Converting and Exporting](#) (page 1405)

Share and Publish Data

Distribute your geospatial data, maps, and designs in various ways.

Share Data

AutoCAD Map 3D makes it easy to share data, both within and outside your organization.

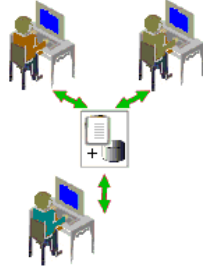

When you edit data in the original source, your changes are immediately visible to others in your organization.

Send Maps to the Field

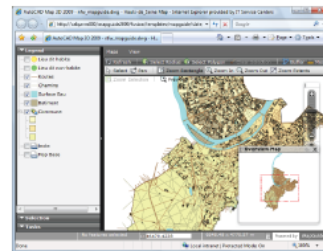
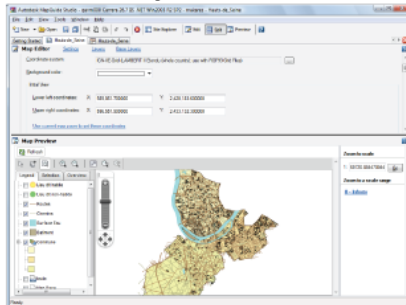
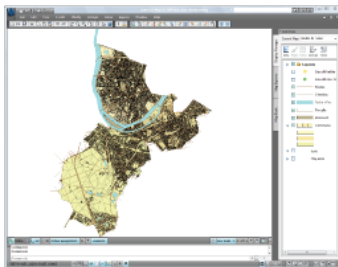

The original map in AutoCAD Map 3D is at the top. On the lower left, the map appears in Autodesk MapGuide Studio. On the right, the map is displayed in a web browser.

- Plot/print single-page or multi-page maps to paper or to a file.

- Use *map books* to divide a large map into tiles, which are rendered on separate pages. You can include a legend, title, and other information on each page.
You can produce *maps with insets* using map books.
- Publish maps to the internet using Autodesk MapGuide® Enterprise software.
All layers, layer definitions, dynamic labels, queries, filters, and styles (including point, line, raster, and other styles) in your map are published. If you set up styles for different zoom levels, the appearance of the map changes as the end-user zooms in or out in a web browser. Zooming changes the appearance based on the styling rules you established in AutoCAD Map 3D.
- Publish your map as a single HTML page. The result is a “snapshot” of the map that anyone can view in a web browser.
- Save maps in *Autodesk DWF* format to use with Autodesk Design Review (a free, downloadable viewer). Distribute or post the results on the web or on an intranet. You can create map books in DWF format.
If you assigned a coordinate system to all the maps in your DWF file, the publishing operation automatically converts the coordinate information to latitude/longitude coordinates. Autodesk Design Review 2008 can automatically navigate to a specific location when you enter coordinates. It displays coordinates of any location in the map when you move your mouse over that location.
- Export to another format, such as DGN or SHP.
- Create comma-separated *reports* as text files, listing information about objects in attached drawing files. You can import the report files into a spreadsheet, database, or document.
- Use eTransmit to package all the files your map uses and send them to another AutoCAD Map 3D user.

Tell me more



Video

- *Show me how to publish a map to a MapGuide server.*
 - *Show me how to create a map book.*
 - *Show me how to publish a map book with attributes to a DWF file.*
-



Procedures

- [To publish your map](#) (page 1361)
- [To export drawing objects to other file formats](#) (page 1408)
- [To print and export attribute data](#) (page 1472)



Tutorials

- Lesson 7: Publish Your Map



Workflow

- Print and Publish Data



GIS Skills

- *Publish a completed map to a MapGuide server.*
- *Create a map book with appropriate-scale tiling for a city.*
- *Produce a multi-sheet DWF file for a map book.*



Related topics

- [Overview of Publishing and Sharing](#) (page 1357)
- [Overview of Converting and Exporting](#) (page 1405)
- [Overview of Exporting Attribute Data](#) (page 1472)
- [Creating a Drawing Object Report \(DWG\)](#) (page 1477)

Customize Your Working Environment

Customize AutoCAD Map 3D

The layout of the ribbon, toolbars, and dockable windows is saved in a workspace.

You can customize an existing workspace or create a new one. You can save different workspaces for different tasks, use them to help you streamline common tasks, or set up best practices for mapping tasks and workflow.

For example, you can set up a map creation workspace to streamline acquiring, integrating, and building maps. Set up another workspace for creating and publishing map books and atlases.

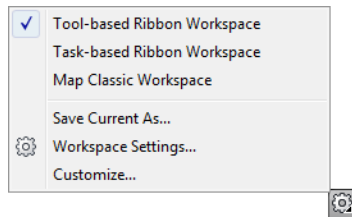

Within a session, you can switch between workspaces.

Customize Your Maps

Customize map settings and optionally save the resulting map as a template. For each map, you can do the following:

- Set the coordinate system
- Attach drawing files
- Save and organize drawing queries in a library
- Define annotation templates
- Set up object data
- Attach external data and link it to drawing objects

Create and Use Automated Workflows

Automate a task that involves multiple activities with workflows. For each activity, you can specify input parameters and settings.

You can use the properties of one activity as the input parameter for a later activity in the workflow. For example, set up an overlay workflow that specifies the feature classes to compare and the type of overlay to perform.

You can also specify that some settings can be changed at run time. For example, use the same overlay workflow for any pair of feature classes, selecting the feature classes when you run the workflow.

See also:

- [Overview of Setting Up AutoCAD Map 3D](#) (page 81)
- [Customizing Your Work Environment](#) (page 84)
- [Overview of Setting Up Your Map File](#) (page 139)

- [Overview of Setting Options](#) (page 217)
- [Overview of Workflows](#) (page 275)

Extend Functionality Using Open Source and API

Extensibility Using Open Source

With the power of FDO Data Access Technology, you can take advantage of the open source world. FDO extends data access. Third party and open source FDO providers support data stores not currently supported by Autodesk. (For example, there are FDO providers for ESRI Personal Geodatabase and PostGIS).

To make it easier for developers to extend capabilities of FDO, Autodesk released FDO as an open source project. Check the <http://fdo.osgeo.org> site. The open source project is under the Open Source Geospatial Foundation (OSGeo) <http://www.osgeo.org>. This initiative enables developers all over the world to tap into powerful geospatial data access technology.

Robust API

AutoCAD Map 3D comes with robust .NET application programming interfaces (APIs) that organizations can use to create custom tools and automate common procedures. AutoCAD Map 3D and Autodesk MapGuide Enterprise software share a unified geospatial API, as well as unified FDO data access technology. Use these tools to build custom applications that share business logic and common code.

Finding Information

Watching Videos

The GIS Skills file contains nearly one hundred videos that show how to use the features of AutoCAD Map 3D. The tutorial “Building a Map” also contains videos for each exercise.

This page lists the GIS Skills videos by category.

Data Preparation

Data Conversion

Data Access

Show me how to bring multiple image files onto a single layer

Show me how to run a query on a feature class

Data Editing

Show me how to draft a new feature for an existing feature class

Show me how to edit features stored in a database or data store

Show me how to edit features using automatic check-out

Show me how to add a point using distance/distance

Show me how to add a point using bearing/bearing

Show me how to split a parcel feature

Show me how to create new features from existing AutoCAD objects

Show me how to check out features for editing in the field

Show me how to check in features after editing in the field

Show me how to make the Data Table transparent

Show me how automatic zoom works

Show me how automatic scroll works

Show me how to export records for selected features

Data Management

Show me how to create a new SDF file and import a schema

Show me how to copy data from one data store to another

Show me how to append a feature class to an SDF file

Show me how to delete properties in the Schema Editor

Show me how to limit what can be entered in a field

Show me how to join attribute data to features

Show me how to manage joins

Show me how to create a calculated field

Styling and Theming Features

Show me how to make a layer visible only at a certain scale range

Show me how to create a second scale range for a road layer

Show me how to replace points with symbols

Show me how to label features

Show me how to label features with automatic resizing

Show me how to set the number of decimal places for labels

Show me how to create a text layer and add text

Show me how to edit text

Show me how to rotate text

Show me how to make the features on a layer semi-transparent

Show me how to theme a parcels layer

Show me how to manually adjust the ranges of a theme

Show me how to exclude zero values and change colors for the ranges

Show me how to theme based on individual values

Analysis

Show me how to color surfaces based on elevation

Show me how to adjust the settings for hillshading

Show me how to delete elevation ranges and change the color of a range

Show me how to add a new elevation range

Show me how to view and navigate in 3D

Show me how to exaggerate the vertical dimension of a surface

Show me how to drape layers on a surface

Show me how to perform a slope analysis of a surface

Show me how to create a contour layer from a surface

Show me how to create a network topology

Show me how to load a topology

Show me how to find the shortest path between two points
Show me how to do an overlay analysis using two topologies
Show me how to create an overlay analysis for features
Show me how to create a buffer zone around a parcel
Show me how to use a buffer zone to select parcels
Show me how to create overlapping buffer zones
Show me how to use a location query with multiple buffers

Sharing Data with Others

Show me how to export a layer to SDF
Show me how to import a layer from SDF
Show me how to save a layer to a .layer file
Show me how to drag .layer files into an existing map

Map Layout and Cartography

Show me how to manage layers with draw order and folders
Show me how to include an AutoCAD layer in the Display Manager
Show me how to place a legend in the map and specify its contents
Show me how to edit the table style for the legend

Printing, Plotting, and Publishing

Show me how to create a map book.
Show me how to publish a map book with attributes to a DWF file
Show me how to plot to a PDF file

Using InfoCenter

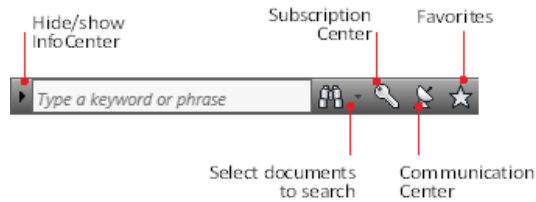

InfoCenter connects you to Help files and online resources.

To look up information

- 1 Type a word or phrase in the InfoCenter field.
- 2 To add a location (file or document) to search, click the arrow next to Search (the magnifying glass) and select Add Search Location.

For example, search the *Help*, the *New Features Workshop*, and specified files at one time.

You can also search a single file or location.

- 3 Click Search.
The results are displayed as links on the InfoCenterSearch Results panel. Click any link to display the topic, article, or document. To find a command, click the Find A Command On The Ribbon entry.

You can change some settings for InfoCenter. See [Setting InfoCenter Options](#) (page 242).

To hide InfoCenter

- Click the arrow to the left of the InfoCenter field. Click it again to redisplay InfoCenter.

Subscription Center

With Autodesk Subscription, you get the latest releases of Autodesk software, incremental product enhancements, personalized web support from Autodesk technical experts, and self-paced e-Learning.

Subscription services are available to subscription members only (available in countries/regions where Autodesk subscriptions are offered).

Subscription resources provide interactive product features over the Internet. Each time you access subscription resources from Subscription Center in an Autodesk product, product information (such as the serial number, version, language, and the subscription contract ID) is sent to Autodesk for verification that your product is on subscription.

Autodesk compiles statistics using the information sent to subscription resources to monitor how they are being used and how they can be improved. Autodesk maintains the information provided by or collected from you in accordance with Autodesk's published privacy policy, which is available at <http://www.autodesk.com/privacy>.

To enroll as a subscriber or visit the Subscription Center

- Click  .

Communication Center

The online Autodesk Communication Center gives you access to the AutoCAD Map 3D knowledge base and other user groups discussing AutoCAD Map 3D.

To check the Autodesk Communication Center

- Click  .

Favorites

You can define favorite entries in the InfoCenter results list panel, the Subscription Center panel, or the Communication Center.

To add a topic to the Favorites list

- 1 Use InfoCenter, Subscription Center, or Communication Center to display a list of results.
- 2 Click the Add To Favorites icon next to the entry to add.
Entries that display a yellow star have been added to the Favorites list.

To view a topic in the Favorites list

- Click  and select the topic.

See also:

- [Setting InfoCenter Options](#) (page 242)
- [Using the Help](#) (page 57)
- [Getting Help with AutoCAD](#) (page 58)
- [Using Other Sources of Information](#) (page 59)

Using the Help

AutoCAD Map 3D Help contains the *AutoCAD Help*, *AutoCAD Map 3D User's Guide*, *Reference Guide*, *Getting Started Guide*, and additional information.

To display Help

- Click  .
Click the question mark to display the *User's Guide*. Click the down arrow to select a document to view.

Watching the Welcome Screen Videos

The Welcome screen displays when you start AutoCAD Map 3D. It contains links that launch videos explaining how to get started with AutoCAD Map 3D. It also has links to further information.

If you turn off the display of the Welcome screen, type `welcomescreen` at the command prompt to see it again.

Navigating the User's Guide

The *User's Guide* contains chapters for each major task area of AutoCAD Map 3D.

The *User's Guide* displays related information on three tabs:

- **Concept** — Conceptual information about performing the task and hints to help you use the feature.
- **Procedure** — Step-by-step instructions to perform the task.

- Quick Reference — The commands you need for this task, and where to find them on the menus and toolbars.

Use the tabs in the left pane to find information:

Contents	The Contents groups topics by subject. Browse by selecting and expanding topics. If you use the Index or Search tabs to find a topic, the Contents tab updates to show you where that topic is. Both AutoCAD Map 3D and AutoCAD Help topics are listed in the Contents.
Index	In the alphabetical list of keywords, look up the name of a feature, command, or operation, or an action you want the program to perform. You can look up topics for both AutoCAD Map 3D and AutoCAD.
Favorites	Create your own list of favorite topics. To add a topic to the list, open the Favorites tab and click Add.
Search	Find information using a question phrased in everyday language. The search ranks resulting topics by relevance. NOTE Search technology varies by language version of the product. The Search tab provides either the traditional Microsoft® search that locates keywords and exact phrases, or a natural-language search that analyzes phrases or questions.

Using the Tutorials

Try the tutorials to get started or to learn advanced functionality in AutoCAD Map 3D. Click Help ► Learning Resources ► Tutorials.

Getting Help with AutoCAD

AutoCAD Map 3D includes the complete functionality of AutoCAD, including all the AutoCAD commands and system variables. Help for the two programs is integrated into a single *Help* file. For help with AutoCAD commands, search for the command name in the *Help*.

New in This Release

- The *Readme* contains updates about this release of AutoCAD Map 3D, including late-breaking product news and known software issues. *View the Readme.*
- *New Features Workshop* — View a series of graphical topics designed to help you learn about the new features in AutoCAD Map 3D and AutoCAD. Click [Help](#) ► [New Features Workshop](#).

Using Other Sources of Information

To see the resources available to help you learn AutoCAD Map 3D, see *Learning Resources*.

Geospatial Guidelines

- *Best Practices for Managing Geospatial Data*— Learn the key concepts of working with geospatial data and the best way to use AutoCAD Map 3D to achieve your goals.
- *GIS Skills for Engineers*— See over 90 animations that help you take your skills to the next level.

Developer Documentation

- [Developer Documentation](#) (page 2053) — Learn how to use the AutoCAD Map 3D Application Programming Interfaces (APIs), including ObjectARX, ObjectARX Managed Wrappers, ActiveX, and AutoLISP. Click [Help](#) ► [Developer Resources](#) ► [AutoCAD Map 3D Developer Help](#).
- *FDO Developer Help* — Extend the functionality of the feature source providers. See *FDO Developer's Guide*, *The Essential FDO*, and the API references for each provider:
 - *FDO Provider for Oracle API Reference*
 - *FDO Provider for ArcSDE API Reference*
 - *FDO Provider for SQL Server API Reference*
 - *FDO Provider for MYSQL API Reference*
 - *FDO Provider for SHP API Reference*
 - *FDO Provider for SDF API Reference*

- *FDO Provider for ODBC API Reference*
- *FDO Provider for Raster API Reference*
- *FDO Provider for WMS API Reference*

Specialized AutoCAD Manuals

- Some AutoCAD manuals, such *Build Your World* and *Getting Started*, are available on the product CD. For information on printing these manuals, see [Printing This Documentation](#) (page 61).

Online Resources

- *Product Support Resources*— Get answers quickly and efficiently through email or get Product Support phone numbers.
- *AutoCAD Map 3D Discussion Groups*— Share product information, ideas, and solutions with other AutoCAD Map 3D and other Autodesk product users.
- *Training Resources*— Learn about the training resources available for AutoCAD Map 3D and other Autodesk products.
- *Developer Center*— Learn about programming and development tools to help customize AutoCAD Map 3D or build your own applications.
- *Subscription Center* — Access your subscription services including support and training through the InfoCenter Communication Center. For more information, see [Using InfoCenter](#) (page 55).
- *Communication Center* — Receive Autodesk company news and product announcements, breaking news from Autodesk Product Support, new article notifications, tips, and more. For more information, see [Using InfoCenter](#) (page 55).

Participating in Autodesk Training

Training programs and products from Autodesk help you learn the key technical features of your Autodesk software and improve your productivity. For the latest information about Autodesk training, visit <http://www.autodesk.com/autocadarchitecture-training> or contact your local Autodesk office.

For information on custom training, authorized Autodesk training centers, how-to tips, and learning tools (such as Autodesk Courseware), go to *Training Resources*.

e-Learning

With Autodesk Subscription, you get the latest releases of Autodesk software, incremental product enhancements, personalized web support from Autodesk technical experts, and self-paced e-Learning.

Subscription services are available to subscription members only (available in countries/regions where Autodesk subscriptions are offered).

For more information about subscription, see [Subscription Center](#) (page 55).

Printing This Documentation

You can print the *Help* and other manuals.

Printing PDF Versions of the Help

Most of the *Help*, including the *AutoCAD Map 3D User's Guide* (the help system), are available in PDF format.

NOTE You must have Adobe® Acrobat Reader™ installed to view and print PDF documents.

To print the AutoCAD Map 3D Users Guide

- 1 Open the AutoCAD Map 3D *User's Guide*.
- 2 Click Print.

WARNING The User's Guide is over 1000 pages long! To save paper, print only the chapters you need.

To print the other manuals

- 1 Insert the AutoCAD Map 3D CD or DVD into the drive.
- 2 When the CD browser starts, click the Documentation tab. If the CD browser does not start automatically, double-click the *Setup.exe* file.
- 3 On the Documentation tab, select the book to print.

4 Click Print.

AutoCAD Map 3D Sample Data and Templates

Use sample data to experiment with map techniques before deploying your own data.

AutoCAD Map 3D sample data includes the following:

- Symbol sets
- Templates
- Map elements, such as north arrows, scale bars, and legends

Use these elements to create maps quickly and easily, enhance new and existing maps, promote standards, and improve consistency. They can also serve as the basis for developing your own templates and data.

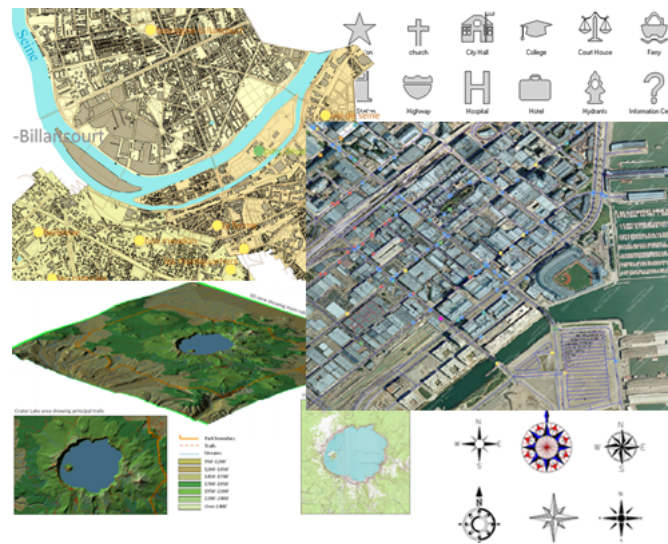

© IGN - 2007, NAVTEQ, DigitalGlobe, Intermap Technologies

AutoCAD Map 3D sample data, symbols, and templates

Sample Real-World Data

With Autodesk Subscription, you get any new upgrades of your Autodesk software and any incremental product enhancements, if these are released during your subscription term. Product enhancements may include extensions, bonus packs or other rich content for AutoCAD Map 3D software. To learn more, visit <http://www.autodesk.com/subscription>.

For all data connections to be correct and connected automatically, copy your sample data to this location: *C:\AutoCAD Map 3D 2011 Sample Data*. If you put it in a different location, you must fix data connections.

The sample data includes the following:

- **Redding, California**

A real-world data set from the city of Redding, California, in the United States. The set includes parcel data, soil drawings, water data, metadata, and more.

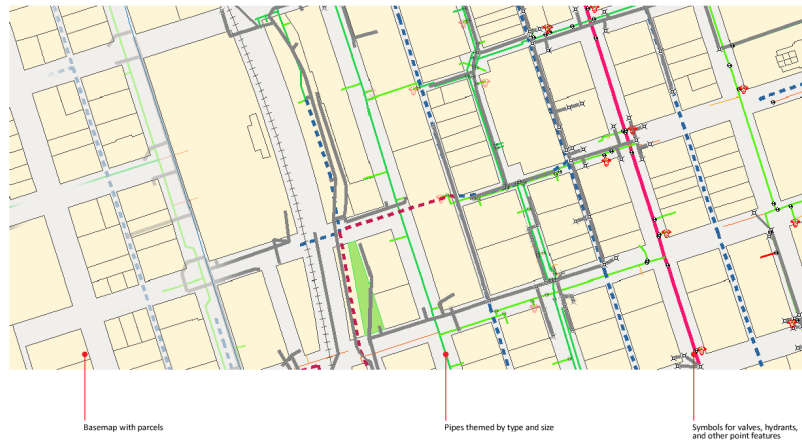

- **Haute-de-Seine**

The Institut Geographique National (the national mapping agency of France) provides data covering “department 92.” Departments are French administrative units, roughly analogous to English counties. Department 92 includes several cities near Paris, in an area called Haute-de-Seine.



© IGN - 2007

**Institut Geographique National (IGN)
provides a comprehensive set of sample
data for Haute-de-Seine.**

- **NAVTEQ data**
NAVTEQ provides data sets for 3-km x 3-km areas of seven sample cities from around the world. NAVTEQ data is used in a broad range of location-based applications, navigation products, and mapping sites. The sets include vector data, street centerline map data, and much more. Use the sample data to get an idea of what NAVTEQ can provide and how to use it to enhance your maps in AutoCAD Map 3D.
- **DigitalGlobe imagery**
DigitalGlobe provides imagery for the seven sample cities. DigitalGlobe is a provider of high resolution aerial and satellite imagery.
- **Intermap 3D elevation data**
Intermap Technologies provides Digital Elevation Models (DEMs) for the seven sample cities. Intermap provides high-quality, precise, 3D digital-elevation data and images.



- DigitalGlobe ImageConnect
ImageConnect is a *plug-in* you can install on top of AutoCAD Map 3D. It allows you to bring in georeferenced satellite and aerial photos from the DigitalGlobe online image server. ImageConnect is a quick, cost-effective way to add high-resolution imagery to your maps.
- Map Book Templates
These templates are installed with AutoCAD Map 3D.



These map book templates are installed with AutoCAD Map 3D.

- **More 3D elevation data**
AutoCAD Map 3D sample data includes additional DEMs to experiment with.
- **Sample maps**
These maps use sample data from NAVTEQ, Intermap Technologies, and DigitalGlobe. There are also real-world maps from Redding, Grand Forks, Crater Lake, and more.

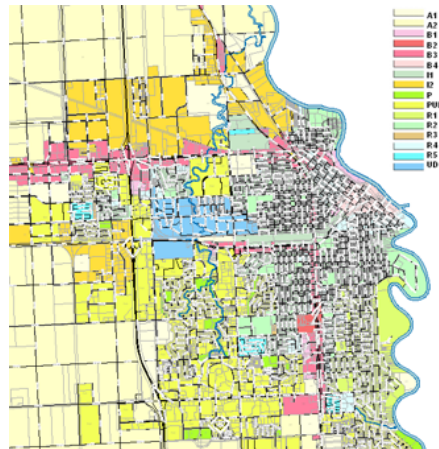

- **Symbols**
The sample data includes a copy of the symbol sets, north arrows, and scale bars that are installed with AutoCAD Map 3D.
When you download these files to the *AutoCAD Map 3D 2011 Sample Data* folder, documentation for their use is also downloaded.
- **Additional sample data and maps, including Crater Lake, US Geology, and Grand Forks, North Dakota are installed here:**
`\\Program Files\\AutoCAD Map 3D 2011\\Sample\\Maps`

Templates for Maps and Map Books

Templates allow you to reuse or standardize map settings, layouts, layer definitions and settings, block definitions, data connections, coordinate system information, and more.

Instead of manually reproducing the settings and common parts of your maps, you save them in a template file (*.dwt*). Then you can use the template as you create new files.

When you create a series of maps, templates save time and improve consistency.

AutoCAD Map 3D comes with two types of templates:

- Templates for creating new maps
There are four templates available to choose from: *map2d.dwt*, *map2diso.dwt*, *map3d.dwt*, *map3diso.dwt*. The templates settings optimize 2D and 3D

display for metric (ISO) and imperial (ANSI) units, respectively. Click  **► New ► Drawing**. Select a template from the list.

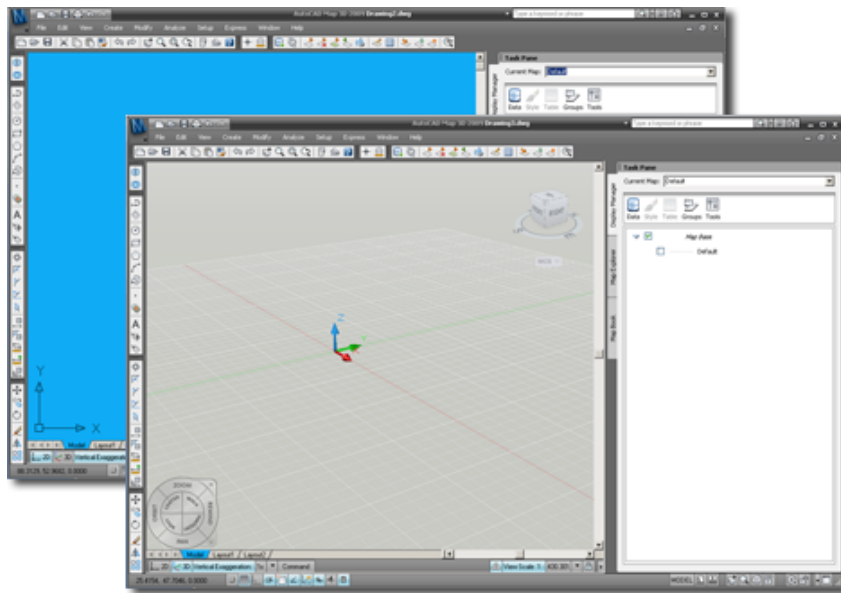

Templates provided with AutoCAD Map 3D include *map2d.dwt* and *map3d.dwt*.

- Templates for creating map books and tiled DWGs
These templates help you create attractive printed map books or tiled DWGs with a minimal amount of layout work. There are three designs available, each with numerous paper sizes, both metric (ISO) and imperial (ANSI). Each design has its own navigation arrows, layout settings, title blocks, and more.

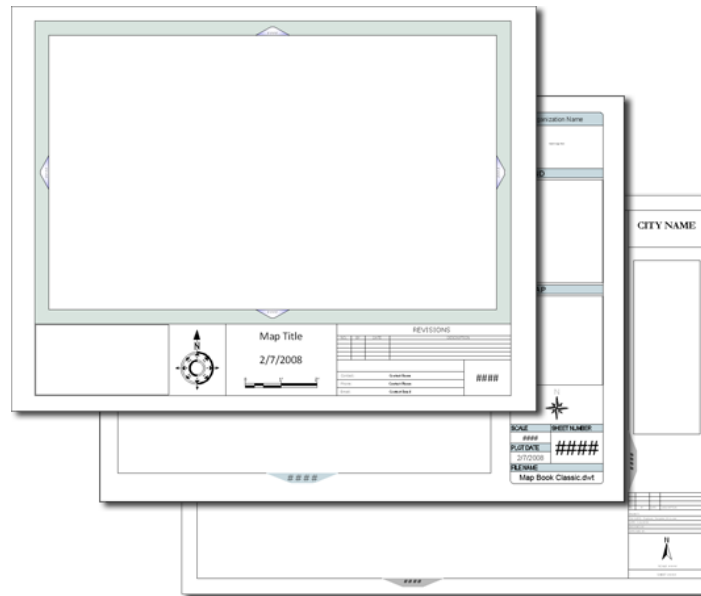

Map book templates provided with AutoCAD Map 3D include Elegant, Classic, and original designs.

You can use both types of templates as-is or adapt them to suit your needs.

Templates are available in *\Documents and Settings\\Local Settings\Application Data\Autodesk\ AutoCAD Map 3D 2011\R17.2\enu\Templates*

If you are an AutoCAD Map 3D subscriber, you can download free industry-specific toolkits. These toolkits include specialized templates. To

enroll in or visit the Subscription Center, click  in the InfoCenter area at the top right of the application window.

See also:

- Lesson 2: Customize a Map Book Template

Symbols for Water, Gas, Electric, and Emergency Response

AutoCAD Map 3D comes with sample symbol sets customized for water networks, gas utilities, electric utilities (North America), and emergency response planning. You can use the sample symbols as-is or as a basis for developing your own symbols.

Using symbols can promote standardization and consistency in your organization, and can also improve communication by using familiar symbology.

Each set of symbols comes in a separate DWG file. For example, there is *Map - Water.dwg*, *Map - Electric.dwg*, and so on. There are several files for Emergency Response.

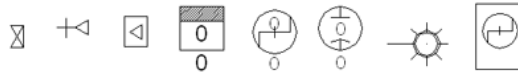

These electric symbols are examples from *Map - Electric.dwg*.



These gas symbols are examples from *Map - Gas.dwg*.



These water symbols are examples from *Map - Water.dwg*.



These emergency response symbols are examples from *Map - ER Incident Centers.dwg*.

The symbols are available in `\Program Files\AutoCAD Map 3D 2011\Sample\Symbols`.

The symbols are in dynamic block format, making them easy to rotate, resize, and color. They have block color properties, which optimizes them for use in DWGs. You can also use them in the Style Editor when styling points.

To set up the symbols for easy drag-and-drop into your maps, you can add them to a Tool Palette.

Symbols for General Use

AutoCAD Map 3D has sample symbols for general-purpose use, such as points of interest, transportation, and local government.

Like the [industry symbols](#) (page 69), general-purpose symbols are usable as-is, or as a basis for developing new symbols.

Using symbols can help promote standardization and consistency in your organization, and can improve communication by using familiar symbology.

The symbols come in two formats:

- Dynamic block versions (*Map - Points of Interest.DWG*) are in dynamic block format so you can scale and rotate them easily. You can control outline and fill colors separately in the Style Editor. The symbols are black by default when viewed in the DWG.



These general-use symbols are examples from *Map - Points of Interest.dwg*.

- Bitmap versions in *.png* format lend a more graphical representation to your points.



These bitmap symbols are examples from *Map - Points of Interest.dwg*.

The general-use symbols are available in `\Program Files\AutoCAD Map 3D 2011\Sample\Symbols`.

North Arrows, Scale Bars, and Other Map Elements

Sample north arrows and scale bars (both metric and imperial) are available as dynamic blocks for you to insert into your maps.

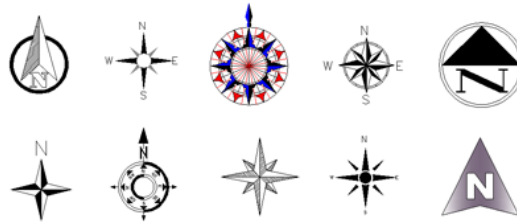

These north arrows are examples from the *Symbols* folder.

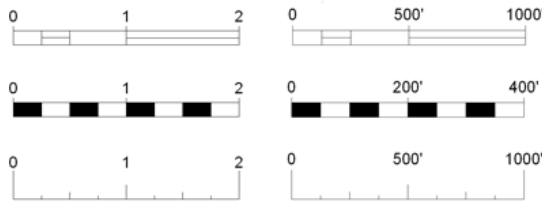

These scale bars are examples from the *Symbols* folder.

Because they are in dynamic block format, these symbols are easy to scale, rotate, and color. Use the scale bar attributes to set the correct scale.

The samples are available in `\Program Files\AutoCAD Map 3D 2011\Sample\Symbols`.

A modern, easy-to-read legend style is automatically available when you add a legend to a map.

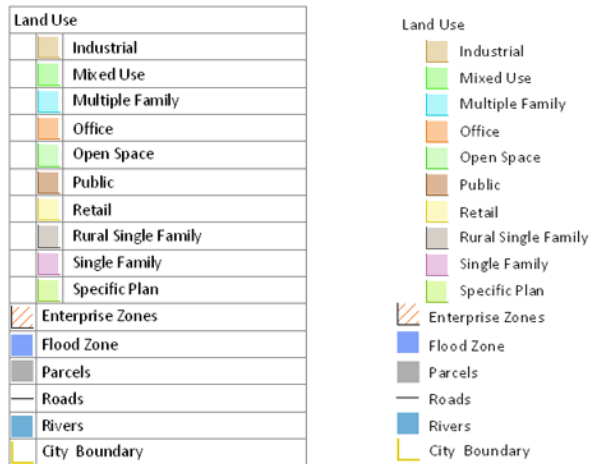

The legend style on the left appears in your onscreen map.
 The legend style on the right appears in the published version.

Geospatial Data Available for Purchase

You can add raster elevation data to 3D maps, vector data, such as land plots or points of interest, or satellite imagery.

Autodesk partners with leading geospatial data providers to provide a geodata portal with high-resolution, precision, geospatial data. Get data quickly, easily, and at lower cost.

Visit the geodata portal at <http://www.autodesk.com/geodata>.

The following types of data are available on the portal:

- Aerial and satellite imagery from DigitalGlobe
- 3D raster elevation data from Intermap Technologies
- Vector data, such as roads and land parcels, from NAVTEQ
- Weather data from WeatherBug



This data is from Intermap Technologies, NAVTEQ, and DigitalGlobe.

Tutorial Sample Files

The tutorials are accessible from the Help menu.

After installation, the tutorial sample files are located in *Program Files\AutoCAD Map 3D 2011\Help\Map 3D Tutorials*. The tutorials advise you to copy the sample files to your *My Documents* folder so you do not modify the original files.

AutoCAD Samples

AutoCAD provides sample drawings, sheet sets, blocks, VBA examples, and more.

After installation, the files are located in *C:\Program Files\AutoCAD Map 3D 2011\Sample*.

User's Guide

This section explains AutoCAD Map 3D's features by introducing concepts, providing step-by-step procedures, and providing quick reference information.

For information on AutoCAD commands, refer to the *AutoCAD Help*.



Setting Up

2



Overview of Setting Up



You can customize AutoCAD Map 3D and set up each map file you create to make your work easier and more productive.

The following tables summarize your setup options on a product-wide and map-wide basis.

On a product-wide level...	Use this method...	To get this result...
Set up user access.	Click Map Setup tab ► Map panel ►  ► User Administration. 	The system administrator assigns login names and passwords to users, and specifies what each user can do within the product. See Setting Up Users and Assigning Rights (page 82).
Set up your workspace.	In the Tool-based Ribbon Workspace, click Tools tab ► Customization panel ► User Interface.	Customize the ribbons, menus, toolbars, and dockable windows. See Customizing Your Work Environment (page 84).
Create new coordinate systems.	Click Map Setup tab ► Coordinate System panel ► Define Global Coordinate System. 	Create a new coordinate system or use a predefined coordinate system as a basis for creating your own. See Defining Coordinate Systems (page 89).

On a product-wide level...	Use this method...	To get this result...
Set up object classification.	<ol style="list-style-type: none"> 1 Select a sample object for the object class. 2 Attach an object definition file. 3 On the Map Explorer tab of the Task Pane, right-click Object Classes. Click Define Object Class. 	<p>Define a set of standard objects for your organization so that new drawing objects of that type use the properties you defined.</p> <p>See Overview of Setting Up Object Classification (page 117).</p>
Set up for digitizing	<ol style="list-style-type: none"> 1 Configure the digitizer in the AutoCAD Options dialog box. 2 Register the map using the TABLET command. 3 Set digitizing specifications in the Digitize Setup dialog box. 4 Use the MAPDIGITIZE command to digitize the objects. 	<p>Convert paper-based graphical information into a digital format using drawing commands to trace data from the paper map into a DWG file.</p> <p>See Setting Up for Digitizing (page 130) and Overview of Digitizing Objects (page 1079).</p>
Set default values and settings.	<p>In the Tool-based Ribbon Workspace, click Map Setup tab ► Map panel ► angle-arrow.</p>	<p>Change settings that affect the work environment, how the program starts up, whether users must log in, and settings for your current drawings, data sources, and more.</p> <p>See Setting Options (page 216).</p>
Set options related to images you added with Raster Extension.	<p>In the Tool-based Ribbon Workspace, click Insert tab ► Image panel ► angle-arrow.</p>	<p>Changes settings related to the Raster Extension, such as where image-related files are stored, how images display in maps, and memory usage options. These options do not affect images you added with Data Connect.</p> <p>Setting Raster Image Options (page 249)</p>

On a product-wide level...	Use this method...	To get this result...
Customize and automate import and export operations.	Edit the <i>mapexport.ini</i> file using a text editor such as WordPad.	Modify the .ini files that specify import and export settings. See Customizing the Import and Export .ini Files (page 264).
On a map-wide basis...	Use this method...	To get this result...
Assign a coordinate system.	Click Map Setup tab ► Coordinate System panel ► Assign. 	Specify the coordinate system used for attached drawings and for the current drawing. See Assigning Coordinate Systems (page 142)
Attach drawings.	Drag a drawing file from Windows Explorer to the Map Explorer tab of the Task Pane.	Work with objects from other drawings by attaching those drawings to the current map and querying in the objects. See Overview of Attaching Drawings (page 154)
Modify the settings for attached drawings.	At the Command prompt, enter <code>adedrawings</code> .	Specify how attached drawings work with the current drawing and view information about attached drawings. See Modifying Attached Drawing Settings (page 163).
Set up queries.	<ol style="list-style-type: none"> To save the current query, click Home tab ► Data panel ► Define Query.  To run a saved query, click Create tab ► Object Query panel ► Run.  	Save and reuse drawing queries in a library. See Overview of Using the Query Library (page 174).

On a map-wide basis...	Use this method...	To get this result...
Define annotation templates.	Click Annotate tab ► Map Annotation panel ► Define Template. 	Define the information to display in a drawing object annotation and the layout of that information. Then you can attach instances of the annotation to drawing objects in your drawing. See Defining Annotation Templates (page 190)
Set up object data.	Click Map Setup tab ► Attribute Data panel ► Define Object Data. 	Create tables with fields for text and numerical information. Attach records from the table to drawing objects. See Creating an Object Data Table (page 200).
Set up data sources for drawings.	Drag the database file from Windows Explorer to the Map Explorer tab of the Task Pane.	Attach a database to your map and link records from that table to objects in your map. See Attaching a Data Source (page 208).

Setting Up AutoCAD Map 3D

See also:

- [Overview of Setting Up Your Map File](#) (page 139)
- [Setting Options](#) (page 216)
- [To add a new user](#) (page 83)
- [To create a new workspace](#) (page 85)
- [To add ribbon, menu, and toolbar options](#) (page 85)
- [To add entire ribbon tabs, menus, or toolbars to a workspace](#) (page 86)
- [To switch between Tool-based, Task-based, and Map Classic workspaces](#) (page 86)
- [To restore the default colors](#) (page 86)
- [To show the command line interface for a particular workspace](#) (page 87)
- [To hide the map status bar](#) (page 87)
- [To enable Update Edits Automatically by default](#) (page 88)
- [To disable connection pooling by default](#) (page 88)
- [To turn file selection dialog boxes on or off](#) (page 88)
- [To turn other dialog boxes on or off](#) (page 88)



Overview of Setting Up AutoCAD Map 3D



You can customize AutoCAD Map 3D to make your work easier and more productive. Your changes affect all future sessions of AutoCAD Map 3D.

See also:

- [Overview of Setting Up Your Map File](#) (page 139)
- [Setting Options](#) (page 216)

The following table summarizes your customization options.

To do this...	Use this method...	To get this result...
Assign a coordinate system.	Click Map Setup tab ► Co-ordinate System panel ► Assign. 	Specify the coordinate system used for attached drawings and for the current drawing. See Assigning Coordinate Systems (page 142)
Attach drawings.	Drag the drawing file from Windows Explorer to the Map Explorer tab of the Task Pane.	Work with objects from other drawings by attaching those drawings to the current map and querying in the objects. See Overview of Attaching Drawings (page 154)
Modify the settings for attached drawings.	At the Command prompt, enter adedrawings.	Specify how attached drawings work with the current drawing and view information about attached drawings. See Modifying Attached Drawing Settings (page 163).
Set up queries.	<ol style="list-style-type: none"> 1 To save the current query, click Home tab ► Data panel ► Define Query.  2 To run a saved query, click Create 	Save and reuse queries in a library. See Overview of Using the Query Library (page 174).

To do this...	Use this method...	To get this result...
	tab ► Object Query  panel ► Run.	
Define annotation templates.	Click Annotate tab ► Map Annotation panel ► Define Template. 	Define the information to display in an annotation and the layout of that information. Then you can insert instances of the annotation into your drawing. See Defining Annotation Templates (page 190)
Set up object data.	Click Map Setup tab ► Attribute Data panel ► Define Object Data. 	Create tables with fields for text and numerical information. Attach records from the table to objects. See Creating an Object Data Table (page 200).
Set up data sources for drawings.	Drag the database file from Windows Explorer to the Map Explorer tab of the Task Pane.	Attach a database to your map and link records from that table to objects in your map. See Attaching a Data Source (page 208).

Setting Up Users and Assigning Rights



The system administrator controls who has access to AutoCAD Map 3D by assigning login names and passwords to users. Also, the system administrator can specify the *privileges* or operations available to each user.

AutoCAD Map 3D stores the settings for several AutoCAD Map 3D options with your login name, which means that these option settings are in effect whenever you log in under that name to that copy of AutoCAD Map 3D on that machine. After you log in, AutoCAD Map 3D sets up your user environment, including user privileges and user-specific options, such as Task Pane options and Data Source options.

See also:

- [Setting Task Pane Options](#) (page 221)
- [Setting Data Source Options](#) (page 236)

To add a new user

- 1 Click Map Setup tab ► Map panel ►  ► User Administration. 
- 2 In the [User Administration dialog box](#) (page 1934), under User Profile, in the Login Name box, enter a name for the user.
The login name must be unique. It is not case sensitive. Use any characters except the following: " / \ [] ; | = , + * ? < >
- 3 In the Password box, enter a password for the user. Passwords are case sensitive.
- 4 Under Privileges, specify the operations available to the user by selecting one or more of the following:
 - Superuser — User can perform user administration tasks, set system options, and perform any other AutoCAD Map 3D operation.
The default superuser login name is SuperUser (not case sensitive) and the password is SUPERUSER (case sensitive). If security is an issue, make sure that you change the default superuser login and password.
 - Alter Drawing Set — User can attach and detach drawings. If this option is not selected, the user can activate and deactivate drawings, but cannot attach and detach them.
 - Alter Object Class — User can define and edit object class definitions. If this option is not selected, users can only assign object classes and change the current object classification file.
 - Edit Drawing — User can edit objects and save them back to source drawings. If this option is not selected, the user can edit objects but cannot save them back to source drawings.
 - Draw Query — User can execute Draw mode queries, which copy objects into the current drawing. If this option is not selected, users can do Preview and Report mode queries only.
- 5 Click Add.
- 6 Click OK.

To edit a user profile, select the name in the User List and modify the settings you want. Click Update.

Quick Reference

MAPUSERADMIN

Performs administrative functions

Menu	Setup menu ► User Administration
Command Line	MAPUSERADMIN
Task Pane	In Map Explorer, right-click Current Drawing ► User Admin
Dialog Box	User Administration dialog box

Customizing Your Work Environment

Your work environment – that is, the way the ribbon, menus, toolbars, and dockable windows are laid out – is saved in a workspace.

You can customize a workspace to look and function just the way you want, or create a workspace. You can save different workspaces for different tasks, use them to help you streamline common tasks, or set up best practices for mapping tasks and workflow.

For example, you can set up a map creation workspace to streamline acquiring, integrating, and building maps, and another workspace for creating and publishing map books and atlases.

Within a session, you can easily switch between workspaces.

AutoCAD Map 3D includes three predefined workspaces:

- Tool-based Ribbon Workspace
- Task-based Ribbon Workspace
- Map Classic Workspace

You can customize any of these workspaces and easily switch between them.

See also:

- Workspaces
- [To create a new workspace](#) (page 85)

- [To add ribbon, menu, and toolbar options](#) (page 85)
- [To add entire ribbon tabs, menus, or toolbars to a workspace](#) (page 86)
- [To switch between Tool-based, Task-based, and Map Classic workspaces](#) (page 86)
- [To restore the default colors](#) (page 86)
- [To show the command line interface for a particular workspace](#) (page 87)
- [To hide the map status bar](#) (page 87)
- [To enable Update Edits Automatically by default](#) (page 88)
- [To disable connection pooling by default](#) (page 88)

To create a new workspace

- 1 In the Tool-based Ribbon Workspace, click Tools tab ► Customization panel ► User Interface.
- 2 In the Customize User Interface dialog box, under Customizations In All CUI FILES, right-click the Workspaces node and select New Workspace, or right-click an existing workspace and select duplicate.
- 3 Select the new workspace.
- 4 Under Workspace Contents, click Customize Workspace.
- 5 In the Customizations In All CUI Files tree, check the items you want to include.
- 6 Click Done.
- 7 Click OK.

To add ribbon, menu, and toolbar options

- 1 In the Customize User Interface dialog box, under Customizations In All CUI Files, select the workspace you want to modify.
- 2 Under Customizations In All CUI Files, expand the item you want to customize so that you can see all the items underneath it.
For example, expand the Topology menu to see the topology options underneath.

- 3 Under Command List, click and drag the tool you want to include to the item in Customizations In All CUI Files.
- 4 Click Apply.
- 5 Click OK.

To add entire ribbon tabs, menus, or toolbars to a workspace

- 1 In the Customize User Interface dialog box, under Customizations In All CUI Files, select the workspace you want to modify.
- 2 Under Workspace Contents, click Customize Workspace.
- 3 In the Customizations In All CUI Files tree, check the items you want to include.
- 4 Click Done.
- 5 Click OK.

To switch between Tool-based, Task-based, and Map Classic workspaces

- 1 Click the Workspace Switching button in the bottom-right corner of the application window.
A floating toolbar opens with all workspace options available. You can either dock this toolbar, leave it floating or close it.
- 2 In the toolbar, use the drop-down list to select the workspace you want. Unless you specify otherwise, AutoCAD Map 3D opens with the Tool-based workspace.

For more information, see Workspaces.

To restore the default colors

- 1 Click  ► Options.
- 2 In the Options dialog box, click the Display tab, and then click Colors.
- 3 In the Drawing Window Colors dialog box, select the element you want to change by clicking the images for the Model tab or Layout tabs.
As you click areas of the images, the selection is displayed in the Window Element list. You can also change an attribute by selecting it from the

Window Element list. For example, for the Map background, select Model Tab Background.

- 4 From the Color list, click Select Color.
- 5 In the Select Color dialog box, click the Color Books tab, and then select AutoCAD Map 3D Colors from the Color Book list.
The AutoCAD Map 3D color book displays the default colors used in the application. You can select a color or use the color book as a reference. It does not control the defaults in the application; do not attempt to modify it.
- 6 Select a color by clicking a color chip.
For example, click the blue Map Background chip to use the new map background color (model tab).
- 7 Click OK.
- 8 In the Color Options dialog box, click Apply and Close to record the current option settings in the system registry and close the dialog box.
- 9 In the Options dialog box, click OK.

To show the command line interface for a particular workspace

- 1 In the Tool-based Ribbon Workspace, click Tools tab ► Customization panel ► User Interface.
- 2 In the Customize User Interface dialog box, select a workspace.
- 3 In the Workspace Contents area, expand Palettes, scroll to the bottom of the list, and then click Command Line.
- 4 In the Properties area under Appearance, click Show, and then select Yes from the drop-down list.
- 5 Under Workspace Contents, click the Customize Workspace button.
- 6 Click OK.

To hide the map status bar

- 1 At the Command prompt, enter mapstatusbar.
- 2 Enter hide.

To enable Update Edits Automatically by default

- 1 At the Command prompt, enter `mapeditsetautodefault`
- 2 Enter `active`.

To disable connection pooling by default

- 1 At the Command prompt, enter `mapconnectionpooling`.
- 2 Enter `deactive`.

To turn file selection dialog boxes on or off

NOTE If you use scripts to automate some AutoCAD Map 3D functions, you may find it useful to turn off dialog boxes .

- 1 At the Command prompt, enter `filedia`.
- 2 To turn on dialog boxes , enter 1. To turn off dialog boxes , enter 0.

To turn other dialog boxes on or off

- 1 At the Command prompt, enter `cmddia`.
- 2 To turn on dialog boxes , enter 1. To turn off dialog boxes , enter 0.

Quick Reference

MAPOPTIONS

Sets AutoCAD Map 3D options

Menu	Setup menu ► Autodesk Map Options
Icon	 Options
Command Line	MAPOPTIONS
Task Pane	In Map Explorer, right-click Current Drawing ► Options
Dialog Box	AutoCAD Map Options dialog box

OPTIONS

Customizes the AutoCAD settings

Menu Setup menu ► AutoCAD Options

Command Line OPTIONS

Task Pane Right-click in the drawing area ► Options

MAPEDITSETAUTODEFAULT

Specifies the default setting for updating edits to the feature source automatically

Command Line MAPEDITSETAUTODEFAULT

MAPSTATUSBAR

Toggles the Map status bar on and off

Command Line MAPSTATUSBAR

MAPCONNECTIONPOOLING

Toggles connection pooling on and off

Command Line MAPCONNECTIONPOOLING

Creating New Coordinate Systems

AutoCAD Map 3D comes with an extensive library of coordinate systems. If no suitable coordinate system exists, you can define a customized coordinate system.

See also:

- [Overview of Coordinate Systems](#) (page 143)
- [Overview of Grid Data Files and Datum Shift Issues](#) (page 103)
- [To define coordinate systems](#) (page 90)
- [To work with grid data files and datum shifts](#) (page 102)

Defining Coordinate Systems

You can define customized coordinate systems in AutoCAD Map 3D.

See also:

- [Overview of Coordinate Systems](#) (page 143)
- [Assigning a Coordinate System to the Current Drawing](#) (page 147)

To define coordinate systems

- [To define a coordinate system](#) (page 92)
- [To define a datum](#) (page 94)
- [To define an ellipsoid](#) (page 95)
- [To create a coordinate system category](#) (page 97)
- [To modify or delete a coordinate system](#) (page 98)
- [To modify or delete a datum](#) (page 99)
- [To modify or delete an ellipsoid](#) (page 100)
- [To edit or delete a coordinate system category](#) (page 101)

Overview of Creating New Coordinate Systems

You can create a completely new [global coordinate system](#) (page 2065) or use a predefined coordinate system as a basis for creating your own. You can also modify or delete any coordinate systems that you define. You cannot delete any of the predefined coordinate systems supplied with AutoCAD Map 3D.

When you define a coordinate system you must specify the following parameters:

- [map projection](#) (page 2068) — Used to convert points from latitude and longitude to Cartesian coordinates.
and one of the following:
- [datum](#) (page 2059) — Reference point, line, or surface for mapping.
- [ellipsoid](#) (page 2062) — Geometric surface whose plane sections are all circles or ellipses.

See also:

- [Overview of Coordinate Systems](#) (page 143)
- [Overview of Grid Data Files and Datum Shift Issues](#) (page 103)

For this item...	Define, delete, or modify using this method...
global coordinate system (page 2065)	To define a coordinate system (page 92) To modify or delete a coordinate system (page 98)
Datum	To define a datum (page 94) To modify or delete a datum (page 99)
Ellipsoid	To define an ellipsoid (page 95) To modify or delete an ellipsoid (page 100)
Coordinate system category	To create a coordinate system category (page 97) To edit or delete a coordinate system category (page 101)

Quick Reference

ADEDEF CRDSYS

Defines a global coordinate system

Menu	Setup menu ► Define Global Coordinate System
Command Line	ADEDEF CRDSYS
Dialog Box	Global Coordinate System Manager Dialog Box

Defining a Global Coordinate System

You can define a new [global coordinate system](#) (page 2065) based on your own data or use a predefined coordinate system as a basis for creating your own.

Depending on the projection you use to define a custom coordinate system, you must provide certain information. For example, if you use the Transverse Mercator projection, you must specify a longitude value called the central meridian.

False Origin

When defining a custom coordinate system, you may want to enter a false origin, with northing and easting values. For example, if you are using the Transverse Mercator projection, and the central meridian bisects the mapping region, half of the X coordinates are negative values. Coordinate system definitions usually include an offset called the false origin that is added to all coordinates to make them positive. The X coordinate of this offset is called the false origin easting. The Y coordinate of this offset is called the false origin northing.

Scale Reduction Factor

To produce the smallest possible distance between the projection surface and any point in the region you are mapping, you must specify a scale reduction factor. This is particularly important when you are mapping large regions. For the Transverse Mercator projection, you enter this value in the Scale Reduction field in the Define Global Coordinate System dialog box.

See also:

- [Overview of Coordinate Systems](#) (page 143)
- [Overview of Grid Data Files and Datum Shift Issues](#) (page 103)

To define a coordinate system

- 1 Click Map Setup tab ► Coordinate System panel ► Define Global

Coordinate System. 

- 2 In the Global Coordinate System Manager dialog box, select a category.
- 3 Do one of the following:
 - To create a new coordinate system, click Define.
 - To create a new coordinate system based on an existing, predefined coordinate system, select the coordinate system from the Coordinate Systems In Category list. Click Modify.
- 4 On the General tab of the Define Coordinate System dialog box, enter a unique code in the Code box.

The code must be unique within a category and across all coordinate systems and must not contain spaces. Only the following characters are valid: A-Z (upper or lower case), 0-9, dash, and underscore.

If you are creating a new coordinate system based on an existing coordinate system, you must change the code before you can change any of the other information.

- 5 Enter a description.
AutoCAD Map 3D displays the description in the Coordinate Systems In Category list of the Global Coordinate System Manager dialog box.
- 6 In the Units box, select the units to use for this coordinate system.
- 7 Under Coordinate System Type, select one of the following:
 - To base the coordinate system on a [datum](#) (page 2059), select Geodetic. Click Select to specify the datum.
 - To base the coordinate system on an [ellipsoid](#) (page 2062), select Non-Geodetic. Click Select to specify the ellipsoid.
- 8 On the Projection tab, select a projection.
The projection you choose determines how many projection parameters you must enter and the units you can use.
- 9 Optionally, under False Origin, enter Northing and Easting values.
- 10 Under Projection Parameters, enter values for the remaining fields in the dialog box. Click OK.
These fields vary according to the projection you select.

Quick Reference

ADEDEFGRDSYS

Defines a global coordinate system

Menu	Setup menu ► Define Global Coordinate System
Command Line	ADEDEFGRDSYS
Dialog Box	Global Coordinate System Manager Dialog Box

Defining a New Datum

You can define a new datum based on your own data or use a predefined [datum](#) (page 2059) as a basis for creating your own.

When defining a custom datum, select the conversion technique, either Molodensky, Bursa/Wolfe, or Seven Parameter Transformation. After choosing the conversion technique, specify the appropriate conversion parameters for the technique you chose.

See also:

- [Overview of Coordinate Systems](#) (page 143)
- [Overview of Grid Data Files and Datum Shift Issues](#) (page 103)
- [Defining an Ellipsoid](#) (page 95)

To define a datum

- 1 Click Map Setup tab ► Coordinate System panel ► Define Global Coordinate System.  Select Define or Modify.
- 2 On the General tab of the Define Global Coordinate System dialog box or the Modify Global Coordinate System dialog box, select Geodetic. Click Define.
- 3 In the Datum Manager dialog box, click Define.
- 4 On the General tab of the Define Datum dialog box, enter a code and description for the [datum](#) (page 2059).
The code must be unique within a category and across all coordinate systems and must not contain spaces. Only the following characters are valid: A-Z (upper or lower case), 0-9, dash, and underscore.
AutoCAD Map 3D displays the description in the Datums list of the Datum Manager dialog box.
- 5 Under Ellipsoid, select or define an [ellipsoid](#) (page 2062) to use for the new datum.
For information about defining ellipsoids, see [Defining an Ellipsoid](#) (page 95).
- 6 On the Datum Conversion tab, select a conversion technique from the Datum Conversion Technique list.
- 7 Enter the appropriate conversion parameters for the conversion technique you selected.
Under Conversion Parameters, under Vector Component Deltas To WGS-84 In Meters, enter the vector component deltas to WGS-84.

If you use the Bursa/Wolfe or Seven Parameter Transformation conversion method, fill in all four edit boxes under Rotation Angle From WGS-84 In Arc Seconds.

Quick Reference

ADEDEF CRDSYS

Defines a global coordinate system

Menu Setup menu ► Define Global Coordinate System

Command Line ADEDEF CRDSYS

Dialog Box Global Coordinate System Manager Dialog Box

Defining an Ellipsoid

You can define a new [ellipsoid](#) (page 2062) based on your own data or use a predefined ellipsoid as a basis for creating your own.

When defining a custom ellipsoid, you must specify the calculation method and values used to determine the dimensions of the ellipsoid. After choosing the calculation method, you supply two of the required values, and AutoCAD Map 3D determines the remaining two values for you.

See also:

- [Overview of Coordinate Systems](#) (page 143)
- [Overview of Grid Data Files and Datum Shift Issues](#) (page 103)
- [Defining a New Datum](#) (page 93)

To define an ellipsoid

- 1 Do one of the following:
 - On the General tab of the Define Datum dialog box or the Modify Datum dialog box, under Ellipsoid, click Define.
Click Map Setup tab ► Coordinate System panel ► Define Global Coordinate System.  Select Define or Modify.

- Under Coordinate System Type on the General tab of the Define Global Coordinate System dialog box, select Non-Geodetic. Click Define.
- 2 In the Ellipsoid Manager dialog box, click Define.
 - 3 In the Define Ellipsoid dialog box, enter a code and description for the [ellipsoid](#) (page 2062).
The code must be unique within a category and across all coordinate systems and must not contain spaces. Only the following characters are valid: A-Z (upper or lower case), 0-9, dash, and underscore.
AutoCAD Map 3D displays the description in the Available Ellipsoids list.
 - 4 Under Ellipsoid Dimensions, do the following:
 - 5 Select a calculation method.
 - 6 Enter values for the two parameters that correspond to the calculation method you chose. AutoCAD Map 3D computes the other two values based on the ones you enter.
 - 7 Click OK.

Quick Reference

ADEDEFGRDSYS

Defines a global coordinate system

Menu	Setup menu ► Define Global Coordinate System
Command Line	ADEDEFGRDSYS
Dialog Box	Global Coordinate System Manager Dialog Box

Creating a Coordinate System Category

You can organize your coordinate systems by creating categories and moving coordinate systems into those categories.

See also:

- [Overview of Coordinate Systems](#) (page 143)

- [Overview of Creating New Coordinate Systems](#) (page 90)
- [Overview of Grid Data Files and Datum Shift Issues](#) (page 103)

To create a coordinate system category

- 1 Click Map Setup tab ► Coordinate System panel ► Define Global

Coordinate System. 

- 2 In the Global Coordinate System Manager dialog box, click Category Manager.
- 3 In the Coordinate System Category Manager, click New.
- 4 Type a name in the Category Name box.
- 5 From the Available Categories list, select a category that contains coordinate systems to include in the new category.
- 6 In the Coordinate Systems In Category list, select the coordinate systems to include in the new category.
- 7 Click Add.
You can select any number of coordinate systems from existing categories to include in the new category.
- 8 When you have finished adding coordinate systems, click OK.

Quick Reference

ADEDEF CRDSYS

Defines a global coordinate system

Menu	Setup menu ► Define Global Coordinate System
Command Line	ADEDEF CRDSYS
Dialog Box	Global Coordinate System Manager Dialog Box

Modifying or Deleting a Global Coordinate System

You can modify or delete any coordinate systems that you define. You cannot modify or delete predefined coordinate systems supplied with AutoCAD Map 3D.

See also:

- [Overview of Coordinate Systems](#) (page 143)
- [Overview of Creating New Coordinate Systems](#) (page 90)
- [Creating a Coordinate System Category](#) (page 96)

To modify or delete a coordinate system

- 1 Click Map Setup tab ► Coordinate System panel ► Define Global

Coordinate System.



- 2 In the Global Coordinate System Manager dialog box, select the category that contains the global coordinate system to modify or delete.
- 3 Select the coordinate system from the Coordinate Systems In Category list.
- 4 To modify the coordinate system, click Modify.
To delete the coordinate system, click Remove. Click OK.
- 5 If you are modifying the coordinate system, in the Modify Global Coordinate System dialog box, change information as necessary.
To modify a predefined coordinate system, you must change the code on the General tab before you can change the other coordinate system properties.

Quick Reference

ADEDEF CRDSYS

Defines a global coordinate system

Menu Setup menu ► Define Global Coordinate System
Command Line ADEDEF CRDSYS

Modifying or Deleting a Datum

You can modify or delete any [datum](#) (page 2059) that you define. You cannot modify or delete predefined datums supplied with AutoCAD Map 3D.

If you modify or delete a datum that you have defined, you must also modify or delete any coordinate systems that reference that datum.

See also:

- [Overview of Coordinate Systems](#) (page 143)
- [Overview of Creating New Coordinate Systems](#) (page 90)
- [Overview of Grid Data Files and Datum Shift Issues](#) (page 103)
- [To define an ellipsoid](#) (page 95)

To modify or delete a datum

- 1 On the General tab of the Define Global Coordinate System dialog box or the Modify Global Coordinate System dialog box, select Geodetic. Click Define.
Click Map Setup tab ► Coordinate System panel ► Define Global Coordinate System.  Select Define or Modify.
- 2 In the Datum Manager dialog box, select a [datum](#) (page 2059).
- 3 To modify the datum, click Modify.
To remove the datum, click Remove.
- 4 If you are modifying the datum, on the General tab of the Define Datum dialog box, change the code and description for the datum.
To modify a predefined datum, you must change the code on the General tab before you can change the other datum properties.
- 5 Under Ellipsoid, select or define an [ellipsoid](#) (page 2062) to use for the datum.
For information about defining ellipsoids, see [Defining an Ellipsoid](#) (page 95).
- 6 On the Datum Conversion tab, select a conversion technique from the Datum Conversion Technique list.

- 7 Enter the appropriate conversion parameters for the conversion technique you selected.

Quick Reference

ADEDEFGRDSYS

Defines a global coordinate system

Menu	Setup menu ► Define Global Coordinate System
Command Line	ADEDEFGRDSYS
Dialog Box	Global Coordinate System Manager Dialog Box

Modifying or Deleting an Ellipsoid

You can modify or delete any [ellipsoid](#) (page 2062) that you define. You cannot modify or delete predefined ellipsoids supplied with AutoCAD Map 3D.

If you modify or delete an [ellipsoid](#) (page 2062) that you have defined, you must also modify or delete any coordinate systems that reference that ellipsoid.

See also:

- [Overview of Coordinate Systems](#) (page 143)
- [Overview of Creating New Coordinate Systems](#) (page 90)
- [To define an ellipsoid](#) (page 95)

To modify or delete an ellipsoid

- 1 On the General tab of the Define Datum dialog box or the Modify Datum dialog box, under Ellipsoid, click Define.
- 2 In the Ellipsoid Manager dialog box, select an [ellipsoid](#) (page 2062). Click Map Setup tab ► Coordinate System panel ► Define Global Coordinate System.  Select Define or Modify.
- 3 To modify the ellipsoid, click Modify.
To delete the ellipsoid, click Remove.

- 4 If you are modifying an ellipsoid, enter a code and description for the ellipsoid.
To modify a predefined ellipsoid, you must change the code before you can change the other ellipsoid properties.
- 5 Under Calculation Method, select a calculation method.
- 6 Enter the appropriate ellipsoid dimension parameters for the calculation method you selected.

Quick Reference

ADEDEFCRDSYS

Defines a global coordinate system

Menu	Setup menu ► Define Global Coordinate System
Command Line	ADEDEFCRDSYS
Dialog Box	Global Coordinate System Manager Dialog Box

Modifying or Deleting a Coordinate System Category

You can modify categories by adding or removing coordinate systems, or moving coordinate systems from one category to another. You can also delete categories.

See also:

- [Overview of Coordinate Systems](#) (page 143)
- [Overview of Creating New Coordinate Systems](#) (page 90)
- [Creating a Coordinate System Category](#) (page 96)

To edit or delete a coordinate system category

- 1 Click Map Setup tab ► Coordinate System panel ► Define Global Coordinate System. 
- 2 In the Global Coordinate System Manager dialog box, click Category Manager.

- 3 In the Coordinate System Category Manager, select a category.
- 4 To modify the category, click Edit.
To delete the category, click Remove.
- 5 If you are modifying the category, do one or more of the following:
 - To remove coordinate systems from the category, click the coordinate system names in the list under the Category Name box. Click Remove.
 - To add coordinate systems to the category, click the coordinate system names in the list under the Available Categories list. Click Add.
 - To add coordinate systems from different categories, select the category name in the Available Categories list.

Quick Reference

ADEDEF CRDSYS

Defines a global coordinate system

Menu	Setup menu ► Define Global Coordinate System
Command Line	ADEDEF CRDSYS
Dialog Box	Global Coordinate System Manager Dialog Box

Grid Data Files and Datum Shifts

AutoCAD Map 3D uses grid data files to specify [datum](#) (page 2059) shift information and Grid Data Catalog files to determine the order for those files when converting from one datum to another.

See also:

- [Creating New Coordinate Systems](#) (page 89)
- [Overview of Coordinate Systems](#) (page 143)

To work with grid data files and datum shifts

- [To set up a new grid data file](#) (page 105)
- [To set up a new grid data file for the United States](#) (page 108)

- [To set up a new grid data file for France](#) (page 109)
- [To set up a new grid data file for Australia or New Zealand](#) (page 110)
- [To use the new high accuracy GDA94 datum](#) (page 111)
- [To use version 2 of the Canadian National Transformation](#) (page 112)
- [To use version 1 of the Canadian National Transformation](#) (page 113)
- [To modify a coordinate system definition file](#) (page 116)

Overview of Grid Data Files and Datum Shift Issues

When converting between certain coordinate systems in North America, France, Australia, and New Zealand, AutoCAD Map 3D uses grid-based data files called grid data files to obtain [datum](#) (page 2059) shift information.

For the United States, France, Australia, and New Zealand geography, the grid data files are in the public domain and are distributed with AutoCAD Map 3D. The grid data files which cover Canadian geography are not in the public domain and must be obtained from the proper authorities in Canada.

AutoCAD Map 3D uses Grid Data Catalog (GDC) files to determine the order in which grid data files are used in areas of overlap when converting from one [datum](#) (page 2059) to another.

See also:

- [Creating New Coordinate Systems](#) (page 89)
- [Datum Shift Issues for North American Users](#) (page 112)
- [Grid Data Files for Australia and New Zealand](#) (page 109)
- [Grid Data Files for the United States](#) (page 105)
- [Coordinate System Files](#) (page 113)
- [Australian Datum Transformation and Coordinate System Changes](#) (page 110)

You can do the following with grid data files

To do this...	See this topic...
Set up a new grid data file	Grid Data Catalog (GDC) Files (page 104)
Specify a new grid data file for the United States	Grid Data Files for the United States (page 105)

To do this...	See this topic...
Specify a new grid data file for Australia or New Zealand	Grid Data Files for Australia and New Zealand (page 109)
Use the high accuracy GDA94 datum for Australia	Australian Datum Transformation and Coordinate System Changes (page 110)
Specify a grid data version to resolve differences between source and destination coordinate systems for Canada	Datum Shift Issues for North American Users (page 112)
Modify a coordinate system file	Coordinate System Files (page 113)

Grid Data Catalog (GDC) Files

AutoCAD Map 3D uses Grid Data Catalog (GDC) files to determine the order in which grid data files are used in areas of overlap when converting from one [datum](#) (page 2059) to another in certain parts of the world, such as North America, France, Australia, and New Zealand.

If there is an overlapping coverage, AutoCAD Map 3D selects the grid data file with the smallest grid cell in the region of the conversion. If the grid cell sizes are the same, AutoCAD Map 3D selects the grid data file that appears first in the GDC file.

Grid Data Catalog files are ASCII text files with a *.gdc* extension that are stored, by default, in the **C:\Documents and Settings\All Users\Application Data\Autodesk\Geospatial Coordinate Systems** folder. The base name of a GDC file is based on the transformation with which it is associated. For example, the GDC file for the NAD27 to NAD83 transformation is *Nad27toNad83.gdc*.

Each line in a GDC file points to a grid data file (also known as a datum shift data file). GDC files also often include comments that are preceded by a pound sign (#) and a fallback datum definition that is used when none of the grid data files provide coverage for a point being converted.

See also:

- [Datum Shift Issues for North American Users](#) (page 112)
- [Coordinate System Files](#) (page 113)

- [Overview of Grid Data Files and Datum Shift Issues](#) (page 103)
- [Grid Data Files for the United States](#) (page 105)
- [Grid Data Files for Australia and New Zealand](#) (page 109)
- [Australian Datum Transformation and Coordinate System Changes](#) (page 110)

To set up a new grid data file

- 1 When you obtain a new grid data file, copy it into the appropriate folder under the Autodesk shared coordinate system folder, by default *C:\Documents and Settings\All Users\Application Data\Autodesk\Geospatial Coordinate Systems*.
- 2 Open the appropriate GDC file in any text editor or word processor that can produce an ASCII file, such as Notepad or Wordpad.

NOTE Back up GDC files before you edit them, so you can restore them to their previous state, if necessary.

- 3 Edit the file to point to the name and location of your new grid data file.
- 4 Make other changes needed, such as rearranging or replacing grid data files, changing the fallback [datum](#) (page 2059) definition, or adding comments.

Grid Data Files for the United States

AutoCAD Map 3D uses North American Datum Conversion (NADCON) grid data files from the National Geodetic Survey to obtain latitude and longitude shift information for converting between coordinate systems within the United States. A pair of grid data files is required for each area or state covered: a *.las* file is required for latitude shift values (latitude seconds) and a *.los* file for longitude shift values (longitude seconds).

The NADCON files include grid data files for transformations between NAD83 and state readjustments to HARN (High Accuracy Resolution Network) projects.

The *.las* and *.los* files are in the public domain and are distributed with AutoCAD Map 3D. The files are stored in the Autodesk shared coordinate system folder, by default *C:\Documents and Settings\All Users\Application Data\Autodesk\Geospatial Coordinate Systems\Usa\Nadcon*.

The following is a list of NADCON grid data files.

Files (.las and .los)	NADCON (North American Datum Conversion)	Area/State
conus	NAD27 to NAD83	United States (USA) - lower 48 states including EEZ
alaska	Alaska to NAD83	Alaska
hawaii	Old Hawaiian to NAD83	Hawaii
prvi	Puerto Rico to NAD83	Puerto Rico, Virgin Islands
stlrnc	St. Lawrence Island to NAD83	St Lawrence: off the coast of Alaska
stpaul	St. Paul Island to NAD83	St Paul: Pribiloff Islands off the coast of Alaska
stgeorge	St. George Island to NAD83	St George: Pribiloff Islands off the coast of Alaska
<i>HARN Readjustments</i>		
alhpgn	NAD83 to NAD83 (HARN)	Alabama
azhpgn	NAD83 to NAD83 (HARN)	Arizona
cahpgn	NAD83 to NAD83 (HARN)	California, south of 38 degrees North
cnhpgn	NAD83 to NAD83 (HARN)	California, north of 38 degrees North
cohpgn	NAD83 to NAD83 (HARN)	Colorado
emhpgn	NAD83 to NAD83 (HARN)	Idaho and Montana, east of 113 degrees West
ethpgn	NAD83 to NAD83 (HARN)	Texas, east of 100 degrees West
flhpgn	NAD83 to NAD83 (HARN)	Florida
gahpgn	NAD83 to NAD83 (HARN)	Georgia
kyhpgn	NAD83 to NAD83 (HARN)	Kentucky

Files (.las and .los)	NADCON (North American Datum Conversion)	Area/State
lahpgn	NAD83 to NAD83 (HARN)	Louisiana
mdhpgn	NAD83 to NAD83 (HARN)	Maryland and Delaware
mehpgn	NAD83 to NAD83 (HARN)	Maine
mihpgn	NAD83 to NAD83 (HARN)	Michigan
mshpgn	NAD83 to NAD83 (HARN)	Mississippi
nbhpgn	NAD83 to NAD83 (HARN)	Nebraska
ndhpgn	NAD83 to NAD83 (HARN)	North Dakota
nehpgn	NAD83 to NAD83 (HARN)	New England (Connecticut, Massachusetts, New Hampshire, Rhode Island, and Vermont)
nmhpgn	NAD83 to NAD83 (HARN)	New Mexico
nyhpgn	NAD83 to NAD83 (HARN)	New York
okhpgn	NAD83 to NAD83 (HARN)	Oklahoma
pvhpgn	NAD83 to NAD83 (HARN)	Puerto Rico, Virgin Islands
sdhpgn	NAD83 to NAD83 (HARN)	South Dakota
tnhpgn	NAD83 to NAD83 (HARN)	Tennessee
vahpgn	NAD83 to NAD83 (HARN)	Virginia, excluding West Virginia
wihpgn	NAD83 to NAD83 (HARN)	Wisconsin
wmhpgn	NAD83 to NAD83 (HARN)	Idaho and Montana, west of 113 degrees West
wohpgn	NAD83 to NAD83 (HARN)	Washington and Oregon
wthpgn	NAD83 to NAD83 (HARN)	Texas, west of 100 degrees West
wyhpgn	NAD83 to NAD83 (HARN)	Wyoming

For more information about NADCON grid data files, refer to the *National Geodetic Survey web site*.

See also:

- [Datum Shift Issues for North American Users](#) (page 112)
- [Coordinate System Files](#) (page 113)
- [Overview of Grid Data Files and Datum Shift Issues](#) (page 103)
- [Grid Data Files for Australia and New Zealand](#) (page 109)
- [Australian Datum Transformation and Coordinate System Changes](#) (page 110)

To set up a new grid data file for the United States

- 1 When you obtain a new grid data file, copy it into the appropriate folder under the Autodesk shared coordinate system folder, by default *C:\Documents and Settings\All Users\Application Data\Autodesk\Geospatial Coordinate Systems\Usa\Nadcon*.
- 2 Open the appropriate GDC file in any text editor or word processor that can produce an ASCII file, such as Notepad or Wordpad.

NOTE Back up GDC files before you edit them, so you can restore them to their previous state, if necessary.

- 3 Edit the file to point to the name and location of your new grid data file.
- 4 Make other changes needed, such as rearranging or replacing grid data files, changing the fallback [datum](#) (page 2059) definition, or adding comments.

Grid Data Files for France

AutoCAD Map 3D comes with a grid data catalog file (RgfToNtf.gdc) and a national grid data file (gr3df97a.txt) for France. This file is installed in a folder under the Autodesk shared coordinate system folder, by default *C:\Documents and Settings\All Users\Application Data\Autodesk\Geospatial Coordinate Systems*.

Several French municipalities have developed local grid data files that allow for more precise transformations within their respective regions. You can obtain municipal grid data files from the local GIS or Survey department. If

you add references to such municipal grid data files to the French grid data catalog file, AutoCAD Map 3D will automatically use them as appropriate. Points within the boundaries of the municipal grids will be transformed using the local grid data, and points outside those boundaries will be transformed using national grid data.

To set up a new grid data file for France

- 1 When you obtain a new grid data file, copy it into the appropriate folder under the Autodesk shared coordinate system folder, by default *C:\Documents and Settings\All Users\Application Data\Autodesk\Geospatial Coordinate Systems*.
- 2 Open RgfToNtf.gdc in any text editor or word processor that can produce an ASCII file, such as Notepad or Wordpad.

NOTE Back up GDC files before you edit them, so you can restore them to their previous state, if necessary.

- 3 Edit the file to point to the name and location of your new grid data file.
- 4 Make other changes needed, such as rearranging or replacing grid data files, changing the fallback [datum](#) (page 2059) definition, or adding comments.

Grid Data Files for Australia and New Zealand

AutoCAD Map 3D comes with grid data files for Australia and New Zealand. These files are installed in folders under the Autodesk shared coordinate system folder, by default *C:\Documents and Settings\All Users\Application Data\Autodesk\Geospatial Coordinate Systems*.

Following is a table of the grid data files and GDC files used for Australia and New Zealand.

Area	Transformation	Grid Data File (GSB)	GDC File
Australia	AGD84 to GDA94	QLD_1299.gsb	Agd84ToGda94.gdc
Victoria	AGD66 to GDA94	vic_0799.gsb	Agd66ToGda94.gdc
Tasmania	AGD66 to GDA94	tas_1098.gsb	Agd66ToGda94.gdc
Northern Territory	AGD66 to GDA94	Nt_0599.gsb	Agd66ToGda94.gdc

Area	Transformation	Grid Data File (GSB)	GDC File
New Zealand	New Zealand	nzgd2kgrid9911.gsb	Nzgd49ToNzgd2K.gdc

For more information about Australia and New Zealand coordinate systems, go to <http://www.ga.gov.au>.

See also:

- [Australian Datum Transformation and Coordinate System Changes](#) (page 110)
- [Datum Shift Issues for North American Users](#) (page 112)
- [Coordinate System Files](#) (page 113)
- [Overview of Grid Data Files and Datum Shift Issues](#) (page 103)
- [Grid Data Files for the United States](#) (page 105)

To set up a new grid data file for Australia or New Zealand

- 1 When you obtain a new grid data file, copy it into the appropriate folder under the Autodesk shared coordinate system folder, by default *C:\Documents and Settings\All Users\Application Data\Autodesk\Geospatial Coordinate Systems*.
- 2 Open the appropriate GDC file in any text editor or word processor that can produce an ASCII file, such as Notepad or Wordpad.

NOTE Back up GDC files before you edit them, so you can restore them to their previous state, if necessary.

- 3 Edit the file to point to the name and location of your new grid data file.
- 4 Make other changes needed, such as rearranging or replacing grid data files, changing the fallback [datum](#) (page 2059) definition, or adding comments.

Australian Datum Transformation and Coordinate System Changes

The Geocentric Datum of Australia (GDA) is the new Australian coordinate system, replacing the Australian Geodetic Datum (AGD). GDA is part of a

global coordinate reference frame and is directly compatible with the Global Positioning System (GPS).

Due to differences in the way the two datums were created, the GDA94 coordinates of a point appear to be about 200 meters northeast of the AGD coordinates of the same point. The precise size and orientation of the difference varies from place to place. For more technical information on the GDA, go to <http://www.icsm.gov.au/icsm/gda/>

The new implementation of GDA94 and the associated [datum](#) (page 2059) transformations are available by using the coordinate system files supplied in AutoCAD Map 3D.

See also:

- [Grid Data Files for Australia and New Zealand](#) (page 109)
- [Coordinate System Files](#) (page 113)
- [Overview of Grid Data Files and Datum Shift Issues](#) (page 103)

To use the new high accuracy GDA94 datum

1 Reassign one of the following coordinate systems to your drawing:

- AMG66-49-Grid through AMG66-57-Grid
- AMG-49-Grid through AMG-57-Grid
- MGA-48-Grid through MGA-58-Grid
- ISG_54-2-Grid through ISG_56-2-Grid
- SGC-Grid
- VICT-Grid
- LL-AGD84-Grid

For example, if you have a drawing that uses AM666-49, reassign it to AM666-49-Grid before using GDA94.

2 Do one of the following:

- To define a new coordinate system using high accuracy [datum](#) (page 2059) transformations, use ASTRLA66-Grid and ASTRLA84-Grid.
- To define a new coordinate system using the 3-Dimensional Similarity Transformations, use ASTRLA66-7P, STRLA66-Tasm-7P, ASTRLA66-VictNSW-7P, ASTRLA66-ACT-7P, and ASTRLA84-7P.

Datum Shift Issues for North American Users

If the source and destination coordinate systems use different datums, AutoCAD Map 3D automatically performs a [datum](#) (page 2059) shift. Within North America, this is most often a shift between the NAD27 and NAD83 datums.

For United States users, AutoCAD Map 3D uses the freely distributable [NADCON grid data files](#) (page 105) supplied by USGS.

Canadian users can use either version 1 or version 2 of the Canadian National Transformation supplied by Geomatics Canada. If both versions of the Canadian National Transformation are present, AutoCAD Map 3D uses version 2.

WARNING Geomatics Canada no longer supports version 1, and many Canadian provinces do not consider it to produce valid results. If you are in Canada and doing NAD Shifts, it is recommended that you use version 2.

See also:

- [Creating New Coordinate Systems](#) (page 89)
- [Grid Data Files for Australia and New Zealand](#) (page 109)
- [Grid Data Files for the United States](#) (page 105)
- [Coordinate System Files](#) (page 113)
- [Australian Datum Transformation and Coordinate System Changes](#) (page 110)

To use version 2 of the Canadian National Transformation

- 1 Obtain a copy of the data file.
Contact Information Services, Geodetic Survey Division, Geomatics Canada
615 Booth Street
Ottawa, Ontario, K1A 0E9
(613) 995-4410
<http://www.geod.nrcan.gc.ca>
- 2 Once you have the file, copy it into the Autodesk shared coordinate system folder, by default *C:\Documents and Settings\All Users\Application*

Data\Autodesk\Geospatial Coordinate Systems\Canada, and give it the name Ntv2_0.gsb.

- 3 Using a text editor such as Notepad, open Nad27ToNad83.gdc (located by default in the *C:\Documents and Settings\All Users\Application Data\Autodesk\Geospatial Coordinate Systems* folder).
- 4 Delete the initial pound sign (#) from the line that begins:
#.\Canada\Ntv2_0.gsb.

To use version 1 of the Canadian National Transformation

- 1 Obtain a copy of the data file.
- 2 Copy it into the *C:\Documents and Settings\All Users\Application Data\Autodesk\Geospatial Coordinate Systems\Canada* folder, and give it the name grid11.dac.
- 3 Open Nad27ToNad83.gdc.
- 4 Delete the initial pound sign (#) from the line that begins:
#.\Canada\grid11.dac.

For more information on editing GDC files, see [Grid Data Catalog \(GDC\) Files](#) (page 104).

Coordinate System Files

AutoCAD Map 3D uses certain files for storing coordinate system definitions and defining [datum](#) (page 2059) transformation information.

Following is a list of these files. Files that should not be modified are marked with an asterisk (*).

File	Description
Agd66ToGda94.gdc	Grid Data Catalog file for transformations within Australia. Default grid data files: Vic_0799.gsb, nt_0599.gsb, and TAS_1098.gsb. Default fallback datum (page 2059): ASTRLA66.
Agd84ToGda94.gdc	Grid Data Catalog file for transformations within Australia. Default grid data file:

File	Description
	QLD_1299.gsb. Default fallback datum: ASTRLA84-7P.
GeoidHeight.gdc	Grid Data Catalog file for determining the geoid height for any position in the United States. Default data files are GEO96AN.GEO, GEO96AS.GEO, GEO96HW.GEO, GEO96NC.GEO, GEO96NE.GEO, GEO96NW.GEO, GEO96PR.GEO, GEO96SC.GEO, GEO96SE.GEO, and GEO96SW.GEO. Fallback datum definition is not recommended.
Nad27ToNad83.gdc	Grid Data Catalog file for transformations within North America. Default data files: Conus.l?s, Alaska.l?s, PrVi.l?s, Hawaii.l?s, STGEORGE.l?s, STLRNC.l?s, and ST-PAUL.l?s. Default fallback datum: NAD27-48.
Nad83ToHarn.gdc	Grid Data Catalog file for transformations within North America. Default grid data files: alhp gn.l?s, azhp gn.l?s, cnhp gn.l?s, cohpn gn.l?s, cshpn gn.l?s, emhp gn.l?s, ethpn gn.l?s, flhp gn.l?s, gahpn gn.l?s, hihpn gn.l?s, kshpn gn.l?s, kyhp gn.l?s, lahpn gn.l?s, mdhp gn.l?s, mehpn gn.l?s, mihpn gn.l?s, mshpn gn.l?s, nbhp gn.l?s, ndhp gn.l?s, nehpn gn.l?s, nmhp gn.l?s, nvhp gn.l?s, nyhp gn.l?s, ohhp gn.l?s, okhp gn.l?s, pvhp gn.l?s, sdhp gn.l?s, tnhp gn.l?s, uthpn gn.l?s, vahpn gn.l?s, wihpn gn.l?s, wmhp gn.l?s, wohpn gn.l?s, wthpn gn.l?s, vvhp gn.l?s, and wyhp gn.l?s. Fallback datum definition is not recommended.
Nzgd49ToNzgd2K.gdc	Grid Data Catalog file for transformations within New Zealand. Default grid data file: nzgd2kgrid9911.gsb. Default fallback datum: NZGD49-7P.

File	Description
Rgf93ToNtf.gdc	Grid Data Catalog file for transformations between the RGF93 and NTF datums used within France. Default grid data file: gr3df97a.txt. Default fallback datum: NTF-G.
Vertcon.gdc	Grid Data Catalog file for computing the modeled difference in orthometric height between the North American Vertical Datum of 1988 (NAVD 88) and the National Geodetic Vertical Datum of 1929 (NGVD 29) for a given location specified by latitude and longitude. Default grid data files: VERTCONC.94, VERTCONE.94, and VERTCONW.94. Fallback datum definition is not recommended.
Category.csd *	A binary compiled file used for storing coordinate system category definitions. Also called a dictionary file.
Coordsys.csd *	Coordinate systems dictionary file.
Datums.csd *	Datums dictionary file.
Elipsoid.csd *	Ellipsoids dictionary file.
.mrt files *	Multiple Regression Transformation binary files that store the coefficients required for multiple regression analysis. The base name of the file is the same as the key name of the datum with which it is associated.
.94 files *	Grid data files used by Vertcon.gdc.
.geo files *	Data files for determining the geoid height for any position in the United States. These are in GEOID96 format and are used by GeoidHeight.gdc.

File	Description
.gsb files *	Grid data files for Canada, Australia, and New Zealand. Both latitude and longitude shifts (as well as accuracy values) are incorporated into a single .gsb file. The file structure also supports the concept of multiple grids, and subgrids within a major grid.
.las and .los files *	Grid data files for United States geography.

See also:

- [Overview of Grid Data Files and Datum Shift Issues](#) (page 103)
- [Grid Data Catalog \(GDC\) Files](#) (page 104)
- [Grid Data Files for Australia and New Zealand](#) (page 109)
- [Grid Data Files for the United States](#) (page 105)

To modify a coordinate system definition file

- 1 Find the file to modify in the Autodesk shared coordinate system folder, by default *C:\Documents and Settings\All Users\Application Data\Autodesk\Geospatial Coordinate Systems*.
- 2 Make a backup copy of the file before modifying it.

NOTE Files that should not be modified are marked with an asterisk (*) in the table on the Concept tab of this topic.

- 3 Edit the file in a text editor.

Setting Up Object Classification

- [Overview of Setting Up Object Classification](#) (page 117)
- [Defining an Object Class](#) (page 119)
- [Using Base Object Classes](#) (page 122)
- [Specifying Ranges and Defaults](#) (page 124)
- [Modifying an Object Class Definition](#) (page 127)
- [Creating an Object Classification File](#) (page 128)

See also:

- [Overview of Setting Up Object Classification](#) (page 117)
- [Attaching an Object Class Definition File](#) (page 995)

- [To set up object classification](#) (page 118)
- [To define an object class](#) (page 120)
- [To base a new object class on an existing class](#) (page 123)
- [To specify that an object class can be used only as a base class](#) (page 124)
- [To specify a default value and a range for a property](#) (page 125)
- [To modify an object class definition](#) (page 127)
- [To create a new object classification file](#) (page 129)

See also:

- [Overview of Setting Up Object Classification](#) (page 117)

Overview of Setting Up Object Classification

Object classes define a set of standard objects for your organization. When a user adds one of these standard objects to a drawing that uses object classification, the object is created using the properties you have defined and is a “classified” object.

NOTE Object classification affects drawing objects only. For information about classification methods for geospatial feature data, see [Overview of Geospatial Data](#) (page 551)

A classified object is created using the appropriate object type. It has the object data, external data, and topology data that you have defined for the object class, and all properties included in the object class definition have values that fall within the range you specified for the property.

When users edit the properties of classified objects, they can enter only values that fall within the ranges you have specified for the property.

NOTE To define an object class, you must have [Alter Object Class privileges](#) (page 82).

See also:

- [Using Object Classification](#) (page 981)

- [Understanding Object Classification](#) (page 983)

NOTE Object classification affects drawing objects only. For information about classification methods for geospatial feature data, see [Overview of Geospatial Data](#) (page 551)

To set up object classification

- Determine the standard objects for your organization.
- Determine the hierarchy of object classes.
You can create categories of object classes and have all object classes in a category inherit certain settings from the base object class for that category.
- Create a sample object that has all the data and properties that to include in the object class definition file.
- [Attach](#) (page 995) an existing object definition file or [create](#) (page 129) a new object class definition file.
- [Define](#) (page 120) the new object class.
To use this object class as a [base class](#) (page 123), [set the default value and the range of allowable values](#) (page 125) for each object that you include.
- Store the object class definition file in a location that is accessible to all the people in your organization who need it.
- You can attach the object class definition file to your drawing template so it is attached to all new drawings.

Quick Reference

ATTACHDEF

Changes the current feature definition file

Menu	Click Setup ► Classification Tools ► Attach Definition File.
Command Line	ATTACHDEF
Task Pane	In Map Explorer, under Current Drawing, right-click Object Classes ► Attach Definition File
Dialog Box	Attach Object Class Definition File dialog box

FEATUREDEF

Defines a new object class based on an example in the current drawing

Menu	Click Setup ► Classification Tools ► Define Object Class.
Icon	 Define Object Class
Command Line	FEATUREDEF
Task Pane	In Map Explorer, under Current Drawing, right-click Object Classes ► Define Object Class
Dialog Box	Define Object Classification dialog box

NEWDEF

Creates a new object class definition file

Menu	Click Setup ► Classification Tools ► New Definition File.
Command Line	NEWDEF
Task Pane	In Map Explorer, under Current Drawing, right-click Object Classes ► New Definition File
Dialog Box	New Object Class Definition File dialog box

Defining an Object Class

Define an object class by selecting a sample object in your drawing, choosing which of its properties to include in the definition, and specifying the allowable settings.

For example, if you want to define an object class for maintenance hole covers, select an existing maintenance hole cover in your drawing.

If you do not have a sample object in your drawing, create an object with the data and property settings that you want to include in the object class definition.

For each object class, AutoCAD Map 3D stores information on how to create the object, what properties it should have, what data should be attached, and what topology information should be associated with it. All objects you create using this object class definition have the selected properties and values.

NOTE Object classification affects drawing objects only. For information about classification methods for geospatial feature data, see [Overview of Geospatial Data](#) (page 551)

Editing Object Class Definitions

To define an object class, you must have [Alter Object Class Privileges](#) (page 82).

WARNING Only one person should edit object class definitions at a time. If two people edit at the same time, one set of edits may be lost.

If someone has recently edited the definition file, quit AutoCAD Map 3D and restart to get the updated definitions.

Renaming an Object Class

When you rename an object class, you change the name only in the object class definition file. Any objects tagged with the object class name are unchanged. Since these objects point to a name that no longer exists in the object class definition file, the objects become undefined. You can search for these undefined objects and update their object class name.

See also:

- [Using Base Object Classes](#) (page 122)
- [Modifying an Object Class Definition](#) (page 127)
- [Attaching an Object Class Definition File](#) (page 995)

NOTE To define an object class, you must have [Alter Object Class privileges](#) (page 82).

NOTE Object classification affects drawing objects only. For information about classification methods for geospatial feature data, see [Overview of Geospatial Data](#) (page 551)

To define an object class

- 1 Select a sample object for the object class.
The sample object must have the properties, links, and attributes that you want to include in the definition of the object class.

- 2 If an object definition file is not attached, enter attachdef at the command prompt and attach the file.
- 3 On the Map Explorer tab of the Task Pane, right-click Object Classes. Click Define Object Class.
- 4 When prompted to select a sample object, select the sample object. Press Enter.
- 5 In the [Define Object Classification dialog box](#) (page 1785), enter a name and a description.
- 6 To [base this object class on an existing object class](#) (page 123), select the existing object class from the Based On list.
To use this object class as a base only, select Use As Base Object Classification Only.
- 7 On the Applies To tab, select the object type for this object class.
You must select the object type before you can select properties on the Properties List tab.
For best results, select the most specific object type that applies to all objects in this class.

NOTE If you plan to use this object class with objects from a drawing source, do not select more than one object type.

- 8 On the Properties List tab, select each of the properties you want to include in the definition. For each property, [enter a default value and a range of possible values](#) (page 125).
To specify a line weight, enter the decimal value as an integer. For example, to specify a line weight of 0.13, enter 13.
To define a new property, click New Property. In the [New Property dialog box](#) (page 1791), specify the category and name for the new property.
- 9 On the Class Settings tab, select the object to use to create the feature.
For example, if you are defining an object class for roads, select Polyline as the creation method.

NOTE You can select only objects that match the object type you selected on the Applies To tab.

You can also specify the icon to display for the object class and whether you want the object class to appear on the Map Explorer tab of the Task Pane.

Quick Reference

FEATUREDEF

Defines a new object class based on an example in the current drawing

Menu Click Setup ► Classification Tools ► Define Object Class.

Icon  Define Object Class

Command Line FEATUREDEF

Task Pane In Map Explorer, under Current Drawing, right-click Object Classes ► Define Object Class

Dialog Box Define Object Classification dialog box

Using Base Object Classes

You can create hierarchies of object classes. When you base a new object class on an existing object class, the new object class has all the properties of the base class.

You cannot change base properties, but you can modify their attributes, including the default value and the range of allowable values, and you can include additional properties.

NOTE Object classification affects drawing objects only. For information about classification methods for geospatial feature data, see [Overview of Geospatial Data](#) (page 551)

NOTE To define an object class, you must have [Alter Object Class privileges](#) (page 82).

Sample Use

- 1 Define an object class called Roads with the basic properties that you want to assign to all roads.
- 2 Define object classes called Primary Roads, Local Roads, and Fire Roads, and base each of them on Roads.

Because the new object classes are based on Roads, they include all the properties selected for Roads.

When you select all objects in a base class, objects in object classes based on that class are also selected.

Using Object Classes as Base Classes Only

Sometimes when you create a base class, you intend to use it only as a base for other object classes and not to create objects in drawings. For example, you may not want to use the Roads object class to create roads. You want people to create roads using the Primary Roads and Secondary Roads classes that are based on the Roads class. You can specify that an object class can be used only as a base class.

Editing Base Classes

To edit a definition for an object class, you must have a sample object in the drawing. However, if you use an object class as a base class only, you will not have any example objects. For these object classes, you must edit the .xml definition file directly.

See also:

- [Defining an Object Class](#) (page 119)
- [Setting Up Object Classification](#) (page 116)

NOTE To define an object class, you must have [Alter Object Class privileges](#) (page 82).

NOTE Object classification affects drawing objects only. For information about classification methods for geospatial feature data, see [Overview of Geospatial Data](#) (page 551)

To base a new object class on an existing class

- 1 [Define the object class](#) (page 120).
- 2 For Based On, select the object class on which you want to base this new object class.
The selected properties of the base object class appear in the list.
- 3 You cannot clear any of the properties of the base object class, but you can edit the property attributes, including the default and the range of allowable values.

- 4 Add any additional properties you want, and finish defining the object class.

To specify that an object class can be used only as a base class

- 1 [Define the object class](#) (page 120).
- 2 In the [Define Object Classification dialog box](#) (page 1785), select Use As Base Object Classification Only.

Users can select objects using the base object class, but they cannot create objects using it.

Quick Reference

FEATUREDEF

Defines a new object class based on an example in the current drawing

Menu	Click Setup ► Classification Tools ► Define Object Class.
Icon	 Define Object Class
Command Line	FEATUREDEF
Task Pane	In Map Explorer, under Current Drawing, right-click Object Classes ► Define Object Class
Dialog Box	Define Object Classification dialog box

Specifying Ranges and Defaults

When you define an object class, you can specify a range of allowable values and a default value for new objects created using the object class.

NOTE Object classification affects drawing objects only. For information about classification methods for geospatial feature data, see [Overview of Geospatial Data](#) (page 551)

When someone creates a new object using this object class, AutoCAD Map 3D creates the object using the current settings for the property. If the current

settings do not match the range, the object is created using the specified default value.

When users edit the values for properties associated with the object class, they can only values that are within the allowable range. (This applies only if you edit the properties using the Object Class Data tab of the Properties palette.)

When users classify existing objects, they can skip objects whose values are not within the specified range. If they do not skip these objects, the objects are assigned the default values.

NOTE To define an object class, you must have [Alter Object Class privileges](#) (page 82).

See also:

- [Defining an Object Class](#) (page 119)
- [Setting Up Object Classification](#) (page 116)

NOTE To define an object class, you must have [Alter Object Class privileges](#) (page 82).

NOTE Object classification affects drawing objects only. For information about classification methods for geospatial feature data, see [Overview of Geospatial Data](#) (page 551)

To specify a default value and a range for a property

- 1 [Create the object class and select the object type](#) (page 120) on the Applies To tab of the [Define Object Classification dialog box](#) (page 1785).
- 2 On the Properties List tab, select a property.
- 3 Under Property Attributes, for Default, enter the default value for this property.
- 4 For Range, specify the range of allowable values.
Click ... to select from a list of properties if available, otherwise, enter the values.
 - To enter a list of values, separate them with commas, for example:
1,5,9

- To enter a range of numbers, enclose the first and last numbers in square brackets and separate the numbers with a comma, for example: [3,7]
- You can combine a range with additional values, for example: 1,[3,7],9
- To delete a range, enter two dashes ("--").

Range values are case sensitive. For example, if you specify "Road" as an allowable value in the range, "ROAD" will not match this value and will be considered outside of the range.

See also:

- [Color Range Editor dialog box](#) (page 1783)
- [Layer Range Editor dialog box](#) (page 1789)
- [Linetype Range Editor dialog box](#) (page 1789)
- [Lineweight Range Editor dialog box](#) (page 1790)
- [Plotstyle Range Editor dialog box](#) (page 1792)

Quick Reference

FEATUREDEF

Defines a new object class based on an example in the current drawing

Menu	Click Setup ► Classification Tools ► Define Object Class.
Icon	 Define Object Class
Command Line	FEATUREDEF
Task Pane	In Map Explorer, under Current Drawing, right-click Object Classes ► Define Object Class
Dialog Box	Define Object Classification dialog box

Modifying an Object Class Definition

To add properties to an object class definition, you must have a sample object that includes the properties you want to add.

NOTE Object classification affects drawing objects only. For information about classification methods for geospatial feature data, see [Overview of Geospatial Data](#) (page 551)

Notes and Warnings

When you rename an object class, you change the name only in the object classification file. Any objects tagged with the object class name are unchanged. Since these objects point to an object class name that no longer exists in the object classification file, the objects become undefined. You can search for these undefined objects and update their object class name.

NOTE To modify an object class, you must have [Alter Object Class privileges](#) (page 82).

See also:

- [Defining an Object Class](#) (page 119)
- [Setting Up Object Classification](#) (page 116)

NOTE To modify an object class definition, you must have [Alter Object Class privileges](#) (page 82).

NOTE Object classification affects drawing objects only. For information about classification methods for geospatial feature data, see [Overview of Geospatial Data](#) (page 551)

To modify an object class definition

- 1 Open a drawing that contains an object classified with the object class you want to modify.
To add properties to the object class definition, the sample object must have the properties you want to add to the object class definition.
- 2 If an object classification file is not attached, enter attachdef at the command prompt and attach the file.

- 3 On the Map Explorer tab of the Task Pane, right-click the object class whose definition you want to modify. Click Define Object Class.
- 4 Select the sample object. This object must be classified with the object class you want to modify.
- 5 In the [Define Object Classification dialog box](#) (page 1785), modify properties.
 - You cannot change the object type used for the feature.
 - On the Properties List tab, select or clear properties you want to include in the definition. For each new property, [enter a default value and a range of possible values](#) (page 125).
To specify a line weight, enter the decimal value as an integer. For example, to specify a line weight of 0.13, enter 13.
 - On the Class Settings tab, specify the icon to display for the feature and whether the data appears on the Map Explorer tab of the Task Pane.

Quick Reference

FEATUREDEF

Defines a new object class based on an example in the current drawing

Menu	Click Setup ► Classification Tools ► Define Object Class.
Icon	 Define Object Class
Command Line	FEATUREDEF
Task Pane	In Map Explorer, under Current Drawing, right-click Object Classes ► Define Object Class
Dialog Box	Define Object Classification dialog box

Creating an Object Classification File

The object classification file contains information on object classes you have defined. You can create a new object classification file.

NOTE Object classification affects drawing objects only. For information about classification methods for geospatial feature data, see [Overview of Geospatial Data](#) (page 551)

As a general rule, you want to use the same object classification file across all your drawings. This ensures that you have the same object class definitions for all source drawings attached to a drawing. You may want to attach the object classification file to the drawing template, and make sure that everyone has the same alias to the path.

If users in your organization share the object classification file, store it on the network in a place accessible to all users.

To use object classification, users attach the object classification file to their drawing. They can then create standard objects using the object class definitions.

Only the object classes defined in the object classification file attached to a drawing can be assigned to objects or used to create new objects.

NOTE To create a new object classification file, you must have [Alter Object Class privileges](#) (page 83).

See also:

- [Attaching an Object Class Definition File](#) (page 995)
- [Setting Up Object Classification](#) (page 116)

NOTE Object classification affects drawing objects only. For information about classification methods for geospatial feature data, see [Overview of Geospatial Data](#) (page 551)

To create a new object classification file

- 1 On the Map Explorer tab of the Task Pane, right-click Object Classes. Click New Definition File.
- 2 In the [New Object Class Definition File dialog box](#) (page 1790), specify a name for the new object classification file. Click OK.

NOTE To create a new object classification file, you must have [Alter Object Class privileges](#) (page 83).

Quick Reference

NEWDEF

Creates a new object class definition file

Menu	Click Setup ► Classification Tools ► New Definition File.
Command Line	NEWDEF
Task Pane	In Map Explorer, under Current Drawing, right-click Object Classes ► New Definition File
Dialog Box	New Object Class Definition File dialog box

Setting Up for Digitizing

- [Overview of Digitizing](#) (page 130)
- [Configuring the Digitizer](#) (page 131)
- [Registering the Map](#) (page 133)
- [Setting Digitizing Specifications](#) (page 136)

See also:

- [Digitizing Objects](#) (page 1073)
- [Overview of Digitizing Maps](#) (page 1073)

- [To prepare for digitizing](#) (page 131)
- [To configure the digitizer](#) (page 132)
- [To register the map](#) (page 136)
- [To set digitizing specifications](#) (page 138)

Overview of Digitizing

Digitizing is the process of converting paper-based graphical information into a digital format. When you digitize a map, you use drawing commands to trace data from the paper map into a DWG file.

See also:

- [Digitizing Objects](#) (page 1073)

- [Configuring the Digitizer](#) (page 131)
- [Registering the Map](#) (page 133)
- [Setting Digitizing Specifications](#) (page 136)

To prepare for digitizing

- 1 [Configure the digitizer.](#) (page 132)
- 2 [Register the map.](#) (page 136)
- 3 [Set the digitizing specifications.](#) (page 138)

Quick Reference

OPTIONS

Customizes the AutoCAD settings

- Menu** Setup menu ► AutoCAD Options
- Command Line** OPTIONS
- Task Pane** Right-click in the drawing area ► Options

TABLET

Calibrates, configures, and turns on and off an attached digitizing table

- Command Line** TABLET

MAPDIGISETUP

Sets up user options for digitizing nodes and linear objects

- Menu** Click Map ► Data Entry ► Digitize Setup.
- Command Line** MAPDIGISETUP
- Dialog Box** Digitize Setup dialog box

Configuring the Digitizer

You must configure the digitizer so a movement on the digitizing tablet can be recorded directly into an existing drawing file as you digitize.

To configure the digitizing tablet, you define screen pointing areas. A screen pointing area is a rectangular region on the digitizer surface within which the digitizer acts like a mouse and can access windows, menus, and dialog boxes. You can configure two screen pointing areas, one *fixed* and one *floating*.

When you digitize, the fixed screen pointing area is disabled. To access the menus from the digitizer, use the floating screen pointing area.

You can toggle between the fixed and floating screen pointing areas with the F12 key.

See also:

- [Registering the Map](#) (page 133)
- [Setting Digitizing Specifications](#) (page 136)
- [Digitizing Objects](#) (page 1073)
- [Overview of Digitizing Maps](#) (page 1073)

To configure the digitizer

- 1 Click  ► Options. In the Options dialog box, click the System tab.
- 2 Select your digitizer in the Current Pointing Device list.
- 3 Start the TABLET command, and use the CFG option to configure the tablet. Specify the fixed screen pointing area and a floating screen pointing area in a corner of your tablet area.
- 4 Mark the floating screen area on your tablet with a marker or piece of paper.

When you complete the configuration, two new options appear on the status bar at the bottom of the AutoCAD Map 3D window. Tablet and FLOAT let you toggle the two modes.

Use the Options dialog box to disable the mouse while you are digitizing.

- 1 Click  ► Options. In the Options dialog box, click the System tab.
- 2 Under Accept Input From, select Digitizer Only.
- 3 Click OK.

When you complete digitizing, return to the Options dialog box and select the Digitizer And Mouse option to use both input devices.

Quick Reference

OPTIONS

Customizes the AutoCAD settings

Menu	Setup menu ► AutoCAD Options
Command Line	OPTIONS
Task Pane	Right-click in the drawing area ► Options

TABLET

Calibrates, configures, and turns on and off an attached digitizing table

Command Line	TABLET
---------------------	--------

Registering the Map

Registration is the process of making a map's coordinate system correspond to the Cartesian coordinate system used by AutoCAD Map 3D.

You select specific calibration and control points for each map that you digitize.



The crosses in this illustration mark the digitizer calibration points.

Choosing the Number of Calibration Points

Selecting a maximum of nine points is a good rule; specifying more only increases computation time with little increase in precision. If the original is not badly distorted, four corner points and some intermediate points are sufficient. It is more important to distribute the points evenly around the whole map than to concentrate more points in an area.

Calibration Options

To complete the calibration, select one of the following transformation options:

- Orthogonal — Needs only two digitized and specified calibration points to create a transformation consisting of arbitrary translation, uniform scaling, and rotation. This method is not recommended unless only two control points can be found.
- Affine — Requires three calibration points. Allows a tablet transformation combining translation, independent X and Y scaling, rotation, and some skewing. Provides an arbitrary linear transformation in two-dimensional space. This is the preferred method for registering paper maps drawn in a Cartesian coordinate system.
- Projective — Needs at least four calibration points. Makes a transformation equivalent to a perspective projection of any plane onto another plane. Allows for some stretching of an original paper drawing by different

amounts along a perspective projection. This is the best option for orthophotos.

The TABLET command calculates the errors associated with the available transformation options, depending on how many points you digitized. When the calculations are complete, or when you cancel the calculations, a table showing the results of your calibration appears.

There are four possible responses from the calibration calculations for each transformation type:

- Exact — Number of points specified is correct for this type of transformation.
- Success — More points specified than needed. For a Success, the RMS error and standard deviation are reported.
- Impossible — Not enough points specified to define a transformation.
- Failure — Points specified are colinear or coincidental. The transformation may not have a valid definition.

If you get either Impossible or Failure, do not use that transformation. If all the results are Impossible or Failure, check the calibration on the digitizer, recalibrate, and digitize the map again.

RMS error, Standard Deviation, and Residual Values

The RMS error indicates how uniform or extreme the required transformation is: the lower the value, the better the calibration.

Standard deviation is reported at all calibration points. The residual error is the difference between the actual calibration point and the computed transformation point. A large difference indicates a procedural error. You may have entered the wrong coordinates or digitized a wrong point.

If the RMS and standard deviation values seem high, you might have made an error when entering location values or the map might have slipped during calibration. In this case, restart the procedure to calibrate the digitizer.

See also:

- [Configuring the Digitizer](#) (page 131)
- [Setting Digitizing Specifications](#) (page 136)
- [Digitizing Objects](#) (page 1073)

- [Overview of Digitizing Maps](#) (page 1073)

To register the map

- 1 Tape the map on the tablet. The map on the tablet should be flat, with no bumps or wrinkles, and securely fastened.
- 2 Start the TABLET command and use the CAL option.
- 3 Digitize the control points of the map, and enter *X* and *Y* coordinate values for the locations.
- 4 When you complete the control points, press Enter. Wait for the calculations to complete.
- 5 At the prompt, enter the calibration option to use. Select the transformation that gave an Exact outcome. If all the transformations were a Success, select the option with the lowest RMS and standard deviation errors.

Quick Reference

TABLET

Calibrates, configures, and turns on and off an attached digitizing table

Command Line TABLET

Setting Digitizing Specifications

To use the options provided by the MAPDIGITIZE command, you must configure the digitizer and register the map.

Attaching Data

You can link data to objects as you digitize. Although you can store data in AutoCAD Map 3D as block attributes, you can perform more sophisticated analysis of the data if you use one of the following methods:

- Data linked to an object is stored as object data in the drawing.
- Data linked to an object is stored in an external database.

Label Point

A *label point* is the point used to insert text to describe the digitized object. You can specify a label point for each object as you digitize.

Layer

Plan the layers you will use in your drawing. A *layer* is a logical grouping of data, which simplifies organizing and viewing data. For more information, look up "layers, creating" in the help index.

Each object that represents a different type of map data should go on a separate layer. For example, a polyline representing a coastline could go on a layer named COASTLINE, interstate highways on a layer named INTERSTATE, land boundaries on a layer named LOTS.

If you have not established a scheme for layer names, you can create one using the numeric feature-classification code found in some digital source data. For example, major roads might be on a layer named "170-201". A better naming convention combines names that suggest their function and a structure that allows selection with wild cards and groups of layer names. For example, you might decide that all topographic objects should go on layers beginning with the letters TP. So you might put rivers on a layer named TP_RIVERS, and contours on a layer named TP_CONTOURS. To freeze, thaw, lock, or unlock all layers with topographic data, you use the expression TP*. For more information on wild-card characters, look up "wild-card characters" in the help index.

Block Name or Linetype

To represent nodes using blocks available in the current drawing, select a block name or ACAD_POINT for the block name.

Choosing ACAD_POINT places a point object at each node position. For information about changing the appearance of this point object, look up DDPTYPE in the help index.

Wherever possible, use the linetypes supplied with AutoCAD Map 3D to indicate different types of boundaries, road types, and waterways. Using standard linetypes ensures consistency across maps and helps you keep track of what you have digitized. Associate each linetype with a different layer.

Object Snap

Use object snap to tie nodes or segments to linear objects that are already in place. For example, always use object snap to position junctions of pipes, roads, or railways.

Width

Linear objects that contain three-dimensional information cannot have a width.

See also:

- [Registering the Map](#) (page 133)
- [Configuring the Digitizer](#) (page 131)
- [Digitizing Objects](#) (page 1073)
- [Overview of Digitizing Maps](#) (page 1073)

To set digitizing specifications

- 1 At the command prompt, enter mapdigissetup.
- 2 In the [Digitize Setup dialog box](#) (page 1617), select an object type.
Select Nodes to digitize points or blocks. Select Linear to digitize polylines.
- 3 To attach data to objects as you digitize them, select Attach Data.
Click Data To Attach and select the table to use for the data. As you digitize the objects, you are prompted for the data to attach to the object.
- 4 To change the label point for objects as you digitize them, select Prompt For Label Point.
- 5 Specify the layer for new objects.
- 6 Specify the block (for nodes) or the linetype (for linear objects) to use when creating the new objects.
- 7 Specify whether to snap to the closest endpoint (for nodes) or insertion point (for linear objects).
- 8 For nodes, select whether to specify the rotation and scale of each node block.
For linear objects, select whether the objects are 2D or 3D. For 2D objects, specify a width.
- 9 Click OK to close the dialog box and save your settings.

Quick Reference

MAPDIGISETUP

Sets up user options for digitizing nodes and linear objects

Menu Click Map ► Data Entry ► Digitize Setup.

Command Line MAPDIGISETUP

Dialog Box Digitize Setup dialog box

Setting Up Your Map File

See also:

- [Setting Up AutoCAD Map 3D](#) (page 80)
- [Setting Options](#) (page 216)

- [To log in to AutoCAD Map 3D](#) (page 142)
- [To assign coordinate systems](#) (page 143)
- [To attach drawings](#) (page 154)
- [To set up a query library](#) (page 173)
- [To set up annotation templates](#) (page 186)
- [To set up object data](#) (page 198)
- [To set up data sources for drawings](#) (page 205)





Overview of Setting Up Your Map File

You can set up each map file you create to make your work easier and more productive.

See also:

- [Setting Up AutoCAD Map 3D](#) (page 80)
- [Setting Options](#) (page 216)

The following table summarizes your customization options for a map file.

To do this...	Use this method...	To get this result...
Assign a coordinate system.	Click Map Setup tab ► Coordinate System panel ► Assign. 	Specify the coordinate system used for attached drawings and for the current drawing. See Assigning Coordinate Systems (page 142)
Attach drawings.	Drag the drawing file from Windows Explorer to the Map Explorer tab of the Task Pane.	Work with objects from other drawings by attaching those drawings to the current map and querying in the objects. See Overview of Attaching Drawings (page 154)
Modify the settings for attached drawings.	In the Tool-based Ribbon Workspace, click Home tab ► Data panel ► Define Drawing Set.	Specify how attached drawings work with the current drawing and view information about attached drawings. See Modifying Attached Drawing Settings (page 163).
Set up queries.	<ol style="list-style-type: none"> To save the current query, click Home tab ► Data panel ► Define Query.  To run a saved query, click Create tab ► Object Query panel ► Run.  	Save and reuse queries in a library. See Overview of Using the Query Library (page 174).
Define annotation templates.	Click Annotate tab ► Map Annotation panel ► Define Template. 	Define the information to display in an annotation and the layout of that information. Then you can insert instances of the annotation into your drawing. See Defining Annotation Templates (page 190)

To do this...	Use this method...	To get this result...
Set up object data.	Click Map Setup tab ► Attribute Data panel ► Define Object Data. 	Create tables with fields for text and numerical information. Attach records from the table to objects. See Creating an Object Data Table (page 200).
Set up data sources for drawings.	Drag the database file from Windows Explorer to the Map Explorer tab of the Task Pane.	Attach a database to your map and link records from that table to objects in your map. See Attaching a Data Source (page 208).

Logging Into AutoCAD Map 3D

When you log into AutoCAD Map 3D, your work environment is automatically set up as it was last saved, including user privileges and user-specific options.

Depending on your organization, you may be required to log in. System Administrators can set this AutoCAD Map 3D multi-user option.

If user login is not required, you can work with AutoCAD Map 3D without logging in. However, you can log in at anytime to restore settings that you have saved to your user name or to use privileges associated with your user name.

User Privileges

To perform some AutoCAD Map 3D commands, you must be logged in as a user with the appropriate privileges.

Example: To change Multi-user settings in the AutoCAD Map Options dialog box, you must have Superuser privileges.



The default superuser name is SuperUser (not case sensitive), and the default superuser password is SUPERUSER (case sensitive).

TIP You can customize many AutoCAD Map 3D settings. Some of these customizations are saved to your user name. To customize the settings differently for each drawing, set up multiple user names and log in with the appropriate name for each drawing.

See also:

- [Setting Multi-user Options](#) (page 226)
- [Setting Up Users and Assigning Rights](#) (page 82)

To log in to AutoCAD Map 3D

- 1 Click Map Setup tab ► Map panel ►  ► User Login. 
- 2 In the [User Login dialog box](#) (page 1937), for Login Name, enter the login name provided to you by your system administrator.
- 3 In the Password box, enter your password.
The default superuser login name is SuperUser (case insensitive) and the password is SUPERUSER (case sensitive). If security is an issue, make sure that you change the default superuser login and password. See [To add a new user](#) (page 83).
- 4 Click OK.

Quick Reference

MAPLOGIN

Allows you to log in as an AutoCAD Map 3D user

Menu	Setup menu ► User Login
Command Line	MAPLOGIN
Task Pane	In Map Explorer, right-click Current Drawing ► User Login
Dialog Box	User Login dialog box

Assigning Coordinate Systems

With AutoCAD Map 3D, you can combine data from maps that use different coordinate systems.

See also:

- [Defining Coordinate Systems](#) (page 89)
- [Grid Data Files and Datum Shifts](#) (page 102)

To assign coordinate systems

- [To use coordinate systems with maps](#) (page 145)
- [To assign a coordinate system to a source drawing](#) (page 146)
- [To assign a coordinate system to the current drawing](#) (page 147)
- [To determine if a coordinate system is geodetic](#) (page 149)
- [To turn off a global coordinate system](#) (page 150)
- [To see the assigned coordinate system for a source drawing](#) (page 151)
- [To transform the coordinate system of a drawing](#) (page 152)

Overview of Coordinate Systems

With AutoCAD Map 3D, you can combine data from maps using different coordinate systems. To do this, you specify the coordinate system used for attached drawings and for the current drawing. When you bring objects from attached drawings into the current drawing, the objects are transformed to the coordinate system of the current drawing.

The coordinate system you assign to your drawing specifies the system that was used when creating the drawing. For example, if you created a map using Universal Transverse Mercator, Zone 27, US Survey Feet, you assign the code UTM-27F to the map.

You specify the coordinate system used for the current drawing and for attached source drawings before querying any items from the source drawings. When you query objects from source drawings, AutoCAD Map 3D automatically converts them to the coordinate system of the current drawing. This operation is called *coordinate transformation*. When you save objects back to source drawings, AutoCAD Map 3D reverses the conversion.

The coordinate system code and definition are stored in the drawing file. You can share the drawing with anyone using Autodesk Map 2000 Release 4 or later, and they will have the correct coordinate system.

When the coordinate system you select is assigned to the selected attached drawings, a backup file, with a *.bak* extension, is made of each source drawing before assigning the coordinate system information.

The coordinate systems supplied with AutoCAD Map 3D include the Universal Transverse Mercator System and the State Plane coordinate systems used in the USA, as well as many international coordinate systems used around the world. For a complete listing of supported systems, see the Global Coordinate System Manager dialog box.

Tell me more



Video

- *Show me how to assign a coordinate system to my map.*
- *Show me how to set a map to the coordinate system of the data.*



Procedure

- [To assign a coordinate system to the current drawing](#) (page 147)
- [To assign a coordinate system to a source drawing](#) (page 146)
- [To turn off a global coordinate system](#) (page 150)



Tutorial

- Exercise 1: Create a map



Workflow

- Transform a DWG File to a Different Coordinate System
- Combine Data with Different Coordinate Systems



GIS Skill

- *Reproject incoming data to a new coordinate system*



Related topics

- [Overview of Creating New Coordinate Systems](#) (page 90)
 - [Overview of Grid Data Files and Datum Shift Issues](#) (page 103)
-

To use coordinate systems with maps

- [Assign a coordinate system](#) (page 145) to your current drawing and to the source drawings.
- [Set Coordinate System Options](#) (page 230)
- [Define a coordinate system](#) (page 91)

Quick Reference

ADEDEF CRDSYS

Defines a global coordinate system

Menu	Setup menu ► Define Global Coordinate System
Command Line	ADEDEF CRDSYS
Dialog Box	Global Coordinate System Manager Dialog Box

ADESET CRDSYS

Assigns a global coordinate system code for the current drawing or attached drawings

Menu	Setup menu ► Assign Global Coordinate System
Icon	 Assign Coordinate System
Command Line	ADESET CRDSYS
Task Pane	In Map Explorer, right-click Current Drawing ► Coordinate System
Dialog Box	Assign Global Coordinate System dialog box

Assigning a Coordinate System to a Source Drawing

You must specify a coordinate system for each attached source drawing to take advantage of the coordinate transformation capabilities in AutoCAD Map 3D.

See also:

- [Overview of Coordinate Systems](#) (page 143)
- [Transforming the Coordinate System of a Drawing](#) (page 152)
- [Viewing the Assigned Coordinate System for a Source Drawing](#) (page 151)
- [Removing an Assigned Coordinate System](#) (page 150)
- [Overview of Creating New Coordinate Systems](#) (page 90)
- [Overview of Grid Data Files and Datum Shift Issues](#) (page 103)

To assign a coordinate system to a source drawing

- 1 Click Map Setup tab ► Coordinate System panel ► Assign. 
- 2 In the [Assign Global Coordinate System dialog box](#) (page 1598), under Source Drawings, click Select Drawings.
- 3 In the [Select Drawings to Assign Coordinate System dialog box](#) (page 1599), select the source drawings. You cannot assign a coordinate system to a source drawing that currently has queried objects in the current drawing.
- 4 Under Source Drawings, enter the coordinate system code for the selected source drawings.
If you do not know the code, click Select Coordinate System. In the Select Global Coordinate System dialog box, select a category. Select from a list of available coordinate systems. You can also search for coordinate systems by code or description using the Search box. Click Properties to view the properties of the selected coordinate system.
To remove an assigned coordinate system, in the Code box in the Assign Global Coordinate System dialog box, type a period.
- 5 Click OK.

Quick Reference

ADESETCRDSYS

Assigns a global coordinate system code for the current drawing or attached drawings

Menu	Setup menu ► Assign Global Coordinate System
Icon	 Assign Coordinate System
Command Line	ADESETCRDSYS
Task Pane	In Map Explorer, right-click Current Drawing ► Coordinate System
Dialog Box	Assign Global Coordinate System dialog box

Assigning a Coordinate System to the Current Drawing

You must specify a coordinate system for the current drawing to take advantage of the coordinate transformation capabilities in AutoCAD Map 3D.

After you bring objects into the current drawing, do not change the coordinate transformation options if you plan to save changes back to source drawings. The save-back process uses the original settings to determine whether adjustments are necessary to restore objects to the correct coordinate system.

See also:

- [Overview of Coordinate Systems](#) (page 143)
- [Transforming the Coordinate System of a Drawing](#) (page 152)
- [Assigning a Coordinate System to a Source Drawing](#) (page 145)
- [Removing an Assigned Coordinate System](#) (page 150)
- [Overview of Creating New Coordinate Systems](#) (page 90)
- [Overview of Grid Data Files and Datum Shift Issues](#) (page 103)

To assign a coordinate system to the current drawing

- 1 Click Map Setup tab ► Coordinate System panel ► Assign. 
- 2 In the [Assign Global Coordinate System dialog box](#) (page 1598), under Current Drawing, enter the coordinate system code for the current drawing.
If you do not know the code, click Select Coordinate System. In the Select Global Coordinate System dialog box, select a category. Select from a list

of available coordinate systems. You can also search for coordinate systems by code or description using the Search box. Click Properties to view the properties of the selected coordinate system.

- 3 Click OK.

Quick Reference

ADESETCRDSYS

Assigns a global coordinate system code for the current drawing or attached drawings

Menu	Setup menu ► Assign Global Coordinate System
Icon	 Assign Coordinate System
Command Line	ADESETCRDSYS
Task Pane	In Map Explorer, right-click Current Drawing ► Coordinate System
Dialog Box	Assign Global Coordinate System dialog box

Using a Geodetic Coordinate System

All geographic data is created in some coordinate system, and in the context of some [datum](#) (page 2059). A datum includes [ellipsoid](#) (page 2062) information and a datum definition. For example, the Gauss-Kruger Conformal projection system used in Germany uses the Bessel ellipsoid and Potsdam datum definition. Some coordinate systems only specify the ellipsoid; these are non-geodetic. Coordinate systems that specify the complete datum are geodetic.

Most of the coordinate systems supplied with AutoCAD Map 3D are geodetic, but about ten percent are non-geodetic. Therefore, you should determine whether the coordinate systems you use are geodetic or non-geodetic before you assign a coordinate system to a drawing. If you have data in a drawing that uses a non-geodetic coordinate system, but do not know what datum the data came from, you might introduce errors if you convert the drawing to a geodetic coordinate system.

See also:

- [Overview of Coordinate Systems](#) (page 143)
- [Transforming the Coordinate System of a Drawing](#) (page 152)
- [Overview of Creating New Coordinate Systems](#) (page 90)
- [Defining a New Datum](#) (page 93)
- [Defining an Ellipsoid](#) (page 95)

To determine if a coordinate system is geodetic

- 1 Click Map Setup tab ► Coordinate System panel ► Assign. 
- 2 In the [Assign Global Coordinate System dialog box](#) (page 1598), under Current Drawing or Source Drawings, click Select Coordinate System.
- 3 In the Category list, select the category that contains the coordinate system you want.
- 4 In the Coordinate Systems In Category list, select a coordinate system.
- 5 Click Properties.

The type of coordinate system is displayed under Coordinate System Type on the General tab of the Global Coordinate Systems Properties dialog box. If the coordinate system is geodetic, the [datum](#) (page 2059) is displayed in the Datum box.

Quick Reference

ADESETCRDSYS

Assigns a global coordinate system code for the current drawing or attached drawings

Menu

Setup menu ► Assign Global Coordinate System

Icon



Assign Coordinate System

Command Line

ADESETCRDSYS

Task Pane	In Map Explorer, right-click Current Drawing ► Coordinate System
Dialog Box	Assign Global Coordinate System dialog box

Removing an Assigned Coordinate System

For ADE data, using the AutoCAD Map 3D coordinate systems requires many complex calculations that can decrease performance when querying objects from attached drawings and saving back the objects. With FDO data these calculations are unnecessary, so there is no performance impact.

You can turn off a coordinate system while working in a particular drawing.

See also:

- [Overview of Coordinate Systems](#) (page 143)

To turn off a global coordinate system

- 1 Click Map Setup tab ► Coordinate System panel ► Assign. 
- 2 In the [Assign Global Coordinate System dialog box](#) (page 1598), in the Code box under Current Drawing, enter a period (.). Press Enter.
- 3 Click OK.

Quick Reference

ADESETCRDSYS

Assigns a global coordinate system code for the current drawing or attached drawings

Menu Setup menu ► Assign Global Coordinate System

Icon  Assign Coordinate System

Command Line ADESETCRDSYS

Task Pane In Map Explorer, right-click Current Drawing ► Coordinate System

Viewing the Assigned Coordinate System for a Source Drawing

If the current drawing has an assigned coordinate system, you can view the code in the Drawing Settings dialog box.

See also:

- [Overview of Coordinate Systems](#) (page 143)
- [Transforming the Coordinate System of a Drawing](#) (page 152)
- [Assigning a Coordinate System to a Source Drawing](#) (page 145)
- [Removing an Assigned Coordinate System](#) (page 150)

To see the assigned coordinate system for a source drawing

- 1 In the Tool-based Ribbon Workspace, click Home tab ► Data panel ► Define Drawing Set.
- 2 Click Drawing Settings.

AutoCAD Map 3D displays the global coordinate system code for the active drawing to the right of the drawing name.

Quick Reference

ADEDWGSTAT

Displays drawing statistics

Menu	Setup menu ► More DWG Options ► Drawing Statistics
Command Line	ADEDWGSTAT
Task Pane	In Map Explorer, right-click Drawings ► Statistics
Dialog Box	Drawing Statistics dialog box

Transforming the Coordinate System of a Drawing

You can transform an existing map from one coordinate system to another by querying the objects from the attached source drawing into the current drawing.

The original source drawing is unchanged, but the objects in the current drawing use the new coordinate system.

See also:

- [Overview of Coordinate Systems](#) (page 143)
- [Assigning a Coordinate System to a Source Drawing](#) (page 145)
- [Assigning a Coordinate System to the Current Drawing](#) (page 147)
- [Querying Objects from Attached Drawings](#) (page 1235)

To transform the coordinate system of a drawing

- 1 Open a new drawing.
- 2 Attach the drawing whose coordinate system you want to transform. See [Attaching Drawings](#) (page 154).
- 3 In the new drawing, assign the new coordinate system to the current drawing. See [Assigning a Coordinate System to the Current Drawing](#) (page 147).
- 4 If you have not already assigned a coordinate system to the original drawing, do that now. Assign the coordinate system that was used to create the original drawing. See [Assigning a Coordinate System to a Source Drawing](#) (page 146).
- 5 Define a query to bring in all objects from the source drawing. The easiest way to do this is to define a location condition and use the Boundary Type "All." This retrieves all objects in the source drawing. See [Finding All Objects in a Specified Location](#) (page 1241).

As the objects are retrieved from the source drawing into the current drawing, they are transformed from the coordinate system of the source drawing to the coordinate system of the current drawing.

Once the objects are in the new drawing, you can detach the source drawing and save the new drawing. The objects are unchanged in the source drawing, but they use the new coordinate system in the new drawing.

Quick Reference

ADEDRAWINGS

Manages the drawing set

Menu In the Classic workspace, click Setup menu ► Define/Modify Drawing Set

Icon  Define/Modify Drawing Set

Command Line ADEDRAWINGS

Task Pane In Map Explorer, right-click Drawings ► Define/Modify Drawing Set

Dialog Box Define/Modify Drawing Set dialog box

ADEQUERY

Controls defining, modifying, saving, loading, and executing a query

Menu In the Classic workspace, click Setup menu ► More DWG Options ► Define Query

Icon  Define Query

Command Line ADEQUERY

Task Pane In Map Explorer, right-click Current Query ► Define -or- Right-click a query ► Edit

Dialog Box Define Query dialog box

ADESETCRDSYS

Assigns a global coordinate system code for the current drawing or attached drawings

Menu Setup menu ► Assign Global Coordinate System

Icon  Assign Coordinate System

Command Line ADESETCRDSYS

Task Pane	In Map Explorer, right-click Current Drawing ► Coordinate System
Dialog Box	Assign Global Coordinate System dialog box

Attaching Drawings

When you attach a drawing to the current drawing, you can work with any objects and data in that drawing, edit them, and save them back to the attached drawing.

NOTE To attach a geospatial feature source to the current drawing and bring in its features, use Data Connect. See [Overview of Bringing In GIS Features](#) (page 305).

See also:

- [Overview of Bringing in Drawing Data From DWG Files](#) (page 351)

To attach drawings

- [To create a drawing set](#) (page 156)
- [To attach drawings](#) (page 158)
- [To activate a drawing](#) (page 160)
- [To activate a group of drawings](#) (page 160)
- [To create a drive alias](#) (page 161)
- [To open an active attached drawing](#) (page 163)

Overview of Attaching Drawings

You can work with objects from other drawings by *attaching* the other drawings to the current drawing. The group of drawings attached to the current drawing is called a *drawing set*.

Example: You have separate drawings for each quadrant of a town. You attach those drawings to the current drawing, and then view all the quadrants simultaneously.

NOTE To attach a geospatial feature source to the current drawing and bring in its features, use Data Connect. See [Overview of Bringing In GIS Features](#) (page 305).

Aligning Attached Drawings

If an attached drawing has a global coordinate system assigned to it, objects from that drawing are automatically converted to their appropriate size and location in the current drawing.

If an attached drawing does not have a global coordinate system assigned to it, you can specify how to align objects from that drawing when they are copied into the current drawing.



Attached Drawings

Current Drawing

Tile drawings by specifying the drawing offset for each attached drawing, as shown above.

For each attached drawing, you can specify a drawing offset. You can also specify how objects from the attached drawings are scaled or rotated when they are brought into the current drawing.

For information about passwords and security, see AutoCAD help.

See also:

- [Setting Transformation Options](#) (page 167)

- [Viewing Information about Attached Drawings](#) (page 171)
- [Viewing Objects in the Save Set](#) (page 752)

NOTE To attach a geospatial feature source to the current drawing and bring in its features, use Data Connect. See [Overview of Bringing In GIS Features](#) (page 305).

To create a drawing set

- 1 If necessary, [create a drive alias](#) (page 161).
- 2 [Attach the drawings](#) (page 157) you plan to use with the project.
- 3 [Activate the drawings](#) (page 160) to query.

If you no longer use an attached drawing with the current drawing, you can remove the drawing from the drawing set.

To modify the settings for attached drawings, such as the offset, scale, or save back extents, see [Modifying Attached Drawing Settings](#) (page 163).

Quick Reference

ADEDRAWINGS

Manages the drawing set

Menu	In the Classic workspace, click Setup menu ► Define/Modify Drawing Set
Icon	 Define/Modify Drawing Set
Command Line	ADEDRAWINGS
Task Pane	In Map Explorer, right-click Drawings ► Define/Modify Drawing Set
Dialog Box	Define/Modify Drawing Set dialog box

Attaching a Drawing

NOTE To attach a geospatial feature source to the current drawing and bring in its features, use Data Connect. See [Overview of Bringing In GIS Features](#) (page 305).

Nested Drawings

If you attach a drawing that has other drawings already attached to it, those other drawings appear in the list as nested drawings.

You can query objects from nested drawings. If a top-level drawing is not active, you cannot see or activate nested drawings. However, if the top-level drawing is active, you can deactivate a nested drawing.

Working with Xrefs

To query data in an external reference, delete the external reference from the attached drawing and attach the reference drawing to the current drawing.

The Order of Attached Drawings

The order in which you attach drawings can affect the properties of objects retrieved by queries.

If two drawings use the same name for a block, layer, group, or text style, AutoCAD Map 3D uses the definition from the first retrieved object that uses that item.

For example, if you create a query to retrieve objects on LAYER_A, and LAYER_A does not exist in the current drawing, AutoCAD Map 3D uses the definition of LAYER_A in the first active attached drawing that contains objects on LAYER_A. Objects retrieved from LAYER_A in other drawings acquire the color and linetype that is defined for LAYER_A in this drawing. This change also applies when you save changes back to attached drawings.

TIP To maintain consistency between drawings, define blocks, layers, groups, and text styles in the current drawing. For example, if you define a LAYER_A in the current drawing, AutoCAD Map 3D applies the current drawing definition of LAYER_A to objects retrieved from LAYER_A in all attached drawings, and when you save back, applies the current drawing layer definition to the saved objects.

For information about passwords and security, see AutoCAD help.

See also:

- [Overview of Attaching Drawings](#) (page 154)
- [Viewing Information about Attached Drawings](#) (page 171)
- [Viewing Objects in the Save Set](#) (page 752)
- [Modifying Attached Drawing Settings](#) (page 163)

NOTE To attach a geospatial feature source to the current drawing and bring in its features, use Data Connect. See [Overview of Bringing In GIS Features](#) (page 305).

To attach drawings

- Drag the file from Windows Explorer to the Map Explorer tab of the Task Pane.

- or -

- 1 Open the drawing to which you want to attach another drawing.
- 2 In the Tool-based Ribbon Workspace, click Home tab ► Data panel ► Define Drawing Set.
To specify separate filters for file names and for descriptions, click Filter and use the [Drawing Set Display Filter dialog box](#) (page 1922).
To change the drawing description, specify simple transformation settings, or define save back extents, click Drawing Settings and use the [Drawing Settings dialog box](#) (page 1923).
- 3 In the [Define/Modify Drawing Set dialog box](#) (page 1918), click Attach.
- 4 In the Select Drawings to Attach dialog box, select the drawings to attach. Click Add.

To modify the settings for attached drawings, such as the offset, scale, or save back extents, see [Modifying Attached Drawing Settings](#) (page 163).

For information on viewing the attached drawings, see [Viewing All Objects in Selected Attached Drawings](#) (page 745).

Quick Reference

AEDRAWINGS

Manages the drawing set

Menu	In the Classic workspace, click Setup menu ► Define/Modify Drawing Set
Icon	 Define/Modify Drawing Set
Command Line	AEDRAWINGS
Task Pane	In Map Explorer, right-click Drawings ► Define/Modify Drawing Set
Dialog Box	Define/Modify Drawing Set dialog box

Activating a Drawing

When you run a query to retrieve objects from attached drawings, AutoCAD Map 3D retrieves objects only from active drawings.

You cannot make a drawing active or inactive when there are locked objects in the drawing.

NOTE If an attached drawing is active in the current drawing, you cannot open that drawing directly.

NOTE To attach a geospatial feature source to the current drawing and bring in its features, use Data Connect. See [Overview of Bringing In GIS Features](#) (page 305).

See also:

- [Overview of Attaching Drawings](#) (page 154)
- [Overview of Bringing in Drawing Data From DWG Files](#) (page 351)
- [Modifying Attached Drawing Settings](#) (page 163)

NOTE To attach a geospatial feature source to the current drawing and bring in its features, use Data Connect. See [Overview of Bringing In GIS Features](#) (page 305).

To activate a drawing

- In the Map Explorer tab of the Task Pane, right-click the drawing name. Click Activate.

NOTE To activate a nested drawing, you must first activate the drawing to which it is attached.

To activate a group of drawings

- 1 In the Tool-based Ribbon Workspace, click Home tab ➤ Data panel ➤ Define Drawing Set.
- 2 Select the drawings to activate.
- 3 Click Activate.

Quick Reference

ADEDRAWINGS

Manages the drawing set

Menu	In the Classic workspace, click Setup menu ➤ Define/Modify Drawing Set
Icon	 Define/Modify Drawing Set
Command Line	ADEDRAWINGS
Task Pane	In Map Explorer, right-click Drawings ➤ Define/Modify Drawing Set
Dialog Box	Define/Modify Drawing Set dialog box

Creating a Drive Alias

If you plan to share drawings with other users, use drive aliases to specify the location of attached drawings.

Example: You connect to the drawing server as drive J, but another user connects as drive K. This makes it difficult to share drawings, since your drawing specifies J as the location for the attached files. However, if you both

assign the same drive alias to the server, such as ProjectMaps, you can specify the location of the attached drawings by this drive alias.

AutoCAD Map 3D provides a default drive alias called C. To store drawings in a location other than drive C, create a drive alias for the location.

NOTE To attach a geospatial feature source to the current drawing and bring in its features, use Data Connect. See [Overview of Bringing In GIS Features](#) (page 305). Geospatial connections do not require drive aliases.

See also:

- [Overview of Attaching Drawings](#) (page 154)
- [Overview of Bringing in Drawing Data From DWG Files](#) (page 351)
- [Modifying Attached Drawing Settings](#) (page 163)

NOTE To attach a geospatial feature source to the current drawing and bring in its features, use Data Connect. See [Overview of Bringing In GIS Features](#) (page 305). Geospatial connections do not require drive aliases.

To create a drive alias

- 1 In the Tool-based Ribbon Workspace, click Home tab ► Data panel ► Define Drawing Set.
- 2 In the Define/Modify Drawing Set dialog box, click Attach.
- 3 In the Select Drawings to Attach dialog box, click .
- 4 In the [Drive Alias Administration dialog box](#) (page 1928), type a name for the alias.

The name must use only alphanumeric characters (including hyphen and underscore), contain no spaces or colons, and start with a character.

NOTE If you are creating a drive alias for a drawing with an undefined alias, type that alias name exactly.

- 5 Specify a path for the new alias.
- 6 Click Add.

Quick Reference

ADEDEFCRDSYS

Defines a global coordinate system

Menu Setup menu ► Define Global Coordinate System

Command Line ADEDEFCRDSYS

Dialog Box Global Coordinate System Manager Dialog Box

ADEDRAWINGS

Manages the drawing set

Menu In the Classic workspace, click Setup menu ► Define/Modify Drawing Set

Icon  Define/Modify Drawing Set

Command Line ADEDRAWINGS

Task Pane In Map Explorer, right-click Drawings ► Define/Modify Drawing Set

Dialog Box Define/Modify Drawing Set dialog box

Opening an Active Attached Drawing

You cannot directly open an attached drawing that is activated in the current drawing. You must first deactivate it in the current drawing.

NOTE To attach a geospatial feature source to the current drawing and bring in its features, use Data Connect. See [Overview of Bringing In GIS Features](#) (page 305).

See also:

- [Overview of Attaching Drawings](#) (page 154)
- [Overview of Bringing in Drawing Data From DWG Files](#) (page 351)
- [Modifying Attached Drawing Settings](#) (page 163)

NOTE To attach a geospatial feature source to the current drawing and bring in its features, use Data Connect. See [Overview of Bringing In GIS Features](#) (page 305).

To open an active attached drawing

- 1 Do one of the following:
 - [Deactivate](#) (page 160) the attached drawing.
 - Close the drawing containing the attached drawing.

- 2 To open the drawing, click  ► Open ► Drawing.

Quick Reference

ADEDRAWINGS

Manages the drawing set

Menu	In the Classic workspace, click Setup menu ► Define/Modify Drawing Set
Icon	 Define/Modify Drawing Set
Command Line	ADEDRAWINGS
Task Pane	In Map Explorer, right-click Drawings ► Define/Modify Drawing Set
Dialog Box	Define/Modify Drawing Set dialog box

Modifying Attached Drawing Settings

- [Overview of Modifying Attached Drawing Settings](#) (page 164)
- [Creating a Drawing Description](#) (page 166)
- [Setting Transformation Options](#) (page 167)
- [Setting Save Back Extents](#) (page 170)
- [Viewing Information about Attached Drawings](#) (page 171)

See also:

- [Overview of Attaching Drawings](#) (page 154)
- [Overview of Bringing in Drawing Data From DWG Files](#) (page 351)

- [To create a drawing description](#) (page 166)
- [To set transformation options](#) (page 169)
- [To set save back extents](#) (page 170)
- [To view information about attached drawings](#) (page 172)

Overview of Modifying Attached Drawing Settings

You can specify how attached drawings work with the current drawing. You can also view information about attached drawings.

NOTE You cannot specify drawing settings for nested drawings.

NOTE To attach a geospatial feature source to the current drawing and bring in its features, use Data Connect. See [Overview of Bringing In GIS Features](#) (page 305).

See also:

- [Overview of Attaching Drawings](#) (page 154)
- [Overview of Bringing in Drawing Data From DWG Files](#) (page 351)

To do this...	Use this method...
Create a drawing description	In the Tool-based Ribbon Workspace, click Home tab ► Data panel ► Define Drawing Set. Click the Drawing Settings tab. See Creating a Drawing Description (page 166).
Specify how to adjust the scale, rotation, and XY offset of objects retrieved from an attached drawing.	In the Tool-based Ribbon Workspace, click Home tab ► Data panel ► Define Drawing Set. Click the Drawing Settings tab. See Setting Transformation Options (page 167).

To do this...	Use this method...
Specify save back extents that are different from the drawing extents.	In the Tool-based Ribbon Workspace, click Home tab ► Data panel ► Define Drawing Set. Click the Drawing Settings tab. See Setting Save Back Extents (page 170).
View information about attached drawings such as the number and type of objects, symbol tables, object data tables, and object classes.	In the Map Explorer tab of the Task Pane, right-click Drawings. Click Statistics. See Viewing Information about Attached Drawings (page 171).

NOTE To attach a geospatial feature source to the current drawing and bring in its features, use Data Connect. See [Overview of Bringing In GIS Features](#) (page 305).

Quick Reference

ADEDRAWINGS

Manages the drawing set

Menu	In the Classic workspace, click Setup menu ► Define/Modify Drawing Set
Icon	 Define/Modify Drawing Set
Command Line	ADEDRAWINGS
Task Pane	In Map Explorer, right-click Drawings ► Define/Modify Drawing Set
Dialog Box	Define/Modify Drawing Set dialog box

ADEDWGSTAT

Displays drawing statistics

Menu	Setup menu ► More DWG Options ► Drawing Statistics
Command Line	ADEDWGSTAT

Task Pane	In Map Explorer, right-click Drawings ► Statistics
Dialog Box	Drawing Statistics dialog box

Creating a Drawing Description

Providing a description for an attached drawing helps you and other users identify the drawing more easily.

TIP You can filter a drawing list by the drawing description. For example, when you are selecting drawings to Quick View, you could display only drawings with the word 'sewer' in their description.

NOTE Drawing descriptions apply to drawings only. there is no equivalent for geospatial feature sources.

See also:

- [Overview of Attaching Drawings](#) (page 154)
- [Overview of Bringing in Drawing Data From DWG Files](#) (page 351)

To create a drawing description

- 1 In the Tool-based Ribbon Workspace, click Home tab ► Data panel ► Define Drawing Set.
- 2 Click Drawing Settings.
- 3 In the [Drawing Settings dialog box](#) (page 1923), select the drawing for which you want to add a description.
- 4 In the Drawing Description box, enter a description.
- 5 Click Apply.

If you later want to modify the description, return to the Drawing Settings dialog box and enter a new description.

Quick Reference

ADEDRAWINGS

Manages the drawing set

Menu	In the Classic workspace, click Setup menu ► Define/Modify Drawing Set
Icon	 Define/Modify Drawing Set
Command Line	ADEDRAWINGS
Task Pane	In Map Explorer, right-click Drawings ► Define/Modify Drawing Set
Dialog Box	Define/Modify Drawing Set dialog box

Setting Transformation Options

Set simple transformation options to specify how to adjust the scale, rotation, and XY offset of objects retrieved from an attached drawing. Use these settings to make items from the attached drawings appear at the proper orientation, size, and placement in the current drawing.

AutoCAD Map 3D stores this information with the current drawing. The attached drawing does not change, which is useful for overlaying drawings or tiling them.

NOTE This functionality applies to drawing objects only. There is no equivalent for geospatial feature data.

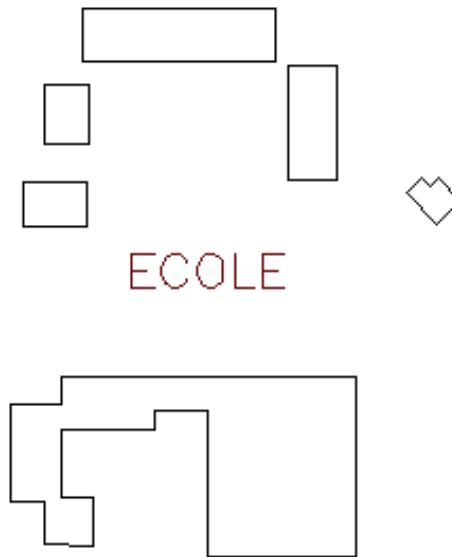

You can rotate objects from attached drawings so they match the rotation of the current drawing.

Example: You have individual maps for each square-mile sector. You create a drawing that encompasses a 5-square mile area, and you attach each of the square-mile maps. You set the appropriate offset for each attached map so it appears correctly in the current drawing.

If you save edited objects back to attached drawings, the objects are restored to their original rotation, scale, and offset.

NOTE If you have set a global coordinate system code, these simple transformation options are unavailable.

Use these simple transformation settings to *temporarily* adjust objects from attached drawings so they align correctly in the current drawing. You can also *permanently* edit the location, rotation, or scale of an object.

See also:

- [Overview of Attaching Drawings](#) (page 154)
- [Overview of Bringing in Drawing Data From DWG Files](#) (page 351)
- [Moving, Rotating, and Scaling an Object](#) (page 931)

NOTE This procedure applies to drawing objects only. There is no equivalent for geospatial feature data.

To set transformation options

- 1 In the Tool-based Ribbon Workspace, click Home tab ► Data panel ► Define Drawing Set.
- 2 Click Drawing Settings.
- 3 In the [Drawing Settings dialog box](#) (page 1923), select the drawing whose objects you want to transform.
- 4 Under Simple Transformation, select On/Off.
- 5 In the Scale box, enter the scale factor to scale the objects.
A value of 2 doubles the size of objects; a value of 0.5, halves the size of objects.
- 6 In the Rotation box, enter the angle in degrees to rotate the objects.
- 7 In the Offset (X,Y) boxes, enter the amount to offset objects using the drawing units from the attached drawing.
- 8 To select coordinates manually, click Pick.
When prompted, specify the points on which to base the simple transformation. AutoCAD Map 3D calculates the scale, rotation, and offset based on the four points you specify; the base point for the rotation is 0,0.
- 9 Click Apply.

This procedure transforms objects from the attached drawing as they are queried into the current drawing. When objects are saved back to the attached drawing, the transformation is undone. To permanently transform selected objects, use the [ADETRANSFORM](#) (page 931) command.

Quick Reference

ADEDRAWINGS

Manages the drawing set

Menu In the Classic workspace, click Setup menu ► Define/Modify Drawing Set

Icon	 Define/Modify Drawing Set
Command Line	ADEDRAWINGS
Task Pane	In Map Explorer, right-click Drawings ► Define/Modify Drawing Set
Dialog Box	Define/Modify Drawing Set dialog box

Setting Save Back Extents

For an attached drawing, you can specify save back extents that are different from the drawing extents.

This is useful if you save objects back to attached drawings based on their location. If you do not specify save back extents, AutoCAD Map 3D uses the attached drawing extents as the save back extents.

NOTE This functionality applies to drawing objects only. There is no equivalent for geospatial feature data.

See also:

- [Overview of Attaching Drawings](#) (page 154)
- [Overview of Bringing in Drawing Data From DWG Files](#) (page 351)
- [Viewing Objects in the Save Set](#) (page 752)

NOTE This procedure applies to drawing objects only. There is no equivalent for geospatial feature data.

To set save back extents

- 1 In the Tool-based Ribbon Workspace, click Home tab ► Data panel ► Define Drawing Set.
- 2 Click Drawing Settings.
- 3 In the [Drawing Settings dialog box](#) (page 1923), select the drawing for which you want to define save back extents.
- 4 Under Save Back Extents, click Define <.

- 5 Specify the boundary by using your pointing device or by entering coordinates on the command line. When you finish specifying the boundary, press Enter.
- 6 Click Apply.

TIP To view the save back extents, click Show <.

NOTE Simple transformations modify the default save back extents but do not affect user-defined save back extents.

Quick Reference

ADEDRAWINGS

Manages the drawing set

Menu	In the Classic workspace, click Setup menu ► Define/Modify Drawing Set
Icon	 Define/Modify Drawing Set
Command Line	ADEDRAWINGS
Task Pane	In Map Explorer, right-click Drawings ► Define/Modify Drawing Set
Dialog Box	Define/Modify Drawing Set dialog box

Viewing Information about Attached Drawings

View information about attached drawings such as the number and type of objects, symbol tables, object data tables, and object classes:

- Object Counts — The number and type of objects in the attached drawing.
- Symbol Tables — Displays information stored in symbol tables, for example, block names, layer names, linetypes, and registered applications (regapps).

NOTE Regapps are registered applications that contain extended data (Xdata).

- Object Data — Displays information stored in object data.

- Object Classes — Displays object classes used in the selected drawings and the number of objects in each object class.

NOTE This functionality applies to drawing objects only. To view information for geospatial feature data, see [Getting Information about Features](#) (page 1125).

See also:

- [Overview of Attaching Drawings](#) (page 154)
- [Overview of Bringing in Drawing Data From DWG Files](#) (page 351)
- [Editing Data in Attached Drawings](#) (page 729)

NOTE This procedure applies to drawing objects only. To view information for geospatial feature data, see [Getting Information about Features](#) (page 1125).

To view information about attached drawings

- 1 In the Map Explorer tab of the Task Pane, right-click Drawings. Click Statistics.
- 2 In the [Drawing Statistics dialog box](#) (page 1926), select drawings from the Active Drawings list.
- 3 Click a button:
 - Object Counts displays the number of each type of object in the selected drawings.
 - Symbol Tables displays all symbol tables in the selected drawings.
 - Object Data displays all link templates, object data tables, and attributes.
 - Object Classes displays objects used in the selected drawings and the type of data in each object class.

Quick Reference

ADEDWGSTAT

Displays drawing statistics

Menu	Setup menu ► More DWG Options ► Drawing Statistics
Command Line	ADEDWGSTAT
Task Pane	In Map Explorer, right-click Drawings ► Statistics
Dialog Box	Drawing Statistics dialog box

Setting Up a Query Library

You can save and organize your drawing queries in the query library.

NOTE This functionality applies to drawing objects only. To filter geospatial feature data when you add it to your map, see [Filtering Features When You Add Them to a Map](#) (page 309).

See also:

- [Defining Queries](#) (page 1218)
- [Executing Queries](#) (page 1287)

To set up a query library

NOTE This functionality applies to drawing objects only. To filter geospatial feature data when you add it to your map, see [Filtering Features When You Add Them to a Map](#) (page 309).

- [To use the query library](#) (page 174)
- [To save a query](#) (page 177)
- [To run a query from the Query Library](#) (page 178)
- [To run a query from Map Explorer](#) (page 179)
- [To run an external query](#) (page 179)
- [To reference an external query in the query library](#) (page 180)
- [To add a category to the query library](#) (page 182)
- [To edit a query saved with the current drawing](#) (page 184)
- [To edit an external query](#) (page 184)

Overview of Using the Query Library

If you plan to run a query more than once, you can save it. Once you have saved a query, you can run it anytime.

- [Saving a Query](#) (page 176)— Save the current query to the query library or to an external file.
- [Running a Saved Query](#) (page 178)— Run a query saved in the query library.

Each drawing has a query library where you can organize your saved queries into categories.

- [Adding an External Query to Your Library](#) (page 180)
- [Using Query Library Categories](#) (page 181)
- [Editing a Saved Query](#) (page 183)

NOTE This functionality applies to drawing objects only. To filter geospatial feature data when you add it to your map, see [Filtering Features When You Add Them to a Map](#) (page 309).

See also:

- [Defining Queries](#) (page 1237)
- [Executing Queries](#) (page 1287)

NOTE This procedure applies to drawing objects only. To filter geospatial feature data when you add it to your map, see [Filtering Features When You Add Them to a Map](#) (page 309).

To use the query library

- 1 On the Map Explorer of the Task Pane, right-click Query Library. Click Administration.
- 2 In the [Query Library Administration dialog box](#) (page 1858), under Category, select the category for the query you want, or click New to [create a new category](#) (page 182).
- 3 Under Available Queries, select the query.

You can assign the query to a different category, change the name, description, or location of the query, or add an external query to the library.

- 4 If you have modified the settings for an existing query, click Update. If you have added a new query, click Add.
- 5 Click OK.

Quick Reference

ADEQUERYLIB

Maintains the library of queries

Menu	Setup menu ► More DWG Options ► Query Library
Icon	 Query Library
Command Line	ADEQUERYLIB
Task Pane	In Map Explorer, right-click Query Library ► Administration
Dialog Box	Query Library Administration dialog box

ADERUNQUERY

Runs queries in the Query Library

Menu	Click Map ► Query ► Run Topology Query.
Icon	 Run Query
Command Line	ADERUNQUERY
Task Pane	In Map Explorer, right-click Current Query ► Execute As Preview-or- Right-click Current Query ► Execute As Defined-or- Right-click a query ► Execute As Preview-or- Right-click a query ► Execute As Defined
Dialog Box	Run Library Query dialog box

ADERUNXQUERY

Runs externally saved queries

Menu Edit menu ► More DWG Querying Options ► Run External Query

Command Line ADERUNXQUERY

Saving a Query

If you plan to use a query more than once, you can save it.

You can save the query with the current drawing, or you can save it to an external file. Saving to an external file is useful if you want to share a query with another user or use it in another drawing.

If you save the query to an external file you can specify several additional settings:

- **Save List Of Active Drawings** — Sets the drawing status to Active for drawings involved in the saved query.
- **Save Location Coordinates** — Stores the coordinates used for location queries. If you do not save the location query coordinates, AutoCAD Map 3D prompts you for them when you execute the query.
- **Keep Reference In Library** — Maintains a list of the external queries in the Query Library. If you plan to reference the query in the Query Library, you must provide a name and description for it.
- **Save Alter Properties** — Saves the property alteration definition with the query.
- **Auto Execute** — Executes the query in addition to loading it. If you do not select Auto Execute, AutoCAD Map 3D displays the query in the Define Query dialog box and waits for you to click Execute Query. Do not select this option if you want to modify a query before you run it.

NOTE This functionality applies to drawing objects only. To filter geospatial feature data when you add it to your map, see [Filtering Features When You Add Them to a Map](#) (page 309).

See also:

- [Overview of Queries](#) (page 1235)
- [Executing Drawing Queries](#) (page 1287)

■ [Adding an External Query to Your Library](#) (page 180)

NOTE This procedure applies to drawing objects only. To filter geospatial feature data when you add it to your map, see [Filtering Features When You Add Them to a Map](#) (page 309).

To save a query

- 1 Click Home tab ► Data panel ► Define Query. 
- 2 Make sure the query to save is the current query. If it is not, modify the current query or click load a different query.
- 3 Click Save Query.
- 4 In the [Save Current Query dialog box](#) (page 1862), select a category for the query.
- 5 Enter a name and description for the query.
- 6 Select any other query options you want.
- 7 To save the query to an external file, select Save To External File and specify a file name.
To display the external query in the Run Library Query dialog box and the Query Library Administration dialog box, select Keep Reference In Library.
- 8 Click OK.

Quick Reference

ADEQUERY

Controls defining, modifying, saving, loading, and executing a query

Menu	In the Classic workspace, click Setup menu ► More DWG Options ► Define Query
Icon	 Define Query
Command Line	ADEQUERY

Task Pane	In Map Explorer, right-click Current Query ► Define -or- Right-click a query ► Edit
Dialog Box	Define Query dialog box

Running a Saved Query

After you save queries, you can load, revise, and execute them.

NOTE If you plan to modify an externally saved query before executing it, do not set Auto Execute in the Save Current Query dialog box. That way, when you run the query, AutoCAD Map 3D displays the query in the Define Query dialog box but does not execute it.

NOTE This functionality applies to drawing objects only. To filter geospatial feature data when you add it to your map, see [Filtering Features When You Add Them to a Map](#) (page 309).

See also:

- [Overview of Queries](#) (page 1235)
- [Executing Drawing Queries](#) (page 1287)
- [Adding an External Query to Your Library](#) (page 180)

NOTE This procedure applies to drawing objects only. To filter geospatial feature data when you add it to your map, see [Filtering Features When You Add Them to a Map](#) (page 309).

- [To run a query from the Query Library](#) (page 178)
- [To run a query from Map Explorer](#) (page 179)
- [To run an external query](#) (page 179)

To run a query from the Query Library

- 1 Click **Create** tab ► **Object Query** panel ► **Run**. 
- 2 In the [Run Library Query dialog box](#) (page 1861), select the category for the query.

- 3 Select the query in the Available Queries list.
- 4 Click Execute Query.

To run a query from Map Explorer

- 1 On the Map Explorer of the Task Pane, right-click the query name.
- 2 Do one of the following:
 - Click Execute As Preview to execute the query as a preview query, regardless of whether it was defined as a preview, draw, or report mode query.
 - Click Execute As Defined to execute the query using the query mode with which it was defined.

To run an external query

- 1 Click Create tab ► Object Query panel ► External. 
- 2 In the Run External Query dialog box, select the query.
- 3 Click OK.

If you turned off the Auto Execute option when you saved the query, the query loads but does not execute. To execute the query, click Home tab ► Data

panel ► Define Query.  In the Define Query dialog box, click Execute Query.

Quick Reference

ADERUNQUERY

Runs queries in the Query Library

Menu Click Map ► Query ► Run Topology Query.

Icon  Run Query

Command Line ADERUNQUERY

Task Pane	In Map Explorer, right-click Current Query ► Execute As Preview-or- Right-click Current Query ► Execute As Defined-or- Right-click a query ► Execute As Preview-or- Right-click a query ► Execute As Defined
Dialog Box	Run Library Query dialog box

ADERUNXQUERY

Runs externally saved queries

Menu	Edit menu ► More DWG Querying Options ► Run External Query
Command Line	ADERUNXQUERY

Adding an External Query to Your Library

You can list an external query in the query library. By adding a reference to the external query to the library, you can organize the query with your other queries. In addition, you can give the query a name and a description to help you identify it.

You can add an external query to the Query Library for more than one drawing.

NOTE This functionality applies to drawing objects only. To filter geospatial feature data when you add it to your map, see [Filtering Features When You Add Them to a Map](#) (page 309).

See also:

- [Overview of Queries](#) (page 1235)
- [Executing Drawing Queries](#) (page 1287)

NOTE This procedure applies to drawing objects only. To filter geospatial feature data when you add it to your map, see [Filtering Features When You Add Them to a Map](#) (page 309).

To reference an external query in the query library

- 1 Click Create tab ► Object Query panel ► Library.



- 2 In the [Query Library Administration dialog box](#) (page 1858), select a category.
- 3 Under Selected Query, make sure that the Query Type is set to External.
- 4 Click Browse. Select the file that contains the external query.
- 5 Specify a name and description for the query.
- 6 Click OK.

To execute the query, click Create tab ► Object Query panel ► Run.



Quick Reference

ADEQUERYLIB

Maintains the library of queries

Menu	Setup menu ► More DWG Options ► Query Library
Icon	 Query Library
Command Line	ADEQUERYLIB
Task Pane	In Map Explorer, right-click Query Library ► Administration
Dialog Box	Query Library Administration dialog box

Using Query Library Categories

The Query Library lets you organize your queries into categories.

You can move a query to a new category, or change the name or description of a query. If you move an external query, you can specify the new location for the query.

NOTE This functionality applies to drawing objects only. To filter geospatial feature data when you add it to your map, see [Filtering Features When You Add Them to a Map](#) (page 309).

See also:

- [Overview of Queries](#) (page 1235)
- [Executing Drawing Queries](#) (page 1287)
- [Adding an External Query to Your Library](#) (page 180)

NOTE This procedure applies to drawing objects only. To filter geospatial feature data when you add it to your map, see [Filtering Features When You Add Them to a Map](#) (page 309).

To add a category to the query library

- 1 Click Create tab ► Object Query panel ► Library. 
- 2 In the [Query Library Administration dialog box](#) (page 1858), do one of the following:
 - To add a category, under Category, click New.
Enter a name for the category. Click OK. Do not include spaces in the name.
 - To assign a query to a different category, under Category, select the current category of the query.
From the Available Queries list, select the query. Click Category.
In the [Change Category dialog box](#) (page 1835), under New Category, select the new category for the query. Click OK.
 - To change the name or description of a query, under Category, select the category for the query.
Under Available Queries, select the query.
Under Selected Query, edit the name or description of the query. For external queries, you can specify a new location for the query.
Click Update.
 - To delete a category, select the category and click Remove.
You cannot remove a category that contains queries. You must first delete the queries or move the queries to a different category and then remove the empty category.
 - To rename a category, select the category and click Rename.
All queries assigned to the previous category name are assigned to the new name. The old category name no longer exists.

- 3 Click OK.

Quick Reference

ADEQUERYLIB

Maintains the library of queries

Menu	Setup menu ► More DWG Options ► Query Library
Icon	 Query Library
Command Line	ADEQUERYLIB
Task Pane	In Map Explorer, right-click Query Library ► Administration
Dialog Box	Query Library Administration dialog box

Editing a Saved Query

Once you have saved a query to the query library, you can reload the query at any time to review it or revise it.

If you save the query to an external file, it is saved as an AutoLISP script. Using a text editor, you can modify an external query file and include AutoLISP API commands. For more information, refer to "Editing Query Files", under "Using Interface Functions" in the online AutoCAD Map 3D AutoLISP Reference.

NOTE This functionality applies to drawing objects only. To filter geospatial feature data when you add it to your map, see [Filtering Features When You Add Them to a Map](#) (page 309).

See also:



- [Overview of Queries](#) (page 1235)
- [Executing Drawing Queries](#) (page 1287)
- [Adding an External Query to Your Library](#) (page 180)

NOTE This procedure applies to drawing objects only. To filter geospatial feature data when you add it to your map, see [Filtering Features When You Add Them to a Map](#) (page 309).

To edit a query saved with the current drawing

- 1 On the Map Explorer of the Task Pane, right-click a query name. Click Edit. The [Define Query dialog box](#) (page 1838) appears with the selected query loaded.
- 2 [Modify any conditions](#) (page 1258).
- 3 [Modify any property alterations](#) (page 1286).
- 4 In the Define Query dialog box, click Save.
To save the changes to a new query, enter a new name and description. Click OK.
- 5 In the Define Query dialog box, click OK to save your changes without running the query.

To edit an external query

- 1 Click Create tab ► Object Query panel ► External. 
- 2 In the Run External Query dialog box, select the query.
- 3 Click OK.
The external query runs and becomes the current query.
- 4 Click Home tab ► Data panel ► Define Query. 
- 5 [Modify any conditions](#) (page 1258).
- 6 [Modify any property alterations](#) (page 1286).
- 7 Click Save.

NOTE To be able to edit an external query before you execute it, do not set Auto Execute in the Save Current Query dialog box. That way, when you execute the query, AutoCAD Map 3D loads the query in the Define Query dialog box but does not execute it.

Quick Reference

ADEQUERY

Controls defining, modifying, saving, loading, and executing a query

Menu	In the Classic workspace, click Setup menu ► More DWG Options ► Define Query
Icon	 Define Query
Command Line	ADEQUERY
Task Pane	In Map Explorer, right-click Current Query ► Define -or- Right-click a query ► Edit
Dialog Box	Define Query dialog box

Setting Up Annotation Templates

NOTE Annotation templates are for drawing objects only. To label geospatial features, see [Adding Labels to Features](#) (page 1091).

Tell me more



Video

- *Show me how to label features.*
- *Show me how to label features with automatic resizing.*
- *Show me how to place a legend in the map and specify its contents.*
- *Show me how to edit the table style for a legend.*



Procedure

- [To label features](#) (page 1093)
- [To insert annotation](#) (page 1103)
- [To create a legend](#) (page 1118)



Tutorial

- Tutorial: Annotating Your Map

- Exercise 3: Add labels
- Lesson 6: Create a Legend



- Style and Label a Linear Feature



- *Label features and optimize placement.*
- *Create and edit a legend.*



- [Styling Features](#) (page 639)
- [Setting Up Annotation Templates](#) (page 185)

To set up annotation templates

NOTE Annotation templates are for drawing objects only. To label geospatial features, see [Adding Labels to Features](#) (page 1091).

- [To set up annotation](#) (page 189)
- [To make an XREFed drawing with annotation templates available in the current drawing](#) (page 189)
- [To define an annotation template](#) (page 192)
- [To change an annotation template](#) (page 196)
- [To delete all references to a selected annotation template](#) (page 197)
- [To delete an annotation template](#) (page 197)

Overview of Annotation Templates

In an annotation template, you define the information to display in the annotation and the layout of that information. Annotation templates are stored as specially named blocks within your drawing.

After you create an annotation template, you can insert instances of the annotation into your drawing. Creating annotation templates and inserting annotation is like creating and inserting blocks.

NOTE Annotation templates are for drawing objects only. To label geospatial features, see [Adding Labels to Features](#) (page 1091).

Labeling Objects Using Annotation Templates

Use annotation to label drawing objects with data values, such as the following:

- Attributes, such as [object data](#) (page 2070) or linked [external data](#) (page 2062)
- Display properties, such as line weight
- Geometric values, such as line direction
- Graphics, such as arrows, static text, or other geometry, added with standard AutoCAD drawing commands

NOTE Annotation templates are for drawing objects only. To label geospatial features, see [Adding Labels to Features](#) (page 1091).

You create one “tag” for each item in the annotation template. For example, one tag might contain the static text, “Area:” followed by a tag containing the property .AREA. You use the Block Editor to position the tags relative to each other. When you attach the annotation to an object, the values appear in the same position as their tags.

Annotation templates are stored in the drawing as blocks. Unlike regular blocks, annotation templates have the following characteristics:

- The block name is prefixed with "ACMAP_ANN_TEMPLATE_" followed by the annotation template name as specified in the [Define Annotation Template dialog box](#) (page 1572).
- The extension dictionary of the block contains special table objects.

Using Expressions in Annotation Templates

You can insert static text in the annotation template. It will appear on each object to which you attach annotation.

You can also specify properties or define values using expressions. The values of the properties or expressions are determined when the annotation is inserted.

For example, create an annotation template that specifies the text “Diameter” followed by an expression that calculates the diameter of a circle. Then insert instances of the annotation template on several circle objects. Each one will display “Diameter,” followed by that circle’s diameter.

When you change the text, properties, or expressions in an annotation template, existing annotations based on that template do not change. Use the

Refresh or Update command to apply your changes to the annotations that use the template you changed.

Using Annotation Templates from XREFs

To use an annotation template stored in another drawing, use the XBIND command to attach that drawing as an XREF.

Block names in the XREFed drawing have a prefix that consists of the XREF drawing file name followed by a vertical bar. Because the annotation commands identify annotation templates by looking for the "ACMAP_ANN_TEMPLATE_" at the beginning of the block name, you must rename the templates in the XREFed drawing to make them available in the current drawing.

For more information, see Bind External References in the AutoCAD help.

Tell me more



Video

- *Show me how to label features.*
- *Show me how to label features with automatic resizing.*
- *Show me how to place a legend in the map and specify its contents.*
- *Show me how to edit the table style for a legend.*



Procedure

- [To label features](#) (page 1093)
- [To insert annotation](#) (page 1103)
- [To create a legend](#) (page 1118)



Tutorial

- Tutorial: Annotating Your Map
- Exercise 3: Add labels
- Lesson 6: Create a Legend



Workflow

- Style and Label a Linear Feature



GIS Skill

- *Label features and optimize placement.*

- [Create and edit a legend.](#)



Related topics

- [Styling Features](#) (page 639)
- [Setting Up Annotation Templates](#) (page 185)

See also:

- [Overview of Annotation](#) (page 1100)

NOTE Annotation templates are for drawing objects only. To label geospatial features, see [Adding Labels to Features](#) (page 1091).

To set up annotation

- 1 [Define an annotation template.](#) (page 192)
- 2 [Attach annotation to objects.](#) (page 1103)
- 3 If you BIND an XREFed drawing containing annotation templates, remove the prefix from the XREFed annotation template block names to make them available in the current drawing.

To make an XREFed drawing with annotation templates available in the current drawing

- 1 Using the RENAME command, select Blocks from the Named Objects list.
- 2 Select the annotation template from the list of blocks in the Items list.
You will find blocks with names like
xrefdwgname\$O\$ACMAP_ANN_TEMPLATE_templatename.
- 3 Remove *xrefdwgname\$O\$* from the name of each template you want.

Quick Reference

MAPANNTEMPLATE

Defines and modifies annotation templates

Menu

Click Setup ► Define Annotation Template, .

Icon	 Define Annotation Template
Command Line	MAPANNTEMPLATE
Dialog Box	Define Annotation Template dialog box

MAPANNTEXT

Creates and edits annotation text

Icon	 Edit Annotation Text
Command Line	MAPANNTEXT
Dialog Box	Annotation Text dialog box

Defining Annotation Templates

An annotation template can include text and graphics.

NOTE Annotation templates are for drawing objects only. To label geospatial features, see [Adding Labels to Features](#) (page 1091).

You create one “tag” for each item in the annotation template. For example, one tag might contain the static text, “Area:” followed by a tag containing the property .AREA. You use the Block Editor to position the tags relative to each other. When you attach the annotation to an object, the values appear in the same position as their tags.

You can add graphics by drawing them in the Block Editor. You determine the text contents using static text, properties, and expressions.

The specific values of the properties and expressions are determined when you attach an annotation template to drawing objects.

For example, you can define the annotation template to include a static label (such as “Area:”), followed by a property (for example, .AREA). You can specify the label location as .CENTER. When you attach the annotation template to a drawing object, the annotation appears in the center of that object and displays the word Area, followed by the area of that object.

When you change the text, properties, or expressions in an annotation template, the existing annotations based on that template do not change. Use the Refresh or the Update command to apply the changes.

Tell me more



Video

- *Show me how to label features.*
- *Show me how to label features with automatic resizing.*
- *Show me how to place a legend in the map and specify its contents.*
- *Show me how to edit the table style for a legend.*



Procedure

- [To label features](#) (page 1093)
- [To insert annotation](#) (page 1103)
- [To create a legend](#) (page 1118)



Tutorial

- Tutorial: Annotating Your Map
- Exercise 3: Add labels
- Lesson 6: Create a Legend



Workflow

- Style and Label a Linear Feature



GIS Skill

- *Label features and optimize placement.*
- *Create and edit a legend.*



Related topics

- [Styling Features](#) (page 639)
- [Setting Up Annotation Templates](#) (page 185)

See also:

- [Attaching Annotation to Objects](#) (page 1103)
- [Refreshing Annotation](#) (page 1105)
- [Updating Annotation](#) (page 1106)

NOTE Annotation templates are for drawing objects only. To label geospatial features, see [Adding Labels to Features](#) (page 1091).

To define an annotation template

1 Click Annotate tab ► Map Annotation panel ► Define Template. 

2 In the [Define Annotation Template dialog box](#) (page 1572), click New.
You can change the other settings in this dialog box later in the procedure.

3 In the [New Annotation Template Name dialog box](#) (page 1576), type a name for the template, and click OK.

The ribbon changes to show the Block Editor tab. You use the Block Editor to define the annotation template, which is a special type of block.

4 Click Block Editor tab ► Annotation panel ► Edit Annotation Text 
Then press Enter to create a new annotation tag.

A single annotation template can contain multiple tags, as well as graphic elements.

5 In the [Annotation Text dialog box](#) (page 1570), specify the text to include in this annotation tag.

- For Attribute, enter a Tag name and Value for the annotation text.



For the value, enter static text or click  to use the Expression Chooser to specify an expression whose value varies depending on the object being annotated.

The Expression Chooser lists the properties, object data, block attributes, and other data associated with the current drawing.

NOTE Each tag name must be unique within the template.

- Specify the Object Properties and Text Options for the annotation text.

For most of the options, you can choose a static value from the dropdown list or specify an expression that is evaluated against the object when you insert the annotation.

Click  to create an expression. Within the Edit Expression dialog box, click  to select from a list of available properties and attributes. Click  to use a value from within the Block Editor. If you select ByBlock for Color or Lineweight, the settings in the Define Annotation Template dialog box will be used.

■ Click OK to return to the Block Editor.

6 In the Block Editor, click a location for this tag.

Since an annotation template can have multiple tags, you need to specify their locations relative to each other. Clicking a location here allows you to position this tag relative to any others in the template. When you insert an annotation, it appears at the Insertion Point specified in the [Define Annotation Template dialog box](#) (page 1572), with all its tags shown in their relative locations, as defined in the template.

7 Optionally, to include graphical elements as a part of the annotations, create them in the Block Editor.

Use AutoCAD drawing commands to create geometry or insert graphical elements.

8 When you finish adding elements to the template, click Close Block Editor on the Block Editor toolbar.

You are prompted to save your changes. When you do, the Define Annotation Template dialog box is redisplayed.

9 In the [Define Annotation Template dialog box](#) (page 1572), specify default properties and insertion options.

These settings control the appearance of the annotation template block. If you selected ByBlock for Color or Lineweight in the Annotation Text dialog box, these are the settings that will be used.

10 Click OK.

The Block Editor closes and your drawing is redisplayed. You can now [attach the annotation template to a drawing object or objects](#) (page 1103). When you do, the annotation (showing the appropriate values and settings for the selected object) will appear.

Quick Reference

MAPANNTemplate

Defines and modifies annotation templates

Menu Click Setup ► Define Annotation Template, Ä¶.

Icon  Define Annotation Template

Command Line MAPANNTemplate

Dialog Box Define Annotation Template dialog box

MAPANNTExt

Creates and edits annotation text

Icon  Edit Annotation Text

Command Line MAPANNTExt

Dialog Box Annotation Text dialog box

Changing Annotation Templates

You can change the contents of an existing template. For example, you can change the expression that determines the value or location of the text element. You can add or remove text or graphics.

If you change only the graphic elements in the template, the elements update automatically. However, if you change text elements, refresh or update the annotations associated with that template to see the changes in your drawing.

NOTE Annotation templates are for drawing objects only. To label geospatial features, see [Adding Labels to Features](#) (page 1091).

Tell me more



- *Show me how to label features.*
- *Show me how to label features with automatic resizing.*

- *Show me how to place a legend in the map and specify its contents.*
- *Show me how to edit the table style for a legend.*

 Procedure

- [To label features](#) (page 1093)
- [To insert annotation](#) (page 1103)
- [To create a legend](#) (page 1118)

 Tutorial

- Tutorial: Annotating Your Map
- Exercise 3: Add labels
- Lesson 6: Create a Legend

 Workflow

- Style and Label a Linear Feature

 GIS Skill

- *Label features and optimize placement.*
- *Create and edit a legend.*

 Related topics

- [Styling Features](#) (page 639)
- [Setting Up Annotation Templates](#) (page 185)

See also:

- [Overview of Annotation](#) (page 1100)
- [Refreshing Annotation](#) (page 1105)
- [Updating Annotation](#) (page 1106)

NOTE Annotation templates are for drawing objects only. To label geospatial features, see [Adding Labels to Features](#) (page 1091).

To change an annotation template

- 1 Click Annotate tab ► Map Annotation panel ► Define Template. 
 - 2 In the Template Name list, click the template to change.
 - 3 Do one or more of the following:
 - Click Copy to make a copy of the template.
 - Click Rename to rename the template.
 - Click Edit Template Contents to modify the text or graphical elements of the template.
 - Change any properties or insertion options.
- See [Defining Annotation Templates](#) (page 190) for information about changing the contents, properties, or options for an annotation template.
- 4 If you changed any text elements, use [Refresh](#) (page 1105) or [Update](#) (page 1106) to apply your changes to existing annotations that use this template.

Quick Reference

MAPANNTEMPLATE

Defines and modifies annotation templates

Menu Click Setup ► Define Annotation Template, 

Icon  Define Annotation Template

Command Line MAPANNTEMPLATE

Dialog Box Define Annotation Template dialog box

MAPANNTTEXT

Creates and edits annotation text

Icon  Edit Annotation Text

Command Line MAPANNTTEXT

Deleting Annotation Templates

You can delete an annotation template only if you first delete all references to that template from the drawing.

NOTE Annotation templates are for drawing objects only. To label geospatial features, see [Adding Labels to Features](#) (page 1091).

See also:

- [Overview of Annotation](#) (page 1100)
- [Deleting Annotation from Drawings](#) (page 1108)

NOTE Annotation templates are for drawing objects only. To label geospatial features, see [Adding Labels to Features](#) (page 1091).

To delete all references to a selected annotation template

- 1 Delete all references to the annotation template you plan to delete.

- 2 Click Annotate tab ► Map Annotation panel ► Delete Annotation. 

- 3 Select an annotation template. Click OK.

All annotation based on the selected template is deleted.

To delete an annotation template

- 1 Click Annotate tab ► Map Annotation panel ► Define Template. 

- 2 Select the annotation template to delete from the Template Name list.

- 3 Click Delete.

The selected annotation template is deleted.

Quick Reference

MAPANNTEMPLATE

Defines and modifies annotation templates

Menu Click Setup ► Define Annotation Template, .

Icon  Define Annotation Template

Command Line MAPANNTEMPLATE

Dialog Box Define Annotation Template dialog box

Setting Up Object Data

Object data is attribute data that is attached to individual objects and stored in tables in the drawing. To use object data, first define the format for the table, and then create each record as you attach it to an object.

NOTE Object data is for drawing objects only. For information about the attributes (properties) of geospatial features, see [Overview of the Data Table](#) (page 1125). To set up new feature sources for geospatial features, see [Overview of Working with Feature Sources](#) (page 582).

See also:

- [Entering and Editing Object Data](#) (page 1061)
- [Finding All Drawing Objects Containing Specific Data](#) (page 1245)
- [Altering Object Properties Using Object Data](#) (page 1267)

To set up object data

NOTE Object data is for drawing objects only. For information about the attributes (properties) of geospatial features, see [Overview of the Data Table](#) (page 1125). To set up new feature sources for geospatial features, see [Overview of Working with Feature Sources](#) (page 582).

- [To set up object data](#) (page 199)
- [To create an object data table](#) (page 201)
- [To modify an object data table](#) (page 203)

- [To rename or remove an object data table](#) (page 203)

Overview of Setting Up Object Data

Object data tables store text and numerical information related to an object.

NOTE Object data is for drawing objects only. For information about the attributes (properties) of geospatial features, see [Overview of the Data Table](#) (page 1125). To set up new feature sources for geospatial features, see [Overview of Working with Feature Sources](#) (page 582).

See also:

- [Creating an Object Data Table](#) (page 200)
- [Entering and Editing Object Data](#) (page 1061)
- [Finding All Drawing Objects Containing Specific Data](#) (page 1245)
- [Altering Object Properties Using Object Data](#) (page 1267)

NOTE Object data is for drawing objects only. For information about the attributes (properties) of geospatial features, see [Overview of the Data Table](#) (page 1125). To set up new feature sources for geospatial features, see [Overview of Working with Feature Sources](#) (page 582).

To set up object data

- 1 [Specify a set of fields for the table.](#) (page 200)
- 2 Assign a name, description, data type, and default value to each field.
- 3 [Use a separate procedure](#) (page 1064) to attach a record from the table to an object.

Quick Reference

ADEDEFDATA

Defines object data

Menu

Setup menu ► Define Object Data

Icon	 Define Object Data
Command Line	ADEDEFDATA
Dialog Box	Define Object Data dialog box

Creating an Object Data Table

You can create multiple object data tables in a single drawing. For example, you can create one table with pipe flow information and a separate table with inspection information.

NOTE Object data is for drawing objects only. For information about the attributes (properties) of geospatial features, see [Overview of the Data Table](#) (page 1125). To set up new feature sources for geospatial features, see [Overview of Working with Feature Sources](#) (page 582).

Using the Same Table Name in Other Drawings

Take care when naming your tables. If you use the same table name in more than one source drawing, be sure that all tables with same name have the same fields and field types. If your current drawing has more than one source drawing with the same object data table name, AutoCAD Map 3D uses the object table definition (or structure) for the first drawing that you activate. If the other source drawings have tables with the same name but with different fields, you cannot use those tables in the current drawing. If necessary, you can rename or redefine an object data table.

See also:

- [Entering and Editing Object Data](#) (page 1061)
- [Finding All Drawing Objects Containing Specific Data](#) (page 1245)
- [Altering Object Properties Using Object Data](#) (page 1267)

NOTE Object data is for drawing objects only. For information about the attributes (properties) of geospatial features, see [Overview of the Data Table](#) (page 1125). To set up new feature sources for geospatial features, see [Overview of Working with Feature Sources](#) (page 582).

To create an object data table

- 1 Click Map Setup tab ► Attribute Data panel ► Define Object Data. 
- 2 In the [Define Object Data dialog box](#) (page 1805), select a table to modify, or click New Table to create a new table.
 - If you select an existing table, the Object Data Fields list displays fields already defined for the table.
 - If you click New Table, enter a name for the new table.
- 3 To create a new data field, fill in the Field Definition area:
 - Enter a name and description for the field.
 - Select the field type. The type specifies what kind of information can be entered in the field. For example, if you specify a numeric type, you cannot enter letters in the field.
 - Specify the default value for the field. This value is attached to the object unless you change it.
- 4 Click Add to add the new field to the table.
- 5 Add any additional fields to the table.

Quick Reference

ADEDEFDATA

Defines object data

Menu

Setup menu ► Define Object Data

Icon



Define Object Data

Command Line

ADEDEFDATA

Dialog Box

Define Object Data dialog box

Modifying an Object Data Table

You can add, modify, and delete fields in newly defined object data tables until you perform a save operation (either saving objects back to source drawings or saving the current drawing). Once you perform a save operation, only a Superuser can modify the table. Also, if you have already queried any object from a source drawing, you cannot modify an object data table.

When you modify an object data field, AutoCAD Map 3D updates all instances of the field attached to objects. If the object data table is large, this process can take a long time.

NOTE Object data is for drawing objects only. For information about the attributes (properties) of geospatial features, see [Overview of the Data Table](#) (page 1125). To set up new feature sources for geospatial features, see [Overview of Working with Feature Sources](#) (page 582).

Renaming and Deleting Tables

If you have Superuser privileges, you can rename or delete object data tables. If you have already queried any object from a source drawing, you cannot rename or delete an object data table.

If you rename a table, the new name must not duplicate an existing table name.

WARNING When you delete an object data table from a drawing, the table is deleted from all attached, active source drawings.

See also:

- [Creating an Object Data Table](#) (page 200)
- [Entering and Editing Object Data](#) (page 1061)
- [Finding All Drawing Objects Containing Specific Data](#) (page 1245)
- [Altering Object Properties Using Object Data](#) (page 1267)

Use the MAPLOGIN command to log in as a Superuser, or contact your system administrator.

NOTE Object data is for drawing objects only. For information about the attributes (properties) of geospatial features, see [Overview of the Data Table](#) (page 1125). To set up new feature sources for geospatial features, see [Overview of Working with Feature Sources](#) (page 582).

To modify an object data table

- 1 Click Map Setup tab ► Attribute Data panel ► Define Object Data. 
- 2 In the [Define Object Data dialog box](#) (page 1805), for Table, select the object data table to modify.
- 3 Click Modify.
- 4 In the [Define New Object Data Table dialog box](#) (page 1803), delete, add, or update the fields:
 - To add a field, under Field Definition, enter a name, type, description, and default value for the field. Click Add.
 - To modify a field, under Object Data Fields, select the field to modify. Under Field Definition, change any information. Click Update. AutoCAD Map 3D updates the object data field and all instances of it attached to objects. If you change the data type of a field from Real to Integer, AutoCAD Map 3D drops everything to the right of the decimal point, leaving only the value to the left of the decimal point.
 - To delete a field, under Object Data Fields, select the field to delete. Click Delete.

To rename or remove an object data table

- 1 Click Map Setup tab ► Attribute Data panel ► Define Object Data. 
- 2 In the Define Object Data dialog box, under Table, select the object data table you want to rename or remove.
- 3 To rename the table, click Rename. In the [Rename Table dialog box](#) (page 1797), enter a new table name and click OK.
To delete the table, click Delete. The table and its object data fields and field values are deleted from every object to which they are attached.

NOTE When you delete an object data table from a drawing, the table is deleted from all attached, active source drawings.

Quick Reference

ADEDEFDATA

Defines object data

Menu Setup menu ► Define Object Data

Icon  Define Object Data

Command Line ADEDEFDATA

Dialog Box Define Object Data dialog box

Using Data from Feature Sources

A feature is the spatial description of a real-world entity such as a road, a utility pole, or a river. Features are stored in a spatial database or file. The spatial database or file is referred to as a feature source. You can bring feature source data into your map using Data Connect. For detailed information about using feature sources, see [Working with Feature Sources](#) (page 582).

Setting Up Data Sources for Drawings

You can attach a database to your drawing and link records from that table to objects in your drawing.

NOTE This functionality is for drawing objects only. For information about joining an external database to a geospatial feature class, see [Joining Data to GIS Features](#) (page 507).

To set up data sources for drawings

NOTE This functionality is for drawing objects only. For information about joining an external database to a geospatial feature class, see [Joining Data to GIS Features](#) (page 507).

- [To use a database in a drawing](#) (page 206)
- [To display information about a database table](#) (page 206)
- [To open a table or database query](#) (page 206)
- [To open a linked table or query](#) (page 206)
- [To attach a data source by dragging the database file to the Task Pane](#) (page 209)
- [To attach a data source by right-clicking the Data Sources folder in the Task Pane](#) (page 209)
- [To configure a data source automatically](#) (page 213)
- [To configure a data source manually](#) (page 213)
- [To modify an existing data link file](#) (page 213)
- [To connect a data source](#) (page 215)
- [To disconnect a data source](#) (page 215)

Overview of Attaching Data Sources to Drawings

A data source is a database table or a set of tables.

When you attach a data source to a drawing, the data source is listed on the Map Explorer tab of the Task Pane. You can view and edit data in the data source or link records from the data source to objects in the drawing.

While keeping the data source attached, you can disconnect the data source to save resources and reconnect when you are ready to work with the data.

TIP You can work with an external database table without using the database application itself.

NOTE This functionality is for drawing objects only. For information about joining an external database to a geospatial feature class, see [Joining Data to GIS Features](#) (page 507).

See also:

- [Overview of Linking Database Records to Objects](#) (page 522)
- [Viewing External Data Linked to Drawing Objects](#) (page 1146)

NOTE This functionality is for drawing objects only. For information about joining an external database to a geospatial feature class, see [Joining Data to GIS Features](#) (page 507).

- [To use a database in a drawing](#) (page 206)
- [To display information about a database table](#) (page 206)
- [To open a table or database query](#) (page 206)
- [To open a linked table or query](#) (page 206)

To use a database in a drawing

Do one of the following:

- From Windows Explorer, drag a database file to the Map Explorer tab of the Task Pane.
If the Map Explorer tab does not immediately display the data source, right-click a blank space in the Map Explorer tab. Click Refresh.
- Right-click the Data Sources folder on the Map Explorer tab and select Attach.
AutoCAD Map 3D automatically creates the files it needs to communicate with the database application. However, for some database types, you must configure these files yourself.

- Click Map Setup tab ► Attribute Data panel ► Attach Data Source.



To display information about a database table

- Right-click the table name in the Map Explorer tab. Click Properties.
You can see information such as column names and types.

To open a table or database query

- Double-click the item.

To open a linked table or query

- Double-click the link template name.

NOTE If you connect your database using the dbConnect command, the instructions in this section of the Help will not work . For information on using the dbConnect command and features, look up "dbconnect" in the help index.

Quick Reference

MAPATTACHDB

Attaches a data source to the current drawing

Menu	File menu ► Attach/Detach ► Attach External Records
Command Line	MAPATTACHDB
Task Pane	Drag a data source onto the Map Explorer tab

MAPCONFIGDB

Configures the connection to an external data source

Menu	Click Setup ► Create/Edit a Source of Data ► External Records.
Command Line	MAPCONFIGDB
Task Pane	In Map Explorer, right-click Data Sources ► Configure
Dialog Box	Configure Data Source dialog box

MAPCONNECTDB

Connects to an attached data source

Menu	File menu ► Connect/Disconnect ► Connect To External Records
Command Line	MAPCONNECTDB
Task Pane	In Map Explorer, right-click a data source or a link template ► Connect-or- To connect all data sources: Right-click Data Sources ► Connect All
Dialog Box	Connect Data Source dialog box

MAPDETACHDB

Detaches a data source from the current drawing

Menu	File menu ► Attach/Detach ► Detach External Records
Command Line	MAPDETACHDB
Task Pane	In Map Explorer, right-click a data source ► Detach
Dialog Box	Source dialog box

MAPDISCONNECTDB

Disconnects an attached, connected database

Menu	File menu ► Connect/Disconnect ► Disconnect From External Records
Command Line	MAPDISCONNECTDB
Task Pane	In Map Explorer, right-click a data source ► Disconnect-or- To disconnect all data sources: Right-click Data Sources ► Disconnect All
Dialog Box	Disconnect Data Source dialog box

Attaching a Data Source

To use data from an external data source, attach the data source to the drawing. When you attach a data source, it appears in the Map Explorer tab of the Task Pane along with the tables and database queries associated with it.

For the following data sources, AutoCAD Map 3D automatically creates the files it needs to communicate with the data source:

- .dbf
- .db
- .mdb
- .xls (must have at least one named range)
- .udl

For other data sources, you must [manually create the files](#) (page 210) before you can attach the data source.

NOTE This functionality is for drawing objects only. For information about joining an external database to a geospatial feature class, see [Joining Data to GIS Features](#) (page 507).

Tips

You can [set an option](#) (page 235) to have AutoCAD Map 3D prompt you for the database version each time you attach a data source or you can specify a default version.

AutoCAD Map 3D stores the [UDL \(Universal Data Link\)](#) (page 2078) files in a specific directory. If it does not find a UDL file in this directory, it creates a new UDL file. You can change the directory used for UDL files.

See also:

- [Configuring a Data Source](#) (page 210)
- [Associating Database Versions with File Extensions](#) (page 242)
- [Setting Data Source Options for Drawings](#) (page 235)
- [Overview of Linking Database Records to Objects](#) (page 522)
- [Viewing External Data Linked to Drawing Objects](#) (page 1146)

NOTE This functionality is for drawing objects only. For information about joining an external database to a geospatial feature class, see [Joining Data to GIS Features](#) (page 507).

To attach a data source by dragging the database file to the Task Pane

- 1 Using Explorer or My Computer, select the database file and drag it to the Map Explorer tab of the Task Pane.
You can drag and drop databases with the following extensions: *.udl*, *.db*, *.dbf*, *.mdb*, and *.xls*.
- 2 If prompted, select a version and click OK.
- 3 If prompted, enter your user name and password.

To attach a data source by right-clicking the Data Sources folder in the Task Pane

- 1 Right-click the Data Sources folder on the Map Explorer tab of the Task Pane and select Attach.

- 2 In the Attach Data Source dialog box, select the file location and type. You can attach databases with the following extensions: *.udl*, *.db*, *.dbf*, *.mdb*, and *.xls*.
- 3 Click Attach.

AutoCAD Map 3D creates the necessary configuration files and attaches the database.

For information on using specific database types with AutoCAD Map 3D, see the AutoCAD help.

Quick Reference

MAPATTACHDB

Attaches a data source to the current drawing

Menu	File menu ► Attach/Detach ► Attach External Records
Command Line	MAPATTACHDB
Task Pane	Drag a data source onto the Map Explorer tab

MAPDETACHDB

Detaches a data source from the current drawing

Menu	File menu ► Attach/Detach ► Detach External Records
Command Line	MAPDETACHDB
Task Pane	In Map Explorer, right-click a data source ► Detach
Dialog Box	Source dialog box

Configuring a Data Source

Microsoft Windows uses [UDL \(Universal Data Link\)](#) (page 2078) files to point to specific data sources. The UDL file lists the location of the data, the type of database, the version of the database, and the appropriate database driver.

For each data source that you use with AutoCAD Map 3D, you must have a UDL file in the AutoCAD Map 3D data source directory. Once the UDL file

exists in the data source directory, you can attach the data source to any drawing.

For most data sources, AutoCAD Map 3D creates the UDL file automatically when you attach a database. However, for some database types, you must create the UDL file manually.

When you edit or create a UDL file, you use the Microsoft Windows Data Link Properties dialog box. For more information on using this dialog box, refer to your Microsoft Windows documentation.

NOTE This functionality is for drawing objects only. For information about joining an external database to a geospatial feature class, see [Joining Data to GIS Features](#) (page 507).

Drivers

To read external data files, AutoCAD Map 3D uses drivers that translate the data to a standard format. The first time you use a data source with AutoCAD Map 3D, AutoCAD Map 3D determines the appropriate driver for the data source. It stores this information in the UDL file.

AutoCAD Map 3D supports these drivers:

- Jet provider, which works with Microsoft Access database files
- SQL Server provider
- Oracle provider
- ODBC driver, which works with ODBC-compliant databases

These drivers are installed with AutoCAD Map 3D.

Because the ODBC provider works with many different database types, it requires additional information about each specific database type. It gets this information from a Data Source Name (DSN) that registers information about the database type. You need only one DSN for each database type.

For the following ODBC-compliant databases, AutoCAD Map 3D creates a DSN for you when you attach the database:

- Microsoft Access
- dBase
- Microsoft Excel
- Paradox

- Microsoft Visual FoxPro

By default, AutoCAD Map 3D connects to Microsoft Access using the Jet provider, which does not require a DSN. If you want to connect to Microsoft Access using the ODBC driver, you must create a DSN.

For information on creating a DSN, refer to your Microsoft Windows documentation.

Displaying Configuration Dialog Boxes

When you attach a data source that does not already have a UDL file, AutoCAD Map 3D creates the UDL file and determines the settings for Windows data source configuration.

If the Expert variable is set to 3 or more, AutoCAD Map 3D determines the settings, and displays the data source configuration dialog boxes so you can review or modify the settings.

NOTE If you are using the ODBC provider, before you manually create the data link file, you must have a DSN (Data Source Name) for the database software. Windows may have created this file when you installed your database software.

See also:

- [Accessing Data from ODBC](#) (page 342)
- [Setting Data Source Options for Drawings](#) (page 235)
- [Overview of Linking Database Records to Objects](#) (page 522)
- [Viewing External Data Linked to Drawing Objects](#) (page 1146)

NOTE This functionality is for drawing objects only. For information about joining an external database to a geospatial feature class, see [Joining Data to GIS Features](#) (page 507).

- [To configure a data source automatically](#) (page 213)
- [To configure a data source manually](#) (page 213)
- [To modify an existing data link file](#) (page 213)

To configure a data source automatically

- Drag and drop one of the following database types onto the Map Explorer tab of the Task Pane:
 - Microsoft Access
 - dBASE
 - Microsoft Excel (must have at least one named range; do not use DATABASE or other reserved words as a range name)
 - Paradox
 - Microsoft Visual FoxPro

To configure a data source manually

- 1 At the command prompt, enter *mapconnectdb*.
- 2 Type a name for the data source and click OK. The data link file will have the same name.
- 3 On the Provider tab of the Data Link Properties dialog box, select the database provider. If you are using the ODBC provider, select the name of the DSN.
- 4 Enter additional information as needed and click OK. The Data Link Properties dialog box is a Microsoft Windows dialog box.

For help on database configuration, see the AutoCAD help. Additional information is available by clicking Help in the Data Link Properties dialog box.

To modify an existing data link file

- 1 At the command prompt, enter *mapconnectdb*.
- 2 Select the data source and click OK.
- 3 Make the modifications and click OK. The Data Link Properties dialog box is a Microsoft Windows dialog box.

NOTE If you modify a data link file for a data source that is currently attached and connected, the changes will not take effect until the next time you connect the data source.

NOTE If you have more than one copy of a UDL file, be sure to edit the copy in the AutoCAD Map 3D data links directory.

Quick Reference

EXPERT

Controls whether certain prompts are issued (system variable)

Command Line EXPERT

MAPCONFIGDB

Configures the connection to an external data source

Menu Click Setup ► Create/Edit a Source of Data ► External Records.

Command Line MAPCONFIGDB

Task Pane In Map Explorer, right-click Data Sources ► Configure

Dialog Box Configure Data Source dialog box

Connecting a Data Source

To free up memory or database connections, you can disconnect a data source but keep it attached to the current drawing. When you want to use the data source again, reconnecting is a one-step process.

TIP You can set an option to [automatically connect](#) (page 235) to all attached data sources each time you open a drawing.

NOTE This functionality is for drawing objects only. For information about joining an external database to a geospatial feature class, see [Joining Data to GIS Features](#) (page 507).

See also:

- [Setting Data Source Options for Drawings](#) (page 235)
- [Overview of Attaching Data Sources to Drawings](#) (page 205)
- [Overview of Linking Database Records to Objects](#) (page 522)

- [Viewing External Data Linked to Drawing Objects](#) (page 1146)

NOTE This functionality is for drawing objects only. For information about joining an external database to a geospatial feature class, see [Joining Data to GIS Features](#) (page 507).

To connect a data source

- On the Map Explorer tab of the Task Pane, double-click the data source.

To disconnect a data source

- Right-click the data source. Click Disconnect.

Quick Reference

MAPCONNECTDB

Connects to an attached data source

Menu	File menu ► Connect/Disconnect ► Connect To External Records
Command Line	MAPCONNECTDB
Task Pane	In Map Explorer, right-click a data source or a link template ► Connect-or- To connect all data sources: Right-click Data Sources ► Connect All
Dialog Box	Connect Data Source dialog box

MAPDISCONNECTDB

Disconnects an attached, connected database

Menu	File menu ► Connect/Disconnect ► Disconnect From External Records
Command Line	MAPDISCONNECTDB
Task Pane	In Map Explorer, right-click a data source ► Disconnect-or- To disconnect all data sources: Right-click Data Sources ► Disconnect All
Dialog Box	Disconnect Data Source dialog box

Setting Options

You can change many settings that affect the work environment, how the program starts up, whether users must log in, and settings for your current drawings, data sources, and more.

See also:

- [Setting Raster Image Options](#) (page 249)
- [Setting Data Source Options for Drawings](#) (page 235)

- [Setting AutoCAD Options](#) (look up “interface options, setting” in the help index)

- [To use the AutoCAD Map Options dialog box](#) (page 218)
- [To set Task Pane options](#) (page 221)
- [To hide or display the Task Pane at startup](#) (page 221)
- [To hide or display the Task Pane within your current session](#) (page 221)
- [To refresh Map Explorer](#) (page 221)
- [To adjust the transparency of the Task Pane](#) (page 222)
- [To set drawing options](#) (page 225)
- [To set multi-user options](#) (page 227)
- [To set system options](#) (page 229)
- [To specify coordinate system options](#) (page 231)
- [To specify coordinate tracker options](#) (page 232)
- [To set coordinate geometry options](#) (page 234)
- [To change the azimuth bearing quickly](#) (page 234)
- [To set data source options](#) (page 236)
- [To change the expert setting](#) (page 236)
- [To change the default data link file directory](#) (page 236)
- [To set Data View options](#) (page 238)
- [To specify Feature Edit Options](#) (page 240)
- [To set metadata options](#) (page 241)
- [To associate database versions with files extensions](#) (page 243)
- [To set query options](#) (page 245)
- [To have hatch created by property alteration be associative](#) (page 247)
- [To set AutoCAD Map 3D options](#) (page 249)

Overview of Setting Options

The following table summarizes the options you can set and where these settings are located.

To change settings for...	Go to...
Default display of the Task Pane	AutoCAD Map Options dialog box ► Task Pane (page 1909) tab.
The current drawing	AutoCAD Map Options dialog box ► Current Drawing (page 1909) tab.
Login and object locking	AutoCAD Map Options dialog box ► Multi-User (page 1915) tab
Log files and data sources	AutoCAD Map Options dialog box ► System (page 1916) tab
Coordinate systems	AutoCAD Map Options dialog box ► Current Drawing (page 1909) tab
Coordinate geometry	Coordinate Geometry Setup dialog box (page 1917)
Data sources for drawings (and file extension associations for them) and the Data View window	AutoCAD Map Options dialog box ► Data Source (page 1914) tab
Metadata	Metadata Options dialog box (page 1484)
Queries	AutoCAD Map Options dialog box ► Query (page 1911)tab NOTE There are also query-related settings on the following tabs: <ul style="list-style-type: none"> ■ Save Back (page 1913) ■ System (page 1916) ■ Task Pane (page 1909)
Associative hatch for drawing objects with boundaries	AutoCAD Map Options dialog box ► Query (page 1911)tab

To change settings for...	Go to...
Raster images	Raster Extension Options dialog box (page 1879)
Import defaults	mapimport.ini (page 271) and mapforeign-fileproperties.ini (page 274)
Export defaults	mapexport.ini (page 269)

To use the AutoCAD Map Options dialog box

- 1 In the Tool-based Ribbon Workspace, click Map Setup tab ► Map panel ► angle-arrow.
- 2 Click a tab.
- 3 In the [AutoCAD Map Options dialog box](#) (page 1908), modify options.
- 4 Click OK to save the settings.

Quick Reference

MAPOPTIONS

Sets AutoCAD Map 3D options

Menu	Setup menu ► Autodesk Map Options
Icon	 Options
Command Line	MAPOPTIONS
Task Pane	In Map Explorer, right-click Current Drawing ► Options
Dialog Box	AutoCAD Map Options dialog box

OPTIONS

Customizes the AutoCAD settings

Menu	Setup menu ► AutoCAD Options
Command Line	OPTIONS

Task Pane Right-click in the drawing area ► Options

MAPDOCKWSPACE

Docks and undocks the Task Pane

Command Line MAPDOCKWSPACE

Task Pane Double-click the title bar (floating) or the double bar at the top of the pane (docked)

Dialog Box MAPDOCKWSPACE (Dock Task Pane command)

MAPWSPACE

Shows or hides the Task Pane

Menu View menu ► Task Pane

Command Line MAPWSPACE

Task Pane Right-click a blank area ► Close

Dialog Box MAPWSPACE (Task Pane command)

MAPWSREFRESH

Redisplays the Task Pane

Command Line MAPWSREFRESH

Task Pane Right-click a blank area ► Refresh

Dialog Box MAPWSREFRESH

MAPCGAZBASE

Sets the azimuth base

Command Line MAPCGAZBASE

MAPCGSETUP

Specifies coordinate geometry settings

Menu At the Command prompt, enter mapcgsetup.

Icon



COGO Options

Command Line MAPCGSETUP

Dialog Box Setting Coordinate Geometry Options

MAPIOPTIONS

Specifies default image correlation settings, display options, detach options, paths, and memory settings

Menu Setup menu ► Raster Options

Command Line MAPIOPTIONS

Dialog Box Raster Extension Options dialog box

Setting Task Pane Options

You can specify what to display in the Task Pane and what displays when you start the program.

- **Map Explorer Categories To Display** — Lets you select which categories (nodes) you want to display on the Map Explorer tab of the Task Pane. The visibility of some nodes is dependent on the visibility of others. For example, the Tables node is visible in the Map Explorer tab of Task Pane only when you select both Data Sources and Tables.

NOTE When you attach drawings with the Topologies node visible, AutoCAD Map 3D creates a list of all the topologies to display under Topologies in Map Explorer. If you attach a large number of drawings containing topologies at the same time, the creation of the topology list increases the processing time. To reduce processing time, hide the Topologies node before attaching the drawings.

- **Show Task Pane On Startup** — Specifies whether to display the Task Pane when you start AutoCAD Map 3D.
- **Show Properties Palette On Startup** — Specifies whether to display the Properties palette when you start AutoCAD Map 3D.

See also:

- The Task Pane
- [Getting Information About Drawing Objects](#) (page 1143)
- [To set Task Pane options](#) (page 221)

- [To hide or display the Task Pane at startup](#) (page 221)
- [To hide or display the Task Pane within your current session](#) (page 221)
- [To refresh Map Explorer](#) (page 221)
- [To adjust the transparency of the Task Pane](#) (page 222)

To set Task Pane options

- 1 In the Tool-based Ribbon Workspace, click Map Setup tab ► Map panel ► angle-arrow.
- 2 In the [AutoCAD Map Options dialog box](#) (page 1908), select the Task Pane tab.
- 3 Modify the options you want:
 - Under Map Explorer Categories To Display, select the categories to display on the Map Explorer tab of the Task Pane.
 - Select which palettes you want to show at startup.
- 4 Click OK.

To hide or display the Task Pane at startup

- 1 In the Tool-based Ribbon Workspace, click Map Setup tab ► Map panel ► angle-arrow.
- 2 In the [AutoCAD Map Options dialog box](#) (page 1908), click the [Task Pane](#) (page 1909) tab.
- 3 Select Show Task Pane On Startup.

To hide or display the Task Pane within your current session

- In the Tool-based Ribbon Workspace, click View tab ► Palettes panel ► Map Task Pane

To refresh Map Explorer

- Right-click a clear area in Map Explorer, and click Refresh; or enter mapwsrefresh at the Command prompt.

To adjust the transparency of the Task Pane

- 1 Right-click the title bar of the Task Pane and choose Transparency.
- 2 In the Transparency dialog box, adjust the transparency level.
- 3 Click OK.

Quick Reference

MAPOPTIONS

Sets AutoCAD Map 3D options

Menu	Setup menu ► Autodesk Map Options
Icon	 Options
Command Line	MAPOPTIONS
Task Pane	In Map Explorer, right-click Current Drawing ► Options
Dialog Box	AutoCAD Map Options dialog box

MAPDOCKWSPACE

Docks and undocks the Task Pane

Command Line	MAPDOCKWSPACE
Task Pane	Double-click the title bar (floating) or the double bar at the top of the pane (docked)
Dialog Box	MAPDOCKWSPACE (Dock Task Pane command)

MAPWSPACE

Shows or hides the Task Pane

Menu	View menu ► Task Pane
Command Line	MAPWSPACE
Task Pane	Right-click a blank area ► Close
Dialog Box	MAPWSPACE (Task Pane command)

MAPWSREFRESH

Redisplays the Task Pane

Command Line MAPWSREFRESH

Task Pane Right-click a blank area ► Refresh

Dialog Box MAPWSREFRESH

Setting Drawing Options

You can specify general settings and coordinate transformation options for the current drawing. If you are working with drawings that use different global coordinate systems, AutoCAD Map 3D standardizes the drawings based on the global coordinate system of the the current drawing.

NOTE Once you bring objects into the current drawing, do not change the coordinate transformation options if you plan to save changes back to source drawings. The save-back process determines whether adjustments are necessary to restore objects to the correct coordinate system when you save them back to source drawings.

NOTE These options affect drawing files that you attach to the current map drawing. They do not affect geospatial feature sources.

Activate Attached Source Drawings

Set any of the following options:

- **From Last Session At Startup** — Activates the drawings that were active the last time you quit AutoCAD Map 3D. If you do not select this option, all drawings are inactive on startup.
- **After Attaching** — Sets the status of a drawing to Active when you attach it. If you do not select this option, all drawings are inactive when you attach them.

Coordinate Transformation Adjustments: Adjust Sizes And Scales area

Set any of the following options:

- **For Changes In Units** — Use this option when you are working with text and block objects from a source drawing that uses different coordinate system units than the current drawing. For example, if your source drawing uses meters and the current drawing uses U.S. Survey Feet, you can scale

text and blocks so that their size or scale measures in feet rather than meters.

If you do not select this option, AutoCAD Map 3D does not adjust the size or scale of text and block objects. For example, if you have a block that is 5 meters long in the source drawing, it will be 5 feet long when you bring it into the current drawing.

Do not change this setting after you bring objects into the current drawing, or you might introduce unintended changes to text and blocks when you save them back to their source drawings.

- For Map Distortion — Use this option to adjust the size and scale of text and blocks to correct for map distortion introduced when you represent a spherical object (earth) in a Cartesian coordinate system. For example, two objects, located at the northern and southern extremes of a map, of equal length in coordinate system X remain the same length when transformed to coordinate system Y. If you do not select this option, AutoCAD Map 3D scales the two objects to different lengths in coordinate system Y according to the relative map distortion (or grid scale factor). For Map Distortion in the Adjust Sizes And Scales area is available only if you selected the previous option, For Changes In Units.

Coordinate Transformation Adjustments: Adjust Rotations area

Set any of the following options:

- For Map Distortion — Adjusts the angle of text and blocks to correct for map distortion due to the convergence angle (the deviation of the Y axis of a Cartesian coordinate system from true north).
- For Zero-Rotation Objects — Specifies that text and blocks that have a rotation value of zero in the source drawing are adjusted to correct distortion due to the convergence angle. If you select this option, AutoCAD Map 3D calculates the convergence angle for text and blocks with a zero rotation value. If you do not select this option, AutoCAD Map 3D does not rotate text and blocks with a zero rotation value, even if there is a convergence angle. For Zero-Rotation Objects is available only if you selected the previous option, For Map Distortion, in the Adjust Rotations area.

Select Adjust Elevations to adjust the elevation (Z axis) of objects when you select For Changes In Units and For Map Distortion under Adjust Sizes And Scales.

Data Source Options

Set any of the following options:

- Select Reconnect Data Source When Drawing Opens to reconnect the databases that were connected the last time you quit AutoCAD Map 3D.
- In the Number Of SQL Conditions To Keep In History List box, enter the number of SQL conditions to store in the SQL condition history list. Reducing the size of this list saves memory and reduces the number of conditions you must scroll through when you search for a particular condition. The first condition added to the list is the first one dropped when AutoCAD Map 3D reaches the maximum number you specify.

See also:

- [Activating a Drawing](#) (page 159)
- [Overview of Coordinate Systems](#) (page 143)
- [Setting Data Source Options for Drawings](#) (page 235)

To set drawing options

- 1 In the Tool-based Ribbon Workspace, click Map Setup tab ► Map panel ► angle-arrow.
- 2 In the [AutoCAD Map Options dialog box](#) (page 1908), select the [Current Drawing](#) (page 1909) tab.
- 3 Modify the options you want. For information on each option, see the Concept tab of this topic.
- 4 Click OK.

Quick Reference

MAPOPTIONS

Sets AutoCAD Map 3D options

Menu	Setup menu ► Autodesk Map Options
Icon	 Options
Command Line	MAPOPTIONS
Task Pane	In Map Explorer, right-click Current Drawing ► Options
Dialog Box	AutoCAD Map Options dialog box

Setting Multi-user Options

You can specify options that affect how AutoCAD Map 3D operates for all users, across all drawings. For example, you can set login or object locking options. The system administrator controls these settings.

These options apply to all AutoCAD Map 3D users in a single installation and are set by the system administrator. The settings affect all drawings and, in network installations, are common to all users.

Force User Login

You must have Superuser privilege to set this option.

If Force User Login is enabled, users are required to log in at AutoCAD Map 3D startup. If a user attempts to halt log in by pressing the Escape key, AutoCAD Map 3D assigns view-only privileges, and the user cannot alter the drawing set, edit drawings, or perform queries. Once logged in, a user may log in under a different login name, even while working in a drawing with active source drawings.

If Force User Login is not enabled and the user does not log in, AutoCAD Map 3D uses the user's operating system login name to identify the user when locking objects, creating the .DWK file, and restoring options. A user may log in using his or her login name while working in drawings, including drawings with attached source drawings.

Enable Object Locking

Protects objects that are being edited from modification by other AutoCAD Map 3D users.

NOTE Object locking affects drawing files only. For information on using geospatial feature data in a multi-user environment, see [Overview of Working with Features](#) (page 684).

You cannot change the Enable Object Locking option while drawings are attached. If this option is not selected, only one user at a time can attach a drawing.

Object locking is recommended on networked systems to avoid conflicts when querying and editing. If you are working on a stand-alone system, you do not need object locking.

See also:

- [Logging Into AutoCAD Map 3D](#) (page 141)
- [Sharing Attached Drawings](#) (page 731)

NOTE Object locking affects drawing files only. For information on using geospatial feature data in a multi-user environment, see [Overview of Working with Features](#) (page 684).

To set multi-user options

- 1 In the Tool-based Ribbon Workspace, click Map Setup tab ► Map panel ► angle-arrow.
- 2 In the [AutoCAD Map Options dialog box](#) (page 1908), select the [Multi-User](#) (page 1915) tab.
- 3 Modify the options you want. For information on each option, see the Concept tab of this topic.
- 4 Click OK.

Quick Reference

MAPOPTIONS

Sets AutoCAD Map 3D options

Menu	Setup menu ► Autodesk Map Options
Icon	 Options
Command Line	MAPOPTIONS
Task Pane	In Map Explorer, right-click Current Drawing ► Options

Setting System Options

You can specify options that affect the operation of a single installation of AutoCAD Map 3D.

NOTE If you have enabled [Force User Login](#) (page 226) on the Multi-User Options tab, you must log in as a Superuser to set System Options. The default superuser login name is SuperUser (not case sensitive) and the password is SUPERUSER (case sensitive).

Log File Options

- Select Log File Active to create a log file for AutoCAD Map 3D messages.
- In the File Name box, provide the path and name for a log file in which to record error, warning, and diagnostic messages. The default name is *acadmap.log*. Optionally, you can click Browse to search your file system for an existing file. AutoCAD Map 3D appends messages to the file you select.
- Specify one of the following under Message Level:
 - Level 0: Error Messages — The log file contains error messages that describe potential problems you may encounter. For example, if you attempt to attach a drawing that is already attached, AutoCAD Map 3D produces an error message that is stored in the log file.
 - Level 1: Error And Warning Messages — The log file contains warning messages in addition to error messages. Warning messages alert you to potential problems. For example, if you use duplicate link template names, AutoCAD Map 3D produces a warning message that is stored in the log file.
 - Level 2: Error, Warning And Diagnostic Messages — The log file contains status messages as well as error and warning messages.

Number of Drawings Loaded Into Memory At Once

When you attach and activate drawings, AutoCAD Map 3D opens them in memory. You do not see the open drawings, but AutoCAD Map 3D must open them to perform operations.

The number of drawings that AutoCAD Map 3D can open in memory at the same time depends on several factors. These include the size of the drawings, amount of memory, and your system setup.

The number you specify here does not limit the number of active drawings. AutoCAD Map 3D opens and closes files in memory as it needs them. If your system has a lot of memory, you can enter a larger number (up to 200) to make queries go faster.

Default Directories

To specify a default directory for externally saved queries or cache files, enter the path in the appropriate box. Or click Browse to locate an existing directory.

NOTE These options affect drawing files only. They do not affect geospatial feature sources.

See also:

- [Editing Data in Attached Drawings](#) (page 729)
- [Overview of Using the Query Library](#) (page 174)

To set system options

- 1 In the Tool-based Ribbon Workspace, click Map Setup tab ► Map panel ► angle-arrow.
- 2 In the [AutoCAD Map Options dialog box](#) (page 1908), select the [System](#) (page 1916) tab.
- 3 Modify the options you want. For information on each option, see the Concept tab of this topic.
- 4 To enhance the performance of AutoCAD Map 3D, click Clear Cache.
- 5 Click OK.

NOTE If you have enabled [Force User Login](#) (page 226) on the Multi-User Options tab, you must log in as a Superuser to set System Options. The default superuser login name is SuperUser (not case sensitive) and the password is SUPERUSER (case sensitive).

Quick Reference

MAPOPTIONS

Sets AutoCAD Map 3D options

Menu Setup menu ► Autodesk Map Options

Icon  Options

Command Line MAPOPTIONS

Task Pane In Map Explorer, right-click Current Drawing ► Options

Dialog Box AutoCAD Map Options dialog box

Setting Coordinate System Options

You can set several options to determine how AutoCAD Map 3D performs coordinate system transformations and responds when you open drawings with embedded coordinate system definitions.

These options apply only to the current drawing. Each time you open a drawing, these settings take effect, but they do not affect other drawings.

Coordinate Transformation Adjustments

Coordinate transformation allows the manipulation of the coordinate geometry. Use the Coordinate Transformation Adjustment options to specify how AutoCAD Map 3D performs coordinate transformations through adjustments for size, scale, rotation, and elevation.

After you query objects into a drawing from source drawings, do not change the coordinate transformation options if you plan to save changes back to the source drawings.

NOTE The AutoCAD Map 3D simple transformation options, available in the Drawing Settings dialog box, cannot be used with coordinate transformations.

Storing Coordinate Systems in the Drawing

When you open a drawing that has a coordinate system that is not in your dictionary, AutoCAD Map 3D can add that coordinate system definition to

your dictionary. You can choose to always add the definitions, never add the definitions, or have AutoCAD Map 3D prompt you each time.

Units

Specify the units to use when displaying geodetic distance.

See also:

- [Overview of Coordinate Systems](#) (page 143)
- [Defining Coordinate Systems](#) (page 89)
- [Overview of Bringing in Drawing Data From DWG Files](#) (page 351)
- [Setting Drawing Options](#) (page 223)

To specify coordinate system options

- 1 In the Tool-based Ribbon Workspace, click Map Setup tab ► Map panel ► angle-arrow.
- 2 In the [AutoCAD Map Options dialog box](#) (page 1908), click the [Current Drawing](#) (page 1909) tab.
- 3 Under Coordinate Transformation Adjustments, specify how you want AutoCAD Map 3D to perform coordinate transformations.
- 4 Click the [Coordinate Systems tab](#) (page 1916).
 - Under Coordinate System Definitions Stored In Drawing, specify how you want AutoCAD Map 3D to respond when you open drawings with embedded coordinate system definitions.
 - Under Geodetic Distance, select the units to use when displaying geodetic distance.
- 5 Click OK.

Quick Reference

MAPOPTIONS

Sets AutoCAD Map 3D options

Menu Setup menu ► Autodesk Map Options

Icon	 Options
Command Line	MAPOPTIONS
Task Pane	In Map Explorer, right-click Current Drawing ► Options
Dialog Box	AutoCAD Map Options dialog box

Setting Coordinate Tracker Options

You can track multiple coordinate systems in your map using the [Track Coordinates Dialog Box](#) (page 1601). The Track Coordinates dialog box contains one or more Coordinate Trackers that display the coordinates of the cursor as you move around your map. You can specify how much information the tracker coordinates displays, and the precision of the coordinates.

See also:

- [Tracking Coordinates](#) (page 1149)

To specify coordinate tracker options

- 1 In the Tool-based Ribbon Workspace, click Analyze tab ► Geo Tools panel ► Coordinate Track.
- 2 In the Track Coordinates dialog box, click . The [Coordinate Tracker Options Dialog Box](#) (page 1600) appears.
- 3 In the Coordinate Tracker Options dialog box, set any of the following options:
 - Display coordinate system descriptions: view a description of the coordinate system in the Track Coordinates dialog box.
 - Format Lat/Long as D,M,S: display lat/long coordinates in degrees/minutes/seconds format.
 - Include Square ID: view the MGRS square ID when tracking MGRS coordinates.
 - Precision Level: specify the precision level of MGRS coordinates.

- Lettering Scheme: specify the lettering scheme for MGRS coordinates. Use AA (MGRS-New) for the WSG84 datum. Use AL (MGRS-Old) for older datums.
- Digitization Location: For the digitization location within a given MGRS square, specify left top, center top, right top, left center, center, right center, left bottom, center bottom, or right bottom.

4 Click OK.

Quick Reference

MAPTRACKCS

Tracks the coordinates of the cursor in any coordinate system

Menu Analyze menu ► Track Coordinate System.

Icon  Track Coordinates

Command Line MAPTRACKCS

Task Pane In Map Explorer, right-click Current Drawing ► Track Coordinates

Setting Coordinate Geometry Options

You can set the following coordinate geometry options:

- If North on your map is not aligned with the Y axis, specify the angle for North.
- If your COGO information sometimes includes elevation information, set the COGO commands to prompt for 3D data. If you never include 3D data, you can turn off this prompt.
- Specify units of measure for your coordinate geometry input. For Linear Units, select US Feet, International Feet, Meters, or Chains. For Angle Format, select Decimal Degrees, Degrees/Minutes/Seconds, Grads, Radians, or Surveyor's Units.
- If azimuth bearings on your map are measured relative to South, set the azimuth base to South. Otherwise, leave it set to North.

- Create a text log for coordinate geometry entered through the [COGO Input dialog box](#) (page 1668).

See also:

- [Overview of Coordinate Geometry Commands](#) (page 1027)

To set coordinate geometry options

- 1 In the Tool-based Ribbon Workspace, click Home tab ► Draw panel ► COGO drop-down ► COGO Options.
- 2 In the [Coordinate Geometry Setup dialog box](#) (page 1917), set any of the following options.
 - To change the setting for North, under Set North Direction, specify the direction from the Y axis to North on your map. Enter a number that represents the angular distance measured clockwise from the Y axis.
 - To have AutoCAD Map 3D always prompt for elevation, grade, or slope, select Prompt For 3D Data Input.
 - Specify units of measure for Linear Units and Angle Format.
 - Specify whether bearings in your map are relative to North or South.
 - To have AutoCAD Map 3D write a text log for coordinate geometry entered through the [COGO Input dialog box](#) (page 1668) to the AutoCAD Text Window, check Create Text Log.
- 3 Click OK to save your settings.

To change the azimuth bearing quickly

- 1 At the command prompt, enter *mapcgazbase*.
- 2 Enter *n* for North or *s* for South and press Enter.

Quick Reference

MAPCGAZBASE

Sets the azimuth base

Command Line	MAPCGAZBASE
MAPCGSETUP	
Specifies coordinate geometry settings	
Menu	At the Command prompt, enter mapcgsetup.
Icon	 COGO Options
Command Line	MAPCGSETUP
Dialog Box	Setting Coordinate Geometry Options

Setting Data Source Options for Drawings

You can specify several options for attaching data sources for drawing objects.

NOTE These options affect drawing data only. They do not affect geospatial feature data sources.

- Specify whether data sources, tables, database queries, and link templates appear on the Map Explorer tab of the Task Pane.
- Specify whether AutoCAD Map 3D automatically reconnects the data sources that were connected the last time you closed this drawing.
- Specify the default driver to use when you drop an MDB file onto the Map Explorer tab.
- Specify the default database version for files with a .db, .dbf, or .xls file extension that you drop on the Map Explorer tab.
- Change the Expert setting to display or hide the data source configuration dialog boxes. An Expert setting of 3 or above displays the configuration dialog boxes. An Expert setting of 2 or less hides the dialog boxes.
- Change the default location for [UDL \(Universal Data Link\)](#) (page 2078) files.

See also:

- [Overview of Attaching Data Sources to Drawings](#) (page 205)
- [Overview of Linking Database Records to Objects](#) (page 522)
- [To set Data View options](#) (page 238)

NOTE These options affect drawing data only. They do not affect geospatial feature data sources.

- [To set data source options](#) (page 236)
- [To change the expert setting](#) (page 236)
- [To change the default data link file directory](#) (page 236)

To set data source options

- 1 In the Tool-based Ribbon Workspace, click Map Setup tab ► Map panel ► angle-arrow.
- 2 In the [AutoCAD Map Options dialog box](#) (page 1908):
 - On the [Task Pane](#) (page 1909) tab, select the items to display on the Map Explorer tab.
 - On the [Current Drawing](#) (page 1909) tab, specify whether to automatically connect to attached data sources when you open a drawing and how many filters or conditions should be stored in the History List.
 - On the [Data Source](#) (page 1914) tab, specify the default driver to use when you drop an MDB file on the Map Explorer tab of the Task Pane. Click Associate to specify the default database version

To change the expert setting

- 1 At the command prompt, enter expert.
- 2 Enter an expert setting.

For information on the Expert system variable, look up "system variables" in the help index.

To change the default data link file directory

- 1 Click  ► Options.
- 2 On the Files tab of the Options dialog box, specify the Data Sources Location.

Quick Reference

OPTIONS

Customizes the AutoCAD settings

Menu	Setup menu ► AutoCAD Options
Command Line	OPTIONS
Task Pane	Right-click in the drawing area ► Options

MAPOPTIONS

Sets AutoCAD Map 3D options

Menu	Setup menu ► Autodesk Map Options
Icon	 Options
Command Line	MAPOPTIONS
Task Pane	In Map Explorer, right-click Current Drawing ► Options
Dialog Box	AutoCAD Map Options dialog box

Setting Data View Options

Data View options apply to a single user's AutoCAD Map 3D environment. All drawings opened by a particular user display these settings, but they do not affect others who open the same drawings.

NOTE Data View is for drawing data only. For options related to the Data Table, which displays the properties of geospatial feature data, see [Overview of the Data Table](#) (page 1127).

Display Of Multiple Tables

You can specify the number of Data Views to use when displaying tables.

- **Show Each Table In A Separate Data View:** Opens a new Data View window for each open table. Move between tables by clicking the window you want.

- **Show All Tables In One Data View:** Opens only one Data View window. When you open a new table, the previous table is automatically closed.

Data Views

You can specify the behavior of the Data View.

- **Open In Read-Only Mode:** Opens the Data View in read-only mode. When this option is selected, you cannot edit data in the Data View.
- **Save Format And Style Changes With Drawing:** Saves all formatting changes, such as column width, font, color, or borders, that you make in the Data View.
- **Keep On Top:** Specifies whether the Data View window remains on top of all other windows, even when it is not the active window.

See also:

- [Overview of Viewing External Data Sources for Drawing Objects](#) (page 1048)
- [Overview of Linking Database Records to Objects](#) (page 522)

NOTE Data View is for drawing data only. For options related to the Data Table, which displays the properties of geospatial feature data, see [Overview of the Data Table](#) (page 1127).

To set Data View options

- 1 In the Tool-based Ribbon Workspace, click Map Setup tab ► Map panel ► angle-arrow.
- 2 In the [AutoCAD Map Options dialog box](#) (page 1908), select the [Data Source](#) (page 1914) tab.
- 3 Modify the options you want.
- 4 To change the number of filters that AutoCAD Map 3D displays in the Table Filter History dialog box, select the [Current Drawing](#) (page 1909) tab. Enter a new number.
- 5 Click OK.

Quick Reference

OPTIONS

Customizes the AutoCAD settings

Menu	Setup menu ► AutoCAD Options
Command Line	OPTIONS
Task Pane	Right-click in the drawing area ► Options

MAPOPTIONS

Sets AutoCAD Map 3D options

Menu	Setup menu ► Autodesk Map Options
Icon	 Options
Command Line	MAPOPTIONS
Task Pane	In Map Explorer, right-click Current Drawing ► Options
Dialog Box	AutoCAD Map Options dialog box

Setting Geospatial Feature Editing Options

You can specify options for editing geospatial features.

NOTE These options affect geospatial feature data only. For options related to editing drawing objects, see [Setting Multi-user Options](#) (page 226).

- **Automatic Checkout:** You must check out geospatial features before editing them. This option allows you check out features automatically when you edit them.
- **Automatic Edit Update:** When you edit geospatial features in AutoCAD Map 3D you can also update the original data resources. This option allows you to automate updating your feature source.

- **Feature Checkout Options:** You can check out geospatial features with as drawing objects or geospatial features.

Features checked out as AutoCAD drawing objects	Features checked out as geospatial features
Allows you to use many common ACAD editing commands	Allows you to use some common ACAD editing commands in addition to geospatial feature-specific editing commands (for example, MAPFEATURESPLIT (page 1652) and MAPFEATUREMERGE (page 1651))
Edited features represented as AutoCAD geometries (for example, closed polylines are used to represent polygonal features)	Edited features are represented as geospatial geometries (for example, MAPPOLYGONS).
Most existing custom or third-party editing applications (LISP, VB, or ObjectARX) should continue to work. Some may require minor updates.	Supports multipart (multipolygons, multilines, and multipoints) geospatial features and editing, such as the Hawaiian islands.
Some existing AutoCAD Map 3D editing commands will continue to work on features (for example, rubber sheeting [ADERSHEET (page 1648)]).	Preserves and allows you to edit M and Z values.
Allows you to use feature styling.	Allows you to use feature styling.

- **Split Prompt Options:** Specify defaults for the prompts displayed when you split a polygonal feature. Specify whether to display the prompts during a split operation.
- **Checkin Prompt Timer:** This option allows you to set a recurring check-in prompt.

See also:

- [Editing Features](#) (page 701)
- [Splitting Features](#) (page 705)

NOTE These options affect geospatial feature data only. For options related to editing drawing objects, see [Setting Multi-user Options](#) (page 226).

To specify Feature Edit Options

- 1 In the Tool-based Ribbon Workspace, click Map Setup tab ► Feature Data panel ► angle-arrow.

- 2 In the [Feature Editing Options dialog box](#) (page 1929), select the options you want. If you select the checkin prompt, specify the prompt interval in minutes.
- 3 Click OK.

Quick Reference

MAPFEATUREEDITOPTIONS

Specifies options for editing features

Icon



Feature Edit Options

Command Line

MAPFEATUREEDITOPTIONS

Dialog Box

Feature Editing Options dialog box

Setting Metadata Options

AutoCAD Map 3D 2011 supports FGDC metadata down to the feature source and object class levels. You can set options for your metadata on the Metadata Options dialog box. Options for metadata include metadata template import and export, latitude/longitude precision, and automatic updating.

See also:

- [Setting Metadata Options](#) (page 1484)

To set metadata options

- 1 [Launch the Metadata Viewer](#) (page 1487).
- 2 On the Metadata Viewer toolbar, click Options.
- 3 In the [Metadata Options dialog box](#) (page 1756), do any of the following:
 - To use a metadata template, click the Template tab and select Use Template and select the template you want from the list. If no templates appear, click Import and import an FGDC-compliant template.

- To set Latitude/longitude precision, click the Preference tab and set the number of digits that display after the decimal point for your reported latitude and longitude values from 0 to 10. Both values are 6 by default.

4 Click OK.

Quick Reference

MAPMETADATAOPTIONS

Displays the Metadata Options dialog box

Command Line MAPMETADATAOPTIONS

Dialog Box Metadata Options

Setting InfoCenter Options

The InfoCenter, located at the top of the application window, helps you find information about AutoCAD Map 3D 2011 quickly. When you type a question into its text-entry box, the InfoCenter searches the AutoCAD Map 3D documentation as well as any documents you add to the search settings.

Using the InfoCenter, you can:

- Search a custom set of the documents, such as all the User Guides and Tutorials. If you are a developer, you can set InfoCenter to search your favorite developer Help.
- Search a specific document.
- Add your own documents to the search.
- Keep up-to-date on your favorite RSS feeds, such as the Knowledge Base and the Discussion Boards.

For details about the InfoCenter, see the AutoCAD help.

Associating Database Versions with File Extensions

This information applies only to drawing objects.

When you drag and drop a database onto the Map Explorer tab of the Task Pane, you can select the version of the database used to create the database.

By default, AutoCAD Map 3D prompts you each time to specify the version that was used. If you created all your databases with a specific version of the software, you can set an option to select that version automatically.

See also:

- [Attaching a Data Source](#) (page 208)
- [Configuring a Data Source](#) (page 210)
- [Setting Data Source Options for Drawings](#) (page 235)
- [Overview of Linking Database Records to Objects](#) (page 522)
- [Viewing External Data Linked to Drawing Objects](#) (page 1146)

To associate database versions with files extensions

- 1 In the Tool-based Ribbon Workspace, click Map Setup tab ► Map panel ► angle-arrow.
- 2 In the [AutoCAD Map Options dialog box](#) (page 1908), select the [Data Source](#) (page 1914) tab.
- 3 Under Associate Database Versions With File Extensions, select Associate.
- 4 In the [Associate Database Versions dialog box](#) (page 1675), under each database name, do one of the following:
 - To be prompted each time you drag and drop a database file onto the Map Explorer tab of the Task Pane, select Always Prompt.
 - To associate a database file extension with a specific version of the database software, select Always Use. Select the correct version. When you drop a database file onto the Map Explorer tab, AutoCAD Map 3D checks the file extension and uses the specified version of the database software.

Quick Reference

MAPOPTIONS

Sets AutoCAD Map 3D options

Menu	Setup menu ► Autodesk Map Options
Icon	 Options
Command Line	MAPOPTIONS
Task Pane	In Map Explorer, right-click Current Drawing ► Options
Dialog Box	AutoCAD Map Options dialog box

Setting Query Options (DWG)

You can set several options that determine how queries run, how they appear onscreen, and how they are saved.

NOTE These options affect drawing queries only. For information about filtering geospatial feature data when you add it to your map, see [Filtering Features When You Add Them to a Map](#) (page 309).

On the Task Pane Tab

You can hide or display the query node on the Map Explorer tab of the Task Pane.

NOTE The Queries option that appears under the Data Sources category is for database queries.

Options you set on the Task Pane tab apply to a single user's AutoCAD Map 3D environment. All drawings opened by a particular user display these settings, but they do not affect others who open the same drawings.

On the Query Tab

You can set specific query options, including the default joining operator, display parameters for preview queries, and options for location conditions.

Options you set on the Query tab apply only to the current drawing. Each time you open this drawing, these settings take effect, but they do not affect other drawings.

On the Save Back Tab

You can set options that determine if queried objects are added to the save set.

Options you set on the Save Back tab apply only to the current drawing. Each time you open this drawing, these settings take effect, but they do not affect other drawings.

On the System Tab

You can specify a default directory for externally saved queries.

See also:

- The Task Pane
- [Overview of Queries](#) (page 1235)

NOTE These options affect drawing queries only. For information about filtering geospatial feature data when you add it to your map, see [Filtering Features When You Add Them to a Map](#) (page 309).

To set query options

- 1 In the Tool-based Ribbon Workspace, click Map Setup tab ► Map panel ► angle-arrow.
- 2 Click the [Task Pane](#) (page 1909) tab to hide or display the query node on the Map Explorer tab of the Task Pane.
- 3 Click the [Query](#) (page 1911) tab to set specific query options.
- 4 Click the [Save Back](#) (page 1913) tab set options that determine if queried objects are added to the save set.
- 5 Click the [System](#) (page 1916) tab to specify a default directory for externally saved queries.
- 6 Click OK.

Quick Reference

MAPOPTIONS

Sets AutoCAD Map 3D options

Menu Setup menu ► Autodesk Map Options

Icon  Options

Command Line	MAPOPTIONS
Task Pane	In Map Explorer, right-click Current Drawing ► Options
Dialog Box	AutoCAD Map Options dialog box

Using Associative Hatch

You can set an option to specify whether hatch objects created by property alteration queries and thematic mapping are associative.

NOTE This option affects drawing objects only.



Hatch patterns used in thematic maps.

Associative hatch maintains a link between a hatch object and its boundary: if the boundary is modified, the hatch updates automatically. However, if the boundary is modified so that it no longer encloses the hatch or if any of the boundary objects are deleted, the association between the hatch and the boundary is lost.

When querying multiple files, it is easy to lose the association between a hatch object and its boundary. If you want associative hatch, the easiest solution may be to delete the old hatch object and recreate the associative hatch after you finish modifying the attached drawings.

To maintain an existing association, keep in mind these points:

- If you modify an object that is part of a hatch boundary, be sure that your changes do not break the boundary. That is, you can enlarge a circle, but do not trim it. You can extend the corner of a square, but do not open it up.
- To save a new associative hatch object to an attached drawing, all the boundary objects must be in the same attached drawing. In addition, all objects must be saved to the attached drawing at the same time. If any of the boundary objects are saved to a different file or are saved at a different time, the association is lost.

- When you add an associative hatch object to the save set, all its boundary objects are added automatically. If any of the boundary objects are locked, the hatch is not added to the save set.
- When you remove an associative hatch object from the save set, boundary objects are removed from the save set automatically.
- When you add a boundary object to the save set, hatch objects associated with that boundary are *not* added to the save set automatically. To maintain the association, add the hatch object to the save set.
- When combining solid hatch with text, use the DRAWORDER command to make the text visible on top of the hatch.

See also:

- [Overview of Altering the Properties of Queried Drawing Objects](#) (page 1259)
- [Setting Polygon Options](#) (page 977)

NOTE This option affects drawing objects only.

To have hatch created by property alteration be associative

- 1 In the Tool-based Ribbon Workspace, click Map Setup tab ► Map panel ► angle-arrow.
- 2 Select the [Query](#) (page 1911) tab.
- 3 Under Query Options, select Create Associative Hatch Objects.

Quick Reference

MAPOPTIONS

Sets AutoCAD Map 3D options

Menu	Setup menu ► Autodesk Map Options
Icon	 Options
Command Line	MAPOPTIONS
Task Pane	In Map Explorer, right-click Current Drawing ► Options

Saving Option Settings

AutoCAD Map 3D saves your options in one of three places, depending on the option type.

- Drawing options are saved in the drawing.
- User and installation options are saved in the *acadmap.ini* file. On startup, AutoCAD Map 3D searches for the *acadmap.ini* file first in the current directory, then in all the directories listed in the AutoCAD Map 3D path, and finally in the AutoCAD Map 3D executable directory. If it does not find the *acadmap.ini* file, the program creates the file in the current working directory.
- Multi-user options are saved in the binary *acadmap.sys* file. The *acadmap.sys* file is located in the AutoCAD Map 3D executable directory. After setting the multi-user options, the system administrator should make the file read only to prevent users from modifying or deleting it.

NOTE When you uninstall AutoCAD Map 3D, *acadmap.ini* is also uninstalled. If you have modified the settings in this file, you should save *acadmap.ini* prior to uninstalling. If you uninstall and then reinstall AutoCAD Map 3D, you can simply replace the newly installed *acadmap.ini* with the saved one. Note that Map release 4 and earlier saved option settings in the *ade.ini* file. If you uninstall release 4 or earlier and then install a newer release of AutoCAD Map 3D, you cannot replace the newly installed *acadmap.ini* with the saved *ade.ini*. Instead, you will need to reset your options in the AutoCAD Map 3D Options dialog box.

See also:

- [Setting Drawing Options](#) (page 223)
- [Setting Task Pane Options](#) (page 220)
- [Setting System Options](#) (page 228)
- [Setting Multi-user Options](#) (page 226)
- [Setting Data Source Options for Drawings](#) (page 235)
- [Setting Up Users and Assigning Rights](#) (page 82)

To set AutoCAD Map 3D options

- 1 In the Tool-based Ribbon Workspace, click Map Setup tab ► Map panel ► angle-arrow.
- 2 In the [AutoCAD Map Options dialog box](#) (page 1908), modify the options you want.
- 3 Click OK.

Quick Reference

OPTIONS

Customizes the AutoCAD settings

Menu	Setup menu ► AutoCAD Options
Command Line	OPTIONS
Task Pane	Right-click in the drawing area ► Options

MAPOPTIONS

Sets AutoCAD Map 3D options

Menu	Setup menu ► Autodesk Map Options
Icon	 Options
Command Line	MAPOPTIONS
Task Pane	In Map Explorer, right-click Current Drawing ► Options
Dialog Box	AutoCAD Map Options dialog box

Setting Raster Image Options

or raster images inserted with Raster Extension, set options in the Raster Extension Options dialog box.

- [To change options for images inserted with Raster Extension](#) (page 250)
- [To set the resource file directory](#) (page 251)
- [To change how image frames are displayed](#) (page 253)

- [To change the image display quality](#) (page 254)
- [To choose an image detach method](#) (page 255)
- [To turn on Shift + left-click](#) (page 256)
- [To set the correlation defaults](#) (page 257)
- [To configure memory for images](#) (page 259)

Overview of Setting Raster Image Options

Raster image options are available for images you insert using the Raster Extension. You can connect to many raster image files using Data Connect, but you may still use the Raster Extension to insert and correlate raster images with formats that Data Connect does not support, or to specify correlation information for images that do not contain this information within their files.

See also:

- [Overview of Adding Rasters and Surfaces](#) (page 437)
- [Using Other Raster Image Formats](#) (page 453)
- [Modifying Raster Images](#) (page 489)

To change options for images inserted with Raster Extension

- [Set the resource file directory.](#) (page 251)
- [Change how frames are displayed.](#) (page 253)
- [Change image display quality.](#) (page 254)
- [Choose a method for detaching images.](#) (page 255)
- [Use Shift + Left-click to select raster images.](#) (page 256)
- [Set correlation defaults.](#) (page 257)
- [Configure image-related memory options.](#) (page 259)

Quick Reference

MAPIOPTIONS

Specifies default image correlation settings, display options, detach options, paths, and memory settings

Menu	Setup menu ► Raster Options
Command Line	MAPIOPTIONS
Dialog Box	Raster Extension Options dialog box

Setting the Resource Files Directory

Resource files store information about the insertion point, scale, rotation, and density of an image. The Resource File Directory indicates where AutoCAD Map 3D searches for resource files for images you insert with Raster Extension (not those you add with Data Connect). Resource files have the same base name as the raster image with a .res extension.

When you insert an image, AutoCAD Map 3D looks for associated correlation sources, such as world files, resource files, and tab files. By default, AutoCAD Map 3D looks in the directory containing the image. However, for resource files, you can specify an additional location. The additional location applies only to resource files (.res). It does not apply to other correlation sources.

See also:

- [Overview of Adding Rasters and Surfaces](#) (page 437)
- [Using Other Raster Image Formats](#) (page 453)
- [Modifying Raster Images](#) (page 489)
- [Viewing Image Information](#) (page 474)
- [Creating a Search Path for Raster Images](#) (page 479)

To set the resource file directory

- 1 In the Tool-based Ribbon Workspace, click Insert tab ► Image panel ► angle-arrow.
- 2 In the [Raster Extension Options dialog box](#) (page 1879), select the Paths tab.
- 3 Under Resource File Directory, type the directory path for the resource files or click Browse to select a directory.
- 4 If you want AutoCAD Map 3D to search the Resource File Directory before searching the image directory, select Use Resource File Directory Before Using Image Directory.

- 5 Click OK to save your changes.

Quick Reference

MAPIOPTIONS

Specifies default image correlation settings, display options, detach options, paths, and memory settings

Menu	Setup menu ► Raster Options
Command Line	MAPIOPTIONS
Dialog Box	Raster Extension Options dialog box

Changing How Image Frames Are Displayed

For images you insert with Raster Extension, you can choose to display the image frame in front of an image, behind an image, or you can hide the frame. When the frame is behind the image, you can still select the image by selecting the frame. However, if you hide the frame, you cannot select the image by selecting the frame.

These options do not apply to images you add with Data Connect.

NOTE If you use the Toggle Frames command to hide frames, and then redisplay them, the frames appear in front of the images.

See also:

- [Overview of Adding Rasters and Surfaces](#) (page 437)
- [Using Other Raster Image Formats](#) (page 453)
- [Manually Adjusting the Image Frame During Insertion](#) (page 465)
- [Selecting an Image](#) (page 493)
- [Displaying Image Frames](#) (page 494)
- [Using Shift + Left-click to Select Images](#) (page 256)

To change how image frames are displayed

- 1 In the Tool-based Ribbon Workspace, click Insert tab ► Image panel ► angle-arrow.
- 2 In the [Raster Extension Options dialog box](#) (page 1879), select the General tab.
- 3 Under Display Preferences, select an option from the Image Frame list.
 - Frame Drawn Above Image displays the frame above the image.
 - Frame Drawn Below Image hides the frame behind the image. You can still select the image by selecting the frame.
 - Frames Off hides the frame. If frames are hidden, you select images by pressing Shift + left-click [select method](#) (page 493).
- 4 Click OK.

Quick Reference

MAPIOPTIONS

Specifies default image correlation settings, display options, detach options, paths, and memory settings

Menu	Setup menu ► Raster Options
Command Line	MAPIOPTIONS
Dialog Box	Raster Extension Options dialog box

Changing Image Display Quality

For images you insert with Raster Extension, you can choose high quality or draft quality display. High quality dithers the pixels so that the areas between shading appear more gradual. Draft quality can speed up the performance of your system, but may reduce the quality of how some color and grayscale images appear onscreen. These options do not affect images you add with Data Connect.

NOTE The display quality setting affects only how AutoCAD Map 3D displays the image onscreen. It does not alter the contents of the image file.

See also:

- [Overview of Adding Rasters and Surfaces](#) (page 437)
- [Using Other Raster Image Formats](#) (page 453)
- [Modifying Raster Images](#) (page 489)
- [Changing Image Display Quality and Speed](#) (page 498)
- [Adjusting Image Brightness, Contrast, and Fade](#) (page 496)

To change the image display quality

- 1 In the Tool-based Ribbon Workspace, click Insert tab ► Image panel ► angle-arrow.
- 2 In the [Raster Extension Options dialog box](#) (page 1879), select the General tab.
- 3 Under Display Preferences, select a Display Quality option:
 - High dithers the pixels, making differences in shading more gradual. If you are using a 256 color palette to display images, dithering helps make an image that has more than 256 shades appear more realistic.
 - Draft does not dither the pixels. This setting is recommended for bitonal images.
- 4 Click OK.

Quick Reference

MAPIOPTIONS

Specifies default image correlation settings, display options, detach options, paths, and memory settings

Menu	Setup menu ► Raster Options
Command Line	MAPIOPTIONS
Dialog Box	Raster Extension Options dialog box

Choosing an Image Detach Method

When you delete images you added with Raster Extension, from a map, information about that image is still stored in the map file. To delete this information, detach the image. You can choose whether images are detached automatically when you remove the last instance of the image from the map. This option does not affect images you added with Data Connect.

See also:

- [Overview of Adding Rasters and Surfaces](#) (page 437)
- [Using Other Raster Image Formats](#) (page 453)
- [Modifying Raster Images](#) (page 489)
- [Hiding, Unloading, Detaching, and Erasing Images](#) (page 482)

To choose an image detach method

- 1 In the Tool-based Ribbon Workspace, click Insert tab ► Image panel ► angle-arrow.
- 2 In the [Raster Extension Options dialog box](#) (page 1879), select the General tab.
- 3 Under Image Detach Preferences, select one of the following methods:
 - Ask Before Detach prompts you to detach an image when you erase all image frames that reference that image.
 - Always Detach automatically detaches an image when you erase all image frames that reference that image.
 - Never Detach does not detach an image when you erase all image frames that reference that image.
- 4 Click OK.

NOTE You can manually detach an image by using the IMAGE command.

Quick Reference

MAPIOPTIONS

Specifies default image correlation settings, display options, detach options, paths, and memory settings

Menu	Setup menu ► Raster Options
Command Line	MAPIOPTIONS
Dialog Box	Raster Extension Options dialog box

Using Shift + Left-click to Select Images

For images you insert with Raster Extension, you can change your selection method. This is useful when you are zoomed in on the image and you cannot see the image frame. This option does not affect images you add with Data Connect.

See also:

- [Overview of Adding Rasters and Surfaces](#) (page 437)
- [Using Other Raster Image Formats](#) (page 453)
- [Selecting an Image](#) (page 493)
- [Modifying Raster Images](#) (page 489)

To turn on Shift + left-click

- 1 In the Tool-based Ribbon Workspace, click Insert tab ► Image panel ► angle-arrow.
- 2 In the [Raster Extension Options dialog box](#) (page 1879), select the General tab.
- 3 Select Shift + Left-click Image Select to be able to [select images](#) (page 493) by pressing Shift and clicking the left mouse button.
Clear if you do not want to use this feature.
- 4 Click OK.

Quick Reference

MAPIOPTIONS

Specifies default image correlation settings, display options, detach options, paths, and memory settings

Menu	Setup menu ► Raster Options
Command Line	MAPIOPTIONS
Dialog Box	Raster Extension Options dialog box

Setting Correlation Defaults

Most images have correlation data that is stored in the image file header or in a correlation source file. However, some images may not have any correlation data. For those cases, you can specify default correlation data. In addition, if the correlation source does not contain information on scale or density, AutoCAD Map 3D uses the default settings for those items.

NOTE If you have multiple images that require the same insertion point, scale, rotation, and density, setting default correlation data can save you time .

See also:

- [Overview of Adding Rasters and Surfaces](#) (page 437)
- [Using Other Raster Image Formats](#) (page 453)
- [Correlating a Raster Image During Insertion](#) (page 462)
- [Setting Image Density](#) (page 467)
- [Viewing Image Information](#) (page 474)
- [Modifying the Correlation Settings for an Image](#) (page 501)

To set the correlation defaults

- 1 In the Tool-based Ribbon Workspace, click Insert tab ► Image panel ► angle-arrow.
- 2 In the [Raster Extension Options dialog box](#) (page 1879), select the Image Defaults tab.
- 3 Under Insertion Point, type default insertion point coordinates in the X and Y boxes. The precision of these points depends on the precision value in the Drawing Units dialog box. For more information about the AutoCAD UNITS command, see the AutoCAD help.

- 4 To set an elevation for image frames, type the elevation in the Z insertion point box.
This value is useful to establish the elevation of a floor plan image, for example.
- 5 In the Rotation box, type a default rotation angle for images. The unit of measurement depends on the selected value in the Drawing Units dialog box.
- 6 In the Scale box, type a default scale for images. Image scale does not change the scale of the vector drawing.
- 7 In the Density box, type a default density for images. Usually this is the scanned resolution. For example, if the majority of your images were scanned at 300 dots per inch, then type 300 in this box.
- 8 In the Units box, select the default unit for the insertion point and density of images. For example, if the majority of your images were scanned at 300 dots per inch, then select Inch as the default.
- 9 Click OK.

Quick Reference

MAPIOPTIONS

Specifies default image correlation settings, display options, detach options, paths, and memory settings

Menu	Setup menu ► Raster Options
Command Line	MAPIOPTIONS
Dialog Box	Raster Extension Options dialog box

Configuring Memory Use

AutoCAD Map 3D reserves 25% of the total physical memory (RAM) on your system for inserting images with the Raster Extension. If you increase the default amount, more of the physical memory is used for images and less is available for other operations in AutoCAD Map 3D and for other applications you might be running.

If you require additional memory for your images, the Raster Extension uses a temporary swap file. For example, if you insert a 100 MB file, and the Memory Limit is 8 MB, AutoCAD Map 3D stores the remaining 92 MB in a temporary file. You can specify where the swap file is created.

You can change the following Raster Extension memory settings:

- **Temporary File Location** — The default directory for the temporary swap files is the Windows *temp* directory.

TIP For best performance, use a local drive for your temporary swap file. It is recommended that you do not use the drive where the operating system is installed as the drive for the swap file unless this is your only local drive.

- **Memory Limit** — Specify the maximum amount of computer memory that AutoCAD Map 3D can use to store image files.

NOTE The more physical RAM you have, the higher you can make your Memory Limit. The higher the Memory Limit, the less swapping to hard disk occurs and the faster your images load and display. However, do not allocate all available physical RAM because doing so slows overall performance.

NOTE Close and restart AutoCAD Map 3D after adjusting these settings.

See also:

- [Overview of Adding Rasters and Surfaces](#) (page 437)
- [Using Other Raster Image Formats](#) (page 453)
- [Unloading an Image](#) (page 486)

To configure memory for images

- 1 In the Tool-based Ribbon Workspace, click Insert tab ► Image panel ► angle-arrow.
- 2 In the [Raster Extension Options dialog box](#) (page 1879), select the Memory tab.
- 3 To locate a drive for your temporary swap file location, click Browse under Temporary File Location, and locate a drive.

- 4 To change the amount of memory reserved for inserting images, type a new value in the Memory Limit box. Be careful that you do not use all of your system resources.

NOTE You can click Default to return this setting to the recommended value.

- 5 Click OK to accept the changes.

You must quit and restart AutoCAD Map 3D for these settings to take effect.

Quick Reference

MAPIOPTIONS

Specifies default image correlation settings, display options, detach options, paths, and memory settings

Menu	Setup menu ► Raster Options
Command Line	MAPIOPTIONS
Dialog Box	Raster Extension Options dialog box

Customizing and Automating Import and Export

Use profiles and .ini files to customize and automate import and export.

- [To create a profile](#) (page 263)
- [To use a profile](#) (page 263)
- [To export to SHP as folder-based rather than file-based](#) (page 269)
- [To export to SHP as file-based rather than folder-based](#) (page 269)
- [To change the segmentation size for splines, polylines with bulges, arcs, and ellipses](#) (page 270)
- [To change the default seed file for exporting DGN files](#) (page 270)
- [To export DGN files in imperial units rather than metric](#) (page 270)
- [To import Shapefiles, MIF/MID, TAB, or VPF as folder-based, multi-select, or file-based](#) (page 271)
- [To specify DGN cell import options](#) (page 272)
- [To import objects using RGB \(True Color\) colors](#) (page 272)
- [To specify language encoding settings for GML in Asian languages](#) (page 273)
- [To specify object properties](#) (page 274)

Overview of Customizing Import and Export

Use profiles and .ini files to customize and automate import and export.

To customize or automate this...	Use this method...
Export settings	Save a profile in the Export dialog box. See Using Profiles (page 262)
Import settings	Save a profile in the Import dialog box. See Using Profiles (page 262)
Export defaults	Edit the mapexport.ini file. See Customizing the Import and Export .ini Files (page 264)
Import defaults	Edit the mapimport.ini file. See Customizing the Import and Export .ini Files (page 264)

Quick Reference

MAPEXPORT

Exports drawing objects and their attribute data to an external file format

Menu Click File ► Convert DWG To ► Map 3D Export.

Icon  Export Map File

Command Line MAPEXPORT

Dialog Box Export dialog box

MAPIMPORT

Imports an external file format into AutoCAD Map 3D

Menu Click File ► Create DWG From ► Map 3D Import.

Icon  Import Map File

Command Line MAPIMPORT

Using Profiles

To reuse or share your settings, save them as a profile.

Export Profiles

When you save an export profile, it does not store the current file name or the current selection set.

When you load an export profile, if the specified data source doesn't exist, Include Table Data is set to No.

Import Profiles

When you save an import profile, it does not store the current file name.

When you load an import profile, the table settings are reset for any input layers that match an input layer name in the saved profile. Layers that do not match an input layer in the saved profile are not reset.

- If the specified coordinate system code is not in the dictionary, the coordinate system is set to <None>.
- If the data field name for a layer does not exist, the drawing layer is set to Layer 0. If the specified drawing layer does not exist, it will be created.
- If the data field name to use for the block name does not exist, or if the specified block does not exist, the block is set to ACAD_POINT.

When you load an import profile containing object class settings, AutoCAD Map 3D checks for potential problems and handles them as follows:

- If the appropriate object classification file is not attached to the drawing, the object class settings are ignored.
- If the object class settings for a layer contradict the import file, the object class settings are not applied.
- If the specified object class does not exist, the object class assignment is set to <None>.
- If the object class attribute settings conflict with the import file, AutoCAD Map 3D displays the [Conflict Resolution dialog box](#) (page 1701).

Compatibility with Previous Releases

- Profiles saved with AutoCAD Map 3D 2004-2007 and versions 4.5, 5, and 6 are compatible with this release.
- Profiles saved with Autodesk Map 2000 Release 4 or earlier cannot be used with this release.
- Profiles created in this release may contain additional information that cannot be used with previous releases. Such incompatible profile information is ignored when a profile is used in a previous release.

See also:

- [Overview of Converting Geospatial Data to Drawing Objects](#) (page 378)
- [Overview of Converting and Exporting](#) (page 1405)

To create a profile

- 1 In the [Import dialog box](#) (page 1711) or [Map Export dialog box](#) (page 1723), specify the settings to save.
- 2 Click Save.
- 3 Enter a name for the profile.

To use a profile

- 1 In the [Import dialog box](#) (page 1711) or [Map Export dialog box](#) (page 1723), click Load.
- 2 Select the profile.

Quick Reference

MAPEXPORT

Exports drawing objects and their attribute data to an external file format

Menu

Click File ► Convert DWG To ► Map 3D Export.

Icon



Export Map File

Command Line

MAPEXPORT

Dialog Box Export dialog box

MAPIMPORT

Imports an external file format into AutoCAD Map 3D

Menu Click File ► Create DWG From ► Map 3D Import.

Icon



Import Map File

Command Line MAPIMPORT

Dialog Box Import dialog box

Customizing the Import and Export .ini Files

Some of the defaults for import and export settings are stored in *.ini* (initialization) files. When you use a new format with AutoCAD Map 3D, the information about that format is added automatically to the *.ini* files. However, in some instances, you may want to modify these files yourself. In addition, you can set some formatting options in these files.

You can modify the following *.ini* files:

- *mapexport.ini* — Set options to export a file-based format as a folder based format (which is especially useful for Shapefiles); to specify how to segment arcs and circles; to define the default seed file for exporting DGN files (which determines defaults such as units of measure and 2D vs. 3D); and to specify language encoding settings for exporting GML data in Asian languages.
- *mapimport.ini* — Set options to use for file or folder selection; to set default import options for DGN; to import object colors to their RGB (True Color) equivalent; and to specify language encoding settings for importing GML data in Asian languages.
- *mapforeignfileproperties.ini* — Set options to specify linetype, line weight, font, and justification.

Exporting to ArcView Shape Files

If you are exporting to ArcView Shape files, you can treat it as a folder-based format. To do this, you must modify the following items in the *MapExport.ini* file:

- Specify that it requires a folder rather than a file.
- Specify that it requires a prefix name.
- Specify that it no longer requires a type (point/line/polyline/text).

If you modify these items, be sure to modify them only for a driver that supports this change.

Segmenting Certain Entity Types When Exporting

When you export Splines and polylines with bulges, they are broken into polyline segments. The *SegmentationDegrees* option determines the number of degrees used for segmentation. By default, *SegmentationDegrees* is 2 degrees.

In addition, when you exporting to a file format that does not support arcs or ellipses, such as Shape or Coverage, or does not support ellipses that have axes at an angle, such as MIF/MID, you can further modify the segmentation by changing the value for *FME_ARC_DEGREES_PER_EDGE*. By default, *FME_ARC_DEGREES_PER_EDGE* is 5 degrees.

You can change *SegmentationDegrees* and *FME_ARC_DEGREES_PER_EDGE* to be larger or smaller.

Exporting to MicroStation DGN Files

When exporting to DGN files, AutoCAD Map 3D reads a seed file to determine default information, such as whether the destination DGN file is be in imperial units or metric and whether the file is 2D or 3D. There are separate seed files for DGN version 7 and version 8. For more information about seed files, see [MicroStation Design \(DGN\) Versions 7 and 8](#) (page 405).

To change the default units of measure (or other defaults), you must change the default seed files specified in the *MapExport.ini* file.

Specifying the File and Folder Selection Options to Use for Import

By default, when you import ArcView Shape files, MapInfo MIF/MID, MapInfo TAB, or VPF files, you can select one or more files in a folder to import. This is called multi-select.

If you want, you can change the settings in the *mapimport.ini* file so that these formats are considered folder-based formats (you select a folder and all the files in the folder are imported) or single-select formats (only one file can be selected for import). Note that VPF can be folder-based or multi-select only.

Importing DGN Cells

When you import data from a DGN file, you can specify many of the DGN import options available in Driver Options.

Importing Object Colors as RGB (True Color) Colors

By default, objects are imported using the ACI (AutoCAD Color Index) color. When you import from DGN or MIF/MID, you can specify that objects maintain their RGB color values.

Even if you import using RGB colors, white objects are always imported to the ACI White, which displays white on a black background and black on a white background. Black objects are assigned the ByLayer color. If you want to export objects to MIF/MID as black, change the layer color to black before exporting.

Note that if your Model Tab Background color is something other than Black or White and you import using RGB colors, you may not be able to see objects whose color is close to the background color.

Language Encoding Settings for Importing and Exporting GML Data

When exporting GML data in Asian languages, you must verify that *mapexport.ini* contains the language encoding settings needed to export valid GML data for the language you want.

Using Fixed schema mode when exporting is recommended, as it can recognize certain multi-byte characters that can be problematic in Create mode.

When importing GML data in Asian languages, you must verify that the language encoding settings specified in AutoCAD Map 3D's *mapimport.ini* file match the settings in your incoming file. The settings must match for the import to be successful.

Adding Custom Tags

If you are familiar with the options for a driver, you can add custom tags. Use the format:

Driver:XXX

Where *XXX* is the code you want to send to the driver. Add the line to the appropriate section of the *MapExport.ini* file. Incorrect tags will have unpredictable results.

Location of the .ini File

When exporting, AutoCAD Map 3D looks first for the *.ini* file in the current directory. If no *.ini* file is there, it uses the *.ini* file in the *C:\Documents and Settings\All Users\Application Data\Autodesk\AutoCAD Map 3D 2011\R18.1* folder. To always use the same settings, do not create additional *.ini* files.

Changing Font, Line Style, Line Weight, or Justification

You can set several formatting options in the *mapforeignfileproperties.ini* file. Use the [DGN_V7_FieldMapping] or [DGN_V8_FieldMapping] section to enable a particular formatting option:

- `igds_font=MapFont`
- `igds_justification=MapJustification`
- `igds_weight=MapLineWeight`
- `igds_style=MapLineStyle`

DGN Fonts

Use the [DGN_V7_Font] section or [DGN_V8_Font] section to map DGN font numbers to textstyles that you've defined.

DGN Line Styles

Use the [DGN_V7_LineStyle] or [DGN_V8_LineStyle] section to map DGN line styles to line styles loaded in the AutoCAD Map 3D drawing.

DGN Line Weight

Use the [DGN_V7_LineWeight] or [DGN_V8_LineWeight] section to map DGN linewidths to allowable AutoCAD Map 3D linewidth values.

The DGN line weight range is 0-31. AutoCAD Map 3D line weights are in 100ths of a millimeter and only the following values are supported: 0, 5, 9, 13, 15, 18, 20, 25, 30, 35, 40, 50, 53, 60, 70, 80, 90, 100, 106, 120, 140, 158, 200, 211, -1, -2 and -3. The AutoCAD Map 3D values -1, -2, and -3 indicate ByLayer, ByBlock, and by line weight default respectively.

DGN Justification

Use the [DGN_V7_Justification] or [DGN_V8_Justification] section to map the DGN justification to AutoCAD vertical and horizontal modes or AutoCAD attachment.

DGN justification values range from 0-14:

0 is Left/Top, 8 is Center/Bottom, 1 is Left/Center, 9 is Right Margin/Top, 2 is Left/Bottom, 10 is Right Margin/Center, 3 is Left Margin/Top, 11 is Right Margin/Bottom, 4 is Left Margin/Center, 12 is Right/Top, 5 is Center/Bottom, 13 is Right/Center, 6 is Center/Top, 14 is Right/Bottom, 7 is Center/Center, Default is 5

The following values are supported for AutoCAD Map 3D justifications:

TopLeft, TopCenter, TopRight, MiddleLeft, MiddleCenter, MiddleRight, BottomLeft, BottomCenter, BottomRight, BaseLeft, BaseCenter, BaseRight, BaseAlign, BottomAlign, MiddleAlign, TopAlign, BaseFit, BottomFit, MiddleFit, TopFit, BaseMid, BottomMid, MiddleMid, TopMid

MIF Justification

Use the [MIF_Justification] section to set justification for MIF. Allowed MIF Justifications are left, center, and right.

When importing from MIF to AutoCAD Map 3D, the last mapping in the table is used.

Arc/INFO and E00 Justification

Use the [ARCINFO_Justification] and [E00_Justification] sections to set justification for Arc/INFO and E00.

When importing from Arc/INFO or E00 to AutoCAD Map 3D, the last mapping in the table is used.

See also:

- [Overview of Converting Geospatial Data to Drawing Objects](#) (page 378)
- [Overview of Converting and Exporting](#) (page 1405)
- [Supported Formats](#) (page 1412)
- [To export to SHP as folder-based rather than file-based](#) (page 269)
- [To export to SHP as file-based rather than folder-based](#) (page 269)
- [To change the segmentation size for splines, polylines with bulges, arcs, and ellipses](#) (page 270)

- To change the default seed file for exporting DGN files (page 270)
- To export DGN files in imperial units rather than metric (page 270)
- To specify DGN cell import options (page 272)
- To import Shapefiles, MIF/MID, TAB, or VPF as folder-based, multi-select, or file-based (page 271)
- To import objects using RGB (True Color) colors (page 272)
- To specify language encoding settings for GML in Asian languages (page 273)
- To specify object properties (page 274)

To export to SHP as folder-based rather than file-based

- 1 Open the *mapexport.ini* file using a text editor such as WordPad.
This file is located in the *C:\Documents and Settings\All Users\Application Data\Autodesk\AutoCAD Map 3D 2011\R18.1* folder
- 2 Find the [SHP] section.
- 3 Specify File=False.
- 4 Specify Rootname=True.
- 5 Specify EntTypes=All.
- 6 Save and close the *..ini* file.

To export to SHP as file-based rather than folder-based

- 1 Open the *mapexport.ini* file using a text editor such as WordPad.
This file is in the *C:\Documents and Settings\All Users\Application Data\Autodesk\AutoCAD Map 3D 2011\R18.1* folder.
- 2 Find the [SHP] section.
- 3 Specify File=True.
- 4 Specify Rootname=False.
- 5 Specify EntTypes=Types.
- 6 Save and close the *.ini* file.

To change the segmentation size for splines, polylines with bulges, arcs, and ellipses

- 1 Open the *mapexport.ini* file using a text editor such as WordPad.
This file is in the *C:\Documents and Settings\All Users\Application Data\Autodesk\AutoCAD Map 3D 2011\R18.1* folder.
- 2 Find the [Options] section.
- 3 To change the segmentation of splines and polylines with bulges, edit the SegmentationDegrees value to the number you want.
By default, the value is two degrees.
- 4 To change the segmentation of arcs and ellipses, find the File section pertaining to one of the following file formats: Arc/INFO, E00, MIF, MapInfo, or Shape.
- 5 Delete the semicolon at the beginning of the following line:
Driver:FME_ARC_DEGREES_PER_EDGE=5
- 6 Change the FME_ARC_DEGREES_PER_EDGE value to the number you want.
- 7 Save and close the *.ini* file.

To change the default seed file for exporting DGN files

- 1 Open the *mapexport.ini* file using a text editor such as WordPad.
This file is in the *C:\Documents and Settings\All Users\Application Data\Autodesk\AutoCAD Map 3D 2011\R18.1* folder.
- 2 Find the [DGCN_V7] or [DGN_V8] section . This is where the default seed file is specified.
- 3 Change the default seed file to the seed file you want.

NOTE Make sure to choose a seed file for the appropriate version of DGN. If you export to DGN version 7 using a DGN version 8 seed file, the operation will fail.

- 4 Save and close the *.ini* file.

To export DGN files in imperial units rather than metric

- 1 Open the *mapexport.ini* file using a text editor such as WordPad.

2 Find the [DGN_V7] or [DGN_V8] section.

3 Change the default seed file to the seed file you want.

For example, change the default seed file to one that specifies imperial units rather than metric:

```
Driver:RUNTIME_MACROS=_SEED,"C:\Program Files\Common  
Files\Autodesk Shared\GIS\ImportExport\4.0\design\seed3d_ft.dgn"
```

NOTE Make sure to choose a seed file for the appropriate version of DGN. If you export to DGN version 7 using a DGN version 8 seed file, the operation will fail.

4 Save and close the .ini file.

To import Shapefiles, MIF/MID, TAB, or VPF as folder-based, multi-select, or file-based

1 Open the *mapimport.ini* file using a text editor such as WordPad.

This file is located in the *C:\Documents and Settings\All Users\Application Data\Autodesk\AutoCAD Map 3D 2011\R18.1* folder

2 Find the File section pertaining to one of the following file formats: ShapeFile, MIF/MID, TAB, or VPF.

The File section is preceded by a comment such as, "This section determines how you want to Import MIF/MID files" and has several lines containing the word File.

3 Delete the semicolon at the beginning of the line for the option you want:

■ **File=MultiSelect**

The format will be considered a multi-select, file-based format. This means that you will be able to select one or more individual files in the Import Location dialog box to include in the import process.

■ **File=SingleSelect**

The format will be considered a single-select, file-based format. This means that you will be able to select one file only in the Import Location dialog box. Note that this is not a valid option for VPF.

■ **File=False**

The format will be considered a folder-based format and all files in the selected folder will be included in the import process.

- 4 Make sure there is a semicolon at the beginning of the line for the options you do not want to use. The semicolon tells AutoCAD Map 3D to ignore the line.
- 5 Save and close the .ini file.

To specify DGN cell import options

- 1 Open the *mapimport.ini* file using a text editor such as WordPad. This file is in the *C:\Documents and Settings\All Users\Application Data\Autodesk\AutoCAD Map 3D 2011\R18.1* folder.
- 2 Find the [DGN_V7_V8] section.

NOTE You can also use the [Cell Expansion options in the Import dialog box](#) (page 405) to expand cells as blocks or points, or to explode them.

- 3 Find Driver:DGN_XPAND_CELL.
- 4 Change this to CELLS2BLOCKS, EXPLODECELLS, or CELLS2POINTS.
- 5 Save and close the .ini file.

To import objects using RGB (True Color) colors

- 1 Open the *mapimport.ini* file using a text editor such as WordPad. This file is in the *C:\Documents and Settings\All Users\Application Data\Autodesk\AutoCAD Map 3D 2011\R18.1* folder.
- 2 Find the Color section for either DGN_V7-V8 or MIF (MapInfo).
- 3 Delete the semicolon at the beginning of the line for the option you want:
 - Color=Closest ACI only
The RGB values from the file will be converted to the closest ACI value.
 - Color=RGB only
The RGB values from the file will be preserved. Objects whose color is black (0,0,0) will be assigned the color ByLayer. Objects whose color is white (255,255,255) will be assigned the color ACI White.
 - Color=Equivalent ACI and RGB

For any RGB value that exactly matches an ACI, the objects will be imported using the ACI color value. All other objects will use their RGB values.

- 4 Make sure there is a semicolon at the beginning of the line for the options you do not want to use. The semicolon tells AutoCAD Map 3D to ignore the line.
- 5 Save and close the .ini file.

To specify language encoding settings for GML in Asian languages

- 1 Open the *mapimport.ini* or *mapexport.ini* file using a text editor such as WordPad.
- 2 Find the [GML2] section.
- 3 Delete the semicolon at the beginning of the lines for the language encoding settings you want to use. For example, for *mapimport.ini*, here are the settings you can use for Japanese.

Driver:GML2_FEATURE_ENCODING=Shift-JIS

Driver:GML2_MAPPING_FILE_ENCODING=Shift-JIS

For *mapexport.ini* you can use:

Driver:GML2_FEATURE_ENCODING=Shift-JIS

Driver:GML2_OUTPUT_ENCODING=Shift-JIS

Driver:GML2_MAPPING_FILE_ENCODING=Shift-JIS

Below, is a summary of some of the specific settings you can use.

Language	Possible Settings
Chinese	Big5 GB2312 GB18030 GBK
Japanese	EUC-JP Shift-JIS
Korean	EUC-KR KSC5601

- 4 Save and close the .ini file.

To specify object properties

- 1 Open the *mapforeignfileproperties.ini* file using a text editor such as WordPad.

This file is in the *C:\Documents and Settings\All Users\Application Data\Autodesk\AutoCAD Map 3D 2011\R18.1* folder.

- 2 For information on each of the settings, refer to the instructions in the file.

Quick Reference

MAPEXPORT

Exports drawing objects and their attribute data to an external file format

Menu Click File ► Convert DWG To ► Map 3D Export.

Icon  Export Map File

Command Line MAPEXPORT

Dialog Box Export dialog box

MAPIMPORT

Imports an external file format into AutoCAD Map 3D

Menu Click File ► Create DWG From ► Map 3D Import.

Icon  Import Map File

Command Line MAPIMPORT

Dialog Box Import dialog box

Setting Up and Running Workflows

Use workflows to automate a set of activities.

- [To use workflows](#) (page 276)
- [To run a workflow](#) (page 278)
- [To edit a workflow](#) (page 284)

- [To create a workflow](#) (page 287)
- [To change the display of the Workflow Designer window](#) (page 289)

Overview of Workflows

Use workflows to automate a set of activities, such as the steps involved in an [overlay analysis](#) (page 1309).

A workflow specifies the activities to perform and the parameters for those activities. For example, in an overlay, the workflow specifies the feature classes or layers to compare. You can specify that workflows prompt at run time for the values of the parameters. If you prefer, you can specify the parameters in the workflow itself and turn off the prompts. You can edit an existing workflow or create one.

You can run built-in or custom workflows. The built-in workflows include:

- **Overlay:** Connect to (and create layers for) two data stores. Perform an intersection overlay. Use the result of that overlay operation to erase the portions of the layers that were within the intersection.
- **Connect and Edit:** Connect to SDF, SHP, and WMS data stores and add the connected data to AutoCAD Map 3D. Execute the AutoCAD command Pedit (pausing for user input), and then check in all features.
- **Batch-save .Layer Files:** Connect to each SDF file in a specified directory and add it to AutoCAD Map 3D. Save each resulting Display Manager layer as a *.layer* file.
- **Connect, Analyze, and Print:** Connect to a data store, add its data to AutoCAD Map 3D as a Display Manager layer, and change the symbol for that layer. Select a set of features for buffer analysis, create the buffer, and change the symbol for the resulting buffer layer. Select the features on the buffer layer and display their attributes. Plot the map.
- **Select, Zoom, and Display Features:** Load two *.layer* files. Prompt the person running the workflow to select some features manually. Zoom to the extents of the selected features and highlight them. Display the attributes for the highlighted features. Select a different set of features by location. Zoom to the extents of the selected features and highlight them. Display the attributes for the highlighted features.

NOTE If you do not see the built-in workflows in the drop-down list of workflows, click Open Workflow From File in that list and navigate to the *Program Files\Autodesk\AutoCAD Map 3D 2011\Sample\Workflow* folder. Select the *.xml* file for the workflow to open.

NOTE If you use Windows 7, you must have write access to run a workflow. If you have limited access, AutoCAD Map 3D cannot save the workflow. The workflow must be saved before it is run.

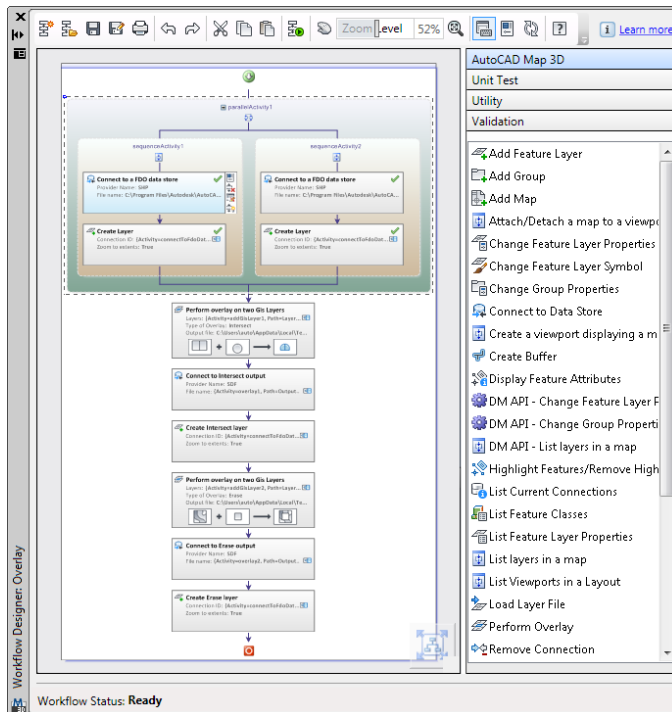

Use the Workflow Designer to create or edit the sequence and parameters for the activities in the workflow.

To use workflows

- To run a workflow (page 278)
- To edit a workflow (page 284)
- To create a workflow (page 287)
- To change the display of the Workflow Designer window (page 289)

Quick Reference

MAPWORKFLOWOPEN

Allows you to use a saved workflow

Menu Click Setup menu ► Workflow Designer.

Icon  Open Workflow

Command Line MAPWORKFLOWOPEN

MAPWORKFLOWRUN

Runs a workflow

Menu In the Classic workspace, click Setup menu ► Workflow Designer.

Icon  Run Workflow

Command Line MAPWORKFLOWRUN

MAPWORKFLOWCREATE

Creates a workflow

Menu Click Setup menu ► Workflow Designer.

Command Line MAPWORKFLOWCREATE

MAPWORKFLOWEDIT

Edits a workflow

Menu Click Setup menu ► Workflow Designer.

Icon  Edit Workflow

Command Line MAPWORKFLOWEDIT

Running Workflows

A workflow automates a set of activities. A workflow can include activities such as the following:

- Connecting to data
- Creating a Display Manager layer for a geospatial data store
- Performing an [overlay analysis](#) (page 1309)
- Chaining to another workflow

You can run any workflow, even if you did not create it. Recently used workflows are listed on the Workflow drop-down list, which also contains an option for opening any saved workflow. If the workflow requires information from you (for example, the location of a file or data store), it prompts you during run-time. For a list of the sample workflows provided with AutoCAD Map 3D, see [Overview of Workflows](#) (page 275).

NOTE If you use Windows 7, you must have write access to run a workflow. If you have limited access, AutoCAD Map 3D cannot save the workflow. The workflow must be saved before it is run.

To run a workflow

- 1 In the Tool-based Ribbon Workspace, on the Tools tab ► Workflow panel, select a workflow from the list.

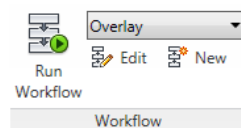

If the workflow you want is not in the list, click Open Workflow From File at the bottom of the list.

- 2 Click  .

NOTE If you use Windows 7, you must have write access to run a workflow. If you have limited access, AutoCAD Map 3D cannot save the workflow. The workflow must be saved before it is run.

- 3 If prompted, specify the values for the parameters of the workflow.
For example, the Overlay workflow requires you to specify the data store to connect to.

Perform overlay on two Gis Layers ?

Data type:

Layers

Feature classes

Source layer:

{Activity=addGisLayer1, Path=LayerName} ▾

Overlay layer:

{Activity=addGisLayer2, Path=LayerName} ▾

Save to:

C:\Users\auto\AppData\Local\Temp\intersect 📁

Overlay type:

Intersect ▾

▼ Show optional parameters

Prompt for parameters at run time

OK Cancel

If the workflow requires parameters for any of its activities, it displays a prompt.

- To connect to database, specify login credentials.
- To connect to a file, select the appropriate provider and click  and navigate to the file.
- To connect to a SHP folder instead of a file, select the SHP provider and click the folder icon to specify the folder.

The workflow performs the activities in its definition and displays the result.

For example, the built-in Overlay workflow connects to the specified data stores, performs the overlay, and displays the resulting layers in your map. The overlay itself is saved to the specified SDF file. AutoCAD Map 3D Connects to that SDF file and adds a Display Manager layer for it. The connections appear in Map Explorer and in the Data Connect window.

NOTE If the workflow fails, an error message displays. Open the Workflow Designer to find the error. The activity that failed displays a red X or an exclamation mark.

- 4 If you changed any parameters in response to a prompt, you can save or discard the changes when the workflow is complete.

Quick Reference

MAPWORKFLOWOPEN

Allows you to use a saved workflow

Menu Click Setup menu ► Workflow Designer.

Icon  Open Workflow

Command Line MAPWORKFLOWOPEN

MAPWORKFLOWRUN

Runs a workflow

Menu In the Classic workspace, click Setup menu ► Workflow Designer.

Icon  Run Workflow

Command Line MAPWORKFLOWRUN

Editing or Creating Workflows

A workflow automates a set of activities. You can change any existing workflow or create one from scratch. For example, change the predefined Overlay workflow to perform a Union, rather than an Intersect. Create a workflow to connect to a set of data stores and add Display Manager layers for them.

Use the Workflow Designer to edit or create workflows.

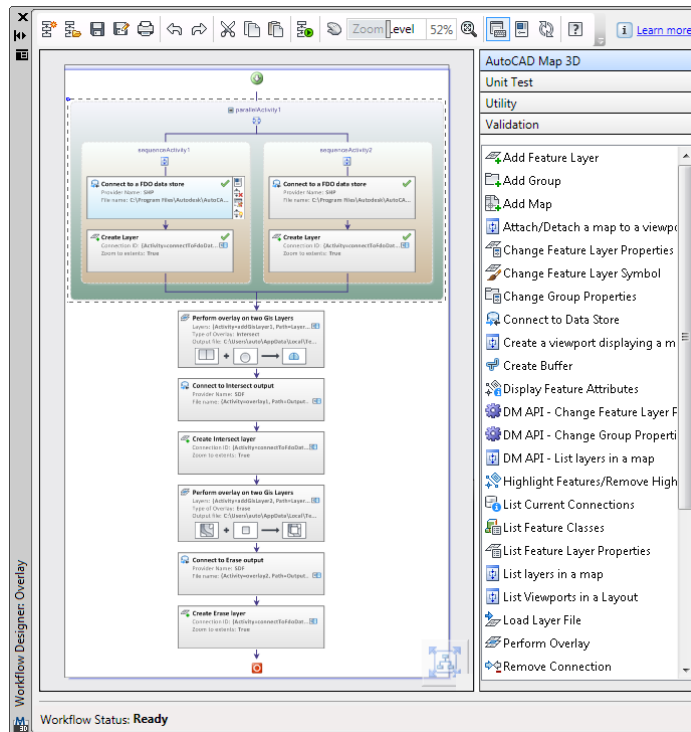

Activities in the workflow appear as a diagram in the Workflow Designer.

Utility and AutoCAD Map 3D Activities

The Activity panel on the right side of the Workflow Designer contains two categories of activities. AutoCAD Map 3D activities are specific to AutoCAD Map 3D (including an activity that runs AutoCAD commands).

Utility activities are generic, and are based on C# syntax. They include the following types of activities:

- Directory commands (such as listing the contents of a folder)

- Logical commands (such as If/Else and For Each)
- Workflow structure commands (such as Parallel, Sequence, and Prompt User).

For information about the available activities, see [Workflow Activity Input dialog boxes](#) (page 2025).

Parallel and Sequence Activities

In a workflow, *parallel* activities are independent of one another. For example, when connecting to two data stores, parallel connections ensure that the second connection executes even if the first one fails.

A *sequence* activity depends on previous activities. For example, within the parallel activity at the top of the overlay workflow are two sets of sequence activities. Each one connects to a particular data store and then creates a layer for that data store. If the connection fails, the layer cannot be created.

Setting Activity Parameters

Each workflow activity has a set of parameters. Optionally, you can set default parameters and specify that the workflow display a prompt at run-time. The person running the workflow can then substitute other values. For example, you can set default data stores for an overlay, but allow others to substitute different data stores when they run the workflow.

Some parameters are required. For example, a Connect To Data Store activity requires the name of the provider and the location of the data store to connect to. Some parameters are optional, for example, the Display Name for the activity. All optional parameters have default values you can change.

NOTE Although Display Name is optional, it is a good idea to name all activities. If activities are not named, you can confuse them when you bind a parameter of one activity to the output of a previous one. See the following section.

Binding Parameters

Often, a sequence activity is *bound* to a preceding activity. When you bind an activity, you set its parameter to be the result of a previous activity. For example, you can use the output of an activity that creates a layer as the source layer for a subsequent overlay operation.

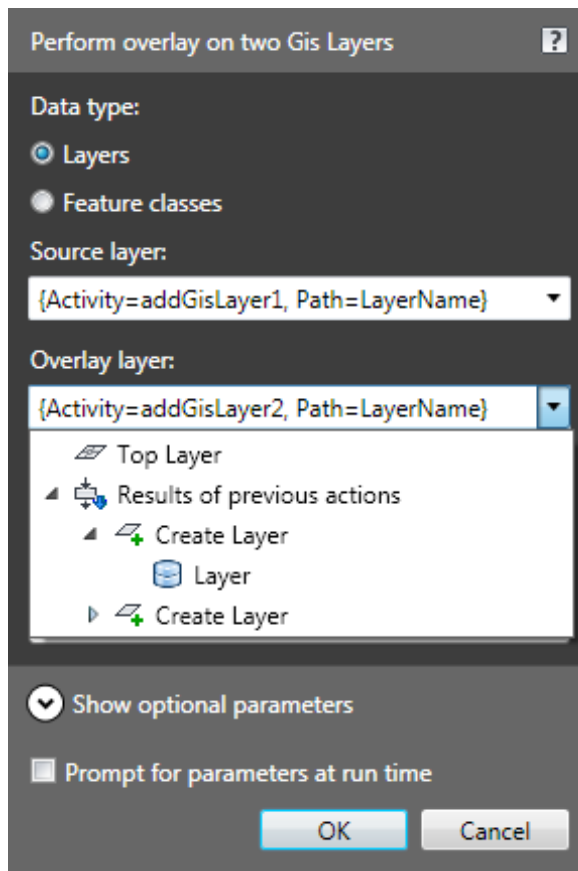

Bind the parameter for an activity to a property from a previous activity.

Adding Activities to Workflows

If you can write simple code in a .NET-compliant language, you can add activities to the Workflow Designer. Workflow activities perform predetermined functions based on predetermined sets of inputs.

Use the sample activity set (*Automation*) as a model. *Automation* contains activities for running AutoCAD Map 3D in an automated fashion, without using the actual application. The files for this sample activity are installed with the ObjectARX SDK.

Build your activities in a .NET class library (a *.dll* file). Place this *.dll* file in the `\Program Files\AutoCAD Map 3D 2011\PlugIns\Workflow\Activities` folder and restart AutoCAD Map 3D. The activities then appear in the Workflow Designer.

For more information on creating custom workflow activities, see the *sdk.doc.main.chm*.

- [To edit a workflow](#) (page 284)
- [To create a workflow](#) (page 287)

To edit a workflow

- 1 In the Tool-based Ribbon Workspace, click Tools tab ► Workflow panel. Select a workflow from the drop-down list.

If the workflow you want is not in the list, click Open Workflow From File at the bottom of the list. After you open a workflow, select it from the list.

NOTE If you use Windows 7, you must have write access to run a workflow. If you have limited access, AutoCAD Map 3D cannot save the workflow. The workflow must be saved before it is run.

- 2 In the Tool-based Ribbon Workspace, click Tools tab ► Workflow panel ► Edit.
- 3 In the [Workflow Designer](#) (page 2022), [pan or zoom](#) (page 289) as needed.
- 4 If necessary, expand the activity to edit.

For example, to change the settings for activities inside the Parallel Activity at the top of the workflow, click its plus sign. The Parallel Activity contains activities for the feature classes that are compared in the Overlay workflow and creates the Display Manager layers for these feature classes.

NOTE To set parameters for some utility activities (For Each, If/Else, and

While), click  in the Workflow Designer toolbar. In the Properties palette that displays, click the cell for the parameter to set. Click the browse button that appears to select parameters from a list, if available.

- 5 To [set the parameters for an activity](#) (page 2025), do any of the following:
 - Double-click the activity box.
 - Click  .

- Right-click the activity and click Set Up Parameters.

For information about the available activities and their parameters, see [Workflow Activity Input dialog boxes](#) (page 2025). For a tutorial on workflows, see Lesson 5: Edit a Predefined Workflow.

- 6 To bind an activity to the output of a previous activity from the input editor, do the following:
 - In the activity input dialog box for the activity, click the down arrow next to the parameter to bind.
 - Under Results Of Previous Actions, click the property to bind to.

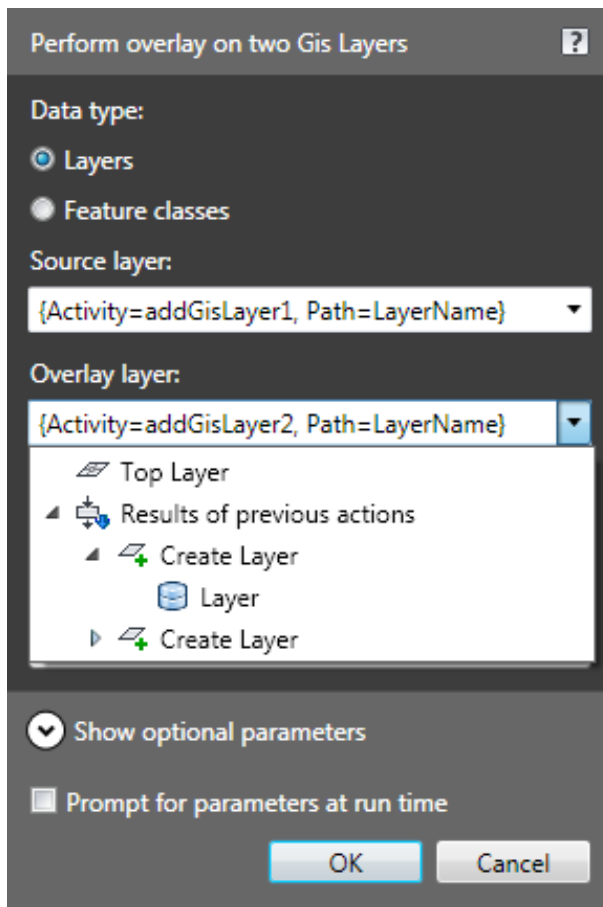

To use a layer created by a previous activity, select it from the list under Results Of Previous Actions.

NOTE There is a shortcut for adding an activity and automatically binding it to the previous activity. Right-click an activity and click the activity to add. For example, right-click an Overlay activity and click Add Feature Layer to create a new Display Manager layer that stores the output of the Overlay operation.

7 Optionally, do any of the following:

- To add another activity, drag it from the Activities panel to the desired position in the workflow diagram, or right-click the activity that precedes the new one.

When you right-click, the list contains activities that would logically follow the current one. When you add an activity in this way, you can automatically bind it to the one you right-clicked. For example, right-click an Overlay activity and click Add Feature Layer to create a new Display Manager layer that stores the output of the Overlay operation.



- To delete an activity, click  on its box.

- To turn the run-time prompt for an activity on or off, click  on its box.

When the run-time prompt is on, anyone running this workflow must provide the input for this activity. For example, the person running the workflow must provide data store connection information for a Connect To Data Store activity.

- To disable or enable the activity, click  on its box.

Disable an activity temporarily to resolve problems with a workflow. If you are not sure which activity is causing the problem, disable them one at a time when you run the workflow. This can isolate the issue.

- Undo or redo any changes during this editing session using  

8 Save any changes to the workflow by clicking  at the top of the Workflow Designer window.

To save your changes as a new workflow, click  instead.

Workflows saved in AutoCAD Map 3D 2011 format cannot be opened in AutoCAD Map 3D 2010. To use your workflow with AutoCAD Map 3D 2010, make sure that the workflow contains only activities that were

supported in that version. Then use Save As and change Save As Type to Map 3D 2010 Workflow File. To maintain the version formatting, you must continue to use the 2010 Save As option each time you save the workflow

- 9 Click  to run the workflow from within the Workflow Designer, which validates the activities.

As each activity executes successfully, a green check mark appears at the top right corner of the activity box. If an exclamation mark appears instead of the check mark, the activity is missing parameter values. Click the exclamation point to see what is missing and correct the problem. If a red X appears instead of the check mark, the activity failed.

Click the status link in the Workflow Status area (at the bottom of the Workflow Designer window) to see the log.

In the log window, find the row for the activity that failed. The description column explains the error.

- 10 Optionally, click  to print the workflow.

To create a workflow

- 1 In the Tool-based Ribbon Workspace, click Tools tab ► Workflow panel ► New.
- 2 To create a workflow that uses multiple data connections, add a Parallel activity.
 - In the [Workflow Designer](#) (page 2022), click the System panel header on the right side of the window.
 - Drag the Parallel activity to the diagram area in the Workflow Designer (where you see Drag And Drop Map Activities Here). Use a separate Sequence activity for each connection. By default, the Parallel activity has two Sequence activities. If you need more, drag them into the Parallel activity.
 - For each connection, drag a Connect To Data Store activity into a Sequence activity.
 - To create a layer for these connections, use an Add Feature Layer activity. Drag this activity just below each Connect To Data Store activity (within the Sequence activity for that connection).

- 3 To create a workflow that uses a single data store, do the following:
 - Drag the Connect To Data Store activity to the diagram area in the Workflow Designer (where you see Drag And Drop Map Activities Here).
 - Optionally, create a layer for the connection by dragging a Create Feature Layer activity just below it.
- 4 Add any other desired activities.

For information about the available activities and their parameters, see [Workflow Activity Input dialog boxes](#) (page 2025). For a tutorial on workflows, see Lesson 5: Edit a Predefined Workflow.

NOTE To set parameters for some utility activities (For Each, If/Else, and

While), click  in the Workflow Designer toolbar. In the Properties palette that displays, click the cell for the parameter to set. Click the browse button that appears to select parameters from a list, if available.

- 5 Save the workflow by clicking  at the top of the Workflow Designer window.

Workflows saved in AutoCAD Map 3D 2011 format cannot be opened in AutoCAD Map 3D 2010. To use your workflow with AutoCAD Map 3D 2010, make sure that the workflow contains only activities that were supported in that version. Then use Save As and change Save As Type to Map 3D 2010 Workflow File. To maintain the version formatting, you must continue to use the 2010 Save As option each time you save the workflow

- 6 Click  to run the workflow from within the Workflow Designer, which validates the activities.

As each activity executes successfully, a green check mark appears at the top right corner of the activity box. If an exclamation mark appears instead of the check mark, the activity is missing a parameter. If a red X appears, the activity failed. Click the link in the Workflow Status area (at the bottom of the Workflow Designer window) to see the log.

- 7 Optionally, click  to print the workflow.

Quick Reference

MAPWORKFLOWCREATE

Creates a workflow

Menu Click Setup menu ► Workflow Designer.

Command Line MAPWORKFLOWCREATE

MAPWORKFLOWEDIT

Edits a workflow

Menu Click Setup menu ► Workflow Designer.

Icon



Edit Workflow

Command Line MAPWORKFLOWEDIT

Changing the Workflow Designer Display

As you work in the Workflow Designer, you can do the following:

- Adjust the magnification and focus of the design area
- Refresh the display
- Hide or show the Settings and Activities panels



The Settings panel displays the parameters for the selected activity in an editable table. The Activities panel displays the list of activities you can add to a workflow.

To change the display of the Workflow Designer window

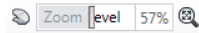
- To pan or zoom, use these techniques:
 - To move to a different part of the workflow, use the scroll bars or click Pan.
 - To zoom in or out, adjust the magnification slider.
 - To zoom to the extents of the workflow, click Show The Entire Workflow.



Pan, zoom, or show the entire workflow.

- To show or hide the activities panel, click .
- To show or hide the Settings panel for the selected activity, click . In the Settings panel, you can view and edit values for the parameters of the current activity. Click the cell for the parameter to set. Click the browse button that appears to select parameters from a list, if available.

NOTE To set parameters for some utility activities (For Each, If/Else, and While), you must use the Properties palette (instead of the input editor).

- To refresh the display, click .

Bringing In Data

3

Overview of Bringing In Data

A map file in AutoCAD Map 3D is a specialized drawing (DWG) file in which you can combine data from many sources. A map file holds all the information required to create, edit, view, and publish your map, including the following:



- AutoCAD drawing objects and information about attached drawing files
- Attribute or point data stored in a spreadsheet or database that can be linked to drawing objects
- Information required to connect to databases like Oracle and ArcSDE
- Information required to connect to geospatial features stored in a relational database, such as Microsoft® SQL Server, SQL Server Spatial, Oracle® Spatial, PostgreSQL/PostGIS, and MySQL
- Information required to connect to geospatial features stored in a geospatial data file format, such as an ESRI® SHP, Microsoft® SQLite, or Autodesk® SDF file
- Information required to connect to geospatial features stored in middleware, such as ESRI® ArcSDE®
- Information required to connect to web-based resources such as WFS (Web Feature Service) sites and WMS (Web Map Service) sites
- Information needed to connect to raster images, including [DEM](#) (page 2059) surfaces that show elevation
- Metadata
- Styling information

- Map layouts
- Data from third-party providers, leveraging the power of Open Source

AutoCAD Map 3D is your window onto all this data. You have two ways to access data: you can connect to drawing files, geospatial files, or other data sources and view and edit entities in their original sources, saving your changes in the native format; or you can convert the data to DWG format, breaking any connection to the original source.

To do this...	Use this method...	To get this result...
Edit features from the following sources in their native format: <ul style="list-style-type: none"> ■ ArcSDE (page 316) ■ Autodesk SDF (page 337) ■ ESRI SHP (page 335) ■ MySQL (page 332) ■ ODBC (page 342) ■ Oracle (page 312) ■ PostgreSQL/Post-GIS (page 340) ■ SQL Server (page 323) ■ SQL Server Spatial (page 323) ■ SQLite (page 323) ■ WFS (page 346) 	<ol style="list-style-type: none"> 1 In Display Manager, click Data ► Connect To Data. 2 Select the data source and feature classes. 	All features in the selected feature class appear in the map. Any edits you make are saved back to the original source.
Use formats that are not listed in the Data Connect window (page 540)	<ul style="list-style-type: none"> ■ To connect to the data, use an open-source or third-party provider (page 540). ■ To use a copy of the data (page 378), Click Insert 	If you use a provider to connect to the data, you can edit it directly in its native format. If you convert and import it, you edit a copy of the data in DWG format.

To do this...	Use this method...	To get this result...
	tab ► Import pan- el ► Map Import . 	
Join attribute data to features from Oracle, SDF, etc. (page 507)	<ol style="list-style-type: none"> 1 Connect to the source of attribute data (for example, connect to an ODBC source such as a Microsoft Access table) from the Task Pane. Click Data ► Connect To Data. 2 Right-click a layer and click Create A Join. 3 Specify the connected attribute data source. 	Both the original data for the feature layer and the joined data appear in the Data Table.
Add DWG objects from the current drawing (page 350)	<ol style="list-style-type: none"> 1 In Display Manager, click Data ► Add Drawing Data ► Query Current Drawing. 2 Define a query to retrieve objects. 	Only the objects that match your query are added to the map.
Add drawing objects from other drawings	<ol style="list-style-type: none"> 1 Attach the drawings to the current drawing. (page 154). 2 In Display Manager, click Data ► Add Drawing Data ► Query Source Drawing. 3 Define a query to retrieve objects. See Bringing In Drawing Data From DWG Files (page 350). 	Only the objects that match your query are added to the map. When you edit the objects, you can choose to update the original drawings or not.

To do this...	Use this method...	To get this result...
Convert geospatial data to drawing data (page 378)	<ul style="list-style-type: none"> ■ Click Insert tab ► Import panel ► Map Import . 	<p>A copy of the data is added to the map in DWG format. The connection to the original source is broken, and changes are not saved back to that source.</p>
Convert SDF files to drawing data (page 387)	<ul style="list-style-type: none"> ■ Click Insert tab ► Import panel ► Map Import .  <p>Use this method for the current version of SDF. See Overview of Converting Geospatial Data to Drawing Objects (page 378).</p> <ul style="list-style-type: none"> ■ In the Tool-based Ribbon Workspace, click Insert tab ► Import panel ► SDF2. Use this method for the version supported by MapGuide 6.5 and earlier. See Importing Autodesk SDF 2 (page 389). 	<p>A copy of the data is added to the map in DWG format. The connection to the original source is broken, and changes are not saved back to that source.</p>
Add attribute data to use with drawing objects	<ol style="list-style-type: none"> 1 Add the data source to the map. See Setting Up Data Sources for Drawings (page 204). 2 Define a link template for the data. See Creating a Link Template (page 525). 3 Link records to drawing objects. See Manually Linking Database Records to Objects (page 528). 	<p>You can view or edit the data by double-clicking the table name in Map Explorer.</p>

To do this...	Use this method...	To get this result...
Add raster images (page 437) in the following formats: DEM, ESRI Grid, DTED, JPEG and JPEG2K , PNG, MrSID, TIFF, ECW	<ol style="list-style-type: none"> 1 In Display Manager, click Data ► Connect To Data. 2 Specify the folder that contains the raster and select the raster. 	The image appears in your map, where you can style it or move it behind other features.
Add raster images in other formats (page 454)	<ol style="list-style-type: none"> 1 Click Home tab ► Data panel ► Insert An Image.  2 Select the image and specify the image placement and settings. <p>For ECW and MrSID formats, you must download the free raster object enabler available from autodesk.com</p>	The image appears in your map, where you can clip it (page 504) or change its transparency (page 499), brightness and other settings (page 489).
Connect to data from Civil 3D (page 543)	<ol style="list-style-type: none"> 1 From Civil 3D, export feature data (such as parcels and alignments) in SDF format and save surfaces in DEM format. 2 Connect to the resulting files in AutoCAD Map 3D. 	The data appears in your map like any other SDF or DEM data.
Add survey data (page 370)	<ul style="list-style-type: none"> ■ Add LandXML files (page 371). ■ Add ASCII point data (page 373). 	The survey points appear in your map and are stored in a new survey data store.

See also:

- [Creating a Map](#) (page 296)

Before You Bring In Data

Creating a Map

When you create a new map file, you do the following:

- **Choose a template.**

The *map2d.dwt* template contains the optimal display settings, tools, and views for 2D maps, while the *map3d.dwt* template is optimized for 3D maps. You can also create your own templates. For information on this, see the AutoCAD Help topic called “Use a Template File to Start a Drawing.”

- **Assign a coordinate system.**

Data you add to your map file is transformed to use the coordinate system assigned to your map. When you save it back to its source, it is transformed back to its original coordinate system.

- **Add data.**

You can combine data from many sources.

- **Geospatial data**

For many geospatial formats, such as Oracle and ArcSDE, you can connect to the source to add data using [FDO](#) (page 2062) Data Access Technology. You access data live, in its native format. You can extend your data access capabilities by adding an open source or third-party [FDO provider](#) (page 2063).

You can also convert data from most of these formats to DWG format. To do this, you import the data (rather than connect to it). However, this method adds only a snapshot of the data and your changes do not update the data at its source.

For other formats, such as MicroStation Design (DGN) and Arc/INFO, you must import the data.

- **Drawing (DWG) data**

You can attach AutoCAD drawing files to your map and query in objects from those drawings, or import data from non-drawing sources to add it as drawing data.

NOTE When you import data, you make a copy of the data and bring that copy into your map as drawing objects. When you edit the data, you are editing the copy. The original data is unchanged.

- **Raster data**

Connect to raster images and surfaces, or use the Raster Extension feature.

■ **Attribute data**

Join additional attributes to GIS features, or add attributes to drawing objects using database linking or object data.

■ **Data from AutoCAD Civil 3D**

Export Civil 3D feature data, such as parcels and alignments, in SDF format. Connect to the resulting SDF file in AutoCAD Map 3D. You can also save surfaces as DEMs in Civil 3D and connect to the resulting DEM files in AutoCAD Map 3D. You can also bring in LandXML files using the Survey feature.

■ **Survey Data**

Create a new survey data store and then bring in LandXML or ASCII point data.

■ **Create Display Manager layers.**

Geospatial data that you add to your map is automatically organized into display layers by feature class. You can also add drawing data to layers. Layers give you control over draw order (Z-order), styling, and more.

See also:

- [Assigning a Coordinate System to the Current Drawing](#) (page 147)
- [Bringing in GIS Features](#) (page 303)
- [Overview of Bringing in Drawing Data From DWG Files](#) (page 351)
- [Converting Data From Other Formats to Drawing Objects](#) (page 377)
- [Joining Data to GIS Features](#) (page 507)
- [Adding Attributes to Drawing Objects](#) (page 521)
- [Adding Rasters and Surfaces](#) (page 437)
- [Using Open Source FDO Providers](#) (page 540)
- [Bringing In AutoCAD Civil 3D Data](#) (page 543)
- [Bringing in Survey Data](#) (page 370)
- [Organizing Layers in Your Map](#) (page 300)
- [Overview of Visualization and Styling](#) (page 631)

- [Overview of Creating Themes](#) (page 1163)
- [Overview of Creating New Features](#) (page 686)
- [Getting Help with AutoCAD](#) (page 58)

To create a map

- 1 Start a new drawing, choosing either the *map2d.dwt* or *map3d.dwt* template, or a custom map template you created.
- 2 [Assign a coordinate system to the map.](#) (page 147)

NOTE If you do not assign a coordinate system to the map, data that you bring into the map will appear using its native coordinate system. If you bring in data from more than one coordinate system, entities may not align correctly in the map.

- 3 Add [features](#) (page 308) and [drawing objects](#) (page 354) to the map.

To add geospatial data to a map

- Drag and drop file-based sources into your map.
- Use Data Connect to connect to any non-DWG data source and add the feature classes you want.
- Use data-based queries to add a subset of data from the data source to your map.

To add AutoCAD drawing data to a map

- Use data-based queries to add objects from a drawing (find all objects on a particular layer, all objects of a certain size, all objects with certain properties).
 - Define areas to add (draw a selection window).
 - Add specific drawing layers.
- 4 Optionally, add attribute data to [features](#) (page 507) and [drawing objects](#) (page 521).
 - 5 Optionally, [To add a raster-based surface to your map](#) (page 442).

- 6 Optionally, [add open-source or third-party providers](#) (page 540) to access additional data formats, [add data from AutoCAD Civil 3D](#) (page 543), or [add survey data](#) (page 370).
- 7 [Organize the layers](#) (page 300) that comprise your map.
- 8 Change the appearance of the map using [styles](#) (page 631) and [themes](#) (page 1163).

NOTE You can create multiple display maps from the same data. See [Creating Multiple Display Maps](#) (page 638).

- 9 Optionally, [create new features](#) (page 688) or drawing objects. You can use many [AutoCAD commands](#) (page 58).

Quick Reference

ADESETCRDSYS

Assigns a global coordinate system code for the current drawing or attached drawings

Menu	Setup menu ► Assign Global Coordinate System
Icon	 Assign Coordinate System
Command Line	ADESETCRDSYS
Task Pane	In Map Explorer, right-click Current Drawing ► Coordinate System
Dialog Box	Assign Global Coordinate System dialog box

ADEATTACHDATA

Attaches object data to objects

Menu	Create menu ► Attach/Detach Object Data
Icon	 Attach/Detach Object Data
Command Line	ADEATTACHDATA
Dialog Box	Attach/Detach Object Data dialog box

Connect Feature Source

Connects a feature source

Menu Click File ► Connect To Data.

Icon  Connect

Command Line MAPCONNECT

Task Pane In Display Manager click Data ► Connect to Data.

Organizing Layers in Your Map

Display Manager organizes the data in your map into layers, which you can display and style independently. Each layer contains one type of data. For example, you might have a layer of drawing objects, a layer that represents a feature class from Oracle, a DEM surface layer, and a raster image layer. When you use [FDO](#) (page 2062) to connect to a data source (via Data Connect), each feature class or image in that data source becomes a separate layer automatically. You can create drawing layers for drawing objects, and these objects can be members of multiple layers.

NOTE Display Manager layers are different from the classic “AutoCAD layers” you see in the Layer Properties Manager. AutoCAD users cannot see Display Manager layers unless they use AutoCAD Map 3D. You use different techniques to style the two different layer types.

View the layers in Display Manager in two ways:

- **Groups** organizes the list of layers. For example, you can create a group for as-built data and a separate group for proposed changes.
- **Draw Order** determines the draw order of the layers. Items at the top of the draw order are drawn on top of items below them on the list.

If an object is a member of more than one layer, it inherits the style of each layer of which it is a member. For example, if a line is in both the Transportation layer and the Roads layer, it inherits the styles of both layers. If the layers specify conflicting style or visibility settings, the object uses the style and visibility settings of whichever layer is higher in the Display Manager list.

You can specify a thumbnail icon for drawing layers, which is used in Display Manager and in any legends you create for this map. This affects drawing layers only, and is not available for feature layers.

See also:

- [Overview of the Display Manager](#) (page 634)
- [Controlling Display Order](#) (page 636)
- [Bringing in GIS Features](#) (page 303)
- [Bringing In Drawing Data From DWG Files](#) (page 350)
- [Adding Rasters and Surfaces](#) (page 437)
- [Converting Data From Other Formats to Drawing Objects](#) (page 377)

- [To add a feature layer using FDO \(Oracle, ArcSDE, SDE, SHP, WFS\)](#) (page 301)
- [To add a drawing layer](#) (page 301)
- [To add a raster-based surface to your map](#) (page 442)
- [To create a group](#) (page 301)
- [To change the draw order](#) (page 302)
- [To change the thumbnail style for a drawing layer](#) (page 302)

To add a feature layer using FDO (Oracle, ArcSDE, SDE, SHP, WFS)

- [Connect to the FDO source.](#) (page 303)

To add a drawing layer

- [Attach a drawing and query in objects](#) (page 350)

To add a raster or surface layer

- [Connect to the raster or surface file or folder.](#) (page 437)

To create a group

- 1 In [Display Manager](#) (page 2060), click Groups.

- 2 In [Display Manager](#) (page 2060), click Data ► New Group.
- 3 To change the group name, select the group then click the existing name. Type a new name and press Enter.
- 4 Drag layers into the group.

NOTE Until you use the Draw Order view to specify a draw order, AutoCAD Map 3D uses the Groups order as a default draw order for the map. Once you use the Draw Order view, changes in the Groups view do not affect the draw order.

To change the draw order

- 1 In [Display Manager](#) (page 2060), click Draw Order if needed.

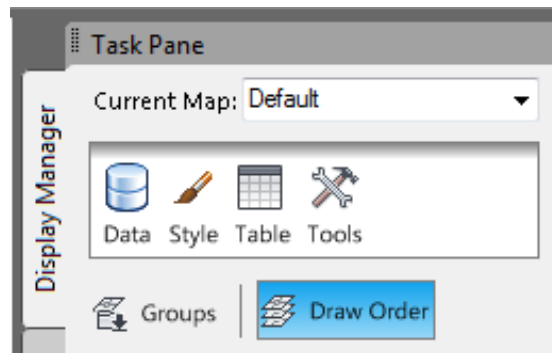

- 2 Drag layers up or down to change their display order.

Items at the top of the draw order are drawn on top of items below them on the list.

To change the thumbnail style for a drawing layer

- 1 Select the layer.
- 2 In [Display Manager](#) (page 2060), click the Style button.
- 3 On the Display tab of the Properties palette, next to Thumbnail Preview, select the style of thumbnail to use.
For example, select the polyline icon to display an icon of a wavy line, or choose the polygon icon to display hatch or fill.

This setting affects both the Display Manager layer and the legend for this map.

Quick Reference

Change the display order of Display Manager layers

Control which layers appear on top (or behind) other layers

Task Pane In Display Manager, drag an item up or down in the list

New Display Manager Group

Creates a new Display Manager group

Task Pane In Display Manager, click Data ► New Group

Sort Layers in Display Manager

Sorts the map layers alphabetically

Task Pane In Display Manager, click the thin down arrow next to the Map list and choose Sort Contents

Bringing in GIS Features

NOTE This topic applies to geospatial data. To bring in drawing (DWG) objects, see [Overview of Bringing in Drawing Data From DWG Files](#) (page 351).

When you access data through [FDO](#) (page 2062), you use an [FDO provider](#) (page 2063) to connect directly to a data source, such as SDF, SHP, Oracle, SQL Server, or ArcSDE, and work in its native format.

For FDO data sources with geometry, you select the feature classes to include in your map.

A feature is the spatial description of a real-world entity, such as a road, a utility pole, or a river. Features are organized into collections, called feature classes, and are stored in a spatial database or file. The spatial database or file is sometimes referred to as a [feature source](#) (page 2063).

See also:

- [Filtering Features When You Add Them to a Map](#) (page 309)
- [Overview of Geospatial Data](#) (page 551)
- [Working with FDO Schemas](#) (page 553)

- [To access data through FDO](#) (page 308)
- [To filter feature data when you add it to a map](#) (page 310)
- [To change the coordinate system assigned to the data you are adding to a map](#) (page 311)
- [To bring in features from Oracle](#) (page 314)
- [To use AutoCAD Map 3D 2011 to access FDO data stores that were created in AutoCAD Map 3D 2007 and earlier](#) (page 315)
- [To set up your system for ArcSDE 9.2 \(or if you use the 9.1 client and you access the ArcSDE 9.2 server\)](#) (page 318)
- [To set up your system for ArcSDE 9.1 \(or if you use the 9.2 client and you access the ArcSDE 9.1 server\)](#) (page 318)
- [To bring in features from ESRI ArcSDE](#) (page 319)
- [To set up a direct connection to the underlying database](#) (page 320)
- [For an Oracle database:](#) (page 320)
- [For a SQL Server database:](#) (page 321)
- [For an Oracle database, copy the following DLL files:](#) (page 321)
- [For a SQL Server database, copy the following DLL files:](#) (page 321)
- [For an Oracle database, set the following parameters:](#) (page 322)
- [For a SQL Server database, set the following parameters:](#) (page 322)
- [To bring in features from SQL Server](#) (page 324)
- [To use AutoCAD Map 3D 2011 to access FDO data stores that were created in AutoCAD Map 3D 2007 and earlier](#) (page 325)
- [To bring in features from SQL Server Spatial](#) (page 328)
- [To bring in features from SQLite](#) (page 331)
- [To bring in features from MySQL](#) (page 333)
- [To use AutoCAD Map 3D 2011 to access FDO data stores that were created in AutoCAD Map 3D 2007 and earlier](#) (page 334)
- [To bring in features from SHP](#) (page 336)
- [To bring in features from SDF](#) (page 338)
- [To bring in features from PostgreSQL/PostGIS](#) (page 341)
- [To access ODBC data](#) (page 344)
- [To create a DSN in Windows XP](#) (page 345)
- [To define the table ranges required to access Excel data](#) (page 346)
- [To bring in features from WFS](#) (page 348)
- [To reconnect to feature data without losing styling information](#) (page 350)

Overview of Bringing In GIS Features

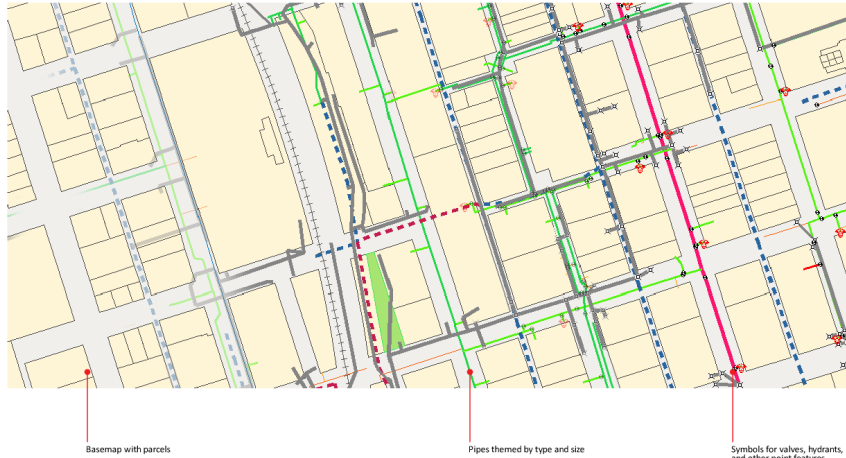

This map of a water distribution system is made up of features stored in a set of SDF files.

NOTE This topic applies to geospatial data. To bring in drawing (DWG) objects, see [Overview of Bringing in Drawing Data From DWG Files](#) (page 351).

A feature is the spatial description of a real-world entity such as a road, a utility pole, or a river. Features are stored in a spatial database or file. The spatial database or file is referred to as a [feature source](#) (page 2063).

The feature source could be a database (such as Oracle, ArcSDE, SQL Server, or MySQL), a file-based feature source (such as SDF or SHP), a web server (such as WFS), or a table of feature geometry data (such as Microsoft Access).

Once you connect to a feature source, you select the types of features to include in your map. Each type of feature is called a [feature class](#) (page 2063). AutoCAD Map 3D displays all the features from the selected features classes in your map, and each feature class becomes a layer in Display Manager. For example, a feature class called Roads contains individual streets and appears on a layer called Roads in Display Manager. You can apply a single style to this layer, and all the streets in the layer will use that style.

A [schema](#) (page 2073) is the definition of multiple feature classes and the relationships between them. It determines the criteria an individual feature must meet in order to be a member of a particular feature class. For some feature sources, you can add and edit a schema and its feature classes and

properties. For more information about editing schemas, see [Working with Schemas](#) (page 593).

NOTE WMS and Raster are used to access images, not features. You cannot edit or lock these images, and they do not use schemas.

Tell me more



Video

- *Show me how to bring in data from a web server using WMS.*
- *Show me how to bring in point data from an ODBC database.*
- *Show me how to bring in a subset of features using a query.*



Procedure

- [To access data through FDO](#) (page 308)
- [To filter feature data when you add it to a map](#) (page 310)



Tutorial

- Exercise 2: Use Data Connect to add data to your map



Workflow

- Create a Feature Map



GIS Skills

- *Access data published on a public web server*
- *Bring in point data from a Microsoft Access database*
- *Bring in a subset of features using a query*



Related topics

- [About Geospatial Feature Classes, Data Stores, and Schemas](#) (page 551)
 - [Overview of Geospatial Data](#) (page 551)
 - [Working with FDO Schemas](#) (page 553)
-

FDO Provider Capabilities

You use [FDO](#) (page 2062) to connect directly to a data source and work in its native format. Each data source type uses its own [FDO provider](#) (page 2063), and each provider has different capabilities.

For example, Oracle and ArcSDE support locking on the feature level. When you check out a feature, other users cannot edit it, even though they can view your edits and edit other features in the feature source. Oracle and ArcSDE also support persistent locking, so the object stays locked until you check it back in.

SHP feature sources, on the other hand, support locking on the file level. When you check out a feature, its entire SHP file is locked. Other users cannot edit features from that file until you close the map, which releases your lock (even if you still have features checked out at the time). Be careful to check in your changes before you close the map.

[Versioning](#) (page 2078) allows multiple copies of a spatial dataset to be stored and tracked by date of creation, date of change, and so on. Not every FDO provider supports versioning.

The following table lists the level of locking, versioning, and schema editing supported by each feature source type.

Feature Source Type	Lock Level	Versions	Persistent Locking	Edit Schema
ArcSDE (page 316)	None	No	No	Yes
MySQL (page 332)	None	No	No	Yes
ODBC (page 342)	File	No	No	No
Oracle (page 312)	Feature	Yes	Yes	Yes
PostgreSQL/Post-GIS (page 340)	Feature	Yes	Yes	Yes
SDF (page 337)	None	No	No	Yes
SHP (page 335)	File	No	No	Yes

Feature Source Type	Lock Level	Versions	Persistent Locking	Edit Schema
SQL Server (page 323) SQL Server Spatial (page 326)	None	No	No	Yes
SQLite (page 330)	File	No	No	Yes
WFS (page 346)	N/A	N/A	No	No
WMS (page 445)	N/A	N/A	N/A	N/A
Raster (page 437)	N/A	N/A	N/A	N/A

To access data through FDO

NOTE This topic applies to geospatial data. To bring in drawing (DWG) objects, see [the procedures for bringing in drawing objects](#). (page 354).

- 1 Make sure that your feature source is set up correctly. If you have questions, refer to the *Readme* file.
- 2 Find out your user name and password, if required.
Your CAD Manager or Database Administrator can help you with this.
- 3 Open or [create](#) (page 296) the map that will include the data from this feature source.
- 4 If you are working with data from various coordinate systems, assign a coordinate system to the current map. See [Assigning a Coordinate System to the Current Drawing](#) (page 147).
AutoCAD Map 3D converts all the data you bring into this map to the assigned coordinate system. If you edit the data and save it back to its source, AutoCAD Map 3D converts it back to the original coordinate system.
- 5 In [Display Manager](#) (page 2060), click Data ► Connect To Data.
- 6 In the left pane of the Data Connect window, select the feature source.
- 7 In the right pane, enter a name for this connection and specify the information required to connect to the feature source. Click Connect.

8 In the Add Data To Map section, under Schema, select the feature classes to include in your map.

If this feature source contains only a single feature class, that feature class is selected automatically. If it contains multiple feature classes, you can right-click any of them and select Select All or Select None.

9 If necessary, click Edit Coordinate Systems to [specify the coordinate system for the incoming data](#) (page 311).

10 Click Add To Map.

To bring in a subset of the data, click the down arrow and select Add To Map With Query. See [Filtering Features When You Add Them to a Map](#) (page 309). To filter data after you have added the data to your map, see [Filtering Feature Layers](#) (page 1216).

Features from the selected feature classes appear in your map. You can style, theme, and edit the features.

If you need additional properties related to this data, you can connect additional data to a feature source layer using a [join](#) (page 507).

Quick Reference

Connect Feature Source

Connects a feature source

Menu

Click File ► Connect To Data.

Icon



Command Line

MAPCONNECT

Task Pane

In Display Manager click Data ► Connect to Data.

Filtering Features When You Add Them to a Map

NOTE This topic applies to geospatial data. To filter drawing (DWG) objects, see [Overview of Bringing in Drawing Data From DWG Files](#) (page 351).

When you connect to a geospatial data store, you can choose Add To Map With Query to filter the data you bring into your map.

You can filter a single layer or multiple layers at one time. You can filter the data by its location in the map or by property conditions that you define. For example, you can add only streets that cross a circle you draw on the map, or only parcels on a particular street.

See also:

- [Filtering Feature Layers](#) (page 1216)
- [Creating Expressions - Reference](#)

To filter feature data when you add it to a map

NOTE This topic applies to geospatial data. To bring in drawing (DWG) objects, see [the procedures for bringing in drawing objects](#). (page 354).

- 1 [Connect to the data source](#) (page 308) in the Data Connect window.
- 2 Under Add Data To Map, check the layers to add.
If this feature source contains only a single feature class, that feature class is selected automatically. If it contains multiple feature classes, you can right-click any of them and select Select All or Select None.
- 3 Click the Add To Map down arrow and select Add To Map With Query to create your expression.
In the [View/Create Query Statement dialog box](#) (page 1610), the list of layers at the top of the window shows any existing filters for the selected layers. If the layers use a common query (specifying a property that all the layers have in common), that query is listed separately. Any query you create applies to all selected layers.
- 4 Create the expression for your query.
For help with any expression element, see [Creating Expressions - Reference](#).
 - To filter the layer based on one of its properties (for example, to add only the parcels whose Address property specifies a particular street), create a query that evaluates a property.
If multiple layers are selected, only the properties they have in common are available.
 - To filter the layer based on location (for example, to bring in only roads within a circle you define by drawing it on the map), create a location-based query.

Quick Reference

Connect Feature Source

Connects a feature source

Menu Click File ► Connect To Data.

Icon  Connect

Command Line MAPCONNECT

Task Pane In Display Manager click Data ► Connect to Data.

Changing Coordinate Systems

If necessary, you can change the coordinate system of data you add to your map.

You must specify the original coordinate system for the data. Do not specify the coordinate system for the current map—AutoCAD Map 3D transforms the data to the target coordinate system when it adds it to your map. Hold your cursor over the entry in the Data Connect window to see its coordinate system and spatial context information.

To change the coordinate system assigned to the data you are adding to a map

- 1 In [Display Manager](#) (page 2060), click Data ► Connect To Data.
- 2 In the Data Connect window, select the appropriate data provider in the Data Connections By Provider list.
- 3 Navigate to the data store and select it.
- 4 Click Connect.
- 5 Hold your cursor over the name of the data store to see a pop-up window that displays its coordinate system, for example, UTM27-10.
When you add data to your map, you must specify its original coordinate system. AutoCAD Map 3D automatically converts the data from that coordinate system to the one specified for your map.
- 6 Click Edit Coordinate Systems and, in the [Edit Spatial Contexts](#) (page 1605) dialog box, click the entry.

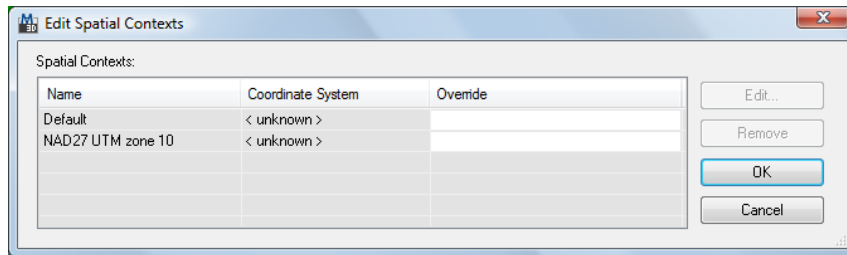

Select the entry and click Edit to specify the coordinate system for the surface

NOTE To copy the spatial context information to the clipboard (for example, to check against your records or for use with a Technical Support specialist), right-click the entry and click Copy Coordinate System.

- 7 Click Edit.
- 8 In the [Select Coordinate System dialog box](#) (page 1609), select the coordinate system you saw in the pop-up window.
Select the appropriate category from the pulldown list, and then scroll through the entries until you find the one you want.
- 9 Click OK twice to return to the Data Connect window.

Bringing In Features from Oracle

You can bring features from an Oracle data source into your map, creating a [feature layer](#) (page 2063) in Display Manager. When you do this, you can:

- Select the feature classes to include in your map.
- Set conditions to limit the features in your map.
- View and edit the features
- Style, theme, and edit the features.
- Lock individual features when you check them out for editing.
- Keep features checked out and locked even when you close your drawing. Features are not checked back in and unlocked until you specify.
- Automatically update the data source with any edits you make. Your edits are immediately visible to anyone else using the data source.

- Create versions of your data. [Versioning](#) (page 2078) creates a copy of the data in the data source. Your changes are made to the new version of the data. Versioning is useful for proposed changes or changes that need approval. When the changes are final, you can make your version the current one.
- Use a data source set up for AutoCAD Map 3D. If your data source schema is not set up to work with AutoCAD Map 3D, AutoCAD Map 3D creates a custom mapping so you can use the data in your map.
- View and edit the schema definition.
- Create an Oracle data source.
- Move SHP data into Oracle to take advantage of better data sharing.
- Bring in a static copy of Oracle data as drawing objects.
- Customize the Oracle [FDO provider](#) (page 2063).

NOTE Functionality for OSE (the Oracle Spatial OO40, which is similar to OLE DB) is not available in a 64-bit environment. The Oracle library that OSE is built on (Oracle Object for OLE) is 32-bit only. There is no 64-bit version.

In the 2008 release of AutoCAD Map 3D, a new column called **geometrytype** was added to the table named **F_AttributeDefinition**. To use AutoCAD Map 3D 2011 to access FDO data stores that were created in AutoCAD Map 3D 2007 and earlier, you must first connect to the data store containing this table and run a SQL script. Instructions for this are on the Procedure tab of this topic. To do this, you must have the privileges required to execute the ALTER TABLE request. In the command line, enter the following:

```
sqlplus <datastorename>/<yourpassword>@<tnsServiceName>  
@<MapInstallDir>/Fdo/bin/com/AlterSchemaOracle.sql; exit;
```

NOTE For information on customizing this provider, refer to the *FDO API Reference* and the *FDO Provider for Oracle API Reference*. The API has custom commands for gathering information about a provider, transmitting client services exceptions, getting lists of accessible data stores, creating connection objects, and creating and dropping spatial indexes.

See also:

- [Working with Oracle Data](#) (page 554)

- [Creating a Data Store](#) (page 586)
- [Migrating Data](#) (page 615)
- [Importing From Oracle](#) (page 409)
- [Styling Features](#) (page 639)
- [To create a map with styled feature layers](#) (page 641)
- [To edit a feature using feature editing commands](#) (page 705)

To bring in features from Oracle

- 1 Make sure that your feature source is set up correctly.
- 2 In [Display Manager](#) (page 2060), click Data ► Connect To Data.
- 3 In the Data Connect window, select Add Oracle Connection in the Data Connections By Provider list.
- 4 In the [Feature Source Connection dialog box](#) (page 1607), under Connection Name, type a name for this connection.
You can give the connection any name you like. This name appears in Map Explorer as the name of the feature source.
- 5 Under Service Name, enter the service name for the Oracle data store. If you do not know this name, check with your System Administrator.
- 6 Click Login.
- 7 In the [User Credentials dialog box](#) (page 1610), enter your Oracle user name and password. If your organization uses Windows authentication to log in to Oracle, select Use Windows Authentication.
Optionally, select Remember Password if you want AutoCAD Map 3D to log you in whenever you open this drawing.
- 8 Under Data Store, enter the data store name. If you do not know this name, check with your System Administrator.
To select from a list of data stores, click the down arrow.

NOTE If the data store is not in the list, it may not use a AutoCAD Map 3D schema. Select Show All Data Stores to add these to the list. AutoCAD Map 3D creates a mapping to use these data stores with AutoCAD Map 3D.

- 9 Optionally, select a version of the data store.

- 10 Click Connect.
- 11 In the feature class list, select the feature classes to include in the map.
If this feature source contains only a single feature class, that feature class is selected automatically. If it contains multiple feature classes, you can right-click any of them and select Select All or Select None.
- 12 Click Add To Map.
To bring in a subset of the data, click the down arrow and select [Add To Map With Query](#) (page 309). To filter data after you've added the data to your map, see [Filtering Feature Layers](#) (page 1216).

Features from the selected feature classes appear in your map. You can style, theme, and edit the features.

If you need additional properties related to this data, you can connect additional data to a feature source layer using a [join](#) (page 507).

To use AutoCAD Map 3D 2011 to access FDO data stores that were created in AutoCAD Map 3D 2007 and earlier

- 1 Verify that you have the privileges required to execute the ALTER TABLE request.
- 2 In the command line, enter the following:

```
sqlplus <datastorename>/<yourpassword>@<tnsServiceName>
@<MapInstallDir>/Fdo/bin/com/AlterSchemaOracle.sql;
exit;
```

Quick Reference

Connect Feature Source

Connects a feature source

Menu	Click File ► Connect To Data.
Icon	 Connect
Command Line	MAPCONNECT
Task Pane	In Display Manager click Data ► Connect to Data.

Bringing In Features from ArcSDE

When you view and edit features from an ArcSDE data source, you can do the following:

- If you use SQL Server or Oracle as the underlying relational database management system for ArcSDE, you can use either Windows or ArcSDE authentication.
- Select the feature classes to include in your map.
- Set conditions to limit the features in your map.
- Style, theme, and edit the features.
- Lock individual features when you check them out for editing.
- Keep features checked out and locked even when you close your drawing. Features are not checked back in and unlocked until you specify.
- Automatically update the data source with any edits you make. Your edits are immediately visible to anyone else using the data source.
- Create versions of your data. [Versioning](#) (page 2078) creates a copy of the data in the data source. Your changes are made to the new version of the data. Versioning is useful for proposed changes or changes that need approval. When the changes are final, you can make your version the current one. To use this feature, you must have versioning support turned on in your database. To use versioning, you must enable versions for the ArcSDE table.

NOTE Long transactions must be set in the data store to be available in AutoCAD Map 3D.

- View the schema definition.
- Bring in a static copy of ArcSDE data as drawing objects.

Supported Versions

AutoCAD Map 3D supports ArcSDE 9.1, 9.2, 9.3, and 9.3.1. The 9.3.1 version is available as either a 32-bit or 64-bit provider on Windows. (For previous versions, and on Linux, it is available in 32-bit only.) The 64 bit support is available only with the 64-bit ESRI ArcSDE 9.3.1 client libraries.

Setting Up ArcSDE for Use with AutoCAD Map 3D

To use ArcSDE, install the following *DLL* files on the computer on which you run AutoCAD Map 3D:

For version 9.1	For version 9.2 through 9.3.1
<i>pe91.dll</i>	<i>pe.dll</i>
<i>sde91.dll</i>	<i>sde.dll</i>
<i>sg91.dll</i>	<i>sg.dll</i>

The provider for this data store checks for the latest versions of the *DLL* files first, and uses them if they are found. If they are not found, it checks for (and uses) the 9.1 versions. The client *DLL* version should match the server version that is being used.

If the client and server versions of ArcSDE do not match (for example if you use the 9.1 client and you access the ArcSDE 9.3.1 server), set up your system for the server version you are using.

Set up the services and hosts files for the appropriate version, and then use these names when you connect to the data in the Data Connect dialog box. For example, specify *arcsdehost\esri_sde_nv*, and not the values. Setup instructions are on the Procedure tab of this topic.

You can copy these *DLL* files into the *FDO/bin* directory of AutoCAD Map 3D. Alternatively, you can set the PATH environment variable to reference the local folder containing these *DLL* files. To accomplish this, you can install an ArcGIS 9.1 Desktop application or the ArcSDE SDK. For more information about ArcGIS 9.1 Desktop applications and the ArcSDE SDK, refer to the ESRI documentation.

Connecting Directly to the Database

ArcSDE provides a direct connection option. This option connects the client directly to the Oracle or SQL Server database engine, rather than through the separate ArcSDE process used in a normal connection. See the Procedure tab of this topic for instructions on setting up this option.

NOTE For information on customizing this provider, refer to the *FDO API Reference* and the *FDO Provider for ArcSDE API Reference*.

See also:

- [Working with ESRI ArcSDE Data](#) (page 579)
- [Importing ESRI ArcSDE Data](#) (page 391)
- [Styling Features](#) (page 639)
- [To create a map with styled feature layers](#) (page 641)
- [To edit a feature using feature editing commands](#) (page 705)

To set up your system for ArcSDE 9.2 (or if you use the 9.1 client and you access the ArcSDE 9.2 server)

- 1 Install the following *DLL* files on the computer on which you run AutoCAD Map 3D.

Copy the files to the directory in which the ArcSDE provider is installed. Usually, the directory is *C:\Program Files\AutoCAD Map 3D 2011\FDO\bin*

pe.dll

sde.dll

sg.dll

- 2 Add entries in your *C:\Windows\system32\drivers\etc\services* file.

The entries look like this:

```
esri_92ora 6161/tcp #ArcSDE 9.2 - Oracle
esri_92sql 6161/tcp #ArcSDE 9.2 - SQLServer 2005
esri_sde 5151/tcp #ArcSDE 9.1- Oracle
esri_sde_ss 5152/tcp #ArcSDE 9.2 - SQLServer
```

- 3 If you have trouble connecting, add a new line in your *C:\Windows\system32\drivers\etc\hosts* file.

The line looks like this:

```
192.168.0.100 arcsdehost
```

To set up your system for ArcSDE 9.1 (or if you use the 9.2 client and you access the ArcSDE 9.1 server)

- 1 Install the following *DLL* files on the computer on which you run AutoCAD Map 3D.

Copy the files to the directory in which the ArcSDE provider is installed. Usually, the directory is *C:\Program Files\AutoCAD Map 3D 2011\FDO\bin*

pe91.dll
sde91.dll
sg91.dll

- 2 Add entries in your *C:\Windows\system32\drivers\etc\services* file.

The entries look like this:

```
esri_92ora 6161/tcp #ArcSDE 9.2 - Oracle
esri_92sql 6161/tcp #ArcSDE 9.2 - SQLServer 2005
esri_sde 5151/tcp #ArcSDE 9.1- Oracle
esri_sde_ss 5152/tcp #ArcSDE 9.2 - SQLServer
```

- 3 If you have trouble connecting, add a new line in your *C:\Windows\system32\drivers\etc\hosts* file.

The line looks like this:

```
192.168.0.100 arcsdehost
```

To bring in features from ESRI ArcSDE

- 1 Make sure your feature source is set up correctly. For a list of issues, refer to the *Readme*.
- 2 In [Display Manager](#) (page 2060), click Data ► Connect To Data.
- 3 In the Data Connect window, select Add ArcSDE Connection in the Data Connections By Provider list.
- 4 Under Connection Name, type a name for this connection.
You can give the connection any name you like. This name appears in Map Explorer as the name of the feature source.
- 5 Under Server Name and Instance Name, enter the information for the ArcSDE database. If you do not know the name, check with your System Administrator.
- 6 Click Login.
- 7 In the [User Credentials dialog box](#) (page 1610), specify the login credentials to use to log into this data store.
 - If you use SQLServer as your underlying relational database management system and want to use your Windows Authentication credentials, select Windows Authentication and click Login.

- To use your ArcSDE login credentials, enter your user name and password and click Login. (If you use SQL Server, ArcSDE will pass your credentials to SQL Server.)
- 8 Click OK.
 - 9 In Data Connect, under Data Store, enter the database name. If you do not know this name, check with your System Administrator.
To select from a list of databases, click the down arrow. AutoCAD Map 3D connects to the specified server and instance and lists the available databases. If you set up your hosts and services files as described, use these names. For example, specify *arcsdehost\esri_sde_mv*, and not the values.
 - 10 Optionally, select a version of the database.
 - 11 Click Connect.
 - 12 In the feature class list, select the feature classes to include in the map. If this feature source contains only a single feature class, that feature class is selected automatically. If it contains multiple feature classes, you can right-click any of them and select Select All or Select None.
 - 13 Click Add To Map.
To bring in a subset of the data, click the down arrow and select [Add To Map With Query](#) (page 309). To filter data after you've added the data to your map, see [Filtering Feature Layers](#) (page 1216).

Features from the selected feature classes appear in your map.

If you need additional properties related to this data, you can connect additional data to a feature source layer using a [join](#) (page 507).

To set up a direct connection to the underlying database

- 1 Set up connections to the underlying databases.

For an Oracle database:

- Install the Oracle client software on the client machine where you run AutoCAD Map 3D.
- Open the Oracle port (for example, 1521) on the database machine firewall.

- Use the Oracle Net Manager tool to set up a `tnsnames` entry for the target database (or update `tnsnames.ora` manually).
- Test your connection to the target database using SQL Plus.

For a SQL Server database:

- Install the SQL Native client software on the client machine where you run AutoCAD Map 3D.
- Open the SQL Server port (for example, 1433) on the database machine firewall.
- Set the target SQL Server database to support remote connect.
- Test your connection to the target database using SQL Server Management Studio.

2 Copy additional *DLL* files into the `fldo\bin` directory.

Because the connection does not use the separate ArcSDE server process, the client needs additional ArcSDE libraries. These *DLL* files are available in the ArcSDE SDK.

For an Oracle database, copy the following *DLL* files:

- `gsrvrora11g93.dll` or `gsrvrora10g93.dll`, depending on whether the Oracle client is 10gr2 or 11g. (This depends on the Oracle client version and not the Oracle server version.)
- `sdeora11gsrvr93.dll` or `sdeora10gsrvr93.dll`
- `xerces-c_2_7.dll`
- `icuuc22.dll`
- `icudt22l.dll`

For a SQL Server database, copy the following *DLL* files:

- `gsrvrsql93.dll`
- `sdesqlsrvr93.dll`
- `xerces-c_2_7.dll`
- `icuuc22.dll`

- icudt221.dll

3 Adjust the connection parameters.

For an Oracle database, set the following parameters:

- **Server name:** Specify the server name or the IP address.
- **Instance name:** Enter `sde:oracle10g` or `sde:oracle11g`, depending on the version of Oracle on the client.
- **User name:** Specify the user name that is valid on the Oracle server.
- **Password:** Enter `<password>@<OracleSID>` where `OracleSID` is the SID configured in the client in step 1.
- **Datastore:** Enter the datastore name manually, for example, `sde`.
- **Version:** Enter the version manually. It defaults to the root version if you do not specify the version.

For a SQL Server database, set the following parameters:

- **Server name:** Specify the server name or the IP address.
- **Instance name:** If you use the default instance of MSSQLSERVER, enter `sde:sqlserver:<servername>`. Otherwise, enter `sde:sqlserver:<servername>\<instance_name>`.
- **User name/password:** Specify the user name that is valid for the SQL Server database.
- **Datastore:** Enter the datastore name manually, for example, `sde`.
- **Version:** Enter the version manually. It defaults to the root version if you do not specify the version.

For more information and other options, see the ESRI documentation for ArcSDE connection syntax.

Quick Reference

Connect Feature Source

Connects a feature source

Menu	Click File ► Connect To Data.
Icon	 Connect
Command Line	MAPCONNECT
Task Pane	In Display Manager click Data ► Connect to Data.

Bringing In Features from SQL Server

AutoCAD Map 3D supports both SQL Server and [SQL Server Spatial](#) (page 326).

For SQL Server, both the 2008 version (using the native spatial support that Microsoft added in that version) and the 2005 version (with custom spatial support added by Autodesk) are supported. If you use SQL Server 2008 or later, we recommend moving to the new SQL Server Spatial provider. While the SQL Server Spatial provider does not read datastores created by the old SQL Server provider, you can use [Bulk Copy](#) (page 617) to move the data into that format.

When you view and edit features from a SQL Server data source, you can do the following:

- Select the feature classes to include in your map.
- Set conditions to limit the features in your map.
- Style, theme, and edit the features.
- Automatically update the data source with any edits you make.
Your edits are immediately visible to anyone else using the data source.
- View and edit the schema definition.
- Create a SQL Server data source.
- Move other geospatial data (for example, SHP data) into SQL Server, to take advantage of better data sharing.

NOTE You can customize the SQL Server [FDO provider](#) (page 2063). The API has custom commands to support schema read/write and geospatial and non-geospatial data read/write. For more information, refer to the *FDO API Reference* and the *FDO Provider for SQL Server API Reference*.

See also:

- [Working with SQL Server Data](#) (page 559)
- [Bringing In Features from SQL Server Spatial](#) (page 326)
- [Creating a Data Store](#) (page 586)
- [Migrating Data](#) (page 615)
- [Styling Features](#) (page 639)
- [To create a map with styled feature layers](#) (page 641)
- [To edit a feature using feature editing commands](#) (page 705)

To bring in features from SQL Server

- 1 In [Display Manager](#) (page 2060), click Data ► Connect To Data.
- 2 In the Data Connect window, select Add SQL Server Connection in the Data Connections By Provider list.
- 3 Under Connection Name, type a name for this connection.
You can give the connection any name you like. This name appears in Map Explorer as the name of the feature source.
- 4 Under Service Name, enter the information for the SQL Server data source. If you do not know the name, check with your System Administrator.
- 5 Click Login.
- 6 In the [User Credentials dialog box](#) (page 1610), enter your user name and password.
Optionally, select Remember Password if you want AutoCAD Map 3D to log you in whenever you open this drawing.
- 7 Click OK.
- 8 In Data Connect, under Data Store, enter the data store name. If you do not know this name, check with your System Administrator.
To select from a list of data stores, click the down arrow. AutoCAD Map 3D connects to the specified server and instance and lists the available data stores.
- 9 Click Connect.
- 10 In the feature class list, select the feature classes to include in the map.

If this feature source contains only a single feature class, that feature class is selected automatically. If it contains multiple feature classes, you can right-click any of them and select **Select All** or **Select None**.

11 Click **Add To Map**.

To bring in a subset of the data, click the down arrow and select **Add To Map With Query** (page 309). To filter data after you've added the data to your map, see **Filtering Feature Layers** (page 1216).

Features from the selected feature classes appear in your map. You can style, theme, and edit the features.

If you need additional properties related to this data, you can connect additional data to a feature source layer using a **join** (page 507).

To use AutoCAD Map 3D 2011 to access FDO data stores that were created in AutoCAD Map 3D 2007 and earlier

1 Verify that you have the privileges required to execute the ALTER TABLE request.

2 In the command line, enter the following:

```
cd <MapInstallDir>/Fdo/bin/com
```

3 Do one of the following:

■ For SQL Server 2005, enter `sqlcmd -UMyUserName -P MyPassword -S SQLServerHostName -d MyDatastore -i AlterSchemaSQLServer.sql`

■ For SQL Server 2000, enter `isql -UMyUserName -P MyPassword -S SQLServerHostName -d MyDatastore -i AlterSchemaSQLServer.sql`

Quick Reference

Connect Feature Source

Connects a feature source

Menu

Click **File** ► **Connect To Data**.

Icon



Connect

Command Line

MAPCONNECT

Bringing In Features from SQL Server Spatial

AutoCAD Map 3D supports both [SQL Server](#) (page 323) and SQL Server Spatial.

For SQL Server Spatial, AutoCAD Map 3D supports native SQL Server Spatial data with SQL Server 2008 SP1. If you are using SQL Server 2008, we recommend using the SQL Server Spatial provider. While the SQL Server Spatial provider does not read datastores created by the older SQL Server provider, you can use [Bulk Copy](#) (page 617) to move the data into that format.

When you view and edit features from a SQL Server Spatial data source, you can do the following:

- Use either Windows or SQL Server authentication.
- Select the feature classes to include in your map.
- Set conditions to limit the features in your map.
- Style, theme, and edit the features.
- Automatically update the data source with any edits you make.
Your edits are immediately visible to anyone else using the data source.
- View and edit the schema definition.
- Create a SQL Server Spatial data source.
A geographic type column is created for the geodetic coordinate system. For other systems, a geometric type column is created. Spatial indexes are created automatically for these geometry properties using default spatial index parameters. You can override the defaults using the API.
You can include FDO metadata when you create a SQL Server data store.
- Move other geospatial data (for example, SHP data) into SQL Server Spatial, to take advantage of better data sharing.

NOTE If you close a drawing that uses a SQLServerSpatial connection and then reopen that drawing, you will need to first reconnect to the SQLServerSpatial connection and provide your user name and password. This information is not remembered once the drawing is closed.

NOTE You can customize the SQL Server Spatial [FDO provider](#) (page 2063). The API has custom commands to support schema read/write and geospatial and non-geospatial data read/write. For more information, refer to the *FDO API Reference* and the *FDO Provider for SQL Server API Reference*.

Dealing With Invalid Geometry

SQL Server Spatial validates geometry objects that are added to the database. It validates the values of geometry columns after they are added. As a result, some geometries are flagged as invalid, even though they are saved. This usually affects polygons (for example, polygons that are not closed) and spikes in geometry. Validation is based on OGC rules.

Querying invalid geometries using a spatial filter (for example, using an expression) generates an error and the query fails. This affects SQL Server **geometry** (but not SQL Server **geography**).

NOTE The FDO Provider for SQL Server Spatial uses the **geography** data type for latitude/longitude coordinate systems and the **geometry** data type for all others. The geography data type does not retain invalid geometry values and rejects them right away. It does not support the `STIsValid()` or `IsValid(geometry)` functions described below.

How Invalid Geometry is Handled

The FDO Provider for SQL Server Spatial recognizes that invalid geometries may exist in a table that is being processed. The provider includes code to avoid having queries fail, using the following strategies:

- A query with no spatial filter returns all data.
- A query with a spatial filter skips invalid geometries so that the query does not fail altogether. Valid geometries matching the spatial filter are returned.
- A query using the FDO `EnvelopeIntersects` filter does not skip invalid geometries if a spatial index is included on the geometry column. In this special-case combination, SQL Server Spatial does not fail on the query because it doesn't process the details of the geometry. MapGuide uses this type of filter as its default selection filter.

AutoCAD Map 3D and MapGuide can draw these invalid geometries without a problem.

Using Expressions to Find Invalid Geometry

SQL Server provides a function called `STIsValid()` that returns 1 for valid geometries and 0 for invalid geometries. FDO exposes access to that function using a function called `IsValid(geometry)` at the FDO level. You can use this function in AutoCAD Map 3D and MapGuide when you create an expression to filter or select data. If you select data using no filter or using just the `EnvelopeIntersects` filter, you can create a calculated property in the Data Table using the `IsValid` function to see which geometries are valid or invalid.

Correcting Invalid Geometry

SQL Server Spatial also provides a function you can use to correct invalid geometries on the server. You cannot use this function from within AutoCAD Map 3D and MapGuide, but you can use it directly against SQL Server, for instance, using Management Studio. Here is an example of this method:

```
update dbo.road set geom = geom.MakeValid() where geom.STIsValid()  
= 0;
```

This operation makes the geometry valid by modifying its invalid parts. You may prefer to edit the geometry yourself, rather than use a default correction with uncertain results.

For more information on the `STIsValid()` and `MakeValid()` functions, as well as other aspects of SQL Server Spatial, consult the SQL Server Spatial online documentation.

See also:

- [Working with SQL Server Spatial Data](#) (page 561)
- [Bringing In Features from SQL Server](#) (page 323)
- [Creating FDO-Enabled SQL Server Spatial Data Stores](#) (page 590)
- [Migrating Data](#) (page 615)
- [Styling Features](#) (page 639)
- [To create a map with styled feature layers](#) (page 641)
- [To edit a feature using feature editing commands](#) (page 705)

To bring in features from SQL Server Spatial

- 1 In [Display Manager](#) (page 2060), click Data ► Connect To Data.

- 2 In the Data Connect window, select Add SQL Server Spatial Connection in the Data Connections By Provider list.
- 3 Under Connection Name, type a name for this connection.
You can give the connection any name you like. This name appears in Map Explorer as the name of the feature source.
- 4 Enter the Service Name and click Login.
The service name is set when you install SQL Server Spatial itself.
- 5 In the [User Credentials dialog box](#) (page 1610), specify the login credentials to use to log into this data store.
 - To use your Windows Authentication credentials, select Windows Authentication and click Login.
 - To use your SQL Server login credentials, enter your user name and password and click Login.
- 6 In Data Connect, under Data Store, enter the data store name. If you do not know this name, check with your System Administrator.
To select from a list of data stores, click the down arrow. AutoCAD Map 3D connects to the specified server and instance and lists the available data stores.
- 7 Click Connect.
- 8 In the feature class list, select the feature classes to include in the map.
If this feature source contains only a single feature class, that feature class is selected automatically. If it contains multiple feature classes, you can right-click any of them and select Select All or Select None.
- 9 Click Add To Map.
To bring in a subset of the data, click the down arrow and select [Add To Map With Query](#) (page 309). To filter data after you've added the data to your map, see [Filtering Feature Layers](#) (page 1216).

Quick Reference

Connect Feature Source

Connects a feature source

Menu Click File ► Connect To Data.

Icon	
Command Line	MAPCONNECT
Task Pane	In Display Manager click Data ► Connect to Data.

Bringing In Features From SQLite

When you view and edit features from a SQLite file, you can do the following:

- Select the feature classes to include in your map.
- Set conditions to limit the features in your map.
- Style, theme, and edit the features.
- Automatically update the data source with any edits you make.
Your edits are visible as soon as another person views the saved data file.
- View and edit the schema definition.
- Move data from other geospatial sources (for example, SHP data) into SQLite, to take advantage of better data sharing.

You can bring SQLite data into your map in two ways:

- Use Data Connect to view and edit the data directly in the SQLite file. Use this method to edit geometry and attributes or to style and theme the data. For information, click the Procedure tab at the top of this Help topic.
- Import the data into the current map, which converts the SQLite data to drawing objects. Use this method to clean the data or to create a DWG file. You can export the objects back to SQLite.

See also:

- [Working with SQLite Data](#) (page 565)
- [Styling Features](#) (page 639)
- [To create a map with styled feature layers](#) (page 641)
- [To edit a feature using feature editing commands](#) (page 705)
- [Converting Data From Other Formats to Drawing Objects](#) (page 377)

- [Converting and Exporting](#) (page 1403)
- [Migrating Data](#) (page 615)
- [Editing a Schema](#) (page 610)

To bring in features from SQLite

- 1 In the [Display Manager](#) (page 2060), click Data ► Connect To Data.
- 2 In the Data Connect window, select Add SQLite Connection in the Data Connections By Provider list.
- 3 Under Connection Name, type a name for this connection.
You can give the connection any name you like. This name appears in Map Explorer as the name of the feature source.
- 4 Under Source File, specify the file.
- 5 Click Connect.
- 6 In the feature class list, select the feature classes to include in the map.
If this feature source contains only a single feature class, that feature class is selected automatically. If it contains multiple feature classes, you can right-click any of them and select Select All or Select None.
- 7 Verify that the coordinate systems are correct. You can [change an incorrect coordinate system if necessary](#) (page 311).
- 8 Click Add To Map.
To bring in a subset of the data, click the down arrow. Select [Add To Map With Query](#) (page 309). To filter data after you've added the data to your map, see [Filtering Feature Layers](#) (page 1216).

Features from the selected feature classes appear in your map. You can style, theme, and edit the features.

If you need additional properties related to this data, you can use a [join](#) (page 507).

Bringing In Features from MySQL

When you view and edit features from a MySQL data source, you can do the following:

- Select the feature classes to include in your map.
- Set conditions to limit the features in your map.
- Style, theme, and edit the features.
- Automatically update the data source with any edits you make.
Your edits are immediately visible to anyone else using the data source.
- Use a data store set up for AutoCAD Map 3D or in other applications. If your data source schema is not set up to work with AutoCAD Map 3D, for example, AutoCAD Map 3D creates a custom mapping so you can use the data in your map.
- View and edit the schema definition.
- Create a MySQL data source.
- Move data from other geospatial sources (for example, SHP data) into MySQL, to take advantage of better data sharing.

For AutoCAD Map 3D 2011, the recommended version of MySQL is 5.0.27.

In the 2008 release of AutoCAD Map 3D, a new column called **geometrytype** was added to the table named **F_AttributeDefinition**. To use AutoCAD Map 3D 2011 to access FDO data stores that were created in AutoCAD Map 3D 2007 and earlier, you must first connect to the data store containing this table and run a SQL script. Instructions for this are on the Procedure tab of this topic.

NOTE The MySQL architecture supports different storage engines, each with varying characteristics and capabilities. The API has custom commands for gathering information, transmitting exceptions, getting lists of accessible data stores, and creating connection objects. There is support for spatial data types and spatial query operations. For more information, refer to the *FDO API Reference* and the *FDO Provider for MYSQL API Reference*.

See also:

- [Working with MySQL Data](#) (page 567)
- [Creating a Data Store](#) (page 586)

- [Migrating Data](#) (page 615)
- [Styling Features](#) (page 639)
- [To create a map with styled feature layers](#) (page 641)
- [To edit a feature using feature editing commands](#) (page 705)

To bring in features from MySQL

- 1 Before connecting to a MySQL database, install the library file *libmysql.dll*.
- 2 In [Display Manager](#) (page 2060), click Data ► Connect To Data.
- 3 In the Data Connect window, select Add MySQL Connection in the Data Connections By Provider list.
- 4 Under Connection Name, type a name for this connection.
You can give the connection any name you like. This name appears in Map Explorer as the name of the feature source.
- 5 Under Service Name, enter the information for the MySQL data source.
If you do not know the name, check with your System Administrator.
- 6 Click Login.
- 7 In the [User Credentials dialog box](#) (page 1610), enter your user name and password.
Optionally, select Remember Password if you want AutoCAD Map 3D to log you in whenever you open this drawing.
- 8 Click OK.
- 9 In Data Connect, under Data Store, enter the data store name. If you do not know this name, check with your System Administrator.
To select from a list of data stores, click the down arrow. AutoCAD Map 3D connects to the specified server and instance and lists the available data stores.

NOTE If the data store is not in the list, it may not use a AutoCAD Map 3D schema. Select Show All Data Stores to add these to the list. AutoCAD Map 3D creates a mapping to use these data stores with AutoCAD Map 3D.

- 10 Click Connect.
- 11 In the feature class list, select the feature classes to include in the map.

If this feature source contains only a single feature class, that feature class is selected automatically. If it contains multiple feature classes, you can right-click any of them and select Select All or Select None.

12 Click Add To Map.

To bring in a subset of the data, click the down arrow and select [Add To Map With Query](#) (page 309). To filter data after you've added the data to your map, see [Filtering Feature Layers](#) (page 1216).

Features from the selected feature classes appear in your map. You can style, theme, and edit the features.

If you need additional properties related to this data, you can connect additional data to a feature source layer using a [join](#) (page 507).

To use AutoCAD Map 3D 2011 to access FDO data stores that were created in AutoCAD Map 3D 2007 and earlier

- 1 Verify that you have the privileges required to execute the ALTER TABLE request.
- 2 In the command line, enter the following:

```
cd <MapInstallDir>/Fdo/bin/com
mysql --user=MyUserName --password=MyPasswordMyDatabase
<AlterSchemaMySQL.sql> MyLogFile
quit
```

Quick Reference

Connect Feature Source

Connects a feature source

Menu

Click File ► Connect To Data.

Icon



Command Line

MAPCONNECT

Task Pane

In Display Manager click Data ► Connect to Data.

Bringing In Features from SHP

You can access existing spatial and attribute data in ESRI SHP files, which store both geometry and attributes (data) for features. A single shape can have several separate files: SHP (shape geometry), SHX (shape index), PRJ (projection information), CPG (code page files), IDX (spatial index), and DBF (shape attributes in dBASE format). AutoCAD Map 3D treats each SHP and associated DBF file as a feature class with a single geometry property.

When you connect to or import SHP polygon data, AutoCAD Map 3D checks the geometry to see if there are multiple closed outer loops. If so, it treats the geometry as multi-polygon (a polygon with multiple exterior rings). It does not treat unclosed outer loops as multi-polygon.

When you create a multi-polygon in AutoCAD Map 3D and then save or export it to SHP format, it will appear in its native SHP file as a multi-polygon.

If you brought in this type of geometry in a previous release and added styling, you may need to update the style definitions.

When you view and edit features from a SHP data source, you can do the following:

- Select the feature classes to include in your map.
- Set conditions to limit the features in your map.
- Style, theme, and edit the features.
- Lock the file when you connect to it.
- Automatically update the data source with any edits you make.
- View and edit the schema definition.

You can bring SHP data into your map in two ways:

- Use Data Connect to view and edit the data directly in the SHP file. Use this method to edit geometry and attributes or to style and theme the data. For information, click the Procedure tab at the top of this Help topic.
- Import the data into this drawing, which converts it to drawing objects. Use this method to clean the data or to create a DWG file. You can export the objects back to SHP format.

NOTE For information on customizing the SHP [FDO provider](#) (page 2063), refer to the *FDO API Reference* and the *FDO Provider for SHP API Reference*.

See also:

- [Converting Data From Other Formats to Drawing Objects](#) (page 377)
- [Converting and Exporting](#) (page 1403)
- [Working with SHP Data](#) (page 572)
- [Styling Features](#) (page 639)
- [To create a map with styled feature layers](#) (page 641)
- [To edit a feature using feature editing commands](#) (page 705)

To bring in features from SHP

- 1 In [Display Manager](#) (page 2060), click Data ► Connect To Data.
- 2 In the Data Connect window, select Add SHP Connection in the Data Connections By Provider list.
- 3 Under Connection Name, type a name for this connection.
You can give the connection any name you like. This name appears in Map Explorer as the name of the feature source.
- 4 Under Source File Or Folder, specify the location of the file. To include multiple files in a group, specify a folder.
Click  to browse to a file. Click the folder icon to browse to a folder.
- 5 Click Connect.
- 6 In the feature class list, select the feature classes to include in the map.
If this feature source contains only a single feature class, that feature class is selected automatically. If it contains multiple feature classes, you can right-click any of them and select Select All or Select None.
- 7 Verify that the coordinate systems are correct. You can [change an incorrect coordinate system if necessary](#) (page 311).
- 8 Click Add To Map.
To bring in a subset of the data, click the down arrow and select [Add To Map With Query](#) (page 309). To filter data after you've added the data to your map, see [Filtering Feature Layers](#) (page 1216).

Features from the selected feature classes appear in your map. You can style, theme, and edit the features.

If you need additional properties related to this data, you can connect additional data to a feature source layer using a [join](#) (page 507).

Quick Reference

Connect Feature Source

Connects a feature source

Menu	Click File ► Connect To Data.
Icon	 Connect
Command Line	MAPCONNECT
Task Pane	In Display Manager click Data ► Connect to Data.

Bringing In Features from SDF

You can access spatial and attribute data in an Autodesk Spatial Data File (SDF). SDF supports spatial indexing and can store geometric and non-geometric data with minimum overhead.

When you view and edit features from an SDF data source, you can do the following:

- Select the feature classes to include in your map.
- Set conditions to limit the features in your map.
- Style, theme, and edit the features.
- Automatically update the data source with any edits you make.
- View and edit the schema definition.
- Move SDF data into other geospatial formats, to take advantage of better data sharing

NOTE The procedures here apply to the current version of SDF (SDF3). For SDF 2 files (created for MapGuide version 6.5 or earlier), you cannot use these procedures. Instead, [import](#) (page 389) the file.

You can bring SDF data into your map in three ways:

- Use Data Connect to view and edit the data directly in the SDF file. Use this method to edit geometry and attributes or to style and theme the data. For information, click the Procedure tab at the top of this Help topic.
- Import the data into the current map, which converts the SDF data to drawing objects. Use this method to clean the data or to create a DWG file. You can export the objects back to SDF.
- For SDF 2 files (created for MapGuide version 6.5 or earlier), use the separate [SDF 2 Import](#) (page 389) and [SDF 2 Export](#) (page 1417) commands.

NOTE For information on customizing this provider, refer to the *FDO API Reference* and the *FDO Provider for SDF API Reference*.

See also:

- [Editing a Schema](#) (page 610)
- [Importing Autodesk SDF 2](#) (page 389)
- [Converting Data From Other Formats to Drawing Objects](#) (page 377)
- [Converting and Exporting](#) (page 1403)
- [Working with SDF Data](#) (page 569)
- [Migrating Data](#) (page 615)
- [Styling Features](#) (page 639)
- [To create a map with styled feature layers](#) (page 641)
- [To edit a feature using feature editing commands](#) (page 705)

To bring in features from SDF

- 1 In the [Display Manager](#) (page 2060), click Data ► Connect To Data.
- 2 In the Data Connect window, select Add SDF Connection in the Data Connections By Provider list.
- 3 Under Connection Name, type a name for this connection.
You can give the connection any name you like. This name appears in Map Explorer as the name of the feature source.
- 4 Under Source File, specify the file.

- 5 Click Connect.
- 6 In the feature class list, select the feature classes to include in the map.
If this feature source contains only a single feature class, that feature class is selected automatically. If it contains multiple feature classes, you can right-click any of them and select Select All or Select None.
- 7 Verify that the coordinate systems are correct. You can [change an incorrect coordinate system if necessary](#) (page 311).
- 8 Click Add To Map.
To bring in a subset of the data, click the down arrow and select [Add To Map With Query](#) (page 309). To filter data after you've added the data to your map, see [Filtering Feature Layers](#) (page 1216).

Features from the selected feature classes appear in your map. You can style, theme, and edit the features.

If you need additional properties related to this data, you can connect additional data to a feature source layer using a [join](#) (page 507).

NOTE For SDF files created for MapGuide version 6.5 or earlier, you cannot use this procedure. Instead, [import](#) (page 389) the file.

Quick Reference

Connect Feature Source

Connects a feature source

Menu	Click File ► Connect To Data.
Icon	 Connect
Command Line	MAPCONNECT
Task Pane	In Display Manager click Data ► Connect to Data.

Bringing in Features from PostgreSQL/PostGIS

The OSGeo FDO provider for PostgreSQL/PostGIS has 32-bit and 64-bit versions on Windows and Linux. For AutoCAD Map 3D, it is certified for PostGIS 1.4.0 with PostgreSQL 8.4.

PostGIS adds support for geographic objects to the PostgreSQL object-relational database so that the PostgreSQL server can be used as a back end spatial database for GIS. When you view and edit features from a PostgreSQL data source, you can do the following:

- Select the feature classes to include in your map.
- Set conditions to limit the features in your map.
- Style, theme, and edit the features.
- Automatically update the data source with any edits you make.
Your edits are immediately visible to anyone else using the data source.
- View and edit the schema definition.
- Create a PostgreSQL data source.
- Move other geospatial data (for example, SHP data) into PostgreSQL, to take advantage of better data sharing.

Setting Up PostgreSQL for Use with AutoCAD Map 3D

For a 32-bit environment

When you install AutoCAD Map 3D, the following *DLL* files are installed in the *AutoCAD Map 3D\FDO\BIN* directory on the computer on which you run AutoCAD Map 3D:

- comerr32.dll
- krb5_32.dll
- libeay32.dll
- libiconv-2.dll
- libintl-2.dll
- libpq.dll
- ssleay32.dll

- gssapi32.dll
- iconv.dll
- k5sprt32.dll

If you need to replace these files, copy them from the server bin directory (*C:\Program Files\PostgreSQL\8.4\bin*) into the path or the *AutoCAD Map 3D\FDO\BIN* directory on the computer on which you run AutoCAD Map 3D.

For a 64-bit environment

For a 64-bit client, the following *DLL* files are installed in the *AutoCAD Map 3D\FDO\BIN* directory on the computer on which you run AutoCAD Map 3D:

- libeay32.dll
- libpq.dll
- ssleay32.dll

NOTE You must install the 64-bit client DLL on 64-bit machines. You cannot install the 32-bit client.

See also:

- [Working with PostgreSQL/PostGIS Data](#) (page 574)
- [Creating a Data Store](#) (page 586)
- [Migrating Data](#) (page 615)
- [Styling Features](#) (page 639)
- [To create a map with styled feature layers](#) (page 641)
- [To edit a feature using feature editing commands](#) (page 705)

To bring in features from PostgreSQL/PostGIS

- 1 In [Display Manager](#) (page 2060), click Data ► Connect To Data.
- 2 In the Data Connect window, select Add PostgreSQL Connection in the Data Connections By Provider list.

- 3 Under Connection Name, type a name for this connection.
You can give the connection any name you like. This name appears in Map Explorer as the name of the feature source.
- 4 Enter the Service Name and click Login.
The service name is set when you install the PostgreSQL server.
- 5 In the [User Credentials dialog box](#) (page 1610), specify the login credentials to use to log into this data store.
- 6 In Data Connect, under Data Store, enter the data store name. If you do not know this name, check with your System Administrator.
To select from a list of data stores, click the down arrow. AutoCAD Map 3D connects to the specified server and instance and lists the available data stores.
- 7 Click Connect.
- 8 In the feature class list, select the feature classes to include in the map.
If this feature source contains only a single feature class, that feature class is selected automatically. If it contains multiple feature classes, you can right-click any of them and select Select All or Select None.
- 9 Click Add To Map.
To bring in a subset of the data, click the down arrow and select [Add To Map With Query](#) (page 309). To filter data after you've added the data to your map, see [Filtering Feature Layers](#) (page 1216).

Accessing Data from ODBC

Use an ODBC connection to access attribute or point data in Microsoft Access, Microsoft Excel, or dBASE.

Attribute data allows you to join information from a non-geometry source to a geometric feature. For example, you can join assessor data to a parcel layer. For information about joins, see [Joining Data to GIS Features](#) (page 507).

Point data can include survey points, [LiDAR](#) (page 2066) data, or GPS data, which is typically specified either by Latitude and Longitude columns or by XY coordinates.

By default, AutoCAD Map 3D maps each table in the database to a “feature class” while each column becomes a “property.”

When you view and edit data from an ODBC database, you can do the following:

- Select the feature classes to include in your map.
- Set conditions to limit the features in your map.
- Style, theme, and edit the features.
- Lock the file when you connect to it.
- Automatically update the data source with any edits you make. Your edits are immediately visible to anyone else using the data source.
- Define feature classes for any relational database table with X, Y (and, optionally, Z) columns. Object locations are stored in separate properties in the object definition of a feature, which is accessible through the Geometry class property. You cannot create or delete feature schemas.

Microsoft Excel Data

To access Microsoft Excel data, you must define table ranges in Excel. These named ranges in the worksheet can then be treated as separate ODBC tables, with each one mapping to an [FDO](#) (page 2062) feature class. If you do not define named ranges, no feature classes are available to add to your map. Instructions for defining a table range are on the Procedure tab of this topic.

Microsoft Access Data

Some Microsoft Access databases have autogenerated primary keys. You can load data from Microsoft Access databases without these primary keys and use that data for joins, and so on. However, without a primary key you cannot create and update data.

To perform a AutoCAD Map 3D location query in a Microsoft Access database that contains long integer values (longs), use the tools in Access to remove the indexes from location-based x/y columns.

NOTE For information on customizing this provider, refer to the *FDO API Reference* and the *FDO Provider for ODBC API Reference*.

Tell me more



Video

- *Show me how to bring in point data from an ODBC database.*



Procedure

- [To create a DSN in Windows XP](#) (page 345)
- [To access ODBC data](#) (page 344)



Tutorial

- Lesson 2: Analyze Data With External Information Using Joins



Workflow

- Join Attribute Data to a Geospatial Feature



GIS Skill

- *Bring in point data from a Microsoft Access database*



Related topics

- [About Geospatial Feature Classes, Data Stores, and Schemas](#) (page 551)
- [Working with ODBC Data](#) (page 576)

- [To access ODBC data](#) (page 344)
- [To create a DSN in Windows XP](#) (page 345)
- [To define the table ranges required to access Excel data](#) (page 346)

To access ODBC data

- 1 In the [Display Manager](#) (page 2060), click Data ► Connect To Data.
- 2 In the Data Connect window, select Add ODBC Connection in the Data Connections By Provider list.
- 3 Under Connection Name, type a name for this connection.
You can give the connection any name you like. This name appears in Map Explorer as the name of the feature source.
- 4 Under Source Type, select one of the following:
 - Data Source Name (DSN) — Use a DSN you have defined in your Windows Control Panel. See the following.

- Connection String — The connection string specifies the driver and path to use.
- 5 Under source, specify the table.
 - Data Source Name (DSN) — Click the browse button and select the DSN.
 - Connection String — Specify the driver and path. For a Microsoft Access database, use the format:

```
Driver={Microsoft Access Driver
(*.mdb)};DBQ=pathname\filename.mdb
```

 Where *pathname\filename.mdb* is the complete path and filename of the Microsoft Access database. Note the curly braces and the space before “ (*.mdb) ” For more information, see the ODBC documentation on the Microsoft Web site.
 - 6 If required by the table, enter your user name and password.
 - 7 Click Connect.
 - 8 Under Add Data To Map, select the tables.
 - 9 For each table, specify the coordinate system.
 - 10 Specify the columns to use for point geometry. This can be latitude/longitude or X, Y, and Z Coordinates. To specify the column name, click in the field, then click the down arrow to choose from a list of column names.
 - 11 Click Add To Map.

If Add To Map is grayed out, check that you have specified the coordinate system and X and Y columns for the table.

To create a DSN in Windows XP

- 1 From your Windows desktop, click Start menu ► Settings ► Control Panel and open the Administrative Tools control panel.
- 2 Double-click Data Sources (ODBC).
- 3 In the ODBC Data Source Administrator, click User DSN or System DSN. A User DSN is visible only to you. A System DSN is visible to all users on the current machine.
- 4 Click Add and select the driver to use.

For example, to create a DSN for an Access database, select Microsoft Access Driver.

- 5 In the ODBC Microsoft Access dialog box enter information about the data. When you finish, click OK. Click OK again to close the ODBC Data Source Administrator dialog box.

The DSN you defined appears in the DSN list in the Data Connect window.

To define the table ranges required to access Excel data

- 1 In Excel, open the Excel worksheet.
- 2 Select all the data.
- 3 Define a named range.
- 4 Enter a name for the feature class, for example, Country_Literacy.
- 5 Close Excel.

Quick Reference

Connect Feature Source

Connects a feature source

Menu Click File ► Connect To Data.

Icon  Connect

Command Line MAPCONNECT

Task Pane In Display Manager click Data ► Connect to Data.

Bringing In Features from WFS

You can bring in web-based features that have been published to a public web server using the WFS (Web Feature Service) open standard developed by the Open GIS Consortium (OGC).

NOTE This topic applies to geospatial data. To bring in drawing (DWG) objects, see [Overview of Bringing in Drawing Data From DWG Files](#) (page 351).

Once you have located the WFS data you want, determine the URL of the page that serves the published layers. Often, this is not a standard web page that you can open in a browser, but a page that has been programmed using a scripting language such as CGI, PHP, or ASP. See the following for some examples. You paste the address into the Data Connect window in AutoCAD Map 3D to access the data on that page.

When you bring in features from a WFS data source, you can do the following:

- Select the feature classes to include in your map.
- Set conditions to limit the features in your map.
- Reproject the data to the coordinate system of your map. Attribute data may also be available for the WFS layers.
- Style and theme features. You cannot edit features from a WFS data source.

Example WFS Data Sources

WFS Data Source	Description
http://demo.cubewerx.com/demo/cubeserv/cubeserv.cgi?datastore=Foundation	Data layers such as boundaries, terrains, physiography, utilities, and more.
http://regis.intergraph.com/wfs/dcmetro/request.asp?	Virginia, USA Census tracts, Congressional districts, counties, interstates, POI, and places.

NOTE For information on customizing this provider, refer to the *FDO API Reference* and *The Essential FDO*.

Tell me more



Video

- *Show me how to bring in data from a web server using WMS*



Procedure

- [To bring in features from WFS](#) (page 348)
- [To work with WFS data](#) (page 582)



GIS Skill

- *Access data published on a public web server*



Related topics

- [Working with WFS Data](#) (page 581)
- [Adding an Image from a WMS \(Web Map Service\)](#) (page 445)
- [Styling Features](#) (page 639)

To bring in features from WFS

NOTE This topic applies to geospatial data. To bring in drawing (DWG) objects, see [Overview of Bringing in Drawing Data From DWG Files](#) (page 351).

- 1 In the [Display Manager](#) (page 2060), click Data ► Connect To Data.
- 2 In the Data Connect window, select Add WGS Connection in the Data Connections By Provider list.
- 3 Under Connection Name, type a name for this connection.
You can give the connection any name you like. This name appears in Map Explorer as the name of the feature source.
- 4 Under server name, specify the URL for the WFS server. Click the down arrow to choose from a list of recently used URLs.
- 5 If necessary, enter your user name and password.
- 6 Click Connect.
- 7 In the Add Data To Map area, select the feature classes to include.
If this feature source contains only a single feature class, that feature class is selected automatically. If it contains multiple feature classes, you can right-click any of them and select Select All or Select None.
- 8 For each feature class you select, verify the coordinate system. You can [change an incorrect coordinate system if necessary](#) (page 311).
- 9 Click Add To Map.
To bring in a subset of the data, click the down arrow and select [Add To Map With Query](#) (page 309). To filter data after you've added the data to your map, see [Filtering Feature Layers](#) (page 1216).

Features from the selected feature classes appear in your map. If you need additional properties related to this data, you can connect additional data to a feature source layer using a [join](#) (page 507).

Quick Reference

Connect Feature Source

Connects a feature source

Menu Click File ► Connect To Data.

Icon  Connect

Command Line MAPCONNECT

Task Pane In Display Manager click Data ► Connect to Data.

Repairing Broken Feature Connections

NOTE This topic applies to geospatial data. To bring in drawing (DWG) objects, see [Overview of Bringing in Drawing Data From DWG Files](#) (page 351).

If a data file moves from its original location, you may get an error when you open the map that references that data. For example, someone else might create a map using an SDF file. That person then sends the map and SDF file to you. If you store the SDF file with a different path name than the one used by the original map creator, AutoCAD Map 3D displays an error.

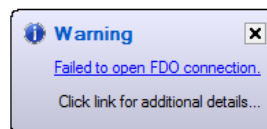
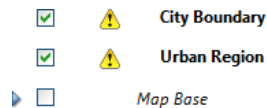

To resolve this problem, you must reconnect the data using the correct path. By doing so, you maintain styling information.

TIP To avoid this problem, use eTransmit to package and transfer files for a map. Although this method does not work for database data (such as Oracle or SQL Server data stores), it preserves the connections of all file-based data, such as SDF and SHP.

See also:

- [Using eTransmit](#) (page 1376)

To reconnect to feature data without losing styling information

NOTE This topic applies to geospatial data. To bring in drawing (DWG) objects, see [Overview of Bringing in Drawing Data From DWG Files](#) (page 351).

- 1 In Data Connect, select the data connection that is broken.
For example, select SDF_1, if the first SDF connection is broken.
- 2 For Source File Or Folder, type or browse to the correct data store location.
- 3 Click Connect, but do not click Add.
Clicking Add creates a new layer in your map, without the styling information from the original layer.

Bringing In Drawing Data From DWG Files

NOTE This topic applies to AutoCAD drawing objects. To bring in geospatial data, see [Overview of Bringing In GIS Features](#) (page 305).

Your map can include drawing objects from the current drawing or from other drawings. To include objects from other drawings, you must first attach those drawings to your map.

NOTE To open a DWG file that was created with, or contains, feature source

provider data, do not double-click the icon that represents the file. Click  ►
Open ► Drawing.

Each set of objects you select is stored in a layer in Display Manager. A layer that includes drawing objects is a [drawing layer](#) (page 2060).

Drawing layers in Display Manager are different from “classic” AutoCAD layers that you see in the AutoCAD Layer Properties Manager. AutoCAD users who do not have AutoCAD Map 3D do not have Display Manager and so cannot see Display Manager layers.

You style AutoCAD layers using the Layer Properties Manager. When you bring in data by object class, location, property, or query, and store that data in a Display Manager drawing layer, you can style and theme the layer using

Display Manager tools, and use the mapping and GIS tools available in AutoCAD Map 3D.

See also:

- [Attaching a Drawing](#) (page 157)
- [Use these procedures to bring drawing objects into your map](#) (page 354)
- [To bring in drawing objects from AutoCAD layers in the current drawing](#) (page 356)
- [To bring in drawing objects based on object classes in the current drawing](#) (page 357)
- [To bring in drawing objects based on location](#) (page 359)
- [To bring in drawing objects based on object properties](#) (page 362)
- [To bring in drawing objects based on object data or external \(SQL\) data](#) (page 364)
- [To bring in drawing objects based on object data](#) (page 364)
- [To bring in drawing objects based on external \(SQL\) data](#) (page 365)
- [To bring in drawing objects based on topology](#) (page 367)
- [To bring in drawing objects by combining query conditions](#) (page 369)

Overview of Bringing in Drawing Data From DWG Files

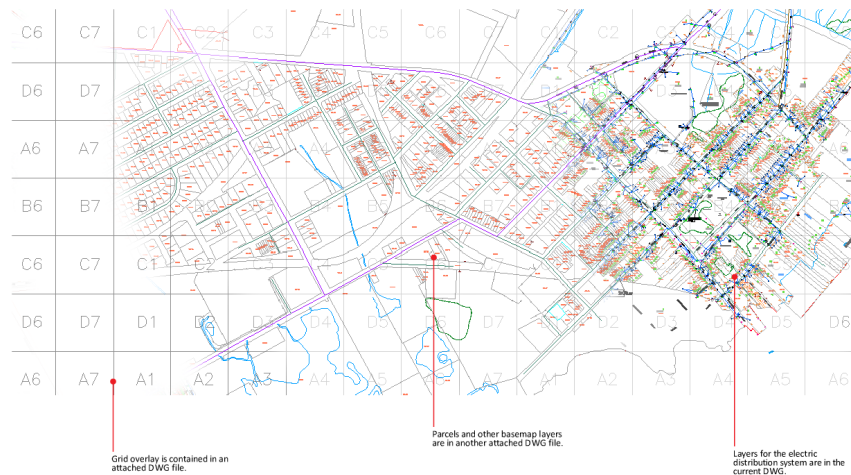

This map of an electrical distribution system is based on several attached DWG files.

NOTE This topic applies to AutoCAD drawing objects. To bring in geospatial data, see [Overview of Bringing In GIS Features](#) (page 305).

You can include drawing objects in your map so you can view, edit, style, and theme them.

You can select objects from the current drawing and from attached drawings. For information about attached drawings, see [Attaching Drawings](#) (page 154).

Each set of objects you select is stored in a [drawing layer](#) (page 2060) in Display Manager.

When you create a drawing layer based on...	It includes...	From...
AutoCAD Layer (page 355)	All the objects on the selected AutoCAD layer	The current drawing
Object class (page 356)	All the objects in the selected object class	The current drawing class
Topology (page 367)	All the objects in the selected topology	The current drawing
Location (page 358)	All the objects in the specified location	The current drawing, attached source drawings, or a selected topology
Object property (page 361)	All objects that have the selected property, such as elevation, layer, or area	The current drawing, attached source drawings, or a selected topology
Attached data (page 363)	All objects with the specified data, such as object data or linked records from an external database	The current drawing, attached source drawings, or a selected topology

In this city map example, there are separate drawing layers for each set of entities comprising the water system.

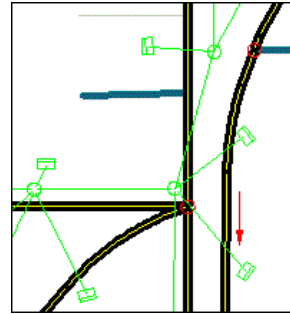
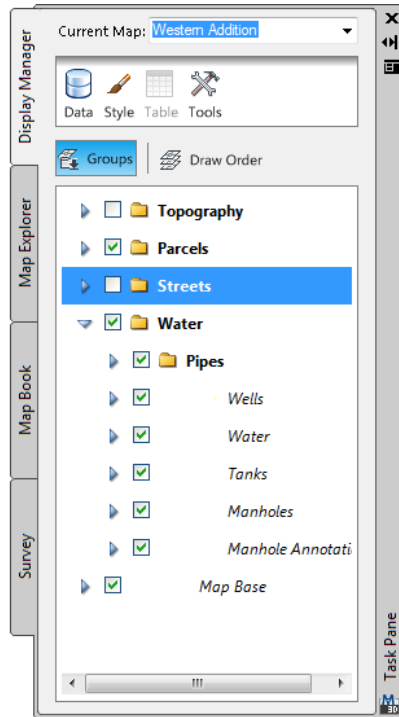

Use the Display Manager check boxes to turn off layers, which hides the objects on that layer, or to turn off styles, which displays the drawing objects on that layer without styles. For more information on styling drawing layers, see [Overview of Styling Drawing Layers](#) (page 652).

Map Base

Objects in the current drawing that are not included in any layer are included in the Map Base layer. You can hide all objects on this layer.

NOTE Objects from attached drawings that you have queried into the current drawing using a standard query are added to the Map Base layer. To style these objects separately in your map, create a query to bring them into the display.

Tell me more



Video

- *Show me how to run a query on a set of attached DWG files.*
- *Show me how to include an AutoCAD layer in Display Manager.*



Procedure

- [To bring drawing objects into your map](#) (page 354)
- [To bring in drawing objects from AutoCAD layers in the current drawing](#) (page 356)



Tutorial

- Exercise 2: Attach a drawing file



Workflow

- Create a CAD Map



GIS Skills

- *Include AutoCAD layers in the Display Manager*
- *Bring in a subset of features using a query*



Related topics

- [Attaching Drawings](#) (page 154)

Use these procedures to bring drawing objects into your map

NOTE This topic applies to AutoCAD drawing objects. To bring in geospatial data, see [procedures for bringing in geospatial data](#). (page 308).

- [To bring in drawing objects from AutoCAD layers in the current drawing](#) (page 356)
- [To bring in drawing objects based on object classes in the current drawing](#) (page 357)
- [To bring in drawing objects based on location](#) (page 359)
- [To bring in drawing objects based on object properties](#) (page 362)

- [To bring in drawing objects based on object data or external \(SQL\) data \(page 364\)](#)
- [To bring in drawing objects based on topology \(page 367\)](#)

Quick Reference

ADEQUERY

Controls defining, modifying, saving, loading, and executing a query

Menu	In the Classic workspace, click Setup menu ► More DWG Options ► Define Query
Icon	 Define Query
Command Line	ADEQUERY
Task Pane	In Map Explorer, right-click Current Query ► Define -or- Right-click a query ► Edit
Dialog Box	Define Query dialog box

Bringing In Drawing Objects from AutoCAD Layers

NOTE This topic applies to AutoCAD drawing objects. To bring in geospatial data, see [Overview of Bringing In GIS Features \(page 305\)](#).

In your map, you can create a [drawing layer \(page 2060\)](#) in Display Manager that includes all the objects from selected AutoCAD layers in the current drawing.

For example, you can create a layer that includes all the fire hydrants by selecting the HYDRANT AutoCAD layer.

You can organize layers into groups. Grouping layers lets you quickly turn off the display of all the objects in the group.

TIP To select just some of the objects on an AutoCAD layer, use a query to add the objects to your map and combine several conditions. For example, select only the fire hydrants within 1000 meters of a corporation yard.

To bring in drawing objects from AutoCAD layers in the current drawing

NOTE This topic applies to AutoCAD drawing objects. To bring in geospatial data, see [procedures for bringing in geospatial data](#). (page 308).

- 1 In [Display Manager](#) (page 2060), click Data ► Add Drawing Data ► Drawing Layer.
- 2 In the [Select Layers dialog box](#) (page 1631), select the AutoCAD layers that include the objects to display.
AutoCAD Map 3D creates a layer in Display Manager for each AutoCAD layer you select.
- 3 To group the layers, select Group Selection.
If you combine the layers in a group, you can turn the display of the group on or off.
- 4 Click OK.

The new layer appears in Display Manager. All objects on the selected AutoCAD layer are included in this layer. If you selected multiple AutoCAD layers, multiple layers are created in your map. To see the objects, you may need to zoom to the drawing extents. Click Map Setup tab ► Map panel ► Zoom

Drawing Extents. 

Quick Reference

New Display Manager Layer - AutoCAD Layer

Creates a new layer from AutoCAD layers in Display Manager

Task Pane	In Display Manager, click Data ► Add Drawing Data ► Drawing Layer
Dialog Box	Select Display Element dialog box

Bringing In Drawing Objects by Object Class

NOTE This topic applies to AutoCAD drawing objects. To bring in geospatial data, see [Overview of Bringing In GIS Features](#) (page 305).

In your map, you can create a [drawing layer](#) (page 2060) in Display Manager that includes all the objects in an object class in the current drawing.

For example, to create a layer that includes all the primary roads, select the PRIMARY_ROADS object class.

You can organize layers into groups. Grouping layers lets you quickly turn off the display of all the objects in the group.

TIP To select just some of the objects in an object class, use a query to add the objects to your map and combine conditions. For example, you can select only the primary roads in the West quadrant of the county.

See also:

- [Combining Conditions](#) (page 368)
- [Bringing In Drawing Objects from AutoCAD Layers](#) (page 355)
- [Bringing In Drawing Objects Based on Topology](#) (page 367)
- [Bringing In Drawing Objects by Location](#) (page 358)
- [Bringing In Drawing Objects by Property](#) (page 361)
- [Bringing In Drawing Objects Based on Attached Data](#) (page 363)
- [Bringing in GIS Features](#) (page 303)

To bring in drawing objects based on object classes in the current drawing

NOTE This topic applies to AutoCAD drawing objects. To bring in geospatial data, see [procedures for bringing in geospatial data](#). (page 308).

- 1 In [Display Manager](#) (page 2060), click Data ► Add Drawing Data ► Object Class.
- 2 In the [Select Classes dialog box](#) (page 1631), select the object classes that include the objects to display.
AutoCAD Map 3D creates a layer in Display Manager for each object class you select.
- 3 To group the object class layers, select Group Selection.
If you combine the layers in a group, you can turn the display of the group on or off.
- 4 Click OK.

The new layer appears in Display Manager. All objects in the selected object class are included in this layer. If you selected multiple object classes, multiple layers are created. To see the objects, you may need to zoom to the drawing

extents. Click Map Setup tab ► Map panel ► Zoom Drawing Extents.



Quick Reference

New Display Manager Layer - Object Class

Creates a new object class layer in the Display Manager

Task Pane In Display Manager, click Data ► Add Drawing Data ► Object Class

Dialog Box Select Object Classes dialog box

Bringing In Drawing Objects by Location

NOTE This topic applies to AutoCAD drawing objects. To bring in geospatial data, see [Overview of Bringing In GIS Features](#) (page 305).

In your map, you can create a [drawing layer](#) (page 2060) in Display Manager that includes the objects in a specified location. You can select from objects in the current map, in attached drawings, or in a topology.

For example, you can select all utility poles within 100 feet of a specified road or all parks within a specified quadrant of the city.

TIP You can use a query to combine a location condition with other conditions. For example, you can find all parcels that are zoned residential and are within 500 meters of a contaminated well.

Tell me more



Video

- [Show me how to run a query on a set of attached DWG files.](#)



Procedure

- [To bring in drawing objects based on location](#) (page 359)

- [To bring in drawing objects by combining query conditions](#) (page 369)



Tutorial

- Exercise 3: Query in data from the drawing



Workflow

- Create a CAD Map



GIS Skill

- *Bring in a subset of features using a query*



Related topics

- [Attaching Drawings](#) (page 154)
- [Combining Conditions](#) (page 368)
- [Bringing In Drawing Objects by Object Class](#) (page 356)
- [Bringing In Drawing Objects from AutoCAD Layers](#) (page 355)
- [Bringing In Drawing Objects by Property](#) (page 361)
- [Bringing In Drawing Objects Based on Attached Data](#) (page 363)

To bring in drawing objects based on location

NOTE This topic applies to AutoCAD drawing objects. To bring in geospatial data, see [procedures for bringing in geospatial data](#). (page 308).

- 1 Do one of the following:
 - In [Display Manager](#) (page 2060), click Data ► Add Drawing Data ► Query Current Drawing.
 - In Display Manager, click Data ► Add Drawing Data ► Query Source Drawing. Be sure you have [attached](#) (page 154) the DWG files to query.
 - In Display Manager, click Data ► Add Drawing Data ► Query Topology.

- 2 In the [Define Query dialog box](#) (page 1838), click Location.
- 3 In the [Location Condition dialog box](#) (page 1849), select a boundary to determine the type of area to query.
Select Fence to specify a new polyline; select Polyline to use an existing polyline.
- 4 Choose a selection type:
 - Inside includes only objects that are completely inside the boundary.
 - Crossing includes all objects that are inside the boundary or crossing the boundary.
- 5 If you select the Polyline boundary, specify a polyline mode.
- 6 To define the coordinates of the boundary, click Define and use any AutoCAD Map 3D selection method to define the boundary.
- 7 Click OK.
- 8 Optionally, define another condition. See [Combining Conditions](#) (page 369).
- 9 In the Define Query dialog box, click OK.

The new layer appears in Display Manager. Objects that meet the conditions of the query are included in this layer. To see the objects, you may need to zoom to the drawing extents. Click Map Setup tab ► Map panel ► Zoom

Drawing Extents. 

Quick Reference

New Display Manager Layer - Query

Creates a new query layer in Display Manager

Task Pane	In Display Manager, click Data ► Add Drawing Data and then select a query type
Dialog Box	Define Query dialog box

Bringing In Drawing Objects by Property

NOTE This topic applies to AutoCAD drawing objects. To bring in geospatial data, see [Overview of Bringing In GIS Features](#) (page 305).

In your map, you can create a [drawing layer](#) (page 2060) in Display Manager that includes objects that have a specific property. You can select from objects in the current map, or from objects in attached drawings.

For example, you can select all roads with a dashed linetype.

TIP You can combine a property condition with other conditions to create specific queries. For example, you could find all parcels that are zoned Residential and have an elevation lower than 50.

Additional Information

- If an object has the property set to BYLAYER, it will be selected only if you set the search value to BYLAYER.
For example, if you search for a DASHED linetype, you will get only objects that have the linetype set to DASHED; you will not get objects that have that linetype because they reside on a layer with a DASHED linetype. To get these objects, you must set the search value to BYLAYER.
- Custom objects do not appear in the Object Type values list until you load the DBX module for the object.
- Because topology information is stored in object data, use a data condition to search for the following properties of topology objects: area, length, perimeter, direction, direct resistance, and reverse resistance.

See also:

- [Attaching Drawings](#) (page 154)
- [Combining Conditions](#) (page 368)
- [Bringing In Drawing Objects from AutoCAD Layers](#) (page 355)
- [Bringing In Drawing Objects by Object Class](#) (page 356)
- [Bringing In Drawing Objects Based on Topology](#) (page 367)
- [Bringing In Drawing Objects by Location](#) (page 358)
- [Bringing In Drawing Objects Based on Attached Data](#) (page 363)

- [Bringing in GIS Features](#) (page 303)

To bring in drawing objects based on object properties

NOTE This topic applies to AutoCAD drawing objects. To bring in geospatial data, see [procedures for bringing in geospatial data](#). (page 308).

- 1 Do one of the following:
 - In [Display Manager](#) (page 2060), click Data ► Add Drawing Data ► Query Current Drawing.
 - In Display Manager, click Data ► Add Drawing Data ► Query Source Drawing. Be sure you have [attached](#) (page 154) the DWG files to query.
 - In Display Manager, click Data ► Add Drawing Data ► Query Topology.
- 2 In the [Define Query dialog box](#) (page 1838), click Property.
- 3 In the [Property Condition dialog box](#) (page 1855), select a property.
- 4 Select an operator.
For some properties, such as layer, the only available operator is = (equal).
- 5 Enter a value for the property.
To select from a list of values, click Values. For example, if you select the layer property, click Values to display a list of layers in the drawings.
You can use wild-card characters to enter values for the following properties: Block Name, Color, Text Style, Object Type, Group, Layer, Feature Class, Linetype, and Plotstyle.
- 6 Click OK.
- 7 Optionally, define another condition. See [Combining Conditions](#) (page 369).
- 8 In the Define Query dialog box, click OK.

The new layer appears in Display Manager. Objects that meet the conditions of the query are included in this layer. To see the objects, you may need to zoom to the drawing extents. Click Map Setup tab ► Map panel ► Zoom

Drawing Extents. 

Quick Reference

New Display Manager Layer - Query

Creates a new query layer in Display Manager

Task Pane In Display Manager, click Data ► Add Drawing Data and then select a query type

Dialog Box Define Query dialog box

Bringing In Drawing Objects Based on Attached Data

NOTE This topic applies to AutoCAD drawing objects. To bring in geospatial data, see [Overview of Bringing In GIS Features](#) (page 305).

In your map, you can add a [drawing layer](#) (page 2060) in Display Manager that contains objects based on attribute data associated with the object, for example, object data or data in a linked external database. Select from objects in the current map, or from objects in attached drawings.

For example, if you have a linked database that lists pavement surfaces, you can select all objects with a gravel pavement surface.

TIP Combine a data condition with other conditions to create specific queries. For example, you could find all parcels that are zoned Residential and are within 500 yards of a contaminated well.

Notes

- You cannot retrieve objects based on constant block attributes.
- For Data queries, the Database Link option tests the link data stored on the object, not the data in the database table. To retrieve objects based on data in the linked database table, create a SQL condition.
- Because topology information is stored in object data, use a data condition to search for the following properties of topology objects: area, length, perimeter, direction, direct resistance, and reverse resistance.

See also:

- [Attaching Drawings](#) (page 154)

- [Combining Conditions](#) (page 368)
- [Bringing In Drawing Objects from AutoCAD Layers](#) (page 355)
- [Bringing In Drawing Objects by Object Class](#) (page 356)
- [Bringing In Drawing Objects Based on Topology](#) (page 367)
- [Bringing In Drawing Objects by Location](#) (page 358)
- [Bringing In Drawing Objects by Property](#) (page 361)
- [Bringing in GIS Features](#) (page 303)
- [To bring in drawing objects based on object data or external \(SQL\) data](#) (page 364)
- [To bring in drawing objects based on object data](#) (page 364)
- [To bring in drawing objects based on external \(SQL\) data](#) (page 365)

To bring in drawing objects based on object data or external (SQL) data

- [To select objects based on object data](#) (page 364)
- [To select objects based on external \(SQL\) data](#) (page 365)

To bring in drawing objects based on object data

NOTE This topic applies to AutoCAD drawing objects. To bring in geospatial data, see [procedures for bringing in geospatial data](#). (page 308).

- 1 Do one of the following:
 - In [Display Manager](#) (page 2060), click Data ► Add Drawing Data ► Query Current Drawing.
 - In Display Manager, click Data ► Add Drawing Data ► Query Source Drawing. Be sure you have [attached](#) (page 154) the DWG files to query.
 - In Display Manager, click Data ► Add Drawing Data ► Query Topology.
- 2 In the [Define Query dialog box](#) (page 1838), click Data.
- 3 In the [Data Condition dialog box](#) (page 1836), select the type of data to use.

- 4 Specify the location of the data.
 - To retrieve objects based on object class, in the Class list, select the object class of the objects to retrieve. Under Properties, select the specific properties to query.
 - To retrieve objects based on object data, select the table and field to query.
If two attached drawings have a table with the same name, AutoCAD Map 3D recognizes only the fields defined in the first drawing you activate.
 - To retrieve objects based on database link data, in the Link Template list, select the link template associated with the objects to retrieve. Under Key Columns, select the key column to query.
To search for objects in attached drawings, only link templates defined in your attached drawing are displayed in the list.
 - To retrieve objects based on block attribute information, in the Blocks list, select the block that contains the attribute tag information to query. Under Attribute Tags, select the attribute tag to query, or select * in the Blocks list to see a list of all the attribute tags of all the blocks in the active drawing.
- 5 Select an operator.
When you query database link data, only the = operator is available.
- 6 Enter the data value.
You can use wild-card characters for Value. For more information about wild cards, see [Wildcard Characters](#) (page 1537).
- 7 Click OK.
- 8 In the Define Query dialog box, click OK.

NOTE Before you execute a query with a SQL condition, verify that the appropriate data source is attached and connected.

To bring in drawing objects based on external (SQL) data

- 1 Do one of the following:
 - In [Display Manager](#) (page 2060), click Data ► Add Drawing Data ► Query Current Drawing.

- In [Display Manager](#) (page 2060), click Data ► Add Drawing Data ► Query Source Drawing. Be sure you have [attached](#) (page 154) the DWG files to query.
 - In [Display Manager](#) (page 2060), click Data ► Add Drawing Data ► Query Topology.
- 2 In the [Define Query dialog box](#) (page 1838), click SQL.
 - 3 In the [SQL Link Condition dialog box](#) (page 1866), select the link template for the table to search.
If you chose Attached Drawings in Step 1, the link template list includes only link templates for active attached drawings. If the link template is not listed, verify that it is defined in the attached drawing.
 - 4 Create a SQL condition by selecting a column, an operator, and a value. To type the condition, click Type Condition.
 - 5 Click Add Condition to add the condition to the Current SQL Condition list.
 - 6 To add more conditions, select And or Or. Create another condition.
 - 7 When you finish building the SQL condition, click OK.
 - 8 Optionally, define another condition. See [Combining Conditions](#) (page 369).
 - 9 In the Define Query dialog box, click OK.

The new layer appears in Display Manager. Objects that meet the conditions of the query are included in this layer. To see the objects, you may need to zoom to the drawing extents. Click Map Setup tab ► Map panel ► Zoom

Drawing Extents. 

Quick Reference

New Display Manager Layer - Query

Creates a new query layer in Display Manager

Task Pane In Display Manager, click Data ► Add Drawing Data and then select a query type

Bringing In Drawing Objects Based on Topology

NOTE This topic applies to AutoCAD drawing objects. To bring in geospatial data, see [Overview of Bringing In GIS Features](#) (page 305).

You can create a [drawing layer](#) (page 2060) in Display Manager that includes all the objects in a topology.

For example, to create a layer that includes all the objects in the Streets topology, select the STREETS topology.

You can organize layers into groups. Grouping layers lets you quickly turn off the display of all the objects in the group.

TIP To select just some of the objects in a topology, combine conditions. For example, you could find only the streets with four or more lanes.

See also:

- [Attaching Drawings](#) (page 154)
- [Combining Conditions](#) (page 368)
- [Bringing In Drawing Objects from AutoCAD Layers](#) (page 355)
- [Bringing In Drawing Objects by Object Class](#) (page 356)
- [Bringing In Drawing Objects by Location](#) (page 358)
- [Bringing In Drawing Objects by Property](#) (page 361)
- [Bringing In Drawing Objects Based on Attached Data](#) (page 363)
- [Creating Topologies](#) (page 821)

To bring in drawing objects based on topology

NOTE This topic applies to AutoCAD drawing objects. To bring in geospatial data, see [procedures for bringing in geospatial data](#). (page 308).

- 1 In [Display Manager](#) (page 2060), click Data ► Add Drawing Data ► Topology.

- 2 In the [Select Display Element dialog box](#) (page 1631), select the topologies that include the objects to display.
AutoCAD Map 3D creates a layer in Display Manager for each topology you select.
- 3 To group topology layers, select Group Selection.
If you combine the layers in a group, you can turn the display of the group on or off.
- 4 Click OK.

The new layer appears in Display Manager. All objects in the selected topology are included in this layer. If you selected multiple topologies, multiple layers are created. To see the objects, you may need to zoom to the drawing extents.

Click Map Setup tab ► Map panel ► Zoom Drawing Extents. 

Quick Reference

New Display Manager Layer - Topology

Creates a new topology layer in Display Manager

Task Pane	In Display Manager, click Data ► Add Drawing Data ► Topology
Dialog Box	Select Display Element dialog box

Combining Conditions

NOTE This topic applies to AutoCAD drawing objects. To bring in geospatial data, see [Overview of Bringing In GIS Features](#) (page 305).

You can combine query conditions to select specific drawing objects for a new [drawing layer](#) (page 2060) in Display Manager.

For example, you can combine a layer condition with a location condition to find utility lines in the West quadrant of a city.

You can select from objects in the current map, in attached drawings, or in a topology.

See also:

- [Attaching Drawings](#) (page 154)
- [Bringing In Drawing Objects from AutoCAD Layers](#) (page 355)
- [Bringing In Drawing Objects by Object Class](#) (page 356)
- [Bringing In Drawing Objects Based on Topology](#) (page 367)
- [Bringing In Drawing Objects by Location](#) (page 358)
- [Bringing In Drawing Objects by Property](#) (page 361)
- [Bringing In Drawing Objects Based on Attached Data](#) (page 363)

To bring in drawing objects by combining query conditions

NOTE This topic applies to AutoCAD drawing objects. To bring in geospatial data, see [procedures for bringing in geospatial data](#). (page 308).

- 1 Do one of the following:
 - In [Display Manager](#) (page 2060), click Data ► Add Drawing Data ► Query Current Drawing.
 - In Display Manager, click Data ► Add Drawing Data ► Query Source Drawing. Be sure you have [attached](#) (page 154) the DWG files to query.
 - In Display Manager, click Data ► Add Drawing Data ► Query Topology.
- 2 In the [Define Query dialog box](#) (page 1838), create the first condition by clicking Query Type.
 - Location — Selects objects based on their location. Click Zoom Ext to zoom to the extents of all active attached drawings.
 - Property — Selects objects based on an object property, such as layer, color, or area.
 - Data — Selects objects based on object class, object properties, database links, object data, or attributes.
 - SQL — Selects objects based on linked external data.

When you finish defining the condition, you return to the Define Query dialog box with the condition listed in the Current Query area.

- 3 Before you create the next condition, select a joining operator.
 - And — Finds objects only if both conditions are true.
 - Or — Finds objects if either condition is true.
 - And Not — Finds objects only if the first condition is true and the second condition is false.
 - Or Not — Finds objects if either the first condition is true or the second condition is false.
- 4 Create the next condition by clicking Query Type.
- 5 Continue to create conditions.
- 6 To group conditions, select the first and last condition in the group. Click Group. Conditions inside the parentheses are evaluated first.
- 7 When you finish defining conditions, click OK.

The new layer appears in Display Manager. Objects that meet the conditions of the query are included in this layer. To see the objects, you may need to zoom to the drawing extents. Click Map Setup tab ► Map panel ► Zoom

Drawing Extents. 

Quick Reference

New Display Manager Layer - Query

Creates a new query layer in Display Manager

Task Pane In Display Manager, click Data ► Add Drawing Data and then select a query type

Dialog Box Define Query dialog box

Bringing in Survey Data

AutoCAD Map 3D allows you to manage survey point data. You can import survey points in LandXML or ASCII format, view point data in the Point Table (a survey-point specific version of the [Data Table](#) (page 1613)), edit survey points, add points using coordinate geometry commands, and export points to

LandXML format. Using the bulk copy feature, you can also export points to another data store to create geospatial features.

Before you import survey data, [create](#) (page 1000) or [connect to](#) (page 1000) a Survey Data Store.

See also:

- [Working with Survey Data](#) (page 996)
- [To bring LandXML data into a Survey Data Store](#) (page 371)
- [To bring ASCII point data into a Survey Data Store](#) (page 373)
- [To bring LiDAR data into your map](#) (page 374)
- [To add a point cloud to your map](#) (page 376)
- [To add a point cloud to your map using the Point Cloud Manager](#) (page 376)
- [To create a point cloud layer for point cloud objects already in your map](#) (page 376)
- [To adjust the display density point clouds in your map](#) (page 377)

Bringing in LandXML Data

You can bring in survey point data in LandXML format. AutoCAD Map 3D supports LandXML versions 1.0, 1.1, and 1.2.

When you import a LandXML file into AutoCAD Map 3D, it appears in the survey tree as a Project. Projects are the primary organizational group within a survey data store.

See also:

- [Overview of Working with Survey Data](#) (page 997)
- [Working with Survey Data Stores](#) (page 999)
- [Working with Projects](#) (page 1001)
- [Exporting Survey Points to a LandXML File](#) (page 1471)

To bring LandXML data into a Survey Data Store

- 1 [Create](#) (page 1000) or [connect to](#) (page 1000) a Survey Data Store.
- 2 On the Survey tab of the Task Pane, click Data ► Import LandXML. The Import LandXML dialog box appears.

- 3 Browse to and select the LandXML file you want to import.
- 4 Click Open.
 - If AutoCAD Map 3D cannot recognize the coordinate system of your LandXML data, the [LandXML Coordinate System dialog box](#) (page 1717) appears. Assign a coordinate system by entering the appropriate coordinate system code or selecting one from a list, then click OK.
- 5 The LandXML file is brought into your Survey Data Store.

Quick Reference

Import LandXML Data

Import LandXML data to a survey data store.

Task Pane On the Survey tab, right-click a survey data store ►
 Import LandXML -or- On the Survey tab, click Data
 ► Import LandXML

Bringing in ASCII Point Data

You can bring in survey point data in a variety of ASCII formats. ASCII survey point data can be brought in to any node in the survey tree.

Select the format of the source data using the Format drop-down list in the [Import ASCII Points dialog box](#) (page 1716). Formats describe the layout of the data in your source files using the following convention:

- P is point ID
- E is Easting, or longitudinal values
- N is Northing or latitudinal values
- Z is elevation values
- D is description



Make sure that you select the correct format plus delimiter type (comma or space) for your data source.

The Autodesk Uploadable File format is as follows: PNEZD (Point Identification, Y, X, Z, Description). It is a comma-separated format, and uses the # character for comment text.

See also:

- [Overview of Working with Survey Data](#) (page 997)
- [Working with Survey Data Stores](#) (page 999)

To bring ASCII point data into a Survey Data Store

- 1 [Create](#) (page 1000) or [connect to](#) (page 1000) a Survey Data Store.
- 2 Right-click any node in the Survey Tree on the Survey tab of the Task Pane.
- 3 Select Import ASCII Points. The [Import ASCII Points dialog box](#) (page 1716) appears.
- 4 In the File Location section, click . The Import ASCII File dialog box appears.
- 5 Browse to and select the ASCII file you want to import, then click Open.
- 6 In the Formatting section, select the data format and Z-Unit (elevation unit) for the file. Valid elevation units are meters, US feet, international feet, and chains.
- 7 The Preview section will show a sample of the data you are about to import. Check the preview to verify that you have selected the correct file and formatting.
- 8 In the Coordinate System Assignment section, enter the coordinate system of the file you are importing. Click  to select the coordinate system from a list.
- 9 Click OK. The ASCII point data is brought into your Survey Data Store.

Quick Reference

Import ASCII Point Data

Import ASCII point data to a survey data store.

Task Pane	On the Survey tab, right-click a survey data store ► Import ASCII Points.
Dialog Box	Import ASCII Points dialog box

Bringing in LiDAR Data

You can bring [LiDAR](#) (page 2066) [point cloud](#) (page 2071) data into your map using the [Point Cloud Manager](#) (page 1897). Point clouds are large data sets composed of 3D point data. Geographic LiDAR data is most commonly available in [LAS](#) (page 2066) (LiDAR Aerial Survey) or ASCII (.xyz) format. AutoCAD Map 3D 2011 accepts LiDAR data in either LAS version 1.2 or space-delimited ASCII text (.xyz) format.

See also:

- [Overview of Point Clouds](#) (page 1012)
- [Overview of LiDAR Data](#) (page 1012)
- [Using LiDAR Data to Create a Point Cloud Data Store](#) (page 1019)
- [Managing LiDAR Data](#) (page 1015)
- [Exporting Point Cloud Data](#) (page 1451)

To bring LiDAR data into your map

- 1 Click Create tab ► Point Cloud panel ► Index File.
- 2 In the [Point Cloud Manager](#) (page 1897), click Add File. The Open dialog box appears.
- 3 Select the file or files to bring in.
- 4 Click Open.
The files appear in the Point Cloud Manager.

Quick Reference

MAPPOINTCLOUDMANAGER

Creates and manages indexed point cloud data stores.

Command Line MAPPOINTCLOUDMANAGER

Dialog Box Point Cloud Manager

Bringing in Point Cloud Data

You can bring point cloud data into your map from an indexed point cloud data store or from a point cloud drawing object. Point clouds appear as layers in the Display Manager and as AutoCAD drawing objects in your map. For more information on working with AutoCAD drawing objects, see [Working with Drawing Objects](#) (page 727).

You can add point clouds from indexed point cloud data stores created in AutoCAD Map 3D or in AutoCAD. Index files created in AutoCAD Map 3D have the .ISD file extension. Index files created in AutoCAD have the .PCG file extension.

If you are using a point cloud drawing object in your map that was created using AutoCAD Civil 3D, you will not be able to view the point cloud styling applied by AutoCAD Civil 3D unless you download and install the AutoCAD Civil 2010 object enabler. You can get the AutoCAD Civil 2010 object enabler from the Autodesk website:

<http://usa.autodesk.com/adsk/servlet/ps/dl/item?siteID=123112&sid=13084151&linkID=9240858>.

You can add, merge, and filter indexed point cloud data store files using the [Point Cloud Manager](#) (page 1897).

After you add point clouds to your map, you can adjust the density of the points displayed in your map using the Points Display slider. The density setting of the Points Display slider applies to all point clouds in your map. You do not need to set the display density for each point cloud individually.

See also:

- [Overview of Point Clouds](#) (page 1012)
- [Overview of LiDAR Data](#) (page 1012)
- [Overview of Point Cloud Files and Objects](#) (page 1013)
- [Bringing in LiDAR Data](#) (page 374)
- [Using LiDAR Data to Create a Point Cloud Data Store](#) (page 1019)
- [Creating Surfaces From Point Cloud Data](#) (page 1021)

- [Filtering Point Cloud Data](#) (page 1024)
- [Exporting Point Cloud Data](#) (page 1451)

To add a point cloud to your map

- 1 In the Display Manager, click Data ► Add Point Cloud Data ► From Index File.
- 2 In the Select Point Cloud Index dialog box, select the index file for the point cloud data store to add to your map
- 3 Click Open.
AutoCAD Map 3D adds a point cloud layer to the Display Manager, and add the point cloud drawing object to your map.

To add a point cloud to your map using the Point Cloud Manager

NOTE You cannot add point cloud index files created in AutoCAD (.PCG files) using the Point Cloud Manager.

- 1 In the Point Cloud ribbon tab, click Index File to display the [Point Cloud Manager](#) (page 1897), or enter *mappointcloudmanager* at the command prompt.
- 2 Click Add File. The Open dialog box appears.
- 3 Select the .ISD files you want to bring in.
- 4 Click Open.
The files are added to the Point Cloud Manager. You can now create merge files and filter your point cloud data the same way you [work with LiDAR data](#). (page 1015)

To create a point cloud layer for point cloud objects already in your map

- 1 Click Data ► Add Drawing Data ► Point Cloud.
- 2 In the Select Point Cloud dialog box, select the point cloud object or objects.
- 3 To add point cloud objects to a Display Manager group, select Group Selection.
- 4 Click OK.

AutoCAD Map 3D adds a point cloud layer to the Display Manager.

To adjust the display density point clouds in your map

- 1 Click Create ribbon tab ► Point Cloud Panel ► Point Cloud drop-down list.
- 2 Adjust the Point Cloud Density slider to the right to increase the display density of your point cloud objects. Adjust the slider to the left to decrease the display density.
- 3 Alternately, at the command prompt enter *pointclouddensity*, then enter a value from 1 through 100.

Quick Reference

MAPPOINTCLOUDMANAGER

Creates and manages indexed point cloud data stores.

Command Line MAPPOINTCLOUDMANAGER

Dialog Box Point Cloud Manager

Converting Data From Other Formats to Drawing Objects

You can import maps from other formats into AutoCAD Map 3D. The imported data is brought into the current drawing and the geometry is converted to drawing objects. The attribute data and display options associated with the objects can also be imported.

In addition, you can specify an area of the map to import, assign incoming objects to existing object classes, and automatically perform a coordinate conversion on the objects as they are imported.

When you directly access data through FDO (using Data Connect), you make all edits and changes directly to the source. When you import data, you bring in a copy of the data and you cut the connection to the data source. Your changes are made only to the copy in your map.

NOTE Data you import becomes AutoCAD drawing objects in your map. To connect to the data in its original format, see [Overview of Bringing In GIS Features](#) (page 305). To convert the drawing objects to a geospatial format, see [Overview of Converting and Exporting](#) (page 1405).

See also:

- [Supported Import Formats](#) (page 387)
- [Bringing in GIS Features](#) (page 303)
- [Converting and Exporting](#) (page 1403)
- [Digitizing Maps](#) (page 1617)

NOTE Data you import becomes AutoCAD drawing objects in your map. To connect to the data in its original format, see [Overview of Bringing In GIS Features](#) (page 305). To convert the drawing objects to a geospatial format, see [Overview of Converting and Exporting](#) (page 1405).

- [To import data from other formats](#) (page 381)
- [To style drawing data on import](#) (page 385)
- [To specify an area to import](#) (page 418)
- [To specify an AutoCAD layer during import](#) (page 419)
- [To assign an object class to an input layer](#) (page 421)
- [To perform a coordinate conversion](#) (page 424)
- [To specify the data to import](#) (page 426)
- [To specify how to import points](#) (page 428)
- [To import polygons](#) (page 430)
- [To create centroids for polygons and closed polylines](#) (page 433)
- [To import objects with links to an external database](#) (page 434)
- [To import a file with attribute data and display the data as text](#) (page 435)

Overview of Converting Geospatial Data to Drawing Objects

During import, AutoCAD Map 3D copies data from the input file into the active AutoCAD Map 3D drawing and converts the data to drawing objects.

Connecting to Data Directly vs. Importing

You can work with your data using Data Connect or by importing it.

When you use Data Connect (from Display Manager), you view and edit data in its source. Edits are saved back to the source. The data stays in its original location.

When you import data, you make a copy of the data and bring that copy into your map. When you edit the data, you are editing the copy. The original data is unchanged.

For some formats, such as MicroStation Design (DGN), Arc/INFO, and SDF 2 (Autodesk MapGuide 6.5 and earlier), you can only import and export the data. For most other formats, you can either connect directly to the data or use import and export.

For more information, see [Overview of Bringing In GIS Features](#) (page 305).

Before You Import a File

Before you import a file, determine the following:

- Determine whether to limit the import to the current display area or to an area that you define.
- Decide where to put objects: on an existing layer in the map, on a new layer, or on a layer specified in the file you are importing.
- Determine which incoming data values to use to populate the object class data fields, and decide how to handle data values that do not fall within the acceptable object class range (keep them as-is or assign them default object class values).
- Assign a coordinate system to the current AutoCAD Map 3D drawing. You need to know which coordinate system is used with the input files.
- Determine whether to import the data as object data or as external data, and whether to use an existing table or create a new one.
- Import point objects as points, text, or blocks. When you import as blocks, be sure you have copied the block you want into the AutoCAD Map 3D drawing.

Supported Formats

For information on importing specific formats, see the following:

- [Importing Autodesk SDF \(Spatial Data Files\)](#) (page 387) (version 3, MapGuide Enterprise)
- [Importing Autodesk SDF 2](#) (page 389)

- [Importing DXF Files](#) (page 391)
- [Importing ESRI Arc/INFO Coverages](#) (page 394)
- [Importing From ESRI ArcSDE](#) (page 391)
- [Importing ESRI Shape Files](#) (page 397)
- [Importing Geographic Markup Language \(GML\) Files](#) (page 412)
- [Importing MapInfo MIF/MID Files](#) (page 400)
- [Importing MapInfo TAB Files](#) (page 402)
- [MicroStation Design \(DGN\) Versions 7 and 8](#) (page 405)
- [Oracle](#) (page 409)
- [Importing SDTS \(Spatial Data Transfer Standard\) Files](#) (page 413)
- [Importing VPF \(Vector Product Format\) Files](#) (page 416)

Tell me more



Procedure

- [To bring in drawing objects from AutoCAD layers in the current drawing](#) (page 356)
- [To bring in drawing objects based on object classes in the current drawing](#) (page 357)
- [To bring in drawing objects based on location](#) (page 359)
- [To bring in drawing objects based on object properties](#) (page 362)
- [To bring in drawing objects based on object data or external \(SQL\) data](#) (page 364)
- [To bring in drawing objects based on topology](#) (page 367)



Tutorial

- [Lesson 4: Import SDF Files as DWG Layers](#)
-



Workflow

- Send GIS Data to AutoCAD



Related topics

- [Converting and Exporting](#) (page 1403)
- [Bringing in GIS Features](#) (page 303)

NOTE Data you import becomes AutoCAD drawing objects in your map. To connect to the data in its original format, see [Overview of Bringing In GIS Features](#) (page 305). To convert the drawing objects to a geospatial format, see [Overview of Converting and Exporting](#) (page 1405).

To import data from other formats

- 1 Do one of the following:

- Import data from an Oracle or ArcSDE data source. Click Insert



tab ► Import panel ► Map Import.

You cannot use the rest of this procedure. Instead, see [Importing From Oracle](#) (page 409) or [Importing From ESRI ArcSDE](#) (page 391).

- Import an SDF file. Click Insert tab ► Import panel ► Map Import .



- If you are importing an Autodesk SDF 2 file, click Insert tab ► Import panel ► SDF2.

Do not follow the rest of this procedure. Instead, see [Importing Autodesk SDF 2](#) (page 389).

- Import a DXF file. Click  ► Open ► Drawing. Change Files of Type to DXF.

Select the file you want and click Open. Do not follow the rest of this procedure.

- Import any other file type. Click Insert tab ► Import panel ► Map



Import .

Continue with the following steps.

- 2 In the Import Location dialog box, under Files Of Type, select the format of the map to import.
- 3 Select the file or folder to import. Click OK.
- 4 For formats with additional options, in the Import dialog box, click Driver Options.

For more information about the formats with additional options and their associated driver options, see one of the following:

- [Importing ESRI Shape Files](#) (page 397)
- [Importing ESRI Arc/INFO Coverages](#) (page 394)
- [Importing Geographic Markup Language \(GML\) Files](#) (page 412)
- [Importing MapInfo MIF/MID Files](#) (page 400)
- [Importing MapInfo MIF/MID Files](#) (page 400)
- [MicroStation Design \(DGN\) Versions 7 and 8](#) (page 405)
- [Importing SDTS \(Spatial Data Transfer Standard\) Files](#) (page 413)
- [Importing VPF \(Vector Product Format\) Files](#) (page 416)

NOTE Change any driver options before you modify other settings in the Import options dialog box. Changing driver options can invalidate other changes you have made in this dialog box.

- 5 In the [Import dialog box](#) (page 1711), under Spatial Filter, specify whether to limit the area where data will be imported:
 - None — Place no area limits on the incoming file.
 - Current Display — Limit the import to the current drawing area.
 - Define Window — Limit the import to an area you define. To use this option, click Select. Respond to the prompts to define the area.
- 6 Specify the import settings for each input layer (sometimes called a theme, level, or file).
 - [Drawing Layer](#) (page 419)— Select a target layer for each layer in the incoming file.
 - [Object Class](#) (page 421)— Assign incoming objects to an existing object class and map incoming attribute data to the data fields in the object class. The Object Class fields are available only if you have object

classes defined in your map. For more information about setting up object classes, see [Setting Up Object Classification](#) (page ?).

- [Input Coordinate System](#) (page 424)— Specify the coordinate system of the incoming file. If the AutoCAD Map 3D drawing has a coordinate system assigned to it, incoming objects are converted to the coordinate system of the drawing.
- [Data](#) (page 426)— For each layer, specify how to import data.
- [Points](#) (page 428)— For each layer, specify how to treat incoming point objects.

NOTE If you import points that you assigned to an object class with a creation method of Blocks, use the Points column to convert the points to blocks so the objects can be classified. Object classification does not automatically convert points to blocks.

- 7 By default, polygons are imported as polygon objects. To import them as closed polylines, select Import Polygons As Closed Polylines.
- 8 If you assigned incoming objects to object classes and want to use the object class defaults for any incoming data that is out of the defined object class range, select Use Class Defaults For Out Of Range Values. If you do not select this option, incoming data will be imported as is, which may include some out of range values. If you later view the data on the Object Class tab of the Properties palette, AutoCAD Map 3D automatically modifies the data, using defaults as needed, so that the data is in range and properly classified.
- 9 To save your settings as a profile, click Save. Saved profiles can be loaded when you import other files, and they can be used to automate command-line scripts.
- 10 Click OK to begin the import process.

If you cancel the Import operation, all objects imported prior to canceling will remain in the AutoCAD Map 3D drawing. You can delete these objects and any associated data.

Notes and Warnings

- To copy the contents of a field, right-click in the field to copy and click Copy. Right-click in the target field and click a Paste option. To copy the

contents of a field to all other layers, right-click in the field to copy and click Paste To All Layers.

- When pasting into Object Class fields, the object class name and the data mappings are pasted separately. The paste data mappings options are available only if the same fields exist in the incoming data for all mapped fields.
- You cannot copy a "By Data" or "ACAD_TEXT" setting.

Quick Reference

MAPIMPORT

Imports an external file format into AutoCAD Map 3D

Menu Click File ► Create DWG From ► Map 3D Import.

Icon  Import Map File

Command Line MAPIMPORT

Dialog Box Import dialog box

MAPIMPORTFDO

Import FDO data.

Menu Click File ► Create DWG From ► FDO Connection.

Command Line MAPIMPORTFDO



Styling Drawing Data Converted From a Geospatial Data Store

When you convert data from a geospatial format to DWG format, you can set up appropriate DWG layers and styling information for the incoming data automatically. This allows you to send out appropriately styled drawing files to AutoCAD users.

You use AutoCAD layers to set up the styles. You can also create blocks, linetypes, and other elements you need for styling. You save these items in a drawing template, and then create a new map using that template to hold the imported data.

NOTE Data you import becomes AutoCAD drawing objects in your map. To connect to the data in its original format, see [Overview of Bringing In GIS Features](#) (page 305). To convert the drawing objects to a geospatial format, see [Overview of Converting and Exporting](#) (page 1405).

To style drawing data on import

- 1 Create a drawing file in AutoCAD Map 3D that defines all the coordinate system, layers, blocks, linetypes, and other elements you need for styling.
 - In Map Explorer, right-click Current Drawing ► Coordinate System and specify the coordinate system.
 - Create layers. At the Command prompt, enter layer. For information about creating block and other elements, see the AutoCAD Help.
- 2 Change the properties of the layer to reflect the styling you want. For more information about styling layers, see [Overview of Styling Drawing Layers](#) (page 652).
- 3 Save the resulting drawing as a template (DWT) file.
 - Click  ► Save As ► AutoCAD Drawing Template.
 - In the Files Of Type list, choose AutoCAD Drawing Template (*.dwt).
 - Name and save the file.
 - Set the template options (English or Metric and New Layer Notification) and click OK. For more information about these options, see the AutoCAD Help.
- 4 When you are ready to import the data, create a new map using the template you created.
 - Click  ► New ► Drawing.
 - Select the template you created and click OK.
- 5 Import the data into the new file.
 - Click Insert tab ► Import panel ► Map Import . 

- Specify the file to import and click OK.
- 6 In the [Import dialog box](#) (page 1711), under Import Properties For Each Layer Imported, specify the import settings for each input layer (sometimes called a theme, level, or file).
- [Drawing Layer](#) (page 419)— Select a target layer for each layer in the incoming file.
 - [Object Class](#) (page 421)— Assign incoming objects to an existing object class and map incoming attribute data to the data fields in the object class. The Object Class fields are available only if you have object classes defined in your map. For more information about setting up object classes, see [Setting Up Object Classification](#) (page ?).
 - [Input Coordinate System](#) (page 424)— Specify the coordinate system of the incoming file. If the AutoCAD Map 3D drawing has a coordinate system assigned to it, incoming objects are converted to the coordinate system of the drawing.
 - [Data](#) (page 426)— For each layer, specify how to import data.
 - [Points](#) (page 428)— For each layer, specify how to treat incoming point objects.

NOTE If you import points that you assigned to an object class with a creation method of Blocks, use the Points column to convert the points to blocks so the objects can be classified. Object classification does not automatically convert points to blocks.

7 Click OK.

- 8 Click Map Setup tab ► Map panel ► Zoom Drawing Extents. 
- The imported objects use the styling information specified in your template.

Quick Reference

MAPIMPORT

Imports an external file format into AutoCAD Map 3D

Menu	Click File ► Create DWG From ► Map 3D Import.
Icon	 Import Map File
Command Line	MAPIMPORT
Dialog Box	Import dialog box

Supported Import Formats

Importing Autodesk SDF (Spatial Data Files)

SDF is a native Autodesk file-based geospatial format that is optimized for storing large, classified data sets. You can [connect to SDF files](#) (page 338) to edit the original data in its source, or import it to convert the data into AutoCAD drawing objects. Once you import data, the connection to the original source is lost. If you update the source, your changes will not appear in the imported copy.

SDF is similar to SHP format in that it contains both spatial data and attribute data. However, unlike SHP, it stores both types of data in a single file rather than a set of files.

When drawing data is stored as SDF, you can use Autodesk MapGuide Enterprise 2007 to style and publish the data to the Internet. You can also [publish map data directly to MapGuide](#) (page 1376), without exporting to SDF.

Versions

The current version, which works with AutoCAD Map 3D and Autodesk MapGuide Enterprise, is SDF version 3. AutoCAD Map 3D refers to this version as “SDF.”

SDF version 2 is still supported by MapGuide 6.5 (and earlier releases), and AutoCAD Map 3D can import and export SDF 2 using a separate import/export interface.

Advantages

SDF has the following advantages over DWG:

- It stores and manages an order of magnitude more data than DWG

- It is very fast, allowing Autodesk applications, such as AutoCAD Map 3D and MapGuide, to read and display tens of thousands of features per second.
- It provides the power of a database without the overhead and cost of a full relational database management system (RDBMS) such as SQL Server or Oracle.
- An SDF file can store a single feature class, or it can store multiple feature classes.
- It is easy to manage, providing access to the database schema.

Importing

When importing SDF, you can import each feature class in the SDF to a separate layer. You can specify how you want to bring in attribute data and points. You can also set an option to import polygons as closed polylines.

Driver Options

SDF has no import driver options.

See also:

- [Customizing the Import and Export .ini Files](#) (page 264)

NOTE Data you import becomes AutoCAD drawing objects in your map. To connect to the data in its original format, see [Overview of Bringing In GIS Features](#) (page 305). To convert the drawing objects to a geospatial format, see [Overview of Converting and Exporting](#) (page 1405).

To import an SDF file

- [Import from SDF](#) (page 381) – Imports from SDF (version 3).
- [Import from SDF 2](#) (page 389)– Imports from SDF (version 2).

To access and work with SDF

- [Connect to SDF](#) (page 338)– Allows you to view and edit the SDF data live in its native format (SDF version 3).

Quick Reference

MAPIMPORT

Imports an external file format into AutoCAD Map 3D

Menu Click File ► Create DWG From ► Map 3D Import.

Icon  Import Map File

Command Line MAPIMPORT

Dialog Box Import dialog box

Importing Autodesk SDF 2

While importing SDF 2 files (Autodesk MapGuide 6.5 and earlier), you can perform coordinate conversions, create object data tables from the key, name, and URL fields, and create hyperlinks on imported objects. Import a selected portion of the SDF by specifying four corner points of an area.

NOTE SDF 2 files can only be imported (and exported). They cannot be accessed using Data Connect. However, SDF 3 files, using the new MapGuide technology, use Data Connect. For information, see [To bring in features from SDF](#) (page 338).

See also:

- [Importing Autodesk SDF \(Spatial Data Files\)](#) (page 387)
- [Exporting DWG Data to SDF2 Format](#) (page 1417)
- [Bringing In Features from SDF](#) (page 337)

NOTE Data you import becomes AutoCAD drawing objects in your map. To convert the drawing objects to a geospatial format, see [Overview of Converting and Exporting](#) (page 1405).

To import SDF 2 files

- 1 In the Tool-based Ribbon Workspace, click Insert tab ► Import

panel ► SDF2. 

- 2 In the Autodesk MapGuide Import dialog box, select a file. Click Open.
- 3 In the [Autodesk MapGuide Import dialog box](#) (page 1582), under Import Layer, select the target AutoCAD layer for the SDF information.
To create a new AutoCAD layer, click Create New Layer. In the [New Layer dialog box](#) (page 1579), specify a name for the new layer.
- 4 Under Coordinate Conversion, select Convert From. Enter a coordinate system code.
To select the code from a list, click Select Coordinate System.
- 5 Under Data Elements, select Assign To Object Data Table. Specify the object data table and fields.
To create a new table or field, click Create New Table or Create New Field.
In the [Define New Object Data Table dialog box](#) (page 1803) or [Define New Object Data Field dialog box](#) (page 1578), specify the information for the new table or field.
- 6 Optionally, under Data Elements, select Create Hyperlinks From URL.
- 7 Under Import By Location, select Define An Area To Import From The SDF File and enter the coordinates for the area to import.
The coordinates must be in the coordinate system of the SDF file.
- 8 To save your settings as a profile, click Save.
- 9 Click OK.
The objects in the SDF file are imported into the drawing.

Quick Reference

MAPSDFIN

Imports an SDF 2 format file from Autodesk MapGuide 6.5 or earlier

Menu	Click File ► Create DWG From ► Autodesk SDF 2 (MapGuide 6.x).
Command Line	MAPSDFIN
Dialog Box	Autodesk MapGuide Import dialog box

Importing DXF Files

You can use DXF files created by other applications to bring information into AutoCAD Map 3D. When you import objects from DXF files, they do not have links to other objects or to data. For example, a polygon that encloses a parcel ID is not linked to the parcel ID except visually. Data imported from a DXF file does not have any links to object data or external databases.

You cannot attach a source drawing to a DXF file or attach DXF files to another drawing.

See also:

- [Saving Drawing Objects to a DXF File](#) (page 1458)

To import a DXF file

- 1 Click  ► Open ► Drawing.
- 2 In the Select File dialog box, under Files Of Type, select DXF (*.dxf).
- 3 Select the file. Click Open.

Quick Reference

OPEN

Opens an existing drawing file

Menu File menu ► Open

Icon  Open Drawing

Command Line OPEN

Importing From ESRI ArcSDE

You can import data from a connected ESRI ArcSDE database into your map DWG. Using this option, your data will be imported as drawing objects. The data will be a snapshot of your ArcSDE data. Once you import data, the connection to the original source is lost. If you update the source, your changes will not appear in the imported copy.

You can also [connect to a live ArcSDE database](#) (page 319) to edit the original data in its source (edits will go into the database).

See also:

- [Bringing In Features from ArcSDE](#) (page 316)

To import data from an ESRI ArcSDE data source

NOTE You can also [connect to a live ArcSDE database](#) (page 319) to edit the original data in its source (edits will go into the database).

- 1 Before moving ArcSDE data into your map, assign a coordinate system to the map. This lets you position your data accurately in a real-world geographic location and align imported survey or GPS point data.
- 2 In [Display Manager](#) (page 2060), click Data ► Connect To Data.
For more information, see [Bringing In Features from ArcSDE](#) (page 316)

NOTE Follow the steps up until clicking Connect; then stop. Do not add the features to your map.

- 3 At the Command prompt, enter mapimportfdo.
- 4 In the Map Import From FDO dialog box, select the ArcSDE data source connection from which to import data.
- 5 Click OK.
- 6 In the [Import dialog box](#) (page 1711), review the Current Drawing Coordinate System to make sure it is correct.
- 7 Under Spatial Filter, specify whether to limit the area where data will be imported:
 - None — Place no area limits on the incoming file.
 - Current Display — Limit the import to the current drawing area.
 - Define Window — Limit the import to an area you define. To use this option, click Select. Respond to the prompts to define the area.
- 8 Specify the import settings for each input layer:
 - [Drawing Layer](#) (page 419)— Select a target layer for each layer in the incoming file.

- [Object Class](#) (page 421)— Assign incoming objects to an existing object class and map incoming attribute data to the data fields in the object class. The Object Class fields are available only if you have object classes defined in your map. For more information about setting up object classes, see [Setting Up Object Classification](#) (page ?).
- [Input Coordinate System](#) (page 424)— Specify the coordinate system of the incoming file. If the AutoCAD Map 3D drawing has a coordinate system assigned to it, incoming objects are converted to the coordinate system of the drawing.
- [Data](#) (page 426)— For each layer, specify how to import data.
- [Points](#) (page 428)— For each layer, specify how to treat incoming point objects.

NOTE If you are importing points and have assigned them to an object class with a creation method of Blocks, you must use the Points column to convert the points to blocks so that the objects can be classified. Object classification does not convert points to blocks for you.

- 9 By default, polygons are imported as polygon objects. To import them as closed polylines, select Import Polygons As Closed Polylines.
- 10 If you assigned incoming objects to object classes and want to use the object class defaults for any incoming data that's out of the defined object class range, select Use Class Defaults For Out Of Range Values.
If you do not select this option, incoming data will be imported as is, which may include some out of range values. If you later view the data on the Object Class tab of the Properties palette, AutoCAD Map 3D automatically modifies the data, using defaults as needed, so that the data is in range and properly classified.
- 11 To save your settings as a profile, click Save. These saved profiles can be loaded when you import other files, and they can be used to automate command-line scripts.
- 12 Click OK to begin the import process.
If you cancel the import operation, all objects imported prior to canceling will remain in the AutoCAD Map 3D drawing. You can delete these objects and any associated data.

Quick Reference

MAPIMPORTFDO

Import FDO data.

Menu Click File ► Create DWG From ► FDO Connection.

Command Line MAPIMPORTFDO

Importing ESRI Arc/INFO Coverages

ESRI Arc/INFO coverages can only be imported (and exported). They cannot be accessed using Data Connect. AutoCAD Map 3D supports Arc/INFO version 7.2, 7.3, and 8.x, and E00.

Importing

Arc/INFO stores coverages on your hard disk as a directory of files.

In the coverage directory, each file contains specific data pertaining to the coverage. For example, ARC files contain coordinates for arcs and LAB files contain the coordinates for label points.

NOTE ARC files also contain TIC and Bounds settings. For import, these are driver options, and are not imported or displayed by default. Tics are points with known real-world coordinates. Coverages use tics to ensure that stacked coverages and adjoining tiled coverages align accurately.

The following table shows how coverage features are translated to drawing objects on import:

Coverage Feature	Drawing Object
Point	Point on <i>_point</i> layer, PAT attributes in object data or in an external database.
Arc	Sketch on <i>_arc</i> layer, AAT attributes in object data or in an external database.
Polygon	Closed polyline on <i>_poly</i> layer, PAT in object data attached to polyline. In addition, all segments are duplicated as sketches on the <i>_arc</i> layer.

Coverage Feature	Drawing Object
Point, Arc, and Polygon with FAT (feature allocation table) in dBASE	Geometry converted as above, attribute in object data.
Annotation	Text on <i>_text</i> layer. Text arrows on <i>_textarrow</i> layer.
Tics	Points on <i>_tic</i> layer, attributes in object data.

Importing Restrictions

The following features are not supported when importing an ARC/INFO coverage into a drawing:

- feature attribute tables
- text attributes
- route systems
- address files
- turntables
- LOG files
- fonts
- symbols
- linetypes
- shades

If a coverage has a field that describes Z values, commonly SPOT or ELEVATION, the field is treated only as an attribute. It is not translated into a Z value. You may be able to use a property alteration query to change the elevation of the resulting drawing objects. (This will depend on the object type. Elevation is not supported for all object types.)

When importing polygon coverages, polygon areas may be imported as closed polylines. If you plan to recreate the topology in AutoCAD Map 3D, use the MAPCREATECENTROIDS command to create centroids and move any attribute data from the polyline or polygon to the centroids. Use the *_arc* layer to create the topology using the topology commands.

In addition, AutoCAD Map 3D supports the coverage exchange format E00.

Driver Options

You can set the following options when importing ARC/INFO coverages or E00 files:

Option	Description
Text Curves	Select Follow, Fit, or Ignore.
Optional Feature Types	Select Extract Bounds, or Extract Tics.

See also:

- [Customizing the Import and Export .ini Files](#) (page 264)
- [Exporting To ESRI Arc/INFO Coverages](#) (page 1419)

NOTE Data you import becomes AutoCAD drawing objects in your map. To convert the drawing objects to a geospatial format, see [Overview of Converting and Exporting](#) (page 1405).

- [To import from Arc/INFO](#) (page 396)
- [To recreate an Arc/INFO topology in AutoCAD Map 3D](#) (page 396)

To import from Arc/INFO

- [Use the Import instructions.](#) (page 381)

To recreate an Arc/INFO topology in AutoCAD Map 3D

- 1 Use the MAPCREATECENTROIDS command to [create centroids](#). (page 885)
- 2 [Move any attribute data from the polyline or polygon to the centroids](#) (page 885)
- 3 Use the _arc layer to create the topology using the topology commands.

Quick Reference

MAPIMPORT

Imports an external file format into AutoCAD Map 3D

Menu	Click File ► Create DWG From ► Map 3D Import.
Icon	 Import Map File
Command Line	MAPIMPORT
Dialog Box	Import dialog box

Importing ESRI Shape Files

AutoCAD Map 3D supports up to ArcView version 3.2 and 8.x.

About SHP Files

ESRI SHP files store both geometry and attributes (data) for features. A single shape can have as many as five physical files with the same filename, but different file extensions:

- *.shp*— Geometric data. Data for multiple points, polylines, and polygons can be stored in one SHP file, but each SHP file can store only one type of geometry. For example, a line SHP file can contain data for rivers, roads, and pipes.
- *.shx* — A geometric index to the map features, which can be used by some applications to find features in disparate sections of a large map.
- *.dbf*— Attribute data associated with the map features.
- *.prj*—Projection and coordinate system data. This file is created only if your map has an assigned coordinate system.
- *.idx*—Identifies the index field for the related SHP file, which is the unique identifier for each entity in the SHP file.

Importing

You can [connect to SHP files](#) (page 336) to edit the original data in its source, or import it to convert the data into AutoCAD drawing objects. Once you import data, the connection to the original source is lost. If you update the source, your changes will not appear in the imported copy.

By default, AutoCAD Map 3D considers SHP files a multi-select, file-based format, that is, you select one or more individual *.shp* files during a single import process. You can change the default in the *mapimport.ini* file so that AutoCAD Map 3D considers SHP files a folder-based format (all files in the

folder are included in the import) or a single-select format (only one file can be selected for import).

When you connect to or import SHP data, AutoCAD Map 3D checks the geometry to see if there are multiple closed outer loops. If so, it treats the geometry as multi-polygon (a polygon with multiple exterior rings). It does not treat unclosed outer loops as multi-polygon.

When you create a multi-polygon in AutoCAD Map 3D and then save or export it to SHP format, it will appear in its native SHP file as a multi-polygon.

When importing SHP files, it is important that you have the complete set of *.shp*, *.shx*, and *.dbf* in the same folder. The import operation will work if you have only the *.shp* file, but only the geometries will be imported. To import data with its geometry, you need the full set of files.

The link to the data stored in the *.dbf* file can be maintained during the import operation, or the data can be imported into object data in the AutoCAD Map 3D drawing.

You can import TEXTSTRING information from SHP classes you bring back into AutoCAD Map 3D by importing points as text.

Import Restrictions

SHP files do not include color information. Imported objects have the same color as the AutoCAD Map 3D layer.

Point symbols, line styles, and fill styles are not maintained when importing from SHP files. Before the translation, put these items into one or more fields in the associated database so you can reassign the display properties of the graphical objects using these values in the drawing file.

Driver Options

SHP does not have import driver options.

See also:

- [Customizing the Import and Export .ini Files](#) (page 264)
- [Specifying How to Import Points](#) (page 427)
- [Exporting to ESRI SHP](#) (page 1424)

NOTE Data you import becomes AutoCAD drawing objects in your map. To connect to the data in its original format, see [Overview of Bringing In GIS Features](#) (page 305). To convert the drawing objects to a geospatial format, see [Overview of Converting and Exporting](#) (page 1405).

- [To import SHP data](#) (page 399)
- [To change the single file/folder default setting for SHP files](#) (page 399)
- [To access and work with SHP files](#) (page 399)

To import SHP data

- [Use the Import instructions.](#) (page 381)

To change the single file/folder default setting for SHP files

- Modify the settings in the *mapimport.ini* file.
For more information, see [To export to SHP as folder-based rather than file-based](#) (page 269)

To access and work with SHP files

- [Connect to SHP](#) (page 335) – Allows you to view and edit the SHP live in its native format
- [Bulk Copy](#) (page 615) – Move data to and from SHP to other geospatial data stores.

To import TEXTSTRING information from SHP classes you bring back into AutoCAD Map 3D

- Select the import option to import points as text. See [Specifying How to Import Points](#) (page 427).

Quick Reference

MAPIMPORT

Imports an external file format into AutoCAD Map 3D

Menu Click File ► Create DWG From ► Map 3D Import.

Icon	 Import Map File
Command Line	MAPIMPORT
Dialog Box	Import dialog box

Importing MapInfo MIF/MID Files

MIF/MID is a file standard used by MapInfo, a desktop mapping system. AutoCAD Map 3D supports MapInfo up to version 7 MIF/MID files.

About MapInfo MIF/MID Files

MapInfo MIF/MID format stores both geometry and attributes (data) for features, and is a set of two physical files that work together:

- *.mif*— Vector geometric data. A single *.mif* file can contain many different types of geometry.
- *.mid*— Attributes for the geometric data.

Importing

MapInfo MIF/MID files can only be imported (and exported). They cannot be accessed using Data Connect. By default, AutoCAD Map 3D considers MapInfo MIF/MID a multi-select, file-based format, that is, you select one or more individual *.mif* files during a single import process. To change the default so that AutoCAD Map 3D considers MIF/MID a folder-based format (all files in the folder are included in the import) or a single-select format (only one file can be selected for import), modify the settings in the *mapimport.ini* file.

When you import MapInfo MIF/MID files, it is important that you have both the *.mif* and *.mid* files in the same folder.

Symbol types are similar to AutoCAD Map 3D point objects. You cannot import MIF/MID symbol types directly. However, if you store the symbol type information in a column in a MID file, you can map each symbol type to a block in the current AutoCAD Map 3D drawing. To do this, prepare the MIF file by putting the name of the symbol type into a field in the database. Prepare the AutoCAD Map 3D drawing by creating similar symbols as blocks in the AutoCAD Map 3D drawing. Then, during import, perform a point-block mapping and select the check box to get the block name from data and select the symbol type field you created.

In MapInfo, polygons are represented as closed areas. When you import polygons into AutoCAD Map 3D, they appear as polygons unless you select Import Polygons As Closed Polylines in the Import dialog box.

By default, object colors are imported to their closest ACI (AutoCAD Color Index) color. To import object colors using RGB (True Color), edit the *mapimport.ini* file.

To change the default text justification setting for MIF/MID, edit the *mapforeignfileproperties.ini* file.

Driver Options

MapInfo MIF/MID has no import driver options.

See also:

- [Customizing the Import and Export .ini Files](#) (page 264)
- [Exporting To MapInfo MIF/MID](#) (page 1431)

NOTE Data you import becomes AutoCAD drawing objects in your map. To convert the drawing objects to a geospatial format, see [Overview of Converting and Exporting](#) (page 1405).

- [To import from MapInfo MIF/MID](#) (page 401)
- [To change import settings for MapInfo MIF/MID](#) (page 401)
- [To import object colors using RGB \(True Color\)](#) (page 401)
- [To change the default text justification setting for MIF/MID](#) (page 402)

To import from MapInfo MIF/MID

- [Use the Import instructions.](#) (page 381)

To change import settings for MapInfo MIF/MID

- Edit the *mapimport.ini* file.
For more information, see [To edit the .ini file](#) (page 271).

To import object colors using RGB (True Color)

- Edit the *mapimport.ini* file.
For more information, see [To edit the .ini file](#) (page 272).

To change the default text justification setting for MIF/MID

- Edit the *mapforeignfileproperties.ini* file.
Use the [MIF_Justification] section to set justification for MIF. Allowed MIF Justifications are left, center, and right. For more information, see [To edit the .ini file](#) (page 274).

Quick Reference

MAPIMPORT

Imports an external file format into AutoCAD Map 3D

Menu Click File ► Create DWG From ► Map 3D Import.

Icon  Import Map File

Command Line MAPIMPORT

Dialog Box Import dialog box

Importing MapInfo TAB Files

MapInfo TAB, also referred to as the MapInfo native format, is a two-dimensional format that stores both feature geometry and attributes (data) in a set of physical files that have the following file extensions:

About MapInfo TAB Files

- *.tab*— The main file for a MapInfo table. It is associated with the appropriate *.dat*, *.id*, *.map*, and *.ind* files.
- *.dat*— Tabular data for a table in MapInfo's native format.
- *.id*— An index to a MapInfo graphical objects *.map()* file.
- *.map*— Contains geographic information describing map objects.
- *.ind*— An index to a MapInfo tabular (*.dat*) file.

With AutoCAD Map 3D, you can import and export MapInfo TAB up to version 7.

Importing

MapInfo TAB files can only be imported (and exported). They cannot be accessed using Data Connect. By default, AutoCAD Map 3D considers MapInfo TAB a multi-select, file-based format, that is, you select one or more individual *.tab* files during a single import process. To change the default so that AutoCAD Map 3D considers MapInfo TAB a folder-based format (all files in the folder are included in the import) or a single-select format (only one file can be selected for import), modify the settings in the *mapimport.ini* file.

When you import MapInfo TAB files, it is important that you have the complete set of physical files (*.tab*, *.dat*, *.id*, *.map*, and *.ind*) in the same folder.

Symbol types are similar to AutoCAD Map 3D point objects. You cannot import TAB symbol types directly. However, if you store the symbol type information in a column in a DAT file, you can map each symbol type to a block in the current AutoCAD Map 3D drawing. To do this, prepare the TAB file by putting the name of the symbol type into a field in the database. Prepare the AutoCAD Map 3D drawing by creating similar symbols as blocks in the AutoCAD Map 3D drawing. Then, during import, perform a point-block mapping and select the check box to get the block name from data and select the symbol type field you created.

In MapInfo, polygons are represented as closed areas. When you import polygons, the polygons appear as polygons in AutoCAD Map 3D unless you select Import Polygons As Closed Polylines in the Import dialog box.

By default, object colors are imported to their closest ACI (AutoCAD Color Index) color. To import object colors using RGB (True Color), you must edit the *mapimport.ini* file.

To change the default text justification setting for TAB, edit the *mapforeignfileproperties.ini* file.

Driver Options

MapInfo TAB has no import driver options.

See also:

- [Customizing the Import and Export .ini Files](#) (page 264)
- [Exporting To MapInfo TAB](#) (page 1433)

NOTE Data you import becomes AutoCAD drawing objects in your map. To convert the drawing objects to a geospatial format, see [Overview of Converting and Exporting](#) (page 1405).

- [To import from MapInfo TAB](#) (page 404)
- [To import object colors using RGB \(True Color\)](#) (page 404)
- [To change the default text justification setting for MapInfo TAB](#) (page 404)

To import from MapInfo TAB

- [Use the Import instructions.](#) (page 381)

To import object colors using RGB (True Color)

- Edit the *mapimport.ini* file.
For more information, see [To edit the .ini file](#) (page 272).

To change the default text justification setting for MapInfo TAB

- Edit the *mapforeignfileproperties.ini* file.
Use the [MAPINFO_Justification] section to set justification for TAB.
Allowed TAB Justifications are left, center, and right. For more information, see [Customizing the Import and Export .ini Files](#) (page 264).

Quick Reference

MAPIMPORT

Imports an external file format into AutoCAD Map 3D

Menu Click File ► Create DWG From ► Map 3D Import.

Icon  Import Map File

Command Line MAPIMPORT

Dialog Box Import dialog box

MicroStation Design (DGN) Versions 7 and 8

You can import and export Microstation DGN version 7 and 8. Bentley Systems, Inc., and MicroStation programs use the DGN format. Like DWG, a single DGN file can contain points, lines, areas, text, and other object types.

Importing

Microstation DGN files can only be imported (and exported). They cannot be accessed using Data Connect. Data-element information is stored in an external database file and linked to graphic objects. AutoCAD Map 3D imports database link information so you can [maintain the linkage during import](#) (page 433).

By default, object colors are imported to their closest ACI (AutoCAD Color Index) color. To import object colors using RGB (True Color), edit the *mapimport.ini* file.

For DGN8, the Input Layer column lists the model name. To see the layers for a specific model, you may need to scroll the list.

Driver Options for DGN 7

You can set the following options when importing DGN 7 files:

Option	Description
Group Elements By	Choose Geometry to group incoming objects by entity type. Choose Level to group them by their DGN level or level name. Only levels that contain elements will be imported.
Linkage Extraction	Allows you to extract MSLinks and FRAMME attribute linkage values from the DGN 7 file. If you select MSLinks, AutoCAD Map 3D imports up to three links per object for DGN 7. For each link, two fields are added to the object data table: <i>mslinks_n</i> , which specifies the key value, and <i>entity_num_n</i> , which specifies the table. If you select FRAMME, the following fields are added to the object data table: <i>comp_count</i> , <i>comp_num</i> , <i>dgnfile</i> , <i>feat_num</i> , <i>state_num</i> , and <i>ufid</i> .
Coordinate Units	Each DGN 7 file defines a UOR (unit of resolution); in addition, it can define Sub units and Master units. Select Master or Sub to specify which of these units in the DGN 7 file matches the default unit in the AutoCAD Map 3D map. For example, if the default unit in your AutoCAD Map 3D map is meters, and meters are the Sub unit in the imported file, select Sub. If you

Option	Description
	<p>select Sub or Master, the UORs in the DGN 7 file are converted to Sub or Master units according to the conversion factor in the DGN file header.</p> <p>When you import the file, one Master or Sub unit (whichever you choose) will become one drawing unit in your AutoCAD Map 3D map. The Unit Ratio value indicates the ratio between the Master and Sub units. For example, if the ratio is 1:12 (as it would be for Feet/Inches), imported object coordinates will be scaled 12 times bigger if you select Sub.</p> <hr/> <p>NOTE When you import or export a DGN file with a master unit of Imperial feet, AutoCAD Map 3D converts the master unit from feet to meters. In addition, it does not recognize any subunit selection during the import or export process.</p>
Element Expansion	<p>Select the options to use during import. For example, select Explode Complex Strings to return each component of a complex chain as its own feature (no feature will be returned for the complex chain as a whole). Otherwise, all elements of the complex chain merge into a single linear feature, any arcs in the complex chain become linestrings, and any linkages on the component elements themselves are lost. Select Propagate Member Linkages to return the linkages attached to the first component of the complex chain to supplement any existing linkages. Otherwise, any linkages on the component elements themselves are lost and only linkages attached to the complex chain itself are returned.</p>
Cell Expansion	<p>By default, cells are converted into blocks, maintaining the cell grouping. You can choose to convert the cells to points instead. You can also explode the contents of the cells into their component parts, but the explosion is one level deep only.</p>
Reference Files	<p>Select Create DWG to read all external reference files (xrefs) attached to the source data set. If the reference file has nested references, they are also imported, but circular references are not. If you select this option, you specify a location for the folder for these files. If the folder already exists, you can choose to replace it (overwrite its contents) or cancel and specify a different location. The default folder location is the same as the selected DGN file location.</p>

Option	Description
	If you select Ignore, reference files are not imported and you cannot change the location of the folder.

Driver Options for DGN 8

You can set the following options when importing DGN 8 files:

Option	Description
Group Elements By	Choose Geometry to group incoming objects by entity type. Choose Level or Level Names to group them by their DGN level or level name. Only levels that contain elements will be imported.
Cell Expansion	By default, cells are converted into blocks, maintaining the cell grouping. You can choose to convert the cells to points instead. You can also explode the contents of the cells into their component parts, but the explosion is one level deep only.
Coordinate Units	<p>Each DGN 8 file can define Sub units and Master units. Specify which of these units in the DGN 8 file matches the default unit in the AutoCAD Map 3D map. For example, if the default unit in your AutoCAD Map 3D map is meters, and meters are the Sub unit in the imported file, select Sub.</p> <p>When you import the file, one Master or Sub unit (whichever you choose) will become one drawing unit in your AutoCAD Map 3D map. The Unit Ratio value indicates the ratio between the Master and Sub units. For example, if the ratio is 1:12 (as it would be for Feet/Inches), imported object coordinates will be scaled 12 times bigger if you select Sub.</p> <p>NOTE When you import or export a DGN file with a master unit of Imperial feet, AutoCAD Map 3D converts the master unit from feet to meters. In addition, it does not recognize any sub-unit selection during the import or export process.</p>
Element Expansion	Select the options to use during import. For example, select Explode Complex Strings to return each component of a complex chain as its own feature (no feature will be returned for the complex chain as a whole). Otherwise, all elements of the complex chain merge into a single linear feature, any

Option	Description
	arcs in the complex chain become linestrings, and any linkages on the component elements themselves are lost.
Linkage Extraction	Allows you to extract MSLinks and FRAMME attribute linkage values from the DGN 8 file. For each link, two fields are added to the object data table: <code>mslinks_n</code> , which specifies the key value, and <code>entity_num_n</code> , which specifies the table. If you select FRAMME, the following fields are added to the object data table: <code>comp_count</code> , <code>comp_num</code> , <code>dgnfile</code> , <code>feat_num</code> , <code>state_num</code> , and <code>ufid</code> .
Read Reference Files	<p>Select Create DWG to read all external reference files (xrefs) attached to the source data set. If the reference file has nested references, they are also imported, but circular references are not. If you select this option, you specify a location for the folder for these files. If the folder already exists, you can choose to replace it (overwrite its contents) or cancel and specify a different location. The default folder location is the same as the selected DGN file location.</p> <p>If you select Ignore, reference files are not imported and you cannot change the location of the folder.</p>

Other Import Options

You can set several options in the *MapForeignFileProperties.ini* file. See [Customizing and Automating Import and Export](#) (page 260).

See also:

- [Customizing the Import and Export .ini Files](#) (page 264)
- [Importing Objects with Links to an External Database](#) (page 433)
- [Exporting To MicroStation Design \(DGN\) Versions 7 and 8](#) (page 1435)

NOTE Data you import becomes AutoCAD drawing objects in your map. To convert the drawing objects to a geospatial format, see [Overview of Converting and Exporting](#) (page 1405).

- [To import object colors using RGB \(True Color\)](#) (page 409)
- [To maintain a link to external data when you import DGN files](#) (page 409)

- [To import DGN files](#) (page 409)

To import object colors using RGB (True Color)

- Edit the *mapimport.ini* file.
For more information, see [To edit the .ini file](#) (page 272).

To maintain a link to external data when you import DGN files

- Use a link template to [maintain the linkage during import](#) (page 433).

To import DGN files

- [Use the Import instructions.](#) (page 381)
For driver options, see [Design File Input Settings](#) (page 1734).

Quick Reference

MAPIMPORT

Imports an external file format into AutoCAD Map 3D

Menu	Click File ► Create DWG From ► Map 3D Import.
Icon	 Import Map File
Command Line	MAPIMPORT
Dialog Box	Import dialog box

Importing From Oracle

You can import data from a connected Oracle database into your map. Using this option, your data will be imported as drawing objects. The data will be a snapshot of your Oracle data. You can also make a live connection with Oracle (one where edits will go into the database).

See also:

- [Bringing In Features from Oracle](#) (page 312)
- [Exporting DWG Data to an FDO Data Store](#) (page 1461)

NOTE Data you import becomes AutoCAD drawing objects in your map. To connect to the data in its original format, see [Overview of Bringing In GIS Features](#) (page 305). To convert the drawing objects to a geospatial format, see [Overview of Converting and Exporting](#) (page 1405).

To import data from an Oracle data source

- 1 Before moving Oracle data into your map, assign a coordinate system to the map. This lets you position your data accurately in a real-world geographic location and align imported survey or GPS point data.
- 2 In [Display Manager](#) (page 2060), click Data ► Connect To Data.
For more information, see [Bringing In Features from Oracle](#) (page 312)

NOTE Follow the steps through clicking Connect, then stop. Do not add the features to your map.

- 3 At the Command prompt, enter mapimportfdo.
- 4 In the Map Import From FDO dialog box, select the Oracle data source connection from which to import data.
- 5 Click OK.
- 6 In the [Import dialog box](#) (page 1711), review the Current Drawing Coordinate System to make sure it is correct.
- 7 Under Spatial Filter, specify whether to limit the area where data will be imported:
 - None — Place no area limits on the incoming file.
 - Current Display — Limit the import to the current drawing area.
 - Define Window — Limit the import to an area you define. To use this option, click Select. Respond to the prompts to define the area.
- 8 Specify the import settings for each input layer:
 - [Drawing Layer](#) (page 419)— Select a target layer for each layer in the incoming file.
 - [Object Class](#) (page 421)— Assign incoming objects to an existing object class and map incoming attribute data to the data fields in the object class. The Object Class fields are available only if you have object classes defined in your Map drawing. For more information about

setting up object classes, see [Setting Up Object Classification](#) (page ?).

- [Input Coordinate System](#) (page 424)— Specify the coordinate system of the incoming file. If the AutoCAD Map 3D drawing has a coordinate system assigned to it, incoming objects are converted to the coordinate system of the drawing.
- [Data](#) (page 426)— For each layer, specify how to import data.
- [Points](#) (page 428)— For each layer, specify how to treat incoming point objects.

NOTE If you are importing points and have assigned them to an object class with a creation method of Blocks, you must use the Points column to convert the points to blocks so that the objects can be classified. Object classification does not convert points to blocks for you.

- 9 By default, polygons are imported as polygon objects. To import them as closed polylines, select Import Polygons As Closed Polylines.
- 10 If you assigned incoming objects to object classes and want to use the object class defaults for any incoming data that is out of the defined object class range, select Use Class Defaults For Out Of Range Values. If you do not select this option, incoming data will be imported as is, which may include some out of range values. If you later view the data on the Object Class tab of the Properties palette, AutoCAD Map 3D automatically modifies the data, using defaults as needed, so that the data is in range and properly classified.
- 11 To save your settings as a profile, click Save. These saved profiles can be loaded when you import other files, and they can be used to automate command-line scripts.
- 12 Click OK to begin the import process.
If you cancel the import operation, all objects imported prior to canceling will remain in the AutoCAD Map 3D drawing. You can delete these objects and any associated data.

Quick Reference

MAPIMPORTFDO

Import FDO data.

Menu Click File ► Create DWG From ► FDO Connection.
Command Line MAPIMPORTFDO

Importing Geographic Markup Language (GML) Files

GML (Geography Markup Language) is an OpenGIS® Implementation specification that defines an XML encoding for the transport and storage of geographic information. The specification can be found on the *OpenGIS Consortium web site*.

You can import GML into and export it out of AutoCAD Map 3D.

Importing

With AutoCAD Map 3D, you can import GML version 2 or version 3. There is a separate drop-down option that also allows you to import Ordnance Survey of Great Britain MasterMap GML version 2 files.

Because the GML format is flexible and allows you to specify your own schemas, semantics, and options, there are many variations of the format. AutoCAD Map 3D reads many of these, but some may not be compatible with the AutoCAD Map 3D GML driver.

In addition, before importing GML data in Asian languages, you must verify that the language encoding settings specified in the AutoCAD Map 3D *mapimport.ini* file match the settings in your incoming file. The settings must match for the import to be successful. For more information, see [Customizing the Import and Export .ini Files](#) (page 264).

Driver Options

GML has no import driver options.

See also:

- [Customizing the Import and Export .ini Files](#) (page 264)
- [Exporting To Geographic Markup Language \(GML\)](#) (page 1429)

NOTE Data you import becomes AutoCAD drawing objects in your map. To convert the drawing objects to a geospatial format, see [Overview of Converting and Exporting](#) (page 1405).

- [To verify language encoding settings for import from GML](#) (page 413)
- [To import GML files](#) (page 413)

To verify language encoding settings for import from GML

- Make sure the language encoding settings in the *mapimport.ini* file match the settings in your incoming file.
For more information, see [Customizing the Import and Export .ini Files](#) (page 264).

To import GML files

- [Use the Import instructions.](#) (page 381)

Quick Reference

MAPIMPORT

Imports an external file format into AutoCAD Map 3D

Menu Click File ► Create DWG From ► Map 3D Import.

Icon



Import Map File

Command Line MAPIMPORT

Dialog Box Import dialog box

Importing SDTS (Spatial Data Transfer Standard) Files

AutoCAD Map 3D supports SDTS (Spatial Data Transfer Standard). SDTS is an import-only format. You cannot export to this format.

Importing

When you select an SDTS catalogue file, AutoCAD Map 3D imports objects and attributes from the dataset specified in the catalogue file. Typically, a dataset is a group of *.ddf* files with the same filename prefix.

AutoCAD Map 3D imports only one record per object. If an object has multiple records attached, only one of the records will be imported.

Driver Options

SDTS has no import driver options.

NOTE Data you import becomes AutoCAD drawing objects in your map. To convert the drawing objects to a geospatial format, see [Overview of Converting and Exporting](#) (page 1405).

To import SDTS files

- [Use the Import instructions.](#) (page 381)

Quick Reference

MAPIMPORT

Imports an external file format into AutoCAD Map 3D

Menu Click File ► Create DWG From ► Map 3D Import.

Icon  Import Map File

Command Line MAPIMPORT

Dialog Box Import dialog box

Importing SQLite Files

SQLite is a file-based geospatial format. You can [connect to SQLite files](#) (page 331) to edit the original data in its source, or import it to convert the data into AutoCAD drawing objects. Once you import data, the connection to the original source is lost. If you update the source, your changes do not appear in the imported copy.

SQLite is like SHP format in that it contains both spatial data and attribute data. However, unlike SHP, it stores both types of data in a single file rather than a set of files.

Advantages

SQLite has the following advantages over DWG:

- It stores and manages an order of magnitude more data than DWG
- It provides the power of a database without the overhead and cost of a full relational database management system (RDBMS) such as SQL Server or Oracle.
- A SQLite file can store a single feature class, or it can store multiple feature classes.
- It is easy to manage, providing access to the database schema.

Importing

When importing SQLite, you can import each feature class in the file to a separate layer. You can specify how you want to bring in attribute data and points. You can also set an option to import polygons as closed polylines.

Driver Options

SQLite has no import driver options.

See also:

- [Customizing the Import and Export .ini Files](#) (page 264)

NOTE Data you import becomes AutoCAD drawing objects in your map. To connect to the data in its original format, see [Overview of Bringing In GIS Features](#) (page 305). To convert the drawing objects to a geospatial format, see [Overview of Converting and Exporting](#) (page 1405).

To import a SQLite file

- [Import a SQLite file](#) (page 381)– Converts the current contents of the file to drawing objects and inserts them in your map.

To access and work with SQLite

- [Connect to SQLite](#) (page 331)– Allows you to view and edit the SQLite data live in its native format.

Quick Reference

MAPIMPORT

Imports an external file format into AutoCAD Map 3D

Menu Click File ► Create DWG From ► Map 3D Import.

Icon  Import Map File

Command Line MAPIMPORT

Dialog Box Import dialog box

Importing VPF (Vector Product Format) Files

You can import Vector Product Format (VPF) files into AutoCAD Map 3D. You cannot export to this format.

VPF is a standard format, structure, and organization for large geographic databases that are based on a georelational data model. It is commonly used by military departments and defense agencies.

The VPF specification is available on the *National Imaging and Mapping Agency (NIMA) web site*

Importing

By default, AutoCAD Map 3D considers Vector Product Format (VPF) a multi-select, file-based format, that is, you select one or more individual files during a single import process. You can edit the *mapimport.ini* file to specify that all files in the folder are included in the import or that only one file can be selected for import.

NOTE VPF data sets can be very large. You can use a spatial filter to limit the size of the DWG you create from VPF data. See [Specifying an Area to Import](#) (page 417).

Driver Options

VPF has no import driver options.

See also:

- [Customizing the Import and Export .ini Files](#) (page 264)

NOTE Data you import becomes AutoCAD drawing objects in your map. To convert the drawing objects to a geospatial format, see [Overview of Converting and Exporting](#) (page 1405).

To change the default so that AutoCAD Map 3D considers VPF a folder-based format

- Modify the settings in the *mapimport.ini* file.
For more information, see [To import Shapefiles, MIF/MID, TAB, or VPF as folder-based, multi-select, or file-based](#) (page 271).

To import from VPF

- [Use the Import instructions.](#) (page 381)

Quick Reference

MAPIMPORT

Imports an external file format into AutoCAD Map 3D

Menu	Click File ► Create DWG From ► Map 3D Import.
Icon	 Import Map File
Command Line	MAPIMPORT
Dialog Box	Import dialog box

Specifying an Area to Import

When importing data from another file format, you can specify (or limit) the area into which incoming objects will be imported.

You can import objects into the current drawing area, into an area you define in the map, or import the entire file.

NOTE Data you import becomes AutoCAD drawing objects in your map. To connect to the data in its original format, see [Overview of Bringing In GIS Features](#) (page 305). To filter the data to specify the area to add to your map, see [Filtering Features When You Add Them to a Map](#) (page 309).

See also:

- [Converting Data From Other Formats to Drawing Objects](#) (page 377)

To specify an area to import



- 1 Click **Insert** tab ► **Import** panel ► **Map Import**.
 - 2 In the [Import dialog box](#) (page 1711), under **Spatial Filter**, specify whether to limit the area into which data will be imported:
 - **None** — Place no area limits on the incoming file.
 - **Current Display** — Limit the import to the current drawing area.
 - **Define Window** — Limit the import to a rectangular area you define. To use this option, click **Select**. Drag your cursor from right to left to define the area. Objects within the rectangular window are imported.
- AutoCAD Map 3D does not display a preview of the incoming data.
 - If the coordinate system assigned to the Map drawing differs from the coordinate system specified in the **Coordinate System** column, AutoCAD Map 3D will perform a reverse transformation to determine the correct coordinate space (area) for the incoming data.

Quick Reference

MAPIMPORT

Imports an external file format into AutoCAD Map 3D

Menu Click **File** ► **Create DWG From** ► **Map 3D Import**.

Icon	 Import Map File
Command Line	MAPIMPORT
Dialog Box	Import dialog box

Specifying an AutoCAD Layer During Import

When you import data (as opposed to using [Data Connect](#) (page 303)), the imported material is converted to AutoCAD drawing objects. By default, AutoCAD Map 3D imports data to an AutoCAD layer with the same name as the layer (sometimes called a schema, level, or file) in the input file. If an AutoCAD layer with this name already exists, objects are copied to that layer. Otherwise, a new AutoCAD layer is created and objects are copied to the new layer.

If you assign the input layer to an object class with a layer property, the default will instead be the default AutoCAD layer defined by the object class, and the Drawing Layer field displays <By Class>.

You can specify one of the following layer options:

- Put objects on an existing AutoCAD layer.
- Put objects on a new AutoCAD layer.
- Put objects on an AutoCAD layer based on data attached to the objects.
- Put objects on the AutoCAD layer specified by the assigned object class (available only if you assigned the input layer to an object class with a layer property).

See also:

- [Converting Data From Other Formats to Drawing Objects](#) (page 377)
- [Bringing In Drawing Objects from AutoCAD Layers](#) (page 355)

To specify an AutoCAD layer during import

- 1 Click Insert tab ► Import panel ► Map Import . 

- 2 In the [Import dialog box](#) (page 1711), review the target drawing layer for each input layer (sometimes called a schema, level, or file) in the incoming file.
- 3 To change the AutoCAD layer, click in the Drawing Layer field for the input layer to change. In the [Layer Mapping dialog box \(Import\)](#) (page 1719), do one of the following:
 - To import objects to an existing AutoCAD layer, click Create on Existing Layer. Click the down arrow and select the layer.
 - To import objects to a new AutoCAD layer, click Create On New Layer. Click in the cell and enter a layer name.
 - To import objects to an AutoCAD layer whose name is specified in data stored on the imported object, click Use Data Field For Layer Name. Select the data field to use. Click OK to close the Layer Mapping dialog box.

During import, AutoCAD Map 3D reads the specified data value for each object. If the data value specifies a layer that already exists, the object is imported to that layer. If the data value specifies a layer that does not exist, the layer is created. If an object does not have a data value attached, the object is imported to Layer 0.
 - To import objects to a layer with the same name as the input layer, right-click the Drawing Layer column heading in the table. Click Use Input Layer Names.
 - To import objects to the layer specified by the assigned object class, verify that <By Class>; is displayed in the Drawing Layer field. If it is not, type <By Class>; into the field.

NOTE If the layer specified in the Drawing Layer column is different from the one specified in Object Class, AutoCAD Map 3D uses the Drawing Layer setting unless it violates the range specified by the Object Class.

Quick Reference

MAPIMPORT

Imports an external file format into AutoCAD Map 3D

Menu Click File ► Create DWG From ► Map 3D Import.

Icon	 Import Map File
Command Line	MAPIMPORT
Dialog Box	Import dialog box

Assigning an Object Class During Import

When you import data (as opposed to using [Data Connect](#) (page 303)), the imported material is converted to AutoCAD drawing objects. As you import objects, you can assign them to an existing object class in the AutoCAD Map 3D drawing and map the incoming attribute data to the object class definition.

For example, objects being imported from a SHP input layer can be classified and included in the "LAND USE" object class, and data values from the SHP file can be mapped to the "LAND USE" object class definition.

Because some of the incoming data values may conflict with data ranges defined in the object class, AutoCAD Map 3D gives you the option of using the object class default values instead of the incoming data values for values that are not within the acceptable range. This ensures that incoming data is accurately classified but may require changing incoming data values.

To assign an object class, you must first define object classes in your AutoCAD Map 3D drawing. For more information, see [Setting Up Object Classification](#) (page 116).

See also:

- [Converting Data From Other Formats to Drawing Objects](#) (page 377)
- [Setting Up Object Classification](#) (page 116)

To assign an object class to an input layer

- 1 Click Insert tab ► Import panel ► Map Import . 
- 2 In the [Import dialog box](#) (page 1711), review the settings in the Object Class column.

NOTE To make selections in the Object Class column, first define object classes in the AutoCAD Map 3D drawing. If there are no object classes defined, the fields in the Object Class column are grayed-out. For more information, see [Setting Up Object Classification](#) (page 116).

- 3 For each layer in the incoming file, click in the Object Class field.
- 4 Select an object class.
- 5 Click  to map incoming attribute data to the AutoCAD Map 3D object class definition.
- 6 In the [Object Class Attribute Mapping dialog box](#) (page 1710), verify that the object class you just selected is highlighted in the Select An Object Class list.
- 7 On the right, review the Input Fields list, which displays the incoming attribute data fields that are available to be mapped to Target Fields in the object class definition.
- 8 For each Input Field to map, click the down-arrow under Target Fields, and select a target field in the object class definition. The syntax used for the target field is:
CATEGORY:TABLE:FIELD
 - CATEGORY — Type of data, for example "OD" for object data, or "LT" for link template (linked external database).
 - TABLE — Object data table name or database table name.
 - FIELD — Data field name.After you map a target field, it no longer appears in the Target Fields list. This ensures that each target field is mapped to only one incoming data field.
- 9 Map as many of the Target Fields as needed. If there are no more target fields in the Target Fields list, you've mapped them all. If you do not map a target field, the default object class value is used.
- 10 Click OK to close the Object Class Attribute Mapping dialog box.
- 11 To use object class default values for incoming data values that are not within the specified object class range, select Use Class Defaults For Out Of Range Values. Properties such as Layer and Color are also enforced.

This ensures that incoming data will be accurately classified but may require AutoCAD Map 3D to change some of the incoming data values.

- If you are importing points and have assigned them to an object class with a creation method of Blocks, use the Points column to convert the points to blocks so that the objects can be classified. Object classification does not convert points to blocks for you. For more information, see [To specify how to import points](#) (page 428).
- To copy the object class names and attribute mapping settings from one layer to another, right-click in the Object Class field to copy. Click Copy. Then right-click in the field in the target layer and choose whether to paste the object class name or attribute mapping. To copy to all other layers, right-click and choose whether to paste the name or the attribute mapping to all layers. If attribute mapping conflicts are detected, the paste attribute mappings options is not available.

Quick Reference

MAPIMPORT

Imports an external file format into AutoCAD Map 3D

Menu Click File ► Create DWG From ► Map 3D Import.

Icon



Import Map File

Command Line MAPIMPORT

Dialog Box Import dialog box

Performing a Coordinate Conversion During Import

As you import objects, you can convert them from the coordinate system of the input file to the coordinate system of the AutoCAD Map 3D drawing.

To perform this conversion, you must first [assign a coordinate system to the current drawing](#) (page 147). Then, for each layer that you import, you must specify the appropriate coordinate system.

NOTE Data you import becomes AutoCAD drawing objects in your map. To connect to the data in its original format, see [Overview of Bringing In GIS Features](#) (page 305). To change the coordinate system when you connect to the data, see [Changing Coordinate Systems](#) (page 311).

See also:

- [Converting Data From Other Formats to Drawing Objects](#) (page 377)
- [Overview of Coordinate Systems](#) (page 143)

To perform a coordinate conversion

- 1 Click Insert tab ► Import panel ► Map Import . 
- 2 In the [Import dialog box](#) (page 1711), note the coordinate system assigned to the current drawing.

NOTE If the current drawing does not have a coordinate system assigned, click Assign Global Coordinate System and select the coordinate system for the current drawing.

- 3 For each layer in the incoming file, click in the Input Coordinate System field.
- 4 Enter a new global coordinate system code, or click  to select from a list of global coordinate systems.
- 5 In the Select Global Coordinate System dialog box, select the category and coordinate system for the incoming layer.
- 6 Click OK to close the Select Global Coordinate System dialog box.

You can copy the settings from one layer to another. Right-click in the field to copy. Click Copy. Then right-click in the field in the target layer. Click Paste. To copy the setting to all other layers, click Paste To All Layers.

Quick Reference

MAPIMPORT

Imports an external file format into AutoCAD Map 3D

Menu	Click File ► Create DWG From ► Map 3D Import.
Icon	 Import Map File
Command Line	MAPIMPORT
Dialog Box	Import dialog box

Importing Attribute Data

When you import data (as opposed to using [Data Connect](#) (page 303)), the imported material is converted to AutoCAD drawing objects. As you import objects, you can import the attribute data attached to the objects.

You can import the data to one of the following:

- Existing object data table — By default, incoming fields are imported into object data fields with the same name. If no object data field exists with the same name, the incoming field is not imported. If you don't want to do this, use Object Data Mapping to map incoming fields manually to object data fields with other names or to create new fields. Incoming data is converted to the data type of the existing object data field. If this conversion fails (for example, if you import characters to an integer field), AutoCAD Map 3D uses 0 for integers, 0.0 for real numbers, and "" for text.
- New object data table — By default, the fields in the new object data table match the fields you've chosen to import. If you do not want to do this, use Object Data Mapping to select the fields to import or to change the names of the object data fields. When the data is imported, it will be converted to the following object data types:
 - Integer32, Integer16, and Boolean data types are converted to the Integer data type. For Boolean data, False is converted to 0 and True is converted to 1.
 - Float, Double, and Decimal data types are converted to the Real data type.
 - Char and Date data types are converted to the Character data type.



Data is imported only if it is attached to an incoming object. If no objects are found for an input layer, then the object data table will not be created.

- External database — Imported data is added to the external database table as new records.
- External database, link only — If you do not need to add the data to the external database, you can import just the links to the data. When you import links only, the link from the object to the external data are maintained, but the external database is not modified. This is much faster than importing the entire record. This is a good option when importing SHP data.

See also:

- [Converting Data From Other Formats to Drawing Objects](#) (page 377)
- [To import objects with links to an external database](#) (page 434)
- [Setting Up Object Data](#) (page 198)

To specify the data to import

- 1 Click Insert tab ► Import panel ► Map Import . 
- 2 In the [Import dialog box](#) (page 1711), review the settings in the Data column.
- 3 To change the setting for a layer, click in the Data field for the layer to change. Click .
- 4 In the [Attribute Data dialog box](#) (page 1699), select an option:
 - If you do not want to import data, click Do Not Import Attribute Data and close the dialog box.
 - To import data as object data, click Create Object Data and enter a name for the object data table or select an existing object data table. Select Add Unique Key Field to create a unique key for each incoming record automatically.
Click Select Fields. In the [Object Data/External Database Mapping dialog box](#) (page 1732), map incoming fields to object data fields.
 - To import data to an external database, click Add To Database Table and select a link template.
To import only the link data, select Create Link Only.

Click Select Fields to map incoming fields to fields in the external database table.

5 Click OK to close the Attribute Data dialog box.

- To import data to object data tables with the same name as the input layer names, right-click the Data column header in the table. Click Use Input Layer Name For Table Name.
- To import data to an external database, attach the data source and define the link template before you start the import process.
- If conflicts are found between the settings made in the Data column and an assigned object class definition, AutoCAD Map 3D displays the [Conflict Resolution dialog box](#) (page 1701), where you can resolve the conflicts before proceeding with the import.

Quick Reference

MAPIMPORT

Imports an external file format into AutoCAD Map 3D

Menu Click File ► Create DWG From ► Map 3D Import.

Icon  Import Map File

Command Line MAPIMPORT

Dialog Box Import dialog box

Specifying How to Import Points

When you import data (as opposed to using [Data Connect](#) (page 303)), the imported material is converted to AutoCAD drawing objects. As you import point data, you can choose how the points are treated.

NOTE If you are importing survey points, see [Bringing in Survey Data](#) (page 370).

- Import points as points, using ACAD_POINT.
- Import points as text, using text specified in data attached to the objects.

- Import points as blocks, using a specified block definition.
- Import points as blocks, using a block name specified in data attached to the objects.

If you import points as blocks, you can choose to import the attribute data with the objects. If an attribute name on the block that is being created matches a field name on the incoming point, the data for that attribute will be imported with the point.



NOTE If the attribute data includes the values used to link the object to an external database, you can [recreate these links](#) (page 530) in the AutoCAD Map 3D drawing using the ADEGENLINK command.

See also:

- [Converting Data From Other Formats to Drawing Objects](#) (page 377)
- [Accessing Data from ODBC](#) (page 342)

To specify how to import points

NOTE If you are importing survey points, see [Bringing in Survey Data](#) (page 370).

- 1 Click Insert tab ► Import panel ► Map Import . 
- 2 In the [Import dialog box](#) (page 1711), review the settings in the Points column.
- 3 To change the setting for a layer, click in the Points field for that layer. Do one of the following:
 - To import points as points, click the down arrow and select ACAD_POINT.
 - To import points as mtext, click  in the [Import dialog box](#) (page 1711), click Create As Text From Data, and select the data field to use. If an object does not have a value in the selected data field, the point is imported using ACAD_POINT.
Text uses the text style for the current drawing. To change the text style for the current drawing, click Text Style and select a style.
 - To import points to a specific block, click the down arrow and select the block name.

- To import points to a block whose name is specified in data stored on the imported objects, click  in the Point Mapping dialog box, click Get Block Name From Data, and select the data field to use. During import, AutoCAD Map 3D reads the specified data value for each object. If the data value stored on the object specifies a valid block name, the object is imported to that block. If the data value stored on the object specifies a block name that does not exist or if the object does not have a data value attached, the point is imported using ACAD_POINT.
- 4 To fill attributes with values from fields in the input file, select Get Attribute Values From Fields. This works with either the Create As Blocks or the Get Block Name From Data option.

NOTE This option works only if incoming field names match the block attribute tags. If they do not match, you can map specific incoming fields to specific block attributes using the Object class column.

- 5 Click OK to close the Point Mapping dialog box.

Quick Reference

MAPIMPORT

Imports an external file format into AutoCAD Map 3D

Menu Click File ► Create DWG From ► Map 3D Import.

Icon  Import Map File

Command Line MAPIMPORT

Dialog Box Import dialog box

Importing Polygons

When you import data (as opposed to using [Data Connect](#) (page 303)), the imported material is converted to AutoCAD drawing objects. By default, polygons are imported as polygon objects. However, to use the polygons in a topology, you must import them as polylines and create centroids for them.

If a polygon has attribute data attached, the data is initially attached to the polyline. You must move the attribute data from the polyline to the centroid.

See also:

- [Converting Data From Other Formats to Drawing Objects](#) (page 377)
- [Creating Centroids for Polygons](#) (page 431)

To import polygons

- 1 Click Insert tab ► Import panel ► Map Import .  Then [import the attribute data as object data](#) (page 426).
- 2 If you plan to use the polygons in a polygon topology, in the [Import dialog box](#) (page 1711), select the option to Import Polygons As Closed Polylines.

NOTE To set the default state of this option, use the MAPUSEMPOLYGON command.

- 3 Run [To create centroids for polygons and closed polylines](#) (page 887) to create centroids in the polygons and move the data from each closed polyline or polygon to its centroid.

Quick Reference

MAPCREATECENTROIDS

Creates a centroid in a polygon and moves data to the centroid

Menu Create menu ► Centroids

Icon  Create Centroids

Command Line MAPCREATECENTROIDS

Dialog Box Create Centroids dialog box

MAPIMPORT

Imports an external file format into AutoCAD Map 3D

Menu	Click File ► Create DWG From ► Map 3D Import.
Icon	 Import Map File
Command Line	MAPIMPORT
Dialog Box	Import dialog box

Creating Centroids for Polygons

If you have polygon objects or closed polylines with data attached to them, you can create centroids and move the data to the centroid. This is useful:

- After you import or digitize objects.
- Before using editing commands such as Drawing Cleanup, Boundary Break, or Boundary Trim.
- When working with topology.

NOTE This functionality applies only to drawing objects. It does not apply to features from a feature source.

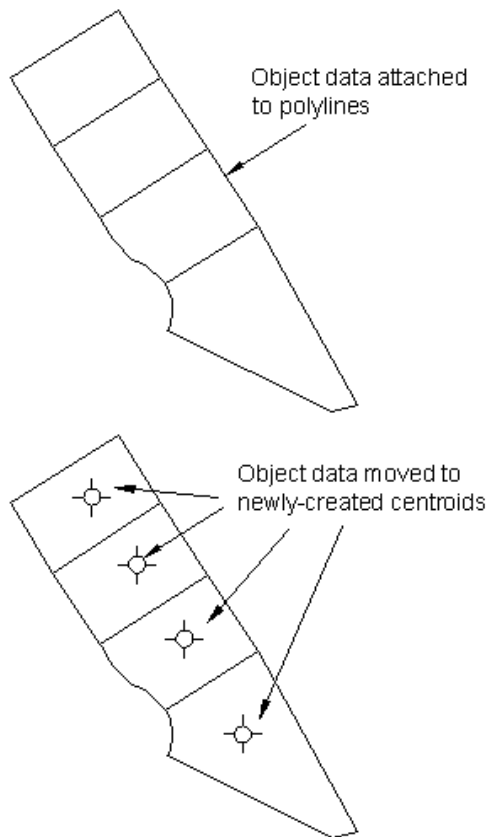

Object data attached to closed polylines (top) and object data moved to centroids (bottom).

AutoCAD Map 3D checks that the lines do not intersect each other, and that the area is greater than 0. It then creates a centroid inside each selected polygon or closed polyline and moves any object data or SQL link data to the centroid. For an object shaped like a figure eight, AutoCAD Map 3D creates one centroid.

Centroids are created with a Z value of 0.

See also:

- [Overview of Converting Geospatial Data to Drawing Objects](#) (page 378)
- [Importing Polygons](#) (page 429)

NOTE This procedure applies only to drawing objects. It does not apply to features from a feature source.

To create centroids for polygons and closed polylines



- 1 Click Create tab ► Drawing Object panel ► Create Centroids.
- 2 In the [Create Centroids dialog box](#) (page 1801), specify whether to create centroids for all closed objects or only for selected closed objects. If only for selected closed objects, select the polygons and closed polylines.

TIP Click the Quick Select tool to view and filter the object type as you select objects.

- 3 Specify the layer on which the centroids should be created.
- 4 Specify the block to use for centroids, or use ACAD_POINT.
- 5 Click OK.

Quick Reference

MAPCREATECENTROIDS

Creates a centroid in a polygon and moves data to the centroid

Menu Create menu ► Centroids

Icon  Create Centroids

Command Line MAPCREATECENTROIDS

Dialog Box Create Centroids dialog box

Importing Objects with Links to an External Database

When you import data (as opposed to using [Data Connect](#) (page 303)), the imported material is converted to AutoCAD drawing objects. If objects in a file you are importing have links to attribute data in a separate database, you can maintain those links.

See also:

- [Converting Data From Other Formats to Drawing Objects](#) (page 377)
- [Importing Attribute Data](#) (page 425)
- [Overview of Linking Database Records to Objects](#) (page 522)

To import objects with links to an external database

- 1 Make sure you have [created a link template](#) (page 526) for the external database, and that the database is [attached](#) (page 209) and connected.



- 2 Click Insert tab ► Import panel ► Map Import .
- 3 In the [Import dialog box](#) (page 1711), click in a field in the Data column. Click  .
- 4 In the [Attribute Data dialog box](#) (page 1699), select Add To Database Table.
- 5 Select the link template to use.
- 6 Select Create Link Only.
- 7 Click OK to close the Attribute Data dialog box.

When you import objects, the attribute data on the objects will be converted to link data for the selected link template.

Quick Reference

MAPIMPORT

Imports an external file format into AutoCAD Map 3D

Menu Click File ► Create DWG From ► Map 3D Import.

Icon  Import Map File

Command Line MAPIMPORT

Dialog Box Import dialog box

MAPOD2ASE

Converts object data tables to linked external database tables

Menu	Click Setup ► Convert Object Data to Database Links.
Command Line	MAPOD2ASE
Dialog Box	Convert Object Data to Database Links dialog box

Displaying Attribute Data as Text

When you import data (as opposed to using [Data Connect](#) (page 303)), the imported material is converted to AutoCAD drawing objects. If you have attribute data attached to the objects you import, you can display that data as text next to the object. This works whether you import the data as object data, external data linked to the object, or block attributes.

TIP If you are importing points, you can import the points directly as attribute data. See [Specifying How to Import Points](#) (page 427).

See also:

- [Converting Data From Other Formats to Drawing Objects](#) (page 377)
- [Adding Annotation](#) (page 1103)

To import a file with attribute data and display the data as text



- 1 Click Insert tab ► Import panel ► Map Import . Then [import the attribute data as object data](#) (page 426). Save and close the file.
- 2 Open a drawing and [attach the drawing file](#) (page 154) containing the imported objects.
- 3 Define a query that includes the objects you want. If you have only one file attached, [define a Location condition](#) (page 1241) to find all objects in the source drawing.
- 4 As part of the query, [define a property alteration that displays the object data as text](#) (page 1278). When specifying the text, click Expression and choose the object data table that contains the imported attribute data.
- 5 Optionally, [save the changes](#) (page 754) back to the attached (source) file.

Quick Reference

AEDRAWINGS

Manages the drawing set

Menu In the Classic workspace, click Setup menu ► Define/Modify Drawing Set

Icon  Define/Modify Drawing Set

Command Line AEDRAWINGS

Task Pane In Map Explorer, right-click Drawings ► Define/Modify Drawing Set

Dialog Box Define/Modify Drawing Set dialog box

ADEQUERY

Controls defining, modifying, saving, loading, and executing a query

Menu In the Classic workspace, click Setup menu ► More DWG Options ► Define Query

Icon  Define Query

Command Line ADEQUERY

Task Pane In Map Explorer, right-click Current Query ► Define -or- Right-click a query ► Edit

Dialog Box Define Query dialog box

ADESAVEOBS

Saves objects in the save set back to source drawings

Menu In the Classic workspace, click File menu ► Save Source Drawing Save Set

Icon  Save to Source Drawings

Command Line ADESAVEOBS

Dialog Box Save Objects to Source Drawings dialog box

MAPIMPORT

Imports an external file format into AutoCAD Map 3D

Menu Click File ► Create DWG From ► Map 3D Import.

Icon



Import Map File

Command Line MAPIMPORT

Dialog Box Import dialog box

Adding Rasters and Surfaces

- [To add a raster image to the map](#) (page 440)
- [To add a raster-based surface to your map](#) (page 442)
- [To add 2D rasters to your map](#) (page 444)
- [To add a WMS-based image to your map](#) (page 447)
- [To make a raster image transparent](#) (page 450)
- [To specify an image insertion point](#) (page 451)
- [To insert the image manually](#) (page 452)
- [To enter the coordinates for the image insertion point](#) (page 452)

Overview of Adding Rasters and Surfaces

When creating a map, you can add raster images and surfaces to the display.

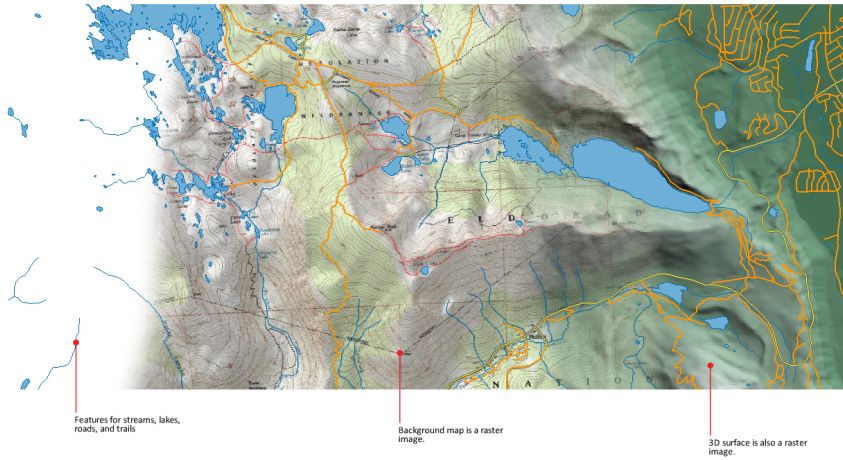

Adding one or more images in the background of your map adds context and gives the map visual appeal.

Use the following raster image and surface types in your map.

Raster Type	Formats
Raster-based surfaces (page 441)	DEM (Digital Elevation Model), ESRI Grid, or Digital Terrain Elevation Data (DTED)
2D raster (page 443)	JPEG and JPEG2K (Joint Photographic Experts Group), PNG (Portable Network Graphic), MrSID (Multi-Resolution Seamless Image Database), TIFF (Tagged Image File Format), ECW (Enhanced Compressed Wavelet)
WMS raster (page 445)	Maps on a server
Other raster formats (page 453)	BMP, CALS-I, ECW, FLIC, GeoSPOT, IG4, IGS, IKONOS, JFIF, LANDSAT FAST, L7A, NITF, PCX, PICT, Quickbird TIFF, RLC 1 and 2, TARGA

NOTE Layers in the map are rendered based on the draw order of the layers in Display Manager. To display drawing objects in front of the raster image, put the raster image layer at the bottom of the list.

Tell me more



Video

- *Show me how to bring multiple images onto a single layer.*
- *Show me how to insert an image using a guide.*
- *Show me how to bring in data from a web server using WMS.*



Procedure

- [To add raster images using Data Connect](#) (page 442)
- [To add raster images that use formats unsupported by Data Connect](#) (page 459)



Tutorial

- Exercise 5: Add a raster image



Workflow

- Style Surfaces



GIS Skills

- *Bring in data from multiple image files to a single layer*
- *Transform an image so that it is correctly aligned*
- *Access data published on a public web server*



Related topics

- [Organizing Layers in Your Map](#) (page 300)
- [Specifying Image Insertion Point](#) (page 451)
- [Using Other Raster Image Formats](#) (page 453)
- [Adding an Image from a WMS \(Web Map Service\)](#) (page 445)

To add a raster image to the map

- 1 In [Display Manager](#) (page 2060), click Data ► Connect To Data.
- 2 In the Data Connect window, select Add Raster Image or Surface Connection in the Data Connections By Provider list.
If you are adding a WMS image, see [Adding an Image from a WMS \(Web Map Service\)](#) (page 445). If you are adding an image whose format does not appear in the Data Connect window, see [Using Other Raster Image Formats](#) (page 453).
- 3 Under Connection Name, type a name for this connection.
You can give the connection any name you like. This name appears in Map Explorer as the name of the feature source.
- 4 Click the folder icon to browse to the folder containing multiple images, or click the image icon to specify a single image.
- 5 Click Connect.
- 6 In the Add Data To Map area, select the images to include.
If this source contains only a single image, that image is selected automatically. If it contains multiple images, you can right-click any of them and select Select All or Select None.
- 7 For each image you select, make sure the Coordinate System and Vertical Units entries are correct.
 - Hold your cursor over an image name to see its native coordinate system. The Coordinate System entry should match this.
 - Scroll the table if necessary to see all the columns.
 - To change the coordinate system, click Edit Coordinate Systems and choose the appropriate coordinate system.
 - To change the vertical units, click the current entry to display a down arrow that lets you choose a different one.
- 8 To combine all the images on one map layer, select Combine Into One Layer. This is useful for combining a series of images to create a single layer; for example, you can combine GeoTIFs of each county to create a state map.
- 9 Click Add To Map.
- 10 If prompted, [specify the location, scale, and rotation](#) (page 451) for each image.

Some image files contain placement information and are placed automatically in your map. For images that do not contain placement information, you are prompted for the location, scale, and insertion point.

- 11 In Display Manager, make sure that the image layer is in the correct display order.

You can move the raster layer below objects and features.

- In Display Manager, click Groups ► Draw Order. (If this button is already labeled Draw Order, you can omit this step.)
- Drag the raster layer down in the list. Layers at the bottom of the list appear behind the ones above them.

NOTE You must [use a different process](#) (page 453) to insert an image whose format is not available in Data Connect, or to specify correlation information for an image whose file does not specify it.

Quick Reference

Connect Feature Source

Connects a feature source

Menu	Click File ► Connect To Data.
Icon	 Connect
Command Line	MAPCONNECT
Task Pane	In Display Manager click Data ► Connect to Data.

Adding Raster-Based Surfaces to Your Map

You can add 3D raster-based surfaces to your map. For example, add DEM (Digital Elevation Model), ESRI Grid, or Digital Terrain Elevation Data (DTED) surfaces.

After you add raster-based surfaces to your map, you can create contour maps to help you analyze 3D terrain. You can use raster-based theming to analyze

elevation, slope, and aspect, and drape map data over surfaces. You can view the data in 3D with walkthrough and flythrough options.

See also:

- [Analyzing Raster-Based Surfaces](#) (page 1186)
- [Adding an Image from a WMS \(Web Map Service\)](#) (page 445)

To add a raster-based surface to your map

- 1 In [Display Manager](#) (page 2060), click Data ► Connect To Data.
- 2 In the Data Connect window, select Add Raster Image or Surface Connection in the Data Connections By Provider list.
- 3 Under Connection Name, type a name for this connection.
You can give the connection any name you like. This name appears in Map Explorer as the name of the feature source.
- 4 Specify the folder that contains your surface. Click the folder icon to browse to the folder.
- 5 Click Connect.
- 6 Hold your cursor over the name of the surface file to see a pop-up window that displays its coordinate system, for example, UTM27-10.
When you add data to your map, you must specify its original coordinate system. AutoCAD Map 3D automatically converts the data from that coordinate system to the one specified for your map.
- 7 Click Edit Coordinate Systems and, in the [Edit Spatial Contexts](#) (page 1605) dialog box, click the entry and click Edit.

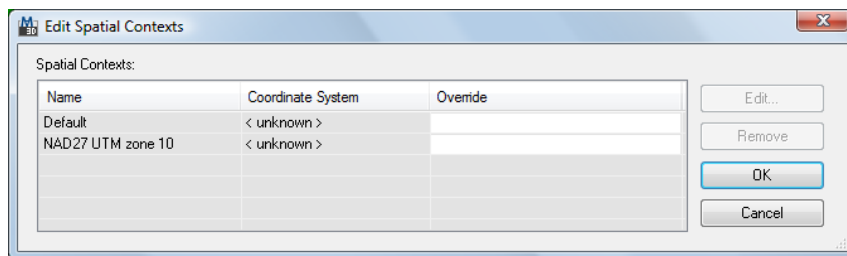

Select the entry and click Edit to specify the coordinate system for the surface

- 8 Select the coordinate system you saw in the pop-up window. Click OK twice to return to the Data Connect window.
- 9 In the Add Data To Map area, select the surfaces to include.
If this source contains only a single surface, that surface is selected automatically. If it contains multiple surfaces, you can right-click any of them and select Select All or Select None.
- 10 To combine all the images on one map layer, select Combine Into One Layer. This is useful for combining a series of images to create a single layer.
- 11 Click Add To Map.

The surface is added to your map.

Quick Reference

Connect Feature Source

Connects a feature source

Menu	Click File ► Connect To Data.
Icon	 Connect
Command Line	MAPCONNECT
Task Pane	In Display Manager click Data ► Connect to Data.

Adding 2D Rasters

You can add a two-dimensional image to your map. For example, add an aerial photograph, an artist's sketch, or your company logo.

Use the steps on the Procedure tab to add images in these formats:

- JPEG and JPEG2K (Joint Photographic Experts Group)
- PNG (Portable Network Graphic)
- MrSID (Multi-Resolution Seamless Image Database)
- TIFF (Tagged Image File Format)

- ECW (Enhanced Compressed Wavelet)

You can also [add surface-based rasters](#) (page 441) such as DEM and ESRI Grid files.

NOTE You must [use a different process](#) (page 453) to insert an image whose format is not available in Data Connect, or to specify correlation information for an image whose file does not specify it.

See also:

- [Adding Raster-Based Surfaces to Your Map](#) (page 441)
- [Using Other Raster Image Formats](#) (page 453)
- [Adding an Image from a WMS \(Web Map Service\)](#) (page 445)

To add 2D rasters to your map

- 1 In [Display Manager](#) (page 2060), click Data ► Connect To Data.
- 2 In the Data Connect window, select Add Raster Image or Surface Connection in the Data Connections By Provider list.
- 3 Under Connection Name, type a name for this connection.
You can give the connection any name you like. This name appears in Map Explorer as the name of the feature source.
- 4 Click the folder icon to browse to the folder containing multiple images, or click the image icon to specify a single image.
- 5 Click Connect.
- 6 In the Add Data To Map area, select the images to include.
If this source contains only a single image, that image is selected automatically. If it contains multiple images, you can right-click any of them and select Select All or Select None.
- 7 For each image you select, make sure the Coordinate System and Vertical Units entries are correct.
 - Hold your cursor over an image name to see its native coordinate system. The Coordinate System entry should match this.
 - Scroll the table if necessary to see all the columns.

- To change the coordinate system, click Edit Coordinate Systems and choose the appropriate coordinate system.
 - To change the vertical units, click the current entry to display a down arrow that lets you choose a different one.
- 8 To combine all the images on one map layer, select Combine Into One Layer. This is useful for combining a series of images to create a single layer.
 - 9 Click Add To Map.
 - 10 If prompted, [specify the location, scale, and rotation](#) (page 451) for each image.
Some image files contain placement information and are placed automatically in your map. For images that do not contain placement information, you are prompted for the location, scale, and insertion point.

The image is added to your map.

Quick Reference

Connect Feature Source

Connects a feature source

Menu	Click File ► Connect To Data.
Icon	 Connect
Command Line	MAPCONNECT
Task Pane	In Display Manager click Data ► Connect to Data.

Adding an Image from a WMS (Web Map Service)

You can incorporate web-based raster image data (such as satellite photographs) that have been published to a public web server using the WMS (Web Map Service) open standard developed by the Open GIS Consortium (OGC). AutoCAD Map 3D supports WMS versions 1.1.0, 1.1.1, and 1.3.

Data from WMS web services can be used to provide background layers for your map. With WMS data, you take the data as it is; you cannot reproject it.

The number of Web Map Services (WMS) that implement OpenGIS interfaces on the Internet is increasing all the time, as more organizations adopt the open standards.

Once you have located some WMS data, determine the URL of the page that serves the published layers. Often, this is not a standard web page that you can open in a browser, but a page that has been programmed using a scripting language such as CGI, PHP, or ASP. A typical web server address looks like this:

`http://wms.jpl.nasa.gov/wms.cgi`

Paste the address into the Data Connect window in AutoCAD Map 3D.

NOTE Websites that host web services appear and disappear or are under construction. Not all sites that you find will work perfectly (or at all).

You can also [bring in web-based feature data](#) (page 346).

Example WMS Image Sources

WMS Image Source	Description
<code>http://maps.customweather.com/image</code>	Weather data
<code>http://wms.jpl.nasa.gov/wms.cgi?</code>	Global SRTM and DTED data
<code>http://globe.digitalearth.gov/viz-bin/wmt.cgi</code>	All types of data for the globe - soils, temperature, land cover, boundaries, etc.
<code>http://terraservice.net/ogccapabilities.ashx</code>	USGS orthographic and topographic maps
<code>http://demo.cubewerx.com/demo/cubeserv/cubeserv.cgi?</code>	Source of different types of data layers, such as boundaries, terrains, physiography, utilities, SRTM, etc.
<code>http://edcw2ks51.cr.usgs.gov/servelet/com.esri.wms.Esrimap?WMTVER=1.1.0&ServiceName=133urban&</code>	Various orthographic images for USA cities, for example, San Francisco, Reno, and Chattanooga.
<code>http://www2.dmsolutions.ca/cgi-bin/mswms_gmap</code>	Various Canadian features - provincial boundaries, lakes, railroads, and more.

WMS Image Source	Description
http://demo.deegree.org:8080/deegree/wms?	Geospatial data from NGA (U.S.), Intevation (Germany) and OGC (U.S.)
http://www.ga.gov.au/bin/getmap.pl?dataset=national&	Geoscience Australia national geoscience datasets

Tell me more



Video

- [Show me how to bring in data from a web server using WMS](#)



Procedure

- [To add a WMS-based image to your map](#) (page 447)



GIS Skill

- [Access data published on a public web server](#)



Related topics

- [Creating and Viewing Metadata](#) (page 1486)
- [Bringing In Features from WFS](#) (page 346)
- [Styling Features](#) (page 639)

To add a WMS-based image to your map

- 1 In [Display Manager](#) (page 2060), click Data ► Connect To Data.
- 2 In the Data Connect window, select Add WMS Connection in the Data Connections By Provider list.
- 3 Under Connection Name, type a name for this connection.
You can give the connection any name you like. This name appears in Map Explorer as the name of the feature source.
- 4 Specify the URL for the WMS server. Click the down arrow to choose from a list of recently-used URLs.
- 5 Specify the WMS version of the data you want.

The Open GIS Consortium updates the WMS format periodically, so there are multiple versions. AutoCAD Map 3D requests the highest version (currently 1.3.0) by default. If you do not change this setting, the server will provide the highest version it supports. Some servers support multiple WMS versions, each corresponding to a different set of capabilities and resulting layers. If you must use a specific version of the image, select it from the list. The server may or may not support the version you request.

- 6 Click Connect.
- 7 If necessary, enter your user name and password.
- 8 In the Add Data To Map area, select the images to include.
If this source contains only a single image, that image is selected automatically. If it contains multiple images, you can right-click any of them and select Select All or Select None.
- 9 For each image you select, do the following:
 - Click the Image Format entry to the right of the image name to choose the format for the image you add to your map.
The available format types include PNG, TIF, JPG, and BMP.
 - Click the Server CS Code entry for the image and choose from the available coordinate systems for the server (the EPSG codes).
A WMS layer can support multiple coordinate systems. AutoCAD Map 3D may not recognize all the EPSG codes the WMS server provides. If this occurs, you can choose the EPSG code that best serves your purposes.
WMS layers inherit supported EPSG values from their parent objects, so a child layer (one indented below a parent layer in the list) may have both its own EPSG setting and the setting of its parent.
 - Click the Layer CS Code entry to choose the coordinate system for the layer.
Unless you know the coordinate system of the source image, do not change the default. AutoCAD Map 3D will automatically convert the image to the coordinate system for your map when it adds the image.
 - Click the Style entry to choose one of the available styles.
 - Click the Background entry to specify a transparent background for the layer or choose a background color from the list.
- 10 To combine all the images on one map layer, select Combine Into One Layer. This is useful for combining a series of images to create a single

layer; for example, you can combine images of each county to create a state map.

If you combine the images, you must specify a single Image Format, Server CS Code, and Background for the resulting layer.

When you select **Combine Into One Layer**, an **Order** entry appears next to each selected layer. Click the entry to change the order of the selected images within the combined layer.

11 Click **Add To Map**.

The image is added to your map.

Quick Reference

Connect Feature Source

Connects a feature source

Menu

Click **File** ► **Connect To Data**.

Icon



Connect

Command Line

MAPCONNECT

Task Pane

In **Display Manager** click **Data** ► **Connect to Data**.

Making an Image Transparent

When you add a raster image to a map using **Data Connect**, it appears in a **Display Manager** layer. You can edit the properties of this layer to add an “opacity” property, and then set that opacity property to a value below 1 to change the transparency of the layer.

To do this, you must save the layer to a file and edit the file in a text editor, such as **Notepad**.

NOTE The transparency will not appear in printed versions of the map.

See also:

- [Adding Raster-Based Surfaces to Your Map](#) (page 441)

- [Adding 2D Rasters](#) (page 443)
- [Adding an Image from a WMS \(Web Map Service\)](#) (page 445)

To make a raster image transparent

- 1 [Add the raster](#) (page 437) to AutoCAD Map 3D.
You can use any type of raster, including a WMS image. The image does not need to be transparent or have an opacity setting already.
- 2 Right-click the layer containing the image and choose Save Layer.
Save the layer to a *.layer* file.
- 3 Open the resulting *.layer* file in a text editor, such as Notepad, and find the <FeatureName> entry.
- 4 Just under the <FeatureName> entry, add the opacity setting, using the following syntax:
`<Opacity>0.6</Opacity>`
An opacity setting of 1 makes the layer completely opaque. A setting of .1 makes it virtually transparent.
- 5 Save the *.layer* file.
- 6 In AutoCAD Map 3D, switch the Task Pane to [Display Manager](#) (page 2060) and remove the original raster layer.
- 7 Add any other entities to your map that will appear on layers beneath the translucent image, and theme or style those layers.
- 8 Click Data ► Load Layer and select the *.layer* file you edited.
The translucent raster image overlays the opaque layers, and they appear beneath it.

Quick Reference

Connect Feature Source

Connects a feature source

Menu Click File ► Connect To Data.

Icon	 Connect
Command Line	MAPCONNECT
Task Pane	In Display Manager click Data ► Connect to Data.

Specifying Image Insertion Point

If an image does not contain location information, you can specify its insertion point and rotation so the image is inserted correctly in relation to other data. You can also adjust the scale so it matches the scale of the other data.

AutoCAD Map 3D saves the insertion-point setting with the drawing. The changes are not saved back to the image file or to the correlation source file. To modify the settings stored in the image file, use an image-editing application such as Autodesk Raster Design. If you modify the original settings in the image, reinsert the image to see the changes in your map.

See also:

- [Adding Rasters and Surfaces](#) (page 437)
- [To specify an image insertion point](#) (page 451)
- [To insert the image manually](#) (page 452)
- [To enter the coordinates for the image insertion point](#) (page 452)

To specify an image insertion point

- 1 In the [Display Manager](#) (page 2060), click Data ► Connect To Data.
- 2 In the Data Connect window, select Add Raster Image or Surface Connection in the Data Connections By Provider list.
- 3 Under Connection Name, type a name for this connection.
You can give the connection any name you like. This name appears in Map Explorer as the name of the feature source.
- 4 Under Source File Or Folder, click the folder icon and browse to the folder than contains your image. Click Connect.
- 5 Select the image to insert and click Add To Map.

- 6 In the Image Insertion dialog box specify where to insert the image. You can enter X,Y coordinates for the image, or manually specify the insertion point in the drawing. Each option is described below.

To insert the image manually

- 1 In the Image Insertion dialog box, on the Insertion tab, click Pick.
- 2 Pick the base point for the frame.
You can also type coordinates at the command prompt.
- 3 Type a rotation angle or pick a point to define the rotation angle.
Rotation is in degrees or in the units set by the AUNITS variable. The image is rotated around the insertion point.
- 4 Pick the second corner point to define the size of the frame.
The Image Insertion dialog box displays the new coordinates, rotation, and scale.
- 5 Click OK to insert the image into the specified frame.

To enter the coordinates for the image insertion point

- 1 Specify the insertion point for the lower-left corner of the image frame.
The insertion point values on the Source tab use the unit specified at the bottom of the Source tab. The insertion point values on the Insertion tab are translated to the current AutoCAD Map 3D drawing unit.
- 2 Specify the rotation.
Use current drawing angle units. This value uses the lower-left corner as the base point.
- 3 Specify the scale.
If the image you insert contains correlation information, the image is inserted at the scale specified by that information. Otherwise, the image is inserted at a scale factor of 1 image unit of measurement to 1 AutoCAD Map 3D unit of measurement.
A scale factor greater than 1 enlarges the image, while a scale factor less than 1 makes the image smaller. For example, to make the image twice as large, type 2 in the Scale box.
You can change the scale to align the image with the vector geometry in the drawing. For example, if your raster image has a scale of 1 inch equals

50 feet or 1:600, and your AutoCAD Map 3D drawing has a scale of 1 unit equals 1 inch, enter 600 as the scale.

4 Specify the units for insertion point and density.

For bitmaps, the density unit used in the image may be in dots per inch. For satellite photos, the density may be in miles. This unit is also used for the insertion point.

For example, if your image was scanned at 300 dpi, then select Inches as the unit.

Quick Reference

Connect Feature Source

Connects a feature source

Menu Click File ► Connect To Data.

Icon  Connect

Command Line MAPCONNECT

Task Pane In Display Manager click Data ► Connect to Data.

MAPIINSERT

Inserts a raster image

Menu Create menu ► Insert An Image

Command Line MAPIINSERT

Dialog Box Insert Image dialog box

Using Other Raster Image Formats

Use this feature to connect to raster image formats that are not supported by Data Connect, or to specify correlation information for images that do not contain this information within their files. Images attached using the following methods support a limited set of styles.

NOTE To use this technique to insert some raster image formats, such as ECW and SID, you must first download the free Raster Object Enabler from autodesk.com.

NOTE If the image you are inserting is supported, connect to it and add it to your map using [Data Connect](#) (page 437). This gives you more control over styling and other options.

- [To insert raster images](#) (page 455)
- [To manage raster images](#) (page 473)
- [To manage the appearance of raster images](#) (page 482)
- [To modify raster images](#) (page 490)

Inserting Raster Images

Use the Raster Extension features to insert and correlate raster images with formats that are not supported by Data Connect, or to specify correlation information for images that do not contain this information within their files.

To use this technique to insert some raster image formats, such as ECW and SID, you must first download the free Raster Object Enabler from autodesk.com.

- [Overview of Inserting Raster Images Outside Data Connect](#) (page 455)
- [Inserting a Raster Image](#) (page 459)
- [Correlating a Raster Image During Insertion](#) (page 462)
- [Manually Adjusting the Image Frame During Insertion](#) (page 465)
- [Setting Image Density](#) (page 467)
- [Adding an Image in a Drawing to a Display Manager Layer](#) (page 470)
- [Inserting an Image from the Command Line](#) (page 470)

NOTE If you are inserting large images or multiple images at once, you can set Raster Extension memory options.

NOTE If the image you are inserting is supported, connect to it and add it to your map using [Data Connect](#) (page 437). This gives you more control over styling and other options.

See also:

- [Configuring Memory Use](#) (page 258)
- [Overview of Adding Rasters and Surfaces](#) (page 437)

To insert raster images

- [To insert a raster image \(overview\)](#) (page 459)
- [To insert a raster image](#) (page 460)
- [To correlate an image during insertion](#) (page 464)
- [To adjust the image frame manually during insertion](#) (page 465)
- [To change the density unit when inserting an image](#) (page 469)
- [To set the default density value and density unit](#) (page 469)
- [To add an image to a new Display Manager layer](#) (page 470)
- [To insert an image from the Command prompt](#) (page 471)

Overview of Inserting Raster Images Outside Data Connect

You can connect to many raster image files using Data Connect. Use the Raster Extension features to insert and correlate raster images with formats that are not supported by Data Connect, or to specify correlation information for images that do not contain this information within their files.

Some image-editing applications, such as Autodesk® Raster Design, store information about image location in an associated correlation source file.

When you insert a raster image using the Insert An Image command (Click



Home tab ► Data panel ► Insert An Image.), AutoCAD Map 3D reads coordinate correlation information and places the image in the precise coordinate location in the drawing.

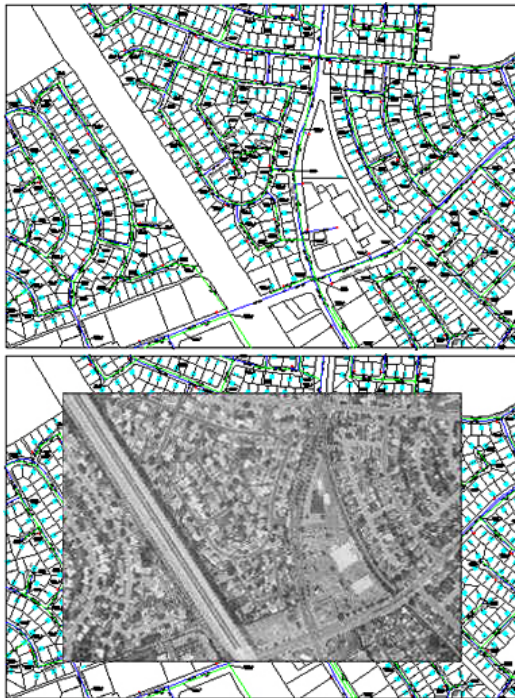

Inserting a raster image into a city map. Move your cursor over the image to see the results.

After you insert the image, you can [change the image display order](#) (page 475) to have the features and drawing objects display on top of the image.

When you insert an image, AutoCAD Map 3D links the image to the drawing file through a path name or a data-management document ID. When you update a linked image, the updates appear in the drawing. Because the image itself is not included in the drawing, the image does not increase drawing size.

Once you have inserted an image, you can reinsert it multiple times treating it as if it were a block. Each insertion has its own clip boundary and its own settings for brightness, contrast, fade, and transparency. A single image can be cut into multiple pieces that can be rearranged in your drawing.

NOTE If you are inserting large images or multiple images at once, you can set Raster Extension memory options. See [Configuring Memory Use](#) (page 258).

Supported Image Formats

AutoCAD Map 3D supports the most common image file formats used in computer graphics, document management, mapping, and geographic information systems (GIS). Images can be bitonal, 8-bit gray (grayscale), 8-bit color (indexed color), or 24-bit color (true color).

Several image file formats support images with transparent pixels. When image transparency is on, AutoCAD Map 3D recognizes those transparent pixels and allows graphics on the AutoCAD Map 3D screen to show through those pixels. (In bitonal images, background pixels can be treated as transparent.) Transparent images can be grayscale or color.

In addition, you can select the transparent color for grayscale or color images, and you can set the opacity for raster images.

AutoCAD Map 3D supports the following raster file formats. Some formats, such as SID and ECW, are supported as OLE objects and not as image files. AutoCAD Map 3D determines the file format from the file contents, not from the file extension.

Type	Description and version	File extension
BMP	Windows and OS/2 bitmap format	.bmp, .rle, .dib
CALS-I	Computer Aided Acquisition and Logistics Support	.rst, .gp4, .mil, .cal, .cg4
DOQ	Digital orthophoto quadrangle raster image format (used for aerial photos that are processed to remove distortion)	.doq
ECW	Enhanced Compressed Wavelet (a highly compressed multiresolution image format from ER Mapper)	.ecw
FLIC	Autodesk digital animation format	.flc, .fli
GeoSPOT	SPOT Image Corporation format with georeferencing information	.bil
GeoTIFF	TIFF with georeferencing information	.tif
GIF	Graphics Interchange Format (a raster image format from CompuServe)	

Type	Description and version	File extension
IG4	Image Systems Group 4	.ig4
IGS	Image Systems Gray Scale	.igs
IKONOS	8- or 16-bit satellite imagery	
JFIF	JPEG File Interchange Format	.jpg
JPEG and JPEG 2000	Joint Photographics Expert Group	.jpg
LANDSAT FAST L7A	Multispectral image format used by the Landsat 7 satellite	
NITF	National Imaging Transmission Format (a multiframe image format commonly used by US federal agencies and NATO)	
PCX	PC Paintbrush Exchange	.pcx
PICT	Macintosh PICT1, PICT2	.pct
PNG	Portable Network Graphics	.png
Quickbird TIFF	Multispectral image format from DigitalGlobe's Quickbird Satellite	
RLC 1 and 2	Run Length Encoding format (version 1 has no header; version 2 has IST headers)	.rlc
SID (MrSID)	Multi-Resolution Seamless Image Database (a highly compressed LizardTech format)	.sid
TARGA	TrueVision image file format	.tga
TIFF	Tagged Image File Format	.tif

NOTE You can also use [Data Connect](#) (page 437) to add JPEG, PNG, MrSID, and TIFF images.

See also:

- [Overview of Adding Rasters and Surfaces](#) (page 437)

To insert a raster image (overview)

- 1 To insert an ECW or SID file, you must first download the free Raster Object Enabler from *autodesk.com*.
- 2 [Locate the image](#) (page 460) to insert.
- 3 [Specify correlation settings](#) (page 464) for the image.
- 4 [Specify image density](#) (page 469).
- 5 [Add the image to a Display Manager layer](#) (page 470).

Quick Reference

MAPIINSERT

Inserts a raster image

Menu	Create menu ► Insert An Image
Command Line	MAPIINSERT
Dialog Box	Insert Image dialog box

Inserting a Raster Image

When you insert an image into a drawing using the Insert An Image command, you can preview the image, modify the image frame (also referred to as a boundary, a frame is a vector object that encloses the image) and image density, and [correlate the image](#) (page 462) with existing vector information or with a previously correlated image. You can use correlation settings from an external file, or you can enter the settings manually. You can also [modify the correlation settings after you insert the image](#) (page 501).

After you insert several images, use REGEN to display the correct draw order of the images. See [Changing Image Draw Order](#) (page 475).

NOTE If the image you are inserting is supported, connect to it and add it to your map using [Data Connect](#) (page 437). This gives you more control over styling and other options.

Tell me more



- [Show me how to insert an image using a guide.](#)
- [Show me how to transform an image.](#)



- [To add raster images that use formats unsupported by Data Connect \(page 459\)](#)



- [Transform an image so that it is correctly aligned](#)



- [Overview of Adding Rasters and Surfaces \(page 437\)](#)
- [Specifying Image Insertion Point \(page 451\)](#)
- [Using Other Raster Image Formats \(page 453\)](#)

To insert a raster image

- 1 To insert an ECW or SID file, you must first download the free Raster Object Enabler from autodesk.com.

- 2 Click Home tab ► Data panel ► Insert An Image. 

- 3 In the [Insert Image dialog box](#) (page 1878), select the drive and folder that contains the image(s).

- 4 In the Files Of Type box, select the file format of the image(s) to insert.

NOTE To insert more than one image type at a time, select All Images.

- 5 In the list of images, select the images to insert.

TIP For information about an image, click Information to display the file size, creation date, and other information, as well as a preview of the image.

6 To view or modify the image correlation data, select Modify Correlation.

7 Click Open.

If Modify Correlation is not selected or if you are inserting more than one image, the Image Correlation dialog box does not appear and the images are inserted using their default correlation information. AutoCAD Map 3D searches in this order for correlation information:

- World file
- Resource file (.res extension)
- Tab file (.tab file)
- Image file
- Settings from the Raster Extension Options dialog box

If you selected Modify Correlation, the Image Correlation dialog box displays. The image frame, which indicates where the image will be inserted, is displayed in your drawing.

TIP If you cannot see the image frame, use the ZOOM or PAN commands to bring it into view while leaving the Image Correlation dialog box open.

8 Do one of the following:

- To insert the image using the current settings, click OK.
- To use a different [correlation source](#) (page 464), select the correlation source from the Correlation Source list.
- To change the insertion point, rotation, or scale, type the appropriate values. For more information, see [To correlate an image during insertion](#) (page 464).
- To resize or orient the image to existing vectors or images, click the image frame while the Image Correlation dialog box is open.
- To define the insertion point, rotation, and scale onscreen, select the Insertion tab. Click Pick. For more information, see [To adjust the image frame manually during insertion](#) (page 465).
- To specify the density units for the image, select the Source tab. Select [Units](#) (page 469).

9 Click OK.

The image is inserted on the current AutoCAD layer and its correlation data is saved in the drawing file. The next time you open the drawing, the image is displayed automatically using these settings.

Quick Reference

MAPIINSERT

Inserts a raster image

Menu	Create menu ► Insert An Image
Command Line	MAPIINSERT
Dialog Box	Insert Image dialog box

Correlating a Raster Image During Insertion

When you insert an image using the Insert An Image command, you can correlate the image with your existing vectors or a previously correlated image. You can change the insertion point and rotation of the image so that it is inserted correctly in relation to other data. You can also adjust the scale so that it matches the scale of the other data.

NOTE If the image you are inserting is supported, connect to it and add it to your map using [Data Connect](#) (page 440). This gives you more control over styling and other options.

You can set the following options when inserting an image:

- Correlation source
- Insertion point (georeferencing correlation information)
- Rotation
- Scale
- Density
- Units for insertion point and density
- Color

If you modify the correlation settings, AutoCAD Map 3D saves the changes with the drawing. The changes are not saved back to the image file or to the correlation source file.

NOTE To modify the settings stored in the image file, use an image-editing application such as . If you modify the original settings in the image, you must reinsert the image to see the changes.

Correlation Settings

- **Correlation Source** — Displays available correlation sources. (See the Correlation Sources section, following.) If a source is not listed, it may not be in the same directory as the image file or, if it is a resource (.res) file, it may not be on the specified resource file path.

NOTE To specify the path for resource (.res) files, at the Command prompt, enter `mapioptions`. Select the Paths tab.

- **Insertion Point** — The insertion point is the lower left corner of the image before any rotation is applied.
The insertion point values on the Source tab of the Image Insertion dialog box use the unit specified at the bottom of the Source tab. The insertion point values on the Insertion tab are translated to the current AutoCAD Map 3D drawing unit.
You can edit the settings or select an insertion point in the drawing by clicking Pick on the Insertion tab and then picking a location in the drawing.
- **Rotation** — Rotation is in degrees or in the units set by the AUNITS variable. The image is rotated around the insertion point.
- **Scale** — If the image you insert contains correlation information, the image is inserted at the scale specified by that information. Otherwise, the image is inserted at a scale factor of 1 image unit of measurement to 1 AutoCAD Map 3D unit of measurement. You can change the scale to align the image with the vector geometry in the drawing. For example, if your raster image has a scale of 1 inch equals 50 feet or 1:600, and your AutoCAD Map 3D drawing has a scale of 1 unit equals 1 inch, enter `600` as the scale on the Insertion tab.
- **Density** — For bitmaps, the density unit used in the image may be in dots per inch. For satellite photos, the density may be in miles. This unit is also used for the insertion point.

To see how your correlation settings translate to AutoCAD Map 3D units, select the Insertion tab. To preview the settings in the drawing, click Apply.

NOTE To modify correlation settings after you insert an image use the Properties palette.

Correlation Sources

When you insert an image, AutoCAD Map 3D searches for correlation files for the image and displays them in the Correlation Source list of the Image Correlation dialog box. You may see the following sources listed.

- World File (Various file extensions)
- Resource File (.res) — You can specify an alternate location for resource files. See [Setting the Resource Files Directory](#) (page 251).
- Tab File (.tab)
- Image File — For certain types of images, correlation data can be saved as part of the image file. These file types include RLC, IG4, IGS, GeoTags in GeoTIFF, or HDR File in GeoSPOT.
- Default — The values that you set on the Image Defaults tab of the Raster Extension Options dialog box.

See also:

- [Modifying the Correlation Settings for an Image](#) (page 501)

To correlate an image during insertion

- 1 [Insert an image](#) (page 460)
- 2 In the [Image Correlation dialog box](#) (page 1873), do one or more of the following:
 - Select a correlation source.
 - Type new coordinates for the image frame. The insertion point represents the lower-left corner of the frame.
 - Scale the image.
For example, to make the image twice as large, type 2 in the Scale box.
 - Rotate the image. The units of the rotation value depend on the setting of the AUNITS system variable.

NOTE You can click the frame while the Insert An Image dialog box is open and use the grips to move, scale, or rotate the frame.

- 3 Click Apply to see your changes.
- 4 Click OK to insert the image.

AutoCAD Map 3D inserts the image on the current layer and saves its correlation data in the drawing file. The next time you open the drawing, the image displays using these settings.

TIP If your image is not visible, zoom to the drawing extents. Click Map Setup

tab ► Map panel ► Zoom Drawing Extents. 

Quick Reference

MAPIINSERT

Inserts a raster image

Menu	Create menu ► Insert An Image
Command Line	MAPIINSERT
Dialog Box	Insert Image dialog box

Manually Adjusting the Image Frame During Insertion

If you do not know the exact coordinates for the image, you can specify the insertion point, rotation angle, and scale of the image by adjusting the frame at the time of insertion. As you draw the frame onscreen, the program maintains the aspect ratio of the image that you are inserting.

See also:

- [Modifying the Correlation Settings for an Image](#) (page 501)

To adjust the image frame manually during insertion

- 1 [Insert an image](#) (page 460).

- 2 In the [Image Correlation dialog box](#) (page 1873), on the Insertion tab, click Pick.

An outline of the frame appears onscreen. This outline reflects the aspect ratio of the image that you are inserting.

- 3 Pick the base point for the frame.
You can also type coordinates at the Command prompt, or, if there is already correlation data for the image, press Enter to accept the existing coordinates.
- 4 Type a rotation angle or pick a point to define the rotation angle.
- 5 Pick the second corner point to define the size of the frame.

TIP You can use UNDO to undo a point.

The Image Correlation dialog box is redisplayed with the new coordinates, rotation, and scale.

- 6 Click OK to insert the image into the specified frame.
AutoCAD Map 3D inserts the image on the current layer and saves its correlation data in the drawing file. The next time you open the drawing, the image displays using these settings.

TIP You can select the frame and use the grips or standard AutoCAD Map 3D commands to size, move, or rotate the image while the Image Correlation dialog box is open.

Quick Reference

MAPIINSERT

Inserts a raster image

Menu Create menu ► Insert An Image

Command Line MAPIINSERT

Dialog Box Insert Image dialog box

Setting Image Density

For some images, the density value and units are already stored in the image file or correlation source. When you use the Insert An Image command to add an image that does not have correlation information, AutoCAD Map 3D uses the settings from the Image Defaults tab in the Raster Extension Options dialog box.

NOTE If the image you are inserting is supported, connect to it and add it to your map using [Data Connect](#) (page 440). This gives you more control over styling and other options.

You can change the density unit when you insert an image but not the density value. You must set the default density value from the Raster Extension Options dialog box.

- **Density** — Shows the dots (or pixels) per unit for the image. If this information was not stored with the image or the correlation source, then AutoCAD Map 3D uses the default density from the Raster Extension Options dialog box.
- **Units** — Select the units for the density from the Units list. For example, if your image was scanned at 300 dots per inch, then select Inch as the density unit.

Some image formats, such as GeoTIFF, GeoSPOT, and any image with a World file for correlation source, have density units that are in real-world coordinates. For example, a satellite photo can be based on dots-per-mile. In this case, select Mile as the density unit.

The density unit that you specify can vary depending on what type of image you are inserting. The following two examples explain the difference between inserting an image that was scanned using dots per inch, and an aerial photo/satellite photo that was saved in real-world units.

Setting Density Units for an Image That Is Not Georeferenced

The following example shows the relationship between paper scale, density units, and insertion scale for an image that is not georeferenced (an image that was not saved with real-world unit data). Any image that is drawn using a scale (such as a floor plan) and captured with a scanner will likely fall into this category.

The image in the following example was drawn at a paper scale of 1" = 48", scanned at 300 dots per inch, then inserted into a drawing using 300 as the

density value and Inches as the density unit. Then it was scaled based on its paper scale of 1" = 48".

The density units that you select when you insert an image that is not georeferenced should match the units at which the image was scanned. In this case, the units are inches because the image was scanned in dots per inch.

NOTE Remember that the scale must be based on the same units. For example, if the scale in the original floor plan is 1" = 4', you must convert both sides to the same unit. In this case, convert the 4 feet to inches, which is why you use 1" = 48" as the scale factor.

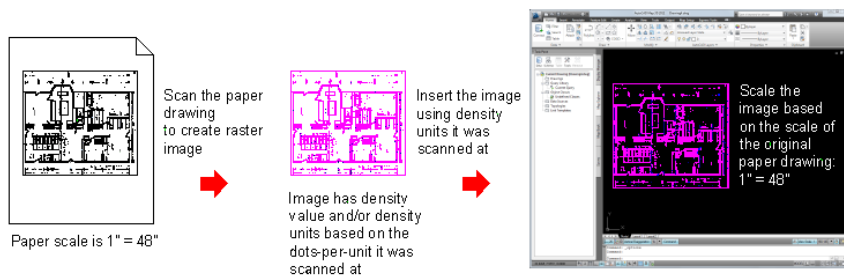

Setting Density Units for an Image That Is Georeferenced

The following example shows the relationship between density units and a georeferenced image. Because there is no paper scale to consider, you can insert the image using the units that the image represents, such as feet or miles, and you do not have to scale the image when you insert it.

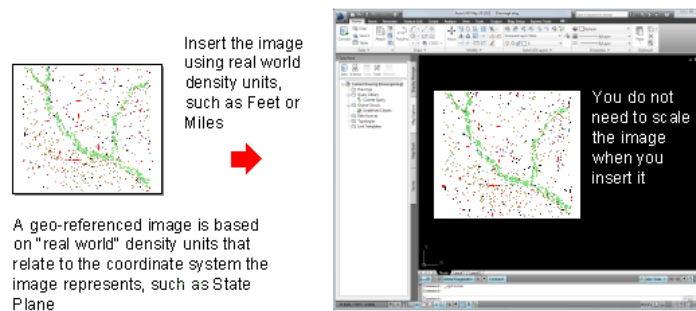

Georeferenced images include GeoSPOT and GeoTIFF file types, and images that use World files as their correlation source.

See also:

- [Overview of Adding Rasters and Surfaces](#) (page 437)
- [Using Other Raster Image Formats](#) (page 453)

To change the density unit when inserting an image



- 1 Click Home tab ► Data panel ► Insert An Image.
- 2 In the [Insert Image dialog box](#) (page 1878), select the image(s) to insert.
- 3 Select Modify Correlation.
- 4 Click Open.
- 5 Select the Source tab. Select the units.

To set the default density value and density unit

- 1 In the Tool-based Ribbon Workspace, click Insert tab ► Image panel ► angle-arrow.
- 2 In the [Import dialog box](#) (page 1711), select the Image Defaults tab.
- 3 In the Density box, type a default density for images. This should be the scanned [resolution](#) (page 2072). For example, if the majority of your images were scanned at 300 dots per inch, type 300.
- 4 In the Units box, select the default unit for the insertion point and density of images. For example, if the majority of your images were scanned at 300 dots per inch, then select Inch.
- 5 Click OK.

Quick Reference

MAPIINSERT

Inserts a raster image

Menu	Create menu ► Insert An Image
Command Line	MAPIINSERT
Dialog Box	Insert Image dialog box

Adding an Image in a Drawing to a Display Manager Layer

You can move an image you inserted directly into the current drawing with the Insert An Image command to a new [Display Manager](#) (page 2060) layer. This allows you to position it relative to other Display Manager layers.

See also:

- [Overview of Adding Rasters and Surfaces](#) (page 437)
- [Using Other Raster Image Formats](#) (page 453)

To add an image to a new Display Manager layer

- 1 Insert the image using the Insert An Image command. Click Home

tab ► Data panel ► Insert An Image. 

- 2 In Display Manager, click Data ► Add Drawing Data ► Raster Image.

- 3 In the Select Image dialog box, select the image.

- 4 To group the image layers, select Group Selection.

If you combine the image layers in a group, you can turn the display of the group on or off.

- 5 Click OK.

Quick Reference

MAPIINSERT

Inserts a raster image

Menu Create menu ► Insert An Image

Command Line MAPIINSERT

Dialog Box Insert Image dialog box

Inserting an Image from the Command Line

You can insert an image at the Command prompt by setting the FILEDIA variable to <0>. This feature is useful if you already have correlation data stored

with your images or to use an AutoLISP routine to insert images into your drawing.

NOTE If the image you are inserting is supported, connect to it and add it to your map using [Data Connect](#) (page 440). This gives you more control over styling and other options.

AutoCAD Map 3D uses correlation data if available, searching for a correlation source in the following order:

- world file
- resource file
- tab file
- image file

AutoCAD Map 3D uses the correlation information from the first source that it locates. If it cannot find a correlation file, then the image is inserted using the default insertion point information that you defined in the Raster Extension Options dialog box. You can specify a default location for resource files, and you can specify that AutoCAD Map 3D search for correlation information in the resource directory before checking the image directory. If the correlation source does not include information on scale or density, AutoCAD Map 3D uses the scale and density specified on the Image Defaults tab of the Raster Extension Options dialog box.

See also:

- [Setting the Resource Files Directory](#) (page 251)
- [Setting Correlation Defaults](#) (page 257)

To insert an image from the Command prompt

- 1 Set the FILEDIA system variable to 0.
Consult the AutoCAD Command Reference if you need more information.
- 2 At the Command prompt, enter `mapinsert`.
- 3 Do one of the following:
 - Type the name of the image to insert including its file extension.
If you do not specify a path to the image, then AutoCAD Map 3D searches for the image using the Project Files Search Path set in the Files tab of the AutoCAD Options dialog box.

- Type the path to the image, the image name, and the file extension, for example: `c:\Projects\Images\contour.rlc`
AutoCAD Map 3D searches for the image on the path that you specify. If it cannot locate the image on this path, then it searches for the image using the Project Files Search Path.

NOTE When FILEDIA is set to <0>, you can display the Insert Image dialog box by typing a tilde (~) in response to a command prompt.

When AutoCAD Map 3D locates the image, it inserts it into your drawing. If there is correlation data stored with the image, then AutoCAD Map 3D inserts the image using this data.

TIP If you cannot see the image after you insert it, zoom to the extents of the drawing or use the Image Management dialog box to [zoom to the image](#) (page 481).

Quick Reference

MAPIINSERT

Inserts a raster image

Menu	Create menu ► Insert An Image
Command Line	MAPIINSERT
Dialog Box	Insert Image dialog box

MAPIOPTIONS

Specifies default image correlation settings, display options, detach options, paths, and memory settings

Menu	Setup menu ► Raster Options
Command Line	MAPIOPTIONS
Dialog Box	Raster Extension Options dialog box

Managing Raster Images

You can view and modify information about images you inserted using the Insert An Image command.



To manage raster images



- [To display the Image Management dialog box](#) (page 474)
- [To display the Image Information dialog box](#) (page 475)
- [To display the Properties palette](#) (page 475)
- [To change the draw order of images](#) (page 477)
- [To change the draw order of images and objects](#) (page 477)
- [To change an image name](#) (page 479)
- [To create a search path](#) (page 480)
- [To zoom to an image](#) (page 481)

Overview of Managing Raster Images

When you insert an image into a drawing using the Insert An Image command, only information about the image is stored in the drawing, along with a pointer to the actual image.

You can view and modify this stored information.

To do this...	Use this method...
View information about images in maps.	Display the Image Management or Image Information dialog box, or the Properties palette. See Viewing Image Information (page 474).
Change the draw order of raster images and vector objects you inserted using the Insert An Image command.	Click Insert tab ► Image panel ► Image Management.  See Changing Image Draw Order (page 475).
Change the name of an image you inserted using the Insert An Image command.	Click Insert tab ► Image panel ► Image Management.  See Changing an Image Name (page 478).

To do this...	Use this method...
Specify the location of an image you inserted using the Insert An Image command, if it has been moved or deleted.	Click  ► Options. On the Files tab, select Project Files Search Path. Click Add. See Creating a Search Path for Raster Images (page 479).
Zoom to images you inserted using the Insert An Image command.	Click Insert tab ► Image panel ► Image Management.  See Zooming to an Image (page 481).

Viewing Image Information

You can view information about images in maps in the following ways:

- The Image Management dialog box displays information about the number of instances of an image in the map, the draw order of images, and other image information.
- The Image Information dialog box displays information about the file, the image, properties, and correlation information.
- The Properties palette provides access to image properties.

NOTE These options work for all images, no matter how they were added to your map.

See also:

- [Overview of Adding Rasters and Surfaces](#) (page 437)
- [Using Other Raster Image Formats](#) (page 453)

To display the Image Management dialog box

- Click Insert tab ► Image panel ► Image Management. 

You can click Layout to modify the columns in the Image Management dialog box. You can hide or display topic columns, or change the order of topic columns.

To display the Image Information dialog box

- 1 Click the frame of the image to select it.

NOTE If you are zoomed in and cannot see the image frame, press **Shift + left-click** (page 493) to select the image.

- 2 Right-click the image ► Image ► Information.

To display the Properties palette

- 1 In the drawing, select the image to modify.
- 2 Right-click the image. Click Properties.

Quick Reference

MAPIINFO

Displays file, image, object property, and correlation information about selected images

Menu	View menu ► Imaging Tools ► Information
Command Line	MAPIINFO
Dialog Box	Image Information dialog box

MAPIMANAGE

Allows you to view a list of images in the current drawing, change drawing order, erase or zoom to selected images

Menu	Click Setup ► Image Management.
Command Line	MAPIMANAGE
Dialog Box	Image Management dialog box

Changing Image Draw Order

When you insert raster images, the images draw in the order in which you insert them. You can change the draw order of:

- Raster images.

- Raster images and vector objects.



You can change the draw order of images and vector objects. By sending an image to the back, the vector objects display on top of the image. Move your cursor over the image to see the results.

NOTE If you change the draw order and then undo the change, images may not appear in the correct draw order. Use the REGEN command to display the correct draw order of the images.

The following conditions affect the image draw order:

- Image insertion order
AutoCAD Map 3D uses image insertion order first. For example, if you insert images A, B, C in that order, and then reorder them so that they are arranged as B, C, A, use REGEN when you open that drawing again to restore the order to B, C, A.

AutoCAD Map 3D always uses this optimization feature and applies it to the draw order of all objects, not just to images.

■ **Image selection**

You can set an option to draw hatch marks over a selected image. Click



► Options. Select the Display tab. Under Display Performance, set Highlight Raster Image Frame Only to off.

If Highlight Raster Image Frame Only is off, when you select an image, it rises to the top of the display order, obscuring any vectors that cross it. Use the REGEN command to restore the proper display order.

NOTE For images you added with [Data Connect](#) (page 2059), use [Display Manager](#) (page 2060) to change the draw order. See [Organizing Layers in Your Map](#) (page 300).

See also:

- [Overview of Adding Rasters and Surfaces](#) (page 437)
- [Using Other Raster Image Formats](#) (page 453)

NOTE For images you added with [Data Connect](#) (page 2059), use [Display Manager](#) (page 2060) to change the draw order. See [Organizing Layers in Your Map](#) (page 300).

To change the draw order of images

- 1 Click Insert tab ► Image panel ► Image Management. 
- 2 In the [Image Management dialog box](#) (page 1875), select an image name and drag it up or down in the Image column.
The current draw order is indicated in the Image column. The top image in the list is drawn on top of all the other images and is the last drawn. The last image in the list is drawn beneath any images that may overlap it.

To change the draw order of images and objects

- 1 Select the image.

2 Do one of the following:

- Click Home tab ► Modify panel ► Bring To Front drop-down ► Bring To Front
- Click Home tab ► Modify panel ► Bring To Front drop-down ► Send To Back

If necessary, use REGEN.

NOTE Changes made using Draw Order are reflected in the Image Management dialog box.

Quick Reference

REGEN

Regenerates the drawing and refreshes the current viewport

Menu View menu ► Regen

Command Line REGEN

MAPIMANAGE

Allows you to view a list of images in the current drawing, change drawing order, erase or zoom to selected images

Menu Click Setup ► Image Management.

Command Line MAPIMANAGE

Dialog Box Image Management dialog box

Changing an Image Name

Image names are not necessarily the same as image file names. When you attach an image to a drawing using the Insert An Image command, AutoCAD Map 3D uses the file name without the file extension as the image name. You can change the image name without affecting the name of the file.

NOTE This command does not affect images you added using [Data Connect](#) (page 440).

See also:

- [Overview of Adding Rasters and Surfaces](#) (page 437)
- [Using Other Raster Image Formats](#) (page 453)

To change an image name

- 1 Click Insert tab ► Image panel ► Image Management. 
- 2 In the Image Manager dialog box, select the image name.
- 3 Click the image name again to edit it.
- 4 Enter the new name.
- 5 Click OK.

TIP You can also change the image name by pressing F2 while in the Image Manager dialog box and editing the name.

Quick Reference

IMAGE

Manages images

Menu

Setup menu ► Image Management

Icon



Manage Images

Command Line

IMAGE

Task Pane

Select an image. Right-click in drawing area ► Image ► Image Manager

Creating a Search Path for Raster Images

When you insert an image with the Insert An Image command, AutoCAD Map 3D stores the location of the image in the drawing file. When you open a drawing, AutoCAD Map 3D searches this stored location for the file. If the image has been moved or deleted, AutoCAD Map 3D searches the Project Files Search Path.

NOTE This command does not affect images you added using [Data Connect](#) (page 440).

See also:

- [Overview of Adding Rasters and Surfaces](#) (page 437)
- [Using Other Raster Image Formats](#) (page 453)

To create a search path

- 1 Click  ► Options.
- 2 On the Files tab, select Project Files Search Path. Click Add.
A folder named Projectx (where x indicates the next available number) appears under Project Files Search Path.
- 3 Enter a name for the project.
The project name cannot contain leading spaces or terminating spaces.
- 4 Click Apply.
- 5 With the project name selected, click Set Current.
- 6 Click Add.
A path entry is created under the project name.
- 7 Enter the search path or click Browse to select a directory.
- 8 Click OK.

For more information about using project files and alternate search paths, refer to PROJECTNAME in the online AutoCAD Command Reference.

Quick Reference

OPTIONS

Customizes the AutoCAD settings

Menu	Setup menu ► AutoCAD Options
Command Line	OPTIONS

Task Pane

Right-click in the drawing area ► Options

Zooming to an Image

You can zoom to images you inserted with the Insert An Image command.

NOTE This command does not affect images you added using [Data Connect](#) (page 440).

See also:

- [Overview of Adding Rasters and Surfaces](#) (page 437)
- [Using Other Raster Image Formats](#) (page 453)

To zoom to an image

- 1 Click Insert tab ► Image panel ► Image Management. 
- 2 In the [Image Management dialog box](#) (page 1875), select an image.
- 3 Right-click the image. Click Zoom To.

Quick Reference

MAPIMANAGE

Allows you to view a list of images in the current drawing, change drawing order, erase or zoom to selected images

Menu	Click Setup ► Image Management.
Command Line	MAPIMANAGE
Dialog Box	Image Management dialog box

Hiding, Unloading, Detaching, and Erasing Images

You can increase redrawing speed by hiding or unloading images you inserted using the Insert An Image command that you do not need in the current drawing session.

- [Overview of Hiding, Unloading, Detaching, and Erasing Images](#) (page 482)
- [Hiding an Image](#) (page 485)
- [Unloading an Image](#) (page 486)
- [Erasing an Image](#) (page 487)
- [Detaching an Image](#) (page 488)

See also:

- [Overview of Adding Rasters and Surfaces](#) (page 437)
- [Using Other Raster Image Formats](#) (page 453)

To manage the appearance of raster images

- [To hide an image](#) (page 485)
- [To unload an image](#) (page 486)
- [To erase an image](#) (page 487)
- [To detach an image](#) (page 489)

Overview of Hiding, Unloading, Detaching, and Erasing Images

When you insert an image using the Insert An Image command, AutoCAD Map 3D stores information about the image in the drawing, loads the image into memory, displays it onscreen, and locks the image file on the disk.

NOTE This command does not affect images you added using [Data Connect](#) (page 440).

You can increase redrawing speed by hiding or unloading images you do not need in the current drawing session. Hidden images are not displayed or plotted; only their drawing boundaries are displayed. You can choose to hide an image regardless of the current viewport coordinate system. If you no longer need the image in the drawing, you can erase a single instance of the image or you can detach the image to erase all instances of the image and the image information.

Aside from locking the image file, none of these actions modify the original image file itself.

See also:

- [Overview of Adding Rasters and Surfaces](#) (page 437)
- [Using Other Raster Image Formats](#) (page 453)

To do this...	Use this method...
Hide an image you added using the Insert An Image command.	Select and right-click the image frame ► Image ► Show Image. See Hiding an Image (page 485).
Remove an image you added using the Insert An Image command from memory (unload it).	At the command prompt, enter <i>externalreferences</i> . Right-click the image and click Unload. See Unloading an Image (page 486).
Erase an image you added using the Insert An Image command from the map.	Select the image. Click Home tab ► Modify panel ► Erase. See Erasing an Image (page 487).
Remove all instances of an image you added using the Insert An Image command from the map (detach it).	Click Insert tab ► Image panel ► Image Management.  Click the image and click Detach. See Detaching an Image (page 488).

Quick Reference

PROPERTIES

Displays the Properties palette, which allows you to edit the properties of objects

Menu	Analyze ► Properties
Icon	 Properties
Command Line	PROPERTIES
Task Pane	Select object. Right-click in drawing area ► Properties

MAPISHOWIMAGE

Hides or displays a raster image

Menu Right-click a selected image frame ► Image ► Show Image

Command Line MAPISHOWIMAGE

ERASE

Removes objects from a drawing

Menu Modify menu ► Erase

Icon  Erase

Command Line ERASE

Task Pane Select objects to erase. Right-click in drawing area ► Erase

MAPIOPTIONS

Specifies default image correlation settings, display options, detach options, paths, and memory settings

Menu Setup menu ► Raster Options

Command Line MAPIOPTIONS

Dialog Box Raster Extension Options dialog box

IMAGE

Manages images

Menu Setup menu ► Image Management

Icon  Manage Images

Command Line IMAGE

Task Pane Select an image. Right-click in drawing area ► Image ► Image Manager

Hiding an Image

When you hide an image, the image does not display onscreen, nor does it plot. Only the image boundary displays onscreen. However, the image is still loaded in memory, and the image file is still locked on the disk. It cannot be deleted or modified. Hiding images is a convenient way to speed regeneration time. You can redisplay the image when you are ready to plot.

This command is not available if you have selected more than one image. To show or hide multiple images, use the Properties palette.

NOTE This command does not affect images you added using [Data Connect](#) (page 440).

NOTE You can also control the display of images by using the LAYER command. When you insert an image, it is inserted on the current layer, but you can move it to another layer. You can then use the LAYER command to control the layer visibility.

The images are also affected by other layer attributes such as whether a layer is locked or frozen. If you are working with several images and you do not want to modify certain images, then move those images to a separate layer and lock the layer.

See also:

- [Overview of Adding Rasters and Surfaces](#) (page 437)
- [Using Other Raster Image Formats](#) (page 453)

To hide an image

- 1 Select the image frame.
- 2 Right-click the image ► Image ► Show Image.

To show a hidden image, follow the same steps.

NOTE You can also modify this setting on the Properties palette.

Quick Reference

PROPERTIES

Displays the Properties palette, which allows you to edit the properties of objects

Menu	Analyze ► Properties
Icon	 Properties
Command Line	PROPERTIES
Task Pane	Select object. Right-click in drawing area ► Properties

MAPISHOWIMAGE

Hides or displays a raster image

Menu	Right-click a selected image frame ► Image ► Show Image
Command Line	MAPISHOWIMAGE

Unloading an Image

To conserve memory and enhance performance, unload images that you do not need to view and/or plot.

NOTE This command does not affect images you added using [Data Connect](#) (page 440).

When you unload an image, you remove the image from memory. It does not display onscreen, nor does it plot, and it is no longer locked on the disk. Only the image boundary displays onscreen. Information about the image, such as its path and scale, remains in the drawing. Before you can plot the image, you must reload it into memory.

See also:

- [Changing Image Display Quality and Speed](#) (page 498)
- [Overview of Adding Rasters and Surfaces](#) (page 437)
- [Using Other Raster Image Formats](#) (page 453)

To unload an image

- 1 At the command prompt, enter *externalreferences*.

2 In the External References palette, right-click the image.

3 Click Unload.

This status is saved with the drawing when you close the drawing.

Quick Reference

IMAGE

Manages images

Menu

Setup menu ► Image Management

Icon



Manage Images

Command Line

IMAGE

Task Pane

Select an image. Right-click in drawing area ► Image ► Image Manager

Erasing an Image

When you erase an image, that instance of the image is erased from the document. Erasing an image does not delete the image information. You can set an option so that when the last instance of an image is erased from the drawing, AutoCAD Map 3D detaches the image, deleting the image information.

NOTE This command does not affect images you added using [Data Connect](#) (page 440).

See also:

- [Choosing an Image Detach Method](#) (page 255)
- [Overview of Adding Rasters and Surfaces](#) (page 437)
- [Using Other Raster Image Formats](#) (page 453)

To erase an image

1 Select the image.

- 2 Click Home tab ► Modify panel ► Erase.

If you erase all instances of an image within a drawing, you may be prompted to [detach the image](#) (page 489) from the drawing.

Quick Reference

ERASE

Removes objects from a drawing

Menu Modify menu ► Erase

Icon  Erase

Command Line ERASE

Task Pane Select objects to erase. Right-click in drawing area ► Erase

MAPIOPTIONS

Specifies default image correlation settings, display options, detach options, paths, and memory settings

Menu Setup menu ► Raster Options

Command Line MAPIOPTIONS

Dialog Box Raster Extension Options dialog box

Detaching an Image

When you detach an image, all instances of the image are removed from the drawing, the image information is deleted, and the image file is unlocked. Detach images that you no longer need in the drawing.

NOTE This command does not affect images you added using [Data Connect](#) (page 440).

See also:

- [Choosing an Image Detach Method](#) (page 255)

- [Overview of Adding Rasters and Surfaces](#) (page 437)
- [Using Other Raster Image Formats](#) (page 453)

To detach an image

- 1 Click Insert tab ► Image panel ► Image Management. 
- 2 In the Image Manager dialog box, select the image name.
- 3 Click Detach.

The image is no longer linked to the drawing file, and all instances of the image are removed from the drawing.

Quick Reference

IMAGE

Manages images

Menu Setup menu ► Image Management

Icon  Manage Images

Command Line IMAGE

Task Pane Select an image. Right-click in drawing area ► Image ► Image Manager

Modifying Raster Images

You can modify an image with grip modes, adjust an image for contrast, clip the image with a rectangle or polygon, or use an image as a cutting edge for a trim.

- [Overview of Modifying Raster Images](#) (page 490)
- [Selecting an Image](#) (page 493)
- [Displaying Image Frames](#) (page 494)
- [Changing Image Alignment](#) (page 495)
- [Adjusting Image Brightness, Contrast, and Fade](#) (page 496)
- [Changing Image Display Quality and Speed](#) (page 498)

- [Making an Image Transparent](#) (page 499)
- [Modifying the Correlation Settings for an Image](#) (page 501)
- [Modifying Other Image Properties](#) (page 503)
- [Clipping an Image](#) (page 504)

To modify raster images

- [To select an image by pressing Shift + left-click](#) (page 493)
- [To turn on the Shift + left-click option](#) (page 494)
- [To display image frames](#) (page 495)
- [To change image alignment](#) (page 496)
- [To adjust brightness, contrast, and fade](#) (page 497)
- [To change image display quality](#) (page 498)
- [To hide a drawing or show clipped images](#) (page 498)
- [To make an image transparent](#) (page 500)
- [To change the color that is transparent](#) (page 500)
- [To modify the correlation settings for an image](#) (page 502)
- [To modify image properties](#) (page 503)
- [To clip an image](#) (page 506)

Overview of Modifying Raster Images

You can copy, move, or clip raster images. You can modify an image with grip modes, adjust an image for contrast, clip the image with a rectangle or polygon, or use an image as a cutting edge for a trim.

NOTE This command does not affect images you added using [Data Connect](#) (page 440).

Image Frames

AutoCAD Map 3D inserts images into frames. A frame is a rectangular vector object that encloses the image. When you select the frame, you create a selection set that you can manipulate using any editing command. You can copy, move, stretch, rotate, and scale images.

To do this...	Use this method...
Select an image you added with the Insert An Image command.	Press Shift while you click the image. See Selecting an Image (page 493).

To do this...	Use this method...
Display frames for images you added with the Insert An Image command.	Click Insert tab ► Image panel ► Toggle Frames.  See Displaying Image Frames (page 494).
Change the alignment and scale of an image you added with the Insert An Image command.	At the Command prompt, enter align. See Changing Image Alignment (page 495).
Adjust the brightness, contrast, and fade of an image you added with the Insert An Image command.	At the Command prompt, enter imageadjust. See Adjusting Image Brightness, Contrast, and Fade (page 496).
Adjust the image display quality of an image you added with the Insert An Image command.	At the Command prompt, enter imagequality. See Changing Image Display Quality and Speed (page 498).
For an image you added with the Insert An Image command, make all pixels of a specific color in a grayscale or color image transparent.	Right-click the image. Click Properties. In the Properties palette, select Transparency. See Making an Image Transparent (page 499).
Specify a precise location for an image you added with the Insert An Image command	Right-click the image. Click Properties. In the Properties palette, change the position or rotation of the image. See Modifying the Correlation Settings for an Image (page 501).
For an image you added with the Insert An Image command, modify frame properties.	Right-click the image. Click Properties. In the Properties palette, change the color, layer, or linetype. See Modifying Other Image Properties (page 503).
Display only a portion of an image you added with the Insert An Image command.	At the Command prompt, enter imageclip. See Clipping an Image (page 504).

Quick Reference

MAPIOPTIONS

Specifies default image correlation settings, display options, detach options, paths, and memory settings

Menu	Setup menu ► Raster Options
Command Line	MAPIOPTIONS
Dialog Box	Raster Extension Options dialog box

MAPIFRAME

Makes frames enclosing raster images visible or invisible

Menu	View menu ► Imaging Tools ► Toggle Frames
Command Line	MAPIFRAME
Dialog Box	MAPIFRAME (Image Frame command)

ALIGN

Aligns objects with other objects in 2D and 3D

Command Line	ALIGN
---------------------	-------

PROPERTIES

Displays the Properties palette, which allows you to edit the properties of objects

Menu	Analyze ► Properties
Icon	 Properties
Command Line	PROPERTIES
Task Pane	Select object. Right-click in drawing area ► Properties

IMAGECLIP

Creates new clipping boundaries for an image object

Icon	 Clip Image
-------------	--

Command Line	IMAGECLIP
Task Pane	Select an image. Right-click in drawing area ► Image ► Clip

Selecting an Image

If an image frame is visible, you can select the image by clicking the frame or by drawing a crossing window around a frame edge. When you select an image by selecting its frame, grips are displayed.

NOTE This command does not affect images you added using [Data Connect](#) (page 440).

You can also select an image by placing your cursor over the image and pressing Shift + left-click. This feature is useful when you are zoomed in to the image and you cannot see the image frame or if the image frames are turned off.

After you select an image frame, you can:

- Right-click to display the Raster Extension shortcut menu.
- Select a grip. Right-click to display the AutoCAD Map 3D shortcut menu.
- Manipulate the image using AutoCAD Map 3D commands.

NOTE You can set an option to draw hatch marks over a selected image. Click



► Options. Select the Display tab. Under Display Performance, set Highlight Raster Image Frame Only to off. If Highlight Raster Image Frame Only is off, when you select an image, it rises to the top of the display order, obscuring any vectors that cross it. Use the REGEN command to restore the proper display order.

See also:

- [Overview of Adding Rasters and Surfaces](#) (page 437)
- [Using Other Raster Image Formats](#) (page 453)

To select an image by pressing Shift + left-click

- 1 Position your pointer so that it is over the image or images to select.
- 2 Press Shift and click the left mouse button.

If you clicked more than one image, the [Image Select dialog box](#) (page 1877) appears. This dialog box displays the names of all the images that are inserted into your drawing. The image or images that are already selected are highlighted (not just the images that you selected by pressing Shift + left-click).

- 3 Click the images in the list to select. Click OK. To select all the images in your drawing, click Select All. To clear the selection set, click Select None.

NOTE If Shift + left-click is not working, you may need to load the Raster Extension by using an image command such as Insert An Image, or you may need to turn on the option.

To turn on the Shift + left-click option

- 1 In the Tool-based Ribbon Workspace, click Insert tab ► Image panel ► angle-arrow.
- 2 In the Raster Extension Options dialog box, select the General tab.
- 3 Select Shift + Left Click Image Select.
- 4 Click OK to exit the dialog box.

Quick Reference

MAPIOPTIONS

Specifies default image correlation settings, display options, detach options, paths, and memory settings

Menu	Setup menu ► Raster Options
Command Line	MAPIOPTIONS
Dialog Box	Raster Extension Options dialog box

Displaying Image Frames

An image frame is a vector object that encloses each image you insert.

NOTE This command does not affect images you added using [Data Connect](#) (page 440).

Hiding an image frame ensures that the image cannot be moved or modified accidentally by a single- or double-click and prevents the frame from being plotted or displayed. When image frames are hidden, clipped images are still displayed to their specified frame limits; only the frame is affected. Showing and hiding image frames affects all images attached to your drawing.

When you attach an image to a drawing, the image frame inherits the current color, layer, linetype, and linetype scale.

See also:

- [Changing How Image Frames Are Displayed](#) (page 252)
- [Modifying Other Image Properties](#) (page 503)

To display image frames

- Click Insert tab ► Image panel ► Toggle Frames. 

NOTE If frames are invisible or an image is on a locked or frozen layer or a layer that is turned off, then you cannot select the image by clicking the frame. However, if frames are hidden but the image is on an editable layer, then you can select the image using [Shift + left-click](#) (page 493).

Quick Reference

MAPIFRAME

Makes frames enclosing raster images visible or invisible

Menu View menu ► Imaging Tools ► Toggle Frames

Command Line MAPIFRAME

Dialog Box MAPIFRAME (Image Frame command)

Changing Image Alignment

You can change the alignment and scale of an image. You can reference two points in vector space and two points on a raster image to move, scale, and

rotate the image to the vector coordinates. This process performs a simple transformation but does not rubber sheet the image.

See also:

- [Moving, Rotating, and Scaling an Object](#) (page 931)

To change image alignment

- 1 At the Command prompt, enter align.
- 2 Select the image and press Enter.
- 3 Specify a first source point on the image and a first destination point in the drawing.
- 4 Specify a second source point on the image and a second destination point in the drawing.
- 5 Press Enter.
- 6 To scale the image, type y (Yes) and press Enter.

The image aligns with the drawing according to the reference points you specified.

Quick Reference

ALIGN

Aligns objects with other objects in 2D and 3D

Command Line ALIGN

Adjusting Image Brightness, Contrast, and Fade

When you adjust image brightness, contrast, and fade in AutoCAD Map 3D, the changes you make affect the display of the image as well as the plotted output, but do not affect the original raster image file. Adjust brightness to darken or lighten an image. Adjust contrast to make poor-quality images easier to read. Adjust fade to make vectors easier to see over images or to create a watermark effect in your plotted output.

NOTE This command does not affect images you added using [Data Connect](#) (page 440).

NOTE Bitonal images *cannot* be adjusted for brightness, contrast, or fade. Bitonal images fade to the current screen background when displayed, and fade to white (the color of most paper) when plotted.

See also:

- [Overview of Adding Rasters and Surfaces](#) (page 437)
- [Using Other Raster Image Formats](#) (page 453)

To adjust brightness, contrast, and fade

- 1 At the Command prompt, enter imageadjust.
- 2 Select the image to modify. Press Enter.
- 3 In the Image Adjust dialog box, specify settings:
 - To adjust brightness or contrast, use the Brightness or Contrast slider bar.
 - To adjust image fade, use the Fade slider bar.
- 4 Click OK.

Quick Reference

PROPERTIES

Displays the Properties palette, which allows you to edit the properties of objects

Menu	Analyze ► Properties
Icon	 Properties
Command Line	PROPERTIES
Task Pane	Select object. Right-click in drawing area ► Properties

Changing Image Display Quality and Speed

Changing Image Display Quality

You can change image display quality. Draft-quality images may be grainier, but they display more quickly than high-quality images. Changing the image display quality setting affects all images attached to your drawing with the Insert An Image command.

NOTE This command does not affect images you added using [Data Connect](#) (page 440).

Hiding Images

You can hide an image. Hidden images are not displayed or plotted; only the drawing frame is displayed. You can choose to hide an image regardless of the current viewport coordinate system.

Clipping Images

You can clip the image so that only the parts of the image you want visible are displayed. To display more than one piece of the image, create additional insertions of the image, each with a different clip boundary.

NOTE This command does not affect images you added using [Data Connect](#) (page 440).

See also:

- [Hiding, Unloading, Detaching, and Erasing Images](#) (page 482)
- [Changing Image Display Quality](#) (page 253)

To change image display quality

- 1 At the Command prompt, enter imagequality.
- 2 Type d (draft) or h (high). Press Enter.

To hide a drawing or show clipped images

- 1 Click the frame of the image or images to change.

NOTE If you are zoomed in and cannot see the image frames, press Shift + left-click to select the image or images.

- 2 Right-click the image. Click Properties.
- 3 In the Properties palette, select one of the display options.
 - Select Show Image and set it to No if you do not want to display the image.
 - Select Show Clipped and set it to Yes to display any clip boundaries you have made on an image using the imageclip command.

Quick Reference

PROPERTIES

Displays the Properties palette, which allows you to edit the properties of objects

Menu	Analyze ► Properties
Icon	 Properties
Command Line	PROPERTIES
Task Pane	Select object. Right-click in drawing area ► Properties

Making an Image Transparent

You can make all pixels of a specific color in a grayscale or color image transparent. (The transparency color of a bitonal image is always the background color of the image.) This is useful for overlaying two images or placing an image in front of objects.

NOTE This command does not affect images you added using [Data Connect](#) (page 440).

This option is not available if the image is currently unloaded or if the Raster Extension is not loaded. To load the Raster Extension, use an image command, such as Insert An Image.

NOTE The transparency color is stored in the drawing as an AutoCAD Map 3D custom object. If you send the drawing to other users, they can see the transparency color only by opening the drawing in AutoCAD Map 3D or Autodesk Raster Design. If they open the drawing in AutoCAD, they see a message that AutoCAD cannot reference the custom object and will not display the transparent color.

You can also change the opacity of an entire raster image, so that the image is translucent and items below it are visible.

See also:

- [Overview of Adding Rasters and Surfaces](#) (page 437)
- [Using Other Raster Image Formats](#) (page 453)

To make an image transparent

- 1 Select the image.
- 2 Right-click the image. Click Properties.
- 3 In the Properties palette, select Transparency.
- 4 Click the down arrow at the right of the box and select Yes.

Specify which color will be transparent.

To change the color that is transparent

- 1 Zoom in close to the image so that you can accurately select the color.
- 2 Click the image frame.

NOTE If you are zoomed so you cannot see the image frame, press Shift + left-click to select the image.

- 3 Right-click the image. Click Properties.
- 4 In the Properties palette, select Transparency Color.
If Transparency Color does not appear in the Properties palette, the image may not be loaded or the Raster Extension may not be loaded. To load the image, select the image. Right-click the image ► Image ► Show Image. To load the Raster Extension, choose an image command such as Insert An Image.

NOTE You can choose the transparency color for grayscale and color images. In bitonal images, the transparency color is always the background color of the image.

- 5 Click  to display the [Transparency Color dialog box](#) (page 1883).
- 6 Click Select and pick the desired color on the image. Click OK.
- 7 To turn on transparency, select Transparency in the Properties palette and set it to Yes.

Quick Reference

PROPERTIES

Displays the Properties palette, which allows you to edit the properties of objects

Menu	Analyze ► Properties
Icon	 Properties
Command Line	PROPERTIES
Task Pane	Select object. Right-click in drawing area ► Properties

Modifying the Correlation Settings for an Image

You can specify a precise location for an image.

NOTE This command does not affect images you added using [Data Connect](#) (page 440).

NOTE When you change the insertion point values, AutoCAD Map 3D repositions the image in the drawing and saves the settings in the drawing. However, these correlation changes are saved only in the drawing and are not saved back to the original image file. To change the original correlation information in the image file, use an image-editing application such as Autodesk Raster Design.

See also:

- [Overview of Adding Rasters and Surfaces](#) (page 437)

- [Using Other Raster Image Formats](#) (page 453)

To modify the correlation settings for an image

- 1 Select the image.
- 2 Right-click the image. Click Properties.
- 3 In the Properties palette, do one of the following:
 - To move the image, type new coordinates in the Position X, Y, and Z boxes. This insertion point represents the lower-left corner of the image frame before any rotation is applied.
 - To rotate the image, type a new value in the Rotation box. The units of the rotation value depend on the units that the drawing is using. AutoCAD Map 3D rotates the image around the insertion point.
 - To scale the image, type a new value in the Scale box. For example, to make the image twice as large, type 2 in the Scale box.
- 4 Close the Properties palette.

TIP You can also click the Pick icon to [adjust the frame](#) (page 465) location and size.

Quick Reference

PROPERTIES

Displays the Properties palette, which allows you to edit the properties of objects

Menu Analyze ► Properties

Icon  Properties

Command Line PROPERTIES

Task Pane Select object. Right-click in drawing area ► Properties

Modifying Other Image Properties

Use the Properties palette to modify image properties such as the following:

- Frame color, layer, linetype, and linetype scale
- Image brightness, contrast, and fade
- Location
- Rotation, width, height, and scale
- Image transparency and transparency color

The settings apply only to the selected images.

NOTE This command does not affect images you added using [Data Connect](#) (page 440).

Rotation is in degrees (or the units set by the AUNITS system variable); scale, width, and height are based on the unit of measurement used in the drawing.

When you insert an image, it is inserted on the current AutoCAD layer. Since AutoCAD Map 3D controls the visibility and behavior of the layers, you can move an image to another AutoCAD layer to take advantage of the layer properties. For example, to display images, but not edit them, move the images to an AutoCAD layer and lock the layer.

See also:

- [Overview of Adding Rasters and Surfaces](#) (page 437)
- [Using Other Raster Image Formats](#) (page 453)

To modify image properties

- 1 Click the frame or frames of the image or images to change.

NOTE If you are zoomed in and cannot see the image frames, press Shift + left-click to select the image or images.

- 2 Right-click the image. Click Properties.
- 3 In the Properties palette, select the property to modify. For example:
 - Color — Select a color or click Select Color to display the Select Color dialog box.

Select the desired color or select ByLayer to set the frame color of the image to the color of the layer it is on. The frame color is also the foreground color for bitonal images.

Click OK to apply the new color to the selected image or images.

- Layer — Select the target AutoCAD layer for the image or images.
- Linetype — Select a linetype for the image frame or frames. Select any linetype that is loaded in your drawing or select ByLayer to use the linetype defined for that layer.

Quick Reference

PROPERTIES

Displays the Properties palette, which allows you to edit the properties of objects

Menu	Analyze ► Properties
Icon	 Properties
Command Line	PROPERTIES
Task Pane	Select object. Right-click in drawing area ► Properties

Clipping an Image

By clipping an image, you can display and plot only a portion of the image. The clipping boundary can be a rectangle or a two-dimensional polygon with vertices constrained to lie within the boundaries of the image. Multiple instances of the same image can have different clipping boundaries.

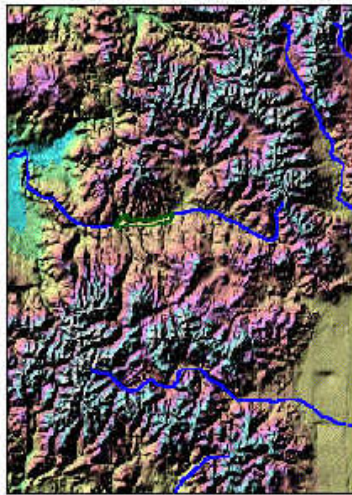
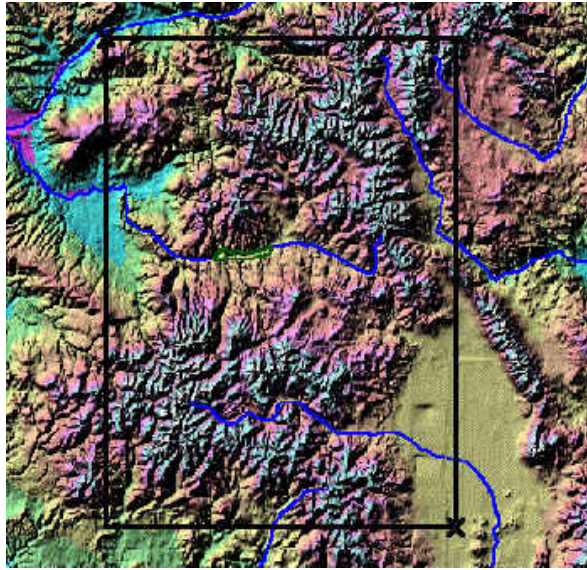

Image Clip lets you show only the part of an image you require. Move your cursor over the image to see the clipped portion of the image.

You can display a clipped image using the clipping boundary, or you can hide the clipping boundary and display the original image boundaries.

NOTE To clip an image, the image boundary must be visible. See [Displaying Image Frames](#) (page 494).

A clip boundary is a display-only feature that you can use for viewing and plotting purposes. It does not permanently change image data. When you delete a clipping boundary, the original image boundary is restored. To clip the image permanently, use an image-editing application such as Autodesk Raster Design.

NOTE This command does not affect images you added using [Data Connect](#) (page 440).

See also:

- [Displaying Image Frames](#) (page 494)
- [Overview of Adding Rasters and Surfaces](#) (page 437)
- [Using Other Raster Image Formats](#) (page 453)

To clip an image

- 1 At the Command prompt, enter `imageclip`.
- 2 [Select the image](#) (page 493) to clip. You can clip one image at a time.
- 3 Press Enter or type `n` to create a new clip boundary.
- 4 Type `r` to create a rectangular boundary, or type `p` to create a polygonal boundary.
- 5 Pick the points to define the clip boundary. You must pick at least three points to define a polygonal boundary.

To restore the image, use these steps: At the Command prompt, enter `imageclip`. Type `off`.

You can modify the clip boundary by defining a new boundary for the image or by using object grips.

You can also choose to show or hide clip boundaries by changing the [image display properties](#) (page 498) in the Properties palette.

Quick Reference

IMAGECLIP

Creates new clipping boundaries for an image object

Icon



Clip Image

Command Line

IMAGECLIP

Task Pane

Select an image. Right-click in drawing area ► Image ► Clip

Joining Data to GIS Features

You can add properties from a different data source to GIS features in your map using joins. For example, you can join employment rates stored in a Microsoft Access database file to city features stored in an SDF file, or to counties stored in an Oracle database. Once you join the two data sources, you can use the joined information to style the feature, the same way you use its native information. For example, you can theme the city features based on the employment rates you joined.

NOTE These options are available for geospatial data only, and not for drawing objects. To join attribute data to drawing objects, see [Overview of Linking Database Records to Objects](#) (page 522).

Overview of Joins

Use joins to add extra data to GIS features in your map. For example, join income data to a parcel layer to add that information to those features. You can join data from the Internet, other organizations you work with, or GIS data repositories.

NOTE Joins are available for geospatial data only, and not for drawing objects. To join attribute data to drawing objects, see [Overview of Linking Database Records to Objects](#) (page 522).

After you create the join, you can use the additional properties the same way you use the native properties of the feature class: to label, theme, style, and analyze the features of the layer.

For example, after you join a table of voter turnout data to a map of regions in your area, you can create a theme that varies in appearance, depending on the number of participating voters in each region.

With joins, you can keep your data in separate tables, focused on specific topics, instead of in one large database or file. This can ease administration and reduce complexity.

Typically, a join connects a separate table of data (a secondary table) to a feature class layer (the primary table). The most common type of join is a one-to-one join, which connects one record in a table of data to one feature in a feature class.

Typically, you join data tables from an application such as Microsoft Access to FDO layers from SDE, SHP, Oracle, and ArcSDE data. However, you can also join feature sources such as SHP to other feature sources.

Tell me more



Video

- [Show me how to join attribute data to features.](#)
- [Show me how to manage joins.](#)



Procedure

- [Create a join.](#) (page 512)



Tutorial

- Lesson 2: Analyze Data With External Information Using Joins



Workflow

- Join Attribute Data to a Geospatial Feature



GIS Skill

- [Join attribute data to features](#)



Related topics

- [Overview of the Data Table](#) (page 1125)

- [Create a join.](#) (page 512)
- [Modify joins.](#) (page 515)

- [Edit joined data.](#) (page 517)
- [Export data from the Data Table.](#) (page 520)

Creating a Join

A join adds the properties from a data table (secondary table) to an existing Feature Class layer (primary table). The original data remains unchanged in its source—the join exists only within your map.

The secondary table can be an actual table, such as a named range in an Excel spreadsheet, or the tabular data contained in a feature source, such as an Oracle database or an SDF file.

NOTE Joins are available for geospatial data only, and not for drawing objects. To join attribute data to drawing objects, see [Overview of Linking Database Records to Objects](#) (page 522).

One-to-One Joins

The most common type of join is a one-to-one join, in which one feature is matched to one secondary record, and any additional secondary records are ignored. For example, if you are joining a table of income data to a layer representing parcels, you may have more than one income value for a particular property (if there are multiple residences on that parcel, for instance, or multiple earners in a residence). In a one-to-one join, the first income value found for a parcel is matched to that parcel, and any other income information is ignored.

One-to-Many Joins

You can also create a one-to-many join. In this case, when there are multiple secondary records for a single feature, additional features are generated to represent the extra values. Using the same example as above, a parcel that matches multiple income values will result in multiple Data Table entries for that parcel, each with a separate income value (even though there is still only one actual feature). If you style the parcel layer based on income values, only one is visible in your display map. You can still edit the feature in your map (for example, to resize it). The real feature in your data will be updated.

NOTE Adding features to your map can have performance implications; some operations take longer when there is more feature data.

Join Keys

To be joined, the primary and secondary tables must contain matching fields with common values. These matching fields are the join keys.

For example, when joining a data table containing employment rates to a layer representing counties, the join key might be `County_Name`, if that field is common to both tables.

A join key does not need to have the same name in both data sources, but it must have the same data type (numeric, string, Boolean, and so on). For example, you can match the `Parcel_ID` field in one table to the `Lot_Number` field in the second table, so long as `Parcel_ID` and `Lot_Number` use the same data type.

NOTE Joins that use String fields are case-sensitive. The values in the fields must match exactly. Jones will not match JONES.

Advanced Joining

You can join multiple secondary tables to a feature layer. There are several ways to do this.

You can join a new table to the joined secondary table to create a “chain” of joins. For example, you can begin by joining income information to a layer of parcel features, using the `Parcel_ID` as the common join key. Then you can add a join to a table of employment data, using `Job_Title` as a common join key between the income table and the employment table. Even though the parcel feature does not contain a property for `Job_Title`, you can style the parcels by job type after you complete both joins.

You can join multiple tables to a single feature using the same join key. For example, you can join a table of traffic information to a roads layer, using the `Road_Name` field as the join key. You can then join a second table of maintenance schedules to the roads layer, using the same join key.

You can also join multiple tables to a single feature using different join keys. For example, you can join population information to a layer representing counties, using the `County_Name` field as the join key. Then you can join flood-zone data to the same layer using `Elevation` as the join key.

In all cases, you can use all of the joined data when styling or theming the feature layer.

Using Joins for Calculated Fields

You can create a calculated field that uses native data and joined data. For example, if you join assessor data to parcel data, you can create a field that represents the cost per acre for each parcel. You create a calculated field using an expression.

Non-matching Data

When you create a join, you can specify how to deal with features in the primary table that do not find a match in the secondary table. For example, if you are joining assessor data to a parcel layer, you can decide what to do with parcels that have no assessment data. The choices are as follows:

- Keep All Records On The Left – Keeps all features, even if there is no match in the secondary table (a left outer join).
- Keep Only Left-Side Records With A Match – Hides features if there is no matching record in the secondary table (an inner join).

Tell me more



Video

- [Show me how to join attribute data to features.](#)



Procedure

- [Create a join.](#) (page 512)



Tutorial

- [Lesson 2: Analyze Data With External Information Using Joins](#)



Workflow

- [Join Attribute Data to a Geospatial Feature](#)



GIS Skill

- [Join attribute data to features](#)



Related topics

- [Modifying or Removing Joins](#) (page 514)
- [Editing Joined Data](#) (page 515)

- [Using Joins with Calculated Properties](#) (page 518)
- [Accessing Data from ODBC](#) (page 342)
- [Overview of the Data Table](#) (page 1125)

NOTE Joins are available for geospatial data only, and not for drawing objects. To join attribute data to drawing objects, see [Overview of Linking Database Records to Objects](#) (page 522).

To create a join

- 1 Prepare to create a join by doing the following:
 - Ensure the primary and secondary sources share one or more common fields, for example Parcel_ID or County_Name. These fields do not have to have the same name in both sources, but they must use the same data type.
 - Simplify your secondary table data as much as possible. For example, remove unnecessary records or tables.
 - Connect to both the primary and secondary sources using one of the FDO Providers in Data Connect. When you connect to a secondary source that has no geometry data, you need not add anything to the map—you can just establish the connection and close the Data Connect window.

NOTE If your secondary source is a Microsoft Access or Microsoft Excel table, connect to it using an ODBC connection. For information about setting up ODBC sources, see [Accessing Data from ODBC](#) (page 342).

- 2 In Display Manager, right-click a feature layer ► Create A Join.

NOTE Once you create a join, this command changes to Joins ► Manage Joins and displays the [Manage Layer Data dialog box](#) (page 1607). In that dialog box, you can add, edit, or delete joins.

The layer you right-click is the primary source.

- 3 In the Table (Or Feature Class) To Join To list in the [Create a Join / Edit a Join dialog box](#) (page 1603), select the table or feature class whose data you will to join to the layer.

Your selection is the secondary source. If this source contains multiple tables, choose the one to use for the join.

- 4 In the This Column From The Left Table list, select the join key (the common field or property) for the primary source, for example, Parcel_ID or County_Name.
- 5 In the Matches This Column From The Right Table list, select the matching field or property in the secondary source.
Only fields with matching data types are displayed in the right-hand list. The fields need not have the same name in both data sources, but they must have the same data type (numeric, string, Boolean, and so on). For example, you can match the Parcel_ID field in one table to the Lot_Number field in the second table, so long as Parcel_ID and Lot_Number use the same data type.
- 6 Under Type Of Joins, select the type of join to create:
 - Keep All Records On The Left (a left outer join)
 - Keep Only Left-Side Records With A Match (an inner join)
- 7 Under Relationship With Secondary Records (Cardinality), choose one of the following:
 - One-To-One matches one secondary source record to each primary source item. Any extra secondary source records are ignored.
 - One-To-Many creates a new feature for each extra record in the secondary source.
- 8 Click OK.

In the [Data Table](#) (page 1125) for the primary source (the feature layer to which you joined the data), the newly joined properties are appended to the right of the native feature data. The joined properties are gray, to indicate that they are read-only. In the column title, the name of the table you joined precedes the property name.

NOTE To edit joined data, you must edit the secondary source itself, and not the layer to which it is joined. See [Editing Joined Data](#) (page 515).

Quick Reference

MAPDEFINEJOIN

Defines a join for feature data.

Command Line MAPDEFINEJOIN

Task Pane In the Task Pane, right-click a layer ► Create Join.

Modifying or Removing Joins

After you create a join, you can change the settings you specified when you created it. You can remove one (of multiple) joins from a feature layer, or remove all joins from the feature layer at once, restoring the properties for that layer to its native data only.

NOTE Joins are available for geospatial data only, and not for drawing objects. To join attribute data to drawing objects, see [Overview of Linking Database Records to Objects](#) (page 522).

Tell me more



Video

- [Show me how to manage joins.](#)



Procedure

- [To modify a join](#) (page 515)



Tutorial

- Lesson 2: Analyze Data With External Information Using Joins



Workflow

- Join Attribute Data to a Geospatial Feature



GIS Skill

- [Join attribute data to features](#)



Related topics

- [Overview of Joins](#) (page 507)
 - [Creating a Join](#) (page 509)
 - [Editing Joined Data](#) (page 515)
 - [Using Joins with Calculated Properties](#) (page 518)
-

NOTE Joins are available for geospatial data only, and not for drawing objects. To join attribute data to drawing objects, see [Overview of Linking Database Records to Objects](#) (page 522).

To modify a join

- 1 In Display Manager, right-click the feature layer with the join to modify, and select Manage Joins.
- 2 In the [Manage Layer Data dialog box](#) (page 1607), select the join to modify, and click Edit.
- 3 In the Edit A Join dialog box, change any settings.
The settings are the same ones you used when you [created the join](#) (page 512). For example, you can change this join from One-To-Many to One-To-One to get rid of extra features created by the original join.
- 4 To delete one (or multiple) joins for this feature layer, click the join to delete (use Ctrl or Shift to select multiple joins). Click Delete.
- 5 When you are finished, click OK.

Changes can affect the styles, themes, and labels you set up in your map, if they were based on the joined data.

Quick Reference

MAPDEFINEJOIN

Defines a join for feature data.

Command Line MAPDEFINEJOIN

Task Pane In the Task Pane, right-click a layer ► Create Join.

Editing Joined Data

You can edit the records in joined geospatial data.

NOTE Joins are available for geospatial data only, and not for drawing objects. To join attribute data to drawing objects, see [Overview of Linking Database Records to Objects](#) (page 522).

To help you maintain the integrity of your original data, a few limitations apply when editing joined data:

- When you edit a feature layer that has a [one-to-one join](#) (page 2070) in the Data Table, you can change the native feature data (from the primary table) but you cannot change the joined properties (from the secondary table). To edit the joined data, display Map Explorer, expand the data source containing the table to edit, select that table, and click Table.

NOTE You cannot add or delete records from an ODBC data source using the Data Table. Use the source application, for example Microsoft Access, to do this.

- For one-to-one joins, you can delete records from the primary source only. You cannot edit one-to-one inner joins.
- You can insert records in the primary source for a [left outer join](#) (page 2066). You cannot do so for an [inner join](#) (page 2065), because the lack of a matching secondary record would make the feature disappear.
- You cannot edit inner joins or one-to-many joins. To make changes, you must open the table itself from Map Explorer.
- In general, you cannot edit primary keys.
Each feature class has a property whose value uniquely identifies each feature within that class. This is called the primary key. Many feature classes use a single property for this purpose, for example, FeatureId. However, a feature class could have a list of properties such as street number, street name, and street type to uniquely identify a house address.
An [FDO provider](#) (page 2063) may also support the concept of autogenerated ID values. When you add objects to your map using such a provider, the identity property will not have a value, but it is still the primary key.
- When [working offline](#) (page 721), the above rules apply, and you cannot insert records at all.

See also:

- [Viewing Data for a Selected Layer, Join, Unfiltered Feature Class, or Non-Spatial Data Table](#) (page 1134)
- [Editing Features using the Data Table](#) (page 711)

NOTE Joins are available for geospatial data only, and not for drawing objects. To join attribute data to drawing objects, see [Overview of Linking Database Records to Objects](#) (page 522).

To edit joined data

For this type of join or data...	Edit	Insert	Delete
One-to-One	You can edit the primary table (the native feature data) when you display the Data Table for the feature layer. To edit the secondary table (joined data) open the table in Map Explorer. You cannot edit the primary key (page 2071), but you can edit the join key.	You cannot insert data for an inner join (page 2065) because it might cause the new primary record to “disappear” when there is no matching secondary record. For a left outer join (page 2066), you can insert records only in the primary table.	You can delete only records only in the primary table.
One-to-Many	You cannot edit the primary table (the native feature data) or the secondary table (joined data) in the Data Table from Display Manager. Instead, open the tables in Map Explorer.	Not available.	Not available.
Offline	You can edit (as above) while you work offline, but you cannot insert records.	Not available.	You can delete only records only in the primary table.
Feature data	You can edit read/write feature sources.	You can insert data for read/write feature sources.	You can delete data from read/write feature sources.

For this type of join or data...	Edit	Insert	Delete
ODBC data table	You can edit records in Data Table.	Not available. Use the source application, such as Microsoft Access, to insert records.	Not available. Use the source application, such as Microsoft Access, to delete records.

Quick Reference

MAPDEFINEJOIN

Defines a join for feature data.

Command Line MAPDEFINEJOIN

Task Pane In the Task Pane, right-click a layer ► Create Join.

Using Joins with Calculated Properties

Calculated properties combine information in existing properties using expressions. The existing fields can be native to the current feature layer, or they can be joined to that feature layer. For example, you can join an assessor database to a parcel layer and create a calculated property to determine value per acre based on the parcel value in the assessor data and the parcel area in the parcel layer.

NOTE Joins are available for geospatial data only, and not for drawing objects. To join attribute data to drawing objects, see [Overview of Linking Database Records to Objects](#) (page 522).

See also:

- [Creating Calculated Properties](#) (page 1132)
- [Creating a Calculation](#)
- [Creating Expressions - Reference](#)

NOTE Joins are available for geospatial data only, and not for drawing objects. To join attribute data to drawing objects, see [Overview of Linking Database Records to Objects](#) (page 522).

To create a calculated property based on joined data

- 1 [Connect to both data sources and join them, based on a common property.](#) (page 509)
- 2 In the Display Manager, select the primary source (the feature layer to which you joined the data) and click Table.
- 3 In the Data Table, click Options ► Create A Calculation.

NOTE If a calculation already exists, click Options ► Manage Calculations.

- 4 Create the expression for the calculation.
The available properties and values reflect both the source layer and the joined data.
For help with any expression element, see [Creating Expressions - Reference](#).

Quick Reference

MAPDEFINEJOIN

Defines a join for feature data.

Command Line MAPDEFINEJOIN

Task Pane In the Task Pane, right-click a layer ► Create Join.

Sharing Joined Data with Others

Use these techniques to share joined data and join definitions with others:

- [Export layer\(s\) to an SDF file](#) (page 1469) – When you export feature layers to an SDF version 3 file, joined properties are included. The SDF file can be reused or shared with other AutoCAD Map 3D, Civil 3D, and MapGuide customers or other programs that support SDF. The resulting file does not contain styling data.

- [Save a layer to a .LAYER file](#) (page 1469) – When you save a layer to a *.layer* file, it retains its styling information and pointers to the data source that defines its geometry and attributes (including joined data). You can drag and drop saved layers into any map to reuse them, or use them with MapGuide Enterprise.
- [Copy or export data from the Data Table](#) (page 1473) – When you copy selected features in the Data Table and past them into other programs like Microsoft Access or Excel, joined properties are included. You can also export selected data to a comma-separated file for use in other programs.

NOTE Joins are available for geospatial data only, and not for drawing objects. To join attribute data to drawing objects, see [Overview of Linking Database Records to Objects](#) (page 522).

NOTE Joins are available for geospatial data only, and not for drawing objects. To join attribute data to drawing objects, see [Overview of Linking Database Records to Objects](#) (page 522).

[To save layer and joined properties to an SDF file](#) (page 1470)

[To export layer connections and joins to a .LAYER file](#) (page 1471)

[To export data from the Data Table](#) (page 1474)

Quick Reference

MAPEXPORT

Exports drawing objects and their attribute data to an external file format

Menu Click File ► Convert DWG To ► Map 3D Export.

Icon  Export Map File

Command Line MAPEXPORT

Dialog Box Export dialog box

MAP2SDF

Exports an SDF 2 format file for use with Autodesk MapGuide, versions 6.5 and earlier.

Menu	Click File ► Convert DWG To ► Autodesk SDF2 (MapGuide6.x...).
Command Line	MAP2SDF
Dialog Box	Autodesk MapGuide Export dialog box

Adding Attributes to Drawing Objects

Link attribute data to objects in your drawing.

See also:

- [Setting Up Data Sources for Drawings](#) (page 204)

To add attribute data to drawing objects

- [To store attribute data in the drawing](#) (page 522)
- [To link records to objects](#) (page 523)
- [To create a link template](#) (page 526)
- [To open a linked database table](#) (page 527)
- [To link a record to an object manually](#) (page 529)
- [To link records to objects using object data automatically](#) (page 531)
- [To link records to objects using text or block attribute data automatically](#) (page 532)
- [To convert object data to a linked database table](#) (page 534)
- [To edit or delete a database link](#) (page 537)
- [To delete links for a group of objects](#) (page 537)
- [To edit the database path in a link template](#) (page 539)
- [To delete a link template](#) (page 539)

Storing Attribute Data in the Drawing (Object Data)

Object data is attribute data that is attached to individual objects and stored in tables in the drawing. To use object data, first define the format for the table, and then create each record as you attach it to an object.

NOTE Object data applies to drawing objects only. For information on viewing and editing geospatial attributes, see [Overview of the Data Table](#) (page 1125).

See also:

- [Setting Up Object Data](#) (page 198)

- [Entering and Editing Object Data](#) (page 1061)
- [Bringing In Drawing Objects Based on Attached Data](#) (page 363)

NOTE Object data applies to drawing objects only. For information on viewing and editing geospatial attributes, see [Overview of the Data Table](#) (page 1125).

To store attribute data in the drawing

- [To create an object data table](#) (page 201)
- [To attach data to an object](#) (page 1064)
- [To bring in drawing objects based on object data](#) (page 364)

Overview of Linking Database Records to Objects

You can create a link between a record in an external database and an object in your drawing. Once the link exists, use the information in the database to help you analyze, select, and display objects in your drawing.

For example, you can link property ownership data to a map of a housing development. Select records based on property value and highlight all objects linked to those records. Alternately, select all the houses in a specified area and highlight records that are linked to the selected houses.

Linking records takes two steps:

- Create a link template for each database. The link template specifies which column in the database table to use as a key column.
- Link specific objects to specific records in the table.

When you link a record from a database to an object in your drawing, AutoCAD Map 3D stores link data on the object.

NOTE Link templates apply to drawing objects only. For information on viewing and editing geospatial attributes, see [Overview of the Data Table](#) (page 1125). For information on joining data to a geospatial feature class, see [Overview of Joins](#) (page 507).

Tell me more



Procedure

- [To link records to objects](#) (page 523)



Workflow

- [Attach Attribute Data to Drawing Objects](#)



Related topics

- [Setting Up Data Sources for Drawings](#) (page 204)
- [Creating a Link Template](#) (page 525)

NOTE Link templates apply to drawing objects only. For information on viewing and editing geospatial attributes, see [Overview of the Data Table](#) (page 1125). For information on joining data to a geospatial feature class, see [Overview of Joins](#) (page 507).

To link records to objects

- 1 Before you can link a database record to an object, you must [attach the data source to the drawing](#) (page 209) and [create a link template for the table](#) (page 526).
- 2 Create links using one of the following methods:
 - [Manually link a specific record to a specific object](#) (page 529).
 - [Link objects automatically based on text or blocks in the drawing](#) (page 532).
 - [Convert existing object data to a linked database table](#) (page 534).
- 3 If necessary you can [edit the link](#) (page 537).

Quick Reference

ADEGENLINK

Automatically links objects to object data or external database records

Menu

In the Classic workspace, click Setup menu ► More Link Template Options ► Generate Links

Command Line	ADEGENLINK
Task Pane	In Map Explorer, right-click a link template ► Generate Links
Dialog Box	Generate Data Links dialog box

(Data View) Link Records to Objects

Links the selected records to objects in your drawing

Menu	In the Data View: Links ► Link Records To Objects
Icon	 Link Records to Objects

MAPDELETELINKS

Deletes database links from objects

Menu	Setup menu ► More Link Template Options ► Delete Links
Command Line	MAPDELETELINKS
Task Pane	In Map Explorer, right-click a link template ► Delete Links
Dialog Box	Select Link Templates dialog box

MAPLINKMANAGER

Edits the link data attached to an object

Menu	Setup menu ► More Link Template Options ► Link Manager
Command Line	MAPLINKMANAGER

MAPOD2ASE

Converts object data tables to linked external database tables

Menu	Click Setup ► Convert Object Data to Database Links.
Command Line	MAPOD2ASE
Dialog Box	Convert Object Data to Database Links dialog box

Creating a Link Template

A link template specifies how to link objects in a drawing to records in a specific database table.

NOTE Link templates apply to drawing objects only. For information on viewing and editing geospatial attributes, see [Overview of the Data Table](#) (page 1125). For information on joining data to a geospatial feature class, see [Overview of Joins](#) (page 507).

A link template specifies the name of the database table and the key columns to use to uniquely identify each record.

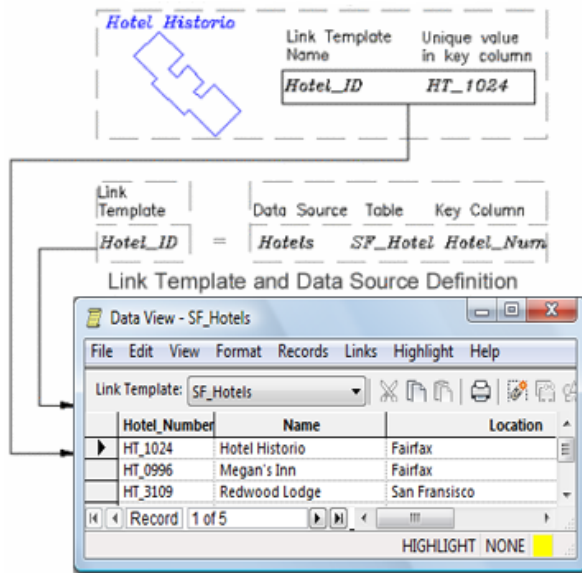

The link template is stored in the current drawing.

See also:

- [Overview of Linking Database Records to Objects](#) (page 522)

NOTE Link templates apply to drawing objects only. For information on viewing and editing geospatial attributes, see [Overview of the Data Table](#) (page 1125). For information on joining data to a geospatial feature class, see [Overview of Joins](#) (page 507).

NOTE Before you create a link template, make sure the data source for the table is currently [attached](#) (page 209) and [connected](#) (page 215).

To create a link template

- 1 In [Map Explorer](#) (page 2068), right-click the table and click Define Link Template.
- 2 In the [Define Link Template dialog box \(MAPDEFINELT\)](#) (page 1683), type a name for the link template.
- 3 Under Key Selection, select the column to use as the key by clicking the check box in the Key column.
AutoCAD Map 3D uses the value in the key column to uniquely identify a record, so select a column or a combination of columns that contains a unique value for each record in the database.
- 4 Click OK.

NOTE If the link template does not immediately appear on the Map Explorer tab of the Task Pane, right-click a blank space in Map Explorer. Click Refresh.

Quick Reference

(Data View) Define Link Template

Creates a new link template

Menu	In the Data View: Links ► Define Link Template
Icon	 Define Link Template
Dialog Box	Define Link Template dialog box (MAPDEFINELT)

MAPDEFINELT

Defines a link template for a database table

Menu	Click Setup ► More Link Template Options ► Delete Link Template.
Icon	 Define Link Template

Command Line	MAPDEFINELT
Task Pane	In Map Explorer, right-click a data source table or query ► Define Link Template
Dialog Box	Define Link Template dialog box (MAPDEFINELT)

Opening a Linked Database Table

Once you have defined a link template for a table, you can open the table as a linked table. When a table is opened as a linked table, AutoCAD Map 3D tracks the relationship between the records in the table and the objects in your drawing.

NOTE Link templates apply to drawing objects only. For information on viewing and editing geospatial attributes, see [Overview of the Data Table](#) (page 1125). For information on joining data to a geospatial feature class, see [Overview of Joins](#) (page 507).

See also:

- [Viewing External Data Linked to Drawing Objects](#) (page 1146)
- [Finding Records in a Database Linked to Drawing Objects](#) (page 1221)

NOTE Link templates apply to drawing objects only. For information on viewing and editing geospatial attributes, see [Overview of the Data Table](#) (page 1125). For information on joining data to a geospatial feature class, see [Overview of Joins](#) (page 507).

To open a linked database table

- In [Map Explorer](#) (page 2068), double-click a link template. Depending on the data source option setting, the linked table opens in either Edit mode or View mode. If the table is write-protected, it opens in View mode. Queries always open in View mode.
- To open a table in View mode, right-click the link template. Click View Linked Table.
In the [Select Link Template Key dialog box](#) (page 1797), select a link template for the database table containing the data matching your object data table and a validation option.

Quick Reference

MAPVIEWLINK

Opens a database table associated with a specific link template to view in the Data View

Menu Click Map ► Database ► View Data ► View Linked Table.

Command Line MAPVIEWLINK

Task Pane In Map Explorer, right-click a link template ► View Linked Table

Dialog Box Select Link Template dialog box

Manually Linking Database Records to Objects

You can create a link between an object in the drawing and a record in a database table.

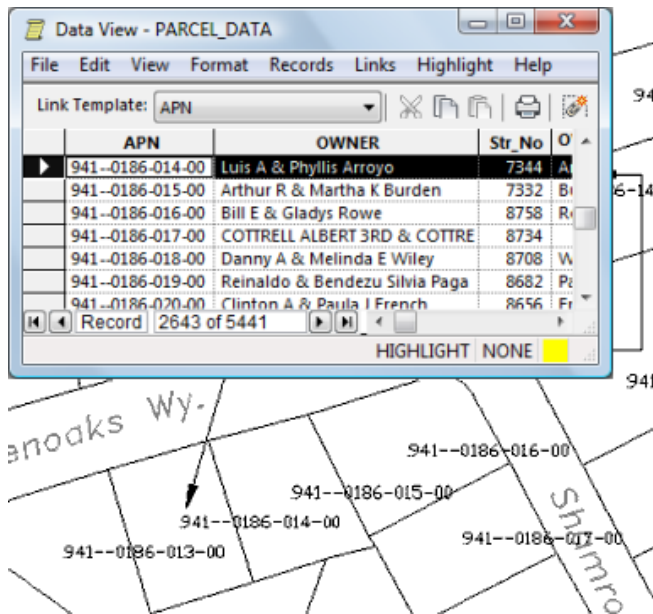

You cannot create links for non-graphical objects, such as layers and linetypes.

NOTE You can link records to drawing objects. You cannot link records to features from a feature source. For information on viewing and editing geospatial attributes, see [Overview of the Data Table](#) (page 1125). For information on joining data to a geospatial feature class, see [Overview of Joins](#) (page 507).

Link Data

When you create a link, link data is stored on the object. The link data has two parts: the name of the link template to use, and the actual value to search for in the key column. The record with the matching key value is linked to the object.

See also:

- [Overview of Linking Database Records to Objects](#) (page 522)
- [Setting Up Data Sources for Drawings](#) (page 204)
- [Creating a Link Template](#) (page 525)
- [Automatically Linking Database Records to Objects](#) (page 530)

NOTE You can link records to drawing objects. You cannot link records to features from a feature source. For information on viewing and editing geospatial attributes, see [Overview of the Data Table](#) (page 1125). For information on joining data to a geospatial feature class, see [Overview of Joins](#) (page 507).

NOTE To link records to objects, you must first [define a link template for the table](#) (page 525), and you must [open the table as a linked table](#) (page 527).

To link a record to an object manually

- 1 Open a linked database table in the [Data View](#) (page 1052).
- 2 In the Data View window, select a record.
- 3 In the Data View, click Links menu ► Link Records To Objects.
- 4 Select the objects in your drawing. Press Enter.

NOTE If you are linking data to a polygon and plan to use the data with topology functions, be sure to link the data to the centroid of the polygon. Topology functions do not use data linked to the polygon border.

Quick Reference

(Data View) Link Records to Objects

Links the selected records to objects in your drawing

Menu In the Data View: Links ► Link Records To Objects

Icon  Link Records to Objects

Automatically Linking Database Records to Objects

If information in your drawing, such as object data, text, or block attribute data, matches information in a database table, you can automatically create links from each selected object to a matching record in the database table.

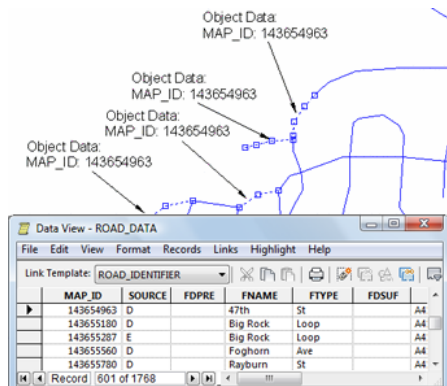

For example, if each parcel in a parcel map has attached object data that contains the parcel ID, you can automatically link each parcel to the correct record in a database of parcel information.

Or if you have district code stored as block attribute data and also have a table that has a column for district codes, you can automatically link each code in the map to the corresponding record in the table.

If no matching record is found in the database table, you can set an option to create the record.

If you are using block or text, you can set an option to use the insertion point of the block or text as the label point for the object.

NOTE You can link records to drawing objects. You cannot link records to features from a feature source. For information on viewing and editing geospatial attributes, see [Overview of the Data Table](#) (page 1125). For information on joining data to a geospatial feature class, see [Overview of Joins](#) (page 507).

See also:

- [Overview of Linking Database Records to Objects](#) (page 522)
- [Creating a Link Template](#) (page 525)
- [Setting Up Data Sources for Drawings](#) (page 204)
- [Defining the Text Insertion Point](#) (page 936)
- [Converting Object Data to Database Links](#) (page 533)
- [Manually Linking Database Records to Objects](#) (page 528)

Before you begin, be sure you have [defined a link template](#) (page 526) for the database you will use, and the objects to link to are accessible. You cannot create links to objects on layers that are locked, frozen, or turned off.

NOTE You can link records to drawing objects. You cannot link records to features from a feature source. For information on viewing and editing geospatial attributes, see [Overview of the Data Table](#) (page 1125). For information on joining data to a geospatial feature class, see [Overview of Joins](#) (page 507).



To link records to objects using object data automatically

- 1 At the Command prompt, enter mapod2ase.
- 2 In the [Convert Object Data to Database Links dialog box](#) (page 1680), under Source Object Data Table, select an object data table.
- 3 Select Remove Data From Objects Processed to delete the object data after creating the link.
- 4 Under Target Link Template, select Link Object Data To Database.
- 5 Click Define to specify the link template.
- 6 In the [Select Existing Link Template dialog box](#) (page 1689), under Link Template, select an available link template.
- 7 For each key field in the link template, select a field in the object data table.

- 8 Select a Database Validation option:
 - None — Creates links without checking to see if a matching record exists in the table
 - Link Must Exist — Creates a link only if the value in the drawing matches the key field value of an existing record. If no record has a matching value, a link is not created for that object.
 - Create If New — Creates a new record in the table if no existing record has a matching value.
- 9 Click OK.
- 10 In the Convert Object Data To Database Links dialog box, specify how to select objects with attached object data.

You can select objects automatically or manually, and you can use a filter to restrict selection to specified layers.
- 11 Click Proceed.

To link records to objects using text or block attribute data automatically

- 1 Click Map Setup tab ► Attribute Data panel ►  ► Generate Links.

- 2 In the Generate Data Links dialog box, select a linkage type.
- 3 Under Data Links, select Create Database Links.
- 4 Select a link template.

If you are creating links to enclosed text, select a link template that has only one key field.
- 5 If you are creating links to blocks or enclosed blocks, select the name of the block.

For each key field in the link template, select a tag from the block attribute. You can assign a tag to only one key field.
- 6 Select a Database Validation option.
- 7 Optionally, select Use Insertion Point As Label Point.
- 8 Click OK.

- 9 Enter a to use all blocks or text objects, or enter s to select block or text objects.

Quick Reference

MAPOD2ASE

Converts object data tables to linked external database tables

Menu	Click Setup ► Convert Object Data to Database Links.
Command Line	MAPOD2ASE
Dialog Box	Convert Object Data to Database Links dialog box

ADEGENLINK

Automatically links objects to object data or external database records

Menu	In the Classic workspace, click Setup menu ► More Link Template Options ► Generate Links
Command Line	ADEGENLINK
Task Pane	In Map Explorer, right-click a link template ► Generate Links
Dialog Box	Generate Data Links dialog box

Converting Object Data to Database Links

You can convert object data into linked records in an external database table.

You can do one of the following

- Create a new table in an existing data source. For the new link template, you can use an existing field as the key field, or you can have AutoCAD Map 3D create a new field and assign a unique value to each record.
- Add the data to an existing database table.

NOTE Object data is available for drawing objects only. For information on viewing and editing geospatial attributes, see [Overview of the Data Table](#) (page 1125).

Field Names in the New Table

By default, the fields in the new database table have the same names as the fields in the object data table. AutoCAD Map 3D resolves any conflicts in the following ways:

- Truncates fields that are too long and adds an incremental digit to the resulting duplicate field names
- Replaces unsupported characters in a field name with an underscore (_)
- Converts unsupported field types to character
- Converts point fields to a character string and separates coordinates with commas

In addition, if you have object data that matches information in a database table, you can automatically create links from each selected object to a matching record in the database table.

See also:

- [Overview of Linking Database Records to Objects](#) (page 522)
- [Creating a Link Template](#) (page 525)
- [Setting Up Data Sources for Drawings](#) (page 204)
- [Automatically Linking Database Records to Objects](#) (page 530)

NOTE Object data is available for drawing objects only. For information on viewing and editing geospatial attributes, see [Overview of the Data Table](#) (page 1125).

If you plan to create a new table in an existing data source, make sure the appropriate data source is currently [attached](#) (page 209) and [connected](#) (page 215).

NOTE During the conversion, field names in the object data table become field names in the database table. Make sure that the field names in your object data table are not SQL reserved words such as DATE, SELECT, or CURRENT. If necessary, rename the fields in your object data table before you convert it.

To convert object data to a linked database table

- 1 At the Command prompt, enter mapod2ase.

- 2 In the [Convert Object Data to Database Links dialog box](#) (page 1680), under Source Object Data Table, select an object data table.
- 3 Select Remove Data From Objects Processed to delete the object data after creating the link.
- 4 Under Target Link Template, select Convert Object Data To Database.
- 5 Click Define to specify the link template.
- 6 In the [Define Link Template dialog box \(MAPOD2ASE\)](#) (page 1682), select an available data source. Click Connect.
- 7 Enter a table name.
- 8 In the [Link Template Key Column Entry dialog box](#) (page 1620), specify the fields to use as key fields (columns). To enter more than one field name, separate names with a comma.
To select from a list of field names in the object data table, or to rename the fields, click Select to display the Select Link Template Key(s) dialog box.
You can use an existing object data field as the key column or create a new field. If you select Generate Key Field, specify a name for the field in the Generate Key area. AutoCAD Map 3D sets the first record in the database table to 1, and increments each subsequent record by 1. Click OK to close the Select Link Template Key(s) dialog box.
- 9 In the Define Link Template dialog box, enter a name for the link template and click OK.
The link template stores the address of the database table and the name of the key field. Accept the default or enter a new unique name.
- 10 In the Convert Object Data To Database Links dialog box, specify how to select objects with attached object data.
You can select objects automatically or manually, and you can use a filter to restrict selection to specified layers.
- 11 Click Proceed.

AutoCAD Map 3D converts the object data into linked database tables.

Quick Reference

MAPOD2ASE

Converts object data tables to linked external database tables

Menu	Click Setup ► Convert Object Data to Database Links.
Command Line	MAPOD2ASE
Dialog Box	Convert Object Data to Database Links dialog box

Editing Database Links

To link an object to a different record in a database table, you can either delete the old link and create a new link, or you can edit the link data stored on the object.

The link data specifies the following:

- the link template for the database table
- the link value for the record

The object is linked to the record in the database table where the value in the key column matches the link value on the object. If you edit the link value, you link the object to a different record in the table.

For example, a database has a record for each piece of equipment. The link template for the database table specifies the serial number column as the key column. If you replace a piece of equipment, you must edit the link value on the object in the drawing to reflect the new serial number. This links the object to the record with the new serial number.

NOTE You can link records to drawing objects. You cannot link records to features from a feature source. For information on viewing and editing geospatial attributes, see [Overview of the Data Table](#) (page 1125). For information on joining data to a geospatial feature class, see [Overview of Joins](#) (page 507).

Editing Linked Objects

If you move, copy, or delete a linked object, the link data is moved, copied, or deleted with it. Deleting the object and its link data does not affect the data in the database table.

You can also delete the link from the object.

See also:

- [Overview of Linking Database Records to Objects](#) (page 522)

- [Creating a Link Template](#) (page 525)
- [Setting Up Data Sources for Drawings](#) (page 204)

NOTE You can link records to drawing objects. You cannot link records to features from a feature source. For information on viewing and editing geospatial attributes, see [Overview of the Data Table](#) (page 1125). For information on joining data to a geospatial feature class, see [Overview of Joins](#) (page 507).

To edit or delete a database link

- 1 Click Map Setup tab ► Attribute Data panel ►  ► Link Manager.



- 2 Select the object with the link to edit.
- 3 In the Link Manager dialog box, review or edit the link data.
- 4 To modify link data, click the value to edit. Type a new value, or click... to select from a list of values in the database.
- 5 To delete a link, click the link template and click Delete.
- 6 When you finish, click OK.

To delete links for a group of objects

- 1 Click Map Setup tab ► Attribute Data panel ►  ► Delete Links. 

- 2 Select the object or objects with the links to delete.
- 3 In the Select Link Templates dialog box, select the link templates whose links you will delete from the objects.
- 4 Click OK.

Quick Reference

MAPDELETELINKS

Deletes database links from objects

Menu	Setup menu ► More Link Template Options ► Delete Links
Command Line	MAPDELETELINKS
Task Pane	In Map Explorer, right-click a link template ► Delete Links
Dialog Box	Select Link Templates dialog box

MAPLINKMANAGER

Edits the link data attached to an object

Menu	Setup menu ► More Link Template Options ► Link Manager
Command Line	MAPLINKMANAGER

Editing a Link Template

If you rename a database table or change the location of the database, you must edit the link template associated with that database table.

When you edit a link template, all objects in the drawing that reference the link template use the new information.

If you no longer use a link template in a drawing, you can delete the link template from the current drawing. When you delete a link template, all links that reference that link template are deleted from the drawing.

NOTE You can link records to drawing objects. You cannot link records to features from a feature source. For information on viewing and editing geospatial attributes, see [Overview of the Data Table](#) (page 1125). For information on joining data to a geospatial feature class, see [Overview of Joins](#) (page 507).



See also:

- [Overview of Linking Database Records to Objects](#) (page 522)
- [Creating a Link Template](#) (page 525)
- [Setting Up Data Sources for Drawings](#) (page 204)



NOTE You can link records to drawing objects. You cannot link records to features from a feature source. For information on viewing and editing geospatial attributes, see [Overview of the Data Table](#) (page 1125). For information on joining data to a geospatial feature class, see [Overview of Joins](#) (page 507).

NOTE The following procedure edits the link template in the active drawing. It does not update the *asi.ini* file (which stores data source mapping information), source drawings, or other drawings that use this link template.

To edit the database path in a link template

- 1 Click Map Setup tab ► Attribute Data panel ►  ► Edit Link Template Properties. 
- 2 Select the link template. Click OK.
- 3 In the [Link Template Properties dialog box](#) (page 1686), select a new data source, catalog, schema, or table.
- 4 Click OK.
- 5 Right-click the Map Explorer tab of the Task Pane. Click Refresh.

To delete a link template

- 1 Click Map Setup tab ► Attribute Data panel ►  ► Delete Link Template. 
- 2 In the Select Link Template dialog box, select the link template. Click OK.

Quick Reference

MAPDELETELT

Deletes a link template

Menu Setup menu ► More Link Template Options ► Delete Link Template

Command Line	MAPDELETELT
Task Pane	In Map Explorer, right-click a link template ► Delete Link Template
Dialog Box	Select Link Template dialog box

MAPPROPSLT

Edits the database table name or location in a link template

Menu	Setup menu ► Edit Link Template Properties
Command Line	MAPPROPSLT

Using Open Source FDO Providers

To make it easier to extend the capabilities of FDO Data Access Technology used within AutoCAD Map 3D, Autodesk has released FDO as an open source project under the Open Source Geospatial Foundation™ (OSGeo™).

This has enabled developers from all over the world to tap into powerful web mapping and geospatial data access technology and develop additional FDO data providers that work with AutoCAD Map 3D.

Often, developers make the providers they develop available for free. They can be integrated into AutoCAD Map 3D and then used to access additional data formats not included in the box.

Examples of Third Party and Open Source Providers Available	Description
OGR Provider (supports vector formats such as ESRI Personal Database, GRASS, and SDTS).	Open source, available on http://fdo.osgeo.org
GDAL Provider (supports raster formats such as NITF, Imagine, PCIDSK, and HDF).	Open source, available on http://fdo.osgeo.org
SL-King Oracle Provider.	Available on http://usa.autodesk.com/adsk/servlet/item?siteID=123112&id=8824908
Safe Software FME Provider for FDO.	Available on http://usa.autodesk.com/adsk/servlet/item?siteID=123112&id=8824908

Check <http://fdo.osgeo.org> and <http://usa.autodesk.com/adsk/servlet/item?siteID=123112&id=8824908> periodically for additional providers.

If you are a developer, you can also create your own data providers. The open source version of FDO Data Access Technology and developer documentation is available on <http://fdo.osgeo.org>.

NOTE FDO Providers from sources other than Autodesk are not supported or warranted by Autodesk.

- [To download a third party or open source FDO Provider](#) (page 541)
- [To integrate a new FDO Provider into AutoCAD Map 3D](#) (page 541)
- [To develop a new FDO Provider](#) (page 542)

To download a third party or open source FDO Provider

- Go to <http://usa.autodesk.com/adsk/servlet/item?siteID=123112&id=8824908> or <http://fdo.osgeo.org> to see the providers available for download.

To integrate a new FDO Provider into AutoCAD Map 3D

- 1 Close AutoCAD Map 3D if it is running.
- 2 In Windows Explorer, navigate to `\AutoCAD Map 3D 2011\FDO\bin`.
- 3 Make a backup copy of *providers.xml*. Give the back up a new name such as *providers_backup.xml*.
- 4 In WordPad, open `\AutoCAD Map 3D 2011\FDO\bin\providers.xml`.

NOTE Do not use Notepad.

- 5 Copy a section for an existing provider, for example the section OSGEO WMS, and paste it to a new location in the XML file.
Be sure that you copy the entire section, from `<Feature Provider>` to `</FeatureProvider>`.
- 6 Modify the following elements in the new section as needed:
 - Name – Name of your new provider.
 - Display Name – Name that will be displayed in the Data Connect window in AutoCAD Map 3D

- Description – Description that will be displayed in the Data Connect window
- IsManaged – False if the provider was developed using unmanaged code like C++; True if uses managed code.
- Version – The DLL version number. The version number must match the version number of the DLLs.
- FeatureDataObjectsVersion – FDO version number
- LibraryPath - Path to the DLLs for the new provider

7 Save and close *providers.xml*.

8 Start AutoCAD Map 3D.

9 In Display Manager, click Data ► Connect to Data.

The provider you added should appear under Data Connections By Provider.

10 In the Data Connect window, under Data Connections By Provider, select the new provider. For example, select “Add OGR Connection”.

11 Enter the connection information.

NOTE For the OGR provider, you need to enter the complete path to the geodatabase for Data Source.

12 The ReadOnly field indicates whether you can edit the data. TRUE means the data is read-only. FALSE means it will be read / write.

13 Click Login.

14 Click Connect to bring the data into your map.

To develop a new FDO Provider

- Go to <http://fdo.osgeo.org> to download the API and access the documentation needed to develop a provider.

Bringing In AutoCAD Civil 3D Data

You can bring in the following types of data from AutoCAD Civil 3D projects:

- Features (Alignments, points, parcels, and pipe networks)
- Surfaces

To bring in Civil 3D data, you must first export it from Civil 3D to formats that can be read by AutoCAD Map 3D.

The following table lists the AutoCAD Civil 3D features and attributes that are exported to the SDF file.

AutoCAD Civil 3D Feature	Exported Attributes
Alignment	<ul style="list-style-type: none">■ Alignment Name■ Length■ Design Speed■ Starting Station■ Ending Station
Point	<ul style="list-style-type: none">■ Point Number■ Point Name■ Elevation■ Description■ Raw Description■ Latitude■ Longitude
Parcel	<ul style="list-style-type: none">■ Parcel Name■ Parcel Number■ Area■ Perimeter
Pipe	<ul style="list-style-type: none">■ Network Name■ Length

- Slope
- Inside Diameter
- Outside Diameter
- Shape
- Elevation at Start
- Elevation at End
- Structure Start
- Structure End

Structure

- Network Name
- Rim Elevation
- Structure Name

Tell me more



Video

- [Show me how to bring in data from AutoCAD Civil 3D.](#)



Procedure

- [To export features from AutoCAD Civil 3D to SDF \(page 545\)](#)
- [To export surfaces from AutoCAD Civil 3D to DEM \(page 545\)](#)
- [To access the DEM from a map \(page 545\)](#)



GIS Skill

- [Bring in parcel data from AutoCAD Civil 3D](#)



Related topics

- [Bringing In Features from SDF \(page 337\)](#)
- [Adding Raster-Based Surfaces to Your Map \(page 441\)](#)

- [To export features from AutoCAD Civil 3D to SDF](#) (page 545)
- [To access the SDF file from a map](#) (page 545)
- [To export surfaces from AutoCAD Civil 3D to DEM](#) (page 545)
- [To access the DEM from a map](#) (page 545)

To export features from AutoCAD Civil 3D to SDF

- 1 Open the project in AutoCAD Civil 3D. In AutoCAD Civil 3D, export the project to SDF.
- 2 In the Export To SDF dialog box, specify a name for the SDF file.
- 3 Specify the coordinate system.

NOTE If the drawing already has a coordinate system specified, it is used automatically and the Select Coordinate System controls in the Export To SDF dialog box are grayed.

- 4 Click OK to export the file.

To access the SDF file from a map

- 1 In [Display Manager](#) (page 2060), click Data ► Connect To Data.
- 2 In the Data Connect window, under Data Connections By Provider, select Add SDF Connection.
- 3 Specify information to connect to the SDF file. For more information, see [To bring in features from SDF](#) (page 338).

To export surfaces from AutoCAD Civil 3D to DEM

- 1 Open the project in AutoCAD Civil 3D.
- 2 In AutoCAD Civil 3D, export the surface as a DEM file.

To access the DEM from a map

- 1 In [Display Manager](#) (page 2060), click Data ► Connect To Data.
- 2 In the Data Connect window, under Data Connections By Provider, select Add Raster Image Or Surface Connection.

- 3 Specify information to connect to the DEM file. For more information, see [To add a raster-based surface to your map](#) (page 442).

Quick Reference

Connect Feature Source

Connects a feature source

Menu Click File ► Connect To Data.

Icon  Connect

Command Line MAPCONNECT

Task Pane In Display Manager click Data ► Connect to Data.

Managing Data

4

Overview of Managing Data

Different geospatial data formats have different capabilities. Use the following table to determine the options available for your data stores.

NOTE WMS and raster data providers are not covered here. For information about those providers, see [Adding an Image from a WMS \(Web Map Service\)](#) (page 445) and [Overview of Adding Rasters and Surfaces](#) (page 437).

NOTE This functionality affects geospatial feature data only. For information about managing drawing objects and drawing files, see [Overview of Setting Up Your Map File](#) (page 140).

Oracle	Postgr- eSQL	SQL Serv- er	SQL Serv- er Spatial	SQLite	MySQL	ODBC	SDF	SHP	ESRI ArcSDE	WFS
Set up users (page 584)	Set up users (page 584)	Set up users (page 584)	Set up users (page 584)		Set up users (page 584)					
Create data stores (page 586)	Create data stores (page 586)	Create data stores (page 586)	Create data stores (page 590)	Create data stores (page 586)	Create data stores (page 586)	Set up data stores (page 576)	Create data stores (page 586)	Create data stores (page 586)		
Add data to your map (page 312)	Add data to your map (page 340)	Add data to your map (page 323)	Add data to your map (page 326)	Add data to your map (page 330)	Add data to your map (page 332)	Add data to your map	Add data to your map	Add data to your map	Add data to your map	Add data to your map

Oracle	PostgreSQL	SQL Server	SQL Server Spatial	SQLite	MySQL	ODBC	SDF	SHP	ESRI ArcSDE	WFS
						(page 342)	(page 337)	(page 335)	(page 316)	(page 346)
Style data (page 639)	Style data (page 639)	Style data (page 639)	Style data (page 639)	Style data (page 639)	Style data (page 639)		Style data (page 639)	Style data (page 639)	Style data (page 639)	Style data (page 639)
Examine or edit attribute data (page 711)	Examine or edit attribute data (page 711)	Examine or edit attribute data (page 711)	Examine or edit attribute data (page 711)	Examine or edit attribute data (page 711)	Examine or edit attribute data (page 711)	Examine or edit attribute data (page 711)	Examine or edit attribute data (page 711)	Examine or edit attribute data (page 711)	Examine or edit attribute data (page 711)	
Join data to a different feature. (page 509)	Join data to a different feature. (page 509)	Join data to a different feature. (page 509)	Join data to a different feature. (page 509)	Join data to a different feature. (page 509)	Join data to a different feature. (page 509)	Join data to a different feature. (page 509)	Join data to a different feature. (page 509)	Join data to a different feature. (page 509)	Join data to a different feature. (page 509)	Join data to a WFS feature. (page 509)
Create a schema (page 596)	Create a schema (page 596)	Create a schema (page 596)	Create a schema (page 596)	Create a schema (page 596)	Create a schema (page 596)		Create a schema (page 596)	Create a schema (page 596)		
View a schema (page 608)	View a schema (page 608)	View a schema (page 608)	View a schema (page 608)	View a schema (page 608)	View a schema (page 608)	View a schema (page 608)	View a schema (page 608)	View a schema (page 608)	View a schema (page 608)	View a schema (page 608)
Edit a schema (page 610)	Edit a schema (page 610)	Edit a schema (page 610)	Edit a schema (page 610)	Edit a schema (page 610)	Edit a schema (page 610)		Edit a schema (page 610)			

Oracle	PostgreSQL	SQL Server	SQL Server Spatial	SQLite	MySQL	ODBC	SDF	SHP	ESRI ArcSDE	WFS
Delete a schema (page 613)	Delete a schema (page 613)	Delete a schema (page 613)	Delete a schema (page 613)	Delete a schema (page 613)	Delete a schema (page 613)		Delete a schema (page 613)			
Copy data to/from a different data format (page 615)	Copy data to/from a different data format (page 615)	Copy data to/from a different data format (page 615)	Copy data to/from a different data format (page 618)	Copy data to/from a different data format (page 615)	Copy data to/from a different data format (page 615)	Copy data to/from a different data format (page 615)	Copy data to/from a different data format (page 615)	Copy data to/from a different data format (page 615)	Copy data to/from a different data format (page 615)	Copy data to/from a different data format (page 615) NOTE You can copy data into an ArcSDE schema if the data store and schema are already defined in the target.

Oracle	PostgreSQL	SQL Server	SQL Server Spatial	SQLite	MySQL	ODBC	SDF	SHP	ESRI ArcSDE	WFS
						<p>NOTE You can use Bulk Copy to copy ODBC data to a different provider, such as Oracle, MySQL, SQL Server, SDF, and SHP. You can copy data to an ODBC data store, but you must define the target schema properly, and have write permissions.</p>				

About Geospatial Feature Classes, Data Stores, and Schemas

Overview of Geospatial Data

Geospatial data is organized as follows:

- **Feature:** The spatial representation of a real-world entity, such as a specific road or an individual utility pole, that specifies the geometry and other properties of the feature.
- **Feature class:** A category of features with rules that define the allowable data types, default values, and constraints for its member features. For example, you might have feature classes for a set of roads, utility poles, and so on.
- **Schema:** A collection of related feature classes.
- **Data store:** A collection of feature data in a single storage location. SDF data stores allow only one schema per file, but database stores such as Oracle or SQL Server can have multiple schemas. (SHP files can include only one geometry type per file, but you can store and copy multiple SHP files in a folder. You can use a configuration file to support multiple schemas when you establish your connection to a SHP file.)

NOTE This functionality affects geospatial feature data only. For information about managing drawing objects and drawing files, see [Overview of Setting Up Your Map File](#) (page 140)

The data hierarchy

Geospatial data is stored in a hierarchical fashion, like a set of tables: each row within a table is an individual feature, and each column is a [property](#) (page 2071) of that feature. The entire table (including its name, column names, data types, default values, and constraints) represents a feature class. The set of related tables is called a schema, and the entire collection of data resides in a data store.

For example, you might use a data store such as Oracle, which can encompass multiple schemas. The database might define the utilities for a town, with schemas for different types of utilities, such as electrical and water. The electrical schema would include feature classes for utility poles and boxes, while the water schema would include feature classes for pipes and hydrants.

Properties

Each feature class has properties that define it. The Pole feature class would have properties such as identification number, name, model, material, height, installation date, and so on. The properties that define a feature class can have data types, default values, and constraints. These can help ensure that a feature meets certain criteria in order to be included in a particular feature class. For example, the “Large Roads” feature class can include a field called “Lanes.” The constraint for “Lanes” can specify that its value must be six or higher in order for a road to be included in the “Large Roads” feature class.

Data stores

Features can be stored in a spatial database (such as Oracle, MySQL, PostgreSQL/PostGIS, or SQLServer), or in the ESRI ArcSDE data store, which can use either an Oracle- or SQL Server-based spatial database. Features can be stored in a file (such as SQLite, SHP, or SDF). Related SHP files might be stored in a folder.

Features can be accessed from a web-based service (such as WFS or WMS). AutoCAD Map 3D also supports ODBC (Open Database Connectivity), a standardized interface for accessing a database from a program.

A data store usually contains a spatial context, which describes the spatial metadata or parameters within which geometry for a collection of features resides. The spatial context can specify the coordinate system, extents, and tolerance. A data store can include multiple spatial contexts, for example, one context for ground-based data and another context for schematic data.

For more information about features, feature classes, and schemas (including diagrams that illustrate these concepts), see “What Are Features?” and “What is a Schema?” in *Best Practices for Managing Geospatial Data*, available from the Help menu in AutoCAD Map 3D.

Working with features in your map

To add a feature to your map, you connect to its data store and select the feature classes to include. After you connect to a data store in AutoCAD Map 3D, that data store is a [feature source](#) (page 2063) for the current map. Feature sources are listed by provider (for example, all SDF feature sources are listed together in Data Connect). Each feature class you add becomes a [feature layer](#) (page 2063) in your map. You can apply filters and spatial queries to the layers to show only some of the features within that layer. Filters are based on attributes, and queries are based on spatial location.

See also:

- [Overview of Bringing In GIS Features](#) (page 305)
- [Editing Features using the Data Table](#) (page 711)
- [Styling Features](#) (page 639)
- [Viewing a Schema](#) (page 608)
- [Migrating Data](#) (page 615)

To work with geospatial data

NOTE This functionality affects geospatial feature data only. For information about managing drawing objects and drawing files, see [Overview of Setting Up Your Map File](#) (page 140)

- [Set up users for database data stores](#) (page 585)
- [Create data stores](#) (page 588), if your data source supports that option.
- [Add data to your map](#) (page 308)
- [Style the data](#) (page 641)
- [Examine or edit attribute data for any feature](#) (page 712)
- [View the schema](#) (page 609) for any data source.
- [Create a schema](#) (page 598), if your data source supports that option.
- [Edit a schema](#) (page 612), if your data source supports that option.
- [Delete a schema](#) (page 614), if your data source supports that option.
- [Copy data to/from a different data format](#) (page 621), if your data source supports that option.

Working with FDO Schemas

You can view a [schema](#) (page 2073), [feature class](#) (page 2063), or [property](#) (page 2071) from any [FDO provider](#) (page 2063), but the ability to change them depends on the provider and your access rights. You cannot edit or delete any schema, feature class, or property if there are existing features that use it.

You can create schemas within AutoCAD Map 3D, or import existing FDO schemas into your maps.

NOTE This functionality affects geospatial feature data only. For information about managing drawing objects and drawing files, see [Overview of Setting Up Your Map File](#) (page 140)

See also:

- [Overview of Geospatial Data](#) (page 551)
- [Viewing a Schema](#) (page 608)
- [Creating a Schema](#) (page 596)
- [Editing a Schema](#) (page 610)
- [Deleting Schemas](#) (page 613)

To work with FDO schemas

NOTE This functionality affects geospatial feature data only. For information about managing drawing objects and drawing files, see [Overview of Setting Up Your Map File](#) (page 140)

- [View the schema](#) (page 609) for any data source.
- [Create a schema](#) (page 598), if your data source supports that option.
- [Import](#) (page 608) existing FDO schemas into a map.
- [Edit a schema](#) (page 612), if your data source supports that option.
- [Delete a schema](#) (page 614), if your data source supports that option.

Working with Oracle Data

AutoCAD Map 3D, supports Oracle versions 10gr2, 11g, and XE. You can create and edit an Oracle [data store](#) (page 2059) and [schema](#) (page 2073), and you can access existing spatial schemas in Oracle that were created by other applications. Oracle has comprehensive support for all the data types and operations that AutoCAD Map 3D supports, including [spatial index](#) (page 2075), [long transaction](#) (page 2067), and [persistent locking](#) (page 2070).

NOTE Functionality for OSE (the Oracle Spatial OO40, which is similar to OLE DB) is not available in a 64-bit environment. The Oracle library that OSE is built on (Oracle Object for OLE) is 32-bit only. There is no 64-bit version.

Before you add features to an Oracle data store, make sure your user privileges for that Oracle data store are adequate and appropriate, and that the data in that data store is accurate and current.

You can [add a user for an Oracle data store using a utility](#) (page 584) provided with AutoCAD Map 3D.

NOTE This functionality affects geospatial feature data only. For information about linking records in an external database to objects in a drawing, see [Overview of Linking Database Records to Objects](#) (page 522). For information about moving data between DWG and Oracle, see [Migrating DWG Data to GIS](#) (page 628).

What Oracle Schemas Support

An Oracle schema can support the following:

- Inheritance
- Multiple schemas
- Object properties (with limitations)
- Association properties (with limitations)
- Schema overrides
- Auto ID generation
- Data store scope unique ID generation
- Default values
- Inclusive value range constraints
- Exclusive value range constraints
- Value constraints list
- Null value constraints
- Unique value constraints
- Composite unique value constraints
- Spatial contexts

- These geometry types: point, line string, polygon, multi-point, multi-line string, multi-polygon, curve string, curve polygon, multi-curve string, multi-curve polygon, linear ring, line string segment, circular arc segment, and ring
- Multi-geometry

Restrictions of Oracle Schemas

When you create an Oracle schema, the following restrictions apply:

- A [feature class](#) (page 2063) must define or inherit at least one [identity property](#) (page 2071).
- You cannot add a non-nullable data property to a class that already has data.
- Identity properties cannot be nullable.
- Read-only identity properties must be auto-generated.
- The length for string properties must be between 1 byte and 4000 bytes, inclusive.
- For decimal properties, precision must be between 1 and 38, inclusive, and scale must be between -84 and 127, inclusive.
- A feature class can have multiple geometric properties. Although it is not mandatory, having a main geometry as an attribute of the feature class can help you to identify which geometry property to use as the default for queries and rendering. Both HasMeasure and HasElevation are supported.

Version Enabling

The Autodesk FDO Provider for Oracle included with AutoCAD Map 3D 2011 creates tables in the FDO [data store](#) (page 2059) that are not automatically version-enabled. Therefore, when you create a new Oracle data store using the default options, the resulting table is not version-enabled, so [persistent locking](#) (page 2070) and [long transaction](#) (page 2067) are not supported. (This differs from previous releases.)

Oracle Workspace Manager (OWM) is used for versioning and persistent locking support.

NOTE Versioning and persistent locking are not available with the Oracle XE version.

See also:

- [Overview of Geospatial Data](#) (page 551)
- [Setting Up Database Users](#) (page 584)
- [Creating a Data Store](#) (page 586)
- [Bringing In Features from Oracle](#) (page 312)
- [Creating a Join](#) (page 509)
- [Editing Features using the Data Table](#) (page 711)
- [Creating a Schema](#) (page 596)
- [Viewing a Schema](#) (page 608)
- [Editing a Schema](#) (page 610)
- [Migrating Data](#) (page 615)

To enable versioning for an Oracle data store

- 1 You enable versioning with the Oracle SQL*Plus tool, which you use to execute the scripts. Before executing the scripts, make sure that the following conditions are true:
 - You connect directly to the Oracle user (or FDO data store) to be processed.
 - The Oracle user executing the script has sufficient privileges (has been granted the Workspace Manager role WM_ADMIN_ROLE).
 - The Oracle user executing the script is the only user processing or accessing the current Oracle user (or FDO data store) during the execution of the script. Otherwise, a script failure may result from a session conflict.
- 2 To create a script log file, execute the `spool <log file name>;` command before invoking the scripts and the `spool off;` command after the invoked script finishes. The log file can help you resolve any issues encountered by the scripts.
- 3 Read the documentation contained within the script files themselves to determine what privileges are required for each script, how to run the scripts, and what errors may occur.

Problems can occur if you respond incorrectly to errors you encounter while running a script.

- 4 Execute the *EnableVersioning.sql* script in the */FDO/bin/com* folder in your AutoCAD Map 3D folder.

This will enable the tables for OWM.

NOTE The *DisableVersioning.sql* script in the same folder provides the opposite functionality.

- 5 If you create a data store in AutoCAD Map 3D 2011 that you want to use with the 2007 version of AutoCAD Map 3D, you must set the value of the lock and long transaction options in the table `F_Options` in the generated data store to 2. You can do this with the supplied SQL script *EnableVersioning.sql*, which also enables versioning for all tables and allows the creation of conditional data. Do not make this change to `F_Options` in the database if you do not plan to use it with the previous version of AutoCAD Map 3D.

To work with Oracle data

NOTE This functionality affects geospatial feature data only. For information about linking records in an external database to objects in a drawing, see [Overview of Linking Database Records to Objects](#) (page 522). For information about moving data between DWG and SDF format, see [Migrating DWG Data to GIS](#) (page 628).

- [Set up users](#) (page 584)
- [Create data stores](#) (page 586)
- [Add Oracle features to your map](#) (page 312)
- [Style Oracle features](#) (page 639)
- [Join Oracle data to a different feature](#) (page 509)
- [Examine or edit attribute data](#) (page 711)
- [Create an Oracle schema](#) (page 596)
- [View an Oracle schema](#) (page 608)
- [Edit an Oracle schema](#) (page 610)
- [Copy data to/from a different data format](#) (page 615)

Working with SQL Server Data

AutoCAD Map 3D supports SQL Server version 2005 and [SQL Server Spatial](#) (page 561). Both provide comprehensive data support, along with spatial indexing, optimistic concurrency, and read-committed transaction isolation. It uses a revision number for optimistic concurrency.

AutoCAD Map 3D supports SQL Server authentication for SQL Server data stores. The [FDO](#) (page 2062) User is mapped to the SQL Server login. Grant access to the databases whose data you want to use.

NOTE This functionality affects geospatial feature data only. For information about linking records in an external database to objects in a drawing, see [Overview of Linking Database Records to Objects](#) (page 522).

What SQL Server Schemas Support

A SQL Server [schema](#) (page 2073) can support the following:

- Inheritance
- Multiple schemas
- Object properties (with limitations)
- Association properties (with limitations)
- Schema overrides
- Auto ID generation
- Default values
- Inclusive value range constraints
- Exclusive value range constraints
- Value constraints list
- Null value constraints
- Unique value constraints
- Composite unique value constraints
- Spatial contexts

- The following geometry types:
 - Polygons: polygon, multi-polygon, curve polygon, multi-curve polygon, circular arc segment
 - Points: point, multi-point
 - Rings: ring, linear ring
 - Line strings: line string, line string segment, multi-line string, curve string, multi-curve string

- Multi-geometry

Restrictions of SQL Server Schemas

When you create a SQL Server schema, the following restrictions apply:

- A [feature class](#) (page 2063) must define or inherit at least one [identity property](#) (page 2071).
- Identity properties cannot be nullable.
- Read-only identity properties must be auto-generated.
- A feature class can have multiple geometric properties. Although it is not mandatory, having a main geometry as an attribute of the feature class can help you to identify which geometry property to use as the default for queries and rendering. Both HasMeasure and HasElevation are supported.
- The maximum length of a string is 8000 characters.
- For decimal properties, the precision must be between 1 and 38, inclusive, and the scale must be between 0 and 38, inclusive.

See also:

- [Overview of Geospatial Data](#) (page 551)
- [Setting Up Database Users](#) (page 584)
- [Creating a Data Store](#) (page 586)
- [Bringing In Features from SQL Server](#) (page 323)
- [Styling Features](#) (page 639)
- [Creating a Join](#) (page 509)

- [Editing Features using the Data Table](#) (page 711)
- [Creating a Schema](#) (page 596)
- [Viewing a Schema](#) (page 608)
- [Editing a Schema](#) (page 610)
- [Deleting Schemas](#) (page 613)
- [Migrating Data](#) (page 615)

To work with SQL Server data

NOTE This functionality affects geospatial feature data only. For information about linking records in an external database to objects in a drawing, see [Overview of Linking Database Records to Objects](#) (page 522).

- [Set up users](#) (page 584)
- [Create data stores](#) (page 586)
- [Add SQL Server features to your map](#) (page 323)
- [Style SQL Server features](#) (page 639)
- [Join SQL Server data to a different feature](#) (page 509)
- [Examine or edit attribute data](#) (page 711)
- [Create a SQL Server schema](#) (page 596)
- [View a SQL Server schema](#) (page 608)
- [Edit a SQL Server schema](#) (page 610)
- [Delete a SQL Server schema](#) (page 613)
- [Copy data to/from a different data format](#) (page 615)

Working with SQL Server Spatial Data

AutoCAD Map 3D supports SQL Server Spatial through version 2008 SP1. Use SQL Server Spatial for the following:

- To connect to Microsoft® SQL Server™ Spatial data stores

- To read, create, and edit schemas for SQL Server Spatial data stores.

AutoCAD Map 3D supports SQL Server authentication and Windows authentication for SQL Server Spatial data stores. The [FDO](#) (page 2062) User is mapped to the SQL Server login. Grant access to the databases whose data you want to use.

SQL Server Spatial includes two spatial data types: geometry and geography. Geography is used for geodetic data, such as latitude/longitude data. Geometry is meant for all other spatial data. The two spatial data types support similar operations.

Geometric properties have a Geometry or Geography column, depending on the coordinate system of the associated spatial context for the property. If the coordinate system is geodetic, it has a Geography column. Otherwise, it has a Geometry column. A coordinate system is Geodetic if its “well known text” (WKT) starts with GEOGCS.

NOTE This functionality affects geospatial feature data only. For information about linking records in an external database to objects in a drawing, see [Overview of Linking Database Records to Objects](#) (page 522).

What SQL Server Spatial Schemas Support

A SQL Server [schema](#) (page 2073) can support the following:

- Inheritance
- Multiple schemas
- Object properties (with limitations)
- Association properties (with limitations)
- Schema overrides
- Auto ID generation
- Default values
- Inclusive value range constraints
- Exclusive value range constraints
- Value constraints list
- Null value constraints

- Unique value constraints
- Composite unique value constraints
- Spatial contexts
- The following geometry types:
 - Polygons: polygon, multi-polygon
 - Points: point, multi-point
 - Line strings: line string, multi-line string
- Multi-geometry

Restrictions of SQL Server Spatial Schemas

When you create a SQL Server schema, the following restrictions apply:

- A [feature class](#) (page 2063) must define or inherit at least one [identity property](#) (page 2071).
- M and Z dimensions are not supported.
- Identity properties cannot be nullable.
- Read-only identity properties must be auto-generated.
- A feature class can have multiple geometric properties. It is not mandatory, but using a main geometry as an attribute of the feature class can help identify the geometry property to use as the default for queries and rendering.
- The maximum length of a string is 4000 characters.
- For decimal properties, the precision must be from 1 through 38, inclusive, and the scale must be from 0 through 38, inclusive.
- Long transactions and persistent locking are not supported.

See also:

- [Overview of Geospatial Data](#) (page 551)
- [Setting Up Database Users](#) (page 584)
- [Creating FDO-Enabled SQL Server Spatial Data Stores](#) (page 590)

- [Bringing In Features from SQL Server](#) (page 323)
- [Styling Features](#) (page 639)
- [Creating a Join](#) (page 509)
- [Editing Features using the Data Table](#) (page 711)
- [Creating a Schema](#) (page 596)
- [Viewing a Schema](#) (page 608)
- [Editing a Schema](#) (page 610)
- [Migrating Data](#) (page 615)

To work with SQL Server Spatial data

NOTE This functionality affects geospatial feature data only. For information about linking records in an external database to objects in a drawing, see [Overview of Linking Database Records to Objects](#) (page 522).

- [Set up users](#) (page 584)
- [Create data stores](#) (page 590)

A geographic type column is created for the geodetic coordinate system. For other systems, a geometric type column is created.

You can include FDO metadata when you create a SQL Server data store. Spatial indexes are created automatically for geometry properties (Microsoft SQL Server Spatial geometry types), using default spatial index parameters. You can override the defaults using the API.
- [Connect to SQL Server Spatial data stores.](#) (page 326)

Use either Windows or SQL Server authentication.
- [Style SQL Server features](#) (page 639)
- [Join SQL Server data to a different feature](#) (page 509)
- [Examine or edit attribute data](#) (page 711)
- [Create a SQL Server schema](#) (page 596)
- [View a SQL Server schema](#) (page 608)
- [Edit a SQL Server schema](#) (page 610)
- [Copy data to/from a different data format](#) (page 615)

Working with SQLite Data

The OSGeo FDO provider for SQLite is an open-source, file-based provider developed by Autodesk. This read/write provider supports one update user at a time with any number of read users.

You can do the following in AutoCAD Map 3D:

- Create a SQLite data store
- Connect to a SQLite data store
- Import from SQLite
- Export to SQLite
- Save a Display Manager layer to SQLite

Each SQLite data store can contain one schema and a single spatial context. The name of the schema must be "Default."

What SQLite Schemas Support

A SQLite [schema](#) (page 2073) can support the following:

- All FDO property types except raster, object, association, and LOB properties
- Auto-generated properties for int32 and int64 properties
- All FDO geometry and geometry component types, including arc segments
- 2D, 3D, and measure (M)
- Single and composite primary keys
- Null value constraints
- Unique value constraints
- Range and list constraints
- Default values
- Select, Select Aggregate, Insert, Update, and Delete commands
- SQL commands
- Transactions with commit and rollback
- All FDO spatial operators except distance

- Standard FDO expressions and filters
- Parameter binding for all commands (at the API level)

Restrictions of SQLite Schemas

When you create or modify a SQLite schema, the following restrictions apply:

- SQLite native data supports only the following base property types: int64, double, string and Geometry.
- If there is data in the class, you cannot modify the primary key or constraints.
- Persistent locking and long transactions are not supported.
- You cannot change the schema name for a SQLite data store. The schema name must be "Default."
- You cannot add comments in the Schema or Feature Class Description fields.

To work with SQLite data

NOTE This functionality affects geospatial feature data only. For information about linking records in an external database to objects in a drawing, see [Overview of Linking Database Records to Objects](#) (page 522).

- [Create data stores](#) (page 586).
- [Connect to SQLite data.](#) (page 330)
- [Style SQLite features](#) (page 639).
- [Join SQLite data to a different feature](#) (page 509).
- [Examine or edit attribute data](#) (page 711).
- [View a SQLite schema](#) (page 608)
- [Edit a SQLite schema](#) (page 610)
- [Export drawing data to SQLite](#) (page 1447).
- [Save a Display Manager layer as an SQLite file.](#) (page 1469)
- [Copy data to/from a different data format](#) (page 615)

Working with MySQL Data

AutoCAD Map 3D supports MySQL 5.0.27. In AutoCAD Map 3D, you can create, edit, and delete a MySQL [data store](#) (page 2059) or [schema](#) (page 2073). You can also use MySQL to access databases created by other applications. AutoCAD Map 3D supports native MySQL geometry, indexing, two-dimensional geometry (compatible with the OGC Simple Feature specification), and spatial query operations, but not transactions. Auto-generated properties are automatically incremented (auto-incremented). MySQL uses a revision number for optimistic concurrency.

NOTE If you cannot connect to your MySQL data source, you may see an error message: "Specified credentials are not valid or the provider is unable to establish a connection." To resolve the issue, copy the *libmysql.dll* file into the *AutoCAD Map 3D\FDO\bin* folder and try again.

NOTE This functionality affects geospatial feature data only. For information about linking records in an external database to objects in a drawing, see [Overview of Linking Database Records to Objects](#) (page 522).

What MySQL Schemas Support

A MySQL schema can support the following:

- Inheritance
- Multiple schemas
- Object properties (with limitations)
- Association properties (with limitations)
- Schema overrides
- Auto ID generation
- Default values
- Null value constraints
- Unique value constraints
- Composite unique value constraints
- Spatial contexts

- The following geometry types:
 - Polygons: polygon, multi-polygon, curve polygon, multi-curve polygon, circular arc segment
 - Points: point, multi-point
 - Rings: ring, linear ring
 - Line strings: line string, line string segment, multi-line string, curve string, multi-curve string

- Multi-geometry

Restrictions of MySQL Schemas

When you create a MySQL schema, the following restrictions apply:

- A [feature class](#) (page 2063) must define or inherit at least one [identity property](#) (page 2071).
- Inclusive value range constraints are not supported.
- Identity properties cannot be nullable.
- Read-only identity properties must be auto-generated.
- A feature class can have multiple geometric properties. It is not mandatory, but using a main geometry as an attribute of the feature class can help identify the geometry property to use as the default for queries and rendering. Both HasMeasure and HasElevation are supported.
- The maximum length of a string is 65,535 bytes.
- For decimal properties, the precision must be from 1 through 65, inclusive, and the scale must be from 0 through 30, inclusive.

See also:

- [Overview of Geospatial Data](#) (page 551)
- [Setting Up Database Users](#) (page 584)
- [Creating a Data Store](#) (page 586)
- [Bringing In Features from MySQL](#) (page 332)
- [Styling Features](#) (page 639)

- [Creating a Join](#) (page 509)
- [Editing Features using the Data Table](#) (page 711)
- [Creating a Schema](#) (page 596)
- [Viewing a Schema](#) (page 608)
- [Editing a Schema](#) (page 610)
- [Deleting Schemas](#) (page 613)
- [Migrating Data](#) (page 615)

To work with MySQL data

NOTE This functionality affects geospatial feature data only. For information about linking records in an external database to objects in a drawing, see [Overview of Linking Database Records to Objects](#) (page 522).

- [Set up users](#) (page 584)
- [Create data stores](#) (page 586)
- [Add MySQL features to your map](#) (page 332)
- [Style MySQL features](#) (page 639)
- [Join MySQL data to a different feature](#) (page 509)
- [Examine or edit attribute data](#) (page 711)
- [Create a MySQL schema](#) (page 596)
- [View a MySQL schema](#) (page 608)
- [Edit a MySQL schema](#) (page 610)
- [Delete a MySQL schema](#) (page 613)
- [Copy data to/from a different data format](#) (page 615)

Working with SDF Data

The Autodesk SDF file format is a standalone, file-based spatial database format. It supports multiple features classes and properties in a single file. SDF provides spatial indexing, interoperability, and high performance for large data sets.

NOTE This functionality affects geospatial feature data only. For information about linking records in an external database to objects in a drawing, see [Overview of Linking Database Records to Objects](#) (page 522). For information about moving data between DWG and SDF format, see [Migrating DWG Data to GIS](#) (page 628).

Characteristics of the SDF File Format

The SDF file format has the following characteristics:

- SDF files can be read on different platforms.
- One [schema](#) (page 2073) in a single SDF file supports multiple [feature classes](#) (page 2063).
- SDF files have their own spatial indexing.
- SDF files can store geometric and non-geometric data with minimal overhead.
- The SDF file format supports a single writer at any time, with multiple readers.

What SDF Schemas Support

An SDF schema can support the following:

- Auto ID generation
- Default values
- Exclusive and inclusive value range constraints
- Value list constraints
- Null value constraints
- Spatial contexts
- The following geometry types:
 - Polygons: polygon, multi-polygon, curve polygon, multi-curve polygon, circular arc segment
 - Points: point, multi-point
 - Rings: ring, linear ring
 - Line strings: line string, line string segment, multi-line string, curve string, multi-curve string

- Multi-geometry

See also:

- [Overview of Geospatial Data](#) (page 551)
- [Setting Up Database Users](#) (page 584)
- [Creating a Data Store](#) (page 586)
- [Bringing In Features from SDF](#) (page 337)
- [Styling Features](#) (page 639)
- [Creating a Join](#) (page 509)
- [Editing Features using the Data Table](#) (page 711)
- [Creating a Schema](#) (page 596)
- [Viewing a Schema](#) (page 608)
- [Editing a Schema](#) (page 610)
- [Deleting Schemas](#) (page 613)
- [Migrating Data](#) (page 615)

To work with SDF data

NOTE This functionality affects geospatial feature data only. For information about linking records in an external database to objects in a drawing, see [Overview of Linking Database Records to Objects](#) (page 522). For information about moving data between DWG and SDF format, see [Migrating DWG Data to GIS](#) (page 628).

- [Create data stores](#) (page 586)
- [Add SDF features to your map](#) (page 337)
- [Style SDF features](#) (page 639)
- [Join SDF data to a different feature](#) (page 509)
- [Examine or edit attribute data](#) (page 711)
- [Create an SDF schema](#) (page 596)
- [View an SDF schema](#) (page 608)

- [Edit an SDF schema](#) (page 610)
- [Delete an SDF schema](#) (page 613)
- [Copy data to/from a different data format](#) (page 615)

Working with SHP Data

The standalone ESRI SHP file format supports GIS data using the following file types:

- SHP (shape geometry)
- SHX (shape index)
- PRJ (projection information)
- CPG (code page files)
- IDX (spatial index)
- DBF (shape attributes in dBASE format)

You must have either a SHP or DBF file present to connect to data or work with [schemas](#) (page 2073). Otherwise, these files are optional. If they do not exist initially, the system creates files with empty records.

NOTE This functionality affects geospatial feature data only. For information about linking records in an external database to objects in a drawing, see [Overview of Linking Database Records to Objects](#) (page 522).

Characteristics of the SHP File Format

The Schema Editor treats each SHP file, and its associated DBF file, as a [feature class](#) (page 2063) with a single geometry [property](#) (page 2071) and, optionally, data attribute properties. The SHP file format supports a single writer at any time, but can have multiple readers.

SHP files can include only one geometry type per file, but you can store and copy multiple SHP files in a folder. You can use a configuration file to support multiple schemas when you establish your connection to a folder containing SHP files.

What SHP Schemas Support

A SHP schema can support the following:

- A single geometry type per file
- Spatial contexts (determined by coordinate system information in the PRJ file)
- Auto ID generation
- Null value constraints
- The following geometry types:
 - Polygons: polygon, multi-polygon

NOTE When you connect to or import SHP polygon data, AutoCAD Map 3D checks the geometry to see if there are multiple closed outer loops. If so, it treats the geometry as multi-polygon (a polygon with multiple exterior rings). It does not treat unclosed outer loops as multi-polygon. You can create a multi-polygon in AutoCAD Map 3D and then save or export it to SHP format. It then appears in its native SHP file as a multi-polygon.

- Points: point, multi-point
- Rings: linear ring
- Line strings: line string, line string segment, multi-line string

See also:

- [Overview of Geospatial Data](#) (page 551)
- [Setting Up Database Users](#) (page 584)
- [Creating a Data Store](#) (page 586)
- [Bringing In Features from SHP](#) (page 335)
- [Styling Features](#) (page 639)
- [Creating a Join](#) (page 509)
- [Editing Features using the Data Table](#) (page 711)
- [Viewing a Schema](#) (page 608)
- [Migrating Data](#) (page 615)

To work with SHP data

NOTE This functionality affects geospatial feature data only. For information about linking records in an external database to objects in a drawing, see [Overview of Linking Database Records to Objects](#) (page 522).

- [Create data stores](#) (page 586)
- [Add SHP features to your map](#) (page 335)
- [Style SHP features](#) (page 639)
- [Join SHP data to a different feature](#) (page 509)
- [Examine or edit attribute data](#) (page 711)
- [View a SHP schema](#) (page 608)
- [Copy data to/from a different data format](#) (page 615)

Working with PostgreSQL/PostGIS Data

AutoCAD Map 3D uses the OSGeo FDO Provider for PostgreSQL/PostGIS, which accesses Postgres and PostGIS databases and is certified with PostGIS 1.4.0 with PostgreSQL 8.4. PostGIS adds support for geographic objects to the PostgreSQL object-relational database so that the PostgreSQL server can be used as a back end spatial database for GIS.

What PostgreSQL/PostGIS Schemas Support

A PostgreSQL/PostGIS [schema](#) (page 2073) can support the following:

- Reading and writing data with database transaction support
- Creation and modification of schemas
- Feature classes and regular classes
- All basic FDO data types except for BLOB and Byte types
- All geometry types except curve types. Circular arcs are not supported
- 2D geometry
- Multiple schemas
- Auto-ID generation for int32 and int64 data types

- Null value constraints
- Unique value constraints
- Range constraints
- List constraints
- Default values
- All spatial filters
- All FDO expression functions

Restrictions of PostgreSQL/PostGIS Schemas

When you create a PostgreSQL/PostGIS schema, the following restrictions apply:

- Object properties and association properties are not supported
- Inheritance is not supported
- The Byte data type is not supported. Byte properties are converted to Int16.
- Z and M values are not supported.

To work with PostgreSQL/PostGIS data

NOTE This functionality affects geospatial feature data only. For information about linking records in an external database to objects in a drawing, see [Overview of Linking Database Records to Objects](#) (page 522).

- [Set up users](#) (page 584)
- [Create data stores](#) (page 586)
- [Add PostgreSQL/PostGIS features to your map](#) (page 340)
- [Style PostgreSQL/PostGIS features](#) (page 639)
- [Join PostgreSQL/PostGIS data to a different feature](#) (page 509)
- [Examine or edit attribute data](#) (page 711)
- [Create a PostgreSQL/PostGIS schema](#) (page 596)
- [View a PostgreSQL/PostGIS schema](#) (page 608)

- [Edit a PostgreSQL/PostGIS schema](#) (page 610)
- [Delete a PostgreSQL/PostGIS schema](#) (page 613)
- [Copy data to/from a different data format](#) (page 615)

Working with ODBC Data

To set up a Data Source Name (DSN) for your ODBC data store, you add a DSN in Windows. The configuration options you specify depend on the type of ODBC data store you use. The login ID and password you enter when setting up your DSN are used only for defining the DSN. These credentials are not when you connect with the ODBC provider through FDO.

NOTE For MySQL, be sure to install the MySQL driver from MyODBC 3.51 at <http://dev.mysql.com/downloads/connector/odbc/3.51.html>.

NOTE This functionality affects geospatial feature data only. For information about linking records in an external database to objects in a drawing, see [Overview of Linking Database Records to Objects](#) (page 522).

What ODBC Schemas Support

For ODBC, AutoCAD Map 3D supports point geometry, with X, Y, and optionally, Z columns for defining points. Although the default column names are X, Y, and Z, when you select the columns to represent these points, you must override the defaults. This information is stored in the map file itself. If you perform the same steps in another map, you must override the settings again.

In some cases, ODBC schemas support default values.

Restrictions of ODBC Schemas

- There is no spatial indexing.
- Geometry points are stored as separate properties in the object definition.
- The existing [schema](#) (page 2073) is used; you cannot edit or delete it. You cannot add a new schema or add [FDO](#) (page 2062) metadata to the [data store](#) (page 2059).

See also:

- [Overview of Geospatial Data](#) (page 551)
- [Accessing Data from ODBC](#) (page 342)
- [Creating a Join](#) (page 509)
- [Editing Features using the Data Table](#) (page 711)

NOTE This functionality affects geospatial feature data only. For information about linking records in an external database to objects in a drawing, see [Overview of Linking Database Records to Objects](#) (page 522).

- [To set up an ODBC data store for use with AutoCAD Map 3D](#) (page 577)
- [To set up a database range for Excel](#) (page 578)
- [To work with ODBC data](#) (page 578)

To set up an ODBC data store for use with AutoCAD Map 3D

- 1 From your Windows desktop, click Start menu ► Settings ► Control Panel and open the Administrative Tools control panel.
- 2 Double-click Data Sources (ODBC).
- 3 Click Add.
- 4 Select a driver.
 - For a SQL Server data store, use the SQL Server or SQL Native Client driver. Specify either Windows NT or SQL Server, and select the default database that matches yours.
 - For an Oracle provider, do not use the Microsoft ODBC for Oracle driver because it is incompatible with AutoCAD Map 3D. Instead, use the driver installed with the Oracle client.
- 5 Click Finish.
- 6 Specify the DSN information.
 - For a MySQL Server data store, specify the Data Source Name, Server, User, Password, and Database.
 - For an Oracle provider, specify the following:
 - Data Source Name

- TNS Service Name (the service to which you are connecting)
 - User ID (the database to access).
The User ID predefines the tables available in AutoCAD Map 3D. It is the equivalent of the OWNER field in an Oracle metaschema. If you do not specify it here, the entire schema of the Oracle instance (based on your user privileges) is used. It is case sensitive and must match the value in the Oracle instance (all uppercase is the usual case). This process can take several minutes, depending on your Oracle instance.
- 7 Under Database, click Select and select the data store to use.
 - 8 Click OK in the Select Database and ODBC Microsoft Access Setup dialog boxes.
 - 9 In the ODBC Data Source Administrator dialog box, select the new data source and click Configure.
 - 10 Specify the appropriate configuration options for your data store type:
 - For SQL Server, some column data types (for example, *nchar*) can cause a failure when connecting to the SQL Server. They are converted to unsupported formats by the ODBC driver.
 - For a MySQL Server data store, some column types can return the wrong length and prevent the ODBC provider from reporting the column. To resolve this issue, check Don't Optimize Column Width.
 - For a Microsoft Excel schemas, specify at least one named range. You can then expose different named ranges in the worksheet as different ODBC tables. Also, the ODBC tables map to FDO classes.

To set up a database range for Excel

- 1 Open the Excel worksheet.
- 2 Select all the data in the worksheet.
- 3 Define a named range for all the data in the table.
Do not use DATABASE or any other reserved word as a range name.

To work with ODBC data

- [Add data to your map](#) (page 342)

- [Join ODBC data to a different feature](#) (page 509)
- [Examine or edit attribute data](#) (page 711)

Working with ESRI ArcSDE Data

You can connect through ArcSDE to an underlying Oracle or SQL Server database. You can insert, select, update, and delete feature data in existing ArcSDE [schemas](#) (page 2073). You cannot create or modify an ArcSDE schema in AutoCAD Map 3D.

AutoCAD Map 3D supports ArcSDE 9.1, 9.2, 9.3, and 9.3.1.

The 9.3.1 version is available as either a 32-bit or 64-bit provider on Windows. (For previous versions, and on Linux, it is available in 32-bit only.) The 64-bit support is available only with the 64-bit ESRI ArcSDE 9.3.1 client libraries. (The 64-bit client libraries were not available before version 9.3.1.)

Both 32-bit and 64-bit ArcSDE servers are supported for the 9.3.1 version. You can access either server type with a 32-bit or 64-bit client. For example, if you are using AutoCAD Map 3D in a 32-bit environment, you can access a 64-bit ArcSDE server.

To work with ArcSDE, you must install ArcSDE 9.3.1 and a supported [data source](#) (page 2059), such as Oracle 11g, in the network.

Install the following *DLL* files on the computer on which you run AutoCAD Map 3D:

For version 9.1	For version 9.2 through 9.3.1
<i>pe91.dll</i>	<i>pe.dll</i>
<i>sde91.dll</i>	<i>sde.dll</i>
<i>sg91.dll</i>	<i>sg.dll</i>

For instructions on installing the *DLL* files and setting up your *hosts* and *services* files for ArcSDE, see [Bringing In Features from ArcSDE](#) (page 316).

The PATH environment variable must reference the local folder containing these *DLLs*. To accomplish this, you can install an ArcGIS 9.1 Desktop application or the ArcSDE SDK. For more information about ArcGIS 9.1 Desktop applications and the ArcSDE SDK, refer to the ESRI documentation.

NOTE This functionality affects geospatial feature data only. For information about linking records in an external database to objects in a drawing, see [Overview of Linking Database Records to Objects](#) (page 522). For information about moving data between DWG and ArcSDE format, see [Migrating DWG Data to GIS](#) (page 628).

What ESRI ArcSDE Schemas Support

AutoCAD Map 3D uses facilities provided by ArcSDE for [long transaction](#) (page 2067) [versioning](#) (page 2078) and [persistent locking](#) (page 2070). (ArcSDE supports one or the other, but not both, on the same class). AutoCAD Map 3D uses the standard ArcSDE API and ArcSDE-supported storage on both the Oracle and SQL Server platforms. AutoCAD Map 3D does not use [FDO](#) (page 2062) metadata for ArcSDE schema—it uses existing metadata only.

Restrictions of ArcSDE Schemas

If ArcSDE encounters curved segments, it converts them to a series of line segments that approximate the original arc segment (an approximation of the original geometry).

See also:

- [Overview of Geospatial Data](#) (page 551)
- [Editing Features using the Data Table](#) (page 711)
- [Bringing In Features from ArcSDE](#) (page 316)
- [Styling Features](#) (page 639)
- [Creating a Join](#) (page 509)
- [Editing Features using the Data Table](#) (page 711)
- [Viewing a Schema](#) (page 608)
- [Migrating Data](#) (page 615)

NOTE This functionality affects geospatial feature data only. For information about linking records in an external database to objects in a drawing, see [Overview of Linking Database Records to Objects](#) (page 522). For information about moving data between DWG and ArcSDE format, see [Migrating DWG Data to GIS](#) (page 628).

To work with ESRI ArcSDE data

- [Add ArcSDE features to your map](#) (page 316)
- [Style ArcSDE features](#) (page 639)
- [Join ArcSDE data to a different feature](#) (page 509)
- [Examine or edit attribute data](#) (page 711)
- [View an ArcSDE schema](#) (page 608)

Working with WFS Data

An OGC Web Feature Service (WFS) provides access to geographic features that are stored in an opaque [data store](#) (page 2059) in a client/server environment. A client uses WFS to retrieve geospatial data that is encoded in Geography Markup Language (GML) from a single or multiple WFS. The communication between client and server is encoded in XML. If the WFS response includes feature geometries, it is encoded in Geography Markup Language (GML), which is specified in the OpenGIS Geographic Markup Language Implementation Specification. WFS is a read-only provider.

NOTE This functionality affects geospatial feature data only. There is no equivalent for drawing data.

What WFS Schemas Support

A WFS [schema](#) (page 2073) can support the following:

- Inheritance
- Multiple schemas
- Object properties
- Association properties
- These geometry types: point, line string, polygon, multi-point, multi-line string, multi-polygon, multi-geometry, curve string, curve polygon, multi-curve string, multi-curve polygon, linear ring, line string segment, circular arc segment, and ring
- Multi-geometry

See also:

- [Overview of Geospatial Data](#) (page 551)
- [Bringing In Features from WFS](#) (page 346)
- [Styling Features](#) (page 639)
- [Creating a Join](#) (page 509)

NOTE This functionality affects geospatial feature data only. There is no equivalent for drawing objects.

To work with WFS data

- [Add WFS features to your map](#) (page 346)
- [Style WFS features](#) (page 639)
- [Join data to a WFS feature](#) (page 509)

Working with Feature Sources

After you connect to a data store in AutoCAD Map 3D, that data store is a [feature source](#) (page 2063) for the current map.

NOTE This functionality affects geospatial feature data only. For information about linking records in an external database to objects in a drawing, see [Overview of Linking Database Records to Objects](#) (page 522).

Overview of Working with Feature Sources

After you connect to a data store in AutoCAD Map 3D, that data store is a [feature source](#) (page 2063) for the current map. Feature sources are listed by provider (for example, all SDF feature sources are listed together in [Data Connect](#) (page 2059)).

NOTE This functionality affects geospatial feature data only. For information about linking records in an external database to objects in a drawing, see [Overview of Linking Database Records to Objects](#) (page 522). For information about managing drawing objects and drawing files, see [Overview of Setting Up Your Map File](#) (page 140).

Tell me more



Video

- [Show me how to create a new SDF file and import a schema.](#)



Procedure

- [To create a data store for a database provider](#) (page 588)
- [To create a data store for a file-based data provider](#) (page 589)
- [To create a schema](#) (page 598)
- [To import an XML or XMI schema](#) (page 608)



Tutorial

- [Exercise 3: Edit the schema](#)



Workflow

- [Prepare an Existing Oracle Database for Use with AutoCAD Map 3D](#)



GIS Skill

- [Create a GIS data store \(SDF\) to be populated from various sources](#)



Related topics

- [About Geospatial Feature Classes, Data Stores, and Schemas](#) (page 551)
- [Overview of Geospatial Data](#) (page 551)
- [Overview of Bringing In GIS Features](#) (page 305)

NOTE This functionality affects geospatial feature data only. For information about linking records in an external database to objects in a drawing, see [Overview of Linking Database Records to Objects](#) (page 522). For information about managing drawing objects and drawing files, see [Overview of Setting Up Your Map File](#) (page 140).

To set up a **feature source** (page 2063)

- 1 [Set up database users for the feature source, if necessary.](#) (page 585)

- 2 Do one of the following:
 - [Create a database datastore.](#) (page 588)
 - [Create an SDF or SHP data store.](#) (page 589)

NOTE You can also [delete a data store.](#) (page 593)

Setting Up Database Users

You can use the FDO User Manager utility that comes with AutoCAD Map 3D to set up database users for Oracle, SQL Server, PostgreSQL/PostGIS, and MySQL.

NOTE This functionality affects geospatial feature data only. For information about linking records in an external database to objects in a drawing, see [Overview of Linking Database Records to Objects](#) (page 522). For information about managing drawing objects and drawing files, see [Overview of Setting Up Your Map File](#) (page 140).

For an Oracle [data store](#) (page 2059), AutoCAD Map 3D separates the concept of the Oracle user who owns the [schema](#) (page 2073) from the Oracle user who accesses the schema.

When you [create a new Oracle data store in AutoCAD Map 3D](#) (page 586), AutoCAD Map 3D automatically creates a new corresponding Oracle user who is the owner of that data. For example, creating a data store called *mycitydb* creates an Oracle user called *mycitydb*. However, you must also create separate Oracle users for the purpose of accessing the data store. These Oracle users match the end users who will access the data. For example, if an end-user named JSmith will be connecting to the new data store, you create an Oracle user with that name and grant him access to the new data store. This allows different users who access the same data to have different privileges.

To access data that resides in a relational database, AutoCAD Map 3D requires that database users have certain privileges. Use FDO User Manager to add a new user with the appropriate roles. FDO User Manager is a command-line utility that lets you manage database users and accounts consistently across database management systems.

When you create users for an Oracle instance with the FDO User Manager tool, those users have the privileges that support data access operations for that data store. If you access the data store as an Oracle user who was not created using FDO User Manager, the Database Administrator must ensure

that the user has sufficient privileges to work with the data. If you use Oracle Workspace Manager, you **must** use separate users to create the data store and to access the data store, because locking is tracked by individual user and will not be effective if everyone connects as the same data store user.

In FDO User Manager, you choose an [FDO provider](#) (page 2063) and connection and then perform provider-specific tasks, including:

- Adding, dropping, or listing users
- Assigning, revoking, or listing roles and privileges
- Granting, revoking, or listing access to data stores

NOTE Database users are not the same as AutoCAD Map 3D users, which are [managed separately](#) (page 82).

See also:

- [Overview of Geospatial Data](#) (page 551)
- [Setting Up Users and Assigning Rights](#) (page 82)
- [Creating a Data Store](#) (page 586)

NOTE This functionality affects geospatial feature data only. For information about linking records in an external database to objects in a drawing, see [Overview of Linking Database Records to Objects](#) (page 522). For information about managing drawing objects and drawing files, see [Overview of Setting Up Your Map File](#) (page 140).

To manage database users and accounts

- 1 Start FDO User Manager.
By default, FDO User Manager is located in `\Program Files\AutoCAD Map 3D\FDO\bin\`. To start it, either double-click `FdoUserManager.exe` in Windows Explorer or enter `FdoUserManager` at a command prompt. (To invoke `FdoUserManager` from any prompt, add its directory to your path.)
- 2 At the Choose a Provider menu, enter the digit that corresponds to your FDO Provider and press Enter.
- 3 Enter each connection parameter when prompted and press Enter.
For example, enter the required service name and username/password. For more information, contact your database administrator.

- 4 After you are connected, follow the instructions on the screen.

If you are adding a user, enter the user name and password.

New users you create with this utility automatically have the roles and privileges required by the AutoCAD Map 3D FDO functionality. However, FDO User Manager allows you to grant some additional privileges. Use commas to separate the role names, with no spaces. You can enter ? to see a list of roles. To verify the roles after you add them, select List All Roles And Privileges Of A User.

- 5 When you finish, enter 0 (a zero) to exit FDO User Manager.

Creating a Data Store

Features are stored in a [data store](#) (page 2059), which is a collection of feature classes in a single data storage location. To add a feature to your map, you connect to its data store and select each [feature class](#) (page 2063) to include.

The main reason to create a new data store is to [migrate existing data](#) (page 615) to the new [FDO provider](#) (page 2063), or to create new data in that provider format.

NOTE This functionality affects geospatial feature data only. For information about linking records in an external database to objects in a drawing, see [Overview of Linking Database Records to Objects](#) (page 522). For information about moving data between DWG and geospatial formats, see [Migrating DWG Data to GIS](#) (page 628).

You can create new data stores for database FDO Providers (Microsoft SQL Server, SQL Server Spatial, MySQL, PostgreSQL/PostGIS, or Oracle) and file-based FDO Providers (SDE, SHP, or SQLite) from within AutoCAD Map 3D if you have the necessary privileges for the target database or directory. After you create a data store, you can define or import a schema for it, which specifies the feature classes available in that data store and their properties.

Before creating a database data store, make sure you have [created a user for the data store with the proper privileges](#) (page 584).

To overwrite an existing data store, you must first delete the old one. For data stores from database FDO Providers, use DBMS-specific tools to drop existing tables.

After you create a data store and [define a schema](#) (page 596) for it, AutoCAD Map 3D users can create, store, and [access](#) (page 303) geospatial data in that data store.

If you have DWG data that you want to move to a [feature source](#) (page 2063), see [Migrating DWG Data to GIS](#) (page 628).

When you create a data store, you specify the minimum and maximum X and Y spatial extents for new data store in the [Create Data Store Dialog Box](#) (page 1747). This is especially important if you later use [Bulk Copy](#) (page 615) to move data to that data store. You must make sure that the data you are moving are inside the extents of the destination data store. MySQL and Oracle support expanding the extents automatically if incoming data are beyond the scope of the extents.

Tell me more



Video

- [Show me how to create a new SDF file and import a schema.](#)



Procedure

- [To create a data store for a database provider](#) (page 588)
- [To create a data store for a file-based data provider](#) (page 589)
- [To create a schema](#) (page 598)
- [To import an XML or XMI schema](#) (page 608)



Tutorial

- [Exercise 3: Edit the schema](#)



Workflow

- [Prepare an Existing Oracle Database for Use with AutoCAD Map 3D](#)



GIS Skill

- [Create a GIS data store \(SDF\) to be populated from various sources](#)



Related topics

- [About Geospatial Feature Classes, Data Stores, and Schemas](#) (page 551)
- [Overview of Geospatial Data](#) (page 551)
- [Setting Up Database Users](#) (page 584)

- [Importing and Exporting a Schema](#) (page 606)
- [Migrating Data](#) (page 615)
- [Migrating DWG Data to GIS](#) (page 628)

Instructions for creating a data store are different for database data stores and for file-based data stores.

NOTE This functionality affects geospatial feature data only. For information about linking records in an external database to objects in a drawing, see [Overview of Linking Database Records to Objects](#) (page 522). For information about moving data between DWG and geospatial formats, see [Migrating DWG Data to GIS](#) (page 628).

- [To create a data store for a database provider](#) (page 588)
- [To create a data store for a file-based data provider](#) (page 589)

To create a data store for a database provider

- 1 On the Task Pane, click either the [Map Explorer](#) (page 2068) or [Display Manager](#) (page 2060) tab.
- 2 Click Data ► Connect To Data.
- 3 In the Data Connections By Provider list in the Data Connect window, select the appropriate choice (for example, Add Oracle Connection).
- 4 In the right-hand pane, enter a connection name (the name you will call this data store in AutoCAD Map 3D) and the information required to connect to the data store, for example, a service name.

NOTE Do not use the same name you used when you [created a user for the data store](#) (page 584).

- 5 Log into the service for the store.
- 6 In the Data Store list, select Add New Data Store (or type a name that does not appear in the list already) and press *Enter*.
You are asked if you want to create a new data store. Click Yes.
- 7 In the [Create Data Store Dialog Box](#) (page 1747) for this provider, enter the settings for the new data store.

If you are creating an FDO-enabled data store for SQL Server Spatial, see [Creating FDO-Enabled SQL Server Spatial Data Stores](#) (page 590).

8 Click OK.

If the data store is created successfully, you see a confirmation message prompting you to edit its schema. Use the Schema Editor to [create](#) (page 596) or [import](#) (page 606) the schema for the data store.

You are connected to the new data store automatically.

To create a data store for a file-based data provider

1 In Map Explorer, do one of the following:

- Click Schema ► Create SDF.
- Click Schema ► Create SHP.
- Click Schema ► Create SQLite.

2 In the Create File dialog box, specify the path and file name of the data store to create.

3 Enter the coordinate system code for the new data store.

If you do not know the code, follow these steps to select a coordinate system:

- Click .
- In the [Assign Global Coordinate System dialog box](#) (page 1598), select a category.
- Select from a list of available coordinate systems.
Select a coordinate system that both the provider and AutoCAD Map 3D support.
- Click Properties to view the properties of the selected coordinate system.
- Click OK.

4 Click OK.

You must define a schema for the new data store. A confirmation message prompts you to use the [Schema Editor](#) (page 1739) to [create](#) (page 596) or [import](#) (page 606) the schema for the data store.

The new data store is created when you click Apply in the Schema Editor. You are connected to it automatically.

Creating FDO-Enabled SQL Server Spatial Data Stores

You can create a SQL Server data store in [native SQL Server format](#) (page 559) and you can create [an extended SQL Server Spatial data store](#) (page 561) with FDO metadata.

NOTE This functionality affects geospatial feature data only. For information about linking records in an external database to objects in a drawing, see [Overview of Linking Database Records to Objects](#) (page 522). For information about moving data between DWG and geospatial formats, see [Migrating DWG Data to GIS](#) (page 628).

FDO-enabled Data Stores

You specify whether the new data store will be FDO-enabled or not by selecting Use FDO Enabled Schema when you create a data store.

FDO-enabled data stores include additional FDO metadata, but otherwise use native SQL Server schema capabilities.

- Such metadata provides a mechanism for ensuring that class and property names are maintained when you use Bulk Copy to move the data to a different format and back again. For SQL Server, the cases where class and property names are not maintained are rare, since SQL Server can handle names with any Unicode characters. The names cannot be longer than 128 characters, which is not usually a problem.
- FDO data stores maintain class inheritance, while non-FDO data stores do not. ApplySchema for non_FDO data stores maintains the inherited properties for sub-classes but not the relationships between classes and sub-classes.
- Object and object collection properties are supported only with FDO metadata.
- Revision number support for optimistic concurrency is included only with FDO metadata.
- If you select Use FDO Enabled Schema when you create a data store, some columns or tables may be renamed in the SQL Server database to avoid

limitations in SQL Server. The data itself is not altered and can still be queried by an external application. You can later delete the metadata table.

NOTE It is recommended that you use FDO-enabled schemas only if you need their additional capabilities. Otherwise, choose the default, non-FDO-enabled schema.

Selecting a Coordinate System for a Spatial Context

Once you create a data store, you create and apply a schema to it. The schema defines the table and columns into which you will put data. For FDO geometry properties, there are two possible SQL Server Spatial column types: geometry and geography. The geography type is used for geodetic (lat/long) coordinate systems and the geometry type is used for non-geodetic coordinate systems. For both, a spatial index with default parameters is created automatically.

SQL Server Spatial includes a catalog of geodetic coordinate systems, but not non-geodetic coordinate systems. Both geometry and geography column types save SRID values, but only geography type columns reference an entry in the catalog, and in this case the SRID numbers are EPSG numbers.

In AutoCAD Map 3D, when you define a spatial context, you select a coordinate system from the Mentor catalog. To use this coordinate system with SQL Server Spatial, AutoCAD Map 3D must translate the coordinate system information from Mentor into an SRID. SRID is the only identifier that SQL Server can use for both geodetic and non-geodetic coordinate systems. AutoCAD Map 3D uses the EPSG code of the coordinate system as the SRID.

The spatial context creation can fail if either of the following is true:

- The coordinate system does not have an EPSG code.
- The coordinate system is in the SQL Server catalog but its SQL Server WKT definition is not recognized by Mentor.

To resolve these situations, use a translation table in the file *ExtendedCoordSys.txt*. By default, this file is stored in *FDO\bin\com* in the AutoCAD Map 3D installation folder.

If the coordinate system does not have an EPSG code, add it to *ExtendedCoordSys.txt* and specify an SRID for it. Choose an SRID number that is not an EPSG code. The *ExtendedCoordSys.txt* file contains instructions for doing this.

If the SQL Server WKT definition is not recognized by mentor, add the coordinate system to *ExtendedCoordSys.txt* (if it is not already there) and set

the WKT to the Mentor version. The WKT specified in the file takes precedence over the WKT in the SQL Server catalog.

NOTE This functionality affects geospatial feature data only. For information about linking records in an external database to objects in a drawing, see [Overview of Linking Database Records to Objects](#) (page 522). For information about moving data between DWG and geospatial formats, see [Migrating DWG Data to GIS](#) (page 628).

To create a data store for SQL Server Spatial

- 1 On the Task Pane, click either the [Map Explorer](#) (page 2068) or [Display Manager](#) (page 2060) tab.
- 2 Click Data ► Connect To Data.
- 3 In the Data Connections By Provider list in the Data Connect window, select Add SQL Server Spatial Connection).
- 4 In the right-hand pane, enter a connection name (the name you will call this data store in AutoCAD Map 3D) and the information required to connect to the data store, for example, a service name.

NOTE Do not use the same name you used when you [created a user for the data store](#) (page 584).

- 5 Log into the service for the store, using either Windows authentication or SQL Server authentication.
- 6 In the Data Store list, select Add New Data Store (or type a name that does not appear in the list already) and press *Enter*.
You are asked if you want to create a new data store. Click Yes.
- 7 In the [Create Data Store Dialog Box](#) (page 1747) for this provider, enter the settings for the new data store.
Specify whether the new data store will be FDO-enabled or not by selecting or clearing Use FDO Enabled Schema. FDO-enabled data stores include additional FDO metadata, but otherwise use native SQL Server schema capabilities.
- 8 Click OK.
If the data store is created successfully, a confirmation message prompts you to edit its schema. Use the Schema Editor to [create](#) (page 596) or [import](#) (page 606) the schema for the data store.

The Concept tab for this topic describes issues concerning geometric and geographic properties, as well as issues with coordinate systems for SQL Server Spatial data stores.

You are connected to the new data store automatically.

Deleting a Feature Source

When you delete a [feature source](#) (page 2063), you remove all of its data and stylization information from layers in the current map that reference its data store. The [data store](#) (page 2059) itself is unaffected.

To delete a feature source, you must first disconnect from it.

NOTE This functionality affects geospatial feature data only. For information about deleting the templates that link records in an external database to objects in a drawing, see [Editing a Link Template](#) (page 538).

See also:

- [Overview of Geospatial Data](#) (page 551)
- [Creating a Data Store](#) (page 586)
- [Overview of Bringing In Data](#) (page 291)

To delete a feature source

- 1 In Map Explorer, click Data ► Connect to Data.
- 2 In the Data Connections By Provider list in the Data Connect window, right-click the [feature source](#) (page 2063) to delete and click Disconnect. Feature source entries display page icons. Each entry below a feature source is a feature class within that feature source.
- 3 Right-click the feature source again and click Delete.

Working with Schemas

Use the Schema Editor to work with schemas

NOTE This functionality affects geospatial feature data only. For information about linking records in an external database to objects in a drawing, see [Overview of Linking Database Records to Objects](#) (page 522). For information about moving data between DWG and geospatial data stores, see [Migrating DWG Data to GIS](#) (page 628).

Overview of Working with Schemas

Geospatial data is stored in a hierarchical fashion, like a set of tables: each row within a table is an individual feature, and each column is a [property](#) (page 2071) of that feature. The entire table (including its name, column names, data types, default values, and constraints) represents a [feature class](#) (page 2063). The set of related tables is called a schema, and the entire collection of data resides in a data store.

NOTE This functionality affects geospatial feature data only. For information about linking records in an external database to objects in a drawing, see [Overview of Linking Database Records to Objects](#) (page 522). For information about moving data between DWG and geospatial data stores, see [Migrating DWG Data to GIS](#) (page 628).

Tell me more



Video

- *Show me how to create a new SDF file and import a schema.*
- *Show me how to delete properties from a schema.*
- *Show me how to append a feature class to an SDF file.*
- *Show me how to limit what can be entered in a field.*



Procedure

- [To edit a schema](#) (page 612)



Tutorial

- Exercise 3: Edit the schema



Workflow

- Add a Property to an SDF Schema

- Add a New Feature Class to an FDO Data Source



GIS Skill

- *Create a GIS data store (SDF) to be populated from various sources*
- *Edit an existing schema (SDF)*
- *Limit what can be entered in a field*



Related topics

- [About Geospatial Feature Classes, Data Stores, and Schemas](#) (page 551)
- [Overview of Geospatial Data](#) (page 551)
- [Creating a Data Store](#) (page 586)

NOTE This functionality affects geospatial feature data only. For information about linking records in an external database to objects in a drawing, see [Overview of Linking Database Records to Objects](#) (page 522). For information about moving data between DWG and geospatial data stores, see [Migrating DWG Data to GIS](#) (page 628).

To do this...	Use this method...
Create a schema	In the Schema Editor, select Schemas in the Schema tree. Click New Schema on the Schema Editor toolbar. See Creating a Schema (page 596)
Import a schema	In the Schema Editor, select Schemas in the Schema tree. Click Import Schema on the Schema Editor toolbar. See Importing and Exporting a Schema (page 606)
Export a schema	In the Schema Editor, select Schemas in the Schema tree. Click Export Schema on the Schema Editor toolbar. See Importing and Exporting a Schema (page 606)

To do this...	Use this method...
View a schema	In the Schema Editor, click any schema (page 2073), feature class (page 2063), or property (page 2071). See Viewing a Schema (page 608)
Edit a schema	In the Schema Editor, click any schema, feature class, or property. Change any settings. See Editing a Schema (page 610)
Delete a schema	In the Schema Editor, right-click any schema, feature class, or property. Click Delete. See Deleting Schemas (page 613)

See also:

- [Schema Editor](#) (page 1739)

Creating a Schema

Use the Schema Editor to define a new [schema](#) (page 2073) in a [new](#) (page 586) or existing [feature source](#) (page 2063) for a database [FDO provider](#) (page 2063) (Microsoft SQL Server, MySQL, or Oracle) or for an SDF data store. You cannot create a schema for an existing SHP feature source, but you can [create a new file-based data store](#) (page 586) and create a schema for it during the creation process. You must use ESRI tools to create an ArcSDE schema—you cannot use AutoCAD Map 3D to create a schema for ArcSDE.

NOTE This functionality affects geospatial feature data only. For information about linking records in an external database to objects in a drawing, see [Overview of Linking Database Records to Objects](#) (page 522). For information about moving data between DWG and geospatial data stores, see [Migrating DWG Data to GIS](#) (page 628).

Some FDO Providers allow the client to override the default logical and physical mapping specified in their schema. You can use the Schema Editor to override classes, physical table names (to create a new table), Oracle tablespace names, MySQL storage engines, table-type mapping (base or concrete), properties,

and column names when you define a new schema. You cannot map to an existing table.

If you are mapping to an existing table or view in another [data store](#) (page 2059), make sure all column overrides correctly map to existing columns. If you map to a table or view with a different owner, have the owner of that table grant access to the FDO data store. You can create a local view that selects from the other table, and map to the local view, but this may not be necessary. The local view is created automatically if it is not present when you apply your changes.

If you are mapping to a table and column in the current data store that does not yet exist, make sure that the column name is valid for your database.

You must create schema elements hierarchically: create the schema first, then its [feature classes](#) (page 2063), and then its properties.

For feature sources from some FDO Providers, you can create multiple schemas within the same feature source and [change](#) (page 610) the schemas after you define and save them the first time.

You can [view](#) (page 608) a schema from any FDO Provider, but you cannot edit or delete it if there are existing features that use it.

See also:

- [Schema Editor](#) (page 1739)
- [Overview of Geospatial Data](#) (page 551)
- [Creating a Data Store](#) (page 586)
- [Setting Up Constraints in the Schema Editor](#) (page 599)
- [Importing and Exporting a Schema](#) (page 606)
- [Viewing a Schema](#) (page 608)
- [Editing a Schema](#) (page 610)
- [Deleting Schemas](#) (page 613)

NOTE This functionality affects geospatial feature data only. For information about linking records in an external database to objects in a drawing, see [Overview of Linking Database Records to Objects](#) (page 522). For information about moving data between DWG and geospatial data stores, see [Migrating DWG Data to GIS](#) (page 628).

To create a schema

- 1 [Connect](#) (page 303) to the feature source in which you want to create the [schema](#) (page 2073).
- 2 In Map Explorer, select the [feature source](#) (page 2063) in the connection tree (at the top of the pane) and click Schema ► Edit Schema.
- 3 In the [Schema Editor](#) (page 1739), expand the Schema tree and do one of the following:
 - To create a schema, select Schemas (the top-most node in the Schema tree) and click New Schema on the Schema Editor toolbar.
 - To create a [feature class](#) (page 2063), select the parent schema in the Schema tree and click New Feature Class on the Schema Editor toolbar.
 - To create a [property](#) (page 2071), select the parent feature class in the Schema tree and click New Property on the Schema Editor toolbar.
- 4 [Specify the settings for the new schema element](#) (page 1739) in the right-hand pane.
See [Setting Up Constraints in the Schema Editor](#) (page 599) for information on limiting the valid values for a property.
- 5 Repeat the preceding two steps as required to create other schema elements.
- 6 Click Apply to apply your changes and leave the Schema Editor open. When you click Apply or OK, your changes are submitted to the data store. You can add feature classes and properties, but you cannot edit your previous work.
- 7 Click OK to apply any unsaved changes and close the Schema Editor.

Setting Up Constraints in the Schema Editor

When you create a schema, you can limit the values that are valid for particular properties. The types of constraints supported by AutoCAD Map 3D are described in the following table.

Type of Constraint	Description	Data Table Behavior
Range	Valid values must be within the range specified. You can include or exclude the minimum and maximum values. For example, you can specify 1-10 inclusive, and then 1 and 10 are both valid.	Any value outside the specified range generates an error and you must enter a different value.
List	You supply the list entries that are valid for the property.	Click the down-arrow to display the list, and then choose one of the items as a value for the property.
Not null	The value of the property cannot be empty.	If you leave the property value empty when you close the Data Table, an error message prompts you to enter a value.
Unique	The value of the property must be unique within the feature class. If you define the property as an auto-generated field, or if it is defined in the data store as a key field, it will have this constraint.	If you enter a value that is used by any other feature in this feature class, an error message prompts you to change it. You will not see the error message until you check in the feature. If the table has two columns that together must be unique (like "Lastname" and "Firstname"), a message appears on each column involved in the paired uniqueness constraint.

NOTE This functionality affects geospatial feature data only. For information about linking records in an external database to objects in a drawing, see [Overview of Linking Database Records to Objects](#) (page 522). For information about moving data between DWG and geospatial data stores, see [Migrating DWG Data to GIS](#) (page 628).

When you [edit the properties](#) (page 711) in the Data Table, you can enter only the values allowed by the constraint. For example, for a Roads feature, you can specify that the values for the Number_Of_Lanes property be within the range 1 through 8. If you enter 9 lanes, you will receive an error message.

You will see an error message as soon as you enter the invalid value. When you check the feature in, your edits are validated again against the data store and you may be notified of further errors, depending on the capabilities of the data provider.

You cannot edit a schema to convert an existing field to use a different constraint type if the table already contains data. The table must be empty.

Not every data provider supports all constraints. The following table shows supported constraints by provider.

Provider	Range	List	Not Null	Unique
Oracle	Yes	Yes	Yes	Yes
PostgreSQL/PostGIS	Yes	Yes	Yes	Yes
SQL Server	Yes	Yes	Yes	Yes
SQL Server Spatial	Yes	Yes	Yes	Yes
SQLite	Yes	Yes	Yes	Yes
MySQL	No	No	Yes	Yes
SDF	Yes	Yes	Yes	No
ArcSDE	No	No	Yes	Yes
SHP	No	No	Yes	No

The Schema Editor checks the provider capability and allows only the constraints supported by that provider.

A property that uses constraints can have any data type, except for Boolean (which can have not-null constraints only). You cannot constrain properties with BLOB or CLOB data types.

Tell me more



- *Show me how to limit what can be entered in a field.*



- [To create a constrained property](#) (page 601)



- Exercise 4: Add a property



- *Limit what can be entered in a field*



- [About Geospatial Feature Classes, Data Stores, and Schemas](#) (page 551)
- [Overview of Geospatial Data](#) (page 551)
- [Creating a Data Store](#) (page 586)

See also:

- [Schema Editor](#) (page 1739)

NOTE This functionality affects geospatial feature data only. For information about linking records in an external database to objects in a drawing, see [Overview of Linking Database Records to Objects](#) (page 522). For information about moving data between DWG and geospatial data stores, see [Migrating DWG Data to GIS](#) (page 628).

To create a constrained property

- 1 In the [Schema Editor](#) (page 1739), expand the Schema tree and select the property to constrain.

- 2 Ensure that the data type for the property allows the constraint you want. For example, Boolean properties can have not-null constraints only.
- 3 Do one of the following:
 - To specify a range for the property, set Constraint Type to Range and specify the range values.
In the Constraint Type field, click the down-arrow and click Range. Enter a minimum and maximum value for the range and, for each one, specify whether the range is inclusive or exclusive of that value. For example, if the range is 1-10, specify whether 1 and 10 are included or not.
 - To specify a list of possible values, set Constraint Type to List and specify the list values.
In the Constraint Type field, click the down-arrow and click List. Click Value List and click . Type the list, pressing Enter after each item.
If the data type for this property is String, specify the maximum length of the string before entering values in the list.
If the data type for this property is Decimal, define the precision and scale before entering values in the list. If you enter values in the list that exceed the precision or scale, those values are rounded.
If the data type for this property is DateTime, the list editor displays a calendar from which you can select specific dates. Once you choose the first date, the list creates a new entry and you can choose the next date.
When you click OK, AutoCAD Map 3D checks the values in the list. If the values are not valid, for example, if they do not match the data type or they exceed the length of the string definition, you will see an error message.
 - To ensure that the property is not allowed to have an empty value, set Nullable to False.
In the Nullable field, click the down-arrow and click True or False. If you set Nullable to False, you can enter a Default Value to ensure that new features have an entry for this property.
- 4 To specify a “uniqueness” constraint, select the appropriate feature class in the tree on the left.
You can specify a single-property uniqueness constraint or a composite-property uniqueness constraint. A single-property uniqueness constraint ensures that the value for that property is unique within the feature class. A composite-property uniqueness constraint (sometimes

called a “paired constraint”) specifies multiple properties whose combined values are unique. For example, you can constrain the combined Street_Number, Street_Name, and City fields to uniquely identify a building address.

- Click New (under Specify Constraints (And The Order)).
- Select the boxes for the properties that must have unique values. The properties designated as unique appear in the list at the bottom of the dialog box.
- If desired, use the up and down arrows for the list to change the order of the properties.

5 Click Apply.

Exposing a Native Database View in a Schema

A database view is a virtual or logical table composed of the result set of a query. Unlike ordinary tables in a relational database, a view is not part of the physical schema. It is a dynamic, virtual table computed from data in the database. Changing the data in a table alters the data shown in the view.

Views can provide advantages over tables:

- You can use a view to make a subset of data available to certain users.
- A view can join and simplify multiple tables into a single virtual table.
- Views can aggregate data (using a sum, average, or other function) to calculate and present data.

NOTE This functionality affects geospatial feature data only. For information about linking records in an external database to objects in a drawing, see [Overview of Linking Database Records to Objects](#) (page 522). For information about moving data between DWG and geospatial data stores, see [Migrating DWG Data to GIS](#) (page 628).

Mapping Existing Views to Feature Classes

AutoCAD Map 3D automatically displays as classes existing database views that are defined in their native databases. If the view includes geometry, it is displayed as a feature class. The following restrictions apply:

- You cannot create or modify the view definition within AutoCAD Map 3D.
- In the Data Table, you can edit data in views only if you have permissions to do so and only if the data store supports editing of view-based data.
- The ability to insert, update, and delete data in the view depends on how the view is defined in its native data store.
- For existing Oracle schemas, geometry that is included in a view needs a separate entry in the *user_sdo_geom_metadata* table. This allows AutoCAD Map 3D to determine the correct spatial context to use when for that view when displaying it as a feature class.

If you plan to use a database view with AutoCAD Map 3D, keep in mind the following points :

- Your native view must contain a primary key.
- Your native view must use a spatial index.

In the Schema Editor, the columns defined for the view appear as properties, but you cannot edit them. However, you can use the Schema Editor to create feature classes and properties that mimic database views.

For example, although you have an Oracle table, Rivers, with 20 properties, you may want certain people to see only six of those properties. You can use the Schema Editor to create a new feature class based on the existing Rivers table, and add the six properties you want to expose.

Schema Editor allows mapping directly into the physical database objects (tables or views).

Accessing Views from Native Schema

In addition to mapping feature classes to existing views in a FDO-enabled datastore, you can “reverse-engineer” views in native, existing, non-FDO-enabled datastores into feature classes.

To do this, the following must be true:

- The primary key or unique index columns must be exposed in the view.

If the view contains a join, columns that identify each row uniquely must also be exposed.

If a class has no primary key, you can still expose it in AutoCAD Map 3D, but it will be read only.

- For Oracle data stores, if there is geometry in the view, there must be an entry in *user_sdo_geom_metadata* for that geometry. This will provide the spatial context and coordinate system information.
- For Oracle non-simple views, you can specify which columns to use for a primary key for the resulting feature class. Provide this information with the view, as shown in this example:

```
alter view <viewname> add constraint <constraintname> primary key  
(columnnames) disable novalidate;
```

NOTE This procedure is needed only for [FDO](#) (page 2062)-enabled schemas. For existing schema data stores, AutoCAD Map 3D automatically displays the view as a feature class, with no further action on your part.

NOTE This functionality affects geospatial feature data only. For information about linking records in an external database to objects in a drawing, see [Overview of Linking Database Records to Objects](#) (page 522). For information about moving data between DWG and geospatial data stores, see [Migrating DWG Data to GIS](#) (page 628).

To create a feature class that maps to a database view

- 1 Create an FDO-enabled data store.
You can use the Schema Editor to do this. See [Creating a Schema](#) (page 596)
- 2 Create a database view using the native tools for your database.
For Oracle, use `sqlplus`. For SQL Server, use `sqlcmd`. For MySQL, use `mysql`.
- 3 Reconnect to the data store in AutoCAD Map 3D.
- 4 In the [Schema Editor](#) (page 1739), select the target schema Name and click New Feature Class.
For information about creating feature classes and properties, see [Editing a Schema](#) (page 610).
- 5 If the Logical Feature Class tab is displayed, click the Physical Configurations tab.

- 6 For Table Name, type the name of the view you created in step 1. Click OK.
- 7 Switch back to the Logical Feature Class tab and type the name, class type, and other required information.
- 8 Click New Property to add a property.
- 9 Switch to the Physical Configuration tab.
- 10 Type the name of the view column (from the view you created in step 1) to map to the new property. Click OK.
- 11 Switch back to the Logical Property tab and set the property attributes. Attributes such as data type, length, scale, precision, nullability, uniqueness, and other constraints must match the corresponding column attributes. For example, you cannot create a property that has the string data type and map it to a column that uses the number data type.
- 12 Repeat steps 8 through 11 to create the remaining properties.
- 13 Be sure to fill in the Primary Key column for the new view record before you check it in (if it is not defined to be auto-generated).

Importing and Exporting a Schema

You can export a [schema](#) (page 2073) as an XML file to do any of the following:

- Share a schema you created in the Schema Editor with other AutoCAD Map 3D or GIS-software users.
- Back up a schema you created in the Schema Editor as an XML file.
- Save your work in progress if the original data source or directory becomes unavailable.

You can import an XML schema that you exported, and use it to define a new schema for another data store. This is useful for creating multiple data stores based on the same schema.

NOTE This functionality affects geospatial feature data only. For information about linking records in an external database to objects in a drawing, see [Overview of Linking Database Records to Objects](#) (page 522). For information about moving data between DWG and geospatial data stores, see [Migrating DWG Data to GIS](#) (page 628).

The AutoCAD Map 3D XML schema format is a subset of the Geography Markup Language (GML). For information about GML, go to <http://www.opengis.net/gml>. GML was standardized by the Open Geospatial Consortium (OGC). For information about OGC, go to <http://www.opengeospatial.org>. You can also consult the *FDO API Reference* and *The Essential FDO*.

Tell me more



Video

- *Show me how to create a new SDF file and import a schema.*



Procedure

- [To create a data store for a database provider](#) (page 588)
- [To create a data store for a file-based data provider](#) (page 589)
- [To create a schema](#) (page 598)
- [To import an XML or XMI schema](#) (page 608)



Tutorial

- Exercise 3: Edit the schema



Workflow

- Prepare an Existing Oracle Database for Use with AutoCAD Map 3D



GIS Skill

- *Create a GIS data store (SDF) to be populated from various sources*



Related topics

- [About Geospatial Feature Classes, Data Stores, and Schemas](#) (page 551)
- [Overview of Geospatial Data](#) (page 551)
- [Creating a Data Store](#) (page 586)
- [Setting Up Database Users](#) (page 584)
- [Creating a Schema](#) (page 596)
- [Working with Schemas](#) (page 593)

See also:

- [Schema Editor](#) (page 1739)

NOTE This functionality affects geospatial feature data only. For information about linking records in an external database to objects in a drawing, see [Overview of Linking Database Records to Objects](#) (page 522). For information about moving data between DWG and geospatial data stores, see [Migrating DWG Data to GIS](#) (page 628).

To import an XML or XMI schema

- 1 Connect to the feature source into which you want to import the schema.
- 2 In Map Explorer, select the feature source in the connection tree (at the top of the pane) and click Schema ► Edit Schema.
- 3 In the [Schema Editor](#) (page 1739), select Schemas (the top-most node in the Schema tree) and click Import Schema on the Schema Editor toolbar.
- 4 In the Open dialog box, choose the file format for the file you are importing (XML or XMI). Navigate to the file you want and click Open. The Schema tree displays the imported schema.
- 5 Click Apply to make the changes permanent.

To export an XML schema

- 1 Connect to the feature source whose schema you want to export.
- 2 In Map Explorer, select the feature source in the connection tree (at the top of the pane) and click Schema ► Edit Schema.
- 3 In the Schema Editor, select Schemas (the top-most node in the Schema tree) and click Export Schema on the Schema Editor toolbar.
- 4 In the Save dialog box, navigate to the desired directory and enter a name for the file.
- 5 Click Save.

Viewing a Schema

You can inspect a [schema](#) (page 2073) for any [feature source](#) (page 2063), including those of [FDO providers](#) (page 2063) that don't support updateable schemas. When

you open an updateable schema, you can [edit](#) (page 610) it. If you change an updateable schema mistakenly, click Cancel to [undo](#) (page 614) the changes. Providers that support updateable schemas include Microsoft SQL Server, MySQL, SDF, and Oracle.

When you open a non-updateable schema, you cannot edit it.

NOTE This functionality affects geospatial feature data only. For information about linking records in an external database to objects in a drawing, see [Overview of Linking Database Records to Objects](#) (page 522). For information about moving data between DWG and geospatial data stores, see [Migrating DWG Data to GIS](#) (page 628).

See also:

- [Schema Editor](#) (page 1739)
- [Overview of Geospatial Data](#) (page 551)
- [Creating a Data Store](#) (page 586)
- [Creating a Schema](#) (page 596)
- [Importing and Exporting a Schema](#) (page 606)
- [Editing a Schema](#) (page 610)
- [Deleting Schemas](#) (page 613)

NOTE This functionality affects geospatial feature data only. For information about linking records in an external database to objects in a drawing, see [Overview of Linking Database Records to Objects](#) (page 522). For information about moving data between DWG and geospatial data stores, see [Migrating DWG Data to GIS](#) (page 628).

To view a schema

- 1 Connect to the feature source whose schema you want to view.
- 2 In Map Explorer, select the feature source in the connection tree (at the top of the pane) and click Schema ► Edit Schema.
- 3 In the [Schema Editor](#) (page 1739), expand the Schema tree and then click any schema, feature class, or property to view its settings in the right-hand pane.

- 4 When you finish inspecting the schema, click Cancel to close the Schema Editor.

Editing a Schema

You can edit a [schema](#) (page 2073), [feature class](#) (page 2063), or [property](#) (page 2071) if the [FDO provider](#) (page 2063) supports updateable schemas (for example, Microsoft SQL Server, SQL Server Spatial, MySQL, Oracle, and SDF all support updateable schemas). For more information about data types and supported functionality, see [Schema Editor](#) (page 1739).

If you open a non-updateable schema in the Schema Editor you can [view](#) (page 608) its settings, but you cannot change them.

You cannot edit or delete any schema, feature class, or property if there are existing features that use it.

NOTE This functionality affects geospatial feature data only. For information about linking records in an external database to objects in a drawing, see [Overview of Linking Database Records to Objects](#) (page 522). For information about moving data between DWG and geospatial data stores, see [Migrating DWG Data to GIS](#) (page 628).

Z and M Dimensions

The FDO Provider for SQL Server Spatial does not support Z and M dimensions, due to limitations of their support by SQL Server 2008. When you define new geometry properties for feature classes in the AutoCAD Map 3D Schema Editor, the options to include Z and M will not be available.

Naming Restrictions

You can use the Schema Editor to import a feature schema collection from an XML file. When importing, you can modify these schemas to conform to the restrictions of the current provider connection.

For example, if you are connected to an Oracle data store, feature class names may be limited to 22 characters. If you import a feature schema collection that includes feature class names that are longer, you will need to rename those feature classes during import to meet the restrictions of the Oracle connection.

If you import an FDO-enabled SQL Server Spatial schema collection into a non-FDO schema connection, Schema Editor will display error messages that tell you which names need to be adjusted.

NOTE If you try to set a physical override (for example, name a property column to something other than the property name), you'll see an error message about accessing protected memory.

Tell me more



Video

- [Show me how to delete properties from a schema.](#)
- [Show me how to append a feature class to an SDF file.](#)



Procedure

- [To edit a schema](#) (page 612)



Tutorial

- [Exercise 3: Edit the schema](#)



Workflow

- [Add a Property to an SDF Schema](#)
- [Add a New Feature Class to an FDO Data Source](#)



GIS Skill

- [Edit an existing schema \(SDF\)](#)



Related topics

- [About Geospatial Feature Classes, Data Stores, and Schemas](#) (page 551)
- [Overview of Geospatial Data](#) (page 551)
- [Creating a Data Store](#) (page 586)
- [Creating a Schema](#) (page 596)
- [Setting Up Constraints in the Schema Editor](#) (page 599)
- [Importing and Exporting a Schema](#) (page 606)
- [Viewing a Schema](#) (page 608)

See also:

- [Schema Editor](#) (page 1739)

NOTE This functionality affects geospatial feature data only. For information about linking records in an external database to objects in a drawing, see [Overview of Linking Database Records to Objects](#) (page 522). For information about moving data between DWG and geospatial data stores, see [Migrating DWG Data to GIS](#) (page 628).

To edit a schema

NOTE If you edit the schema for a survey data store, make sure that you do not inadvertently remove existing fields or classes. Doing so may affect the performance of the survey data store.

- 1 Connect to the feature source whose schema you want to edit.
- 2 In Map Explorer, select the feature source in the connection tree (at the top of the pane) and click Schema ► Edit Schema.
- 3 In the [Schema Editor](#) (page 1739), expand the Schema tree and click the schema, feature class, or property to edit.
The current settings appear in the right-hand pane.
- 4 [Edit the settings for the schema element.](#) (page 1739)
The settings you can change depend on what the provider supports and which settings are editable. For example, the [long transaction](#) (page 2067) section does not appear or is unavailable if the provider does not support versioning.
- 5 To add a new feature class, select the schema entry on the right and click New Feature Class at the top of the window. Specify the information for the new feature class on the left side of the window.
- 6 To add a new property, select the feature class entry for that property on the right and click New Property at the top of the window. Specify the information for the property on the left side of the window.
See [Setting Up Constraints in the Schema Editor](#) (page 599) for information on limiting the valid values for a property.
- 7 For a feature class and property, click the Physical Configurations tab and edit the physical settings if necessary.

Each provider maps a correspondence between a schema element and a physical object in a feature source. The physical structure of feature sources varies by provider, as do the types of schema mappings and default settings. Oracle, for example, maps each feature class onto a table in the Oracle database where the feature source resides, giving the class and table the same name. You can override these defaults by changing the settings on the Physical Configurations tab. The settings on this tab vary by provider. The tab is unavailable for providers whose defaults cannot be changed.

- 8 Click Apply.
- 9 Repeat the preceding four steps as required to edit other schema elements.
- 10 Click OK to make all the changes permanent.

Deleting Schemas

When you delete a [schema](#) (page 2073), [feature class](#) (page 2063), or [property](#) (page 2071) in the Schema Editor, its icon disappears from the Schema tree, along with the icons of its child elements (if any). However, the changes are not transferred to the underlying [feature source](#) (page 2063) until you apply them. If you delete a feature class, for example, the class and its properties are removed from the Schema tree, but its table remains in the feature source until you click Apply. You can [undo](#) (page 614) changes until you click Apply.

NOTE You cannot delete a schema, feature class, or property if feature data exist for that item.

NOTE This functionality affects geospatial feature data only. For information about linking records in an external database to objects in a drawing, see [Overview of Linking Database Records to Objects](#) (page 522). For information about moving data between DWG and geospatial data stores, see [Migrating DWG Data to GIS](#) (page 628).

See also:

- [Schema Editor](#) (page 1739)
- [Overview of Geospatial Data](#) (page 551)
- [Creating a Data Store](#) (page 586)
- [Creating a Schema](#) (page 596)

- [Importing and Exporting a Schema](#) (page 606)
- [Viewing a Schema](#) (page 608)
- [Editing a Schema](#) (page 610)

NOTE This functionality affects geospatial feature data only. For information about linking records in an external database to objects in a drawing, see [Overview of Linking Database Records to Objects](#) (page 522). For information about moving data between DWG and geospatial data stores, see [Migrating DWG Data to GIS](#) (page 628).

To delete schema elements

- 1 Connect to the feature source containing the schema elements to delete.
- 2 In Map Explorer, right-click the desired connection in the connection tree and select Edit Schema.
- 3 In the [Schema Editor](#) (page 1739), expand the Schema tree to see its feature classes and properties.
- 4 Right-click the schema, feature class, or property to delete, and click Delete for that schema element.
- 5 When prompted, click Yes to confirm the deletion.
The Schema tree updates to show the deletion.
- 6 Repeat the preceding two steps as required to delete other schema elements.
- 7 Click OK to make all the deletions permanent.

Undoing Schema Changes

When you make changes in the Schema Editor, the Schema tree and right-hand pane reflect your changes. However, the changes are not applied to the underlying feature source until you click Apply. If you click Cancel before you click Apply, all changes you made since the last Apply are canceled.

NOTE This functionality affects geospatial feature data only. For information about linking records in an external database to objects in a drawing, see [Overview of Linking Database Records to Objects](#) (page 522). For information about moving data between DWG and geospatial data stores, see [Migrating DWG Data to GIS](#) (page 628).

See also:

- [Schema Editor](#) (page 1739)
- [Overview of Geospatial Data](#) (page 551)
- [Creating a Data Store](#) (page 586)
- [Creating a Schema](#) (page 596)
- [Importing and Exporting a Schema](#) (page 606)
- [Viewing a Schema](#) (page 608)
- [Editing a Schema](#) (page 610)
- [Deleting Schemas](#) (page 613)

NOTE This functionality affects geospatial feature data only. For information about linking records in an external database to objects in a drawing, see [Overview of Linking Database Records to Objects](#) (page 522). For information about moving data between DWG and geospatial data stores, see [Migrating DWG Data to GIS](#) (page 628).

To discard all Schema Editor changes since the last Apply

- In the Schema Editor, click Cancel.

Migrating Data

Use Bulk Copy to copy data from one [feature source](#) (page 2063) to another, either in the same format or in a different one.

NOTE For information about moving data between DWG and geospatial data stores, see [Migrating DWG Data to GIS](#) (page 628).

Overview of Migrating Data

You can use Bulk Copy to copy data from one [feature source](#) (page 2063) to another, either in the same format or in a different one.

You can move DWG objects and their attributes to a variety of geospatial formats and, in some cases, move the data back into AutoCAD drawings.

Tell me more



Video

- [Show me how to copy data from one data store to another.](#)



Procedure

- [To copy data from one feature source to another](#) (page 621)
- [To fix a Bulk Copy geometry problem in the original data store](#) (page 626)
- [To fix a Bulk Copy geometry problem in the resulting data store](#) (page 626)



Tutorial

- [Lesson 3: Move SDF Data to a Different Geospatial Format](#)



Workflow

- [Copy SHP File Data to Microsoft SQL Server, MySQL, or Oracle](#)
- [Create ArcSDE Features from Unclassified Drawings](#)



GIS Skill

- [Bulk copy data from a SHP file to an SDF file](#)



Related topics

- [About Geospatial Feature Classes, Data Stores, and Schemas](#) (page 551)
- [Overview of Geospatial Data](#) (page 551)
- [Creating a Data Store](#) (page 586)
- [Migrating DWG Data to GIS](#) (page 628)

To move data...	Use this method...
From DWG format to SDF	<p>In the Tool-based Ribbon Workspace, click Output tab ► Map Data Transfer panel</p> <p>► Map 3D Export. </p> <p>See Migrating DWG Data to GIS (page 628).</p>
From DWG format to SDF 2 (an earlier version of SDF)	<p>Click Output tab ► Map Data Transfer panel ► As SDF 2.</p> <p>See Exporting DWG Data to SDF2 Format (page 1417).</p>
From a Display Manager layer to SDF	<p>In the Display Manager, right-click a layer ► Export Layer Data To SDF.</p> <p>See Saving or Exporting a Display Manager Layer (page 1469).</p>
From one geospatial format to another	<p>In Map Explorer, click Tools ► Bulk Copy.</p> <p>See Migrating GIS Data (Bulk Copy) (page 617).</p>

Migrating GIS Data (Bulk Copy)

You can use Bulk Copy to copy data from one [feature source](#) (page 2063) to another, either in the same format or in a different one.

NOTE For information about moving data between DWG and geospatial data stores, see [Migrating DWG Data to GIS](#) (page 628).

Using Bulk Copy, you can copy the complete [feature source](#) (page 2063) or a subset based on a specified [schema](#) (page 2073), [feature class](#) (page 2063), or [property](#) (page 2071). You can also filter a Display Manager layer using an expression, and then use Bulk Copy to create a data store that contains only the filtered data.

What You Can Do With Bulk Copy

Use Bulk Copy to do the following:

- Make your own copy of data owned by another department.

- Upgrade from file-based (SDF or SHP) data storage to multi-user database storage (Microsoft SQL Server, MySQL, or Oracle), which provides advanced features, such as [versioning](#) (page 2078) and [long transaction](#) (page 2067).
- Move joined data and calculated fields into a new data store.
- Transform coordinate systems easily. For example, you can do any of the following:
 - Assign a coordinate system to a data store that does not have one.
 - Create a new data store whose coordinate system is different from the source. The target class uses the override coordinate system as the projection for the spatial context.
- Convert a foreign schema to a native format.

Bulk Copying To SDF Format

If you [create a new SDF file](#) (page 589) in AutoCAD Map 3D, you can use it as a target for Bulk Copy. However, you must [delete the default schema](#) (page 614) before copying data to the new SDF file.

Bulk Copying to SHP Format

A single SHP file can hold only one class. To copy multiple classes, to an empty folder through the FDO SHP provider. When you copy to that connection, Bulk Copy creates a new SHP file for each class you copy. Do not create a new SHP file in Schema Editor and use the new SHP as your Bulk Copy target.

A SHP schema cannot be modified once it is applied. To avoid this limitation when you copy SDF data to SHP, export the SDF schema. Then, when you create the target SHP schema, delete its default schema and import the SDF schema. This way, you can fix any errors in the schema. During the Bulk Copy, select the feature class and property names in the To column and match them exactly to the From column.

Depending on the size of the file, you can also import the SDF data and export it as SHP.

Bulk Copying To or From SQL Server Spatial

When you copy data from an FDO-enabled SQL Server Spatial data store to a non-FDO data store, class and property names may not be accepted by the destination data store because naming rules vary between providers. You can

use schema mappings to rename schema elements that you copy, to be sure they meet the naming rules of the destination data store.

You can also pass in a set of schema capabilities to the target data store, so the cloned schemas conform to the capabilities of that data store.

When you copy geodetic polygons with clockwise rings to SQL Server Spatial, check Unmatched Data Or Geometric Type Errors as an error type to ignore.

For geography, SQL Server Spatial considers the inside of a polygon to be to the left of the outer boundary. If a polygon with a clockwise boundary is inserted, the polygon actually covers the rest of the world, excluding what appears to be inside the polygon from an onscreen perspective. If you ignore unmatched geometry type errors when using Bulk Copy, the geometry and orientation are adjusted when the target is SQL Server Spatial. If you do not check this option and you copy a polygon with the wrong orientation to SQL Server Spatial, that object will fail to copy.

Also, SQL Server Spatial does not currently support such polygons that are bigger than one hemisphere.

Other Ways to Migrate Data

If you are moving data from DWG format to any other format, you cannot use Bulk Copy. Instead, see [Migrating DWG Data to GIS](#) (page 628).

If you are moving geospatial data into SDF format, it may be easier to save or export its Display Manager layer to SDF, without going through Bulk Copy. See [Saving or Exporting a Display Manager Layer](#) (page 1469).

Things to Remember

When using Bulk Copy, keep in mind the following points :

- The copied schema is created if it does not exist in the destination feature source.
- The names of schemas, [feature classes](#) (page 2063), and properties in the source feature source do not need to match the names in the destination feature source.
- You can save or load an XML mapping file to set up the mapping between the source and destination feature sources.
- You can copy geometry with no transformation of the coordinates.
- You must make sure that the data you are moving are inside the extents of the destination data store. (When you [create a data store](#) (page 586), you

specify the minimum and maximum X and Y spatial extents for the new data store.) MySQL and Oracle support expanding the extents automatically if incoming data are beyond the scope of the extents.

- If you do not have adequate rights to the target data store, you must either create a new, empty data store as the target or ask your administrator to grant you the rights required to insert data in the target tables.

Tell me more



Video

- [Show me how to copy data from one data store to another.](#)



Procedure

- [To copy data from one feature source to another](#) (page 621)
- [To fix a Bulk Copy geometry problem in the original data store](#) (page 626)
- [To fix a Bulk Copy geometry problem in the resulting data store](#) (page 626)



Tutorial

- [Lesson 3: Move SDF Data to a Different Geospatial Format](#)



Workflows

- [Copy SHP File Data to Microsoft SQL Server, MySQL, or Oracle](#)
- [Create ArcSDE Features from Unclassified Drawings](#)



GIS Skill

- [Bulk copy data from a SHP file to an SDF file](#)



Related topics

- [About Geospatial Feature Classes, Data Stores, and Schemas](#) (page 551)
- [Overview of Geospatial Data](#) (page 551)
- [Understanding How Bulk Copy Converts Data Types](#) (page 623)

- [Fixing Geometry Issues After a Bulk Copy](#) (page 625)
- [Reviewing the Bulk Copy Log Information](#) (page 626)
- [Migrating DWG Data to GIS](#) (page 628)
- [Saving or Exporting a Display Manager Layer](#) (page 1469)

NOTE For information about moving data between DWG and geospatial data stores, see [Migrating DWG Data to GIS](#) (page 628).

To copy data from one feature source to another

- 1 [Connect](#) (page 308) to the source and destination [feature source](#) (page 2063) using Data Connect.

NOTE To copy data to SHP, connect to an empty folder through the FDO SHP provider and use that connection as your Bulk Copy target. Do not create a new SHP file in Schema Editor and use the new SHP as the target.

NOTE If you are copying data to a new SDF file that you created in AutoCAD Map 3D, delete the default schema before you use Bulk Copy. See [Deleting Schemas](#) (page 613).

- 2 If necessary, use Data Connect to specify a new coordinate system for the data stores you plan to use as the source and target in Bulk Copy.
For example, you can assign a coordinate system to a data store that does not specify one, or change the coordinate system for a data store that has one.
- 3 Add any desired joins, calculated fields, or filters to the Display Manager layers you plan to copy.
Bulk Copy will copy the resulting data to the target data store.
- 4 In Map Explorer, click Tools ► Bulk Copy.
- 5 In the [Bulk Copy](#) (page 1744) dialog box, under From, select a feature source in the Connection Name list. This is the source, from which the data will be copied.
Select from all Display Manager layers and connected feature sources. Filtered layers display a filter icon in the list.

If you select a survey data store, you can select only a survey point group as the source. To copy multiple point groups, copy them one by one.

You can also drag the originating feature source onto the target source in the Data Connect dialog box to initiate a Bulk Copy. The item you drag becomes the From entry and the item you drop it on becomes the To entry.

- 6 If the selected feature source supports versioning, select a version in its Version list.
- 7 Under To, select the destination feature source in the top list.
- 8 If the destination feature source supports versioning, select a version in its Version list.

The schema trees in Bulk Copy update automatically as you make your choices.

- 9 Under Select Items To Copy, check the boxes for the individual schemas, features classes, and properties to copy to the destination feature source. Selecting any schema element automatically selects all its child elements (for example, selecting a feature class also selects all its properties). A square (instead of a check) in a check box means that some of the children of the element are not selected.

Calculated fields are appended after the native properties. If there are joined fields, they are grouped under a node representing the join. If there are multiple joins, they appear as they do in the [Manage Layer Data dialog box](#) (page 1607).

In the right-hand tree, AutoCAD Map 3D displays a default name for the item. Select the default name and enter a different one if you want.

The Info area displays the Class (or Connection), Source Coordinate System, Filter Info, and Target Coordinate System. If there are multiple coordinate systems for the classes under the selected connection, the coordinate system field displays "VARIES."

- 10 Select the error types to ignore during processing. For any error types whose boxes are not selected, Bulk Copy stops processing and reports errors when they occur.

If the coordinate system is unknown, it is best to select Coordinate System under Ignore the Following Errors During the Copy Process. For more information about these options, see [Bulk Copy](#) (page 1744).

When you copy geodetic polygons with clockwise rings to SQL Server Spatial, check Unmatched Data Or Geometric Type Errors under Ignore

the Following Errors During the Copy Process to adjust the geometry and orientation properly.

- 11 To save the current settings in an XML mapping file, click Save under Schema Mapping. Click Load to open a saved mapping file.

NOTE Before loading a mapping file, connect to the source and destination feature sources.

- 12 To begin the Bulk Copy operation, click Copy Now.

The data for the specified schema elements is copied from the source feature source to the destination feature source.

Bulk Copy displays the progress of the operation. If you click Cancel during the operation, the copying process stops but the data does not return to its original state. There is no way to roll back the data from within AutoCAD Map 3D once the process is initiated.

When the operation is complete, Bulk Copy reports the results. Click View Log in the Bulk Copy Results dialog box to see [details](#) (page 626).

Understanding How Bulk Copy Converts Data Types

During copying, Bulk Copy retains the same data type when possible but performs a conversion if needed. For example, if you are copying data from a source that uses a Boolean data type and that data type is not available in the target, Bulk Copy converts the data to byte values, if available. If byte is not available, Int16 is used, and so on. The following table illustrates how conversion is performed (for each source data type, Bulk Copy tries to create target data type 1, but if that is not possible it tries data type 2, and so on):

NOTE This functionality affects geospatial feature data only. For information about moving data between DWG and geospatial data stores, see [Migrating DWG Data to GIS](#) (page 628).

Source data type	Target data type 1	Target data type 2	Target data type 3	Target data type 4
Boolean	Byte	Int16	Int32	Int64
Byte	Int16	Int32	Int64	
Int16	Int32	Int64		

Source data type	Target data type 1	Target data type 2	Target data type 3	Target data type 4
Int32	Int64			
Int64	Int32			
Decimal	Double	Single		
Single	Double	Decimal		
Double	Decimal	Single		

The following [FDO providers](#) (page 2063) support the following data types:

	Oracle	Arc-SDE	MySQL	ODBC	SDF	SHP	WFS	SQL Server and SQL Server Spatial
Boolean	Y		Y	Y	Y	Y	Y	Y
Byte	Y		Y	Y	Y		Y	Y
Date/Time	Y	Y	Y	Y	Y	Y	Y	Y
Int16	Y	Y	Y	Y	Y		Y	Y
Int32	Y	Y	Y	Y	Y	Y	Y	Y
Int64	Y		Y	Y	Y		Y	Y
Decimal	Y		Y	Y	Y	Y	Y	Y
Single	Y	Y	Y	Y	Y		Y	Y
Double	Y	Y	Y	Y	Y		Y	Y
String	Y	Y	Y	Y	Y	Y	Y	Y

Bulk Copy copies geometry properties as is, except that it will convert an arc to line segments if the destination does not support arcs.

Bulk Copy uses the following rules when copying an auto-generated identifier from the source [feature source](#) (page 2063):

- If the identifier exists in the destination [schema](#) (page 2073) and is not auto-generated, the identifier is copied from the source feature source.
- If the identifier exists in the destination schema and is auto-generated, the identifier is generated by the destination provider.
- If the identifier does not exist in the destination schema and the destination schema does not support auto-generated identifiers, the schema is created with a non-auto-generated identifier and the identifier is copied from the source feature source.
- If the identifier does not exist in the destination schema and the destination schema supports auto-generated identifiers, the schema is created with an auto-generated identifier and the identifier is generated by the destination provider.

See also:

- [Migrating GIS Data \(Bulk Copy\)](#) (page 617)
- [Reviewing the Bulk Copy Log Information](#) (page 626)
- [Migrating DWG Data to GIS](#) (page 628)

[To copy data from one feature source to another](#) (page 621)

NOTE This functionality affects geospatial feature data only. For information about moving data between DWG and geospatial data stores, see [Migrating DWG Data to GIS](#) (page 628).

Fixing Geometry Issues After a Bulk Copy

For foreign schemas, the Bulk Copy operation uses the first geometry it finds to create the geometry in the target data store. If there are multiple spatial indexes for the geometry properties in the original data store, the geometry property in the resulting data store's schema will be different from the order in the original data store. As a result, the geometry in the new data store may not match the geometry in the source.

You can fix this problem in the original data store or in the resulting data store. If you fix the problem in the resulting data store, you modify the XML file schema and import the modified version into the data store.

NOTE This functionality affects geospatial feature data only. For information about moving data between DWG and geospatial data stores, see [Migrating DWG Data to GIS](#) (page 628).

NOTE This functionality affects geospatial feature data only. For information about moving data between DWG and geospatial data stores, see [Migrating DWG Data to GIS](#) (page 628).

To fix a Bulk Copy geometry problem in the original data store

- Remove the unwanted spatial indexes from the geometric properties in the original data store.
If only one geometric property is indexed, it is chosen as the main geometry for the feature class.

To fix a Bulk Copy geometry problem in the resulting data store

- 1 Connect to the new data store before you perform the Bulk Copy operation.
- 2 Using the [Schema Editor](#) (page 610), [save the source data store to an XML file](#) (page 608).
- 3 Edit the XML file and add the following to the `<xs:complexType>` entry for the feature class in question, where `{geom_prop_name}` is the name of the geometric property to use:

```
fdo:geometryName="{geom_prop_name}"
```
- 4 [Import the modified XML file](#) (page 608) into the target data store and apply the changes.
- 5 Bulk Copy the data from the source to the target data store, making sure to map the geometry properties properly before executing the Bulk Copy.

Reviewing the Bulk Copy Log Information

When you perform a Bulk Copy operation, AutoCAD Map 3D creates a log file that displays information about the source and target of the Bulk Copy operation. It lists any [schemas](#) (page 2073) you created, information about [feature classes](#) (page 2063), the number of objects that were copied, and how much time the operation took. Here is an example:

```
"Source ConnectionProperty: 'File', Value: 'C:\San
Francisco\County\SDF\bayarea_county.sdf'

Property: 'ReadOnly', Value: 'false'Target ConnectionProperty: 'File',
Value: 'C:\old_version.sdf'

Property: 'ReadOnly', Value: 'false'Creating schema 'My_Schema'

Property My_Schema:bayarea_county.COUNTY: String length is 0, setting
to 255

Property My_Schema:bayarea_county.FIPSSTCO: String length is 0,
setting to 255

Inserting class 'My_Schema:bayarea_county'

9 objects inserted

Elapsed Time: 0.000110 seconds

Total: 9 objects inserted"
```

NOTE This functionality affects geospatial feature data only. For information about moving data between DWG and geospatial data stores, see [Migrating DWG Data to GIS](#) (page 628).

See also:

- [Migrating GIS Data \(Bulk Copy\)](#) (page 617)
- [Understanding How Bulk Copy Converts Data Types](#) (page 623)
- [Migrating DWG Data to GIS](#) (page 628)

NOTE This functionality affects geospatial feature data only. For information about moving data between DWG and geospatial data stores, see [Migrating DWG Data to GIS](#) (page 628).

To view the Bulk Copy log

- 1 [Run the Bulk Copy operation.](#) (page 615)
- 2 Click View Log in the Bulk Copy Results dialog box to see the log file.

NOTE The Bulk Copy operation stores its log files under *%temp%*, using the naming convention *bulkcopyxxxxx.log*, where the x characters are replaced by numbers.

Migrating DWG Data to GIS

You can move DWG objects and their attributes to a variety of geospatial formats and, in some cases, move the data back into AutoCAD drawings.

NOTE When you export AutoCAD drawing data from AutoCAD Map 3D to a geospatial data store, attributes remain with the geometry data but any visual stylization you applied is lost, due to the different ways that the two environments deal with stylization.

You can do the following:

- [Export DWG data to the file-based SDF format](#) (page 387)
- [Export DWG data to Oracle](#) (page 1461)
- [Export the current map to DWG format](#) (page 1459)
- [Perform a round-trip data migration](#) (page 1465) from DWG to SDF or Oracle and back again.

Tell me more



Video

- [Show me how to export DWG objects to SDF](#)
- [Show me how to export styled DWG objects](#)
- [Show me how to convert the current map to DWG format.](#)



Procedure

- [To export drawing objects to other file formats](#) (page 1408)
- [To move drawing data to a spatial data store and back using the import method](#) (page 1467)
- [To move drawing data to a spatial data store and back using the Data Connect method](#) (page 1467)



Tutorial

- [Lesson 1: Convert Drawing Layers to Feature Classes](#)
-



Workflow

- [Create ArcSDE Features from Unclassified Drawings](#)



GIS Skill

- [Convert styled DWG objects to features](#)



Related topics

- [About Geospatial Feature Classes, Data Stores, and Schemas](#) (page 551)
- [Exporting DWG Data to an FDO Data Store](#) (page 1461)
- [Moving DWG Data to a Spatial Data Store and Back Again](#) (page 1465)

To move DWG data to a geospatial format

- 1 Decide whether you will move the data to an existing data store, or create a new data store for it.
- 2 Decide whether you will use an existing schema or a new schema for the data.
- 3 [Query the data from the DWG into your map.](#) (page 354)
- 4 Export the data to [SDF](#) (page 1417), or to [an FDO data store \(Oracle or ESRI ArcSDE\)](#) (page 1462).
- 5 After the drawing data has been moved to a GIS format, [add new data to it](#) (page 687) by right-clicking one of its feature class layers and creating a new feature.

Visualization and Styling

5

Overview of Visualization and Styling

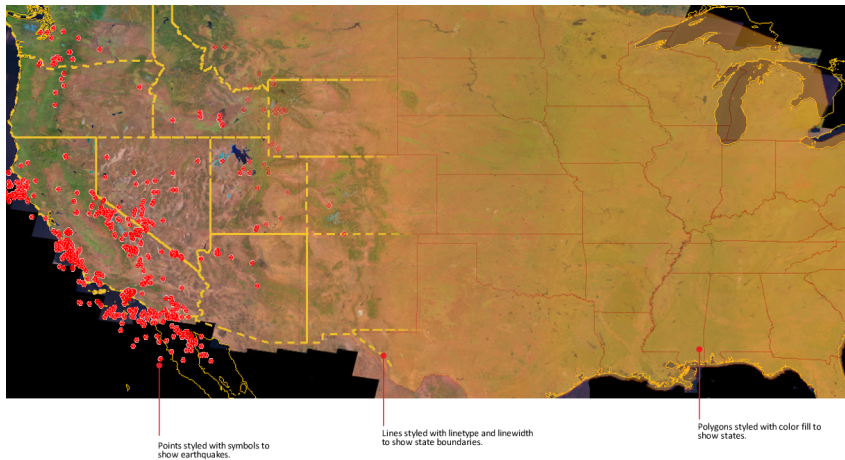

Style both drawing objects and GIS features to enhance the content of a map and make it easy to read.

The methods for styling features and drawing objects are different.

For Drawing Objects	For Features	Description
Show or hide the Display Manager (page 635)	Show or hide the Display Manager (page 635)	Use the Display Manager to style features and drawing objects in your maps, and to adjust the draw order.

For Drawing Objects	For Features	Description
Create a drawing layer (page ?).	Create a feature layer (page 308).	A layer is a set of objects. When you add objects to your map, you add them to a Display Manager layer. Each layer can have its own style.
Query the current drawing (page 1291) or attached drawings (page 1235) to bring in objects that match certain criteria.	Use the Add To Map With Query option to filter the data from the feature source (page 308).	Add a subset of objects from a drawing or feature source to a Display Manager layer.
Create a drawing style (page 660).	Create a feature style. (page 641)	Change color, linetype, linetype scale, line weight, or plotstyle. You can choose the symbol used to represent point objects. For drawing objects, add hatch, text, or annotation. For features, add labels.
Create a drawing theme (page 1181).	Create a feature theme (page 1168).	A theme varies the style based on data associated with the object.
Use scale thresholds. (page 668)	Use scale ranges. (page 643)	Use scale thresholds or ranges to change the style as you zoom in or out, for example, to turn off text as you zoom out.
Style points (page 660).	Style a point layer. (page 646)	Specify a symbol style for a point drawing layer. Use the Point Style area of the Style Editor to create a style for a point feature layer.
Style lines. (page 660)	Style a line layer. (page 649)	Specify an entity style for a line drawing layer. Use the Line Style area of the Style Editor to create a style for a line feature layer.
Style polygons. (page 660)	Style areas or polygons. (page 650)	Specify an entity or hatch style for a polygon drawing layer. Use

For Drawing Objects	For Features	Description
		the Area Style area of the Style Editor to create a style for a polygon feature layer.
Change the display order of layers (page 302).	Change the display order of layers (page 302).	Layers are drawn from the bottom up. Objects in the layer at the top of the Display Manager are drawn last and appear on top of other objects. If an object is a member of more than one layer, it is drawn based on the highest layer to which it belongs. The Draw Order view takes precedence over the order in the Layers By Group view.
Hide layers or styles (page ?).	Hide layers or styles (page ?).	If a layer is turned off, objects from that layer are hidden. When a style is turned off, drawing objects are displayed without styles.
Add a legend. (page 1118)	Add a legend. (page 1118)	The legend lists the styles used in the map.

See also:

- [Overview of Creating and Editing Data](#) (page 681)
- [Overview of the Display Manager](#) (page 634)
- [Styling Features](#) (page 639)
- [Styling Drawing Layers](#) (page 652)
- [Styling Raster Images](#) (page 671)

Controlling the Display of Your Map

Use the [Display Manager](#) (page 2060) to determine which layers appear in your map and the order of those layers. Use the scale control to set your current stylization scale.

Overview of the Display Manager

The [Display Manager](#) (page 2060) displays styles for feature layers and drawing object layers. The styles you create for the map do not affect the actual objects in your map or in their original sources.

Drawing object layers are listed in italic text. Different operations are available for feature and drawing layers. Right-click a layer to see the available commands.

If a feature layer contains multiple geometry types, the Display Manager lists each one under the feature class that contains them. You cannot hide individual geometries from the Display Manager itself, but you can use the Style Editor to [turn them on or off in the layer list](#) (page 641). Only layers that are turned on in Display Manager will appear in a legend.

You can also use the Display Manager to change the display order and assign different styles to different views based on scale.

Although Display Manager updates data automatically, you can update it manually if things get out of synch. You can update the entire map or an individual layer to reread attribute data, re-evaluate expressions for styles and themes, and requery layers. You sometimes must refresh the items in the Display Manager. This operation does not affect the drawing.

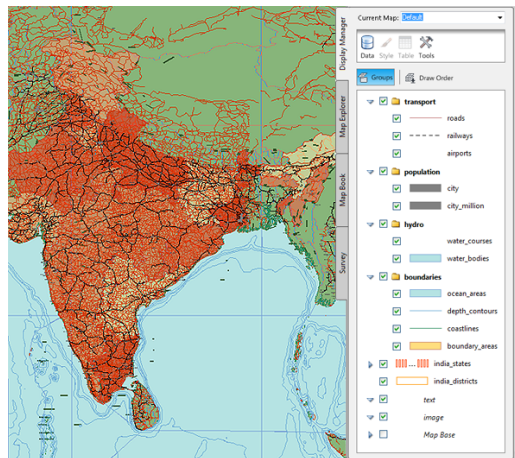

Use the Display Manager to apply styles to features and drawing objects.

Tell me more



Video

- *Show me how to manage layers with draw order and folders.*
- *Show me how to include AutoCAD layers in the Display Manager.*



Procedure

- [To change the order of layers](#) (page 637)
- [To change the draw order](#) (page 302)



Tutorial

- Exercise 2: Change the order of items in the legend
- The Task Pane



GIS Skill

- *Hide and show features as you zoom in and out*
- *Include AutoCAD layers in the Display Manager*



Related topics

- [Organizing Layers in Your Map](#) (page 300)
- [Setting Task Pane Options](#) (page 220)

- [To display the Display Manager](#) (page 635)
- [To update the map or a single layer](#) (page 636)
- [To refresh the Display Manager](#) (page 636)

To display the Display Manager

1 In the Tool-based Ribbon Workspace, click View tab ► Palettes panel

► Map Task Pane. 

2 In the Task Pane, click Display Manager.

To update the map or a single layer

- 1 Right-click the Display Manager or an individual layer.
- 2 Click Update.

To refresh the Display Manager

- On the command line, enter mapwsrefresh.

Controlling Display Order

Layers in the map are displayed in the order in which they appear in the [Display Manager](#) (page 2060) draw order view: layers higher in the list are drawn in front of layers lower down.

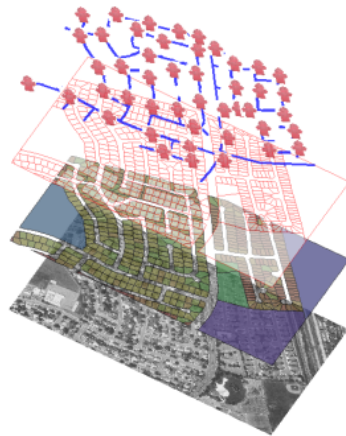

You can change the display order by moving layers up or down in the list. For example, to display drawing objects in front of a raster image, put the raster layer at the bottom of the list.

Tell me more



Video

- *Show me how to manage layers with draw order and folders.*
-



Procedure

- [To change the order of layers](#) (page 637)
- [To change the draw order](#) (page 302)



Tutorial

- Exercise 2: Change the order of items in the legend



GIS Skill

- *Hide and show features as you zoom in and out*



Related topics

- [Organizing Layers in Your Map](#) (page 300)

- [To change the order of layers](#) (page 637)
- [To hide or show layers](#) (page 638)
- [To hide or show styles](#) (page 638)

To change the order of layers

- 1 In [Display Manager](#) (page 2060), make sure Draw Order is selected.

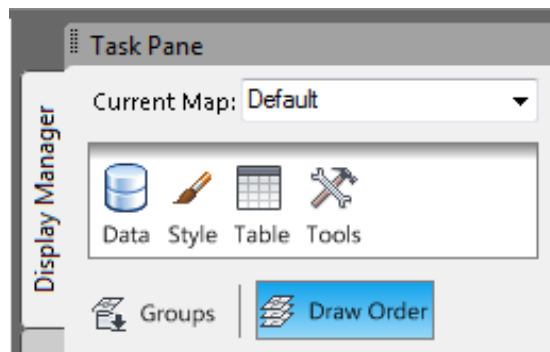

- 2 Click the layer to move.
- 3 Drag the layer up or down in the list.
Drawing objects from layers higher in the list are drawn on top of drawing objects from layers lower in the list.

To hide or show layers

- In [Display Manager](#) (page 2060), select or clear the check box next to the layer name.

To hide or show styles

- In [Display Manager](#) (page 2060), select or clear the check box next to the style name.

Setting Map Scale

The scale control indicates and sets your current stylization scale. The list includes all the scale ranges (for feature data) and thresholds (for drawing data) defined in the current map. If you link scale to zoom, styles update appropriately as you adjust the zoom, and zoom updates when you select a scale. If you use the custom scale box, the correct style is applied based on where the custom value lands within the scale ranges and thresholds.

See also:

- [Defining Scale Ranges](#) (page 643)

To set the map scale

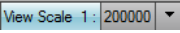
- 1 To link style to scale, close the lock icon  on the Status Bar.
- 2 On the Status Bar, select a scale from the list  or click Custom and enter a value in the Scale box.

Creating Multiple Display Maps

Each map file can contain multiple display maps. Each one has its own set of layers, which are styled independently. For example, you can connect to a data store that contains parcels and then create one display map that themes the parcels by area and another that themes them by population.

If you use the same data store for multiple display maps, you connect to that data store only once, but you add it to each display map separately. You can copy a layer from one map to another and then change its styling.

NOTE If your map file contains data on its base layer, that data appears on all display maps you create in that file. You can clear the check box for the base layer to hide its data.

All display maps in a map file use the same coordinate system.

See also:

- [Overview of the Display Manager](#) (page 634)

To create multiple display maps

- 1 [Connect](#) (page 291) to the data stores to include in the various maps.
You can attach drawings and connect to geospatial feature sources.
- 2 Create a new display map in the Display Manager by clicking Data ► New Map.
- 3 Type a name for the new map in the Current Map box at the top of the Display Manager.
- 4 To copy a layer from another display map, follow these steps:
 - Switch to the display map containing the layer you want by choosing its name in the Current Map box.
 - Right-click the layer and click Copy.
 - Switch to the target display map.
 - Right-click a blank area in the Display Manager and choose Paste.
- 5 [Style](#) (page 631) each layer in the new display map.

Styling Features

- [To create a map with styled feature layers](#) (page 641)
- [To define scale ranges](#) (page 644)
- [To apply styles to points](#) (page 646)
- [To apply styles to lines](#) (page 649)
- [To apply styles to areas](#) (page 650)
- [To load a LAYER file](#) (page 652)

Overview of Styling Features

Styles control how features appear on a map. Default styles are applied to features. When you add point and polygon features to the map, they appear with default symbol, line, and fill styles. Polygons are given a default line style. Each layer is given a distinctive color. For example, polygons are filled with a color that is different from other polygon layers that are already in the map. Change the default styles as needed.

For example, you can specify the scale ranges at which a feature is visible, set line color, and add labels. To specify styles for a layer, you define a style for a scale range. 0 - Infinity is the default scale range. Add narrower scale ranges as you define styles to define how the data appears at various scales. For example, you could create one scale range that displays roads with thick lines when you zoom in, and create a second scale range that displays roads with thin lines when you zoom out.

You can also create a theme that displays data in varying styles to indicate different values.

NOTE This functionality is for geospatial features only. If you are styling a drawing layer, see [Styling Drawing Layers](#) (page 652).

Tell me more



Video

- *Show me how to make a layer visible only at a certain scale range.*
- *Show me how to create a scale range for roads.*
- *Show me how to replace points with symbols.*
- *Show me how to label features.*
- *Show me how to label features with automatic resizing.*
- *Show me how to make the features on a layer semi-transparent.*



Procedure

- [To apply styles to points](#) (page 646)
- [To apply styles to areas](#) (page 650)
- [To apply styles to lines](#) (page 649)

- [To label features](#) (page 1093)



Tutorial

- Lesson 2: Style Map Features



Workflow

- Style and Label a Linear Feature



GIS Skills

- *Hide and show features as you zoom in and out.*
- *Replace points in the map with symbols.*
- *Set transparency for parcels or other features.*
- *Label features and optimize placement.*



Related topics

- [Defining Scale Ranges](#) (page 643)
- [Setting Map Scale](#) (page 638)
- [Styling Point Features](#) (page 645)
- [Styling Line Features](#) (page 648)
- [Styling Area Features](#) (page 650)
- [Adding Labels to Features](#) (page 1091)
- [Creating Themes](#) (page 1162)

NOTE This procedure is for geospatial features only. If you are styling a drawing layer, see [Styling Drawing Layers](#) (page 652).

To create a map with styled feature layers

- 1 In the [Display Manager](#) (page 2060), click Data ► New Map.
- 2 In the Current Map box, enter a name for the new display map.
- 3 [Assign a coordinate system](#) (page 147) to the map.
- 4 [Connect](#) (page 308) to the features you want and add them to the current display map. Attach drawings and [query in](#) (page ?) the drawing objects you want.
- 5 [Define the scale ranges.](#) (page 643)

- 6 Click a layer in Display Manager and click Style to display the Style Editor. If the feature layer you are styling contains multiple geometry types, each one has its own Style Editor section.
- 7 Specify a [point](#) (page 645), [line](#) (page 648), or [polygon](#) (page 650) style or define a theme.
- 8 Optionally:
 - Change the [display order](#) (page 637) of layers. Layers at the top of the list appear on top of other layers.
 - Display or hide a geometry in Display Manager. Select or clear the box labeled Show In Layer List for that geometry. Only the displayed geometries appear in Display Manager and in any legend you insert.
 - Create a [legend](#) (page 1118).

To do this...	Use this method...	Description
Show or hide the Display Manager	In the Tool-based Ribbon Workspace, click View tab ► Palettes panel ► Map Task Pane.  In the Task Pane, click Display Manager.	Use the Display Manager to style features and drawing objects in your maps, and to adjust the draw order.
Create a feature layer.	Add a feature to the map using Data Connect. (page 308)	When you connect to a feature from your map, you add the objects in that feature to a Display Manager layer. Each layer can have its own style.
Include only objects that match certain criteria.	Use the Add To Map With Query option to filter the data from the feature source (page 308).	Add a subset of objects from a feature source to a Display Manager layer.
Create a style.	Use the Style Editor (page 641).	Options vary, depending on whether you are styling points, lines, or polygons.

To do this...	Use this method...	Description
Create a theme.	Use the Style Editor (page 1168).	A theme varies the style based on data associated with the object.
Change the style as you zoom in or out.	Use scale ranges. (page 643)	You can define multiple styles and assign each one to a different scale range.
Label individual features.	Include labels as part of a style and assign a property for the labels. (page 1093)	For each feature, the property you assign for the style appears at the scale ranges you specify.
Change the display order of layers.	Use Display Manager to change the Draw Order (page 302).	Layers are drawn from the bottom up. Objects in the layer at the top of the Display Manager are drawn last and appear on top of other objects.
Hide layers or styles.	Check the boxes in the Display Manager for the layers or styles to show (page ?).	If a layer is hidden, objects from that layer are hidden. When a style is hidden, drawing objects are displayed without styles.
Add a legend.	Use the Display Manager to include and style the legend. (page 1118)	The legend lists the styles used in the map.

Defining Scale Ranges

The first step in creating styles for geospatial features is to define your scale ranges.

NOTE This functionality is for geospatial features only. If you are defining ranges for a drawing layer, see [Creating and Modifying a Display Manager Scale Threshold](#) (page 667).

A scale range specifies the zoom level at which a particular style is applied to the display of your features. When the zoom level of the map is within the specified scale range, AutoCAD Map 3D redraws the features using the style associated with the scale range.

The style is applied when the zoom level is greater than or equal to the From value and less than the To value. When setting up adjacent scale ranges, use the same To value as the next range's From value. For example, if one range is 0 - 20,000 set the next range to 20,000 - 40,000.

NOTE When setting up multiple scale ranges for a map, make sure that they do not overlap. For example, the ranges 500,000 - 5,000,000 and 2,000,000 - 10,000,000 overlap. In such cases, when the zoom level is within the overlapping scale range, AutoCAD Map 3D displays the features using the style of the first scale range listed.

Tell me more



- [Show me how to make a layer visible only at a certain scale range.](#)
- [Show me how to create a second scale range.](#)



- [To define scale ranges](#) (page 644)



- Lesson 3: Change the Display by Zoom Level



- [Style and Label a Linear Feature](#)



- [Setting Map Scale](#) (page 638)
- [Overview of Visualization and Styling](#) (page 631)

NOTE This procedure is for geospatial features only. If you are styling a drawing layer, see [Creating and Modifying a Display Manager Scale Threshold](#) (page 668).

To define scale ranges

- 1 In [Display Manager](#) (page 2060), right-click a feature layer.
- 2 Click Edit Style to display the Style Editor.

- 3 In the Style Editor, in the Scale Ranges area, under From, enter the lower end of the scale range. Under To, enter the upper end of the scale range. For example, to make a style visible when the map is zoomed anywhere between 1:250,000 and 1:5,000,000, enter 250000 for From and enter 5000000 for To.
- 4 To add a new scale range, click Add A Scale Range.
- 5 Specify From and To values.
- 6 When working with scale ranges:
 - To copy a scale range, select the range and click Duplicate.
 - To delete a scale range, select the range and click Delete.
 - To change the position of a scale in the list, select the range and click Move Up or Move Down.

Quick Reference

Update Display Manager

Refreshes the current display

Task Pane Right-click the Display Manager. Click Update

Styling Point Features

Use symbols to represent and display point features.

NOTE This functionality is for geospatial features only. If you are styling a drawing layer, see [Creating a Style](#) (page 658).

If precise placement of labels is important, you can display labels instead of symbols at feature point locations. You can also specify whether other labels on other layers obscure symbols on the current layer.

Tell me more



Video

- *Show me how to replace points with symbols.*

- *Show me how to label features.*
- *Show me how to label features with automatic resizing.*



Procedure

- [To apply styles to points](#) (page 646)
- [To label features](#) (page 1093)
- [To place fixed labels at points](#) (page 1099)
- [To allow labels to obscure points on the selected layer](#) (page 1097)



Tutorial

- Exercise 4: Try out the sample data



GIS Skills

- *Replace points in the map with symbols.*
- *Label features and optimize placement.*



Related topics

- [Defining Scale Ranges](#) (page 643)
- [Adding Labels to Features](#) (page 1091)
- [Displaying Fixed Labels at Point Locations](#) (page 1098)
- [Allowing Labels to Obscure Points](#) (page 1096)

NOTE This procedure is for geospatial features only. If you are styling a drawing layer, see [Creating a Style](#) (page 658).

To apply styles to points

- 1 In [Display Manager](#) (page 2060), right-click a feature layer that contains points.
- 2 Click Edit Style.
- 3 In the Style Editor, under Scale Ranges, select the scale range to style.
- 4 In the Point Style area for the selected scale range, click the box under Style.

5 In the [Style Point dialog box](#) (page 1637), select the Style A Point Symbol check box.

6 For Symbol, click .

7 In the Select A Symbol dialog box, specify a symbol library and a symbol. Click OK.

NOTE When creating a block for use as a symbol the Edge color applies to any entities that are defined as ByBlock. The Fill color applies to any entities that are defined as ByLayer.

8 For Size Context, specify the type of units:

- Select Device Space to specify symbol widths and heights in screen units. Available units are Points, Inches, Millimeters, or Centimeters.
- Select Map Space to specify symbol widths and heights in Mapping Coordinate System (MCS) units. Available units are Inches, Feet, Yards, Miles, Millimeters, Centimeters, Meters, and Kilometers.

9 For Units, select the type of units to use.

10 For Width, enter the symbol width or specify the width using a number expression.

For more information, see the [Creating Numeric Expressions](#).

11 For Height, enter the symbol height or specify the height using a number expression.

For more information, see the [Creating Numeric Expressions](#).

12 To maintain width-to-height proportions when you change the width or height of the symbol, select the Maintain Aspect Ratio check box.

13 To change the fill and edge colors of the symbol, use the Fill Color and Edge Color lists.

If you do not change the colors, the default colors from the symbol are used.

14 For Rotation, do one of the following:

- Select a value from the drop-down list.
- Click Any Angle. Specify the angle using the slider or enter an angle in the box. Click OK.

- Click Expression. Specify the rotation using a number expression. For more information, see the [Creating Numeric Expressions](#).

15 Click OK.

Styling Line Features

Specify the thickness, color, and pattern of polyline features. Style a single line or build a composite line with several components and then style each component. For example, to illustrate a highway, create a thick black line and add a thinner, dashed, yellow line.

NOTE This functionality is for geospatial features only. If you are styling a drawing layer, see [Creating a Style](#) (page 658).

Tell me more



Video

- *Show me how to create a scale range for roads.*
- *Show me how to label features.*
- *Show me how to label features with automatic resizing.*



Procedure

- [To apply styles to lines](#) (page 649)
- [To label features](#) (page 1093)
- To use expressions in labels



Tutorial

- Exercise 1: Use a composite style for roads



GIS Skill

- *Hide and show features as you zoom in and out.*
- *Label features and optimize placement.*



Related topics

- [Defining Scale Ranges](#) (page 643)
- [Adding Labels to Features](#) (page 1091)

- [Allowing Labels to Obscure Points](#)
(page 1096)

NOTE This procedure is for geospatial features only. If you are styling a drawing layer, see [Creating a Style](#) (page 658).

To apply styles to lines

- 1 In [Display Manager](#) (page 2060), right-click a feature layer that contains lines.
- 2 Click Edit Style.
- 3 In the Style Editor, under Scale Ranges, select the scale range to style. For more information about scale ranges, see [Defining Scale Ranges](#) (page 643).
- 4 In the Line Style area for the selected scale range, click the box under Style.
- 5 In the [Style Line dialog box](#) (page 1636), select the Apply Styles To The Line check box.
- 6 To style a single line, do the following:
 - For Units (Device Space), select the type of units to measure line thickness.
Lines are specified in Device Space units.
 - Use the lists to specify polyline thickness, color, and pattern.

NOTE Select 0 thickness to draw the line as thinly as possible.

- 7 To build a composite line, do the following:
 - Click Create Composite Lines to expand the Style Line dialog box.
 - Style the first line in the composite.
 - Click New to add a new component to the line.
 - Style the new component as desired.
 - Control the position of the selected component in the overall composite line by clicking the up and down arrows.
- 8 Click OK.

Styling Area Features

Specify the fill style and color, background color, edge style and color, and line thickness used to draw area (polygon) features.

NOTE This functionality is for geospatial features only. If you are styling a drawing layer, see [Creating a Style](#) (page 658).

See also:

- [Defining Scale Ranges](#) (page 643)
- [Adding Labels to Features](#) (page 1091)
- [Allowing Labels to Obscure Points](#) (page 1096)

NOTE This procedure is for geospatial features only. If you are styling a drawing layer, see [Creating a Style](#) (page 658).

To apply styles to areas

- 1 In [Display Manager](#) (page 2060), right-click a feature layer that contains polygons.
- 2 Click Edit Style.
- 3 In the Style Editor, under Scale Ranges, select the scale range to style.
For more information about scale ranges, see [Defining Scale Ranges](#) (page 643).
- 4 In the Area Style area for the selected scale range, click the box under Style.
- 5 To fill polygons, in the [Style Polygon dialog box](#) (page 1639), select the Apply Fill To The Area check box.
- 6 For Fill Pattern, select Solid or a pattern.
 - If you specified Solid fill, specify Foreground Transparency and Foreground Color.
 - If you specified a pattern fill, specify colors for Foreground Color and Background Color. If you do not want a background color for the pattern, click Transparent for Background Color.

NOTE In polygons with transparent backgrounds, the colors you see on the map may differ from the colors displayed in the preview frame because the preview frame always uses a white background, which may differ from the color beneath the transparent objects in your map.

7 add borders to polygons, select the Apply A Border To The Area check box and then do the following:

- For Line Pattern, specify the pattern for the area border.
- For Units (Device Space), select the type of units to use to measure border thickness.
- For Line Thickness, specify a thickness for the area border.

NOTE Select 0 thickness to draw the border as thin as possible.

- For Line Color, specify a color for the area border.

8 Click OK.

Labeling Features

You can label features on feature layers. For more information, see [Adding Labels](#) (page 1091).

Saving and Loading Styled Feature Layers

After you have styled feature layers, you can save the connection and styling information to LAYER files that you can share with other users. A LAYER file contains connection and style information only, no feature data.

NOTE This functionality is for geospatial features only. To save drawing layer styles, see [Saving a Display Style in the Library](#) (page 664).

When you load a LAYER file, AutoCAD Map 3D adds the source file to the Map Explorer, creates the connection, adds the feature layer to the [Display Manager](#) (page 2060), and styles the layer correctly. Drag and drop the LAYER file from Windows Explorer to the Display Manager.

See also:

- [Saving or Exporting a Display Manager Layer](#) (page 1469)

NOTE This procedure is for geospatial features only. To save drawing layer styles, see [Saving a Display Style in the Library](#) (page 664).

To load a **LAYER** file

- Drag and drop the LAYER file from Windows Explorer to the [Display Manager](#) (page 2060).

Styling Drawing Layers

When you define a style for a drawing layer, you specify how AutoCAD Map 3D displays drawing objects on that layer.

- [To create a map with styled drawing layers](#) (page 654)
- [To style a drawing layer](#) (page 657)
- [To create a display style](#) (page 660)
- [To add a display style to a layer](#) (page 662)
- [To modify a display style](#) (page 663)
- [To hide the drawing objects in a layer](#) (page 664)
- [To save a style to the Display Library](#) (page 665)
- [To create a new category in the Display Library](#) (page 665)
- [To reference a style from the Display Library](#) (page 666)
- [To turn off style referencing](#) (page 667)
- [To create or modify a scale threshold](#) (page 668)
- [To view a layer's styles at all scale thresholds](#) (page 670)

Overview of Styling Drawing Layers

When you define a style for a layer, you specify how to display drawing objects on that layer.

NOTE This functionality is for drawing objects only. If you are styling a geospatial feature layer, see [Overview of Styling Features](#) (page 640).

Style the drawing objects in your map by creating layers and then applying one or more styles to the selected layer.

TIP For better performance, create a new display map rather than modifying the default map. There are circumstances when the default map is automatically displayed, and if this map has a lot of objects, it could take a while to display.

- A single map can have many drawing layers.
- You can specify a different style for each drawing layer in your map, and combine multiple styles for a single layer.
- You can create a theme for a drawing layer. A theme varies the style based on data associated with the object, for example, a darker color to represent a higher traffic volume.

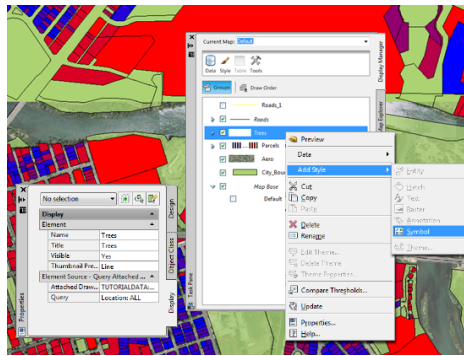

You can apply one or more styles to layers in your map.

If a drawing object is a member of more than one drawing layer, it inherits the style of each layer of which it is a member. For example, if a line is in both the Transportation layer and the Roads object class layer, it inherits the styles of both layers. If the layers specify conflicting style or visibility settings, the drawing object uses the style and visibility settings of whichever layer is higher in the Display Manager list.

Style objects by changing one or more of the following:

- Color
- Linetype
- Linetype scale
- Lineweight
- Plot style

- Symbol or image used to represent objects
- Adding hatch
- Adding text
- Adding annotation

See also:

- [Bringing In Drawing Data From DWG Files](#) (page 350)
- [Creating Multiple Display Maps](#) (page 638)
- [Setting Map Scale](#) (page 638)
- [Theming Drawing Data](#) (page 1176)

NOTE This procedure is for drawing objects only. If you are styling a geospatial feature layer, see [Overview of Styling Features](#) (page 640).

To create a map with styled drawing layers

- 1 In the [Display Manager](#) (page 2060), click Data ► New Map.
- 2 In the Current Map box, enter a name for the new map.
- 3 [Select the objects to style.](#) (page 350)
Each set of drawing objects is a drawing layer.
- 4 For each layer, specify a [style](#) (page 658) or a [theme](#) (page 1178).
- 5 Optionally:
 - [Change the display order](#) (page 636) of drawing layers. Layers at the top of the list appear on top of other layers.
 - Specify different styles at different view scales.
 - Create a [legend](#) (page 1118).

To Do This	Click	Description
Display the Display Manager	In the Tool-based Ribbon Workspace, click View tab ► Palettes panel ►	Use the Display Manager to style features and drawing objects in your maps, and to update the display for different drawing scale thresholds.

To Do This	Click	Description
	 <p>Map Task Pane. In the Task Pane, click Display Manager.</p>	
Create a drawing layer	In the Display Manager, click Data ► Add Drawing Data. Click the type of layer to create.	A drawing layer is a set of objects. Each layer can have its own style. See Bringing In Drawing Data From DWG Files (page 350).
Query objects in the current drawing	In the Display Manager, click Data ► Add Drawing Data ► Query Current Drawing.	A query lets you define conditions to select specific objects. See Bringing In Drawing Data From DWG Files (page 350).
Query objects in attached drawings	In the Display Manager, click Data ► Add Drawing Data ► Query Source Drawings.	A query lets you define conditions to select specific objects. See Bringing In Drawing Data From DWG Files (page 350).
Create a style	Right-click a layer. Click Add Style, and then choose the type of style to create.	Change color, linetype, linetype scale, line weight, or plotstyle; change the symbol used to represent the objects; or add hatch, text, or annotation for objects using this style. See Creating a Style (page 660).
Create a theme style	In the Display Manager, right-click a layer ► Add Style ► Theme.	A theme varies the style based on data associated with the object. See Overview of Theme Styles (page 1181).
Import a theme or map from a previous version of AutoCAD Map 3D	To import a theme: In the Display Manager, click Data ► Add Drawing Data ► Import Old Theme. To import a map: In the Display Manager, click Data ► Add Drawing Data ► Import Old Map.	You can import a theme or map you created in a previous version of AutoCAD Map 3D.

To Do This	Click	Description
Turn a style on or off	Select or clear the check box next to the style name in the Display Manager.	When a style is turned off, drawing objects are displayed without styles.
Create a new scale threshold	In the Display Manager, click Tools ► Show Thresholds. Click the thin down arrow next to the Threshold list, and then click Duplicate. Enter the new threshold and click OK.	Use scale thresholds to change drawing layer styles as you zoom in or out, for example, turn text off as you zoom out. Close the lock icon on the Status Bar to link scale and style. NOTE This functionality applies to drawing layers only. Feature layers use scale ranges. For more information, see Defining Scale Ranges (page 643).
Change the display order of layers	In the Display Manager, click Draw Order so it is active and drag the layer up or down.	Layers are drawn from the bottom up. Objects in the layer at the top of the Display Manager are drawn last and appear on top of other objects. If an object is a member of more than one layer, it is drawn based on the highest layer to which it belongs. The Draw Order view is useful for defining a display order that differs from the layer organization in the Display Manager or the legend.
Hide objects in a layer	Clear the check box next to the layer name	If a layer is turned off, objects from that layer are hidden.
Add a legend	In the Display Manager, click Tools ► Create Legend.	The legend lists the styles used in the map. See Adding a Legend (page 1116).
Update the drawing	Right-click the Display Manager. Click Update.	Reloads the entire drawing, including rereading attribute data, reevaluating expressions for styles and themes, and requerying layers. To update a single layer, right-click the layer. Click Update.
Refresh the Display Manager	On the command line, enter mapwsrefresh.	You sometimes must refresh the items in the Display Manager. This operation does not affect the drawing.

Quick Reference

Update Display Manager

Refreshes the current display

Task Pane Right-click the Display Manager. Click Update

Styling a Drawing Layer

When you define a style for a layer, you specify how objects on that layer appear in the current display map.

NOTE This functionality is for drawing objects only. If you are styling a geospatial feature layer, see [Overview of Styling Features](#) (page 640).

See also:

- [Creating Multiple Display Maps](#) (page 638)
- [Creating Themes for Drawing Layers](#) (page 1178)
- [Creating a Style](#) (page 658)
- [Combining Styles](#) (page 661)
- [Saving a Display Style in the Library](#) (page 664)

NOTE This procedure is for drawing objects only. If you are styling a geospatial feature layer, see [Overview of Styling Features](#) (page 640).

To style a drawing layer

- 1 Select the layer.
- 2 Do one of the following:
 - [Create a new style](#). (page 660)
 - [Copy an existing style](#). (page 665)
 - [Reference a library style](#). (page 666)
 - [Create a theme](#) (page 1181).
- 3 If you want, [add another style to the layer](#) (page 662).

Symbol styles can be combined only with other symbol styles. Themes cannot be combined with any other styles.

- 4 You can [save your style](#) (page 665) in the Display Library.
- 5 If your map does not look exactly as desired, [modify the style](#) (page 663).

Quick Reference

New Display Manager Style

Creates a new Display Manager style

Task Pane In Display Manager, right-click a layer ► Add Style ► (select a style type)

Creating a Style

You can define a style for a drawing layer in a map. All the drawing objects on this layer display using the style.

NOTE This functionality is for drawing objects only. If you are styling a geospatial feature layer, see [Overview of Styling Features](#) (page 640).

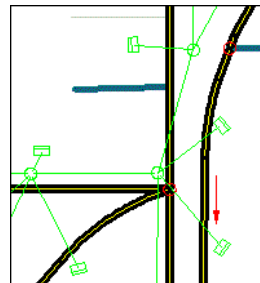

You can create more than one style for a drawing layer. The styles overlay each other.

Style Types

Entity	Specifies color, linetype, linetype scale, line weight, and plotstyle for drawing objects using this style.
Annotation	Adds annotation, such as text, blocks, images, and information based on object properties, to drawing objects using this style.
Hatch	Adds hatch to drawing objects using this style.
Symbol	Uses symbols such as blocks or annotation to represent drawing objects using this style. Can be combined with other symbol styles only.
Text	Adds text to drawing objects using this style.
Raster Image	Specifies brightness, contrast, and fade for images using this style.
Theme	Displays the Thematic Mapping dialog box, where you can create a theme style.

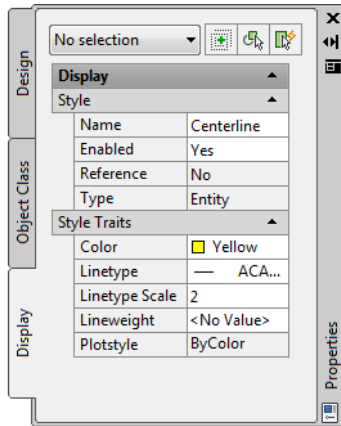

All the properties of the style are displayed on the Display tab of the Properties palette, where you can view or modify them.

See also:

- [Saving a Display Style in the Library](#) (page 664)
- [Referencing a Library Style](#) (page 666)
- [Creating Themes for Drawing Layers](#) (page 1178)

NOTE This procedure is for drawing objects only. If you are styling a geospatial feature layer, see [Overview of Styling Features](#) (page 640).

To create a display style

- 1 In [Display Manager](#) (page 2060), right-click the layer to style. Click Add Style, and then choose the type of style to create.
 - Entity Style
 - Hatch Style
 - Text Style
 - Raster Image Style
 - Annotation Style
 - Symbol Style

- 2 Select the style.
- 3 If the Properties palette is not already visible, right-click the layer and select Properties.
- 4 On the Display tab of the Properties palette, specify style settings.

NOTE When entering an expression, you may need to select an item from the list first. Click  to display the [Edit Expression dialog box](#) (page 1574).

NOTE Some drawing objects might not be styled. The Display Manager does not style drawing objects that have been queried into the current drawing using a standard Query. To style drawing objects from attached drawings, see [Overview of Bringing in Drawing Data From DWG Files](#) (page 351).

Quick Reference

New Display Manager Style

Creates a new Display Manager style

Task Pane In Display Manager, right-click a layer ► Add Style ► (select a style type)

Combining Styles

You can combine styles for a single drawing layer.



Style roads by combining a thick continuous black line with a thin dotted yellow line.

Styles are rendered from bottom to top. That is, the bottom style in the list is rendered first.

NOTE Symbol styles can only be combined with other symbol styles. Themes cannot be combined with any other styles.

NOTE This functionality is for drawing objects only. If you are styling a geospatial feature layer, see [Overview of Styling Features](#) (page 640).

See also:

- [Creating a Style](#) (page 658)

NOTE If the layer has a symbol style applied, you can only combine it with other symbol styles. You cannot combine a theme with any other styles.

NOTE This procedure is for drawing objects only. If you are styling a geospatial feature layer, see [Overview of Styling Features](#) (page 640).

To add a display style to a layer

- 1 Select the layer.
- 2 Do one of the following:
 - [Create a new style](#). (page 660)
 - [Copy](#) (page 665) an existing style.
 - [Reference a library style](#). (page 666)

Quick Reference

New Display Manager Style

Creates a new Display Manager style

Task Pane In Display Manager, right-click a layer ► Add Style ►
(select a style type)

Modifying a Style

The properties of the style are displayed on the Display tab of the Properties palette. Modify the settings as desired.

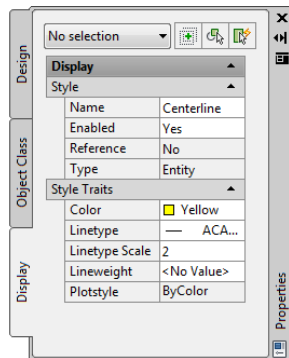

Modify style settings on the Properties palette.

NOTE This functionality is for drawing objects only. If you are styling a geospatial feature layer, see [Overview of Styling Features](#) (page 640).

Style Referencing

If a style references another style, any changes to the style in one location are automatically reflected in any other locations where the style is used. If you turn off referencing for a style, any additional changes you make to that style do not affect the other locations.

See also:

- [Creating a Style](#) (page 658)
- [Referencing a Library Style](#) (page 666)
- [Creating and Modifying a Display Manager Scale Threshold](#) (page 667)

NOTE This procedure is for drawing objects only. If you are styling a geospatial feature layer, see [Overview of Styling Features](#) (page 640).

To modify a display style

- 1 In [Display Manager](#) (page 2060), click the style.
- 2 If the Properties palette is not already visible, click the Style button.
- 3 On the Display tab of the Properties palette, modify style settings.

To hide the drawing objects in a layer

- Clear the check box next to the layer name in Display Manager.

Quick Reference

PROPERTIES

Displays the Properties palette, which allows you to edit the properties of objects

Menu Analyze ► Properties

Icon  Properties

Command Line PROPERTIES

Task Pane Select object. Right-click in drawing area ► Properties

Saving a Display Style in the Library

If you plan to use a style more than once, you can save it in the Display Library.

NOTE This functionality is for drawing objects only. To save and reuse styles for geospatial features, see [Saving and Loading Styled Feature Layers](#) (page 651).

Once a style is saved in the library, you can drag it to a drawing layer.

NOTE If you drag a style from the Display Library to a drawing layer, the style is referenced. If you copy and paste the style, a new style is created.

When you drag a style from the library, you can reference the library style. When a style references a library style, any changes to the style in one location are automatically reflected in the other location.

TIP To have a layer look the same at all scale thresholds, store the style in the Display Library. Then, at every scale threshold, reference the Display Library style. This way, you can automatically modify the style at every scale threshold by updating the style in the Display Library.

See also:

- [Creating a Style](#) (page 658)

- [Referencing a Library Style](#) (page 666)

NOTE This procedure is for drawing objects only. To save and reuse styles for geospatial features, see [Saving and Loading Styled Feature Layers](#) (page 651).

To save a style to the Display Library

- 1 In the [Display Manager](#) (page 2060), right-click the style to save ► Copy.
- 2 If the Display Library is not already displayed, in the Display Manager, click Tools ► Show Library.
- 3 On the Display Styles tab of the Display Library, right-click, and choose Paste.

Note that the style is not referenced. Only dragging from the Display Library to the drawing layer creates a referenced style.

TIP You can also create styles from within the Display Library. Right-click in the Display Library. Click Add Style, and define the style. For more information on creating styles, see [Creating a Style](#) (page 660).

To create a new category in the Display Library

- 1 If the Display Library is not already displayed, in [Display Manager](#) (page 2060), click Tools ► Show Library.
- 2 On the Display Library palette, right-click the Display Styles tab. Click Add Category.

NOTE You must right-click the tab and not in the palette.

- 3 To change the name of the tab, right-click the tab name. Click Rename. Enter a name for the tab.

Quick Reference

Display Library Palette

Turns the Display Library palette on and off

Command Line MAPDISPLAYLIBRARY

Task Pane In Display Manager, click Tools ► Show Library or Hide Library

Copy Display Manager Style

Copies a Display Manager style

Task Pane In Display Manager, right-click the style ► Copy

Referencing a Library Style

When you use a style from the library, the style in the layer *references* the style in the Display Library.

Example: The Display Library has a style called "Pipes" that colors drawing objects blue. Reference this style from any pipe layer.

NOTE This functionality is for drawing objects only. To save and reuse styles for geospatial features, see [Saving and Loading Styled Feature Layers](#) (page 651).

If a style references a library style, any changes to the style in one location are automatically reflected in any other locations where the style is used. That is, if you modify the style in the Display Manager, the style in the Display Library is automatically updated, as are any other styles that reference the style in the Display Library.

If you turn off referencing for a style, any additional changes you make to that style do not affect the other locations.

NOTE Once you turn off referencing for a style, you cannot turn it back on.

See also:

- [Creating a Style](#) (page 658)
- [Saving a Display Style in the Library](#) (page 664)

NOTE This procedure is for drawing objects only. To save and reuse styles for geospatial features, see [Saving and Loading Styled Feature Layers](#) (page 651).

To reference a style from the Display Library

- 1 If the Display Library is not already displayed, in [Display Manager](#) (page 2060), click Tools ► Show Library.

- 2 Select the style in the Display Library.
- 3 Drag it onto the drawing layer to style in the Display Manager.

To turn off style referencing

- 1 In [Display Manager](#) (page 2060), click the style for which to turn off referencing.
- 2 If the Properties palette is not already displayed, right-click the style. Click Properties.
- 3 On the Display tab of the Properties palette, under Style, click the box next to Reference and select No.

NOTE Once you turn off referencing for a style, you cannot turn it back on.

Creating and Modifying a Display Manager Scale Threshold

You can define different styles at different scale thresholds.

Example: Turn on the display of road names only when the drawing scale factor is below 1:5000

NOTE This functionality is for drawing objects only. To use scale ranges with geospatial features, see [Defining Scale Ranges](#) (page 643).

Referenced Styles

To display a layer the same way at multiple scale thresholds, save the styles to the Library. For each new scale threshold, reference the style in the Library. Any changes you make to the style at one scale threshold are reflected at the other scale thresholds.

Turn off referencing for the styles that change from one scale threshold to the next.

Example: Reference the Library Style for the Road layer at all scale thresholds except when you are zoomed out. For that scale threshold, turn off referencing so you can change the display of roads when you zoom out.

See also:

- [Setting Map Scale](#) (page 638)

- [Viewing Styles at All Scale Thresholds](#) (page 669)
- [Bringing In Drawing Data From DWG Files](#) (page 350)

NOTE This procedure is for drawing objects only. To use scale ranges with geospatial features, see [Defining Scale Ranges](#) (page 643).



To create or modify a scale threshold

- 1 Zoom the drawing to the scale factor for which you want to create or modify the threshold.
- 2 To display the Threshold list, in the Display Manager, click Tools ► Show Thresholds.
- 3 Click the thin down arrow next to the Threshold list and click Duplicate.
- 4 In the New Threshold dialog box, enter the new threshold value. Click OK.
- 5 Modify any of the styles for this new scale threshold.

If the styles reference a Library Style, turn off referencing for the selected style before you modify it. To turn off style referencing, select the style. On the Display tab of the Properties palette, next to Reference, select No.

If you do not turn off Reference, any changes you make to the style in this scale threshold are automatically reflected in any styles that reference this style.

NOTE When creating and modifying styles, you can specify how you want to display styles as you change scale thresholds.

- Close the lock icon  on the Status Bar to update the drawing window using the appropriate styles for each drawing scale threshold. Styles change as you adjust the scale threshold.
- Open the lock icon  on the Status Bar to update the drawing window using the styles for the current scale threshold. Styles do not change as you zoom.

Quick Reference

New Display Manager Scale Threshold

Creates a new Display Manager scale threshold

Task Pane In Display Manager, click Tools ► Show Thresholds. Click the thin down arrow next to the Threshold list and choose Duplicate.

Compare Display Manager Scale Thresholds

For the selected layer, lists the Display Manager styles for each scale threshold

Task Pane In Display Manager, right-click the layer and choose Compare Thresholds

PROPERTIES

Displays the Properties palette, which allows you to edit the properties of objects

Menu Analyze ► Properties

Icon  Properties

Command Line PROPERTIES

Task Pane Select object. Right-click in drawing area ► Properties

Viewing Styles at All Scale Thresholds

You can view a layer's styles for each scale threshold in the map.

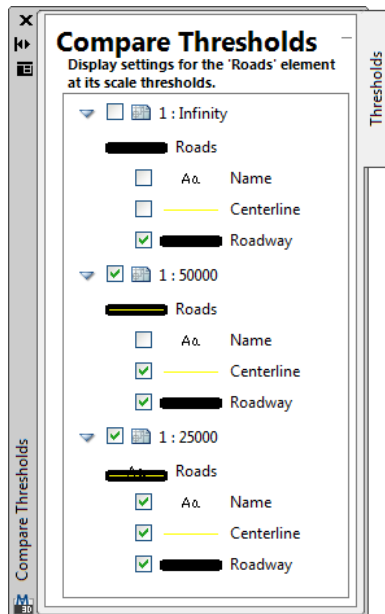

For the layer Roads, the drawing layer styles display more information as you zoom in.

NOTE This functionality is for drawing objects only. To use scale ranges with geospatial features, see [Defining Scale Ranges](#) (page 643).

See also:

- [Creating and Modifying a Display Manager Scale Threshold](#) (page 667)

NOTE This procedure is for drawing objects only. To use scale ranges with geospatial features, see [Defining Scale Ranges](#) (page 643).

To view a layer's styles at all scale thresholds

- 1 In the [Display Manager](#) (page 2060), right-click the layer ► Show Thresholds. For the selected layer, the Compare Thresholds palette lists the styles for each scale threshold defined in the map.
- 2 To view the styles for a different layer, select the layer in Display Manager. The Compare Thresholds palette displays the styles for the new layer.

TIP You can add a style to a layer by dragging and dropping it from the Display Library or another scale threshold.

Quick Reference

Compare Display Manager Scale Thresholds

For the selected layer, lists the Display Manager styles for each scale threshold

Task Pane In Display Manager, right-click the layer and choose Compare Thresholds

Styling Raster Images

You can style and view rasters brought into your map with Data Connect.

Overview of Styling Raster Images

For raster images you add to your map with Data Connect, you can do the following:

- Adjust brightness and contrast.
- Display the image in grayscale or color.
- Make a single color in the raster transparent.
- Zoom to the raster image extents.
- Requery the raster at a different zoom level.

See also:

- [Adding Rasters and Surfaces](#) (page 437)
- [Using Other Raster Image Formats](#) (page 453)
- [Analyzing Raster-Based Surfaces](#) (page 1186)
- [Modifying Raster Images](#) (page 489)

To do this...	Use this method...
Adjust brightness and contrast for images you added with Data Connect.	<p>Select the raster and, in the Style Editor under Raster Style, do one of the following:</p> <ul style="list-style-type: none"> ■ To adjust brightness, enter a value between -50 and 50 in the Brightness box. ■ To adjust contrast, enter a value between -50 and 50 in the Contrast box. <p>See Changing Brightness, Color, or Transparency for Raster Images (page 672)</p>
Display an image you added with Data Connect in grayscale or color.	<p>Select the raster and, in the Style Editor under Raster Style, click the Style drop-down box. Select Color or Greyscale. See Changing Brightness, Color, or Transparency for Raster Images (page 672)</p>
Make a single color transparent in a raster you added with Data Connect.	<p>Select the raster and, in the Style Editor under Raster Style, click Transparent. See Changing Brightness, Color, or Transparency for Raster Images (page 672)</p>
Zoom to the extents of a raster you added with Data Connect.	<p>Right-click the image layer. Click Zoom To Extents. See Viewing Raster Images (page 674)</p>
Requery a raster you added with Data Connect at a different zoom level.	<p>Right-click the image layer. Click Resample Raster. See Viewing Raster Images (page 674)</p>

Changing Brightness, Color, or Transparency for Raster Images

You can use the Style Editor to modify the appearance of raster images brought in to your map using Data Connect. You can adjust the brightness and contrast, set transparency for a single color, and display the image in color or grayscale.

NOTE If you added an image using the Insert An image command, you cannot use this functionality. See [Modifying Raster Images](#) (page 489) instead.

See also:

- [Adding Rasters and Surfaces](#) (page 437)
- [Using Other Raster Image Formats](#) (page 453)
- [Analyzing Raster-Based Surfaces](#) (page 1186)
- [Modifying Raster Images](#) (page 489)

NOTE If you added an image using the Insert An image command, you cannot use this procedure. See [Modifying Raster Images](#) (page 489) instead.

- [To adjust brightness and contrast in a raster image](#) (page 673)
- [To set transparency for a single color.](#) (page 673)
- [To display your image in color or grayscale](#) (page 674)

To adjust brightness and contrast in a raster image

- 1 In the [Display Manager](#) (page 2060), right-click the layer ► Edit Style.
- 2 In the Style Editor, under Raster Style, do one of the following:
 - To adjust brightness, enter a value between -50 and 50 in the Brightness box.
 - To adjust contrast, enter a value between -50 and 50 in the Contrast box.
- 3 Click Apply.

To set transparency for a single color.

- 1 In the [Display Manager](#) (page 2060), right-click the layer ► Edit Style.
- 2 In the Style Editor, under Raster Style, click Transparent.
- 3 In the Transparency Color dialog box, click Select.
- 4 Select a color on your map, then click OK.
- 5 Click Apply.

AutoCAD Map 3D displays all parts of the raster image that match the selected color with 100% transparency.

To display your image in color or grayscale

- 1 In the [Display Manager](#) (page 2060), right-click the layer ► Edit Style.
- 2 In the Style Editor, under Raster Style, click the Style drop-down box.
- 3 Select Color or Grayscale.
- 4 If you select grayscale, adjust the range for grayscale mapping with the Cell Minimum and Cell Maximum values.
- 5 Click Apply.

Viewing Raster Images

When you zoom in on a raster image AutoCAD Map 3D automatically requeries the image from the source to improve the display. You can also use the Resample Raster tool to improve the display of raster feature data if necessary (if you are using server-based raster images, for example). This tool requeries just the displayed portion of the image. When you zoom out, use the Zoom To Extents tool for the feature layer to display the full extents for the zoom position.

NOTE If you added an image using the Insert An image command, you cannot use this functionality. See [Modifying Raster Images](#) (page 489) instead.

See also:

- [Overview of the Display Manager](#) (page 634)
- [Overview of Adding Rasters and Surfaces](#) (page 437)

NOTE If you added an image using the Insert An image command, you cannot use this procedure. See [Modifying Raster Images](#) (page 489) instead.

To requery a raster image

- 1 Display the raster image at the desired zoom level.
- 2 In the [Display Manager](#) (page 2060), right-click the image layer. Click Resample Raster.

To zoom to image extents

- 1 Zoom out as desired.

- 2 Right-click the image layer. Click Zoom To Extents.

Quick Reference

ZOOM

Increases or decreases the apparent size of objects in the current viewport

Menu

View menu ► Realtime

Icon



Command Line

ZOOM

Styling Point Clouds

You can style [point cloud](#) (page 2071)s based on Classification, Elevation, Intensity, and RGB color values. AutoCAD Map 3D has default settings for each style category except RGB. You can modify or change the style settings in the [Point Cloud Style dialog box](#) (page 1902).

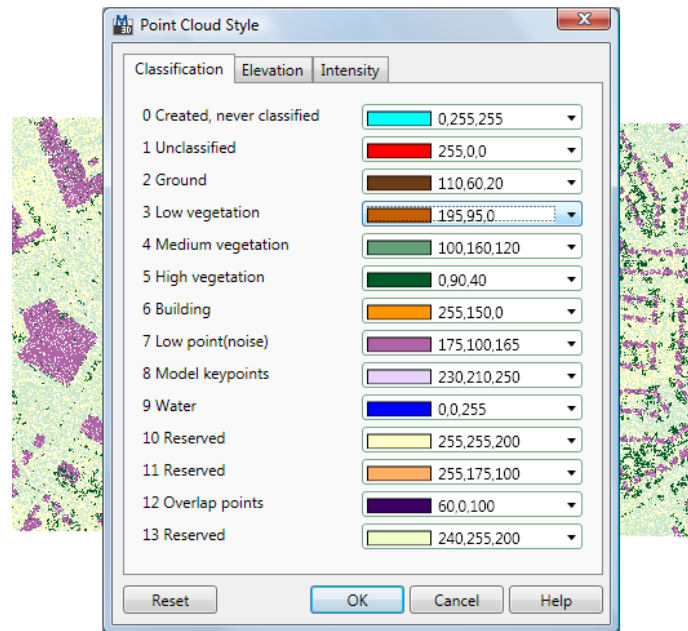

The Point Cloud Style dialog box

[LAS](#) (page 2066) is an industry standard file format defined by the American Society of Photogrammetry and Remote Sensing that includes a system of point classification. A processed LAS file may have points classified as bare earth, high or low vegetation, building, and so on. LAS files may also contain LiDAR intensity values (laser pulse return intensity) and Red/Green/Blue color values (if there is ancillary color data from a camera accompanying the LiDAR scan). Your LAS files may include classification, intensity, and color values, or it may contain only elevation data.

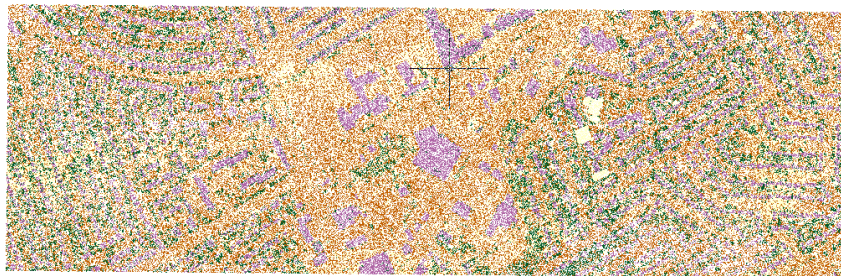

A point cloud styled by classification

NOTE If you are working with a point cloud index created using AutoCAD commands (.PCG file), you can only style by elevation and RGB values.

See also:

- Overview of Point Clouds
- Overview of LiDAR DataLiDAR: data: overviewLiDAR: file types; LiDAR: LAS file format; LiDAR: ASCII format
- [Overview of Point Cloud Files and Objects](#) (page 1013)
- [Bringing in LiDAR Data](#) (page 374)
- [Using LiDAR Data to Create a Point Cloud Data Store](#) (page 1019)
- [Creating Surfaces From Point Cloud Data](#) (page 1021)
- [Managing LiDAR Data](#) (page 1015)
- [Filtering Point Cloud Data](#) (page 1024)
- [Exporting Point Cloud Data](#) (page 1451)

To style point data by classification

- 1 In the Display Manager, right-click the point cloud layer to style, then select Style By ► Classification.
AutoCAD Map 3D applies the default Classification styling to your point cloud.
- 2 To change the default Classification style, right-click the point cloud layer, then select Set Style.
- 3 In the [Point Cloud Style dialog box](#) (page 1902), on the Classification tab, select a new color for each class to change using the drop-down list.
- 4 If you do not see the color that you want in the drop-down list, click More Colors, then select an Index Color, True Color, or Color Book in the Select Color dialog box.
- 5 When you have made all the style changes, click OK.

To style point data by elevation

- 1 In the Display Manager, right-click the point cloud layer to style, then select Style By ► Elevation.

AutoCAD Map 3D applies the default Elevation styling to your point cloud.

- 2 To change the default Elevation style, right-click the point cloud layer, then select Set Style.
- 3 In the [Point Cloud Style dialog box](#) (page 1902), on the Elevation tab, select the number of rules to include in the style range.
By default, AutoCAD Map 3D uses five rules. The style range rules are distributed evenly across the range of elevation values in your point cloud.
- 4 To change the colors used for the style range, select new colors using the drop-down lists.
- 5 If you do not see the color that you want in the drop-down list, click More Colors, then select an Index Color, True Color, or Color Book in the Select Color dialog box.
- 6 When you have made all the style changes, click OK.

To style point data by intensity

- 1 In the Display Manager, right-click the point cloud layer you want to style, then select Style By ► Intensity.
AutoCAD Map 3D applies the default Intensity styling to your point cloud.
- 2 To change the default Intensity style, right-click the point cloud layer, then select Set Style.
- 3 In the [Point Cloud Style dialog box](#) (page 1902), on the Intensity tab, select the number of rules to include in the style range.
By default, AutoCAD Map 3D uses five rules. The style range rules are distributed evenly across the range of intensity values in your point cloud.
- 4 If you want to change the colors used for the style range, select new colors using the drop-down lists.
- 5 If you do not see the color that you want in the drop-down list, click More Colors, then select an Index Color, True Color, or Color Book in the Select Color dialog box.
- 6 When you have made all the style changes, click OK.

To style point data by RGB values

- In the Display Manager, right-click the point cloud layer you want to style, then select Style By ► RGB.

Creating and Editing Data

6

Overview of Creating and Editing Data

AutoCAD Map 3D works on two types of objects: features and drawing objects.

- Features are GIS objects stored in external files and databases. Display and edit them in your map and then save the changes back to the original source. Use the options described in [Working with Features](#) (page 683).
- Drawing objects are AutoCAD objects stored within a map or retrieved from attached drawings using queries. Save changes to drawing objects in the current map or back to the attached source drawing depending on the source of each object. Use the options described in [Working with Drawing Objects](#) (page 727) and [Working with Attribute Data and Object Data](#) (page 1047).

Use both AutoCAD Map 3D and AutoCAD to edit features and drawing objects. Many AutoCAD commands work on both types of objects. Some AutoCAD commands can only be performed on a feature after you extract its geometry and edit it as a drawing object. You can then save your changes back to the original data store with no loss of precision.

Most AutoCAD Map 3D operations are specific to one type of object or the other. Use the right-click menus to see the commands that are available for the selected feature or drawing object.

For features...

Add features to your map using Data Connect.
See [Overview of Bringing In GIS Features](#) (page 305).

For drawing objects...

Add drawing objects to your map by attaching drawings and querying in objects.
See [Overview of Bringing in Drawing Data From DWG Files](#) (page 351).

For features...	For drawing objects...
<p>Use a query to filter one or more layers. See Filtering Feature Layers (page 1216).</p>	<p>Query in drawing objects that match specified criteria and store them on a separate drawing layer (page 368). Other objects become part of the Map Base layer.</p>
<p>Edit features by checking them out and using AutoCAD and AutoCAD Map 3D commands. See Checking Out Features (page 695), Using Feature Editing Commands (page 704), and Using AutoCAD Commands on Features (page 713).</p>	<p>Edit objects directly with AutoCAD and AutoCAD Map 3D commands. See Overview of Using the Map Editing Tools (page 927).</p>
<p>Create new features using Display Manager. See Creating New Features (page 686).</p>	<p>Create objects with AutoCAD and AutoCAD Map 3D commands. See Working with Drawing Objects (page 727).</p>
<p>Create features from drawing objects. See Creating a New Feature from a Drawing Object (page 691).</p>	<p>Create drawing objects from features. See Extracting Feature Geometry (page 715) and Exporting Maps to DWG Format (page 1459).</p>
<p>Maintain data security. Use versioning (for data stores that support it) and check out data to lock it while you use it. See Managing Versions (page 723)</p>	<p>Lock or unlock objects or drawings. See Sharing Attached Drawings (page 729)</p>
<p>Save features back to their sources by checking them in. See Checking In Features (page 693).</p>	<p>Save drawing objects back to their sources by adding them to a save set. See Editing and Saving Objects in Attached Drawings (page 737).</p>
<p>Organize data in feature classes. Use Schema Editor to create and edit these classes. See Overview of Working with Schemas (page 594)</p>	<p>Use Object Classification to group objects by their properties or data. See Using Object Classification (page 981).</p>

For features...	For drawing objects...
Work with attribute data in the Data Table. See Editing Features using the Data Table (page 711).	Work with object data in an object data table. See Entering and Editing Object Data (page 1061).
Work with joined external data in the Data Table. See Editing Joined Data (page 515).	Work with linked external data in Data View. See Overview of Viewing External Data Sources for Drawing Objects (page 1048).
Use special commands available only for features. See Using Feature Editing Commands (page 704).	Use special commands available only for drawing objects. See Cleaning Up Drawing Data (page 765), Creating, Editing, and Managing Topologies (page 820), Using Map Editing Tools (page 926), Digitizing Points Using Coordinates (page 953), Working with Polygon Objects (page 954), and Annotating Drawing Objects (page 1100).
Save features back to their original data store (page 693), copy them to a different spatial data format (page 617), or export to DWG (page 1405).	Save drawing objects back to their original drawings (page 737) or export to a variety of drawing and geospatial data formats (page 1465).

Working with Features

- [Overview of Working with Features](#) (page 684)
- [Creating New Features](#) (page 686)
- [Checking In Features](#) (page 693)
- [Checking Out Features](#) (page 695)
- [Canceling Checkout](#) (page 697)
- [Updating Edits Automatically](#) (page 698)
- [Editing Features](#) (page 701)
- [Working Offline](#) (page 721)
- [Managing Versions](#) (page 723)

To work with features

- [To edit features](#) (page 686)

- [To create new features](#) (page 686)
- [To check in features](#) (page 694)
- [To check out features automatically](#) (page 696)
- [To check out features](#) (page 696)
- [To cancel check out](#) (page 698)
- [To update edits automatically](#) (page 700)
- [To edit features](#) (page 701)
- [To work offline](#) (page 722)
- [To return online](#) (page 722)
- [To clear the cache](#) (page 723)
- [To rebuild the cache](#) (page 723)
- [To create a new version](#) (page 725)
- [To activate a version](#) (page 725)
- [To commit changes back to the data store](#) (page 726)
- [To discard a version](#) (page 726)
- [To address errors](#) (page 726)

Overview of Working with Features

When you connect to a geospatial data source and add it to your map, you can see and edit the feature data. Features must be checked out to be edited. By default, features are automatically checked out upon editing.

NOTE This functionality is for geospatial features only. For information about working with drawing objects, see [Working with Drawing Objects](#) (page 727).

You can use most AutoCAD editing commands to edit feature data. For some of the more advanced commands, you can use [Update Feature Geometry](#) (page 716) to convert a GIS feature to pure AutoCAD geometry. Once you have done this, you can use these other AutoCAD commands, and then update the feature without losing or affecting any of its attributes.

You can also [create features from AutoCAD geometry](#) (page 691). This gives you the same functionality as [Update Feature Geometry](#), but it creates a new feature rather than changing an existing one.

Working in a Multiuser Environment

If you share data in a multiuser environment, be aware of the locking status of the following providers.

- Oracle and ArcSDE support feature level locking that is persistent when the connection with the source is closed and you go offline.

- MySQL and SQL Server do not support feature level locking or persistent locking. Locks are released when the connection is closed.
- SDF does not support locking. Be very careful when working in a multiuser environment.
- SHP supports file locking only as long as you are connected to the data. When you close your map, break the connection, or go offline, the file is unlocked.

Tell me more



Video

- *Show me how to draft a new feature for an existing feature class.*
- *Show me how to edit features stored in a database or data store.*
- *Show me how to check out features for editing in the field.*



Procedure

- [To create new features](#) (page 686)
- [To edit features](#) (page 701)



Tutorial

- Exercise 2: Check out and edit a feature



Workflow

- Edit Features in a Geospatial Feature Source
- Add Features to an Existing ArcSDE Feature Class
- Work Offline from an Enterprise Database



GIS Skill

- *Draft new features for an existing feature class.*
- *Edit feature geometry directly in a SHP file using CAD tools.*
- *Check out features to edit in the field and update the database later.*



Related topics

- [Bringing in GIS Features](#) (page 303)
 - [Checking Out Features](#) (page 695)
-

NOTE These procedures are for geospatial features only. For information about working with drawing objects, see [To work with drawing objects](#) (page 727).

To edit features

- 1 [Attach the data source](#). (page 308)
- 2 If you do not have Auto Checkout turned on, [check out the feature](#). (page 696)
- 3 Do one or both of the following:
 - [Use feature-editing commands to make your changes](#). (page 705)
 - [Use AutoCAD commands to make your changes](#). (page 713)
- 4 [Check the feature back in](#). (page 694)

Creating New Features

To create new features

- [To create new features](#) (page 687)
- [To create a new Point or MultiPoint feature](#) (page 688)
- [To create a new Polygon or MultiPolygon feature](#) (page 689)
- [To create a new LineString or MultiLineString feature](#) (page 691)
- [To create a new feature from geometry](#) (page 692)

Overview of Creating New Features

You can create new features using feature-creation commands or by creating a feature from a drawing object's geometry.

NOTE This functionality is for geospatial features only. For information about creating drawing objects, see the AutoCAD Help.

NOTE If the feature class for a layer does not provide automatically generated IDs for new features, AutoCAD Map 3D will not create new features on the layer. To create new features in this case, turn off [Update Edits Automatically](#) (page 698) . AutoCAD Map 3D will hold the features in a queue instead of attempting to save them to the source immediately. Feature IDs are generated in the queue.

Tell me more



- *Show me how to draft a new feature for an existing feature class.*
- *Show me how to create new features from existing AutoCAD objects.*



- [To create new features](#) (page 686)



- Lesson 4: Create Map Features



- Add Features to an Existing ArcSDE Feature Class



- *Draft new features for an existing feature class.*



- [Updating Edits Automatically](#) (page 698)
- [Checking Out Features](#) (page 695)

NOTE This procedure is for geospatial features only. For information about creating drawing objects, see the AutoCAD Help.

To create new features

- Use Display Manager to create [Point or MultiPoint](#) (page 688) features, [Polygon or MultiPolygon](#) (page 689) features, and [LineString or MultiLineString](#) (page 690) features.
If the provider supports curves, the arc option is available in the LineString, MultiLineString, Polygon, and MultiPolygon creation commands.

- Create a new feature [from a drawing object's geometry](#) (page 691).

Creating New Point and MultiPoint Features

If you have point feature layers in your drawing, you can create new point and multipoint features. Multipoint features are multiple points that behave like a single point feature.

NOTE This functionality is for geospatial features only. For information about creating drawing objects, see the AutoCAD Help.

Use OSNAP to snap to any graphic within a block definition that is used to symbolize a point. You can also use OSNAP Node to snap to the insertion point of an attribute, a block, a shape, or text. OSNAP Node is turned off by default.

NOTE The feature creation commands available for a feature layer depend on the capabilities of the feature class represented by the layer. Feature geometry follows OGC specifications.

See also:

- [Creating a New Feature from a Drawing Object](#) (page 691)
- [Using AutoCAD Commands on Features](#) (page 713)
- OSNAP

NOTE This procedure is for geospatial features only. For information about creating drawing objects, see the AutoCAD Help.

To create a new Point or MultiPoint feature

- 1 Do one of the following:
 - In the [Display Manager](#) (page 2060), right-click the feature layer for the new feature ► Create ► New Point *feature_name*.
 - In the [Display Manager](#) (page 2060), right-click the feature layer for the new feature ► Create ► New MultiPoint *feature_name*.
Here, *feature_name* is the name of the Point or MultiPoint feature layer.
- 2 At the [MAPPOINTCREATE](#) (page 1663) or [MAPMULTIPOINTCREATE](#) (page 1659) prompt, specify the location for the new Point or MultiPoint feature.

For MultiPoint features, specify the location of each point.

- 3 For MultiPoint operations, press *Enter* to complete the operation.
The new feature is added to the Data Table. To add information to the feature, see [Editing Features using the Data Table](#) (page 711).
- 4 Check in the new features.
For more information, see [Checking In Features](#) (page 693).

Creating New Polygon and MultiPolygon Features

If you have polygon feature layers in your drawing, you can create new Polygon and MultiPolygon features. MultiPolygon features behave like a single Polygon feature. You cannot create a non-planar polygon. Every ring of a polygon must be planar and all parts and all rings must be in the same plane.

NOTE This functionality is for geospatial features only. For information about creating drawing objects, see the AutoCAD Help.

NOTE The feature creation commands available for a feature layer depend on the capabilities of the feature class represented by the layer. Feature geometry follows OGC specifications.

A polygon has one outer ring and can have one or more inner rings. A ring within a polygon is considered a hole. To create polygons with multiple outer and inner rings, create a MultiPolygon feature.

See also:

- [Creating a New Feature from a Drawing Object](#) (page 691)
- [Using AutoCAD Commands on Features](#) (page 713)

NOTE This procedure is for geospatial features only. For information about creating drawing objects, see the AutoCAD Help.

To create a new Polygon or MultiPolygon feature

- 1 Do one of the following:
 - In the [Display Manager](#) (page 2060), right-click the feature layer for the new feature ► Create ► New Polygon *feature_name*.

- In the [Display Manager](#) (page 2060), right-click the feature layer for the new feature ► Create ► New MultiPolygon *feature_name*.

Here, *feature_name* is the name of the Polygon or MultiPolygon feature layer.

- 2 When prompted, specify the location for the new Polygon or MultiPolygon feature.
- 3 Use the command line or right-click to complete the new feature.
For more information, see [MAPPOLYGONCREATE](#) (page 1663) and [MAPMULTIPOLYGONCREATE](#) (page 1660).
- 4 Press *Enter* to complete the operation.
The new feature is added to the Data Table. To add information to the feature, see [Editing Features using the Data Table](#) (page 711).
- 5 Check in the new features.
For more information, see [Checking In Features](#) (page 693).

Creating New LineString and MultiLineString Features

If you have line feature layers in your drawing, you can create new LineString and MultiLineString features. MultiLineString features are multiple lines that behave like a single Line feature.

NOTE This functionality is for geospatial features only. For information about creating drawing objects, see the AutoCAD Help.

NOTE The feature creation commands available for a feature layer depend on the capabilities of the feature class represented by the layer. Feature geometry follows OGC specifications.

See also:

- [Creating a New Feature from a Drawing Object](#) (page 691)
- [Using AutoCAD Commands on Features](#) (page 713)

NOTE This procedure is for geospatial features only. For information about creating drawing objects, see the AutoCAD Help.

To create a new LineString or MultiLineString feature

- 1 Do one of the following:
 - In [Display Manager](#) (page 2060), right-click the feature layer for the new feature ► Create ► New LineString *feature_name*.
 - In [Display Manager](#) (page 2060), right-click the feature layer for the new feature ► Create ► New MultiLineString *feature_name*.

Here, *feature_name* is the name of the LineString or MultiLineString feature layer.

- 2 When prompted, specify the location for the new LineString or MultiLineString feature.
- 3 Use the command line or right-click to complete the new feature.
For more information, see [MAPLINESTRINGCREATE](#) (page 1654) and [MAPMULTILINESTRINGCREATE](#) (page 1656).
- 4 Press *Enter* to complete the operation.
The new feature is added to the Data Table. To add information to the feature, see [Editing Features using the Data Table](#) (page 711).
- 5 Check in the new features.
For more information, see [Checking In Features](#) (page 693).

Creating a New Feature from a Drawing Object

You can create new features using drawing object geometry.

NOTE This functionality is for geospatial features only. For information about creating drawing objects, see the AutoCAD Help.

Tell me more



Video

- [Show me how to create new features from existing AutoCAD objects.](#)



Procedure

- [To create a new feature from geometry](#) (page 692)
-



- Add DWG Data to an Existing Feature Source



- *Create new features from existing AutoCAD objects.*



- [Overview of Working with Features](#) (page 684)
- [Checking In Features](#) (page 693)
- [Using AutoCAD Commands on Features](#) (page 713)

NOTE This procedure is for geospatial features only. For information about creating drawing objects, see the AutoCAD Help.

To create a new feature from geometry

- 1 In the [Display Manager](#) (page 2060), right-click the layer to which you want to add the feature. Click New Feature from Geometry.
- 2 When prompted, select the object or objects to convert to features. Press *Enter*.
All selected objects are converted into a single feature. To create multiple features, perform this operation on one object at a time.
- 3 When prompted to erase the drawing object, do one of the following:
 - Click Yes to erase the original drawing object.
 - Click No to keep the drawing object in the drawing.
Keep the object if you plan to use it to create other features. You can store drawing objects on a separate layer and turn off visibility for the layer.
To add information to the feature, see [Editing Features using the Data Table](#) (page 711).
- 4 Check in the new features.
For more information, see [Checking In Features](#) (page 693).

Quick Reference

New Feature from Geometry

Creates a new feature from drawing object geometry

Menu	Click Create ► New Feature from Geometry.
Icon	 New Feature From Geometry
Command Line	MAPCREATEFEATUREFROMGEOMETRY
Task Pane	In Display Manager, right-click the feature layer. Click New Feature from Geometry

Checking In Features

Checking in features saves your changes and additions to the feature source and releases any locks. Check in features before giving a map to someone else to edit. If you and the other person have different versions of AutoCAD Map 3D, some features may not be recognized unless they are checked in.

You can update the source automatically as you edit or wait until you check in the features. If you update the source with edits automatically, be sure to check in features when you are finished working.

NOTE This functionality is for geospatial features only. For information about locking and unlocking drawing files, see [Overview of Sharing Attached Drawings](#) (page 730).

Tell me more



Video

- [Show me how to check in features after editing in the field.](#)



Procedure

- [To check in features](#) (page 694)



Tutorial

- [Exercise 3: Update information for the edited feature](#)
-



- Edit Features in a Geospatial Feature Source



- *Draft new features for an existing feature class.*
- *Check out features to edit in the field and update the database later.*



- [Overview of Working with Features](#) (page 684)
- [Updating Edits Automatically](#) (page 698)

NOTE This procedure is for geospatial features only. For information about locking and unlocking drawing files, see [Methods for Object Locking](#) (page 731).

To check in features

- 1 Select the features to check in using one of the following methods:
 - Click a feature or features.
 - Right-click the feature layer in the [Display Manager](#) (page 2060). Click Select Checked-Out Features.
- 2 Right-click the drawing. Click Check-In Feature.

Quick Reference

Check In Feature

Checks in features, saves your changes and additions to the feature source, and releases locks

Menu

Click Edit ► Check-In.

Icon



Check-In Features

Command Line

MAPCHECKIN

Select Checked-Out Features

Selects features that have been checked out to edit

Menu	Click Edit ► Select Checked-Out Features.
Icon	 Select Checked-Out Features
Command Line	MAPSELECTCHECKEDOUT
Task Pane	In Display Manager, right-click the feature layer

Checking Out Features

Checking out features makes them available to edit. By default, features are checked out automatically when you edit them. Check in features before giving a map to someone else to edit. If you and the other person have different versions of AutoCAD Map 3D, some features may not be recognized unless they are checked in.

If the data source supports locking, features or files will be locked. Checking in or canceling a checkout operation unlocks locked features.

If you plan to work offline, check out the features that you want to edit before going offline.

NOTE This functionality is for geospatial features only. For information about locking and unlocking drawing files, see [Overview of Sharing Attached Drawings](#) (page 730).

Tell me more



Video

- [Show me how to check out features for editing in the field.](#)



Procedure

- [To check out features automatically](#) (page 696)



Tutorial

- [Exercise 2: Check out and edit a feature](#)
-



- Edit Features in a Geospatial Feature Source



- *Check out features to edit in the field and update the database later.*



- [Overview of Working with Features](#) (page 684)
- [Updating Edits Automatically](#) (page 698)
- [Working Offline](#) (page 721)

NOTE This procedure is for geospatial features only. For information about locking and unlocking drawing files, see [Methods for Object Locking](#) (page 731).

To check out features automatically

- In the Tool-based Ribbon Workspace, click Feature Edit tab ► Edit Set panel ► Auto Checkout.

To check out features

NOTE Use this procedure if you do not have Auto Checkout turned on.

- 1 Click a feature or features.
- 2 Right-click the drawing. Click Check-Out Feature.
Grips are displayed on the checked-out feature. If you do not edit using grips you can turn them off. For more information, see *Use Grip Modes* in the AutoCAD Help.

Quick Reference

MAPAUTOCHECKOUT

Automatically checks-out features that are edited

Menu Not available on the menu in the current workspace

Command Line MAPAUTOCHECKOUT

Check Out Feature

Checks out selected features and makes them available for editing

Menu Click Edit ► Check-Out.

Icon



Check-Out Features

Command Line MAPCHECKOUT

MAPFEATUREEDITOPTIONS

Specifies options for editing features

Icon



Feature Edit Options

Command Line MAPFEATUREEDITOPTIONS

Dialog Box Feature Editing Options dialog box

Canceling Checkout

You can cancel the checkout of all, selected, or erased features. You can also cancel the checkout of features by layer. When you cancel check out, locks are released and your changes are discarded.

NOTE If Update Edits Automatically is on, edits are made in the feature source immediately. Canceling checkout will not discard changes or restore erased features.

NOTE This functionality is for geospatial features only. For information about locking and unlocking drawing files, see [Overview of Sharing Attached Drawings](#) (page 730).

See also:

- [Overview of Working with Features](#) (page 684)
- [Working Offline](#) (page 721)
- [Updating Edits Automatically](#) (page 698)

NOTE This procedure is for geospatial features only. For information about locking and unlocking drawing files, see [Methods for Object Locking](#) (page 731).

To cancel check out

1 Click Feature Edit tab ► Edit Set panel ► Cancel Feature Check-out.



2 When prompted, click one of the following options:

Option	Description
All	Cancels check out of all features
Erased	Cancels check out of all erased features
Layer	Prompts for a layer and cancels check out of all features on the selected layer. This option is the same as All if there is only one layer.
Select Objects	Prompts for features or cancels check out of selected features

Quick Reference

Cancel Checkout

Cancels a checkout operation. If you have Update Edits Automatically enabled, cancelling the checkout does not undo changes.

Menu Click Edit ► Cancel Check-Out.

Icon



Cancel Feature Check-Out

Command Line MAPCANCELCHECKOUT

Updating Edits Automatically

You can queue your edits and save them to the source all at once, or you can save them as you work.

NOTE This functionality is for geospatial features only. For information about saving changes back to attached drawing files, see [Setting Save Back Options](#) (page 763).

When Update Edits Automatically is off (the default), your changes remain local until you check them in.

If you turn on Update Edits Automatically, AutoCAD Map 3D immediately attempts to save any edits you have made to checked-out features back to the feature source. If updating fails for any reason, the setting remains off. You can reverse the changes you made (so your version matches the one that is checked in), or check out the drawing, re-enter your edits and then check it in.

NOTE Undo does not reverse this command. Canceling a checkout will not discard changes or restore features to their state before the checkout.

You can [change the default setting](#) (page 84) for Update Edits Automatically.

When you create layers for SHP and SDF data, AutoCAD Map 3D may create a local cache the first time you edit those layers. For large files this may be time-consuming. To avoid this, turn on Update Edits Automatically for large SDF and SHP files.

Persistent Locking

If the feature source provider supports [persistent locking](#) (page 2070), and Update Edits Automatically is on, checking out a feature locks that feature; checking in a feature unlocks it. You can release locks on features by checking them out (if you are the user who locked them) and then checking them back in.

If the feature source provider supports persistent locking and Update Edits Automatically is off, use Cancel Checkout to unlock features without saving your changes to them. When you do this, you synchronize the state of the feature you checked out with those in the feature source. That is, you delete new features created locally, and replace locally modified or deleted features with the versions from the feature source.

Revision Numbers

Some providers (for example, Oracle, SQL Server, and MySQL) support revision numbers, which increment a numeric value in the feature every time you commit a change to that feature in the feature source. This allows AutoCAD Map 3D to see if a feature has been edited by another user. If another user modifies a feature while you have it checked out, a revision-number conflict can occur. This might happen if you check out the feature while you are

offline, or if the feature source provider does not support persistent locking. In such cases, you cannot overwrite the other user's changes to the features. Instead, turn Update Edits Automatically off and choose Cancel Checkout for the features that have conflicts.

See also:

- [Customizing Your Work Environment](#) (page 84)
- [Working Offline](#) (page 721)
- [Canceling Checkout](#) (page 697)

NOTE This procedure is for geospatial features only. For information about saving changes back to attached drawing files, see [To set editing and save back options](#) (page 764).

To update edits automatically

- In the Tool-based Ribbon Workspace, click Feature Edit tab ► Edit Set panel ► Automatic Update

NOTE To change the default setting for Automatic Update, at the Command prompt, type MAPEDITSETAUTODEFAULT and specify Active (checked) or Deactive (unchecked) as the default.

Quick Reference

MAPEDITSETAUTO

Turns on and off the setting for updating edits to the feature source automatically

Menu Click Edit ► Update Edits Automatically.

Command Line MAPEDITSETAUTO

MAPEDITSETAUTODEFAULT

Specifies the default setting for updating edits to the feature source automatically

Command Line MAPEDITSETAUTODEFAULT

Check In Feature

Checks in features, saves your changes and additions to the feature source, and releases locks

Menu	Click Edit ► Check-In.
Icon	 Check-In Features
Command Line	MAPCHECKIN

Editing Features

To edit features

- [To edit a feature using feature editing commands](#) (page 705)
- [To split a feature](#) (page 708)
- [To turn Ignore Split And Merge Rules on or off](#) (page 708)
- [To set split prompt options](#) (page 709)
- [To merge features](#) (page 710)
- [To edit features using the Data Table](#) (page 712)
- [To use AutoCAD commands on features](#) (page 713)
- [To edit feature properties in the Properties palette](#) (page 719)

Overview of Editing Features

Edit features in any of the following ways:

- Use AutoCAD commands
Most common AutoCAD editing commands (such as PEDIT, ROTATE, and TRIM) are available to use with features. To perform an AutoCAD operation that is not available for features, extract the geometry from the feature, modify it using AutoCAD, and then update the feature geometry.

NOTE To use common AutoCAD editing commands on features, make sure you have selected Check Out Features As AutoCAD Drawing Objects in the Feature Checkout Options area of the [Feature Editing Options dialog box](#) (page 1929)

- Use specialized AutoCAD Map 3D commands for certain geometry types

- Change entries in the Data Table
- Change entries in the Properties palette
 Edit the same feature properties in the Data Table or Properties palette.
 Edits in the Properties palette apply to all selected features in the selected layer.

NOTE This functionality is for geospatial features only. For information about editing native drawing objects, see the AutoCAD Help.

To edit this...	Use this method...
<ul style="list-style-type: none"> ■ Point features ■ MultiPoint features ■ LineString features ■ MultiLineString features ■ Polygon features ■ MultiPolygon features 	<p>Use PEDIT for all features except MultiPoint features.</p> <p>You can also use geospatial feature editing commands for all features except Point features:</p> <ul style="list-style-type: none"> ■ Specify that features will be checked out as geospatial features. (page 239) ■ Then change the geometry directly. (page 705)
Feature properties	<p>Modify a feature in the Data Table to change its data. (page 712)</p> <p>Change property values for all selected features on the selected layer in the Properties palette. (page 719)</p>
Feature geometry as AutoCAD drawing objects	<p>Specify that features will be checked out as AutoCAD drawing objects. (page 239)</p> <p>Then use any available AutoCAD commands. (page 713)</p> <hr/> <p>NOTE In some cases, when feature geometry is checked out as AutoCAD drawing objects, geospatial feature editing commands may still be available to use on the geometry.</p> <hr/>

Tell me more



Video

- *Show me how to edit features stored in a database or data store.*
- *Show me how to check out features for editing in the field.*



Procedure

- [To edit features](#) (page 701)



Tutorial

- Lesson 5: Find and Edit Features



Workflow

- Edit Features in a Geospatial Feature Source
- Work Offline from an Enterprise Database



GIS Skill

- *Edit feature geometry directly in a SHP file using CAD tools.*
- *Check out features to edit in the field and update the database later.*



Related topics

- [Extracting Feature Geometry](#) (page 715)
- [Updating Feature Geometry](#) (page 716)
- [Using Feature Editing Commands](#) (page 704)
- [Editing Features using the Data Table](#) (page 711)
- [Using AutoCAD Commands on Features](#) (page 713)
- [Viewing and Editing Feature Properties](#) (page 718)

Quick Reference

MAPDATATABLE

Allows you to view, edit, and filter feature data

Menu Click Edit ► Data Table.

Icon  Table

Command Line MAPDATATABLE

Task Pane In Map Explorer or Display Manager, click the Table button

Dialog Box Data Table Dialog Box

PROPERTIES

Displays the Properties palette, which allows you to edit geometry, direction, and resistance for selected topology objects

Menu Click Modify ► Properties.

Icon  Properties

Command Line PROPERTIES

Task Pane Select objects. Right-click in drawing area ► Properties

Using Feature Editing Commands

Feature editing commands are available for Point, MultiPoint, LineString, MultiLineString, Polygon, or MultiPolygon features. If you do not have Auto Checkout turned on, check out a feature to use the feature editing command specific to the geometry of that feature.

You cannot perform edits that would create a non-planar polygon. Every ring of a polygon must be planar and all parts and all rings must be in the same plane.

NOTE To improve performance when editing features, turn Update Edits Automatically off.

NOTE This functionality is for geospatial features only. For information about editing native drawing objects, see the AutoCAD Help.

See also:

- [Updating Edits Automatically](#) (page 698)
- [Editing Features](#) (page 701)
- [Checking Out Features](#) (page 695)
- [Checking In Features](#) (page 693)

NOTE This functionality is for geospatial features only. For information about editing native drawing objects, see the AutoCAD Help.

To edit a feature using feature editing commands

- 1 Make sure that you have specified that features will be checked out as geospatial features in the [Feature Editing Options dialog box](#) (page 1929) by selecting Geospatial Features in the Feature Checkout Options area.
- 2 [Check out the feature.](#) (page 696)
For more information, see [Checking Out Features](#) (page 695).
- 3 Right-click the feature. Click Edit Feature.
The appropriate feature editing command for the geometry will apply to the feature.
- 4 Edit the Point, MultiPoint, LineString, MultiLineString, Polygon, or MultiPolygon features.
For more information about editing these features see [MAPMULTIPOINTEDIT](#) (page 1659), [MAPLINESTRINGEDIT](#) (page 1655), [MAPMULTILINESTRINGEDIT](#) (page 1658), [MAPPOLYGONEDIT](#) (page 1665), and [MAPMULTIPOLYGONEDIT](#) (page 1662).
- 5 Check in the revised features.
For more information, see [Checking In Features](#) (page 693).

Splitting Features

To split a feature into two parts, for example a parcel, use the [MAPFEATURESPLIT](#) (page 1652) command. The resulting feature property values

are determined by the rules specified in the [Split and Merge Rules dialog box](#) (page 1669).

You can choose to ignore the rules specified in the [Split and Merge Rules dialog box](#) (page 1669) by turning on Ignore Split and Merge Rules.

NOTE This functionality is for geospatial features only. For information about splitting drawing objects, see [Splitting Polygon Objects](#) (page 968).

Split Prompt Options

When you split a feature, you are prompted during the operation. You can [set defaults for some of these options](#) (page 1929) and specify whether to display those prompts during the split operation or not.

- **Create New/Create Multi-part:** Click Create New to split the feature into two pieces. To creating more pieces, click Create Multi-part.
- **Generate New Feature ID/Use Existing:** Click New to auto-generate a unique identifier for the new features. Click Existing to assign the ID of the original feature to all resulting features.
- **Would You Like To Draw Or Select The Line For The Split:** Click Draw to draw a line through the original feature where the split should occur. Click Select to select an existing line or polygon in the original feature that indicates the location of the split.

Splitting Features with Polygons

If you use a polygon (or mpolygon) to split a feature, the output is divided into two groups (inside and outside). The groups are collected into as few multipart types as possible without creating heterogeneous geometric types. A multipart feature is created for each distinct geometric type (point, line, polygon) that was in the input.

In the following example, a polygon was used to split a line. The lines outside the polygon become a multiline feature.

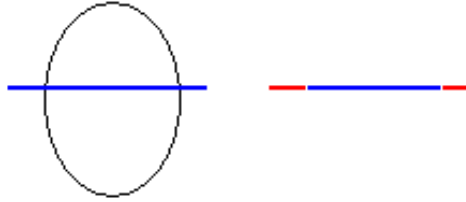

The line segment inside the polygon becomes a line feature (shown in blue on the right). The line segments outside the polygon become a multiline feature (shown in red).

Tell me more



Video

- [Show me how to split a parcel feature.](#)



Procedure

- To create split/merge rules using expressions
- [To set split prompt options](#) (page 709)
- [To turn Ignore Split And Merge Rules on or off](#) (page 708)
- [To split a feature](#) (page 708)



Tutorial

- [Lesson 2: Split a Polygon Feature](#)



Workflow

- [Split a Feature](#)



GIS Skill

- [Split a parcel in two and divide attributes.](#)



Related topics

- [Editing Features](#) (page 701)
- [Using Expressions In Split/Merge Rules](#)
- [Creating Calculated Properties](#) (page 1132)

NOTE This procedure is for geospatial features only. For information about splitting drawing objects, see [To split a polygon object](#) (page 969).

To split a feature

- 1 Optionally, specify split rules.

NOTE To [set these rules](#) (page 1669), in the Data Table click Options ► Set Split and Merge Rules.

- 2 Optionally, specify split prompts.

NOTE To [set these options](#) (page 1929), in the Tool-based Ribbon Workspace, click Feature Edit tab ► Edit Set Panel ► angle arrow.

- 3 Select the feature.

- 4 If you do not have Auto Checkout turned on, check out the feature.
For more information, see [Checking Out Features](#) (page 695).

- 5 Feature Edit tab ► Split/Merge panel ► Split Feature



- 6 Follow the [MAPFEATURESPLIT](#) (page 1652) prompts to specify whether the resulting feature will be a new or a multipart feature.

NOTE If you specified these options in the [Feature Editing Options dialog box](#) (page 1929) and selected Do Not Show These Prompts When Executing Split, you will not see the first two prompts.

- 7 Follow the prompts to specify whether the resulting feature will use a new or existing feature ID.

- 8 Follow the prompts to select or draw a split line.

- 9 Check in the revised features.

For more information, see [Checking In Features](#) (page 693).

To turn Ignore Split And Merge Rules on or off

- In the Tool-based Ribbon Workspace, click Feature Edit tab ► Split/Merge panel ► Ignore Rules .

NOTE To change the default setting for Ignore Split And Merge Rules, at the Command prompt, type [MAPIGNORESPLITMERGERULES](#) (page 1653) and specify Yes or No as the default.

To set split prompt options

- 1 In the Tool-based Ribbon Workspace, click Feature Edit tab ► Edit Set Panel ► angle arrow, or enter *mapfeatureeditoptions* at the Command prompt.
- 2 In the [Feature Editing Options dialog box](#) (page 1929), select the Split Prompt Options you want.
- 3 Click OK.

Quick Reference

MAPFEATURESPLIT

Splits features and assigns feature property values for resulting features

Menu	Modify menu ► Split
Icon	 Split
Command Line	MAPFEATURESPLIT

MAPIGNORESPLITMERGERULES

Determines whether or not the rules for split and merge are used

Menu	Not available on the menu in the current workspace
Command Line	MAPIGNORESPLITMERGERULES
Dialog Box	MAPIGNORESPLITMERGERULES

Merging Features

When you want to merge two or more features, for example separate line segments that represent the same road, use the [MAPFEATUREMERGE](#) (page 1651) command. The resulting feature property values are determined by the rules specified in the [Split and Merge Rules dialog box](#) (page 1669). To ignore

rules specified in this dialog box, turn on Ignore Split and Merge rules (see [To turn Ignore Split And Merge Rules on or off](#) (page 708)).

You can merge two or more features of the same class into one feature. You can also merge features with drawing objects. You can specify a new or existing feature ID for the resulting feature.

NOTE This functionality is for geospatial features only. For information about working with drawing objects, see the AutoCAD Help.

Tell me more



Procedure

- To create split/merge rules using expressions
- [To turn Ignore Split And Merge Rules on or off](#) (page 708)
- [To merge features](#) (page 710)



Workflow

- Merge Features



Related topics

- [Editing Features](#) (page 701)
- Using Expressions In Split/Merge Rules
- [Creating Calculated Properties](#) (page 1132)

NOTE This procedure is for geospatial features only. For information about working with drawing objects, see the AutoCAD Help.

To merge features

- 1 Optionally, specify [merge rules](#) (page 1669).

NOTE To [set these rules](#) (page 1669), in the Data Table click Options ► Set Split and Merge Rules.

- 2 If you do not have Auto Checkout turned on, check out the feature(s). For more information, see [Checking Out Features](#) (page 695).
- 3 Select at least two objects, including at least one feature.

- 4 Click Feature Edit tab ► Split/Merge panel ► Merge Feature .
- 5 Follow the [MAPFEATUREMERGE](#) (page 1651) prompts to specify whether the resulting feature will use a new or existing feature ID.
- 6 Check in the merged feature.
For more information, see [Checking In Features](#) (page 693).

Quick Reference

MAPFEATUREMERGE

Merges features and assigns feature property values for the resulting feature

Menu Click Feature Edit tab ► Split/Merge panel ► Merge



Icon



Command Line MAPFEATUREMERGE

MAPIGNORESPLITMERGERULES

Determines whether or not the rules for split and merge are used

Menu Not available on the menu in the current workspace

Command Line MAPIGNORESPLITMERGERULES

Dialog Box MAPIGNORESPLITMERGERULES

Editing Features using the Data Table

Use the Data Table to view and edit features. Select data in the Data Table window or select areas of your map to see their data in the table.

NOTE When you edit feature data in the Data Table, the corresponding geometry is checked out and locked, if possible. You must check in the geometry when you are finished editing.

NOTE This functionality is for geospatial features only. For information about editing attributes associated with drawing objects, see [Working with Attribute Data and Object Data](#) (page 1047).

See also:

- [Overview of the Data Table](#) (page 1125)
- [Setting Up Constraints in the Schema Editor](#) (page 599)
- [Checking Out Features](#) (page 695)
- [Checking In Features](#) (page 693)
- [Updating Edits Automatically](#) (page 698)
- [Editing Features](#) (page 701)
- [Viewing and Editing Feature Properties](#) (page 718)

NOTE This procedure is for geospatial features only. For information about editing attributes associated with drawing objects, see [To use attribute data and object data](#) (page 1047).

To edit features using the Data Table

- 1 In [Map Explorer](#) (page 2068), expand the Data Source entry and select the feature layer to edit.

- 2 Click .

The Data Table window opens, displaying the feature data contained in your map. If you have [joined data](#) (page 507) to a layer in your map, the joined data is displayed, but it is gray. You cannot edit it in the Data Table. Instead, select the original data source and update that in the Data Table. Your changes will appear the next time you display this data as joined data.

- 3 Select and edit cells in the Data Table window.

When you edit data related to a feature, that feature is checked out automatically (and the Update Edits Automatically setting is turned on). Non-feature data cannot be checked out, so all edits to that type of data are written back to their underlying sources immediately. You cannot edit non-feature data unless you are connected to its source. See [Updating Edits Automatically](#) (page 698).

Some data fields are “constrained” to allow only certain values. When you enter values for constrained fields, you are prompted to enter only valid values. For example, the prompt might tell you to enter only values between one and ten.

- 4 Check in the revised features.
For more information, see [Checking In Features](#) (page 693).
- 5 Close the Data Table window when you are finished.

Quick Reference

MAPDATATABLE

Allows you to view, edit, and filter feature data

Menu	Click Edit ► Data Table.
Icon	 Table
Command Line	MAPDATATABLE
Task Pane	In Map Explorer or Display Manager, click the Table button
Dialog Box	Data Table Dialog Box

Using AutoCAD Commands on Features

To use AutoCAD commands on features

- [To edit features with AutoCAD commands](#) (page 715)
- [To extract feature geometry](#) (page 716)
- [To update feature geometry](#) (page 717)

Editing Features with AutoCAD Commands

By default, many common AutoCAD editing commands (such as PEDIT, JOIN, ROTATE, and TRIM) can be used on features directly.

NOTE You can use these commands, as well as all other AutoCAD commands, on drawing objects in AutoCAD Map 3D.

Use PEDIT on a single or multipart feature. You can edit polygonal features and linear features (with or without M or Z values), but not point features. You can use the Join option to connect linear features. For single linear features, the feature ID for the first feature you selected is used for the resulting feature. For multipart linear features, you can join only features whose end points touch; the first selected feature is updated using the current Merge rules.

You can use the JOIN command on non-closed linear features with or without M or Z values. If the features are all on the same layer, the geometry and attributes of the source feature are updated, using the current Merge rules. The joined feature is removed.

You can use the AutoCAD OSNAP modes when editing features. Snap to any graphic within a block definition that is used to symbolize a point. You can also use OSNAP Node to snap to the insertion point of of an attribute, a block, a shape, or text. OSNAP Node is turned off by default.

If there is an AutoCAD operation you cannot perform on a feature, you can [extract the feature geometry](#) (page 715), edit it using AutoCAD commands, and then [update the feature geometry](#) (page 716). Feature data and rules are preserved.

You can also merge AutoCAD geometry with existing features directly, without extracting feature geometry first.

NOTE When you use EXPLODE on features, they are converted to AutoCAD drawing objects.

Tell me more



Video

- *Show me how to edit features using automatic check-out.*



Procedure

- [To edit features with AutoCAD commands](#) (page 715)



Workflow

- Edit Features in a Geospatial Feature Source



GIS Skill

- *Edit feature geometry directly in a SHP file using CAD tools.*
 - *Edit features as polylines using PEDIT.*
-



Related topics

- [Extracting Feature Geometry](#) (page 715)
- [Updating Feature Geometry](#) (page 716)
- [Checking Out Features](#) (page 695)
- [Checking In Features](#) (page 693)
- [Updating Edits Automatically](#) (page 698)

NOTE You can use these commands, as well as all other AutoCAD commands, on drawing objects in AutoCAD Map 3D.

To edit features with AutoCAD commands

- 1 If you do not have Auto Checkout turned on, check out the feature.
For more information, see [Checking Out Features](#) (page 695).
- 2 Do one of the following:
 - Enter an AutoCAD command and follow the prompts to select and edit the feature.
 - Select the feature and use its grips to edit the feature.
 - Select the feature and then enter an AutoCAD command and follow its prompts.

NOTE For help with AutoCAD commands, search for the command name in the Help file or press F1 while you are using the command.

- 3 Check in the revised features.
For more information, see [Checking In Features](#) (page 693).

Extracting Feature Geometry

Extract the geometry from a feature to use AutoCAD commands that are not available for features.

NOTE This functionality is for geospatial features only. There is no equivalent for drawing objects.

See also:

- [Editing Features](#) (page 701)
- [Checking Out Features](#) (page 695)
- [Checking In Features](#) (page 693)
- [Updating Feature Geometry](#) (page 716)

NOTE This procedure is for geospatial features only. There is no equivalent for drawing objects.

To extract feature geometry

- 1 Check out the feature.
For more information, see [Checking Out Features](#) (page 695).
- 2 Right-click the feature. Click Extract Geometry From Feature.

After you make your changes, you can merge the updated geometry back into the feature.

Quick Reference

Extract Feature Geometry

Creates new drawing objects from the selected feature geometry

Menu	Click Modify ► Advanced Feature Editing ► Extract Geometry from Feature.
Icon	 Extract Feature Geometry
Command Line	MAPEXTRACTFEATUREGEOMETRY

Updating Feature Geometry

You can merge new or existing drawing object geometry with a feature. If you have extracted the geometry from a feature to edit it using AutoCAD, you must update the feature geometry when you are finished editing.

You can use this command to combine spatially connected entities. For example, you can use a line and an arc to update the geometry of a single feature (resulting in one linestring or polyline). If the data store of a feature does not support curves, this command transforms the curves into line segments.

For polygons, this command allows you to work on the boundary geometry instead of the polygon itself.

NOTE This functionality is for geospatial features only. There is no equivalent for drawing objects.

See also:

- [Editing Features](#) (page 701)
- [Checking Out Features](#) (page 695)
- [Checking In Features](#) (page 693)
- [Extracting Feature Geometry](#) (page 715)

NOTE This procedure is for geospatial features only. There is no equivalent for drawing objects.

To update feature geometry

- 1 Right-click the feature you want to merge with a drawing object. Click Update Feature From Geometry.
- 2 When prompted, select the drawing object to merge. Press Enter.
- 3 When prompted to erase the drawing object, do one of the following:
 - Click Yes to erase the original drawing object.
 - Click No to keep the drawing object in the drawing. Keep the object if you plan to use it to create other features. You can store drawing objects on an AutoCAD layer and turn off visibility of the layer.
- 4 Check in the edited feature.
For more information, see [Checking In Features](#) (page 693).

Quick Reference

Update Feature from Geometry

Merges new or existing drawing object geometry with a feature

Menu Click Modify ► Advanced Feature Editing ► Update Feature from Geometry.

Icon  Update Feature Geometry

Command Line MAPUPDATEFEATUREGEOMETRY

Viewing and Editing Feature Properties

View and edit the properties for one or more selected features in the Properties palette. The properties are the same as those you can edit in the Data Table.

Your edits apply to all selected features in the selected layer. The feature source is updated immediately if Update Edits Automatically is on.

You can select both drawing objects and geospatial features at the same time. Use the drop-down list at the top of the Properties palette to switch between viewing the properties of all selected entities, viewing feature properties only, or viewing the properties for drawing objects by geometry type.

NOTE For more information about viewing properties for drawing objects, see Properties Palette.

You can view the properties for up to 2000 features. If you select more features than that, all of them will be selected in your map and in Data Table. However, only the first 2000 features selected will be shown in the Properties palette.

When you select features on multiple layers, the drop-down list at the top of the Properties palette indicates how many checked-out features are selected. (If the features you selected are not checked out, the list shows only a single selection for each layer.)

The General properties indicate whether the Feature Class shown is for one or more layers, and whether the Feature ID is for one or more features. For multiple layers or features, these fields contain the text “VARIES.”

Properties for all selected layers are shown. You can change the Filter By Layer entry to see the properties for a single selected layer, or to switch between

selected layers. For example, if you selected features that are stored on four different layers, select one of those layers to see its properties only. However, any features that were selected on the other layers remain selected.

To set the value for a property to "NULL," click in the value field and select <NULL> from the drop-down list in that field. If <NULL> does not appear in the list, the property cannot have a null value.

NOTE Do not enter the text string "Null." This will not produce a null value, but will be treated as a text string.

See also:

- [Editing Features using the Data Table](#) (page 711)
- Properties Palette
- [Updating Edits Automatically](#) (page 698)
- [Setting Up Constraints in the Schema Editor](#) (page 599)
- [Displaying and Editing Object Data for a Drawing Object](#) (page 1068)

NOTE For more information about viewing properties for drawing objects, see Properties Palette.

To edit feature properties in the Properties palette

- 1 Select the features and objects to edit.

To change a single value for multiple features (for example, to change the zoning type for multiple parcels to Commercial), select only those features.

NOTE You can select both features and drawing objects. However, you must select *either* features or drawing object types to see any properties.

- 2 Right-click any selected feature or object and click Properties on the menu that appears.
- 3 In the Properties palette, do any of the following:
 - To view only features, or only a particular type of drawing object, change the selection in the drop-down list at the top of the Properties palette.
To see only features, select Map Features from the list.

Drawing objects are listed by their geometry type. For example, to see only the properties for the line objects you selected, select Lines from the list.

- To see the properties for a single selected layer, or to switch between selected layers, click the entry for Layer under Filter By Layer. Select a layer.

For example, if you selected features that are stored on four different layers, select one of those layers to see its properties only. Any features that were selected on the other layers remain selected.

- To change a value, click in its field and enter a new value. If you enter a value that uses the wrong data type (for example, if you enter text in a field that allows only numerals), the value reverts back to the last valid value. If you specify an invalid date value in a date field, you will see an error message.

For properties that have value constraints, click in the field to see a list with the available values. If you enter an invalid value for a constrained property, you will see an error message.

For other fields, hover over the property name to see information on the acceptable values.

To set the value for a property to “NULL,” click in the value field and select <NULL> from the drop-down list in that field. If <NULL> does not appear in the list, the property cannot have a null value.

NOTE Do not enter the text string “Null.” This will not produce a null value, but will be treated as a text string.

Your edits apply to all selected features in the selected layer. The feature source is updated immediately if Update Edits Automatically is on.

For more information on changing drawing object properties, see [Displaying and Editing Object Data for a Drawing Object](#) (page 1068).

Quick Reference

PROPERTIES

Displays the Properties palette, which allows you to edit geometry, direction, and resistance for selected topology objects

Menu	Click Modify ► Properties.
Icon	 Properties
Command Line	PROPERTIES
Task Pane	Select objects. Right-click in drawing area ► Properties

Working Offline

When you work offline, AutoCAD Map 3D caches all your feature data connections.

NOTE This functionality is for geospatial features only. For information about working with shared drawing files, see [Overview of Sharing Attached Drawings](#) (page 730).

Clear the cache periodically to improve performance. To be sure that you are working with the most current data for a data source, rebuild its cache by refreshing its layer.

Tell me more



Video

- *Show me how to check out features for editing in the field.*
- *Show me how to edit features stored in a database or data store.*
- *Show me how to check in features after editing in the field.*



Procedure

- [To work offline](#) (page 722)



Workflow

- Edit Features in a Geospatial Feature Source
 - Work Offline from an Enterprise Database
-



GIS Skill

- *Check out features to edit in the field and update the database later.*



Related topics

- [Bringing in GIS Features](#) (page 303)
- [Editing Features](#) (page 701)
- [Checking Out Features](#) (page 695)
- [Checking In Features](#) (page 693)

NOTE These procedures are for geospatial features only. For information about working with shared drawing files, see [Use these techniques for object locking.](#) (page 731)

- [To work offline](#) (page 722)
- [To return online](#) (page 722)
- [To clear the cache](#) (page 723)
- [To rebuild the cache](#) (page 723)

To work offline

- 1 Click Edit Feature tab ► Edit Set panel ► Automatic Update.
- 2 Check out the features you plan to use.
For more information, see [Checking Out Features](#) (page 695).
- 3 Click the Online/Offline toggle on the Status Bar. 

NOTE AutoCAD Map 3D caches the feature source. This can take some time.

You can still check out and edit features while you are offline. When you return online, AutoCAD Map 3D attempts to lock features that you checked out while you were offline. Non-feature data cannot be checked out, so you cannot edit it unless you are connected to its source.

To return online

- 1 Click the Offline/Online toggle on the Status Bar. 

- 2 Check in the checked out features.
For more information, see [Checking In Features](#) (page 693).

To clear the cache

- 1 Click Map Setup tab ► Map panel ► angle-arrow.
- 2 In the [AutoCAD Map Options dialog box](#) (page 1908), click the System tab.
- 3 Click Clear Cache. Click OK.

To rebuild the cache

- Right-click a feature layer in Display Manager ► Refresh Layer.

Quick Reference

MAPWORKOFFLINE

Caches all checked-out features so you can work without being connected.

Icon



Online/Offline toggle on the Status Bar

Command Line

_MAPWORKOFFLINE

Managing Versions

For feature sources that support versioning, you can create a version, edit objects in that version, and then merge (commit) changes from the child version back to the parent version.

NOTE This functionality is for geospatial features only. For information about working with shared drawing files, see [Overview of Sharing Attached Drawings](#) (page 730).

Support for versioning depends on the feature source. However, the following guidelines apply to most feature sources that support versioning:

- Features queried from one version of the feature source can be saved back to that version only. If you plan to edit features, be sure to query the features from the version where you plan to save the edits.
- Objects locked in one version of the feature source are automatically locked in all versions (if the feature source supports locking). This reduces the chance of a conflict where an object is edited in two versions of the feature source.
Conflicts can still occur, for example if one version is edited offline. In these cases, you must specify how to resolve the conflicts before you save the version.
- You must be working online and be connected to the data store to manage versions.
- You cannot save or discard a version if it has children.
- You cannot save or discard a version if it has checked out features. You must first unlock the objects by either checking them in or canceling check out.
- When you save or discard a version, all features in the drawing that were queried from that version are removed from the drawing.
- When you discard a version, all edits saved to that version are discarded.
- You cannot undo saving or discarding a version.

Error handling

Errors can occur when you add, activate, drop, or merge versions. Some errors may be caused by actions within the [Manage Versions dialog box](#) (page 1748), while others may be the result of activity within the data store itself.

The affected item in the dialog box displays an error indicator. To see the cause of the error, hold your cursor over this indicator. If you create a version and the operation fails, you will see a new version with an error indicator. The version has not really been created. It is a placeholder to display the error.

Errors remain visible until you close the dialog box, fix the errors, and redisplay the dialog box.

See also:

- [Overview of Bringing In GIS Features](#) (page 305)
- [Overview of Working with Features](#) (page 684)

- [To create a new version](#) (page 725)
- [To activate a version](#) (page 725)
- [To commit changes back to the data store](#) (page 726)
- [To discard a version](#) (page 726)

NOTE These procedure are for geospatial features only. For information about working with shared drawing files, see [Use these techniques for object locking](#). (page 731).

To create a new version

- 1 In [Map Explorer](#) (page 2068), right-click the feature source and click Manage Versions.
This command is available only for feature sources that support versioning.
- 2 In the [Manage Versions dialog box](#) (page 1748), select a version under Version (in the lower half of the dialog box) and click Add.
- 3 Enter a name for the new version and an optional comment.
- 4 Click Close.

To activate a version

- 1 In [Map Explorer](#) (page 2068), right-click the feature source and click Manage Versions.
- 2 In the [Manage Versions dialog box](#) (page 1748), select the version and click Activate.
All queries are performed on the active version of the feature source. Switching versions can take some time to execute, because the data store may need to flush and reload the feature cache.
- 3 Click Close.

To commit changes back to the data store

- 1 Check in all features, or cancel checkout for them.
- 2 In [Map Explorer](#) (page 2068), right-click the feature source and click Manage Versions.
- 3 In the [Manage Versions dialog box](#) (page 1748), select the version and click Merge.

This option is available for child versions only. If you merge the active version, its parent version is activated and then the selected version is merged and removed from the Version tree.

You cannot merge a version if it has children.

- 4 Click Close.

To discard a version

- 1 Check in any checked out features, or cancel checkout for them.
- 2 Make sure that the parent version is not connected in any other drawing.
- 3 In [Map Explorer](#) (page 2068), right-click the feature source and click Manage Versions.
- 4 In the [Manage Versions dialog box](#) (page 1748), select the version and click Drop.

All edits saved to the version are discarded. This option is available for child versions only. If you drop the active version, its parent version is activated and then the selected version is dropped and removed from the Version list.

You cannot drop a version if it has children.

- 5 Click Close.

To address errors

If an error occurs during version management, the affected item in the dialog box displays an error indicator.

- 1 To see the cause of the error, hold your cursor over the error indicator.
If you create a version and the operation fails, you will see a new version with an error indicator. The version has not really been created. It is a placeholder to display the error.

- 2 If necessary, close the [Manage Versions dialog box](#) (page 1748) and correct the error.
- 3 Redisplay the dialog box to make sure that the error has been cleared.

Working with Drawing Objects

To work with drawing objects

- [To edit data in attached drawings](#) (page 729)
- [To clean up drawing data](#) (page 765)
- [To create, edit, and manage topologies](#) (page 821)
- [To use Map editing tools](#) (page 927)
- [To work with polygon objects](#) (page 954)
- [To use object classification](#) (page 981)

Overview of Working with Drawing Objects

Create and edit drawing objects using AutoCAD and AutoCAD-based commands.

NOTE This functionality is for drawing objects only. However, you can use many AutoCAD commands to edit geospatial features as well. See [Using AutoCAD Commands on Features](#) (page 713).

Tell me more



Video

- *Show me how multi-user editing works.*
- *Show me how to clean up errors in my data.*
- *Show me how to create a network topology.*



Procedure

- [Use the following techniques to work with drawing data.](#) (page 728)



Tutorial

- Exercise 2: Attach a drawing file

- Exercise 3: Query in data from the drawing

 **Workflow**

- Find and Edit Objects in Attached Drawings

 **GIS Skill**

- *Edit DWG files in a multi-user environment.*
- *Clean up duplicates, gaps, and other accuracy problems in DWG files.*
- *Create a network topology to show how lines are connected.*

 **Related topics**

- [Editing Data in Attached Drawings](#) (page 729)
- [Cleaning Up Drawing Data](#) (page 765)
- [Creating, Editing, and Managing Topologies](#) (page 820)
- [Using Map Editing Tools](#) (page 926)
- [Working with Polygon Objects](#) (page 954)
- [Using Object Classification](#) (page 981)

NOTE These procedures are for drawing objects only. However, you can use many AutoCAD commands to edit geospatial features as well. See [To use AutoCAD commands on features](#) (page 713).

Use the following techniques to work with drawing data.

To do this...

Use this method...

Work in a multiuser environment.

- [Turn on object locking.](#) (page 733)
 - [Find out who locked an object.](#) (page 735)
 - [Release locked objects for use by others.](#) (page 736)
-

To do this...	Use this method...
Edit and save objects in attached drawings.	Query objects from attached drawings into the current map, or edit objects from attached drawings and save them back. (page 737)
Correct common map errors resulting from surveying, digitizing, and scanning errors, and remove unnecessary detail.	Use drawing cleanup. (page 767)
Use topology to analyze a set of objects and data and their relationship.	Create node, network, or polygon topologies. (page 824)
Edit map-related data.	Use map editing tools. (page 927)
Digitize new points in existing maps with precision.	Specify the exact coordinates of the points. (page 953)
Work with polygon objects.	Use specialized polygon options. (page 954)
Indicate textual values on an object.	Use annotation. (page ?)
Organize drawing objects based on the real-world features that they represent.	Use object classification. (page 1101)

Editing Data in Attached Drawings

NOTE These procedures are for drawing objects only. However, you can use many AutoCAD commands to edit geospatial features as well. See [To use AutoCAD commands on features](#) (page 713).

To edit data in attached drawings

- [To use object locking](#) (page 730)
- [To edit and save objects](#) (page 737)

Sharing Attached Drawings

- [Overview of Sharing Attached Drawings](#) (page 730)

- [Turning On Object Locking](#) (page 733)
- [Finding Out Who Locked an Object](#) (page 734)
- [Releasing All Locked Objects for a Specific User](#) (page 736)

See also:

- [Editing and Saving Objects in Attached Drawings](#) (page 737)

NOTE These procedures are for drawing objects only. For information about locking geospatial feature data, see [Checking Out Features](#) (page 695).

To use object locking

- [To turn on object locking](#) (page 733)
- [To find out who locked an object](#) (page 735)
- [To release all locked objects](#) (page 736)

Overview of Sharing Attached Drawings

Object locking lets multiple network users simultaneously retrieve, edit, and save back different objects while working in the same attached drawing. If object locking is not selected, only one user can have write access to an active drawing.

NOTE This functionality is for drawing objects only. For information about locking geospatial feature data, see [Checking Out Features](#) (page 695).

Tell me more



Video

- [Show me how multi-user editing works.](#)



Procedure

- [To edit data in attached drawings](#) (page 729)



Tutorial

- Exercise 2: Attach a drawing file
- Exercise 3: Query in data from the drawing



Workflow

- Find and Edit Objects in Attached Drawings



GIS Skill

- *Edit DWG files in a multi-user environment.*



Related topics

- [Turning On Object Locking](#) (page 733)
- [Finding Out Who Locked an Object](#) (page 734)
- [Releasing All Locked Objects for a Specific User](#) (page 736)

NOTE These procedures are for drawing objects only. For information about locking geospatial feature data, see [Checking Out Features](#) (page 696).

Use these techniques for object locking.



To do this...

Use this method...



Turn on object locking.

Click Map Setup tab ► Map panel ► angle-arrow.
See [Turning On Object Locking](#) (page 733).

Find out who has locked an object.

Click Home tab ► Data panel ► 
► Show Who Has It. 
See [Finding Out Who Locked an Object](#) (page 734)

Release locked objects.

Click Map Setup tab ► Map panel ► 
► Drawing Maintenance. 
See [Releasing All Locked Objects for a Specific User](#) (page 736).

Quick Reference

MAOPTIONS

Sets AutoCAD Map 3D options

Menu	Setup menu ► Autodesk Map Options
Icon	 Options
Command Line	MAOPTIONS
Task Pane	In Map Explorer, right-click Current Drawing ► Options
Dialog Box	AutoCAD Map Options dialog box

ADEWHOHASIT

Displays the current owner of a selected locked object

Menu	Click File ► Drawing Save Set Options ► Who Has It?.
Icon	 Show Who Has It
Command Line	ADEWHOHASIT
Dialog Box	Who Has It Information dialog box

ADEDWGMAINT

Removes locks from objects

Menu	Setup menu ► More DWG Options ► Drawing Maintenance
Command Line	ADEDWGMAINT
Task Pane	In Map Explorer, right-click Drawings ► Maintenance
Dialog Box	Drawing Maintenance dialog box

Turning On Object Locking

If object locking is enabled, two network AutoCAD Map 3D users can edit different objects in the same drawing at the same time, but cannot edit the *same* object at the same time.

NOTE This functionality is for drawing objects only. For information about locking geospatial feature data, see [Checking Out Features](#) (page 695).

Any objects that you add to the save set are locked. Other users can view these objects, but cannot save modifications back to the attached drawings until you unlock the objects.

When you finish editing the objects, save them back to their attached drawings. The objects are automatically unlocked.

Only a [superuser](#) (page 2075) can change object locking settings. See [Setting Up Users and Assigning Rights](#) (page 82).

See also:

- [Logging Into AutoCAD Map 3D](#) (page 141)
- [Sharing Attached Drawings](#) (page 729)

NOTE You must have [superuser](#) (page 2075) privileges to change the Enable Object Locking setting. See [Setting Up Users and Assigning Rights](#) (page 82).

NOTE These procedures are for drawing objects only. For information about locking geospatial feature data, see [Checking Out Features](#) (page 696).

To turn on object locking

- 1 In the Tool-based Workspace, click Map Setup tab ► Map panel ► angle-arrow.
- 2 In the [AutoCAD Map Options dialog box](#) (page 1908), select the Multi User tab.
- 3 Under Multi User Options, select Enable Object Locking.
- 4 Click OK.

Quick Reference

MAPOPTIONS

Sets AutoCAD Map 3D options

Menu	Setup menu ► Autodesk Map Options
Icon	 Options
Command Line	MAPOPTIONS
Task Pane	In Map Explorer, right-click Current Drawing ► Options
Dialog Box	AutoCAD Map Options dialog box

Finding Out Who Locked an Object

Use the Who Has It operation at any time to find out who locked an object.

NOTE If the DWK file has been deleted, the user names are no longer available. When this happens, AutoCAD Map 3D displays user names and drawing names as *UNKNOWN*.

NOTE This functionality is for drawing objects only. For information about locking geospatial feature data, see [Checking Out Features](#) (page 695).

Tell me more



Video

- [Show me how multi-user editing works.](#)



Procedure

- [To edit data in attached drawings](#) (page 729)



Tutorial

- Exercise 2: Attach a drawing file
 - Exercise 3: Query in data from the drawing
-



Workflow

- Find and Edit Objects in Attached Drawings



GIS Skill

- *Edit DWG files in a multi-user environment.*



Related topics

- [Turning On Object Locking](#) (page 733)
- [Sharing Attached Drawings](#) (page 729)
- [Releasing All Locked Objects for a Specific User](#) (page 736)

NOTE This procedure is for drawing objects only. For information about locking geospatial feature data, see [Checking Out Features](#) (page 696).

To find out who locked an object

- 1 Home tab ► Data panel ►  ► Show Who Has It 
- 2 Select the object.

The [Who Has It Information dialog box](#) (page 1889) displays the name of the user who has the object locked, the drawing that the object comes from, the name of the current drawing, and the date and time the object was locked.

Quick Reference

ADEWHOHASIT

Displays the current owner of a selected locked object

Menu

Click File ► Drawing Save Set Options ► Who Has It?.

Icon

Show Who Has It

Command Line

ADEWHOHASIT

Dialog Box

Who Has It Information dialog box

Releasing All Locked Objects for a Specific User

If a system failure occurs while objects are locked, you must manually release the object locks. However, only a [superuser](#) (page 2075) can remove locks set by other users.

NOTE If a drawing is activated in another user's drawing, you will not be able to release locks in that drawing.

When you remove locks, the object is also removed from the save set. You can restore the locks by adding the objects to the save set again.



NOTE This functionality is for drawing objects only. For information about locking geospatial feature data, see [Checking Out Features](#) (page 695).

See also:

- [Logging Into AutoCAD Map 3D](#) (page 141)
- [Turning On Object Locking](#) (page 733)
- [Sharing Attached Drawings](#) (page 729)

NOTE This procedure is for drawing objects only. For information about locking geospatial feature data, see [Checking Out Features](#) (page 696).

To release all locked objects

- 1 Click Map Setup tab ► Map panel ►  ► Drawing Maintenance. 
- 2 In the [Drawing Maintenance dialog box](#) (page 1920), under Active Drawings, select the drawing that contains the locks to release.
- 3 Select User List.
The names of the users responsible for the locks appear under User Name.
The number of objects locked by each user appears under Number of Objects Locked.
- 4 Select Remove Locks.

If you do not have [superuser](#) (page 2075) privileges, you can remove only the locks that you have set. AutoCAD Map 3D removes the objects from the save set.

If you have superuser privileges, you can select a user name and remove all the locks set by that user.

Quick Reference

ADEDWGMAINT

Removes locks from objects

Menu	Setup menu ► More DWG Options ► Drawing Maintenance
Command Line	ADEDWGMAINT
Task Pane	In Map Explorer, right-click Drawings ► Maintenance
Dialog Box	Drawing Maintenance dialog box

Editing and Saving Objects in Attached Drawings

- [Overview of Editing and Saving Objects in Attached Drawings](#) (page 738)
- [Zooming to the Extents of Selected Drawings](#) (page 743)
- [Viewing All Objects in Selected Attached Drawings](#) (page 745)
- [Editing Objects in Attached Drawings](#) (page 747)
- [Adding an Object to the Save Set](#) (page 750)
- [Viewing Objects in the Save Set](#) (page 752)
- [Saving Queried Objects Back to Attached Drawings](#) (page 753)
- [Saving New Objects to Attached Drawings](#) (page 754)
- [Saving Objects to the Current Drawing](#) (page 756)
- [Saving Objects to a New Drawing](#) (page 758)
- [Removing an Object from the Save Set](#) (page 759)
- [Solving Problems When Saving Back to Attached Drawings](#) (page 760)
- [Setting Save Back Options](#) (page 763)

NOTE These procedures are for drawing objects only. For information about saving geospatial feature data back to its source, see [Checking In Features](#) (page 694).

To edit and save objects

- [To zoom to the extents of selected drawings](#) (page 745)
- [To view objects in source drawings](#) (page 746)
- [To edit objects in attached drawings](#) (page 748)

- [To save the edited objects back to their attached source drawings](#) (page 749)
- [To add objects to the save set and lock the objects](#) (page 751)
- [To view objects in the save set](#) (page 752)
- [To save queried objects back to attached source drawings](#) (page 754)
- [To save new objects to attached drawings](#) (page 756)
- [To save objects to the current drawing](#) (page 757)
- [To save objects to a new drawing](#) (page 758)
- [To remove objects from the save set and unlock the objects](#) (page 759)
- [To redefine block definitions on save back](#) (page 761)
- [To save back individual block components](#) (page 762)
- [To check that the hatch pattern is in the save set](#) (page 762)
- [To set editing and save back options](#) (page 764)

Overview of Editing and Saving Objects in Attached Drawings

When you use AutoCAD Map 3D with multiple drawings, you can query objects from attached drawings into the current drawing and create new drawings, or you can edit the objects from the attached drawings and then save them back.

NOTE This functionality is for drawing objects only. For information about saving geospatial feature data back to its source, see [Checking In Features](#) (page 693).

Tell me more



Video

- [Show me how multi-user editing works.](#)



Procedure

- [To edit and save objects](#) (page 737)



Tutorial

- Exercise 2: Attach a drawing file
- Exercise 3: Query in data from the drawing



Workflow

- Find and Edit Objects in Attached Drawings
-



GIS Skill

- *Edit DWG files in a multi-user environment.*



Related topics

- [Overview of Queries](#) (page 1235)
- [Editing Data in Attached Drawings](#) (page 729)
- [Cleaning Up Drawing Data](#) (page 765)
- [Using Map Editing Tools](#) (page 926)
- [Working with Polygon Objects](#) (page 954)

NOTE These procedures are for drawing objects only. For information about saving geospatial feature data back to its source, see [Checking In Features](#) (page 694).

To do this...

Use this method...

Zoom to the extents of selected drawings

In Map Explorer, right-click Drawings. Click Zoom Extents.
See [Zooming to the Extents of Selected Drawings](#) (page 743)

View objects in source drawings

In Map Explorer, right-click Drawings. Click Quick View.
See [Viewing All Objects in Selected Attached Drawings](#) (page 745)









Edit objects in attached drawings

1 [Run a query](#) (page 1235) to retrieve the objects to edit.

2 Click Home tab ► Data panel ► 

► Add To Save Set.  Select the objects to edit.

See [Editing Objects in Attached Drawings](#) (page 747)

To do this...	Use this method...
Add objects to the save set and lock the objects	Click Home tab ► Data panel ►  ► Add To Save Set.  See Adding an Object to the Save Set (page 750)
View objects in the save set	Click Home tab ► Data panel ►  ► Show Objects In Save Set.  See Viewing Objects in the Save Set (page 752)
Save objects back to attached source drawings	Add objects to the save set. Click Home tab ► Data panel ►  ► Save To  Source.  See Saving Queried Objects Back to Attached Drawings (page 753) and Saving New Objects to Attached Drawings (page 754)
Save objects to the current drawing or a new drawing.	Click  ► Save. Click  ► Save As ► AutoCAD Drawing. See Saving Objects to the Current Drawing (page 756) and Saving Objects to a New Drawing (page 758).
Set editing and save back options	Click Map Setup tab ► Map panel ► angle-arrow. See Setting Save Back Options (page 763)

Quick Reference

ADEZEXTENTS

Zooms to display the drawing extents

Menu	Click Map ► Drawings ► Zoom Drawing Extents.
Icon	 Zoom Drawing Extents
Command Line	ADEZEXTENTS
Task Pane	In Map Explorer, right-click Drawings ► Zoom Extents
Dialog Box	Zoom Drawing Extents dialog box

ADEQVIEWDWGS

Performs a quick display of active drawings

Menu	View menu ► Quick View Drawings
Command Line	ADEQVIEWDWGS
Task Pane	In Map Explorer, right-click Drawings ► Quick View-or- Right-click a drawing ► Quick View
Dialog Box	Quick View Drawings dialog box

ADEQUERY

Controls defining, modifying, saving, loading, and executing a query

Menu	In the Classic workspace, click Setup menu ► More DWG Options ► Define Query
Icon	 Define Query
Command Line	ADEQUERY
Task Pane	In Map Explorer, right-click Current Query ► Define -or- Right-click a query ► Edit
Dialog Box	Define Query dialog box

ADESELOBSJ

Creates a set of objects to be saved to source drawings

Menu File menu ► Drawing Save Set Options ► Add Items To Save Set

Icon  Add Objects to Save Set

Command Line ADESELOBJS

Dialog Box ADESELOBJS (Select Objects for Save Back command)

ADEREMOBS

Removes objects from the save set so they aren't saved to source drawings

Menu File menu ► Drawing Save Set Options ► Remove Items From Save Set

Icon  Remove Objects from Save Set

Command Line ADEREMOBS

Dialog Box ADEREMOBS (Remove Objects from Save Set command)

ADESAVEOBS

Saves objects in the save set back to source drawings

Menu In the Classic workspace, click File menu ► Save Source Drawing Save Set

Icon  Save to Source Drawings

Command Line ADESAVEOBS

Dialog Box Save Objects to Source Drawings dialog box

SAVE

Saves the drawing under the current file name or a specified name

Menu File menu ► Save

Command Line SAVE

SAVEAS

Saves an unnamed drawing with a file name or renames the current drawing

Menu	File menu ► Save As
Command Line	SAVEAS

MAPOPTIONS

Sets AutoCAD Map 3D options

Menu	Setup menu ► Autodesk Map Options
Icon	 Options
Command Line	MAPOPTIONS
Task Pane	In Map Explorer, right-click Current Drawing ► Options
Dialog Box	AutoCAD Map Options dialog box

Zooming to the Extents of Selected Drawings

Use Zoom Extents to zoom the current drawing to the extents of the selected source drawings. Adjust the current drawing extents to view all objects after you execute a query.

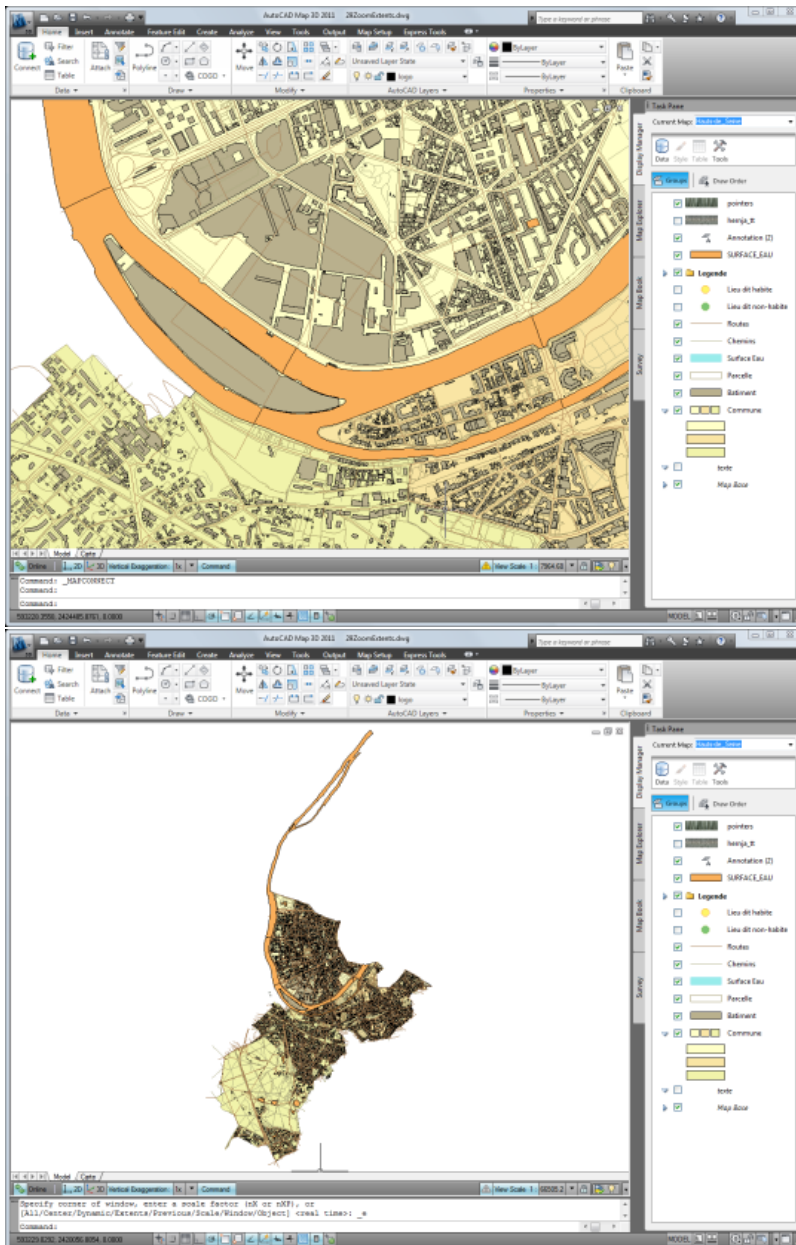

The drawing coordinates in the lower-left corner of the screen reflect the new extents of the current drawing.

NOTE You can also zoom to the extents of a particular geospatial feature layer in the Display Manager. Right-click the layer and click Zoom To Extents.

See also:

- [Setting Save Back Extents](#) (page 170)

To zoom to the extents of selected drawings

- 1 In Map Explorer, right-click Drawings. Click Zoom Extents.
- 2 In the [Zoom Drawing Extents dialog box](#) (page 2014), select the drawings to view.
- 3 Click OK.

The command zooms the current drawing to the extents of the selected source drawings. The drawing coordinates in the lower-left corner of your screen reflect the new extents of the current drawing.

NOTE You can also zoom to the extents of a particular geospatial feature layer in the Display Manager. Right-click the layer and click Zoom To Extents.

Quick Reference

ADEZEXTENTS

Zooms to display the drawing extents

Menu	Click Map ► Drawings ► Zoom Drawing Extents.
Icon	 Zoom Drawing Extents
Command Line	ADEZEXTENTS
Task Pane	In Map Explorer, right-click Drawings ► Zoom Extents
Dialog Box	Zoom Drawing Extents dialog box

Viewing All Objects in Selected Attached Drawings

Use Quick View to preview the contents of one or more active source drawings.

NOTE This functionality is for drawing objects only. There is no equivalent for geospatial feature data.

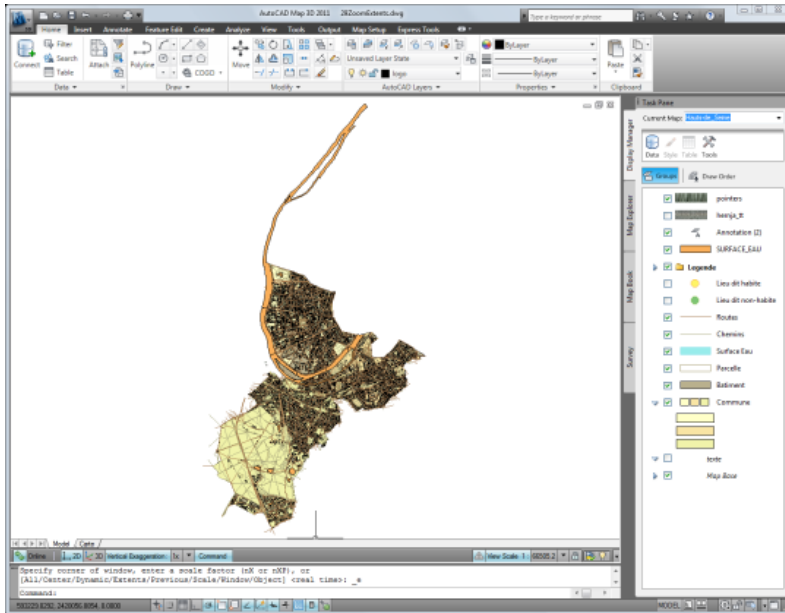

Quick View shows all objects in the selected source drawings.

You can plot the results of a Quick View.

NOTE Quick View displays objects but does not bring them into the drawing. The display contains one selectable picture for each source drawing. To bring objects into the current drawing, define a query that copies the objects from the source drawing into the current drawing. Quick View does not display shapes.

See also:

■ [Overview of Queries](#) (page 1235)

NOTE This procedure is for drawing objects only. There is no equivalent for geospatial feature data.

To view objects in source drawings

- 1 In Map Explorer, right-click Drawings. Click Quick View.

- 2 In the [Quick View Drawings dialog box](#) (page 2013), select the drawings to quick view.
To control the display of nested drawings, select them individually.
- 3 To filter the list of active drawings on the basis of file names, descriptions, or both, click Filter, specify the filter, and click OK. Then select Filter.
- 4 Select Zoom To The Extents Of Selected Drawings to see the extents of all the drawings to review with Quick View.
- 5 Click OK.

The objects in the active source drawing appear. Although you see many objects, each set of objects appears as a single object from each drawing. If you attempt to select several objects, AutoCAD Map 3D reports “one object found” for each of the source drawings.

You can zoom and pan, but you cannot select or edit individual objects. When you regenerate or redraw, the pictures are cleared from the current drawing.

To edit the objects, define a query that copies the objects from the source drawing into the current drawing. For more information, see [Overview of Queries](#) (page 1235).

Quick Reference

ADEQVIEWDWGS

Performs a quick display of active drawings

Menu	View menu ► Quick View Drawings
Command Line	ADEQVIEWDWGS
Task Pane	In Map Explorer, right-click Drawings ► Quick View-or- Right-click a drawing ► Quick View
Dialog Box	Quick View Drawings dialog box

Editing Objects in Attached Drawings

To view and edit objects in attached drawings, create a query that specifies the objects you want. When you run the query, AutoCAD Map 3D finds all the objects in the attached drawings that match the query criteria, and copies those objects to the current drawing.

Example: You have separate drawings for each quadrant of a town. You create a main drawing and attach the other drawings, and then view all water mains in the town or all emergency routes.

NOTE This functionality is for drawing objects only. To filter geospatial feature data with a query, see [Filtering Features When You Add Them to a Map](#) (page 309).

You can save the queried objects back to their attached drawings by adding them to the save set before you edit them. When you save the current drawing, AutoCAD Map 3D prompts you to save the objects in the save set back to their attached drawings. If you do not add modified objects to the save set, you can save the modifications to the current drawing or to a new drawing, but the changes are not saved back to the attached drawings.

Markup objects are not added to the save set. To copy them from the current drawing to an attached drawing, open the attached drawing directly. Copy the markup objects in the current drawing and paste them into the other drawing.

WARNING If you work with an attached drawing from a previous release and save back your changes, AutoCAD Map 3D updates the attached drawing to the current format. To retain the attached drawing in the previous drawing format, do not save back your changes.

See also:

- [Overview of Queries](#) (page 1235)
- [Editing and Saving Objects in Attached Drawings](#) (page 737)

NOTE This procedure is for drawing objects only. To filter geospatial feature data with a query, see [Filtering Features When You Add Them to a Map](#) (page 310).

To edit objects in attached drawings

- 1 [Run a query](#) (page 1235) to retrieve the objects to edit.

- 2 Click Home tab ► Data panel ►  ► Add To Save Set.  Select the objects to edit.

AutoCAD Map 3D locks the objects in the attached drawings so no other users can modify them.

3 Edit the objects.

To save the edited objects back to their attached source drawings

► Click Home tab ► Data panel ►  ► Save To Source. 

Quick Reference

ADEQUERY

Controls defining, modifying, saving, loading, and executing a query

Menu	In the Classic workspace, click Setup menu ► More DWG Options ► Define Query
Icon	 Define Query
Command Line	ADEQUERY
Task Pane	In Map Explorer, right-click Current Query ► Define -or- Right-click a query ► Edit
Dialog Box	Define Query dialog box

ADESAVEOBS

Saves objects in the save set back to source drawings

Menu	In the Classic workspace, click File menu ► Save Source Drawing Save Set
Icon	 Save to Source Drawings
Command Line	ADESAVEOBS
Dialog Box	Save Objects to Source Drawings dialog box

Adding an Object to the Save Set

If you modify an object that was queried from an attached drawing, AutoCAD Map 3D prompts you to add the object to the save set, which locks the object. If an object is locked, other users cannot modify the object.

TIP Lock the objects *before* you edit them. This ensures that other users are not modifying the same objects. To lock an object before editing, manually add the object to the save set.

When you save changed objects back to attached drawings, only objects in the save set are saved back.

NOTE You can [set an option](#) (page 763) to automatically add modified objects to the save set without prompting, or you can turn the prompt off.

New objects are not automatically added to the save set. You must manually add them to the save set.

NOTE This functionality is for drawing objects only. To save edits back to geospatial feature sources, see [Checking In Features](#) (page 693) and [Updating Edits Automatically](#) (page 698).

Additional Information

Keep these points in mind as you modify objects and add them to the save set:

- If an object is on a locked layer in the attached drawing or you are working in the Layout tab, you cannot add the object to the save set.
- If your system administrator has [enabled object locking](#) (page 729), AutoCAD Map 3D locks the objects in the attached drawing when you add the objects to the save set.
- By breaking a queried object into two pieces using the BREAK, TRIM, FILLET, CHAMFER, or EXPLODE commands, you create both an altered queried object and a new object. When you save back the objects, the queried object is automatically saved back to its attached source drawing, and the new object is automatically added to the save set. However, the new object does not have an associated attached drawing; you must specify the drawing to which it will be saved.
- If you experience a system failure while objects are locked, use the Drawing Maintenance command to [release the object locks](#) (page 736).



- AutoCAD Map 3D cannot save edits back to a detached drawing. If you query and edit objects from an attached drawing, do not detach that drawing from the current drawing before you perform the save back operation.
- If you decide you do not want to save changes to an object back to the attached source drawing, remove the object from the save set. The changes are maintained in the current drawing, but are not saved back to the attached drawing.
- If you delete an object after adding it to the save set, you can restore it by removing erased objects from the save set. AutoCAD Map 3D restores all erased objects in the save set.
- After you add objects to the save set, you can undo the operation using the UNDO command.

See also:

- [Removing an Object from the Save Set](#) (page 759)
- [Releasing All Locked Objects for a Specific User](#) (page 736)
- [Sharing Attached Drawings](#) (page 729)
- [Setting Save Back Options](#) (page 763)
- [Solving Problems When Saving Back to Attached Drawings](#) (page 760)

NOTE This procedure is for drawing objects only. To save edits back to geospatial feature sources, see [Checking In Features](#) (page 694) and [Updating Edits Automatically](#) (page 700).

To add objects to the save set and lock the objects

- 1 Click Home tab ► Data panel ►  ► Add To Save Set. 
- 2 At the [ADESELOBJS \(Select Objects for Save Back command\)](#) (page 1886) prompt, enter n to add all new objects to the save set, or enter s and select the objects to add.

Quick Reference

ADESELOBJS

Creates a set of objects to be saved to source drawings

Menu File menu ► Drawing Save Set Options ► Add Items To Save Set

Icon  Add Objects to Save Set

Command Line ADESELOBJS

Dialog Box ADESELOBJS (Select Objects for Save Back command)

Viewing Objects in the Save Set

Objects that you have added to the save set are locked. You can highlight these locked objects in your drawing.



NOTE This functionality is for drawing objects only. For information about editing geospatial feature data, see [Checking Out Features](#) (page 695).

See also:

- [Adding an Object to the Save Set](#) (page 750)
- [Removing an Object from the Save Set](#) (page 759)
- [Turning On Object Locking](#) (page 733)

NOTE This procedure is for drawing objects only. For information about editing geospatial feature data, see [Checking Out Features](#) (page 696).

To view objects in the save set

- 1 Click Home tab ► Data panel ►  ► Show Objects In Save Set. 
- 2 All locked objects are highlighted.

To remove the highlighting, press Enter.

Quick Reference

ADESHOWOBS

Displays the objects in the save set

Menu	File menu ► Drawing Save Set Options ► Show Items In Drawing Save Set
Icon	 Show Objects in Save Set
Command Line	ADESHOWOBS
Dialog Box	ADESHOWOBS (Show Objects in Save Set command)

Saving Queried Objects Back to Attached Drawings

Objects saved back to their attached drawings replace the original objects.

AutoCAD Map 3D lets you save objects to attached drawings in read-only directories.

You cannot undo a Save To Source Drawings operation. Once you perform a Save DWG Save Set operation, attached drawings contain the modified objects.



WARNING If you work with an attached drawing from a previous release and save back your changes, AutoCAD Map 3D updates the attached drawing to the current format. To retain the attached drawing in the previous drawing format, do not save back your changes.

See also:



- [Adding an Object to the Save Set](#) (page 750)
- [Removing an Object from the Save Set](#) (page 759)
- [Sharing Attached Drawings](#) (page 729)
- [Solving Problems When Saving Back to Attached Drawings](#) (page 760)

To save queried objects back to attached source drawings

1 To make sure that objects are in the save set, click Home tab ► Data

panel ►  ► Show Objects In Save Set. 

Click Home tab ► Data panel ►  ► Add To Save Set.  Select the objects to save.

2 Click Home tab ► Data panel ►  ► Save To Source. 

3 In the [Save Objects to Source Drawings dialog box](#) (page 1887), select Save Queried Objects.

4 Click OK.

Quick Reference

ADESAVEOBS

Saves objects in the save set back to source drawings

Menu In the Classic workspace, click File menu ► Save Source Drawing Save Set

Icon  Save to Source Drawings

Command Line ADESAVEOBS

Dialog Box Save Objects to Source Drawings dialog box

Saving New Objects to Attached Drawings

To add *new* objects to attached drawings, select save order options for the new objects.

- **Selective** — Prompts you to select the objects to save to each attached drawing.
- **Area** — Saves new objects in to the attached drawing within whose save back extents the objects lie. By default, the save back extents correspond

to the drawings extents. You can change the save back extents of attached drawings.

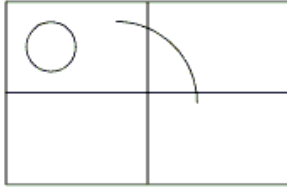

The newly created arc crosses three tiled attached drawings. It is saved to the first drawing in the list of attached drawings. Drawings are listed in the order in which you attach them.

- Layer — Saves new objects to attached drawing layers that use the same names as the current drawing layers on which the objects lie. If more than one active drawing contains a given layer name, AutoCAD Map 3D saves the object to the first drawing that contains that layer.
- None — Disables all other save back options. For example, to specify the objects to save and the attached drawing in which to save them manually, set the first save back option to Selective, and set the other two options to None.

If AutoCAD Map 3D is unable to save new objects using option 1, it uses the setting for save order option 2, and so forth.

You can save objects to attached drawings located in read-only directories.





NOTE This functionality is for drawing objects only. To save edits back to geospatial feature sources, see [Checking In Features](#) (page 693) and [Updating Edits Automatically](#) (page 698).

See also:

- [Adding an Object to the Save Set](#) (page 750)
- [Removing an Object from the Save Set](#) (page 759)
- [Sharing Attached Drawings](#) (page 729)

NOTE This procedure is for drawing objects only. To save edits back to geospatial feature sources, see [Checking In Features](#) (page 694) and [Updating Edits Automatically](#) (page 700).

To save new objects to attached drawings

- 1 To add the objects to the save set, click Home tab ► Data panel ►  ► Add To Save Set.  Enter n to add all new objects to the save set, or enter s and select the objects to add.
- 2 Click Home tab ► Data panel ►  ► Save To Source. 
- 3 In the [Save Objects to Source Drawings dialog box](#) (page 1887), select Save Newly Created Objects.
- 4 Specify the Save Order.
- 5 Select the drawings to save objects to.
- 6 Click OK.
When you use the Selective save method, select the objects to save to each attached drawing.

Quick Reference

ADESAVEOBS

Saves objects in the save set back to source drawings

Menu	In the Classic workspace, click File menu ► Save Source Drawing Save Set
Icon	 Save to Source Drawings
Command Line	ADESAVEOBS
Dialog Box	Save Objects to Source Drawings dialog box

Saving Objects to the Current Drawing

When you query objects from attached drawings into the current drawing, AutoCAD Map 3D creates an association between the original object in the attached drawing and the copy of the object in the current drawing.

If you edit one of these queried objects, you can save the edited object back to the attached drawing, or you can save the edited object to the current drawing. If you save an object to the current drawing, the original object is unchanged in the attached drawings.

TIP When you close the current drawing, the association between queried objects and their attached drawings is removed. If you want to save changes back to the original drawing, you must save back before you close the current drawing.

NOTE This functionality is for drawing objects only. To save edits back to geospatial feature sources, see [Checking In Features](#) (page 693) and [Updating Edits Automatically](#) (page 698).

See also:

- [Adding an Object to the Save Set](#) (page 750)
- [Editing and Saving Objects in Attached Drawings](#) (page 737)
- [Removing an Object from the Save Set](#) (page 759)

NOTE This procedure is for drawing objects only. To save edits back to geospatial feature sources, see [Checking In Features](#) (page 694) and [Updating Edits Automatically](#) (page 700).

To save objects to the current drawing

- 1 Click  ► Save.
- 2 If prompted to save objects to attached source drawings, do not do so at this time, since this removes them from the current drawing.

To save the objects to both the current drawing and attached drawings, first clear Erase Saved Back Objects on the [Save Back tab](#) (page 764) of the [AutoCAD Map Options dialog box](#) (page 1908).

Quick Reference

SAVE

Saves the drawing under the current file name or a specified name

Menu	File menu ► Save
Command Line	SAVE

Saving Objects to a New Drawing

When you save objects to a new drawing, you create a copy of the current drawing, including objects, options, queries, and attached drawings. If you queried objects from attached drawings, the original objects are unchanged in the attached drawings.

NOTE This functionality is for drawing objects only. To save geospatial feature edits to a new data store, see [Migrating GIS Data \(Bulk Copy\)](#) (page 617).

See also:

- [Overview of Queries](#) (page 1235)
- [Editing and Saving Objects in Attached Drawings](#) (page 737)

NOTE This procedure is for drawing objects only. To save geospatial feature edits to a new data store, see [Migrating GIS Data \(Bulk Copy\)](#) (page 621).

To save objects to a new drawing

- 1 Run a query to retrieve the objects. Use Draw mode to copy the retrieved objects to the current drawing.
- 2 Click  ► Save As ► AutoCAD Drawing.
- 3 Enter a name for the new drawing.
- 4 If prompted to save objects to attached source drawings, do not do so at this time, since this removes them from the current drawing.

To save the objects to both a new drawing and to attached drawings, first clear Erase Saved Back Objects on the [Save Back tab](#) (page 764) of the [AutoCAD Map Options dialog box](#) (page 1908).

Quick Reference

SAVEAS

Saves an unnamed drawing with a file name or renames the current drawing

Menu File menu ► Save As
Command Line SAVEAS

Removing an Object from the Save Set

Manually removing an object from the save set releases the lock on the object.

Generally, when you edit an object that was queried in from an attached drawing, that object is locked so no one else can edit it. When you save objects back to attached drawings, the locks are automatically removed. (To change this default setting, use the Map Options command.)

NOTE This functionality is for drawing objects only. To save edits back to geospatial feature sources, see [Checking In Features](#) (page 693) and [Updating Edits Automatically](#) (page 698).

See also:

- [Adding an Object to the Save Set](#) (page 750)
- [Editing and Saving Objects in Attached Drawings](#) (page 737)

NOTE This procedure is for drawing objects only. To save edits back to geospatial feature sources, see [Checking In Features](#) (page 694) and [Updating Edits Automatically](#) (page 700).

To remove objects from the save set and unlock the objects

- 1 Click Home tab ► Data panel ►  ► Remove Objects From Save Set.



- 2 Enter s to select the objects to remove, or enter e to remove objects that have been erased from the current drawing.
If you enter s, select the objects to remove from the save set. Press Enter when you finish selecting objects.
- 3 Click OK.

Quick Reference

ADEREMOBS

Removes objects from the save set so they aren't saved to source drawings

Menu File menu ► Drawing Save Set Options ► Remove Items From Save Set

Icon  Remove Objects from Save Set

Command Line ADEREMOBS

Dialog Box ADEREMOBS (Remove Objects from Save Set command)

Solving Problems When Saving Back to Attached Drawings

Several issues can arise when you save queried objects back to attached drawings.

NOTE This functionality is for drawing objects only. There is no equivalent for geospatial feature data.

Redefining Blocks on Save Back

When you retrieve a block, you can use the EXPLODE command to break the block into its component elements. Edit the separate objects and then use the BLOCK command to redefine the block.

To save the redefined block definition back to the attached source drawing, select the Redefine Block Definitions On Save Back option on the Save Back tab of the [AutoCAD Map Options dialog box](#) (page 1908). AutoCAD Map 3D sets this option by default.

Exploding Blocks and Save Back

If you explode a block, the block definition is deleted and you are prompted to add the separate objects to the save set. If you answer Yes and use the default settings, the block components are erased and are not saved back. To save the individual objects back to the attached source drawings, you must add the individual components of the block to the save set.

Saving Back Dimensions

If you set a global coordinate system or use the Transform editing tool, you might have problems saving back dimensions. If you use a location query to retrieve one or more dimensions and save the dimension back to the attached source drawings, you might find that another location query will not retrieve the dimension. In this case, you should detach the source drawing and reattach it before repeating the location query.

Saving Back Hatch Patterns

When you create an associative hatch pattern, information is written to the boundary objects. When you add such a hatch pattern to a save set, the boundary is also added to ensure data integrity.

When you modify a queried hatch boundary object, the geometry is modified and AutoCAD Map 3D automatically updates the hatch pattern. You are prompted to add the boundary to the save set. Even if you answer Yes, the hatch pattern might not be added to the save set. Check that the hatch pattern is in the save set before you save back the changed objects.

When you add an associative hatch pattern to the save set, AutoCAD Map 3D attempts to add the boundary objects that define the hatch pattern. If all boundary objects are not available, you cannot add the hatch pattern to the save set.

See also:

- [Saving Queried Objects Back to Attached Drawings](#) (page 753)
- [Saving New Objects to Attached Drawings](#) (page 754)
- [Adding an Object to the Save Set](#) (page 750)
- [Removing an Object from the Save Set](#) (page 759)

NOTE This procedure is for drawing objects only. There is no equivalent for geospatial feature data.

To redefine block definitions on save back

- 1 Click Map Setup tab ► Map panel ► angle-arrow.
- 2 In the [AutoCAD Map Options dialog box](#) (page 1908), click the Save Back tab.

- 3 Under Save Back To Source Drawings, select Redefine Block Definitions On Save Back.
- 4 Click OK.

To save back individual block components

- 1 Click Home tab ► Data panel ►  ► Add To Save Set. 
- 2 Select all the block components.
- 3 Press Enter.

To check that the hatch pattern is in the save set

- 1 Click Home tab ► Data panel ►  ► Show Objects In Save Set. 
- 2 If the hatch pattern is not highlighted, make sure that all boundary objects are added to the save set.

Quick Reference

ADESELOBJS

Creates a set of objects to be saved to source drawings

Menu File menu ► Drawing Save Set Options ► Add Items To Save Set

Icon  Add Objects to Save Set

Command Line ADESELOBJS

Dialog Box ADESELOBJS (Select Objects for Save Back command)

ADESHOWOBS

Displays the objects in the save set

Menu File menu ► Drawing Save Set Options ► Show Items In Drawing Save Set

Icon	 Show Objects in Save Set
Command Line	ADESHOWOBS
Dialog Box	ADESHOWOBS (Show Objects in Save Set command)

MAPOPTIONS

Sets AutoCAD Map 3D options

Menu	Setup menu ► Autodesk Map Options
Icon	 Options
Command Line	MAPOPTIONS
Task Pane	In Map Explorer, right-click Current Drawing ► Options
Dialog Box	AutoCAD Map Options dialog box

Setting Save Back Options

A number of options affect how queried objects are saved back to attached drawings or feature sources. These options apply to the current drawing.

NOTE This functionality is for drawing objects only. For information on Automatic Update options for geospatial feature data, see [Updating Edits Automatically](#) (page 698).

Save Set and Edit Set Options

- **Don't Add Objects Automatically** — Edited objects are not added to the save set, and you are not prompted to add them. Use this option if you are creating a new drawing and are not planning to save changes back to attached drawings. You can still [manually add objects to the save set](#) (page 750).
- **Prompt To Add Objects** — When you edit an object that was retrieved from an attached drawing or a feature source, you are prompted to add the object to the save set.

Use this option if you plan to save some edited objects, but not others, back to attached drawing or feature source.

- **Add Objects Automatically Without Prompting** — When you edit an object that was retrieved from an attached drawing or feature source, the object is automatically added to the save set.
Use this option if you plan to save most modified objects back to attached drawings and feature sources.

NOTE To add new objects to attached drawings, add them to the save set manually. AutoCAD Map 3D does not prompt you to add them.

See also:

- [Adding an Object to the Save Set](#) (page 750)
- [Saving Objects to the Current Drawing](#) (page 756)
- [Saving New Objects to Attached Drawings](#) (page 754)
- [Saving Queried Objects Back to Attached Drawings](#) (page 753)
- [Saving Objects to a New Drawing](#) (page 758)
- [AutoCAD Map Options dialog box](#) (page 1908)

NOTE This procedure is for drawing objects only. For information on Automatic Update options for geospatial feature data, see [Updating Edits Automatically](#) (page 700).

To set editing and save back options

- 1 Click Map Setup tab ► Map panel ► angle-arrow.
- 2 In the [AutoCAD Map Options dialog box](#) (page 1908), select the Save Back tab.
- 3 Set the options you want.
 - Use the Save Set options to specify settings for saving objects to attached drawings.
 - Use the Edit Set options to specify settings for saving objects to feature sources.

- 4 Click OK.

Quick Reference

MAPOPTIONS

Sets AutoCAD Map 3D options

Menu	Setup menu ► Autodesk Map Options
Icon	 Options
Command Line	MAPOPTIONS
Task Pane	In Map Explorer, right-click Current Drawing ► Options
Dialog Box	AutoCAD Map Options dialog box

Cleaning Up Drawing Data

Use Drawing Cleanup to correct common map errors resulting from surveying, digitizing, and scanning errors. You can also remove unnecessary detail from complex maps.

NOTE This functionality is for drawing objects only. There is no equivalent for geospatial feature data.

NOTE These procedures are for drawing objects only. There are no equivalents for geospatial feature data.

To clean up drawing data

- [To clean up objects in a map](#) (page 767)
- [To select and anchor objects for drawing cleanup](#) (page 770)
- [To select cleanup actions and set options](#) (page 773)
- [To specify how to convert the objects after cleanup](#) (page 776)
- [To set up markers for interactive mode](#) (page 779)
- [To save Drawing Cleanup settings as a profile](#) (page 781)
- [To load an existing drawing cleanup profile](#) (page 781)
- [To edit a drawing cleanup profile](#) (page 781)
- [To select a correction method](#) (page 782)

- [To select cleanup actions and set options](#) (page 787)

Overview of Cleaning Up Maps

Use Drawing Cleanup to correct common geometry errors resulting from surveying, digitizing, and scanning before you define a topology, perform a map analysis, plot a map, or export to a geospatial data format.

You can also remove unnecessary detail from complex maps.

Example: You digitized paper maps and now some street intersections do not align correctly. You want clean the maps before you create a topology.

NOTE This functionality is for drawing objects only. There is no equivalent for geospatial feature data.

You can perform the following cleanup actions:

- delete duplicate objects
- erase short objects
- break crossing objects
- extend undershoots
- extend to apparent intersections
- snap clustered nodes
- dissolve pseudo nodes
- erase dangling objects (overshoots)
- simplify objects
- delete zero-length objects
- weed 3D polyline vertices

WARNING To edit topologies, use the [topology editing commands](#) (page 851). Drawing Cleanup can make a topology invalid. In addition, when a cleanup action creates a new object or breaks an object into multiple segments, classification information remains with the segment that contains the start point of the original object. Classify other segments manually.

Tell me more



Video

- [Show me how to clean up errors in my data](#)



Tutorial

- [Lesson 2: Clean Up Your Drawings](#)



Procedure

- [To clean up drawing data](#) (page 765)



Workflow

- [Add DWG Data to an Existing Feature Source](#)



GIS Skill

- [Clean up duplicates, gaps, and other accuracy problems in DWG files.](#)



Related topics

- [Correction Methods](#) (page 782)
- [Cleanup Actions](#) (page 787)
- [Overview of Editing a Topology](#) (page 852)

WARNING To edit topologies, use the [topology editing commands](#) (page 851). Drawing Cleanup can make a topology invalid.

NOTE This procedure is for drawing objects only. There is no equivalent for geospatial feature data.

To clean up objects in a map

- 1 Open the drawing containing the objects to clean or query the objects into the current drawing.
- 2 Because your map may be altered during the cleanup operation, back up your data before starting.

- 3 Click Tools tab ► Map Edit panel ► Clean Up.



- 4 In the [Drawing Cleanup](#) (page 1591) dialog box, follow these steps:
 - [Selecting and Anchoring Objects](#) (page 770). Select the objects to include in the cleanup operation and the objects to anchor. Click Next.
 - [Setting Cleanup Options](#) (page 773). Select cleanup actions and set the parameters for each action you select. Specify whether to correct errors automatically or to review and confirm each correction. Click Next.
 - [Converting Objects After Cleanup](#) (page 776). Specify how to treat the original objects after the cleanup operation is complete. Click Next.
 - [Setting Markers for Interactive Mode](#) (page 777). If you selected Interactive mode in Setting Cleanup Options to review error corrections, specify the error markers to use. Click Next.
 - [Saving Cleanup Settings](#) (page 781). To save your settings as a profile, click Save.
- 5 Click Finish.

AutoCAD Map 3D performs the cleanup with the options and values you specified.
- 6 Depending on whether you selected Interactive or Automatic, AutoCAD Map 3D does one of the following:
 - If you selected [Interactive mode](#) (page 783), AutoCAD Map 3D displays a list of detected errors. You can review the errors and decide how to handle them. For example, you can place markers on the errors, correct them, or ignore them.
 - If you selected [Automatic mode](#) (page 782), AutoCAD Map 3D corrects all detected errors automatically and reports a summary of the results on the command line.

You can run the operation again to verify that you corrected all existing errors. Cleaning up geometry in a drawing creates new geometry and new relationships between the objects. You may need to repeat the cleanup operation.

Quick Reference

MAPCLEAN

Performs drawing cleanup operations

Menu Modify menu ► Drawing Cleanup

Icon



Drawing Cleanup

Command Line MAPCLEAN

Dialog Box Drawing Cleanup

Step 1: Selecting and Anchoring Objects

Start by selecting the objects to include in the cleanup. You can automatically select all objects or select objects manually.

You also select the objects to anchor. Anchored objects are reference points and are not altered or moved; objects being cleaned are moved towards anchored objects.

In addition, you can filter object selection by layer and object class so that only objects that belong to the specified layers and object classes are selected.

Example: Select all objects on the Roads layer for cleanup, and anchor survey points in the Monuments object class so that they maintain their accuracy.

NOTE In general, you can clean up linear objects only (lines, arcs, circles, and polylines), although a few cleanup actions support additional object types, including points, blocks, text, and mtext. Anchoring supports these additional object types. Any unsupported object types are not cleaned up or anchored.

NOTE This functionality is for drawing objects only. There is no equivalent for geospatial feature data.

See also:

- [Overview of Cleaning Up Maps](#) (page 766)
- [Select Objects Page](#) (page 1595)
- [Overview of Cleanup Actions](#) (page 788)

NOTE This procedure is for drawing objects only. There is no equivalent for geospatial feature data.

To select and anchor objects for drawing cleanup

- 1 Click Tools tab ► Map Edit panel ► Clean Up. 
- 2 On the [Select Objects Page](#) (page 1595), under Objects To Include In Drawing Cleanup, select the objects to clean up.
 - Choose the method to use for selecting objects. Click Select All to select all objects. Click Select Manually to select individual objects.
 - To limit object selection to objects on specific layers or in specific object classes, specify the layers and object classes to include.
 - If you chose Select Manually, click Select Objects To Be Included to select objects in the drawing area. Press Enter to return to the Select Objects page.

In general, you can clean up linear objects only (lines, arcs, circles, and polylines). A few cleanup actions support additional object types, such as points, blocks, text, and mtext. Unsupported object types are not cleaned up.

The status line shows how many objects are selected and how many have been filtered out.
- 3 Under Objects To Anchor In Drawing Cleanup, select the objects to use as reference points during the drawing cleanup. These points are not altered. You can anchor linear objects, points, blocks, text, and mtext.
 - To limit object selection to objects on specific layers or in specific object classes, specify the layers and object classes to include.
 - Click Select Objects To Be Anchored. Select the objects to anchor. Press Enter to return to the Select Objects page.
- 4 Click Next.
- 5 Continue with [To select cleanup actions and set options](#) (page 773).

Quick Reference

MAPCLEAN

Performs drawing cleanup operations

Menu Modify menu ► Drawing Cleanup

Icon	 Drawing Cleanup
Command Line	MAPCLEAN
Dialog Box	Drawing Cleanup

Step 2: Setting Cleanup Options

As you clean up a map, you select one or more cleanup actions to perform. Each cleanup action detects a different type of map error, for example, duplicate objects, undershoots, or zero-length objects.

NOTE This functionality is for drawing objects only. There is no equivalent for geospatial feature data.

For best results, run Simplify Objects and Weed Polylines individually. Run other cleanup actions individually or with a minimum of other actions.

Cleanup Actions

You can perform the following cleanup actions:

- [Delete Duplicates](#) (page 793)
- [Erase Short Objects](#) (page 795)
- [Break Crossing Objects](#) (page 797)
- [Extend Undershoots](#) (page 799)
- [Apparent Intersection](#) (page 802)
- [Snap Clustered Nodes](#) (page 804)
- [Dissolve Pseudo Nodes](#) (page 807)
- [Erase Dangling Objects](#) (page 809)
- [Simplify Objects](#) (page 811)
- [Zero-Length Objects](#) (page 815)
- [Weed Polylines](#) (page 816)

Order of Cleanup Actions

The order of cleanup actions can produce different results. Specify the order by moving cleanup actions up or down in the list. The action at the top of the list is performed first.

Setting Cleanup Options

Set the options for each cleanup action individually. For more information, see the individual help topics about each cleanup action.

Understanding the Tolerance Setting

Tolerance is the minimum distance allowed between linear objects or nodes. If two linear objects or nodes are separated by a distance less than the tolerance, AutoCAD Map 3D corrects the error.

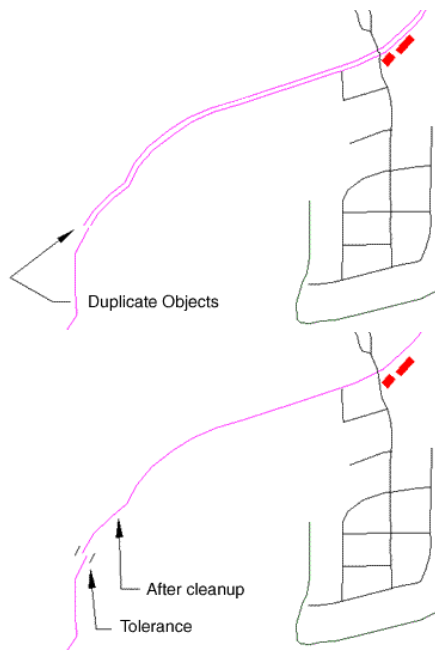

If you set the tolerance too low, AutoCAD Map 3D might miss some errors. If you set the tolerance too high, AutoCAD Map 3D might correct linear objects that are not errors. Decide if the data constitutes an error and choose a suitable tolerance to eliminate errors.

For example, a tolerance of 10 would eliminate dangles less than 10 meters long; but in some cases, such dangles might be the correct mapping of a short pipe or street.

See also:

- [Overview of Cleaning Up Maps](#) (page 766)
- [Select Actions Page](#) (page 1588)
- [Overview of Cleanup Actions](#) (page 788)

NOTE This procedure is for drawing objects only. There is no equivalent for geospatial feature data.

To select cleanup actions and set options

- 1 On the [Select Actions Page](#) (page 1588), select the cleanup actions to perform by adding them to the Selected Actions list.
To add a cleanup action to the Selected Actions list, select the action in the [Cleanup Actions](#) (page 787) list, and click Add.
For best results, run Simplify Objects and Weed Polylines individually. Run other cleanup actions individually or with a minimum of other actions.
- 2 In the Selected Actions list, specify the order of cleanup actions. The order can affect results. The first action in the list is performed first. To change the order, highlight an action and click the up or down arrow.
- 3 In the Selected Actions list, select the action for which you want to specify settings.
- 4 Under Cleanup Parameters, specify the settings to use for the selected action. For more information about each cleanup action, click one of the following links:
 - [Delete Duplicates](#) (page 793)
 - [Erase Short Objects](#) (page 795)
 - [Break Crossing Objects](#) (page 797)
 - [Extend Undershoots](#) (page 799)
 - [Apparent Intersection](#) (page 802)
 - [Snap Clustered Nodes](#) (page 804)

- [Dissolve Pseudo Nodes](#) (page 807)
 - [Erase Dangling Objects](#) (page 809)
 - [Simplify Objects](#) (page 811)
 - [Zero-Length Objects](#) (page 815)
 - [Weed Polylines](#) (page 816)
- 5 To review detected errors before correcting them, under Options, select Interactive. To have AutoCAD Map 3D correct all detected errors without further input from you, select Automatic.
-
- NOTE** Simplify Objects and Weed Polylines are not interactive operations. AutoCAD Map 3D makes these changes automatically during cleanup.
-
- 6 Click Next.
- 7 Continue with [Step 3: Specifying How to Convert Objects After Cleanup](#) (page 775).

Quick Reference

MAPCLEAN

Performs drawing cleanup operations

Menu Modify menu ► Drawing Cleanup

Icon  Drawing Cleanup

Command Line MAPCLEAN

Dialog Box Drawing Cleanup

Step 3: Specifying How to Convert Objects After Cleanup

As you clean up a map, you can specify how to treat the original objects after the cleanup operation is complete.

- **Modify Original Objects** — Uses the original layer and as much of the original data as possible. For example, linear objects are extended where necessary.
- **Retain Original And Create New Objects** — Keeps the original objects and creates new objects on a layer you specify. For example, to extend an undershoot, new linear objects are created on the specified layer for the undershoot and target linear objects, and the originals are retained.
- **Delete Original And Create New Objects** — Deletes all the original objects and creates new objects on a layer you specify. For example, the original undershoot is deleted, and a new linear object is created that extends to the required location.

NOTE This functionality is for drawing objects only. There is no equivalent for geospatial feature data.

NOTE When you create new objects, existing object data and database links are copied to the new objects. All created objects are assigned the current value of the ELEVATION system variable.

Converting Objects to Polylines

You can specify whether to convert lines, arcs, and 3D polylines to 2D polylines, and convert circles to arcs or 2D polylines. If you convert arcs to polylines, the polyline is created using a true arc, not a set of straight line segments. If you convert a circle to a polyline, the polyline is created using two true arcs, not a set of straight line segments. Use these conversion options in the following cases:

- You plan to use the results of the drawing cleanup operation in another program that accepts only polylines.
- You want to modify the line width of the arcs, circles, or lines so you can use them in a thematic map. You can assign line width only to polylines.

NOTE If you convert objects to different entity types during the cleanup process, classified objects may be modified so that they no longer meet the object class definition and will be unclassified.

See also:

- [Overview of Cleaning Up Maps](#) (page 766)
- [Overview of Setting Up Object Classification](#) (page 117)
- [Cleanup Methods Page](#) (page 1585)

NOTE This procedure is for drawing objects only. There is no equivalent for geospatial feature data.

To specify how to convert the objects after cleanup

- 1 On the [Cleanup Methods Page](#) (page 1585), under Cleanup Method, specify how to treat the objects after the conversion process is complete.

NOTE Creating new objects may increase file size significantly.

- 2 If you are creating new objects, select the layer to use.
- 3 Under Convert Selected Objects, specify whether to convert lines, arcs, and 3D polylines to 2D polylines, and convert circles to arcs or 2D polylines.
- 4 To save your settings as a profile, click Save.
- 5 Do one of the following:
 - If you selected [Interactive](#) (page 783) on the Select Actions page, click Next to continue with [To set up markers for interactive mode](#) (page 779).
 - If you selected [Automatic](#) (page 782) on the Select Actions page, click Finish to start the cleanup process.

Quick Reference

MAPCLEAN

Performs drawing cleanup operations

Menu Modify menu ► Drawing Cleanup

Icon



Drawing Cleanup

Command Line	MAPCLEAN
Dialog Box	Drawing Cleanup

Step 4: Setting Up Markers for Interactive Mode

When you review errors interactively, AutoCAD Map 3D places error markers on detected errors to help you locate the errors more quickly and evaluate whether they need correction.

NOTE This functionality is for drawing objects only. There is no equivalent for geospatial feature data.

If you correct an error, the marker is removed. If you do not correct the error, you can remove the marker and skip the error, or leave the marker in the map for later reference.

You can mark each error with a different shape and color marker to indicate each type of operation.

If you clean up a map multiple times, you can remove or maintain markers from earlier operations. You can also remove or maintain markers after the current operation.

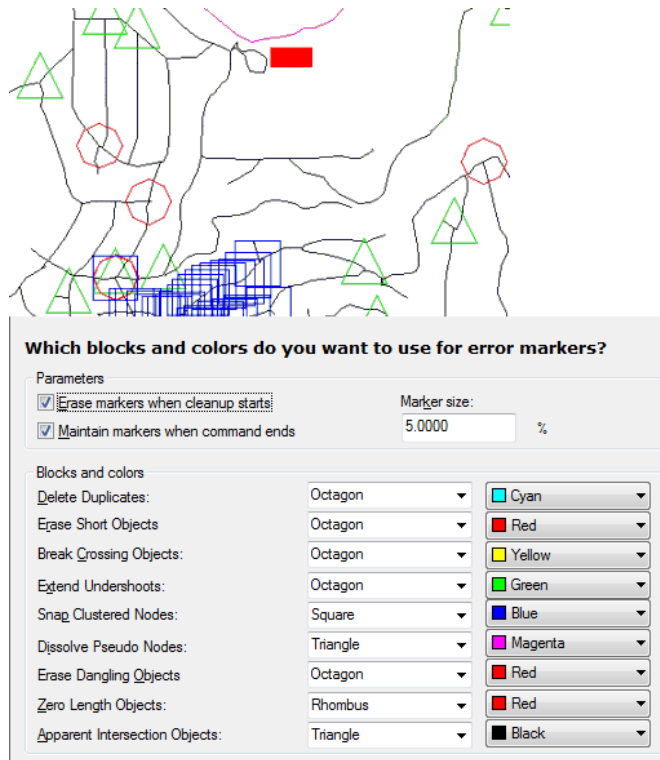

Set the type and color of markers used to mark errors.

- If you correct errors automatically, errors are not marked.
- The markers used in drawing cleanup are the same as those used when creating a polygon topology. Before beginning either operation, existing markers are removed.

See also:

- [Overview of Cleaning Up Maps](#) (page 766)
- [Using Interactive Mode to Review and Confirm Corrections](#) (page 783)
- [Error Markers Page](#) (page 1587)
- [Creating a Polygon Topology](#) (page 833)

NOTE The Error Markers page is available only if you select Interactive in [Step 2](#) (page 773).

NOTE This procedure is for drawing objects only. There is no equivalent for geospatial feature data.

To set up markers for interactive mode

- 1 To remove markers placed by an earlier cleanup operation, on the [Error Markers Page](#) (page 1587), select Erase Markers When Cleanup Starts. This is useful if you repeat the cleanup process to catch errors missed in the first pass.
- 2 To leave markers after this cleanup operation, select Maintain Markers When Command Ends.
- 3 In the Marker Size box, specify a marker size. A value between 3% and 7% is usually suitable.
- 4 Under Blocks And Colors, select the marker shape and color for each type of error.
- 5 To save your settings as a profile, click Save.
- 6 Click Finish.
The [Drawing Cleanup Errors dialog box](#) (page 1593) appears, where you [review errors before correcting them](#) (page 785).

You can run the operation again to verify that you corrected all existing errors. Cleaning up geometry in a drawing creates new geometry and new relationships between the objects. You may need to repeat the cleanup operation.

Quick Reference

MAPCLEAN

Performs drawing cleanup operations

Menu Modify menu ► Drawing Cleanup

Icon  Drawing Cleanup

Command Line	MAPCLEAN
Dialog Box	Drawing Cleanup

Saving Cleanup Settings as a Profile

Once you have specified the settings for drawing cleanup, you can save them as a profile for later use. Profiles are also useful when you automate the drawing cleanup process with scripts. Drawing cleanup profiles are saved as *.dpf files.

NOTE This functionality is for drawing objects only. There is no equivalent for geospatial feature data.

Saving Drawing Cleanup Settings as a Profile

Drawing Cleanup profiles include all the options specified in the drawing cleanup dialog boxes, including the layer names used for object selection and anchoring, cleanup actions and settings, cleanup methods, and error marker settings (if any). Drawing Cleanup profiles do not include the actual objects selected and anchored on the specified layers.

Loading Drawing Cleanup Profiles

Load a profile to make the saved settings current. Settings that are loaded include the object selection and anchoring criteria, cleanup actions and settings, cleanup methods, and error marker settings.

Editing Drawing Cleanup Profiles

You can edit Drawing Cleanup profiles in AutoCAD Map 3D and save your changes, either replacing an existing profile or saving it as a new profile.

WARNING Do not edit Drawing Cleanup profiles outside of AutoCAD Map 3D. Doing so may produce unexpected results.

See also:

- [Overview of Cleaning Up Maps](#) (page 766)

NOTE This procedure is for drawing objects only. There is no equivalent for geospatial feature data.

To save Drawing Cleanup settings as a profile

- 1 Click Tools tab ► Map Edit panel ► Clean Up. 
- 2 Specify the settings to save.
- 3 Click Save.
- 4 In the Save Drawing Cleanup Profile dialog box, enter a name for the profile. Click Save.

To load an existing drawing cleanup profile

- 1 Click Tools tab ► Map Edit panel ► Clean Up. 
- 2 Click Load.
- 3 In the Select Drawing Cleanup Profile dialog box, select the profile to load.
- 4 Click Open.
The settings from the selected profile are made current.

To edit a drawing cleanup profile

- 1 Load the profile as described above.
- 2 Make changes to the Drawing Cleanup settings.
- 3 Save the profile.

Quick Reference

MAPCLEAN

Performs drawing cleanup operations

Menu Modify menu ► Drawing Cleanup

Icon  Drawing Cleanup

Command Line MAPCLEAN

Correction Methods

You can correct errors automatically or review each error and decide how to fix it.

NOTE This functionality is for drawing objects only. There is no equivalent for geospatial feature data.

See also:

- [Overview of Cleaning Up Maps](#) (page 766)
- [Step 3: Specifying How to Convert Objects After Cleanup](#) (page 775)
- [Step 4: Setting Up Markers for Interactive Mode](#) (page 777)

NOTE This procedure is for drawing objects only. There is no equivalent for geospatial feature data.

To select a correction method

- [To correct errors automatically](#) (page 783)
- [To review errors before correcting them](#) (page 785)

Using Automatic Mode to Correct Errors

You can configure AutoCAD Map 3D so that it cleans up detected errors automatically. The results of the cleanup are displayed on the command line.

NOTE This functionality is for drawing objects only. There is no equivalent for geospatial feature data.

See also:

- [Overview of Cleaning Up Maps](#) (page 766)
- [Step 3: Specifying How to Convert Objects After Cleanup](#) (page 775)
- [Using Interactive Mode to Review and Confirm Corrections](#) (page 783)

NOTE This procedure is for drawing objects only. There is no equivalent for geospatial feature data.

To correct errors automatically

- 1 Click Tools tab ► Map Edit panel ► Clean Up. 
- 2 On the Drawing Cleanup - [Select Objects Page](#) (page 1595), select the objects to clean and the objects to anchor. Click Next.
- 3 In the Select Actions Page, select cleanup actions by adding them to the Selected Actions list. Specify the cleanup parameters for each action.
- 4 In the Options area, select Automatic.
- 5 Click Next to go to the Cleanup Methods Page where you specify how you want to treat the objects after the cleanup process is complete.
- 6 Click Finish.
AutoCAD Map 3D corrects the errors and displays a summary of the results on the command line.

Quick Reference

MAPCLEAN

Performs drawing cleanup operations

Menu Modify menu ► Drawing Cleanup

Icon  Drawing Cleanup

Command Line MAPCLEAN

Dialog Box Drawing Cleanup

Using Interactive Mode to Review and Confirm Corrections

Use the Interactive option in the Select Actions Page if you want to review the list of errors detected by the Drawing Cleanup command, place error markers showing their location in the map, and zoom to and highlight errors

to better examine them. Correct errors one at a time or correct all the errors detected for a selected cleanup action as a single action.

NOTE This functionality is for drawing objects only. There is no equivalent for geospatial feature data.

You can [configure error markers](#) (page 777) on the Drawing Cleanup - [Error Markers Page](#) (page 1587). You can also indicate whether to maintain markers both from earlier cleanup operations and after the current cleanup operation.

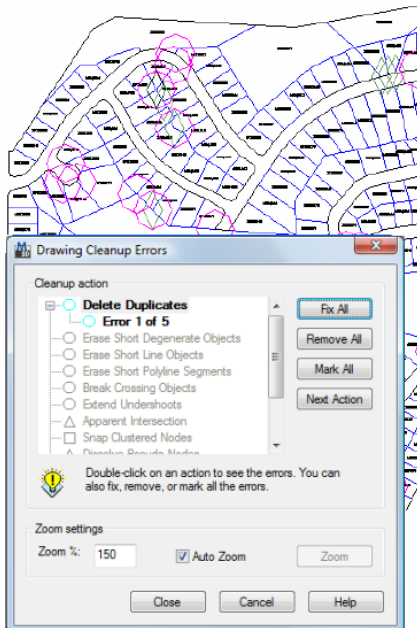

Review, mark, and correct errors interactively.

- All cleanup actions are represented in the [Drawing Cleanup Errors dialog box](#) (page 1593), except for Simplify Objects, which is not an interactive operation.
- If you are cleaning up short objects, AutoCAD Map 3D divides the detected errors into three groups: Short Degenerate Objects, Short Line Objects, and Short Polyline Objects so you can evaluate and correct these types of errors separately. If you are cleaning up zero length objects, AutoCAD Map 3D divides the errors into two groups: Zero Length Line Objects and Zero Length Polyline Objects.

- When you fix an error or group of errors, it may affect the errors further down the list. For example, if you break two crossing objects and create four new, shorter objects, the new objects may be shorter than the tolerance specified for Erase Short Objects tolerance. Drawing Cleanup would detect these as new, additional errors and add them to the list.
- Objects are not updated visually until you close the dialog box. When you review the new errors, objects will not appear in their corrected state.

See also:

- [Overview of Cleaning Up Maps](#) (page 766)
- [Step 3: Specifying How to Convert Objects After Cleanup](#) (page 775)
- [Step 4: Setting Up Markers for Interactive Mode](#) (page 777)
- [Using Automatic Mode to Correct Errors](#) (page 782)

NOTE This procedure is for drawing objects only. There is no equivalent for geospatial feature data.

To review errors before correcting them

- 1 Click Tools tab ► Map Edit panel ► Clean Up. 
- 2 On the Drawing Cleanup - [Select Objects Page](#) (page 1595), select the objects to clean and the objects to anchor. Click Next.
- 3 In the Select Actions Page, select the cleanup actions to perform by adding them to the Selected Actions list. Specify the cleanup parameters for each action.
- 4 To review errors before correcting them, in the Options area, select Interactive.
- 5 On the left side of the dialog box, click Error Markers in the list.
You can also continue clicking Next to set all the parameters for the cleanup operation. After you click Next on the Cleanup Methods page, you can set the markers.
- 6 In the Error Markers Page, specify the size, shape, and color of the error markers to use for each cleanup action. Also specify whether to remove markers from earlier operations or remove markers after this cleanup.

- 7 To [save your settings in a profile](#) (page 781), click Save.
- 8 Click Finish to run the cleanup process and review the list of detected errors in the [Drawing Cleanup Errors dialog box](#) (page 1593).

In the [Drawing Cleanup Errors dialog box](#) (page 1593), the first cleanup action with detected errors is selected. All other actions are shaded. Cleanup actions are listed in the order specified on the Drawing Cleanup - [Select Actions Page](#) (page 1588). The icons to the left of the action name show you what the error marker for that action looks like.

All cleanup actions are represented in the [Drawing Cleanup Errors dialog box](#) (page 1593), with the exception of Simplify Objects, which is not an interactive operation. For short objects, AutoCAD Map 3D divides the detected errors into three groups: Short Degenerate Objects, Short Line Objects, and Short Polyline Objects. If you are cleaning up zero length objects, AutoCAD Map 3D divides the errors into two groups: Zero Length Line Objects and Zero Length Polyline Objects.
- 9 You can address all errors for each cleanup action as follows:
 - To correct all errors for the selected action, click Fix All.

NOTE Corrections are made after you finish reviewing and correcting all errors.

 - To display error markers for all errors for the selected action, making them easily visible in the map, click Mark All.
 - To ignore all errors for a selected action and remove any error markers, click Remove All.
 - To go to the next cleanup action in the list without correcting errors, click Next Action.
- 10 To address errors one at a time, click the plus (+) next to the cleanup action. Select Error 1 of... and choose an option:
 - To correct the current error and go to the next one, click Fix.

NOTE Corrections appear after you finish reviewing and correcting all errors.

 - To leave a marker on the current error, click Mark.
 - To go to the next error in the list without making a correction and remove any error marker, click Remove.

- To skip an error, click Next.
- 11** You can highlight and zoom to errors in the map by setting the following options under Zoom Settings:
- To zoom to selected errors dynamically, select Auto Zoom.
 - To indicate the percent of the drawing display that selected error occupies, enter a value in the Zoom % box. For example, specify 100% to zoom the display to the extents of the selected error, or specify 60% to display more of the drawing outside the selected error. Specify 0 to maintain the current zoom level.
 - To zoom to the selected error, clear the Auto Zoom check box and click Zoom.
- 12** Click Close to make the corrections to your map.

Quick Reference

MAPCLEAN

Performs drawing cleanup operations

Menu Modify menu ► Drawing Cleanup

Icon  Drawing Cleanup

Command Line MAPCLEAN

Dialog Box Drawing Cleanup

Cleanup Actions

Drawing Cleanup actions detect map errors (for example, duplicate objects, undershoots, or zero length objects), simplify complex 2D maps, and weed and supplement 3D polylines.

To select cleanup actions and set options

- [To select cleanup actions and set options](#) (page 791)
- [To delete duplicate objects](#) (page 794)
- [To erase short linear objects](#) (page 796)

- [To break crossing objects](#) (page 799)
- [To extend undershoots](#) (page 801)
- [To extend objects to their apparent intersection](#) (page 803)
- [To snap clustered nodes](#) (page 806)
- [To dissolve pseudo nodes](#) (page 808)
- [To erase dangling objects](#) (page 810)
- [To simplify objects](#) (page 814)
- [To identify zero-length objects](#) (page 815)
- [To weed or add vertices to a 3D polyline](#) (page 819)





Overview of Cleanup Actions





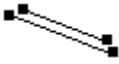
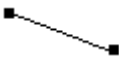
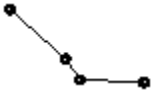











Drawing Cleanup actions can be used to detect map errors (for example, duplicate objects, undershoots, or zero length objects), simplify complex 2D maps, and to weed and supplement 3D polylines. Because Drawing Cleanup can alter your data, make a backup of your data before cleaning up a map.

NOTE This functionality is for drawing objects only. There is no equivalent for geospatial feature data.

For best results, run cleanup actions individually or with a minimum of other actions.

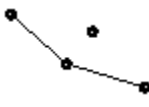
The following table shows examples of problems that Drawing Cleanup can correct.

Before Drawing Cleanup	After Drawing Cleanup	Description of Problem	Cleanup Action
		Duplicate objects	Delete Duplicates (page 793)
		Short objects	Erase Short Objects (page 795)
		Crossing objects	Break Crossing Objects (page 797)

Before Drawing Cleanup	After Drawing Cleanup	Description of Problem	Cleanup Action
		Undershoots	Extend Undershoots (page 799)
		Objects could be extended along their natural paths to intersect at a projected point	Apparent Intersection (page 802)
		Node cluster	Snap Clustered Nodes (page 804)
		Pseudo-nodes	Dissolve Pseudo Nodes (page 807)
		Dangles or overshoots	Erase Dangling Objects (page 809)
		2D linear object simplification	Simplify Objects (page 811)
		Zero-length objects	Zero-Length Objects (page 815).
		Too many or too few vertices in a 3D poly-line	Weed Polylines (page 816)

Order of Cleanup Actions

The order of cleanup actions can produce different results. Specify the order by moving cleanup actions up or down in the list. The action at the top of the list is performed first.

Setting Cleanup Options

Set the options for each cleanup action individually. For more information, see the individual help topics about each cleanup action.

Cleaning for Topology

Some types of errors should be fixed before you create a topology. The following table indicates data errors that should be considered when you are creating a network or polygon topology. Node topologies do not usually require cleanup.

Error	Network Topology	Polygon Topology
Duplicates	Must remove	Must remove
Short Linear Objects	Can remove	Can remove
Crossing Linear Objects	Check for validity. See Creating a Network Topology (page 829).	Must remove
Undershoots	Must remove	Must remove
Node Cluster	Must remove	Must remove
Pseudo Nodes	Can remove	Can remove
Dangles or overshoots	Check for validity. Can remove	Must remove
Simplify Linear Objects	Can apply	Can apply
Zero-Length Objects	Must remove	Must remove

In addition, if you have closed polylines (polygons) that may be missing centroids, you should [create centroids](#) (page 885) for them before using them in topology.

Notes

- Drawing Cleanup affects objects on layers that are OFF. It does not affect objects on layers that are FROZEN. It is recommended that you use drawing cleanup on a layer-by-layer basis, or on selective sets of layers. Avoid using automatic cleanup for all objects on all layers.
- All tools except Weed Polylines work in two dimensions only, ignoring Z-values. When you use the 2D tools, Z data (indicating elevations) might be lost when processing objects at different elevations.

See also:

- [Overview of Cleaning Up Maps](#) (page 766)
- [Step 2: Setting Cleanup Options](#) (page 771)
- [Overview of Editing a Topology](#) (page 852)

NOTE This procedure is for drawing objects only. There is no equivalent for geospatial feature data.

To select cleanup actions and set options

- 1 Click Tools tab ► Map Edit panel ► Clean Up. 
- 2 On the Select Actions page, select the cleanup actions to perform by adding them to the Selected Actions list.
To add an action to the Selected Actions list, select the action in the Cleanup Actions list. Click Add.
 - [To delete duplicate objects](#) (page 794)
 - [To erase short linear objects](#) (page 796)
 - [To break crossing objects](#) (page 799)
 - [To extend undershoots](#) (page 801)
 - [To extend objects to their apparent intersection](#) (page 803)
 - [To snap clustered nodes](#) (page 806)
 - [To dissolve pseudo nodes](#) (page 808)
 - [To erase dangling objects](#) (page 810)

- [To simplify objects](#) (page 814)
 - [To identify zero-length objects](#) (page 815)
 - [To weed or add vertices to a 3D polyline](#) (page 819)
- 3 In the Selected Actions list, specify the order in which to perform the cleanup actions. The order is important and can affect your results. The first action in the list will be performed first. To change the order, highlight an action and click the up or down arrow.

NOTE For best results, run Simplify Objects and Weed Polylines individually. If you run one of these with other actions, it will always be run before other actions, regardless of its position in the list. In addition, these actions will only be run once, regardless of how many times they are listed.

- 4 In the Selected Actions list, select an action.
Each action has its own set of options. Set up each one individually. For information about the settings for an action, click one of the preceding links.
- 5 Under Cleanup Parameters, enter the settings for the selected action.
- 6 To review detected errors before correcting them, under Options, select Interactive. To have AutoCAD Map 3D automatically correct all detected errors, select Automatic.

NOTE Simplify Objects and Weed Polylines are not interactive operations. AutoCAD Map 3D makes these changes automatically during cleanup.

- 7 Continue specifying Drawing Cleanup settings.

Quick Reference

MAPCLEAN

Performs drawing cleanup operations

Menu Modify menu ► Drawing Cleanup

Icon  Drawing Cleanup

Command Line	MAPCLEAN
Dialog Box	Drawing Cleanup

Delete Duplicates

Delete Duplicates locates objects that share the same start and end points as well as all other points within the tolerance distance. You can delete one of the objects.

You can include the following object types:

- Linear objects
- Points
- Blocks
- Text
- Mtext

WARNING Do not use Delete Duplicates with polygon topology because it deletes important topology data.

NOTE This functionality is for drawing objects only. There is no equivalent for geospatial feature data.

- The coordinate locations of objects and the number of vertices (i.e., object geometry) are considered when checking for duplicates, therefore, objects with different directions, objects of different types (for example, lines and polylines), and objects with different properties (for example, linetype and color) can be considered as duplicates.
- You can choose to consider Z-value (elevation) when checking for duplicates. For blocks, text, and mtext, you can also choose whether to consider object rotation.
- Objects with the same geometry, but on different layers, are considered duplicates. Use the Select Objects page to select objects on one layer at a time.

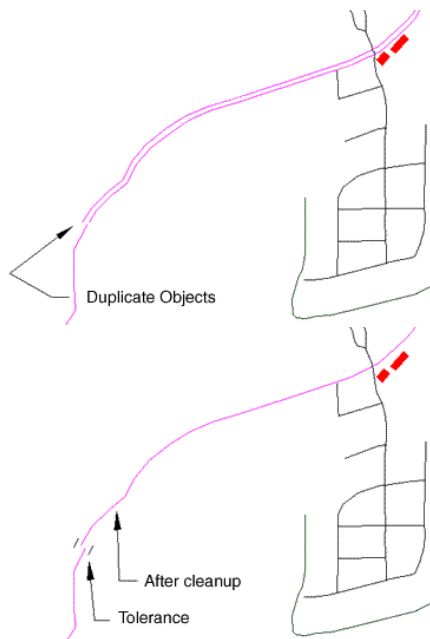

NOTE When deleting duplicate edges that are polyline segments, the command deletes lines and arcs before breaking polylines. The command removes only objects with the same geometry, even if the objects are on different layers.

See also:

- [Overview of Cleaning Up Maps](#) (page 766)
- [Step 2: Setting Cleanup Options](#) (page 771)
- [Overview of Cleanup Actions](#) (page 788)
- [Overview of Editing a Topology](#) (page 852)

NOTE This procedure is for drawing objects only. There is no equivalent for geospatial feature data.

To delete duplicate objects

- 1 Click Tools tab ► Map Edit panel ► Clean Up. 

- 2 On the Select Actions page, in the Cleanup Actions list, click Delete Duplicates. Click Add.
- 3 In the Select Actions list, click Delete Duplicates to display the cleanup parameters for this action.
- 4 Under Cleanup Parameters, set Tolerance to a value slightly higher than the distance between the objects.
Enter a value in the Tolerance box or click Pick to select two points that define the tolerance.
- 5 Select the object types to include in the Delete Duplicates calculation.
- 6 To include rotation in the delete duplicates calculation for Blocks, Text, or Mtext, select Rotation.
- 7 To include z-values (elevation) in the delete duplicates calculation, select Z-values.
- 8 Continue specifying Drawing Cleanup settings.

Quick Reference

MAPCLEAN

Performs drawing cleanup operations

Menu Modify menu ► Drawing Cleanup

Icon  Drawing Cleanup

Command Line MAPCLEAN

Dialog Box Drawing Cleanup

Erase Short Objects

Using the Erase Short Objects cleanup action, you can locate any objects shorter than the specified tolerance and erase them. This removes short isolated linear objects and short linear objects that are part of a polyline.

NOTE This functionality is for drawing objects only. There is no equivalent for geospatial feature data.

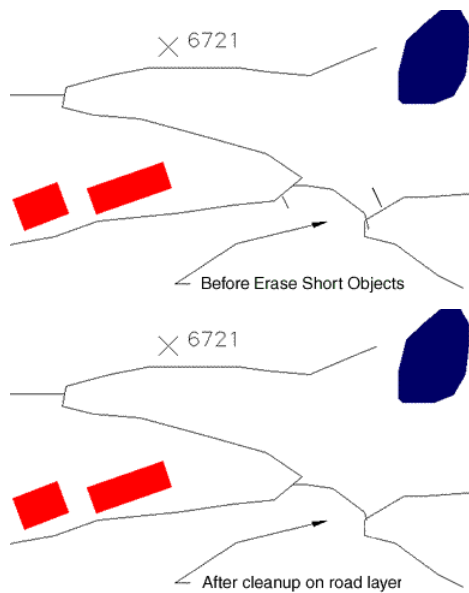

This action is like the Dissolve Pseudo-Nodes action, except Erase Short Objects removes both the linear object and associated nodes.

Depending on your data, use Snap Clustered Nodes next, to correct errors that might result from the Erase Short Objects option.

See also:

- [Overview of Cleaning Up Maps](#) (page 766)
- [Step 2: Setting Cleanup Options](#) (page 771)
- [Overview of Cleanup Actions](#) (page 788)
- [Dissolve Pseudo Nodes](#) (page 807)

NOTE This procedure is for drawing objects only. There is no equivalent for geospatial feature data.

To erase short linear objects

- 1 Click Tools tab ► Map Edit panel ► Clean Up. 

- 2 On the Select Actions page, in the Cleanup Actions list, click Erase Short Objects. Click Add.
- 3 In the Select Actions list, click Erase Short Objects to display the cleanup parameters for this action.
You can enter a value into the Tolerance box or click Pick to go to the map and select two points that define the tolerance to use.
- 4 Under Cleanup Parameters, set Tolerance to a value slightly smaller than the shortest length you want to retain.
- 5 Continue specifying Drawing Cleanup settings.

Quick Reference

MAPCLEAN

Performs drawing cleanup operations

Menu	Modify menu ► Drawing Cleanup
Icon	 Drawing Cleanup
Command Line	MAPCLEAN
Dialog Box	Drawing Cleanup

Break Crossing Objects

Use Break Crossing Objects to locate objects that cross each other and have no node at the crossing, break the crossing objects, and create a node at the crossing. This action takes a complex system of lines, arcs, circles, and polylines and breaks them at intersections into individual, unambiguous objects.

NOTE This functionality is for drawing objects only. There is no equivalent for geospatial feature data.

This action is important when you are establishing network topology or working with topographic contours. The first example shows four linear objects in a network topology that were digitized as two linear objects; after you use Break Crossing Objects, the linear objects are four separate objects that intersect at a common point.

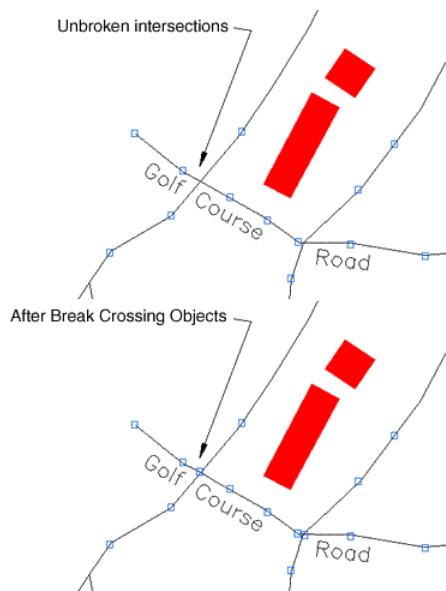

Closed objects, such as contours and lakes, can be cleaned up with the Break Crossing Objects and Erase Dangling Objects actions. Use Break Crossing Objects to create separate objects, and then use [Erase Dangling Objects](#) (page 809) or the ERASE command. Verify that the shape created after editing reflects the intended shape and that a distorted, closed area is not created.

NOTE AutoCAD Map 3D does *not* refer to a tolerance value when breaking crossing objects. The Break Crossing Objects action corrects apparent problems across layers and may break lines meant to indicate separate objects, such as rivers and roads. Use Break Crossing Objects with one layer at a time to avoid this problem. Using the Break Crossing Objects action on an arc whose endpoints are very close may result in the duplication or extension of the arc.

See also:

- [Overview of Cleaning Up Maps](#) (page 766)
- [Step 2: Setting Cleanup Options](#) (page 771)
- [Overview of Cleanup Actions](#) (page 788)
- [Erase Dangling Objects](#) (page 809)
- [Overview of Editing a Topology](#) (page 852)

NOTE This functionality is for drawing objects only. There is no equivalent for geospatial feature data.

To break crossing objects

1 Click Tools tab ► Map Edit panel ► Clean Up. 

2 On the Select Actions page, in the Cleanup Actions list, click Break Crossing Objects. Click Add.

3 Continue specifying Drawing Cleanup settings.

- Break Crossing Objects does not use a tolerance value or other cleanup parameters.
- Using the Break Crossing Objects action on an arc whose endpoints are very close may result in the duplication or extension of the arc.

Quick Reference

MAPCLEAN

Performs drawing cleanup operations

Menu Modify menu ► Drawing Cleanup

Icon  Drawing Cleanup

Command Line MAPCLEAN

Dialog Box Drawing Cleanup

Extend Undershoots

Undershoots are often caused by inaccurate digitizing or when converting scanned data. Using the Extend Undershoots cleanup action, you can locate objects that come within the specified tolerance radius of each other, but do not meet.

NOTE This functionality is for drawing objects only. There is no equivalent for geospatial feature data.

If one object can be extended to cross the other, it will be extended (while maintaining the same direction) and snapped to a point on the object. If no node exists, one will be created at the intersection.

If two objects pass within the specified tolerance and can be snapped without changing their direction, they will be snapped together. If no node exists at that point, one will be created.

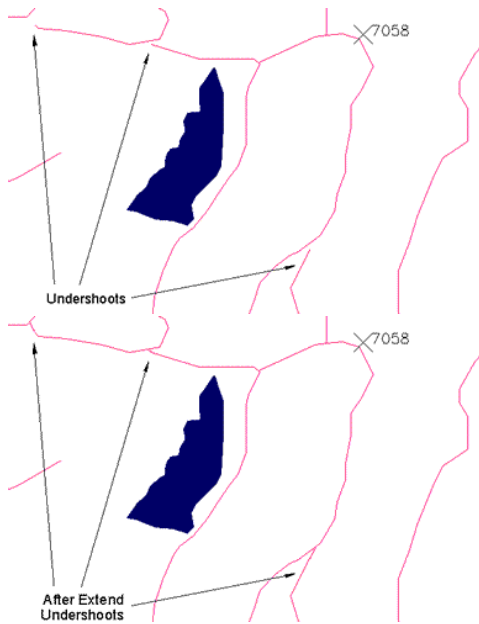

Undershoots are often found in the same drawing as *dangles*. Dangles, or overshoots, occur when a linear object goes beyond an intersection with a target linear object. See [Erase Dangling Objects](#) (page 809).

The Extend Undershoots action works in the same way as [Break Crossing Objects](#) (page 797) works with undershoots, except that with Extend Undershoots, you must select the Break Target option to break the target linear objects at the intersections.

NOTE Using the Extend Undershoots action on an arc whose endpoints are very close may result in the duplication or extension of the arc.

See also:

- [Overview of Cleaning Up Maps](#) (page 766)

- [Step 2: Setting Cleanup Options](#) (page 771)
- [Overview of Cleanup Actions](#) (page 788)
- [Erase Dangling Objects](#) (page 809)
- [Break Crossing Objects](#) (page 797)

NOTE This procedure is for drawing objects only. There is no equivalent for geospatial feature data.

To extend undershoots

- 1 Click Tools tab ► Map Edit panel ► Clean Up. 
- 2 On the Select Actions page, in the Cleanup Actions list, click Extend Undershoots. Click Add.
- 3 In the Select Actions list, click Extend Undershoots to display the cleanup parameters for this action.
- 4 Under Cleanup Parameters, set Tolerance to a value slightly larger than the largest gap.
You can enter a value into the Tolerance box or click Pick to go to the map and select two points that define the tolerance to use.
- 5 To break target linear objects at the intersections during the Extend Undershoots operation, select Break Target.
- 6 Continue specifying Drawing Cleanup settings.

NOTE Using the Extend Undershoots option on an arc whose endpoints are very close may result in the duplication or extension of the arc.

Quick Reference

MAPCLEAN

Performs drawing cleanup operations

Menu Modify menu ► Drawing Cleanup

Icon	 Drawing Cleanup
Command Line	MAPCLEAN
Dialog Box	Drawing Cleanup

Apparent Intersection

With Apparent Intersection, you can locate two objects that do not intersect but that could be extended (within a specified tolerance radius) along their natural paths to intersect at a projected point.

The tolerance is used as a radius distance from the end of the two links. If the endpoints of the objects and the apparent intersection fall within the specified tolerance radius distance, and the objects can be extended without changing their direction, they will be extended to the apparent intersection.

NOTE Apparent Intersection is based on the AutoCAD EXTEND command and uses its Edge and Extend options. For more information, see *EXTEND* in the AutoCAD Help.

NOTE This functionality is for drawing objects only. There is no equivalent for geospatial feature data.

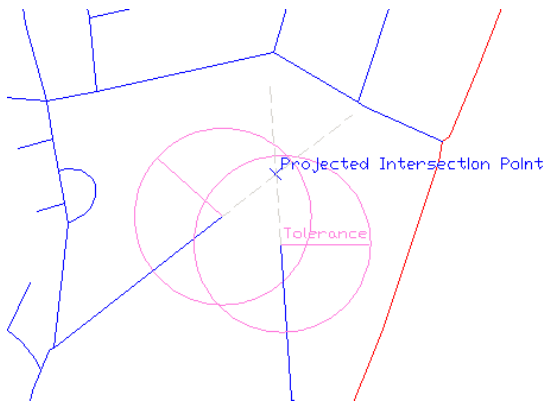

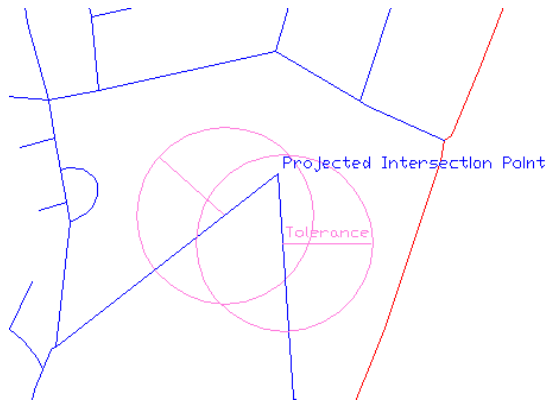

See also:

- [Overview of Cleaning Up Maps](#) (page 766)
- [Step 2: Setting Cleanup Options](#) (page 771)
- [Overview of Cleanup Actions](#) (page 788)

NOTE This procedure is for drawing objects only. There is no equivalent for geospatial feature data.

To extend objects to their apparent intersection

1 Click Tools tab ► Map Edit panel ► Clean Up. 

2 On the Select Actions page, in the Cleanup Actions list, click Apparent Intersection. Click Add.

3 In the Select Actions list, click Apparent Intersection to display the cleanup parameters for this action.

4 Under Cleanup Parameters, set the Tolerance to a value slightly higher than the radius of a circle that includes the endpoints of the objects and their projected intersection point. (Imagine a point where the objects would intersect if they extended along their natural paths).

You can enter a value into the Tolerance box or click Pick to go to the map and select two points that define the tolerance to use.

If AutoCAD Map 3D does not find an apparent intersection, try increasing the Tolerance value.

5 Continue specifying Drawing Cleanup settings.

Quick Reference

MAPCLEAN

Performs drawing cleanup operations

Menu Modify menu ► Drawing Cleanup

Icon  Drawing Cleanup

Command Line MAPCLEAN

Dialog Box Drawing Cleanup

Snap Clustered Nodes

Use Snap Clustered Nodes to correct multiple nodes near the same point. With Snap Clustered Nodes, you locate nodes within a specified tolerance radius distance of each other and snap them to a single location. Nodes at the ends of lines and polylines are automatically included in this cleanup action. You can also include stand-alone nodes (points and blocks).

NOTE This functionality is for drawing objects only. There is no equivalent for geospatial feature data.

The snap point will be one of the existing nodes, and you can choose whether you want it to be one of the link endpoints or one of the stand-alone nodes. Based on your settings, AutoCAD Map 3D determines the best snap point, calculating which point has the most weight based on its relative location to the other nodes. Also considered are anchored nodes. While anchored nodes are not altered or moved during the Snap Clustered Nodes operation, they are included in the calculation that determines the snap point.

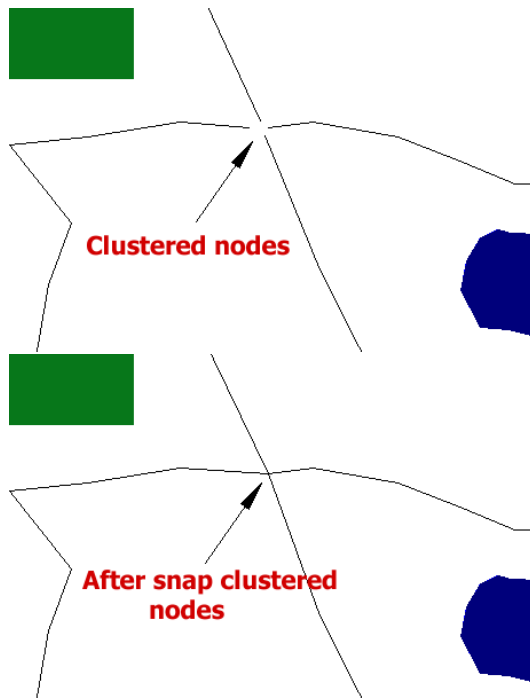

When using Snap Clustered Nodes, keep in mind the following:

- Nodes are moved to a single location but are not deleted, which can result in multiple objects at the same location. Use Delete Duplicates to remove duplicate objects.
- You can anchor objects during object selection so they do not change during the snap operation. Note, however, anchored objects are included in the selection set and will affect the snap point.
- As the endpoints of the links move, the direction of the links can also change.
- Text and MText are excluded from the Snap Clustered Nodes operation.

See also:

- [Overview of Cleaning Up Maps](#) (page 766)
- [Step 2: Setting Cleanup Options](#) (page 771)
- [Overview of Cleanup Actions](#) (page 788)

NOTE This functionality is for drawing objects only. There is no equivalent for geospatial feature data.

To snap clustered nodes

- 1 Click Tools tab ► Map Edit panel ► Clean Up. 
- 2 On the Select Actions page, in the Cleanup Actions list, click Snap Clustered Nodes. Click Add.
- 3 In the Select Actions list, click Snap Clustered Nodes to display the cleanup parameters for this action.
- 4 Under Cleanup Parameters, set Tolerance to a value slightly higher than the radius of a circle that includes the link endpoints and nodes to snap together.
You can enter a value into the Tolerance box or click Pick to go to the map and select two points that define the tolerance to use.
- 5 The endpoints of lines and polylines are automatically included in the Snap Clustered Nodes operation. To include stand-alone nodes in the calculation as well, select the types to include:
 - Points
 - BlocksText and Mtext are automatically excluded.
- 6 Select the snap behavior to use:
 - Snap To Node – Snaps to an existing node.
 - Snap To Link – Snaps to an existing link endpoint.
- 7 Continue specifying Drawing Cleanup settings.

Quick Reference

MAPCLEAN

Performs drawing cleanup operations

Menu Modify menu ► Drawing Cleanup

Icon



Drawing Cleanup

Command Line

MAPCLEAN

Dialog Box

Drawing Cleanup

Dissolve Pseudo Nodes

A pseudo-node is an unnecessary node in a geometric link that is shared by only two objects. For example, a long link might be divided unnecessarily into many, smaller links by pseudo-nodes.

NOTE This functionality is for drawing objects only. There is no equivalent for geospatial feature data.

Using the Dissolve Pseudo-Nodes cleanup action, you can locate any pseudo-nodes, dissolve the node, and join the two objects. This option removes nodes that are at the intersection of two linear objects, but leaves the vertex in place.

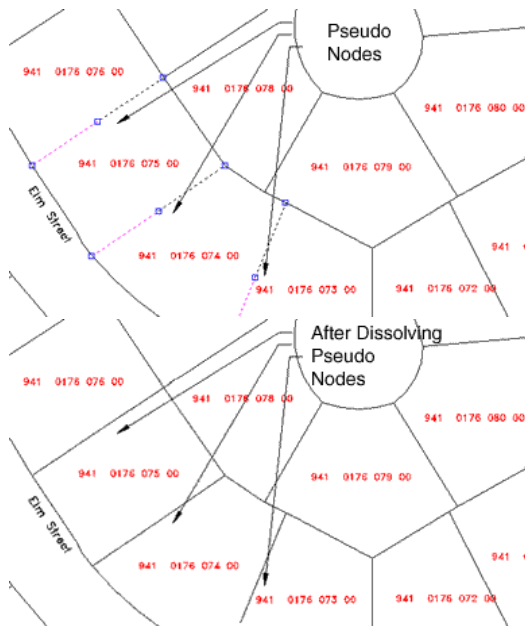

NOTE AutoCAD Map 3D does not refer to a tolerance value when dissolving pseudo nodes.

When you dissolve a pseudo node on a 2D polyline with different Z values, the first Z-value on the object is used. On a 3D polyline, the Z-value on the first vertex is used. The object remains a 3D polyline. For all other properties, the values on the first object are used.

WARNING Using Dissolve Pseudo-Nodes may result in the loss of certain types of data. For example, if two lines have object data attached, the resulting single polyline retains object data from only one of the lines. Similarly, if two lines on different layers share an end point, the resulting polyline will reside on only one of the layers.

See also:

- [Overview of Cleaning Up Maps](#) (page 766)
- [Step 2: Setting Cleanup Options](#) (page 771)
- [Overview of Cleanup Actions](#) (page 788)
- [Erase Short Objects](#) (page 795)
- [Snap Clustered Nodes](#) (page 804)
- [Simplify Objects](#) (page 811)

NOTE This procedure is for drawing objects only. There is no equivalent for geospatial feature data.

To dissolve pseudo nodes

- 1 Click Tools tab ► Map Edit panel ► Clean Up. 
- 2 On the Select Actions page, in the Cleanup Actions list, click Dissolve Pseudo Nodes. Click Add.
- 3 Continue specifying Drawing Cleanup settings.

NOTE Dissolve Pseudo Nodes does not use a tolerance value or other cleanup parameters.

Quick Reference

MAPCLEAN

Performs drawing cleanup operations

Menu Modify menu ► Drawing Cleanup

Icon  Drawing Cleanup

Command Line MAPCLEAN

Dialog Box Drawing Cleanup

Erase Dangling Objects

Use Erase Dangling Objects to locate an object with at least one end point that is not shared by another object, and erase the object.

NOTE This functionality is for drawing objects only. There is no equivalent for geospatial feature data.

The Erase Dangling Objects action searches for and deletes all line, arc, and polyline dangling edges, and nodes. Dangling objects do not include closed polylines.





A dangle is often caused by inaccurate digitizing where an object extends beyond its intended intersection with a target object. Use [Break Crossing Objects](#) (page 797) before using Erase Dangling Objects.

See also:

- [Overview of Cleaning Up Maps](#) (page 766)
- [Step 2: Setting Cleanup Options](#) (page 771)
- [Overview of Cleanup Actions](#) (page 788)
- [Break Crossing Objects](#) (page 797)

NOTE This procedure is for drawing objects only. There is no equivalent for geospatial feature data.

To erase dangling objects

- 1 Click Tools tab ► Map Edit panel ► Clean Up. 
- 2 On the Select Actions page, in the Cleanup Actions list, click Erase Dangling Objects. Click Add.
- 3 In the Select Actions list, click Erase Dangling Objects to display the cleanup parameters for this action.
- 4 Under Cleanup Parameters, set Tolerance to a value slightly larger than the longest dangle to erase.
Enter a value into the Tolerance box or click Pick to go to the map and select two points that define the tolerance to use.

5 Continue specifying Drawing Cleanup settings.

Quick Reference

MAPCLEAN

Performs drawing cleanup operations

Menu Modify menu ► Drawing Cleanup

Icon  Drawing Cleanup

Command Line MAPCLEAN

Dialog Box Drawing Cleanup

Simplify Objects

When maps are digitized, edges may be defined with more detail than necessary. Use Simplify Objects to reduce unnecessary complexity in contour lines, rivers, and coastlines. Simplifying objects, also known as generalizing or weeding, reduces the number of points on a complex line.

NOTE This functionality is for drawing objects only. There is no equivalent for geospatial feature data.

Simplify Objects works in two dimensions, ignoring Z-values. For information about how to add and remove vertices from 3D polylines, see [Weed Polylines](#) (page 816).

When you use Simplify Objects, you simplify complex polylines by removing all interior nodes that fall within the specified tolerance width. Polyline segments falling within the same corridor are generalized into a single polyline. Branching points, dead ends, and endpoints of polylines are not generalized.

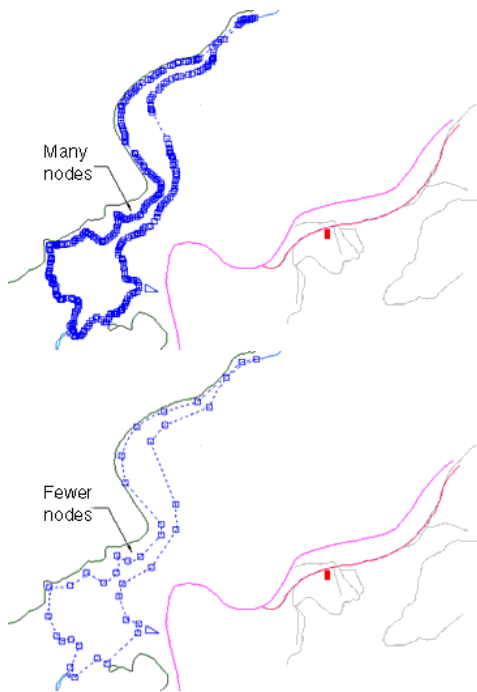

Setting the Tolerance

AutoCAD Map 3D converts a set of connected polyline segments within the same tolerance into a single polyline. You specify the tolerance corridor width. The corridor values vary according to the scale of the map; maps with coordinate values of millions use larger values than those using hundreds.

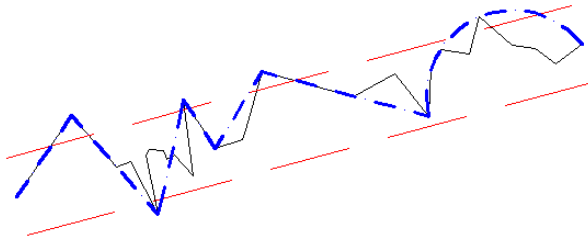

Simplifying linear objects removes as many points as possible from a polyline while keeping it within the original tolerance corridor.

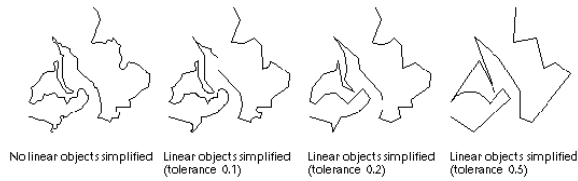

A coastline simplified at different tolerance settings

For best results, follow these guidelines:

- Run Simplify Objects individually. If you perform Simplify Objects with other cleanup actions, AutoCAD Map 3D performs Simplify Objects first, regardless of its position in the Selected Actions list.
- Use [deleting duplicates](#) (page 793) before simplifying linear objects.
- If your objects are lines, not plines, use Dissolve Pseudo Nodes to create a single pline.
- Simplify Objects removes width from polylines. Save your map before you simplify linear objects, so you can return to the original lines if necessary.

NOTE Simplify Objects is not an interactive operation. AutoCAD Map 3D makes the changes automatically during cleanup.

See also:

- [Overview of Cleaning Up Maps](#) (page 766)
- [Step 2: Setting Cleanup Options](#) (page 771)
- [Overview of Cleanup Actions](#) (page 788)
- [Weed Polylines](#) (page 816)
- [Delete Duplicates](#) (page 793)
- [Using Interactive Mode to Review and Confirm Corrections](#) (page 783)

NOTE Simplify Objects works in two dimensions, ignoring Z-values. For information about how to add and remove vertices from 3D polylines, see [Weed Polylines](#) (page 816).

NOTE This procedure is for drawing objects only. There is no equivalent for geospatial feature data.

To simplify objects

- 1 Click Tools tab ► Map Edit panel ► Clean Up. 
- 2 On the Select Actions page, in the Cleanup Actions list, click Simplify Objects. Click Add.

NOTE For best results, run Simplify Objects individually. If you run Simplify Objects with other actions, AutoCAD Map 3D runs Simplify Objects first, regardless of its position in the Selected Actions list.

- 3 In the Select Actions list, click Simplify Objects to display the cleanup parameters for this action.
- 4 Under Cleanup Parameters, set Tolerance to an appropriate value.
You can enter a value into the Tolerance box or click Pick to go to the map and select two points that define the tolerance to use.
- 5 To allow the introduction of arcs during the Simplify Objects operation, select Create Arcs.
- 6 Accept all other defaults.
AutoCAD Map 3D automatically simplifies objects. Do not use the Interactive option.
- 7 Continue specifying Drawing Cleanup settings.

Quick Reference

MAPCLEAN

Performs drawing cleanup operations

Menu Modify menu ► Drawing Cleanup

Icon  Drawing Cleanup

Command Line MAPCLEAN

Dialog Box Drawing Cleanup

Zero-Length Objects

Use Zero-Length Objects to locate lines, arcs, and polylines that have a start point and an end point but have zero-length, or are missing an end point, and erase them. The Zero-Length Objects cleanup action does not evaluate closed polylines.

Zero-length objects can be introduced inadvertently when importing data from other applications or when digitizing map data.

NOTE AutoCAD Map 3D does not refer to a tolerance value when identifying zero-length objects.

NOTE This functionality is for drawing objects only. There is no equivalent for geospatial feature data.

See also:

- [Overview of Cleaning Up Maps](#) (page 766)
- [Step 2: Setting Cleanup Options](#) (page 771)
- [Overview of Cleanup Actions](#) (page 788)

NOTE This procedure is for drawing objects only. There is no equivalent for geospatial feature data.

To identify zero-length objects

- 1 Click Tools tab ► Map Edit panel ► Clean Up. 
- 2 On the Select Actions page, in the Cleanup Actions list, click Zero Length Objects. Click Add.
- 3 Continue specifying Drawing Cleanup settings.

NOTE Zero Length Objects does not use a tolerance value or other cleanup parameters.

Quick Reference

MAPCLEAN

Performs drawing cleanup operations

Menu Modify menu ► Drawing Cleanup

Icon



Drawing Cleanup

Command Line MAPCLEAN

Dialog Box Drawing Cleanup

Weed Polylines

Use Weed Polylines to add and remove vertices on 3D polylines. This is helpful to control the drawing file size and contour appearance, or to remove redundant information.

NOTE This functionality is for drawing objects only. There is no equivalent for geospatial feature data.

Enter Weeding Factors and Supplementing Factors to determine if a vertex should be added or removed from the 3D polyline.

Weeding Factors

Use Weeding Factors to reduce the number of points generated along 3D polylines. Weeding factors ignore vertices that are closer together than the Distance factor and that deflect less than the Angle factor. A larger distance and deflection angle weeds a greater number of points. The distance factor is measured in linear units and the angle factor is measured in angular units.

Weeding Factors must be less than Supplementing Factors.

A point on the 3D polyline is weeded by calculating its location in relation to the vertices before and after it. If the length between these three points is less than the weeding length value, and the deflection angle is less than the weeding angle value, then the middle point is not added to the contour data file.

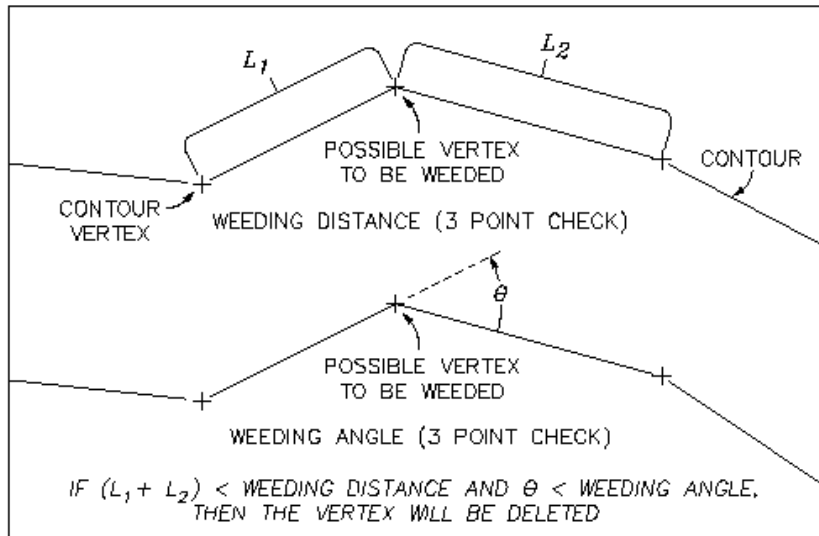

Weeding factor parameters

Supplementing Factors

Use Supplementing Factors to supplement or add vertices along 3D polylines. The supplementing distance is the maximum distance between vertices. If the distance between vertices on a contour is greater than the Supplementing Factors, then points are added along the contour at equal intervals that are less than or equal to the supplementing distance. The smaller the distance, the greater the number of supplemented points.

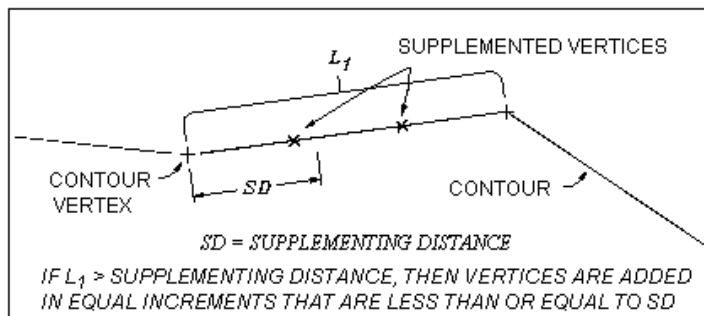

Supplementing Factors parameters

Bulge

For curves, the bulge value is a ratio of the distance from the arc to the chord divided by half the length of the chord. The bulge factor adds vertices to a polyline curve, creating an approximation of the curve using straight line segments. The length of these segments varies depending on the bulge factor and the degree of curvature.

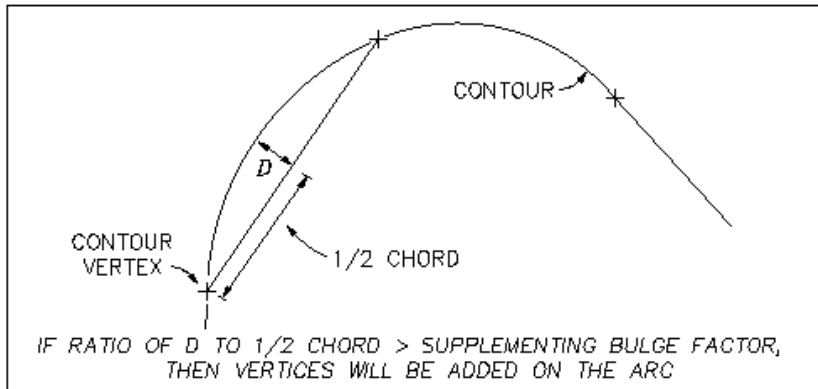

Bulge factor parameters

■ Notes

- Run Weed Polylines individually. If you run it with other operations, it will always be run before other actions, regardless of its position in the list. In addition, it will only be run once, regardless of how many times it is listed.
- Weed Polylines is not an interactive operation. AutoCAD Map 3D makes the changes automatically during cleanup.

See also:

- [Overview of Cleaning Up Maps](#) (page 766)
- [Step 2: Setting Cleanup Options](#) (page 771)
- [Overview of Cleanup Actions](#) (page 788)
- [Using Interactive Mode to Review and Confirm Corrections](#) (page 783)

NOTE This procedure is for drawing objects only. There is no equivalent for geospatial feature data.

To weed or add vertices to a 3D polyline

- 1 Click Tools tab ► Map Edit panel ► Clean Up. 
- 2 On the Select Objects page, select the 3D polylines from which to remove extra vertices or add vertices. Click Next.
- 3 On the Select Actions page, in the Cleanup Actions list, click Weed Polylines. Click Add >.

NOTE Run Weed Polylines by itself (without other cleanup actions). If you run it with other actions, Weed Polylines runs only once, regardless of how many times it is listed in the Selected Actions list, and it always runs before other actions, regardless of its position in the list.

- 4 In the Select Actions list, click Weed Polylines to display the Cleanup Parameters for this action.
- 5 Under Weeding Factors, enter the weeding distance in the Distance box, or click Pick and use your pointing device to specify distance by selecting two locations in the drawing.
- 6 For Angle, enter the deflection angle, or click Pick to specify the angle by selecting a starting point, a vertex, and an ending point.
 - A point on a 3D polyline is weeded by calculating its location in relation to the vertices before and after it. If the length between these three points is less than the weeding Distance value, and the deflection angle is less than the weeding Angle value, then the middle point is weeded out.
 - A larger distance and deflection angle weeds a greater number of points.
 - The weeding distance must be less than the supplementing distance.
 - When using Pick to specify measurements, measurements are displayed dynamically using a tooltip. The format and precision of the measurements are determined by the UNITS command.
- 7 Under Supplementing Factors, enter the supplementing Distance, or click Pick to specify distance in the drawing.

The supplementing distance is the maximum distance between vertices. If the distance between vertices on a contour is greater than the supplementing factor, then points are added along the contour at equal

intervals that are less than or equal to the supplementing distance. The smaller the distance, the greater the number of supplemented points.

- 8 For Bulge, enter the bulge factor value, or click Pick to specify it in the drawing.

The bulge factor adds vertices to a polyline curve, creating an approximation of the curve using straight line segments. The bulge value is a ratio of the distance from the arc to the chord divided by half the length of the chord.

- 9 Continue specifying Drawing Cleanup settings. Click Finish.

When the operation is complete, the total number of original vertices, the total number of vertices removed, and the number of new vertices is reported on the command line.

Quick Reference

MAPCLEAN

Performs drawing cleanup operations

Menu Modify menu ► Drawing Cleanup

Icon  Drawing Cleanup

Command Line MAPCLEAN

Dialog Box Drawing Cleanup

Creating, Editing, and Managing Topologies

A topology is defined by a set of objects and data and their relationship. Use the information in these sections to create, analyze, edit, and manage topologies.

NOTE This functionality is for drawing objects only. There is no equivalent for geospatial feature data. However, you can use buffers to analyze features by proximity and perform overlay analysis on two geospatial feature layers. See [Buffering Features in Your Map](#) (page 1306) and [Overlaying Two Feature Sources](#) (page 1309).

NOTE This procedure is for drawing objects only. There is no equivalent for geospatial feature data. However, you can use buffers to analyze features by proximity and perform overlay analysis on two geospatial feature layers. See [Buffering Features in Your Map](#) (page 1308) and [Overlaying Two Feature Sources](#) (page 1316).

To create, edit, and manage topologies

- [To create a topology](#) (page 822)
- [To edit a topology](#) (page 851)
- [To manage topologies](#) (page 899)

Creating Topologies

Topology defines how map features represented by points, lines, and polygons are connected and how to account for their adjacency. For example, topology can show that parcels do not overlap, or that delivery routes follow roads. Using AutoCAD Map 3D, you can create node, network, or polygon topologies.

For network topologies, you can specify the direction of movement allowed for links and the resistance for links and nodes.

NOTE This functionality is for drawing objects only. There is no equivalent for geospatial feature data. However, you can use buffers to analyze features by proximity and perform overlay analysis on two geospatial feature layers. See [Buffering Features in Your Map](#) (page 1306) and [Overlaying Two Feature Sources](#) (page 1309).

- [Overview of Creating Topologies](#) (page 822)
- [Creating a Node Topology](#) (page 826)
- [Creating a Network Topology](#) (page 829)
- [Creating a Polygon Topology](#) (page 833)
- [Cleaning Data for a Polygon Topology](#) (page 838)
- [Creating Topologies for a Land Use Map](#) (page 839)
- [Sliver Polygons](#) (page 841)
- [Specifying the Direction for a Link](#) (page 845)
- [Specifying the Resistance for a Link or Node](#) (page 849)

NOTE This procedure is for drawing objects only. There is no equivalent for geospatial feature data. However, you can use buffers to analyze features by proximity and perform overlay analysis on two geospatial feature layers. See [Buffering Features in Your Map](#) (page 1308) and [Overlaying Two Feature Sources](#) (page 1316).

To create a topology

- To create a topology (page 825)
- create a node topology (page 827)
- To create a network topology (page 831)
- To fix crossing objects (page 839)
- To create a topology for a land use and land cover map (page 840)
- To find sliver polygons when you create a polygon topology (page 843)
- To find sliver polygons when overlaying two topologies (page 843)
- To specify the direction for a link (page 847)
- To edit the resistance of a link or node in a network topology (page 850)

Overview of Creating Topologies

Using AutoCAD Map 3D, you can create node, network, or polygon topologies.

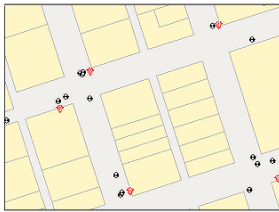

Node Topology: Fire Hydrants and Valves



Network Topology: Roads

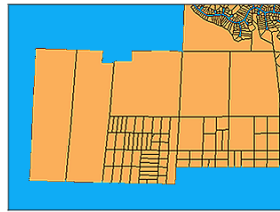

Polygon Topology: County Boundaries

NOTE This functionality is for drawing objects only. There is no equivalent for geospatial feature data. However, you can use buffers to analyze features by proximity and perform overlay analysis on two geospatial feature layers. See [Buffering Features in Your Map](#) (page 1306) and [Overlaying Two Feature Sources](#) (page 1309).

Node Topologies

- Define the interrelation of nodes (point objects).
- Are often used in conjunction with other topologies in analysis.

Network Topologies

- Connect links (lines) to form a linear network.
- Links can connect nodes.

An example of network topology is a water-distribution application that traces the flow of water from a pumping station to residences. A street network is another example. For network topologies, you can specify the direction for a link and specify the resistance for a link or node.

Polygon Topologies

- Define polygons that represent enclosed areas such as land parcels and census tracts. A single link defines the common boundary between adjacent areas.

Uses of polygon topology include tax assessment and land planning in which parcels of land are represented by polygons. Political boundaries, such as voting districts, city, state, or provincial boundaries, special districts, and school districts, are other examples of the use of polygon topology.

Notes

When you create a topology, keep the following points in mind:

- Before you create network or polygon topologies, use the drawing cleanup tools to [clean up your map](#) (page 765). Node topologies do not usually require cleanup.
- Before you create a topology, freeze all layers containing objects in paper space (Layout tab). Otherwise, these objects are included in the topology creation when you use the Select All objects option.
- MAPTOPOCREATE can create topologies on layers that are turned off. It does not affect layers that are frozen.
- When creating network or polygon topologies, if you enable the Create New Nodes option, AutoCAD Map 3D detects where lines are connected and assigns nodes to end points. It creates physical or explicit node objects at all link end points where no objects exist. If the layer you specify does not exist already, AutoCAD Map 3D creates the layer with a color of 7 and a CONTINUOUS linetype.
- You can create nodes using ACAD_POINT. To change their appearance and size, at the Command prompt, enter ddptype.
- When you create a topology, information is stored as object data on each element of the topology and is saved with the map. Each node, link, or polygon is automatically given a unique identification (ID) number. Each ID is automatically processed when you use any topology command.

WARNING Using the BREAK command affects topology. If you use BREAK, you must use MAPTOPOCREATE again to recreate the topology. You might also need to clean up the geometry in the drawing again.

Tell me more



Video

- *Show me how to create a network topology.*
- *Show me how to load a topology.*
- *Show me how to find the shortest path between two points.*
- *Show me how to do an overlay analysis using two topologies.*



Procedure

- [To create a topology](#) (page 825)



GIS Skill

- *Create a network topology to show how lines are connected.*
- *Find the shortest path through a network.*
- *Find which lines are within a particular polygon (overlay analysis).*



Related topics

- [Cleaning Up Drawing Data](#) (page 765)
- [Editing Topologies](#) (page 851)
- [Managing Topologies](#) (page 898)

NOTE This procedure is for drawing objects only. There is no equivalent for geospatial feature data. However, you can use buffers to analyze features by proximity and perform overlay analysis on two geospatial feature layers. See [Buffering Features in Your Map](#) (page 1308) and [Overlaying Two Feature Sources](#) (page 1316).

To create a topology

- 1 Bring the nodes or links into the current drawing:
 - Attach the drawings containing the objects, then query the objects into the current drawing.
 - Open the drawing containing the objects.
- 2 Click Create tab ► Topology panel ► New. 
- 3 In the [Create Topology - Select Topology dialog box](#) (page 1969), enter a name and description for the new topology.
- 4 Under Topology Type, select the topology to create. Follow the steps for that topology:
 - [create a node topology](#) (page 827)
 - [To create a network topology](#) (page 831)
 - [To create a polygon topology](#) (page 836)
- 5 When you are done specifying settings, click Finish to create the topology.
- 6 If appropriate, save the topology information back to source drawings.

As you create the topology, if AutoCAD Map 3D finds errors, it gives a warning message and highlights the errors. Correct any errors; then create the topology over again.

Quick Reference

MAPTOPOCREATE

Creates a new topology

Menu

Click Map ► Topology ► Create.

Icon



Create Topology

Command Line

MAPTOPOCREATE

Task Pane

In Map Explorer, right-click Topologies ► Create

Dialog Box

Create Topology dialog box

PROPERTIES

Displays the Properties palette, which allows you to edit the properties of objects

Menu Analyze ► Properties

Icon  Properties

Command Line PROPERTIES

Task Pane Select object. Right-click in drawing area ► Properties

Creating a Node Topology

You can create a node topology with point objects, blocks, or text. A node topology used in association with a network or polygon topology can hold information about junctions and intersections between elements of the topology.

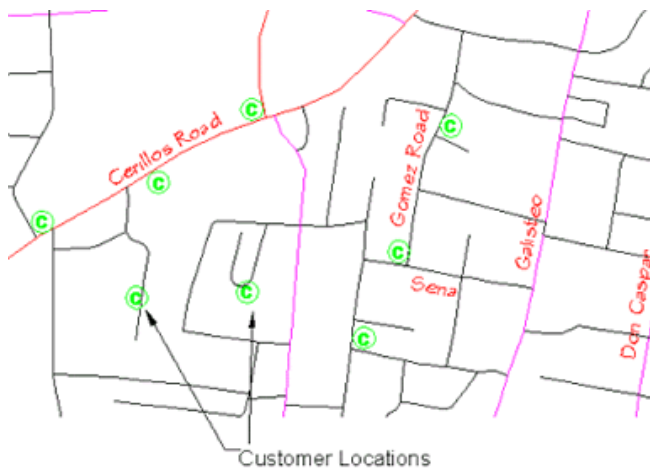

Customer locations can be used as the basis for a node topology.

NOTE This functionality is for drawing objects only. There is no equivalent for geospatial feature data. However, you can use buffers to analyze features by proximity and perform overlay analysis on two geospatial feature layers. See [Buffering Features in Your Map](#) (page 1306) and [Overlaying Two Feature Sources](#) (page 1309).

Object Data for Node Topology

Information about a node topology is held in an object data table as shown in this table.

Topology Name	Object Data Table	Object Data Field
SAMPLE_NODE	TPMNODE_SAMPLE_NODE	ID

See also:

- [Overview of Creating Topologies](#) (page 822)
- [Changing the Appearance of Points](#) (page 869)
- [Creating a Network Topology](#) (page 829)
- [Creating a Polygon Topology](#) (page 833)

NOTE This procedure is for drawing objects only. There is no equivalent for geospatial feature data. However, you can use buffers to analyze features by proximity and perform overlay analysis on two geospatial feature layers. See [Buffering Features in Your Map](#) (page 1308) and [Overlaying Two Feature Sources](#) (page 1316).

create a node topology

- 1 Do one of the following to bring nodes into the current drawing:
 - Attach the drawings containing the nodes. Query the nodes into the current drawing.
 - Open the drawing containing the nodes.
 - Import nodes from another file format.
- 2 Click Create tab ► Topology panel ►  New.
- 3 In the [Create Topology - Select Topology dialog box](#) (page 1969):
 - Click Node to specify the type of topology to create.
 - Enter a name and description for the new topology. Names can contain letters, numbers, and the underscore, hyphen, and dollar characters. Names cannot include spaces.
 - Click Next.

- 4 In the [Create Node Topology - Select Nodes dialog box](#) (page 1959), specify the nodes to include in the topology:
 - To include all nodes in the map, click Select All.
 - To manually select the nodes to include, click Select Manually. Click Select Nodes to select the nodes in the map. When you finish selecting nodes, press Enter.
 - To filter (restrict) node selection by layer (only the nodes that are on specified layers will be selected), specify those layers in the Layers box. To select from a list of layers in the map, click Select Layers. If the layer is not listed, it may be Frozen, Locked, or Off. To use all layers, enter an asterisk (*).
 - To use only selected blocks as node objects, specify those blocks in the Blocks box. To use points as nodes, select the ACAD_POINT block.
 - To filter node selection by object class, specify those object classes in the Object Classes box. Only nodes that belong to the specified object classes will be included in the topology.

The layer, block, and object class filters apply to both automatic and manual selection of nodes.
- 5 Click Finish to create the topology.
- 6 If appropriate, save the topology information back to source drawings.

Quick Reference

MAPTOPOCREATE

Creates a new topology

Menu Click Map ► Topology ► Create.

Icon  Create Topology

Command Line MAPTOPOCREATE

Task Pane In Map Explorer, right-click Topologies ► Create

Dialog Box Create Topology dialog box

Creating a Network Topology

Network topology defines the interconnection of links and, optionally, nodes at link junctions. Networks may contain loops. Network segments have a specified direction. Links can be lines, open polylines, or arcs. You can use information from different layers to define a network topology.

NOTE This functionality is for drawing objects only. There is no equivalent for geospatial feature data. However, you can use buffers to analyze features by proximity and perform overlay analysis on two geospatial feature layers. See [Buffering Features in Your Map](#) (page 1306) and [Overlaying Two Feature Sources](#) (page 1309).

If you plan to use the network topology for direction analysis, you can use PEDIT to join a series of objects with the same flow direction into one object with nodes at each vertex. The directions derived from arc objects might be arbitrary; to control and edit these directions easily, use PEDIT to join segments with the same direction.

When you create the network topology with nodes at each intersection, the nodes do not significantly increase file size. You can use the nodes for [path traces](#) (page 1324), [best route analysis](#) (page 1328), and [flood traces](#) (page 1333).

Object Data for Network Topology

Network topology information is stored on the links and nodes as object data. Each element of the network topology has different object data values.

Topology Name	Object Data Table	Object Data Field
SAMPLE_NET	TPMLINK_SAMPLE_NET	ID
		START_NODE
		END_NODE
		DIRECTION
		DIRECT_RESISTANCE
		REVERSE_RESISTANCE

By default, each link is bidirectional. Both resistance and direction are stored as object data. You can edit both [direction](#) (page 845) and [resistance](#) (page 849) values.

If you create nodes when you create the network topology, the object data table for each node has the following information.

Topology Name	Object Data Table	Object Data Field
SAMPLE_NET	TPMNODE_SAMPLE_NET	ID
		RESISTANCE

Tell me more



Video

- *Show me how to create a network topology.*
- *Show me how to load a topology.*
- *Show me how to find the shortest path between two points.*
- *Show me how to do an overlay analysis using two topologies.*



Procedure

- [To create a network topology](#) (page 831)



GIS Skill

- *Create a network topology to show how lines are connected.*
- *Find the shortest path through a network.*
- *Find which lines are within a particular polygon (overlay analysis).*



Related topics

- [Overview of Creating Topologies](#) (page 822)
- [Creating a Node Topology](#) (page 826)
- [Changing the Appearance of Points](#) (page 869)
- [Creating a Polygon Topology](#) (page 833)
- [Performing a Shortest Path Trace](#) (page 1324)

- [Performing a Best Route Analysis](#) (page 1328)
- [Performing a Flood Trace](#) (page 1333)

NOTE This procedure is for drawing objects only. There is no equivalent for geospatial feature data. However, you can use buffers to analyze features by proximity and perform overlay analysis on two geospatial feature layers. See [Buffering Features in Your Map](#) (page 1308) and [Overlaying Two Feature Sources](#) (page 1316).

To create a network topology

- 1 Do one of the following to bring the linework into the current drawing:
 - Attach the drawings containing the linework. Query the linework into the current drawing.
 - Open the drawing containing the linework.
 - Import the linework from another file format.
- 2 Click Create tab ► Topology panel ► New. 
- 3 In the [Create Topology - Select Topology dialog box](#) (page 1969), do the following:
 - Click Network to specify the type of topology to create.
 - Enter a name and description for the new topology. Names can contain letters, numbers, and the underscore, hyphen, and dollar characters. Names cannot include spaces.
 - Click Next.
- 4 In the [Create Network Topology - Select Links dialog box](#) (page 1956), specify the links to include in the topology:
 - To include all links in the map, click Select All.
 - To manually select the links to include, click Select Manually. Click Select Links to select the links in the map. When you finish selecting links, press Enter.
 - To filter (restrict) link selection by layer (only links on the specified layers will be selected), specify the layers in the Layers box. To select

from a list of layers in the map, click Select Layers. If the layer is not listed, it may be Frozen, Locked, or Off. To use all layers, enter an asterisk (*).

- To filter link selection by object class, specify the object classes in the Object Classes box. Only links that belong to the specified object classes will be included in the topology. Layer and object class filters apply to both the automatic and manual selection of links.
 - Click Next.
- 5 In the [Create Network Topology - Select Nodes dialog box](#) (page 1957), select the nodes to include:
 - To include all nodes, click Select All.
 - To select nodes manually, click Select Manually. Click Select Nodes to select the nodes.
 - To filter (restrict) node selection by layer (only the nodes on the specified layers are selected), specify the layers in the Layers box.
 - To use only selected blocks as node objects, specify the blocks in the Blocks box. To use points as nodes, select the ACAD_POINT block.
 - To filter node selection by object class, specify the object classes in the Object Classes box. Only nodes that belong to the specified object classes are included in the topology.
 - To have AutoCAD Map 3D create node objects at the endpoint of links, click Next. Otherwise, go to step 7.
 - 6 In the [Create Network Topology - Create New Nodes dialog box](#) (page 1955), do the following:
 - To create new nodes, select Create New Nodes.
 - Select a layer for the new nodes.
 - Select a block to use for the nodes. To use a point object, select ACAD_POINT. Modify the appearance of a point object using the PDMODE and PDSIZE system variables. For more information, see *POINT* in the AutoCAD Help.
 - 7 Click Finish to create the topology.
 - 8 If appropriate, save the topology information back to source drawings.

For information about adding direction and resistance, see the following topics:

[Specifying the Direction for a Link](#) (page 845)

[Specifying the Resistance for a Link or Node](#) (page 849)

Quick Reference

MAPTOPOCREATE

Creates a new topology

Menu Click Map ► Topology ► Create.

Icon



Create Topology

Command Line MAPTOPOCREATE

Task Pane In Map Explorer, right-click Topologies ► Create

Dialog Box Create Topology dialog box

Creating a Polygon Topology

Polygon topology is an extension of network topology and focuses on area-based relationships. Every area forms a polygon; and each polygon in a topology consists of a set of links. A polygon in a topology has a centroid, which is a point or block element within the polygon, and contains information about the area it encloses.

NOTE This functionality is for drawing objects only. There is no equivalent for geospatial feature data. However, you can use buffers to analyze features by proximity and perform overlay analysis on two geospatial feature layers. See [Buffering Features in Your Map](#) (page 1306) and [Overlaying Two Feature Sources](#) (page 1309).

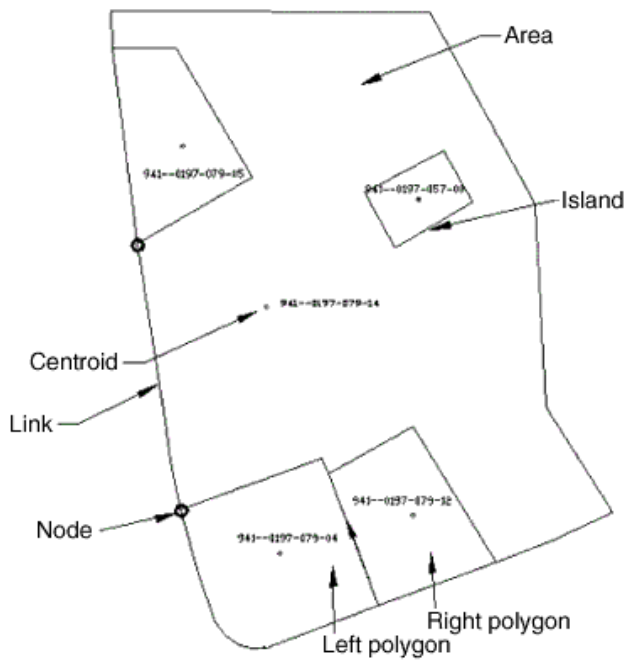

A polygon in a topology consists of a centroid containing information about the surrounding links. Intersecting links can have nodes. A polygon can contain one or more islands.

You cannot create a polygon topology from ellipses or from closed polylines that share an edge or intersection with other polygons. You must explode a closed polyline before you create the topology. You can use information from different layers to define a polygon topology.

Object Data for Polygon Topology

Information about a polygon topology is held in the centroids and links. The object data table for each centroid has the following information.

Topology Name	Object Data Table	Object Data Field
SAMPLE_POLY	TPMCNTR_SAMPLE_POLY	ID
		AREA
		PERIMETER

Topology Name	Object Data Table	Object Data Field
		LINKS_QTY

The object data table for each link in a polygon topology has the following information.

Topology Name	Object Data Table	Object Data Field
SAMPLE_POLY	TPMLINK_SAMPLE_POLY	ID
		START_NODE
		END_NODE
		DIRECTION
		DIRECT_RESISTANCE
		REVERSE_RESISTANCE
		LEFT_POLYGON
		RIGHT_POLYGON

If you create nodes when you create the polygon topology, the object data table for each node has the following information.

Topology Name	Object Data Table	Object Data Field
SAMPLE_POLY	TPMNODE_SAMPLE_POLY	ID
		RESISTANCE

See also:

- [Overview of Creating Topologies](#) (page 822)
- [Creating a Node Topology](#) (page 826)
- [Creating a Network Topology](#) (page 829)
- [Sliver Polygons](#) (page 841)
- [Cleaning Up Drawing Data](#) (page 765)

- [Querying a Topology](#) (page 1348)

NOTE This procedure is for drawing objects only. There is no equivalent for geospatial feature data. However, you can use buffers to analyze features by proximity and perform overlay analysis on two geospatial feature layers. See [Buffering Features in Your Map](#) (page 1308) and [Overlaying Two Feature Sources](#) (page 1316).

To create a polygon topology

- 1 Do one of the following to bring linework into the current drawing:
 - Attach the drawings containing the linework. Query the linework into the current drawing.
 - Open the drawing containing the linework.
 - Import the linework from another file format.
- 2 Click Create tab ► Topology panel ► New. 
- 3 In the [Create Topology - Select Topology dialog box](#) (page 1969):
 - Under Topology Type, click Polygon to indicate that you want to create a polygon topology.
 - Enter a Topology Name and Topology Description for your new topology.
Names can contain letters, numbers, and the underscore, hyphen, and dollar characters. Names cannot include spaces.
 - Click Next.
- 4 Follow the on-screen instructions to specify the objects to use to create the topology. You can also have AutoCAD Map 3D create any missing nodes and centroids.
 - Use the [Create Polygon Topology - Select Links dialog box](#) (page 1964) to select the linear objects to use to generate polygons for the topology. To use a closed polyline to create polygon topology, you must first explode the closed polyline.
 - Use the [Create Polygon Topology - Select Nodes dialog box](#) (page 1965) to select the node objects to include in the topology.

- Use the [Create Polygon Topology - Create New Nodes dialog box](#) (page 1961) to have AutoCAD Map 3D create node objects where needed. Specify the layer and block to use for the new node objects.
 - Use the [Create Polygon Topology - Select Centroids dialog box](#) (page 1962) to select the centroids to use.
 - Use the [Create Polygon Topology - Create New Centroids dialog box](#) (page 1960) to create centroids where needed. Specify the layer and block to use for the new centroids.
- 5 In the [Create Polygon Topology - Set Error Markers dialog box](#) (page 1967), indicate whether to highlight and/or mark detected errors with blocks. AutoCAD Map 3D automatically checks for Missing Centroids and Intersections. Additionally, you can choose to have AutoCAD Map 3D check for Duplicate Centroids, Incomplete Areas, and Sliver Polygons.
- To highlight errors with red Xs, select Highlight Errors.
 - To mark errors with blocks of the shape and color you specify, select Mark Errors With Blocks.
 - In the Marker Size box, specify the marker size as a percent of the screen size. A value between 3% and 7% is usually suitable.
 - If you chose the Mark Errors With Blocks option, specify the shape and color of the block to use to mark each error.
- 6 Click Finish to create the polygon topology.
To remove highlighting, use the REDRAW, REGEN, or SAVE command.
To remove an error marker, select it and press Delete.
- 7 If appropriate, save the topology information back to source drawings.

Quick Reference

MAPTOPOCREATE

Creates a new topology

Menu

Click Map ► Topology ► Create.

Icon



Create Topology

Command Line	MAPTOPOCREATE
Task Pane	In Map Explorer, right-click Topologies ► Create
Dialog Box	Create Topology dialog box

Cleaning Data for a Polygon Topology

Clean up your data before creating polygon topology; eliminate gaps, intersections, or overlaps between any of the linework in a polygon topology. In addition, eliminate zero length objects or areas with missing centroids.

NOTE This functionality is for drawing objects only. There is no equivalent for geospatial feature data. However, you can use buffers to analyze features by proximity and perform overlay analysis on two geospatial feature layers. See [Buffering Features in Your Map](#) (page 1306) and [Overlaying Two Feature Sources](#) (page 1309).

If AutoCAD Map 3D cannot create a polygon topology because the links in the polygons that cross over do not have a node where they meet, the intersections are highlighted with an X or marked with an error marker (block) that you configure. Missing centroids are also highlighted or marked in the same way.

NOTE The markers used to mark polygon topology errors are the same as those used to mark drawing cleanup errors. Before creating a polygon topology, AutoCAD Map 3D removes any markers present from previous drawing cleanup operations. Conversely, when you run a drawing cleanup operation, AutoCAD Map 3D removes any markers present from creating a polygon topology.

See also:

- [Overview of Creating Topologies](#) (page 822)
- [Creating a Polygon Topology](#) (page 833)
- [Cleaning Up Drawing Data](#) (page 765)
- [Sliver Polygons](#) (page 841)

NOTE This procedure is for drawing objects only. There is no equivalent for geospatial feature data. However, you can use buffers to analyze features by proximity and perform overlay analysis on two geospatial feature layers. See [Buffering Features in Your Map](#) (page 1308) and [Overlaying Two Feature Sources](#) (page 1316).

To fix crossing objects

- 1 Use [drawing cleanup](#) (page 765) to break the crossing objects.
- 2 Optionally, detect duplicate centroids, incomplete areas, and [sliver polygons](#) (page 841).
- 3 Create the topology again.
You can ensure there are no missing centroids by selecting the Create Missing Centroids option on the Create Polygon Topology - Create New Centroids screen.

Quick Reference

MAPCLEAN

Performs drawing cleanup operations

Menu	Modify menu ► Drawing Cleanup
Icon	 Drawing Cleanup
Command Line	MAPCLEAN
Dialog Box	Drawing Cleanup

Creating Topologies for a Land Use Map

You can create a specialized polygon topology for a land use or land cover map.

NOTE This functionality is for drawing objects only. There is no equivalent for geospatial feature data. However, you can use buffers to analyze features by proximity and perform overlay analysis on two geospatial feature layers. See [Buffering Features in Your Map](#) (page 1306) and [Overlaying Two Feature Sources](#) (page 1309).

See also:

- [Overview of Creating Topologies](#) (page 822)
- [Creating a Polygon Topology](#) (page 833)

NOTE This procedure is for drawing objects only. There is no equivalent for geospatial feature data. However, you can use buffers to analyze features by proximity and perform overlay analysis on two geospatial feature layers. See [Buffering Features in Your Map](#) (page 1308) and [Overlaying Two Feature Sources](#) (page 1316).

To create a topology for a land use and land cover map

- 1 Create areas for each type.
- 2 Add text or a block to each area to identify the type.
- 3 Create one topology named LAND_USE.
 - In the [Create Polygon Topology - Select Centroids dialog box](#) (page 1962), click Select Manually.
 - Click Select Objects  .
 - Select the text or block objects.
- 4 [Query](#) (page 1348) the centroid value from the polygon topology with the topology query command.

Quick Reference

MAPTOPOCREATE

Creates a new topology

Menu Click Map ► Topology ► Create.

Icon  Create Topology

Command Line MAPTOPOCREATE

Task Pane In Map Explorer, right-click Topologies ► Create

Dialog Box Create Topology dialog box

Sliver Polygons

A sliver polygon is very long and thin; its perimeter is very large compared to its area. When overlaying two topologies, AutoCAD Map 3D checks for sliver polygons. When creating a new polygon topology, checking for sliver polygons is optional.

NOTE This functionality is for drawing objects only. There is no equivalent for geospatial feature data. However, when you perform [overlay analysis](#) (page 1309) on two geospatial feature layers, you can [check for sliver polygons](#) (page 1565).

If a sliver polygon is detected, AutoCAD Map 3D highlights its centroid with an X. To clear the Xs, use the REGEN command.

Though sliver polygons are not considered errors by AutoCAD Map 3D and your topology can still be considered correct and complete, the sliver polygons may be unintentional, for example, the result of digitizing errors. If you see sliver polygons, you may want to double-check your data to make sure it is correct and that the sliver polygons are expected.

For example, imagine you digitize two adjacent polygons, such as a parcel and a flood plain, and there are slight overlaps between the two. Then, you create topologies for each, overlay the topologies, and the resulting topology contains sliver polygons. These may be correct or not, depending on your data. If the boundaries between the adjacent polygons are meant to be the same, then the sliver polygons are incorrect and you must correct your data. If the boundaries are not meant to be the same, then sliver polygons are correct.

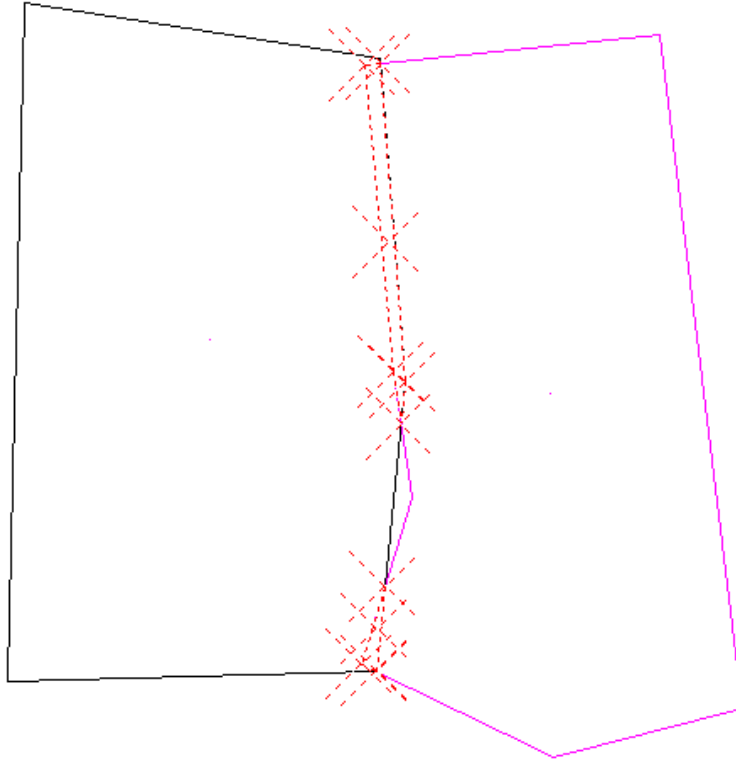

Sliver polygons detected during an overlay (the Xs indicate the sliver polygons).

Tell me more



Video

- *Show me how to do an overlay analysis using two topologies.*



Procedure

- [To find sliver polygons when overlaying two topologies](#) (page 843)



GIS Skill

- *Find which lines are within a particular polygon (overlay analysis).*
-



Related topics

- [Overview of Creating Topologies](#) (page 822)
- [Overlaying Two Topologies](#) (page 1336)
- [Creating a Polygon Topology](#) (page 833)
- [Correcting or Completing a Topology](#) (page 918)

-
- [To find sliver polygons when you create a polygon topology](#) (page 843)
 - [To find sliver polygons when overlaying two topologies](#) (page 843)

NOTE This procedure is for drawing objects only. There is no equivalent for geospatial feature data. However, when you perform [overlay analysis](#) (page 1316) on two geospatial feature layers, you can [check for sliver polygons](#) (page 1565).

To find sliver polygons when you create a polygon topology

- 1 Follow the basic steps to [create a polygon topology](#) (page 833).
- 2 In the [Create Polygon Topology - Set Error Markers dialog box](#) (page 1967), select the option for checking for Sliver Polygons.
- 3 Do one of the following:
 - To highlight errors with red Xs, select Highlight Errors.
 - To mark errors with blocks of the shape and color you specify, select Mark Errors With Blocks.
In the Marker Size box, specify the marker size as a percent of the screen size. A value between 3% and 7% is usually suitable. Specify the shape and color of the block to use to mark each error.
- 4 Click Finish to create the polygon topology and locate sliver polygons. To remove highlighting, use the REDRAW, REGEN, or SAVE command. To remove an error marker, select it and press Delete.

To find sliver polygons when overlaying two topologies

- 1 In [Map Explorer](#) (page 2068), under Current Drawing, right-click the source topology ► Analysis ► Overlay.

- 2 In [Topology Overlay Analysis - Analysis Type dialog box](#) (page 1999), select Identity as the type of overlay analysis to perform. Click Next.
The result topology includes areas that appear in the source topology and areas in the overlay topology that are within the source topology boundary.
- 3 In the [Topology Overlay Analysis - Select Overlay Topology dialog box](#) (page 2007), select the polygon topology to use as the overlay topology. Click Next.
- 4 In the Topology Overlay Analysis - New Topology dialog box, do the following:
 - Select Highlight to highlight the resulting topology on screen. Select the highlight color.
 - Enter a name and description for the new topology, and specify the layer to place it on.
 - Click Next.
- 5 If desired, specify how to copy data to the result topology, whether to create new nodes to complete the resulting topology, and the block to use for centroids.
- 6 Click Finish.

Quick Reference

MAPTOPOCREATE

Creates a new topology

Menu Click Map ► Topology ► Create.

Icon  Create Topology

Command Line MAPTOPOCREATE

Task Pane In Map Explorer, right-click Topologies ► Create

Dialog Box Create Topology dialog box

MAPCLEAN

Performs drawing cleanup operations

Menu	Modify menu ► Drawing Cleanup
Icon	 Drawing Cleanup
Command Line	MAPCLEAN
Dialog Box	Drawing Cleanup

MAPANOVERLAY

Overlays one topology with another, and creates a new topology

Menu	Click Map ► Topology ► Overlay.
Icon	 Overlay Topology
Command Line	MAPANOVERLAY
Task Pane	In Map Explorer, right-click a topology ► Analysis ► Overlay
Dialog Box	Topology Overlay Analysis - Analysis Type dialog box

Specifying the Direction for a Link

You can specify the direction of movement allowed for a link in a network topology. AutoCAD Map 3D uses this direction when tracing through network topology for path traces, best route analysis, and flood traces.

NOTE This functionality is for drawing objects only. There is no equivalent for geospatial feature data.

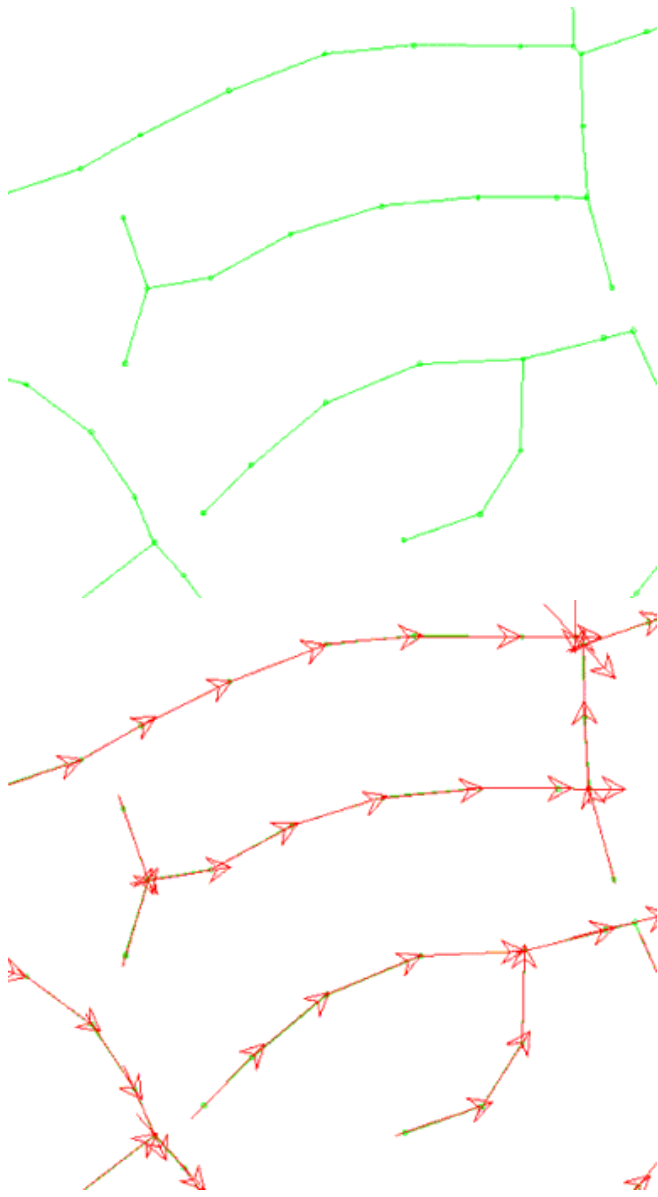

Direction	Property in the Properties palette	Object data value
Bi-Directional (two-way)	Bi-Directional	0

Direction	Property in the Properties palette	Object data value
Same as created. Movement along the link is allowed only in the direction that the link was created.	Forward	1
Reverse of created direction. Movement along the link is allowed only in the opposite direction that the link was created.	Reverse	-1

The default direction of an arc, or a two-point polyline with an arc segment, is counterclockwise. Set the value to Bi-Directional (0) or Forward (1) for counterclockwise, and to Reverse (-1) for clockwise.

To reverse the direction of selected links, right-click a network topology in Map Explorer. Click Reverse Link Direction. You can also use the MAPRL command.

See also:

- [Overview of Creating Topologies](#) (page 822)
- [Creating a Network Topology](#) (page 829)
- [Performing a Shortest Path Trace](#) (page 1324)
- [Performing a Best Route Analysis](#) (page 1328)
- [Performing a Flood Trace](#) (page 1333)
- [Specifying the Resistance for a Link or Node](#) (page 849)
- [Editing the Direction for a Link](#) (page 870)
- [Updating a Topology](#) (page 891)

NOTE This procedure is for drawing objects only. There is no equivalent for geospatial feature data.

To specify the direction for a link

- 1 Verify that the network topology containing the link is loaded. You can specify link direction for network topologies only.
- 2 In the map, double-click the link for which you want to specify direction.

If more than one topology contains the same link, select one of the topologies. [Update the other topologies](#) (page 891) later.

- 3 In the Properties palette, under the Topo properties, choose a setting for the Flow Direction property:
 - Bi-Directional — Movement is allowed in both directions.
 - Forward — Movement is allowed only in the direction that the link was created.
 - Reverse — Movement is allowed only in the opposite direction of the direction that the link was created.

The new direction setting is assigned to the link.

NOTE You can also store a direction value in an object data table or an external database table. When you run a shortest path trace, best route analysis, or flood trace, you can specify the location of this data. When storing this data, use 0 for Bi-Directional, 1 for Forward, and -1 for Reverse.

Quick Reference

MAPEDITDIR

Edits the direction of a link in a network topology

Command Line	MAPEDITDIR
Dialog Box	MAPEDITDIR (Edit Direction command)

MAPRL

Reverses a link in a topology

Command Line	MAPRL
Task Pane	In Map Explorer, right-click a topology ► Reverse Link Direction

PROPERTIES

Displays the Properties palette, which allows you to edit the properties of objects

Menu	Analyze ► Properties
-------------	----------------------

Icon	 Properties
Command Line	PROPERTIES
Task Pane	Select object. Right-click in drawing area ► Properties

Specifying the Resistance for a Link or Node

Direct Resistance is the resistance to travel in the direction that a link was created, while Reverse Resistance is the resistance in the opposite direction along a link.

For both types, you can specify a resistance for any link in the network topology. This resistance specifies the difficulty in traversing the link. The default resistance is the length of the link.

AutoCAD Map 3D uses this resistance when doing a shortest path trace, best route analysis, or flood trace. For an example of using resistance to show travel times, see [Performing a Flood Trace](#) (page 1333).

You can also specify the Resistance of a node in a network topology, such as setting resistance for a valve in a pipe network, or a junction in a road network.

NOTE This functionality is for drawing objects only. There is no equivalent for geospatial feature data.

See also:

- [Overview of Creating Topologies](#) (page 822)
- [Creating a Network Topology](#) (page 829)
- [Performing a Shortest Path Trace](#) (page 1324)
- [Performing a Best Route Analysis](#) (page 1328)
- [Performing a Flood Trace](#) (page 1333)
- [Editing the Resistance for a Link or Node](#) (page 874)
- [Specifying the Direction for a Link](#) (page 845)

NOTE This procedure is for drawing objects only. There is no equivalent for geospatial feature data.

To edit the resistance of a link or node in a network topology

- 1 Verify that the network topology containing the link or node is loaded. Be sure to load the topology from the current drawing. You can specify resistance for network topologies only.
- 2 In the map, double-click the link or node for which you want to specify resistance.
If more than one topology contains the same link or node, select one of the topologies. [Update the other topologies](#) (page 891) later.
- 3 In the Properties palette, under the group of Topo properties, enter new values for resistance. You must enter a numeric value.
 - For a node, enter a value for Resistance, which is the resistance to cross the node.
 - For a link, enter values for Direct Resistance and Reverse Resistance. Direct resistance is the resistance to travel in the direction that a link was created, while reverse resistance is the resistance in the opposite direction along a link. The default value is the length of the link.

The new resistance values are assigned to the objects.

NOTE You can also store a resistance value in object data or an external database. When you run a flood trace, path trace, or best route analysis, specify the location of this data.

If you are entering the commands on the command line, use the MAPEDITRES1 command to edit the Direct Resistance of links and the Resistance of nodes; use the MAPEDITRES2 command to edit the Reverse Resistance of links.

Quick Reference

MAPEDITRES1

Edits the direct resistance of a node or link in a network topology

Command Line MAPEDITRES1

Dialog Box MAPEDITRES1 (Edit Direct Resistance command)

MAPEDITRES2

Edits the reverse resistance of a link in a network topology

Command Line	MAPEDITRES2
Dialog Box	MAPEDITRES2 (Edit Reverse Resistance command)

PROPERTIES

Displays the Properties palette, which allows you to edit the properties of objects

Menu	Analyze ► Properties
Icon	 Properties
Command Line	PROPERTIES
Task Pane	Select object. Right-click in drawing area ► Properties

Editing Topologies

Use the topology editing commands, which are accessible from Map Explorer or the command line, to make changes to a topology without losing the integrity of the topology.

NOTE This functionality is for drawing objects only. There is no equivalent for geospatial feature data.

NOTE These procedures are for drawing objects only. There are no equivalents for geospatial feature data.

To edit a topology

- [To edit a topology](#) (page 854)
- [To edit a node](#) (page 860)
- [To reposition a node at the end point of a link](#) (page 863)
- [To reposition a link](#) (page 863)
- [To join two links, break a link, or reverse a link's direction](#) (page 864)
- [To modify the resistance or direction of a link](#) (page 864)
- [To divide a polygon into two smaller polygons](#) (page 867)
- [To merge two polygons into one polygon](#) (page 868)
- [To change the appearance of points](#) (page 870)
- [To edit the direction of a link](#) (page 873)
- [To edit the resistance of a link or node in a network topology](#) (page 875)
- [To create a node on an existing link](#) (page 878)
- [To add an existing node to a topology](#) (page 878)

- To create a link and add it to a topology (page 880)
- To add an existing link to a topology (page 881)
- To add a polygon to a polygon topology using existing linework (page 884)
- To add a polygon to a polygon topology by creating new linework (page 884)
- To create centroids for polygons and closed polylines (page 887)
- To delete a link, node, or polygon (page 889)
- To update a topology (page 892)
- To retrieve objects to edit (page 894)
- To edit the objects (page 895)
- To create closed polylines from a polygon topology (page 898)

Overview of Editing a Topology

Use topology editing commands to make changes to a topology without losing the integrity of the topology. If you use object-editing commands such as ERASE or STRETCH to modify a topology, important data may be lost. To repair a topology edited with these commands, use the [Update option](#) (page 891).

NOTE This functionality is for drawing objects only. There is no equivalent for geospatial feature data.

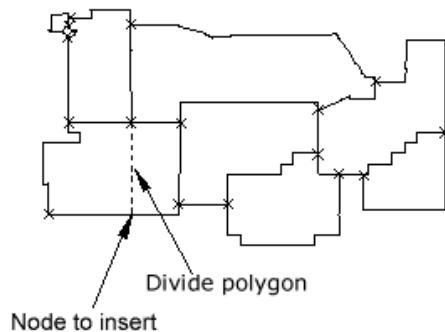

Edits to this polygon topology consist of [adding a node](#) (page 877) and then [dividing the polygon](#) (page 866) with a link.

To edit a topology, the topology data and geometry must be loaded in the current drawing. You can edit only one topology at a time, and multi-user editing of a topology is not permitted. When you load a topology, an audit checks topology integrity. This audit is only concerned with topology data,

not with geometry. Any incomplete objects are registered, because only complete objects can be edited.

To add or insert objects into a topology, the current drawing must be where the topology was created. If the topology was created in a source drawing, you must open that drawing to add objects to the topology. Make the layer containing the topology objects current so new objects have the same properties as objects already in the topology.

If you edit a topology and then use the Undo command, the altered geometry is restored to its former state but the altered topology remains current. To perform further editing on the topology, [unload and reload](#) (page 906) the topology. This applies to all topology functions.

Editing Topologies from More than One Drawing

To edit a topology that spans more than one drawing, you must edit the topology in the drawing where it was created. The other drawings will be attached to this drawing. First, query the topology into the drawing, then [unload](#) (page 906) the topology from the source drawings and retrieve the topology into the current drawing. You can edit part of a topology by querying just the part you want, but the topology editing commands do not allow you to edit the edges of a topology or an incomplete topology.

The safest option is to use a query to retrieve the entire topology. However, if the topology is large, it may impair performance. With large topologies, query the area to edit plus enough of an area around the edit area to ensure that the objects to be edited are complete.

Editing a Network Topology

To modify a network topology, for example, adding a new pipe to a water network, you can add nodes and links to an existing network topology, and then [update](#) (page 891) the topology to include the new pipes.

Before you edit a topology object, make sure the layer containing the topology objects is the current layer.

See also:

- [Loading or Unloading Topologies](#) (page 906)
- [Querying a Topology](#) (page 1348)
- [Correcting or Completing a Topology](#) (page 918)
- [Creating a Network Topology](#) (page 829)

NOTE To edit a topology, use the AutoCAD Map 3D topology edit commands. When you edit a topology, the topology must be loaded from the current drawing. To add an object to a topology, the current drawing must be the drawing where the topology was created.

NOTE This procedure is for drawing objects only. There is no equivalent for geospatial feature data.

To edit a topology

- [To edit a node](#) (page 860)
- [To reposition a node at the end point of a link](#) (page 863)
- [To divide a polygon into two smaller polygons](#) (page 867)
- [To change the appearance of points](#) (page 870)
- [To specify the direction for a link](#) (page 847)
- [To edit the resistance of a link or node in a network topology](#) (page 850)
- [To create a node on an existing link](#) (page 878)
- [To create a link and add it to a topology](#) (page 880)
- [To add a polygon to a polygon topology using existing linework](#) (page 884)
- [To create centroids for polygons and closed polylines](#) (page 887)
- [To delete a link, node, or polygon](#) (page 889)
- [To update a topology](#) (page 892)
- [To retrieve objects to edit](#) (page 894)

Quick Reference

DDPTYPE

Specifies the display mode and size of point objects

Menu	Setup menu ► More Formatting Options ► Point Style
Command Line	DDPTYPE

MAPAL

Adds a link to a topology

Command Line MAPAL

Task Pane In Map Explorer, right-click a network topology ► Add New Links

MAPAN

Adds a node to a topology

Command Line MAPAN

Task Pane In Map Explorer, right-click a node topology ► Add Node

MAPAP

Adds a polygon to a polygon topology

Command Line MAPAP

Task Pane In Map Explorer, right-click a polygon topology ► Add Polygon

MAPBL

Breaks a link in a topology at a specified point

Command Line MAPBL

Task Pane In Map Explorer, right-click a network topology ► Break Link

MAPCREATECENTROIDS

Creates a centroid in a polygon and moves data to the centroid

Menu Create menu ► Centroids

Icon



Create Centroids

Command Line MAPCREATECENTROIDS

Dialog Box Create Centroids dialog box

MAPDL

Deletes a link in a topology

Command Line MAPDL

Task Pane In Map Explorer, right-click a network topology ► Delete Links

MAPDN

Deletes a node in a topology

Command Line MAPDN

Task Pane In Map Explorer, right-click a node topology ► Delete Node

MAPDP

Deletes a polygon from a polygon topology

Command Line MAPDP

Task Pane In Map Explorer, right-click a polygon topology ► Delete Polygon

MAPDVP

Divides a polygon in a polygon topology by allowing you to add a link

Command Line MAPDVP

Task Pane In Map Explorer, right-click a polygon topology ► Divide Polygon

MAPEDITDIR

Edits the direction of a link in a network topology

Command Line MAPEDITDIR

Dialog Box MAPEDITDIR (Edit Direction command)

MAPEDITRES1

Edits the direct resistance of a node or link in a network topology

Command Line MAPEDITRES1

Dialog Box MAPEDITRES1 (Edit Direct Resistance command)

MAPEDITRES2

Edits the reverse resistance of a link in a network topology

Command Line MAPEDITRES2

Dialog Box MAPEDITRES2 (Edit Reverse Resistance command)

MAPIL

Inserts a link in a topology

Command Line MAPIL

Task Pane In Map Explorer, right-click a network topology ► Insert New Link

MAPIN

Inserts a node in a topology

Command Line MAPIN

Task Pane In Map Explorer, right-click a node topology ► Insert Node

MAPJL

Joins two links in a topology

Command Line MAPJL

Task Pane In Map Explorer, right-click a network topology ► Join Links

MAPMEL

Repositions an end point of a link in a topology

Command Line MAPMEL

Task Pane In Map Explorer, right-click a network topology ► Move End Of Link

MAPML

Moves a link in a topology

Command Line MAPML

Task Pane In Map Explorer, right-click a network topology ► Move Links

MAPMN

Moves a node in a topology or moves a node at the end of a link in network or polygon topologies

Command Line MAPMN

Task Pane In Map Explorer, right-click a node topology ► Move Node

MAPMP

Merges polygons in a polygon topology

Command Line MAPMP

Task Pane In Map Explorer, right-click a polygon topology ► Merge Polygon

MAPRL

Reverses a link in a topology

Command Line MAPRL

Task Pane In Map Explorer, right-click a topology ► Reverse Link Direction

PROPERTIES

Displays the Properties palette, which allows you to edit the properties of objects

Menu Analyze ► Properties

Icon  Properties

Command Line PROPERTIES

Task Pane Select object. Right-click in drawing area ► Properties

Editing a Node

You can move a node in a node topology, or move a node at the end point of a link in a network or polygon topology. Moving the node at the end point of a link also moves that end of the chosen link. Edits to nodes and links in a polygon topology change the centroid, the area, and perimeter values.

NOTE This functionality is for drawing objects only. There is no equivalent for geospatial feature data.

When you move a node, AutoCAD Map 3D checks its new location.

- In node topologies, if there is an existing node in the same location, you must specify which node to keep.
- In network or polygon topologies, you must specify whether to join the links and which node to use to join them.

You can also delete nodes. For more information, see [Deleting Links, Nodes, and Polygons](#) (page 888).

If you're working with a network topology, you can also modify the [resistance](#) (page 850) of nodes.

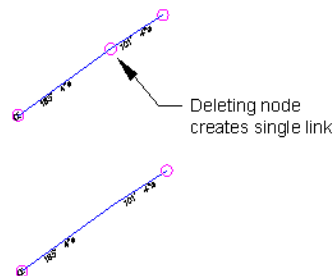

Deleting one node that indicates adjoining links creates a single link.

To turn an explicit node into an implicit node, unload the topology, delete the point or block representing the explicit node, and then reload the topology.

To turn an implicit node into an explicit node, first insert a block or point at the implicit node point (use an Intersection or End snap to position the block accurately). Then, if you are working with a node topology, right-click the topology name in Map Explorer. Click Add Node. You cannot use the Insert

Node option. If you are working with a network or polygon topology, use the MAPAN command.

If you retrieve the nodes of a network or polygon topology, but not the connecting links, you can still move the nodes. However, the current topology knows nothing about the connecting links because all the link information is stored on the links, and saving any edited nodes back to the source drawings will create an incorrect topology.

See also:

- [Loading or Unloading Topologies](#) (page 906)
- [To create a node on an existing link](#) (page 878)
- [To delete a link, node, or polygon](#) (page 889)
- [To edit the resistance of a link or node in a network topology](#) (page 850)

NOTE This procedure is for drawing objects only. There is no equivalent for geospatial feature data.

To edit a node

- 1 Open the drawing where the topology was created and load the topology.
- 2 Do one of the following:
 - For a node topology, in Map Explorer, right-click the topology name. Click Move Nodes.
 - For a network or polygon topology, type mapmn at the command line.
- 3 When prompted, click the nodes to move.
- 4 Press Enter when you finish selecting nodes.
- 5 Specify the base point or displacement.
- 6 Specify the second point of displacement.

The two points you specify define a displacement vector that indicates how far the selected objects are to be moved and in what direction. If you press Enter at the Specify Second Point of Displacement prompt, the first point is interpreted as relative X,Y,Z displacement. For example, if you specify 2,3 for the base point and press Enter at the next prompt,

the object moves 2 units in the X direction and 3 units in the Y direction from its current position.

In a node topology, if the node's new location is the same as an existing node, specify which node to keep. In a network topology, specify whether to join the links and which node to keep.

Quick Reference

MAPMN

Moves a node in a topology or moves a node at the end of a link in network or polygon topologies

Command Line	MAPMN
Task Pane	In Map Explorer, right-click a node topology ► Move Node

MAPNODEEDIT

Edits a node in a topology

Command Line	MAPNODEEDIT
Dialog Box	MAPNODEEDIT (Edit Topology Node command)

PROPERTIES

Displays the Properties palette, which allows you to edit the properties of objects

Menu	Analyze ► Properties
Icon	 Properties
Command Line	PROPERTIES
Task Pane	Select object. Right-click in drawing area ► Properties

Editing a Link

There are several ways you can edit links in a network or polygon topology.

NOTE This procedure is for drawing objects only. There is no equivalent for geospatial feature data.

You can do any of the following:

- Move a link to a new location.
- Reposition one of the nodes at the end point of a link. Moving the node at the end point of a link moves that end of the chosen link.
If you move an end point to the same location as an existing end point, AutoCAD Map 3D prompts you to join the links and specify which node to keep. If you select a line or arc when moving links or end points of links, it is converted to a polyline.
- Join two links in a network or polygon topology by removing an intersection or pseudo-node.
- Break a link at a specified break point. AutoCAD Map 3D inserts a node at the break point.
- Reverse the direction of a link in a network topology.
- Specify the resistance, reverse resistance, and direction of a link.

Edits to links in a polygon topology change the centroid, the area, and the perimeter values.

See also:

- [Loading or Unloading Topologies](#) (page 906)
- [To create a node on an existing link](#) (page 878)
- [Editing a Node](#) (page 859)
- [To delete a link, node, or polygon](#) (page 889)
- [Specifying the Direction for a Link](#) (page 845)
- [Specifying the Resistance for a Link or Node](#) (page 849)
- [Adding a Link](#) (page 880)

NOTE This procedure is for drawing objects only. There is no equivalent for geospatial feature data.

- [To reposition a node at the end point of a link](#) (page 863)

- [To reposition a link](#) (page 863)
- [To join two links, break a link, or reverse a link's direction](#) (page 864)
- [To modify the resistance or direction of a link](#) (page 864)

To reposition a node at the end point of a link

- 1 Open the drawing where the topology was created and load the topology.
- 2 Do one of the following:
 - For a network topology, in Map Explorer, right-click the topology name. Click Move End Of Link.
 - For a polygon topology, type MAPMEL on the command line.
- 3 When prompted, click the node (end point) to move.
- 4 When prompted, click the location of the new end point.
If the new location is the same as an existing end point in the topology, specify whether to join the links and which node to keep.

To reposition a link

- 1 Open the drawing where the topology was created and load the topology.
- 2 Do one of the following:
 - For a network topology, in Map Explorer, right-click the topology name. Click Move Links.
 - For a polygon topology, type MAPML on the command line.
- 3 When prompted, click the link to reposition.
- 4 When prompted, click any additional links to reposition.
- 5 Press Enter when you finish selecting links.
- 6 Specify the base point or displacement.
- 7 Specify the second point of displacement.

The two points define a displacement vector that indicates how far the selected objects are moved and in what direction. If you press Enter at the Specify Second Point of Displacement prompt, the first point is interpreted as relative X,Y,Z displacement. For example, if you specify 2,3 for the base point and press Enter at the next prompt, the object

moves 2 units in the X direction and 3 units in the Y direction from its current position.

To join two links, break a link, or reverse a link's direction

- 1 Open the drawing where the topology was created and load the topology.
- 2 Do one of the following:
 - For a network topology, in Map Explorer, right-click the topology name. Click a menu option.
 - To join two links in a polygon topology, type MAPJL on the command line. To break a link in a polygon topology, type MAPBL on the command line. You cannot reverse a link's direction in a polygon topology.
Follow the command line prompts.

To modify the resistance or direction of a link

- For information about specifying values for resistance, see [To edit the resistance of a link or node in a network topology](#) (page 850).
- For information about specifying direction, [To specify the direction for a link](#) (page 847).

Quick Reference

MAPBL

Breaks a link in a topology at a specified point

Command Line	MAPBL
Task Pane	In Map Explorer, right-click a network topology ► Break Link

MAPEDITDIR

Edits the direction of a link in a network topology

Command Line	MAPEDITDIR
Dialog Box	MAPEDITDIR (Edit Direction command)

MAPEDITRES1

Edits the direct resistance of a node or link in a network topology

Command Line MAPEDITRES1

Dialog Box MAPEDITRES1 (Edit Direct Resistance command)

MAPEDITRES2

Edits the reverse resistance of a link in a network topology

Command Line MAPEDITRES2

Dialog Box MAPEDITRES2 (Edit Reverse Resistance command)

MAPJL

Joins two links in a topology

Command Line MAPJL

Task Pane In Map Explorer, right-click a network topology ► Join Links

MAPMEL

Repositions an end point of a link in a topology

Command Line MAPMEL

Task Pane In Map Explorer, right-click a network topology ► Move End Of Link

MAPML

Moves a link in a topology

Command Line MAPML

Task Pane In Map Explorer, right-click a network topology ► Move Links

MAPRL

Reverses a link in a topology

Command Line MAPRL

Task Pane In Map Explorer, right-click a topology ► Reverse Link Direction

PROPERTIES

Displays the Properties palette, which allows you to edit the properties of objects

Menu Analyze ► Properties

Icon  Properties

Command Line PROPERTIES

Task Pane Select object. Right-click in drawing area ► Properties

Editing a Polygon

You can divide a polygon into two smaller polygons by drawing a link between two nodes that define the polygon. You can also remove a boundary between two polygons and combine them into one polygon. You can specify the centroid to remove. Splitting and combining polygons change the centroid, the area, and perimeter values.

You can also use the commands for [editing nodes](#) (page 859) and [editing links](#) (page 861) to edit a polygon topology. When you do, AutoCAD Map 3D changes the centroid, the area, and perimeter values of the polygons automatically.

NOTE This functionality is for drawing objects only. There is no equivalent for geospatial feature data.

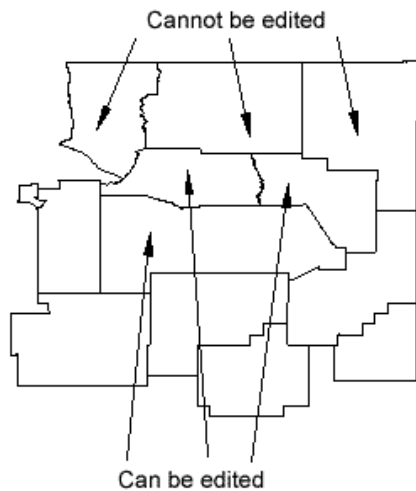

Polygons at the edge of a queried polygon topology cannot be edited.

See also:

- [Overview of Creating Topologies](#) (page 822)
- [Creating a Polygon Topology](#) (page 833)
- [Querying a Topology](#) (page 1348)
- [Adding a Polygon](#) (page 882)
- [To delete a link, node, or polygon](#) (page 889)
- [Editing a Link](#) (page 861)
- [Editing a Node](#) (page 859)

NOTE This procedure is for drawing objects only. There is no equivalent for geospatial feature data.

To divide a polygon into two smaller polygons

- 1 Open the drawing where the polygon topology was created and load the topology.
- 2 In Map Explorer, right-click the topology name. Click Divide Polygon.
- 3 Specify a node for the first divide point.

- 4 Specify the node for the second divide point.

To merge two polygons into one polygon

- 1 Open the drawing where the polygon topology was created and load the topology.
- 2 In Map Explorer, right-click the topology name. Click Merge Polygon.
- 3 Specify the link (boundary between two polygons) to remove.
- 4 Specify the centroid to remove.
- 5 On the command line, type Y to merge the polygons.

Quick Reference

MAPDVP

Divides a polygon in a polygon topology by allowing you to add a link

Command Line	MAPDVP
Task Pane	In Map Explorer, right-click a polygon topology ► Divide Polygon

MAPMP

Merges polygons in a polygon topology

Command Line	MAPMP
Task Pane	In Map Explorer, right-click a polygon topology ► Merge Polygon

PROPERTIES

Displays the Properties palette, which allows you to edit the properties of objects

Menu	Analyze ► Properties
Icon	 Properties
Command Line	PROPERTIES
Task Pane	Select object. Right-click in drawing area ► Properties

Changing the Appearance of Points

If you create nodes as ACAD_POINT, you can change their appearance.

NOTE This functionality is for drawing objects only. There is no equivalent for geospatial feature data.

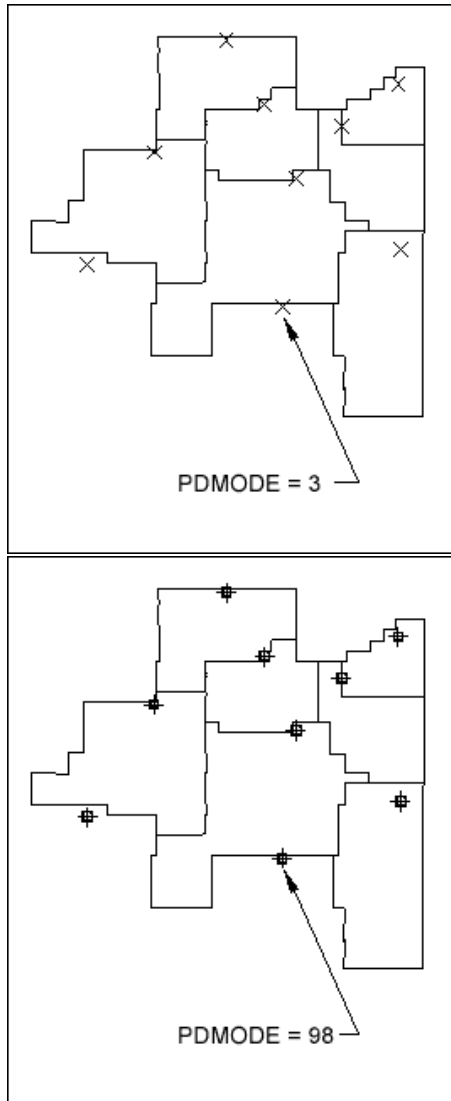

See also:

- [Overview of Creating Topologies](#) (page 822)
- [Creating a Node Topology](#) (page 826)
- [Adding a Node](#) (page 877)

NOTE This procedure is for drawing objects only. There is no equivalent for geospatial feature data.

To change the appearance of points

- 1 At the Command prompt, enter `ddptype`.
- 2 In the Point Style dialog box, select any of the point modes.
You can also change the Point Size to improve the visibility of the points.
- 3 Click OK.
- 4 On the command line, enter `regen`.

Nodes you created using `ACAD_POINT` appear in the point style you selected.

To reset the node display, use the Point Style dialog box to reset the point style. Then enter `regen` on the command line.

Quick Reference

DDPTYPE

Specifies the display mode and size of point objects

Menu	Setup menu ► More Formatting Options ► Point Style
Command Line	DDPTYPE

Editing the Direction for a Link

You can specify the direction of movement allowed for a link in a network topology. AutoCAD Map 3D uses this direction when tracing through network topology for path traces, best route analysis, and flood traces.

NOTE This functionality is for drawing objects only. There is no equivalent for geospatial feature data.



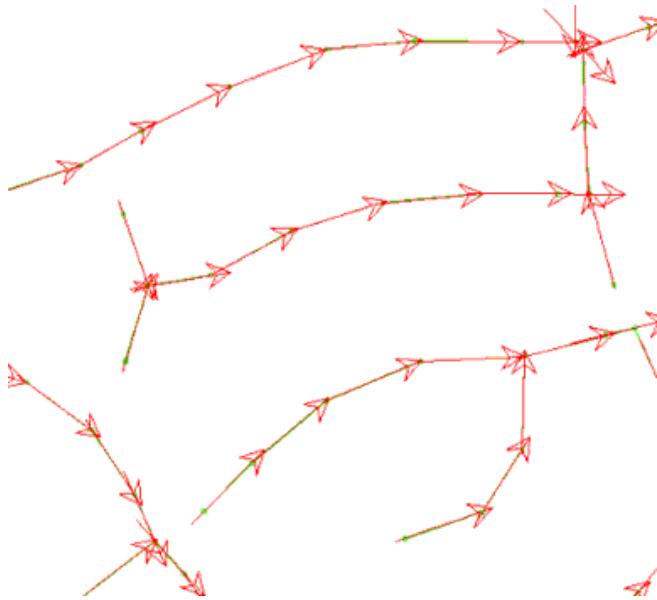

Direction	Property in the Properties palette	Object data value
Bi-Directional (two-way)	Bi-Directional	0
Same as created. Movement along the link is allowed only in the direction that the link was created.	Forward	1
Reverse of created direction. Movement along the link is allowed only in the opposite direction that the link was created.	Reverse	-1

The default direction of an arc, or a two-point polyline with an arc segment, is counterclockwise. Set the value to Bi-Directional (0) or Forward (1) for counterclockwise, and to Reverse (-1) for clockwise.

To reverse the direction of selected links, right-click a network topology in Map Explorer. Click Reverse Link Direction. You can also use the MAPRL command.

See also:

- [Loading or Unloading Topologies](#) (page 906)
- [Adding a Link](#) (page 880)
- [To delete a link, node, or polygon](#) (page 889)
- [Specifying the Direction for a Link](#) (page 845)
- [Specifying the Resistance for a Link or Node](#) (page 849)
- [Performing a Shortest Path Trace](#) (page 1324)
- [Performing a Best Route Analysis](#) (page 1328)
- [Performing a Flood Trace](#) (page 1333)

NOTE This procedure is for drawing objects only. There is no equivalent for geospatial feature data.

To edit the direction of a link

- 1 Verify that the network topology containing the link is loaded. You can specify link direction for network topologies only.
- 2 In the map, double-click the link.
If more than one topology contains the same link, select one of the topologies. [Update the other topologies](#) (page 891) later.
- 3 In the Properties palette, under the Topo properties, choose a setting for the Flow Direction property:
 - Bi-Directional — Movement is allowed in both directions.
 - Forward — Movement is allowed only in the direction that the link was created.
 - Reverse — Movement is allowed only in the opposite direction of the direction that the link was created.

The new direction setting is assigned to the link.

NOTE You can also store a direction value in an object data table or an external database table. When you run a shortest path trace, best route analysis, or flood trace, you can specify the location of this data. When storing this data, use 0 for Bi-Directional, 1 for Forward, and -1 for Reverse.

Quick Reference

MAPEDITDIR

Edits the direction of a link in a network topology

Command Line MAPEDITDIR

Dialog Box MAPEDITDIR (Edit Direction command)

MAPRL

Reverses a link in a topology

Command Line MAPRL

Task Pane In Map Explorer, right-click a topology ► Reverse Link Direction

PROPERTIES

Displays the Properties palette, which allows you to edit the properties of objects

Menu Analyze ► Properties

Icon  Properties

Command Line PROPERTIES

Task Pane Select object. Right-click in drawing area ► Properties

Editing the Resistance for a Link or Node

Direct Resistance is the resistance to travel in the direction that a link was created, while Reverse Resistance is the resistance in the opposite direction along a link.

NOTE This functionality is for drawing objects only. There is no equivalent for geospatial feature data.

For both types, you can specify a resistance for any link in the network topology. This resistance specifies the difficulty in traversing the link. The default resistance is the length of the link.

AutoCAD Map 3D uses this resistance when doing a shortest path trace, best route analysis, or flood trace. For an example of using resistance to show travel times, see [Performing a Flood Trace](#) (page 1333).

You can also specify the Resistance of a node in a network topology, such as setting resistance for a valve in a pipe network, or a junction in a road network.

See also:

- [Loading or Unloading Topologies](#) (page 906)
- [Adding a Link](#) (page 880)
- [To delete a link, node, or polygon](#) (page 889)
- [Specifying the Direction for a Link](#) (page 845)
- [Specifying the Resistance for a Link or Node](#) (page 849)
- [Performing a Shortest Path Trace](#) (page 1324)
- [Performing a Best Route Analysis](#) (page 1328)
- [Performing a Flood Trace](#) (page 1333)

NOTE This procedure is for drawing objects only. There is no equivalent for geospatial feature data.

To edit the resistance of a link or node in a network topology

- 1 Verify that the network topology containing the link or node is loaded. Be sure to load the topology from the current drawing. You can specify resistance for network topologies only.
- 2 In the map, double-click the link or node.
If more than one topology contains the same link or node, select one of the topologies. [Update the other topologies](#) (page 891) later.
- 3 In the Properties palette, under the group of Topo properties, enter new values for resistance. You must enter a numeric value.
 - For a node, enter a value for Resistance, which is the resistance to cross the node.
 - For a link, enter values for Direct Resistance and Reverse Resistance. Direct resistance is the resistance to travel in the direction that a link was created, while reverse resistance is the resistance in the opposite direction along a link. The default value is the length of the link.

The new resistance values are assigned to the objects.

NOTE You can also store a resistance value in object data or an external database. When you run a flood trace, path trace, or best route analysis, specify the location of this data.

If you are entering the commands on the command line, use the [MAPEDITRES1 \(Edit Direct Resistance command\)](#) (page 1939) to edit the Direct Resistance of links and the Resistance of nodes; use the [MAPEDITRES2 \(Edit Reverse Resistance command\)](#) (page 1940) to edit the Reverse Resistance of links.

Quick Reference

MAPEDITRES1

Edits the direct resistance of a node or link in a network topology

Command Line	MAPEDITRES1
Dialog Box	MAPEDITRES1 (Edit Direct Resistance command)

MAPEDITRES2

Edits the reverse resistance of a link in a network topology

Command Line	MAPEDITRES2
Dialog Box	MAPEDITRES2 (Edit Reverse Resistance command)

PROPERTIES

Displays the Properties palette, which allows you to edit the properties of objects

Menu	Analyze ► Properties
Icon	 Properties
Command Line	PROPERTIES
Task Pane	Select object. Right-click in drawing area ► Properties

Adding a Node

You can add nodes to an existing topology. To add nodes, the current drawing must be where the topology was created and the geometry (point, block, or text object) must already exist. You can add a node to the end of a link or a vertex in network or polygon topologies.

NOTE This functionality is for drawing objects only. There is no equivalent for geospatial feature data.

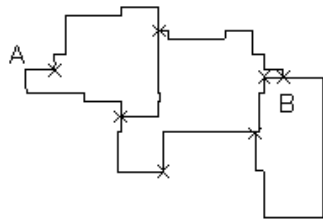

Original polygon topology

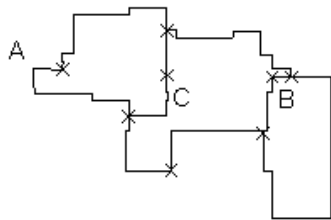

Add node at C

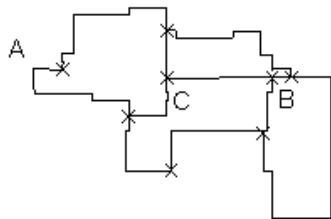

Add link from B to C

Adding a node to an existing topology.

See also:

- [Overview of Creating Topologies](#) (page 822)
- [Loading or Unloading Topologies](#) (page 906)
- [Deleting Links, Nodes, and Polygons](#) (page 888)
- [Updating a Topology](#) (page 891)
- [Adding a Link](#) (page 880)

NOTE This procedure is for drawing objects only. There is no equivalent for geospatial feature data.

To create a node on an existing link

- 1 Open the drawing where the topology was created and load the topology. To create a node and add it to a topology, the current drawing must be the drawing where the topology was created.

NOTE To add the same point to more than one topology, select one of the topologies. [Update the other topologies](#) (page 891) later.

- 2 Do one of the following:
 - To add a node to a node topology, in Map Explorer, right-click the topology name. Click Insert Node.
 - To add a node to a network or polygon topology, type mapin on the command line.
- 3 When prompted, select the block to use for the node.
- 4 When prompted, specify the location for the node. You can use an object snap such as Midpoint. Enter any other node information.

To add an existing node to a topology

- 1 Open the drawing where the topology was created and load the topology.
- 2 Create the point, block, or text object that you will use as the node.
- 3 Be sure to load the topology you want to add the node to from the current drawing.

- 4 Do one of the following:
 - To add a node to a node topology, in Map Explorer, right-click the topology name. Click Add Node.
 - To add a node to a network or polygon topology, type mapan on the command line.
- 5 When prompted, select the object to use as the node.

Quick Reference

MAPAN

Adds a node to a topology

Command Line	MAPAN
Task Pane	In Map Explorer, right-click a node topology ► Add Node

MAPIN

Inserts a node in a topology

Command Line	MAPIN
Task Pane	In Map Explorer, right-click a node topology ► Insert Node

PROPERTIES

Displays the Properties palette, which allows you to edit the properties of objects

Menu	Analyze ► Properties
Icon	 Properties
Command Line	PROPERTIES
Task Pane	Select object. Right-click in drawing area ► Properties

Adding a Link

You can add a new or existing link to a network or polygon topology. The current drawing must be where the topology was created.

NOTE This functionality is for drawing objects only. There is no equivalent for geospatial feature data.

Create new links between existing nodes. [Add nodes](#) (page 877) as needed. New links cannot cross other links. If you draw a line or arc, it is converted to a polyline.

When adding links to polygon topologies, AutoCAD Map 3D updates the centroid, the area, and perimeter values of the polygons. You can also divide a polygon using the MAPDVP command.

You cannot add links to node topologies.

See also:

- [Adding a Node](#) (page 877)
- [Editing a Link](#) (page 861)
- [Editing a Polygon](#) (page 866)
- [Editing the Direction for a Link](#) (page 870)
- [Editing the Resistance for a Link or Node](#) (page 874)

NOTE This procedure is for drawing objects only. There is no equivalent for geospatial feature data.

To create a link and add it to a topology

- 1 Open the drawing where the topology was created and load the topology.
- 2 Do one of the following:
 - To create a new link in a network topology, in Map Explorer, right-click the topology name. Click Insert New Link.
 - To create a link in a polygon topology, type MAPIL on the command line.
- 3 At the prompt, click the start point for the new link.
- 4 When prompted, click the next point(s).

- 5 To finish entering points, press Enter.
- 6 Optionally, modify the values for [resistance](#) (page 850) and [direction](#) (page 847).

To add an existing link to a topology

- 1 Open the drawing where the network or polygon topology was created and load the topology.
- 2 Do one of the following:
 - To add a link to a network topology, in Map Explorer, right-click the topology name. Click Add New Links.
 - To add a link to a polygon topology, type MAPAL on the command line.
- 3 At the prompt, click the link to add to the topology.
- 4 Click any additional links to add.
- 5 When you finish selecting links, press Enter.
- 6 Optionally, modify the values for [resistance](#) (page 850) and [direction](#) (page 847).

Quick Reference

MAPAL

Adds a link to a topology

Command Line	MAPAL
Task Pane	In Map Explorer, right-click a network topology ► Add New Links

MAPIL

Inserts a link in a topology

Command Line	MAPIL
Task Pane	In Map Explorer, right-click a network topology ► Insert New Link

PROPERTIES

Displays the Properties palette, which allows you to edit the properties of objects

Menu Analyze ► Properties

Icon  Properties

Command Line PROPERTIES

Task Pane Select object. Right-click in drawing area ► Properties

Adding a Polygon

You can add a polygon using existing objects or new linework as a perimeter. To add a polygon to a polygon topology, the current drawing must be where the topology was created.

NOTE This functionality is for drawing objects only. There is no equivalent for geospatial feature data.

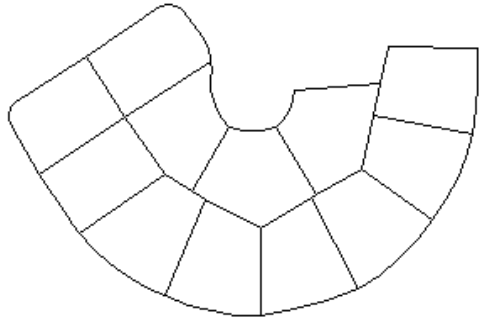

Original polygon topology

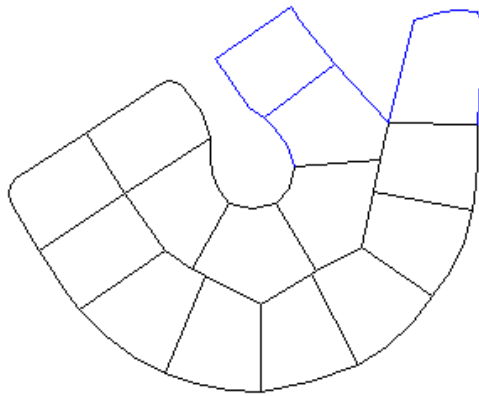

After adding polygons

New polygons can be added to an existing polygon topology.

See also:

- [Overview of Creating Topologies](#) (page 822)
- [Creating a Polygon Topology](#) (page 833)
- [Loading or Unloading Topologies](#) (page 906)

NOTE This procedure is for drawing objects only. There is no equivalent for geospatial feature data.

To add a polygon to a polygon topology using existing linework

- 1 Open the drawing where the polygon topology was created and load the topology.
To add a polygon to a polygon topology, the current drawing must be the drawing where the topology was created.
- 2 Do one of the following:
 - In Map Explorer, right-click the topology name. Click Add Polygon.
 - Type mapap on the command line.
- 3 In the map, select the border objects of the polygons to add.
- 4 Press Enter when you finish selecting polygons.
- 5 If you have blocks defined in the drawing, you are prompted to specify a block to use for the centroid. Press Enter to use ACAD_POINT, or type a block name and press Enter.

To add a polygon to a polygon topology by creating new linework

- 1 Open the drawing where the polygon topology was created and load the topology.
- 2 On the command line, type MAPIL.
- 3 When prompted, specify the location for a new link. The link must define a polygon.

Quick Reference

MAPAP

Adds a polygon to a polygon topology

Command Line	MAPAP
Task Pane	In Map Explorer, right-click a polygon topology ► Add Polygon

MAPIL

Inserts a link in a topology

Command Line	MAPIL
Task Pane	In Map Explorer, right-click a network topology ► Insert New Link

Creating Centroids for Polygons

If you have polygon objects or closed polylines with data attached to them, you can create centroids and move the data to the centroid. This is useful:

- After you import or digitize objects.
- Before using editing commands such as Drawing Cleanup, Boundary Break, or Boundary Trim.
- When working with topology.

NOTE This functionality is for drawing objects only. There is no equivalent for geospatial feature data.

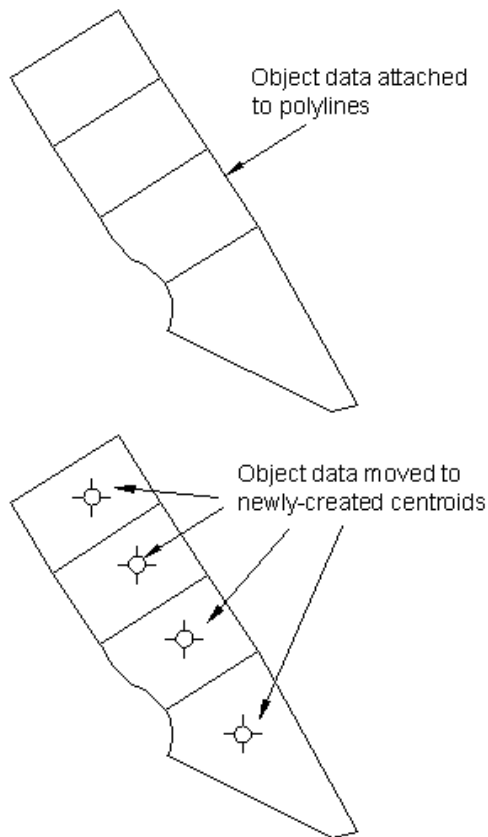

Object data attached to closed polylines (above) and object data moved to centroids (below).

AutoCAD Map 3D checks that the lines do not intersect each other, and that the area is greater than 0. It then creates a centroid inside each selected polygon or closed polyline and moves any object data or SQL link data to the centroid. For an object shaped like a figure eight, AutoCAD Map 3D creates one centroid.

Centroids are created with a Z value of 0.

See also:

- [Overview of Creating Topologies](#) (page 822)
- [Creating a Polygon Topology](#) (page 833)
- [Loading or Unloading Topologies](#) (page 906)

- [Importing Polygons](#) (page 429)
- [Defining the Text Insertion Point](#) (page 936)

NOTE This procedure is for drawing objects only. There is no equivalent for geospatial feature data.

To create centroids for polygons and closed polylines

- 1 Click Create tab ► Drawing Object panel ► Create Centroids. 
- 2 In the [Create Centroids dialog box](#) (page 1801), specify whether to create centroids for all closed objects or only for selected closed objects. If only for selected closed objects, select the polygons and closed polylines.

TIP Click the Quick Select tool to view and filter the object type as you select objects.

- 3 Specify the layer on which the centroids should be created.
- 4 Specify the block to use for centroids, or use ACAD_POINT.
- 5 Click OK.

Quick Reference

MAPCREATECENTROIDS

Creates a centroid in a polygon and moves data to the centroid

Menu Create menu ► Centroids

Icon  Create Centroids

Command Line MAPCREATECENTROIDS

Dialog Box Create Centroids dialog box

Deleting Links, Nodes, and Polygons

You can delete a node in a node, network, or polygon topology; a link in a network or polygon topology; or a polygon in a polygon topology. When you delete nodes, links, or polygons, object data and external database links may be lost.

WARNING Both the topology information and associated objects are deleted.

NOTE This functionality is for drawing objects only. There is no equivalent for geospatial feature data.

- Deleting a node shared by two links joins the links together. First and last point information on the resulting link is updated.
- Deleting a dangling link deletes the dangling end node.
- Deleting a link deletes any associated nodes, unless the link is also part of another topology or the nodes are referenced by another link.
- Deleting a polygon deletes the centroid and all references to it in surrounding links, unless objects are part of another topology or are referenced by another polygon.

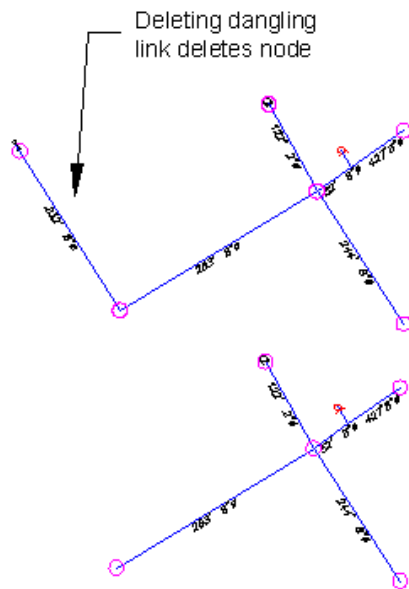

When you remove a link, any nodes that are not connected to other links are also removed.

See also:

- [Overview of Creating Topologies](#) (page 822)
- [Loading or Unloading Topologies](#) (page 906)
- [Adding a Node](#) (page 877)
- [Adding a Link](#) (page 880)
- [Editing a Node](#) (page 859)
- [Editing a Link](#) (page 861)

NOTE This procedure is for drawing objects only. There is no equivalent for geospatial feature data.

To delete a link, node, or polygon

- 1 Open the drawing where the topology was created and load the topology.

- 2 Do one of the following:
 - To delete a node from a node topology, in Map Explorer, right-click the topology. Click Delete Node. To delete a node from a network or polygon topology, type MAPDN on the command line.
 - To delete a link from a network topology, in Map Explorer, right-click the topology. Click Delete Links. To delete a link from a polygon topology, type MAPDL on the command line.
 - To delete a polygon from a polygon topology, in Map Explorer, right-click the topology. Click Delete Polygon.
- 3 Select the object(s) to delete. To select a polygon, click near its centroid.

Quick Reference

MAPDL

Deletes a link in a topology

Command Line MAPDL

Task Pane In Map Explorer, right-click a network topology ► Delete Links

MAPDN

Deletes a node in a topology

Command Line MAPDN

Task Pane In Map Explorer, right-click a node topology ► Delete Node

MAPDP

Deletes a polygon from a polygon topology

Command Line MAPDP

Task Pane In Map Explorer, right-click a polygon topology ► Delete Polygon

PROPERTIES

Displays the Properties palette, which allows you to edit the properties of objects

Menu	Analyze ► Properties
Icon	 Properties
Command Line	PROPERTIES
Task Pane	Select object. Right-click in drawing area ► Properties

Updating a Topology

Objects in a topology have relationship data stored in an object data table. If you modify the objects using the [topology editing commands](#) (page 852), the topology data on the objects is updated. However, you must manually update the topology data in the following circumstances:

- If you modify the objects using standard AutoCAD commands, such as Move.
- If the object is referenced by more than one topology. (Only the selected topology is updated when you modify the object. Use the Update option to update the remaining topologies that reference the object.)

NOTE If the update options cannot restore integrity, try using Recreate. In Map Explorer, right-click a topology ► Administration ► Recreate. When you recreate a topology, the topology is completely recreated. Any editing changes you made to the topology object data are erased.

NOTE This functionality is for drawing objects only. There is no equivalent for geospatial feature data.

See also:

- [Overview of Creating Topologies](#) (page 822)
- [Loading or Unloading Topologies](#) (page 906)

NOTE This procedure is for drawing objects only. There is no equivalent for geospatial feature data.

To update a topology

- 1 Verify that the topology containing the objects to update is [loaded](#) (page 907).
 - To update nodes in a node topology, in Map Explorer, right-click the topology name. Click Update. To update nodes in a network or polygon topology, type MAPNODUPD on the command line.
 - To update links in a network topology, in Map Explorer, right-click the topology name. Click Update. To update links in a polygon topology, type MAPLINKUPD on the command line.
 - To update polygons links in a polygon topology, in Map Explorer, right-click the topology name. Click Update. You can also type MAPPOLYUPD on the command line.
- 2 Select the objects to update. Press Enter
The topology data for the object is updated in the topology.

If you delete an object from one topology, and the object belongs to another topology, the physical object is not removed from the drawing. The second topology is not changed and no update is necessary for the deleted object.

Quick Reference

MAPLINKUPD

Updates links in a network topology

Command Line	MAPLINKUPD
Task Pane	In Map Explorer, right-click a topology ► Update
Dialog Box	MAPLINKUPD (Update Topology Link command)

MAPNODUPD

Updates nodes in a topology

Command Line	MAPNODUPD
Task Pane	In Map Explorer, right-click a topology ► Update
Dialog Box	MAPNODUPD (Update Topology Node command)

MAPPOLYUPD

Updates a polygon topology

Command Line	MAPPOLYUPD
Task Pane	In Map Explorer, right-click a topology ► Update
Dialog Box	MAPPOLYUPD (Update Topology Polygon command)

PROPERTIES

Displays the Properties palette, which allows you to edit the properties of objects

Menu	Analyze ► Properties
Icon	 Properties
Command Line	PROPERTIES
Task Pane	Select object. Right-click in drawing area ► Properties

Editing a Partial Topology

In general, when editing a topology, you should retrieve the entire topology. However, if the topology is large, it may impair performance. With large topologies, you can query in just a part of the topology.

NOTE This functionality is for drawing objects only. There is no equivalent for geospatial feature data.

[Topology editing tools](#) (page 851) do not allow you to edit incomplete objects at the edges of the queried area. Your query must retrieve enough of an area around the edit area to ensure that the objects to be edited are complete.

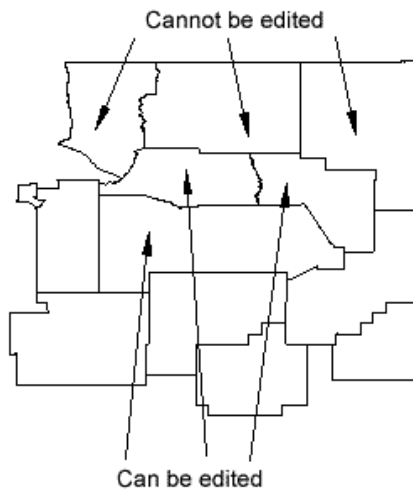

Polygons at the edge of a queried polygon topology cannot be edited.

See also:

- [Correcting or Completing a Topology](#) (page 918)
- [Overview of Creating Topologies](#) (page 822)
- [Loading or Unloading Topologies](#) (page 906)

NOTE This procedure is for drawing objects only. There is no equivalent for geospatial feature data.

To retrieve objects to edit

- 1 Open a drawing, attach the source drawings that contain the topology you wish to edit, and make those source drawings active. Zoom to the extents of the active source drawings.
- 2 In Display Manager, click Data menu ► Add Drawing Data ► Query Topology.
- 3 In the [Topology Query dialog box](#) (page 2008), click Load.
- 4 In the [Topology Selection dialog box](#) (page 2011), select the topology to query. Click OK.

- 5 In the [Load Topology From Source Drawing dialog box](#) (page 1978), make sure that both the Topology Objects options are not selected. Click OK.
- 6 In the [Topology Query dialog box](#) (page 2008), select or define a query.
 - To load an existing query, click Load Query and select the query.
 - To define a new query, click Define Query, and then [define a query](#) (page 1353) to retrieve the topology geometry you require.
- 7 Select Draw mode and execute the query.

Now that the objects are in the current drawing, you can edit them.

To edit the objects

- 1 [Unload](#) (page 907) the topology from the source drawings. Load the topology in the current drawing.
- 2 Make any edits to the topology with the [editing topology tools](#) (page 851).
- 3 Add the changes to the save set.
- 4 [Save back the changes to the source drawings](#) (page 754). Do not save the current drawing.

Quick Reference

ADESAVEOBS

Saves objects in the save set back to source drawings

Menu

In the Classic workspace, click File menu ► Save Source Drawing Save Set

Icon



Save to Source Drawings

Command Line

ADESAVEOBS

Dialog Box

Save Objects to Source Drawings dialog box

MAPTOPOLOAD

Loads a topology

Menu	Click Analyze ► More Topology Options ► Load Topology.
Icon	 Load Topology
Command Line	MAPTOPOLOAD
Task Pane	In Map Explorer, right-click a topology ► Administration ► Load Topology
Dialog Box	Topology Selection dialog box

MAPTOPOQUERY

Queries topologies

Menu	Click Setup ► More DWG Options ► Define Topology Query.
Icon	 Query Topology
Command Line	MAPTOPOQUERY
Task Pane	In Map Explorer, right-click a topology ► Analysis ► Topology Query
Dialog Box	Topology Query dialog box

MAPTOPOUNLOAD

Unloads a topology

Menu	Click Map ► Topology ► Administration ► Unload.
Icon	 Unload Topology
Command Line	MAPTOPOUNLOAD
Task Pane	In Map Explorer, right-click a topology ► Administration ► Unload Topology
Dialog Box	Topology Selection dialog box

PROPERTIES

Displays the Properties palette, which allows you to edit the properties of objects

Menu	Analyze ► Properties
Icon	 Properties
Command Line	PROPERTIES
Task Pane	Select object. Right-click in drawing area ► Properties

Creating Closed Polylines from a Polygon Topology

You can create closed polylines from a polygon topology. This is useful if you want to give data to an AutoCAD user so the user can hatch polygonal areas.

NOTE This functionality is for drawing objects only. There is no equivalent for geospatial feature data.

While creating closed polylines from polygon topology, you can create a group containing all the elements of complex areas, such as islands. If the islands themselves have nested islands or other polygons, these nested polygons will form a separate grouping automatically, creating different levels of grouping. If two or more inner polygons are not nested but share the same outer boundary, they will be treated as one group.

You can manipulate grouped data with the GROUP command. For more information, see *GROUP* in the AutoCAD Help.

You can also copy the object data and the external database links held in the centroids to the closed polylines.

See also:

- [Overview of Creating Topologies](#) (page 822)
- [Creating a Polygon Topology](#) (page 833)
- [Loading or Unloading Topologies](#) (page 906)
- [Exporting Polygons from a Polygon Topology](#) (page 1457)

NOTE This procedure is for drawing objects only. There is no equivalent for geospatial feature data.

To create closed polylines from a polygon topology

- 1 Click Create tab ► Topology panel ► Create Closed Polylines. 
- 2 In the [Create Closed Polylines dialog box](#) (page 1953), click Load to load the polygon topology or select from the Name list.
All polygons in the selected topology are automatically selected.
- 3 Under How To Close, specify the layer to create the polylines.
- 4 Select Group Complex Polygons if you want to create a group containing all the elements of complex areas, such as islands.
- 5 Select Copy Object Data From Centroid To Pline and Copy Database Links From Centroid To Pline if you want to copy the object data and external database links held in the centroids to the closed polylines.
- 6 Click OK.

Quick Reference

MAPCLPLINE

Creates polylines from a polygon topology

Menu	Create menu ► Create Closed Polylines
Command Line	MAPCLPLINE
Dialog Box	Create Closed Polylines dialog box

Managing Topologies

- [Overview of Managing Topologies](#) (page 899)
- [Loading or Unloading Topologies](#) (page 906)
- [Highlighting and Identifying Topology](#) (page 909)
- [Viewing Topology Data](#) (page 913)
- [Viewing Topology Statistics](#) (page 915)
- [Saving Topology to Source Drawings](#) (page 916)
- [Correcting or Completing a Topology](#) (page 918)
- [Saving and Loading Settings Using Profiles](#) (page 922)
- [Renaming Topologies and Changing Their Descriptions](#) (page 924)
- [Deleting Topologies](#) (page 925)

NOTE These procedures are for drawing objects only. There are no equivalents for geospatial feature data.

To manage topologies

- [To load a topology](#) (page 907)
- [To unload a topology](#) (page 908)
- [To highlight all objects in a selected topology](#) (page 911)
- [To highlight and identify the topologies associated with an object](#) (page 911)
- [To change the color used for highlighting](#) (page 912)
- [To remove highlighting and restore objects to their original color](#) (page 912)
- [To view topology object data](#) (page 914)
- [To view and edit the properties of topology objects in the Properties palette](#) (page 914)
- [To view topology statistics](#) (page 916)
- [To save topology to source drawings](#) (page 917)
- [To audit, recreate, or complete a topology](#) (page 920)
- [To test the integrity of a network topology](#) (page 920)
- [To save topology analysis settings in a profile](#) (page 922)
- [To load an existing topology profile](#) (page 923)
- [To rename or delete profiles](#) (page 923)
- [To change the name, description, or both of a topology](#) (page 925)
- [To delete a topology](#) (page 926)

Overview of Managing Topologies

Using topology administration tools, you can do the following:

- Load or unload an existing topology
- Rename or delete a topology
- Audit or check the status of a topology to ensure its integrity
- Recreate a topology that was edited with commands other than the topology editing tools
- Get statistics on the topologies in the current drawing
- Highlight all objects in a topology, and all topologies for a selected object.

When you use these tools, all source drawings associated with a named topology must be attached and active.

NOTE This functionality is for drawing objects only. There is no equivalent for geospatial feature data.

Tell me more



Video

- [Show me how to load a topology.](#)



Procedure

- [To manage topologies](#) (page 899)



GIS Skill

- [Create a network topology to show how lines are connected.](#)
- [Find the shortest path through a network.](#)



Related topics

- [Overview of Creating Topologies](#) (page 822)
- [Saving Topology to Source Drawings](#) (page 916)
- [Editing Topologies](#) (page 851)
- [Saving New Objects to Attached Drawings](#) (page 754)



NOTE This procedure is for drawing objects only. There is no equivalent for geospatial feature data.

To do this...

Load an existing topology.

Use this method...

In Map Explorer, right-click the topology name ► Administration ► Load Topology.
See [Loading or Unloading Topologies](#) (page 906)

To do this...	Use this method...
Unload an existing topology.	In Map Explorer, right-click the topology name ► Administration ► Unload Topology. See Loading or Unloading Topologies (page 906)
Rename a topology.	In Map Explorer, right-click the topology name ► Administration ► Rename. See Renaming Topologies and Changing Their Descriptions (page 924)
Audit or recreate a topology	In Map Explorer, right-click the topology name. Click an option from the Administration submenu. See Correcting or Completing a Topology (page 918)
Test the integrity of a topology	Click Analyze tab ► Drawing Object panel ► Network Analysis.  See Correcting or Completing a Topology (page 918)
Get statistics on the topologies in the current drawing	In Map Explorer, right-click the topology name ► Statistics. See Viewing Topology Statistics (page 915)
View the properties of topology objects	Click View tab ► Palettes panel ► Properties. Select the object. In the Properties palette, under the Topo group, view the topology properties. See Viewing Topology Data (page 913)
View topology object data	Click Tools tab ► Map Edit panel ► Edit Object Data.  Select the object. See Viewing Topology Data (page 913)

To do this...	Use this method...
Highlight all objects in a topology.	In Map Explorer, right-click the topology name ► Show Geometry. See Highlighting and Identifying Topology (page 909)
Highlight the topologies associated with an object.	In Map Explorer, right-click the Topologies folder ► Show Topology. Click an object in the map. See Highlighting and Identifying Topology (page 909)
Delete a topology	In Map Explorer, right-click the topology name ► Administration ► Delete. See Deleting Topologies (page 925)

Quick Reference

MAPTOPOLOAD

Loads a topology

Menu

Click Analyze ► More Topology Options ► Load Topology.

Icon



Load Topology

Command Line

MAPTOPOLOAD

Task Pane

In Map Explorer, right-click a topology ► Administration ► Load Topology

Dialog Box

Topology Selection dialog box

MAPTOPOUNLOAD

Unloads a topology

Menu

Click Map ► Topology ► Administration ► Unload.

Icon



Unload Topology

Command Line	MAPTOPOUNLOAD
Task Pane	In Map Explorer, right-click a topology ► Administration ► Unload Topology
Dialog Box	Topology Selection dialog box

MAPSHOWGEOM

Highlights and identifies topologies for the selected object

Menu At the Command prompt, enter mapshowgeom.

Icon  Show Geometry

Command Line MAPSHOWGEOM

Task Pane In Map Explorer, right-click Topologies ► Show Geometry

MAPSHOWTOPO

Highlights objects in the selected topology

Menu Click Map ► Topology ► Show Topology Geometry.

Icon  Show Topology

Command Line MAPSHOWTOPO

Task Pane In Map Explorer, right-click a topology ► Show Topology

MAPTOPOSTATS

Displays detailed information about a topology

Menu Click Map ► Topology ► Administration ► Statistics.

Command Line MAPTOPOSTATS

Task Pane In Map Explorer, right-click a topology ► Statistics

Dialog Box Topology Statistics dialog box

ADESAVEOBS

Saves objects in the save set back to source drawings

Menu In the Classic workspace, click File menu ► Save Source Drawing Save Set

Icon  Save to Source Drawings

Command Line ADESAVEOBS

Dialog Box Save Objects to Source Drawings dialog box

ADESELOBS

Creates a set of objects to be saved to source drawings

Menu File menu ► Drawing Save Set Options ► Add Items To Save Set

Icon  Add Objects to Save Set

Command Line ADESELOBS

Dialog Box ADESELOBS (Select Objects for Save Back command)

MAPTOPOAUDIT

Checks that a topology is complete and contains no errors

Menu Click Map ► Topology ► Administration ► Audit.

Command Line MAPTOPOAUDIT

Task Pane In Map Explorer, right-click a topology ► Administration ► Audit

MAPTOPOCOMP

Completes a network or polygon topology

Menu Click Map ► Topology ► Administration ► Complete.

Icon  Complete Topology

Command Line MAPTOPOCOMP

Task Pane In Map Explorer, right-click a topology ► Administration ► Complete

MAPTOPORECR

Reestablishes a topology that was edited with nontopology editing commands such as STRETCH, PEDIT, and MOVE

Menu Click Map ► Topology ► Administration ► Recreate.

Icon



Recreate Topology

Command Line MAPTOPORECR

Task Pane In Map Explorer, right-click a topology ► Administration ► Recreate

Dialog Box Topology Selection dialog box

MAPANOVERLAY

Overlays one topology with another, and creates a new topology

Menu Click Map ► Topology ► Overlay.

Icon



Overlay Topology

Command Line MAPANOVERLAY

Task Pane In Map Explorer, right-click a topology ► Analysis ► Overlay

Dialog Box Topology Overlay Analysis - Analysis Type dialog box

MAPANTOPONET

Traces through a network topology (shortest path, best route, or flood trace)

Menu Click Map ► Topology ► Network Analysis.

Icon



Network Analyze

Command Line MAPANTOPONET

Task Pane In Map Explorer, right-click a network topology ► Analysis ► Network Analysis

Dialog Box Network Topology Analysis - Select Method dialog box

MAPTOPOREN

Changes the name and description of a topology

Menu	Click Map ► Topology ► Administration ► Rename.
Command Line	MAPTOPOREN
Task Pane	In Map Explorer, right-click a topology ► Administration ► Rename
Dialog Box	Rename Topology dialog box

MAPTOPODEL

Removes topology data from objects and optionally deletes the objects

Menu	Click Map ► Topology ► Administration ► Delete.
Command Line	MAPTOPODEL
Task Pane	In Map Explorer, right-click a topology ► Administration ► Delete
Dialog Box	Topology Selection dialog box

Loading or Unloading Topologies

When you load a topology, AutoCAD Map 3D loads topologies in the current drawing and retrieves topologies from attached drawings into the current drawing. If you save a drawing with a topology and later open the drawing, reload the topology to use it.

NOTE This functionality is for drawing objects only. There is no equivalent for geospatial feature data.

In Map Explorer, topologies with colorful icons are loaded. Topologies with grayed-out icons are unloaded.

When loading a topology from a source drawing, select Create Objects When Loaded to create the topology in the current drawing. Otherwise, the topology is loaded without retrieving the topology geometry.

Tell me more



Video

■ [Show me how to load a topology.](#)



Procedure

- [To load a topology](#) (page 907)



GIS Skill

- *Create a network topology to show how lines are connected.*
- *Find the shortest path through a network.*



Related topics

- [Overview of Creating Topologies](#) (page 822)
- [Saving Topology to Source Drawings](#) (page 916)
- [Adding an Object to the Save Set](#) (page 750)
- [Saving New Objects to Attached Drawings](#) (page 754)
- [Saving Objects to the Current Drawing](#) (page 756)

NOTE This procedure is for drawing objects only. There is no equivalent for geospatial feature data.

To load a topology

- 1 In Map Explorer, right-click the topology name ► Administration ► Load Topology.
- 2 If the topology is stored in a source drawing, the [Load Topology From Source Drawing dialog box](#) (page 1978) appears, where you can specify the following:
 - **Create Topology Objects When Loaded** — Select this check box to copy the topology objects into the current drawing as the topology is loaded. If this option is not selected, the objects are loaded but are not copied into the current drawing.
 - **Select Topology Objects For Save Back** — Select this option to add objects in the current drawing to the save back set if they are referenced by the selected topology. This means that the objects will be saved back to their source drawings and replace the original objects.

- **Audit Geometry of Topology Objects** — Select this option to verify that objects for the selected topology are geometrically correct. Any objects that are not correct are highlighted.

In Map Explorer, the icon for the topology becomes colorful, indicating that the topology is loaded.

To unload a topology

- In Map Explorer, right-click the topology name ► Administration ► Unload Topology.

In Map Explorer, the icon for the topology is shaded to indicate it has been unloaded.

Quick Reference

MAPTOPOLOAD

Loads a topology

Menu	Click Analyze ► More Topology Options ► Load Topology.
Icon	 Load Topology
Command Line	MAPTOPOLOAD
Task Pane	In Map Explorer, right-click a topology ► Administration ► Load Topology
Dialog Box	Topology Selection dialog box

MAPTOPOUNLOAD

Unloads a topology

Menu	Click Map ► Topology ► Administration ► Unload.
Icon	 Unload Topology
Command Line	MAPTOPOUNLOAD

Task Pane	In Map Explorer, right-click a topology ► Administration ► Unload Topology
Dialog Box	Topology Selection dialog box

Highlighting and Identifying Topology

Using the topology highlighting and identification tools, you can do the following:

- **Show Geometry**—Highlight the objects in a topology.
Use Show Geometry to show the location and extent of a topology.
- **Show Topology**—Identify and highlight the topologies associated with an object.
Use Show Topology to show the location and extent of all the topologies associated with an object. AutoCAD Map 3D identifies the topologies by name on the command line.

The color used for highlighting is the Selected Grip Color, which you can specify in the AutoCAD Options dialog box.

These tools work only with topologies that have been loaded in the current drawing.

NOTE This functionality is for drawing objects only. There is no equivalent for geospatial feature data.

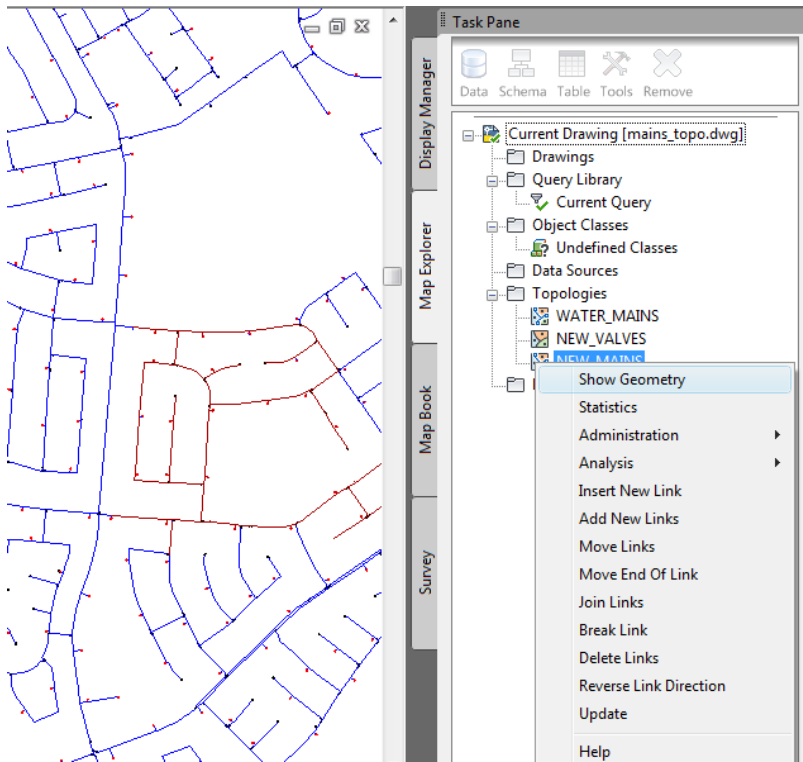

Highlight objects in the selected topology.

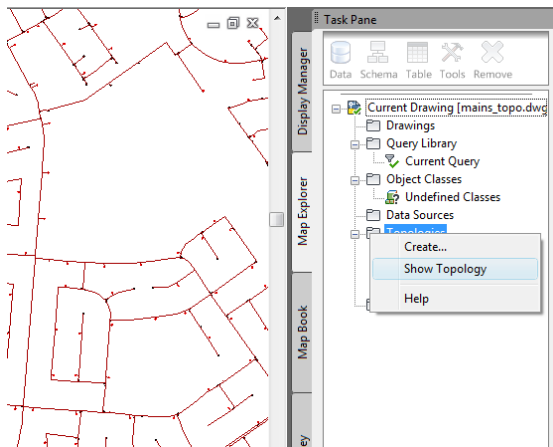

Highlights and identifies topologies for the selected object.

See also:

- [Overview of Creating Topologies](#) (page 822)
- [Loading or Unloading Topologies](#) (page 906)

NOTE This procedure is for drawing objects only. There is no equivalent for geospatial feature data.

- [To highlight all objects in a selected topology](#) (page 911)
- [To highlight and identify the topologies associated with an object](#) (page 911)
- [To change the color used for highlighting](#) (page 912)
- [To remove highlighting and restore objects to their original color](#) (page 912)

To highlight all objects in a selected topology

- 1 In Map Explorer, verify that the topology you want to highlight is [loaded](#) (page 907). A topology must be loaded before it can be highlighted.
- 2 Right-click the topology name. Click Show Geometry.
In the drawing, AutoCAD Map 3D highlights all objects in the selected topology. To return objects to their original color, press ESC.

To highlight and identify the topologies associated with an object

- 1 In Map Explorer, right-click the Topologies folder. Click Show Topology.
- 2 In the map, click the object.
If the object belongs to one or more topologies, AutoCAD Map 3D highlights all objects that belong to those topologies and lists the topology names on the command line. If the object does not belong to a topology, AutoCAD Map 3D reports that on the command line.

NOTE Only topologies that are loaded are considered.

- 3 Select another object to highlight and identify, or press ESC to end the command.

To change the color used for highlighting

- 1 Click  ► Options.
- 2 In the Options dialog box, click the Selection tab.
- 3 From the Selected Grip Color list, select the color to use for highlighting topologies.
- 4 Click OK.

To remove highlighting and restore objects to their original color

- Press Esc.

Quick Reference

MAPSHOWGEOM

Highlights and identifies topologies for the selected object

Menu At the Command prompt, enter mapshowgeom.

Icon  Show Geometry

Command Line MAPSHOWGEOM

Task Pane In Map Explorer, right-click Topologies ► Show Geometry

MAPSHOWTOPO

Highlights objects in the selected topology

Menu Click Map ► Topology ► Show Topology Geometry.

Icon  Show Topology

Command Line MAPSHOWTOPO

Task Pane In Map Explorer, right-click a topology ► Show Topology

Viewing Topology Data

Information about each topology you create is stored in an object data table in the current drawing as shown in this table.

NOTE This functionality is for drawing objects only. There is no equivalent for geospatial feature data.

Topology Name	Object Data Table	Object Data Field	Information Stored
EXAMPLE	TPMDESC_EXAMPLE	TYPE	Topology type
		TOLERANCE	Setting of VIEWRES when created or edited
		LINK_LAYER	Layer for links
		LINK_COLOR	Color of links
		CREATE_NODE	Nodes in topology; 0=No, 1=Yes
		NODE_LAYER	Layer for nodes
		NODE_TYPE	Type of nodes
		NODE_BLOCK	Block used for nodes
		CREATE_CNTR	Centroids in topology; 0=No, 1=Yes
		CNTR_LAYER	Layer for centroids
		CNTR_COLOR	Color of centroids
		CNTR_TYPE	Type of centroids
		CNTR_BLOCK	Block used for centroids

This information can be used in a topology query. Depending on the type of topology, other object data tables are created and attached to the elements of the topology.

You can also view and edit data associated with the objects in a topology using the Properties palette. For example, for a link in a network topology, you can view general information about the link, such as the ID of the start and end nodes, and you can edit specific information such as the direction, direct resistance, and reverse resistance of a link.

See also:

- [Overview of Creating Topologies](#) (page 822)
- [Loading or Unloading Topologies](#) (page 906)
- [Querying a Topology](#) (page 1348)
- [Displaying and Editing Object Data for a Drawing Object](#) (page 1068)
- [Viewing Properties and Attributes of Drawing Objects](#) (page 1145)
- [Viewing Topology Statistics](#) (page 915)

NOTE This procedure is for drawing objects only. There is no equivalent for geospatial feature data.

To view topology object data

- 1 Click Tools tab ► Map Edit panel ► Edit Object Data. 
- 2 Select the object.
- 3 In the [Edit Object Data dialog box](#) (page 1795), view the topology data.
If the topology data is not displayed, select a topology table from the Table list. The topology tables start with the letters "TPM."

To view and edit the properties of topology objects in the Properties palette

- 1 Click View tab ► Palettes panel ► Properties.
- 2 Select the object.
- 3 In the Properties palette, under the Topo group, view the topology properties.
For example, if you choose a link in a network topology, you can see the type object you selected, information about the start and end nodes, flow direction, direct resistance, and reverse resistance.

- 4 To view the properties of another object, select it in the map.

Quick Reference

ADEEDITDATA

Edits attached object data

Menu Modify menu ► Edit Object Data

Icon  Edit Object Data

Command Line ADEEDITDATA

Dialog Box Edit Object Data dialog box

PROPERTIES

Displays the Properties palette, which allows you to edit the properties of objects

Menu Analyze ► Properties

Icon  Properties

Command Line PROPERTIES

Task Pane Select object. Right-click in drawing area ► Properties

Viewing Topology Statistics

You can view information about a topology, including:

- Basic Information — name, description, and type (node, network, or polygon).
- Extents — coordinates of the lower-left corner and upper-right corner of the bounding rectangle for the topology.
- Object Counts — number of nodes, links, and polygons in the topology.
- Details — about area, perimeter, and length, including totals, averages, minimum values, maximum values, variance, and deviation. These apply to network and polygon topologies only.

Variance is the average of the squares of any given area, perimeter, or length minus the square of the average. Deviation is the square root of variance.

NOTE This functionality is for drawing objects only. There is no equivalent for geospatial feature data.

See also:

- [Overview of Creating Topologies](#) (page 822)
- [Loading or Unloading Topologies](#) (page 906)
- [Viewing Topology Data](#) (page 913)

NOTE This procedure is for drawing objects only. There is no equivalent for geospatial feature data.

To view topology statistics

- 1 In Map Explorer, right-click the topology name ► Statistics.
- 2 Review statistics in the [Topology Statistics dialog box](#) (page 2011).
- 3 Click OK.

Quick Reference

MAPTOPOSTATS

Displays detailed information about a topology

Menu	Click Map ► Topology ► Administration ► Statistics.
Command Line	MAPTOPOSTATS
Task Pane	In Map Explorer, right-click a topology ► Statistics
Dialog Box	Topology Statistics dialog box

Saving Topology to Source Drawings

You can save the topology in the current drawing or save it back to the attached source drawings.

NOTE This functionality is for drawing objects only. There is no equivalent for geospatial feature data.





If you retrieved data from source drawings, you can save back the topology information to the source drawings, and also save the current drawing. Future work with the topology should be done in the current drawing with the source drawings active and attached. This method ensures that complete and correct object data associated with the topology is available.

See also:

- [Loading or Unloading Topologies](#) (page 906)
- [Adding an Object to the Save Set](#) (page 750)
- [Saving New Objects to Attached Drawings](#) (page 754)
- [Saving Objects to the Current Drawing](#) (page 756)

NOTE This procedure is for drawing objects only. There is no equivalent for geospatial feature data.

To save topology to source drawings

- 1 Click Home tab ► Data panel ►  ► Add To Save Set. 
- 2 Use any selection method to add the topology objects to the save set.
- 3 Click Home tab ► Data panel ►  ► Save To Source. 
- 4 In the [Save Objects to Source Drawings dialog box](#) (page 1887), under What To Save, make sure Save Queried Objects is selected.
If you created new node or centroid objects, or if you added objects to a topology, also select Save Newly Created Objects.
- 5 If you are saving new objects, select a save order.
- 6 Click OK.

Quick Reference

ADESAVEOBS

Saves objects in the save set back to source drawings

Menu In the Classic workspace, click File menu ► Save Source Drawing Save Set

Icon  Save to Source Drawings

Command Line ADESAVEOBS

Dialog Box Save Objects to Source Drawings dialog box

ADESELOBS

Creates a set of objects to be saved to source drawings

Menu File menu ► Drawing Save Set Options ► Add Items To Save Set

Icon  Add Objects to Save Set

Command Line ADESELOBS

Dialog Box ADESELOBS (Select Objects for Save Back command)

Correcting or Completing a Topology

If parts of the topology are incomplete (not closed or only part of a polygon), they are marked and excluded from editing. Two examples of incomplete topologies created by queries are shown in the following illustration. The outer polygons in the grid are incomplete because their outside links are parts of polygons not included in the query.

NOTE This functionality is for drawing objects only. There is no equivalent for geospatial feature data.

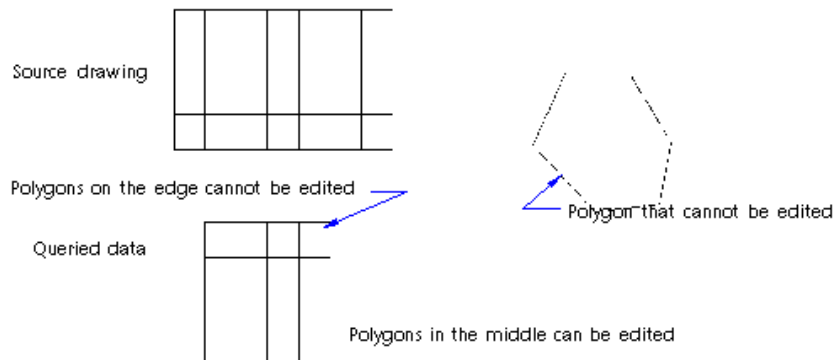

If you use a location query to retrieve polygons, make sure that you use a Crossing window. If you are using data that is shared with other users, be sure that you load the topology to ensure that you are using current data.

Completing a Topology

When you complete a topology, AutoCAD Map 3D looks at the objects and object data in a drawing, and attempts to complete a network or polygon topology by retrieving further drawing objects, such as links and centroids referenced by the topology object data tables. Complex polygons, with one or more islands, must be fully represented, and all internal islands referenced by a polygon must be present for the option to work.

This option completes dangling edges in a network topology, and all incomplete areas in polygon topologies; however, it might fill islands as well.

Auditing and Recreating a Topology

When you audit a topology, AutoCAD Map 3D checks that a topology is complete and contains no errors. Any errors found are marked but are not fixed. Errors in a node topology are not marked.

To reestablish a topology that was edited with nontopology editing commands such as STRETCH and PEDIT, you *recreate* the topology; however, topology data might be lost. You can only recreate a topology in the current drawing; to recreate topology in an attached drawing, use a query to retrieve the geometry first. Load the topology before using recreate.

To modify the geometry of a topology (the nodes, links, or polygons), use the topology editing tools explained in [Editing Topologies](#) (page 851).

To create closed polylines for a non-AutoCAD Map 3D user, click Create tab ► Topology panel ► [Create Closed Polylines](#) (page 897). This also works

when you are exporting data to an external file format that does not support topologies.

See also:

- [Overview of Analyzing Drawing Topologies](#) (page 1319)
- [Querying a Topology](#) (page 1348)
- [Creating a Network Topology](#) (page 829)
- [Editing a Partial Topology](#) (page 893)
- [Sliver Polygons](#) (page 841)

NOTE This procedure is for drawing objects only. There is no equivalent for geospatial feature data.

To audit, recreate, or complete a topology

- In Map Explorer, right-click the topology name. Click an option from the Administration submenu.

To test the integrity of a network topology

- 1 Click Analyze tab ➤ Drawing Object panel ➤ Network Analysis. 
- 2 Select the network the topology to test.
- 3 In the [Network Topology Analysis - Select Method dialog box](#) (page 1983), click [Flood Trace](#) (page 1334). Click Next.
- 4 Select select a starting point for the analysis. Click Next.
- 5 Set the Maximum Resistance to a value so that all links will be flooded. Click Next.
- 6 Select Highlight. Choose a color that is different from the color of the links.
- 7 Click Finish.

If some links are not flooded, the topology may be incorrect. Use the [topology editing tools](#) (page 852) to correct the topology.

Quick Reference

MAPTOPOAUDIT

Checks that a topology is complete and contains no errors

Menu Click Map ► Topology ► Administration ► Audit.

Command Line MAPTOPOAUDIT

Task Pane In Map Explorer, right-click a topology ► Administration ► Audit

MAPTOPOCOMP

Completes a network or polygon topology

Menu Click Map ► Topology ► Administration ► Complete.

Icon



Complete Topology

Command Line MAPTOPOCOMP

Task Pane In Map Explorer, right-click a topology ► Administration ► Complete

MAPTOPORECR

Reestablishes a topology that was edited with nontopology editing commands such as STRETCH, PEDIT, and MOVE

Menu Click Map ► Topology ► Administration ► Recreate.

Icon



Recreate Topology

Command Line MAPTOPORECR

Task Pane In Map Explorer, right-click a topology ► Administration ► Recreate

Dialog Box Topology Selection dialog box

Saving and Loading Settings Using Profiles

You can save your topology overlay analysis or network analysis (path trace, best route analysis, or flood trace) settings in a profile and use them again later. This can save time if you plan to use the same settings more than once. Profiles are also useful when you automate topology analysis with scripts. Topology profiles are saved as *.tpf files.

You can edit topology profiles in AutoCAD Map 3D and then save your changes, choosing either to replace an existing profile or save it as a new profile.

NOTE You cannot use profiles to save settings for creating topologies, buffering topologies, or dissolving topologies. Topology profiles can be used to save topology overlay analysis or network topology analysis (path trace, best route analysis, or flood trace) settings only.

NOTE This functionality is for drawing objects only. There is no equivalent for geospatial feature data.

WARNING Do not edit topology profiles outside of AutoCAD Map 3D. Doing so may produce unexpected results.

See also:

- [Performing a Shortest Path Trace](#) (page 1324)
- [Performing a Best Route Analysis](#) (page 1328)
- [Performing a Flood Trace](#) (page 1333)
- [Overlaying Two Topologies](#) (page 1336)

NOTE This procedure is for drawing objects only. There is no equivalent for geospatial feature data.

To save topology analysis settings in a profile

- 1 Do one of the following:

- Click Analyze tab ► Drawing Object panel ► Object Overlay.



- Click Analyze tab ► Drawing Object panel ► Network Analysis. 
- 2 Specify the settings to save. For more information, see [Analyzing Drawing Topologies](#) (page 1318).
 - 3 Click Save.
 - 4 In the Save Topology Profile dialog box, enter a name for the profile. Click Save.

To load an existing topology profile

- 1 In any of the Topology Overlay Analysis or Network Topology Analysis dialog boxes, click Load.
- 2 In the Select Topology Profile dialog box, select the profile to load. Topology profiles are saved as *.tpf files.
- 3 Click Open.
The settings from the selected profile become current.

To rename or delete profiles

- Right-click the profile in the Select Topology Profile or Save Topology Profile dialog box. Click Rename or Delete.

Quick Reference

MAPANOVERLAY

Overlays one topology with another, and creates a new topology

Menu	Click Map ► Topology ► Overlay.
Icon	 Overlay Topology
Command Line	MAPANOVERLAY
Task Pane	In Map Explorer, right-click a topology ► Analysis ► Overlay
Dialog Box	Topology Overlay Analysis - Analysis Type dialog box

MAPANTOPONET

Traces through a network topology (shortest path, best route, or flood trace)

Menu	Click Map ► Topology ► Network Analysis.
Icon	 Network Analyze
Command Line	MAPANTOPONET
Task Pane	In Map Explorer, right-click a network topology ► Analysis ► Network Analysis
Dialog Box	Network Topology Analysis - Select Method dialog box

Renaming Topologies and Changing Their Descriptions

You can change the name, description, or both of a complete, loaded topology. When you rename a topology, AutoCAD Map 3D renames the object data table containing the topology relationship data.

NOTE This functionality is for drawing objects only. There is no equivalent for geospatial feature data.

Before you rename a topology or change its description, do the following:

- Attach all source drawings that are referenced by the topology. If the source drawings are not attached, you could corrupt your data set.
- Load the topology from the current drawing.
- To rename a topology or change its description without creating a backup of an attached drawing, disable the Create Backup File Of Source Drawing option of the Save Back tab of the AutoCAD Map Options dialog box.

NOTE You cannot undo this operation using the UNDO command.

See also:

- [Loading or Unloading Topologies](#) (page 906)
- [Overview of Attaching Drawings](#) (page 154)
- [Setting Save Back Options](#) (page 763)

NOTE This procedure is for drawing objects only. There is no equivalent for geospatial feature data.

To change the name, description, or both of a topology

- 1 In Map Explorer, right-click the topology name ► Administration ► Rename.

You can only rename topologies that are loaded and completely represented.

- 2 In the [Rename Topology dialog box](#) (page 1988), edit the name or description. Click OK.

Names can contain letters, numbers, and the underscore and hyphen characters. Names cannot contain spaces.

Quick Reference

MAPTOPOREN

Changes the name and description of a topology

Menu	Click Map ► Topology ► Administration ► Rename.
Command Line	MAPTOPOREN
Task Pane	In Map Explorer, right-click a topology ► Administration ► Rename
Dialog Box	Rename Topology dialog box

Deleting Topologies

When you delete a topology, the topology relationship data (object data) is deleted from objects referenced by the selected topology. You can choose to delete the referenced objects as well.

NOTE This functionality is for drawing objects only. There is no equivalent for geospatial feature data.

Load a topology and verify that it is completely represented before deleting it. This ensures that all pieces of the topology are deleted, including pieces in attached source drawings. If you delete an incomplete topology, the corrupt topology still exists in the source drawings that were not attached.

See also:

- [Loading or Unloading Topologies](#) (page 906)
- [Overview of Creating Topologies](#) (page 822)

NOTE This procedure is for drawing objects only. There is no equivalent for geospatial feature data.

To delete a topology

- 1 In Map Explorer, right-click the topology name ► Administration ► Delete.

NOTE Load a topology and verify that it is completely represented before deleting it.

- 2 In the [Delete Topology dialog box](#) (page 1971), select Delete Geometry to delete the referenced objects from the current drawing. The topology relationship data is automatically deleted when you delete a topology.
- 3 Click OK to delete the topology.

Quick Reference

MAPTOPODEL

Removes topology data from objects and optionally deletes the objects

Menu	Click Map ► Topology ► Administration ► Delete.
Command Line	MAPTOPODEL
Task Pane	In Map Explorer, right-click a topology ► Administration ► Delete
Dialog Box	Topology Selection dialog box

Using Map Editing Tools

You can use the AutoCAD Map 3D editing tools to edit your maps and spatial data. For information about editing objects and design data, see the AutoCAD Help.

To use Map editing tools

- [To use the AutoCAD Map 3D editing tools](#) (page 928)
- [To move, rotate, or scale an object](#) (page 931)
- [To rubber sheet two maps](#) (page 935)
- [To define text location](#) (page 937)
- [To fill a closed polyline with a solid-looking hatch](#) (page 939)
- [To break objects at a boundary](#) (page 941)
- [To save the data back to the source drawings after a boundary break](#) (page 942)
- [To create an enlarged map section](#) (page 943)
- [To trim objects inside a boundary](#) (page 945)
- [To use grips](#) (page 947)
- [To create centroids for polygons and closed polylines](#) (page 950)
- [To match map edges](#) (page 951)
- [To save the edited objects back to the source drawings](#) (page 952)
- [To digitize points using coordinates](#) (page 953)

Overview of Using the Map Editing Tools

AutoCAD Map 3D provides special editing tools for editing maps and spatial data, as well as AutoCAD editing tools for editing drawing objects and design data.

Examples: Stretching a new subdivision map into a preexisting parcel map and aligning the two maps geographically, breaking a large city map into three tiled sections, or creating a seamless join across two or more maps.

WARNING If you use these methods on a topology, they can make it invalid and impossible to re-create. Use [topology editing commands](#) (page 851) instead.

NOTE These commands work on drawing objects only. For information about editing geospatial feature data, see [Using Feature Editing Commands](#) (page 704) and [Using AutoCAD Commands on Features](#) (page 713). For information about AutoCAD commands, see the AutoCAD Help.

Tell me more



Video

- [Show me how to georeference parcels by rubbersheeting.](#)



Procedure

- [To use Map editing tools](#) (page 927)



Workflow

- [Find and Edit Objects in Attached Drawings](#)



GIS Skill

- [Georeference parcels by rubbersheeting.](#)



Related topics

- [Overview of Bringing in Drawing Data From DWG Files](#) (page 351)
- [Editing Topologies](#) (page 851)

NOTE These commands work on drawing objects only. For information about editing geospatial feature data, see [Using Feature Editing Commands](#) (page 704) and [Using AutoCAD Commands on Features](#) (page 713). For information about AutoCAD commands, see the AutoCAD Help.

To use the AutoCAD Map 3D editing tools

- 1 Open the drawing containing the objects you want to edit or query the objects into the current drawing.
- 2 Use one or more of the following AutoCAD Map 3D editing commands:
 - [Transform](#) (page 931)
 - [Rubber Sheet](#) (page 935)
 - [Define Text Location](#) (page 937)
 - [Fill Closed Polylines](#) (page 939)
 - [Fill Polygons](#) (page 963)
 - [Boundary Break](#) (page 941)
 - [Create an Enlarged Map Section](#) (page 942)
 - [Boundary Trim](#) (page 945)
 - [Manually Edit](#) (page 947)
 - [Creating Centroids for Polylines](#) (page 948)

- [Match Map Edges](#) (page 951)

Notes and Warnings

- To perform general and object-specific editing operations, use the AutoCAD editing commands. For more information, see the AutoCAD Help.
- Do not use any of the methods described above to edit topologies; you might not be able to recreate the topology. Use the [topology editing commands](#) (page 851) instead.

Quick Reference

ADEFILLPOLYG

Fills a selected polygon

Command Line ADEFILLPOLYG
Dialog Box ADEFILLPOLYG (Fill Closed Polyline command)

ADERSHEET

Performs rubber sheeting on selected objects

Menu Modify menu ► Rubber Sheet
Command Line ADERSHEET
Dialog Box ADERSHEET (Rubber Sheet command)

ADETEXTLOC

Specifies a new label point for an object

Menu Create menu ► Map Labelpoint Location

Icon  Map Labelpoint Location

Command Line ADETEXTLOC
Dialog Box ADETEXTLOC (Map Labelpoint Location command)

ADETRANSFORM

Moves, scales, and rotates a set of objects

Menu Modify menu ► Transform
Command Line ADETRANSFORM
Dialog Box ADETRANSFORM (Transform command)

MAPBREAK

Breaks objects along a selected or defined boundary

Menu Modify menu ► Boundary Break

Icon  Boundary Break

Command Line MAPBREAK

Dialog Box Break Objects at Boundary dialog box

MAPCREATECENTROIDS

Creates a centroid in a polygon and moves data to the centroid

Menu Create menu ► Centroids

Icon  Create Centroids

Command Line MAPCREATECENTROIDS

Dialog Box Create Centroids dialog box

MAPTRIM

Trims objects to a set of edges

Menu Modify menu ► Boundary Trim

Icon  Boundary Trim

Command Line MAPTRIM

Dialog Box Trim Objects At Boundary dialog box

Moving, Rotating, and Scaling an Object

You can simultaneously move, rotate, and scale a group of objects using the Transform editing tool.

NOTE This command works on drawing objects only. For information about editing geospatial feature data, see [Using Feature Editing Commands](#) (page 704) and [Using AutoCAD Commands on Features](#) (page 713). For information about AutoCAD commands, see the AutoCAD Help.

Differences From Simple Transformation Settings

The Transform editing tool works very differently from the [Simple Transformation settings](#) (page 167) in the [Drawing Settings dialog box](#) (page 1923). The Simple Transformation settings temporarily adjust the position of objects as they are retrieved during the query process. AutoCAD Map 3D reverses these transformations during save back. The Transform editing tool permanently scales, moves, and rotates objects within the current drawing.

See also:

- [ADETRANSFORM \(Transform command\)](#) (page 1649)

NOTE This command works on drawing objects only. For information about editing geospatial feature data, see [Using Feature Editing Commands](#) (page 704) and [Using AutoCAD Commands on Features](#) (page 713). For information about AutoCAD commands, see the AutoCAD Help.

To move, rotate, or scale an object

- 1 Click Tools tab ► Map Edit panel ► Transform. 
- 2 At the [ADETRANSFORM \(Transform command\)](#) (page 1649) prompt, specify whether you want to select objects or use all objects on a specified layer.
- 3 Select the objects you want to transform, or select a layer.
- 4 Define the base point.
The rotation and scaling occur around this point.
- 5 Specify a base rotation and scale, separated by a comma. For a simple transformation, set the base rotation to 0 and the base scale to 1.
- 6 Define a new zero point.

Selected objects are offset by the difference between the original base point and the new point.

- 7 Define a new rotation and scale, separated by a comma.

Selected objects are rotated the difference between the new rotation and the old rotation. They are scaled based on the ratio of the new scale to the old scale.

Quick Reference

ADETRANSFORM

Moves, scales, and rotates a set of objects

Menu	Modify menu ► Transform
Command Line	ADETRANSFORM
Dialog Box	ADETRANSFORM (Transform command)

Rubber Sheeting Two Maps

Rubber sheeting is a nonuniform adjustment of a data set based on the movement of known control points to new locations. For example, data collected by aerial survey may be inaccurate because of flight alignment and camera inaccuracies. By comparing this data with accurate ground survey data, the aerial data can be stretched or rubber sheeted over the accurate data using control points and monuments common to both data sets.

NOTE This command works on drawing objects only. For information about editing geospatial feature data, see [Using Feature Editing Commands](#) (page 704) and [Using AutoCAD Commands on Features](#) (page 713). For information about AutoCAD commands, see the AutoCAD Help.

Use rubber sheeting when you want two or more different data sets from different sources to align geographically: for example, when stretching a new subdivision map into a preexisting parcel map.

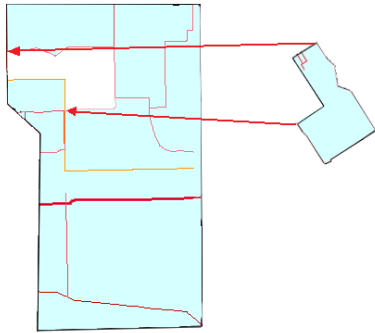

The reference map is correct, but the map with new details is severely distorted. By running the Rubber Sheeting command and selecting common control points, the two maps can be correctly aligned.

When selecting points for rubber sheeting, select points in order around the perimeter of the object or region to be rubber sheeted.

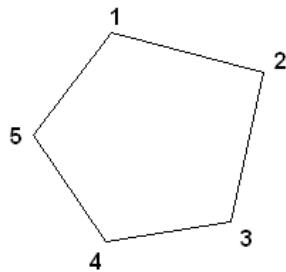

correct

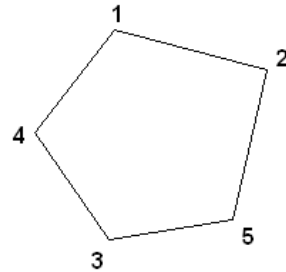

incorrect

The selected points are treated as the vertices of a polygon, so you will get better results if you select the points sequentially around the perimeter.

Objects that have a given shape, such as circles, arcs, and ellipses, retain their original shape.

WARNING Use rubber sheeting only when absolutely necessary because it can severely compromise the accuracy of your data.

Because rubber sheeting is not a linear transformation, it is difficult to reverse the effects of the transformation and return a drawing to its original state. You should save your drawing before you perform a rubber sheeting operation.

Changing Scale

Do not rubber sheet two maps drawn at different scales. If you do, the command matches objects and changes the original scaling of text and blocks to match the new scaling, which can change data significantly. You should use rubber sheeting as a last resort after exhausting other methods of object editing and coordinate adjustment.

If you are working with two maps that have different scales and coordinate systems, first decide which coordinate system to use for the reference map. Then set the coordinate systems for the current and source maps.

Tell me more



- [Show me how to georeference parcels by rubbersheeting.](#)



- [To rubber sheet two maps](#) (page 935)



- [Find and Edit Objects in Attached Drawings](#)



- [Georeference parcels by rubbersheeting.](#)



- [ADERSHEET \(Rubber Sheet command\)](#) (page 1648)
- [Overview of Coordinate Systems](#) (page 143)

Rubber sheet the less accurate data to fit the more accurate data. Perform a query to bring in the source drawing and apply rubber sheeting to the two maps. If you have set up a system of control points, or monuments, use this data as the reference to which you rubber sheet other maps.

NOTE This command works on drawing objects only. For information about editing geospatial feature data, see [Using Feature Editing Commands](#) (page 704) and [Using AutoCAD Commands on Features](#) (page 713). For information about AutoCAD commands, see the AutoCAD Help.

To rubber sheet two maps



- 1 Click Tools tab ► Map Edit panel ► Rubber Sheet.
- 2 At the [ADERSHEET \(Rubber Sheet command\)](#) (page 1648) prompt, for Base point 1, specify the first common feature on map 2, the warped map.
- 3 When prompted on the command line for Reference point 1, specify the corresponding feature on map 1, the accurate map.
- 4 Follow the prompts on the command line and continue specifying base and reference points. When you are done, press Enter.
The order in which you select the points and the spread of the points will affect the results. For complex curved figures, the more vertices you enter, the more accurate the proportionate stretching.
- 5 Select the objects to rubber sheet. Enter a to select objects by area, or s to select objects individually. If you queried all objects in the warped map onto their own layer, select that layer.
- 6 Press Enter to complete the process.

Quick Reference

ADERSHEET

Performs rubber sheeting on selected objects

Menu	Modify menu ► Rubber Sheet
Command Line	ADERSHEET
Dialog Box	ADERSHEET (Rubber Sheet command)

Defining the Text Insertion Point

You can add text to objects using the Alter Properties feature in the [Define Query dialog box](#) (page 1838). By default, AutoCAD Map 3D positions the text at the centroid of the object.

NOTE This command works on drawing objects only. For information about editing geospatial feature data, see [Using Feature Editing Commands](#) (page 704) and [Using AutoCAD Commands on Features](#) (page 713). For information about AutoCAD commands, see the AutoCAD Help.

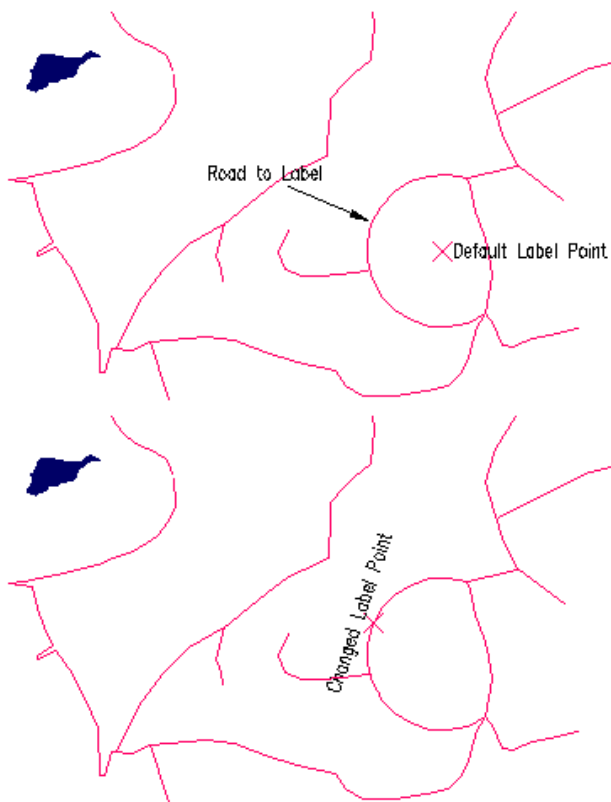

The text position relative to the object is called the *label point*. You can redefine the label point using the Map Labelpoint Location option.

To use the label point, choose the `.LABELPT` dot variable in the [Define Text dialog box](#) (page 1846) when you create the Property Alteration definition in the [Define Query dialog box](#) (page 1838).

See also:

- [Adding Text to Queried Drawing Objects](#) (page 1276)
- [Dot Variables](#) (page 1546)

NOTE This command works on drawing objects only. For information about editing geospatial feature data, see [Using Feature Editing Commands](#) (page 704) and [Using AutoCAD Commands on Features](#) (page 713). For information about AutoCAD commands, see the AutoCAD Help.

The label point of an object specifies the starting point for text added during a query property alteration. To define the label point for an object, do the following:

To define text location

- 1 Click Annotate tab ► Map Annotation panel ► Define Text Location.



- 2 Select the object.
- 3 Click the place on the object where you want the label point to be located.

To use this label point as the text insertion point during a [property alteration](#) (page 1278), choose LABELPT as the insert point.

Quick Reference

ADETEXTLOC

Specifies a new label point for an object

Menu	Create menu ► Map Labelpoint Location
Icon	 Map Labelpoint Location
Command Line	ADETEXTLOC
Dialog Box	ADETEXTLOC (Map Labelpoint Location command)

Filling a Closed Polyline

You can fill closed polylines in your drawing with solid fills and hatch patterns. For example, you can use one color to show counties with a population over 10,000 and another color to show counties under 10,000.

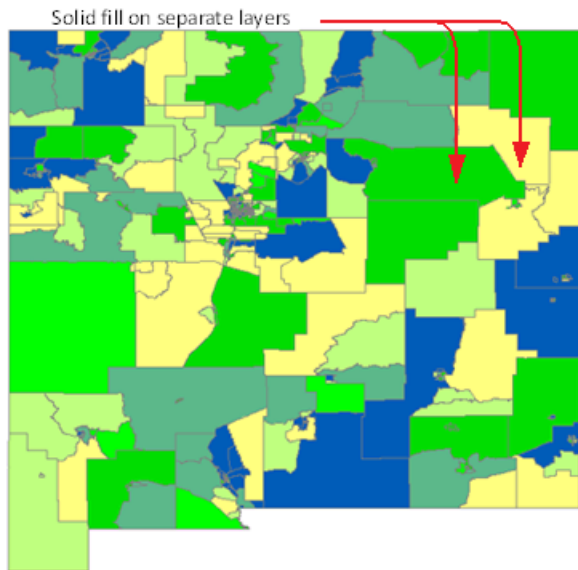

Filling closed polylines

NOTE This command works on drawing objects only. For information about editing geospatial feature data, see [Using Feature Editing Commands](#) (page 704) and [Using AutoCAD Commands on Features](#) (page 713). For information about AutoCAD commands, see the AutoCAD Help.

The ADEFILLPOLYG command always creates a hatch object with the solid fill hatch style.

You can also use the BHATCH command to fill closed polylines. Use the MPFILL command to fill polygon objects.

NOTE If you move closed polylines that you filled using ADEFILLPOLYG, you must move the hatch object as well. AutoCAD Map 3D considers the closed polyline and the hatch object as separate objects.

To fill closed polylines automatically with hatch patterns or solid fills when performing queries, use the Alter Properties feature in the [Define Query dialog box](#) (page 1838).

If you set the Create Associative Hatch Objects option on the Query tab of the [AutoCAD Map Options dialog box](#) (page 1908), AutoCAD Map 3D creates associative hatch objects for hatch objects created by the ADEFILLPOLYG command, the ADEQUERY command (using Alter Properties), and the MAPTHEMATIC command (using a fill).

See also:

- [Using Associative Hatch](#) (page 246)
- [Altering the Properties of Queried Drawing Objects](#) (page 1259)
- [Modifying Polygon Objects](#) (page 962)
- [Altering the Properties of Queried Drawing Objects](#) (page 1259)

NOTE This command works on drawing objects only. For information about editing geospatial feature data, see [Using Feature Editing Commands](#) (page 704) and [Using AutoCAD Commands on Features](#) (page 713). For information about AutoCAD commands, see the AutoCAD Help.

To fill a closed polyline with a solid-looking hatch

- 1 On the command line, enter adefillpolyg.
- 2 At the [ADEFILLPOLYG \(Fill Closed Polyline command\)](#) (page 1647) prompt, specify whether you want to select objects or fill all objects on a specified layer.
- 3 Select the objects or specify a layer.
- 4 Specify the color for the fill.

Quick Reference

ADEFILLPOLYG

Fills a selected polygon

Command Line	ADEFILLPOLYG
Dialog Box	ADEFILLPOLYG (Fill Closed Polyline command)

Breaking Objects at a Closed Boundary

Using the Boundary Break option, you can break any objects that cross a given line. This capability lets you save maps back to source drawings with clean edges or plot maps without overlapping borders. It functions like the AutoCAD BREAK command for a selected set of objects and a polyline boundary.

NOTE This command works on drawing objects only. For information about editing geospatial feature data, see [Using Feature Editing Commands](#) (page 704) and [Using AutoCAD Commands on Features](#) (page 713). For information about AutoCAD commands, see the AutoCAD Help.

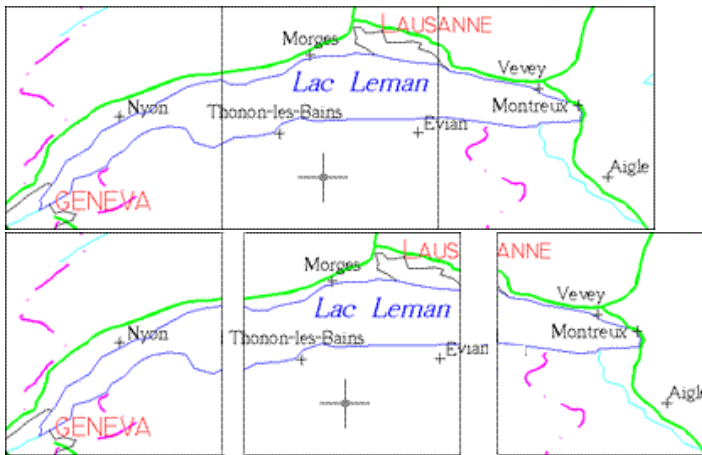

The text Thonon-les-Bains remains in the central map because the text has a MiddleCenter justification and insertion point.

The Boundary Break option

- Breaks vectors and edge objects with start and end points that straddle a cutting edge.
- Does not break objects such as blocks, text, hatch patterns, and other objects with a single insertion point that do not form edges; the insertion point determines which map contains the object.

Specifying the Boundary Edge

When breaking objects, you can draw a boundary, choose one or more existing objects that form a closed boundary, or use the save back extents of the active

source drawings as the boundary. Using save back extents combines the extents of all active source drawings as the boundary.

The edges of the boundary do not have to form a rectilinear shape. If you are breaking using lines of latitude and longitude, the edges form a trapezoidal shape.

Retaining Object Data

You can also choose to retain existing attached object data and links to external database records on the objects created by the break.

Once the objects are broken, you can save the data back to the source drawings.

See also:

- [Editing and Saving Objects in Attached Drawings](#) (page 737)
- [Defining the Text Insertion Point](#) (page 936)
- [Overview of Polygons](#) (page 955)

NOTE This command works on drawing objects only. For information about editing geospatial feature data, see [Using Feature Editing Commands](#) (page 704) and [Using AutoCAD Commands on Features](#) (page 713). For information about AutoCAD commands, see the AutoCAD Help.

To break objects at a boundary

- 1 Open a drawing and attach the maps you want.
- 2 Define and execute a query to retrieve the objects to break.
- 3 Click Tools tab ► Map Edit panel ► Boundary Break. 
- 4 In the [Break Objects at Boundary dialog box](#) (page 1666), under Boundaries, choose how to specify the boundaries for breaking:
 - Use Save Back Extents Of Active Source Drawings — Uses the combined extents of all active source drawings as the boundary.
 - Select Boundaries — Allows you to choose existing objects in the current drawing. These objects need to form a closed area but do not need to be single objects. Click Select and select the objects to use.
 - Define Boundary — Allows you to draw a single closed boundary on screen. Click Define and specify the boundary.

- 5 Under Objects To Break, specify whether to select objects manually or automatically, and whether to use only objects on selected layers.
- 6 Under Break Method, specify whether to exclude topology objects, and whether to retain object data on the objects.
- 7 Click OK.
- 8 In the Confirm Save Back dialog box, click Yes.
The objects are broken according to the location of the save back extents.

To save the data back to the source drawings after a boundary break

- 1 Click Home tab ► Data panel ►  Save To Source.
- 2 Under What To Save, make sure that both Save Queried Objects and Save Newly Created Object are selected.
- 3 Under Save Order For Newly Created Objects, select Area. Click OK.

Quick Reference

MAPBREAK

Breaks objects along a selected or defined boundary

Menu Modify menu ► Boundary Break

Icon  Boundary Break

Command Line MAPBREAK

Dialog Box Break Objects at Boundary dialog box

Creating an Enlarged Map Section

You can use Boundary Break to show an enlargement of a selected area.

NOTE This command works on drawing objects only. For information about editing geospatial feature data, see [Using Feature Editing Commands](#) (page 704) and [Using AutoCAD Commands on Features](#) (page 713). For information about AutoCAD commands, see the AutoCAD Help.



Use **Boundary Break** to isolate an area, then move and scale up the selected area. This is useful for map inserts.

Adding an inset to a map communicates the focus of the map better.

See also:

- [Breaking Objects at a Closed Boundary](#) (page 940)
- [Trimming Objects at a Boundary](#) (page 944)

NOTE This command works on drawing objects only. For information about editing geospatial feature data, see [Using Feature Editing Commands](#) (page 704) and [Using AutoCAD Commands on Features](#) (page 713). For information about AutoCAD commands, see the AutoCAD Help.

To create an enlarged map section

- 1 Draw a rectangle around the area you want to enlarge.
- 2 [Break the boundaries](#) (page 941) inside the rectangle.
- 3 Copy objects from the rectangle to a new location.
- 4 Rescale the objects to a larger size.

Quick Reference

MAPBREAK

Breaks objects along a selected or defined boundary

Menu Modify menu ► Boundary Break

Icon  Boundary Break

Command Line MAPBREAK

Dialog Box Break Objects at Boundary dialog box

Trimming Objects at a Boundary

Using the Boundary Trim command, you can specify a closed boundary as a trimming edge for a selected set of objects. You can use this option to trim objects inside or outside a boundary. Use Boundary Trim to quickly clear a circular or rectilinear area in a complex map in order to insert a legend or label.

NOTE This command works on drawing objects only. For information about editing geospatial feature data, see [Using Feature Editing Commands](#) (page 704) and [Using AutoCAD Commands on Features](#) (page 713). For information about AutoCAD commands, see the AutoCAD Help.

You can use this command to enhance plotted maps. After trimming objects inside an area, you can add text that will not be obscured.

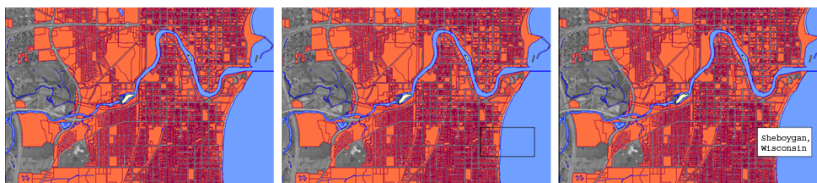

Rectangle showing area to be trimmed

Text in trimmed area

You can use a boundary to trim all objects inside the boundary or outside the boundary.

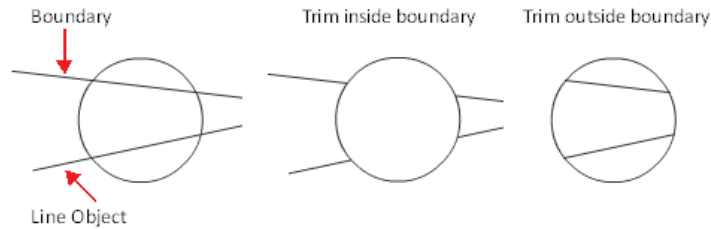

See also:

- [Overview of Creating Topologies](#) (page 822)
- [Overview of Polygons](#) (page 955)

NOTE This command works on drawing objects only. For information about editing geospatial feature data, see [Using Feature Editing Commands](#) (page 704) and [Using AutoCAD Commands on Features](#) (page 713). For information about AutoCAD commands, see the AutoCAD Help.

To trim objects inside a boundary

- 1 Open a drawing and attach the maps you want.
- 2 Define and execute a query to retrieve the objects to trim.

- 3 Click Tools tab ► Map Edit panel ► Boundary Trim. 

- 4 In the [Trim Objects At Boundary dialog box](#) (page 1672), under Boundary, select how to specify the boundary:

- Reference Last Query Boundary — Use the boundary you used in the last query.
- Select Boundary — Use an object in the current drawing as the boundary. Click Select and select the object to use. The object needs to form a closed area.
- Define Boundary — Use a boundary you define. Click Define and specify the boundary.

- 5 Under Objects To Trim, specify whether to select objects manually or automatically, and whether to use only objects on selected layers.
- 6 Under Trim Method, specify whether to trim inside or outside the boundary. Specify whether to exclude topology objects, and whether to retain object data on the objects.
If you select Retain Object Data, object data and external link data is duplicated on each piece of a trimmed object. If data is not retained, it remains attached only to the original location.
- 7 Under Objects That Cannot Be Trimmed, specify what to do with text, hatch patterns, and blocks that cross the boundary.
- 8 Click OK.
- 9 To save the trim with your topology, save your changes back to the source drawings.
To save the trim results without modifying the original topology, save the changes to a new drawing.

Quick Reference

MAPTRIM

Trims objects to a set of edges

Menu	Modify menu ► Boundary Trim
Icon	 Boundary Trim
Command Line	MAPTRIM
Dialog Box	Trim Objects At Boundary dialog box

Manually Editing Objects

Although the automatic AutoCAD Map 3D editing tools can correct many problems, you may need to edit a drawing manually. Use commands such as FILLET, TRIM, and EXTEND to correct situations like those shown in the following illustration.

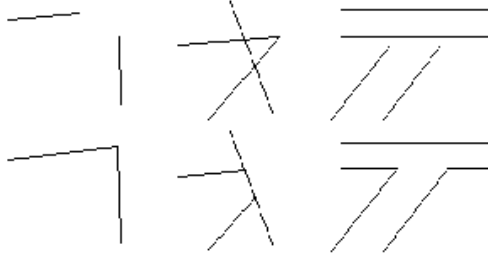

WARNING Using these editing commands to edit a topology can corrupt the topology. Instead, use the [Editing topologies](#) (page 851) commands.

NOTE This command works on drawing objects only. For information about editing geospatial feature data, see [Using Feature Editing Commands](#) (page 704) and [Using AutoCAD Commands on Features](#) (page 713). For information about AutoCAD commands, see the AutoCAD Help.

You can also use object grips to correct errors. Using grips, you can quickly correct overlaps of coincident boundaries, such as county lines and roads or geological boundaries and fault lines.

See also:

- [Overview of Editing a Topology](#) (page 852)

NOTE This command works on drawing objects only. For information about editing geospatial feature data, see [Using Feature Editing Commands](#) (page 704) and [Using AutoCAD Commands on Features](#) (page 713). For information about AutoCAD commands, see the AutoCAD Help.

To use grips

- 1 Click  ► Options. Click the Selection tab.
- 2 Make sure that Enable Grips is selected and click OK.
You can also edit the size and color of the grips. Once grips are enabled, squares appear on objects when you select them without starting a command. These squares are the object grips.
- 3 Select an object so its grips appear.
- 4 Select an object grip.

To select more than one grip, hold down the Shift key as you select each grip.

- 5 Select a new point. The grip you selected is relocated to the selected point, stretching the rest of the objects associated with that grip.

As you move the cursor, it snaps or locks onto an object grip when it moves into the square zone representing the grip. You can use this feature instead of using an object snap such as Endpoint or Midpoint.

Quick Reference

OPTIONS

Customizes the AutoCAD settings

Menu	Setup menu ► AutoCAD Options
Command Line	OPTIONS
Task Pane	Right-click in the drawing area ► Options

Creating Centroids for Polylines

If you have polygon objects or closed polylines with data attached to them, you can create centroids and move the data to the centroid.

NOTE This command works on drawing objects only. For information about editing geospatial feature data, see [Using Feature Editing Commands](#) (page 704) and [Using AutoCAD Commands on Features](#) (page 713). For information about AutoCAD commands, see the AutoCAD Help.

This is useful in the following situations:

- After you import or digitize objects.
- Before using editing commands such as Drawing Cleanup, Boundary Break, or Boundary Trim.
- When working with topology.

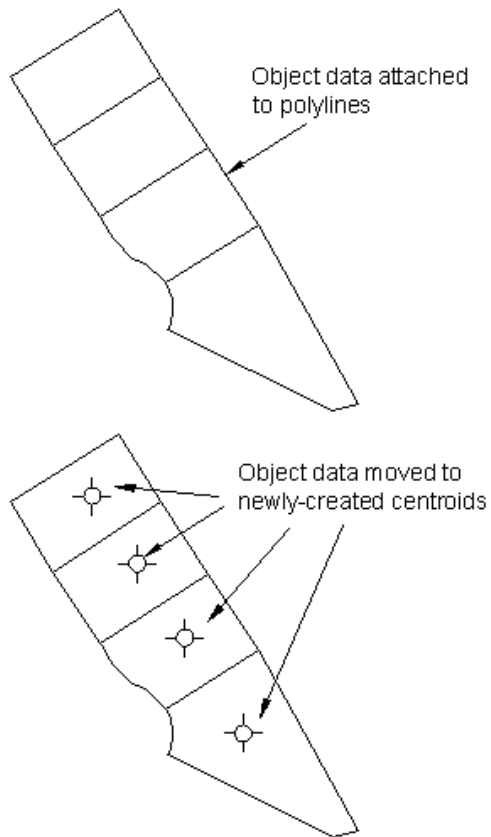

Object data attached to closed polylines (above) and object data moved to centroids (below).

AutoCAD Map 3D checks that the lines do not intersect each other, and that the area is greater than 0. It then creates a centroid inside each selected polygon or closed polyline and moves any object data or SQL link data to the centroid. For an object shaped like a figure eight, AutoCAD Map 3D creates one centroid.

Centroids are created with a Z value of 0.

See also:

- [Creating a Polygon Topology](#) (page 833)
- [Creating Centroids for Polygons](#) (page 885)

NOTE This command works on drawing objects only. For information about editing geospatial feature data, see [Using Feature Editing Commands](#) (page 704) and [Using AutoCAD Commands on Features](#) (page 713). For information about AutoCAD commands, see the AutoCAD Help.

To create centroids for polygons and closed polylines

- 1 Click Create tab ► Drawing Object panel ► Create Centroids. 
- 2 In the [Create Centroids dialog box](#) (page 1801), specify whether to create centroids for all closed objects or only for selected closed objects. If only for selected closed objects, select the polygons and closed polylines.

TIP Click the Quick Select tool to view and filter the object type as you select objects.

- 3 Specify the layer on which the centroids should be created.
- 4 Specify the block to use for centroids, or use ACAD_POINT.
- 5 Click OK.

Quick Reference

MAPCREATECENTROIDS

Creates a centroid in a polygon and moves data to the centroid

Menu Create menu ► Centroids

Icon  Create Centroids

Command Line MAPCREATECENTROIDS

Dialog Box Create Centroids dialog box

Matching Map Edges

Maps that are digitized at different times or that use different coordinate systems can appear distorted at their edges. *Edge matching* creates a seamless join across two or more maps.

NOTE This command works on drawing objects only. For information about editing geospatial feature data, see [Using Feature Editing Commands](#) (page 704) and [Using AutoCAD Commands on Features](#) (page 713). For information about AutoCAD commands, see the AutoCAD Help.

Use the edge-matching process on one layer at a time. You might edge match the roads on the two maps first.

You can avoid using edge matching by digitizing a complete map in one session, rather than breaking the map into smaller sections. If you must digitize a map in sections, allow a 3-5% overlap along the edges of a map tile and digitize both linear and point features on each tile that are common to both tiles of the map.

See also:

- [Overview of Digitizing Maps](#) (page 1073)
- [Digitizing Points Using Coordinates](#) (page 953)

NOTE This command works on drawing objects only. For information about editing geospatial feature data, see [Using Feature Editing Commands](#) (page 704) and [Using AutoCAD Commands on Features](#) (page 713). For information about AutoCAD commands, see the AutoCAD Help.

To match map edges



- 1 Open a drawing and attach the maps you want to match at edges.
- 2 Define a query to retrieve the objects to match:

- Click Home tab ► Data panel ► Define Query. 
- Define a location condition with a buffer fence option. When defining the buffer fence, select the edge to match and specify a suitable buffer fence width.
- You can also add a property condition to select objects on a specific layer.

- 3 Click Tools tab ► Map Edit panel ► Clean Up. 

- 4 On the Drawing Cleanup - [Select Objects Page](#) (page 1595), click Select All. You can specify the layer(s) you want to use, for example, the layer containing road data, and anchor objects as needed. Click Next.
- 5 On the [Select Actions Page](#) (page 1588), in the Cleanup Actions list, click Snap Clustered Nodes and then click Add.
- 6 In the Selected Actions list, click Snap Clustered Nodes. Under Cleanup Parameters, set Tolerance to a value just greater than the offset distance between objects. You can type a value in the Tolerance box or click Pick to specify the tolerance in the drawing.
- 7 Under Options, choose Automatically. Click Next.
- 8 In the Cleanup Methods Page, under Cleanup Method, select Modify Original Objects.
- 9 You can [save your settings in a profile](#) (page 781) to use again later.
- 10 Click Finish to start the drawing cleanup operation.
- 11 In the Confirm Save Back dialog box, click Yes.
The objects are now contiguous across the map edges. Repeat steps 4 - 11 for all other layers and objects in the edge matching part of the maps.

To save the edited objects back to the source drawings

- 1 Click Home tab ► Data panel ►  ► Save To Source. 
- 2 Under What To Save, make sure Save Queried Objects is selected. Click OK.
All the objects are now matched at their edges.

Quick Reference

MAPCLEAN

Performs drawing cleanup operations

Menu Modify menu ► Drawing Cleanup

Icon  Drawing Cleanup

Command Line	MAPCLEAN
Dialog Box	Drawing Cleanup

Digitizing Points Using Coordinates

You can digitize new points in existing maps with precision by using the Track Coordinates feature to specify the exact coordinates of the points.

NOTE This command works on drawing objects only. For information about editing geospatial feature data, see [Using Feature Editing Commands](#) (page 704) and [Using AutoCAD Commands on Features](#) (page 713). For information about AutoCAD commands, see the AutoCAD Help.

See also:

- [Tracking Coordinates](#) (page 1149)
- [Matching Map Edges](#) (page 950)

NOTE This command works on drawing objects only. For information about editing geospatial feature data, see [Using Feature Editing Commands](#) (page 704) and [Using AutoCAD Commands on Features](#) (page 713). For information about AutoCAD commands, see the AutoCAD Help.

To digitize points using coordinates

- 1 In Map Explorer, right-click the current drawing. Click Track Coordinates.
- 2 In the Track Coordinates pane, click Select Coordinate System.
- 3 In the [Assign Global Coordinate System dialog box](#) (page 1598), choose the coordinate system.
- 4 Click OK.
The Track Coordinates pane displays the code and description of the coordinate system you chose.
- 5 Start the command for which you want to enter coordinates.
- 6 In the X and Y text boxes, type the coordinates of the point to digitize.
- 7 Do one of the following:
 - Click Digitize.

- Press *Enter*.

The appropriate coordinates are entered on the command line. You can continue to enter coordinates.

Quick Reference

MAPTRACKCS

Tracks the coordinates of the cursor in any coordinate system

Menu Analyze menu ► Track Coordinate Sytem.

Icon



Track Coordinates

Command Line MAPTRACKCS

Task Pane In Map Explorer, right-click Current Drawing ► Track Coordinates

Working with Polygon Objects

A polygon is a closed area that stores information about its inner and outer boundaries, and about other polygons nested or grouped with it. The polygon object (called the mpolygon) allows accurate translation of data between AutoCAD Map 3D and other GIS packages.

NOTE This functionality is for drawing objects only. For information about polygonal geospatial feature data, see [Overview of Editing Features](#) (page 701) and [Creating New Polygon and MultiPolygon Features](#) (page 689).

NOTE This procedure is for drawing objects only. For information about polygonal geospatial feature data, see [Overview of Editing Features](#) (page 701) and [Creating New Polygon and MultiPolygon Features](#) (page 689).

To work with polygon objects

- [To work with polygons](#) (page 957)
- [To create a polygon object](#) (page 960)
- [To set the Fill property for polygon objects](#) (page 961)
- [To add boundaries](#) (page 963)

- [To delete boundaries](#) (page 964)
- [To move boundaries](#) (page 964)
- [To edit nodes on a boundary](#) (page 965)
- [To change the boundary type](#) (page 965)
- [To rebalance the polygon object](#) (page 965)
- [To edit the fill property for the polygon object](#) (page 966)
- [To specify a different color for the polygon fill and outline](#) (page 967)
- [To set the default fill pattern for polygons](#) (page 967)
- [To split a polygon object](#) (page 969)
- [To convert polylines to polygons](#) (page 971)
- [To convert a polygon topology to polygons](#) (page 974)
- [To create centroids for polygons and closed polylines](#) (page 977)
- [To change the default setting for importing polygons](#) (page 978)
- [To change the default fill for polygons](#) (page 978)
- [To change the display of polygon edges](#) (page 979)

Overview of Polygons

A polygon is an object type with closed boundaries. Polygons store information about their inner and outer boundaries, and about other polygons nested within them or grouped with them.

NOTE This functionality is for drawing objects only. For information about polygonal geospatial feature data, see [Overview of Editing Features](#) (page 701) and [Creating New Polygon and MultiPolygon Features](#) (page 689).

Polygons can represent areas such as city limits, county boundaries, state borders, buildings, and parcels, as well as more complex objects, such as islands.

Example: A state map could be composed of a single polygon with an outer boundary representing the state, interior boundaries representing lakes, and boundaries within those boundaries representing islands. A country map could be composed of individual polygons representing each state.

The following table defines common terms used to describe the structure of polygons.

Term	Definition
Boundaries	Closed boundaries that make up a polygon. Polygons can have multiple non-intersecting boundaries, or boundaries nested within boundaries.

Term	Definition
Balancing	Process of recalculating which boundaries are outer or inner. Nested boundaries are alternately classified as outer and inner. That is, the outermost boundary is classified as an outer boundary. A boundary nested within this boundary is an inner boundary. A boundary nested within the inner boundary is classified as an outer boundary.
Inner boundary	Nested boundary that is totally within an outer boundary.
Outer boundary	The outermost boundary for any discreet set of boundaries that define the polygon, or a boundary residing within an inner boundary. A polygon can have several unnested outer boundaries and several nested outer boundaries.

Understanding Boundaries

The figure below shows two polygon objects, each with three boundaries. The one on the left has two discrete outer boundaries and one inner boundary. The inner boundary is nested within the second discrete outer boundary. The polygon on the right also has two outer boundaries and one inner boundary. However, the second outer boundary is nested within the inner boundary.

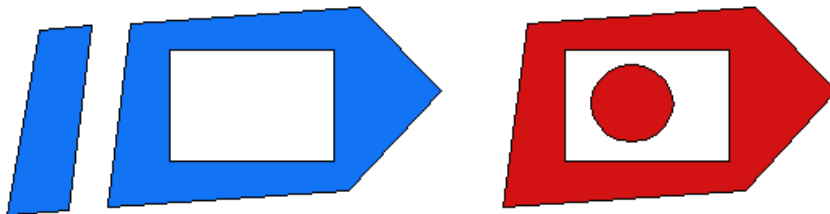

Polygon objects maintain a tree structure to keep track of the boundaries and identify nesting levels. The illustration below shows the different tree structures for the two objects shown above. The first polygon tree contains two branches, while the second polygon tree contains a single branch.

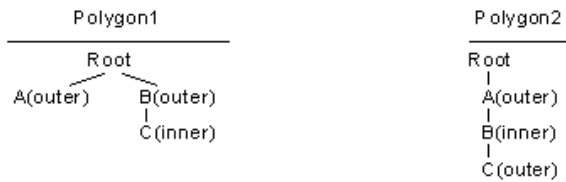

In addition to outer and inner boundaries, there is an Annotation boundary type. This boundary has the characteristics of an inner boundary, but only affects the display of the pattern fill and is ignored when calculating the area or interior of the polygon object. Its primary purpose is to allow you to annotate your drawings without the fill pattern of the polygon obscuring the annotations. The annotation will typically consist of text or blocks.

See also:

- [Creating Polygon Objects](#) (page 960)
- [Modifying Polygon Objects](#) (page 962)
- [Setting Polygon Options](#) (page 977)

NOTE This procedure is for drawing objects only. For information about polygonal geospatial feature data, see [Overview of Editing Features](#) (page 701) and [Creating New Polygon and MultiPolygon Features](#) (page 689).

To work with polygons

- [To create a polygon object](#) (page 960)
- [To add boundaries](#) (page 963)
- [To convert polylines to polygons](#) (page 971)
- [To convert a polygon topology to polygons](#) (page 974)
- [To create centroids for polygons and closed polylines](#) (page 977)
- [To change the default setting for importing polygons](#) (page 978)

Quick Reference

MAPCREATECENTROIDS

Creates a centroid in a polygon and moves data to the centroid

Menu Create menu ► Centroids

Icon  Create Centroids

Command Line MAPCREATECENTROIDS

Dialog Box Create Centroids dialog box

MAPPOLYLINETOPOLYGON

Converts closed polylines to polygons

Menu At the Command prompt, enter mappolylinetopolygon.

Icon  Convert Polylines to Polygons

Command Line MAPPOLYLINETOPOLYGON

MAPTOPOLOGYTOPOLYGONS

Converts an existing polygon topology to polygons

Menu At the Command prompt, enter maptopologytopolygons.

Icon  Convert Topology to Polygons

Command Line MAPTOPOLOGYTOPOLYGONS

Dialog Box Create Polygons From Topology dialog box

MAPUSEMPOLYGON

Turns on and off the ability to use mapping polygons

Command Line MAPUSEMPOLYGON

Dialog Box MAPUSEMPOLYGON

MAPMPEDIT

Edits polygons

Menu	Click Modify ► Edit MPolygon.
Icon	 Edit Polygon
Command Line	MAPMPEDIT
Dialog Box	MAPMPEDIT (Edit Polygon command)

MPFILL

Sets the default fill for polygons

Menu	At the Command prompt, enter mpfill.
Icon	 Polygon Fill Settings
Command Line	MPFILL
Dialog Box	Polygon Fill Properties dialog box

MPOLYGON

Create polygon

Menu	Create ► Mpolygon
Icon	 MPolygon
Command Line	MPOLYGON

MPSPLIT

Splits an existing polygon into two new polygons

Menu	At the Command prompt, enter mpsplit.
Icon	 Split Polygon
Command Line	MPSPLIT
Dialog Box	MPSPLIT (Split Polygon command)

Creating Polygon Objects

Create polygon objects by selecting existing closed polyline objects and circles, or by specifying points.

NOTE This functionality is for drawing objects only. For information about polygonal geospatial feature data, see [Creating New Polygon and MultiPolygon Features](#) (page 689).

The boundaries of a polygon object can overlap or touch, but they cannot cross. When you pick points to draw a boundary, a point will be rejected if it causes the boundary to cross itself or if it crosses a previous boundary created by the command.

You select the fill color and pattern used to fill polygon objects. For color, you can choose from a variety of colors including true colors and colors from imported color books. For pattern, you can choose a predefined hatch pattern, a simple line pattern of your own design, a more complex hatch pattern, or a solid color. You can also create a gradient fill, which uses a transition between shades of one color or between two colors. Gradient fills can be used to give the appearance of light reflecting on an object.

See also:

- [Converting Polylines to Polygons](#) (page 970)
- [Converting Polygon Topology to Polygons](#) (page 972)
- [Modifying Polygon Objects](#) (page 962)
- [Setting Polygon Options](#) (page 977)

NOTE This procedure is for drawing objects only. For information about polygonal geospatial feature data, see [Creating New Polygon and MultiPolygon Features](#) (page 689).

To create a polygon object

- 1 Click Home tab ► Draw panel ► Creates Polygons.
- 2 Click in the drawing to specify a start point, or select an existing object to include in the polygon.
- 3 Optionally, enter a to draw an arc as part of the polygon.
- 4 Repeat Step 2 to add objects or specify more points.

- 5 Enter c to close the polygon.

To set the Fill property for polygon objects

- 1 On the command line, enter mppfill. Press Enter.
- 2 Enter f.
- 3 In the [Polygon Fill Properties dialog box](#) (page 1824), set the polygon fill properties.

These properties are applied to the polygon that you are drawing and all new polygons you create or convert.

To fill with...	Do this in the Polygon Fill Properties dialog box...
Solid	<ul style="list-style-type: none"> ■ Click the Hatch tab. ■ For Pattern Type, select Predefined. ■ For Pattern Name, select Solid. ■ For Fill Color, select the fill color. Click Select Color to select from a large palette of colors.
Predefined hatch pattern	<ul style="list-style-type: none"> ■ Click the Hatch tab. ■ For Pattern Type, select Predefined. ■ For Pattern Name, select a pattern.
User defined hatch pattern	<ul style="list-style-type: none"> ■ Click the Hatch tab. ■ For Pattern Type, select User Defined. ■ Specify the angle and spacing of the hatch pattern.
One or two color gradient	<ul style="list-style-type: none"> ■ Click the Gradient tab. ■ Select the number of colors to use for the gradient fill. ■ Select the colors. ■ Use the Shade/Tint slider to adjust the color. ■ Click a pattern. ■ Select Center to create a symmetrical fill, or clear Center to move the "highlight" up and to the left. ■ Specify an angle for the "highlighted" area.

- 4 Continue creating the polygon by following the steps in the previous procedure.

Quick Reference

MPOLYGON

Create polygon

Menu

Create ► Mpolygon

Icon



MPolygon

Command Line

MPOLYGON

Modifying Polygon Objects

You can edit a polygon by editing its boundaries (adding, deleting, moving, or disconnecting them), changing its fill properties, moving nodes in a boundary, changing individual boundary types to Inner or Outer, or rebalancing the polygon. For explanations of these terms, see [Overview of Polygons](#) (page 955).

NOTE This functionality is for drawing objects only. For information about editing polygonal geospatial feature data, see [MAPPOLYGONEDIT](#) (page 1665).

Rebalancing Polygons

If you add or delete boundaries, be sure to rebalance the polygon. A polygon becomes unbalanced when it does not have correct information about which is an inner boundary and which is an outer boundary. When you rebalance the polygon, the nesting order follows an alternating outer/inner/outer order.

Area of a Polygon

The area between an inner and outer boundary is filled or not filled in an alternating manner. In a balanced polygon, the filled area represents the total area of the polygon object. The total area of the polygon is calculated by subtracting the sum of the area of all inner boundaries from the sum of the area of all outer boundaries.

Filling a Polygon

You can change the default fill color and pattern assigned to polygons. For color, you can choose from a variety of colors including true colors and colors from imported color books. For fill pattern, you can select a predefined hatch pattern, define your own hatch pattern, choose a solid color, or define a one- or two-color gradient fill.

To style polygons to use one color for the fill and a different color for the outline, create a Display Manager layer for the polygons. For that layer, create both a hatch style and an entity style. The hatch style will control the polygon fill; the entity style will control the polygon outline. However, the entity style must appear above the hatch style in Display Manager for the polygon to appear correctly in the drawing.

See also:

- [Creating Polygon Objects](#) (page 960)
- [Setting Polygon Options](#) (page 977)
- [Overview of Polygons](#) (page 955)

NOTE This procedure is for drawing objects only. For information about editing polygonal geospatial feature data, see [To edit a feature using feature editing commands](#) (page 705).

- [To add boundaries](#) (page 963)
- [To delete boundaries](#) (page 964)
- [To move boundaries](#) (page 964)
- [To edit nodes on a boundary](#) (page 965)
- [To change the boundary type](#) (page 965)
- [To rebalance the polygon object](#) (page 965)
- [To edit the fill property for the polygon object](#) (page 966)
- [To specify a different color for the polygon fill and outline](#) (page 966)
- [To set the default fill pattern for polygons](#) (page 967)

To add boundaries

- 1 At the Command prompt, enter [mapmpedit](#) (page 1818).

- 2 In the drawing area, select the polygon to edit.
- 3 Enter a.
- 4 Select the polygon or closed polyline to add to the polygon.
The boundary is added to the polygon and assigned an inner or outer boundary type based on its relationship to the rest of the object
- 5 Repeat Step 2 to add any other boundaries.
- 6 When the selection is completed, you can rebalance the polygon by entering r.

To delete boundaries

- 1 At the Command prompt, enter [mapmpedit](#) (page 1818).
- 2 Select the polygon to edit.
- 3 Enter d to delete the boundary, or enter c to delete the boundary from the polygon but preserve it as an object.
- 4 Click a boundary object to delete from the polygon.
The boundary is removed from the polygon.
- 5 Repeat Step 2 to delete any other boundaries.
- 6 When the selection is completed, you can enter r to rebalance the polygon.

To move boundaries

- 1 At the Command prompt, enter [mapmpedit](#) (page 1818).
- 2 Select the polygon to edit.
- 3 Enter m.
- 4 Click a boundary object to move within the polygon.
Any nested boundaries within the boundary are also selected.
- 5 Click in the drawing to specify the base point.
- 6 Click in the drawing to specify the displacement point.
- 7 Repeat these steps to move any other boundaries.

To edit nodes on a boundary

- 1 At the Command prompt, enter [mapmpedit](#) (page 1818).
- 2 Select the polygon to edit.
- 3 Enter e.
- 4 Click a boundary object to edit.
- 5 Click the node to edit.

TIP Press the Spacebar to move to the next node.

Enter r to remove the node, m to move the node, or i to insert a new node.

You can not modify the boundary in a way that would make it cross another boundary in the polygon. For example, you cannot delete a node if that would make the current boundary cross an inner boundary.

- 6 When you finish editing nodes, press x to exit node-editing mode.

To change the boundary type

- 1 At the Command prompt, enter [mapmpedit](#) (page 1818).
- 2 Select the polygon to edit.
- 3 Enter b.
- 4 Click the boundary object for which you want to change the type.
- 5 Enter o, i, or a (Outer/Inner/Annotation).
Annotation boundaries behave the same as inner boundaries, but have no effect on area calculations.

To rebalance the polygon object

- 1 At the Command prompt, enter [mapmpedit](#) (page 1818).
- 2 Select the polygon to edit.
- 3 Enter r.
The Rebalance option recalculates the polygon tree and reassigns the Inner/Outer property of all the boundaries based on their nesting level.

To edit the fill property for the polygon object

- 1 At the Command prompt, enter [mapmpedit](#) (page 1818).
- 2 Select the polygon to edit.
- 3 Enter f.
- 4 In the [Polygon Fill Properties dialog box](#) (page 1824), edit the polygon fill properties. These properties are applied to the polygon that you are editing.

To fill with...	Do this in the Polygon Fill Properties dialog box...
Solid	<ul style="list-style-type: none">■ Click the Hatch tab.■ For Pattern Type, select Predefined.■ For Pattern Name, select Solid.■ For Fill Color, select the fill color. Click Select Color to select from a large palette of colors.
Predefined hatch pattern	<ul style="list-style-type: none">■ Click the Hatch tab.■ For Pattern Type, select Predefined.■ For Pattern Name, select a pattern.
User defined hatch pattern	<ul style="list-style-type: none">■ Click the Hatch tab.■ For Pattern Type, select User Defined.■ Specify the angle and spacing of the hatch pattern.
One or two color gradient	<ul style="list-style-type: none">■ Click the Gradient tab.■ Select the number of colors to use for your gradient fill.■ Select the colors.■ Use the Shade/Tint slider to adjust the color.■ Click a pattern.■ Select Center to create a symmetrical fill, or clear Center to move the "highlight" up and to the left.■ Specify an angle for the "highlighted" area.

To specify a different color for the polygon fill and outline

- 1 Create a Display Manager layer for the polygons. In Display Manager, click Data ► Add Drawing Data ► Drawing Layer.
- 2 Right-click the new layer and click Add Style ► Entity.
- 3 Right-click the Entity Style entry and click Properties.
- 4 Change the Color for the Entity to the desired outline color.
- 5 Right-click the layer again and click Add Style ► Hatch.
- 6 Right-click the Hatch Style entry and click Properties.
- 7 Change the Color for the Hatch to the desired fill color.
- 8 At the Command prompt, enter Regen.

To set the default fill pattern for polygons

- 1 At the Command prompt, enter mpsfill. Press Enter.
- 2 Select the fill pattern and properties.
All polygons you create or convert will use the new default fill.

Editing Using Grips

In addition to the options described above, you can edit a polygon object using grips in the same way that you edit a polyline object (stretch a vertex, move, rotate, scale, and so on).

Quick Reference

MAPMPEDIT

Edits polygons

Menu

Click Modify ► Edit MPolygon.

Icon



Edit Polygon

Command Line

MAPMPEDIT

Dialog Box

MAPMPEDIT (Edit Polygon command)

MPFILL

Sets the default fill for polygons

Menu At the Command prompt, enter mpfill.

Icon



Polygon Fill Settings

Command Line MPFILL

Dialog Box Polygon Fill Properties dialog box

Splitting Polygon Objects

You can split an existing polygon into two new polygons. The existing polygon is deleted.

NOTE This functionality is for drawing objects only. For information about splitting polygonal geospatial feature data, see [Splitting Features](#) (page 705).

Example: If a parcel is subdivided, you can split the existing parcel.

When you split a polygon, the split line cannot cross itself or cross an internal boundary of the polygon.

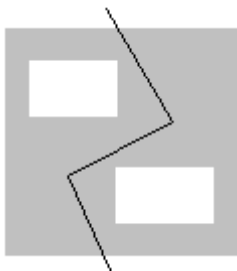

This split is allowed.

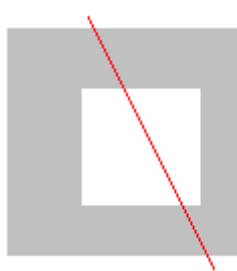

This split is *not* allowed because it crosses an internal boundary.



This split is *not* allowed because it touches one of the vertices of the internal boundary.

When you split the polygon, you can choose to copy any existing data from the original polygon to both of the new polygons.

See also:

- [Modifying Polygon Objects](#) (page 962)
- [Setting Polygon Options](#) (page 977)

NOTE This procedure is for drawing objects only. For information about splitting polygonal geospatial feature data, see [To split a feature](#) (page 708).

To split a polygon object

- 1 On the command line, enter [mpspl](#) (page 1821). Press Enter.
- 2 Select the polygon to split.
- 3 Specify the line to split the polygon:
 - To split the polygon by drawing a line, enter d.
Click in the drawing to specify the first point for the line.
Click to specify the next point, or enter a to draw an arc. For more information on drawing arcs, see *ARC* in the AutoCAD Help.
 - To split the polygon by using an existing line, enter s. Select the line or lines.
- 4 To copy attached data from the original polygon to the two new polygons, enter y.
Otherwise, the data is deleted.

Quick Reference

MPSPPLIT

Splits an existing polygon into two new polygons

Menu At the Command prompt, enter mpsplit.

Icon



Split Polygon

Command Line MPSPPLIT

Dialog Box MPSPPLIT (Split Polygon command)

Converting Polylines to Polygons

You can convert all, or a selection of, the closed polylines in an existing drawing to polygon objects. When you convert a closed polyline, the original polyline is erased and is replaced with a polygon object.

NOTE This functionality is for drawing objects only. For information about converting polygonal geospatial feature data to polygons, see [Importing Polygons](#) (page 429).

When exporting objects to other formats, use polygons to preserve information about islands, holes, or discontinuous polygons.

Here are some typical situations in which you may want to convert polylines to polygons.

Converting Polylines to Polygons

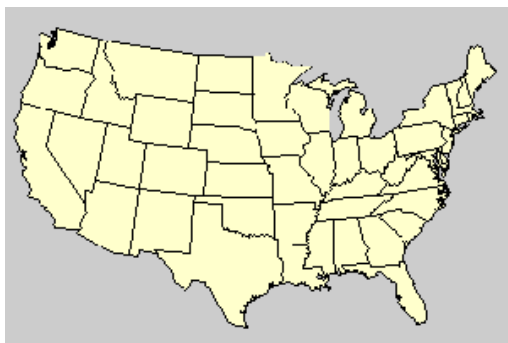

This illustration shows a map made of polylines. Every closed polyline is converted to a polygon.

Converting Nested Polylines to Polygons

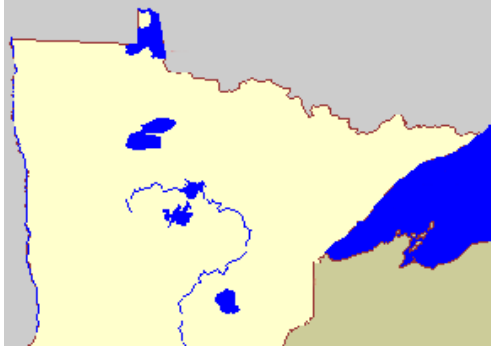

This illustration shows a state with lakes as closed polylines.

To create a complex polygon with islands, holes, or discontinuous polygons, first use the GROUP command to group the objects that you want to include in the polygon. Then use the MAPPOLYLINETOPOLYGON command.

WARNING When you group objects, only the data from the outermost boundary is maintained. The data from nested objects is lost.

To preserve nested data, you may want to convert your polylines in steps. For example, in the illustration above, you could first query in the state and lake boundaries, group all these objects, and create a polygon. The resulting polygon will show the state with holes for the lakes, and will maintain only the state data. Next, query in the lake polylines, do not group them, and then convert the lake polylines to polygons. Each of the polygons representing the lakes will have its data attached.

See also:

- [Converting Polygon Topology to Polygons](#) (page 972)
- [Overview of Polygons](#) (page 955)
- [Setting Polygon Options](#) (page 977)

NOTE This procedure is for drawing objects only. For information about converting polygonal geospatial feature data to polygons, see [To import polygons](#) (page 430).

To convert polylines to polygons

- 1 Set the PROXYGRAPHICS system variable to 0.

- 2 On the command line, enter [mappolylinetopolygon](#) (page 1817). Press Enter.
- 3 If you already had a selection set, the selected closed polylines are converted. If you did not have a selection set, select the polylines to convert. Press Enter.

Each closed polyline in the selection set is converted. If the polyline belongs to a group, only the first (outermost) polyline is converted. Other polylines in the group are copied into the polygon as additional boundaries and the polygon is rebalanced.

When objects are converted to polygons, they use the color or hatch set by the [MPFILL command](#) (page 978).

Quick Reference

MAPPOLYLINETOPOLYGON

Converts closed polylines to polygons

Menu At the Command prompt, enter `mappolylinetopolygon`.

Icon  Convert Polylines to Polygons

Command Line `MAPPOLYLINETOPOLYGON`

Converting Polygon Topology to Polygons

You can create polygons from a polygon topology. The polygon topology is not changed.

NOTE This functionality is for drawing objects. There is no equivalent for geospatial feature data.

When exporting objects to other formats, use polygons to preserve information about islands, holes, or discontinuous polygons.

Here are some typical situations in which you may want to create polygons from a polygon topology.

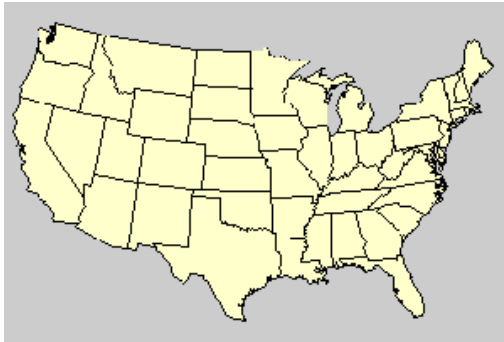

This illustration shows a polygon topology. You can create polygons for each polygon in the polygon topology, which is useful when exporting to other formats.

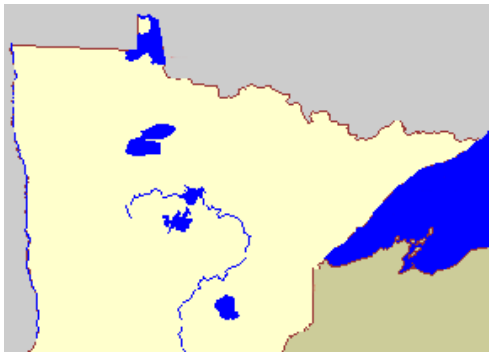

This illustration shows lakes as part of a state topology. To create a polygon for the state with "holes" in it for the lakes, select the Group Complex Polygons option.

Converting Polygon Topology with Nested Boundaries

When you have nested polygons in your topology, you have several options on how to convert them.

If you select the Group Complex Polygons option and all the polygons have centroids, AutoCAD Map 3D will create a single balanced polygon.

If you do not select the Group Complex Polygons option, AutoCAD Map 3D will create separate polygons, one for each centroid.

To create a single polygon from polygons nested within each other, each nested polygon must have a centroid. For example, if you have three polygons nested one within another, and the middle polygon does not have a centroid, AutoCAD Map 3D will create separate polygons for the inner polygon and the outer polygon.

See also:

- [Converting Polylines to Polygons](#) (page 970)
- [Overview of Polygons](#) (page 955)
- [Setting Polygon Options](#) (page 977)

NOTE This procedure is for drawing objects. There is no equivalent for geospatial feature data.

To convert a polygon topology to polygons

- 1 On the command line, enter `maptopologytopolygons`. Press Enter.
- 2 In the [Create Polygons From Topology dialog box](#) (page 1823), for Name, select the topology to convert.
Click Load Topology to select and load the topology.
- 3 For Layer, select the layer on which you want to place the converted polygons.
Click Layer Settings to create a new layer and set its properties.
- 4 Optionally, select Group Complex Polygons to create a single polygon from nested polygons in the topology.
If one polygon is inside another, they both become boundaries in the resulting polygon object. There is no specific limit to the nesting level of polygons grouped with this option, but in some conditions the resulting inner/outer type of individual boundaries may not be what you anticipated. You can use the [MAPMPEDIT](#) (page 963) command to correct this.
- 5 Optionally, select Copy Object Data From Centroid to copy object data from the polygons to the new polygon objects.
If you selected Group Complex Polygons, the object data is copied only from the outermost polygon.
- 6 Optionally, select Copy Database Links From Centroid to copy database links from the polygons to the new polygon objects.
If you selected Group Complex Polygons, the database links are copied only from the outermost polygon.
- 7 Click OK.

When objects are converted to polygons, they use the color or hatch set by the [MPFILL command](#) (page 978).

Quick Reference

MAPTOPOLOGYTOPOLYGONS

Converts an existing polygon topology to polygons

Menu	At the Command prompt, enter maptologytopolygons.
Icon	 Convert Topology to Polygons
Command Line	MAPTOPOLOGYTOPOLYGONS
Dialog Box	Create Polygons From Topology dialog box

Creating Centroids for Polygons

If you have data attached to polygon objects or closed polylines, you can create centroids for the polygons or closed polylines and move the data to the centroid.

NOTE This functionality is for drawing objects only. For information about converting polygonal geospatial feature data to polygons and creating centroids for them, see [Importing Polygons](#) (page 429).

This is useful after you import or digitize objects, before using editing commands such as Drawing Cleanup, Map Break, or Map Trim, or when working with topology.

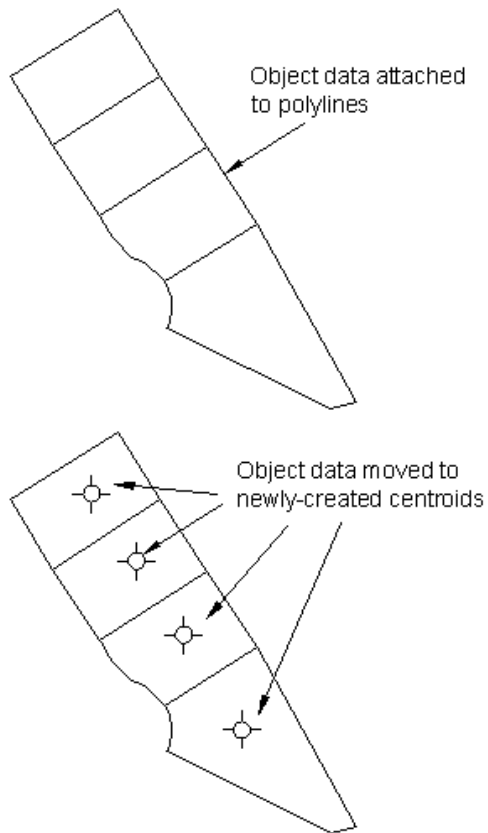

Object data attached to closed polylines (above) and object data moved to centroids (below).

When you use this feature, AutoCAD Map 3D checks that the selected polygons or closed polylines are clean; that is, that the lines do not intersect each other, and that the area is greater than 0.

It creates a centroid inside each selected polygon or closed polyline and moves any object data or SQL link data to the centroid. For a 'figure eight' object, AutoCAD Map 3D creates one centroid.

Centroids are created with a Z value of 0.

See also:

- [Creating Polygon Objects](#) (page 960)

- [Overview of Polygons](#) (page 955)

NOTE This functionality is for drawing objects only. For information about converting polygonal geospatial feature data to polygons and creating centroids for them, see [To import polygons](#) (page 430).

To create centroids for polygons and closed polylines



- 1 Click Create tab ► Drawing Object panel ► Create Centroids.
- 2 In the [Create Centroids dialog box](#) (page 1801), specify whether to create centroids for all closed objects or only for selected closed objects. If only for selected closed objects, select those polygons and closed polylines.

TIP Use Quick Select to view and filter the object type as you select objects.

- 3 Specify the layer on which the centroids should be created.
- 4 Specify the block to use for centroids, or use ACAD_POINT.
- 5 Click OK.

Quick Reference

MAPCREATECENTROIDS

Creates a centroid in a polygon and moves data to the centroid

Menu Create menu ► Centroids

Icon  Create Centroids

Command Line MAPCREATECENTROIDS

Dialog Box Create Centroids dialog box

Setting Polygon Options

AutoCAD Map 3D uses polygons by default for import and export. If you do *not* want to use polygons, for example, for compatibility with an older drawing,

you can select the option to import polygons as polylines. You can also change the default setting for this option.

When objects are imported as polygons, they use the default fill color and pattern set by the MPFILL command. Boundaries come in as usual, using the default layer color unless another color is specified in the imported file.

You can change the default fill color and pattern assigned to polygons. For color, you can choose from a variety of colors including true colors and colors from imported color books. For fill pattern, you can select a predefined hatch pattern, define your own hatch pattern, choose a solid color, or define a one- or two-color gradient fill.

You can also change the display of polygon boundaries to display just the edges, just the fill, or both.

See also:

- [Importing Polygons](#) (page 429)
- [Creating Polygon Objects](#) (page 960)
- [Overview of Polygons](#) (page 955)

- [To change the default setting for importing polygons](#) (page 978)
- [To change the default fill for polygons](#) (page 978)
- [To change the display of polygon edges](#) (page 979)

To change the default setting for importing polygons

- 1 On the command line, enter [MAPUSEMPOLYGON](#) (page 1818).
You are asked whether you want to use polygons.
- 2 Type off or on. Press Enter.

If you turn off mpolygons, AutoCAD Map 3D creates closed polylines for polygon objects that it imports.

To change the default fill for polygons

- 1 On the command line, enter mpfill. Press Enter.

2 In the [Polygon Fill Properties dialog box](#) (page 1824), select the polygon fill properties.

To fill with...	Do this in the Polygon Fill Properties dialog box...
Solid	<ul style="list-style-type: none">■ Click the Hatch tab.■ For Pattern Type, select Predefined.■ For Pattern Name, select Solid.■ For Fill Color, select the fill color. Click Select Color to select from a large palette of colors.
Predefined hatch pattern	<ul style="list-style-type: none">■ Click the Hatch tab.■ For Pattern Type, select Predefined.■ For Pattern Name, select a pattern.
User defined hatch pattern	<ul style="list-style-type: none">■ Click the Hatch tab.■ For Pattern Type, select User Defined.■ Specify the angle and spacing of the hatch pattern.
One or two color gradient	<ul style="list-style-type: none">■ Click the Gradient tab.■ Select the number of colors to use for your gradient fill.■ Select the colors.■ Use the Shade/Tint slider to adjust the color.■ Click a pattern.■ Select Center to create a symmetrical fill, or clear Center to move the "highlight" up and to the left.■ Specify an angle for the "highlighted" area.

All polygons you create or convert will use the new default fill. You can change the fill for an existing polygon with [MAPMPEDIT \(Edit Polygon command\)](#) (page 1818).

To change the display of polygon edges

1 On the command line, enter polydisplay.

- 2 Enter e to view edges only, f to view fill only, or b to view both edges and fill.
- 3 On the command line, enter regen.

Quick Reference

MAPUSEMPOLYGON

Turns on and off the ability to use mapping polygons

Command Line	MAPUSEMPOLYGON
Dialog Box	MAPUSEMPOLYGON

MPFILL

Sets the default fill for polygons

Menu At the Command prompt, enter mpfill.

Icon  Polygon Fill Settings

Command Line MPFILL

Dialog Box Polygon Fill Properties dialog box

POLYDISPLAY

Specifies whether to display edges only, fill only, or both for polygons

Menu At the Command prompt, enter polydisplay.

Icon  Polygon Display Mode

Command Line POLYDISPLAY

Adding and Deleting Annotation

Use annotation to quickly and easily label objects with their attribute values, display properties, and geometric values. For more information see [Annotating Drawing Objects](#) (page 1100).

Using Object Classification

Use object classification to organize drawing objects in your map based on the real-world objects that they represent. When you create an object using object classification, the object automatically has properties and values assigned to it based on its classification.

NOTE This functionality applies to drawing objects only. For information about the classification systems used by geospatial feature data, see [About Geospatial Feature Classes, Data Stores, and Schemas](#) (page 551).

- [Overview of Object Classification](#) (page 981)
- [Creating Classified Drawing Objects](#) (page 987)
- [Assigning an Object Class](#) (page 988)
- [Editing Object Class Data](#) (page 991)
- [Selecting Objects by Object Class](#) (page 992)
- [Attaching an Object Class Definition File](#) (page 995)

See also:

- [Overview of Object Classification](#) (page 981)
- [Setting Up Object Classification](#) (page 116)

To use object classification

- [To use object classification](#) (page 983)
- [To create a classified drawing object](#) (page 988)
- [To assign an object class to an existing object](#) (page 989)
- [To unclassify an object](#) (page 990)
- [To edit object class data for an object](#) (page 991)
- [To select objects in your current map, based on their object class](#) (page 993)
- [To select objects in source drawings, based on their object class](#) (page 993)
- [To attach an object class definition file](#) (page 995)

Overview of Object Classification

Object classification helps organize and select objects in your drawings.

NOTE This functionality applies to drawing objects only. For information about the classification systems used by geospatial feature data, see [About Geospatial Feature Classes, Data Stores, and Schemas](#) (page 551).

Use object classification to organize objects in your drawing based on the real-world features that they represent, for example, roads or manholes. When you create an object using object classification, the object automatically has properties and values assigned to it based on its object classification. In addition, you can find or select all objects in an object class.

Setting Up Object Classification

- Start by determining the standard objects you use in your organization. For example, if your organization produces road maps, you may want a set of standard road objects, such as Primary Road and Secondary Road.
- Determine the set of properties and data for each standard object type. For each one, define an object class that specifies the properties and data for that object type. All object class definitions are stored in an object class definition file.
For example, you may want all Primary Roads to be use a polyline with a thick line weight, be on the Primary Roads layer, and have object data associated with them that lists values for speed limit and number of lanes. Similarly, Secondary Roads might go on the Secondary Roads layer, use a thin line weight, and include information on surface type.
- Use object class definitions to create objects with a standard set of properties and data assigned to them.
For example, if you use the Create Classified Object command to create a Primary Road, it is created with a polyline, a thick line weight, on the Primary Roads layer, and with object data that lists values for speed limit and number of lanes. When you create a secondary road, it is on the Secondary Roads layer, with a thinner line weight, and different values for surface type and number of lanes.

When you select an object that was created using object classification, the properties that are associated with that object class are displayed on the Object Class tab of the Properties palette. For example, when you select a road, the Properties palette shows you the layer, line weight, surface type, and number of lanes. Edit properties by entering new values in the window.

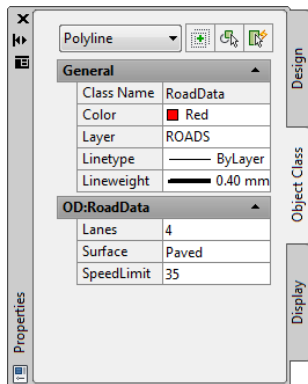

When you select a road in your drawing, the Object Class tab shows all the properties associated with the object class Road. Edit a value by clicking in the box and selecting an item from the list.

Tell me more



Procedure

- [To set up object classification](#) (page 118)
- [To use object classification](#) (page 981)



Tutorial

- [Tutorial: Classifying Drawing Objects](#)



Workflow

- [Set Up Your DWG Data](#)
- [Move CAD Data to GIS](#)



Related topics

- [Setting Up Object Classification](#) (page 116)
- [Checking Out Features](#) (page 695)

NOTE This functionality applies to drawing objects only. For information about the classification systems used by geospatial feature data, see [About Geospatial Feature Classes, Data Stores, and Schemas](#) (page 551).

To use object classification

- 1 [Attach an object class definition file](#) (page 995).

- 2 [Define an object class](#) (page 120).
This step is often performed by the CAD Manager in your organization.
- 3 Use object classification to standardize the objects in your drawings.
 - [Create new objects using object classification](#) (page 987).
These new objects are created using the standard properties specified for the object class.
 - [Assign an object class to an existing object](#) (page 989).
The properties and data associated with the object are changed to match the standards specified for the object class.

Once you have drawing objects in your drawing, you can do the following:

- [Edit object class data for an object](#) (page 991).
- [Select objects by object class](#) (page 993).
- [Query objects from source drawings by object class name](#) (page 1244).
- [Query objects from source drawings by object class properties](#) (page 1248).
- [Modify objects based on their object class](#) (page 1267).
- [Add text to objects based on object class values](#) (page 1278).
- [Create a report that lists the object class properties of selected objects](#) (page 1477).
- [View information about attached drawings](#) (page 172).

Quick Reference

PROPERTIES

Displays the Properties palette, which allows you to edit the properties of objects

Menu	Analyze ► Properties
Icon	 Properties
Command Line	PROPERTIES
Task Pane	Select object. Right-click in drawing area ► Properties

CLASSIFY

Classifies existing objects

Menu Click Map ► Feature Classification ► Classify Objects.

Icon



Classify Objects

Command Line CLASSIFY

Task Pane In Map Explorer, under Current Drawing, right-click Object Classes ► Select Classified Objects

Dialog Box Classify dialog box

Create Classified Object

Creates a new object based on the object classification definition

Task Pane In Map Explorer, under Current Drawing, right-click an object class ► Create Classified Object

FEATUREDEF

Defines a new object class based on an example in the current drawing

Menu Click Setup ► Classification Tools ► Define Object Class.

Icon



Define Object Class

Command Line FEATUREDEF

Task Pane In Map Explorer, under Current Drawing, right-click Object Classes ► Define Object Class

Dialog Box Define Object Classification dialog box

MAPSELECTCLASSIFIED

Selects all classified objects

Menu Click Map ► Feature Classification ► Select Features.

Icon



Select Classified Objects

Command Line	MAPSELECTCLASSIFIED
Task Pane	In Map Explorer, under Current Drawing, right-click Object Classes ► Select Classified Objects
Dialog Box	MAPSELECTCLASSIFIED (Select Classified Objects command)

MAPSELECTUNCLASSIFIED

Selects all objects that have no classification assigned to them

Menu	Click Map ► Feature Classification ► Select Unclassified.
Command Line	MAPSELECTUNCLASSIFIED
Task Pane	In Map Explorer, under Current Drawing, right-click Object Classes ► Select Unclassified
Dialog Box	MAPSELECTUNCLASSIFIED (Select Unclassified Objects command)

MAPSELECTUNDEFINED

Selects all objects whose classification is not defined in the current object class definition file

Menu	Click Map ► Feature Classification ► Select Undefined.
Command Line	MAPSELECTUNDEFINED
Task Pane	In Map Explorer, under Current Drawing, right-click Object Classes ► Select Undefined
Dialog Box	MAPSELECTUNDEFINED (Select Undefined Objects command)

NEWDEF

Creates a new object class definition file

Menu	Click Setup ► Classification Tools ► New Definition File.
Command Line	NEWDEF
Task Pane	In Map Explorer, under Current Drawing, right-click Object Classes ► New Definition File

Dialog Box	New Object Class Definition File dialog box
UNCLASSIFY	
	Removes classification from an object
Menu	Click Modify ► Unclassify Objects.
Icon	 Unclassify Objects
Command Line	UNCLASSIFY
Task Pane	In Map Explorer, under Current Drawing, right-click Object Classes ► Select Classified Objects

Creating Classified Drawing Objects

Use object classes to create new objects with a predefined set of properties and values.

NOTE This functionality applies to drawing objects only. For information about the classification systems used by geospatial feature data, see [About Geospatial Feature Classes, Data Stores, and Schemas](#) (page 551).

When you create a drawing object using object classification, properties are set to allowable values and data is attached. In addition, the object is tagged with the name of its object class.

For example, if you create a road using a Road object class, you are prompted to create a normal polyline. The polyline is created on the Roads layer, has the default properties for a road, and has the data values specified for a road feature.

After you create a classified object, you can use the Object Class tab of the Properties palette to edit the data associated with the object class.

To create classified objects, you must have an object class definition file attached to your drawing. For information on the location of the object class definition file, consult your CAD Manager.

NOTE If an object class was defined with a create method of None, or if it was defined as a base class only, you cannot create an object using that object class.

See also:

- [Overview of Object Classification](#) (page 981)
- [Editing Object Class Data](#) (page 991)
- [Attaching an Object Class Definition File](#) (page 995)

NOTE This functionality applies to drawing objects only. For information about the classification systems used by geospatial feature data, see [About Geospatial Feature Classes, Data Stores, and Schemas](#) (page 551).

To create a classified drawing object

- 1 In Map Explorer, right-click an object class. Click Create Classified Object. If no object classes are listed in Map Explorer, [attach an object class definition file](#) (page 995). For information on the location of the object class definition file, consult your CAD Manager.
- 2 Create the object as prompted.
When you create the object, object data, external data, and topology data are attached. Other properties included in the object class definition are set to the current drawing setting. If this setting is not within the range of allowable values for this property, the default value is used.
- 3 If necessary, [edit the properties](#) (page 991) for this object.

Quick Reference

Create Classified Object

Creates a new object based on the object classification definition

Task Pane In Map Explorer, under Current Drawing, right-click an object class ► Create Classified Object

Assigning an Object Class

Classify existing objects by assigning object classes to them. When you classify an object, the properties and data of the selected [object class](#) (page 2069) are assigned to the object.

NOTE This functionality applies to drawing objects only. For information about the classification systems used by geospatial feature data, see [About Geospatial Feature Classes, Data Stores, and Schemas](#) (page 551).

Before you assign an object class, make sure that the properties specified in the object class definition are available in the drawing. For example, if the object class definition specifies a linetype, make sure the specified linetype is loaded into the drawing. Any properties that are not available are not updated for the classified objects.

To classify objects, you must have an object class definition file attached to your drawing. For information on the location of the object class definition file, consult your CAD Manager.

See also:

- [Attaching an Object Class Definition File](#) (page 995)
- [Overview of Object Classification](#) (page 981)

NOTE This functionality applies to drawing objects only. For information about the classification systems used by geospatial feature data, see [About Geospatial Feature Classes, Data Stores, and Schemas](#) (page 551).

To assign an object class to an existing object

- 1 In Map Explorer, right-click the object class to assign to the object. Click Classify Objects.

If no object classes are listed in Map Explorer, [attach an object class definition file](#) (page 995). For information on the location of the object class definition file, consult your CAD Manager.

- 2 In the [Classify Objects dialog box](#) (page 1783), select the options you want and click OK.
 - Select Include Objects to classify objects even if the values for properties associated with the object class are not within the range of allowable values specified for the feature.
For these objects, the values that are outside the allowable range will be reset to the default value.
 - Select Exclude Objects to ensure that you do not overwrite an object class already assigned to an object.

- 3 Select the objects to classify.

If objects do not match the object type of the object class, they are filtered out of the selection set and are not classified.

To unclassify an object

- 1 In Map Explorer, right-click Object Classes. Click Unclassify Objects.
- 2 Select the objects to unclassify.
- 3 When you finish selecting objects, press Enter.
The object classification tag is removed from the selected objects.

Quick Reference

CLASSIFY

Classifies existing objects

Menu	Click Map ► Feature Classification ► Classify Objects.
Icon	 Classify Objects
Command Line	CLASSIFY
Task Pane	In Map Explorer, under Current Drawing, right-click Object Classes ► Select Classified Objects
Dialog Box	Classify dialog box

UNCLASSIFY

Removes classification from an object

Menu	Click Modify ► Unclassify Objects.
Icon	 Unclassify Objects
Command Line	UNCLASSIFY
Task Pane	In Map Explorer, under Current Drawing, right-click Object Classes ► Select Classified Objects

Editing Object Class Data

Edit [object class](#) (page 2069) data for the selected object from the Object Class tab of the Properties palette.

NOTE This functionality applies to drawing objects only. For information about the classification systems used by geospatial feature data, see [About Geospatial Feature Classes, Data Stores, and Schemas](#) (page 551).

If you enter values on the Object Class tab that are outside the allowable range for this property, the value resets to the default value. If you edit this data elsewhere, such as on the Categories tab of the Properties palette, you can enter values that are outside the range.

See also:

- [Assigning an Object Class](#) (page 988)
- [Creating Classified Drawing Objects](#) (page 987)
- [Overview of Object Classification](#) (page 981)

NOTE This functionality applies to drawing objects only. For information about the classification systems used by geospatial feature data, see [About Geospatial Feature Classes, Data Stores, and Schemas](#) (page 551).

To edit object class data for an object

- 1 Select the object.
- 2 If the Properties palette is not already displayed, right-click the object. Click Properties.
- 3 In the Properties palette, select the Object Class tab.
- 4 Review and edit any information.
You must enter a value that is within the allowable range for this object class.

Quick Reference

PROPERTIES

Displays the Properties palette, which allows you to edit the properties of objects

Menu Analyze ► Properties

Icon  Properties

Command Line PROPERTIES

Task Pane Select object. Right-click in drawing area ► Properties

Selecting Objects by Object Class

In your current map, you can create a selection set of objects, based on their [object class](#) (page 2069). For example, you could select all Roads.

NOTE This functionality applies to drawing objects only. For information about the classification systems used by geospatial feature data, see [About Geospatial Feature Classes, Data Stores, and Schemas](#) (page 551).

When you select all objects in a base class, objects in object classes based on that class are also selected.

You can use Quick Select to select objects with specific properties, such as all two-line roads. You can also select all objects that have not been assigned to any object class

In addition, you can use queries to select objects by object class in your source drawing and query them into the current drawing.

See also:

- [Assigning an Object Class](#) (page 988)
- [Creating Classified Drawing Objects](#) (page 987)
- [Editing Object Class Data](#) (page 991)
- [Using Object Classification](#) (page 981)

NOTE This functionality applies to drawing objects only. For information about the classification systems used by geospatial feature data, see [About Geospatial Feature Classes, Data Stores, and Schemas](#) (page 551).

To select objects in your current map, based on their object class

To select this...	Use this method...
Objects assigned to a specific object class	In Map Explorer, right-click the object class name ► Select Classified Objects (MAPSELECTCLASSIFIED (page 1779)).
Objects assigned to any object class (all classified objects)	In Map Explorer, right-click Object Classes ► Select Classified Objects (MAPSELECT-CLASSIFIED (page 1779)).
Objects that have not been assigned to any object class (all unclassified objects)	In Map Explorer, right-click Object Classes ► Select Unclassified (MAPSELECTUN-CLASSIFIED (page 1780)).
All undefined objects An undefined object was assigned to an object class, but that object class is not defined in the definition file attached to the drawing.	In Map Explorer, right-click Object Classes ► Select Undefined ((MAPSELECTUN-DEFINED (page 1780))).
Objects based on a property value	<ol style="list-style-type: none">1 Right-click in the map.2 Click Quick Select.3 In the Quick Select dialog box, under Object Type, select the object class.4 Under Properties, select the object class property.5 Select an operator and a value.

To select objects in source drawings, based on their object class

To select this...	See...
Objects in source drawings based on the object class name or a specific value of an object class property	To retrieve drawing objects based on their properties (page 1244)
Objects in source drawings based on the value of specific object class data	To retrieve drawing objects based on their object data (page 1248)

Quick Reference

MAPSELECTCLASSIFIED

Selects all classified objects

Menu Click Map ► Feature Classification ► Select Features.

Icon



Select Classified Objects

Command Line MAPSELECTCLASSIFIED

Task Pane In Map Explorer, under Current Drawing, right-click Object Classes ► Select Classified Objects

Dialog Box MAPSELECTCLASSIFIED (Select Classified Objects command)

MAPSELECTUNCLASSIFIED

Selects all objects that have no classification assigned to them

Menu Click Map ► Feature Classification ► Select Unclassified.

Command Line MAPSELECTUNCLASSIFIED

Task Pane In Map Explorer, under Current Drawing, right-click Object Classes ► Select Unclassified

Dialog Box MAPSELECTUNCLASSIFIED (Select Unclassified Objects command)

MAPSELECTUNDEFINED

Selects all objects whose classification is not defined in the current object class definition file

Menu Click Map ► Feature Classification ► Select Undefined.

Command Line MAPSELECTUNDEFINED

Task Pane In Map Explorer, under Current Drawing, right-click Object Classes ► Select Undefined

Dialog Box MAPSELECTUNDEFINED (Select Undefined Objects command)

Attaching an Object Class Definition File

The [object class definition](#) (page 2069) file includes information on how to create each object class you have defined. You can change the object class definition file that is associated with the current map. Only definitions in the associated definition file can be assigned to objects or used to create new features.

NOTE For information on the location of the object class definition file, consult your CAD Manager.

NOTE This functionality applies to drawing objects only. For information about the classification systems used by geospatial feature data, see [About Geospatial Feature Classes, Data Stores, and Schemas](#) (page 551).

See also:

- [Overview of Object Classification](#) (page 981)
- [Creating an Object Classification File](#) (page 128)

NOTE This functionality applies to drawing objects only. For information about the classification systems used by geospatial feature data, see [About Geospatial Feature Classes, Data Stores, and Schemas](#) (page 551).

To attach an object class definition file

- 1 In Map Explorer, right-click Object Class Definition ► Attach Object Class Definition File.
- 2 Select the object class definition file. Click Open.

Quick Reference

ATTACHDEF

Changes the current feature definition file

Menu	Click Setup ► Classification Tools ► Attach Definition File.
Command Line	ATTACHDEF
Task Pane	In Map Explorer, under Current Drawing, right-click Object Classes ► Attach Definition File

Working with Survey Data

- [Overview of Working with Survey Data](#) (page 997)
- [Working with Survey Data Stores](#) (page 999)
- [Working with Projects](#) (page 1001)
- [Working with Surveys](#) (page 1002)
- [Working with Point Groups](#) (page 1004)
- [Working with Survey Points](#) (page 1005)
- [Creating Surfaces From Survey Data](#) (page 1009)

NOTE Survey data is a particular type of geospatial data. You cannot use survey functionality for drawing objects.

To work with survey data

- [To create a survey data store](#) (page 1000)
- [To connect to a survey data store](#) (page 1000)
- [To view points in the active data store only](#) (page 1000)
- [To add a point group to a project](#) (page 1001)
- [To rename a project](#) (page 1002)
- [To remove a project from a survey data store](#) (page 1002)
- [To view or edit project properties](#) (page 1002)
- [To add a point group to a survey](#) (page 1003)
- [To remove a point group from a survey](#) (page 1003)
- [To rename a survey](#) (page 1003)
- [To remove a survey from a project](#) (page 1003)
- [To view or edit survey properties](#) (page 1004)
- [To rename a point group](#) (page 1004)
- [To remove a point group from a project or survey](#) (page 1005)
- [To view or edit point group properties](#) (page 1005)
- [To create survey points](#) (page 1006)
- [To create survey points using coordinate geometry](#) (page 1006)
- [To move points from one point group to another](#) (page 1006)
- [To remove points from a point group](#) (page 1007)
- [To delete survey points](#) (page 1007)
- [To view and edit survey point data in the Point Table](#) (page 1008)
- [To zoom to survey points on the map](#) (page 1008)
- [To create geospatial features from survey points](#) (page 1008)
- [To create a surface from a source file](#) (page 1009)
- [To create a surface from a data connection](#) (page 1010)

- To create a surface from points in your drawing (page 1011)

Overview of Working with Survey Data

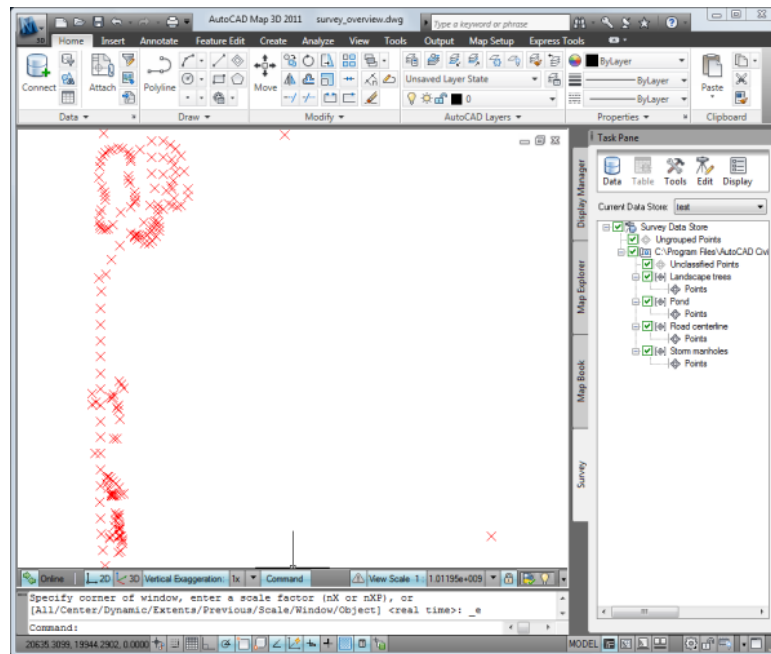

You can manage survey data on the Survey tab of the Task Pane

AutoCAD Map 3D allows you to manage survey point data.

NOTE Survey data is a particular type of geospatial data. You cannot use survey functionality for drawing objects.

You can do the following with survey data:

- Import survey points in LandXML or ASCII format
- View point data in the Point Table (a survey-point specific version of the [Data Table](#) (page 1613))
- Edit survey points
- Add points using coordinate geometry commands

- Export points to LandXML format
- Use the Bulk Copy feature to export points to another data store to create geospatial features.
For example, if each survey point represents a telephone pole, you can export the points to an SDF file called *Telephone_poles.sdf*. You can then add *Telephone_poles.sdf* to your map using Data Connect and work with the point data as geospatial features.

Survey data is kept in a dedicated SDF data store. You can add new properties and classes to the survey data store schema, but be careful not to alter or remove the existing properties and classes.

Points in a survey data store are in read-only mode until you click Edit at the top of the Task Pane. Clicking Edit puts AutoCAD Map 3D into direct edit mode, which means that any changes you make to the points in AutoCAD Map 3D are immediately applied to the data store. You can reorganize survey points without entering Edit mode (for example, you can move points between point groups).

When working with survey data, you must work online. If you work offline, AutoCAD Map 3D disconnects from the survey data store, and the survey tree disappears.

NOTE Survey data is a particular type of geospatial data. You cannot use survey functionality for drawing objects.

Use the following methods to work with survey data.

To do this...	Use this method...
Create or connect to a new survey data store.	<ul style="list-style-type: none"> ■ Create a Survey Data Store (page 1000) ■ Connect to a Survey Data Store (page 1000)
Bring in survey point data.	<ul style="list-style-type: none"> ■ Bring in LandXML Data. (page 371) ■ Bring in ASCII Point Data. (page 373)
Manage survey point data.	<ul style="list-style-type: none"> ■ Create Survey Points (page 1006) ■ Create Survey Points Using Coordinate Geometry (page 1006)

To do this...	Use this method...
	<ul style="list-style-type: none"> ■ View and Edit Survey Point Data in the Point Table (page 1008)
Create geospatial features from survey points.	Create Geospatial Features from Survey Points (page 1008)
Export survey point data to LandXML.	Export Survey Points to LandXML (page 1471)

Working with Survey Data Stores

Survey data is kept in a dedicated SDF data store. You can add new properties and classes to the survey data store schema, but be careful not to alter or remove the existing properties and classes. Within a survey data store, survey points are organized into projects, surveys, point groups, and unclassified points. Before you import any survey data, you must connect to or create a survey data store.

NOTE Survey data is a particular type of geospatial data. You cannot use survey functionality for drawing objects.



NOTE If you connect to two separate survey data stores with different coordinate systems, you may not be able to view the survey points contained in both data stores. AutoCAD Map 3D transforms the coordinate systems of the data stores to the coordinate system of the map for display. If the coordinate systems of the data stores are incompatible with the coordinate system of the map, AutoCAD Map 3D cannot display both data stores. For example, AutoCAD Map 3D is not able to display a data store in a New York state plane coordinate system and a California state plane coordinate system in a single drawing. If you use data stores with such disparate coordinate systems, best practice dictates that you use separate drawings for each data store.

Working with Ungrouped Points

All points that do not fall into one of the survey data store categories (project, survey, or point group) are grouped together in the Ungrouped Points node under the Data Store node. You can edit, delete, or move ungrouped points to other point groups. For more information on working with ungrouped points, see [Working with Survey Points](#) (page 1005).

NOTE Survey data is a particular type of geospatial data. You cannot use survey functionality for drawing objects.

To create a survey data store

- 1 On the Survey tab of the Task Pane, click Data ► New Survey Data Store.
- 2 In the [New Data Store dialog box](#) (page 1891), click  in the File Location section.
- 3 In the Create New Survey Data Store dialog box, enter a name for and select a location to which to save your file, then click Save.
- 4 In the New Data Store dialog box, enter a coordinate system for your survey data store in the Coordinate System assignment section. To select a coordinate system from a list, click .
- 5 Click OK.

To connect to a survey data store

- 1 On the Survey tab of the Task Pane, click Data ► Connect to Survey Data Store.
- 2 In the Connect to Survey Data Store dialog box, browse to and select the desired survey data store.
- 3 Click Open.

To view points in the active data store only

You can view only the points for the active data store by clicking the Display button in the Survey Task Pane toolstrip. When you click Display, AutoCAD Map 3D hides the objects and features in all other Display Manager layers.

- 1 Select the survey data store for which you would like to view points from the Current Data Store drop-down list.
- 2 Click the Display button on the Survey Task Pane toolstrip.

Quick Reference

Survey Data Store

Store survey point data in an SDF file.

Task Pane On the Survey tab, click Data ► New Survey Data Store to create a new data store. Click Data ► Connect to Survey Data Store to connect to an existing survey data store.

Dialog Box New Data Store dialog box

Working with Projects

When you import a LandXML file into AutoCAD Map 3D, it appears in the Survey Tree as a Project. Projects are the primary organizational group within a survey data store.

NOTE Survey data is a particular type of geospatial data. You cannot use survey functionality for drawing objects.

Projects contain point groups and surveys. Any points that are not assigned to a point group appear in the Unclassified Points group. For more information on working with ungrouped points, see [Working with Survey Points](#) (page 1005).

You can add a new point group to a project, rename a project, or remove a project from a survey data store. You can also view and edit project properties in the [Project Properties dialog box](#) (page 1892).

NOTE Survey data is a particular type of geospatial data. You cannot use survey functionality for drawing objects.

To add a point group to a project

- 1 Right-click a project in the survey data store.
- 2 Select New Point Group. The new point group appears in the survey data tree.
- 3 Enter a name for the new point group.

To rename a project

- 1 Right-click the project you want to rename.
- 2 Select Rename Project.
- 3 Enter the new name for the project, then press *Enter*.

To remove a project from a survey data store

- 1 Right-click the project you want to remove.
- 2 Select Remove Project.
- 3 Click Yes in the Confirm Remove Project message box to remove the project from the survey data store.

To view or edit project properties

- 1 Right-click the project and select Properties. The [Project Properties dialog box](#) (page 1892) appears.
- 2 To edit project properties, click the field you wish to edit and enter your data. Fields with constrained values will display a drop-down list.

Quick Reference

Survey Project Properties

View or edit survey project properties.

Task Pane	On the Survey tab, right-click a project ► Properties.
Dialog Box	Project Properties dialog box

Working with Surveys

Surveys are organizational groups within a project. Surveys contain point groups.

NOTE Survey data is a particular type of geospatial data. You cannot use survey functionality for drawing objects.

Any points that are not assigned to a point group appear in the Unclassified Points group. For more information on working with ungrouped points, see [Working with Survey Points](#) (page 1005).

You can add a new point group to a survey, remove a point group from a survey, rename a survey, or remove a survey from a project. You can also view and edit survey properties in the [Survey Properties dialog box](#) (page 1893). You cannot create a new survey in AutoCAD Map 3D. Surveys are created by external surveying hardware and software, and must be imported to your survey data store in a LandXML file.

NOTE Survey data is a particular type of geospatial data. You cannot use survey functionality for drawing objects.

To add a point group to a survey

- 1 Right-click a survey in the project.
- 2 Select New Point Group. The new point group appears in the survey data tree.
- 3 Enter a name for the new point group.

To remove a point group from a survey

- Right-click the point group you wish to remove, then select Remove Point Group.

To rename a survey

- 1 Right-click the survey you want to rename.
- 2 Select Rename Survey.
- 3 Enter the new name for the survey, then press *Enter*.

To remove a survey from a project

- 1 Right-click the survey you want to remove.
- 2 Select Remove Survey.
- 3 Click Yes in the Confirm Remove Survey message box to remove the survey from the project.

To view or edit survey properties

- 1 Right-click the survey and select Properties. The [Survey Properties dialog box](#) (page 1893) appears.
- 2 To edit survey properties, click the field to edit and enter your data in the [Field Note Editor](#) (page 1894). Fields with constrained values will display a drop-down list.

Quick Reference

Survey Properties

View or edit survey properties.

Task Pane	On the Survey tab, right-click a survey ► Properties.
Dialog Box	Survey Properties dialog box

Working with Point Groups

Point groups are included in projects and surveys. Point groups contain survey points. Groups typically define some common set of survey points, such as a road centerline.

You can rename point groups or remove them from the survey data store. You can also view and edit point group properties in the [Point Group Properties dialog box](#) (page 1894)

NOTE Survey data is a particular type of geospatial data. You cannot use survey functionality for drawing objects.

NOTE Survey data is a particular type of geospatial data. You cannot use survey functionality for drawing objects.

To rename a point group

- 1 Right-click the point group you want to rename.
- 2 Select Rename Point Group.
- 3 Enter the new name for the point group, then press *Enter*.

To remove a point group from a project or survey

- 1 Right-click the point group you want to remove.
- 2 Select Remove Point Group.
- 3 Click Yes in the Confirm Remove Point Group message box to remove the point group from the project.

To view or edit point group properties

- 1 Right-click the point group and select Properties. The [Point Group Properties dialog box](#) (page 1894) appears.
- 2 To edit point group properties, click the field you wish to edit and enter your data. Fields with constrained values will display a drop-down list.

Quick Reference

Survey Point Group Properties

View or edit survey point group properties.

Task Pane	On the Survey tab, right-click a point group ► Properties.
Dialog Box	Point Group Properties dialog box

Working with Survey Points

AutoCAD Map 3D allows you to create, manage, export, and migrate survey points. You can view and edit survey point data in the drawing window and Point Table, export survey points to LandXML, and create geospatial features from survey points using Bulk Copy.

NOTE Survey data is a particular type of geospatial data. You cannot use survey functionality for drawing objects.

To create, edit, or delete survey points, you must first click the Edit button on the Survey Task Pane toolstrip. When you click Edit, AutoCAD Map 3D enters direct edit mode. In direct edit mode, all changes you make in AutoCAD Map 3D are immediately made to the source data in the survey data store.

For information on exporting survey points to a LandXML file, see [Exporting Survey Points to a LandXML File](#) (page 1471).

NOTE Survey data is a particular type of geospatial data. You cannot use survey functionality for drawing objects.

To create survey points

- 1 Click Edit in the Survey Task Pane toolbar.
- 2 Right-click the project, survey, or point group to which you want to add a point.
- 3 Select Create New Point.
- 4 Specify the location of the new point on the map.
- 5 AutoCAD Map 3D creates the point and displays the Point Table.

To create survey points using coordinate geometry

- 1 Click Edit in the Survey Task Pane toolbar.
- 2 Right-click the project, survey, or point group to which you want to add a point.
- 3 Select Create COGO Point. The [COGO Input dialog box](#) (page 1668) appears.
- 4 Select the desired coordinate geometry routine and enter the appropriate information. For more information on entering coordinate geometry, see [Overview of Coordinate Geometry Commands](#) (page 1027).
- 5 Click Create Point.

To move points from one point group to another

You can move points between point groups with standard copy and paste commands. You can also CTRL-Drag points from one group to another. Note that when you copy points from one group to another, you are not duplicating those points. Rather, you are creating references to those points and adding them to the new point group. You can move points between point groups without entering direct edit mode.

- 1 Right-click the Points node in the point group you want to move.
- 2 Select Copy.

- 3 Right-click the Points node in the point group to which you want to move the copied points.
- 4 Select Paste.

You can also copy and paste individual points, or a selection of points, using the Point Table.

- 1 In the Point Table, select the rows containing the points you wish to copy.
- 2 Right-click the row header (the grey row selection button to the left of the object ID number) for that data and select Copy Points.
- 3 In the Data drop-down list, select the node to which you wish to paste the copied points.
- 4 Right-click any row header in the Data Table and select Paste Points. If you are pasting points to an empty point group, right-click the left-most column header (the Sort row header) and select Paste Points.

To remove points from a point group

You can remove selected points from a point group using the Point Table. When you remove a point from a point group, you are not deleting the point data. Rather, you are removing the reference to that point from the point group.

- 1 In the Point Table, select the rows containing the points you wish to remove.
- 2 Right-click the row header (the grey row selection button to the left of the object ID number) for the selected points and select Remove Points.
- 3 In the Confirm Remove Points dialog box, click Yes.

To delete survey points

You can delete survey points from your survey data store. You must work in direct edit mode to delete survey points. Deleting survey points removes them from your survey data store and from the connected data source.

- 1 Click Edit in the Survey Task Pane toolbar.
- 2 Right-click the points node and select Delete Points.
- 3 In the Confirm Delete All Points dialog box, click Yes.

You can also delete selected points from a point group using the Point Table.

- 1 Click Edit in the Survey Task Pane toolbar.
- 2 In the Point Table, select the rows containing the points you wish to delete.
- 3 Right-click the row header (the grey row selection button to the left of the object ID number) for the selected points and select Delete Points.
- 4 In the Confirm Delete Points dialog box, click Yes.

To view and edit survey point data in the Point Table

- 1 Click Edit in the Survey Task Pane toolbar if you want to edit the point data. You do not need to enter direct edit mode if you only want to view the data in the Point Table.
- 2 Select the project, survey, or point group you want to view or edit, then click Table in the Survey Task Pane toolbar. The Point Table appears.
- 3 View the survey point data in the Point Table. To edit data, click the desired field and edit the data as appropriate. Fields with constrained values will display a drop-down list. Uneditable fields will be shaded.

To zoom to survey points on the map

You can zoom to any collection of points in the survey data store.

- 1 Right-click the Survey Data Store, Project, Survey, or Point Group for which you want to view points.
- 2 Select Zoom to... to zoom to the selected points.

To create geospatial features from survey points

- 1 Right-click the project, survey, or point group from which you want to create geospatial features.
- 2 Select Export Points. The [Bulk Copy](#) (page 1744) dialog box appears.
- 3 Follow the instructions for [Migrating GIS Data \(Bulk Copy\)](#) (page 617) to create point features from your survey points.

Creating Surfaces From Survey Data

AutoCAD Map 3D 2011 allows you to create GeoTIFF raster surfaces from point data. You can enter point data in a variety of text formats as well as from AcDb point data and block references in your drawing. AutoCAD Map 3D also supports LandXML data sources that include a surface element; you cannot use a LandXML data source that contains only points.



If you are adding data from an ASCII point file and your text file contains lines that do not represent point data, enter a # character at the beginning of such lines. AutoCAD Map 3D ignores all text lines that begin with the # character.

AutoCAD Map 3D creates a raster surface in GeoTIFF format from the data you enter and adds it to your map as a feature layer. You can then style your surface using all of the visualization and styling tools of the Display Manager. You will also see a new Raster connection in the Data Connect window.

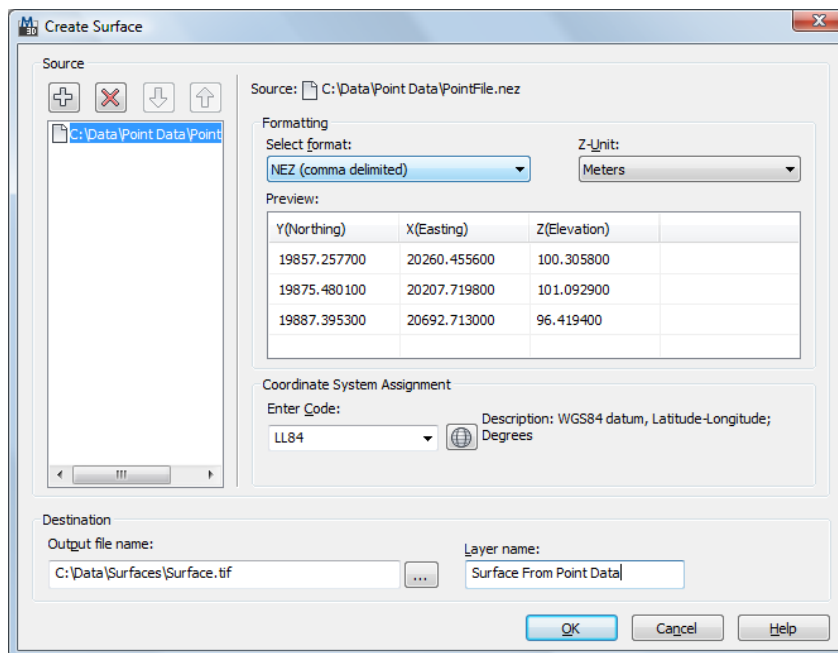
To create a surface from a source file





- 1 In the Tool-based Ribbon Workspace, click Create tab > Surface panel > 3D Surface or enter MAPCREATESURFACE at the command line.

- 2 In the [Create Surface dialog box](#) (page 1895), click  and select File.
- 3 In the Select a Point File dialog box, select the file format and navigate to your point file.
- 4 Click Open.
- 5 In the Formatting section, specify the formatting and vertical (Z) unit of your data file.
- 6 In the Output File Name field, click  and enter a file name and save location. If you do not specify a save location, the raster file will be saved to My Documents.
- 7 In the Layer Name field, enter a name for the new Display Manager raster layer.
- 8 In the Coordinate System Assignment section, specify the coordinate system of the source data. You can either enter the code in the text field, or click to choose from a list. You must specify the coordinate system for each data source you use.
- 9 Click OK. AutoCAD Map 3D generates a raster surface in GeoTIFF format and adds it to a new feature layer in your map. You can also see the new raster connection in Data Connect.



To create a surface from a data connection

You can create a surface using point data stored in a database or geospatial file format (such as Autodesk SDF).

- 1 If you are using an ODBC data source, specify the coordinate columns and add the data to your map as a vector layer before creating a surface.
- 2 In the Tool-based Ribbon Workspace, click Create tab > Surface panel > 3D Surface or enter MAPCREATESURFACE at the command line.
- 3 In the [Create Surface dialog box](#) (page 1895), click  and select Connection.
- 4 In the [Source Data dialog box](#) (page 1897), select the data source.
- 5 Click OK.

- 6 In the Output File Name field, click  and enter a file name and save location. If you do not specify a save location, the raster file will be saved to My Documents.
- 7 In the Layer Name field, enter a name for the new Display Manager raster layer.
- 8 In the Coordinate System Assignment section, specify the coordinate system of the source data. You can either enter the code in the text field, or click  to choose from a list. You must specify the coordinate system for each data source you use.
- 9 Click OK. AutoCAD Map 3D generates a raster surface in GeoTIFF format and adds it to a new feature layer in your map. You can also see the new raster connection in Data Connect.

To create a surface from points in your drawing

- 1 In the Tool-based Ribbon Workspace, click Create tab > Surface panel > 3D Surface or enter MAPCREATESURFACE at the command line.
- 2 In the [Create Surface dialog box](#) (page 1895), click  and select Points In Drawing.
- 3 Select the points in your drawing from which to create the surface. These points must include elevation data.
- 4 In the Output File Name field, click  and enter a file name and save location. If you do not specify a save location, the raster file will be saved to My Documents.
- 5 In the Layer Name field, enter a name for the new Display Manager raster layer.
- 6 Click OK. AutoCAD Map 3D generates a raster surface in GeoTIFF format and adds it to a new feature layer in your map. You can also see the new raster connection in Data Connect.

Quick Reference

MAPCREATESURFACE

Creates a 3D raster surface from point data.

Command Line MAPCREATESURFACE

Dialog Box Create Surface dialog box

Working With Point Cloud Data

The following sections describe how to work with point cloud data.

Overview of Point Clouds

[Point clouds](#) (page 2071) are large data sets composed of 3D point data. Aerial [LiDAR](#) (page 2066) (Light Detection And Ranging) laser scanners are the most common instruments used to collect geographic point cloud data.

AutoCAD Map 3D 2011 includes features for working with point cloud data. You can create highly accurate digital elevation models ([DEM](#) (page 2059)s) using point cloud data. Because point cloud data sets are so large (commonly containing millions, and occasionally billions, of points), AutoCAD Map 3D must create an indexed point cloud data store before it can effectively work with the data. Once the data is indexed, AutoCAD Map 3D brings the point cloud into your map as an AutoCAD drawing object (AcDb entity) and adds a point cloud layer to the Display Manager. You can filter the indexed point cloud data by classification, elevation, intensity, or location on your map. You can also group and style your point cloud data using the Display Manager. To create a raster-based surface from your point cloud data, use the [Surface Manager](#) (page 1898).

Overview of LiDAR Data

Geographic LiDAR data is most commonly available in [LAS](#) (page 2066)(LiDAR Aerial Survey) or ASCII (.xyz) format. LAS is an industry standard file format defined by the American Society of Photogrammetry and Remote Sensing that includes a system of point classification. A processed LAS file may have points classified as bare earth, high or low vegetation, building, and so on.

Because LAS files are produced from aerial surveys, they tend to contain long swaths or strips of terrain data. The survey planes generally fly a long distance in one direction collecting data, then fly back collecting data along a parallel path. This process is often repeated many times. You may need to combine

these survey swaths and filter them by location to get the point cloud data relevant to your map.

To use LiDAR data

- [Bring in LiDAR data](#) (page 374)
- [Manage LiDAR data](#) (page 1015)
- [Use LiDAR data to create a point cloud data store](#) (page 1019)

Quick Reference

MAPPOINTCLOUDMANAGER

Creates and manages indexed point cloud data stores.

Command Line MAPPOINTCLOUDMANAGER

Dialog Box Point Cloud Manager

MAPSURFACEMANAGER

Creates a 3D raster surface from point cloud data.

Command Line MAPSURFACEMANAGER

Dialog Box Surface Manager

Overview of Point Cloud Files and Objects

AutoCAD Map 3D uses the data contained in point cloud data stores to create point clouds. These point clouds are standard AutoCAD drawing objects (AcDb entities). Point clouds appear in the Display Manager as drawing object layers. Most commands for working with point clouds are available on the right click menu in the Display Manager as well as on the contextual Point Cloud ribbon tab. To view the Point Cloud ribbon tab, select a point cloud layer in the Display Manager. This guide primarily documents the right-click menu options.

You can filter and style point clouds, use them to create surfaces, and export them to LAS, ASCII, or SDF format.

To use point clouds in your map

- [Bring point cloud data into your map](#) (page 375)

- [Filter point cloud data](#) (page 1024)
- [Create surfaces from point cloud data](#) (page 1021)
- [Style point cloud data](#) (page 675)
- [Export point cloud data](#) (page 1451)

Quick Reference

MAPPOINTCLOUDMANAGER

Creates and manages indexed point cloud data stores.

Command Line MAPPOINTCLOUDMANAGER

Dialog Box Point Cloud Manager

MAPSURFACEMANAGER

Creates a 3D raster surface from point cloud data.

Command Line MAPSURFACEMANAGER

Dialog Box Surface Manager

Managing LiDAR Data

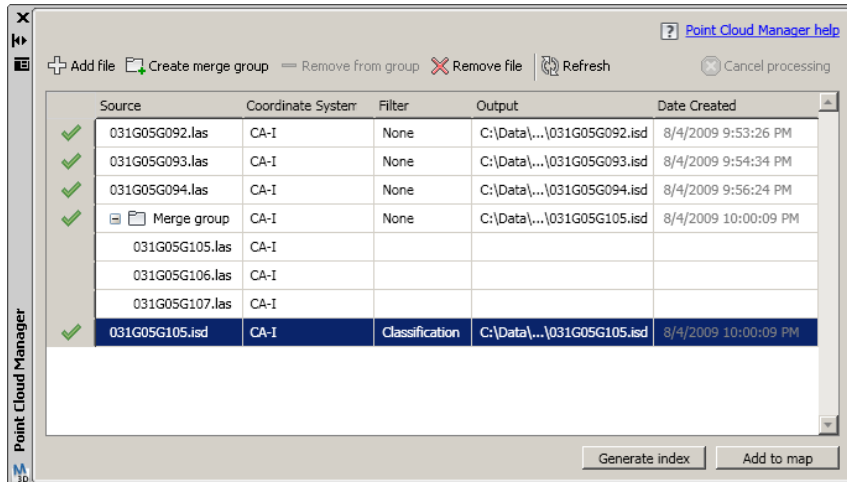

The Point Cloud Manager

After you have brought files into the [Point Cloud Manager](#) (page 1897), you can gather them into merge groups, specify coordinate systems for your point cloud data store files, and apply filters to control what data will be included in their associated point cloud data store.

When you create a Merge Group, AutoCAD Map 3D assigns several LiDAR source files to a single point cloud data store. You might want to create a merge group to apply a spatial filter across several source files, for example.

You can also create a group of point clouds in Display Manager that uses separate point cloud data stores for each LiDAR source file.

AutoCAD Map 3D assigns a default name and save location for the point cloud data store index file. You can view the default output name and location in the Output field in the Point Cloud Manager.

In most cases, AutoCAD Map 3D automatically determines the coordinate system of your LiDAR data based on information in the LAS file and displays it in the Coordinate System field of the Point Cloud Manager. When you create a point cloud data store, AutoCAD Map 3D assigns the source coordinate system to it by default. If you are using an ASCII data source, or if AutoCAD Map 3D cannot determine the appropriate coordinate system, you can specify the coordinate system for your point cloud data store in this field.

When you remove a merge group from the Point Cloud Manager, the files contained within the group remain. To remove files from the Point Cloud Manager, select the file and click Remove File. All files added to the Point Cloud Manager appear there until you explicitly remove them.

You can apply a filter to your LiDAR source data to control what points are included in your point cloud data store. You can also filter point cloud data after it has been added to your map. If you are considering creating a filtered point cloud data store from your LiDAR data, try filtering the point cloud data in Display Manager first. This allows you to experiment with various filters before applying them to your source files.

See also:

- [Overview of Point Clouds](#) (page 1012)
- [Overview of LiDAR Data](#) (page 1012)
- [Overview of Point Cloud Files and Objects](#) (page 1013)
- [Bringing in LiDAR Data](#) (page 374)
- [Using LiDAR Data to Create a Point Cloud Data Store](#) (page 1019)
- [Creating Surfaces From Point Cloud Data](#) (page 1021)
- [Filtering Point Cloud Data](#) (page 1024)
- [Exporting Point Cloud Data](#) (page 1451)

To specify a coordinate system for your point cloud data store

- 1 In the [Point Cloud Manager](#) (page 1897), click the Coordinate System field.
- 2 Do one of the following:
 - If you know the coordinate system code, enter it into the Coordinate System field.
 - To choose the coordinate code from a list, click . Select the appropriate coordinate system from the list, then click OK.

To specify an output file name and save location

- 1 Click the Output field in the [Point Cloud Manager](#) (page 1897), then click . The Save As dialog box appears.

- 2 Enter a new file name and save location, then click Save.

To create a merge group

- 1 In the [Point Cloud Manager](#) (page 1897), click Create Group.
A new merge group appears in the Point Cloud Manager.
- 2 To rename the merge group, click in the Source field and enter a new name.
- 3 Shift-click or control-click to select the source files in the Point Cloud Manager, then drag them into the merge group.
- 4 To specify an output file name and save location other than the one assigned by default, click the Output field, then click  .
- 5 In the Save As dialog box, enter the file name and save location, then click Save.
- 6 To add another file to a merge group, click the file in the Point Cloud Manager and drag it into the merge group.
You can also right click the merge group and select Add Files to bring in additional files from your LiDAR data repository.
- 7 To remove files from a merge group, select the file or files, then click Remove From Group in the Point Cloud Manager.
When you remove files from a merge group, they remain in the Point Cloud Manager. To remove files from the Point Cloud Manager, select the file or files and click Remove File.

To remove a merge group from the Point Cloud Manager

- 1 Select the merge group in the [Point Cloud Manager](#) (page 1897).
- 2 Click Remove Group.

To filter LiDAR data

- 1 In the [Point Cloud Manager](#) (page 1897), click the Filter field. appears.

- 2 In the [Filter Point Cloud dialog box](#) (page 1900) in the Filter By drop-down box, select one of the following filters:
 - Classification: if your LiDAR data has been classified, you can select which point classes to include in your point cloud data store. Shift-click or control-click to select multiple classes.
 - Elevation: type the elevation ranges you want to include in your point cloud data store. Use hyphens to define ranges and commas to separate them; for example, 150-200, 350-400, 1200-2000.
 - Intensity: you can use LiDAR intensity values to filter data. Use hyphens to define ranges and commas to separate them; for example, 0.25-2.00, 3.50-4.00, 120.00-200.00.
 - Spatial: click the Locate on Map button to apply a spatial filter for your point cloud data store. You can make a spatial selection using a circle, rectangle, polygon, or proximity to an object on your map.

Click Apply Filter.

AutoCAD Map 3D displays the filter type in the Filter field.

To remove a filter from your LiDAR data

- 1 In the [Point Cloud Manager](#) (page 1897), click the Filter field. The [Filter Point Cloud dialog box](#) (page 1900) appears.
- 2 In the Filter By drop-down box, select the filter type you want to remove.
- 3 Click Clear Filter.

To remove a file from the Point Cloud Manager

- 1 Select the file in the [Point Cloud Manager](#) (page 1897).
- 2 Click Remove File.

Quick Reference

MAPPOINTCLOUDMANAGER

Creates and manages indexed point cloud data stores.

Command Line MAPPOINTCLOUDMANAGER

Dialog Box Point Cloud Manager

Using LiDAR Data to Create a Point Cloud Data Store

Once you have brought your LiDAR data into the [Point Cloud Manager](#) (page 1897), you are ready to create a point cloud data store. A point cloud data store is an index file (.ISD) that AutoCAD Map 3D refers to when it creates point cloud objects. These index files can be very large, up to ten times as large as their LAS source files. AutoCAD Map 3D may take a long time to generate these index files, and you must ensure that you have sufficient disk space to store them.

NOTE You can also create a point cloud index file using AutoCAD commands. Point cloud index files created using AutoCAD commands have the .PCG file extension. For information on creating point cloud index files using AutoCAD commands, see the AutoCAD Help.

See also:

- [Overview of Point Clouds](#) (page 1012)
- [Overview of LiDAR Data](#) (page 1012)
- [Overview of Point Cloud Files and Objects](#) (page 1013)
- [Bringing in LiDAR Data](#) (page 374)
- [Creating Surfaces From Point Cloud Data](#) (page 1021)
- [Managing LiDAR Data](#) (page 1015)
- [Filtering Point Cloud Data](#) (page 1024)
- [Exporting Point Cloud Data](#) (page 1451)

To create a point cloud data store

- 1 In the [Point Cloud Manager](#) (page 1897), select the source file or merge group for which you want to create a point cloud data store.
- 2 Check the Output field to confirm the file name and save location of your index file.
- 3 Click Generate Index.
- 4 To cancel the indexing process, click Cancel Processing.

- 5 When AutoCAD Map 3D is done creating the index file, a green check mark appears next to the file or merge group name. You can now take one of the following actions:
 - To add the point cloud to your map, click Add to Map. AutoCAD Map 3D adds the point cloud drawing object to your map, and adds a point cloud layer to the Display Manager.
 - To add a group of point clouds to your map, shift-click or control-click to select a group of files, then click Add to Map. AutoCAD Map 3D adds the point cloud drawing object to your map, and adds a point cloud layer to the Display Manager.

NOTE You can also create a group of point clouds in the Display Manager. Right-click in Display Manager and select Data ► New Group, then click and drag point cloud layers into the new group.

See also:

- [Overview of Point Cloud Files and Objects](#) (page 1013)
- [Bringing in LiDAR Data](#) (page 374)
- [Creating Surfaces From Point Cloud Data](#) (page 1021)
- [Managing LiDAR Data](#) (page 1015)
- [Filtering Point Cloud Data](#) (page 1024)
- [Exporting Point Cloud Data](#) (page 1451)

Quick Reference

MAPPOINTCLOUDMANAGER

Creates and manages indexed point cloud data stores.

Command Line MAPPOINTCLOUDMANAGER

Dialog Box Point Cloud Manager

Creating Surfaces From Point Cloud Data

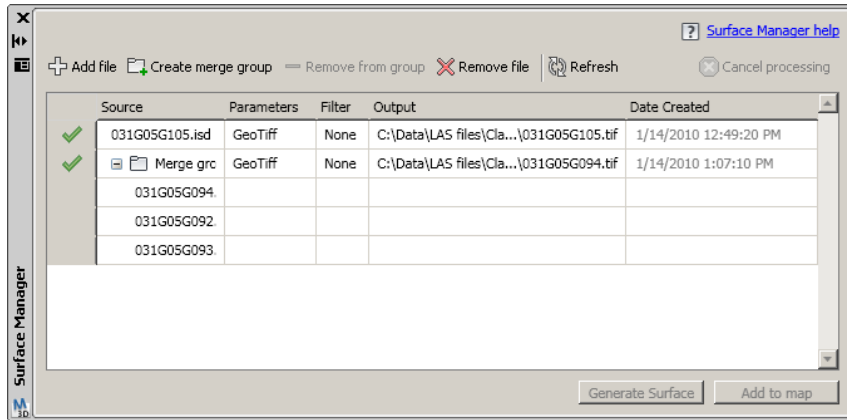

The Surface Manager

You can create a raster-based [surface](#) (page 2076) from point cloud data in either GeoTIFF or ESRI ASC format. After you have created your surface, you can view, theme, and analyze it like any other raster-based surface in AutoCAD Map 3D. For more information on working with raster-based surfaces, see [Adding Rasters and Surfaces](#) (page 437), [Analyzing Raster-Based Surfaces](#) (page 1186), and [Styling Raster Images](#) (page 671).

The [Surface Manager](#) (page 1898) also allows you to assign multiple input files to a single surface file using merge groups. You might want to create a merge group in order to apply a spatial filter across several input files, for example. The source files for a merge group must use the same coordinate system.

Before you create a surface from point cloud data, ensure that the data is projected in a local coordinate system that uses feet or meters for vertical units. If the source data is not in a local coordinate system, you can either assign a local system to it in the [Point Cloud Manager](#) (page 1897), or assign a local system to your drawing. Assigning a local coordinate system to the point cloud data using the Point Cloud Manager will give you better performance.

NOTE AutoCAD Map 3D automatically resamples the raster-based surfaces when you zoom in and out in your map. However, surfaces do not display well at some zoom levels, especially at small view scales. To improve the appearance of the surface in your map, you can resample the raster image by right-clicking the raster layer in the Display Manager and selecting Resample Raster. If resampling the surface does not improve the image quality, view the grid at a larger view scale.

See also:

- [Overview of Point Clouds](#) (page 1012)
- [Overview of LiDAR Data](#) (page 1012)
- [Overview of Point Cloud Files and Objects](#) (page 1013)
- [Bringing in LiDAR Data](#) (page 374)
- [Using LiDAR Data to Create a Point Cloud Data Store](#) (page 1019)
- [Managing LiDAR Data](#) (page 1015)
- [Filtering Point Cloud Data](#) (page 1024)
- [Exporting Point Cloud Data](#) (page 1451)

To create a surface from a point cloud

- 1 In the Display Manager, right-click a point cloud layer and select Create Surface. The [Surface Manager](#) (page 1898) appears.
- 2 To create a merge group, click Create Group in the [Create Surface dialog box](#) (page 1895), then shift-click or control-click and drag the desired source files into the group.
- 3 To filter the points used to create the surface, click the Filter field. The [Filter Point Cloud dialog box](#) (page 1900) appears.
- 4 In the Filter By drop-down box, select one of the following filters:
 - Classification: if your point cloud data has been classified, you can select which point classes to use when creating the surface. Shift-click or control-click to select multiple classes.
 - Elevation: type the elevation ranges you want to use to create the surface. Use hyphens to define ranges and commas to separate them; for example, 150-200, 350-400, 1200-2000.
 - Intensity: you can use LiDAR intensity values to filter data. Use hyphens to define ranges and commas to separate them; for example, 0.25-2.00, 3.50-4.00, 120.00-200.00.
 - Spatial: click the Locate on Map button to apply a spatial filter to your point cloud. You can make a spatial selection using a circle, rectangle, polygon, or proximity to an object on your map.

- 5 To specify what type of surface to create, click the Parameters field. The [Grid Parameters dialog box](#) (page 1901) appears. You can:
 - Specify a GeoTIFF or ESRI ASC surface.
 - Specify a file name and save location for the grid file.
 - Specify parameters for cell size, cell units (meters, US feet, Survey feet, International feet), and search radius. These settings affect the resolution of the grid file only.
 - Fill gaps: when you check the Fill Gaps check box, you can select how AutoCAD Map 3D fills gaps in your surface. Choose a fill method from the drop-down list: Nearest Neighbor, Normal Distribution, Normal Distribution Smooth, Square Distance, or Square Distance Smooth.
- 6 To specify an output file name and save location other than the one assigned by default, click the Output field, then click . The Save As dialog box appears. Enter the file name and save location, then click Save.
- 7 Click Generate Surface. AutoCAD Map 3D begins to create the surface.
- 8 To cancel the surface creation process, click Cancel Processing.
- 9 When AutoCAD Map 3D is done creating the surface, a green check mark appears next to the file or merge group name. Do one of the following:
 - To add the surface to your map, click Add to Map. AutoCAD Map 3D adds the surface to your map, and a raster layer to the Display Manager. It also creates a raster connection in Data Connect.
 - To add a surface group to your map, shift-click or control-click to select a group of files, then click Add to Map. AutoCAD Map 3D adds a new raster connection to Data Connect. Select the new raster connection, then select the surfaces you would like to include and click Add to Map. If your surfaces are all the same file type, you can select Combine Into One Layer and specify a layer name.

NOTE You can also connect to surfaces created from point cloud data using Data Connect as you would for any other raster data. For more information on connecting to raster data through Data Connect, see [Adding Raster-Based Surfaces to Your Map](#) (page 441).

Quick Reference

MAPSURFACEMANAGER

Creates a 3D raster surface from point cloud data.

Command Line MAPSURFACEMANAGER

Dialog Box Surface Manager

Filtering Point Cloud Data

You can filter point clouds by point classification, elevation, LiDAR intensity, and location on your map. You can also create a new point cloud data store from your filtered point cloud data.

Filters applied in the Display Manager or Point Cloud Ribbon only control the display of points in your map. They do not remove any of the points from the point cloud. To create a new point cloud containing a subset of your source data, use the filter in the Point Cloud Manager. For more information on filtering point cloud data, see Lesson 4: Work with Point Cloud Data.

NOTE If you are working with a point cloud created using AutoCAD commands (.PCG file), you can only filter by elevation and location on map.

See also:

- [Overview of Point Clouds](#) (page 1012)
- [Overview of LiDAR Data](#) (page 1012)
- [Overview of Point Cloud Files and Objects](#) (page 1013)
- [Bringing in LiDAR Data](#) (page 374)
- [Using LiDAR Data to Create a Point Cloud Data Store](#) (page 1019)
- [Creating Surfaces From Point Cloud Data](#) (page 1021)
- [Managing LiDAR Data](#) (page 1015)
- [Exporting Point Cloud Data](#) (page 1451)

To filter point cloud data

- 1 In the Display Manager, right-click a point cloud layer and select Filter Point Cloud.
- 2 In the [Filter Point Cloud dialog box](#) (page 1900), in the Filter By drop-down box, select one of the following filters:
 - Classification: if your point cloud data has been classified, you can select which point classes to display. Shift-click or control-click to select multiple classes.
 - Elevation: type the elevation ranges you want to display in your map. Use hyphens to define ranges and commas to separate them; for example, 150-200, 350-400, 1200-2000.
 - Intensity: you can use LiDAR intensity values to filter data. Use hyphens to define ranges and commas to separate them; for example, 0.25-2.00, 3.50-4.00, 120.00-200.00.
 - Spatial: click the Locate on Map button to apply a spatial filter to your point cloud. You can make a spatial selection using a circle, rectangle, polygon, or proximity to an object on your map.
- 3 Click Apply Filter.
The filtered points are displayed in your map.

To create a new point cloud data store from filtered point cloud data

- 1 In the Display Manager, right-click the filtered point cloud layer from which you want to create a new point cloud data store, then select Data ► Add Point Cloud Data ► Create New Index.
The [Point Cloud Manager](#) (page 1897) appears with a row for your new point cloud data store highlighted, and with the filter type displayed in the Filter field.

NOTE You cannot create a new index from an AutoCAD point cloud index (.PCG file).

- 2 In the Point Cloud Manager, select a file name and save location for your new point cloud data store, then click Generate Index.
AutoCAD Map 3D begins to create the index file.

NOTE By default, AutoCAD Map 3D gives the new index file the same name as the source file. Be sure that you specify a new name for your filtered point cloud data store to avoid overwriting your source file.

- 3 To cancel the indexing process, click Cancel Processing.
- 4 When AutoCAD Map 3D is done creating the index file, a green check mark appears next to the file or merge group name. Do one of the following: To add the point cloud to your map, click Add to Map.
AutoCAD Map 3D adds the point cloud drawing object to your map, and adds a point cloud layer to the Display Manager.

To remove a filter from your point cloud data

- 1 In the Display Manager, right-click a point cloud layer and select Filter Point Cloud.
- 2 In the [Filter Point Cloud dialog box](#) (page 1900), in the Filter By drop-down box, select the filter type you want to remove.
- 3 Click Clear Filter.

Quick Reference

MAPPOINTCLOUDMANAGER

Creates and manages indexed point cloud data stores.

Command Line MAPPOINTCLOUDMANAGER

Dialog Box Point Cloud Manager

Entering Coordinate Geometry

Use coordinate geometry to enter accurate geometry when creating objects. For example, you can create parcel boundaries from legal documents or survey data.

To enter coordinate geometry

- [To create a point using the COGO Input dialog box](#) (page 1028)

- [To create a point using the COGO Input dialog box transparently](#) (page 1028)
- [To use COGO commands](#) (page 1029)
- [To specify a point using angle and distance](#) (page 1032)
- [To specify a point using bearing and distance](#) (page 1034)
- [To specify a point using bearings from two existing points](#) (page 1036)
- [To specify a point using a deflection angle and a distance](#) (page 1038)
- [To specify a point using distances from two existing points](#) (page 1040)
- [To specify a point using azimuth and distance](#) (page 1042)
- [To specify a point using distance and offset from a line](#) (page 1044)
- [To create an inverse report](#) (page 1046)

Overview of Coordinate Geometry Commands

Use the coordinate geometry (COGO) input commands to enter accurate geometry when creating objects. For example, you can create parcel boundaries from legal documents or survey data.

You can access COGO commands from the [COGO Input dialog box](#) (page 1668). The COGO Input dialog box is available on the ribbon as well as on the tool bar of the Task Pane Survey tab. You can also enter COGO data “transparently” (while running other commands) by entering **'mapcogo** at the command prompt.

For example, start the Polyline (PLINE) command. When prompted for the next point in the polyline, enter **'mapcogo**. The COGO Input dialog box appears. Select a COGO routine, and enter the COGO data to calculate the new point. When you finish specifying the point, the Polyline command prompts you to enter the next point. You can enter the point normally, or you can start another transparent command to specify the point.

NOTE You can still access most COGO commands transparently by typing an apostrophe (') plus the command name (AD, BB, BD, DD, DDIST, ZD). Orthogonal/Offset and Inverse Report are only available from the COGO Input dialog box.

It can be very helpful to enable node object snapping when specifying points using coordinate geometry. Node object snapping allows you to snap to point objects in the drawing window, which makes selecting points much easier. You can enable this option in the AutoCAD Drafting Settings dialog box. See the AutoCAD help for more information.

See also:

- [Using Angle and Distance to Specify a Point](#) (page 1032)
- [Using Bearing and Distance to Specify a Point](#) (page 1034)
- [Using Bearings from Two Points to Specify a Point](#) (page 1036)
- [Using Deflection and Distance to Specify a Point](#) (page 1037)
- [Using Distances from Two Points to Specify a Point](#) (page 1040)
- [Using Azimuth and Distance to Specify a Point](#) (page 1042)
- [Using Distance and Offset from a Line to Specify a Point](#) (page 1044)
- [Creating an Inverse Report](#) (page 1045)
- [Setting Coordinate Geometry Options](#) (page 233)
- [Tutorial: Working with Survey Data](#)

To create a point using the COGO Input dialog box

- 1 Click Home tab ► Draw panel ► COGO drop-down ► COGO Input.
- 2 In the [COGO Input dialog box](#) (page 1668), select the routine to use.
- 3 Enter the appropriate data in the Input section.
- 4 Click Calculate. AutoCAD Map 3D calculates the new point, and previews it on your map. Click Pan to pan to the new point.
- 5 Click Create Point.

To create a point using the COGO Input dialog box transparently

- 1 Start a command, such as PLINE.
- 2 When prompted for input, instead of specifying the input, enter 'mapcogo at the command prompt.
- 3 In the [COGO Input dialog box](#) (page 1668), select the routine you want to use.
- 4 Enter the appropriate data in the Input section.
- 5 Click Calculate. AutoCAD Map 3D calculates the new point, and previews it on your map. Click the Pan button to pan to the new point.
- 6 Click Create Point.

- 7 When the transparent command finishes, continue responding to the prompts for the original command.

To use COGO commands

To do this...	Use this method...
Use an angle and a distance from another point to create an object.	Use COGO to enter angle and distance to specify a point. (page 1032)
Use a bearing and a distance from another point to create an object.	Use COGO to enter bearing and distance to specify a point. (page 1034)
Use bearings from two points to create a point.	Use COGO to enter two bearings to specify a point. (page 1036)
Use a deflection angle and a distance from another point to create an object.	Use COGO to enter deflection angle and distance to specify a point. (page 1038)
Use distances from two points to create a point.	Use COGO to enter two distances to specify a point. (page 1040)
Use azimuth and distance from another point to create an object.	Use COGO to enter azimuth and distance to specify a point. (page 1042)
Use an offset distance from a line to create a point.	Use COGO to enter distance and offset to specify a point. (page 1044)
Generate an inverse report to determine the relationship between two points.	Use COGO to create an inverse report. (page 1045)

Quick Reference

MAPCOGO

Specifies data for coordinate geometry calculations and reports

Menu	Click Home tab ► Draw panel ► COGO Drop-down ► COGO Input.
Command Line	MAPCOGO
Dialog Box	COGO Input dialog box

AD

Specifies a point based on angle and distance from a given point

Icon



Angle/Distance

Command Line

'AD

Dialog Box

COGO Input dialog box

BB

Specifies a coordinate geometry point using two points and two bearings

Menu

Click Home tab ► Draw panel ► COGO
Drop-down ► COGO Input.

Icon



Bearing/Bearing

Command Line

'BB

Dialog Box

COGO Input dialog box

BD

Specifies a point based on bearing and distance from a given point

Menu

Click Home tab ► Draw panel ► COGO
Drop-down ► COGO Input.

Icon



Bearing/Distance

Command Line

'BD

Dialog Box

COGO Input dialog box

DD

Specifies a point based on deflection and distance from a given point

Menu

Click Home tab ► Draw panel ► COGO
Drop-down ► COGO Input.

Icon  Deflection/Distance

Command Line 'DD

Dialog Box COGO Input dialog box

DDIST

Specifies a coordinate geometry point using two points and two distances

Menu Click Home tab ► Draw panel ► COGO
Drop-down ► COGO Input.

Icon  Distance/Distance

Command Line 'DDIST

Dialog Box COGO Input dialog box

ZD

Specifies a point based on azimuth and distance from a given point

Menu Click Home tab ► Draw panel ► COGO
Drop-down ► COGO Input.

Icon  Azimuth Distance

Command Line 'ZD

Dialog Box COGO Input dialog box

MAPCGSETUP

Specifies coordinate geometry settings

Menu At the Command prompt, enter mapcgsetup.

Icon  COGO Options

Command Line MAPCGSETUP

Dialog Box Setting Coordinate Geometry Options

Using Angle and Distance to Specify a Point

When creating an object, such as a line or an arc, you can specify a point by specifying an angle and a distance from another point.

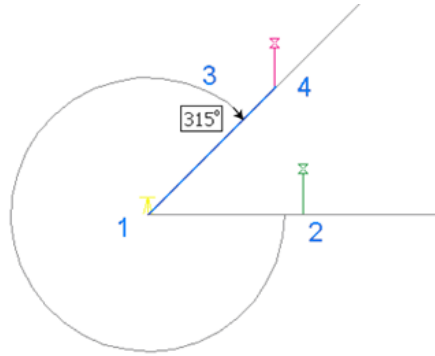



Select the line from which to measure the angle by selecting an existing line in your drawing, or by specifying a starting and ending point (1 and 2) for the line. Then specify the angle (3) and the distance from the starting point (4).

See also:

- [Overview of Coordinate Geometry Commands](#) (page 1027)

To specify a point using angle and distance

- 1 Click Home tab ► Draw panel ► COGO drop-down ► COGO Input.
 - To use the Angle/Distance routine transparently, start a command, such as PLINE or ARC, then enter **'mapcogo'**.
- 2 In the [COGO Input dialog box](#) (page 1668), select the Angle/Distance routine.
- 3 Specify the line to use to measure the angle. Click  to select the line on the map.
 - For the first point of an object, specify a starting point and ending point for the line, or select an existing line in the drawing.

- For a later point in the object, specify just the ending point for the line. The previous point of the object is the starting point of the line.
- 4 Enter the angle from the line you just specified to the line that specifies the new point. Click  to select the angle on the map.

- 5 Enter the distance from the starting point to the new point. Click  to select the distance on the map.
- 6 Click Calculate. AutoCAD Map 3D calculates the new point, and previews it on your map. Click the Pan button to pan to the new point.

NOTE If you turn on the Prompt For 3D Data Input option in the [Coordinate Geometry Setup dialog box](#) (page 1917), you can enter an elevation value in the Result section of the [COGO Input dialog box](#) (page 1668).

- 7 Click Create Point.

Quick Reference

MAPCOGO

Specifies data for coordinate geometry calculations and reports

Menu	Click Home tab ► Draw panel ► COGO Drop-down ► COGO Input.
Command Line	MAPCOGO
Dialog Box	COGO Input dialog box

AD

Specifies a point based on angle and distance from a given point

Icon	 Angle/Distance
Command Line	'AD
Dialog Box	COGO Input dialog box

Using Bearing and Distance to Specify a Point

When creating an object, such as a line or an arc, you can specify a point by specifying a bearing and a distance from another point.

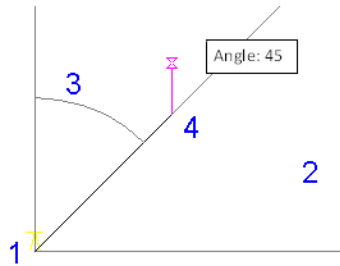



Select a starting point (1) and a quadrant (2). Then specify the bearing angle (3) and the distance from the starting point (4).

See also:

- [Overview of Coordinate Geometry Commands](#) (page 1027)

To specify a point using bearing and distance

- 1 Click Home tab ► Draw panel ► COGO drop-down ► COGO Input.
 - To use the Bearing/Distance routine transparently, start a command, such as PLINE or ARC, then enter **'mapcogo'**.
- 2 In the [COGO Input dialog box](#) (page 1668), select the Bearing/Distance routine.
- 3 For the first point of an object, specify a starting point. For a later point in the object, the previous point for the object is the starting point. Click  to select the point on the map.
- 4 Enter the quadrant (NE, SE, SW, NW). If you are entering surveyor's units, quadrant entry will be disabled.
- 5 Enter the angle. Click  to specify the angle on the map.

Use the current angular units setting, decimal values, such as 45.1111, or surveyor's units, such as N 45d3'55" E.



- 6 Enter the distance from the starting point. Click  to select the distance on the map.
- 7 Click Calculate. AutoCAD Map 3D calculates the new point, and previews it on your map. Click the Pan button to pan to the new point.

NOTE If you turn on the Prompt For 3D Data Input option in the [Coordinate Geometry Setup dialog box](#) (page 1917), you can enter an elevation value in the Result section of the [COGO Input dialog box](#) (page 1668).

- 8 Click Create Point.

Quick Reference

MAPCOGO

Specifies data for coordinate geometry calculations and reports

Menu	Click Home tab ► Draw panel ► COGO Drop-down ► COGO Input.
Command Line	MAPCOGO
Dialog Box	COGO Input dialog box

BD

Specifies a point based on bearing and distance from a given point

Menu	Click Home tab ► Draw panel ► COGO Drop-down ► COGO Input.
Icon	 Bearing/Distance
Command Line	'BD
Dialog Box	COGO Input dialog box

Using Bearings from Two Points to Specify a Point

The bearing/bearing command allows you to specify a point using the projections from two existing lines or points and two bearings. You can also enter the data in segments (point, bearing).

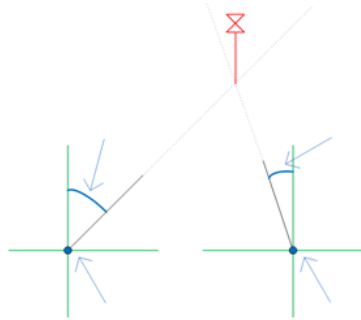

Specify the two points and bearings from those points to calculate the location of a third point.

See also:

- [Overview of Coordinate Geometry Commands](#) (page 1027)
- Tutorial: Working with Survey Data

To specify a point using bearings from two existing points

- 1 Click Home tab ► Draw panel ► COGO drop-down ► COGO Input.
 - To use the Bearing/Bearing routine transparently, start a command, such as PLINE or ARC, then enter 'mapcogo.
- 2 In the [COGO Input dialog box](#) (page 1668), select the Bearing/Bearing routine.

- 3 Enter the coordinates for the first point, or click  to select the point on the map or in the data table.

- 4 Select the quadrant for the bearing, then specify the bearing direction in degrees. Click  to specify the bearing on the map.

- 5 Repeat steps 3-5 for the second point and bearing.
- 6 Click Calculate. AutoCAD Map 3D calculates the new point, and previews it on your map. Click the Pan button to pan to the new point.

NOTE If you turn on the Prompt For 3D Data Input option in the [Coordinate Geometry Setup dialog box](#) (page 1917), you can enter an elevation value in the Result section of the [COGO Input dialog box](#) (page 1668).

- 7 Click Create Point.

Quick Reference

MAPCOGO

Specifies data for coordinate geometry calculations and reports

Menu	Click Home tab ► Draw panel ► COGO Drop-down ► COGO Input.
Command Line	MAPCOGO
Dialog Box	COGO Input dialog box

BB

Specifies a coordinate geometry point using two points and two bearings

Menu	Click Home tab ► Draw panel ► COGO Drop-down ► COGO Input.
Icon	 Bearing/Bearing
Command Line	'BB
Dialog Box	COGO Input dialog box

Using Deflection and Distance to Specify a Point

When creating an object, such as a line or an arc, you can specify a point by specifying a deflection angle and a distance from another point.

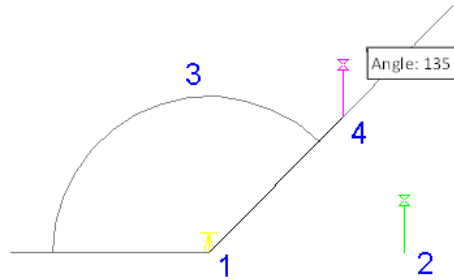



Select the line from which to measure the deflection angle by either selecting an existing line in your drawing, or by specifying a starting and ending point (1 and 2) for the line. Then specify the deflection angle (3) and the distance from the starting point (4).

See also:

- [Overview of Coordinate Geometry Commands](#) (page 1027)

To specify a point using a deflection angle and a distance

- 1 Click Home tab ► Draw panel ► COGO drop-down ► COGO Input.
 - To use the Deflection/Distance routine transparently, start a command, such as PLINE or ARC, then enter **'mapcogo'**.
- 2 In the [COGO Input dialog box](#) (page 1668), select the Deflection/Distance routine.
- 3 Specify the line to use to measure the angle. Click  to select the line on the map.
 - For the first point of an object, specify a starting point and ending point for the line, or select an existing line in the drawing.
 - For a later point in the object, specify just the ending point for the line. The previous point of the object is the starting point of the line.
- 4 Enter the deflection angle from the line you just specified to the line of  the new direction. Click  to specify the angle on the map.

Use the current angular units setting, decimal values, such as 45.1111, or surveyor's units, such as N 45d3'55" E.



- 5 Enter the distance from the starting point. Click  to select the distance on the map.
- 6 Click Calculate. AutoCAD Map 3D calculates the new point, and previews it on your map. Click the Pan button to pan to the new point.

NOTE If you turn on the Prompt For 3D Data Input option in the [Coordinate Geometry Setup dialog box](#) (page 1917), you can enter an elevation value in the Result section of the [COGO Input dialog box](#) (page 1668).

- 7 Click Create Point.

Quick Reference

MAPCOGO

Specifies data for coordinate geometry calculations and reports

Menu	Click Home tab ► Draw panel ► COGO Drop-down ► COGO Input.
Command Line	MAPCOGO
Dialog Box	COGO Input dialog box

DD

Specifies a point based on deflection and distance from a given point

Menu	Click Home tab ► Draw panel ► COGO Drop-down ► COGO Input.
Icon	 Deflection/Distance
Command Line	'DD
Dialog Box	COGO Input dialog box

Using Distances from Two Points to Specify a Point

The distance/distance command allows you to calculate a new point using two points and two distances to the new point. You can only select one of the calculated points.

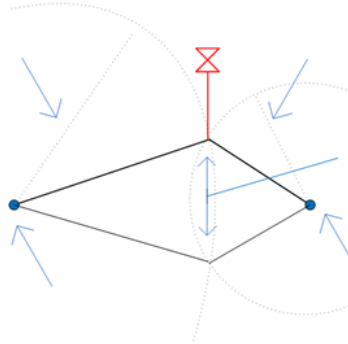



Select the first point and distance, then the second point and distance. Choose one of the two intersections to create your new point.

See also:

- [Overview of Coordinate Geometry Commands](#) (page 1027)
- [Tutorial: Working with Survey Data](#)

To specify a point using distances from two existing points

- 1 Click Home tab ► Draw panel ► COGO drop-down ► COGO Input.
 - To use the Distance/Distance routine transparently, start a command, such as PLINE or ARC, then enter **'mapcogo'**.
- 2 In the [COGO Input dialog box](#) (page 1668), select the Distance/Distance routine.
- 3 Enter the coordinates for the first point, or click  to select the point on the map or in the data table.

- 4 Select the distance from the first point. Click  to specify the distance on the map.
- 5 Repeat steps 3-5 for the second point and distance.
- 6 Click Calculate. AutoCAD Map 3D calculates the new point, and previews it on your map. Click the Pan button to pan to the new point. If there is no intersection, the Result box will be shaded, and will display “No intersection found!”

NOTE If you turn on the Prompt For 3D Data Input option in the [Coordinate Geometry Setup dialog box](#) (page 1917), you can enter an elevation value in the Result section of the [COGO Input dialog box](#) (page 1668).

- 7 Select the intersection you want, then click Create Point.

Quick Reference

MAPCOGO

Specifies data for coordinate geometry calculations and reports

Menu	Click Home tab ► Draw panel ► COGO Drop-down ► COGO Input.
Command Line	MAPCOGO
Dialog Box	COGO Input dialog box

DDIST

Specifies a coordinate geometry point using two points and two distances

Menu	Click Home tab ► Draw panel ► COGO Drop-down ► COGO Input.
Icon	 Distance/Distance
Command Line	'DDIST
Dialog Box	COGO Input dialog box

Using Azimuth and Distance to Specify a Point

When creating an object, such as a line or an arc, you can specify a point by specifying azimuth and distance from another point. Azimuth is the clockwise angle from the North (or South) meridian.

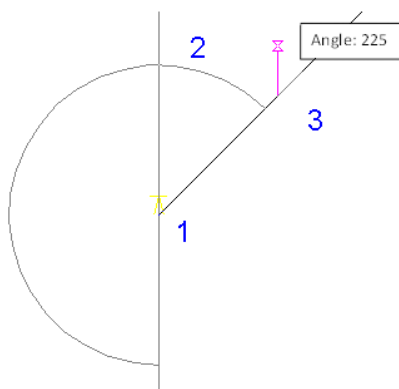

Select a starting point (1). Then specify the azimuth angle (2) and the distance from the starting point (3).

See also:

- [Overview of Coordinate Geometry Commands](#) (page 1027)

To specify a point using azimuth and distance

- 1 Click Home tab ► Draw panel ► COGO drop-down ► COGO Input.
 - To use the Azimuth/Distance routine transparently, start a command, such as PLINE or ARC, then enter **'mapcogo'**.
- 2 In the [COGO Input dialog box](#) (page 1668), select the Azimuth/Distance routine.
- 3 For the first point of an object, specify a starting point for the measurement. For a later point in the object, the previous point you

specified for the object is the starting point. Click  to select a point on the map.

- 4 Enter the azimuth, which is the clockwise angle from the North (or South)

meridian to the line of the new direction. Click  to specify the angle on the map.

Enter the angle using the current angular units setting, decimal values, such as 45.1111, or surveyor's units, such as N 45d3'55" E.

- 5 Enter the distance from the starting point to the new point. Click  to select the distance on the map.
- 6 Click Calculate. AutoCAD Map 3D calculates the new point, and previews it on your map. Click the Pan button to pan to the new point.

NOTE If you turn on the Prompt For 3D Data Input option in the [Coordinate Geometry Setup dialog box](#) (page 1917), you can enter an elevation value in the Result section of the [COGO Input dialog box](#) (page 1668).

- 7 Click Create Point.

Quick Reference

MAPCOGO

Specifies data for coordinate geometry calculations and reports

Menu	Click Home tab ► Draw panel ► COGO Drop-down ► COGO Input.
Command Line	MAPCOGO
Dialog Box	COGO Input dialog box

ZD

Specifies a point based on azimuth and distance from a given point

Menu	Click Home tab ► Draw panel ► COGO Drop-down ► COGO Input.
-------------	--

Icon	 Azimuth Distance
-------------	--

Command Line	'ZD
Dialog Box	COGO Input dialog box

Using Distance and Offset from a Line to Specify a Point

You can specify a point using distance and offset from an existing line. You select the line, enter a distance from the start point, and an offset on either side of the line. This command is called Orthogonal/Offset, and it is accessible only from the [COGO Input dialog box](#) (page 1668).

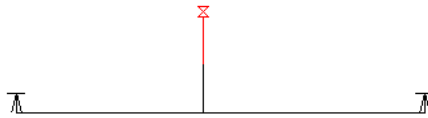

Select a line, a distance from the start point of the line, and an offset distance.

See also:

- [Overview of Coordinate Geometry Commands](#) (page 1027)

To specify a point using distance and offset from a line

The Orthogonal/Offset command does not work as a transparent command. It is only accessible from the [COGO Input dialog box](#) (page 1668).

- 1 Click Home tab ► Draw panel ► COGO drop-down ► COGO Input.
 - To use the Orthogonal/Offset routine transparently, start a command, such as PLINE or ARC, then enter **'mapcogo**.
- 2 In the [COGO Input dialog box](#) (page 1668), select the Orthogonal/Offset routine.

- 3 Enter the coordinates for the start and end points of the line, or click



to select the line on the map.

- 4 Enter the distance from the start point, or click  to specify the distance on the map.
- 5 Repeat steps 3-4 for the second point and distance.
- 6 Click Calculate. AutoCAD Map 3D calculates the new point, and previews it on your map. Click the Pan button to pan to the new point.

NOTE If you turn on the Prompt For 3D Data Input option in the [Coordinate Geometry Setup dialog box](#) (page 1917), you can enter an elevation value in the Result section of the [COGO Input dialog box](#) (page 1668).

- 7 Click Create Point.

Quick Reference

MAPCOGO

Specifies data for coordinate geometry calculations and reports

Menu	Click Home tab ► Draw panel ► COGO Drop-down ► COGO Input.
Command Line	MAPCOGO
Dialog Box	COGO Input dialog box

Creating an Inverse Report

An inverse report gives you information about the relationship between two points. The inverse report command is only accessible from the [COGO Input dialog box](#) (page 1668).

The inverse report gives you the following information about the relationship between the two points:

- Bearing

- Quadrant
- Horizontal Distance
- Vertical Distance
- Slope Distance
- Vertical Angle
- Percent Slope

See also:

- [Overview of Coordinate Geometry Commands](#) (page 1027)

To create an inverse report

- 1 Click Home tab ► Draw panel ► COGO drop-down ► COGO Input.
- 2 In the [COGO Input dialog box](#) (page 1668), select the Inverse Report routine.

- 3 Enter the coordinates for the first point, or click  to select the point on the map or in the data table.

- 4 Enter the coordinates for the second point, or click  to select the point on the map or in the data table.

- 5 View the report in the Report area of the [COGO Input dialog box](#) (page 1668).

Quick Reference

MAPCOGO

Specifies data for coordinate geometry calculations and reports

Menu	Click Home tab ► Draw panel ► COGO Drop-down ► COGO Input.
Command Line	MAPCOGO
Dialog Box	COGO Input dialog box

Working with Attribute Data and Object Data

To use attribute data and object data

- [To use the Data View](#) (page 1047)
- [To enter and edit object data](#) (page 1061)

Viewing External Data Sources for Drawing Object Data

Use the Data View to view and edit external database tables that are linked to drawing objects. If you have [joined data to geospatial features](#) (page 507), use the Data Table to view that information.

- [Overview of Viewing External Data Sources for Drawing Objects](#) (page 1048)
- [Opening a Database Table](#) (page 1052)
- [Editing a Database](#) (page 1055)
- [Changing the Look of the Data View](#) (page 1057)
- [Freezing and Hiding Data View Columns](#) (page 1059)

See also:

- [Finding Records in a Database Linked to Drawing Objects](#) (page 1221)
- [Editing Features using the Data Table](#) (page 711)

NOTE This procedure is for drawing objects only. If you have [joined data to geospatial features](#) (page 507), use the Data Table to view that information.

To use the Data View

- [To use the Data View to view and edit external database tables](#) (page 1048)
- [To open a table using the Task Pane](#) (page 1053)
- [To edit a database record that is linked to a drawing object](#) (page 1056)
- [To turn off AutoCommit](#) (page 1056)
- [To save changes manually when AutoCommit is off](#) (page 1056)
- [To change the width of a column in Data View](#) (page 1058)
- [To change the formatting of cells in a column in Data View](#) (page 1058)
- [To freeze columns in the Data View](#) (page 1059)
- [To hide columns in the Data View](#) (page 1060)

Overview of Viewing External Data Sources for Drawing Objects

Use the Data View to view and edit external database tables that are linked to drawing objects.

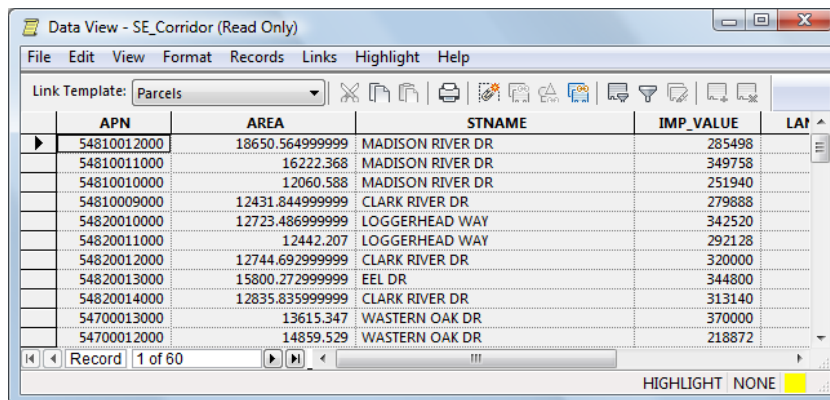

The screenshot shows a window titled "Data View - SE_Corridor (Read Only)". The window contains a table with the following columns: APN, AREA, STNAME, IMP_VALUE, and LAI. The table contains 15 rows of data. The status bar at the bottom indicates "Record 1 of 60" and "HIGHLIGHT NONE".

APN	AREA	STNAME	IMP_VALUE	LAI
54810012000	18650.564999999	MADISON RIVER DR	285498	
54810011000	16222.368	MADISON RIVER DR	349758	
54810010000	12060.588	MADISON RIVER DR	251940	
54810009000	12431.844999999	CLARK RIVER DR	279888	
54820010000	12723.486999999	LOGGERHEAD WAY	342520	
54820011000	12442.207	LOGGERHEAD WAY	292128	
54820012000	12744.692999999	CLARK RIVER DR	320000	
54820013000	15800.272999999	EEL DR	344800	
54820014000	12835.835999999	CLARK RIVER DR	313140	
54700013000	13615.347	WASTERN OAK DR	370000	
54700012000	14859.529	WASTERN OAK DR	218872	

The Data View shows records in an attached database table.

Using the Data View, you can sort and filter the records in the table. In addition, if you open the table in Edit mode, you can edit the data in the database table.

NOTE This functionality is for drawing objects only. If you have [joined data to geospatial features](#) (page 507), use the Data Table to view that information.

See also:

- [Finding Records in a Database Linked to Drawing Objects](#) (page 1221)
- [Overview of the Data Table](#) (page 1125)

NOTE This procedure is for drawing objects only. If you have [joined data to geospatial features](#) (page 507), use the Data Table to view that information.

To use the Data View to view and edit external database tables

- [To open a table using the Task Pane](#) (page 1053)
- [To edit a database record that is linked to a drawing object](#) (page 1056)
- [To find a database record in the Data View](#) (page 1225)

- [To print a database table](#) (page 1475)

Quick Reference

AutoCommit

Automatically saves database changes when the cursor leaves the record

Task Pane In Map Explorer, right-click a data source ► Auto Commit

Commit

Manually saves changes when AutoCommit is turned off

Task Pane In Map Explorer, right-click a data source ► Commit

(Data View) Append

Adds a new, blank record to the bottom of a database table

Menu In the Data View: Records ► Append

Icon  Append Record

(Data View) Find

Finds specified text

Menu In the Data View:Edit ► Find

(Data View) Format Column

Changes the formatting of cells in a column

Menu In the Data View: Format ► Column

Dialog Box Column dialog box

(Data View) Freeze Column

Freezes the selected column to the left of the Data View window

Menu In the Data View: View ► Freeze Column

(Data View) Header and Footer

Specifies header and footer for printing in the Data View

Menu In the Data View: File ► Header and Footer

Dialog Box Header/Footer dialog box

(Data View) Format Column

Changes the formatting of cells in a column

Menu In the Data View: Format ► Column

Dialog Box Column dialog box

(Data View) Page Setup

Sets the print options for Data View

Menu In the Data View: File ► Page Setup

Dialog Box Page Setup dialog box

(Data View) Print

Prints the current view of the database table

Menu In the Data View: File ► Print

Icon  Print

(Data View) Sort

Sorts records in ascending or descending order based on the selected column, or specifies a sort order based on more than one column

Menu In the Data View: View ► Sort ► Multiple Columns

(Data View) Undo

Reverses the most recent operation

Menu In the Data View:Edit ► Undo

(Data View) Unfreeze All Columns

Unfreezes all columns

Menu In the Data View: View ► Unfreeze All Columns

(Data View) Unfreeze All Columns

Unfreezes all columns

Menu In the Data View: View ► Unfreeze All Columns

MAPBROWSELINK

Opens a database table associated with a specific link template to edit in the Data View

Menu Click Map ► Database ► View Data ► Edit Linked Table.

Command Line MAPBROWSELINK

Task Pane Double-click a link template

Dialog Box Select Link Template dialog box

MAPBROWSETBL

Opens a database table to edit in the Data View

Menu Click Map ► Database ► View Data ► Edit Table.

Command Line MAPBROWSETBL

Task Pane Double-click a table

Dialog Box Select Table dialog box (MAPBROWSETBL)

MAOPTIONS

Sets AutoCAD Map 3D options

Menu Setup menu ► Autodesk Map Options

Icon  Options

Command Line MAOPTIONS

Task Pane In Map Explorer, right-click Current Drawing ► Options

Dialog Box AutoCAD Map Options dialog box

MAPRUNDBQUERY

Runs a database query and opens a database table displaying the results of the query in the Data View

Menu	Click Map ► Database ► View Data ► Execute Query.
Command Line	MAPRUNDBQUERY
Task Pane	Double-click the database query.
Dialog Box	Select Query dialog box

MAPVIEWLINK

Opens a database table associated with a specific link template to view in the Data View

Menu	Click Map ► Database ► View Data ► View Linked Table.
Command Line	MAPVIEWLINK
Task Pane	In Map Explorer, right-click a link template ► View Linked Table
Dialog Box	Select Link Template dialog box

MAPVIEWTBL

Opens a database table to view in the Data View

Menu	Click Map ► Database ► View Data ► View Table.
Command Line	MAPVIEWTBL
Task Pane	Right-click a table ► View Table
Dialog Box	Select Table dialog box (MAPBROWSETBL)

Opening a Database Table

The Data View (which displays external data linked to drawing objects) provides two modes for opening tables:

- **View mode:** You can change the way the table looks on screen by formatting columns, sorting records, or filtering records, and you can create links between the data and objects in your drawing. You cannot edit the contents of the database table.

- Edit mode: In addition to formatting the table on screen, you can edit the data in the table and add or delete records.

Database queries or views are always opened in View mode.

NOTE This functionality is for drawing objects only. If you have [joined data to geospatial features](#) (page 507), use the Data Table to view that information.

See also:

- [Viewing External Data Linked to Drawing Objects](#) (page 1146)
- [Overview of Linking Database Records to Objects](#) (page 522)
- [Creating a Link Template](#) (page 525)
- [Overview of Attaching Data Sources to Drawings](#) (page 205)

NOTE This procedure is for drawing objects only. If you have [joined data to geospatial features](#) (page 507), use the Data Table to view that information.

To open a table using the Task Pane

- To view or edit a table, double-click it in Map Explorer.
- To create or edit links to a table, double-click its link template.
- To run a query, double-click the database query name.

The table opens in either Edit mode or View mode, depending on the setting on the [Data Source](#) (page 1914) tab of the [AutoCAD Map Options dialog box](#) (page 1908). If the table is write-protected, it opens in View mode. Queries always open in View mode.

Quick Reference

MAPBROWSELINK

Opens a database table associated with a specific link template to edit in the Data View

Menu Click Map ► Database ► View Data ► Edit Linked Table.

Command Line	MAPBROWSELINK
Task Pane	Double-click a link template
Dialog Box	Select Link Template dialog box

MAPBROWSETBL

Opens a database table to edit in the Data View

Menu	Click Map ► Database ► View Data ► Edit Table.
Command Line	MAPBROWSETBL
Task Pane	Double-click a table
Dialog Box	Select Table dialog box (MAPBROWSETBL)

MAPRUNDBQUERY

Runs a database query and opens a database table displaying the results of the query in the Data View

Menu	Click Map ► Database ► View Data ► Execute Query.
Command Line	MAPRUNDBQUERY
Task Pane	Double-click the database query.
Dialog Box	Select Query dialog box

MAPVIEWLINK

Opens a database table associated with a specific link template to view in the Data View

Menu	Click Map ► Database ► View Data ► View Linked Table.
Command Line	MAPVIEWLINK
Task Pane	In Map Explorer, right-click a link template ► View Linked Table
Dialog Box	Select Link Template dialog box

MAPVIEWTBL

Opens a database table to view in the Data View

Menu	Click Map ► Database ► View Data ► View Table.
-------------	--

Command Line	MAPVIEWTBL
Task Pane	Right-click a table ► View Table
Dialog Box	Select Table dialog box (MAPBROWSETBL)

Editing a Database

Data View displays external data linked to drawing objects. You can edit a table in the Data View as you would any database table. You can add or delete records, or edit a record's values. You can also search a particular column for occurrences of a specific value.

NOTE This functionality is for drawing objects only. If you have [joined data to geospatial features](#) (page 507), use the Data Table to view that information.

To edit values in a table in Data View, you must have the proper user authorizations, and you must open the table in Edit mode. See [Opening a Database Table](#) (page 1052).

You can add records only to the end of a table. You *cannot* insert a record elsewhere in a table.

Undoing an Edit

While you are still in the record, use Undo and Redo to affect the last change you made to the current record.

WARNING Be careful when deleting records. Undo does not restore a deleted record. Your data is deleted permanently.

AutoCommit

AutoCAD Map 3D automatically saves (commits) your changes to the database as soon as your cursor leaves the record.

If you do not want edits saved automatically, turn off AutoCommit for this data source.

When AutoCommit is off, you can manually commit your changes. If you do not manually commit your changes, AutoCAD Map 3D commits the changes when you close all Data View windows for that data source or disconnect the data source.

To use Replace, you must open the table in Edit mode and turn AutoCommit off.

The AutoCommit setting applies to all tables in the selected data source.

See also:

- [Viewing External Data Linked to Drawing Objects](#) (page 1146)
- [Overview of Linking Database Records to Objects](#) (page 522)
- [Creating a Link Template](#) (page 525)
- [Overview of Attaching Data Sources to Drawings](#) (page 205)
- [Setting Up Users and Assigning Rights](#) (page 82)

NOTE This procedure is for drawing objects only. If you have [joined data to geospatial features](#) (page 507), use the Data Table to view that information.

To edit a database record that is linked to a drawing object

- 1 Open a database table in the Data View in Edit mode.
- 2 Click the data to edit.
- 3 Type the new value.

You can undo changes to the current cell. In the Data View, click Edit menu ► Undo. To undo all changes to a record, before leaving the record, choose Undo Record.

To paste text from the Windows clipboard into a cell, click in the cell where you want to paste the text. In the Data View, click Edit menu ► Paste.

WARNING You cannot use Undo Record after you move off the record you're editing.

To turn off AutoCommit

- In Map Explorer, right-click a data source. Click AutoCommit. If the command is not on the menu, you may have clicked a single table or you may have clicked the data sources node. Be sure to right-click a data source.

To save changes manually when AutoCommit is off

- In Map Explorer, right-click a data source. Click Commit.

Quick Reference

AutoCommit

Automatically saves database changes when the cursor leaves the record

Task Pane In Map Explorer, right-click a data source ► Auto Commit

Commit

Manually saves changes when AutoCommit is turned off

Task Pane In Map Explorer, right-click a data source ► Commit

(Data View) Append

Adds a new, blank record to the bottom of a database table

Menu In the Data View: Records ► Append

Icon  Append Record

(Data View) Sort

Sorts records in ascending or descending order based on the selected column, or specifies a sort order based on more than one column

Menu In the Data View: View ► Sort ► Multiple Columns

(Data View) Undo

Reverses the most recent operation

Menu In the Data View:Edit ► Undo

Changing the Look of the Data View

Data View displays external data linked to drawing objects. You can change Data View, for example, to make a column narrower to fit better on your screen or to widen a column to display all the text.

You can change the font, color, and alignment of text in the column. You can also change the width and color of the column borders.

NOTE To preserve your formatting changes, be sure the Save Format And Style Changes With Drawing option is selected on the Data Source tab of the [AutoCAD Map Options dialog box](#) (page 1908). If this option is not selected, formatting information for the table is removed from the current drawing when you close the Data View.

When you detach a data source, AutoCAD Map 3D erases Data View formatting information for all tables in that data source.

NOTE This functionality is for drawing objects only. If you have [joined data to geospatial features](#) (page 507), use the Data Table to view that information.

See also:

- [Viewing External Data Linked to Drawing Objects](#) (page 1146)
 - [Overview of Linking Database Records to Objects](#) (page 522)
 - [Creating a Link Template](#) (page 525)
 - [Overview of Attaching Data Sources to Drawings](#) (page 205)
-

NOTE This procedure is for drawing objects only. If you have [joined data to geospatial features](#) (page 507), use the Data Table to view that information.

To change the width of a column in Data View

- 1 Move the cursor to the divider line next to the title of the column.
- 2 When the cursor becomes the double arrow, click and drag the column to the desired width.

To change the formatting of cells in a column in Data View

- 1 Click the title of the column to select the column.
- 2 In the Data View, click Format menu ► Column.
- 3 In the [Column dialog box](#) (page 1676), select the font, cell colors, text colors, border, and alignment options you want.
- 4 Click OK.

Quick Reference

(Data View) Format Column

Changes the formatting of cells in a column

Menu In the Data View: Format ► Column

Dialog Box Column dialog box

Freezing and Hiding Data View Columns

You can freeze and hide columns in the Data View.

- Freeze columns to make them visible at all times. The selected columns become the left-most columns in the Data View. They are frozen in that position and do not scroll off the screen. For example, freeze the parcel owner's name to have it remain on screen as you scroll through the rest of the record.
- Hide columns that you do not want to display or print. The columns remain part of the database, and you can redisplay them at any time. For example, hide maintenance comments when you print the table.

NOTE This functionality is for drawing objects only. If you have [joined data to geospatial features](#) (page 507), use the Data Table to view that information.

See also:

- [Viewing External Data Linked to Drawing Objects](#) (page 1146)
- [Overview of Linking Database Records to Objects](#) (page 522)
- [Creating a Link Template](#) (page 525)
- [Overview of Attaching Data Sources to Drawings](#) (page 205)

NOTE This procedure is for drawing objects only. If you have [joined data to geospatial features](#) (page 507), use the Data Table to view that information.

To freeze columns in the Data View

- 1 Open the database table in the Data View.

- 2 Select one or more columns.
- 3 In the Data View, click View menu ► Freeze Column.

To release frozen columns, in the Data View, select the columns and click View menu ► Unfreeze All Columns.

To hide columns in the Data View

- 1 In the Data View, select the column header of the column that you want to hide.
- 2 Right-click the column header. Click Hide.

To redisplay all hidden columns, right-click the grid header in the Data View. Click Unhide All.

Quick Reference

(Data View) Format Column

Changes the formatting of cells in a column

Menu In the Data View: Format ► Column

Dialog Box Column dialog box

(Data View) Format Column

Changes the formatting of cells in a column

Menu In the Data View: Format ► Column

Dialog Box Column dialog box

(Data View) Unfreeze All Columns

Unfreezes all columns

Menu In the Data View: View ► Unfreeze All Columns

(Data View) Unfreeze All Columns

Unfreezes all columns

Menu In the Data View: View ► Unfreeze All Columns

Entering and Editing Object Data

To enter and edit object data

- [To attach data to an object](#) (page 1064)
- [To attach multiple records to an object](#) (page 1066)
- [To attach data to objects automatically](#) (page 1067)
- [To display and edit data for a drawing object](#) (page 1069)
- [To delete object data from a drawing object](#) (page 1069)
- [To convert object data to a linked database table](#) (page 1071)

Overview of Entering and Editing Object Data

Object data is attribute data that is attached to individual objects and stored in tables in the drawing. Object data tables store text and numerical information related to an object.

NOTE This functionality is for drawing objects only. To view attribute data for geospatial features, use the [Data Table](#) (page 711).

To use object data, first define the format for the table, and then create each record as you attach it to an object.

After you define an object data table, you can associate it with one or more drawing objects. When you attach object data to a drawing object, AutoCAD Map 3D creates a new record in the selected table and attaches the record to the object. You can create more than one record for each object, and you can attach records from more than one table to an object.

NOTE This procedure is for drawing objects only. To view attribute data for geospatial features, use the [Data Table](#) (page 711).

To do this...	Use this method...
Create an object data table.	At the Command prompt, type <code>adedef-data</code> . See Creating an Object Data Table (page 200).
Attach object data to objects	Do any of the following: <ul style="list-style-type: none">■ Attach object data manually to selected objects (page 1064) by specifying the data values for each object.

To do this...	Use this method...
	<ul style="list-style-type: none"> ■ Automatically create and attach object data (page 1066) based on existing block attributes or text. ■ Attach object data as you digitize objects (page 1082). <p>See Specifying Object Data for a Drawing Object (page 1063)</p>
View or edit object data.	Right-click the object ► Properties. See Displaying and Editing Object Data for a Drawing Object (page 1068)
Delete object data.	Click Tools tab ► Map Edit panel ► Edit  Object Data. See Displaying and Editing Object Data for a Drawing Object (page 1068)
Convert object data to a linked database table.	At the Command prompt, enter map2ase. See Converting Object Data to a Linked Database Table (page 1070)

Quick Reference

ADEATTACHDATA

Attaches object data to objects

Menu Create menu ► Attach/Detach Object Data

Icon  Attach/Detach Object Data

Command Line ADEATTACHDATA

Dialog Box Attach/Detach Object Data dialog box

ADEEDITDATA

Edits attached object data

Menu	Modify menu ► Edit Object Data
Icon	 Edit Object Data
Command Line	ADEEDITDATA
Dialog Box	Edit Object Data dialog box

ADEGENLINK

Automatically links objects to object data or external database records

Menu	In the Classic workspace, click Setup menu ► More Link Template Options ► Generate Links
Command Line	ADEGENLINK
Task Pane	In Map Explorer, right-click a link template ► Generate Links
Dialog Box	Generate Data Links dialog box

MAPOD2ASE

Converts object data tables to linked external database tables

Menu	Click Setup ► Convert Object Data to Database Links.
Command Line	MAPOD2ASE
Dialog Box	Convert Object Data to Database Links dialog box

Specifying Object Data for a Drawing Object

After you define an object data table, you can associate it with one or more drawing objects. When you attach object data to a drawing object, AutoCAD Map 3D creates a new record in the selected table and attaches the record to the object. You can create more than one record for each object, and you can attach records from more than one table to an object.

NOTE This functionality is for drawing objects only. To view attribute data for geospatial features, use the [Data Table](#) (page 711).

You can attach object data in these ways:

- [Attach object data manually to selected objects](#) (page 1064) by specifying the data values for each object.
- [Automatically create and attach object data](#) (page 1066) based on existing block attributes or text.
- [Attach object data as you digitize objects](#) (page 1082).

When you attach object data to queried objects, AutoCAD Map 3D prompts you to add the object to the save set.

See also:

- [Creating an Object Data Table](#) (page 200)
- [Running a Drawing Query in Draw Mode](#) (page 1290)

Before you attach data to objects, create the object data table and execute a Draw mode query to copy the objects into the current drawing.

NOTE You cannot attach data to geospatial features, but you can [join external data to geospatial features](#). (page 507)

To attach data to an object

- 1 Click Create tab ► Drawing Object panel ► Attach/Detach Object Data.



- 2 In the [Attach/Detach Object Data dialog box](#) (page 1794), select a table.
- 3 To change the value for a field in the table, select the data field and type a new value in the Value box. Press Enter.
- 4 To overwrite any values for this table already attached to the object, select Overwrite.
If cleared, the object will have both the old and the new values attached.
- 5 Click Attach To Objects.
- 6 Select the objects.

NOTE If you are attaching data to a polygon and plan to use the data with topology functions, be sure to attach the data to the centroid of the polygon. Topology functions do not use data attached to the polygon border.

A record with the specified values is attached to each selected object.

Quick Reference

ADEATTACHDATA

Attaches object data to objects

Menu Create menu ► Attach/Detach Object Data

Icon



Attach/Detach Object Data

Command Line ADEATTACHDATA

Dialog Box Attach/Detach Object Data dialog box

Specifying Multiple Records for an Object

By adding multiple records to the same object, you can keep track of historical information related to the object. For example, if you have a table called PipeMaintenance, with fields called Inspector, InspectionDate, and Condition, you might attach a record to a pipe object each time the pipe is inspected.

NOTE You cannot attach data to geospatial features, but you can [join external data to geospatial features](#). (page 507)

See also:

- [Creating an Object Data Table](#) (page 200)
- [Entering and Editing Object Data](#) (page 1061)

NOTE You cannot attach data to geospatial features, but you can [join external data to geospatial features](#). (page 507)

To attach multiple records to an object

- 1 Click Tools tab ► Map Edit panel ► Edit Object Data. 
- 2 Select the object to which you want to add a record.
- 3 In the [Edit Object Data dialog box](#) (page 1795), select the attached table to which you want to add a record.
- 4 Click Insert Record.
Record # changes from 1 of 1 to 2 of 2 as AutoCAD Map 3D advances to the newly created record.
- 5 For each field in the record, update the value as necessary.
Select the field in the object data field list. Enter the new value in the Value box. Press Enter. Repeat this process for each field in the record.
- 6 Click OK.

The new record is attached to the selected object.

Quick Reference

ADEEDITDATA

Edits attached object data

Menu	Modify menu ► Edit Object Data
Icon	 Edit Object Data
Command Line	ADEEDITDATA
Dialog Box	Edit Object Data dialog box

Automatically Specifying Object Data for Objects

You can automatically attach object data records to objects in a drawing. For example, you can convert block attribute data to object data and attach it to objects in one operation.

First, you must create the object data table to use for the new data. Then when you perform the Generate Links operation, AutoCAD Map 3D automatically records the existing data in the new object data table.

NOTE You cannot create links to objects on layers that are locked, frozen, or turned off.

NOTE You cannot attach data to geospatial features, but you can [join external data to geospatial features](#). (page 507)

See also:

- [Creating an Object Data Table](#) (page 200)
- [Entering and Editing Object Data](#) (page 1061)

NOTE You cannot attach data to geospatial features, but you can [join external data to geospatial features](#). (page 507)

NOTE Create the object data table before you begin this procedure.

To attach data to objects automatically

- 1 Click Map Setup tab ► Attribute Data panel ►  ► Generate Links.



- 2 In the [Generate Data Links dialog box](#) (page 1807), select a linkage type:
 - **Blocks** — Create links from block attribute data. The records are attached to the blocks themselves.
 - **Text** — Create links from text. The records are attached to the text objects.
 - **Enclosed Blocks** — Create links from block attribute data. The records are attached to the polyline that encloses the block. Blocks that are not enclosed by a polyline are not linked.
 - **Enclosed Text** — Create links from text that lies within a closed polyline. The records are attached to the closed polyline that encloses the text. Text that is not enclosed by a polyline is not linked.
- 3 Under Data Links, select Create Object Data Records.

- 4 Select a table.
If you are creating links for enclosed text, select a table that has only one field.
- 5 If you are creating links for blocks or enclosed blocks, select the name of the block.
- 6 Click OK.
- 7 Enter s to select blocks or text objects, or enter a to use all blocks with the specified name or all text objects.

Quick Reference

ADEGENLINK

Automatically links objects to object data or external database records

Menu	In the Classic workspace, click Setup menu ► More Link Template Options ► Generate Links
Command Line	ADEGENLINK
Task Pane	In Map Explorer, right-click a link template ► Generate Links
Dialog Box	Generate Data Links dialog box

Displaying and Editing Object Data for a Drawing Object

After you attach object data to a drawing object, you can edit the object data record or delete a record from an object. You must have Edit Drawing privilege to edit object data.

For information on changing user privileges, see [Setting Up Users and Assigning Rights](#) (page 82).

NOTE This functionality is for drawing objects only. To display and edit the attribute data for a geospatial feature, see [Editing Features using the Data Table](#) (page 711).

See also:

- [Creating an Object Data Table](#) (page 200)

■ [Entering and Editing Object Data](#) (page 1061)

NOTE This procedure is for drawing objects only. To display and edit the attribute data for a geospatial feature, see [Editing Features using the Data Table](#) (page 711).

To display and edit data for a drawing object

- 1 Select the object in your drawing.

TIP If the drawing contains more than one object in the same location, press Ctrl while you select the object. This turns on the AutoCAD Map 3D cycle feature, which allows you to select each object at that location, one by one, as you click. Click until you select the object you want. Press Enter.

- 2 If the Properties palette is not open, right-click the object. Click Properties.
- 3 In the Properties palette, scroll to view the object data information.
- 4 To edit data, click the data to change and enter the new data.

NOTE If the object is a member of an object class, select the Object Class tab in the Properties palette and see if the object data is listed on that tab. If it is, edit the data using the Object Class tab. This tab checks that the values you enter to make sure they meet the standards set for the object class.

To delete object data from a drawing object

- 1 Click Tools tab ► Map Edit panel ► Edit Object Data. 
- 2 Select the object in your drawing.
- 3 To delete the current record from the selected object, click Delete Record.
- 4 If the object has more than one record from the selected table, click Next or Last to view a different record. If the object has records attached from more than one table, select a table from the Table list to view object data from that table. To delete object data for a different object, click Select Object and select the object.

Quick Reference

ADEEDITDATA

Edits attached object data

Menu Modify menu ► Edit Object Data

Icon  Edit Object Data

Command Line ADEEDITDATA

Dialog Box Edit Object Data dialog box

Converting Object Data to a Linked Database Table

Object data is an efficient method for storing small amounts of attribute data that you want to associate with drawing objects, but external databases store larger amounts of data more efficiently, and allow for more complex queries.

NOTE You cannot attach data to geospatial features, but you can [join external data to geospatial features](#). (page 507)

With AutoCAD Map 3D, you can convert object data into a linked database table that has the same data structure as the object data table. For each object containing object data in the specified table, AutoCAD Map 3D does the following:

- Reads the object data
- Creates a new record in the external database table
- Attaches link data to the object that links the object to the record

When AutoCAD Map 3D converts the data, it creates a new table in an existing data source. It also creates a link template for the new table. In the link template, you can choose to use an existing field as the key field, or you can have AutoCAD Map 3D create a new field and assign a unique value to each record.

Field Names in the New Table

By default, the fields in the new database table have the same names as the fields in the object data table. AutoCAD Map 3D resolves any conflicts in the following ways:

- Truncates fields that are too long and adds an incremental digit to the resulting duplicate field names
- Replaces unsupported characters in a field name with an underscore (_)
- Converts unsupported field types to character
- Converts point fields to a character string and separates coordinates with commas

See also:

- [Creating an Object Data Table](#) (page 200)
- [Entering and Editing Object Data](#) (page 1061)
- [Overview of Attaching Data Sources to Drawings](#) (page 205)
- [Overview of Linking Database Records to Objects](#) (page 522)

NOTE You cannot attach data to geospatial features, but you can [join external data to geospatial features](#). (page 507)

This procedure creates a new table in an existing data source. Make sure that the appropriate data source is attached.

NOTE During the conversion, field names in the object data table become field names in the database table. Make sure that the field names in your object data table are not SQL reserved words such as DATE, SELECT, or CURRENT. If necessary, rename the fields in your object data table before you convert it.

To convert object data to a linked database table

- 1 At the Command prompt, enter mapod2ase.
- 2 In the [Convert Object Data to Database Links dialog box](#) (page 1680), under Source Object Data Table, select an object data table.
- 3 Select Remove Data From Objects Processed to delete the object data after creating the link.

- 4 Under Target Link Template, click Define to specify the link template.
- 5 In the [Define Link Template dialog box \(MAPOD2ASE\)](#) (page 1682), select an available data source. Click Connect.
- 6 Enter a table name.
- 7 Specify the fields to use as key fields (columns). To enter more than one field name, separate names with a comma.
To select from a list of field names in the object data table, or to rename the fields, click Select to display the Select Link Template Key(s) dialog box.
You can use an existing object data field as the key column or create a new field. If you select Generate Key Field, specify a name for the field in the Generate Key area. AutoCAD Map 3D sets the first record in the database table to 1, and increments each subsequent record by 1. Click OK to close the Select Link Template Key(s) dialog box.
- 8 In the Define Link Template dialog box, enter a name for the link template and click OK.
The link template stores the address of the database table and the name of the key field. Accept the default or enter a new unique name.
- 9 In the [Convert Object Data to Database Links dialog box](#) (page 1680), specify how to select objects with attached object data.
You can select objects automatically or manually, and you can use a filter to restrict selection to specified layers.
- 10 Click Proceed.

AutoCAD Map 3D converts the object data into linked database tables.

Quick Reference

MAPOD2ASE

Converts object data tables to linked external database tables

Menu	Click Setup ► Convert Object Data to Database Links.
Command Line	MAPOD2ASE
Dialog Box	Convert Object Data to Database Links dialog box

Digitizing Objects

To attach attribute data to objects as you digitize them, use the MAPDIGITIZE command.

- [Overview of Digitizing Maps](#) (page 1073)
- [Overview of Digitizing Objects](#) (page 1079)
- [Digitizing Using MAPDIGITIZE](#) (page 1081)
- [Attaching Object Data As You Digitize](#) (page 1082)
- [Linking Database \(SQL\) Records as You Digitize](#) (page 1084)

See also:

- [Overview of Digitizing Maps](#) (page 1073)
- [Setting Up for Digitizing](#) (page 130)
- [Cleaning Up Maps](#) (page 767)
- [Converting Data From Other Formats to Drawing Objects](#) (page 377)

To digitize objects

- [To digitize a map](#) (page 1078)
- [To digitize the objects](#) (page 1080)
- [To digitize links and nodes](#) (page 1081)
- [To attach object data as you digitize](#) (page 1083)
- [To link database records as you digitize](#) (page 1085)

Overview of Digitizing Maps

Digitizing is the process of converting paper-based graphical information into a digital format. When you digitize a map, you use drawing commands to trace data from the paper map into a DWG file.

NOTE This process creates drawing objects. To convert the drawing objects into geospatial feature data, see [Overview of Publishing and Sharing](#) (page 1357).



Road to be Digitized

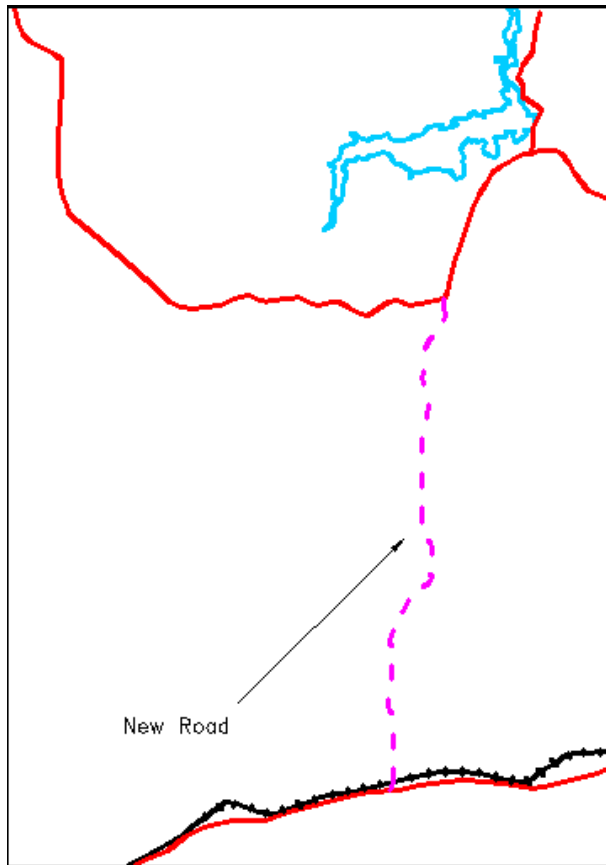

Planning for Digitizing

Before you begin to digitize, consider the following:

- Suitability of source maps
- Global coordinate system
- Tiling maps
- Layer organization
- Data storage: internal or external

- Representation of node, network, and polygon topologies

If possible, plan on completing all digitizing for one map in one session because the map media may distort over time.

Digitizing Linear Objects

Linear objects are objects such as lines, arcs, and polylines.

- If you plan to use topography later to generate 3D views from digital terrain models, place linear objects at the elevations (Z- values) they represent.
- If you use the SKETCH command to trace an irregular line, make sure the variable SKETCHINC is set to a reasonable value, because each line segment ends at the interval set by SKETCHINC. The SKETCH command can create huge files for one small line when SKETCHINC is set to a small value.
- When digitizing irregular curves with PLINE or [MAPDIGITIZE](#) (page 1081), the spacing of the selected vertex points should depend on the curvature of the line. Straighter segments require fewer points.

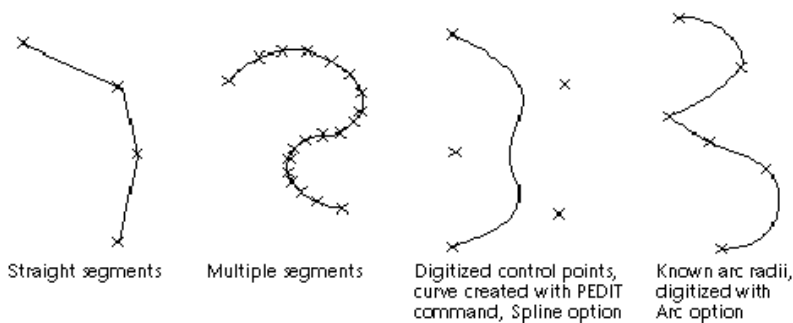

Examples of digitized curves

- However accurately you work, you lose data when you digitize a curve. You need to digitize more points when you create sharp curves to ensure that the line is as accurate as possible; however, while you reduce the data loss, you increase file size and complexity. If you know the parameters used to define a regular curve, such as the radius or length, use the Arc option of the PLINE and [MAPDIGITIZE](#) (page 1081) commands for digitizing. Irregular lines, such as topography contours, should be continuous polylines. They can be smoothed with the Fit option of PEDIT if necessary. Set the PLINAGEN system variable to 1 (on) *before* digitizing, so that any dashed linetypes are evaluated correctly.

- When you finish digitizing a segment, mark it on the paper map so you do not repeat the digitizing. Double digitizing increases file size.

Digitizing Topology

When digitizing data that will be used to create a topology, follow these principles to achieve the most accurate results.

- Boundaries (or other polylines) should be completed with the Near, Intersection, or Endpoint object snaps to ensure that closed areas such as parcels, buildings, and water bodies are in fact complete polygons.
- Line segments should be snapped to existing end points where they intersect.
- When you are digitizing data for network topology, do not duplicate objects. For example, do not double-digitize boundary lines separating adjacent polygons. It's better to digitize adjacent polygons on the same layer with common lines defining common boundaries. If one edge serves two or more purposes, digitize the line once, then use the COPY and CHPROP commands to put a duplicate line on a different layer.

After you digitize the linear elements that form the basis of the topology, you should [clean up any problems](#) (page 767) before you create the topology.

Digitizing Control Data Points and Monuments

When you are trying to match digitized maps with existing digital maps, you can use some known-to-be-accurate points common to both maps.

- Control Data Points — A system of geodetic control points covers the entire United States. The latitude and longitude, and often elevation, are established for these points. Similar systems exist for other countries, such as Bench Marks and Trigonometry Points throughout the United Kingdom.
- Monuments — If you are working with maps for a city or county, points used for establishing locations for all maps probably already exist: these points can include features such as public buildings, hill summits, and parts of highways.

When you are digitizing a map, use the following procedures to establish known control points:

- Create a layer called REFERENCE. On it, digitize at least four points corresponding to real-world coordinates such as the coordinate intersections

of latitude and longitude lines. These points should either appear at the corners of your map sheet or surround the map features to be digitized. Be careful to note on the drawing the location of these reference points and their real-world coordinates. Use these points to register the map with the TABLET command, as described in [Registering the Map](#) (page 133).

- To ensure accuracy, you can also digitize other points such as control points and monument locations that have known positions. Digitizing more control points is important for [Matching Map Edges](#) (page 950) or [Rubber Sheetting Two Maps](#) (page 932) operations.

Placing Annotation

While you are digitizing, you can add text to indicate nodes or important locations on a map. Use the STYLE command to define a text style that uses a simple font, such as *isocp.shx*, with a fixed text height so that you do not have to enter a text height each time you enter text. You can modify the text style and height when you finish digitizing.

Use the TEXT command to enter text as you digitize. Text should be single-line entries on the same layer as the feature it describes. If required, enter complex or lengthy text with the MTEXT command after you finish digitizing. For more information, look up "text" in the Help index.

Try to avoid overlaying the insertion point of the text and end points of the objects you are annotating.

See also:

- [Setting Up for Digitizing](#) (page 130)
- [Digitizing Objects](#) (page 1073)

NOTE This process creates drawing objects. To convert the drawing objects into geospatial feature data, see [Overview of Publishing and Sharing](#) (page 1357).

To digitize a map

- 1 [Set up for digitizing](#) (page 131).
- 2 [Digitize the objects](#) (page 1081).

Quick Reference

OPTIONS

Customizes the AutoCAD settings

Menu	Setup menu ► AutoCAD Options
Command Line	OPTIONS
Task Pane	Right-click in the drawing area ► Options

MAPDIGISETUP

Sets up user options for digitizing nodes and linear objects

Menu	Click Map ► Data Entry ► Digitize Setup.
Command Line	MAPDIGISETUP
Dialog Box	Digitize Setup dialog box

MAPDIGITIZE

Digitizes nodes and linear objects with settings from mapdigisetup

Menu	Click Map ► Data Entry ► Digitize.
Command Line	MAPDIGITIZE
Dialog Box	MAPDIGITIZE (Digitize command)

Overview of Digitizing Objects

To digitize objects, use one of the following methods:

- To attach attribute data as you digitize objects, use the MAPDIGITIZE command. You can also specify the label point, layer, block or linetype, rotation and scale, 2D or 3D, and snap options.
- To digitize objects without attaching attribute data or specifying other settings as you digitize, use the drawing commands.

NOTE These processes create drawing objects. To convert the drawing objects into geospatial feature data, see [Overview of Publishing and Sharing](#) (page 1357).

Digitizing Using the MAPDIGITIZE Command

Use the MAPDIGITIZE command if you want to use the special options it provides, such as attaching object data as you digitize.

NOTE Before you begin digitizing, be sure that you have configured the digitizer, registered the map, and set the digitizing specifications. See [Setting Up for Digitizing](#) (page 130).

For detailed information on digitizing linear objects, topologies, and control points, or on placing annotations, see [Overview of Digitizing Maps](#) (page 1073).

Digitizing Using Drawing Commands

You can also digitize using drawing commands. However, you should avoid commands such as CIRCLE, RECTANGLE, and 3DFACE. Instead, use ARC, LINE, and PLINE to represent map features in the simplest possible forms. This usage simplifies map cleanup.

See also:

- [Overview of Digitizing Maps](#) (page 1073)
- [Setting Up for Digitizing](#) (page 130)
- [Converting Data From Other Formats to Drawing Objects](#) (page 377)

NOTE Before you begin digitizing, be sure you have [configured your digitizer](#) (page 132) and [registered your map](#) (page 136).

To digitize the objects

- 1 Check that TABLET is enabled in the status line. If not, double-click TABLET to enable Tablet mode.
- 2 To use the MAPDIGITIZE command, [set the digitizing options](#) (page 130).
- 3 Digitize lines by starting the LINE, PLINE, or [MAPDIGITIZE](#) (page 1081) command as appropriate.
Press F12 to access menus and dialog boxes in the floating screen area you defined.
- 4 Continue to add lines and arc segments until you are done. Press Enter.

When you finish digitizing, use [Drawing Cleanup](#) (page 765) to clean the linework and fix errors.

NOTE These processes create drawing objects. To convert the drawing objects into geospatial feature data, see [Overview of Publishing and Sharing](#) (page 1357).

Quick Reference

MAPDIGITIZE

Digitizes nodes and linear objects with settings from mapdigisetaup

Menu	Click Map ► Data Entry ► Digitize.
Command Line	MAPDIGITIZE
Dialog Box	MAPDIGITIZE (Digitize command)

Digitizing Using MAPDIGITIZE

The MAPDIGITIZE command lets you attach object data or external data as you digitize.

NOTE Before you begin digitizing, be sure that you have configured the digitizer, registered the map, and set the digitizing specifications. See [Setting Up for Digitizing](#) (page 130).

Press F12 for access to the menus and any dialog boxes in the floating screen area you defined.

NOTE These processes create drawing objects. To convert the drawing objects into geospatial feature data, see [Overview of Publishing and Sharing](#) (page 1357).

See also:

- [Attaching Object Data As You Digitize](#) (page 1082)
- [Linking Database \(SQL\) Records as You Digitize](#) (page 1084)

Before you use the MAPDIGITIZE command, [set the digitizing specifications](#) (page 138).

To digitize links and nodes

- 1 On the command line, enter MAPDIGITIZE. Press Enter.

- 2 At the [MAPDIGITIZE \(Digitize command\)](#) (page 1615) prompt, specify the first point or polyline to digitize.
- 3 If you selected Attach Data in the [Digitize Setup dialog box](#) (page 1617), enter object data for the new object.
- 4 If you selected Prompt For Label Point in the [Digitize Setup dialog box](#) (page 1617), specify a label point for the new object.
- 5 If you selected Prompt For Rotation, enter the rotation in degrees for the node block. If you selected Prompt For Scale, enter the change in scale. For example, enter 90 to rotate the block 90 degrees. Enter 2 to double the size of the block.
- 6 Continue to specify points or polylines.

Data created by digitizing is not complete until you have cleaned up and verified the data. See [Overview of Cleaning Up Maps](#) (page 767).

NOTE These processes create drawing objects. To convert the drawing objects into geospatial feature data, see [Overview of Publishing and Sharing](#) (page 1357).

Quick Reference

MAPDIGITIZE

Digitizes nodes and linear objects with settings from mapdigissetup

Menu	Click Map ► Data Entry ► Digitize.
Command Line	MAPDIGITIZE
Dialog Box	MAPDIGITIZE (Digitize command)

Attaching Object Data As You Digitize

You can attach object data to nodes and links (linear objects) as you digitize them. You can specify one object data table for nodes and another for links.

See also:

- [Linking Database \(SQL\) Records as You Digitize](#) (page 1084)
- [Overview of Digitizing Maps](#) (page 1073)

Before you set up for digitizing, the object data table must already exist. See [Creating an Object Data Table](#) (page 200).

To attach object data as you digitize

- 1 On the command line, enter MAPDIGISETUP. Press Enter.
- 2 Under Object Type, select the object type to digitize.
- 3 Select Attach Data. Click Data To Attach.
- 4 In the [Data to Attach dialog box](#) (page 1616), select the object data table to use. Click OK.
- 5 For information on completing the other options in the [Digitize Setup dialog box](#) (page 1617), see [To set digitizing specifications](#) (page 138).
- 6 Click OK.
- 7 On the command line, enter MAPDIGITIZE to begin digitizing.

As you digitize each object, AutoCAD Map 3D prompts you to enter object data values for each field in the selected object data table.

Quick Reference

ADEDEFDATA

Defines object data

Menu

Setup menu ► Define Object Data

Icon



Define Object Data

Command Line

ADEDEFDATA

Dialog Box

Define Object Data dialog box

MAPDIGISETUP

Sets up user options for digitizing nodes and linear objects

Menu

Click Map ► Data Entry ► Digitize Setup.

Command Line

MAPDIGISETUP

Dialog Box

Digitize Setup dialog box

MAPDIGITIZE

Digitizes nodes and linear objects with settings from mapdigissetup

Menu Click Map ► Data Entry ► Digitize.

Command Line MAPDIGITIZE

Dialog Box MAPDIGITIZE (Digitize command)

Linking Database (SQL) Records as You Digitize

You can attach data in an external database to objects as you digitize. You can select one link template for nodes and another for links (linear objects). Before you begin this process, be sure that the link templates already exist.

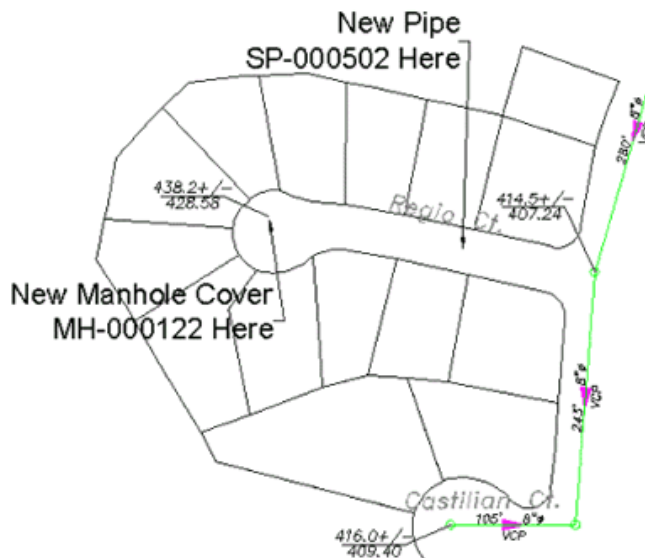

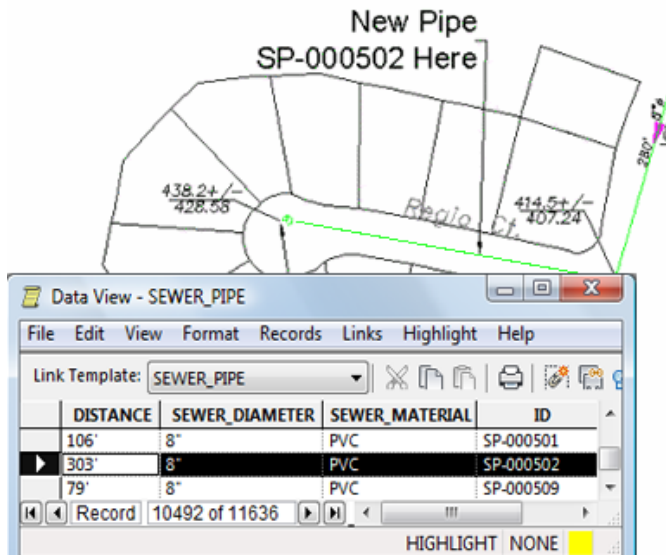

NOTE These processes create drawing objects. To convert the drawing objects into geospatial feature data, see [Overview of Publishing and Sharing](#) (page 1357).

See also:

- [Attaching Object Data As You Digitize](#) (page 1082)
- [Overview of Digitizing Maps](#) (page 1073)

To link database records as you digitize

- 1 On the command line, enter MAPDIGISETUP. Press Enter.
- 2 Under Object Type, select the object type to digitize.
- 3 Select Attach Data. Click Data To Attach.
- 4 In the [Data to Attach dialog box](#) (page 1616), under Object Data Type, select Database Link.
- 5 For Link Template, select the link template to use.
- 6 Specify a Record Validation method. Click OK.
- 7 For information on completing the other options in the [Digitize Setup dialog box](#) (page 1617), see [To set digitizing specifications](#) (page 138).

- 8 Click OK.
- 9 On the command line, enter MAPDIGITIZE to begin digitizing.

AutoCAD Map 3D prompts you for a key value for each object. The database validation option you select here determines what happens as you enter a value for each digitized object:

- **Validate** —AutoCAD Map 3D checks whether the value you enter exists in the database table. If the value exists, the link data is attached to the object; if the value does not exist, AutoCAD Map 3D requests a new value. Use this option to link each object to an existing record in the table.
- **Validate and Create** —AutoCAD Map 3D checks whether the value you enter exists in the database table. If the value exists, the link data is attached to the object; if the value does not exist, AutoCAD Map 3D creates a new record in the database table with this value in the key column, and attaches the link data to the object. Use the [Link Template Data Entry dialog box](#) (page 1619) to enter values for the other columns in the new record.
- **No Validation** —AutoCAD Map 3D attaches the link data to the object without checking that the value exists in the table. Use this option if you do not have a corresponding database record and do not want to create one at this time.

NOTE These processes create drawing objects. To convert the drawing objects into geospatial feature data, see [Overview of Publishing and Sharing](#) (page 1357).

Quick Reference

MAPDEFINELT

Defines a link template for a database table

Menu	Click Setup ► More Link Template Options ► Delete Link Template.
Icon	 Define Link Template
Command Line	MAPDEFINELT
Task Pane	In Map Explorer, right-click a data source table or query ► Define Link Template

Dialog Box Define Link Template dialog box (MAPDEFINELT)

MAPDIGISETUP

Sets up user options for digitizing nodes and linear objects

Menu Click Map ► Data Entry ► Digitize Setup.

Command Line MAPDIGISETUP

Dialog Box Digitize Setup dialog box

MAPDIGITIZE

Digitizes nodes and linear objects with settings from mapdigisetup

Menu Click Map ► Data Entry ► Digitize.

Command Line MAPDIGITIZE

Dialog Box MAPDIGITIZE (Digitize command)

Annotating Maps

7

Overview of Annotating Maps

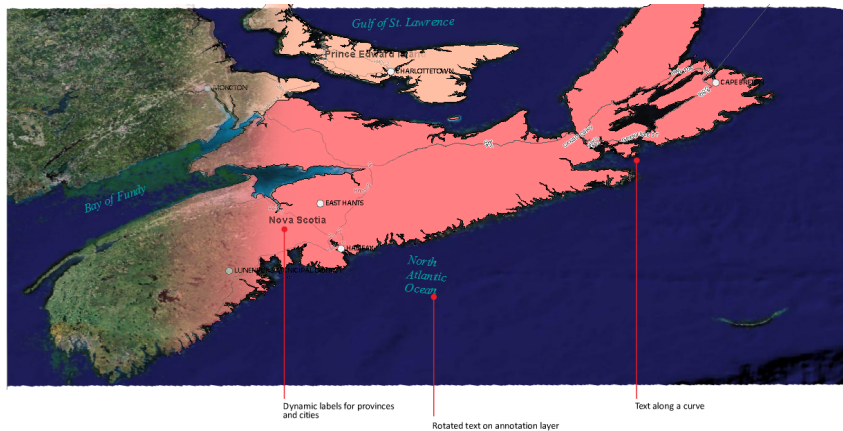

Dynamic labels and drawing object annotations are placed automatically next to each feature or drawing object on the related layer. Use Mtext or annotation layers to add text that is not linked to a feature or object.

Annotations are notes or other types of explanatory symbols or objects that are commonly used to add information to your map. The following types of annotation can be added to your map:

Annotation Type	Works with	Description	More Information
Labels	Individual Features	Displays selected properties on each feature	Adding Labels (page 1091)

Annotation Type	Works with	Description	More Information
Drawing object annotation	Drawing objects	Displays selected properties, object data, or linked data on each drawing object	Annotating Drawing Objects (page 1100)
Annotation layers	Maps with feature layers	Displays freestanding text features (not related to a specific feature) and is stored in a data table	Creating Text Layers (page 1109)
AutoCAD text objects	Any map	Displays freestanding objects (not related to a specific object) created with the TEXT and MTEXT commands	Annotating with AutoCAD Text Objects (page 1119)
Legends	Maps with feature layers	Provides a key to feature styles in your map	Adding a Legend (page 1116)

Tell me more



Video

- *Show me how to label features.*
- *Show me how to label features with automatic resizing.*
- *Show me how to place a legend in the map and specify its contents.*
- *Show me how to edit the table style for a legend.*



Procedure

- [To label features](#) (page 1093)
- [To insert annotation](#) (page 1103)
- [To create a legend](#) (page 1118)



Tutorial

- Tutorial: Annotating Your Map
- Exercise 3: Add labels
- Lesson 6: Create a Legend



Workflow

- [Style and Label a Linear Feature](#)



GIS Skill

- [Label features and optimize placement.](#)
- [Create and edit a legend.](#)



Related topics

- [Styling Features](#) (page 639)
- [Setting Up Annotation Templates](#) (page 185)

Adding Labels

Labels mark each feature in the specified Display Manager feature layer. They are defined as part of the feature layer style.

NOTE This functionality is for geospatial features only. To label drawing objects, see [Annotating Drawing Objects](#) (page 1100).

You can specify a property to display in the label. For example, you can label roads with their names. You can also use expressions in labels. For example, you can label parcels with an expression that determines the net value of the property, or use an expression to concatenate two properties, such as address and street name.

See also:

- [Theming Features](#) (page 1165)
- [Styling Features](#) (page 639)

Adding Labels to Features

Add labels to features on feature layers.

NOTE This functionality is for geospatial features only. To label drawing objects, see [Annotating Drawing Objects](#) (page 1100).

For linear features (such as roads or rivers), you can specify one of the following:

- Multiline (Specifies that the label can have multiple lines of text, but no advanced placement functionality.)
- Advanced placement (specifies a single-line label which follows a path and shrinks to fit. A single label is used for feature segments that have the same property value.)

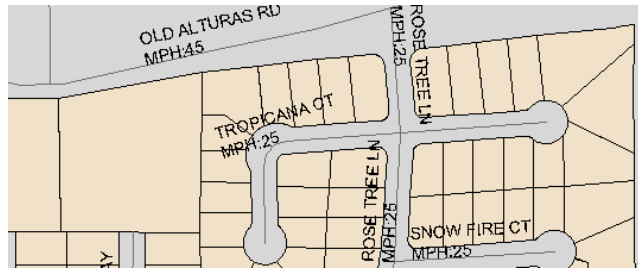

Multiline labels

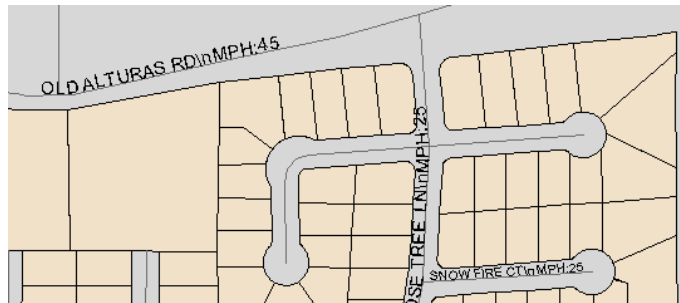

Advanced placement labels

If a feature does not have linear geometry, only multiline labels are available.

For all features, you can specify the label text, font, size, format, color, background style and color, alignment, and rotation. These settings affect the entire label. For example, if you specify a color, all lines in the label use that color.

For polyline features, you can specify horizontal and vertical label placement. For point features, you can [specify a fixed location for the label](#) (page 1098).

If a feature label obscures another label, it is not displayed. Feature labels are drawn on top of point symbols, lines, and polygons. By default, feature labels

do not obscure point symbols. You can [allow feature labels to obscure point symbols](#) (page 1096).

NOTE For performance reasons, the maximum number of labels drawn is 2000. If there are so many labels that geometry would be obscured if they were drawn, AutoCAD Map 3D does not draw them.

Tell me more



Video

- [Show me how to label features.](#)
- [Show me how to label features with automatic resizing.](#)



Procedure

- [To label features](#) (page 1093)
- [To use expressions in labels](#)



Tutorial

- [Tutorial: Annotating Your Map](#)
- [Exercise 3: Add labels](#)



Workflow

- [Style and Label a Linear Feature](#)



GIS Skill

- [Label features and optimize placement.](#)



Related topics

- [Displaying Fixed Labels at Point Locations](#) (page 1098)
- [Allowing Labels to Obscure Points](#) (page 1096)

NOTE This procedure is for geospatial features only. To label drawing objects, see [Annotating Drawing Objects](#) (page 1100).

To label features

- 1 In [Display Manager](#) (page 2060) right-click the feature layer to label.
- 2 Click Edit Style.

- 3 In the Style Editor, under Scale Ranges, select the scale range to style.
For more information about scale ranges, see [Defining Scale Ranges](#) (page 643).
- 4 In the geometry styling area for the selected scale range, click the box under Feature Label.
- 5 In the [Style Label dialog box](#) (page 1634), make sure the Create A Label check box is selected.
- 6 For linear features, select Multiline or Advanced Placement. (For all other feature geometries, these choices are grayed and Multiline is used.)
Multiline specifies that the label can have multiple lines of text, but no advanced placement functionality.
Advanced Placement specifies a single-line label which follows a path and shrinks to fit. A single label is used for linear feature segments that have the same property value.
- 7 For Property To Display, do one of the following:
 - Select a property.
 - Select Expression (at the bottom of the list) to use an expression to specify label text.

For more information, see the [Using Expressions to Label Features](#).
- 8 For Font, select a font from the list.
- 9 For Size Context, specify the type of units and then select the appropriate Units:
 - Select Device Space to specify symbol widths and heights in screen units. Available units are Points, Inches, Millimeters, Centimeters, or Meters.
 - Select Map Space to specify symbol widths and heights in Mapping Coordinate System (MCS) units. Available units are Inches, Feet, Yards, Miles, Millimeters, Centimeters, Meters, and Kilometers.
- 10 For Size, enter the text size or specify the size using a number expression.
For more information, see the [Creating Numeric Expressions](#).
- 11 To apply bold, italic, or underlining, click one or more of the Format options.
- 12 For Text Color, click a color.

- 13** From the Background Style list, select one of the following:
- **Ghosted:** Draws an opaque border around each character. Use Background Color to specify a color for the outline.
 - **Opaque:** Draws a background behind the labels. They are displayed as rectangles with text inside. Use Background Color to specify a color for the rectangles.
 - **Transparent:** No background is applied to the labels, which are displayed only as text on the map.
- 14** Specify the label's horizontal and vertical position, relative to the feature. You can select one of the available positions or select a layer property that contains alignment information for each feature. Your options depend on the type of geometry you are styling.

Geometry	Alignment Options
Points that display fixed labels instead of symbols. For more information, see Displaying Fixed Labels at Point Locations (page 1098).	Horizontal and Vertical
Other points	None
Line	Vertical only
Polygon (area)	None

- 15** For Rotation, do one of the following:
- Select a value from the list.
 - **Click Any Angle.** Specify the angle using the slider or enter an angle in the box. Click OK.
 - **Click Expression.** Specify the rotation using a numeric expression. See [Creating Numeric Expressions](#).
- 16** Click OK in the Style Label dialog box and close the Style Editor to see the results.

Allowing Labels to Obscure Points

By default, AutoCAD Map 3D does not [draw a label](#) (page 1091) if doing so would block a point symbol on another layer. The appearance of the label is evaluated each time you change the zoom level. When you zoom in far enough to allow sufficient space for the label, it is displayed.

NOTE This functionality is for geospatial features only. To label drawing objects, see [Annotating Drawing Objects](#) (page 1100).

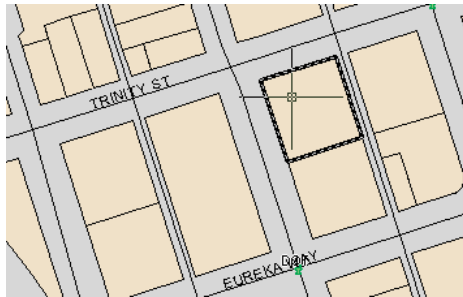

You can specify that labels for a different layer obscure points on the current layer.

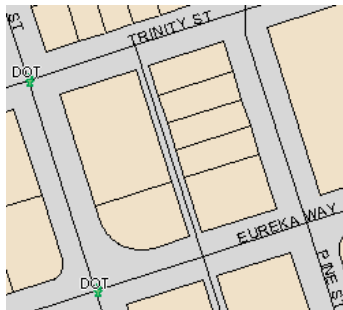

If you specify that labels cannot obscure points, AutoCAD Map 3D moves the labels out of the way.

You can specify that labels on other layers be allowed to obscure points on the selected layer, regardless of the zoom level.

Tell me more



Video

- [Show me how to label features.](#)
- [Show me how to label features with automatic resizing.](#)



Procedure

- [To allow labels to obscure points on the selected layer](#) (page 1097)
- [To use expressions in labels](#)



Tutorial

- [Tutorial: Annotating Your Map](#)
- [Exercise 3: Add labels](#)



Workflow

- [Style and Label a Linear Feature](#)



GIS Skill

- [Label features and optimize placement.](#)



Related topics

- [Displaying Fixed Labels at Point Locations](#) (page 1098)
- [Adding Labels to Features](#) (page 1091)

NOTE This procedure is for geospatial features only. To label drawing objects, see [Annotating Drawing Objects](#) (page 1100).

To allow labels to obscure points on the selected layer

- 1 In the [Display Manager](#) (page 2060), select the point layer. Click the Style button.
- 2 In the Style Editor, click Allow Other Labels To Obscure Feature Symbols On This Layer.

Displaying Fixed Labels at Point Locations

If exact placement of labels is important for a point layer, disable the point layer style and place fixed labels at feature locations.

NOTE Fixed labels are always displayed, even if they obscure other labels or features. While feature labels are drawn after all layer features have been drawn, fixed labels are drawn according to the draw order of their layer within a map, and may be obscured by features from other layers.

NOTE This functionality is for geospatial features only. To label drawing objects, see [Annotating Drawing Objects](#) (page 1100).

Tell me more



Video

- [Show me how to label features.](#)
- [Show me how to label features with automatic resizing.](#)



Procedure

- [To place fixed labels at points](#) (page 1099)
- [To use expressions in labels](#)



Tutorial

- [Tutorial: Annotating Your Map](#)
- [Exercise 3: Add labels](#)



Workflow

- [Style and Label a Linear Feature](#)



GIS Skill

- [Label features and optimize placement.](#)



Related topics

- [Defining Scale Ranges](#) (page 643)
 - [Styling Point Features](#) (page 645)
 - [Adding Labels to Features](#) (page 1091)
 - [Allowing Labels to Obscure Points](#) (page 1096)
-

NOTE This procedure is for geospatial features only. To label drawing objects, see [Annotating Drawing Objects](#) (page 1100).

To place fixed labels at points

- 1 In Display Manager, right-click the point layer to label and click Edit Style.
- 2 In the Style Editor, under Scale Ranges, select the scale range to style. For more information about scale ranges, see [Defining Scale Ranges](#) (page 643).
- 3 Select the Labels Are Fixed (Not Dynamic) check box.
- 4 In the style geometry area for the selected scale range, click the box under Style.
- 5 To remove the point symbol, at the top of the [Style Point dialog box](#) (page 1637), clear the Style a Point Symbol check box. Click OK.
- 6 In the style geometry area for the selected scale range, click the box under Feature Label.
- 7 To turn on and style the label, in the Style Label dialog box, select the Create A Label check box.
- 8 Specify the label text and style. For more information about feature labels, see [Adding Labels to Features](#) (page 1091).
- 9 Use the Horizontal Alignment and Vertical Alignment lists to specify the position of the label relative to the feature. You can select one of the available positions or select a layer property that contains alignment information for each feature. The alignment values in the property must be specified as follows:
 - Horizontal: Left, Center, or Right.
 - Vertical: Baseline, Bottom, Capline, Halfline, or Top.
- 10 Click OK and close the Style Editor to see the results.

Annotating Drawing Objects

Use annotation to label drawing objects with their properties and geometric values. If you have created [object data](#) (page 2070) for the objects, or linked [external data](#) (page 2062) to them, you can display these attributes in annotation as well.

NOTE This functionality is for drawing objects only. To label geospatial features, see [Adding Labels to Features](#) (page 1091).

See also:

- [Setting Up Annotation Templates](#) (page 185)
- [Theming Drawing Data](#) (page 1176)

NOTE This procedure is for drawing objects only. To label geospatial features, see [Adding Labels to Features](#) (page 1091).

To add and delete annotation

- [To use annotation](#) (page 1101)
- [To insert annotation](#) (page 1103)
- [To refresh annotation based on a specific template](#) (page 1105)
- [To update annotation based on a specific template](#) (page 1107)
- [To delete all annotation based on a selected annotation template](#) (page 1108)

Overview of Annotation

Use annotation to display related values on a drawing object.

NOTE This functionality is for drawing objects only. To label geospatial features, see [Adding Labels to Features](#) (page 1091).

Annotation can include the following:

Type of information	Example
Attributes	Object data or linked data in an external database
Display properties	Line weight, line type, etc.

Type of information	Example
Geometric values	Dimensions, line direction, etc.
Graphics	Arrows, static text, or other geometry

You define the contents of annotation in an [annotation template](#) (page 2055). You can specify values, link them to data sources (such as object data tables or link templates) or define them with expressions. The actual values defined by expressions are determined when the annotation is inserted.

When you add or remove elements in an annotation template, or change its properties or expressions, existing annotations based on that template do not refresh automatically. Use the [Refresh](#) (page 1105) or the [Update](#) (page 1106) command to see those changes.

See also:

- [Overview of Annotation Templates](#) (page 186)
- [Setting Up Annotation Templates](#) (page 185)

NOTE This procedure is for drawing objects only. To label geospatial features, see [Adding Labels to Features](#) (page 1091).

To use annotation

- [Define an annotation template](#) (page 190)
- [Attach annotation to objects](#) (page 1103)
- [Refresh annotation](#) (page 1105)
- [Update annotation](#) (page 1106)
- [Delete annotation from drawings](#) (page 1108)
- [Delete annotation templates](#) (page 197)

Quick Reference

MAPANDELETE

Deletes all annotation based on the selected template

Menu Setup menu ► More Annotation Options ► Delete

Icon



Delete

Command Line MAPANNDELETE

Dialog Box Annotation Delete dialog box

MAPANNINSERT

Adds annotation to objects based on the selected annotation template

Menu Create menu ► Insert Annotation

Icon



Insert Annotation

Command Line MAPANNINSERT

Dialog Box Insert Annotation dialog box

MAPANNREFRESH

Refreshes existing annotation

Menu Setup menu ► More Annotation Options ► Refresh

Icon



Refresh

Command Line MAPANNREFRESH

Dialog Box Annotation Refresh dialog box

MAPANNTEMPLATE

Defines and modifies annotation templates

Menu Click Setup ► Define Annotation Template, .

Icon



Define Annotation Template

Command Line MAPANNTEMPLATE

Dialog Box Define Annotation Template dialog box

MAPANNTEXT

Creates and edits annotation text

Icon



Edit Annotation Text

Command Line

MAPANNTEXT

Dialog Box

Annotation Text dialog box

MAPANNUPDATE

Updates existing annotation

Menu

Setup menu ► More Annotation Options ► Update

Icon



Update

Command Line

MAPANNUPDATE

Dialog Box

Annotation Update dialog box

Attaching Annotation to Objects

After you have defined an [annotation template](#) (page 2055), use the MAPANNINSERT command to attach annotation to selected objects in your drawing.

NOTE This functionality is for drawing objects only. To label geospatial features, see [Adding Labels to Features](#) (page 1091).

See also:

- [Defining Annotation Templates](#) (page 190)
- [Changing Annotation Templates](#) (page 194)

NOTE This procedure is for drawing objects only. To label geospatial features, see [Adding Labels to Features](#) (page 1091).

To insert annotation

- 1 Click Annotate tab ► Map Annotation panel ► Insert.



- 2 In the [Insert Annotation dialog box](#) (page 1574), select the check box for the [annotation template](#) (page 2055) to use.

To insert annotations based on multiple templates, select the check box for each template.

- 3 Optionally, click Advanced to change the default options and properties for the annotation.

The information from the Advanced section is applied only to the highlighted template.

NOTE If you subsequently [update](#) (page 1107) this annotation template, select the Retain option to maintain these settings.

- 4 Click Insert.
- 5 Select the objects to annotate. Press Enter.

Quick Reference

MAPANNINSERT

Adds annotation to objects based on the selected annotation template

Menu Create menu ► Insert Annotation

Icon



Insert Annotation

Command Line MAPANNINSERT

Dialog Box Insert Annotation dialog box

MAPANNTEMPLATE

Defines and modifies annotation templates

Menu Click Setup ► Define Annotation Template, Ä¶.

Icon



Define Annotation Template

Command Line MAPANNTEMPLATE

Dialog Box Define Annotation Template dialog box

Refreshing Annotation

When you change the expressions in an [annotation template](#) (page 2055), you can refresh all existing annotations using that annotation template to apply those changes. The expressions in existing annotations do not update automatically.

When you refresh the annotations, you can choose whether to update the string values only or whether to update all properties of the annotation (for example, its position and layer location).

NOTE This functionality is for drawing objects only. To label geospatial features, see [Adding Labels to Features](#) (page 1091).

See also:

- [Attaching Annotation to Objects](#) (page 1103)
- [Defining Annotation Templates](#) (page 190)
- [Changing Annotation Templates](#) (page 194)

NOTE This procedure is for drawing objects only. To label geospatial features, see [Adding Labels to Features](#) (page 1091).

To refresh annotation based on a specific template

- 1 Click Annotate tab ► Map Annotation panel ► Refresh Annotation. 
- 2 In the [Annotation Refresh dialog box](#) (page 1569), select an annotation template and click OK.

TIP You can select more than one template at a time.

- 3 On the command line, select Full Annotation or Strings Only.
 - **Strings Only** — Reevaluates only the expression-based text in the annotation, but changes nothing else.
For example, if you use the expression `.AREA` as the value of the annotation text, the annotation displays the area of the circle. If you change the diameter of the circle, and refresh the annotation with the Strings Only option, the text changes to reflect the new area of the circle.

- Full Annotation — Reevaluates any expression-based text, as well as other properties of the annotation (for example, the insertion point and the layer on which the annotation resides).
For example, if you use the expression .CENTER to specify the insertion point of the text, the annotation is displayed in the center of the circle. If you resize and move the circle, the Strings Only option changes the text to reflect the new size, but does not change the position of the text. The annotation text is longer centered in the circle. The Full Annotation option updates the text to reflect the new size and moves the annotation to the center of the relocated, resized circle.

4 Press Enter.

Quick Reference

MAPANNREFRESH

Refreshes existing annotation

Menu Setup menu ► More Annotation Options ► Refresh

Icon  Refresh

Command Line MAPANNREFRESH

Dialog Box Annotation Refresh dialog box

Updating Annotation

When you add or remove text in an [annotation template](#) (page 2055), you can update all existing annotations using that annotation template to apply those changes. The text in existing annotations does not update automatically.

The Update command completely erases and regenerates all annotation based on a specified annotation template.

When you update the annotations, you can choose whether to retain or discard any advanced settings you specified when you inserted the original annotation.

NOTE This functionality is for drawing objects only. To label geospatial features, see [Adding Labels to Features](#) (page 1091).

See also:

- [Attaching Annotation to Objects](#) (page 1103)
- [Defining Annotation Templates](#) (page 190)
- [Changing Annotation Templates](#) (page 194)

NOTE This procedure is for drawing objects only. To label geospatial features, see [Adding Labels to Features](#) (page 1091).

To update annotation based on a specific template

- 1 Click Annotate tab ► Map Annotation panel ► Update Annotation. 
- 2 In the [Annotation Update dialog box](#) (page 1571), select an [annotation template](#) (page 2055), and click OK.

TIP You can select more than one template at a time.

- 3 On the command line, choose Retain or Discard.
 - **Retain** — Regenerates all annotation that uses the selected template, maintaining any advanced settings from the original annotation. Text you added or removed in the annotation template is changed in the existing annotations, and any modifications you made to specific annotations remain.
For example, if you changed the insert point or rotation in the [Insert Annotation dialog box](#) (page 1574) when you created the annotations, the Retain option regenerates them using those overrides.
 - **Discard** — Regenerates all annotation that uses the selected template, using the default values in the template. Text you added or removed in the annotation template is changed in the existing annotations, but any overrides are lost.
For example, if you changed the insert point or rotation when you created the annotations, the Discard option regenerates the annotation using the annotation template values for these settings, instead of your overrides.
- 4 Press Enter.

Quick Reference

MAPANNUPDATE

Updates existing annotation

Menu Setup menu ► More Annotation Options ► Update

Icon  Update

Command Line MAPANNUPDATE

Dialog Box Annotation Update dialog box

Deleting Annotation from Drawings

You can delete all annotation based on a selected [annotation template](#) (page 2055).

NOTE This functionality is for drawing objects only. To label geospatial features, see [Adding Labels to Features](#) (page 1091).

See also:

- [Attaching Annotation to Objects](#) (page 1103)
- [Defining Annotation Templates](#) (page 190)
- [Changing Annotation Templates](#) (page 194)

NOTE This procedure is for drawing objects only. To label geospatial features, see [Adding Labels to Features](#) (page 1091).

To delete all annotation based on a selected annotation template

- 1 Click Annotate tab ► Map Annotation panel ► Delete Annotation. 
- 2 In the [Annotation Delete dialog box](#) (page 1569), select an [annotation template](#) (page 2055).

TIP You can select more than one template at a time.

3 Click OK.

Quick Reference

MAPANNDELETE

Deletes all annotation based on the selected template

Menu Setup menu ► More Annotation Options ► Delete

Icon  Delete

Command Line MAPANNDELETE

Dialog Box Annotation Delete dialog box

Working with Text Layers

Creating Text Layers

Text layers allow you to control the placement and appearance of text very precisely. The [labels that are generated automatically for features on the map](#) (page 1091) are placed dynamically and shift position as you zoom in and out. This is useful for maps that are intended for viewing on the web using [Autodesk MapGuide](#) (page 1376). For plotted or printed map sheets, text layers may be more appropriate.

Each text layer is its own feature class, and is stored in its own SDF file in a particular coordinate system. A single text layer can contain multiple text features. For example, you might create features that represent individual lines in a map title.

Once you add and check in text features, you can use the text again in another map. You connect to a text layer SDF file as you would to any SDF file.

You can edit existing text features to change their contents or style. Text layer style settings (which apply to the entire layer) are stored with the layer. Style overrides (which apply only to a specific text feature) are stored with that feature in the SDF file.

NOTE The text layer uses expressions to generate text features from corresponding entries in the data store (which you can view using the [Data Table](#) (page 2059)). Most users need not modify these expressions, though they offer advanced capabilities for specific uses.

Tell me more



- *Show me how to create a text layer and add text.*
- *Show me how to edit text on a text layer.*
- *Show me how to rotate text.*



- [To create a text layer](#) (page 1110)
- [To add text to a text layer](#) (page 1114)
- [To style a text layer](#) (page 1112)



- *Add a text layer and edit text*



- Tutorial: Annotating Your Map



- [Annotating with AutoCAD Text Objects](#) (page 1119)
- [Adding Labels to Features](#) (page 1091)
- [Annotating Drawing Objects](#) (page 1100)

To create a text layer

- 1 In the [Display Manager](#) (page 2060), click Data ► New Text Layer.
- 2 In the Choose Spatial Database File dialog box, provide a name and location for the SDF file that will store the layer information. Click Save.

NOTE If you specify an existing file, the new layer overwrites the existing layer.

- 3 In the Specify Coordinate System dialog box, set the coordinate system for the layer. Click OK.

The new text layer is added to the Display Manager. The default layer name is Annotation, but you can select that name and type a new one.

Quick Reference

MAPTEXTLAYERCREATE

Creates an annotation layer for freestanding text features

Command Line MAPTEXTLAYERCREATE

Task Pane In the Display Manager, click Data ► New Text Layer

Styling a Text Layer

After you have added the text layer, specify the text style. The layer style is the base style for any text features you add, but you can override the styling for any feature, or for individual characters within features.

Tell me more



Video

- [Show me how to create a text layer and add text.](#)
- [Show me how to edit text on a text layer.](#)
- [Show me how to rotate text.](#)



Procedure

- [To create a text layer](#) (page 1110)
- [To add text to a text layer](#) (page 1114)
- [To style a text layer](#) (page 1112)



GIS Skill

- [Add a text layer and edit text.](#)



Tutorial

- [Tutorial: Annotating Your Map](#)
-



Related topics

- [Annotating with AutoCAD Text Objects](#) (page 1119)
- [Adding Labels to Features](#) (page 1091)
- [Annotating Drawing Objects](#) (page 1100)

To style a text layer

1 In the [Display Manager](#) (page 2060), select the text layer.

2 Click  Style Style .

3 In the Style Editor, under Style click  .

4 In the [Style Text Layer dialog box](#) (page 1640), for Size Context, specify the type of units and then select the appropriate Units.

- Select **Device** to specify symbol widths and heights in screen units. Available units are Points, Inches, Millimeters, or Centimeters.
- Select **Map** to specify symbol widths and heights in Mapping Coordinate System (MCS) units. Available units are Inches, Feet, Miles, Millimeters, Centimeters, Meters, and Kilometers.

5 For Text Type, select one of the following:

- **Plain**—Formats text uniformly, using the settings specified in this dialog box. The text has no formatting information itself.
- **Mtext**—Formats text as multiline. The settings you specify in this dialog box are used by default, but you can override them when you insert individual text features.

The Edit Expression button lets you specify an expression for this setting for advanced use cases. We recommend that you do not use expressions for Text Type.

6 For Text, leave the "LABEL_TEXT" value unchanged.

This is the name of a property in the feature class. It specifies that the text for each text feature is whatever you specify in the [Edit Text Instance dialog box](#) (page 1627) when you create the text feature. The Delete Expression button lets you replace this expression for advanced use cases.

For more information on inserting text features, see [Adding Text to a Text Layer](#) (page 1113).

- 7 For Font Name, specify the font to use on the text layer.
The Edit Expression button lets you specify an expression for this setting for advanced use cases.
- 8 For Font Size, leave the "NullValue(SIZE,number)" expression.
The initial setting for font height is in mapping units and is based on the existing view. We recommend that you try the suggested height and adjust the number as needed. If individual instances require a different height, adjust the value in the SIZE column in the Data Table after you insert the text instances.
- 9 Specify other font styling using the drop downs.
If you select MText for Text Type, you can override some of these settings using controls in the [Edit Text Instance dialog box](#) (page 1627) when you insert the text features.
- 10 For Horizontal Alignment, Vertical Alignment, and Rotation, leave the "HORIZONTAL_ALIGNMENT", "VERTICAL_ALIGNMENT", and "ORIENTATION" expression values unchanged. These are the names of properties in the feature class.
The Delete Expression buttons let you replace the expressions for these settings for advanced use cases. If necessary, you can modify these values in the Data Table after you insert the text features.
- 11 Click OK and close the Style Editor.

Adding Text to a Text Layer

After you have [created the text layer](#) (page 1109) and [specified its style settings](#) (page 1111), you can add specific text instances.

Tell me more



Video

- *Show me how to create a text layer and add text.*
 - *Show me how to edit text on a text layer.*
 - *Show me how to rotate text.*
-



Procedure

- [To create a text layer](#) (page 1110)
- [To add text to a text layer](#) (page 1114)
- [To style a text layer](#) (page 1112)



GIS Skill

- *Add a text layer and edit text.*



Tutorial

- [Tutorial: Annotating Your Map](#)



Related topics

- [Annotating with AutoCAD Text Objects](#) (page 1119)
- [Adding Labels to Features](#) (page 1091)
- [Annotating Drawing Objects](#) (page 1100)

To add text to a text layer

- 1 In the [Display Manager](#) (page 2060), right-click the text layer. Click Create
 - Create New Annotation.
- 2 Click in the map to specify a location for the text feature.
- 3 In the [Edit Text Instance dialog box](#) (page 1627), enter the desired text.
- 4 To change the appearance of the text, select the characters to change and specify a different font, style, or size.

Style overrides to apply to this particular text instance only. If you do not specify overrides, the [style you assigned to the layer](#) (page 1112) is applied.

NOTE You cannot undo style overrides, but you can reset the attributes to match the base style.

- 5 Click OK.
- 6 Deselect the text feature to see the styling changes.
- 7 When you have finished adding text features, click Check-in Features.

Quick Reference

MAPTEXTCREATE

Adds text features to an annotation layer

Command Line	MAPTEXTCREATE
Task Pane	In the Display Manager, right-click an annotation layer, and click Create ► Create New Annotation
Dialog Box	Edit Text Instance dialog box

Editing an Instance on a Text Layer

Each text instance is a feature. Check out text features to modify them. Check in text features when you are finished editing.

Tell me more



Video

- [Show me how to create a text layer and add text.](#)
- [Show me how to edit text on a text layer.](#)
- [Show me how to rotate text.](#)



Procedure

- [To create a text layer](#) (page 1110)
- [To add text to a text layer](#) (page 1114)
- [To style a text layer](#) (page 1112)



Tutorial

- [Tutorial: Annotating Your Map](#)



GIS Skill

- [Add a text layer and edit text.](#)



Related topics

- [Annotating with AutoCAD Text Objects](#) (page 1119)
 - [Adding Labels to Features](#) (page 1091)
 - [Annotating Drawing Objects](#) (page 1100)
-

To edit a text instance

- 1 Right-click the text instance and click Edit Text Instance.
- 2 In the [Edit Text Instance dialog box](#) (page 1627), select the text to modify.
- 3 Change the text or apply different styles to the selected characters.
- 4 Click OK.

Quick Reference

MAPTEXTEDIT

Allows you to edit text features on an annotation layer





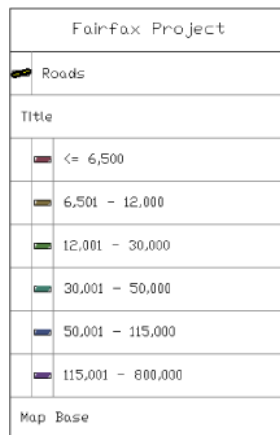

Command Line MAPTEXTCREATE

Dialog Box Edit Text Instance dialog box

Adding a Legend

A legend lists the styles in your map.



Fairfax Project	
	Roads
Title	
	<= 6,500
	6,501 - 12,000
	12,001 - 30,000
	30,001 - 50,000
	50,001 - 115,000
	115,001 - 800,000
Map Base	

The legend helps viewers understand the color-coding in a map.

The legend includes all visible layers in the Display Manager (both drawing layers and geospatial feature layers). To show the ranges for a theme, make

sure that the layer with the theme is expanded so that the ranges are visible. To ensure that a layer does not appear in the legend, clear its check box before generating the legend.

The legend is always placed in the model view. To include a legend in a layout view for plotting or publishing, create a viewport for the legend and place it at the appropriate location in your layout

Legend Style

The legend is displayed in a table. By default, legends use the Legend table style. You can modify the Legend table style, or define and apply a different table style, using the TABLESTYLE command. The Table Style Editor is the standard AutoCAD dialog box, which links to the Text Style Editor. For more information, see the AutoCAD Help.

Tell me more



Video

- [Show me how to place a legend in the map and specify its contents.](#)
- [Show me how to edit the table style for a legend.](#)



Procedure

- [To create a legend](#) (page 1118)



Tutorial

- [Lesson 6: Create a Legend](#)



Workflow

- [Use Themes to Reveal Patterns in Data](#)



GIS Skill

- [Create and edit a legend.](#)



Related topics

- [Overview of the Display Manager](#) (page 634)
- [Getting Help with AutoCAD](#) (page 58)

To create and modify the legend, do any of the following operations.

- [To create a legend](#) (page 1118)

- [To change the icon used for thumbnails](#) (page 1118)
- [To edit titles or text in the legend](#) (page 1118)
- [To edit the Legend table style](#) (page 1119)
- [To update the Legend](#) (page 1119)

To create a legend

- 1 Zoom the drawing to the desired scale threshold.
The default legend size is based on the window size when the legend is created.
- 2 In the [Display Manager](#) (page 2060), click Groups ► Draw Order.
- 3 Drag the Display Manager layers into the order in which you want them to appear in the legend.
- 4 Clear the check box for any layer that should not appear in the legend.
For example, if there are no objects on the Base Layer, clear its check box.
- 5 In Display Manager, click Tools ► Create Legend.
- 6 Click a spot in the drawing to place the legend.

To change the icon used for thumbnails

- 1 In the [Display Manager](#) (page 2060), right-click a drawing layer. Click Properties.

NOTE You can change the thumbnail for drawing layers only, not feature layers.

- 2 On the Display tab of the Properties palette, next to Thumbnail Preview, select the style of thumbnail to use.
For example, select the polyline icon to display an icon of a wavy line, or choose the polygon icon to display hatch or fill.
The thumbnail settings affect both the legend and the Display Manager.

To edit titles or text in the legend

- 1 To change the titles for layers in the legend, select the layer names in the Display Manager and enter new ones.

- 2 In the [Display Manager](#) (page 2060), click Tools ► Update Legend.
- 3 To change text in the legend itself (for example, the legend title), double-click the cell containing the text to change and enter new text.

NOTE Your changes are discarded if you update the legend again.

To edit the Legend table style

- 1 At the Command prompt, enter tablestyle.
- 2 In the Table Style dialog box, do one of the following:
 - Select the Legend style and click Modify.
 - Click New to create a table style and specify a name for the style.
- 3 In the Modify Table Style dialog box, specify the settings.

To update the Legend

- In the [Display Manager](#) (page 2060), click Tools ► Update Legend.

Quick Reference

Display Manager Legend

Creates a Display Manager legend

Task Pane In Display Manager, click Tools ► Create Legend

Annotating with AutoCAD Text Objects

You can create and modify several types of AutoCAD text objects. You can control most text style settings by defining text styles. For more information see [Overview of Creating Text](#) and [Overview of Text Styles](#).

For more information about all types of AutoCAD annotation, see [Annotate Drawings](#).

Analyzing Data

8

Overview of Analyzing Data

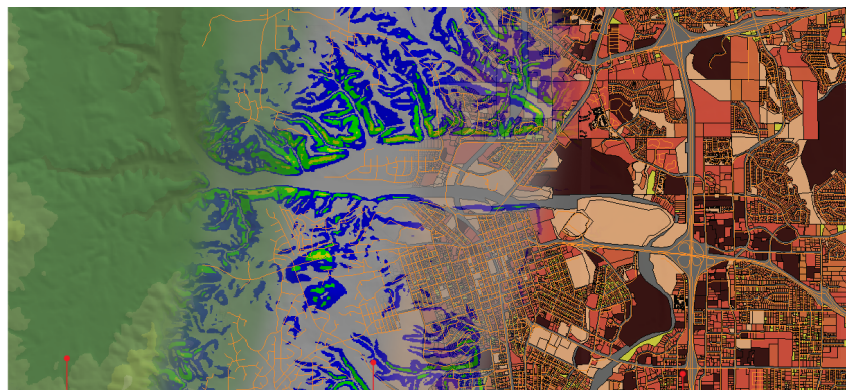

3D surface (raster format) with analysis by elevation

The same 3D surface, with analysis by slope

Parcels layer, themed by land value

This map shows some of the various types of analysis available for raster surfaces and features.

The analysis tools in AutoCAD Map 3D help turn your raw map data into useful information that can help you answer questions, support decisions, test hypotheses, and reveal patterns that may not be immediately obvious.

Tools and methods for analysis vary, depending on whether you are using drawing data or geospatial feature data.

For Drawing Objects	For Features	Description
View object properties and attributes. (page 1145) View external data linked to objects. (page 1146)	View feature source and attribute data. (page 1125) View native data and data joined to features from a separate source. (page 1134)	Drill down to get detailed information about features and objects you want to focus on.
Find, search, filter and query drawing data (page 1218)	Find and select features (page 1206) Use buffers to filter data. (page 1306)	Find the data you need. Create buffers around features based on distance and identify features within that buffer to see how areas are affected by conditions. For example, find parcels within a certain distance from planned construction, or roads close to flood plains.
Track coordinates and measure geodetic distances. (page 1147)	Track coordinates and measure geodetic distances. (page 1147)	Take real-world measurements based on coordinate geometry
Add distances, display continuous distance, display angles between points in the map, display coordinate geometry for lines and arcs, and determine slope and grade (page 1153).	Use themes to analyze height, slope, and aspect. (page 1202)	Use inquiry commands to extract geometric information from drawing objects such as lines, curves, closed polylines, and polygons. For supported raster formats, analyze surface slope, aspect, and elevation.
Theme drawing data. (page 1176)	Theme geospatial features. (page 1165)	Use themes to highlight data distribution and patterns.
Analyze topology (page 1318)	Drape 2D data onto 3D surfaces (page 1192) Add contour lines. (page 1189) Analyze features by proximity, using buffers (page 1306) Overlay feature sources (page 1309)	For drawing objects, use topology to analyze spatial relationships between drawing objects. For supported raster formats, view data in 3D for more real-world analysis, including walk-throughs and recorded anima-

For Drawing Objects	For Features	Description
		tions. Use contour lines to help you analyze terrain. Compare features that are related spatially using buffer zones and overlays.

Tell me more



Video

- *Show me how to join attribute data to features.*
- *Show me how to color surfaces based on elevation.*
- *Show me how to view and navigate in 3D.*
- *Show me how to theme a parcels layer.*
- *Show me how to create a network topology.*
- *Show me how to create a buffer zone around a parcel.*



Procedures

- [To get information about features and objects](#) (page 1125)
- [To measure and track coordinates](#) (page 1147)
- [To create themes](#) (page 1163)
- [To analyze raster-based surfaces](#) (page 1186)
- [To find, filter, and query data](#) (page 1206)
- [To analyze drawing topologies](#) (page 1319)



Tutorial

- Tutorial: Analyzing Data



- Analyze Data



- *Join attribute data to features.*
- *Color a surface by elevation and adjust hillshading.*
- *Change the elevation ranges for a surface.*
- *View a site in 3D.*
- *Drape vector and raster layers over a surface.*
- *Analyze the slope and aspect of a site.*
- *Create a network topology to show how lines are connected.*
- *Select features by location using a buffer.*



- [Styling Features](#) (page 639)

Getting Information About Features and Objects

Information about features and drawing objects can be stored within the feature or object source, as well as in an external source, such as a spreadsheet application.

For geospatial features, attribute data is part of the feature itself. Additionally, you can join external data to any feature. Using the Data Table, you can view and edit all the feature source data included in your map.

For drawing objects, you can create object tables within the drawing itself to store object attribute data. You can also link to external data using link templates. You view and edit attribute or object class data using the Properties palette or the Display Manager.

See also:

- [Joining Data to GIS Features](#) (page 507)
- [Storing Attribute Data in the Drawing \(Object Data\)](#) (page 521)

- [Overview of Linking Database Records to Objects](#) (page 522)

To get information about features and objects

- [To get information about features](#) (page 1125)
- [To get information about drawing objects](#) (page 1143)

Getting Information about Features

To get information about features

- [To access the Data Table](#) (page 1127)
- [To search to select data](#) (page 1131)
- [To create a calculated property](#) (page 1133)
- [To view data for a selected layer](#) (page 1135)
- [To view joined data](#) (page 1135)
- [To view unfiltered feature class data](#) (page 1135)
- [To view non-spatial data](#) (page 1136)
- [To highlight features using the Data Table](#) (page 1137)
- [To remove highlighting](#) (page 1138)
- [To highlight rows of data](#) (page 1139)
- [To zoom to a view](#) (page 1141)
- [To export from the Data Table](#) (page 1142)

Overview of the Data Table

Use the Data Table to access, view and edit data for multiple feature sources in a single window. The Data Table displays the data for all the features you have added to your map.

NOTE The Data Table displays attribute data for geospatial features only. To display attribute data for drawing objects, see [Overview of Drawing Object Information](#). (page 1144)

NOTE Before you can access the Data Table, you must connect to the feature sources you want to view or edit and add the data to the map.

You can isolate layers of data, sort, zoom to and edit data directly while connected to a “live” feature source, or view, attach and edit attribute data by linking to a spreadsheet application.

Some data fields are “constrained” to allow only certain values. When you enter values for constrained fields, you are prompted to enter only valid values. For example, the prompt might tell you to enter only values between 1 and 10.

You can join attribute data from a separate data source to a layer in the Data Table. You can use native and joined data to form the basis of the new, calculated field. Calculated fields are available only within AutoCAD Map 3D. They are not saved back to the original data store.

NOTE The Data Table uses your system’s default decimal separator for both display and exporting to CSV files. You can specify the default decimal separator in your Regional and Language Options in the Windows Control Panel.

Tell me more



Video

- *Show me how to make the Data Table transparent.*
- *Show me how automatic zoom works.*
- *Show me how automatic scroll works.*
- *Show me how to create a calculated field.*



Procedures

- [To access the Data Table](#) (page 1127)
- [To search to select data](#) (page 1131)
- [To view data for a selected layer](#) (page 1135)
- [To highlight features using the Data Table](#) (page 1137)
- [To create a calculated property](#) (page 1133)
- [To export from the Data Table](#) (page 1142)



Tutorial

- Lesson 5: Find and Edit Features
 - Lesson 2: Analyze Data With External Information Using Joins
-



Workflow

- [Edit Features in a Geospatial Feature Source](#)
- [Join Attribute Data to a Geospatial Feature](#)



GIS Skills

- [Zoom to features by selecting rows in the Data Table \(and vice-versa\).](#)
- [Calculate fields in the Data Table.](#)
- [Generate a report by exporting records to a spreadsheet.](#)
- [Theme based on individual values.](#)



Related topics

- [Editing Features using the Data Table \(page 711\)](#)
- [Viewing Data for a Selected Layer, Join, Unfiltered Feature Class, or Non-Spatial Data Table \(page 1134\)](#)
- [Joining Data to GIS Features \(page 507\)](#)
- [Setting Up Constraints in the Schema Editor \(page 599\)](#)
- [Creating Calculated Properties \(page 1132\)](#)

To access the Data Table

- 1 [Connect](#) (page 303) to the geospatial data to view or edit.
- 2 In the [Display Manager](#) (page 2060), select the layer whose data you want to view.
- 3 Click  .

4 The Data Table window displays the properties for the layer you selected.

To do this...	Use this method...	For more information, see...
View data for a feature in your map.	<ol style="list-style-type: none"> 1 Select a layer in Display Manager. 2 Click  . 	Viewing Data for a Selected Layer, Join, Unfiltered Feature Class, or Non-Spatial Data Table (page 1134)
View non-spatial data	<ol style="list-style-type: none"> 1 In the Data Table, click the Data menu. 2 Select the non-spatial table to view. 	Viewing Data for a Selected Layer, Join, Unfiltered Feature Class, or Non-Spatial Data Table (page 1134)
Dock the Data Table	<ol style="list-style-type: none"> 1 Right-click the Data Table title bar and select Allow Docking. 2 Drag the Data Table by its title bar to the top or bottom of the application window. 	Data Table Dialog Box (page 1613)
Make the Data Table transparent.	<ol style="list-style-type: none"> 1 Right-click the title bar of the Data Table and choose Transparency. 2 In the Transparency dialog box, adjust the transparency level and click OK. 	
Minimize the Data Table automatically when you click outside it.	Right-click the title bar of the Data Table and choose Auto-Hide.	
Find data that meets conditions that you specify.	Click Search to Select at the bottom of the Data Table.	Using Expressions to Select Feature Data (page 1130)

To do this...	Use this method...	For more information, see...
Highlight areas in your map.	In the Data Table, select the row or rows of data to highlight.	Viewing Data for a Selected Layer, Join, Unfiltered Feature Class, or Non-Spatial Data Table (page 1134)
Remove highlighting	From the Options list in the Data Table, select Select None.	Highlighting Features Using the Data Table (page 1136)
Zoom to related areas in your map.	<ol style="list-style-type: none"> 1 In the Data Table, click Auto-Zoom (unless it is already on). 2 Select the rows of data to view. 	Zooming to a View Using the Data Table (page 1140)
Edit information in the Data Table	<ol style="list-style-type: none"> 1 Select and edit cells in the Data Table. 2 Check in the feature when you are finished. 	Editing Features using the Data Table (page 711)
Export information from the Data Table.	<ol style="list-style-type: none"> 1 Select the rows of data to export. 2 From the Options list in the Data Table, select Export. 3 Specify a name and location for the exported .csv file. 	Exporting from the Data Table (page 1473)

Quick Reference

MAPDATATABLE

Allows you to view, edit, and filter feature data

Menu Click Edit ► Data Table.

Icon	 Table
Command Line	MAPDATATABLE
Task Pane	In Map Explorer or Display Manager, click the Table button
Dialog Box	Data Table Dialog Box

Using Expressions to Select Feature Data

You can use the Data Table to find geospatial feature data that meets conditions that you specify. For example, you can search for all parcels with an area greater than five acres. When AutoCAD Map 3D completes the search, it highlights the data rows in the Data Table and the associated features on your map.

NOTE The Data Table displays attribute data for geospatial features only. To display attribute data for drawing objects, see [Overview of Drawing Object Information](#). (page 1144)

NOTE To search multiple layers at one time, use Home tab ► Data panel ► Search.

Tell me more



Video

- *Show me how automatic zoom works.*
- *Show me how automatic scroll works.*



Procedures

- [To search to select data](#) (page 1131)



Tutorial

- Lesson 5: Find and Edit Features



Workflow

- Edit Features in a Geospatial Feature Source



GIS Skills

- *Zoom to features by selecting rows in the Data Table (and vice-versa).*
-



Related topics

- [Searching For and Selecting Features](#) (page 1214)
- [Viewing Data for a Selected Layer, Join, Unfiltered Feature Class, or Non-Spatial Data Table](#) (page 1134)
- [Highlighting Features Using the Data Table](#) (page 1136)
- [Highlighting Data Table Rows Using the Map](#) (page 1138)
- [Zooming to a View Using the Data Table](#) (page 1140)
- [Creating Expressions - Reference](#)

To search to select data

- 1 Select the geospatial feature layer in Display Manager that contains the data to view.
- 2 To select data based on its location in the map, zoom the drawing window to the extents of the selected feature class.
- 3 Click  on the toolbar to open the Data Table window.
- 4 Click Search to Select at the bottom of the Data Table.
- 5 Create the expression for your search:
 - **Locate On Map** — Selects all features in a location you specify. You can specify whether to select features completely within the selection area, within or crossing the selection area, or within a specified distance of the selection area. See [Filtering by Location](#). For example, use a location condition to find all manholes in one section of town, or all parcels that touch a road, or all water pipes within 100 meters of a road.
 - **Property Evaluation** — Selects all features that have the property value you specify. Insert a property, an operator, and a value. See [Evaluating Properties](#). For example, to select all pipes with a diameter greater than 10, specify `Diameter > 10`.
You can view and insert available values for a property from a list.

- 6 To create a complex property evaluation, insert an AND or OR operator, and then insert another property, operator, and value combination. Every operator must be preceded by a property. For example, to find parcels whose last purchase date is after 1990 and before 2005, the expression must look like this:

```
Purchase_Date > 1990 AND Purchase_Date < 2005
```
- 7 Validate your expression.
- 8 To reuse your expression in the future, from the Options list in the Data Table, select Save Expression.
- 9 When the expression is complete and valid, click OK. AutoCAD Map 3D highlights both the selected rows in the Data Table and the associated features on your map.

Quick Reference

MAPDATATABLE

Allows you to view, edit, and filter feature data

Menu Click Edit ► Data Table.

Icon  Table

Command Line MAPDATATABLE

Task Pane In Map Explorer or Display Manager, click the Table button

Dialog Box Data Table Dialog Box

Creating Calculated Properties

You can calculate a new property for any feature, based on its existing native properties and any joined data for that feature layer. You can use the resulting property to filter or select data. For example, you can calculate the area of parcels and then select parcels whose areas are above a certain area value.

You can store the resulting calculation as a new property in the Data Table. It will be available whenever you open the map in which you created it, but

it is not saved back to the original data store. Calculated properties are gray in the Data Table, because you cannot edit them.

NOTE The Data Table displays attribute data for geospatial features only. To display attribute data for drawing objects, see [Overview of Drawing Object Information](#). (page 1144)

There are two special calculations you can perform: finding the area of a polygon and finding the length of a linear feature (or the perimeter of a polygon feature).

Tell me more



- *Show me how to create a calculated field.*



- [To create a calculated property](#) (page 1133)



- Lesson 2: Analyze Data With External Information Using Joins



- *Calculate fields in the Data Table.*



- Creating a Calculation
 - Creating Expressions - Reference
-

To create a calculated property

- 1 In the Display Manager, right-click the feature layer for which you want to create a calculated property. Click Create A Calculation.

NOTE Once you create a calculation, this menu command changes to Manage Calculations and displays the [Manage Layer Data dialog box](#) (page 1607). In that dialog box, you can add, edit, or delete calculations.

NOTE You can also create a calculated property from within the Data Table by clicking Options ► Create A Calculation. Once you create a calculation, click Options ► Manage Calculations to add, edit, or delete calculations.

- 2 Create the calculation.



- 3 Click  on the toolbar to open the Data Table window. The column representing the calculated property appears at the far right side of the Data Table.

Quick Reference

MAPDATATABLE

Allows you to view, edit, and filter feature data

Menu Click Edit ► Data Table.

Icon  Table

Command Line MAPDATATABLE

Task Pane In Map Explorer or Display Manager, click the Table button

Dialog Box Data Table Dialog Box

Viewing Data for a Selected Layer, Join, Unfiltered Feature Class, or Non-Spatial Data Table

You can use the Data Table to view data for selected layers, joins, unfiltered feature classes, or non-spatial data tables.

NOTE The Data Table displays attribute data for geospatial features only. To display attribute data for drawing objects, see [Overview of Drawing Object Information](#). (page 1144)

See also:

- [Zooming to a View Using the Data Table](#) (page 1140).
- [Highlighting Features Using the Data Table](#) (page 1136)
- [Highlighting Data Table Rows Using the Map](#) (page 1138)

- [To view data for a selected layer](#) (page 1135)
- [To view joined data](#) (page 1135)
- [To view unfiltered feature class data](#) (page 1135)
- [To view non-spatial data](#) (page 1136)

To view data for a selected layer

- 1 Select the layer in Display Manager that contains the geospatial feature class data to display.
- 2 Click  on the toolstrip to open the Data Table window.
- 3 Select the row or rows of data to view in your map.
Specific areas of your map are highlighted based on the data you select.

To view joined data

- 1 Select the layer in Display Manager that contains the geospatial feature class data to view.
- 2 Click  to open the Data Table.
The Data Table displays the data in joined tables in read-only format: you cannot edit data in joined tables from the primary table. For more information about joins, see [Overview of Joins](#) (page 507)

To view unfiltered feature class data

- 1 Select the layer in Display Manager that contains the geospatial feature class data you want to view.
- 2 Click  to open the Data Table window.
- 3 From the Data drop-down list, select the Feature Class data source.

Selecting the Feature Class data source displays all records, including any that are not associated with feature attributes. The selection and highlighting options are not available when viewing this table.

To view non-spatial data

- 1 On the top toolbar, click  to open the Data Table window.
- 2 In the Data drop-down list, select the non-spatial table you want to view. The Data drop-down list will display all non-spatial data for a given connected data source.

Quick Reference

MAPDATATABLE

Allows you to view, edit, and filter feature data

Menu	Click Edit ► Data Table.
Icon	 Table
Command Line	MAPDATATABLE
Task Pane	In Map Explorer or Display Manager, click the Table button
Dialog Box	Data Table Dialog Box

Highlighting Features Using the Data Table

You can select specific features in the Data Table and highlight them automatically in your map. For example, you can select the Data Table rows that represent parcels on one or two streets to see those parcels highlighted in the map. If Auto-Zoom is on, the map will also zoom to the extents of the selected features.

NOTE The Data Table displays attribute data for geospatial features only. To display attribute data for drawing objects, see [Overview of Drawing Object Information](#). (page 1144)

Tell me more



Video

- [Show me how automatic zoom works.](#)
- [Show me how automatic scroll works.](#)



Procedures

- [To highlight features using the Data Table](#) (page 1137)



Tutorial

- [Lesson 5: Find and Edit Features](#)



Workflow

- [Edit Features in a Geospatial Feature Source](#)



GIS Skills

- [Zoom to features by selecting rows in the Data Table \(and vice-versa\).](#)



Related topics

- [Searching For and Selecting Features](#) (page 1214)
- [Highlighting Data Table Rows Using the Map](#) (page 1138)
- [Zooming to a View Using the Data Table](#) (page 1140)
- [Viewing Data for a Selected Layer, Join, Unfiltered Feature Class, or Non-Spatial Data Table](#) (page 1134)

To highlight features using the Data Table

- 1 In Display Manager, select the layer containing the geospatial feature set to view.
- 2 Click  to open the Data Table window.
- 3 Select a row or rows of data to highlight the corresponding features in your map.

To remove highlighting

- From the Options list in the Data Table, select Select None.
The highlighting is removed from the Data Table and your map.

Quick Reference

MAPDATATABLE

Allows you to view, edit, and filter feature data

Menu	Click Edit ► Data Table.
Icon	 Table
Command Line	MAPDATATABLE
Task Pane	In Map Explorer or Display Manager, click the Table button
Dialog Box	Data Table Dialog Box

Highlighting Data Table Rows Using the Map

You can select features in your map to highlight the corresponding rows of data in the Data Table.

NOTE The Data Table displays attribute data for geospatial features only. To display attribute data for drawing objects, see [Overview of Drawing Object Information](#). (page 1144)

Tell me more



- [Show me how automatic zoom works.](#)
- [Show me how automatic scroll works.](#)



- [To highlight rows of data](#) (page 1139)



- [Lesson 5: Find and Edit Features](#)
-



Workflow

- [Edit Features in a Geospatial Feature Source](#)



GIS Skills

- [Zoom to features by selecting rows in the Data Table \(and vice-versa\).](#)



Related topics

- [Searching For and Selecting Features](#) (page 1214)
- [Highlighting Data Table Rows Using the Map](#) (page 1138)
- [Highlighting Features Using the Data Table](#) (page 1136)
- [Zooming to a View Using the Data Table](#) (page 1140)
- [Viewing Data for a Selected Layer, Join, Unfiltered Feature Class, or Non-Spatial Data Table](#) (page 1134)

To highlight rows of data

- 1 In Display Manager, select the layer containing the geospatial feature set to view.
- 2 Click  to open the Data Table window.
- 3 Click Auto-Scroll (if it is not already on) to turn on the automatic scroll feature in the Data Table.
- 4 Select any area or feature in your map.

The Data Table scrolls and highlights the corresponding rows of data.

Quick Reference

MAPDATATABLE

Allows you to view, edit, and filter feature data

Menu

Click Edit ► Data Table.

Icon	 Table
Command Line	MAPDATATABLE
Task Pane	In Map Explorer or Display Manager, click the Table button
Dialog Box	Data Table Dialog Box

Zooming to a View Using the Data Table

You can select rows of data in the Data Table to zoom in directly to data in your map.

NOTE The Data Table displays attribute data for geospatial features only. To display attribute data for drawing objects, see [Overview of Drawing Object Information](#). (page 1144)

Tell me more



Video

- [Show me how automatic zoom works.](#)
- [Show me how automatic scroll works.](#)



Procedures

- [To zoom to a view](#) (page 1141)



Tutorial

- [Lesson 5: Find and Edit Features](#)



Workflow

- [Edit Features in a Geospatial Feature Source](#)



GIS Skills

- [Zoom to features by selecting rows in the Data Table \(and vice-versa\).](#)



Related topics

- [Searching For and Selecting Features](#) (page 1214)
- [Highlighting Features Using the Data Table](#) (page 1136)

- [Highlighting Data Table Rows Using the Map](#) (page 1138)
- [Viewing Data for a Selected Layer, Join, Unfiltered Feature Class, or Non-Spatial Data Table](#) (page 1134)

To zoom to a view

- 1 In Display Manager, select the layer containing the geospatial feature set to view.
- 2 Click  to open the Data Table window.
- 3 In the Data Table, click Auto-Zoom (unless it is already on).
- 4 Select the rows of data to view. AutoCAD Map 3D automatically zooms to the corresponding data.

Quick Reference

MAPDATATABLE

Allows you to view, edit, and filter feature data

Menu	Click Edit ► Data Table.
Icon	 Table
Command Line	MAPDATATABLE
Task Pane	In Map Explorer or Display Manager, click the Table button
Dialog Box	Data Table Dialog Box

Exporting Data from the Data Table

You can export the data in the Data Table to a .csv (comma-separated text file) that can be opened in most spreadsheet applications.

NOTE The Data Table displays attribute data for geospatial features only. To display attribute data for drawing objects, see [Overview of Drawing Object Information](#). (page 1144)

Tell me more



Video

- *Show me how to export records for selected features.*



Procedure

- [To export from the Data Table](#) (page 1142)



Tutorial

- Exercise 5: Export the data to CSV for use in a report



GIS Skills

- *Generate a report by exporting records to a spreadsheet.*



Related topics

- [Editing Features using the Data Table](#) (page 711)
- [Overview of the Data Table](#) (page 1125)
- [Exporting and Printing Attribute Data](#) (page 1472).

To export from the Data Table

- 1 In the Data Table, select the rows of data to export.
- 2 From the Options list in the Data Table, select Export.
- 3 Save the .csv file to the specified name and folder.

Quick Reference

MAPDATATABLE

Allows you to view, edit, and filter feature data

Menu	Click Edit ► Data Table.
Icon	 Table
Command Line	MAPDATATABLE
Task Pane	In Map Explorer or Display Manager, click the Table button
Dialog Box	Data Table Dialog Box

Getting Information About Drawing Objects

You can store information about drawing objects in object data tables or in linked external sources.

NOTE Object data and linked external sources are available for drawing objects only. For information about storing information for geospatial features, see [Overview of the Data Table](#) (page 1125).

See also:

- [Storing Attribute Data in the Drawing \(Object Data\)](#) (page 521)
- [Overview of Linking Database Records to Objects](#) (page 522)

To get information about drawing objects

- [To view properties and attributes for a drawing object](#) (page 1146)
- [To view external data linked to drawing objects](#) (page 1147)

Overview of Drawing Object Information

You can associate drawing objects with properties and attributes contained in your map, as well as data contained in common spreadsheet application databases. Within your map, you can view and edit this data.

NOTE Object data and linked external sources are available for drawing objects only. For information about storing information for geospatial features, see [Overview of the Data Table](#) (page 1125).

You can get information about drawing objects in the following ways.

To do this...	Use this method...	For more information, see...
View and edit object data	<ol style="list-style-type: none">1 Right-click a drawing object in the map.2 Click Properties.	Displaying and Editing Object Data for a Drawing Object (page 1068)
View and edit object class data.	<ol style="list-style-type: none">1 Right-click a classified drawing object in the map.2 Click Properties.3 Click the Object Class tab.	Editing Object Class Data (page 991)
Edit external data linked to drawing objects	<ol style="list-style-type: none">1 Open a database table in the Data View.2 Click the data to edit.3 Enter the new value.	Editing a Database (page 1055)
Find data in the Data View.	<ol style="list-style-type: none">1 Open a database table in the Data View.2 Position the cursor in the column to search.3 In the Data View window, click Edit menu ► Find.4 Enter the characters to find.5 Click Find Next.	Finding Records in a Database Linked to Drawing Objects (page 1221)
Highlight drawing objects in your map that are linked to a database record.	<ol style="list-style-type: none">1 Open a linked database table in the Data View.2 In the Data View window, select a record.	Highlighting Drawing Objects Linked to a Database Record (page 1225)

To do this...	Use this method...	For more information, see...
	<ol style="list-style-type: none"> In the Data View, click Highlight menu ► Highlight Objects. 	
Remove highlighting	At the Command prompt, enter regen.	Highlighting Drawing Objects Linked to a Database Record (page 1225)
Highlight records linked to a selected drawing object	<ol style="list-style-type: none"> Open a linked database table in the Data View. In the Data View, click Highlight menu ► Highlight Records ► Select Object. Select the objects in your drawing. Press Enter. 	Highlighting Records Linked to a Selected Object (page 1228)
Print information from the Data View.	<ol style="list-style-type: none"> In the Data View, specify print options, header, footer, or filters. In the Data View, click File menu ► Print. Click OK. 	Printing from the Data View (page 1474)

Viewing Properties and Attributes of Drawing Objects

View object data and object class data for drawing objects in the Properties palette.

NOTE Object data is available for drawing objects only. To view information for geospatial features, see [Overview of the Data Table](#) (page 1125).

See also:

- [Entering and Editing Object Data](#) (page 1061)

- [Editing Object Class Data](#) (page 991)

To view properties and attributes for a drawing object

- Right-click an object and click Properties.
The Properties palette opens showing all the information contained in the object data of your drawing layer.

NOTE Object data is available for drawing objects only. To view information for geospatial features, see [Overview of the Data Table](#) (page 1125).

Quick Reference

PROPERTIES

Displays the Properties palette, which allows you to edit the properties of objects

Menu Analyze ► Properties

Icon  Properties

Command Line PROPERTIES

Task Pane Select object. Right-click in drawing area ► Properties

Viewing External Data Linked to Drawing Objects

You can view the external data contained in your map by linking to an external database, usually a common spreadsheet application.

NOTE Linked external data is available for drawing objects only. To link geospatial features to external data sources, see [Overview of Joins](#) (page 507).

See also:

- [Overview of Linking Database Records to Objects](#) (page 522)
- [Viewing External Data Sources for Drawing Object Data](#) (page 1047)

To view external data linked to drawing objects

- 1 In [Map Explorer](#) (page 2068), expand Link Templates and right-click a link template.
- 2 Click View Linked Table.
The Data View window opens.
- 3 Click the Highlight Linked Objects icon. 
- 4 In your map, select the objects whose data you want to view and press Enter.
The Data View window reappears. The records that are linked to the selected objects are highlighted.
- 5 Use the navigation buttons to move between highlighted records.



Quick Reference

(Data View) Highlight Objects

Highlights objects linked to the selected records

Menu In the Data View: Highlight ► Highlight Objects

Icon  Highlight Objects

Measuring and Tracking Coordinates

To measure and track coordinates

- [To track coordinates](#) (page 1150)
- [To add a coordinate tracker to the Track Coordinates pane](#) (page 1150)
- [The new coordinate tracker displays the code and description of the coordinate system you selected.](#) (page 1151)
- [To create a feature using the coordinate tracker](#) (page 1151)
- [To measure geodetic distance](#) (page 1153)
- [To measure coordinate geometry](#) (page 1154)

Overview of Measuring and Tracking

Once you have assigned coordinate systems to your map, you can locate specific coordinate points and measure the geodetic distance between points. For example, you can determine the coordinates of a maintenance hole or the centerline of a new road.

For drawing objects in your map, there are additional coordinate geometry commands you can use to do the following:

- Add the distances between multiple points
- Determine the total distance between a series of points
- Display angle information for points or intersecting lines
- Display coordinate geometry for lines and arcs
- Determine the slope, grade, and horizontal distance between two points

In addition, you can use AutoCAD commands, such as DIST, AREA, PROPERTIES, and PERIMETER, to obtain information about drawing objects, which can help you do useful calculations. For more information, refer to the AutoCAD Help.

See also:

- [Overview of Coordinate Systems](#) (page 143)
- [Assigning a Coordinate System to the Current Drawing](#) (page 147)
- [Theming Surfaces to Analyze Height, Slope, and Aspect](#) (page 1202)

Use the following methods to measure and track coordinates.

For all map objects	For drawing objects only	Description
Tracking Coordinates (page 1149)		As you move the cursor around in a drawing window, display the cursor location in a specific coordinate system.
Measuring Geodetic Distance (page 1152)		Measure the geodetic distance (which takes into account the curvature of the Earth) between points in your map.

For all map objects	For drawing objects only	Description
	Adding Distances (page 1156)	Calculate the total of several disjunct distances between points in your map.
	Displaying Continuous Distance (page 1158)	Add and display the distance between one point and several other points, or between a series of points. in a drawing.
	Displaying Angle Information (page 1160)	Display the acute and obtuse angle between points or intersecting lines.
	Displaying COGO Information for Lines and Arcs (page 1161)	Display coordinate geometry for lines and arcs, including line and curve details, area, and coordinates.
	Displaying Slope (page 1161)	Display the slope, grade, and horizontal distance between two points.

Tracking Coordinates

As you move the cursor around in a drawing window, you can display the cursor location in the coordinate systems you choose.

For example, if an attached drawing uses one coordinate system and the current drawing uses another, you can track the source drawing's coordinates as you move the cursor around in the current drawing. You can track multiple coordinate systems in the Track Coordinates pane.

The coordinate tracker automatically converts coordinate data from the coordinate system of the map to any coordinate system you select. If you move your cursor outside the extents of the converted coordinate system, you will see null values in the tracker. However, if you are tracking coordinates using the same coordinate system as your map, the tracker will continue to display coordinates even beyond the boundaries of the coordinate system. Because you are tracking coordinates in the same coordinate system as the map, no conversion is performed, and AutoCAD Map 3D will always return coordinate values.

You can also use the coordinate tracker to create features using the Digitize button.

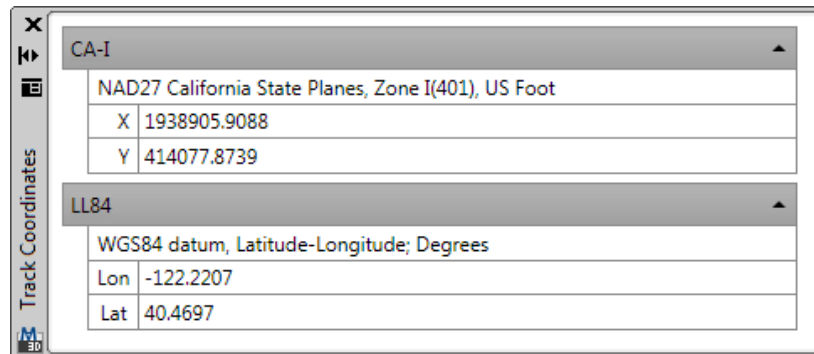

Track Coordinates pane

See also:

- [Overview of Coordinate Systems](#) (page 143)
- [Attaching Drawings](#) (page 154)
- [Setting Coordinate Tracker Options](#) (page 232)

To track coordinates

- 1 Click Analyze tab ► Geo Tools panel ► Coordinate Track. The Track Coordinates pane appears.
- 2 Click the coordinate tracker toolbar.
- 3 Choose the coordinate system to track in the coordinate tracker drop-down list. If you know the code of the coordinate system you want, you can type the code.
- 4 The Track Coordinates pane displays the code and description of the coordinate system.

As you move the cursor over the drawing window, the coordinate tracker updates the cursor's coordinates in the selected coordinate system.

To add a coordinate tracker to the Track Coordinates pane

- 1 In the coordinate tracker toolbar, click . A new coordinate tracker appears in the Track Coordinates pane.
- 2 Click the coordinate tracker toolbar.

- 3 Choose the coordinate system to track in the coordinate tracker drop-down list. If you know the code of the coordinate system you want, you can type the code. The new coordinate tracker displays the code and description of the coordinate system you selected.
- 4 Repeat steps 1-3 to add more coordinate trackers to the Track Coordinates pane.

The new coordinate tracker displays the code and description of the coordinate system you selected.

- In the coordinate tracker toolbar, click . The selected coordinate tracker is removed from the Track Coordinates pane.

To create a feature using the coordinate tracker

- 1 Start a command, such as LINE or MPOLYGON.
- 2 Enter the coordinates for the geometric point in the coordinate tracker, then click .
- 3 Continue as appropriate for the feature you are creating.

Tips

- If the coordinate tracker remains empty as you move the cursor in the drawing window, either there is no coordinate system assigned to the current drawing or the cursor is in a region of the window that is not valid for the specified coordinate system. You cannot track coordinates in layout space.
- You can track coordinates using the coordinate system of a specific attached drawing. In Map Explorer, right-click the attached drawing ► Track Drawing's Coordinates. The Track Coordinates pane opens, preset to the specified attached drawing's coordinate system. If Track Drawing's Coordinates is not available, there is no coordinate system assigned to the attached drawing.

Quick Reference

MAPTRACKCS

Tracks the coordinates of the cursor in any coordinate system

Menu Analyze menu ► Track Coordinate Sytem.

Icon  Track Coordinates

Command Line MAPTRACKCS

Task Pane In Map Explorer, right-click Current Drawing ► Track Coordinates

Measuring Geodetic Distance

You can measure the geodetic distance between points in your map. Geodetic distance takes into account the curvature of the Earth. Therefore, the geodetic distance between any two points is longer than the straight line distance between the same two points.

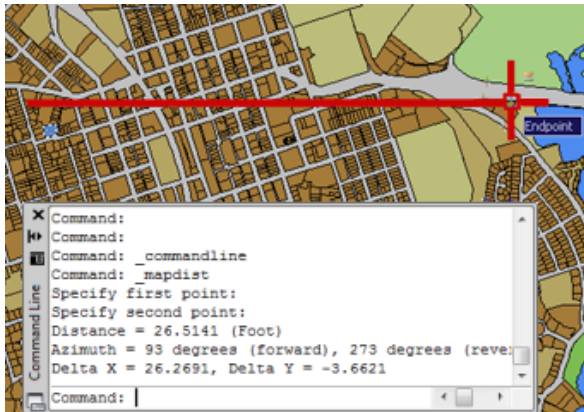

Measure geodetic distance between points in your map

See also:

- [Measuring and Tracking Coordinates](#) (page 1147)
- [Overview of Coordinate Systems](#) (page 143)
- [To track coordinates](#) (page 1150)

To measure geodetic distance

- 1 Click Analyze tab ► Geo Tools panel ► Geo Distance. 
- 2 At the [MAPDIST](#) (page 1597) prompt, specify the starting point by clicking in the map or typing the coordinates of the point.
- 3 At the second prompt, specify the end point by clicking in the map or typing the coordinates of the point.
The results of the calculation are displayed on the command line. If you do not see the command line, press Ctrl + 9 to display it.

Notes

- If the map file does not have an [assigned coordinate system](#) (page 147), the result is a simple straight line distance calculation.
- You can [change the units](#) (page 1150) in which the distance is displayed.

Quick Reference

MAPDIST

Measures the geodetic distance between points

Menu Analyze menu ► Geodetic Distance

Icon  Geodetic Distance

Command Line MAPDIST

Dialog Box MAPDIST

Measuring Coordinate Geometry

Use the inquiry commands to extract geometric information from drawing objects.

NOTE You cannot use these commands for geospatial features.

To measure coordinate geometry

- [To add distances](#) (page 1157)
- [To display the distance between points](#) (page 1159)
- [To display angle information](#) (page 1160)
- [To display COGO information for lines and arcs](#) (page 1161)
- [To display the slope between two points](#) (page 1162)

Overview of Measuring Coordinate Geometry

Use the inquiry commands to extract geometric information from drawing objects such as lines, curves, closed polylines, and polygons. This can help you verify the accuracy of your data, or send the data to the field.

NOTE Inquiry commands are specific to drawing objects. They do not work on geospatial features.

NOTE The COGO inquiry commands use the World Coordinate System (WCS) and ignore current User Coordinate System (UCS) settings. Therefore, north is always considered to point along the WCS positive Y axis, and inquiry results are reported in WCS coordinates.

See also:

- [Measuring and Tracking Coordinates](#) (page 1147)
- [Setting Coordinate Geometry Options](#) (page 233)
- [Overview of Coordinate Systems](#) (page 143)

NOTE You cannot use these commands for geospatial features.

To do this...



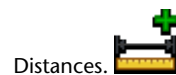

Add distances.

Use this method...

Click Analyze tab ► Inquiry panel ► Add



Distances. See [Adding Distances](#) (page 1156)

To do this...	Use this method...
Display the distance between points.	Click Analyze tab ► Inquiry panel ► Continuous Distance.  See Displaying Continuous Distance (page 1158)
Display angle information.	Click Analyze tab ► Inquiry panel ► Angle Information.  See Displaying Angle Information (page 1160)
Display coordinate geometry information for lines and arcs.	Click Analyze tab ► Inquiry panel ► Line & Arc Information.  See Displaying COGO Information for Lines and Arcs (page 1161)
Display the slope between points.	Click Analyze tab ► Inquiry panel ► List Slope.  See Displaying Slope (page 1161)

Quick Reference

MAPCGADIST

Adds the distances between points

Menu Analyze menu ► Inquiry ► Add Distances

Icon  Add Distances

Command Line MAPCGADIST

MAPCGDIST

Displays the distance between points

Menu Analyze menu ► Inquiry ► Continuous Distance

Icon



Continuous Distance

Command Line MAPCGDIST

MAPCGANG

Displays the angle between lines or points

Menu Analyze menu ► Inquiry ► Angle Information

Icon



Angle Information

Command Line MAPCGANG

MAPCGLIST

Displays coordinate geometry information for lines and arcs

Menu Analyze menu ► Inquiry ► Line and Arc Information

Icon



Line and Arc Information

Command Line MAPCGLIST

Adding Distances

You can calculate the total of several disjunct distances by selecting points in your map, entering distances on the command line, or selecting numeric text, such as measurements, in your map.

NOTE You can perform this operation only on drawing objects. It is not available for geospatial features.

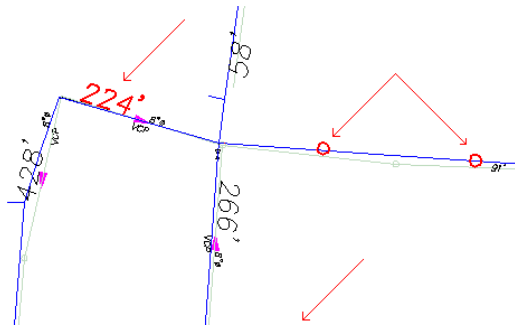

You are prompted to enter a number, specify a distance, or select text. Select all the distances you want to add. You can select numeric text in your drawing, click the start and end points of the distance you want to measure, or enter the number directly on the command line. When you press Enter, AutoCAD Map 3D displays the total of all the distances.

See also:

- [Measuring and Tracking Coordinates](#) (page 1147)
- [Setting Coordinate Geometry Options](#) (page 233)
- [Overview of Coordinate Systems](#) (page 143)
- [Displaying Continuous Distance](#) (page 1158)

To add distances

- 1 Click Analyze tab ► Inquiry panel ► Add Distances. 
 - 2 Specify the first distance by doing one of the following:
 - Enter the distance on the command line.
 - Select two locations in the map.
 - Enter s. Select numeric text in the map, such as a measurement.
 - 3 Enter as many additional distances as you want.
 - 4 When you finish selecting distances, press Enter to view the total of the distances.
- The results of the calculation are displayed on the command line. If you do not see the command line, press Ctrl + 9 to display it.

Quick Reference

MAPCGADIST

Adds the distances between points

Menu Analyze menu ► Inquiry ► Add Distances

Icon



Add Distances

Command Line MAPCGADIST

Displaying Continuous Distance

You can add and display the distance between one point and several other points, or between a series of points in a drawing.

NOTE You can perform this operation only on drawing objects. It is not available for geospatial features.

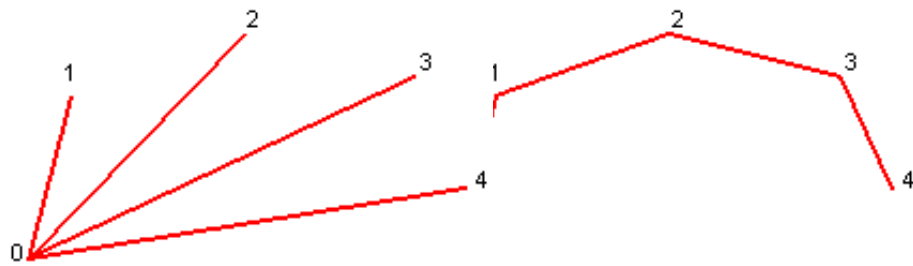

The Base option measures the distance from the starting point to each of the points you select, like the spokes of a wheel.

The Continuous option measures the distance from the starting point to the next point and from that point to the next point, in a continuous line.

See also:

- [Adding Distances](#) (page 1156)
- [Measuring and Tracking Coordinates](#) (page 1147)

- [Setting Coordinate Geometry Options](#) (page 233)
- [Overview of Coordinate Systems](#) (page 143)

To display the distance between points

- 1 Click Analyze tab ► Inquiry panel ► Continuous Distance. 
- 2 Select Base or Continuous.
 - Base: Always measures the distance from the first point you select to each of the additional points you select.
 - Continuous: Measures the distance from one point to the next.
- 3 Select two points to display the distance between the points.
- 4 Select another point. If you selected Base, AutoCAD Map 3D displays the distance from first (or base) point to the new point. If you selected Continuous, AutoCAD Map 3D displays the distance from the last point to the new point.
- 5 When you finish selecting points, press Enter to view the total of the distances.
The results of the calculation are displayed on the command line. If you do not see the command line, press Ctrl + 9 to display it.

Quick Reference

MAPCGDIST

Displays the distance between points

Menu Analyze menu ► Inquiry ► Continuous Distance

Icon  Continuous Distance

Command Line MAPCGDIST

Displaying Angle Information

You can display the acute and obtuse angle between points or intersecting lines in a drawing.

NOTE You can perform this operation only on drawing objects. It is not available for geospatial features.

See also:

- [Measuring and Tracking Coordinates](#) (page 1147)
- [Setting Coordinate Geometry Options](#) (page 233)
- [Overview of Coordinate Systems](#) (page 143)
- [Displaying Continuous Distance](#) (page 1158)

To display angle information

- 1 Click Analyze tab ► Inquiry panel ► Angle Information. 
- 2 Select two lines, or enter p to specify points.
- 3 If you entered p, specify a starting point, a vertex, and an ending point. The results of the calculation are displayed on the command line. If you do not see the command line, press Ctrl + 9 to display it.

Quick Reference

MAPCGANG

Displays the angle between lines or points

Menu Analyze menu ► Inquiry ► Angle Information

Icon  Angle Information

Command Line MAPCGANG

Displaying COGO Information for Lines and Arcs

You can display coordinate geometry for lines and arcs. This information includes line and curve details, area, and coordinates.

NOTE You can perform this operation only on drawing objects. It is not available for geospatial features.

See also:

- [Setting Coordinate Geometry Options](#) (page 233)
- [Overview of Coordinate Systems](#) (page 143)

To display COGO information for lines and arcs

- 1 Click Analyze tab ► Inquiry panel ► Line & Arc Information. 
- 2 Select the line or arc, or enter p to specify the points for a line.
- 3 If you entered p, specify a starting point and an ending point for the line. The results of the calculation are displayed on the command line. If you do not see the command line, press Ctrl + 9 to display it.

Quick Reference

MAPCGLIST

Displays coordinate geometry information for lines and arcs

Menu	Analyze menu ► Inquiry ► Line and Arc Information
Icon	 Line and Arc Information
Command Line	MAPCGLIST

Displaying Slope

You can display the slope, grade, and horizontal distance between two points.

NOTE You can perform this operation only on drawing objects. It is not available for geospatial features.

See also:

- [Setting Coordinate Geometry Options](#) (page 233)
- [Overview of Coordinate Systems](#) (page 143)
- [Theming Surfaces to Analyze Height, Slope, and Aspect](#) (page 1202)

To display the slope between two points

- 1 Click Analyze tab ► Inquiry panel ► List Slope. 
- 2 Select a line or an arc, or enter p to specify points.
- 3 If you entered p, specify a starting point and an ending point for the line. The results of the calculation are displayed on the command line. If you do not see the command line, press Ctrl + 9 to display it.

Quick Reference

MAPCGSLIST

Displays the slope between points

Menu Analyze menu ► Inquiry ► List Slope

Icon  List Slope

Command Line MAPCGSLIST

Creating Themes

Themes vary the display of your data based on properties or attributes of the data. For example, instead of styling the lakes so they are all the same shade of blue, you can create a theme to vary the color based on the depth of the lake.

To create themes

- To create a theme for a feature layer (page 1168)
- To theme drawing data (page 1176)

Overview of Creating Themes

A theme varies the display of data based on properties or attributes of the data, for example area, length, pavement type, assessed value, temperature, or land use.

You can use themes to change colors, line types, symbols, text, or other properties that can help you present map information and tell a story. Themes can help make information more visible, illustrate how data is distributed, make data easier to analyze and interpret, and reveal patterns.

For example, you can use darker colors for areas with more rainfall, a larger dot to display cities with a larger population, or a wider line to draw roads with high traffic volume.

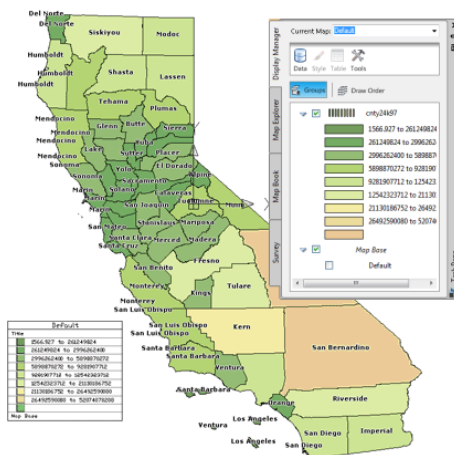

A theme showing counties by area

You can theme on specific values or a range of values. For example, an agricultural theme might show different crops in different colors. Each crop is a specific value. Temperature, however, can be any number along a continuum. When you display this type of data, you define ranges for the values. For example, you could divide temperature values into three ranges: below 30, 30 - 60, and over 60.

You can add labels to a theme to label features or drawing objects. You can also add a legend that lists the conditions of the theme and explains the colors, symbols, line patterns, shadings, and annotation used.

Tell me more



Video

- [Show me how to theme a parcels layer.](#)
- [Show me how to manually adjust the ranges of a theme.](#)
- [Show me how to theme based on individual values.](#)



Procedures

- [To create themes \(page 1163\)](#)
- [To create a theme for a feature layer \(page 1168\)](#)
- [To create a theme for a drawing layer \(page 1181\)](#)



Tutorial

- [Lesson 2: Style Map Features](#)



Workflow

- [Analyze Data](#)



GIS Skills

- [Choose the right type of theme to suit your data.](#)
- [Manually adjust the ranges of a theme.](#)
- [Theme based on individual values.](#)



Related topics

- [Styling Features \(page 639\)](#)
 - [Overview of Creating and Editing Data \(page 681\)](#)
 - [Adding Labels to Features \(page 1091\)](#)
 - [Adding a Legend \(page 1116\)](#)
 - [Defining Scale Ranges \(page 643\)](#)
-

The method you use to theme data depends on the type of layer on which the data is stored.

To theme this type of data...	See...	Description
Feature layers	Theming Features (page 1165)	Display Manager layers from feature sources such as SDF or Oracle that have been added using Data Connect.
Drawing layers	Theming Drawing Data (page 1176)	AutoCAD layers containing drawing objects from DWG files.
Surface layers	Theming Surfaces to Analyze Height, Slope, and Aspect (page 1202)	Raster-based surfaces, such Digital Elevation Models (DEMs), ESRI Grid files, and Digital Terrain Elevation Data (DTED) that have been added using Data Connect.

Theming Features

You can use the theming tool to create themes for layers from feature sources such as SDF, SHP, Oracle Spatial, or ArcSDE. Themes vary the display of features on the feature layer based on properties or attributes associated with that layer.

For example, a theme for a point layer might display retail store locations with a different symbol for each type of store. A polygon layer theme might display each land use classification with a different color or shading.

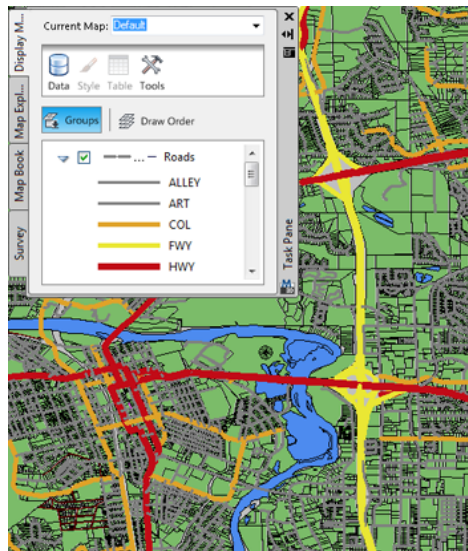

A theme showing roads themed by type

NOTE For information about theming drawing objects, see [Overview of Theming Drawing Data](#) (page 1178).

Theme Rules

A theme for a feature layer has a set of scale ranges and a rule that corresponds to each one. For example, if you are theming by parcel size, the scale ranges would indicate different parcel sizes. The first range might comprise parcels between 1000 square feet and 5000 square feet, the second range might comprise parcels 5001 square feet to 10,000 square feet, and so on. The first rule would describe how the first range appears on the map. For example, the smallest parcels might be lightest in color, and the colors might get darker as the parcel size goes up.

Rules can include a visual style, a legend label, and a feature label.

- **Visual style** options vary, depending on the type of geometry on the layer. Polygon style options include fill and border options; line style options include line thickness, color, and pattern; point style options include a symbol, size specifications, and color.
- **Legend labels** can provide a description of the condition of a rule. For example, you can edit the default legend label so it reads “Small parcels,” instead of “1000...2000.”

- **Feature labels** display the values of a property. For example, you can label parcels with their address or area values.

As a layer is drawn, each feature is compared to the rules in the order that they are listed. The first rule for which the feature meets the condition is used to specify the style and legend label for that feature. A default or empty condition applies to all features and defines the style for features that do not meet any of the preceding rules. A well-constructed theme contains only one default rule and it is last in the list.

Distribution Methods

When you create a range of conditions for a feature theme, you must specify the distribution method. The following methods are available:

Method	Description
Equal	The difference between the high and low values is the same for every range. This method is easy to interpret and is useful for showing continuous data such as rainfall.
Standard Deviation	Features are placed in ranges based on how much their values vary from the mean. AutoCAD Map 3D calculates the mean and then adds or subtracts the standard deviation to or from the mean to create the ranges.
Quantile	Each range contains an equal number of features. This method is useful for showing data in which values are evenly distributed.
Jenks (Natural Breaks)	Ranges are based on natural groupings of data values. Features with similar values are grouped. This method shows the natural groupings in the data.
Individual Values	Features are not grouped. This distribution is useful if values are not continuous, there is a fixed number of values, and many features have the same value.

Tell me more



Video

- *Show me how to theme a parcels layer.*
- *Show me how to manually adjust the ranges of a theme.*

- *Show me how to theme based on individual values.*



- [To create a theme for a feature layer](#) (page 1168)



- Lesson 2: Style Map Features



- Analyze Data



- *Choose the right type of theme to suit your data.*
- *Manually adjust the ranges of a theme.*
- *Theme based on individual values.*



- [Styling Features](#) (page 639)
- [Adding Labels to Features](#) (page 1091)
- [Overview of Creating and Editing Data](#) (page 681)
- [Creating Themes for Drawing Layers](#) (page 1178)
- [Theming Surfaces to Analyze Height, Slope, and Aspect](#) (page 1202)
- [Adding a Legend](#) (page 1116)
- [Defining Scale Ranges](#) (page 643)

NOTE For information about theming drawing objects, see [Overview of Theming Drawing Data](#) (page 1178).

To create a theme for a feature layer

- 1 In [Display Manager](#) (page 2060), select a feature layer. Click the Style icon in the toolbar.

For information about creating a new feature layer, see [Bringing in GIS Features](#) (page 303).

- 2 In the Style Editor, under Scale Ranges, select the scale range to theme.
For more information about scale ranges, see [Defining Scale Ranges](#) (page 643).
- 3 In the Polygon Style, Point Style, or Line Style area, click New Theme.
- 4 To analyze features based on values that fall into various numerical ranges, do the following in the [Theme dialog box](#) (page 1645):
 - For Property, select the property on which to base the theme.
 - For properties with numeric values, specify the Minimum Value and Maximum Value for the range.
 - For properties with numeric values, select a Distribution method. For more information about distribution methods, see the Concepts tab of this topic.
The first rule includes the Minimum Value and the last rule includes the Maximum Value. Styles are interpolated across the range.
You can specify the number of rules to create if Distribution method is Equal, Quantile, or Jenks (Natural Breaks). Properties containing strings use an Individual Values distribution that does not allow the number of rules to be edited. Adjust the number of rules to control the granularity of the theme.
 - If you are editing an existing theme, you can replace any existing rules by selecting Replace existing rules.
- 5 The default Style Range shows the styles that will be used for each rule. Your options depend on the type of geometry stored on this feature layer.
 - For polygon features, see [To set styling options for polygon features](#) (page 1172).
 - For line features, see [To set styling options for line features](#) (page 1174).
 - For point features, see [To set styling options for point features](#) (page 1175).
- 6 To add labels to features in the theme, do the following:
 - Select the Create Feature Labels check box.
 - Next to Label Ramp, click
 - Select Create A Label and specify the criteria for the labels.

For more information about creating feature labels, see [Adding Labels to Features](#) (page 1091). To use expressions for labels, see [Using Expressions to Label Features](#).

7 To create legend labels for the theme, do the following:

- Select the Create Legend Labels check box.
- For Legend Text, enter the text to appear next to each rule in the legend.
For example, if you are theming by size, you could change the legend text to “Square Acreage.”
- For Label Format, specify how to display the legend label.
If you theme a layer on a property that contained area information and you used the label text *Area*, the label formats might look like the following examples:

<Label Text> <Min> to <Max>
Area: 100 to 200

<Label Text> <Min> - <Max>
Area: 100 - 200

<Min> <= <Label Text> <<Max>
100 <= Area < 200

For information on inserting a legend into your map, see [Adding a Legend](#) (page 1116).

Quick Reference

Theme Feature Layer in Display Manager

Creates a theme for a feature layer in Display Manager

Task Pane	In Display Manager, right-click a feature layer. Select Edit Style. In the Style Editor, click the New Theme button.
Dialog Box	Theme dialog box

Theme Options for Polygon Feature Layers

When you create a theme for a feature layer whose geometry consists of polygons, the Style Polygon dialog box provides options for changing the visual appearance of the features in the theme. You can change options relating to the fill and border.

A polygon feature theme can be transparent so that other map data shows through, for example, another theme or another layer of map data. The transparency option is available only when working with themes involving a solid fill.

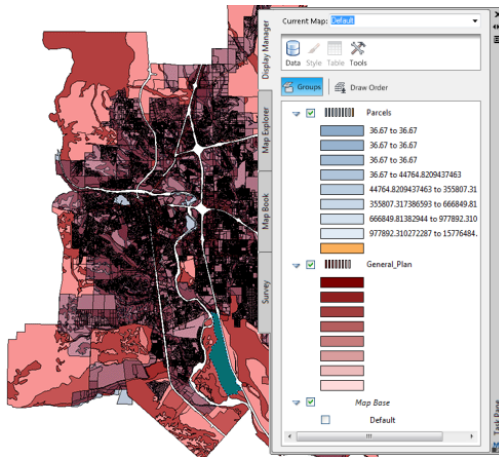

Blue parcel theme made partially transparent so you can see the red planning theme underneath

NOTE For information about theming drawing objects, see [Overview of Theming Drawing Data](#) (page 1178).

Tell me more



Video

- *Show me how to theme a parcels layer.*
- *Show me how to make the features on a layer semi-transparent.*



Procedure

- [To set styling options for polygon features](#) (page 1172)



Tutorial

- Exercise 6: Display the raster image behind other features



Workflow

- Analyze Data



GIS Skills

- *Set transparency for parcels or other features.*



Related topics

- [Styling Features](#) (page 639)
- [Overview of Creating Themes](#) (page 1163)
- [Theming Features](#) (page 1165)
- [Theming Surfaces to Analyze Height, Slope, and Aspect](#) (page 1202)

NOTE For information about theming drawing objects, see [Overview of Theming Drawing Data](#) (page 1178).

To set styling options for polygon features

- 1 [Create a theme for a polygon feature layer](#) (page 1165).
- 2 In the Theme Polygons dialog box, the default Style Range shows the colors that will be used for each rule. To change them, click .
- 3 In the Style Area dialog box, change any of the following:
 - Select Apply Fill To The Polygons and choose a Fill Pattern from the list. To use transparency, choose Solid.
 - If you chose Solid, for Foreground Transparency, specify a value from 0 through 100, where 0 is solid and 100 is transparent.
 - For Foreground Color, select Generated Between Two Colors or Color Palette.
For Generated Between Two Colors, specify the beginning and ending colors for the theme. The intermediate colors will be calculated automatically, but you can adjust them.
For Color Palette, choose a palette from the list.

- Specify a Background Color, if appropriate.
- If you want a border, select Apply A Border To The Polygons and choose a line pattern, thickness, and color.

4 Click OK twice.

Quick Reference

Theme Feature Layer in Display Manager

Creates a theme for a feature layer in Display Manager

Task Pane In Display Manager, right-click a feature layer. Select Edit Style. In the Style Editor, click the New Theme button.

Dialog Box Theme dialog box

Theme Options for Line Feature Layers

When you create a theme for a feature layer whose geometry consists of linear features, the Style Line dialog box provides options for changing the visual appearance of the features in the theme. You can change options relating to the thickness, color, and pattern.

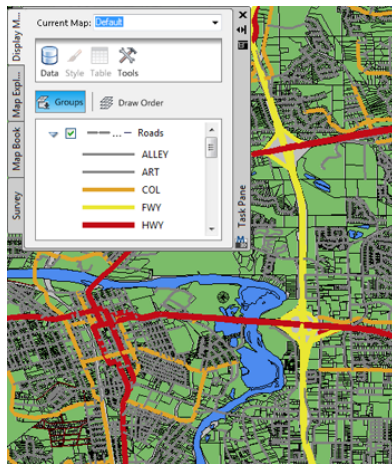

A theme showing roads by road type

NOTE For information about theming drawing objects, see [Overview of Theming Drawing Data](#) (page 1178).

NOTE For information about theming drawing objects, see [Overview of Theming Drawing Data](#) (page 1178).

To set styling options for line features

- 1 [Create a theme for a line feature layer](#) (page 1165).
- 2 In the Theme Lines dialog box, the default Style Range shows the styles that will be used for each rule. To change them, click
- 3 In the Style Line dialog box, change any of the following:
 - For Units (Device Space), select the type of units to measure line thickness. Lines are specified in Device Space units.
 - For Thickness Range, specify the narrowest and widest line thicknesses to use for the style.
 - For Color Range, specify the beginning and ending colors for the theme. The intermediate colors will be calculated automatically, but you can adjust them.
 - Choose a Pattern for the lines from the list.
- 4 Click OK twice.

Quick Reference

Theme Feature Layer in Display Manager

Creates a theme for a feature layer in Display Manager

Task Pane	In Display Manager, right-click a feature layer. Select Edit Style. In the Style Editor, click the New Theme button.
Dialog Box	Theme dialog box

Theme Options for Point Feature Layers

When you create a theme for a feature layer whose geometry consists of point features, the Style Line dialog box provides options for changing the visual appearance of the features in the theme. You can change options relating to the symbol, color, and size of the points.



NOTE For information about theming drawing objects, see [Overview of Theming Drawing Data](#) (page 1178).

See also:

- [Overview of Creating Themes](#) (page 1163)
- [Theming Features](#) (page 1165)
- [Theming Surfaces to Analyze Height, Slope, and Aspect](#) (page 1202)

NOTE For information about theming drawing objects, see [Overview of Theming Drawing Data](#) (page 1178).

To set styling options for point features

- 1 [Create a theme for a point feature layer](#) (page 1165).
- 2 In the Theme Points dialog box, the default Style Range shows the styles that will be used for each rule. To change them, click .
- 3 In the Style Point dialog box, change any of the following:
 - For Symbol, click  and choose a symbol or browse to a symbol file.
 - For Size Context, choose Device Space or Map Space and then select the type of units to measure the point symbols.
In Device Space, you specify symbol widths and heights in screen units. Available units are Points, Inches, Millimeters, or Centimeters.
In Map Space, you specify symbol widths and heights in Mapping Coordinate System(MCS) units. Available units are Inches, Feet, Yards, Miles, Millimeters, Centimeters, Meters, and Kilometers.
If you choose Device Space, symbols remain the same size during a zoom. If you choose Map Space, symbols remain the same size relative to the map. For example, if you make a symbol .1 miles in map units, it will measure .1 miles no matter what zoom level you set.

- Set the size range for the point symbols (width and height). The smallest size will be used for the objects in the lowest scale range and the largest size will be used for the objects in the highest scale range. You can enter a number or use an expression to set size.
- For Fill Color Range and Edge Color Range, specify the beginning and ending colors for the theme. The intermediate colors will be calculated automatically, but you can adjust them.
- Choose a Rotation Range for the symbols from the list, or use an expression to set rotation.

4 Click OK twice.

Quick Reference

Theme Feature Layer in Display Manager

Creates a theme for a feature layer in Display Manager

Task Pane	In Display Manager, right-click a feature layer. Select Edit Style. In the Style Editor, click the New Theme button.
Dialog Box	Theme dialog box

Theming Drawing Data

To theme drawing data

- [To create a theme for a drawing layer](#) (page 1181)
- [To edit a theme for drawing data](#) (page 1182)
- [To change the thumbnail used in the Display Manager](#) (page 1183)
- [To add a legend to your drawing](#) (page 1183)
- [To apply annotation to a theme for a drawing layer](#) (page 1186)

Overview of Theming Drawing Data

Themes for drawing layers vary the stylization of drawing objects based on object properties or data associated with the objects.

For example, you can vary the shade of blue used for parcels, depending on the assessed property value of each parcel.

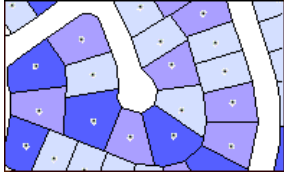

Change the color of each parcel based on assessed property value.

You can also use predefined themes, called [ramps](#) (page 1183).

NOTE For information about theming geospatial features, see [Theming Features](#) (page 1168).

Theme Data

A theme for a drawing layer can be based on any of the following:

- A property of the objects, such as area or length
- Data stored in an object data table, such as pipe diameters
- Data stored in a linked external database, such as parcel values

The data used for a theme on a drawing layer can be specific values, such as pipe material, land use, or pavement type, or a range of values, such as property value, temperature, or population.

If the data is a set of specific values, select which values you want. For example, an agricultural theme might show different crops in different colors. Each crop is a specific value. You can omit some crops.

If the data is ranges of values, select how many ranges you want and how to divide the data. For example, temperature can be any number along a continuum. You could divide temperature values into three ranges: below 30, 30 - 60, and over 60.

You can add a legend that lists the conditions of the theme and explains the colors, symbols, line patterns, shadings, and annotation used.

See also:

- [Adding a Legend](#) (page 1116)
- [Theming Features](#) (page 1165)

■ [Theming Surfaces to Analyze Height, Slope, and Aspect](#) (page 1202)

NOTE For information about theming geospatial features, see [Theming Features](#) (page 1168).

To do this...	Use this method...
Create a theme for a drawing layer.	In Display Manager (page 2060) right-click a drawing layer ► Add Style ► Theme. See Theming Drawing Data (page 1176)
Edit a theme for a drawing layer.	In Display Manager (page 2060) right-click a drawing layer ► Edit Theme. See Theming Drawing Data (page 1176)
Change the thumbnail image for the theme in Display Manager.	On the Display tab of the Properties palette for a drawing layer, select the thumbnail preview. See Theming Drawing Data (page 1176)
Add a legend	In the Display Manager, click Tools ► Create Legend. See Theming Drawing Data (page 1176)

Quick Reference

Theme Drawing Layer in Display Manager

Creates a theme for a drawing layer in Display Manager





Task Pane In Display Manager, right-click a drawing layer. Click Add Style ► Theme.



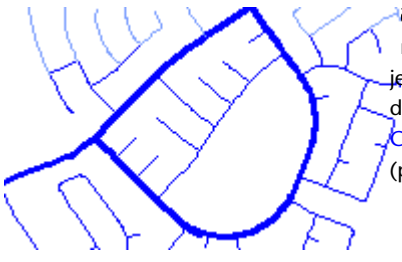

Dialog Box Thematic Mapping dialog box

Creating Themes for Drawing Layers

The following table shows data themed using different styling options and offers some guidance on using those options.

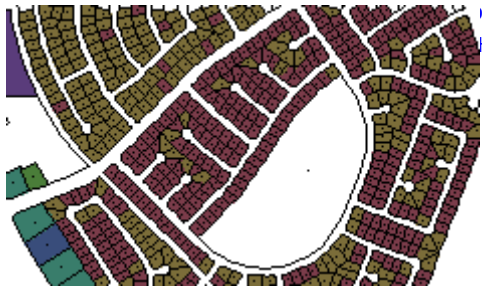
NOTE For information about theming geospatial features, see [Theming Features](#) (page 1168).

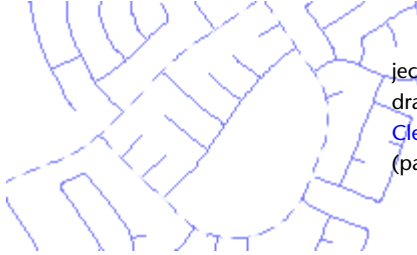
Theme Style	Example	More Information
Alter color		
Alter linetype		To assign line width to circles, arcs, or lines, convert the objects to polylines with the drawing cleanup tools. See Cleaning Up Drawing Data (page 765).
Alter line weight		To assign line width to circles, arcs, or lines, convert the objects to polylines with the drawing cleanup tools. See Cleaning Up Drawing Data (page 765).
Alter plot style		Changes to plot styles appear only in previews and in published drawings.

Theme Style	Example	More Information
Add hatch/fill		Drawing Layer Hatch Scale (page 75)
Add text		Drawing Layer Text Height (page 75)
Alter line style		Assign line width to circles, arcs, or lines, convert the objects to polylines with the drawing cleanup tools. See Cleaning Up Drawing Data (page 765).
Alter block insertion		The factors for blocks vary according to the plot scale and the size of the block. For a map plotted at 1:2000, a unit block (size 1 unit by 1 unit) appears clearly with a scale of 2000.

Theme Style	Example	More Information
Add annotation		; for Drawing Layer themes: Annotation (page 115) ; for Drawing Layer themes: Text Height (page 115)

See also:

- [Adding a Legend](#) (page 1116)
- [Theming Features](#) (page 1165)
- [Theming Surfaces to Analyze Height, Slope, and Aspect](#) (page 1202)



NOTE For information about theming geospatial features, see [Theming Features](#) (page 1168).

- [To create a theme for a drawing layer](#) (page 1181)
- [To edit a theme for drawing data](#) (page 1182)
- [To change the thumbnail used in the Display Manager](#) (page 1183)
- [To add a legend to your drawing](#) (page 1183)

To create a theme for a drawing layer

- 1 In [Display Manager](#) (page 2060) right-click a drawing layer ► Add Style ► Theme.
For information on creating a layer, see [Bringing In Drawing Data From DWG Files](#) (page 350).
- 2 In the [Thematic Mapping dialog box](#) (page 1642), in the Theme Type list, choose the type of theme to create.
 - A Set Of Specific Values — Select this option if the data has a few distinct values, such as pipe material, land use, or pavement type.
 - A Range Of Numeric Values — Select this option if the data can be any value along a continuum, such as property value, temperature,

or population. When you display this type of data, you define ranges for the values.

- 3 Next to the Theme Type list, click Values to specify the data to use for the theme.
- 4 In the [Thematic Values dialog box](#) (page 1644), under Data Values, specify the data to use. For Obtain From, click  to choose from a list of data sources.
- 5 To ignore or exclude certain values in the data, specify them in the Ignore box.
These values, while present in the data, may be inappropriate for use in the theme. Examples include null or empty data values.
- 6 To normalize the data relative to some other data value, for Normalize By, enter a value or an expression. Click  to choose from a list of data sources.
- 7 Click Read Data.
AutoCAD Map 3D reads the values in the selected data source.
If there is no data, verify that there are objects in the layer. The Display Manager does not work with civil objects or objects from attached drawings that have been queried into the current drawing using a standard Query. To use objects from attached drawings with the Display Manager, create a Query layer.
- 8 If you are not working with ranges, select the values to include in your map.
- 9 If you are creating a theme with ranges, under [Data Ranges](#) (page 1629), choose how to divide the values into ranges.
- 10 Click OK to close the dialog box.
- 11 Under [Thematic Details](#) (page 1643), specify how to style objects in the theme, and the text labels to use in the legend.
- 12 Click Done.

To edit a theme for drawing data

- In Display Manager, right-click the drawing theme to edit and choose Edit Theme.

To change the thumbnail used in the Display Manager

- 1 Select the layer.
- 2 Click Display to open Properties palette.
- 3 On the Display tab of the Properties palette, select the thumbnail preview.
For example, choose the polygon icon for parcels or the arc icon for pipes.

To add a legend to your drawing

- In the Display Manager, click Tools ► Create Legend.

See also:

- [Overview of Theming Drawing Data](#) (page 1176)
- [Tips for Drawing Layer Themes: Ramps](#) (page 1183)
- [Thematic Mapping dialog box](#) (page 1642)
- [Thematic Values dialog box](#) (page 1644)
- [Range of Values dialog box](#) (page 1629)
- [Adding a Legend](#) (page 1116)

Quick Reference

Theme Drawing Layer in Display Manager

Creates a theme for a drawing layer in Display Manager

Task Pane In Display Manager, right-click a drawing layer. Click Add Style ► Theme.

Dialog Box Thematic Mapping dialog box

Tips for Drawing Layer Themes: Ramps

For stylizations, you can choose from pre-defined sets of stylizations, called ramps.

	<= 25
	25 - 35
	35 - 45
	45 - 50

A ramp is a pre-built sequence of styles, such as a set of color gradations or a set of line types.

The information required to create the ramp is stored in a separate file in XML format. AutoCAD Map 3D supplies several ramp files that you can use.

NOTE For information about theming geospatial features, see [Theming Features](#) (page 1168).

Tips for Drawing Layer Themes: Hatch Scale

For standard-scale hatch patterns (those that do not have an AR- prefix), the density of the hatching varies according to the hatch scale and plot scale you use.

NOTE For information about theming geospatial features, see [Theming Features](#) (page 1168).

Plot, Display, or View Scale	Hatch Scale	Result
1:2000	1 to 500	Solid
2000	Lines clearly visible	
15000	Sparse, occasional lines	
20000	No hatch or one line only	
1:10000	1 to 2500	Solid
10000	Lines clearly visible	
75000	Sparse, occasional lines	
100000	No hatch or one line only	

You can use solid fills at any scale to fill an enclosed area.



Examples of hatch patterns with different scales on a map plotted at 1:10000

Using too low a scale for hatch patterns can seriously impair results. For a listing of standard hatch patterns, look up "standard libraries" in the help index.

Tips for Drawing Layer Themes: Text Height

Scale and height values for fill patterns, text height, and symbol size vary according to the plotting scale you intend to use. The following table shows suitable text heights for different plot scales.

Plot Scale	Required Text Height on Plot (Text Height)	
1:2000	1	2000
0.5	1000	
1:10000	1	10000
0.5	5000	

NOTE For information about theming geospatial features, see [Theming Features](#) (page 1168).

Tips for Drawing Layer Themes: Annotation

Use an annotation template to add annotation to a theme. You define the annotation templates in your map. They are stored as specially named blocks

within your drawing and define what kind of information you want to be displayed in the annotation, as well as the layout of that information.

Annotation templates can include textual values, such as values from object data or object properties such as a line weight, and graphics, such as images and arrows.

NOTE For information about theming geospatial features, see [Theming Features](#) (page 1168).

See also:

- [Overview of Annotating Maps](#) (page 1089)

To apply annotation to a theme for a drawing layer

- 1 Select the annotation template you want to use.
- 2 Specify the insertion information, such as insertion point, scale, rotation, linetype, and color.

Analyzing Raster-Based Surfaces

AutoCAD Map 3D includes tools to help you view and analyze raster-based 3D surfaces, such as Digital Elevation Models (DEMs), ESRI Grid files, and Digital Terrain Elevation Data (DTED).

For example, you can create contour maps to help you analyze 3D terrain, use raster-based theming to analyze elevation, slope, and aspect, drape map data over surfaces and view the data in 3D, and more.

To add a raster-based surface, you use Data Connect. For more information, see [Overview of Adding Rasters and Surfaces](#) (page 440).

To analyze raster-based surfaces

- [To create contour lines](#) (page 1190)
- [To edit the line styles and labels used for the contour lines](#) (page 1191)
- [To delete a layer of contour lines](#) (page 1191)
- [To drape 2D map data over a 3D surface](#) (page 1193)
- [To switch between 2D and 3D](#) (page 1193)
- [To switch between 2D and 3D](#) (page 1196)
- [To use 3D Zoom](#) (page 1196)
- [To use 3D Pan](#) (page 1196)

- [To use Constrained Orbit or Swivel](#) (page 1196)
- [To use walk](#) (page 1196)
- [To change the Visual Style](#) (page 1197)
- [To specify hillshading settings](#) (page 1200)
- [To turn hillshading on or off](#) (page 1201)
- [To change the vertical exaggeration](#) (page 1201)
- [To theme a surface to analyze height, slope or aspect](#) (page 1203)
- [To change colors in a themed surface](#) (page 1205)

Overview of Analyzing Raster-Based Surfaces

After you add a raster-based surface to your map (such as a Digital Elevation Model or ESRI Grid file), you can analyze it in various ways.

Tell me more



Video

- *Show me how to color surfaces based on elevation.*
- *Show me how to view and navigate in 3D.*
- *Show me how to exaggerate the vertical dimension of a surface.*
- *Show me how to drape layers on a surface.*
- *Show me how to perform a slope analysis of a surface.*
- *Show me how to create a contour layer from a surface.*



Procedures

- [To analyze raster-based surfaces](#) (page 1186)



Tutorial

- Tutorial: Analyzing Data



Workflow

- Style Surfaces
-



GIS Skills

- *Color a surface by elevation and adjust hillshading.*
- *Change the elevation ranges for a surface.*
- *View a site in 3D.*
- *Drape vector and raster layers over a surface.*
- *Analyze the slope and aspect of a site.*
- *Create a contour layer from a surface.*



Related topics

- [Adding Raster-Based Surfaces to Your Map](#) (page 441)

Analyze a raster-based surface (such as a Digital Elevation Model or ESRI Grid file) in the following ways.



[Add contour lines](#) (page 1189) to a surface to make a contour map, also referred to as a topographic map.



[Drape 2D map data on 3D surfaces](#) (page 1192) to view all the data as a 3D texture map.



[View, navigate, and walk or fly through](#) (page 1194) a 3D map to view the map from different perspectives.



[Use hillshading](#) (page 1199) to cast real-world shadows on a surface to make it look more realistic and easier to analyze.



[Change the vertical exaggeration](#) (page 1199) to control how extreme the elevation changes appear.



[Use theming and change colors](#) (page 1202) to analyze elevation, slope, aspect, and more.

Adding and Modifying Contour Lines

You can add contour lines to a raster-based surface in your map to create a contour or topographic map. You add contour lines to surface layers in Display Manager.

With contour lines, each line connects points of equal elevation on the surface. The lines can help you determine the elevation at a specific location on the surface, help clarify and analyze the 3D surface terrain, and help with things like navigation.

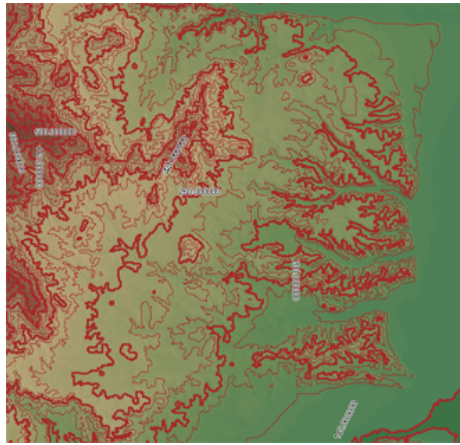

Contour lines added to a DEM surface

Contour lines are stored as new polyline or polygon features in an SDF file, and as a new layer in Display Manager.

You can edit and style the contour lines as you do any other feature layer. You can also delete contour lines and recreate them.

When you add contour lines, you specify the following:

- Name of the new contour layer
- Contour elevation interval
- Units (meters or feet) used to measure elevation
- Major contour interval
- Contour labels
- Whether to create contours as polylines or polygons

- File name of the SDF that will store the contour features

Tell me more



Video

- [Show me how to create a contour layer from a surface.](#)



Procedures

- [To create contour lines](#) (page 1190)



Tutorial

- Lesson 1: Analyze Data Visually, Using Surfaces



Workflow

- [Style Surfaces](#)



GIS Skills

- [Create a contour layer from a surface.](#)



Related topics

- [Adding Raster-Based Surfaces to Your Map](#) (page 441)
- [Draping Map Data Over 3D Surfaces](#) (page 1192)
- [Viewing Surfaces in 3D](#) (page 1194)

-
- [To create contour lines](#) (page 1190)
 - [To edit the line styles and labels used for the contour lines](#) (page 1191)
 - [To delete a layer of contour lines](#) (page 1191)

To create contour lines

- 1 In [Display Manager](#) (page 2060), right-click a surface layer, and select Create Contour Layer.
For information about adding a surface layer, see [Adding Raster-Based Surfaces to Your Map](#) (page 441).
- 2 In the [Generate Contour dialog box](#) (page 1561), enter a name for the new Display Manager layer that will contain the contour lines.

- 3 In the Contour Elevation Interval list, select the difference in elevation between contour lines, for example, 10, 20, or 50.
- 4 Select the units (meters or feet) used to measure the elevation in your surface.
AutoCAD Map 3D attempts to get this unit from the surface itself, but you can change it.
- 5 In the Major Contour Every list, select the interval between major (bold) contour lines.
For example, if you choose 5, every fifth contour line will be bolded.
- 6 To label the major contour lines with the elevations they represent, select the Label The Elevation check box.
- 7 For Create Contour As, select the type of feature to use when creating contour lines (polyline or polygon).
- 8 For Save Contours Into Filename, enter a name for the new SDF file that will store your contour line features.
- 9 Click OK.

The new contour line features are added to your map. They are placed on a new Display Manager layer with the layer name you specified, and stored in an SDF file.

To edit the line styles and labels used for the contour lines

- 1 In Display Manager, click the contour layer and click Style in the toolstrip.
- 2 In the Style Editor, modify the line styles and labels, as you would for other features. For more information, see [Editing Features](#) (page 701).
To change other contour settings, such as elevation interval and units, you must remove the contour layer and recreate it using the settings you want.

To delete a layer of contour lines

- 1 In Display Manager, select the contour layer.
- 2 Click Remove.

Quick Reference

Create Contours

Creates contour lines for 3D raster-based surfaces

Task Pane In Display Manager, right-click a surface layer, and select Create Contour Layer.

Dialog Box Generate Contour dialog box

Draping Map Data Over 3D Surfaces

To drape 2D map data over a surface in your map, switch to a 3D view. AutoCAD Map 3D automatically drapes 2D map data and displays everything in 3D, creating a texture map.

For example, if you have a map with 2D raster satellite images, a 2D parcel layer, and a 3D Digital Elevation Model (DEM), you can switch to 3D to drape the satellite images and parcels over the DEM.

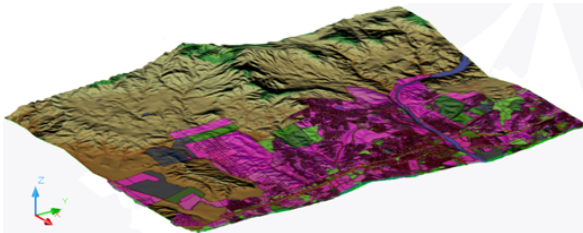

2D parcels and roads draped over a 3D DEM surface

NOTE You cannot edit 2D data while it is draped in a 3D view. Switch back to 2D.

Tell me more



Video

- *Show me how to drape layers on a surface.*
 - *Show me how to view and navigate in 3D.*
-



Procedure

- [To drape 2D map data over a 3D surface](#) (page 1193)



Tutorials

- Lesson 1: Analyze Data Visually, Using Surfaces
- Exercise 4: Try out the sample data



Workflow

- Style Surfaces



GIS Skills

- *Drape vector and raster layers over a surface.*
- *View a site in 3D.*





Related topics

- [Adding Raster-Based Surfaces to Your Map](#) (page 441)
- [Viewing Surfaces in 3D](#) (page 1194)



To drape 2D map data over a 3D surface

- 1 In [Display Manager](#) (page 2060), verify that you have a surface layer in your map.

For information about adding a surface layer, see [Adding Raster-Based Surfaces to Your Map](#) (page 441).

- 2 On the status bar, click  to switch to 3D.
The 3D Navigation toolbar appears, and display driver acceleration is turned on to enhance 3D display performance.
- 3 Use the 3D Navigation tools to move around. For more information, see [Viewing Surfaces in 3D](#) (page 1194).
- 4 To switch back to 2D, click  on the status bar.

To switch between 2D and 3D

- On the status bar, click  to switch to 3D or  to switch to 2D.

Quick Reference

Drape 2D Data Over a Surface

Switch to a 3D view and 2D data is automatically draped over surfaces in your map

Icon



Viewing Surfaces in 3D

When working with maps that include 3D data such as raster-based surfaces, display different views in 3D to explore, examine, and analyze the surface from different perspectives.

Use any of the following options to view your 3D map interactively:

- Switch to 3D view—Displays the 3D Navigation toolbar, which contains the commands you need to change the 3D view (for example 3D Orbit) and turns on display driver acceleration to enhance 3D performance.
- 3D Zoom—Simulates the effect of a camera's zoom lens by making objects appear closer or farther away.
- 3D Pan—Changes the view to match where you move the cursor.
- Constrained Orbit —Moves the surface map around a target.
- Swivel—Simulates panning with a camera in the direction that you drag.
- Walk or Fly—Simulates walking or flying through a 3D model.
- Motion Path Animation—Records and plays back a walk-through or fly-through of a model to visually demonstrate a surface map.
- Other AutoCAD commands—Allow you to view and navigate in 3D. For example, you can use the VISUALSTYLES to hide or show lines and shade 3D data or Camera to place a camera so that you can manipulate and save 3D perspective views.

For more information about the above commands, refer to the AutoCAD Help.

TIP To improve the display of a surface after zooming in, use the Resample Raster option. This resamples / requeries the data so it is as clear as possible, getting rid of things like pixelation. For more information, see [Viewing Raster Images](#) (page 674).

Tell me more



Video

- [Show me how to view and navigate in 3D.](#)



Procedure

- [To switch between 2D and 3D](#) (page 1196)



Workflow

- [Style Surfaces](#)



GIS Skills

- [View a site in 3D.](#)





Related topics

- [Adding Raster-Based Surfaces to Your Map](#) (page 441)
- [Draping Map Data Over 3D Surfaces](#) (page 1192)
- [Viewing Raster Images](#) (page 674)

NOTE The following procedures are intended for maps that include 3D raster-based surfaces, which have been added using Data Connect. See [Adding Raster-Based Surfaces to Your Map](#) (page 441).

- [To switch between 2D and 3D](#) (page 1196)
- [To use 3D Zoom](#) (page 1196)
- [To use 3D Pan](#) (page 1196)
- [To use Constrained Orbit or Swivel](#) (page 1196)
- [To use walk](#) (page 1196)
- [To change the Visual Style](#) (page 1197)

To switch between 2D and 3D

- On the status bar, click  to switch to 3D or  to switch to 2D.

To use 3D Zoom

- 1 On the 3D Navigation toolbar, click 3D Zoom  .
The 3D Navigation toolbar opens when you are in 3D viewing mode.
- 2 Press ENTER, press ESC, or right-click to exit.

To use 3D Pan

- 1 On the 3D Navigation toolbar, click 3D Pan  .
- 2 When the hand cursor appears, hold down the button on your pointing device as you move.
- 3 If you are using a wheel mouse, hold down the wheel button and move the mouse.
- 4 Press ENTER, press ESC, or right-click to exit.

To use Constrained Orbit or Swivel

- 1 On the 3D Navigation toolbar, click 3D Constrained Orbit or Swivel.
- 2 Click and drag the cursor to rotate the view.
- 3 To exit, press ENTER or ESC, or right-click and click Exit.

To use walk

- 1 Verify that the “step size”, or distance you move with each step, is large enough for walking through a surface. Enter the STEPSIZE command and make sure it is set to 80 - 1500 or more. The number you want to use may depend on your zoom level.
- 2 On the 3D Navigation toolbar, click Walk  .
- 3 A window appears describing the keyboard control you use for the walk. Using the arrow keys is one of the convenient options. Click OK.

- 4 Wait briefly as the Position Locator palette appears. Review, change settings as needed, and then minimize or close it.
- 5 Use the keyboard buttons to walk through your surface. For example, use the up arrow key to move forward.
- 6 Press ENTER or ESC when you are done.

To change the Visual Style

- 1 Enter the VISUALSTYLES command.
- 2 In the Visual Styles Manager, double-click the sample image of the visual style.

The selected visual style is applied to your surface.

To improve the display of surfaces after a zoom operation (for example to get rid of pixelation), see [Viewing Raster Images](#) (page 674).

For information about walk and fly mode, 3D swivel, motion path animation, and other AutoCAD commands that can help you view data in 3D, please refer to the AutoCAD Help.

Quick Reference

3DPAN

Starts the interactive 3D view and enables you to drag the view horizontally and vertically

Icon



3D Pan

Command Line

3DPAN

3DZOOM

Zooms in and out on a view of your drawing

Icon



3D Zoom

Command Line

3DZOOM

3DORBIT

Controls the interactive viewing of objects in 3D

Icon



3D Constrained Orbit

Command Line

3DORBIT

3DFORBIT

Controls the interactive viewing of objects in 3D, using an unconstrained orbit

Icon



3D Free Orbit

Command Line

3DFORBIT

3DCORBIT

Starts an interactive 3D view and sets the objects into continuous motion

Icon



3D Continuous Orbit

Command Line

3DCORBIT

3DWALK

Interactively changes the view of a 3D drawing so that you appear to be walking through the model

Icon



3D Walk

Command Line

3DWALK

3DSWIVEL

Changes the target of the view in the direction that you drag

Icon



3D Swivel

Command Line

3DSWIVEL

3DDISTANCE

Starts the interactive 3D view and makes objects appear closer or farther away

Icon



3D Adjust Distance

Command Line

3DDISTANCE

Using Hillshading and Vertical Exaggeration

Hillshading adds shading to 3D surface layers by casting the sun's light across a surface from the direction and angle you specify.

Hillshading produces a more realistic image and helps you better understand the magnitude and relationships of the various elevation changes (that is, the bumps and valleys) on the surface.

Surface with hillshading

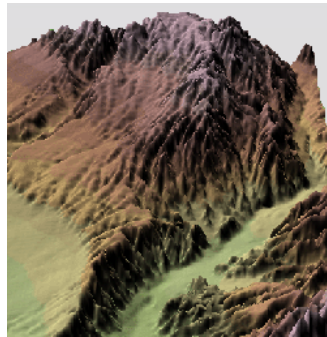

Surface without hillshading

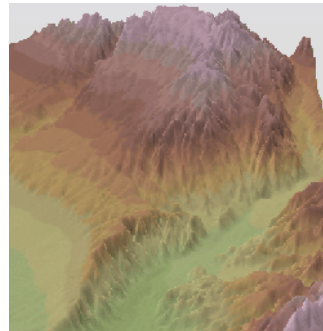

Hillshading is on by default for each surface layer in your map, however, you can choose to turn it off (or on again) at any time on a per layer basis.

You can change the sun settings that AutoCAD Map 3D uses to apply hillshading. These settings are used throughout AutoCAD Map 3D and are applied to all surface layers that have hillshading turned on.

You can also control the appearance of the elevation changes, making them appear more or less extreme, using the vertical exaggeration setting. Increasing the vertical exaggeration intensifies the hillshading, making the elevation changes appear more extreme. The vertical exaggeration setting is applied to all surfaces you are viewing.

In addition to these settings, you can use AutoCAD commands to change the appearance of surfaces. For example, you can use the `VISUALSTYLES` command to display the surface in 3D Wireframe, 3D Hidden, Realistic, and Conceptual. For more information, refer to the AutoCAD Help.

Tell me more



- *Show me how to color surfaces based on elevation.*
- *Show me how to adjust the settings for hillshading.*



- [To specify hillshading settings](#) (page 1200)



- Style Surfaces



- *Color a surface by elevation and adjust hillshading.*



- [Adding Raster-Based Surfaces to Your Map](#) (page 441)

- [To specify hillshading settings](#) (page 1200)
- [To turn hillshading on or off](#) (page 1201)
- [To change the vertical exaggeration](#) (page 1201)

To specify hillshading settings

- 1 Click Analyze tab ► Feature panel ► Surface Hillshade. 
- 2 In the [Hillshade Settings dialog box](#) (page 1562), specify the Direction and Angle of the sun you want to use for hillshading by doing one of the following:
 - Enter the direction and angle of the sun manually:
 - For Direction, specify the direction from which the light should come, for example, East or West. Enter a direction value into the edit box, drag the yellow disk in the compass to the position you want, or use Settings.

- For Angle, specify how high in the sky the light is located, such as near the horizon, directly overhead, or somewhere in between. Enter an angle into the edit box, drag the yellow disk to specify an angle, or use Settings
- Click Settings to specify sun settings in the Sun Properties palette using date, time, and location. Then, redisplay the Hillshade Settings dialog box and click Import.

3 Click OK.

To turn hillshading on or off

- 1 In the [Display Manager](#) (page 2060), right-click a surface layer, and click Edit Display Style.
- 2 Do one of the following:
 - To turn off hillshading, set the Hillshade Band to 0.
 - To turn on hillshading, set the Hillshade Band to 1 and verify that the Elevation Band is set to 1.

To change the vertical exaggeration

- In the status bar, for Exaggeration, select a vertical exaggeration value from the list. Select Custom to specify a value that is not in the list.

A higher number makes the elevation changes appear more extreme. A lower number or a decimal value makes it appear less extreme.

Quick Reference

MAPHILLSHADE

Specifies settings to use when shading 3D raster-based surfaces

Menu	Click Setup ► Hillshade Settings.
Command Line	MAPHILLSHADE
Dialog Box	Hillshade Settings dialog box

Theming Surfaces to Analyze Height, Slope, and Aspect

You can create a theme to change the display of a surface based on height (elevation), slope, or aspect (direction of slope).

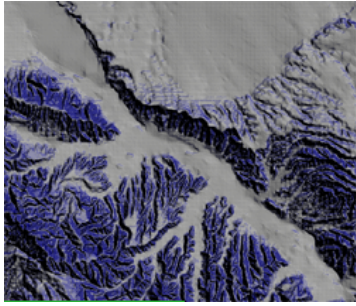
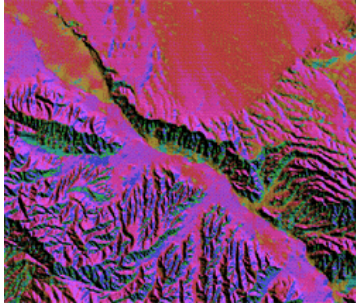
Surface Theme Type	Illustration
Height - Changes the display based on elevation.	
Slope - Changes the display based on ground slope or steepness. For example, you can use gray to show areas with a slope of less than 10%.	
Aspect - Varies the display based on the direction of ground slope.	

Create a theme on height to analyze the elevation data, a theme on slope to help you determine which areas are flat enough for developing houses, or a theme on aspect to help you find the best drainage routes.

Tell me more



Video

- [Show me how to perform a slope analysis of a surface.](#)



Procedures

- [To theme a surface to analyze height, slope or aspect](#) (page 1203)



Workflow

- [Style Surfaces](#)



GIS Skills

- [Analyze the slope and aspect of a site.](#)



Related topics

- [Adding Raster-Based Surfaces to Your Map](#) (page 441)
- [Changing Colors in a Themed Surface](#) (page 1204)
- [Theming Features](#) (page 1165)
- [Using Hillshading and Vertical Exaggeration](#) (page 1199)
- [Adding a Legend](#) (page 1116)
- [Defining Scale Ranges](#) (page 643)

To theme a surface to analyze height, slope or aspect

- 1 In [Display Manager](#) (page 2060), click a surface layer. Click the Style icon in the toolbar.
For information about adding a surface layer, see [Adding Raster-Based Surfaces to Your Map](#) (page 441).
- 2 In the Style Editor, under Scale Range, specify the scale threshold to use. For more information, see [Defining Scale Ranges](#) (page 643).
- 3 In the Band area, for Band 1, select Theme from the Style drop-down list.
- 4 In the Theme dialog box, for Property, select the property to theme on: Height, Slope, or Aspect.

- 5 Specify the other theming option, for example the palette to use. For more information, see [Theme dialog box](#) (page 1645).
- 6 In the Theme dialog box, click OK.
- 7 In the Style Editor, click Apply.

Quick Reference

Theme Surface Layer in Display Manager

Creates a theme for a surface layer in Display Manager. You can theme on height, slope, or aspect.

Task Pane In Display Manager, right-click a surface layer. Select Edit Display Style. In the Style Editor, in the Style list, select Theme.

Dialog Box Theme dialog box

Changing Colors in a Themed Surface

After you have created a theme for a surface, you can change one or more colors to make the image more realistic or to highlight a specific area or characteristic of the surface to help with further analysis.

For example, you might want to change the color of the lowest elevation in a canyon to blue to show that a river runs through it in the spring, or change a group of low elevations to red to highlight an area susceptible to flooding.

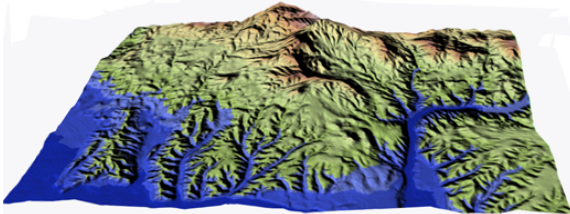

Colors of lowest elevations changed to blue

Tell me more



Video

- [Show me how to color surfaces based on elevation.](#)



Procedure

- [To change colors in a themed surface](#) (page 1205)



Workflow

- [Style Surfaces](#)



GIS Skills

- [Color a surface by elevation and adjust hillshading.](#)
- [Change the elevation ranges for a surface.](#)



Related topics

- [Theming Surfaces to Analyze Height, Slope, and Aspect](#) (page 1202)
- [Adding Raster-Based Surfaces to Your Map](#) (page 441)

To change colors in a themed surface

- 1 In [Display Manager](#) (page 2060), click a surface layer. Click the Style icon in the toolbar.
For information about adding a surface layer, see [Adding Raster-Based Surfaces to Your Map](#) (page 441).
- 2 In the Style Editor, click Band Detail.
- 3 Click the band to change.
For example, for a theme on height, you can select the first band to change the color of the lowest elevation
- 4 Click the down arrow in the band color cell, and choose a new color.
- 5 Click All Bands.
- 6 Click Apply.

Quick Reference

Theme Feature Layer in Display Manager

Creates a theme for a feature layer in Display Manager

Task Pane In Display Manager, right-click a feature layer. Select Edit Style. In the Style Editor, click the New Theme button.

Dialog Box Theme dialog box

Finding and Selecting Data

You can find, select, and filter features and drawing objects in your maps, but the methods you use for features and drawing objects are different.

To find and select features, you can use Filter or Search to Select in the [Data Table](#) (page 2059), the Search interface, or Query To Filter in Display Manager.

To find and select drawing objects, you can use Quick Select, the Data View, or drawing queries.

To find, filter, and query data

- [To find and select features](#) (page 1206)
- [To find and query drawing objects](#) (page 1218)

Finding and Selecting Features

AutoCAD Map 3D provides a few different ways to find, filter, and select just the features you need to work with.

NOTE For information about finding, filtering, and selecting drawing objects, see [Overview of Finding and Querying Drawing Objects](#) (page 1219).

NOTE For information about finding, filtering, and selecting drawing objects, see [Overview of Finding and Querying Drawing Objects](#) (page 1219).

To find and select features

- [To find a subset of data in the Data Table](#) (page 1212)
- [To clear the filter and display all records](#) (page 1212)

- To search to select data (page 1212)
- To search for and select features (page 1214)
- To filter feature layers (page 1217)

Overview of Finding and Selecting Features

You can find and focus on a specific subset of features so you do not have to review the entire set of data manually to find what you need.

NOTE For information about finding and selecting drawing objects, see [Overview of Queries](#) (page 1235) and [Using Quick Select to Select Drawing Objects](#) (page 1219).

Autogenerated_S	ADDRESS	STNAME	APN	ACRES	AREA
16319	915	GROUSE DR	117300004000	0.165	7199.12
16360	818	GROUSE DR	117310036000	0.157	6821.137
16361	824	GROUSE DR	117310035000	0.158	6888.34
16362	830	GROUSE DR	117310034000	0.158	6888.34
16363	836	GROUSE DR	117310033000	0.158	6888.34
16364	842	GROUSE DR	117310032000	0.158	6888.34
16366	854	GROUSE DR	117310030000	0.158	6888.34
16367	860	GROUSE DR	117310029000	0.158	6888.34
16368	866	GROUSE DR	117310028000	0.158	6888.34
16369	872	GROUSE DR	117310027000	0.158	6888.412

Use Filter By in the Data Table to filter a feature class using criteria based on a column of data.

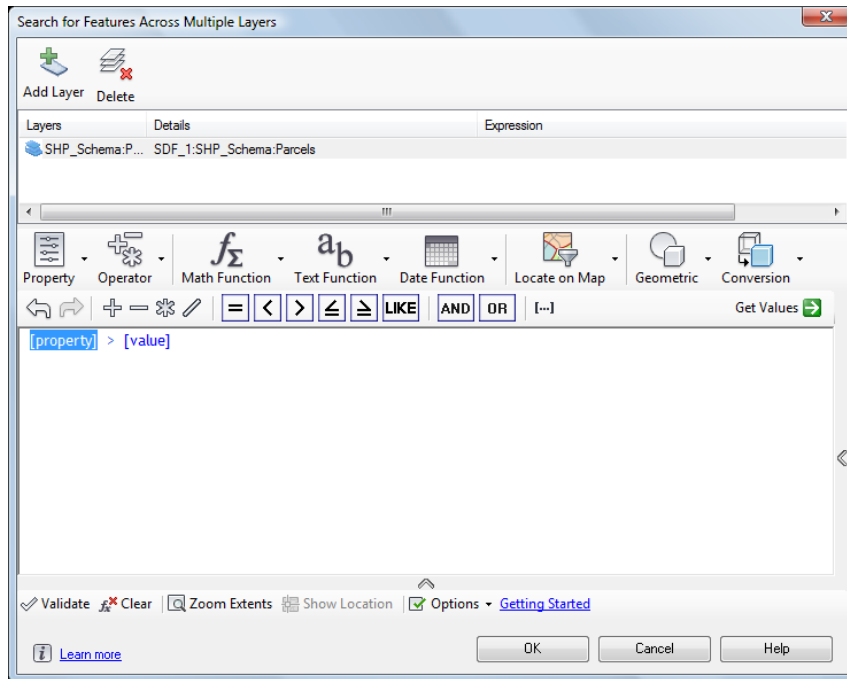

Use Search when you need a more comprehensive way to find features in map.

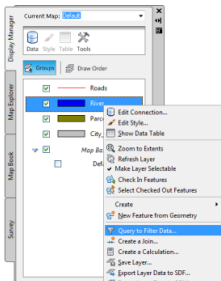

A query is like Search. You define the set of criteria to find and bring in just the data you want.

TIP Using a filter can help you improve performance when working with large sets of feature data. You can filter data **after** you bring it into your map, or you can use Add To Map With Query to apply a filter **while** you bring in the data.

See also:

- [Editing Features using the Data Table](#) (page 711)
- [Bringing in GIS Features](#) (page 308)
- [Overview of Creating Expressions](#)

Use these techniques to find and focus on a specific subset of features to work with.

NOTE For information about finding and selecting drawing objects, see [Overview of Queries](#) (page 1235) and [Using Quick Select to Select Drawing Objects](#) (page 1219).

Method	Description
Filter (Data Table) (page 1210)	Limit the number of records displayed in the Data Table to those that match the criteria you specify. You can zoom to, select, save, or print the filtered results in the map. For example, find the rows of Road data in which Type = Major Road or Address = GROUSE DR, and highlight those features in the map.
Search to Select (Data Table) (page 1210)	Find data that meets conditions that you specify. When AutoCAD Map 3D completes the search query, it highlights the data rows in the Data Table and the associated features on your map. For example, search for all parcels with an area greater than five acres.
Search (in map) (page 1214)	Define attribute and spatial search criteria, combine multiple criteria to create complex searches, and search across multiple feature classes in your map. Features that meet your Search criteria are selected in the map.

Method	Description
Filter Feature Layers (Data Connect or Display Manager) (page 1216)	To reduce the scope of feature layers in your map, you can edit the query that brings in the data. For example, if your map has an SDF layer containing all the parcels in California and you want only the parcels in San Francisco, you can edit the query so that the layer displays only the parcels you want.

Finding and Filtering Data in the Data Table

Use a filter in the Data Table to display only the features or records you want to work with.

NOTE For information about filtering drawing objects, see [Overview of Queries](#) (page 1235) and [Overview of Finding Records in a Linked Database](#) (page 1222).

NOTE When viewing joined data, the Data Table filter function is disabled. You cannot use a filter on joined data.

Start by identifying the column whose values determine whether a feature or record will be included in the results. Then specify the value or string to look for in that column.

The records that match your criteria are selected in the Data Table and highlighted in your map.

For example, to find only the telephone poles with transformers, your filter would specify PoleAttachments equal to Transformer; or to find only the commercial districts in a city, you would specify Land Use equal to Commercial.

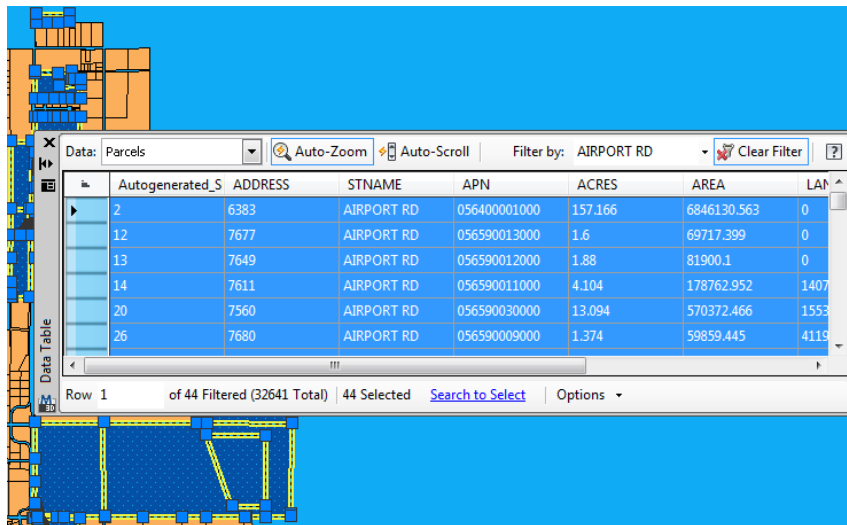

Finding and selecting parcel features with STNAME = AIRPORT RD

Use Filter with Auto-Zoom to magnify the resulting features in the map.

To remove a filter, specify another one, or click Clear Filter in the Data Table.

Searching to Select Data in the Data Table

Use Search To Select in the Data Table to find data that meets conditions that you specify. For example, you can search for all parcels with an area greater than five acres. When AutoCAD Map 3D completes the search, it highlights the data rows in the Data Table and the associated features on your map.

Search supports more advanced criteria, and lets you combine multiple criteria and search across multiple feature classes in your map.

See also:

- [Overview of the Data Table](#) (page 1125)
- [Zooming to a View Using the Data Table](#) (page 1141)
- [Exporting and Printing Data from the Data Table](#) (page 1142)

NOTE For information about filtering drawing objects, see [Overview of Queries](#) (page 1235) and [Overview of Finding Records in a Linked Database](#) (page 1222).

- [To find a subset of data in the Data Table](#) (page 1212)

- [To clear the filter and display all records](#) (page 1212)

- [To search to select data](#) (page 1212)

To find a subset of data in the Data Table

- 1 In Display Manager, select the feature layer to search.
For information about creating a new feature layer, see [Bringing in GIS Features](#) (page 303).
- 2 Click .
- 3 In the [Data Table dialog box](#) (page 1613), change the data source in the Data list if necessary.
- 4 For Filter By, select the column to search, for example, City or Owner Name.
- 5 The label changes to show your column selection.
- 6 In the Filter By box, enter the value to look for.
For example, to find all parcels in the city of Bonn, enter BONN. The string you enter must exactly match the data in the column to be included in the results.
- 7 To zoom to the features in your map, click Auto-Zoom.
- 8 Click Apply Filter.
- 9 The features or records that match your criteria are displayed in the Data Table.
- 10 Select a row in the Data Table to see that feature highlighted in your map. If Auto-Zoom is on, you will zoom to the selected features.

To clear the filter and display all records

- In the Data Table, click Clear Filter , or create a different filter.

To search to select data

- 1 Select the layer in Display Manager that contains the feature class data you want to view.
- 2 Click  on the toolbar to open the Data Table window.

- 3 On the lower bar of the [Data Table dialog box](#) (page 1613), click Search To Select.
- 4 Create an expression for your search. You can create the following types of expressions:
 - **Property Evaluation** expressions compare the value of a property to a value you specify. For example, you can find parcels with an area greater than a value you specify, or streets with a particular number of lanes.
 - **Location Conditions** find data based on its location in the map. For example, you can draw a circle to find all parcels within that circle.

You can save your expression for reuse.
- 5 To create a complex property evaluation, insert an AND or OR operator, and then insert another property, operator, and value combination. Every operator must be preceded by a property. For example, to find parcels whose last purchase date is after 1990 and before 2005, the expression must look like this:

```
Purchase_Date > 1990 AND Purchase_Date < 2005
```
- 6 Validate your expression.
- 7 To reuse your expression in the future, from the Options list in the Search To Select dialog box, select Save Expression.
- 8 When the expression is complete and valid, click OK.

When AutoCAD Map 3D has completed the search, it highlights both the selected rows in the Data Table and the associated features on your map.

Quick Reference

MAPDATATABLE

Allows you to view, edit, and filter feature data

Menu	Click Edit ► Data Table.
Icon	 Table
Command Line	MAPDATATABLE

Task Pane	In Map Explorer or Display Manager, click the Table button
Dialog Box	Data Table Dialog Box

Searching For and Selecting Features

Use the Search command in AutoCAD Map 3D to find and select features in your map based on their location or properties.

NOTE For information about searching for and selecting drawing objects, see [Overview of Queries](#) (page 1235).

A search specifies a set of conditions (also referred to as criteria or rules) that must be true for a feature to be found and selected. A Search can have one or more sets of conditions. You can search the entire map (for example, across multiple feature classes).

For example, you can find just the roads in Shanghai within a circular area you specify. To do this, you specify criteria that limits the results to road features whose City field is "Shanghai" and within the a circle you define.

NOTE To find data in a single feature class based on a single property, you can also [search to select](#) (page 1210) in the Data Table.

See also:

- [Finding and Filtering Data in the Data Table](#) (page 1210)
- [Overview of Finding and Selecting Features](#) (page 1207)
- Overview of Creating Expressions

NOTE For information about searching for and selecting drawing objects, see [Overview of Queries](#) (page 1235).

To search for and select features

- 1 Make sure that you are connected to the feature sources for the feature layers you are searching.
For more information, see [Bringing in GIS Features](#) (page 303).

- 2 Click Home tab ► Data panel ► Search.



- 3 In the Search dialog box, click Add Layer to select the layers to search.
- 4 If you are creating a location condition, click Zoom Extents to zoom the drawing window to the extents of the selected feature classes.
- 5 Create an expression for your search. You can create the following types of expressions:
 - Property Evaluation expressions compare the value of a property to a value you specify. For example, you can find parcels with an area greater than a value you specify, or streets with a particular number of lanes.
 - Location Conditions find data based on its location in the map. For example, you can draw a circle to find all parcels within that circle.

You can save your expression for reuse.

- 6 To create a complex property evaluation, insert an AND or OR operator, and then insert another property, operator, and value combination. Every operator must be preceded by a property. For example, to find parcels whose last purchase date is after 1990 and before 2005, the expression must look like this:

```
Purchase_Date > 1990 AND Purchase_Date < 2005
```

- 7 Validate your expression.
- 8 When the expression is complete and valid, click OK. When AutoCAD Map 3D has completed the search, it highlights both the selected rows in the [Data Table dialog box](#) (page 1613) and the associated features on your map.

Quick Reference

MAPSEARCH

Searches and selects features in your map based on the location and attribute criteria you specify

Menu	Click Edit ► Search.
Icon	 Search
Command Line	MAPSEARCH

Filtering Feature Layers

Filter one or more feature source layers so that only some of the features appear in your map.

NOTE For information about filtering drawing objects, see [Overview of Queries](#) (page 1235).

To filter the layers, define a query condition or a set of conditions that specify which features you want. The procedure is like performing a search.

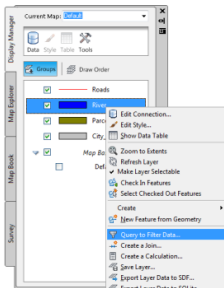

Apply a query to layers so that only some features appear in your map

TIP Using the filter can help you improve performance when working with large sets of feature data. You can filter data after you bring it into your map, or you can use the Add To Map With Query option *while* bringing it in and then use edit query to apply a filter.

You can create a single filter for multiple layers from different data sources, as long as they share the property you are filtering on. For example, if you have an SDF layer of parcels, a SHP layer of parks, and an Oracle layer of hospitals, and they all share a STREET_NAME property, you can filter by street name. You can filter by location for any layers that overlap in space.

You can also create a filter for a group, as long as all the layers in that group are feature layers (not drawing layers) and all the feature layers contain features (that is, none of them are empty).

See also:

- [Filtering Features When You Add Them to a Map](#) (page 309)

- [Searching For and Selecting Features](#) (page 1214)
- [Bringing in GIS Features](#) (page 308)
- [Creating Expressions - Reference](#)

NOTE For information about searching for and selecting drawing objects, see [Overview of Queries](#) (page 1235).

To filter feature layers

- 1 Make sure that you are connected to the feature sources for the feature layers or groups to filter.
For more information, see [Bringing in GIS Features](#) (page 303).
- 2 In the Display Manager, select the layer, layers, or group to filter.
Use Ctrl-click or Shift-click to select multiple layers.
- 3 Right-click any layer or group in the selection and click Query To Filter Data.

NOTE Once you use this command, the command name for the affected layers changes to Layer Filter, with options for Edit Layer Filter and Delete Layer Filter.

- 4 To add more feature layers to the data being searched by the expression, click Add Layer and select the layer to add. To delete a layer, select it in the list and click Delete.
The list of layers at the top of the window shows any existing filters for the selected layers. If the layers use a common query (specifying a property that all the layers have in common), that query is listed separately.
- 5 If you are creating a location condition, click Zoom Extents to zoom the drawing window to the extents of the selected feature class.
- 6 Create an expression for your filter. You can create the following types of expressions:
 - **Property Evaluation** expressions compare the value of a property to a value you specify. For example, you can find parcels with an area greater than a value you specify, or streets with a particular number of lanes.
 - **Location Conditions** find data based on its location in the map. For example, you can draw a circle to find all parcels within that circle.

You can save your expression for reuse.

- 7 To create a complex property evaluation, insert an AND or OR operator, and then insert another property, operator, and value combination.

Every operator must be preceded by a property. For example, to find parcels whose last purchase date is after 1990 and before 2005, the expression must look like this:

```
Purchase_Date > 1990 AND Purchase_Date < 2005
```

- 8 Validate your expression.
- 9 When the expression is complete and valid, click OK.

When AutoCAD Map 3D has completed the search, it highlights both the selected rows in the Data Table and the associated features on your map.

Finding and Querying Drawing Objects

AutoCAD Map 3D provides a few different ways to find, filter, and select just the drawing objects you need to work with.

NOTE For information on finding, filtering, and selecting geospatial features, see [Overview of Finding and Selecting Features](#) (page 1209).

NOTE For information on finding, filtering, and selecting geospatial features, see [Overview of Finding and Selecting Features](#) (page 1209).

To find and query drawing objects

- [To select drawing objects using Quick Select](#) (page 1220)
- [To find records in a database linked to drawing objects](#) (page 1221)
- [To query objects from attached drawings](#) (page 1235)

Overview of Finding and Querying Drawing Objects

Use Quick Select, Data View, and queries to find drawing objects that match a set of criteria. These methods work for drawing objects only.

NOTE For information on finding, filtering, and selecting geospatial features, see [Overview of Finding and Selecting Features](#) (page 1209).

Use these methods to find and select drawing objects.

NOTE For information on finding, filtering, and selecting geospatial features, see [Overview of Finding and Selecting Features](#) (page 1209).

Method	Description
Quick Select (page 1219)	Select drawing objects based on their object properties (such as color), object types, or object classification, or to exclude drawing objects from a selection set. For example, you can select all of the red road objects in a drawing without selecting any other object, or you can select all objects except the red roads.
Data View (page 1221)	Find records in an attached database. If database records are linked to objects in a drawing, you can highlight records linked to objects you select.
Queries (page 1235)	Use queries to retrieve drawing objects and transform them if needed.

Using Quick Select to Select Drawing Objects

You can use Quick Select (QSELECT) to select drawing objects based on their object properties (such as color), object types, or object classification. You can also use Quick Select to exclude drawing objects from a selection set.

NOTE For information on selecting geospatial features, see [Searching For and Selecting Features](#) (page 1214).

For example, you can select all of the red road objects in a drawing without selecting any other object, or you can select all objects except the red roads.

When using Quick Select to select drawing objects based on color, linetype, or line weight, first consider whether these properties are set to BYLAYER in the AutoCAD layer definition. For example, an object may appear red because its color is set to BYLAYER and the layer color is red.

See also:

- [Finding Records in a Database Linked to Drawing Objects](#) (page 1221)
- [Querying Objects from Attached Drawings](#) (page 1235)

For more information about AutoCAD layer definitions, please refer to the AutoCAD Help.

NOTE This procedure applies only to drawing objects. For information on selecting geospatial features, see [Searching For and Selecting Features](#) (page 1214).

To select drawing objects using Quick Select

- 1 Verify that you have drawing objects in your map.
- 2 Enter the QSELECT command.
- 3 In the Quick Select dialog box, under Apply To, select Entire Drawing or the current selection set (if one exists).
To select a group of objects to which you want to apply the filtering criteria, click Select Objects.
- 4 Under Object Type, select a single object type if the objects you want are all one type. Otherwise, select Multiple.
- 5 Under Properties, select the property to use for selection.
For example, to find red objects, select Color.
- 6 Under Operator, select the appropriate operator.
For example, to find red objects, select Equals.
- 7 Under Value, select the appropriate value.
For example, to find red objects, select Red.
- 8 Under How to Apply, select Include in New Selection Set to create a new selection set composed only of objects that match the filtering criteria. Select Exclude From New Selection Set to create a new selection set composed only of objects that do not match the filtering criteria..
- 9 Click OK.
In this example, all red objects in the drawing are selected. Objects that are set to BYLAYER and are red because the layer color is red are not included in the selection set.

For more information about using Quick Select to select or exclude drawing objects, please refer to the AutoCAD Help.

Finding Records in a Database Linked to Drawing Objects

Using the Data View, you can find records in an attached database. If database records are linked to objects in a drawing, you can highlight records linked to objects you select.

NOTE This functionality applies only to drawing objects. For information about working with records for geospatial features, see [Finding and Filtering Data in the Data Table](#) (page 1210)

- [Overview of Finding Records in a Linked Database](#) (page 1222)
- [Finding a Database Record](#) (page 1224)
- [Highlighting Drawing Objects Linked to a Database Record](#) (page 1225)
- [Highlighting Records Linked to a Selected Object](#) (page 1228)
- [Finding Records in the Data View Based on Record Data \(SQL Queries\)](#) (page 1230)
- [Finding Data View Records Based on Object Location](#) (page 1233)

You can also bring in drawing data based on attached data and find all drawing objects containing specific SQL information.

See also:

- [Overview of Finding and Querying Drawing Objects](#) (page 1218)
- [Bringing In Drawing Objects Based on Attached Data](#) (page 363)
- [Finding All Drawing Objects Containing Specific SQL Information](#) (page 1249)
- [Altering the Properties of Queried Drawing Objects](#) (page 1259)
- [Finding and Selecting Features](#) (page 1206)

NOTE These procedures apply only to drawing objects. For information about working with feature data, see [Finding and Selecting Features](#) (page 1206).

To find records in a database linked to drawing objects

- [To find a database record in the Data View](#) (page 1225)
- [To highlight drawing objects linked to a database record](#) (page 1227)

- [To set other Data View highlighting options](#) (page 1227)
- [To highlight records linked to drawing objects](#) (page 1229)
- [To set the record highlight color](#) (page 1229)
- [To use a SQL filter in the Data View](#) (page 1231)
- [To use a spatial filter in the Data View](#) (page 1234)

Overview of Finding Records in a Linked Database

After you create a link between a record in the database table and an object in a drawing, you can use the information in the database table to help you analyze, select, and display objects in your drawing. For example, you can use data from a linked database table to find all pipes installed before 1965.

NOTE These procedures apply only to drawing objects. To join external data to geospatial features, see [Overview of Joins](#) (page 507). To use the Data Table to search that data, see [Finding and Filtering Data in the Data Table](#) (page 1210).

See also:

- [Overview of Linking Database Records to Objects](#) (page 522)
- [Viewing External Data Linked to Drawing Objects](#) (page 1146)
- [Overview of Queries](#) (page 1235)
- [Altering the Properties of Queried Drawing Objects](#) (page 1259)
- [Joining Data to GIS Features](#) (page 507)

NOTE These procedures apply only to drawing objects. To join external data to geospatial features, see [Overview of Joins](#) (page 507). To use the Data Table to search that data, see [Finding and Filtering Data in the Data Table](#) (page 1210).

Use database links to do the following:

To do this...	Use this method...
Find a database record	Use Data View to search the linked database. (page 1225)
Highlight objects in the drawing that are linked to selected records in the database table.	Use Data View to highlight the objects. (page 1227)

To do this...	Use this method...
See which records are linked to selected objects.	Use Data View to highlight the records. (page 1229)
Display only records whose data matches the conditions you specify.	Use a SQL filter in Data View. (page 1231)
Display only records that are linked to drawing objects you select in the drawing.	Use a spatial filter in Data View. (page 1234)
Print linked data.	Print the current contents of Data View. (page 1475)

NOTE These procedures apply only to drawing objects.

See also:

- [Highlighting Features Using the Data Table](#) (page 1136)

Quick Reference

(Data View) AutoHighlight

When records are selected, automatically highlights objects in the drawing linked to the records

Menu In the Data View: Highlight ► Auto Highlight

(Data View) AutoZoom

When records are selected or deselected, automatically adjusts the zoom so that the objects linked to the selected records fill the percent of the screen specified by the Zoom Scale command

Menu In the Data View: Highlight ► Auto Zoom

(Data View) Link Records to Objects

Links the selected records to objects in your drawing

Menu In the Data View: Links ► Link Records To Objects

Icon



Link Records to Objects

(Data View) Zoom Scale

Specifies the percent of the drawing display that the selected objects will occupy

Menu In the Data View: Highlight ► Zoom Scale

Dialog Box Zoom Scale dialog box

Finding a Database Record

Using the Data View, you can search for text strings in a database table.

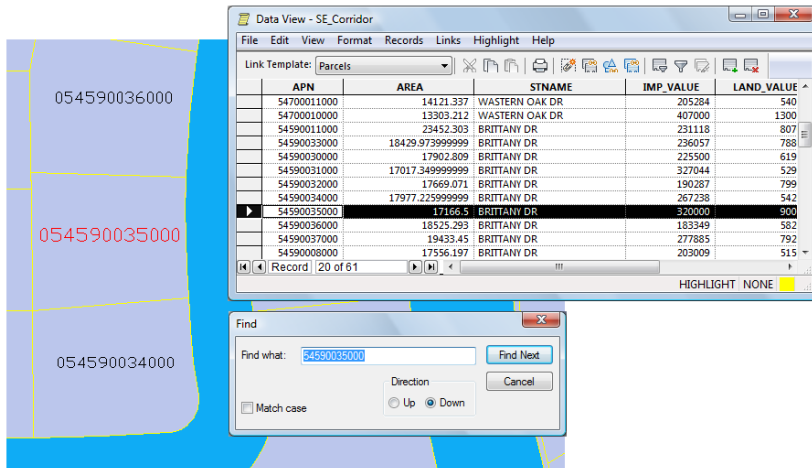

The entered text must match the record exactly.

To use Replace, the table must be open in Edit mode and AutoCommit must be turned off.

NOTE Data View is for drawing objects. Use the [Data Table](#) (page 1210) for geospatial feature data.

See also:

- [Opening a Database Table](#) (page 1052)

- [Editing a Database](#) (page 1055)
- [Changing the Look of the Data View](#) (page 1057)
- [Finding and Selecting Features](#) (page 1206)

To find a database record in the Data View

- 1 Open a database table in the Data View. See [Opening a Database Table](#) (page 1052).
- 2 Position the cursor in the column you want to search.
- 3 Do one of the following:
 - In the Data View, click Edit menu ► Find.
 - In the Data View, click Edit menu ► Replace.
- 4 In the dialog box, enter the characters to find. For Replace, enter the replacement text.
- 5 For Find, click Find Next.
For Replace, click Replace to replace this instance and find the next instance. Click Replace All to replace all instances automatically.

Quick Reference

(Data View) Find

Finds specified text

Menu In the Data View:Edit ► Find

Highlighting Drawing Objects Linked to a Database Record

After you link database records to objects in a drawing, you can highlight objects in the drawing that are linked to selected records in the database table.

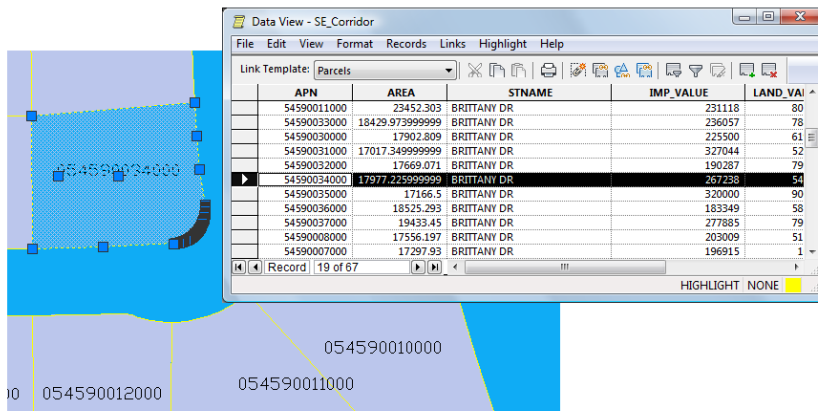

Highlight parcels that are linked to selected records in a database table.

You can set the following options:

- Automatically highlight objects linked to the records you select
- Automatically zoom in on highlighted objects
- Automatically create a selection set of highlighted objects

NOTE Once you set AutoZoom, Zoom Scale, and AutoHighlight, these settings stay in effect for every drawing until you change them.

NOTE Use the Data Table to highlight features. See [Highlighting Features Using the Data Table](#) (page 1136), [Highlighting Data Table Rows Using the Map](#) (page 1138), and [Zooming to a View Using the Data Table](#) (page 1140).

See also:

- [Opening a Database Table](#) (page 1052)
- [Editing a Database](#) (page 1055)
- [Changing the Look of the Data View](#) (page 1057)
- [Finding and Selecting Features](#) (page 1206)

To highlight drawing objects linked to a database record

- 1 Open a linked database table in the Data View. See [Opening a Database Table](#) (page 1052).
- 2 In the Data View window, select a record.
- 3 In the Data View, click Highlight menu ► Highlight Objects.

NOTE This command is available only if you selected a link template for the table.

Objects that are linked to the selected record are highlighted.

To clear the highlighting, enter regen on the Command line.

To set other Data View highlighting options

- Dynamically highlight linked objects – In the Data View, click Highlight menu ► AutoHighlight. When you select a record in the table, AutoCAD Map 3D automatically highlights linked objects.
- Dynamically zoom to linked objects – Make sure AutoHighlight is on. In the Data View, click Highlight menu ► AutoZoom. When you select a record in the table, AutoCAD Map 3D zooms to linked objects. You can change the zoom scale so that the linked objects take up more or less of the screen. In the Data View, click Highlight menu ► Zoom Scale and enter a value.
- Dynamically add highlighted objects to the selection set – In the Data View, click Highlight menu ► AutoSelect.

Quick Reference

(Data View) AutoHighlight

When records are selected, automatically highlights objects in the drawing linked to the records

Menu In the Data View: Highlight ► Auto Highlight

(Data View) AutoZoom

When records are selected or deselected, automatically adjusts the zoom so that the objects linked to the selected records fill the percent of the screen specified by the Zoom Scale command

Menu In the Data View: Highlight ► Auto Zoom

(Data View) Link Records to Objects

Links the selected records to objects in your drawing

Menu In the Data View: Links ► Link Records To Objects

Icon  Link Records to Objects

(Data View) Zoom Scale

Specifies the percent of the drawing display that the selected objects will occupy

Menu In the Data View: Highlight ► Zoom Scale

Dialog Box Zoom Scale dialog box

Highlighting Records Linked to a Selected Object

If objects in a drawing are linked to records in a database table, you can use the Data View to see which records are linked to selected objects.

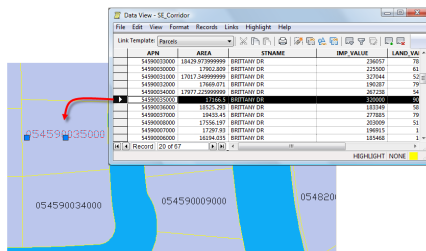

When you select an object in the drawing, linked records are highlighted in the Data View.

See also:

- [Opening a Database Table](#) (page 1052)
- [Editing a Database](#) (page 1055)

- [Changing the Look of the Data View](#) (page 1057)
- [Finding Records in the Data View Based on Record Data \(SQL Queries\)](#) (page 1230)
- [Finding Data View Records Based on Object Location](#) (page 1233)
- [Finding and Selecting Features](#) (page 1206)

To highlight records linked to drawing objects

- 1 Open a linked database table in the Data View. See [Opening a Database Table](#) (page 1052).
- 2 In the Data View, click Highlight menu ► Highlight Records ► Select Object.
- 3 Select the objects in your drawing. Press Enter.
- 4 Use the highlighted records toolbar to move to the first, previous, next, or last highlighted record.
- 5 Optionally, show only highlighted records. In the Data View, click Highlight menu ► Show Highlighted Records Only.

TIP To improve performance, [create a filter](#) (page 1231) to display only relevant records.

To clear the highlighting, click  on the highlight toolbar.

To set the record highlight color

- 1 Do one of the following:
 - In the Data View, click Highlight menu ► Highlight Color.
 - In the status bar, double-click the highlight color.
- 2 In the Select Color dialog box, specify a color. Click OK.

Quick Reference

(Data View) Clear Highlight

Removes the highlighting from records in the table

Menu In the Data View: Highlight ► Highlight Records ► Clear Highlight

Icon  Clear Highlight

(Data View) Highlight Color

Selects the color to use to highlight records with the Highlight Records command

Menu In the Data View: Highlight ► Highlight Color

(Data View) Highlight Records

Highlights records that match objects you select in the drawing

Menu In the Data View: Highlight ► Highlight Records ► Select Objects

Icon  Highlight Records

(Data View) Show Highlighted Records Only

Displays only the currently highlighted records

Menu In the Data View: Highlight ► Show Highlighted Records Only

Finding Records in the Data View Based on Record Data (SQL Queries)

Use a SQL filter in the Data View to display only records whose data matches the conditions you specify. For example, view only records with a specific street name or records where the property value is over a specific amount.

NOTE This functionality applies only to drawing objects. For information on filtering geospatial feature data, see [Using Expressions to Select Feature Data](#) (page 1131).

Filters can improve performance in scrolling through records or in highlighting records.

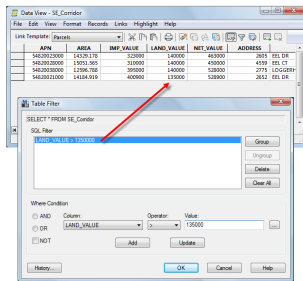

Use a SQL filter to view only records whose data matches specified conditions.

NOTE You can also filter records based on the location of linked objects. If both a SQL filter and a spatial filter are defined, the Data View displays only those records that match both filters.

You can set an option to determine how many filters AutoCAD Map 3D stores.

See also:

- [Opening a Database Table](#) (page 1052)
- [Editing a Database](#) (page 1055)
- [Setting Data View Options](#) (page 237)
- [Changing the Look of the Data View](#) (page 1057)
- [Finding Data View Records Based on Object Location](#) (page 1233)

NOTE This procedure applies only to drawing objects. For information on filtering geospatial feature data, see [Using Expressions to Select Feature Data](#) (page 1131).

To use a SQL filter in the Data View

- 1 Open a database table in the Data View. See [Opening a Database Table](#) (page 1052).
- 2 In the Data View, click Records menu ► SQL Filter.
- 3 In the [Table Filter dialog box](#) (page 1693), define the condition for the filter. To select from a list of conditions previously defined for this table, click History and select the condition. To define a new condition:
 - Under Where Condition, select the column to use as a filter.

- Select an operator.
To use wild-card characters, select the LIKE operator. For example, to list only those streets that begin with the letter C, select the LIKE operator and enter C% in the Value box. Wild-card characters can be used only with string values. For information on wild-card characters, refer to the documentation for your database system software.
- Enter a value or click... to select from the list of possible values.
- After setting your criteria, click Add.

The conditions you set appear in the SQL Filter list.

- 4 To add additional conditions, select AND or OR. Create and add the new condition.
- 5 Click OK.

The Data View displays only those records that match the filter.

You can clear all filters. In the Data View, click Records menu ► Clear Filter.

Quick Reference

(Data View) Clear Filter

Eliminates all current filters and requeries the database

Menu In the Data View: Records ► Clear Filter

Icon  Clear Filter

(Data View) SQL Filter

Displays only records that match conditions you specify

Menu In the Data View: Records ► SQL Filter

Icon  SQL Filter

Dialog Box Table Filter dialog box

Finding Data View Records Based on Object Location

Use a spatial filter to display only records that are linked to drawing objects you select in the drawing.

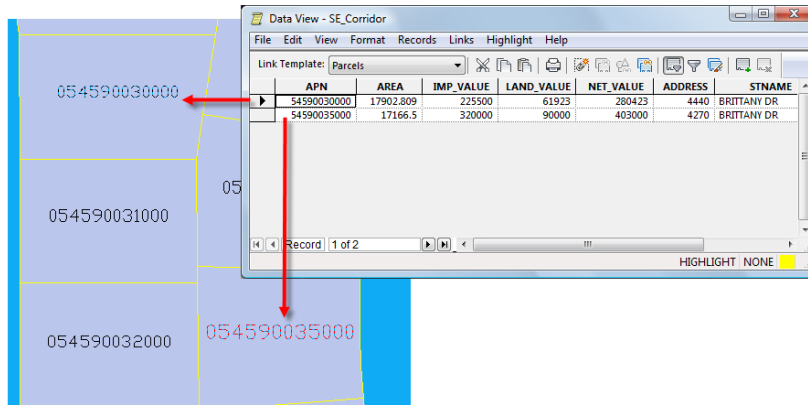

When you apply a spatial filter, the Data View displays only those records that are linked to selected objects in the drawing.

NOTE You can also filter records based on the data in the record. If both a SQL filter and a spatial filter are defined, the Data View displays only those records that match both filters.

NOTE This functionality applies only to drawing objects. For information on filtering geospatial feature data by location, see [Using Expressions to Select Feature Data](#) (page 1131).

See also:

- [Opening a Database Table](#) (page 1052)
- [Editing a Database](#) (page 1055)
- [Setting Data View Options](#) (page 237)
- [Changing the Look of the Data View](#) (page 1057)
- [Finding Records in the Data View Based on Record Data \(SQL Queries\)](#) (page 1230)

NOTE The following procedure applies only to drawing objects. For information about feature data, see [Using Expressions to Select Feature Data](#) (page 1131). In addition, the Spatial Filter command is available only if you have a selected a link template for the table. See [Overview of Linking Database Records to Objects](#) (page 522).

To use a spatial filter in the Data View

- 1 Open a database table in the Data View. See [Opening a Database Table](#) (page 1052).
- 2 Do one of the following:
 - In the Data View, click Records menu ► Spatial Filter.
 - From the toolbar, click .
- 3 Select objects.
- 4 Click OK.

The Data View displays only those records that are linked to the selected objects.

To clear all filters in the Data View – In the Data View, click Records menu ► Clear Filter.

See also:

- [To create a link template](#) (page 526)
- [Overview of Linking Database Records to Objects](#) (page 522)
- [Finding Records in the Data View Based on Record Data \(SQL Queries\)](#) (page 1230)

Quick Reference

(Data View) Clear Filter

Eliminates all current filters and requeries the database

Menu In the Data View: Records ► Clear Filter

Icon  Clear Filter

(Data View) Spatial Filter

Displays only records attached to objects that you select

Menu In the Data View: Records ► Spatial Filter

Icon  Spatial Filter

Querying Objects from Attached Drawings

To query objects from attached drawings

- [To create a query to retrieve information from attached drawings](#) (page 1237)
- [To retrieve drawing objects based on their location](#) (page 1241)
- [To retrieve drawing objects based on their properties](#) (page 1244)
- [To retrieve drawing objects based on their object data](#) (page 1248)
- [To retrieve drawing objects based on linked SQL data](#) (page 1253)
- [To combine query conditions in drawing queries](#) (page 1256)
- [To edit a drawing query condition](#) (page 1258)
- [To modify objects as they are retrieved by a query](#) (page 1259)
- [To execute a drawing query](#) (page 1287)
- [To improve performance](#) (page 1292)
- [To set options for drawing queries](#) (page 1300)

Overview of Queries

Use queries to retrieve the drawing objects you need from attached drawings. When you define a query, you specify the criteria for selecting objects in one or more drawings. You can use four types of criteria: location, property, data, and SQL. A query searches the active attached drawings, selects the objects that match the conditions you specify, and copies the objects to the current drawing.

Only objects in the Model Tab (model space) are queried. Objects from the Layout Tab (paper space) are ignored.







You can view and edit the objects, then save them to a new drawing or save them back to their original drawing.

NOTE This functionality applies only to drawing objects. For information on filtering geospatial feature data, see [Using Expressions to Select Feature Data](#) (page 1131).

Markup Objects

Because markup objects are not stored in the drawing file, you cannot query these objects. To copy them from an attached drawing to the current drawing, open the other drawing directly and copy the markup objects. Then paste them into the current drawing.

Tell me more

 Video	■ <i>Show me how to run a query on a set of attached DWG files.</i>
 Procedures	■ To find and select drawing objects (page 1219)
 GIS Skills	■ <i>Bring in a subset of features using a query.</i>
 Tutorial	■ Exercise 3: Query in data from the drawing
 Workflow	■ Find and Edit Objects in Attached Drawings
 Related topics	■ Attaching Drawings (page 154) ■ Activating a Drawing (page 159) ■ To save a query (page 177) ■ Editing and Saving Objects in Attached Drawings (page 737)

NOTE This procedure applies only to drawing objects. For information on filtering geospatial feature data, see [Using Expressions to Select Feature Data](#) (page 1131).

To create a query to retrieve information from attached drawings

- 1 Open a drawing.
- 2 In [Map Explorer](#) (page 2068), under Current Drawing, right-click the Drawings folder. Click Define/ModifyDrawing Set.
- 3 Make sure that the drawings you want to query are attached and active.
- 4 In [Map Explorer](#) (page 2068), under Current Drawing, right-click Current Query, and then click Define.
- 5 To zoom to the extents of all active drawings, click Zoom Ext in the Define Query Of Attached Drawings dialog box.
- 6 In the [Define Query dialog box](#) (page 1838), select a Query Type to define a condition for your query based on:
 - [Location](#) (page 1241)— such as inside a window you define.
 - [Property](#) (page 1244)— such as color, layer, or elevation.
 - [Data](#) (page 1248)— information stored with the object
 - [SQL](#) (page 1253)— information stored in external databases
- 7 [To add conditions](#) (page 1256), choose And or Or, and choose a query type. To group conditions, select the first and last condition in the group. Click Group. Conditions inside the parentheses are evaluated first.
- 8 If you want, [specify how to alter the properties of the objects retrieved by the query](#) (page 1260).
- 9 Select a Query Mode to [specify how to view the objects](#) (page 1287).
- 10 If you plan to use the query again, [save the query](#) (page 176).
- 11 Click Execute Query.

You can view and edit the objects, then save them to a new file or save them back to their original file.

Quick Reference

ADEQUERY

Controls defining, modifying, saving, loading, and executing a query

Menu	In the Classic workspace, click Setup menu ► More DWG Options ► Define Query
Icon	 Define Query
Command Line	ADEQUERY
Task Pane	In Map Explorer, right-click Current Query ► Define -or- Right-click a query ► Edit
Dialog Box	Define Query dialog box

Finding All Drawing Objects in a Specified Location

Location conditions retrieve drawing objects from a specified location in the drawings.

Example: Find all roads within 100 meters of a power line or all parcels within a specific section of the drawing.

In the following illustrations, the objects that are retrieved are highlighted.

Location Types

Buffer fence

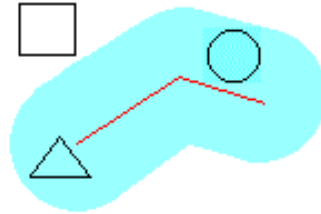

Circle

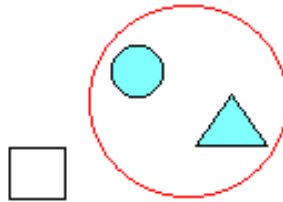

Location Types

Fence

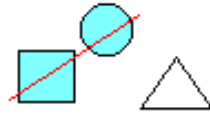

Point



Polygon

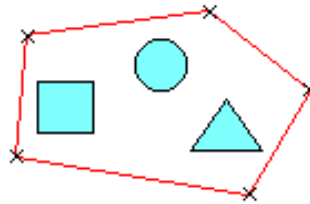

Window

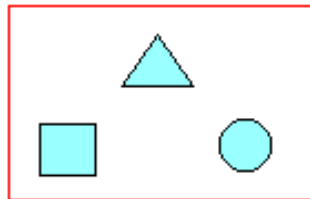

Location Types

All

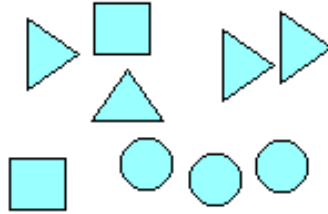

NOTE This functionality applies only to drawing objects. For information on filtering geospatial feature data by location, see [Using Expressions to Select Feature Data](#) (page 1131).

Tell me more



Video

- *Show me how to run a query on a set of attached DWG files.*



Procedure

- [To retrieve drawing objects based on their location](#) (page 1241)



GIS Skills

- *Bring in a subset of features using a query.*



Tutorial

- Exercise 3: Query in data from the drawing



Workflow

- Find and Edit Objects in Attached Drawings



Related topics

- [Finding All Drawing Objects Containing a Specific Property](#) (page 1242)
- [Finding All Drawing Objects Containing Specific Data](#) (page 1245)
- [Finding All Drawing Objects Containing Specific SQL Information](#) (page 1249)

- [Combining Drawing Query Conditions](#) (page 1255)

NOTE This procedure applies only to drawing objects. For information on filtering geospatial feature data by location, see [Using Expressions to Select Feature Data](#) (page 1131).

To retrieve drawing objects based on their location

- 1 In [Map Explorer](#) (page 2068), under Current Drawing, right-click Current Query, and then click Define.
- 2 To zoom to the extents of all active drawings, click Zoom Ext.
- 3 Click Location.
- 4 In the [Location Condition dialog box](#) (page 1849), select a boundary and a selection type.
- 5 Click Define. Specify the boundary.
- 6 In the Define Query Of Attached Drawings dialog box, select a query mode.
- 7 Click Execute Query.

See also:

- [Altering the Properties of Defined Queries](#) (page 1260)
- [Executing Queries](#) (page 1288)
- [To save a query](#) (page 177)

Quick Reference

ADEQUERY

Controls defining, modifying, saving, loading, and executing a query

Menu In the Classic workspace, click Setup menu ► More DWG Options ► Define Query

Icon	 Define Query
Command Line	ADEQUERY
Task Pane	In Map Explorer, right-click Current Query ► Define -or- Right-click a query ► Edit
Dialog Box	Define Query dialog box

Finding All Drawing Objects Containing a Specific Property

Property conditions retrieve drawing objects based on AutoCAD Map 3D object properties such as color, elevation, layer, or linetype

Example: Search for objects on a given layer or of a specified color.

You can use more than one object property in a query, but you must define them one condition at a time.

NOTE This functionality applies only to drawing objects. For information on filtering geospatial feature data by property, see [Using Expressions to Select Feature Data](#) (page 1131).

Object Properties vs. Layer Properties

Some properties, such as Color or Linetype, are often specified BYLAYER, that is, the attribute is set based on the value of the layer rather than the object itself. These objects are not retrieved if you specify a particular color, for instance, in the property query. Instead, you must specify BYLAYER in the property query to retrieve these objects.

For example, querying objects with a DASHED linetype retrieves only objects that have that explicit property, not objects that have that property because they reside on a layer with a DASHED linetype.

If the current drawing does not have a matching layer, queried objects will be displayed according to the characteristics of the layer in the attached drawing. If the active drawing has a matching layer, the queried objects will be displayed according to the characteristics of the layer in the current drawing.

Defining Numeric Range Property Queries

To define a numeric range property condition, combine condition statements that define the upper and lower limit of the range. For example, to retrieve

objects with an elevation between 21.0 and 47.0, use the following condition statements:

Property: ELEVATION > 21

AND Property: ELEVATION < 47

Notes

- If you query against Object Type and IMAGE is not listed even though you have a raster image in an attached drawing, exit the query dialog boxes.
Click Insert tab ► Image panel ► Image Management.  In the Image Management dialog box, click OK. Then define the query again.
- If the property query you define uses text values, you can set an option to specify case-sensitive text. See [Setting Query Options \(DWG\)](#) (page 244).

Tell me more



Video

- *Show me how to run a query on a set of attached DWG files.*



Procedure

- [To retrieve drawing objects based on their properties](#) (page 1244)



GIS Skills

- *Bring in a subset of features using a query.*



Tutorial

- Exercise 3: Query in data from the drawing



Workflow

- Find and Edit Objects in Attached Drawings



Related topics

- [Finding All Drawing Objects in a Specified Location](#) (page 1238)
- [Finding All Drawing Objects Containing Specific Data](#) (page 1245)

- [Finding All Drawing Objects Containing Specific SQL Information](#) (page 1249)
- [Combining Drawing Query Conditions](#) (page 1255)

NOTE This procedure applies only to drawing objects. For information on filtering geospatial feature data by property, see [Using Expressions to Select Feature Data](#) (page 1131).

To retrieve drawing objects based on their properties

- 1 In [Map Explorer](#) (page 2068), under Current Drawing, right-click Current Query, and then click Define.
- 2 Click Property.
- 3 In the [Property Condition dialog box](#) (page 1855), select a property.
- 4 Select an operator.
- 5 Enter a value for the property.
To select from a list of available values, click Values. For example, if you select the property "layer," clicking Values displays a list of all layers in the active attached drawings.
You can use wild-card characters to enter values for the following properties: Block Name, Color, Text Style, Object Type, Group, Layer, Object Class, Linetype, and Plotstyle.
- 6 Click OK.
- 7 In the Define Query of Attached Drawings dialog box, select a query mode.
- 8 Click Execute Query.

See also:

- [Altering the Properties of Defined Queries](#) (page 1260)
- [Executing Queries](#) (page 1288)
- [To save a query](#) (page 177)

Quick Reference

ADEQUERY

Controls defining, modifying, saving, loading, and executing a query

Menu In the Classic workspace, click Setup menu ► More DWG Options ► Define Query

Icon



Define Query

Command Line ADEQUERY

Task Pane In Map Explorer, right-click Current Query ► Define -or- Right-click a query ► Edit

Dialog Box Define Query dialog box

Finding All Drawing Objects Containing Specific Data

Data conditions retrieve drawing objects based on nongraphic information associated with the objects.

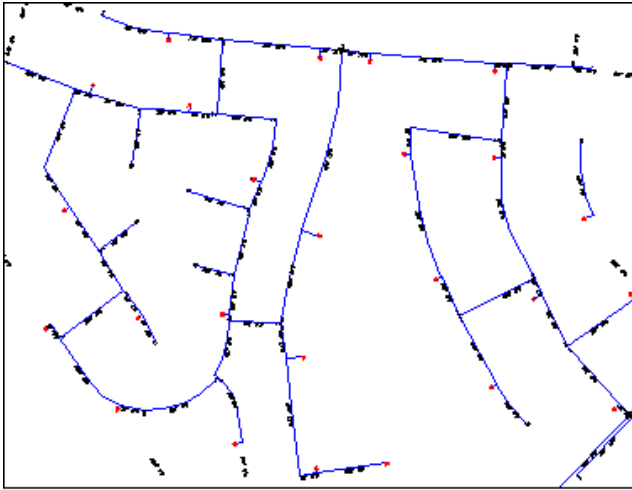

Source Drawing: WATER_DATA

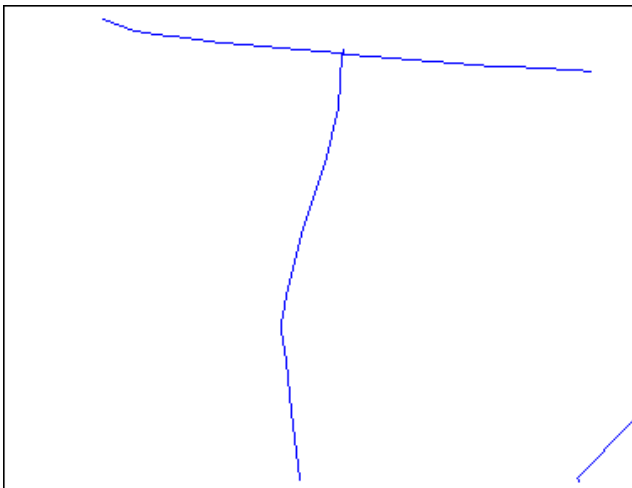

Data: WATER.DIAMETER > 8

If you store pipe diameter information in an object data table, you can use a data condition to retrieve pipe objects based on the diameter information attached to each pipe object. In this case, all pipes with a diameter of 8 or greater are retrieved. Move your cursor over the image to see the results.

NOTE You cannot retrieve objects based on constant block attributes.

NOTE This functionality applies only to drawing objects. For information on filtering geospatial feature data by property, see [Using Expressions to Select Feature Data](#) (page 1131).

Keep in mind the following :

- You must define and attach the data to objects before you can use a data condition.
- The Database Link option tests the link data stored on the object, not the data in the database table. You can [retrieve objects based on data in the linked database table](#) (page 1249).

Tell me more



- *Show me how to run a query on a set of attached DWG files.*



- [To retrieve drawing objects based on their object data](#) (page 1248)



- *Bring in a subset of features using a query.*



- Exercise 3: Query in data from the drawing
- Tutorial: Classifying Drawing Objects



- Find and Edit Objects in Attached Drawings



- [Bringing In Drawing Objects Based on Attached Data](#) (page 363)
- [Bringing In Drawing Objects by Object Class](#) (page 356)
- [Finding All Drawing Objects Containing Specific SQL Information](#) (page 1249)

- [Finding All Drawing Objects in a Specified Location](#) (page 1238)
- [Combining Drawing Query Conditions](#) (page 1255)

NOTE This procedure applies only to drawing objects. For information on filtering geospatial feature data by property, see [Using Expressions to Select Feature Data](#) (page 1131).

To retrieve drawing objects based on their object data

- 1 In [Map Explorer](#) (page 2068), under Current Drawing, right-click Current Query, and then click Define.
- 2 Click Data.
- 3 In the [Data Condition dialog box](#) (page 1836), select the type of data to query.
- 4 Specify the specific data to query.
 - For object class, select the object class of the objects to retrieve. Then, under Properties, select the specific properties to query.
 - For object data, select the table and field to query.
Note that if two attached drawings have a table with the same name, AutoCAD Map 3D recognizes only the fields defined in the first drawing you activate.
 - For database link data, select the link template associated with the objects you want to retrieve. Under Key Columns, select the key column to query.
Because a query retrieves objects from attached drawings, only link templates defined in your attached drawing are displayed in the list.
 - For block attributes, select the block to query. Under Attribute Tags, select the attribute tag to query, or select * from the Blocks list to see a list of all the attribute tags of all the blocks in the active drawing.
- 5 Specify the condition that the data must match by selecting an operator and entering a value in the Value field.
For example, to find all values greater than 8, select the > operator and enter 8 in the Value field.
For information on using wild cards, see [Wildcard Characters](#) (page 1537).

- 6 Click OK.
- 7 In the Define Query Of Attached Drawings dialog box, select a query mode.
- 8 Click Execute Query.

See also:

- [Altering the Properties of Defined Queries](#) (page 1260)
- [Executing Queries](#) (page 1288)
- [To save a query](#) (page 177)

Quick Reference

ADEQUERY

Controls defining, modifying, saving, loading, and executing a query

Menu	In the Classic workspace, click Setup menu ► More DWG Options ► Define Query
Icon	 Define Query
Command Line	ADEQUERY
Task Pane	In Map Explorer, right-click Current Query ► Define -or- Right-click a query ► Edit
Dialog Box	Define Query dialog box

Finding All Drawing Objects Containing Specific SQL Information

A SQL condition checks information in an external database and retrieves drawing objects that are linked to records that match the condition.

Example: If a database table stores information on supplier, owner, and cost of furniture in a set of drawings, you can define a query to show all chairs purchased from a specific supplier.

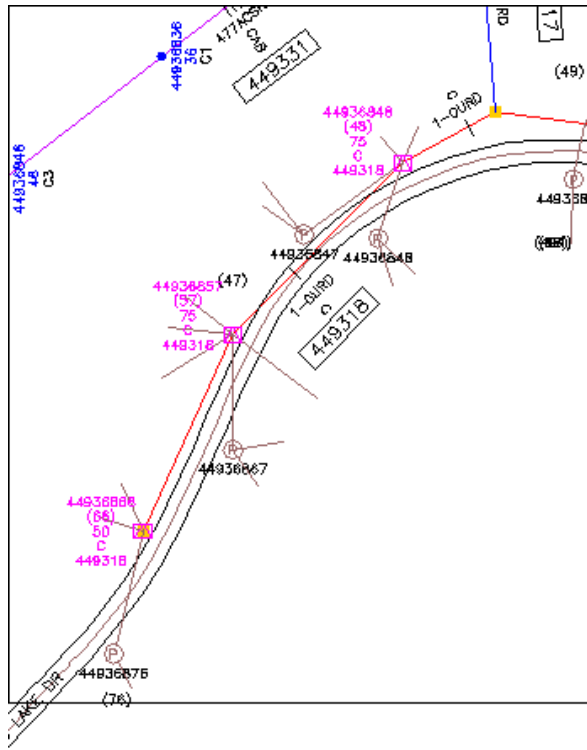

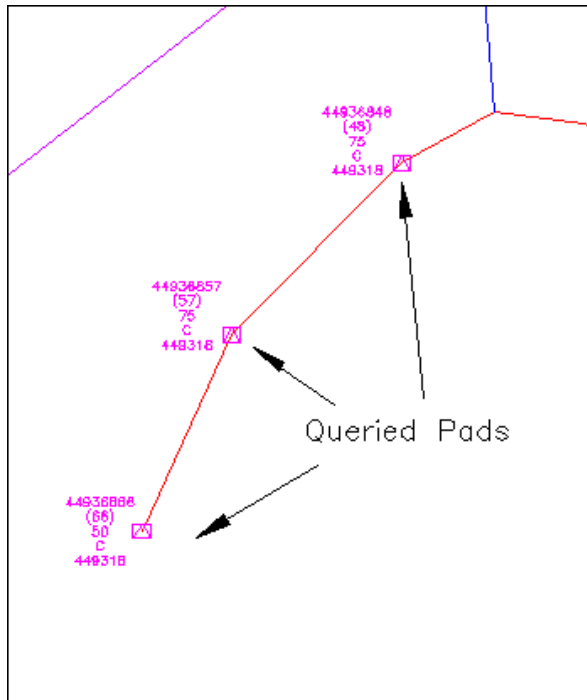

Use a query with a SQL condition to retrieve objects based on the value in a linked data base record. In this example, all pads with a phase type of 'C' are retrieved. Move your cursor over the image to see the results.

NOTE If you are retrieving objects from attached drawings, you must have the same data base attached in both the attached drawing and the current drawing.

You must link SQL data to objects before you can use a SQL query. For more information about connecting to external databases and linking records to objects in your drawings, see [Setting Up Data Sources for Drawings](#) (page 204) and [Overview of Linking Database Records to Objects](#) (page 522).

NOTE This functionality applies only to drawing objects. For information on filtering geospatial feature data by property, see [Using Expressions to Select Feature Data](#) (page 1131).

Specifying a Value

The operator and the value define the condition that the value in the table must match. For example, if you select the operator < (less than) and enter a value of 5, the condition retrieves all objects linked to records in which the value in the table is less than five.

- The value must match the data type of the column. For example, if the column requires a name, enter a text string.
- Enclose string values in single quotes. If the string contains a single quotation mark, precede the single quotation mark with a single quotation mark.
- For dates, use the format `TIMESTAMP'YYYY-MM-DD 00:00:00'`, for example `"Date" > TIMESTAMP'1990-05-30 11:45:00'`

Troubleshooting

Because a SQL condition relies on the ability to connect to a data source, the condition will not work if any part of the connection is broken:

- The query must specify a valid link template.
- The data source must be attached and connected.
- The data source must be in the same directory as when you connected to it. (You must not have moved it after connecting.)
- Links must exist between drawing objects and records in the specified data source.

Tell me more



- *Show me how to run a query on a set of attached DWG files.*



- [To retrieve drawing objects based on linked SQL data](#) (page 1253)



- *Bring in a subset of features using a query.*
-



Tutorial

- Exercise 3: Query in data from the drawing



Workflow

- Find and Edit Objects in Attached Drawings



Related topics

- [Setting Up Data Sources for Drawings](#) (page 204)
- [Overview of Linking Database Records to Objects](#) (page 522)
- [Bringing In Drawing Objects Based on Attached Data](#) (page 363)
- [Finding All Drawing Objects Containing a Specific Property](#) (page 1242)
- [Finding All Drawing Objects in a Specified Location](#) (page 1238)
- [Finding All Drawing Objects Containing Specific Data](#) (page 1245)
- [Combining Drawing Query Conditions](#) (page 1255)

To retrieve drawing objects based on linked SQL data

- 1 Before you execute a query with a SQL condition, be sure that the appropriate data source is attached and connected.
- 2 In [Map Explorer](#) (page 2068), under Current Drawing, right-click Current Query, and then click Define.
- 3 Click SQL.
- 4 In the [SQL Link Condition dialog box](#) (page 1866), select the link template for the table you want to search.
If you are querying attached drawings, the link template list includes only link templates defined in the active attached drawings.
- 5 Create a SQL condition by selecting a column, an operator, and a value. To enter a condition, click Type It. In the [Type SQL Condition dialog box](#) (page 1870), enter the condition.

To reuse a condition you defined previously, click History. Select the condition.

- 6 Click Add Condition to add the condition to the Current SQL Condition list.
- 7 To add more conditions, select And or Or and create another condition.
- 8 When you finish building the SQL condition, click OK.
- 9 In the Define Query Of Attached Drawings dialog box, select a query mode.
- 10 Click Execute Query.

See also:

- [Altering the Properties of Defined Queries](#) (page 1260)
- [Executing Queries](#) (page 1288)
- [To save a query](#) (page 177)

Quick Reference

ADEQUERY

Controls defining, modifying, saving, loading, and executing a query

Menu	In the Classic workspace, click Setup menu ► More DWG Options ► Define Query
Icon	 Define Query
Command Line	ADEQUERY
Task Pane	In Map Explorer, right-click Current Query ► Define -or- Right-click a query ► Edit
Dialog Box	Define Query dialog box

Combining Drawing Query Conditions

You can combine query conditions when creating a query to retrieve drawing objects.

Example: Combine a property condition with a location condition to find all utility poles within 100 meters of a road.

When you combine conditions, use *Or* to specify the union of the conditions, use *And* to specify the intersection of the condition, use *Not* to exclude specific objects from the query.

- **And** — Finds objects only if both conditions are true. For example,
Property: LAYER = First Floor
AND Property: COLOR = BLUE
finds only blue objects on the First Floor layer.
- **Or** — Finds objects if either condition is true. For example,
Property: LAYER = First Floor
OR Property: COLOR = BLUE
finds all objects on the First Floor layer (of any color) and all blue objects on any layer.
- **And Not** — Finds objects only if the first condition is true and the second condition is false. For example,
Property: LAYER = First Floor
AND NOT Property: COLOR = BLUE
finds objects on the First Floor layer that are any color except blue.
- **Or Not** — Finds objects if the first condition is true or the second condition is false. For example,
Property: LAYER = First Floor
OR NOT Property: COLOR = BLUE
finds all objects on the First Floor layer (of any color) and all objects on other layers that are not blue.

You can use *Not* by itself to retrieve all except a specific set of objects. For example, the query definition, Not Property: Layer = Furniture retrieves all objects except those on the Furniture layer.

If you use more than two or three conditions, it is a good idea to group the conditions. Conditions inside the group are evaluated first.

If conditions are not grouped, Not conditions are evaluated first, then And, and last Or.

NOTE This functionality applies only to drawing objects. For information on filtering geospatial feature data conditionally, see [Using Expressions to Select Feature Data](#) (page 1131).

See also:

- [Finding All Drawing Objects in a Specified Location](#) (page 1238)
- [Finding All Drawing Objects Containing a Specific Property](#) (page 1242)
- [Finding All Drawing Objects Containing Specific Data](#) (page 1245)
- [Finding All Drawing Objects Containing Specific SQL Information](#) (page 1249)

To combine query conditions in drawing queries

- 1 In [Map Explorer](#) (page 2068), under Current Drawing, right-click Current Query, and then click Define.
- 2 Choose a Query Type to [define a condition for your query](#) (page 1237).
- 3 In the [Define Query dialog box](#) (page 1838), under Query Type, select a joining operator:
 - And — Finds objects only if both conditions are true.
 - Or — Finds objects if either condition is true.
 - And Not — Finds objects only if the first condition is true and the second condition is false.
 - Or Not — Finds objects if either the first condition is true or the second condition is false.
- 4 Choose a Query Type to define the next condition for your query.
- 5 To group conditions, select the first and last condition in the group. Click Group. Conditions inside the parentheses are evaluated first.
- 6 Select a Query Mode.
- 7 Click Execute Query.

See also:

- [Altering the Properties of Defined Queries](#) (page 1260)
- [Executing Queries](#) (page 1288)
- [To save a query](#) (page 177)

Quick Reference

ADEQUERY

Controls defining, modifying, saving, loading, and executing a query

Menu	In the Classic workspace, click Setup menu ► More DWG Options ► Define Query
Icon	 Define Query
Command Line	ADEQUERY
Task Pane	In Map Explorer, right-click Current Query ► Define -or- Right-click a query ► Edit
Dialog Box	Define Query dialog box

Editing a Drawing Query Condition

When you edit a drawing query, you can modify a condition but you cannot change its type (location, property, data, or SQL). If you want a different query condition type, you must delete the existing condition and define a new one. You can also change the joining operator (And, Or, Not) for a condition.

NOTE This functionality applies only to drawing objects. For information on filtering geospatial feature data conditionally, see [Using Expressions to Select Feature Data](#) (page 1131).

See also:

- [Finding All Drawing Objects in a Specified Location](#) (page 1238)
- [Finding All Drawing Objects Containing a Specific Property](#) (page 1242)
- [Finding All Drawing Objects Containing Specific Data](#) (page 1245)

- [Finding All Drawing Objects Containing Specific SQL Information](#) (page 1249)
- [Altering the Properties of Defined Queries](#) (page 1260)
- [Executing Queries](#) (page 1288)
- [To save a query](#) (page 177)

NOTE This procedure applies only to drawing objects. For information on filtering geospatial feature data conditionally, see [Using Expressions to Select Feature Data](#) (page 1131).

To edit a drawing query condition

- 1 In [Map Explorer](#) (page 2068), under Current Drawing, right-click Current Query, and then click Define.
- 2 To modify a saved query, in the [Define Query dialog box](#) (page 1838), click Load. Select the query.
- 3 In the Define Query Of Attached Drawings dialog box, under Current Query, select the query condition you want to edit. Click Edit.
To change the joining operator, select the new joining operator before you click Edit.
- 4 Make any changes.
For example, if you select a location condition and click Edit, the Location Condition dialog box appears. Click Show to view or change the boundary of the location condition and press Enter to return to the Location Condition dialog box.
- 5 Click OK.

The revised query appears under Current Query.

Quick Reference

ADEQUERY

Controls defining, modifying, saving, loading, and executing a query

Menu In the Classic workspace, click Setup menu ► More DWG Options ► Define Query

Icon	 Define Query
Command Line	ADEQUERY
Task Pane	In Map Explorer, right-click Current Query ► Define -or- Right-click a query ► Edit
Dialog Box	Define Query dialog box

Altering the Properties of Queried Drawing Objects

Use the property alteration feature to modify drawing objects as they are retrieved by a query.

NOTE These procedures apply only to drawing objects. For information on altering geospatial feature data, see [Editing Features Using the Data Table](#) (page 712).

To modify objects as they are retrieved by a query

- [To alter the properties of queried drawing objects](#) (page 1261)
- [To alter all retrieved drawing objects in the same way](#) (page 1263)
- [To alter retrieved objects based on their properties](#) (page 1265)
- [To alter the properties of drawing objects based on their object data](#) (page 1267)
- [To alter retrieved drawing objects based on linked SQL data](#) (page 1270)
- [To define an expression](#) (page 1275)
- [To add text to retrieved drawing objects](#) (page 1278)
- [To define the label point for a drawing object](#) (page 1280)
- [To fill queried drawing objects with a hatch pattern](#) (page 1283)
- [To change the block color in your current drawing](#) (page 1285)
- [To modify a property alteration definition](#) (page 1286)

Overview of Altering the Properties of Queried Drawing Objects

Use the property alteration feature to modify the properties of queried drawing objects as they are queried into the current drawing.

You can modify object properties such as color, linetype, or polyline width, or add text.

Example: You have a set of city maps that show roads as black polylines of the same width. You can plot a map for a contractor that shows the roads to

be repaired in red and roads to be inspected in blue. You can alter the width of the polylines to show road widths. You can also add text to identify elements of your drawing.

Property alteration involves the following three general steps:

- Define a query that retrieves the objects you want to alter.
- Create a property alteration definition that specifies how to alter the retrieved objects.
- Execute the query in Draw mode. You cannot use property alteration in Preview or Report mode queries.

AutoCAD Map 3D performs the query, applies the property alteration definition to the queried objects, and displays the modified objects in the current drawing.

NOTE This functionality applies only to drawing objects. For information on altering geospatial feature data, see [Editing Features Using the Data Table](#) (page 712).

See also:

- [Overview of Queries](#) (page 1235)
- [Executing Queries](#) (page 1288)
- [To save a query](#) (page 177)
- [Altering All Drawing Objects in the Same Way](#) (page 1262)
- [Altering Properties Using Object Properties](#) (page 1264)
- [Altering Object Properties Using Object Data](#) (page 1267)
- [Altering Object Properties Using Linked Data](#) (page 1269)
- [Filling Queried Drawing Objects with a Hatch Pattern](#) (page 1281)
- [Changing the Color of Blocks](#) (page 1284)
- [Modifying a Property Alteration Definition](#) (page 1285)

NOTE This procedure applies only to drawing objects. For information on altering geospatial feature data, see [Editing Features Using the Data Table](#) (page 712).

To alter the properties of queried drawing objects

- 1 In [Map Explorer](#) (page 2068), under Current Drawing, right-click Current Query, and then click Define.
- 2 In the [Define Query dialog box](#) (page 1838), load or create a query.
- 3 Under Options, click Alter Properties.
- 4 In the [Set Property Alterations dialog box](#) (page 1863), select the property to alter.
For example, to change the color of queried objects, select Color.
- 5 In the Expression area, specify how to alter the property.
 - To modify every queried object in the same way, select the new value for the property.
For example, if you are altering the color of objects and you want to change the color of all queried objects to red, click Values and select Red.
 - To modify each object using a value that is stored in an associated data source, select the data source, such as [Property](#) (page 1265), [Data](#) (page 1267), or [SQL](#) (page 1270), and specify the location of the data. For example, if you store color values in an object data table, click Data and select the table and column that contains the color values. Use this method only if the data values stored in the data source exactly specify the value to use. For example, to alter the color of objects, the data source must specify a valid color value.
 - To modify each object based on other properties or on associated data, select the data source and [define a range table](#) (page 1272).
For example, if you store installation dates in an associated data source, you can modify the color of objects based on their installation date. To do this, first select the data source for the installation dates, then define a range table that specifies which colors to use for each range of installation dates.
 - You can [add text to queried objects](#) (page 1278) or [add a hatch pattern to objects](#) (page 1283).
- 6 Click Add to add the property alteration to the Current Property Alterations list.
- 7 When you finish defining the property alteration, click OK.
- 8 Make sure that Alter Properties is selected when you execute the query.

- 9 Under Query Mode, select Draw. You cannot use property alteration in Preview mode or Report mode.
- 10 Click Execute Query.

AutoCAD Map 3D performs the query, applies the property alteration definition to the queried objects, and displays the altered objects in the current drawing.

Quick Reference

ADEQUERY

Controls defining, modifying, saving, loading, and executing a query

Menu	In the Classic workspace, click Setup menu ► More DWG Options ► Define Query
Icon	 Define Query
Command Line	ADEQUERY
Task Pane	In Map Explorer, right-click Current Query ► Define -or- Right-click a query ► Edit
Dialog Box	Define Query dialog box

Altering All Drawing Objects in the Same Way

A simple property alteration modifies all queried drawing objects in the same way.

Here are some examples of using simple property alterations:

- Add a hatch pattern to all water pipes older than 50 years.
- Find every property lot touching a line that represents the path of the new highway. Outline the lots in red and add a hatch pattern.

NOTE This functionality applies only to drawing objects. For information on altering geospatial feature data, see [Editing Features Using the Data Table](#) (page 712).

See also:

- [Overview of Queries](#) (page 1235)
- [Executing Queries](#) (page 1288)
- [Altering Properties Using Object Properties](#) (page 1264)
- [Altering Object Properties Using Object Data](#) (page 1267)
- [Altering Object Properties Using Linked Data](#) (page 1269)
- [Filling Queried Drawing Objects with a Hatch Pattern](#) (page 1281)
- [Changing the Color of Blocks](#) (page 1284)
- [Modifying a Property Alteration Definition](#) (page 1285)

NOTE This procedure applies only to drawing objects. For information on altering geospatial feature data, see [Editing Features Using the Data Table](#) (page 712).

To alter all retrieved drawing objects in the same way

- 1 In [Map Explorer](#) (page 2068), under Current Drawing, right-click Current Query, and then click Define.
- 2 In the Define Query Of Attached Drawings dialog box, load or create a query that retrieves the objects you want to alter.
- 3 Under Options, click Alter Properties.
- 4 In the [Set Property Alterations dialog box](#) (page 1863), select the property to alter.
- 5 In the Expression area, specify how to alter the property.
For example, to change the color of all queried object to red, enter either red or 1 (the numerical equivalent of red), or click Values to select from a list of colors.
- 6 Click Add to add the property alteration to the Current Property Alterations list.
- 7 When you finish defining the property alteration, click OK.
- 8 Make sure that Alter Properties is selected when you execute the query.
- 9 Under Query Mode, select Draw. You cannot use property alteration in Preview mode or Report mode.

10 Click Execute Query.

Quick Reference

ADEQUERY

Controls defining, modifying, saving, loading, and executing a query

Menu	In the Classic workspace, click Setup menu ► More DWG Options ► Define Query
Icon	 Define Query
Command Line	ADEQUERY
Task Pane	In Map Explorer, right-click Current Query ► Define -or- Right-click a query ► Edit
Dialog Box	Define Query dialog box

Altering Properties Using Object Properties

You can define a property alteration that modifies a property of queried drawing objects based on another property of the objects.

Example: If the layers in your attached drawings are named using numbers, you could color objects based on the layer they are on. To do this, under Select Property, select Color as the property to alter. In the expression area, click Property and choose Layer as the new value to use for the color.

The property you specify in the Expression area must have a value that can be used for the property you are altering. For example, if your layers are not named using numbers but instead use names such as Roads and Pipes, the previous example would not work. (To create a modification based on these layer names, use a range table, where you can specify that objects on the layer named Roads be colored red, and objects on the layer named Pipes be colored blue. For more information, see [Creating a Range Table](#) (page 1271).)

You can also modify a property based on the same property. For example, to double the scale of selected objects, select Scale in the Select Property area as the property to change. In the Expression area, select Scale as the property to base the change on and multiply it by two. The expression would look like this:

(* x.scale 2)

NOTE This functionality applies only to drawing objects. For information on altering geospatial feature data, see [Editing Features Using the Data Table](#) (page 712).

Dot Variables

- Use the .Dwgname dot variable to get the drawing name for a queried object.
- Use the .Elevation dot variable to get the Z-values for objects.
- Use the .Height dot variable to get the text height for objects.

For a full listing of the dot variables that you can use for property alteration, see [Dot Variables](#) (page 1546).

See also:

- [Overview of Queries](#) (page 1235)
- [Executing Queries](#) (page 1288)
- [Altering Object Properties Using Object Data](#) (page 1267)
- [Altering Object Properties Using Linked Data](#) (page 1269)
- [Filling Queried Drawing Objects with a Hatch Pattern](#) (page 1281)
- [Changing the Color of Blocks](#) (page 1284)
- [Modifying a Property Alteration Definition](#) (page 1285)

NOTE This procedure applies only to drawing objects. For information on altering geospatial feature data, see [Editing Features Using the Data Table](#) (page 712).

To alter retrieved objects based on their properties

- 1 In [Map Explorer](#) (page 2068), under Current Drawing, right-click Current Query, and then click Define.
- 2 In the Define Query Of Attached Drawings dialog box, load or create a query that retrieves the objects you want to alter.
- 3 In the Define Query Of Attached Drawings dialog box, click Alter Properties.

- 4 In the [Set Property Alterations dialog box](#) (page 1863), under Select Property, select the property to change.
For example, if you have color-coded the objects in your drawing and you now want to move objects to layers based on their color, you would select Layer as the property to change.
- 5 In the Expression area, click Properties and select the property that you want to base the change on.
In this example, we want to move objects based on their current color, so select Color.
Click OK to close the Select Property dialog box.
- 6 Click Add to add the property alteration to the Current Property Alteration list.

See also:

- [Overview of Queries](#) (page 1235)
- [Executing Queries](#) (page 1288)
- [To save a query](#) (page 177)

Quick Reference

ADEQUERY

Controls defining, modifying, saving, loading, and executing a query

Menu	In the Classic workspace, click Setup menu ► More DWG Options ► Define Query
Icon	 Define Query
Command Line	ADEQUERY
Task Pane	In Map Explorer, right-click Current Query ► Define -or- Right-click a query ► Edit
Dialog Box	Define Query dialog box

Altering Object Properties Using Object Data

You can define a property alteration that modifies queried drawing objects based on data that is stored on the objects, such as object data, attribute data, or link data.

NOTE The value stored on the object must be a valid value for the property that you are altering. For example, if you have selected to alter the property Color, the value stored on the object must be a valid color name or number. If the values do not match, [use a range table](#) (page 1272).

NOTE This functionality applies only to drawing objects. For information on altering geospatial feature data, see [Editing Features Using the Data Table](#) (page 712).

See also:

- [Overview of Queries](#) (page 1235)
- [Executing Queries](#) (page 1288)
- [Altering Properties Using Object Properties](#) (page 1264)
- [Altering Object Properties Using Linked Data](#) (page 1269)
- [Filling Queried Drawing Objects with a Hatch Pattern](#) (page 1281)
- [Changing the Color of Blocks](#) (page 1284)
- [Modifying a Property Alteration Definition](#) (page 1285)

NOTE This procedure applies only to drawing objects. For information on altering geospatial feature data, see [Editing Features Using the Data Table](#) (page 712).

To alter the properties of drawing objects based on their object data

- 1 In [Map Explorer](#) (page 2068), under Current Drawing, right-click Current Query, and then click Define.
- 2 In the Define Query Of Attached Drawings dialog box, load or create a query that retrieves the objects you want to alter.
- 3 In the Define Query Of Attached Drawings dialog box, click Alter Properties.

- 4 In the [Set Property Alterations dialog box](#) (page 1863), under Select Property, select the property to change.

For example, if you store pipe diameters as object data, you can display each pipe with a polyline width that matches the pipe diameter. In this example, you would select Width as the property to change.

- 5 In the Expression area, click Data.
- 6 Select one of the following:
 - Attribute — Select a block attribute tag. This will appear in the Expression box as @BlockTagName.
 - Database Link — Select a link template and key column. These will appear in the Expression box as &KeyColumn@LinkTemplate.
 - Object Data — Select an object data table and field. These will appear in the Expression box as :FIELD@TABLENAME.

- 7 Click OK.

- 8 Click Add.

The property alteration definition is displayed in the Current Property Alterations list. When you execute the query with Alter Properties selected, AutoCAD Map 3D changes the selected property of queried objects based on the value stored in the specified data field.

Quick Reference

ADEQUERY

Controls defining, modifying, saving, loading, and executing a query

Menu	In the Classic workspace, click Setup menu ► More DWG Options ► Define Query
Icon	 Define Query
Command Line	ADEQUERY
Task Pane	In Map Explorer, right-click Current Query ► Define -or- Right-click a query ► Edit
Dialog Box	Define Query dialog box

Altering Object Properties Using Linked Data

You can define a property alteration that modifies queried drawing objects based on data stored in a linked database.

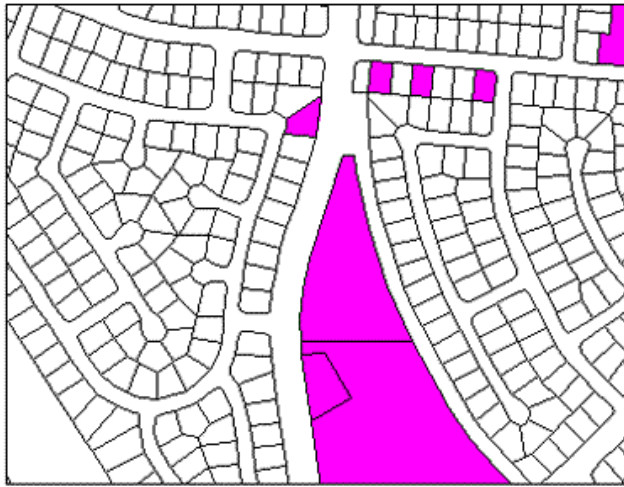

SQL Property: LANDUSE <> RESIDENTIAL

Using Property Alteration, parcels not zoned for residential are displayed with a magenta solid fill, based on an external database record value.

For example, you could retrieve a set of pipes and display each pipe in a color based on the diameter of the pipe.

For information on creating and using a link template, see [Overview of Linking Database Records to Objects](#) (page 522).

NOTE This functionality applies only to drawing objects. For information on altering geospatial feature data, see [Editing Features Using the Data Table](#) (page 712).

See also:

- [Overview of Queries](#) (page 1235)
- [Executing Queries](#) (page 1288)
- [Altering Properties Using Object Properties](#) (page 1264)
- [Altering Object Properties Using Object Data](#) (page 1267)

- [Filling Queried Drawing Objects with a Hatch Pattern](#) (page 1281)
- [Changing the Color of Blocks](#) (page 1284)
- [Modifying a Property Alteration Definition](#) (page 1285)

NOTE This functionality applies only to drawing objects. For information on altering geospatial feature data, see [Editing Features Using the Data Table](#) (page 712).

To alter retrieved drawing objects based on linked SQL data

- 1 In [Map Explorer](#) (page 2068), under Current Drawing, right-click Current Query, and then click Define.
- 2 In the Define Query Of Attached Drawings dialog box, load or create a query that retrieves the objects you want to alter.
- 3 In the Define Query Of Attached Drawings dialog box, click Alter Properties.
- 4 In the [Set Property Alterations dialog box](#) (page 1863), under Select Property, select the property to change.
For example, to modify the color of retrieved objects, select Color as the property to change.
- 5 Click SQL.
- 6 Select a link template.
- 7 Select the external database column whose value you want to use as a value in the expression.
- 8 Click OK.
The SQL column and link template are displayed under Expression in the Set Property Alterations dialog box, preceded by an ampersand (&). The link template is preceded by an at (@) symbol, for example, &Diameter@PIPES.
You can also enter the SQL data variable directly in the Expression box.
- 9 Click Add.
The property alteration definition is added to the Current Property Alterations list.

When you execute the query with Alter Properties selected, AutoCAD Map 3D changes the queried objects based on the value stored in the external database.

For more information on connecting to and using external databases, see [External Databases \(Object Data\)](#) (page 206).

Quick Reference

ADEQUERY

Controls defining, modifying, saving, loading, and executing a query

Menu	In the Classic workspace, click Setup menu ► More DWG Options ► Define Query
Icon	 Define Query
Command Line	ADEQUERY
Task Pane	In Map Explorer, right-click Current Query ► Define -or- Right-click a query ► Edit
Dialog Box	Define Query dialog box

Creating a Range Table

A range table specifies a range of actions to take depending on the value of the specified data or property.

- You can change the color of drawing objects based on their elevation
- If you have a street map and use object data to store information about pavement quality, you can move each street to a layer that corresponds to the pavement quality.
- If you have a county map showing cities, and you use an external database to store population data for each city, you can modify the block symbol for each city based on its population size.

The procedure tab for this topic includes general instructions for creating a range table and specific instructions for creating a sample range table.

NOTE This functionality applies only to drawing objects.

See also:

- [Overview of Queries](#) (page 1235)
- [Executing Queries](#) (page 1288)
- [Altering Properties Using Object Properties](#) (page 1264)
- [Altering Object Properties Using Object Data](#) (page 1267)
- [Altering Object Properties Using Linked Data](#) (page 1269)
- [Filling Queried Drawing Objects with a Hatch Pattern](#) (page 1281)
- [Changing the Color of Blocks](#) (page 1284)
- [Modifying a Property Alteration Definition](#) (page 1285)

- [To create a range table](#) (page 1272)
- [To create a sample range table](#) (page 1273)

To create a range table

- 1 In [Map Explorer](#) (page 2068), under Current Drawing, right-click Current Query, and then click Define.
- 2 In the Define Query Of Attached Drawings dialog box, click Alter Properties.
- 3 If you are creating a range table for a property alteration, in the [Set Property Alterations dialog box](#) (page 1863), select the property to alter.
- 4 Move the cursor to the Expression box and specify the location of the value on which to base the alteration.
Enter a dot variable, a field name, or other valid expression. For example, to modify the color of an object based on its elevation, enter .ELEVATION in the Expression box.
- 5 Click Range.
- 6 In the [Define Range Table dialog box](#) (page 1842), click New to create a new range table.
- 7 Enter a name for the range table and click OK.

- 8 In the Define Range Table dialog box, select an operator and a value for the first condition.

These determines which objects fall in this range.

- 9 Specify the return value for the first condition.

The return value specifies how to modify the selected property. For example, if you are modifying the color of an object based on its elevation, enter the color in the Return Value box.

NOTE In the Expression Value box and Return Value box, you can enter only simple expressions. You cannot enter compound expressions.

- 10 Click Add to add the condition to the Current Range Table Definition.
When you run the property alteration, each object that has the specified expression value (for example, elevation > 200) will be modified according to the specified return value (for example, it will be colored red).
- 11 Specify the remaining conditions.
- 12 Click OK to close the Set Property Alteration dialog box.
- 13 Make sure that Alter Properties is selected.
- 14 Click Execute Query to retrieve the objects and alter them.

Creating an Example Range Table

The following example creates a range table for a property alteration. The example range table colors lots larger than 6000 red and lots 6000 or smaller blue.

To create a sample range table

- 1 In [Map Explorer](#) (page 2068), under Current Drawing, right-click Current Query, and then click Define.
- 2 In the Define Query of Attached Drawings dialog box, click Set Property Alteration.
- 3 In the [Set Property Alterations dialog box](#) (page 1863), select the property Color.
- 4 In the Expression area, click Property and select Area. Click OK.
- 5 Click Ranges.

- 6 In the [Define Range Table dialog box](#) (page 1842), click New.
- 7 Enter the name Color and click OK to close the New Range Table dialog box.
- 8 Enter the description Color areas over 6000.
- 9 In the Condition area, choose the <= operator.
- 10 In the Expression Value area, enter 6000.
- 11 In the Return Value area, enter Blue.
- 12 Click Add.
- 13 In the Condition area, choose the > operator.
- 14 In the Expression Value area, leave the 6000 alone.
- 15 In the Return Value area, enter Red.
- 16 Click Add.
- 17 Click OK to close the Define Range Table dialog box.
- 18 Make sure that the Color range table is selected.
- 19 Click Add to add the color property alteration to the Current Property Alterations list.
- 20 Click OK to close the Set Property Alteration dialog box.
- 21 Make sure that Alter Properties is selected.
- 22 Click Execute Query to retrieve the objects and alter them.

Quick Reference

ADEQUERY

Controls defining, modifying, saving, loading, and executing a query

Menu	In the Classic workspace, click Setup menu ► More DWG Options ► Define Query
Icon	 Define Query
Command Line	ADEQUERY

Task Pane	In Map Explorer, right-click Current Query ► Define -or- Right-click a query ► Edit
Dialog Box	Define Query dialog box

Defining an Expression

Use [Expression Evaluator](#) (page 1541) when you want AutoCAD Map 3D to evaluate drawing data from different sources, or to evaluate data that is different for each object, such as object properties, block attributes, or object data attached to the object.

NOTE This functionality applies only to drawing objects. For information on expressions for geospatial feature data, see [Using Expressions to Select Feature Data](#) (page 1131).

See also:

- [Overview of Queries](#) (page 1235)
- [Executing Queries](#) (page 1288)
- [Altering Properties Using Object Properties](#) (page 1264)
- [Altering Object Properties Using Object Data](#) (page 1267)
- [Altering Object Properties Using Linked Data](#) (page 1269)
- [Filling Queried Drawing Objects with a Hatch Pattern](#) (page 1281)
- [Changing the Color of Blocks](#) (page 1284)
- [Modifying a Property Alteration Definition](#) (page 1285)

NOTE This procedure applies only to drawing objects. For information on expressions for geospatial feature data, see [Using Expressions to Select Feature Data](#) (page 1131).

To define an expression

- 1 In [Map Explorer](#) (page 2068), under Current Drawing, right-click Current Query, and then click Define.
- 2 In the Define Query Of Attached Drawings dialog box, load or create a query.

- 3 Under Options, click Alter Properties.
- 4 In the [Set Property Alterations dialog box](#) (page 1863), select the property to alter.
For example, to change the color of queried objects, select Color.
- 5 In the Expression area, enter an [expression](#) (page 1541).
- 6 Click Add to add the property alteration to the Current Property Alterations list.
- 7 When you finish defining the property alteration, click OK.
- 8 Make sure Alter Properties is selected when you execute the query.
- 9 Under Query Mode, select Draw. You cannot use property alteration in Preview mode or Report mode.
- 10 Click Execute Query.

Quick Reference

ADEQUERY

Controls defining, modifying, saving, loading, and executing a query

Menu	In the Classic workspace, click Setup menu ► More DWG Options ► Define Query
Icon	 Define Query
Command Line	ADEQUERY
Task Pane	In Map Explorer, right-click Current Query ► Define -or- Right-click a query ► Edit
Dialog Box	Define Query dialog box

Adding Text to Queried Drawing Objects

You can add text to queried objects during the property alteration process.

Example: For all retrieved pipes, print the pipe type and diameter.

You can control the text, text height, insertion point, justification, text style, layer, color, and rotation for each text object.

NOTE This functionality applies only to drawing objects. For information on expressions for geospatial feature data, see [Using Expressions to Select Feature Data](#) (page 1131).

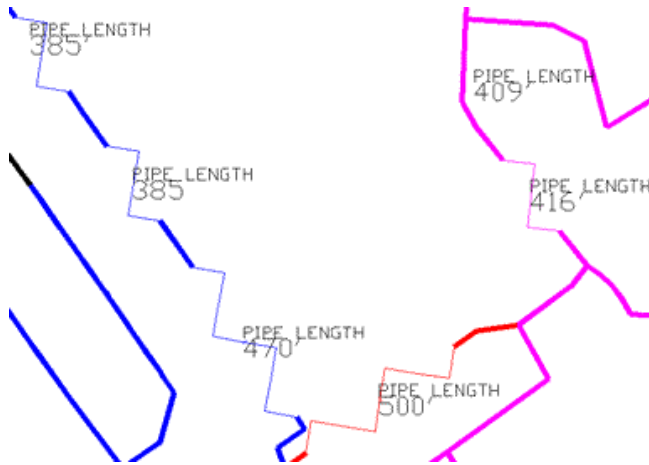

Selected pipes are labeled with their length.

See also:

- [Overview of Queries](#) (page 1235)
- [Executing Queries](#) (page 1288)
- [Altering Properties Using Object Properties](#) (page 1264)
- [Altering Object Properties Using Object Data](#) (page 1267)
- [Altering Object Properties Using Linked Data](#) (page 1269)
- [Filling Queried Drawing Objects with a Hatch Pattern](#) (page 1281)
- [Changing the Color of Blocks](#) (page 1284)
- [Modifying a Property Alteration Definition](#) (page 1285)

To add text to retrieved drawing objects

NOTE This procedure applies only to drawing objects. For information on expressions for geospatial feature data, see [Using Expressions to Select Feature Data](#) (page 1131).

- 1 In [Map Explorer](#) (page 2068), under Current Drawing, right-click Current Query, and then click Define.
- 2 Create or load a query that will retrieve the objects you want to add text to.
- 3 In the Define Query Of Attached Drawings dialog box, click Alter Properties.
- 4 In the [Set Property Alterations dialog box](#) (page 1863), click Text.
- 5 In the [Define Text dialog box](#) (page 1846), specify the text.
Enter text in the Text Value box, or specify the data to use for the text by clicking Expression. For example, click Expression and select Layer to display the name of the layer on each object found by the query.
- 6 Set other text options, such as the size, location, color, layer, and rotation.
- 7 Click OK to close the Define Text dialog box.
- 8 Click OK to close the Property Alteration dialog box.
- 9 Make sure that Alter Properties is selected.
- 10 Click Execute Query to retrieve the objects and alter them.

Quick Reference

ADEQUERY

Controls defining, modifying, saving, loading, and executing a query

Menu In the Classic workspace, click Setup menu ► More DWG Options ► Define Query

Icon  Define Query

Command Line ADEQUERY

Task Pane	In Map Explorer, right-click Current Query ► Define -or- Right-click a query ► Edit
Dialog Box	Define Query dialog box

Modifying the Text Insertion Point for a Drawing Object

The label point of a drawing object specifies the starting point for text added during a query property alteration. The default label point is the centroid of the object. You can redefine the label point. Click Annotate tab ► Map

Annotation panel ► Define Text Location.

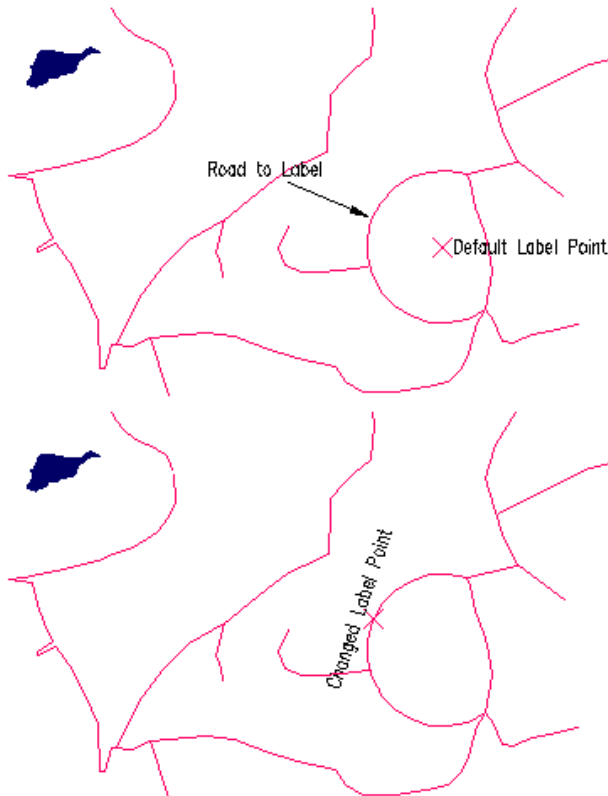

Move the label point from its default location at the center of the arc to a different location. Move your cursor over the image to see the results.

NOTE To use the label point, choose the .LABELPT dot variable in the Define Text dialog box when you create the Property Alteration definition in the Define Query Of Attached Drawings dialog box.

NOTE This functionality applies only to drawing objects. For information on labelling geospatial feature data, see [Adding Labels to Features](#) (page 1091).

See also:

- [Adding Text to Queried Drawing Objects](#) (page 1276)
- [Overview of Queries](#) (page 1235)
- [Executing Queries](#) (page 1288)
- [Altering Properties Using Object Properties](#) (page 1264)
- [Altering Object Properties Using Object Data](#) (page 1267)
- [Altering Object Properties Using Linked Data](#) (page 1269)
- [Filling Queried Drawing Objects with a Hatch Pattern](#) (page 1281)
- [Changing the Color of Blocks](#) (page 1284)
- [Modifying a Property Alteration Definition](#) (page 1285)

To define the label point for a drawing object

NOTE This procedure applies only to drawing objects. For information on labelling geospatial feature data, see [To label features](#) (page 1093).

- 1 Click Annotate tab ► Map Annotation panel ► Define Text Location.



- 2 Select the object.
- 3 Click the place on the object where you want to locate the label point.

To use this label point as the text insertion point during a [property alteration](#) (page 1278), choose LABELPT as the insert point.

Quick Reference

ADETEXTLOC

Specifies a new label point for an object

Menu Create menu ► Map Labelpoint Location

Icon



Map Labelpoint Location

Command Line ADETEXTLOC

Dialog Box ADETEXTLOC (Map Labelpoint Location command)

Filling Queried Drawing Objects with a Hatch Pattern

You can specify a hatch pattern to fill closed polylines and circles during the property alteration process. This applies only to drawing objects.

Example: Create a query that retrieves all land parcels valued above \$450,000 and displays them with a distinguishing pattern.

NOTE If you set the Create Associative Hatch Objects option on the Query tab of the AutoCADMap Options dialog box, AutoCAD Map 3D creates [associative hatch objects](#) (page 246).



SQL Property: LANDUSE <> RESIDENTIAL

Closed polylines retrieved by a query are filled with a magenta solid hatch pattern.

NOTE This functionality applies only to drawing objects. For information on changing the fill for geospatial feature data, see [Overview of Styling Features](#) (page 640).

See also:

- [Using Associative Hatch](#) (page 246)
- [Overview of Queries](#) (page 1235)
- [Executing Queries](#) (page 1288)
- [Altering Properties Using Object Properties](#) (page 1264)
- [Altering Object Properties Using Object Data](#) (page 1267)
- [Altering Object Properties Using Linked Data](#) (page 1269)
- [Changing the Color of Blocks](#) (page 1284)
- [Modifying a Property Alteration Definition](#) (page 1285)

To fill queried drawing objects with a hatch pattern

NOTE This procedure applies only to drawing objects. For information on changing the fill for geospatial feature data, see [To apply styles to areas](#) (page 650).

- 1 In [Map Explorer](#) (page 2068), under Current Drawing, right-click Current Query, and then click Define.
- 2 Create or load a query that will retrieve the objects you want to fill.
- 3 In the Define Query Of Attached Drawings dialog box, click Alter Properties.
- 4 In the [Set Property Alterations dialog box](#) (page 1863), click Hatch.
- 5 In the [Hatch Options dialog box](#) (page 1847), enter a pattern name, click Pattern to select a pattern from the set of hatch patterns, or click Expression to select a data value specifies the hatch name (for example, select a field in an object data table).
AutoCAD Map 3D displays the selected hatch pattern. ISO hatch patterns are not displayed.
If you do not enter a pattern, AutoCAD Map 3D uses a fill that appears solid.
- 6 Enter a scale, rotation, layer, and color for the hatch pattern.
- 7 Click OK to close the Hatch Options dialog box.
Closed polylines and circles that are retrieved during the query are filled with the specified hatch pattern.
- 8 Click OK to close the Property Alteration dialog box.
- 9 Make sure that Alter Properties is selected.
- 10 Under Query Mode, select Draw.
- 11 Click Execute Query to retrieve the objects and alter them.

Quick Reference

ADEQUERY

Controls defining, modifying, saving, loading, and executing a query

Menu	In the Classic workspace, click Setup menu ► More DWG Options ► Define Query
Icon	 Define Query
Command Line	ADEQUERY
Task Pane	In Map Explorer, right-click Current Query ► Define -or- Right-click a query ► Edit
Dialog Box	Define Query dialog box

Changing the Color of Blocks

When you use the Color option of the Set Property Alterations dialog box, the colors of objects change to the color you specify. However, if the queried objects include blocks whose color is set to BYLAYER, the objects in the block retain their original color. To have them use the color you specify, change the block color to BYBLOCK.

NOTE This functionality applies only to drawing objects. For information on changing the color of geospatial feature data, see [Overview of Styling Features](#) (page 640).

See also:

- [Overview of Queries](#) (page 1235)
- [Executing Queries](#) (page 1288)
- [Altering Properties Using Object Properties](#) (page 1264)
- [Altering Object Properties Using Object Data](#) (page 1267)
- [Altering Object Properties Using Linked Data](#) (page 1269)
- [Filling Queried Drawing Objects with a Hatch Pattern](#) (page 1281)
- [Modifying a Property Alteration Definition](#) (page 1285)

To change the block color in your current drawing

NOTE This procedure applies only to drawing objects. For information on changing the color of geospatial feature data, see [To apply styles to areas](#) (page 650).

- 1 Use the INSERT command to add another instance of the block.
- 2 Explode the new block.
- 3 At the Command prompt, enter chprop
Select objects: Select the objects in the exploded block
Enter property to change (Color/LAyer/LType/lScale/LWeight/Thickness)?
C
Enter new color <varies>: BYBLOCK
Enter property to change (Color/LAyer/LType/lScale/LWeight/Thickness)?
Press Enter
- 4 Redefine the block with the BLOCK command and select the objects in the exploded block.

This procedure redefines all instances of the block. The blocks then show the color you defined in the [Set Property Alterations dialog box](#) (page 1863).

Quick Reference

CHPROP

Changes the color, layer, linetype, linetype scale factor, lineweight, thickness, and plot style of an object

Command Line CHPROP

Modifying a Property Alteration Definition

After you have run a query, you may decide to modify a property alteration definition. Or you may want to create a new property alteration based on an existing query.

After you modify the definition, you can save the changes to the current query, or you can save the changes to a new query.

See also:

- [Overview of Queries](#) (page 1235)
- [Executing Queries](#) (page 1288)
- [Altering Properties Using Object Properties](#) (page 1264)
- [Altering Object Properties Using Object Data](#) (page 1267)
- [Altering Object Properties Using Linked Data](#) (page 1269)
- [Filling Queried Drawing Objects with a Hatch Pattern](#) (page 1281)
- [Changing the Color of Blocks](#) (page 1284)

To modify a property alteration definition

- 1 In [Map Explorer](#) (page 2068), under Current Drawing, right-click Current Query, and then click Define.
- 2 In the Define Query Of Attached Drawings dialog box, load the query to modify.
- 3 Click the Alter Properties button.
- 4 In the [Set Property Alterations dialog box](#) (page 1863), under Current Property Alterations, select the property alteration definition to change.
- 5 Double-click the definition.
The value for the property alteration definition appears in the Expression box and the appropriate property is selected.
- 6 Edit or insert a new value and click Update.
The revised property alteration definition appears under Current Property Alterations. If you click Add instead of Update, the revised expression is added to the existing expression in the list.
- 7 Click OK.
- 8 In the Define Query Of Attached Drawings dialog box, click Save.
To save the changes to a new query, enter a new name and description. Click OK.
- 9 In the Define Query Of Attached Drawings dialog box, click OK to save your changes without running the query.

Quick Reference

ADEQUERY

Controls defining, modifying, saving, loading, and executing a query

Menu	In the Classic workspace, click Setup menu ► More DWG Options ► Define Query
Icon	 Define Query
Command Line	ADEQUERY
Task Pane	In Map Explorer, right-click Current Query ► Define -or- Right-click a query ► Edit
Dialog Box	Define Query dialog box

Executing Drawing Queries

After you define a query to retrieve drawing objects, you can execute it in Preview, Draw, or Report mode.

To execute a drawing query

- [To select a query mode for retrieving drawing objects](#) (page 1288)
- [To run a drawing query in Preview mode](#) (page 1290)
- [To run a drawing query in Draw mode](#) (page 1291)

Overview of Executing Queries

After you define a query to retrieve drawing objects, you can execute it in one of three modes:

- **Preview mode** — Displays the objects on screen, but does not retrieve them. When you change the screen, the objects disappear. Use Preview to test your query.
- **Draw Mode** — Retrieves objects (copies them into the current drawing). You can manipulate and edit them, save them back to their attached drawings, save them to the current drawing, or save them to a new drawing. The objects are not changed in the attached drawings unless you save your changes back to the attached drawings.

- Report Mode — Writes specified information about the objects to a separate file.

Once AutoCAD Map 3D copies the objects that meet the query criteria into the current drawing, it does not duplicate those objects if you run the query again. If an object meets the criteria of more than one query, AutoCAD Map 3D retrieves only one copy of that object. Therefore, you will never have multiple copies of the same object in a drawing.

See also:

- [Overview of Queries](#) (page 1235)
- [Overview of Finding and Querying Drawing Objects](#) (page 1218)

To select a query mode for retrieving drawing objects

- 1 In [Map Explorer](#) (page 2068), under Current Drawing, right-click Current Query, and then click Define.
- 2 Define or load a query.
- 3 Under Query Mode, select [Preview](#) (page 1290), [Draw](#) (page 1291), or [Report](#) (page 1477).
If you select Report mode, click Options to [define a report template](#) (page 1479).
- 4 Click Execute Query.

Quick Reference

ADEQUERY

Controls defining, modifying, saving, loading, and executing a query

Menu	In the Classic workspace, click Setup menu ► More DWG Options ► Define Query
Icon	 Define Query
Command Line	ADEQUERY

Task Pane	In Map Explorer, right-click Current Query ► Define -or- Right-click a query ► Edit
Dialog Box	Define Query dialog box

Running a Drawing Query in Preview Mode

Preview mode provides a quick preview of the drawing objects the query will display in the current drawing. You can run a query in Preview mode and check the objects the query produces. If there are too few or too many objects, or objects are displayed in the wrong location, revise the query as necessary.

NOTE You can plot the results of a Preview query. If you assigned colors to different pen widths in your plotter setup, plotting the results of a Preview query recognizes those plotter assignments for different pen widths.

Queries in Preview mode show objects on layers that are locked; however, Preview mode does not show objects on layers that are Off or Frozen. Although you see many elements in the current drawing following a Preview query, AutoCAD Map 3D treats each set of objects as a single object from each drawing. If you attempt to select several objects, AutoCAD Map 3D reports “one object found” for each of the attached drawings queried. The display of objects is temporary and disappears when you redraw or regenerate. You can zoom and pan to examine the queried objects, but you cannot edit them.

NOTE You can [set the Query option](#) (page 245) Show Insertion Point Only to display blocks as insertion points instead of entire objects for Preview queries.

When referencing blocks or images with the same name but with different paths, a Preview query shows both blocks or images. In Draw mode, the geometry or image displayed is based on the first definition processed.

See also:

- [Overview of Queries](#) (page 1235)
- [Setting Query Options \(DWG\)](#) (page 244)
- [Altering the Properties of Queried Objects](#) (page 1260)
- [Saving a Query](#) (page 177)
- [Running a Drawing Query in Draw Mode](#) (page 1290)

To run a drawing query in Preview mode

- 1 In [Map Explorer](#) (page 2068), under Current Drawing, right-click Current Query, and then click Define.
- 2 Define or load a query.
- 3 Under Query Mode, select Preview.
- 4 Click Execute Query.

To clear objects queried with Preview mode, use the REDRAW or REGEN commands. You can also click Redraw in the Define Query Of Attached Drawings dialog box.

Quick Reference

ADEQUERY

Controls defining, modifying, saving, loading, and executing a query

Menu	In the Classic workspace, click Setup menu ► More DWG Options ► Define Query
Icon	 Define Query
Command Line	ADEQUERY
Task Pane	In Map Explorer, right-click Current Query ► Define -or- Right-click a query ► Edit
Dialog Box	Define Query dialog box

Running a Drawing Query in Draw Mode

Draw mode retrieves drawing objects from attached drawings and copies them into the current drawing. You can save the objects in your current drawing, or you can edit the objects and save them back to the attached drawings. If you decide to edit the queried objects and you have set object locking in System Options, AutoCAD Map 3D locks the individual objects so other users cannot edit them.

Queries in Draw mode retrieve objects from layers that are Off, Locked, or Frozen. Whether the objects remain on layers that are Off, Locked, or Frozen

when they are brought into the current drawing depends on the layers in the current drawing: if the layers exist in the current drawing, the objects take on the characteristics of the existing layers; if the layers do not exist, AutoCAD Map 3D creates new layers with the characteristics of the attached drawing layers.

AutoCAD Map 3D preserves the status of objects on locked layers when it copies them into the current drawing. When you retrieve objects that are on locked layers you cannot save changes back to the attached drawing. If you want to save changes back, open the attached drawing and unlock the layer before performing the query.

AutoCAD Map 3D does not place duplicate copies of objects in the current drawing. Once an object is in the drawing, subsequent queries will not retrieve that object again. See [Sharing Attached Drawings](#) (page 729)

NOTE In Draw mode, if text is queried into the current drawing and the font is missing, AutoCAD Map 3D substitutes another font. The font used is set by the FONTALT system variable.

NOTE When referencing blocks or images with the same name but with different paths, the geometry or image displayed is based on the first definition processed. A Preview query displays both blocks or images.

See also:

- [Overview of Queries](#) (page 1235)
- [Altering the Properties of Queried Objects](#) (page 1260)
- [Saving a Query](#) (page 177)
- [Sharing Attached Drawings](#) (page 729)
- [Running a Drawing Query in Preview Mode](#) (page 1289)

To run a drawing query in Draw mode

- 1 In [Map Explorer](#) (page 2068), under Current Drawing, right-click Current Query, and then click Define.
- 2 Define or load a query.
- 3 Under Query Mode, select Draw.
- 4 Click Execute Query.

AutoCAD Map 3D copies the queried objects from the attached drawings to the current drawing.

AutoCAD Map 3D does not duplicate objects that have already been queried into the current drawing.

Quick Reference

ADEQUERY

Controls defining, modifying, saving, loading, and executing a query

Menu	In the Classic workspace, click Setup menu ► More DWG Options ► Define Query
Icon	 Define Query
Command Line	ADEQUERY
Task Pane	In Map Explorer, right-click Current Query ► Define -or- Right-click a query ► Edit
Dialog Box	Define Query dialog box

Improving Drawing Query Performance

You can improve the performance of a drawing query by creating an index or by removing an assigned coordinate system.

NOTE The following apply only to drawing data. There is no equivalent for geospatial feature data.

To improve performance

- [To create a drawing index](#) (page 1294)
- [To remove a drawing index](#) (page 1294)
- [To remove an assigned coordinate system](#) (page 1296)

Creating a Drawing Index

To reduce the amount of time it takes to perform a drawing query, create an index. Instead of searching all location, property, object data, or database links to find matching data, AutoCAD Map 3D searches only the relevant index.

NOTE Whenever you open a drawing that includes database links, AutoCAD Map 3D automatically creates a database link index and keeps it in memory. To save this database index to the drawing, select the Store Links Index In Drawing File option. To set this option, select AutoCAD Options from the Application menu. Select the System tab. This feature is especially useful when you edit your attached drawings directly.

You can create the following kinds of index:

- Location index — Divides drawings into regions. AutoCAD Map 3D targets just the regions included in the Location query.
- Property index — Organizes object properties. AutoCAD Map 3D targets only the objects with the properties you specify.
- SQLLinks index — Organizes the link templates and key fields of the drawing. AutoCAD Map 3D targets only the objects with the link templates and key field values you specify.
- EED index — Organizes Extended Entity Data (EED) attached to objects in drawings created in AutoCAD Data Extension (ADE) 1.0. You cannot create EED in the current release of AutoCAD Map 3D.
- Object Data index — Organizes object data. AutoCAD Map 3D targets only the objects with the object data you specify. After you generate an object data index, a status message appears beside each indexed field name. The status "Current" means that the object data index on that field is valid and consistent with the attached object data. The status "Out-of-Date" means that the object data index on that field is not consistent with the attached object data. An index could become out-of-date if you modify objects without first loading AutoCAD Map 3D.

See also:

- [Finding All Drawing Objects in a Specified Location](#) (page 1238)
- [Finding All Drawing Objects Containing a Specific Property](#) (page 1242)
- [Finding All Drawing Objects Containing Specific Data](#) (page 1245)

- [Finding All Drawing Objects Containing Specific SQL Information](#) (page 1249)
- [Entering and Editing Object Data](#) (page 1061)

To create a drawing index

- 1 In [Map Explorer](#) (page 2068), right-click Drawings. Click Maintenance.
- 2 In the [Drawing Maintenance dialog box](#) (page 1920), under Active Drawings, select the drawings for which you want to create indexes.
If another user has activated the drawing, you cannot create an index for it.
- 3 Click Drawing Index.
If the selected drawing does not have an index or the index is out of date, the check box beside the index type under Generate Index is selected.
- 4 In the [Drawing Statistics dialog box](#) (page 1926), under Generate Index, select the type of index to create.
To generate an object data index, click Object Data. Select the object data table and fields. Click OK.
- 5 Click OK.
- 6 Click OK to confirm.
AutoCAD Map 3D creates the type of index you specified for each of the selected drawings.
- 7 Click Close.

NOTE When you create an index, you may receive a warning message that AutoCAD Map 3D cannot calculate object extents. This indicates that a third-party application might have created the object and that the application is not loaded or the object may not support the geometric extents methodology of AutoCAD Map 3D.

To remove a drawing index

- 1 In [Map Explorer](#) (page 2068), right-click Drawings. Click Maintenance.
- 2 In the [Drawing Maintenance dialog box](#) (page 1920), under Active Drawings, select the drawings for which you want to remove indexes.
- 3 Click Drawing Index.

- 4 In the [Index Maintenance dialog box](#) (page 1931), under Remove Index, select the type of index to remove. To remove an object data index, click Object Data.
- 5 In the [Remove Object Data Index dialog box](#) (page 1933), select the object data table and fields. Click OK.
- 6 Click OK to confirm.
AutoCAD Map 3D removes the index you specified for each of the selected drawings.
- 7 Click Close.

Quick Reference

ADEDWGMAINT

Removes locks from objects

Menu	Setup menu ► More DWG Options ► Drawing Maintenance
Command Line	ADEDWGMAINT
Task Pane	In Map Explorer, right-click Drawings ► Maintenance
Dialog Box	Drawing Maintenance dialog box

Removing an Assigned Coordinate System

When you retrieve data from an attached drawing, the data is automatically transformed if the attached drawing uses one coordinate system and the current drawing uses a different system. When data is saved back to the attached drawing, the data is automatically transformed to match the coordinate system of the attached drawing.

Performing these transformations can decrease performance when querying objects. To speed up querying, you can remove an assigned coordinate system.

See also:

- [Assigning Coordinate Systems](#) (page 142)

To remove an assigned coordinate system

- 1 In [Map Explorer](#) (page 2068), right-click Current Drawing, and then click Coordinate System.
- 2 In the Assign Global Coordinate System dialog box, under Current Drawing or under Source Drawings, replace the code with a period (.) in the Code box.

Quick Reference

ADESETCRDSYS

Assigns a global coordinate system code for the current drawing or attached drawings

Menu	Setup menu ► Assign Global Coordinate System
Icon	 Assign Coordinate System
Command Line	ADESETCRDSYS
Task Pane	In Map Explorer, right-click Current Drawing ► Coordinate System
Dialog Box	Assign Global Coordinate System dialog box

Troubleshooting Drawing Queries

Issues can arise when you retrieve blocks, text, externally referenced drawings (xrefs), groups, and hatch patterns from drawings. The following information helps you deal with these issues.

NOTE Query functionality applies to drawing objects only. For information about filtering geospatial feature data, see [Overview of Finding and Selecting Features](#) (page 1207).

Block Queries in Preview Mode

In Preview mode, you can display a queried block as a block or simply as an "X" that signifies the block's insertion point. On the Query tab of the AutoCAD Map Options dialog box under Options, select or deselect Show Preview Block

As Point Only. To set this and other query options, see [Setting Query Options](#) (page 245).

Block Attributes and Property Queries

When performing Property queries, you can query using block attributes, but not *constant* attributes. You can define constant attributes that have the same value for every occurrence of the block that contains them. However, Property queries do not recognize constant attributes. Instead, use the block name in the query.

You can, however, specify invisible attributes. An invisible attribute is not displayed or plotted but is stored in the drawing file. For detailed information on attributes, look up attributes in the index of the online help.

See also:

- [Finding All Drawing Objects Containing Specific Data](#) (page 1245)

Queries with Blocks of the Same Name

When queries reference blocks with the same name that lie in two different attached drawings, a Draw query references the block definition first queried into the current drawing; a Preview query references the block definition in the attached drawing.

For example, if a Draw query retrieves a block named parcel1 (a rectangular parcel) from drawing one, and then a block named parcel1 (a square parcel) from drawing two, the current drawing displays the rectangular parcel. The block definition for parcel1 is already in the current drawing. A Preview query displays both the rectangular parcel and the square parcel. Preview queries create temporary objects referenced from the attached drawings.

NOTE The same considerations apply when referencing raster images with the same name but with different paths. A Preview query displays both images. A Draw query, displays the image based on the first definition processed.

See also:

- [Running a Drawing Query in Preview Mode](#) (page 1289)
- [Running a Drawing Query in Draw Mode](#) (page 1290)

Queries and Raster Images

Raster images attached to drawings using the IMAGEATTACH or MAPIINSERT commands are objects that are part of the drawing. When queried, raster images behave like blocks. Raster images resulting from a paste operation, that is, an OLE frame, are *not* recognized as objects in queries.

When a raster image is queried during a Preview query that includes a coordinate conversion or transformation, the image is not displayed.

When a raster image is queried during a Draw query that includes a coordinate conversion or transformation, the object is transformed like a block insert, around the insertion point.

See also:

- [Running a Drawing Query in Preview Mode](#) (page 1289)
- [Running a Drawing Query in Draw Mode](#) (page 1290)

Blocks and Property Alteration (Color)

When using Property Alteration to change the color of retrieved blocks, the color of the components of the attached drawing block must be BYBLOCK. Otherwise, no matter what color change you specify for the Property Alteration, the block retains its original colors when queried.

See also:

- [Overview of Altering the Properties of Queried Drawing Objects](#) (page 1259)
- [Changing the Color of Blocks](#) (page 1284)

Blocks and Property Alteration (Scale)

To set the scale of all the blocks retrieved by the current query to a scale of 2, use Property Alteration and set Scale to 2. This sets the scale of all queried blocks to 2 no matter what their current scale is.

To scale all blocks retrieved by the current query by a factor of 2, use Property Alteration and set Scale to (* .XSCALE 2). This multiplies the existing scale of each queried block by a factor of 2. Make sure that you leave a space between the * and .XSCALE 2.

See also:

- [Overview of Altering the Properties of Queried Drawing Objects](#) (page 1259)

- [Altering Properties Using Object Properties](#) (page 1264)

Property Alteration (Scale and Rotate)

In the Property Alteration dialog box, the Scale option applies only to blocks, the Rotate option applies only to text and blocks.

See also:

- [Overview of Altering the Properties of Queried Drawing Objects](#) (page 1259)
- [Altering Properties Using Object Properties](#) (page 1264)

Thickness, Width, and Property Queries

You can use a Property query to query on extruded polyline thickness using the Thickness option in the Property Condition dialog box. You cannot query on polyline width. AutoCAD Map 3D supports queries on Thickness for the following kinds of objects: line, arc, text, circle, point, solid, 2D polyline, light weight polyline, trace, and shape.

See also:

- [Overview of Altering the Properties of Queried Drawing Objects](#) (page 1259)

Querying Drawings with Xrefs

When you query attached drawings that contain xrefs, AutoCAD Map 3D does not copy the objects in the xref drawing into the current drawing. Instead, only the name of the xref drawing appears at the xref insertion point in the current drawing. To query the xref drawing, attach the drawing separately.

NOTE Queries in Preview mode do not display the xref drawing name, but queries in Draw mode do.

See also:

- [Overview of Attaching Drawings](#) (page 154)
- [Running a Drawing Query in Preview Mode](#) (page 1289)
- [Running a Drawing Query in Draw Mode](#) (page 1290)

Retrieving Groups of Objects

When you retrieve a group of objects, AutoCAD Map 3D treats them as separate and independent objects and then restores the group when you save the objects back to the attached drawings, even if you edit the objects in the group. However, if you create a new object in the current drawing, you cannot associate it with the group to be saved back to the attached drawing.

See also:

- [Saving Queried Objects Back to Attached Drawings](#) (page 753)

Retrieving Hatched Areas

By default, AutoCAD Map 3D retrieves hatched areas, solid objects, and raster images using the bounding box, not the insertion point. To change the default, use the Reference Entire Bounding Area For Objects option on the AutoCAD Map Options dialog box.

If you hatch objects that are formed by retrieving objects from multiple attached drawings, the hatch associativity is lost when you save back.

Associative hatching is designed to work in a single drawing environment. We recommend against querying, editing, and saving back associative hatches. In most cases, hatch associativity is not maintained.

See also:

- [Setting Query Options \(DWG\)](#) (page 244)

To set options for drawing queries

- In the Tool-based Ribbon Workspace, click Map Setup tab ► Map panel ► angle-arrow.
- Click the tab you want.

Quick Reference

ADEQUERY

Controls defining, modifying, saving, loading, and executing a query

Menu	In the Classic workspace, click Setup menu ► More DWG Options ► Define Query
Icon	 Define Query
Command Line	ADEQUERY
Task Pane	In Map Explorer, right-click Current Query ► Define -or- Right-click a query ► Edit
Dialog Box	Define Query dialog box

Analyzing Feature Classes

Use buffers and overlays to analyze feature classes.

NOTE These topics apply only to geospatial feature data. For information about using buffers and overlays for drawing objects, see [Overlaying Two Topologies](#) (page 1336) and [Buffering a Topology](#) (page 1345).

To analyze feature classes

NOTE These procedures apply only to geospatial feature data. For information about using buffers and overlays for drawing objects, see [To overlay two topologies](#) (page 1339) and [To buffer a topology](#) (page 1347).

- [To create a buffer](#) (page 1308)
- [To change your selection or merge options after receiving a buffer warning](#) (page 1309)
- [To perform an Overlay operation](#) (page 1316)

Quick Reference

MAPFDOBUFFERCREATE

Creates a buffer zone around features in your map

Menu	Click Analyze ► Buffer.
Command Line	MAPFDOBUFFERCREATE

Dialog Box Create Buffer dialog box

MAPGISOVERLAY

Performs overlay analysis of feature classes

Menu Click Analyze menu ► GIS Overlay.

Icon 

Command Line MAPGISOVERLAY

Overview of Analyzing Feature Classes

Use buffers and overlays to analyze feature classes.

NOTE This functionality applies only to geospatial feature data. For information about using buffers and overlays for drawing objects, see [Overlaying Two Topologies](#) (page 1336) and [Buffering a Topology](#) (page 1345).

Buffers identify areas at a specified distance from a geographic feature. Once you specify a feature and generate a buffer around it, you can identify or select features that fall inside or outside the boundary of the buffer.

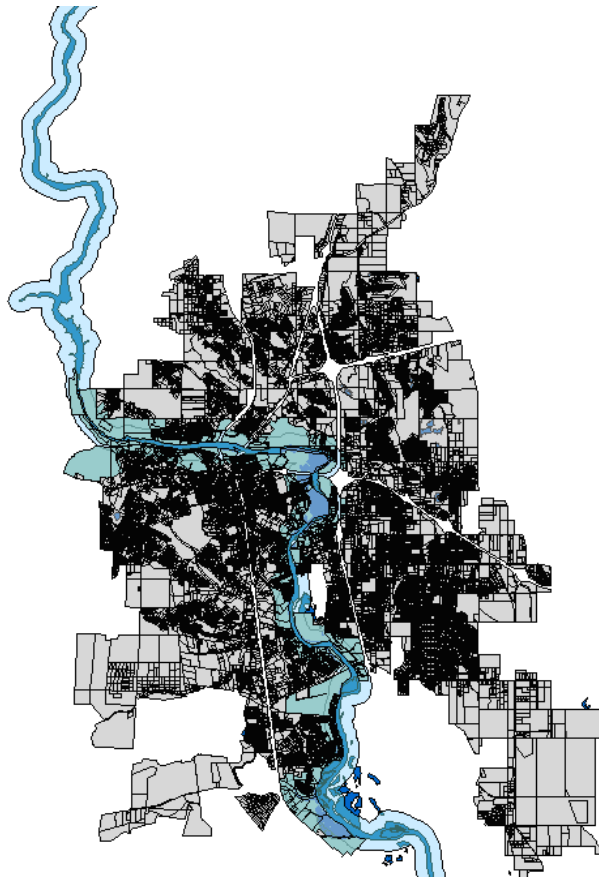

Use buffers to analyze features by proximity.

Overlays compare two feature classes or layers that are spatially related. Once you select the feature classes to compare and the type of overlay to perform, AutoCAD Map 3D creates a new layer and data store containing the results of the comparison. You can connect to the comparison data store as you would to any other data store.

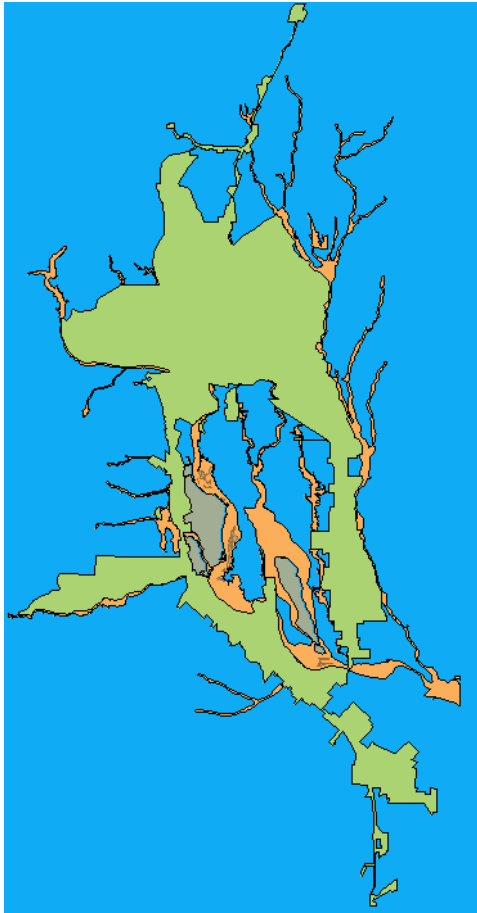

Use overlays to compare two layers that are related spatially.

Tell me more



Video

- *Show me how to create a buffer zone around a parcel.*
- *Show me how to use a buffer zone to select parcels.*
- *Show me how to create overlapping buffer zones.*

- *Show me how to use a location query with multiple buffers.*
- *Show me how to create an overlay analysis for features*

 **Tutorial**

- Lesson 3: Analyze Data by Proximity Using Buffers
- Lesson 4: Perform a Flood Analysis with Overlay
- Lesson 5: Edit a Predefined Workflow

 **Workflow**

- Find and Select Features Within a Buffer Zone

 **Procedures**

- [To create a buffer](#) (page 1308)
- [To perform an Overlay operation](#) (page 1316)

 **GIS Skills**

- *Select features by location using a buffer.*
- *Create overlapping buffer zones around points.*

 **Related topics**

- [Buffering a Topology](#) (page 1345)

To analyze feature classes

NOTE These procedures apply only to geospatial feature data. For information about using buffers and overlays for drawing objects, see [To overlay two topologies](#) (page 1339) and [To buffer a topology](#) (page 1347).

- [To create a buffer](#) (page 1308)
- [To change your selection or merge options after receiving a buffer warning](#) (page 1309)
- [To perform an Overlay operation](#) (page 1316)

Quick Reference

MAPFDOBUFFERCREATE

Creates a buffer zone around features in your map

Menu	Click Analyze ► Buffer.
Command Line	MAPFDOBUFFERCREATE
Dialog Box	Create Buffer dialog box

MAPGISOVERLAY

Performs overlay analysis of feature classes

Menu	Click Analyze menu ► GIS Overlay.
Icon	
Command Line	MAPGISOVERLAY

Buffering Features in Your Map

Use buffers to analyze features by proximity. Select a geospatial feature in your map and specify the distance for the buffer. AutoCAD Map 3D creates a polygon around the feature or features you have selected at the distance you specify.

NOTE This functionality applies only to geospatial feature data. For information about using buffers for drawing objects, see [Buffering a Topology](#) (page 1345).

You can output the buffer to a new layer in your map or append it to an existing buffer layer. If you are buffering multiple features, you can specify whether AutoCAD Map 3D should merge all the buffers into a single buffer, merge only the overlapping buffers, or leave the buffers separate. AutoCAD Map 3D saves buffer data in SDF format.

You can use buffers to select features within the specified buffer distance of other features. For example, if you created a one-mile buffer around a construction zone, you could use this buffer to find all parcels within one mile of the construction area.

Buffer Warnings

If you select a very large number of features to buffer, AutoCAD Map 3D will display a warning and give you the option of reducing the number of features in your selection. AutoCAD Map 3D will also display this warning if you have selected features with very complex geometry, or if you have selected merge options for too many features or features with complex geometry.

NOTE When creating buffers around objects with complicated geometries, such as islands, the buffer might not display correctly. If you use the merge option to merge the buffers for all the geometries of a feature, it will display correctly.

Tell me more



Video

- *Show me how to create a buffer zone around a parcel.*
- *Show me how to use a buffer zone to select parcels.*
- *Show me how to create overlapping buffer zones.*
- *Show me how to use a location query with multiple buffers.*



Tutorial

- Lesson 3: Analyze Data by Proximity Using Buffers



Workflow

- Find and Select Features Within a Buffer Zone



Procedures

- [To create a buffer](#) (page 1308)



GIS Skills

- *Select features by location using a buffer.*
- *Create overlapping buffer zones around points.*





Related topics

- [Buffering a Topology](#) (page 1345)
-

To create a buffer

NOTE This procedure applies only to geospatial feature data. For information about using buffers for drawing objects, see [To buffer a topology](#) (page 1347).

- 1 Click Analyze tab ► Feature panel ► Feature Buffer. 
- 2 In the [Create Buffer dialog box](#) (page 1559), if you have not already selected the feature or features to buffer, click Select Features to select the features interactively on your map.
- 3 To set the buffer distance, enter a value for Distance or click  to enter a distance interactively on your map. Use the measurement units specified by the coordinate system assigned to your map, or choose a different unit from the list.

NOTE If you change the units after you specify the distance, the Distance entry updates to show that measurement in the new units.

- 4 For Output To Layer, specify the Display Manager layer to contain the buffer. If you created other buffers in this map, you can choose one of their layers from the list. By default, AutoCAD Map 3D creates a new layer for your buffer.
- 5 Specify the name of the SDF file to store the buffered features. By default, the buffer file is saved in the current drawing's saved location.
- 6 Select a Merge Results option:
 - No Merging: Overlapping buffers are not merged. The number of resulting buffers is equal to the number of features being buffered.
 - Merge All Buffers: All overlapping buffers are merged into a single buffer and then combined into a single polygon.
 - Merge Overlapping Buffers: Only the overlapping buffers are merged.
- 7 Click OK.
You can style the buffer as you would any other Display Manager layer. All buffers you append to this buffer layer will use the same style. For more information on styling features, see [Styling Features](#) (page 639).

To change your selection or merge options after receiving a buffer warning

- 1 In the [Buffer Warning dialog box](#) (page 1560), click Change.
Proceeding after receiving a buffer warning may take a very long time.
- 2 In the [Create Buffer dialog box](#) (page 1559), do one or both of the following:
 - Click Select Features, then click the features to buffer on your map.
 - Select a new Merge Results option.
- 3 Click OK.

Quick Reference

MAPFDOBUFFERCREATE

Creates a buffer zone around features in your map

Menu	Click Analyze ► Buffer.
Command Line	MAPFDOBUFFERCREATE
Dialog Box	Create Buffer dialog box

Overlaying Two Feature Sources

Use Overlay to compare two feature classes or layers that are spatially related. One class or layer is designated the Source and one is designated the Overlay. The Overlay operation produces an output layer that is also saved as a separate SDF feature store. The contents and attributes of the new layer vary, depending on the type of Overlay operation you perform.

NOTE This functionality applies only to geospatial feature data. For information about using overlays for drawing objects, see [Overlaying Two Topologies](#) (page 1336).

You can overlay feature classes with up to a million features, depending on the size and complexity of the features.

NOTE You can automate Overlay operations using Workflows. For more information, see [Setting Up and Running Workflows](#) (page 274).

Tell me more



Video

- [Show me how to create an overlay analysis for features](#)



Tutorial

- Lesson 4: Perform a Flood Analysis with Overlay
- Lesson 5: Edit a Predefined Workflow



Procedures

- [To perform an Overlay operation](#) (page 1316)



GIS Skills

- [Create an overlay analysis for features.](#)



Related topics

- [Overlaying Two Topologies](#) (page 1336)
-

Attributes in the Resulting Layer

Use the [Split and Merge Rules dialog box](#) (page 1669) to set attributes for layers that are split as a result of an overlay operation. If you do not set these rules, such features follow default rules. Merge rules do not apply. If you overlay two feature sources that you used previously in a different map, you must reset the rules for the new map.

In some cases, attributes from both the Source and Overlay are written to the output. If this results in attributes that have the same name, each one will have the original attribute name and a numeric suffix. For example, you can overlay two layers called Cities and Parcels. If both have a Name attribute, the resulting layer will have attributes called “Name_1” and “Name_2.”

Selecting Source and Overlay Geometries

The geometry in the feature classes or layers you select determines the other choices in the dialog box. You can combine only certain types of geometries. For example, Union and Symmetric Difference support polygon/polygon comparisons only. Also, you cannot choose point geometries for both Source and Overlay. If you select point geometry for Source, you can select only polygon geometry for Overlay.

The order of the geometries you select is important. To compare line and polygon geometries, the line geometry must be the Source layer. If you select a polygon geometry as the Source, line geometries are not available as the Overlay.

The available choices for Type depend on the geometry in the Source and Overlay. However, if the Source or Overlay is binding data, AutoCAD Map 3D cannot determine the geometry types before it executes the operation. In that case, all Type options are available, even if some of them are invalid. The output might be empty if there are no valid geometry combinations.

If either the Source or the Overlay contains multiple geometries, you can select any feature class or layer in Overlay and any overlay operation in Type. However, the output might be empty if there are no valid geometry combinations. Also, if the geometries include both polygons and lines, any lines that intersect polygons will split those polygons, which may not be desired.

Overlay Types

Overlay types include:

- [Intersect](#) (page 1311)
- [Union](#) (page 1312)
- [Erase](#) (page 1313)
- [Identity](#) (page 1313)
- [Clip](#) (page 1314)
- [Paste](#) (page 1315)
- [Symmetric Difference](#) (page 1315)

Intersect

Intersect determines the geometry that overlaps in the Source and Overlay feature sources. Anything that does not overlap is discarded from the output, so the resulting layer represents what the Source and Overlay have in common. Use Intersect to find points or lines that lie within a polygon, or to determine the places where two line features overlap. For example, find tree points that are within park polygons.

The resulting layer has the attributes of both the Source and Overlay features.

Intersect supports the following geometry types:



Intersect: line/line



Intersect: line/polygon



Intersect: point/polygon



Intersect: polygon/polygon

Union

Union determines the geometry that exists in either the Source or Overlay geometry. Where the geometry intersects, additional features are created. The resulting layer is the sum of the two comparison layers. Use Union to combine two related polygon features. For example, create a new feature source that combines the business district and the theater district when these two areas overlap.

The resulting layer has the attributes of both the Source and Overlay features.

Union supports polygon/polygon comparisons only.



Union: polygon/polygon

Erase

Erase determines the geometry from the Source that does not intersect with the Overlay. The intersecting pieces are discarded. Use Erase to subtract a geometric section from a feature class. For example, find all roads that lie outside the enterprise district, or all hospitals that are outside the flood zone.

The resulting layer has the attributes of the Source feature only.

Erase supports the following geometry types:



Erase: line/polygon



Erase: point/polygon



Erase: polygon/polygon

Identity

Identity creates new features where the Source and Overlay features intersect. Use Identity to split features at the point where they intersect with another feature class, and to create new features at that point. For example, divide roads or parcels where they cross county borders.

Feature attributes from both the source and overlay are included in the resulting features, but only the intersecting features will have the values from both. If AutoCAD Map 3D splits an original feature to produce an output feature, it uses the Split/Merge rules to determine how to assign the attributes. When that occurs, attributes of the Overlay feature are appended to the resulting features. Non-intersecting Source features retain their original properties.

Identity supports the following geometry types:



Identity: line/polygon



Identity: point/polygon



Identity: polygon/polygon

Clip

Like Intersect, Clip creates features from the areas of the Source that overlap with the Overlay.

Use Clip to find features that lie within a geometric area. For example, find hydrants within a development, or road segments within a particular neighborhood.

If AutoCAD Map 3D splits an original feature to produce an output feature, it uses the Split/Merge rules to determine how to assign the attributes.

when you use Clip, only feature attributes from the Source are included in the resulting layer.

Clip supports the following geometry types:



Clip: line/polygon

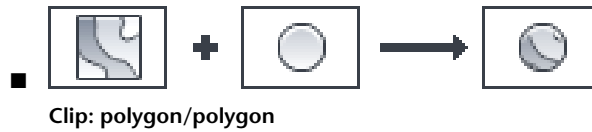

Paste

Paste creates new features by pasting the Overlay features onto the Source features. All Overlay features become new features in the resulting layer. In addition, areas of the Source that do not fall within the geometry of the Overlay become features in the resulting layer. Use Paste to combine two overlapping features. For example, add the attributes of city districts to the developments they overlap.

The output layer has attributes from both the Source and Overlay. Features resulting from the Source geometry have values for Source attributes, but their Overlay attribute values are NULL. Features resulting from the Overlay geometry have values for Overlay attributes, but their Source attribute values are NULL.

Paste supports polygon/polygon comparisons only.



Symmetric Difference

Symmetric Difference determines geometry in the Source and Overlay that does not overlap. Overlapping areas of the features are discarded in the output. The non-overlapping areas become new features. Use Symmetric Difference to find areas that are mutually exclusive in two feature classes. For example, find new housing developments that are outside existing school districts.

The output layer has attributes from both the Source and Overlay. Features resulting from the Source geometry have values for Source attributes, but their Overlay attribute values are NULL. Features resulting from the Overlay geometry have values for Overlay attributes, but their Source attribute values are NULL.

Symmetric Difference supports polygon/polygon comparisons only.



Symmetric difference: polygon/polygon

To perform an Overlay operation

NOTE This procedure applies only to geospatial feature data. For information about using overlays for drawing objects, see [To overlay two topologies](#) (page 1339).

- 1 [Connect](#) (page 308) to the features sources to compare.
To use a feature layer, you must add it to your map. To use a feature class, you must connect to its data store, but you need not add it to the map.
- 2 Analyze tab ► Feature panel ► Feature Overlay 
- 3 On the [Overlay Analysis dialog box - Source and Overlay Type page](#) (page 1563), specify the following:
 - Source: Specify the feature layer or feature class to use as the source. For information about considerations in selecting Source and Overlay entries, see [the Concept tab for this topic](#) (page 1309).
 - Overlay: Specify the feature layer or feature class to use as the overlay.
 - Type: Select the type of overlay comparison to perform. For more information on the available types, see [the Concept tab for this topic](#) (page 1311).
- 4 Click Next.
- 5 On the [Overlay Analysis dialog box - Set Output and Settings page](#) (page 1565), specify the following:
 - Output: Specify the name and location of the SDF file that will contain the result of the Overlay operation.

- **Layer Name:** Specify the name of the Display Manager layer that will contain the result of the Overlay operation.
- **Sliver Tolerance:** Specify which slivers become separate features and which are joined with a neighboring polygon. Set the units for the tolerance setting, then set the maximum and minimum values. To see recommended values, click Suggest. The default suggested values for sliver tolerances are 1/10 of the smallest input area for the Maximum and 1/100 of the smallest input area for the Minimum. When the Overlay operation splits features to produce the output layer, it eliminates polygons that are smaller than the specified tolerance settings. Some such polygons were present in the sources, and some are produced by the Overlay operation itself. The elimination of slivers affects the output layers only. Polygons whose areas are larger than the Maximum value become separate features in the output layer. Polygons whose areas are smaller than the Minimum (and have at least one neighboring polygon) are considered slivers, and are merged with the neighboring polygon that has the longest shared edge. The Overlay operation checks polygons that fall between the two values to see how wide they are. If they are very narrow, they are merged with a neighboring polygon.

NOTE If the resulting polygons are not as desired, try adjusting the tolerance values and repeating the Overlay operation.

To ignore slivers altogether, click Don't Remove Slivers.

- **Ordinate Tolerance:** Specify how far apart two nodes or vertices of a line or polygon must be to be treated as separate points in the output layer. Set the units for the tolerance setting, then set the Length. Any two points that are closer together than the Length value are treated as a single point in the output layer.
- **Output Properties:** Specify which properties from the Source and (if applicable) Overlay are included in the resulting layer. "All" adds all properties to the resulting layer. "Identifiers" adds only the primary identifiers (primary keys or unique fields, such as Feature_ID). "Non-Identifiers" adds only the non-key attributes (such as Land_Value or Speed_Limit, for example). If you add only non-identifiers, the overlay operation generates primary identifiers for the features in the resulting layer.

- 6 Click Finish to perform the Overlay.

The Overlay operation creates a new layer representing the result of the comparison. The new layer is displayed in the map and in Display Manager. The same data is written to the SDF file you specified.

To see just the Overlay output, deselect the check boxes for the other layers in Display Manager.

Quick Reference

MAPGISOVERLAY

Performs overlay analysis of feature classes

Menu Click Analyze menu ► GIS Overlay.

Icon



Command Line MAPGISOVERLAY

Analyzing Drawing Topologies

Topologies are defined by a set of drawing objects and their relationships. (Features are not included in topologies.)

After you create a topology in a drawing, you can analyze it to get useful information about the spatial relationships between drawing objects.

- [Overview of Analyzing Drawing Topologies](#) (page 1319)
- [Performing a Shortest Path Trace](#) (page 1324)
- [Performing a Best Route Analysis](#) (page 1328)
- [Performing a Flood Trace](#) (page 1333)
- [Overlaying Two Topologies](#) (page 1336)
- [Dissolving a Composite Topology](#) (page 1342)
- [Buffering a Topology](#) (page 1345)
- [Querying a Topology](#) (page 1348)
- [Saving a Temporary Topology](#) (page 1354)

Before you can use the topology analysis tools, you must create a topology and make sure it is loaded.

NOTE This functionality applies only to drawing objects. For information about analyzing geospatial feature data, see [Overview of Analyzing Feature Classes](#) (page 1302).

See also:

- [Creating Topologies](#) (page 821)
- [Loading or Unloading Topologies](#) (page 906)

NOTE The following procedures apply only to drawing objects. For information about analyzing geospatial feature data, see [To analyze feature classes](#) (page 1305).

To analyze drawing topologies

- [To perform a shortest path trace](#) (page 1326)
- [To perform a best route analysis](#) (page 1330)
- [To perform a flood trace](#) (page 1334)
- [To overlay two topologies](#) (page 1339)
- [To dissolve a composite topology](#) (page 1343)
- [To buffer a topology](#) (page 1347)
- [To query a topology](#) (page 1353)
- [To convert a temporary topology to a permanent topology](#) (page 1354)

Overview of Analyzing Drawing Topologies

After you have created a drawing topology, you can use it to analyze spatial relationships between the drawing objects. You can:

- Extract or create new information about a set of objects
- Determine the distribution of an object, or objects, over a network or area
- Manage relationships between objects
- Analyze the location, proximity, and orientation of objects
- Evaluate suitability and capability, estimate, predict, and interpret
- Identify conditions at a geographic location, in a spatial area, or along a linear network, and predict effects of future events on these items

Different topologies can contain information on different aspects of a map. For example, a political map shows county lines or cities and towns. A

geological map shows soil types or contour lines. A social map might show the locations of crimes or high-income areas.

Before you can analyze a topology, you must create the topology and make sure it is loaded.

NOTE This functionality applies only to drawing objects. For information about analyzing geospatial feature data, see [Overview of Analyzing Feature Classes](#) (page 1302).

Tell me more



Video

- *Show me how to create a network topology.*
- *Show me how to load a topology.*
- *Show me how to find the shortest path between two points.*
- *Show me how to do an overlay analysis using two topologies.*



Procedures

- [To analyze drawing topologies](#) (page 1319)



GIS Skills

- *Create a network topology to show how lines are connected.*
- *Find the shortest path through a network.*
- *Find which lines are within a particular polygon (overlay analysis).*



Related topics

- [Creating Topologies](#) (page 821)
- [Loading or Unloading Topologies](#) (page 906)

NOTE The following procedures apply only to drawing objects. For information about analyzing geospatial feature data, see [To analyze feature classes](#) (page 1305).

You can analyze drawing topologies in the following ways:

To do this...	Use this method...
Calculate the shortest path between two points in a drawing or determine the optimal route based on values of resistance and direction.	Perform a shortest path trace (page 1326)
Calculate the best route from a starting point in the drawing to one or more visit points, and back to the starting point.	Perform a best route analysis (page 1330)
Determine how many links and nodes can be traveled before the accumulated resistance exceeds the specified maximum resistance.	Perform a flood trace (page 1334)
Compare two existing topologies and keep only common geometry, remove common geometry, or combine geometry in a specified way.	Overlay two topologies (page 843)
Create a new topology by combining polygons that share the same data value in a specified field.	Dissolve a topology (page 1343)
Identify objects within a specified offset of elements in node, network, and polygon topologies.	Buffer a topology (page 1347)
Retrieve a loaded topology and its associated data from the current drawing or an attached drawing, or query part of a topology in a source drawing and work on that part of a topology without having to retrieve all its objects.	Query a topology (page 1353)
Save back the temporary information retrieved by a topology query to the drawings from which it was queried.	Save a temporary topology (page 1354)

Quick Reference

MAPANBUFFER

Creates a buffer around an existing topology

Menu Click Analyze ► Buffer.

Icon  Buffer Topology

Command Line MAPANBUFFER

Task Pane In Map Explorer, right-click a topology ► Analysis ► Buffer

Dialog Box Topology Buffer - Set Buffer Distance dialog box

MAPANDISSOLVE

Removes the boundaries between polygons in a topology or the nodes between links that share a specific attribute

Menu Click Analyze ► Dissolve.

Icon  Dissolve Topology

Command Line MAPANDISSOLVE

Task Pane In Map Explorer, right-click a network or polygon topology ► Analysis ► Dissolve

Dialog Box Topology Dissolve - Set Parameter dialog box

MAPANOVERLAY

Overlays one topology with another, and creates a new topology

Menu Click Map ► Topology ► Overlay.

Icon  Overlay Topology

Command Line MAPANOVERLAY

Task Pane In Map Explorer, right-click a topology ► Analysis ► Overlay

Dialog Box Topology Overlay Analysis - Analysis Type dialog box

MAPANTOPONET

Traces through a network topology (shortest path, best route, or flood trace)

Menu Click Map ► Topology ► Network Analysis.

Icon



Network Analyze

Command Line MAPANTOPONET

Task Pane In Map Explorer, right-click a network topology ► Analysis ► Network Analysis

Dialog Box Network Topology Analysis - Select Method dialog box

MAPTOPOLOAD

Loads a topology

Menu Click Analyze ► More Topology Options ► Load Topology.

Icon



Load Topology

Command Line MAPTOPOLOAD

Task Pane In Map Explorer, right-click a topology ► Administration ► Load Topology

Dialog Box Topology Selection dialog box

MAPTOPOQUERY

Queries topologies

Menu Click Setup ► More DWG Options ► Define Topology Query.

Icon



Query Topology

Command Line MAPTOPOQUERY

Task Pane	In Map Explorer, right-click a topology ► Analysis ► Topology Query
Dialog Box	Topology Query dialog box

Performing a Shortest Path Trace

Using a network topology, which is made up of drawing objects and their relationship data, you can calculate the shortest path between two points in a drawing or determine the optimal route based on values of resistance and direction. This process is known as a *shortest path trace analysis*.

In a drawing of a street network, for example, you might find the shortest path between a fire station and a school.

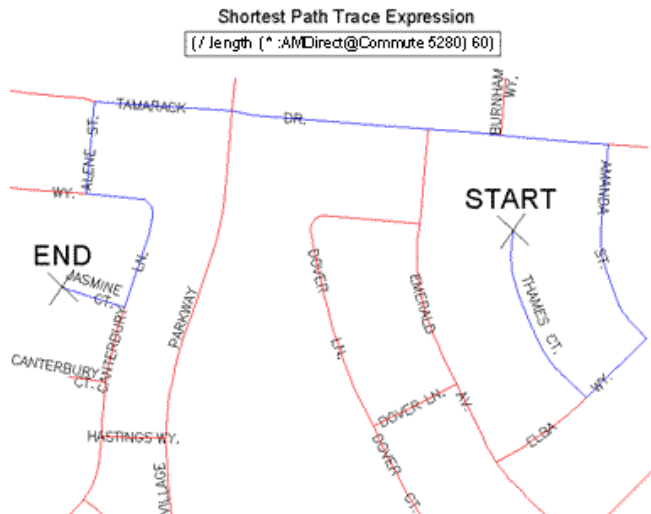

Shortest path trace based on resistance (time taken to traverse a segment).

You can specify a resistance for any link in the network. This resistance specifies the difficulty in traversing the link. The default resistance is the length of the link.

If a path has a total resistance lower than the Minimum Resistance value, the path is ignored. Similarly, if a path has a total resistance greater than the Maximum Resistance value, the path is ignored.

Using SQL Data in Expressions

If you specify an expression that uses SQL data, the Link Template list includes only link templates for the drawing where the topology is loaded:

- In the source drawing, if you loaded the topology from source drawings
- In the current drawing, if you loaded the topology from the current drawing.

Travel Time in Network Topologies

To carry out network path trace analysis on a road network based on time rather than distance, assign a speed or speed limit to each link using an object data field or a field in a linked external database. You then set the Link Direct Resistance property to an expression that uses this speed limit data, for example:

```
(/ .length (* :speed@street_data 5280))
```

which divides the length of each link by the average speed per foot (where 5280 is the number of feet in a mile).

The resulting analysis shows the shortest route, in terms of time, not distance, to get from the first point to the second.

Tell me more



Video

- [Show me how to find the shortest path between two points.](#)



Procedures

- [To perform a shortest path trace](#) (page 1326)



GIS Skills

- [Find the shortest path through a network.](#)





Related topics

- [Creating Topologies](#) (page 821)
- [Specifying the Direction for a Link](#) (page 845)
- [Specifying the Resistance for a Link or Node](#) (page 849)

- [Expression Evaluator](#) (page 1541)
 - [Expression dialog box](#) (page 1807)
-

To perform a shortest path trace

- 1 Verify that you have a network topology available and it is loaded. See [Creating Topologies](#) (page 821) and [To load a topology](#) (page 907).
- 2 In [Map Explorer](#) (page 2068), under Current Drawing, right-click a network topology ► Analysis ► Network Analysis.
- 3 In the [Network Topology Analysis - Select Method dialog box](#) (page 1983), click Shortest Path. Click Next.
- 4 In the Network Topology Analysis - Choose Locations dialog box, click Start Point, and then click  (Select Point) to select the starting point in the map. Press Enter to return to the dialog box.
AutoCAD Map 3D uses the node closest to the location you clicked as the start point. The coordinates of the point are shown in the list.
- 5 Click End Point. To select the ending point, click  (Select Point). Press Enter to return to the dialog box.
AutoCAD Map 3D uses the node closest to the location you clicked as the end point.
- 6 Review the start and end points you have specified. The coordinates of the points are shown in the list.
 - To double-check the location of a point in the map, highlight the coordinates in the list. Click Preview.
 - To delete a point so that you can define a new one, highlight the coordinates in the list. Click Delete.
- 7 Click Next.
- 8 In the Network Topology Analysis - Resistance and Direction dialog box, select limits to put on the trace. For resistance and direction, you can enter a constant or an expression that references an object data field or

linked external database column. The expression will be evaluated for each link. Click  (Expression Evaluator) to select data from a list.

- **Link Direction** — Specify a direction for the trace. If you leave the box blank, bi-directional (0) is used.
- **Reverse** — Select this option to use the reverse of the direction indicated in the Link Direction box.
- **Link Direct Resistance** — Specify the resistance to travel in the direction that a link was created. If you leave the box blank, the length of the line (.LENGTH) is used.
- **Link Reverse Resistance** — Specify the resistance in the opposite direction along a link. If you leave the box blank, the length of the line (.LENGTH) is used.
- **Node Resistance** — Specify the resistance to cross the node, for example, resistance for a valve in a pipe network, or a junction in a road network. If you leave the box blank, zero (0) is used.
- **Maximum Resistance and Minimum Resistance** — Any path that has a total resistance below the minimum or above the maximum is ignored.

For example, if you stored the average speed limit for a link (in miles per hour) in an object data table called `street_data`, you could find the fastest route between two points by entering the expression `(/ .length (* :speed@street_data 5280)` which divides the length of each link by the average speed per foot (where 5280 is the number of feet in a mile).

- 9 Click Next.
- 10 In the Network Topology Analysis - Output dialog box, indicate whether or not to view the results of the trace onscreen and whether to save the trace results as a new topology.
 - To view your shortest path trace onscreen, select **Highlight**. Choose a highlight color from the Color list.
You should use a highlight color that is different from the color of the objects in your map.
 - To save the shortest path trace as a new topology, select **Create Topology**. Enter a name and description for the new topology. The new topology will be created on the existing objects.
- 11 Click **Finish** to perform the shortest path trace.

Quick Reference

MAPANTOPONET

Traces through a network topology (shortest path, best route, or flood trace)

Menu	Click Map ► Topology ► Network Analysis.
Icon	 Network Analyze
Command Line	MAPANTOPONET
Task Pane	In Map Explorer, right-click a network topology ► Analysis ► Network Analysis
Dialog Box	Network Topology Analysis - Select Method dialog box

Performing a Best Route Analysis

Using a network topology, which is made up of drawing objects and their relationship data, you can calculate the best route from a starting point in the drawing, to one or more visit points, and back to the starting point. AutoCAD Map 3D determines the optimal route based on values of resistance and direction. For example, in a street network, you can find the best route to travel when visiting several customer sites from your hotel.

If a path has a total resistance lower than the Minimum Resistance value, the path is ignored. Similarly, if a path has a total resistance greater than the Maximum Resistance value, the path is ignored.

Using SQL Data in Expressions

If you specify an expression that uses SQL data, the Link Template list includes only link templates defined in the drawing where the topology is loaded — in the source drawing, if you loaded the topology from source drawings; in the current drawing, if you loaded the topology from the current drawing. Also, be sure that the appropriate data source is attached and connected in the current drawing.

Travel Time in Network Topologies

To carry out a best route analysis on a road network based on time rather than distance, [assign a speed or speed limit to each link](#) (page 849) using an object

data field or a field in a linked external database. You then set the Link Direct Resistance property to an expression that uses this speed limit data, for example:

```
(/ .length (* :speed@street_data 5280))
```

which divides the length of each link by the average speed per foot (where 5280 is the number of feet in a mile).

The resulting analysis shows the best route, in terms of time, not distance.

Object Data Stored for a Best Route Topology

If you save the results of a best route analysis to a new topology, AutoCAD Map 3D adds topology information, stored as object data, on each element that makes up the best route topology. The object data table contains information about the order of the links visited and the resistance used to calculate the best route. The object data table added is like the one shown in the following table.

Topology Name	Object Data Table	Object Data Field
SAMPLE	BR_SAMPLE	Path Link Visit Order
		Evaluated Link Forward Resistance
		Evaluated Link Reverse Resistance
		Evaluated Start Node Resistance
		Evaluated End Node Resistance
		Evaluated Link Direction

Displaying Visit Order Using Annotation

To display the order in which to visit points, you use AutoCAD Map 3D's annotation feature to label the best route with the object data described above.

Editing a Best Route Topology



If you change the direction or resistance of an object in a best route topology, the best route shown may no longer be the optimal route, and you should recalculate the best route. For example, if you change the direction of a link from bi-directional to forward or reverse, it may change the best route.

NOTE The best route cannot be calculated if the network topology contains negative resistance values or if *all* resistance values equal "0" (or use expressions that evaluate to zero). In layman's terms, if all resistance values equal zero, every possible route is as good as any other route, and there is no "best" route to travel.

See also:

- [Specifying the Resistance for a Link or Node](#) (page 849)
- [Attaching Annotation to Objects](#) (page 1103)
- [Expression Evaluator](#) (page 1541)
- [Expression dialog box](#) (page 1807)
- [Renaming Topologies and Changing Their Descriptions](#) (page 924)
- [Deleting Topologies](#) (page 925)

To perform a best route analysis

- 1 Verify that you have a network topology available and it is loaded. See [Creating Topologies](#) (page 821) and [To load a topology](#) (page 907).
- 2 In [Map Explorer](#) (page 2068) under Current Drawing, right-click a network topology ► Analysis ► Network Analysis.
- 3 In the [Network Topology Analysis - Select Method dialog box](#) (page 1983), click Best Route. Click Next.
- 4 In the Network Topology Analysis - Choose Locations dialog box, click Start Point. Click Select Point  to select the starting point in the drawing. Press Enter to return to the dialog box.
AutoCAD Map 3D uses the node closest to the location you clicked as the start point. The coordinates of the point are shown in the list.
- 5 Click Visit Point. Click  (Select Point).
- 6 In the drawing, click a point to visit during the best route analysis. It does not matter which point you pick first, AutoCAD Map 3D calculates the order in which to visit the sites as part of the calculation.
AutoCAD Map 3D uses the node closest to the location you clicked as the visit point.
- 7 Do one of the following:
 - To accept the point and return to the dialog box, press Enter.

- To discard the point and return to the dialog box, press Esc.
 - To accept the point and specify another point, right-click in the drawing. Click Next Point.
- 8** In the dialog box, review the start points and visit points you have specified.
- To double-check the location of a point in the map, highlight the coordinates in the list. Click Preview.
 - To delete a point so that you can define a new one, highlight the coordinates in the list. Click Delete.
 - To add another visit point, return to Step 5.
- 9** Click Next.
- 10** In the Network Topology Analysis - Resistance and Direction dialog box, select limits to put on the analysis. For resistance and direction, enter a constant or an expression that references an object data field or linked external database column. The expression will be evaluated for each link. Click  (Expression Evaluator) to select data from a list.
- Link Direction — Specifies a direction for the trace. If the box is blank, bi-directional (0) is used.
 - Reverse — Uses the reverse of the direction indicated in the Link Direction box.
 - Link Direct Resistance — Specifies the resistance to travel in the direction that a link was created. If the box is blank, the length of the line (.LENGTH) is used.
 - Link Reverse Resistance — Specifies the resistance in the opposite direction along a link. If the box is blank, the length of the line (.LENGTH) is used.
 - Node Resistance — Specifies the resistance to cross the node (for example, resistance for a valve in a pipe network or a junction in a road network). If the box is blank, zero (0) is used.
 - Maximum Resistance and Minimum Resistance — Any path that has a total resistance below the minimum or above the maximum is ignored.

For example, if you stored the average speed limit for a link (in miles per hour) in an object data table called `street_data`, you could find the fastest

route between two points by entering the expression (`/ .length (* :speed@street_data 5280)`) which divides the length of each link by the average speed per foot (where 5280 is the number of feet in a mile).

NOTE The best route cannot be calculated if the network topology contains negative resistance values or if *all* resistance values equal "0" (or use expressions that evaluate to zero). In layman's terms, if all resistance values are all zero, every possible route is as good as any other route, and there is no "best" route to travel.

- 11 Click Next.
- 12 In the Network Topology Analysis - Output dialog box, indicate whether or not to view the results of the trace onscreen and whether to save the trace results as a new topology.
 - To view the best route analysis onscreen, select Highlight and choose a highlight color.
Use a highlight color that is different from the color of the objects in your map.
 - To save the results of the best route analysis as a new topology, select Create Topology and enter a name and description for the new topology.
AutoCAD Map 3D adds topology information, stored as object data, on each element that makes up the best route topology.
- 13 Click Finish to perform the best route analysis.
To display the order in which to visit points, use annotation to label the best route with the object data stored on the best route topology objects. For more information, see [To insert annotation](#) (page 1103).

Quick Reference

MAPANTOPONET

Traces through a network topology (shortest path, best route, or flood trace)

Menu Click Map ► Topology ► Network Analysis.

Icon  Network Analyze

Command Line MAPANTOPONET

Task Pane	In Map Explorer, right-click a network topology ► Analysis ► Network Analysis
Dialog Box	Network Topology Analysis - Select Method dialog box

Performing a Flood Trace

An analysis that looks out from a point in all directions is called a network flood trace. You can perform a flood trace on a network topology, which is made up of drawing objects and their relationship data.

NOTE This functionality applies only to drawing objects. There is no equivalent for geospatial feature data.

You specify the point where the network starts and the maximum distance the network can traverse. The analysis determines how many links and nodes can be traveled before the accumulated resistance exceeds the specified maximum resistance. For example, you might want to find all restaurants within a 10-minute walk of a hotel.

If you specify an expression that uses SQL data, the Link Template list includes only link templates for the drawing where the topology is loaded:

- In the source drawing, if you loaded the topology from source drawings
- In the current drawing, if you loaded the topology from the current drawing.

Using Flood Trace to Test Network Integrity

You can use flood trace analysis to check the integrity of a network topology. If some links are not flooded, the topology is incomplete; you can use the map editing tools to correct the geometry, and then recreate the topology.

Travel Time in Network Topologies

To carry out network flood trace analysis on a road network based on time rather than distance, [assign a speed or speed limit to each link](#) (page 849) using an object data field or a field in a linked external database. You then set the Link Direct Resistance parameter to an AutoLISP expression that uses this speed limit data.

For example, to determine a flood trace analysis based on a maximum travel time, start a flood trace, select the start point for the analysis, enter the

AutoLISP expression for the Link Direct Resistance, and specify the travel time for Maximum Value. This analysis will show the streets that can be reached from a start node within the specified period of time.

See also:

- [Specifying the Direction for a Link](#) (page 845)
- [Specifying the Resistance for a Link or Node](#) (page 849)
- [Expression Evaluator](#) (page 1541)
- [Expression dialog box](#) (page 1807)

NOTE This procedure applies only to drawing objects. There is no equivalent for geospatial features.

To perform a flood trace

- 1 Verify that you have a network topology available and it is loaded. See [Creating Topologies](#) (page 821) and [To load a topology](#) (page 907).
- 2 In [Map Explorer](#) (page 2068), under Current Drawing, right-click a network topology ► Analysis ► Network Analysis.
- 3 In the [Network Topology Analysis - Select Method dialog box](#) (page 1983), click Flood Trace. Click Next.
- 4 In the Network Topology Analysis - Choose Locations dialog box, click Start Point. Click Select Point  to select the starting point in the map. Press Enter to return to the dialog box.
AutoCAD Map 3D uses the node closest to the location you clicked as the start point. The coordinates of the point are shown in the list.
- 5 Review the start point you have specified. The coordinates of the point are shown in the list.
 - To double-check the location of a point in the map, highlight the coordinates in the list. Click Preview.
 - To delete the point so that you can define a new one, highlight the coordinates in the list. Click Delete.
- 6 Click Next.
- 7 In the Network Topology Analysis - Resistance and Direction dialog box, select limits to put on the trace. For resistance and direction, you can

enter a constant or an expression that references an object data field or linked external database column. The expression will be evaluated for each link. Click  (Expression Evaluator) to select data from a list.

- **Link Direction** — Specify a direction for the trace. If you leave the box blank, bi-directional (0) is used.
- **Reverse** — Select this option to use the reverse of the direction indicated in the Link Direction box.
- **Link Direct Resistance** — Specify the resistance to travel in the direction that a link was created. If you leave the box blank, the length of the line (.LENGTH) is used.
- **Link Reverse Resistance** — Specify the resistance in the opposite direction along a link. If you leave the box blank, the length of the line (.LENGTH) is used.
- **Node Resistance** — Specify the resistance to cross the node, for example, resistance for a valve in a pipe network, or a junction in a road network. If you leave the box blank, zero (0) is used.
- **Specify a maximum resistance for the trace.** The analysis determines how many links and nodes can be traveled before the accumulated resistance exceeds the specified maximum resistance.

For example, to trace out to a maximum length of 5000, set the Link Direct Resistance to .LENGTH and set the Maximum Resistance to 5000. To trace out to the first node on each link, set the Link Direct Resistance to 0, set the Node Resistance to 50 and set a Maximum Resistance of 45.

- 8** Click Next.
- 9** In the Network Topology Analysis - Output dialog box, indicate whether to view the results of the trace onscreen and whether save the flood trace results as a new topology.
 - To view your flood trace onscreen, select Highlight. Select the highlight color.
 - To save the flood path trace as a new topology, select Create Topology. Enter a name and description for the new topology. The new topology is created on the existing objects.
- 10** Click Finish to perform the flood trace.

Quick Reference

MAPANTOPONET

Traces through a network topology (shortest path, best route, or flood trace)

Menu	Click Map ► Topology ► Network Analysis.
Icon	 Network Analyze
Command Line	MAPANTOPONET
Task Pane	In Map Explorer, right-click a network topology ► Analysis ► Network Analysis
Dialog Box	Network Topology Analysis - Select Method dialog box

Overlaying Two Topologies

A powerful form of analysis is possible when you overlay two or more topologies. Topologies can be created only from drawing objects.

NOTE This functionality applies only to drawing objects. To use overlay analysis on geospatial feature data, see [Overlaying Two Feature Sources](#) (page 1309).

There are three types of overlay analysis:

- Nodes with polygons
- Networks with polygons
- Polygons with polygons

To overlay topologies, both must be loaded into the current drawing.

Options for Overlaying Topologies

When you overlay two topologies, you choose the method in which the two selected topologies interact. In some cases, the result varies according to which topology is the source and which is the overlay.

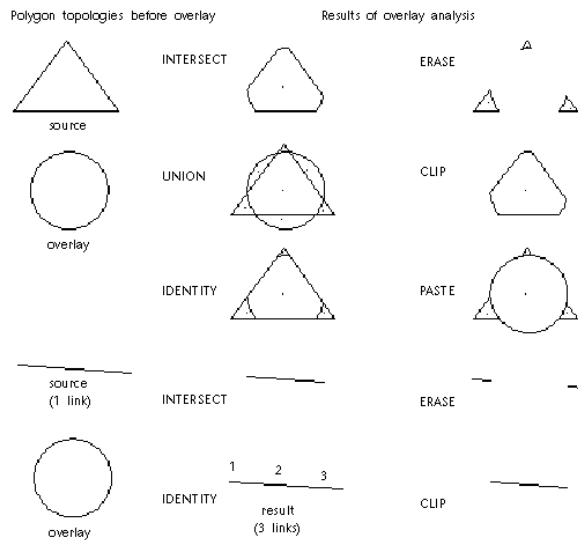

NOTE All the overlay analysis operators change arcs into a series of line segments; for example, a complete circle consists of 32 segments. In the examples shown above, the result topology is a tessellated (or jagged) circle after overlay analysis. This may affect properties of the result topology, and gives different values, such as area and perimeter.

Intersect

Intersect operations combine topologies and keep only the common geometry. Intersect acts like the Boolean AND operation. The results are the same whichever topology is chosen as the first or second. Object data is combined for the two operations.

Here are some examples of using Intersect:

- Which parcels (polygons) fall within 100-year flood zones (polygons)? Intersect shows only the flooded properties, not the whole property.
- Which crimes (nodes) fall within drug-free zones (polygons)?
- Which stream sections (networks) fall within the building area (polygons) and need to be examined for potential negative environmental impact?

Union

Union operations combine polygons with polygons and keep all geometry. Union acts like the Boolean OR operation and can be used only with polygons. For example, you can combine parcels with soils information for property assessment. Use Union to maintain both sets of geometry together and pull them apart as needed.

Identity

Identity operations work like Union on the source topology and like Intersect on the overlay topology. Use Identity to combine nodes, links, or polygons with polygons and keep all the input geometry. Identity creates one topology with one link where the link is crossed by the overlay topology.

When Identity is used with the question, Which parcels (polygons) fall within 100-year flood zones (polygons)?, all the properties in the flood zones are shown intact.

Erase

Erase operations use the overlay polygon topology like a mask and erase everything in the source polygon topology that is covered by the overlay topology.

Clip

Clip operations use the overlay polygon topology as a boundary. The parts of the source polygons outside the overlay polygons are clipped and discarded. You can use this option to show polygons within a boundary polygon, such as a city or state boundary.

Paste

Paste operations paste the overlay polygon topology on top of the source polygons. The source polygons not covered by the overlay remain. The Paste option can be used only with polygons.

Object Data in Overlay Analysis

You can copy selected object data and external database data from the source and overlay topologies to a new object data table in the resulting topology. You specify the name of the new object data table that will store the data in the resulting topology. The object data table name should be a new name. Data fields in the resulting topology look like this:

TOPONAME_FIELD

In addition to any fields you select, overlay analysis creates these object data fields in the resulting topology.

Field Name	Data
TOPOID	Polygon Identification Number
TOPONAME1_ID	Object ID in source topology (TOPONAME1 is name of Source)
TOPONAME2_ID	Object ID in overlay topology (TOPONAME2 is name of Overlay)
TOPONAME1_PERCENTAREA	Percentage area of parent polygon in source topology
TOPONAME2_PERCENTAREA	Percentage area of parent polygon in overlay topology

Tell me more



Video

- [Show me how to do an overlay analysis using two topologies.](#)



Procedures

- [To overlay two topologies](#) (page 1339)



GIS Skills

- [Find which lines are within a particular polygon \(overlay analysis\).](#)



Related topics



- [Creating Topologies](#) (page 821)
- [Loading or Unloading Topologies](#) (page 906)
- [Overview of Analyzing Drawing Topologies](#) (page 1319)

To overlay two topologies

- 1 In [Map Explorer](#) (page 2068), under Current Drawing, right-click the source topology ► Analysis ► Overlay.

-
- 2 **NOTE** Most of the overlay analysis types work only with polygon topologies. For more information about those that work with node or network topologies, see [the Concept tab for this topic](#) (page 1336).

 - 3 In the [Topology Overlay Analysis - Analysis Type dialog box](#) (page 1999), do the following:
 - Select the type of overlay analysis to perform:
 - Intersect — Only areas that appear in both the source and overlay topologies are in the result topology.
 - Union — Areas that appear in either the source or the overlay topologies are in the result topology.
 - Identity — The result topology includes areas that appear in the source topology and areas in the overlay topology that are within the source topology boundary.
 - Erase — The result topology includes areas that appear in the source topology except where it is covered by the overlay topology. The area covered by the overlay polygons is erased from the source polygon area.
 - Clip — The result topology includes areas that appear in the source topology except where they are outside the boundary of the overlay topology. The source polygons are clipped to the outer boundary of the overlay polygons.
 - Paste — The overlay topology is "pasted" on the source topology. The result topology includes the overlay topology and any areas of the source topology that extend beyond the boundaries of the overlay topology.
 - Click Next.
 - 4 In the [Select Overlay Topology dialog box](#), do the following:
 - Select the polygon topology to use as the overlay topology.
 - Click Next.
 - 5 In the [Topology Overlay Analysis - New Topology dialog box](#), do the following:
 - Select **Highlight** to highlight the resulting topology onscreen. Select the highlight color.

- Enter a name and description for the new topology, and specify the layer to place it on.
 - Click Next.
- 6 In the Topology Overlay Analysis - Output Attributes dialog box, do the following to copy data to the result topology:
- For Source Attributes For New Topology, click  (Expression Evaluator) to select the data from the source topology that you want to include in the resulting topology. You can include fields in an object data table or columns in an external database.
 - For Overlay Attributes For New Topology, click  (Expression Evaluator) to select the data from the overlay topology that you want to include in the resulting topology.
 - Enter a name and description for the object data table that will store the data in the new topology. Object data and external database records are attached to the centroids of the result topology.
 - Click Next.
- 7 In the final dialog box, choose whether to create new nodes to complete the resulting topology. If so, specify which a block to use:
- To use a point, leave the box blank or enter ACAD_POINT.
 - To select from a list of block definitions, click the down arrow.
 - To select a block saved as a DWG file, click Browse. Select the file to use.
- 8 For certain overlay operations, you also specify the block to use for centroids.
- 9 Click Finish.

Quick Reference

MAPANOVERLAY

Overlays one topology with another, and creates a new topology

Menu	Click Map ► Topology ► Overlay.
Icon	 Overlay Topology
Command Line	MAPANOVERLAY
Task Pane	In Map Explorer, right-click a topology ► Analysis ► Overlay
Dialog Box	Topology Overlay Analysis - Analysis Type dialog box

Dissolving a Composite Topology

If a topology contains many smaller polygons, you can create a new topology by combining polygons that share the same data value in a specified field. This field is called the dissolve field. The dissolve field can be an object data field or a column in a linked external database.

NOTE This functionality applies only to drawing objects. There is no equivalent for geospatial feature data.

Dissolving Polygons

When you dissolve a topology, AutoCAD Map 3D checks each boundary between polygons to see if the dissolve field value is the same for both. If so, the boundary and one of the centroids are removed. All object fields except for the dissolve and any new topology fields are removed.

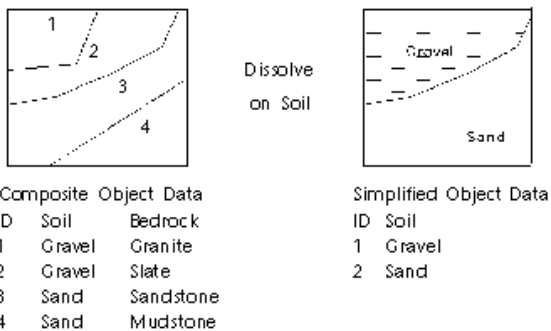

If adjacent polygons do not contain the dissolve field, the boundary is not dissolved and the resulting polygon has a blank value for that field.

Dissolving Network Links

When you dissolve a network topology, AutoCAD Map 3D checks nodes between lines to see whether two lines intersect at a specified node and whether the dissolve field is the same. If so, the node is removed, and the two links are joined to form one link. All object fields except for the dissolve and any new topology fields are removed as shown in the following illustration.

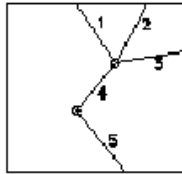

ID	River	Depth
1	Agua Fria	97
2	Grande	204
3	Caliente	42
4	Grande	351
5	Grande	363

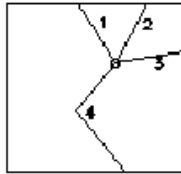

ID	River
1	Agua Fria
2	Grande
3	Caliente
4	Grande

If adjacent lines do not contain the dissolve field, the node is not dissolved and the resulting polyline has a blank value for that field.

See also:

- [Overview of Creating Topologies](#) (page 822)
- [To load a topology](#) (page 907)
- [Overview of Analyzing Drawing Topologies](#) (page 1319)

To dissolve a composite topology

- 1 In [Map Explorer](#) (page 2068), right-click the topology to dissolve ► Analysis ► Dissolve.
- 2 Note that topologies must be loaded before you can work with them. See [To load a topology](#) (page 907).
- 3 In the [Topology Dissolve - Set Parameter dialog box](#) (page 1998), for Dissolve By, specify the data element to use for the new topology. To select a field from an object data table or a column from an external database, click  (Expression Evaluator).

Any two adjacent polygons or connected lines that have the same value for the specified field or column are combined into a single polygon or line.

NOTE When dissolving a topology, AutoCAD Map 3D uses only data that is attached or linked to the centroid of the polygon. It does not use data attached to a polygon border.

- 4 In the Topology Dissolve - New Topology dialog box, select Highlight to highlight the resulting topology onscreen. Specify the highlight color.
- 5 Enter a name and description for the new topology and specify the layer. Click Next.
- 6 In the Topology Dissolve - Output Attributes dialog box, do the following:
 - Click  (Expression Evaluator) to select the data to include in the resulting topology. You can include fields in an object data table or columns in an external database.
 - Enter a name and description for the object data table that will store the data in the new topology.

NOTE If you do not want to populate an Object Data Table with the dissolve information, select the last (empty) item in the list. Selecting this empty item will not copy data from the dissolve topology.

- Click Next.
- 7 In the final dialog box, indicate whether to create new nodes to complete the resulting topology. If so, specify which a block to use:
 - To use a point, leave the box blank or enter ACAD_POINT.
 - To select from a list of block definitions, click the down arrow.
 - To select a block saved as a DWG file, click Browse. Select the file to use.

If you are dissolving a polygon topology, you can also specify the block to use for centroids.

- 8 Click Finish to dissolve the topology.

Quick Reference

MAPANDISSOLVE

Removes the boundaries between polygons in a topology or the nodes between links that share a specific attribute

Menu Click Analyze ► Dissolve.

Icon



Dissolve Topology

Command Line MAPANDISSOLVE

Task Pane In Map Explorer, right-click a network or polygon topology ► Analysis ► Dissolve

Dialog Box Topology Dissolve - Set Parameter dialog box

Buffering a Topology

A buffer analysis identifies objects within a specified offset of elements in node, network, and polygon topologies. A buffer is a zone that is drawn around a topology. For example, you might specify a buffer on either side of a river to show the extent of a flood plain.

NOTE This functionality applies only to drawing objects. To perform buffer analysis on geospatial feature data, see [Buffering Features in Your Map](#) (page 1306).

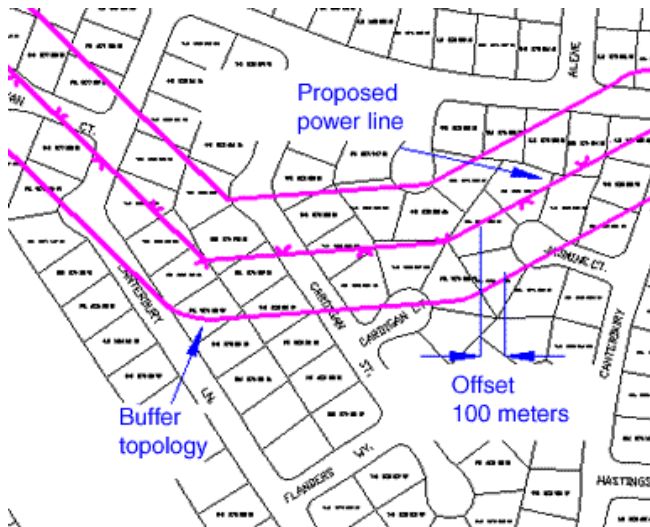

Use Buffer Analysis to show an area around an existing topology. In this case, the buffer analysis of the power line network topology creates a new polygon topology.

For buffering, you create a new polygon topology from an existing node, network, or polygon topology and specify a buffer offset.

The buffer offset can be:

- A positive or negative numeric value
- An expression
- A value specified by object data
- A value linked to an external database record

You can [use negative offset values](#) (page 1541) for polygon topologies only.

TIP You can improve the performance of buffering operations by increasing the RAM to more than the recommended amount, or by increasing the virtual memory on your system. This is recommended if you are buffering large topologies.

See also:

- [Expression Evaluator](#) (page 1541)
- [Buffering Features in Your Map](#) (page 1306)

NOTE This procedure applies only to drawing objects. To perform buffer analysis on geospatial feature data, see [To create a buffer](#) (page 1308).

To buffer a topology

- 1 In [Map Explorer](#) (page 2068), under Current Drawing, right-click a topology
 - Analysis ► Buffer.
- 2 In the [Topology Buffer - Set Buffer Distance dialog box](#) (page 1992), enter the buffer distance. Click Next. The buffer extends the specified distance from the objects.

The buffer offset can be any of the following:

- Numeric value. To decrease the size of existing polygons, enter a negative value.
- An expression that evaluates to a numeric value.
- A value in an object data table or a linked external database. Click  (Expression Evaluator) to select the table and field or the link template and column from a list.

NOTE If you are creating a buffer around a polygon and want to use a value in an object data table or an external database, the data must be attached to the centroid of the polygon.

- 3 In the [Topology Buffer - New Topology dialog box](#), select Highlight to highlight the resulting buffer topology onscreen. Specify a highlight color that is different from the color of the objects.
- 4 Enter a name and description for the new topology and specify the layer to place it on. Click Next.

NOTE If you specify a locked layer, AutoCAD Map 3D can create the buffer geometry but not the buffer topology.

- 5 In the [Topology Buffer - Create New Centroids and Nodes dialog box](#), specify the blocks to use for centroids and node in the resulting buffer topology.
 - To use a point, select ACAD_POINT.
 - To select from a list of block definitions, click the down arrow.
 - To select a block saved as a DWG file, click Browse. Select the file.

- 6 Click Finish to create the buffer topology.

Quick Reference

MAPANBUFFER

Creates a buffer around an existing topology

Menu Click Analyze ► Buffer.

Icon  Buffer Topology

Command Line MAPANBUFFER

Task Pane In Map Explorer, right-click a topology ► Analysis ► Buffer

Dialog Box Topology Buffer - Set Buffer Distance dialog box

Querying a Topology

Use a topology query to retrieve a loaded topology and its associated data from the current drawing or an attached drawing. You can also query part of a topology in a source drawing and work on that part of a topology without having to retrieve all the objects that make up a topology.

NOTE This functionality applies only to drawing objects. There is no equivalent for geospatial feature data.

There are three differences between using standard queries and topology queries:

- Topology queries work with only one topology; standard queries work with all objects in the attached drawings.
- Because topology information is stored in object data, a Data condition can be based on Area, Length, Perimeter, Direction, Direct Resistance, and Reverse Resistance.
- Property alterations work differently with polygon topologies.

Creating a Result Topology

When you use a topology query, you can hold the retrieved information in the current drawing in three types of topology:

- None — No information is added to the geometry in the current drawing.
- Temporary — Information is retrieved and stored in memory as a topology with a name preceded by an asterisk (*).

You cannot save back the temporary topology to the queried drawings. However, you can [save the temporary topology to make it permanent](#) (page 1354), or you can retain the topology in the current drawing.

- Permanent — The query retrieves data and creates a topology in the current drawing. You can save back this topology to the source drawings. The topology name must not be preceded by an asterisk (*).

Location Queries

Location queries on network topology work in the same way as queries on any other linear or point object.

Topology	Data Retrieved by Location Query
Node	Nodes
Network	Links; also nodes if part of topology
Polygon	Polygons if links or centroid selected; also links or nodes if part of polygon topology

Polygons are handled as true areas, not just as boundaries. In the example following, the polygon area crosses through the query boundary so the whole polygon is retrieved, although none of the objects that make up the polygon intersect any part of the query boundary.

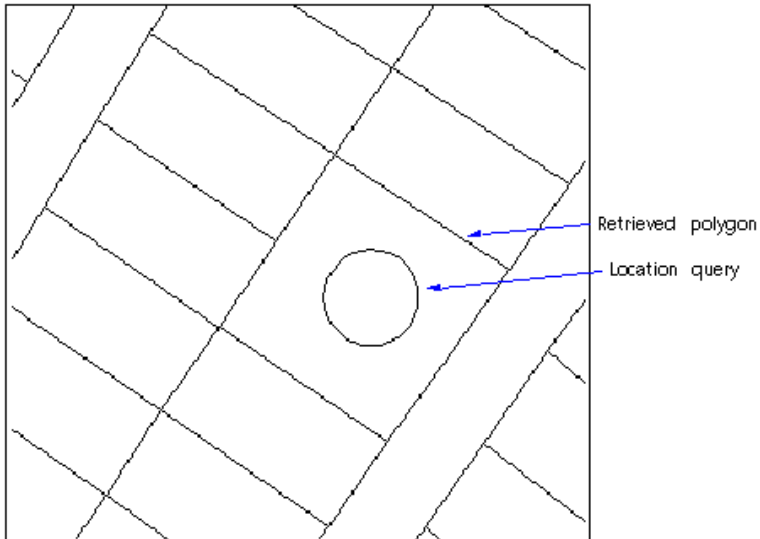

Point location queries also retrieve the polygon that includes the point.

Object Data Queries

Any topology object can be queried using object data, such as node, link, and polygon identifiers; the "from" and "to" node information on links; the left and right side information on links; polygons; and so on.

Topology queries can retrieve data such as areas, perimeters, numbers of links, and more. For example, a query to retrieve objects with an area greater than a specified value gives different results with the two query types:

- A query defined with a standard Define Query Of Attached Drawings retrieves closed polylines with areas of the specified value.
- A Define Topology Query retrieves all polygons with areas of the specified value, whatever the objects making up the polygon (lines, arcs, or open polylines) are.



Property Alteration with Topology Queries

When you define a property alteration for topology objects, only specific elements of the topology are altered, as shown in the following table.

Property Alteration	Modified Objects
Block Name	Nodes in node and network topologies Centroids in polygon topology
Color	Nodes, links, and centroids
Elevation	Nodes, links, and centroids
Height	Nodes in node and network topologies Centroids in polygon topology
Layer	Nodes, links, and centroids
Linetype	Nodes, links, and centroids
Rotation	Nodes in node and network topologies. Centroids in polygon topology
Scale	Nodes, links, and centroids
Text Style	Nodes in node and network topologies Centroids in polygon topology
Width	Links
Text Value	Nodes in node and network topologies Centroids in polygon topology (text appears at the centroid label point)
Thickness	Links
Hatch	Hatched polygons

Saving and Using Queries

If you plan to use a query more than once, you can save it with the current drawing in the Query Library or to an external file, and edit the query or reuse it. The following table shows the options available with topology queries.

Description	Procedure	Command
Save a query	In the Define Query Of Attached Drawings dialog box, click Save. See Saving Queries (page 177).	ADEQUERY
Run Query (internal)	Create tab ► Object Query panel ► Run  See Running a Saved Query (page 178).	ADERUNQUERY
Run External Query	Create tab ► Object Query panel ► External 	ADERUNXQUERY
Use the Query Library	Create tab ► Object Query panel ► Library  See Setting Up a Query Library (page 173).	ADEQUERYLIB

Report Mode

In addition to the dot variables available using the standard Define Query Of Attached Drawings command, Define Topology Query has two extra dot variables.

- .TOPONAME — Contains the topology name.
- .TOPOTYPE — Contains the topology type: NODE, NETWORK, or POLYGON.

Three of the dot variables give different results in topology queries.

- .DRAWING — The drawing name that is the source of the geometry object in the topology.
- .AREA — The value of the AREA object data field for each polygon.

- .PERIMETER — The value of the PERIMETER object data field for each polygon.

The Process Sub-Objects option in the Output Report Options dialog box specifies the objects in a report.

Reported Data		
Topology Type	Process Sub-Objects	Do not Process Sub-Objects
Node	Nodes, objects, and object data	Nodes
Network	Links, start and end node data	Links
Polygon	Centroids, links, and nodes	Centroids

To query a topology

- 1 In [Map Explorer](#) (page 2068), under Current Drawing, right-click a topology
 - Analysis ➤ Topology Query.
- 2 In the [Topology Query dialog box](#) (page 2008), select the topology to query. If the topology is not on the list, click Load and select the topology to use.
- 3 Under Result Topology, specify how to save the results of the query:
 - None — Objects are retrieved into the current drawing, but no topology data is created.
 - Temporary — Objects are retrieved into the current drawing, and the topology data is loaded into memory. This data is not saved to the objects.
 - Permanent — Objects are retrieved into the current drawing, and a new topology is created. If you create a temporary or permanent topology, specify a name and description for the topology.
- 4 To load an existing query, click Load Query and select the query. To define a new query, click Define Query Of Attached Drawings and define the conditions for the query. To close the dialog box, but have AutoCAD Map 3D remember your selections, click OK.

- 5 When you click Define Query, the Define Query Of Attached Drawings dialog box opens. Its operation and options are the same for topology and AutoCAD Map 3D queries, except for some options you have in the Property option in the Query Type area. For more information, see [Overview of Queries](#) (page 1235).

Quick Reference

MAPTOPOQUERY

Queries topologies

Menu	Click Setup ► More DWG Options ► Define Topology Query.
Icon	 Query Topology
Command Line	MAPTOPOQUERY
Task Pane	In Map Explorer, right-click a topology ► Analysis ► Topology Query
Dialog Box	Topology Query dialog box

Saving a Temporary Topology

When you use a topology query, you can store the retrieved information in a temporary topology. The topology name is preceded by an asterisk (*). To save back the temporary topology to the queried drawings, first convert the temporary topology to a permanent topology.

NOTE This functionality applies only to drawing objects. There is no equivalent for geospatial feature data.

See also:

- [Querying a Topology](#) (page 1348)

To convert a temporary topology to a permanent topology

- 1 In [Map Explorer](#) (page 2068), under Current Drawing, right-click the temporary topology you want to convert ► Administration ► Rename.

A temporary topology has a name preceded by an asterisk (*).

- 2 In the [Rename Topology dialog box](#) (page 1988), enter a new name for the topology.

To create a permanent topology, do not start the topology name with an asterisk (*). Also note that topology names can contain letters, numbers, and the underscore, hyphen, and dollar characters. Names cannot include spaces.

- 3 Optionally, enter a new description for the topology.
- 4 Click OK to rename the topology, making it a permanent topology.

Quick Reference

MAPTOPOREN

Changes the name and description of a topology



Menu	Click Map ► Topology ► Administration ► Rename.
Command Line	MAPTOPOREN
Task Pane	In Map Explorer, right-click a topology ► Administration ► Rename
Dialog Box	Rename Topology dialog box

Publishing and Sharing Maps

9

Overview of Publishing and Sharing

There are many ways to output and share map data. Use the following table to determine which option to use for moving your data from one format to another:

To move this data...	To this format...	Use this option...
Entire map	Printer, plotter, or file	In the Tool-based Ribbon Workspace, click Output tab ► Plot panel ► Plot.  See Publishing a Map to a Plotter (page 1363) and Publishing Maps (page 1360)
Entire map	Map book (divides your map into a grid of tiles and renders each tile on a separate page, which can be published to a plotter or a file)	See Publishing Map Books (page 1381)
Entire map	DWG format	In the Tool-based Ribbon Workspace, click Output tab ► Map Data Transfer panel ► Current Map As DWG. See Exporting Maps to DWG Format (page 1459)
Entire map	DWF (Design Web Format) to display in Autodesk Design Review	Click  ► Publish.

To move this data...	To this format...	Use this option...
		See Publishing to DWF (page 1364)
Entire map	PDF file	In the Tool-based Ribbon Workspace, click Output tab ► Export To DWF/PDF panel ► Export ► PDF. See Publishing to PDF (page 1373)
Entire map	Web page	At the Command prompt, enter publishstoweb. See Publishing to a Web Page (page 1373)
Entire map	Autodesk MapGuide Enterprise	Click  ► Publish ► Publish To MapGuide. See Publishing to MapGuide (page 1376)
Entire map	Autodesk MapGuide version 6.5 or earlier	In the Tool-based Ribbon Workspace, click Output tab ► Map Data Transfer panel ► As SDF2.
Entire map and all its dependent files (for example, Xrefs)	A transmittal package	Click  ► Send ► eTransmit. See Using eTransmit (page 1376)
Drawing data	Autodesk SDF (Spatial Data File) ESRI Arc/INFO Coverages ESRI Shapefile GML (Geographic Markup Language) MapInfo MIF/MID MapInfo TAB MicroStation DGN Shape Multiclass VML (Vector Markup Language)	In the Tool-based Ribbon Workspace, click Output tab ► Map Data Transfer panel ► Map 3D Export.  See Overview of Converting and Exporting (page 1405)
Drawing data	Oracle ESRI ArcSDE	In the Tool-based Ribbon Workspace, click Output tab ► Map Data Transfer panel ► To FDO Connection. See Exporting DWG Data to an FDO Data Store (page 1461)

To move this data...	To this format...	Use this option...
Drawing data	Image formats	In the Tool-based Ribbon Workspace, click Output tab ► Map Data Transfer panel ► As Image. See Exporting DWG Data to an Image Format (page 1465)
Drawing data	DXF	Click  ► Save As ► Other Formats See Saving Drawing Objects to a DXF File (page 1458)
Geospatial data	Autodesk SDF (Spatial Data File)	In Display Manager, right-click the layer and choose Export Layer Data to SDF or Save Layer. See Saving or Exporting a Display Manager Layer (page 1469)
Geospatial data	Another geospatial format	In Map Explorer, click Tools ► Bulk Copy See Migrating Data (page 615)
Data attached to geospatial objects	A printer or a comma-separated file	In the Data Table, choose Options ► Export. See Exporting from the Data Table (page 1473)
Data attached to drawing objects	A printer or a comma-separated file	At the Command prompt, enter ad-equery. See Creating a Drawing Object Report (DWG) (page 1477)
External data linked to objects	A printer or a comma-separated file	In the Data View, click File menu ► Print. See (page 1474)
Metadata	A printer or a comma-separated file	See Publishing and Printing Metadata (page 1514) and Sharing Metadata (page 1510)

You can also use the following options to share map data:

- [Export data to a GIS format and back into DWG format](#) (page 1465).
- [Convert Display Manager styles to object properties](#) (page 1459). This allows you to share styled maps with users who do not have Display Manager (for example, users of AutoCAD or a previous version of AutoCAD Map 3D).

Publishing Maps

When you publish a map or [map book](#) (page 2067), AutoCAD Map 3D plots it and sends it to an output format. For example, if you publish your map to a plotter, you print a copy of the map. If you publish it to DWF, you create a file containing the plotted map or map book.

Overview of Publishing Maps

You can publish a map to the following output formats:

- Plotters
- DWF (Design Web Format)
- PDF
- A web page
- A packaged format that includes all dependent files (eTransmit)
- MapGuide
- Map books

Tell me more



Video

- *Show me how to publish a map to a MapGuide server.*
 - *Show me how to create a map book.*
 - *Show me how to publish a map book with attributes to a DWF file.*
-



Procedures

- [To publish your map](#) (page 1361)



Tutorials

- Lesson 7: Publish Your Map



Workflow

- Print and Publish Data



GIS Skills

- *Publish a completed map to a MapGuide server.*
- *Create a map book with appropriate-scale tiling for a city.*
- *Produce a multi-sheet DWF file for a map book.*



Related topics

- [Overview of Publishing and Sharing](#) (page 1357)
- [Overview of Converting and Exporting](#) (page 1405)
- [Overview of Exporting Attribute Data](#) (page 1472)

Use the following methods to publish your map.

To publish to this format...

Use this method

Plotter

In the Tool-based Ribbon Workspace, click Output tab ► Plot panel ► Plot
See [Publishing a Map to a Plotter](#) (page 1363).

DWF (Design Web Format)

Click  ► Publish.
See [Publishing to DWF](#) (page 1364).

PDF

In the Tool-based Ribbon Workspace, click Output tab ► Export To DWF/PDF panel ► Export ► PDF.

To publish to this format...	Use this method
	See Publish a Sheet Set in the AutoCAD Help.
A Web page	At the Command prompt, enter <code>publishweb</code> . See Publishing to a Web Page (page 1373).
eTransmit	 Click  ► Send ► eTransmit. See <i>Package a Set of Files for Internet Transmission</i> in the online Help.
Autodesk MapGuide Enterprise	 Click  ► Publish ► Publish To MapGuide. See Publishing to MapGuide (page 1376).
Autodesk MapGuide version 6.5 or earlier	In the Tool-based Ribbon Workspace, click Output tab ► Map Data Transfer panel ► As SDF2.
Map Books	See Publishing Map Books (page 1381).

Adding a Reference Grid to a Map

You can add a reference system to your map in paper space. Reference systems include reference grids and graticules. A reference grid is a grid that overlays a map. A [graticule](#) (page 2065) is a network of geographic lines, such as latitude and longitude lines.

In AutoCAD Map 3D 2011, you can create a [Military Grid Reference System \(MGRS\)](#) (page 2069) grid. You can define the lettering scheme, scale, and precision of the grid. When you plot your map, the reference grid will be printed over it.

When creating a reference grid, AutoCAD Map 3D will draw grid lines at the precision level, and tick marks at the next level. For example, a 1000 meter grid will have tick marks at every 100 meters.

To add a reference system to a map

- 1 Switch to the layout tab.



- 2 On the Layout Tools tab, click  .
- 3 Select the viewport for the reference system. The [Create Reference System Dialog Box](#) (page 1602) appears.

NOTE You must select a non-rotated, rectangular viewport.

- 4 In the Create Reference System dialog box, specify the following:
 - Reference System: select a lettering scheme for your reference grid. Use MGRS-AA (MGRS-New) with the WSG84 datum. Use MGRS-AL (MGRS-Old) with older datums.
 - Scale: select the view scale for the reference grid.
 - Precision: select the precision of the grid lines. AutoCAD Map 3D will draw grid lines at the precision level, and tick marks at the next level. For example, a 1000 meter grid will have tick marks at every 100 meters.
- 5 Click OK.

Quick Reference

MAPLAYOUTREFERENCESYSTEM

Creates a reference system for a selected viewport on the layout tab of your map.

Command Line	MAPLAYOUTREFERENCESYSTEM
Dialog Box	Create Reference System Dialog Box

Publishing a Map to a Plotter

You can publish to a plotter for a printed copy. The steps for publishing to a plotter are slightly different for a map and [for a map book](#) (page 1401), but you set plotting options the same way for both.

See also:

- [Overview of Map Books](#) (page 1381)

To publish to a plotter

- 1 Save the map.
- 2 In the Tool-based Ribbon Workspace, click Output tab ► Plot panel ► Plot
- 3 Choose a printer or plotter and set any options needed.
For information, type “To plot a drawing” in the Search tab of the help.
- 4 Click OK.

Quick Reference

PLOT

Plots a drawing to a plotter, printer, or file.

Menu Click File menu ► Plot.

Icon  Plot a drawing.

Command Line PLOT

Dialog Box Plot Dialog Box

Publishing to DWF

DWF (Design Web Format™) is an open, secure file format developed by Autodesk for sharing engineering design data. DWF files are highly compressed, so they are small and fast to transmit and view.

- [To publish a map to DWF](#) (page 1365)
- [To publish attribute data to DWF](#) (page 1367)
- [To prepare a map for publishing to DWF](#) (page 1369)
- [To publish a map to DWF](#) (page 1372)

Overview of Publishing to DWF

DWF (Design Web Format™) is an open, secure file format developed by Autodesk for sharing engineering design data. DWF files are highly compressed, so they are small and fast to transmit and view.

DWF files are useful for the following:

- Publishing complex maps that use a variety of feature sources to a compact file that can be used in the field. All information from the original map, including stylization, is represented.
- Sharing maps with people who do not have a copy of AutoCAD Map 3D. These people can download the free viewer to see the maps.

All layers and styles are published, with no loss of information. If you have [joined data](#) (page 507) to layers in your map, the joined data is published. You can include graphical elements, including any draped raster files. You can include attribute data.

If your map has a coordinate system assigned to it, AutoCAD Map 3D includes that coordinate system for each sheet in the published DWF file.

See also:

- [Joining Data to GIS Features](#) (page 507)
- [Publishing Attribute Data to DWF](#) (page 1366)
- [Preparing a Map for Publishing to DWF](#) (page 1368)
- [Publishing Map Books to DWF](#) (page 1400)

To publish a map to DWF

- 1 [Specify attribute data to include with the published DWF.](#) (page 1367)
- 2 [Prepare a map for DWF publishing and set publishing options](#) (page 1369).
- 3 [Publish the map to DWF.](#) (page 1372)

You can also do the following:

- [Publish a map book to DWF](#) (page 1400)

Publishing Attribute Data to DWF

Before publishing maps to DWF™, you can specify which data to include from the following categories:

DWF Publishing Option	Description
object data (page 198)	Data attached to drawing objects
classification data (page 117)	Information about drawing objects that have been assigned to classes
GIS feature sources (page 305)	Spatial data objects
joins (page 507)	Data from records that have been joined to the data for spatial data objects
linked records (page 522) from an external database	Data from records or fields that have been linked to drawing objects
data table information (page 200)	Table type, table name, record ID, and the delimiter. This is useful if your viewer does o't automatically display this information.

For each category of data, you can choose the individual items to include when you publish.

NOTE If your map has a coordinate system assigned to it, AutoCAD Map 3D includes that coordinate system for each sheet in the published DWF file, using the property name "Coordinate System." You cannot choose this as a DWF Publishing Option, and you cannot change the property name. If you turn off all publishing options (by clearing the Publish Map Information box), the coordinate system is not included in the publish operation.

Tell me more



Video

- [Show me how to publish a map book with attributes to a DWF file.](#)



Procedures

- [To publish attribute data to DWF](#) (page 1367)



Tutorials

- Lesson 7: Publish Your Map



Workflow

- Publish to a Georeferenced DWF



GIS Skills

- *Produce a multi-sheet DWF file for a map book.*



Related topics

- [Overview of Publishing and Sharing](#) (page 1357)
- [Overview of Object Classification](#) (page 981)
- [Overview of Object Data](#) (page 1047)
- [Preparing a Map for Publishing to DWF](#) (page 1368)
- [Publishing a Map to DWF](#) (page 1371)

To publish attribute data to DWF

- 1 In the Tool-based Ribbon Workspace, click Output tab ► Export To DWF/PDF panel ► Export To DWF/PDF Options (MAPDWFOPTIONS).



- 2 In the [Map Information dialog box](#) (page 1832), check Publish Map Information.
- 3 Select the properties to include in the DWF.
 - To see specific properties, expand any categories that display a plus sign.
 - Check an item with subitems to select all its subitems.

To save these properties for future use, click the file icon and specify the name and location of the file for the exported properties. You can reload these settings again later by clicking the folder icon.

- 4 Click OK.

NOTE If you clear the Publish Map Information box, the options you checked remain checked, but they are not included in the publish operation. When you check Publish Map Information again, the options are included.

5 [Set up](#) (page 1369) and [publish the map to DWF](#) (page 1372).

Quick Reference

MAPDWFOPTIONS

Sets AutoCAD Map 3D options for publishing to DWF

Menu Click Map ► Tools ► DWF Publishing Options.

Command Line MAPDWFOPTIONS

Preparing a Map for Publishing to DWF

For best results, use the following techniques to prepare your map before publishing to DWF:

- Set the paper size larger than it is set for normal plotting and fit the map to the paper size.
If you publish a detailed drawing to a small paper size, Autodesk Design Review cannot display the detail. Zooming in does not help if the entities in the map are smaller than the pen weight used to draw lines on the paper.
- Use virtual pens to display details.
To be sure that users can see all the available detail in a map, use zero-weight pens. These allow users to zoom in without causing the lines to get thicker. Zero-weight lines display as one pixel wide on screen.
Define pen settings (including weights) using AutoCAD Plot Style Tables, which are stored in .CTB files. You can see a list of CTB files in the Plot Style Manager. The .CTB files are used by page setups, which are stored in .PC3 files. You can see a list of PC3 files in the AutoCAD Page Setup Manager. The .PC3 files are used by several commands, including *PLOT*, *PUBLISH*, and the Sheet Set Manager. For information about the Plot Style Tables and the Plot Style Manager, see *Manage Plot Style Tables* in the AutoCAD Help.
- Set a high display resolution.

By default, DWF files are produced with a vector grid of 1200 dots per inch (DPI), which means the files have roughly the same precision and security as paper.

Specify a DPI setting based on how small your objects are, relative to the plot scale. The maximum number of virtual DWF dots allowed on a page is 231 (2,147,483,647 in each dimension). To find the maximum allowed DPI for your map, divide the maximum number of dots (231) by the number of inches of the longest paper dimension. For example, for 42"x36" paper, you can have a maximum DWF DPI of about 51 million dots-per-inch. However, precision increases file size: a fifty-million-DPI file is about twice the size of a 1200-DPI file (file size is not linear with resolution). Set the DPI for DWF files using the DWF6 ePlot.PC3 settings. See Set the DWF File Resolution in the AutoCAD Help.

NOTE While it is safe to use very large DPI values for vectors, increasing gradient or raster DPI increases your file size exponentially. This can cause system failure.

- [Assign a coordinate system](#) (page 142) to the map.
Make sure that the coordinate system is valid for the data in the map. For example, a coordinate system for Canada might not support converting x,y values to latitude and longitude for a map of Thailand.
- Make sure that the graphics fall within the region of the coordinate system.

See also:

- [Overview of Publishing to DWF](#) (page 1365)
- [Publishing Attribute Data to DWF](#) (page 1366)
- [Publishing a Map to DWF](#) (page 1371)

To prepare a map for publishing to DWF

- 1 Display and set up the layout you plan to use for your publishing job.
A layout is an AutoCAD paper space environment where you can specify the size of your sheet, add a title block, display multiple views, and create dimensions and notes for your map. For more information about creating or editing a layout, see *Create Multiple-View Drawing Layouts (Paper Space)* in the AutoCAD Help.
- 2 [Choose any attributes to include](#) (page 1366) with the published DWF.

3 Save the map.

4 Click  Publish.

NOTE Do not choose an option from the Publish submenu. Click the word Publish in the application menu.

5 In the Publish dialog box, do any of the following:

- For each item in the Sheets to Publish list, click in the Page Setup/3D DWF field and choose or import a layout from the drop-down list. Make sure the Status column shows no errors. To exclude a sheet from the publish operation, right-click it and choose Remove.

NOTE By default, the model space view and the two default layout views are included in the list. You can change the settings for the sheets that are automatically included by clearing the check boxes under Include When Adding Sheets. You can also save the current sheet list and reload it for future publishing jobs.

- To specify publishing options, click Publish Options. To specify the attributes or object data to publish with this map, scroll down to Map Options and click in the field. To use your DWF Publishing settings, this field must be set to “Include.” To [view or change the settings](#) (page 1366), click the button labeled “...” Make sure that the Publish Map Information box in the DWF Publishing Options dialog box is checked. Otherwise, the coordinate system is not included in the publish operation.

To publish each display layer in your map to a separate layer in the DWF, click in the Layer Information field under DWF Data Options and change it to Include. Design Review can display each resulting layer independently. Each DWF layer has the same name as its Display Manager layer, but if multiple layers share the same name, the DWF layer will have _1 appended to the first duplicate name, _2 to the second, and so on.

- Click the DWF file option under Publish To.
- Change any other publishing options as desired. For information about these options, click Help.

6 [Publish the map to DWF](#). (page 1372)

Quick Reference

PUBLISH

Publishes a drawing to DWF format

Menu File menu ► More Plotting Options ► Publish to DWF

Icon  Publish

Command Line PUBLISH

Publishing a Map to DWF

When you publish to DWF, you create an electronic version of the map that can be displayed using Autodesk® Design Review, which you can download from the Autodesk Design Review page on the Autodesk website.

Autodesk Design Review includes the ability to measure, add redline markups, define, and place custom stamps and symbols, convert DWG files to DWF, convert raster image formats to DWF, add/remove/reorder DWF sheets to create custom packages, define and save new 3D views, and more.

Publishing Georeferenced DWFs

As long as you have assigned a coordinate system to all the maps in your DWF file, the publishing operation automatically converts the coordinate information to latitude/longitude coordinates. Autodesk Design Review 2008 can automatically navigate to a specific location when you enter coordinates, and displays coordinates of any location in the map when you move your mouse over that location. When your computer is integrated with a GPS device, field workers can center the map to the coordinates provided by the integrated GPS device on your system, and display the “my coordinates” icon within the map. GPS devices must use the NMEA 0183 protocol. Earlier versions of the DWF Viewer do not support georeferenced DWFs. For product information and a free trial version, refer to the Autodesk Design Review page on the Autodesk website.

NOTE Use the Publish command from Model space to create a georeferenced DWF file. Plotting to DWF will not work, and publishing from Layout space will not work.

See also:

- [Overview of Publishing to DWF](#) (page 1365)
- [Publishing Attribute Data to DWF](#) (page 1366)
- [Preparing a Map for Publishing to DWF](#) (page 1368)

To publish a map to DWF

- 1 Save the map.
- 2 Prepare the map for publishing to DWF. See [Preparing a Map for Publishing to DWF](#) (page 1369).

- 3 Click  Publish.

NOTE Select the Publish command from Model space to create a georeferenced DWF file. Publishing from Layout space will not work.

NOTE Do not choose an option from the Publish submenu. Click the word Publish in the application menu.

- 4 In the Publish dialog box, click the DWF file option under Publish To.
- 5 Set publishing options and click Publish.
- 6 In the Select DWF File dialog box, specify the name and location for the DWF output and click Select.
- 7 Indicate whether to save the current sheet set for future publishing operations.

The status area shows the progress of the publishing operation. When it is complete, a pop-up message lists the details of the job, including any warnings or errors that occurred.

NOTE If you are creating a georeferenced DWF and want to use it with a GPS-enabled device, set the GPS device for NMEA output and WGS84 coordinates. If you are not sure how to do this, review the documentation that came with your GPS device.

Quick Reference

PUBLISH

Publishes a drawing to DWF format

Menu File menu ► More Plotting Options ► Publish to DWF

Icon  Publish

Command Line PUBLISH

Publishing to PDF

Recipients of PDF files can view and print them using Adobe® Reader versions 5 or later. You can publish a single PDF file or multiple PDF files containing separate layouts.

See also:

- [Overview of Publishing Maps](#) (page 1360)

To publish to PDF

- 1 Save the map.
- 2 In the Tool-based Ribbon Workspace, click Output tab ► Export To DWF/PDF panel ► Export ► PDF.

Publishing to a Web Page

You can save your map in HTML format for display as a static web page. The result is a “snapshot” of the map that cannot be edited in AutoCAD Map 3D, but can be viewed by any web browser.

You use a wizard to guide you through the publishing process. Once you have created a web page with this wizard, you can update the information for the web page if the map file changes.

For more information, see *Use the Publish to Web Wizard to Create Web Pages* in the AutoCAD Help.

NOTE You can also use the MapGuide technology to publish map-related data on the web or on an intranet.

See also:

- [Overview of Publishing Maps](#) (page 1360)
- [Publishing to MapGuide](#) (page 1376)

To publish a map as a web page

- 1 Save your map.
- 2 At the Command prompt, enter `publishtowe`.
- 3 Click **Create New Web Page** and click **Next**.

NOTE Once you create a web page with this wizard, you can choose **Edit Existing Web Page**. You select the web page to edit, and then you can change any of the settings for that web page and republish it.

- 4 Specify a name and location for the web page files.
 - Type a name for the web page (without any file name extension).
 - Specify the parent directory for the web page files by clicking the button labeled “...” next to the default path. Choose or create a folder for the files and click **Open**.
 - Type a description for the web page in the space provided.
 - Click **Next**.
- 5 Choose an image type.

As you select an image type from the drop-down list, the description provides information for that option. The last one you select will be used. For JPEG and PNG, you can specify an image size.

 - Review the image types and select the one you want.
 - Select an image size (if appropriate).
 - Click **Next**.
- 6 Choose a page template.

As you select a template from the list, the preview and description update for that option.

- Review the templates and select the one you want.
- Click Next.

7 Choose a formatting theme for the web page.

As you select a theme from the drop-down list, the preview illustrates it.

- Review the themes and select the one you want.
- Click Next.

8 Choose whether to use i-drop™ or not and click Next.

The i-drop option lets you post copies of the DWG files that comprise your map so viewers can access those files.

9 Choose the drawings for your web page.

- Specify the map file for the web page by clicking the button labeled “...” next to the default file name. Choose the file and click Open.
- Choose a layout (model space or one of the layouts you’ve defined for this map file).
- Type a label and a description to annotate the image on the resulting web page
- Click Add.
If you need to change one of your entries, select it in the Image list, make your changes in Image Settings, and click Update.
- Click Next.

10 Click Next on the Generate Images page of the wizard to create the web page.

11 Preview and post the resulting web page.

- Click Preview to see how the web page will look.
If you need to change anything, close the browser window in which the preview appears and click Back to make your changes.
- Click Post Now to post the web page.
Navigate to the location for the web page and click Save.
- Click Send Email to create an email message that contains a link to your web page.

- 12 Click Finish.

Using eTransmit

When you send a map file to another AutoCAD Map 3D user, it is easy to omit some of the dependent files required to edit that map effectively. You can use eTransmit to package all dependent files for a map (for example, SHP, SDF, and MDB files to which you are connected) and ensure that the recipient has all the required information. Then you can email the resulting file to the recipient, along with a report explaining how to use the files.

The eTransmit feature also packages all local edits.

NOTE If your map includes data from a feature store such as an Oracle database, that data will be available to the recipient, even if the recipient does not have access to that data store.

For more information, see *Package a Set of Files for Internet Transmission* in the online Help.

See also:

- [Overview of Publishing Maps](#) (page 1360)

To use eTransmit

- 1 Save the map.
- 2 Click  > Send > eTransmit.

Publishing to MapGuide

The MapGuide technology lets you publish map-related data on the web or on an intranet. The MapGuide technology is available as Autodesk MapGuide Enterprise and under an open source license. For more information, see the Mapping & GIS Solutions page on the Autodesk website.

When you publish to MapGuide, all layers, layer definitions, dynamic labels, queries, filters, and styles (including point, line, raster, and other styles) in your map are published in the format that MapGuide needs.

NOTE If you are using a previous release (Autodesk MapGuide 2008 or earlier), you cannot use this command. Instead, [export your map to SDF2 format](#) (page 1469) and send the resulting file to your MapGuide server.

Metadata is not included when you publish to MapGuide. You can [export metadata from the Metadata Viewer](#) (page 1510).

MapGuide and Joined Data

If you have joined data to layers that you are publishing, you cannot publish the joined data with this command. The layer will be published, but the joined data will not. To publish both, save the layer with the joined data to SDF (which converts the joined data into a flat table) and then publish the resulting SDF file. This publishes only the data that was on the server at the time you created the SDF file. The features are no longer connected to the original databases and data. For more information about saving a layer to SDF, see [Saving or Exporting a Display Manager Layer](#) (page 1469).

MapGuide and SHP or SDF Layers

If your map includes SHP or SDF layers, AutoCAD Map 3D copies the source files for those layers to the server. If your map includes layers that come from a central database, AutoCAD Map 3D includes pointers to the original data stores. If your map includes layers composed of objects from drawing files, AutoCAD Map 3D copies those objects as high-fidelity DWF files.

Tell me more



Video

- [Show me how to publish a map to a MapGuide server.](#)
- [Show me how to export a layer to SDF](#)



Procedures

- [To publish a map for use with MapGuide](#) (page 1378)



Workflow

- [Publish to the Web](#)



GIS Skills

- [Publish a completed map to a MapGuide server.](#)
-



Related topics

- [Overview of Publishing and Sharing](#) (page 1357)
- [Sharing Metadata](#) (page 1510)
- [Saving or Exporting a Display Manager Layer](#) (page 1469)
- [Importing Autodesk SDF \(Spatial Data Files\)](#) (page 387)
- [Saving or Exporting a Display Manager Layer](#) (page 1469)
- [Importing ESRI Shape Files](#) (page 397)

To publish a map for use with MapGuide

- 1 Save the map.
- 2 Click  ► Publish ► Publish To MapGuide.
- 3 In the [Publish to MapGuide dialog box](#) (page 1577), specify the URL for the target website. If the site requires a password, a Connect to Site dialog box appears. Enter your user name and password.
- 4 Check Overwrite existing resources of the same name if you want to overwrite such files.
- 5 Check Show map in web browser after publishing if you want to review the published map immediately.
- 6 Choose a folder for the published files.
- 7 Click Publish. You can monitor the progress and result of the operation in the status bar.

Quick Reference

MAPPUBLISH TOMAPGUIDE

Publish to the new MapGuide technology (Autodesk MapGuide Enterprise 2007 or MapGuide Open Source)

Menu	File ► More Plotting Options ► Publish to Autodesk MapGuide
Command Line	MAPPUBLISHMOMAPGUIDE

Viewing Publish to MapGuide Results

When you publish to Autodesk MapGuide Enterprise, you can check the results of the publish operation, including the number of layers that were published and the number that failed. The following types of problems can occur:

- Layers without assigned coordinate systems may not display correctly in MapGuide.
- Features from third-party data sources, such as Oracle databases or ArcSDE, will cause problems if no corresponding data store exists on the MapGuide server.
- If the program cannot determine the source type for data, or cannot open the current map or configuration file, some data may not be published.
- Layers that are joined to external data sources are not published.
- If a map with the same name already exists on the server, the publish operation will fail if you set the MapGuide publishing options to stop the publish operation in this situation.
- If a folder name or its path contain invalid characters, the publish operation will fail. Invalid characters are \, :, *, ?, ", <, >, |, &, %, =, and /.
- Situations like a session expiration, a timeout, or the inability of the server to parse the XML can also cause the publish operation to fail.

To resolve MapGuide publishing errors

- 1 In the [Publish to MapGuide Results dialog box](#) (page 1578), click View Log. For information on publishing and viewing results, see [Publishing to MapGuide](#) (page 1376).
- 2 Examine the log file to see which layers failed and why.
- 3 Resolve the publishing errors in the following ways:
 - **Errors due to joined data:** You can detach the joined data from the layers before publishing to omit that data but still publish the layers. If you must include the joined data, save layers with joined data to

SDF format (which converts the join into a flat table), remove the layers from the map (turning them off is not sufficient), and publish the resulting map. Then copy the SDF containing the joined data layer to the MapGuide server. This places a “static” copy of the data on the server (the features no longer point to the original databases and data). You must reconstruct the map on the server to add the SDF layer back in. For information on how to save a layer to SDF, see [Saving or Exporting a Display Manager Layer](#) (page 1469).

- **Errors resulting from layers without assigned coordinate systems:** Display the Data Connect dialog box, select the data source whose layers are missing a coordinate system, and click Edit Coordinate Systems. Click Edit and select a coordinate system. Click OK in both dialog boxes to apply your changes.
- **ODBC DSN errors:** If feature sources in the map use an ODBC DSN (Data Source Name) on the local computer, the DSN must exist on the machine where the server resides, and it must have the same name as the DSN on the local machine.
- **Errors related to missing provider components on the server:** If you publish a map layer from a provider that requires software or components, such as an Oracle database, ArcSDE data source, SQL server, or a third-party database provider you set up, you must install that software on the MapGuide server and configure it correctly. For example, if you publish a layer from an Oracle database, you must install the Oracle client on the server.

NOTE MapGuide Enterprise installs some provider support automatically, while the open source version does not. However, in both cases, you will need to install components for some providers.

- **Errors due to a failure to determine the source data type or read the configuration file:** These errors are usually the result of using data from third-party FDO Providers. Contact Autodesk technical support, or the support group for the FDO Provider you are using.
- **Errors due to existing files on the server:** If you specified that this publish operation should stop if it encounters existing files with the same names as new ones, and if those files exist, you can either remove the existing files from the server or change the publishing options to overwrite the existing files. For more information, see [Publishing to MapGuide](#) (page 1376).

- **Errors due to invalid characters:** Rename the offending files or folders to avoid invalid characters.

4 Republish.

Quick Reference

MAPPUBLISHTOMAPGUIDE

Publish to the new MapGuide technology (Autodesk MapGuide Enterprise 2007 or MapGuide Open Source)

Menu	File ► More Plotting Options ► Publish to Autodesk MapGuide
Command Line	MAPPUBLISHTOMAPGUIDE

Publishing Map Books

- [To create and publish a map book](#) (page 1383)
- [To set up a map book template](#) (page 1386)
- [To identify layout placeholders](#) (page 1388)
- [To create a map book](#) (page 1390)
- [To rebuild a map book](#) (page 1391)
- [To import a plot map set](#) (page 1392)

Overview of Map Books

A map book divides your map into multiple “tiles” and displays each tile on a separate page. Picture a grid overlaying your map. Each section of the grid represents a tile. Once you create a map book, you can publish the entire map or selected tiles to a plotter or to DWF.

Each map book is associated with an AutoCAD sheet set. For more information about AutoCAD sheet sets, see *Create and Manage a Sheet Set* in the AutoCAD Help.

NOTE If a map book becomes dissociated from its sheet set (for example, if you rename the map file after creating a map book), you will be prompted to regenerate the sheet set when you select an existing map book or create a new map book. You can choose the sheet set from the older version of the map file, or you can create a new one. To regenerate the sheet set at any other time, right-click the map book (on the Map Book tab of the Task Pane) and choose Rebuild Sheet Set. When you package and send your map files to a recipient using eTransmit, the sheet set is packaged with the map file and your recipient does not have to regenerate it.

To create a map book, you must first set up a map book template. You can start with a sample template and adapt it to your needs. When the template is complete, you generate the map book. You can update the original map at any time and regenerate the map book without changing the template, or you can change the template and regenerate the map book. The new map book will reflect your changes.

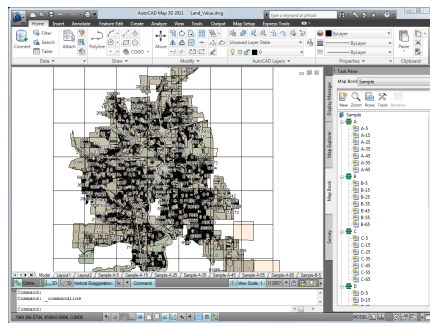

Map book with tiles listed by row and column

You can create more than one map book for a map, but only one can be current at a time.

Tell me more



Video

- [Show me how to create a map book.](#)
- [Show me how to publish a map book with attributes to a DWF file.](#)



Procedures

- [To create and publish a map book \(page 1383\)](#)
-



Tutorials

- [Tutorial: Creating a Map Book With an Inset](#)



Workflow

- [Publish to a Map Book](#)



GIS Skills

- [Create a map book with appropriate-scale tiling for a city.](#)
- [Produce a multi-sheet DWF file for a map book.](#)



Related topics

- [Overview of Publishing and Sharing](#) (page 1357)

To create and publish a map book

- 1 [Set up a map book template](#) (page 1385).
- 2 [Identify layout placeholders](#) (page 1388).
- 3 [Create a map book](#) (page 1389).
- 4 [View or edit the map book tiles](#) (page 1397).
- 5 [Publish the map book](#) (page 1400).

Quick Reference

MAPBOOKCREATE

Creates a map book to publish your data

Menu

In the Map Classic workspace, Click Map ► Map Book.

Command Line

MAPBOOKCREATE

Task Pane



In the Map Book task pane, click New ► Map Book.

Dialog Box

Create Map Book/Edit Map Book dialog box

MAPBOOKCREATEFROMSETTINGS

Creates a new map book from a previously saved map books settings file

Command Line MAPBOOKCREATEFROMSETTINGS

Task Pane



In the Map Book task pane, click New ► Map Book from Settings.

Dialog Box Select Map Book Settings dialog box

MAPBOOKEDITSETTINGS

Edits the settings of an existing map book

Command Line MAPBOOKEDITSETTINGS

Task Pane

In the Map Book task pane, click Tools ► Edit Settings and Rebuild Map Book.

Dialog Box Create Map Book/Edit Map Book dialog box

MAPBOOKIMPORTPLOTSET

Imports settings from a map plot set

Command Line MAPBOOKIMPORTPLOTSET

Task Pane



In the Map Book task pane, click New ► Map Book from Plot Set.

Dialog Box Select Plot Set to Convert dialog box

MAPBOOKPLACEHOLDER

Names the viewports and element placeholders in the layout template

Command Line MAPBOOKPLACEHOLDER

Task Pane

On the Map Book tab, click Tools ► Identify Template Placeholders.

Dialog Box Identify Map Book Template Placeholders dialog box

MAPBOOKSAVESETTINGS

Saves map book settings to an external file

Command Line MAPBOOKSAVESETTINGS

Task Pane On the Map Book tab, right-click a map book name
► Save Settings.

Dialog Box Save Map Book Settings dialog box

Setting Up a Map Book Template

Every map book requires a template that specifies printer settings (such as paper size and the printer driver to use) and defines the size and position of elements on the page (for example, the legend, title block, and map tiles).

A template can contain one or more layouts. If it contains multiple layouts, you must specify the one to use for a particular map book.

Once you define the map book template and save your map, you can publish the map book to a plotter or to a DWF file.

Viewports

In your map book template, each element appears within a *viewport*, which is like a frame on a web page. A viewport has a shape and a position on the page, and you specify the type of information that appears within it. You must include a main viewport in your map book template. Other viewports are optional and can include the following:

- *Tileview viewport* displays the corresponding tile, and determines the shape of that tile. Templates for map books must include a tileview viewport.
- *Keyview viewport* displays a thumbnail view of the entire area included in the map book. You can create a simplified view of the mapped area to use in this viewport, save that view to a separate drawing file, and then link the viewport to that drawing. You can display a different linked file in this viewport, instead of the thumbnail. For example, you can save a detail of the map in a separate file and use the keyview viewport to display it as an inset. You can also display selected AutoCAD layers for the entire map.

NOTE When you generate the map book, you can choose any of the previous alternatives, or you can choose to omit the keyview viewport altogether.

- *Legend viewport* displays a legend, and specifies where it appears in the map book. If you created a display legend for your map, you can select it for

this viewport, or you can select an area of your map to use as a legend. This viewport is optional.

- *Adjacent arrows* are blocks at each edge of the tile that point to and identify the adjacent tile. Each arrow has a property that specifies the adjacent tile in that direction and displays the name of that tile within the arrow. You can specify the text that appears within the arrowheads. When you generate the map book, you can choose a drawing for an adjacent block. That drawing replaces the original adjacent block defined in the template layout.
- *Title block* displays a defined DWG block that can include title information, such as your company or group name and the name of the map. Many organizations have standard title blocks to insert in this element. You can define certain attributes of the title block from within your template. Title blocks defined in the sample templates include a frame that surrounds the entire tile. When you generate the map book, you can choose a drawing for the title block. That drawing replaces the original title block contents defined in the template layout.

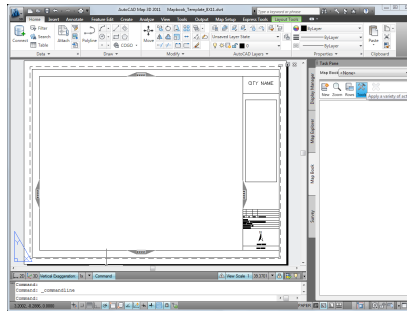

Map book template

See also:

- [Overview of Publishing and Sharing](#) (page 1357)
- [Overview of Map Books](#) (page 1381)

To set up a map book template

- 1 Open an existing map book template. Map book templates for a variety of paper sizes are included in the *Templates* folder. Choose from 8.5x11, 8.5x14, 11x17, A3, or A4.

2 Do the following:

- Right-click a layout tab and choose Rename. Type a new name for this layout.

NOTE If you do not see the layout tabs, click  ► Options ► Display tab, check Display Layout and Model Tabs, and create a new layout.

- Right-click the renamed layout tab. Choose Page Setup Manager to specify plotter and paper information.

NOTE This information will be used every time you publish your map book to a plotter. You cannot change these settings at print time. For more information about this dialog box, type "Page Setup Manager" in the Search tab of the help.

3 Resize the viewports on the layout as needed:

- To resize a viewport, click it to select it. Click and drag a corner grip.
- If you do not want to use one of the viewports that appear on the template, select it and press the Delete key on your keyboard.

4 Customize the viewports on the template as desired:

- Double-click the outside frame of the title block to change its attributes or text properties. Items that display pound signs (###) are variables. Right-click a variable to change its value.
- Double-click an arrow block to change its text properties.

5 When the elements appear as you want them, you must [Identify the layout placeholders](#) (page 1388).

6 After identifying the placeholders, save the map file as a DWT (AutoCAD Drawing Template) file.

NOTE You can also create a map book layout in an existing map, and use that map as your map book template. Be sure to rename the layout tab that you plan to use for map books. You can have multiple layout templates in a map.

Quick Reference

PAGESETUP

Displays the Page Setup Manager for a layout

Menu File menu ► More Plotting Options ► Page Setup Manager

Command Line PAGESETUP

Identifying Layout Placeholders

You must identify each element in your map book template as a placeholder for a particular type of information. For example, you select the viewport intended for the title and identify it as a title block placeholder.

See also:

- [Setting Up a Map Book Template](#) (page 1385)
- [Overview of Map Books](#) (page 1381)

To identify layout placeholders

- 1 Select the layout tab you defined for the map book.
- 2 On the Map Book tab of the Task Pane, click Tools ► Identify Template Placeholders.
- 3 In the [Identify Map Book Template Placeholders dialog box](#) (page 1829), click an item in the Layout Placeholders list. For example, click Main Viewport. Then click Select Placeholders.
- 4 In your layout, click the outline of the viewport to use for the item you selected. For example, for the Main viewport, click the viewport that will display the map tile.
- 5 Repeat steps 3 and 4 for each of the following elements in your layout:
 - Main viewport
 - Keyview viewport
 - Legend viewport
 - Adjacent arrow blocks

- Title block

6 When you have identified all the elements, click Close.

Quick Reference

MAPBOOKPLACEHOLDER

Names the viewports and element placeholders in the layout template

Command Line	MAPBOOKPLACEHOLDER
Task Pane	On the Map Book tab, click Tools ► Identify Template Placeholders.
Dialog Box	Identify Map Book Template Placeholders dialog box

Creating a Map Book

You can create a map book from a map you styled in Display Manager or from objects in model space.

By default, the map book uses the current map in the Display Manager, whether you have saved it or not. If you specify the model space instead, the map book shows the current contents of the model space. You can also choose a map you saved in the Display Manager.

Tell me more



Video

- [Show me how to create a map book.](#)
- [Show me how to publish a map book with attributes to a DWF file.](#)



Procedures

- [To create a map book](#) (page 1390)



Tutorials

- [Tutorial: Creating a Map Book With an Inset](#)
-



- Publish to a Map Book



- *Create a map book with appropriate-scale tiling for a city.*
- *Produce a multi-sheet DWF file for a map book.*

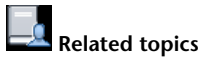

- [Overview of Publishing and Sharing](#) (page 1357)
- [Overview of Map Books](#) (page 1381)
- [Setting Up a Map Book Template](#) (page 1385)

To create a map book

- 1 On the Map Book tab of the Task Pane, click New ► Map Book.
- 2 In the [Create Map Book/Edit Map Book dialog box](#) (page 1827), select an option under each of the following and enter the required information:
 - Source
 - Sheet Template
 - Tiling Scheme
 - Naming Scheme
 - Sheet Set
- 3 Optionally, you can select options under the following:
 - Key
 - Legend
- 4 Click Preview to see a preview of the tile outlines on the map.
- 5 Click Generate.

Quick Reference

MAPBOOKCREATE

Creates a map book to publish your data

Menu In the Map Classic workspace, Click Map ► Map Book.

Command Line MAPBOOKCREATE

Task Pane



In the Map Book task pane, click New ► Map Book.

Dialog Box Create Map Book/Edit Map Book dialog box

Rebuilding a Map Book

If you make changes to a map book template, you must rebuild the map book to apply the changes.

See also:

- [Overview of Map Books](#) (page 1381)
- [Setting Up a Map Book Template](#) (page 1385)

To rebuild a map book

- 1 On the Map Book tab of the Task Pane, select the map book to rebuild.
- 2 Right-click the map book name and click Rebuild.

Importing Plot Map Sets

You can import settings from plot map sets that you created in previous releases of the software.

See also:

- [Creating a Map Book](#) (page 1389)
- [Map Book Settings](#) (page 1392)

To import a plot map set

- 1 Open the file that contains the plot map set.
- 2 On the Map Book tab of the Task Pane, click New ► Map Book From Plot Set.
- 3 Select the plot map set to convert. Click OK.
- 4 In the Create Map Book dialog box, edit the imported plot map set information as desired. Click OK.

Quick Reference

MAPBOOKIMPORTPLOTSET

Imports settings from a map plot set

Command Line MAPBOOKIMPORTPLOTSET

Task Pane



In the Map Book task pane, click New ► Map Book from Plot Set.

Dialog Box Select Plot Set to Convert dialog box

Map Book Settings

- [Overview of Map Book Settings](#) (page 1392)
- [Saving Map Book Settings](#) (page 1394)
- [Creating New Map Books from Saved Settings](#) (page 1395)
- [Editing Map Book Settings](#) (page 1396)

- [To save map book settings](#) (page 1394)
- [To create a new map book from saved settings](#) (page 1395)
- [To edit map book settings](#) (page 1396)

Overview of Map Book Settings

You can save and reuse the settings you specified for a particular map book.

See also:

- [Creating a Map Book](#) (page 1389)
- [Creating New Map Books from Saved Settings](#) (page 1395)
- [Editing Map Book Settings](#) (page 1396)

To do this...	Use this method...
Save map book settings	On the Map Book tab of the Task Pane, right-click the map book name. Click Save Settings. See Saving Map Book Settings (page 1394)
Use saved map book settings	On the Map Book tab of the Task Pane, click New ► Map Book From Settings. See Creating New Map Books from Saved Settings (page 1395)
Edit saved map book settings	On the Map Book tab of the Task Pane, select a map book and click Tools ► Edit Settings And Rebuild Map Book. See Editing Map Book Settings (page 1396)

Quick Reference

MAPBOOKSAVESETTINGS

Saves map book settings to an external file

- Command Line** MAPBOOKSAVESETTINGS
- Task Pane** On the Map Book tab, right-click a map book name
 ► Save Settings.
- Dialog Box** Save Map Book Settings dialog box

MAPBOOKCREATEFROMSETTINGS

Creates a new map book from a previously saved map books settings file

- Command Line** MAPBOOKCREATEFROMSETTINGS

Task Pane	 In the Map Book task pane, click New ► Map Book from Settings.
Dialog Box	Select Map Book Settings dialog box

MAPBOOKEDITSETTINGS

Edits the settings of an existing map book

Command Line	MAPBOOKEDITSETTINGS
Task Pane	In the Map Book task pane, click Tools ► Edit Settings and Rebuild Map Book.
Dialog Box	Create Map Book/Edit Map Book dialog box

Saving Map Book Settings

Map book settings are automatically saved in the map file as soon as you create the map book. You can save these settings in a separate MBS (Map Book Settings) file to use with other map books.

See also:

- [Creating a Map Book](#) (page 1389)
- [Creating New Map Books from Saved Settings](#) (page 1395)

To save map book settings

- 1 On the Map Book tab of the Task Pane, select the map book whose settings you want to use.
- 2 Right-click the map book name. Click Save Settings.
- 3 Give the file a unique name.
- 4 Click Save.

Quick Reference

MAPBOOKSAVESETTINGS

Saves map book settings to an external file

Command Line MAPBOOKSAVESETTINGS

Task Pane On the Map Book tab, right-click a map book name
► Save Settings.

Dialog Box Save Map Book Settings dialog box

Creating New Map Books from Saved Settings

If you saved the settings for a map book in a Map Book Settings file, you can use those settings for a new map book.

See also:

- [Creating a Map Book](#) (page 1389)
- [Saving Map Book Settings](#) (page 1394)

To create a new map book from saved settings

- 1 On the Map Book tab of the Task Pane, click New ► Map Book From Settings.
- 2 Navigate to a map book settings (MBS) file and open it.
- 3 In the Create Map Book dialog box, change the settings as desired.
- 4 Click Generate.

Quick Reference

MAPBOOKCREATEFROMSETTINGS

Creates a new map book from a previously saved map books settings file

Command Line MAPBOOKCREATEFROMSETTINGS

Task Pane



In the Map Book task pane, click New ► Map Book from Settings.

Dialog Box Select Map Book Settings dialog box

Editing Map Book Settings

You can edit the settings of an existing map book.

See also:

- [Creating a Map Book](#) (page 1389)
- [Saving Map Book Settings](#) (page 1394)
- [Rebuilding a Map Book](#) (page 1391)

To edit map book settings

- 1 On the Map Book tab of the Task Pane, select the map book whose settings you want to change, and click Tools ► Edit Settings And Rebuild Map Book.
- 2 In the Edit Map Book dialog box, change the settings as desired.
- 3 Click Generate.

Quick Reference

MAPBOOKEDITSETTINGS

Edits the settings of an existing map book

Command Line	MAPBOOKEDITSETTINGS
Task Pane	In the Map Book task pane, click Tools ► Edit Settings and Rebuild Map Book.
Dialog Box	Create Map Book/Edit Map Book dialog box

Viewing and Editing Map Books

You can view or edit individual tiles and their corresponding layouts.

- [Overview of Viewing and Editing Map Book Tiles](#) (page 1397)
- [Viewing a Map Book](#) (page 1398)
- [Viewing Map Book or Tile Properties](#) (page 1398)
- [Viewing Tiles in Model Space](#) (page 1399)
- [Viewing Layouts](#) (page 1400)

- [To view a map book](#) (page 1398)
- [To hide all map books](#) (page 1398)
- [To view map book or tile properties](#) (page 1399)
- [To view a tile](#) (page 1399)
- [To view several tiles](#) (page 1399)
- [To view all tiles](#) (page 1399)
- [To view a layout](#) (page 1400)

Overview of Viewing and Editing Map Book Tiles

Map books divide a single map into a set of tiles and display each tile on a separate map book page. You use a template to specify the layout of the pages. You can view and change individual tiles or layouts for existing map books.

See also:

- [Overview of Map Books](#) (page 1381)
- [Creating a Map Book](#) (page 1389)

Use the following methods to view and edit map book tiles.

To view or edit this...	Use this method...
An entire map book	On the Map Book tab of the Task Pane, select the map book to view from the Map Book list. See Viewing a Map Book (page 1398).
Map book or tile properties	On the Map Book tab of the Task Pane, right-click a map book or tile and click Properties. See Viewing Map Book or Tile Properties (page 1398).
Map book tiles in model space	On the Map Book tab of the Task Pane, right-click a map book or tile and click Zoom Tiles. See Viewing Tiles in Model Space (page 1399).
Map book tile layouts	On the Map Book tab of the Task Pane, right-click a tile and click Zoom Layout. See Viewing Layouts (page 1400).

Viewing a Map Book

When you open a map containing one or more map books, none of the map books is current until you select one. When you select a map book, you automatically zoom to its extents and see the tile outlines. If the map book is based on a display map, you will see the stylization associated with that display map.

See also:

- [Overview of Map Books](#) (page 1381)
- [Creating a Map Book](#) (page 1389)
- [Overview of Viewing and Editing Map Book Tiles](#) (page 1397)

To view a map book

- On the Map Book tab of the Task Pane, select the map book to view from the Map Book list.

To hide all map books

- On the Map Book tab of the Task Pane, select <None> from the Map Book list.

NOTE If the map book is based on a display map, this will hide only the tile outlines. To turn off stylization, use the Display Manager.

Viewing Map Book or Tile Properties

You can view basic properties about map books or tiles. In the [Map Book Properties dialog box](#) (page 1830), you can view the map's name, scale, orientation, coordinate system, and number of tiles. In the [Tile Properties dialog box](#) (page 1831), you can view a tile's name and the numbers of its adjacent tiles.

NOTE The map book properties are strings, for use as field values in sheets. They do not change the actual properties of the map book.

See also:

- [Overview of Map Books](#) (page 1381)

- [Creating a Map Book](#) (page 1389)
- [Overview of Viewing and Editing Map Book Tiles](#) (page 1397)

To view map book or tile properties

- 1 On the Map Book tab of the Task Pane, do one of the following:
 - Right-click the map book name.
 - Right-click a tile name.
- 2 Click Properties.
- 3 In the [Map Book Properties dialog box](#) (page 1830) or the [Tile Properties dialog box](#) (page 1831), examine the properties.

Viewing Tiles in Model Space

You can view selected tiles in model space.

See also:

- [Overview of Map Books](#) (page 1381)
- [Creating a Map Book](#) (page 1389)
- [Overview of Viewing and Editing Map Book Tiles](#) (page 1397)

To view a tile

- On the Map Book tab of the Task Pane, right-click a tile name. Click Zoom Tile.

To view several tiles

- Select multiple tile names. Right-click one of the selected tiles. Click Zoom Tiles.

To view all tiles

- Right-click the map book containing the tiles. Choose Zoom Tiles.

Viewing Layouts

You can view layouts for selected tiles, one at a time.

See also:

- [Overview of Map Books](#) (page 1381)
- [Creating a Map Book](#) (page 1389)
- [Overview of Viewing and Editing Map Book Tiles](#) (page 1397)

To view a layout

- On the Map Book tab of the Task Pane, right-click a tile name. Click Zoom Layout.

Publishing Map Books

You can publish a map book to a DWF file for electronic distribution or to a plotter for a printed map book based on the current plot settings.

- [To publish a map book to DWF](#) (page 1401)
- [To publish a map book to a plotter](#) (page 1402)

Publishing Map Books to DWF

The steps for [publishing a map to DWF](#) (page 1364) and publishing a map book to DWF are slightly different, but you set DWF Publishing Options the same way for both.

Tell me more



- [Show me how to publish a map book with attributes to a DWF file.](#)



- [To publish a map book to DWF](#) (page 1401)
-



Tutorials

- [Tutorial: Creating a Map Book With an Inset](#)



Workflow

- [Publish to a Map Book](#)



GIS Skills

- [Produce a multi-sheet DWF file for a map book.](#)



Related topics

- [Overview of Publishing and Sharing](#) (page 1357)
- [Overview of Map Books](#) (page 1381)
- [Creating a Map Book](#) (page 1389)
- [Overview of Publishing to DWF](#) (page 1365)
- [Publishing Attribute Data to DWF](#) (page 1366)
- [Publishing a Map to a Plotter](#) (page 1363)

To publish a map book to DWF

- 1 Save the map.
- 2 [Set up options for publishing attribute data](#) (page 1366).
- 3 On the Map Book tab of the Task Pane, select the map book to publish, and click Tools ► Publish To DWF.
- 4 In the Select DWF File dialog box, choose a name and location for the DWF file and click Select.

Publishing Map Books to a Plotter

You can publish to a plotter for a printed copy.

The steps for [publishing a map to a plotter](#) (page 1363) and publishing a map book to a plotter are slightly different. The plotter and plotting options are

specified in your layout for this map book, so the map book is sent to the plotter as soon as you choose the command.

See also:

- [Overview of Map Books](#) (page 1381)
- [Creating a Map Book](#) (page 1389)
- [Publishing a Map to a Plotter](#) (page 1363)

To publish a map book to a plotter

- 1 Save the map.
- 2 Make sure that you have set up the printer or plotter you want to use.
- 3 On the Map Book tab of the Task Pane, select the map book to publish, and click Tools ► Publish To Plotter.

Managing Map Books and Tiles

- [To rename a map book or tile](#) (page 1402)
- [To delete a map book or tile](#) (page 1403)

Rename Map Books or Tiles

You can rename entire map books or individual tiles.

See also:

- [Overview of Map Books](#) (page 1381)
- [Creating a Map Book](#) (page 1389)
- [Delete Map Books or Tiles](#) (page 1403)

To rename a map book or tile

- 1 On the Map Book tab of the Task Pane, do one of the following:
 - Right-click the map book to rename.
 - Right-click the tile to rename.

- 2 Click Rename.
- 3 Type the new name.
- 4 Press Enter.

NOTE Renaming a tile does not rename its associated layout.

Delete Map Books or Tiles

You can delete tiles from a map book or delete the entire map book.

See also:

- [Overview of Map Books](#) (page 1381)
- [Creating a Map Book](#) (page 1389)
- [Rename Map Books or Tiles](#) (page 1402)

To delete a map book or tile

- 1 On the Map Book tab of the Task Pane, do one of the following:
 - Right-click the map book to delete.
 - Right-click the tile to delete.
- 2 Click Delete.
- 3 Click Yes.

WARNING You cannot undo the deletion.

Converting and Exporting

To convert or export drawing objects

- [To prepare your data for export](#) (page 1408)
- [To export drawing objects to other file formats](#) (page 1408)
- [Before moving drawing data to SDF](#) (page 1415)
- [To export drawing objects to SDF](#) (page 1416)
- [To specify the name for the index property used in export](#) (page 1417)

- [Other ways to move data into SDF format](#) (page 1417)
- [To export DWG data to SDF2 format](#) (page 1418)
- [To change the settings AutoCAD Map 3D uses for segmentation](#) (page 1421)
- [To export drawing objects to ESRI Arc/INFO](#) (page 1421)
- [To export DWG data to ESRI ArcSDE:](#) (page 1423)
- [To include all object types when exporting drawing objects to ESRI SHP format](#) (page 1427)
- [To change the settings AutoCAD Map 3D uses for segmentation](#) (page 1427)
- [To export drawing objects to SHP](#) (page 1428)
- [To verify language encoding settings for export to GML](#) (page 1429)
- [To export drawing objects to GML](#) (page 1430)
- [To change the settings AutoCAD Map 3D uses for segmentation](#) (page 1432)
- [To export drawing objects to MapInfo](#) (page 1432)
- [To change the settings AutoCAD Map 3D uses for segmentation](#) (page 1434)
- [To export drawing objects to MapInfo TAB](#) (page 1434)
- [To change the seed file for a single file](#) (page 1437)
- [To change the default seed file](#) (page 1438)
- [To export drawing objects to MicroStation Design \(DGN\)](#) (page 1438)
- [To export multiple feature classes](#) (page 1440)
- [To combine multiple layers into one feature class](#) (page 1442)
- [To change the class names that are assigned automatically](#) (page 1442)
- [To change the settings AutoCAD Map 3D uses for segmentation](#) (page 1445)
- [To export drawing objects to Shape Multiclass](#) (page 1445)
- [To map fields when exporting to Shape Multiclass](#) (page 1446)
- [To create polygons when exporting to SHP Multiclass](#) (page 1446)
- [To export to a single feature class that uses all the items you specified on the Data tab.](#) (page 1446)
- [Before moving drawing data to SQLite](#) (page 1447)
- [To export drawing objects to SQLite](#) (page 1448)
- [To move data into SQLite format](#) (page 1449)
- [To export drawing objects to Vector Markup Language \(VML\)](#) (page 1450)
- [To export point cloud data to LAS or ASCII formats](#) (page 1452)
- [To export point cloud data to Autodesk SDF format](#) (page 1452)
- [To map drawing attributes to feature class properties](#) (page 1454)
- [To map AutoCAD drawing attribute values to feature class property values](#) (page 1454)
- [To export text enclosed in a polyline as attribute data](#) (page 1455)
- [To export polygons from a polygon topology](#) (page 1458)
- [To create a DXF file](#) (page 1459)
- [To save a styled map to DWG format](#) (page 1460)
- [To export DWG data to Oracle:](#) (page 1462)
- [To export DWG data to ESRI ArcSDE:](#) (page 1463)
- [To save drawing objects in an image format](#) (page 1465)

- [To move drawing data to a spatial data store and back using the import method](#) (page 1467)
- [To move drawing data to a spatial data store and back using the Data Connect method](#) (page 1467)
- [To export layers in SDF or SQLite format](#) (page 1470)
- [To save a layer's styles and pointers to its data](#) (page 1471)
- [To export survey points to a LandXML file](#) (page 1471)

Overview of Converting and Exporting

You can share all or some of the drawing objects in your map with users of other software programs by exporting to another format. You can print or export attribute data and metadata separately.

When you export DWG objects, geospatial feature data is ignored. However, you can [export a Display Manager layer](#) (page 1469) containing geospatial data to SDF format, or you can use [Bulk Copy](#) (page 615) to convert features from one geospatial format to another. You can also [export to an FDO data format](#) (page 1461), such as Oracle or ArcSDE

When you convert or export your drawing objects to other formats, you can convert or export not only the objects themselves, but also data associated with the objects. In addition, AutoCAD Map 3D can automatically perform a coordinate conversion on the objects as they are converted or exported.

During conversion or export, AutoCAD Map 3D copies objects from the active map to the specified file or location. To convert or export objects from a source DWG file, query those objects into the active map before you begin the export.

Using Saved Settings

If you saved export settings (from Autodesk Map Release 4.5 or later), you can reload those settings.

Selecting Drawing Objects

You can automatically select all drawing objects, or you can manually select the ones you want. In addition, you can export drawing objects on selected layers or in selected classes. You can also export drawing objects from a polygon topology.

The status bar tells you how many objects are currently selected and how many are filtered out. In addition, you can preview the objects that will be exported.

Data

You can export data associated with drawing objects, including object data, block attributes, linked external data, object properties, and topology data. You can also map drawing attributes to feature class properties during export. Choose the data you want on the Data or Feature Class tab of the Export dialog box.

NOTE You cannot export metadata using the Export dialog box. Instead, export metadata from the Metadata Viewer. See [Sharing Metadata](#) (page 1510).

When you export external data, two options are available:

- If the external file format does not support external databases, export the entire record associated with each linked object. The information from the record is attached to the exported object as attribute data.
- If the external file format supports external database files, export only the key field.

Text

DWG text elements are exported as points (using the insertion point of the text). If your text elements are MTEXT objects, and you want to preserve the actual text as well as text properties such as rotation and style, you must specify the data attributes during export. If you then import the resulting file, you will have AutoCAD points with AutoCAD Map 3D object data. You can use the AutoCAD Map 3D ADE Query feature to alter the point objects and display them as text, using the attributes to define the text value, rotation and style.

When you export to SDF or SHP and then connect to the resulting file in Display Manager, you can display the point and label it using any of the attributes that were defined.

Coordinate Conversion

If the active map has a coordinate system assigned to it, you can convert objects from that coordinate system to a different coordinate system.

NOTE The settings specified in the UNITS command do not affect the export process. The UNITS command affects only the way data is displayed; it does not affect the coordinate values stored with the objects themselves.

Styled Objects

For maps saved or exported from the Display Manager, AutoCAD Map 3D saves or exports original object properties regardless of any map stylizations, except for text. Text entities created by text stylizations are saved or exported. To avoid saving or exporting text entities, turn off any text stylization before exporting your data. For more information, see [Overview of the Display Manager](#) (page 634).

You can export styled objects to DWG format. See [Exporting Maps to DWG Format](#) (page 1459).

Tell me more



Video

- [Show me how to export DWG objects to SDF.](#)
- [Show me how to export the current map to DWG format.](#)
- [Show me how to export a layer to SDF](#)
- [Show me how to save a layer to a .layer file.](#)



Procedures

- [To prepare your data for export](#) (page 1408)
- [To export drawing objects to other file formats](#) (page 1408)



Tutorials

- Lesson 1: Convert Drawing Layers to Feature Classes
- Lesson 7: Use Object Classes When Exporting
- Batch Exporting



Workflow

- [Move CAD Data to GIS](#)



GIS Skills

- [Convert styled DWG objects to features.](#)
- [Export DWG objects to a GIS data store \(SDF\).](#)

- *Exchange data with other users by exporting to SDF format.*
- *Share styles with other users of AutoCAD Map 3D using .layer files.*



Related topics

- [Exporting DWG Data to SDF2 Format](#) (page 1417)
- [Exporting DWG Data to an FDO Data Store](#) (page 1461)
- [Migrating DWG Data to GIS](#) (page 628)
- [Mapping Drawing Attributes to Feature Class Properties](#) (page 1452)
- [Converting Data From Other Formats to Drawing Objects](#) (page 377)

To prepare your data for export

- To convert or export objects from source drawings, query those objects into the current map.
- To perform a coordinate transformation during export, be sure that you have assigned a coordinate system to the map.

NOTE When you export from a map, only drawing objects are exported. Geospatial features are ignored. To move geospatial feature data to another format, use [Migrating GIS Data \(Bulk Copy\)](#) (page 617).

To export drawing objects to other file formats

- 1 In the Tool-based Ribbon Workspace, click Output tab ► Map Data

Transfer panel ► Map 3D Export.



NOTE To export to Oracle or ESRI ArcSDE, see [Exporting DWG Data to an FDO Data Store](#) (page 1461).

- 2 In the Export Location dialog box, select the file format and location for the exported files. For information on the file format choices, see [Supported Formats](#) (page 1412). Click OK.

- 3 In the [Export dialog box](#) (page 1704), specify how to export objects. To use settings that you stored previously, click Load and select the profile containing the settings.
- 4 On the Selection tab, specify the objects to export.
 - To select a subset of objects, click Select manually and choose either Select Objects or Quick Select.
 - To filter the selection to export only objects on specific layers or in specific classes, specify the layers and classes to include.
 - To export polygons from a polygon topology, select the topology.
 - To preview the objects that will be exported, click Preview Filtered Selection.
- 5 On the Data or Feature Class tab, click Select Attributes and select the data to export with the objects.

TIP If you are exporting data from an external database, you can export the entire record from the database or just the key fields. Because the key field values are stored in the map, choosing the key field (listed under Link Templates) makes the export faster.

- 6 On the Feature Class or Options tab, select the options you want.
 - To perform a coordinate conversion, you must have a coordinate system [assigned to the map](#) (page 147).
 - Check Treat closed polylines as polygons (if it is available) unless you want only polygon objects to be exported as polygons.
 - To create multiple classes, select Create Multiple Classes Based On A Drawing Object.
If you are exporting to [Oracle](#) (page 1461), [Autodesk SDF](#) (page 1413), or [ESRI ArcSDE](#) (page 1422), see [Exporting to Multiple Classes](#) (page 1439).
If you are exporting to [Shape Multiclass](#) (page 1443), your choices on the Options tab and on the Data tab work together to determine how attributes are assigned to the exported feature classes. See [Exporting To Shape Multiclass](#) (page 1443).
 - If you are exporting to [DGN version 7 or 8](#) (page 1435), select Map Layers To DGN Levels to map each layer in the current map to a level in the DGN drawing. Specify the layers and the corresponding names for the DGN levels. DGN version 7 names can be numbers or strings. For DGN version 8, names must be strings. Closed polylines are always

exported as polygons; they will be shapes in the DGN v8 file. You cannot clear the Treat Closed Polylines as Polygons check box.

- Click Driver Options to set options specific to the export format you specified. For information on driver options, see the following:
 - [Exporting To ESRI Arc/INFO Coverages](#) (page 1419)
 - [Exporting to ESRI SHP](#) (page 1424)
 - [Exporting To Geographic Markup Language \(GML\)](#) (page 1429)
 - [Exporting To MicroStation Design \(DGN\) Versions 7 and 8](#) (page 1435)
 - [Exporting To Shape Multiclass](#) (page 1443)
 - [Exporting To VML \(Vector Markup Language\)](#) (page 1449)

While other formats are supported, they do not have driver options.

7 Click OK to begin the export process.

Quick Reference

MAPEXPORT

Exports drawing objects and their attribute data to an external file format

Menu Click File ► Convert DWG To ► Map 3D Export.

Icon  Export Map File

Command Line MAPEXPORT

Dialog Box Export dialog box

MAPEXPORTFDO

Export to an FDO data store

Menu Click File ► Convert DWG To ► FDO Connection.

Command Line MAPEXPORTFDO

Supported Objects

When you export drawing data to another format, the following object types are exported:

- Arc
- Attribute Definition
- Text
- Block Reference (exports as point)
- Circle
- Ellipse
- Face
- Hatch
- Line
- MLine
- MText
- Point
- Polygon
- Polyline
- 2dPolyline
- 3dPolyline
- Shape
- Solid
- Spline
- Trace
- Xref (exports as point)

Unsupported Object Types

When you export drawing data to another format, the following object types are not exported:

- Attribute
- Body
- Dimension
- Gradient fill for polygon objects (MPolygons)
- Image
- Leader
- OleFrame
- Ole2Frame
- Proxy objects (from other applications)
- Ray
- Region
- Viewport
- Xline

See also:

- [Overview of Converting and Exporting](#) (page 1405)

Supported Formats

When you export drawing data to another format, the following formats are supported:

- [Autodesk SDF \(Spatial Data File\)](#) (page 1413)
- [Autodesk SDF2](#) (page 1417) (MapGuide 6.5 and earlier)
- [ESRI Arc/INFO Coverages](#) (page 1419)
- [ESRI ArcSDE](#) (page 1422)
- [ESRI ShapeFile](#) (page 1424)

- [GML \(Geographic Markup Language\)](#) (page 1429) (version 3.1.1)
- [MapInfo MIF/MID](#) (page 1431)
- [MapInfo TAB](#) (page 1433)
- [MicroStation Design \(DGN\) Versions 7 and 8](#) (page 1435)
- [Shape Multiclass](#) (page 1443)
- [VML \(Vector Markup Language\)](#) (page 1449)
- [Image Formats](#) (page 1465)

See also:

- [Overview of Converting and Exporting](#) (page 1405)
- [Exporting DWG Data to SDF2 Format](#) (page 1417)
- [Exporting DWG Data to an FDO Data Store](#) (page 1461)
- [Exporting Maps to DWG Format](#) (page 1459)

Exporting To Autodesk SDF (Spatial Data File)

SDF is a native Autodesk file-based geospatial format that is optimized for storing large, classified data sets.

SDF is like SHP format in that it contains both spatial data and attribute data. However, unlike SHP, it stores both types of data in a single file rather than a set of files.

When drawing data is stored as SDF, you can use Autodesk MapGuide Enterprise to style and publish the data to the Internet. You can also [publish map data directly to MapGuide](#) (page 1376), without exporting to SDF.

NOTE When you export from a map, only drawing objects are exported. Geospatial features are ignored. To move geospatial feature data to another format, use [Migrating GIS Data \(Bulk Copy\)](#) (page 617).

Versions

The current version, which works with AutoCAD Map 3D and Autodesk MapGuide Enterprise, is SDF version 3. AutoCAD Map 3D refers to this version as “SDF.”

SDF version 2 is still supported by MapGuide 6.5 (and earlier releases), and AutoCAD Map 3D can import and export SDF 2 using a separate import/export interface.

Advantages

SDF has the following advantages over DWG:

- It stores and manages an order of magnitude more data than DWG
- It is very fast, allowing Autodesk applications, such as AutoCAD Map 3D and MapGuide, to read and display tens of thousands of features per second.
- It provides the power of a database without the overhead and cost of a full relational database management system (RDBMS) such as SQL Server or Oracle.
- An SDF file can store a single feature class, or it can store multiple feature classes.
- It is easy to manage, providing access to the database schema.

Exporting

If you export to an existing file, you can choose to overwrite that file or append the new data to it. Overwriting destroys the existing file and creates a new one. Appending adds the data in the current export operation to the existing data without deleting any existing data.

When you append, any existing classes in the target file remain unchanged. New feature classes and new properties for existing feature classes will be added.

If the target file contains properties for which the source file has no values, the resulting file may show those properties as being null or as having default values, depending on what was specified in the schema.

If the source data contains classes that are not in the target file, those classes will be created and will have the properties of the source data.

NOTE An index property is added to each feature class when you export. You can specify the name for this property in the [MapExport.ini file](#) (page 264).

A message reports on the export results. Because some entities belong to multiple feature classes, the number of entities exported may not match the number of SDF entities created. The message tells you how many DWG entities were exported more than once. If you base the exported feature classes on

object data or link templates, an entity may be exported more than once if more than one data table is attached or linked to it.

Driver Options

SDF has no export driver options.

See also:

- [Customizing the Import and Export .ini Files](#) (page 264)

NOTE When you export from a map, only drawing objects are exported. Geospatial features are ignored. To move geospatial feature data to another format, use [Migrating GIS Data \(Bulk Copy\)](#) (page 617).

- [Before moving drawing data to SDF](#) (page 1415)
- [To specify the name for the index property used in export](#) (page 1417)
- [Other ways to move data into SDF format](#) (page 1417)

Before moving drawing data to SDF

- [Clean up any geometry errors.](#) (page 1591)
Use the AutoCAD Map 3D cleanup tools to correct any geometry errors introduced during drafting, digitizing, or converting the data before you export it.
- [Add attribute data to objects](#) (page 1047) or [classify](#) (page 981) the drawing (DWG) objects you are exporting.
If you create object data tables within a map and add attribute information or linked objects to data in an external data source, such as a database, you can export those attributes. If you classify objects, you can use those classes as the basis for your export.
- Decide how to export the data to SDF.
You can export to a single feature class that uses all the items you specified on the Feature Class tab. To do this, click Create a single class from all selected objects and type a name for that class.
You can [export data to multiple classes at one time](#) (page 1439) and combine the data organization in your drawing with your selections on the Feature Class tab to determine the attributes for each exported feature class.

To export drawing objects to SDF

- 1 In the Tool-based Ribbon Workspace, click Output tab ► Map Data

Transfer panel ► Map 3D Export.



- 2 In the Export Location dialog box, select the Autodesk SDF file format and a location for the exported files. Click OK.
- 3 In the [Export dialog box](#) (page 1704), specify how to export objects. To use settings that you stored previously, click Load and select the profile containing the settings.
- 4 On the Selection tab, specify the objects to export.
 - To select a subset of objects, click Select manually and choose either Select Objects or Quick Select.
 - To filter the selection to export only objects on specific layers or in specific classes, specify the layers and classes to include.
 - To export polygons from a polygon topology, select the topology.
 - To preview the objects that will be exported, click Preview Filtered Selection.
- 5 On the Feature Class tab, do the following:
 - To create multiple classes, select Create Multiple Classes Based On A Drawing Object.
See [Exporting to Multiple Classes](#) (page 1439).
 - Click Select Attributes and select the data to export with the objects.

TIP If you are exporting data from an external database, you can export the entire record from the database or just the key fields. Because the key field values are stored in the map, choosing the key field (listed under Link Templates) makes the export faster.

- 6 On the Options tab, select the options you want.
 - To perform a coordinate conversion, you must have a coordinate system [assigned to the map](#) (page 147).
 - Check Treat closed polylines as polygons (if it is available) unless you want only polygon objects to be exported as polygons.
- 7 Click OK to begin the export process.

To specify the name for the index property used in export

- Specify a different name in the [MapExport.ini file](#) (page 264), under the FDO_SDF entry, where you see *Driver:fdo_index_column*.

Other ways to move data into SDF format

- [Export to SDF 2](#) (page 1417) – Imports and exports the data in the previous SDF format to and from DWG. MapGuide versions 6.5 and earlier require this format.
- [Bulk Copy](#) (page 615) – Moves data to and from SDF (version 3) and other geospatial data stores.

Exporting DWG Data to SDF2 Format

Export drawing objects to SDF 2 format to use as a map layer in Autodesk MapGuide version 6.5 and earlier.

NOTE This format is not readable by the current release of Autodesk MapGuide Enterprise or MapGuide Open Source. You can [publish to Autodesk MapGuide Enterprise format](#) (page 1376).

NOTE When you export from a map, only drawing objects are exported. Geospatial features are ignored. To move geospatial feature data to another format, use [Migrating GIS Data \(Bulk Copy\)](#) (page 617).

Along with the objects, you can export data attached to the objects (such as object data, external data, attribute data, or properties) to use for the following SDF fields:

- SDF Name — the popup label
- Key — the link to an external database
- URL — the embedded web link that jumps to another web page

Export only one type of object — point, line, polygon, or annotation — to an SDF file. The associated SIF file is a spatial index format (SIF) file.

Use the coordinate system set in AutoCAD Map 3D or export the file using a different global coordinate system. You can also define your own coordinate system for the translation.

After creating the SDF 2 file, you can use Autodesk MapGuide Author and Autodesk MapGuide Server to produce the files required to create and deliver web-viewable maps.

For information about Autodesk MapGuide SDF and SIF files, refer to the Autodesk MapGuide SDF Loader Help.

See also:

- [Publishing to MapGuide](#) (page 1376)
- [Importing Autodesk SDF \(Spatial Data Files\)](#) (page 387)
- [Overview of Converting and Exporting](#) (page 1405)
- [Importing Autodesk SDF 2](#) (page 389)

NOTE When you export from a map, only drawing objects are exported. Geospatial features are ignored. To move geospatial feature data to another format, use [Migrating GIS Data \(Bulk Copy\)](#) (page 617).

To export DWG data to SDF2 format

- 1 In the Tool-based Ribbon Workspace, click Output tab ► Map Data Transfer panel ► As SDF2. 
- 2 In the Export dialog box, specify a location and file name. Click Save.
- 3 On the Selection tab of the [Autodesk MapGuide Export dialog box](#) (page 1580), under SDF Type, specify the type of data to export:
 - Point — Points and inserts.
 - Line — Lines, arcs (segmented), polylines, and plines with bulges (segmented).
 - Polygon — Closed polylines and circles.
 - Annotation — Text and mtext (mtext exports a single point object).
- 4 On the Selection tab, specify how to select objects for the export.
- 5 On the Options tab, under SDF Description, type a description for the SDF file to which you are exporting data.

- 6 Under Data Expressions, you can create expressions as follows:
 - Use the Key option to define an expression to act as the link between the SDF file and a field in an external database.
 - Use the Name option to define an expression for the SDF Name field.
 - Use the URL option to define an expression to act as a URL (Uniform Resource Locator).

To create an expression using data attached to the object, such as object data, external data, attribute data, or property values, click... to select from a list of available data and properties.

NOTE When exporting a map to SDF format, if you use an expression that references a SQL value, the export process will require a large amount of swap space. It may be necessary to partition your data into smaller sections.

- 7 Under Coordinate Conversion, select Convert To. To specify a coordinate conversion as part of the file export, enter the coordinate system code.
- 8 Under Other, select Create Key Index File (KIF) to create a KIF file along with the SDF file.
- 9 To save your settings as a profile, click Save.
- 10 Click OK to begin exporting the data.

Quick Reference

MAP2SDF

Exports an SDF 2 format file for use with Autodesk MapGuide, versions 6.5 and earlier.

Menu	Click File ► Convert DWG To ► Autodesk SDF2 (MapGuide6.x...).
Command Line	MAP2SDF
Dialog Box	Autodesk MapGuide Export dialog box

Exporting To ESRI Arc/INFO Coverages

AutoCAD Map 3D supports Arc/INFO version 7.2, 7.3, and 8.x, and E00.

NOTE When you export from a map, only drawing objects are exported. Geospatial features are ignored. To move geospatial feature data to another format, use [Migrating GIS Data \(Bulk Copy\)](#) (page 617).

ESRI Arc/INFO stores coverages on your hard disk as a directory of files. The main coverage directory, called the workspace, always includes one subdirectory called INFO. Each coverage is written to its own subdirectory. If you do not have a coverage workspace on your computer, AutoCAD Map 3D creates one for you when you export to an ARC/INFO coverage.

Arc/INFO uses elevation values but they are stored in the coverage as a field in the attribute table. Select the Elevation property to export elevation.

When exporting, the exported file is stored in memory before it is written to the file. If you run into problems exporting a large drawing, increase the size of your virtual memory.

PC coverages are single precision. UNIX coverages can be single or double precision. AutoCAD Map 3D always exports double-precision coverages, although it does import single- or double-precision coverages.

Map objects such as arcs, splines, and circles are segmented in the coverage. You can change the settings used for segmentation by editing the *mapimport.ini* file.

Exporting Restrictions

When specifying a coverage name, use fewer than 14 characters and do not use periods in the name. If you use double-byte characters, you can use 6 or fewer characters.

If you specify a directory name that already exists and it contains a log or text file, those files may be overwritten.

Arc/INFO also supports a transfer format called E00 which writes all information out to a single file, which can become quite large.

When exporting text or mtext to Arc/Info Coverages, the resulting objects in the Coverage data are annotation. AutoCAD Map 3D does not support attribute data for annotation. As a result any data linked to text objects will be lost during the export process. The text value itself will be maintained.

Driver Options

When exporting to E00 or coverage format, you can set the following options:

Option	Description
Coverage Precision	Select Double or Single. The default is Double.
Compression (available only for E00)	Select None, Partial, or Full.
Linear Topology	Select Create or Bypass. The default is Create.

See also:

- [Customizing the Import and Export .ini Files](#) (page 264)

NOTE When you export from a map, only drawing objects are exported. Geospatial features are ignored. To move geospatial feature data to another format, use [Migrating GIS Data \(Bulk Copy\)](#) (page 617).

- [To change the settings used for segmentation](#) (page 1427)
- [To export drawing objects to ESRI Arc/INFO](#) (page 1421)

To change the settings AutoCAD Map 3D uses for segmentation

- Edit the *mapexport.ini* file.
See [To edit the .ini file](#) (page 269).

To export drawing objects to ESRI Arc/INFO

- 1 In the Tool-based Ribbon Workspace, click Output tab ► Map Data



Transfer panel ► Map 3D Export.

- 2 In the Export Location dialog box, select the ESRI ArcInfo Coverage or ESRI ArcInfo (E00) Export file format and a location for the exported files.
- 3 In the [Export dialog box](#) (page 1704), specify how to export objects. To use settings that you stored previously, click Load and select the profile containing the settings.
- 4 On the Selection tab, specify the objects to export.
 - To select a subset of objects, click Select manually and choose either Select Objects or Quick Select.

- To filter the selection to export only objects on specific layers or in specific classes, specify the layers and classes to include.
 - To export polygons from a polygon topology, select the topology.
 - To preview the objects that will be exported, click Preview Filtered Selection.
- 5 On the Data or Feature Class tab, click Select Attributes and select the data to export with the objects.
-
- TIP** If you are exporting data from an external database, you can export the entire record from the database or just the key fields. Because the key field values are stored in the map, choosing the key field (listed under Link Templates) makes the export faster.
-
- 6 On the Options tab, select the options you want.
- To perform a coordinate conversion, you must have a coordinate system [assigned to the map](#) (page 147).
 - Check Treat closed polylines as polygons (if it is available) unless you want only polygon objects to be exported as polygons.
 - Click Driver Options to set the options described on the Concept tab for this topic.
- 7 Click OK to begin the export process.

Exporting to ESRI ArcSDE

You can export data from your DWG to a connected ESRI ArcSDE database.

NOTE When you export from a map, only drawing objects are exported. Geospatial features are ignored. To move geospatial feature data to another format, use [Migrating GIS Data \(Bulk Copy\)](#) (page 617).

Exporting

You cannot append data to an ESRI ArcSDE data store when exporting from AutoCAD Map 3D. You must map your DWG data to the existing database schemas.

Driver Options

ESRI ArcSDE has no export driver options.

See also:

- [Bringing In Features from ArcSDE](#) (page 316)

To export DWG data to ESRI ArcSDE:

- 1 Query the data you want from the DWG drawing into your map.
- 2 [Connect to the ESRI ArcSDE data store](#) (page 316) to which you want to move the data.
- 3 Before moving drawing data to ESRI ArcSDE, do the following to your DWG drawing objects:
 - [Assign a coordinate system](#) (page 142). This lets you position your data accurately in a real-world geographic location and align imported survey or GPS point data. Once you assign a coordinate system, you can convert to a different system when you export.
 - [Clean up any geometry errors](#) (page 765). Use the AutoCAD Map 3D cleanup tools to correct any errors introduced during drafting, digitizing, or converting the data.
- 4 In the Tool-based Ribbon Workspace, click Output tab ► Map Data



Transfer panel ► To FDO Connection.

- 5 In the dialog box that appears, choose the data source for the export and click OK.
- 6 On the Selection tab of the [Map Export dialog box](#) (page 1723), specify which objects to export.

This tab determines how items are selected for export, and not how they are organized in their exported form. You specify how to organize the exported material on the Feature Class tab.
- 7 On the Feature Class tab, specify which object properties and attributes to export to feature class attributes. Note that you cannot create or modify ArcSDE schemas. You can only map object properties and attributes to existing feature class attributes.

All attributes you specify here are included in all the resulting features you export to ESRI ArcSDE. For information on how the choices on this tab determine the properties of the exported feature class, see [Exporting to Multiple Classes](#) (page 1439).

- 8 On the [Options tab](#) (page 1704), specify whether to convert the coordinate system during the export process and choose the coordinate system. Specify whether to treat closed polylines as polygons when you export.
- 9 Click Save.

Exporting to ESRI SHP

AutoCAD Map 3D supports up to ArcView version 3.2 and 8.x.

NOTE When you export from a map, only drawing objects are exported. Geospatial features are ignored. To move geospatial feature data to another format, use [Migrating GIS Data \(Bulk Copy\)](#) (page 617).

About SHP Files

ESRI SHP files store both geometry and attributes (data) for features. A single shape can have as many as five physical files with the same filename, but different file extensions:

- *.shp*— Geometric data. Data for multiple points, polylines, and polygons can be stored in one SHP file, but each SHP file can store only one type of geometry. For example, a line SHP file can contain data for rivers, roads, and pipes.
- *.shx* — A geometric index to the map features, which can be used by some applications to find features in disparate sections of a large map.
- *.dbf*— Attribute data associated with the map features.
- *.prj*—Projection and coordinate system data. This file is created only if your map has an assigned coordinate system.
- *.idx*—Identifies the index field for the related SHP file, which is the unique identifier for each entity in the SHP file.

Exporting

DWG files can contain multiple geometry types, while SHP files contain only one. Each ESRI SHP file stores a single type of spatial data: point, line, text, or polygon. The text SHP files contain attribute text associated with points.

When you create a multi-polygon in AutoCAD Map 3D and then export it to SHP format, it will appear in its native SHP file as a multi-polygon (a polygon with multiple exterior rings).

When you export, AutoCAD Map 3D automatically filters the selected objects and exports the correct type of object to the corresponding SHP file. The filenames produced by the export operation use the name of the feature class followed by the geometry type, for example, PARCELS_POLYGON.SHP.

NOTE You cannot name a SHP feature class `FeatId`. This is a reserved name.

Export Options

You can export a single object to a single file, or you can export multiple objects to a set of files. There are two methods for multi-file export.

- The single-file option
Unless you have modified the *MapExport.ini* file, choosing ESRI Shapefile from the drop-down list in the Export dialog box exports a single geometry type to a single SHP file. You specify the geometry type on the Selection tab of the Export dialog box.
- The *MapExport.ini* folder export option.
You can [modify the initialization file](#) (page 269) to include all object types when exporting drawing objects to ESRI SHP format. This will remove the object type options and display File Name Prefix field on the Options tab of the Export dialog box, which lets you create a folder of SHP files using this prefix, appended by each object type name.

This method is effective when you export all the geometry from a DWG file and visual fidelity is more important than the preservation of classes and attributes.

All objects of the same geometry type will be grouped in a single SHP. For example, if pipes, roads, and streams are all represented by lines, you will export one SHP containing the geometry and attributes for all three object types. If streams have attributes that are not shared by pipes, those attributes will have null values for pipes.

To create polygons in the SHP files using the folder option, you must select the Treat Closed Polylines As Polygons option. To export closed polylines as lines, select the Line object type. To export closed polylines as polygons,

select the Polygon object type and select Treat Closed Polylines As Polygons on the Options tab.

All new SHP classes that contain text entities will have a property called TEXTSTRING. To bring this information back into AutoCAD Map 3D, select the import option to import points as text.

- The [Shape Multiclass](#) (page 1443) export option.

This is a separate option on the drop-down list in the Export dialog box that exports multiple drawing objects to a set of SHP files in a folder you specify. Each resulting SHP contains the geometry and attributes for a single geometry type, and is stored in files that indicate that type, for example, PARCELS_POLYGON.SHP.

You can specify that the resulting files use a single feature class or multiple feature classes based on layer, object classification, object data, or link templates.

You can also export object data or external database links to the corresponding SHP database (DBF) file.

Export Restrictions

SHP files do not support color; in ArcView, each theme is assigned a color that is used when an item is drawn.

SHP files do not support circular arcs. During export, arcs, splines, and ellipses are converted to segmented polylines. You can change the settings used for segmentation.

Overwriting or Appending

If you export to an existing file, or to a folder containing files with the same names as those that will be generated by the export, you can choose to overwrite the existing data or append the new data to it. Overwriting can destroy existing files when it creates new ones. Appending adds the data in the current export operation to the existing data without deleting any existing data.

If you append and you are transforming the coordinate system for the data, the old data and the new data must both use the same source and target coordinate systems.

You cannot use the append option to update existing data, but only to add new data.

If you are using either the folder or the multi-file Shape option and you choose to append, AutoCAD Map 3D checks the target folder for existing files that

use the same feature class name, even if those files do not have the appropriate geometry indicator in their file names. For example, exporting parcels would usually result in a file called PARCELS_POLYGON.SHP. However, if the folder contains PARCELS.SHP, AutoCAD Map 3D checks its geometry type and appends to it if it contains polygon information.

NOTE If your data meets these criteria but the export operation fails, try deleting the .prj file in the target folder and then retrying the export operation.

Driver Options

When exporting to SHP, you can select two Dimension Shape Files or three Dimension Shape Files from the driver options.

See also:

- [Customizing the Import and Export .ini Files](#) (page 264)

NOTE When you export from a map, only drawing objects are exported. Geospatial features are ignored. To move geospatial feature data to another format, use [Migrating GIS Data \(Bulk Copy\)](#) (page 617).

- [To include all object types when exporting drawing objects to ESRI SHP format](#) (page 1427)
- [To change the settings AutoCAD Map 3D uses for segmentation](#) (page 1427)
- [To export drawing objects to SHP](#) (page 1428)

To include all object types when exporting drawing objects to ESRI SHP format

- 1 [Modify the initialization file](#), (page 269) *MapExport.ini*.
This removes the object type options and display File Name Prefix field on the Options tab of the Export dialog box.
- 2 Choose the ESRI Shapefile file option from the drop-down list in the Export dialog box to export to a folder of files.

To change the settings AutoCAD Map 3D uses for segmentation

- Edit the *mapexport.ini* file.
See [To edit the .ini file](#) (page 269).

To export drawing objects to SHP

NOTE If you are exporting multiple feature classes, see [Exporting To Shape Multiclass](#) (page 1443).

- 1 In the Tool-based Ribbon Workspace, click Output tab ► Map Data

Transfer panel ► Map 3D Export.



- 2 In the Export Location dialog box, select the ESRI Shapefile format and a location for the exported files. Click OK.
- 3 In the [Export dialog box](#) (page 1704), specify how to export objects. To use settings that you stored previously, click Load and select the profile containing the settings.
- 4 On the Selection tab, specify the objects to export.
 - To select a subset of objects, click Select manually and choose either Select Objects or Quick Select.
 - To filter the selection to export only objects on specific layers or in specific classes, specify the layers and classes to include.
 - To export polygons from a polygon topology, select the topology.
 - To preview the objects that will be exported, click Preview Filtered Selection.
- 5 On the Data tab, click Select Attributes and select the data to export with the objects.

TIP If you are exporting data from an external database, you can export the entire record from the database or just the key fields. Because the key field values are stored in the map, choosing the key field (listed under Link Templates) makes the export faster.

- 6 On the Options tab, select the options you want.
 - To perform a coordinate conversion, you must have a coordinate system [assigned to the map](#) (page 147).
 - Check Treat closed polylines as polygons (if it is available) unless you want only polygon objects to be exported as polygons.
 - Click Driver Options to select Two Dimension Shape Files or Three Dimension Shape Files.

- 7 Click OK to begin the export process.

Exporting To Geographic Markup Language (GML)

GML (Geography Markup Language) is an OpenGIS® Implementation specification that defines an XML encoding for the transport and storage of geographic information. The specification can be found on the *Open GIS Consortium web site*.

You can import and export GML in and out of AutoCAD Map 3D.

NOTE When you export from a map, only drawing objects are exported. Geospatial features are ignored. To move geospatial feature data to another format, use [Migrating GIS Data \(Bulk Copy\)](#) (page 617).

Exporting

You can export GML version 3.1.1 files.

If you are exporting GML data in Asian languages, verify that *mapexport.ini* contains the language encoding settings you need to export valid GML data in the desired language.

Driver Options

GML has no export driver options.

See also:

- [Customizing the Import and Export .ini Files](#) (page 264)

NOTE When you export from a map, only drawing objects are exported. Geospatial features are ignored. To move geospatial feature data to another format, use [Migrating GIS Data \(Bulk Copy\)](#) (page 617).

- [To verify language encoding settings for export to GML](#) (page 1429)
- [To export drawing objects to GML](#) (page 1430)

To verify language encoding settings for export to GML

- Make sure the language encoding settings in the *mapexport.ini* file export valid GML data in the desired language.

For more information, see [Customizing the Import and Export .ini Files](#) (page 264).

To export drawing objects to GML

- 1 In the Tool-based Ribbon Workspace, click Output tab ► Map Data

Transfer panel ► Map 3D Export. 

- 2 In the Export Location dialog box, select the GML (Geography Markup Language) file format and a location for the exported files.
- 3 In the [Export dialog box](#) (page 1704), specify how to export objects. To use settings that you stored previously, click Load and select the profile containing the settings.
- 4 On the Selection tab, specify the objects to export.
 - To select a subset of objects, click Select manually and choose either Select Objects or Quick Select.
 - To filter the selection to export only objects on specific layers or in specific classes, specify the layers and classes to include.
 - To export polygons from a polygon topology, select the topology.
 - To preview the objects that will be exported, click Preview Filtered Selection.
- 5 On the Data tab, click Select Attributes and select the data to export with the objects.

TIP If you are exporting data from an external database, you can export the entire record from the database or just the key fields. Because the key field values are stored in the map, choosing the key field (listed under Link Templates) makes the export faster.

- 6 On the Options tab, select the options you want.
 - To perform a coordinate conversion, you must have a coordinate system [assigned to the map](#) (page 147).
 - Check Treat closed polylines as polygons (if it is available) unless you want only polygon objects to be exported as polygons.
- 7 Click OK to begin the export process.

Exporting To MapInfo MIF/MID

MIF/MID is a file standard used by MapInfo, a desktop mapping system. AutoCAD Map 3D supports MapInfo up to version 7 MIF/MID files.

NOTE When you export from a map, only drawing objects are exported. Geospatial features are ignored. To move geospatial feature data to another format, use [Migrating GIS Data \(Bulk Copy\)](#) (page 617).

About MapInfo MIF/MID Files

MapInfo MIF/MID format stores both geometry and attributes (data) for features, and is a set of two physical files that work together:

- *.mif*— Vector geometric data. A single *.mif* file can contain many different types of geometry.
- *.mid*— Attributes for the geometric data.

Exporting

The MIF/MID format does not support ellipses with an angled bounding box (for example, ellipses whose axes are at an angle to the X and Y axes), so when you export such ellipses from AutoCAD Map 3D to MIF/MID, they are segmented. To change the settings AutoCAD Map 3D uses for segmentation, edit the *mapexport.ini* file.

Driver Options

MapInfo MIF/MID has no export driver options.

See also:

- [Customizing the Import and Export .ini Files](#) (page 264)

NOTE When you export from a map, only drawing objects are exported. Geospatial features are ignored. To move geospatial feature data to another format, use [Migrating GIS Data \(Bulk Copy\)](#) (page 617).

- [To change the settings AutoCAD Map 3D uses for segmentation](#) (page 1432)
- [To export drawing objects to MapInfo](#) (page 1432)

To change the settings AutoCAD Map 3D uses for segmentation

- Edit the *mapexport.ini* file.
See [To edit the .ini file](#) (page 269).

To export drawing objects to MapInfo

- 1 In the Tool-based Ribbon Workspace, click Output tab ► Map Data

Transfer panel ► Map 3D Export. 

- 2 In the Export Location dialog box, select the MapInfo MIF/MID file format and a location for the exported files.
- 3 In the [Export dialog box](#) (page 1704), specify how to export objects. To use settings that you stored previously, click Load and select the profile containing the settings.
- 4 On the Selection tab, specify the objects to export.
 - To select a subset of objects, click Select manually and choose either Select Objects or Quick Select.
 - To filter the selection to export only objects on specific layers or in specific classes, specify the layers and classes to include.
 - To export polygons from a polygon topology, select the topology.
 - To preview the objects that will be exported, click Preview Filtered Selection.
- 5 On the Data tab, click Select Attributes and select the data to export with the objects.

TIP If you are exporting data from an external database, you can export the entire record from the database or just the key fields. Because the key field values are stored in the map, choosing the key field (listed under Link Templates) makes the export faster.

- 6 On the Options tab, select the options you want.
 - To perform a coordinate conversion, you must have a coordinate system [assigned to the map](#) (page 147).
 - Check Treat closed polylines as polygons (if it is available) unless you want only polygon objects to be exported as polygons.

- 7 Click OK to begin the export process.

Exporting To MapInfo TAB

MapInfo TAB, also referred to as the MapInfo native format, is a two-dimensional format that stores both feature geometry and attributes (data) in a set of physical files that have the following file extensions:

NOTE When you export from a map, only drawing objects are exported. Geospatial features are ignored. To move geospatial feature data to another format, use [Migrating GIS Data \(Bulk Copy\)](#) (page 617).

About MapInfo TAB Files

- *.tab*— The main file for a MapInfo table. It is associated with the appropriate *.dat*, *.id*, *.map*, and *.ind* files.
- *.dat*— Tabular data for a table in the MapInfo native format.
- *.id*— An index to a MapInfo graphical objects (*.map*) file.
- *.map*— Contains geographic information describing map objects.
- *.ind*— An index to a MapInfo tabular (*.dat*) file.

With AutoCAD Map 3D, you can import and export MapInfo TAB up to version 7.

Exporting

The TAB format does not support ellipses with an angled bounding box (for example, ellipses whose axes are at an angle to the X and Y axes), so when you export ellipses from AutoCAD Map 3D to TAB, they are segmented. You can change the settings AutoCAD Map 3D uses for segmentation in the *mapexport.ini* file.

Driver Options

MapInfo TAB has no export driver options.

See also:

- [Customizing the Import and Export .ini Files](#) (page 264)

NOTE When you export from a map, only drawing objects are exported. Geospatial features are ignored. To move geospatial feature data to another format, use [Migrating GIS Data \(Bulk Copy\)](#) (page 617).

- [To change the default text justification setting for MapInfo TAB](#) (page 404)
- [To export drawing objects to MapInfo TAB](#) (page 1434)

To change the settings AutoCAD Map 3D uses for segmentation

- Edit the *mapexport.ini* file.
See [To edit the .ini file](#) (page 269).

To export drawing objects to MapInfo TAB

- 1 In the Tool-based Ribbon Workspace, click Output tab ► Map Data

Transfer panel ► Map 3D Export. 
- 2 In the Export Location dialog box, select the MapInfo TAB file format and a location for the exported files.
- 3 In the [Export dialog box](#) (page 1704), specify how to export objects. To use settings that you stored previously, click Load and select the profile containing the settings.
- 4 On the Selection tab, specify the objects to export.
 - To select a subset of objects, click Select manually and choose either Select Objects or Quick Select.
 - To filter the selection to export only objects on specific layers or in specific classes, specify the layers and classes to include.
 - To export polygons from a polygon topology, select the topology.
 - To preview the objects that will be exported, click Preview Filtered Selection.
- 5 On the Data tab, click Select Attributes and select the data to export with the objects.

TIP If you are exporting data from an external database, you can export the entire record from the database or just the key fields. Because the key field values are stored in the map, choosing the key field (listed under Link Templates) makes the export faster.

- 6 On the Options tab, select the options you want.
 - To perform a coordinate conversion, you must have a coordinate system [assigned to the map](#) (page 147).
 - Check Treat closed polylines as polygons (if it is available) unless you want only polygon objects to be exported as polygons.
- 7 Click OK to begin the export process.

Exporting To MicroStation Design (DGN) Versions 7 and 8

You can import and export Microstation DGN version 7 and 8. Bentley Systems, Inc., and MicroStation programs use the DGN format, which is like a DWG file; points, lines, areas, text, and other object types can all be present in the same file.

NOTE When you export from a map, only drawing objects are exported. Geospatial features are ignored. To move geospatial feature data to another format, use [Migrating GIS Data \(Bulk Copy\)](#) (page 617).

Exporting

There are two separate choices for Microstation DGN (version 7 and version 8) in the Export dialog box. You can map layers in the map to DGN levels when you export. The default is to map layers to level names using the same name as the layer.

Geometry in DGN 7 files is stored in fixed-point integers. When you export map data with large coordinate values, you can overflow these values with unpredictable results. The seed file you use for export has a dramatic effect on the resulting DGN data.

Every DGN file requires a seed file to give it default information (like the acad.dwg prototype or template file). The seed file controls working units, global origin, the version to export, and so on. Several seed files ship with AutoCAD Map 3D.

The default for a version 7 DGN file is lrgseed.dgn. The default for a version 8 DGN file is lrgseed3d_v8.dgn. Both of these are three-dimensional seed files.

To export to a two-dimensional DGN file, or to set a specific global origin or specific working units, reference the file name of the desired seed file. The global origin and units of resolution should be set in a seed file that is appropriate to your AutoCAD Map 3D drawing coordinates.

The seed file you use significantly affects the outcome of the export process. If the design plane coordinate bounds in the seed file do not fully contain the extents of the AutoCAD Map 3D drawing, AutoCAD Map 3D repeats the export operation automatically using the Compute Optimal Seed File option. If the second export operation fails, manually choose a seed file that works for your region and coordinate system.

Export Restrictions

Closed objects are not filled, even if they were filled originally.

Hatch patterns are not exported. If you export polygon data that is hatched in AutoCAD Map 3D, the resulting data is not filled in MicroStation.

Driver Options for DGN 7

You can set the following options when exporting DGN 7 files:

Option	Description
Coordinate Units	Select the coordinate units of the features: Master or Sub. Select the unit that matches the default unit in your AutoCAD Map 3D drawing. For example, if the default unit in your AutoCAD Map 3D drawing is meters, and you are using a seed file that defines meters as the Master unit, then select Master. The default is the Master unit.
Seed File	Select the seed file, which controls whether or not the output DGN file is two-dimensional or three-dimensional, sets the coordinate units, sets global origin, and so on. You must use a version 7 DGN seed file.
Compute Parameters	Select this option to override all seed file settings and have AutoCAD Map 3D calculate the settings for you. AutoCAD Map 3D determines the largest dimension for the set of exported objects and sets the appropriate range and precision. It sets the UOR per Sub to 10, and sets the Global Origin to the center of the bounding rectangle of the exported objects.
Override Global Origin	Select this option to override the global origin setting in the seed file. Specify the global origin to use.

Driver Options for DGN 8

You can set the following options when exporting DGN 8 files:

Option	Description
Coordinate Units	Select the coordinate units of the features: Master or Sub. Select the unit that matches the default unit in your AutoCAD Map 3D drawing. For example, if the default unit in your AutoCAD Map 3D drawing is meters, and you are using a seed file that defines meters as the Master unit, then select Master. The default is the Master unit.
Seed File	Select the seed file, which controls whether or not the output DGN file is two-dimensional or three-dimensional, sets the coordinate units, sets global origin, and so on.

See also:

- [Customizing the Import and Export .ini Files](#) (page 264)
- [Importing Objects with Links to an External Database](#) (page 433)

NOTE When you export from a map, only drawing objects are exported. Geospatial features are ignored. To move geospatial feature data to another format, use [Migrating GIS Data \(Bulk Copy\)](#) (page 617).

- [To change the seed file for a single file](#) (page 1437)
- [To change the default seed file](#) (page 1438)
- [To export drawing objects to MicroStation Design \(DGN\)](#) (page 1438)

To change the seed file for a single file

- 1 In the Export dialog box, click the Options tab.
- 2 Click Driver Options.
- 3 In the [Design File Output Settings](#) (page 1736), under Seed File, click  .

NOTE If you are a limited rights user, be sure that the seed file is in a location where you have access to it.

- 4 In the Select Seed File dialog box, navigate to the location of the seed file to use and select the file.

NOTE Be sure to specify a seed file designed for the version of DGN you specified in the Export Location dialog box. You cannot use a DGN version 8 seed file when exporting to DGN version 7.

- 5 Click Open.

To change the *default* seed file

- 1 Open the *mapexport.ini* file using a text editor such as WordPad.
This file is in the *C:\Documents and Settings\All Users\Application Data\Autodesk\AutoCAD Map 3D\R17.2* folder.
- 2 Find the section labeled [DGN_V7] or [DGN_V8]. This is where the default seed file is specified.
- 3 Specify the new default seed file.
For example: `Driver:RUNTIME_MACROS=_SEED,"C:\Program Files\Common Files\Autodesk Shared\GIS\ImportExport\4.0\design\seed3d_ft.dgn"`.
- 4 Save and close the .ini file.

To export drawing objects to MicroStation Design (DGN)

- 1 In the Tool-based Ribbon Workspace, click Output tab ► Map Data
Transfer panel ► Map 3D Export. 
- 2 In the Export Location dialog box, select the MicroStation File V7 or V8 file format and a location for the exported files.
- 3 In the [Export dialog box](#) (page 1704), specify how to export objects. To use settings that you stored previously, click Load and select the profile containing the settings.
- 4 On the Selection tab, specify the objects to export.
 - To select a subset of objects, click Select manually and choose either Select Objects or Quick Select.
 - To filter the selection to export only objects on specific layers or in specific classes, specify the layers and classes to include.

- To export polygons from a polygon topology, select the topology.
 - To preview the objects that will be exported, click Preview Filtered Selection.
- 5 On the Data or Feature Class tab, click Select Attributes and select the data to export with the objects.

TIP If you are exporting data from an external database, you can export the entire record from the database or just the key fields. Because the key field values are stored in the map, choosing the key field (listed under Link Templates) makes the export faster.

- 6 On the Options tab, select the options you want.
- To perform a coordinate conversion, you must have a coordinate system [assigned to the map](#) (page 147).
 - Check Treat closed polylines as polygons (if it is available) unless you want only polygon objects to be exported as polygons.
 - Select Map Layers To DGN Levels to map each layer in the current map to a level in the DGN drawing. Specify the layers and the corresponding names for the DGN levels. DGN version 7 names can be numbers or strings. For DGN version 8, names must be strings. Closed polylines are always exported as polygons; they will be shapes in the DGN v8 file. You cannot clear the Treat Closed Polylines as Polygons check box.
 - Click Driver Options to set the options described on the Concept tab of this dialog box.
- 7 Click OK to begin the export process.

Exporting to Multiple Classes

You can export selected data to multiple feature classes during one export operation for the following formats:

- [Autodesk SDF](#) (page 1413)
- [Oracle](#) (page 1461)
- [ESRI ArcSDE](#) (page 1422)

- [SQLite](#) (page 1447)

NOTE When you export from a map, only drawing objects are exported. Geospatial features are ignored. To move geospatial feature data to another format, use [Migrating GIS Data \(Bulk Copy\)](#) (page 617).

Using the Feature Class Tab on the Export Dialog Box

Use the Feature Class tab for attributes that should be associated with all output feature classes. For example, suppose you have created three sets of objects: each set contains water lines, electrical lines, and sewer lines, but you have color-coded them to represent different maintenance dates. You can select objects based on color, and export them to multiple feature classes (water, electrical, and sewer). You can select an attribute on the Feature Class tab (maintenance date, for example), and apply it to all three feature classes when you export them.

However, if the objects you are exporting already have associated attributes, it may be best if you do not select any attributes on the Feature Class tab.

See also:

- [Overview of Converting and Exporting](#) (page 1405)
- [Exporting DWG Data to an FDO Data Store](#) (page 1461)

NOTE When you export from a map, only drawing objects are exported. Geospatial features are ignored. To move geospatial feature data to another format, use [Migrating GIS Data \(Bulk Copy\)](#) (page 617).

- [To export multiple feature classes](#) (page 1440)
- [To combine multiple layers into one feature class](#) (page 1442)
- [To change the class names that are assigned automatically](#) (page 1442)

To export multiple feature classes

- 1 Click Create multiple classes based on a drawing property on the Feature Class tab of the [Export dialog box](#) (page 1405).
- 2 Specify the basis for the target feature classes by selecting an item from the Drawing Object To Use list.
For example, select Layers or Object Data.

Only the methods relevant to your map are listed. For example, if you did not classify objects in the map, you will not see the Object Classification option.

The classification method you choose determines the resulting feature class attributes, as shown in the following table:

Multiple class export classification method	Output	Select Attributes Dialog Box settings	End result
Layers	A feature class for each exported layer	Nothing selected	No attributes in the output feature classes
Layers	A feature class for each exported layer	Attributes selected	All feature classes contain all attributes that were selected in the Select Attributes dialog box.
Object Data (page 198) or Link Templates (page 522)	A feature class for each object associated with an object data table or link template.	Nothing selected	Output feature classes inherit their attributes from the Object Data table or Link Template definitions.
Object data or link templates	A feature class for each object associated with an object data table or link template.	Attributes selected	Output feature classes inherit their attributes from the Object Data table or Link Template definitions AND all attributes selected in the Select Attributes dialog box are also assigned to all output feature classes.
Object class (page 116)	A feature class for each exported object class.	Nothing selected	Output feature classes inherit their attributes from the object class.
Object class	A feature class for each exported object class.	Attributes selected	Output feature classes inherit their attributes from the Object Class AND all attributes selected in the Select Attributes

Multiple class export classification method	Output	Select Attributes Dialog Box settings	End result
			dialog box are also assigned to all output feature classes.

The grid automatically fills with the drawing objects and the names of the feature classes to which they will be mapped. To remove any object from the list, deselect its check box.

- 3 To change the name of the target feature class for an object, click in its Feature Class cell. Select the existing name and enter a new one.
- 4 To change the properties for the feature class, click in its Feature Class cell and then click  within the cell. In the [Feature Class Property Mapping dialog box](#) (page 1727), click Select Attributes to display the [Select Attributes dialog box](#) (page 1729), where you can select the attributes to map to the feature class.
- 5 If you select .COLOR, .LINEWEIGHT, or .LINETYPE, specify the data type for the target feature class property by clicking in the Drawing Attributes cell. In the [New Property Data Type dialog box](#) (page 1726), select a data type.

To combine multiple layers into one feature class

- 1 On the Feature Class tab of the [Export dialog box](#) (page 1405), select Create a single class from all selected objects.
- 2 In the Feature Class column, give the new feature class an appropriate name.
For example, if your DWG file has three layers called text_City, text_County, and text_Region, you can name the combined feature class "Text" in the Feature Class column.

To change the class names that are assigned automatically

- 1 Click the Feature Class field.
- 2 Edit the proposed class names as needed.
- 3 Click OK.

Exporting To Shape Multiclass

Drawing (DWG) objects can contain multiple geometry types, while SHP files contain only one. However, the Shape Multiclass option lets you export multiple drawing objects to a set of SHP files in a folder you specify. Each resulting SHP will contain the geometry and attributes for a single geometry type. For example, if pipes, roads, and streams are all represented by lines, you will export three sets of SHP files, each one containing the geometry and attributes for one of those object types. For information about the set of files produced for SHP and their naming conventions, see [Importing ESRI Shape Files](#) (page 397).

NOTE There is also an [MapExport.ini folder](#) (page 397) export option.

NOTE When you export from a map, only drawing objects are exported. Geospatial features are ignored. To move geospatial feature data to another format, use [Migrating GIS Data \(Bulk Copy\)](#) (page 617).

Exporting

You can specify that the resulting files use a single feature class or multiple feature classes based on layer, object classification, object data, or link templates.

All new SHP classes that contain text entities will have a property called TEXTSTRING. To bring this information back into AutoCAD Map 3D, select the import option to import points as text.

To create polygons when you use this export option, select the Treat Closed Polylines As Polygons option. When you create a multi-polygon in AutoCAD Map 3D and then save or export it to SHP format, it will appear in its native SHP file as a multi-polygon (a polygon with multiple exterior rings).

You can export to a single feature class that uses all the items you specified on the Data tab. To do this, click One class and type a name for that class.

You can [export data to multiple classes at one time](#) (page 1439) and combine the data organization in your drawing with your selections on the Data tab to determine the attributes for each exported feature class.

Export Restrictions

SHP files do not support color; in ArcView, each theme is assigned a color that is used when an item is drawn.

SHP files do not support circular arcs. During export, arcs, splines, and ellipses are converted to segmented polylines. You can change the settings used for segmentation in the *mapexport.ini* file.

You cannot map fields when you export to Shape Multiclass. If you need to map fields, export your DWG data to SDF first, and then use [Migrating Data](#) (page 615) Bulk Copy to export the data to SHP.

Overwriting and Appending

If you export to an existing folder containing files with the same names as those that will be generated by the export, you can choose to overwrite the existing data or append the new data to it. Overwriting can destroy the existing files when it creates new ones. Appending adds the data in the current export operation to the existing data without deleting any existing data. If you append and you are transforming the coordinate system for the data, the old data and the new data must both use the same source and target coordinate systems. You cannot use the append option to update existing data, but only to add new data.

NOTE If your data meets these criteria but the export operation fails, try deleting the relevant .prj files in the target folder and then retry the export operation.

Driver Options

When exporting to SHP files, you can select 2 Dimension Shape Files or 3 Dimension Shape Files from the driver options.

See also:

- [Customizing the Import and Export .ini Files](#) (page 264)
- [Importing ESRI Shape Files](#) (page 397)

NOTE When you export from a map, only drawing objects are exported. Geospatial features are ignored. To move geospatial feature data to another format, use [Migrating GIS Data \(Bulk Copy\)](#) (page 617).

- [To change the settings used for segmentation](#) (page 1445)
- [To export drawing objects to Shape Multiclass](#) (page 1445)
- [To map fields when exporting to Shape Multiclass](#) (page 1446)
- [To create polygons when exporting to SHP Multiclass](#) (page 1446)

- To export to a single feature class that uses all the items you specified on the Data tab. (page 1446)

To change the settings AutoCAD Map 3D uses for segmentation

- Edit the *mapexport.ini* file.
See [To edit the .ini file](#) (page 269).

To export drawing objects to Shape Multiclass

- 1 In the Tool-based Ribbon Workspace, click Output tab ► Map Data



Transfer panel ► Map 3D Export.

- 2 In the Export Location dialog box, select the Shape Multiclass file format and a location for the exported files. Click OK.
- 3 In the [Export dialog box](#) (page 1704), specify how to export objects. To use settings that you stored previously, click Load and select the profile containing the settings.
- 4 On the Selection tab, specify the objects to export.
 - To select a subset of objects, click Select manually and choose either Select Objects or Quick Select.
 - To filter the selection to export only objects on specific layers or in specific classes, specify the layers and classes to include.
 - To export polygons from a polygon topology, select the topology.
 - To preview the objects that will be exported, click Preview Filtered Selection.
- 5 On the Data tab, click Select Attributes and select the data to export with the objects.

TIP If you are exporting data from an external database, you can export the entire record from the database or just the key fields. Because the key field values are stored in the map, choosing the key field (listed under Link Templates) makes the export faster.

- 6 On the Options tab, select the options you want.
 - To perform a coordinate conversion, you must have a coordinate system [assigned to the map](#) (page 147).

- Check Treat closed polylines as polygons (if it is available) unless you want only polygon objects to be exported as polygons.
 - To create multiple classes, select Multiple Classes and specify what the feature classes will be based on (for example, layer). Your choices on the Options tab and on the Data tab work together to determine how attributes are assigned to the exported feature classes. See the Concept tab in this topic for more information.
 - Click Driver Options to select Two Dimension Shape Files or Three Dimension Shape Files.
- 7 Click OK to begin the export process.

To map fields when exporting to Shape Multiclass

- 1 Export your DWG data to SDF first. See [Exporting To Autodesk SDF \(Spatial Data File\)](#) (page 1413).
- 2 Use [Bulk Copy](#) (page 615) to export the data to SHP. Bulk Copy allows you to map fields.

To create polygons when exporting to SHP Multiclass

- 1 In the [Map Export dialog box](#) (page 1723), on the Options tab, select the Treat Closed Polylines As Polygons option.
- 2 Do one of the following:
 - To export closed polylines as lines, select the Line object type.
 - To export closed polylines as polygons, select the Polygon object type and select Treat Closed Polylines As Polygons on the Options tab

To export to a single feature class that uses all the items you specified on the Data tab.

- 1 In the [Map Export dialog box](#) (page 1723), Options tab, select One class.
- 2 Type a name for that class.

You can [export data to multiple classes at one time](#) (page 1439) and combine the data organization in your drawing with your selections on the Data tab to determine the attributes for each exported feature class.

Exporting To SQLite

SQLite is a file-based geospatial format.

SQLite is like SHP format in that it contains both spatial data and attribute data. However, unlike SHP, it stores both types of data in a single file rather than a set of files.

NOTE When you export from a map, only drawing objects are exported. Geospatial features are ignored. To move geospatial feature data to another format, use [Migrating GIS Data \(Bulk Copy\)](#) (page 617).

Exporting

You can specify that the resulting files use a single feature class or multiple feature classes based on layer, object classification, object data, or link templates. SQLite files can have a single schema only, but can contain multiple feature classes.

To create polygons when you use this export option, select the Treat Closed Polylines As Polygons option.

To export to a single feature class that uses all the items you specified on the Data tab, click One class and type a name for that class.

You can [export data to multiple classes at one time](#). (page 1439) Combine the data organization in your drawing with your selections on the Data tab to determine the attributes for each exported feature class.

Driver Options

There are no export driver options for SQLite

See also:

- [Customizing the Import and Export .ini Files](#) (page 264)
- [Importing ESRI Shape Files](#) (page 397)

NOTE When you export from a map, only drawing objects are exported. Geospatial features are ignored. To move geospatial feature data to another format, use [Migrating GIS Data \(Bulk Copy\)](#) (page 617).

Before moving drawing data to SQLite

- [Clean up any geometry errors](#). (page 1591)

Use the AutoCAD Map 3D cleanup tools to correct any geometry errors introduced during drafting, digitizing, or converting the data before you export it.

- [Add attribute data to objects](#) (page 1047) or [classify](#) (page 981) the drawing (DWG) objects you are exporting. You can export information with drawing data in the following circumstances:
 - If you create object data tables and add attribute information
 - If you link objects to data in an external data source, such as a database
 - If you classify objects, you can use those classes as the basis for your export
- Decide how to export the data to SQLite.

You can export to a single feature class that uses all the items you specified on the Feature Class tab. To do this, click Create a single class from all selected objects and type a name for that class.

You can [export data to multiple classes at one time](#) (page 1439). Combine the data organization in your drawing with your selections on the Feature Class tab to determine the attributes for each exported feature class.

To export drawing objects to SQLite

- 1 In the Tool-based Ribbon Workspace, click Output tab ► Map Data

Transfer panel ► Map 3D Export. 

- 2 In the Export Location dialog box, select the SQLite Spatial (sqlite) file format and a location for the exported files. Click OK.
- 3 In the [Export dialog box](#) (page 1704), specify how to export objects. To use settings that you stored previously, click Load and select the profile containing the settings.
- 4 On the Selection tab, specify the objects to export.
 - To select a subset of objects, click Select manually and choose either Select Objects or Quick Select.
 - To filter the selection to export only objects on specific layers or in specific classes, specify the layers and classes to include.
 - To export polygons from a polygon topology, select the topology.

- To preview the objects that will be exported, click Preview Filtered Selection.

5 On the Feature Class tab, do the following:

- To create multiple classes, select Create Multiple Classes Based On A Drawing Object.
See [Exporting to Multiple Classes](#) (page 1439).
- Click Select Attributes and select the data to export with the objects.

TIP If you are exporting data from an external database, you can export the entire record from the database or just the key fields. Because the key field values are stored in the map, choosing the key field (listed under Link Templates) makes the export faster.

6 On the Options tab, select the options you want.

- To perform a coordinate conversion, you must have a coordinate system [assigned to the map](#) (page 147).
- Check Treat closed polylines as polygons (if it is available) unless you want only polygon objects to be exported as polygons.

7 Click OK to begin the export process.

To move data into SQLite format

- [Bulk Copy](#) (page 615) – Moves data to and from SQLite and other geospatial data stores.

Exporting To VML (Vector Markup Language)

AutoCAD Map 3D supports VML (Vector Markup Language). VML, which is written using the XML syntax, is a text-based markup language used for describing vector graphics. VML is an export-only format.

NOTE When you export from a map, only drawing objects are exported. Geospatial features are ignored. To move geospatial feature data to another format, use [Migrating GIS Data \(Bulk Copy\)](#) (page 617).

Exporting

When you export to VML format, AutoCAD Map 3D creates a single HyperText Markup Language (HTML) file with the VML data contained in the <body> region of the HTML.

When you export objects, be sure that the objects have a color that will be visible on the target page. For example, if you are exporting to a page with a white background, be sure that the objects themselves are not white.

You can specify the following attributes for VML objects:

VML Attribute	Description
vml_title	The title of the feature that may be displayed by the VML viewer. (The title appears as a ToolTip when the user places their mouse over the feature. Range: string Default: none)
vml_url	The URL to jump to if this feature is clicked. Range: string Default: none
vml_target	The target frame in the URL. Range: string Default: none
vml_z_index	The z-index of the feature in the output VML file. Positive numbers are in front of the screen; negative numbers are behind the screen. Features having a higher z-index obscure features with a lower z-index. Range: integer Default: 0 for vml_polygon features 10 for vml_polyline features 11 for vml_point features 12 for vml_text features

Driver Options

VML has no export driver options.

NOTE When you export from a map, only drawing objects are exported. Geospatial features are ignored. To move geospatial feature data to another format, use [Migrating GIS Data \(Bulk Copy\)](#) (page 617).

To export drawing objects to Vector Markup Language (VML)

- 1 In the Tool-based Ribbon Workspace, click Output tab ► Map Data

Transfer panel ► Map 3D Export. 

- 2 In the Export Location dialog box, select the Vector Markup Language (VML) file format and a location for the exported files.
- 3 In the [Export dialog box](#) (page 1704), specify how to export objects. To use settings that you stored previously, click Load and select the profile containing the settings.
- 4 On the Selection tab, specify the objects to export.
 - To select a subset of objects, click Select manually and choose either Select Objects or Quick Select.
 - To filter the selection to export only objects on specific layers or in specific classes, specify the layers and classes to include.
 - To export polygons from a polygon topology, select the topology.
 - To preview the objects that will be exported, click Preview Filtered Selection.
- 5 On the Data tab, click Select Attributes and select the data to export with the objects.

TIP If you are exporting data from an external database, you can export the entire record from the database or just the key fields. Because the key field values are stored in the map, choosing the key field (listed under Link Templates) makes the export faster.

- 6 On the Options tab, select the options you want.
 - To perform a coordinate conversion, you must have a coordinate system [assigned to the map](#) (page 147).
 - Check Treat closed polylines as polygons (if it is available) unless you want only polygon objects to be exported as polygons.
- 7 Click OK to begin the export process.

Exporting Point Cloud Data

You can export point cloud data to LiDAR (LAS version 1.2) or space-delimited ASCII (.xyz) formats. These formats can be shared with other applications that read LiDAR data. To use this data in AutoCAD Map 3D, you must import and index the data again. See [Bringing in LiDAR Data](#) (page 374).

You can also export point cloud data to the Autodesk SDF format. You can connect to a point cloud SDF file as you would to any SDF data store. Exporting your point cloud data to SDF format is useful for creating geospatial features from LiDAR data.

NOTE Because point clouds can contain millions or billions of points, SDF files created from point clouds can be very large. Before you export your point cloud to SDF format, filter the point cloud down to the smallest usable size. For best performance, filter the point cloud down to one million points or fewer.

NOTE You cannot export point cloud data from an index file created using AutoCAD commands (.PCG file).

To export point cloud data to LAS or ASCII formats

- 1 Right click the point cloud or point cloud layer you want to export, then select Export Point Cloud. The Export Point Cloud dialog box appears.
- 2 Select the file type to which you want to export your point cloud data in the File of Type field.
- 3 Specify a file name and save location.
- 4 Click Save.

To export point cloud data to Autodesk SDF format

Before you export point cloud data to SDF format, use the [Point Cloud Manager](#) (page 1897) to create a filtered point cloud containing only the necessary points. For best performance, filter your point cloud down to one million points or fewer.

- 1 Right click the point cloud or point cloud layer you want to export, then select Export as SDF. The Export Point Cloud as SDF dialog box appears.
- 2 Specify a file name and save location.
- 3 Click Save.

Mapping Drawing Attributes to Feature Class Properties

You can map drawing attribute properties to feature class properties when you export DWG data to the SDF format. You can also map specific values of the AutoCAD drawing properties .COLOR, .LINETYPE, and .LINEWEIGHT to specific feature class property values. For example, you could specify that all

pipes drawn with green lines are eight-inch pipes, or that all roads drawn with .25 mm lines are two-lane roads.

NOTE When you export from a map, only drawing objects are exported. Geospatial features are ignored. To move geospatial feature data to another format, use [Migrating GIS Data \(Bulk Copy\)](#) (page 617).

Tell me more



Video

- [Show me how to export styled DWG objects.](#)
- [Show me how to view the contents of the SDF file.](#)



Procedures

- [To map drawing attributes to feature class properties](#) (page 1454)
- [To map AutoCAD drawing attribute values to feature class property values](#) (page 1454)



Tutorials

- [Lesson 1: Convert Drawing Layers to Feature Classes](#)
- [Batch Exporting](#)



Workflow

- [Move CAD Data to GIS](#)



GIS Skills

- [Convert styled DWG objects to features.](#)



Related topics

- [Overview of Publishing and Sharing](#) (page 1357)
 - [Exporting To Autodesk SDF \(Spatial Data File\)](#) (page 1413)
 - [Overview of Exporting Attribute Data](#) (page 1472)
-

NOTE When you export from a map, only drawing objects are exported. Geospatial features are ignored. To move geospatial feature data to another format, use [Migrating GIS Data \(Bulk Copy\)](#) (page 617).

To map drawing attributes to feature class properties

- 1 In the [Map Export dialog box](#) (page 1723), click the Feature Class tab.
- 2 Select the drawing objects you want to map to feature class properties.
- 3 In the Feature Class column, click the [...] button.
- 4 In the Feature Class Property Mapping dialog box, select or enter the feature class property to which the drawing attributes should be mapped.
- 5 You can select additional drawing objects and attributes to export by clicking the Select Attributes button.
- 6 Click OK.

To map AutoCAD drawing attribute values to feature class property values

- 1 In the [Map Export dialog box](#) (page 1723), click the Feature Class tab.
- 2 Select the drawing attributes you want to map to feature class properties.
- 3 In the Feature Class column, click the [...] button.
- 4 In the Feature Class Property Mapping dialog box, select the feature class property to which the drawing attribute values should be mapped.
- 5 You can select additional drawing properties and attributes to export by clicking the Select Attributes button.
- 6 In the Drawing Attributes column, click the [...] button in the field of the attribute to be mapped to the feature class property.
- 7 In the New Property Data Type dialog box, select the appropriate data type from the drop-down list.
- 8 Click OK.
- 9 In the Property Value Mapping dialog box, map the drawing attribute values to the specific feature class values.
- 10 Click OK.

Quick Reference

MAPEXPORT

Exports drawing objects and their attribute data to an external file format

Menu Click File ► Convert DWG To ► Map 3D Export.

Icon



Export Map File

Command Line MAPEXPORT

Dialog Box Export dialog box

MAPEXPORTFDO

Export to an FDO data store

Menu Click File ► Convert DWG To ► FDO Connection.

Command Line MAPEXPORTFDO

Exporting Text Enclosed in a Polyline

If your map includes text that is enclosed in a polyline, you can turn that text into object data and export it as attribute data attached to the polyline.

NOTE When you export from a map, only drawing objects are exported. Geospatial features are ignored. To move geospatial feature data to another format, use [Migrating GIS Data \(Bulk Copy\)](#) (page 617).

See also:

- [Overview of Converting and Exporting](#) (page 1405)
- [Setting Up Object Data](#) (page 198)

NOTE When you export from a map, only drawing objects are exported. Geospatial features are ignored. To move geospatial feature data to another format, use [Migrating GIS Data \(Bulk Copy\)](#) (page 617).

To export text enclosed in a polyline as attribute data

- 1 [Create an object data table](#) (page 201) with one field.

- 2 Use the [Generate Links](#) (page 1067) command to automatically attach data to objects.
 In the [Generate Data Links dialog box](#) (page 1807), select the Enclosed Text option. This option links the text data to the polyline enclosing the text.
 Under Data Links, select Create Object Data Records and select the name of the table you created in step 1.
 Click OK and select the objects you want. For each selected object, AutoCAD Map 3D creates a new record in the selected object data table and fills the record with the enclosed text.
- 3 In the Tool-based Ribbon Workspace, click Output tab ► Map Data
 Transfer panel ► Map 3D Export. 
- 4 On the Data or Feature Class tab of the [Map Export dialog box](#) (page 1723), select the table you created in step 1. Select any other export options you want and export the objects.

Quick Reference

ADEDEFDATA

Defines object data

Menu Setup menu ► Define Object Data

Icon  Define Object Data

Command Line ADEDEFDATA

Dialog Box Define Object Data dialog box

ADEGENLINK

Automatically links objects to object data or external database records

Menu In the Classic workspace, click Setup menu ► More Link Template Options ► Generate Links

Command Line ADEGENLINK

Task Pane In Map Explorer, right-click a link template ► Generate Links

Dialog Box Generate Data Links dialog box

MAPEXPORT

Exports drawing objects and their attribute data to an external file format

Menu Click File ► Convert DWG To ► Map 3D Export.

Icon



Export Map File

Command Line MAPEXPORT

Dialog Box Export dialog box

Exporting Polygons from a Polygon Topology

Exporting polygons from a polygon topology is useful when you export data to an external file format that supports polygons.

During this operation, you can create a group containing all the elements of complex areas, such as islands. If the islands themselves have nested islands or other polygons, these nested polygons will form a separate grouping automatically, creating different levels of grouping. If two or more inner polygons are not nested but share the same outer boundary, they are treated as one group.

NOTE When you export from a map, only drawing objects are exported. Geospatial features are ignored. To move geospatial feature data to another format, use [Migrating GIS Data \(Bulk Copy\)](#) (page 617).

See also:

- [Overview of Converting and Exporting](#) (page 1405)
- [Creating Closed Polylines from a Polygon Topology](#) (page 897)
- [Converting Polylines to Polygons](#) (page 970)
- [Converting Polygon Topology to Polygons](#) (page 972)

NOTE When you export from a map, only drawing objects are exported. Geospatial features are ignored. To move geospatial feature data to another format, use [Migrating GIS Data \(Bulk Copy\)](#) (page 617).

To export polygons from a polygon topology

- 1 In the Tool-based Ribbon Workspace, click Output tab ► Map Data

Transfer panel ► Map 3D Export.



- 2 In the [Map Export dialog box](#) (page 1723), select the topology to export. All complete polygons in the selected topology are automatically selected.
- 3 Select Group Complex Polygons to group nested polygons into a single, balanced polygon.

If you do not select the Group Complex Polygons option, AutoCAD Map 3D creates a separate polygon for each centroid.

To create a single polygon from nested polygons, each nested polygon must have a centroid. For example, if three polygons are nested one within another, and the middle polygon does not have a centroid, AutoCAD Map 3D creates separate polygons for the inner polygon and the outer polygon.

- 4 Set any other export options.

Quick Reference

MAPEXPORT

Exports drawing objects and their attribute data to an external file format

Menu Click File ► Convert DWG To ► Map 3D Export.

Icon



Export Map File

Command Line MAPEXPORT

Dialog Box Export dialog box

Saving Drawing Objects to a DXF File

You can create DXF files for use with previous versions of AutoCAD or with any other application that supports the DXF format.

NOTE All topology information, links to external databases, object data, and civil objects are lost when you use this command. Only drawing objects are exported. Geospatial features are ignored. To move geospatial feature data to another format, use [Migrating GIS Data \(Bulk Copy\)](#) (page 617).

See also:

- [Importing DXF Files](#) (page 391)

NOTE All topology information, links to external databases, object data, and civil objects are lost when you use this command. Only drawing objects are exported. Geospatial features are ignored. To move geospatial feature data to another format, use [Migrating GIS Data \(Bulk Copy\)](#) (page 617).

To create a DXF file

- 1 Click  ► Save As ► AutoCAD Drawing.
- 2 Select a type of DXF from the Files of Type list.
- 3 Specify a name and location for the file and click Save.

Quick Reference

SAVEAS

Saves an unnamed drawing with a file name or renames the current drawing

Menu File menu ► Save As

Command Line SAVEAS

Exporting Maps to DWG Format

You can save both geospatial features and DWG objects to DWG format from the Display Manager. This allows you to share styled maps with users who do not have Display Manager (for example, users of AutoCAD or a previous version of AutoCAD Map 3D).

In the output drawing, styling is preserved, but object attributes, labels, and any [joined data](#) (page 507) are not. You can view the output drawing with

previous versions of AutoCAD Map 3D and with AutoCAD, and the output drawing can be used by the Sheet Set Manager.

Each display layer in your map is saved to a corresponding layer in the target drawing.

To output multiple maps based on different zoom scales, you must save individual maps for each desired zoom scale.

Tell me more



Video

- [Show me how to export the current map to DWG format.](#)
- [Show me how the map looks after conversion to DWG format](#)



Procedures

- [To save a styled map to DWG format \(page 1460\)](#)



Workflow

- [Send GIS Data to AutoCAD](#)



GIS Skills

- [Save the current map in DWG format with visual fidelity.](#)



Related topics

- [Moving DWG Data to a Spatial Data Store and Back Again \(page 1465\)](#)
- [Migrating DWG Data to GIS \(page 628\)](#)
- [Geospatial Features and Drawing Objects \(page 9\)](#)
- [Converting Data From Other Formats to Drawing Objects \(page 377\)](#)

To save a styled map to DWG format

- 1 Build your map, styling your feature, and drawing layers as desired.
- 2 Display the map at the scale you want recipients to share.

- 3 In the Tool-based Ribbon Workspace, click Output tab ► Map Data

Transfer panel ► Current Map As DWG.



- 4 In the Save Current Map To DWG dialog box, specify a location and file name for the exported map and click Save.

Exporting DWG Data to an FDO Data Store

You can move DWG (drawing object) data into any Oracle database to which you have connected in AutoCAD Map 3D. You can also move DWG data into existing ESRI ArcSDE data stores to which you have connected in AutoCAD Map 3D.

NOTE Only drawing objects are exported. Geospatial features are ignored. To move geospatial feature data to another format, use [Migrating GIS Data \(Bulk Copy\)](#) (page 617).

Exporting DWG Data to Oracle

When you export to an existing Oracle table, you can use the data to populate both new and existing classes.

You can export a single class at a time and use the Feature Class tab to match your output fields to the existing fields. The left-hand column on the Feature Class tab (on the Export dialog box) is an expression, which allows you to concatenate fields or do calculations on them.

You can [export data to multiple classes at one time](#) (page 1439) and combine the data organization in your drawing with your selections on the Feature Class tab to determine the attributes for each exported feature class.

Object class property values are written to the feature class in Oracle if their data types match. Otherwise, AutoCAD Map 3D attempts to convert to a supported data type.

You can also use scripting to perform export operations. For single-class export, the parameters for each export operation can be saved in a profile and you can export multiple classes with a single script. This is helpful for the cases where the same complex set of operations must be done frequently.

Exporting DWG Data to ESRI ArcSDE

When you export data to ArcSDE format, you can export only to an existing ArcSDE data store with a complete schema. You cannot create or modify ArcSDE schemas using AutoCAD Map 3D.

See also:

- [Overview of Converting and Exporting](#) (page 1405)
- [Exporting to Multiple Classes](#) (page 1439)
- [Bringing In Features from Oracle](#) (page 312)
- [Importing From ESRI ArcSDE](#) (page 391)
- [Migrating GIS Data \(Bulk Copy\)](#) (page 617)

NOTE Only drawing objects are exported. Geospatial features are ignored. To move geospatial feature data to another format, use [Migrating GIS Data \(Bulk Copy\)](#) (page 617).

To export DWG data to Oracle:

- 1 [Connect to the Oracle data store](#) (page 312) to which you want to move the data.
- 2 Before moving drawing data to Oracle, do the following to your DWG drawing objects:
 - [Assign a coordinate system](#) (page 142). This lets you position your data accurately in a real-world geographic location and align imported survey or GPS point data. Once you assign a coordinate system, you can convert to a different system when you export.
 - [Clean up any geometry errors](#) (page 765). Use the AutoCAD Map 3D cleanup tools to correct any errors introduced during drafting, digitizing, or converting the data.
- 3 In the Tool-based Ribbon Workspace, click Output tab ► Map Data Transfer panel ► To FDO Connection.
- 4 In the dialog box that appears, choose the Oracle connection for the export and click OK.
- 5 On the Selection tab of the [Map Export dialog box](#) (page 1723), specify which objects to export.

This tab determines how items are selected for export, and not how they are organized in their exported form. You specify how to organize the exported material on the Feature Class tab.

- 6 On the Feature Class tab, specify which object properties and attributes to export to feature class attributes.
All attributes you specify here will be included in all the resulting features you create in Oracle. For information on how the choices on this tab determine the properties of the exported feature class, see [Exporting to Multiple Classes](#) (page 1439).
- 7 On the [Options tab](#) (page 1704) specify whether to convert the coordinate system during the export process and choose the coordinate system. Specify whether to treat closed polylines as polygons when you export.
- 8 Specify how to create classes in the Oracle data store.
 - To create a single feature class containing all the items you selected on the Selection tab, click Create a single class from all exported objects and type a name for that class.
 - To create multiple feature classes for the items you selected on the Selection tab, click Create multiple classes based on a drawing object and specify an “auto-classification” method
For information about these methods, see [Exporting to Multiple Classes](#) (page 1439).
- 9 To change the automatically assigned class names, click the Feature Class field and edit the names as needed, then click OK.
- 10 Click Save.

To export DWG data to ESRI ArcSDE:

- 1 Query the data you want from the DWG drawing into your map.
- 2 [Connect to the ESRI ArcSDE data store](#) (page 316) to which you want to move the data.
- 3 Before moving drawing data to ESRI ArcSDE, do the following to your DWG drawing objects:
 - [Assign a coordinate system](#) (page 142). This lets you position your data accurately in a real-world geographic location and align imported survey or GPS point data. Once you assign a coordinate system, you can convert to a different system when you export.

- [Clean up any geometry errors](#) (page 765). Use the AutoCAD Map 3D cleanup tools to correct any errors introduced during drafting, digitizing, or converting the data.
- 4 In the Tool-based Ribbon Workspace, click Output tab ► Map Data



 Transfer panel ► To FDO Connection.
 - 5 In the dialog box that appears, choose the data source for the export and click OK.
 - 6 On the Selection tab of the [Map Export dialog box](#) (page 1723), specify which objects to export.

This tab determines how items are selected for export, and not how they are organized in their exported form. You specify how to organize the exported material on the Feature Class tab.
 - 7 On the Feature Class tab, specify which object properties and attributes to export to feature class attributes. Note that you cannot create or modify ArcSDE schemas. You can only map object properties and attributes to existing feature class attributes.

All attributes you specify here are included in all the resulting features you export to ESRI ArcSDE. For information on how the choices on this tab determine the properties of the exported feature class, see [Exporting to Multiple Classes](#) (page 1439).
 - 8 On the [Options tab](#) (page 1704), specify whether to convert the coordinate system during the export process and choose the coordinate system. Specify whether to treat closed polylines as polygons when you export.
 - 9 Click Save.

Quick Reference

MAPEXPORTFDO

Export to an FDO data store

Menu Click File ► Convert DWG To ► FDO Connection.

Command Line MAPEXPORTFDO

Exporting DWG Data to an Image Format

You can save the drawing objects in the current map to an image format, such as BMP, JPEG, or PNG. The resulting image file will not contain geospatial features.

NOTE Only drawing objects are exported. Geospatial features are ignored. If your map includes geospatial features, [convert it to DWG format](#) (page 378) before you use this feature.

When you export to an image format, you use the Render Output File Dialog Box.

See also:

- [Exporting Maps to DWG Format](#) (page 1459)

To save drawing objects in an image format

- 1 In the Tool-based Ribbon Workspace, click Output tab ► Map Data Transfer ► As Image.
- 2 In the dialog box that appears, choose the image format for the new file from the Files of Type list.
- 3 Specify a name and location for the image file and click Save.
- 4 If the format you chose has any further options, specify them in the dialog box that appears and click OK.

For information about these options, see the corresponding topic in the AutoCAD Help. For example, for information about the JPEG options, see the JPEG Image Options Dialog Box topic.

All drawing objects in your map are rendered and saved to the image file.

Moving DWG Data to a Spatial Data Store and Back Again

You can move AutoCAD drawing data from AutoCAD Map 3D to SDF or Oracle and back into AutoCAD Map 3D. For example, you can export drawing objects to an SDF file to give to someone who must change those objects. Once the changes are made, you can incorporate them into your original drawing file.

Attributes

If you connect to the data, rather than import it, and extract the geometry from the feature data, the attributes are lost.

Bringing the Data Back Into AutoCAD Map 3D

After changes have been made to the data, you can bring it back into AutoCAD Map 3D in one of the following ways:

- Import the data in DWG format. If anyone changes the data after that, those changes will not appear in your map unless you reimport. Import gives you a "snapshot" of the data at the moment that you import. This method is best for changes to many objects in one area of the map. It works best if you classify the objects before you export them, and then map to those object classes when you reimport.
- Connect to the data (using Data Connect) and then extract the geometry from the changed features. You can then update your original DWG files with the new information. The data remains in its original format, and any further changes in its data store appear in your map. This method is best for small changes.

If you plan to reimport SDF data using either method, you will get the best results if you export only the properties you want edit to a multi-class SDF file. You can then map the properties to separate layers when you import the SDF file.

Preserving Visual Styles

When you export styled drawing data, the visual styling is lost. You can use two alternative methods to preserve styling information:

- Set up a drawing template file (.dwt) that includes styling information for the drawing objects you wish to include (layers, linetypes, blocks, and so on). For more information on using drawing templates, see the *AutoCAD 2009 User's Guide*.
- Publish your map to the DWF format, which preserves all styling. Use Autodesk Design Review to examine and mark up the resulting map. You can then update the original DWG data from those markups.

See also:

- [Publishing to DWF](#) (page 1364)

- [Overview of Converting and Exporting](#) (page 1405)
- [Exporting DWG Data to an FDO Data Store](#) (page 1461)
- [Importing Autodesk SDF \(Spatial Data Files\)](#) (page 387)
- [Overview of Converting Geospatial Data to Drawing Objects](#) (page 378)
- [To move drawing data to a spatial data store and back using the import method](#) (page 1467)
- [To move drawing data to a spatial data store and back using the Data Connect method](#) (page 1467)

To move drawing data to a spatial data store and back using the import method

- 1 Export the drawing data to an SDF file or to Oracle. See [Overview of Converting and Exporting](#) (page 1405), [Exporting DWG Data to an FDO Data Store](#) (page 1461), and [Importing Autodesk SDF \(Spatial Data Files\)](#) (page 387).

If your drawing data has been styled, be sure to check the appropriate properties on the Feature Class tab of the Export dialog box when you export the data. Although the visual styling will not appear in the resulting feature data, you can reconstruct the styling when you reimport the data later.

- 2 Once the feature data has been changed, open the original DWG file in AutoCAD Map 3D to update it with those changes.
- 3 Remove any objects that will be replaced with the imported data.
- 4 Connect to the data store with the new data and import the data to add it to your original drawing.

See [Overview of Converting Geospatial Data to Drawing Objects](#) (page 378). If your original drawing contains layers that specify visual styling, import the data into the appropriate layer to restore its styling information.

To move drawing data to a spatial data store and back using the Data Connect method

- 1 Export the drawing data to SDF or Oracle.

See [Exporting DWG Data to an FDO Data Store](#) (page 1461), [Overview of Converting and Exporting](#) (page 1405), and [Importing Autodesk SDF \(Spatial Data Files\)](#) (page 387).

If your drawing data has been styled, be sure to check the appropriate properties on the Feature Class tab of the Export dialog box when you export the data. Although the visual styling will not appear in the resulting feature data, you can reconstruct the styling when you reimport the data later.

Alternately, you can use a drawing template that includes all the styling information you wish to include. For more information on using a drawing template to preserve drawing data stylization, see [Preserving Visual Styles](#) (page 1466)

- 2 Once the feature data has been updated, open your original DWG file in AutoCAD Map 3D to update it with those changes.
- 3 Connect to the spatial data source containing the changed data.
See [Bringing in GIS Features](#) (page 303).
- 4 Check out any new or changed features and use Extract Geometry From Feature to convert them to drawing objects.
See [Checking Out Features](#) (page 695) and [Extracting Feature Geometry](#) (page 715)

NOTE The resulting drawing objects will lose any attribute data that was connected to them.

- 5 Check the features back in and remove the display layers that use the feature source data.
- 6 Disconnect from the feature source.
- 7 Click Create tab ► Drawing Object panel ► Attach/Detach Object Data.



- 8 Attach any existing object data to the new geometry.
See [Specifying Object Data for a Drawing Object](#) (page 1063).

Saving or Exporting a Display Manager Layer

You can save or export information about geospatial layers in Display Manager (including annotation layers) to separate files. Only geospatial features are saved or exported. You can export to SDF or SQLite format.

This allows you to package data that is ordinarily stored in a central data store, such as an Oracle database, into a geospatial data file. However, all connection to the original data store is lost and changes you make to the SDF or SQLite file will not update the central data store.

Saving vs. Exporting

If you use the export option, you can export a single layer to an Autodesk SDF (version 3) or a SQLite file. The resulting file contains geometry and attribute data, but no styling data.

If you have [joined data](#) (page 507) to the layers you are exporting, the joined data is also exported. However, metadata is not exported with the layer. For information about exporting metadata, see [Sharing Metadata](#) (page 1510).

If you use the save option, you can save one layer at a time. When you save a layer, you save its styling information and pointers to the data source that defines its geometry and attributes. You can drag and drop saved layers into any map to reuse them.

You cannot use a saved layer and an exported layer together because saved layers point to the current data for the layer while exported layers contain a “snapshot” of the data at the time they were exported, and these data definitions may differ.

Using Exported Layers

You can use exported layers for any of the following:

- As a map layer in Autodesk MapGuide Enterprise or MapGuide Open Source.

NOTE This format is not readable by Autodesk MapGuide version 6.5 or earlier. Instead, see [Exporting DWG Data to SDF2 Format](#) (page 1417).

- To package the layer contents as a personal geospatial data store. The resulting SDF or SQLite file can be opened and edited in any application that supports the format. However, once you export the layers, they lose their connection to their original data store, and any changes you make will not be updated in that data store.

NOTE You can also export all DWG objects to SDF3 or SQLite format, and you can copy features from one geospatial format to another using Bulk Copy.

Tell me more



Video

- [Show me how to export a layer to SDF.](#)
- [Show me how to save a layer to a .layer file.](#)



Procedures

- [To export layers in SDF or SQLite format \(page 1470\)](#)
- [To save a layer's styles and pointers to its data \(page 1471\)](#)



GIS Skills

- [Exchange data with other users by exporting to SDF format.](#)
- [Share styles with other users of AutoCAD Map 3D using .layer files.](#)



Related topics

- [Overview of Publishing and Sharing \(page 1357\)](#)
- [Overview of the Display Manager \(page 634\)](#)
- [Overview of Converting and Exporting \(page 1405\)](#)
- [Importing Autodesk SDF \(Spatial Data Files\) \(page 387\)](#)
- [Migrating Data \(page 615\)](#)

To export layers in SDF or SQLite format

- 1 In the [Display Manager](#) (page 2060), right-click a layer ► **Export Layer Data to SDF** or **Export Layer Data to SQLite**.
- 2 Specify a name and location for the file.
The resulting file will have the extension *.sdf* or *.sqlite*.

- 3 Click Save.

To save a layer's styles and pointers to its data

- 1 In the [Display Manager](#) (page 2060), right-click the layer ► Save Layer.
- 2 Specify a name and location for the file.
The resulting file will have the extension *.layer* .
- 3 Click Save.

Exporting Survey Points to a LandXML File

You can export survey points from a survey data store to a LandXML file. AutoCAD Map 3D supports LandXML versions 1.0, 1.1, and 1.2.

To export survey points to a LandXML file

- 1 On the Survey tab of the Task Pane, click Data ► Export LandXML.
The [Export to LandXML dialog box](#) (page 1709) appears.
- 2 Select the items to export in the left-hand selection window.
- 3 In the File section, click FileName, then click . The [Export to LandXML dialog box](#) (page 1709) appears.
- 4 Enter a name and save location for the LandXML file, then click Save.
- 5 Select the LandXML version in the Version field of the File section.
AutoCAD Map 3D supports LandXML version 1.0, 1.1, and 1.2.
- 6 Confirm the information in the Project and Units section, and edit if necessary.
- 7 Confirm the coordinate system in the Coordinate System Assignment section, and edit if necessary.
- 8 Click OK.

Exporting and Printing Attribute Data

To print and export attribute data

- [To export from the Data Table](#) (page 1474)
- [To print a database table](#) (page 1475)
- [To set print options](#) (page 1476)
- [To specify the header and footer](#) (page 1476)
- [To apply a filter](#) (page 1476)
- [To create a drawing object report](#) (page 1477)

Overview of Exporting Attribute Data

You can export attribute data in the following ways:

- **From the Data Table:** Attribute data for geospatial features appears in the Data Table. You can export all or some of this data to a comma-separated file, which you can then print from a supporting application.
- **From the Data View:** Data you linked to drawing objects from an external source appears in the Data View. You can print some or all of this data, or you can copy and paste it into another application.
- **From the Metadata Viewer:** Metadata is structured information that describes the content, quality, condition, and other characteristics of data. In AutoCAD Map 3D, you can examine this data in the Metadata Viewer. You can share metadata by exporting it from the Metadata Viewer.
- **As a report:** You can query objects in attached drawings to retrieve object data and properties that match your criteria. You define a template to specify which of that information to include in the resulting report, which is written out to a comma-separated file.

See also:

- [Exporting from the Data Table](#) (page 1473)
- [Overview of the Data Table](#) (page 1125)
- [Printing from the Data View](#) (page 1474)
- [Viewing External Data Sources for Drawing Object Data](#) (page 1047)
- [Sharing Metadata](#) (page 1510)

■ [Creating a Drawing Object Report \(DWG\)](#) (page 1477)

Use the following methods to export or print attribute data.

To export this type of data...	Use this method
Geospatial attribute data	In the Data Table, select the desired data and click Options ► Export. See Exporting from the Data Table (page 1473).
External data linked to drawing objects	In the Data View, specify print options and click File menu ► Print. See Printing from the Data View (page 1474).
Drawing object data and properties (as a report)	In the Tool-based Ribbon Workspace, click Home tab ► Data panel ► Define Query. Define and execute the query. Then click Report in the same dialog box to create a report template and specify a file name for the report. See Creating a Drawing Object Report (DWG) (page 1477).
Metadata	In the Metadata Viewer, click Export or Publish. Select the source data type and specify the location for the exported data. See Sharing Metadata (page 1510).

Exporting from the Data Table

Attribute data for geospatial features appears in the Data Table. You can export all or some of this data to a comma-separated file. Exported data is stored in a comma-separated file for use in other applications, such as Microsoft® Access™ or Excel™.

If your data includes decimal values, the exported data uses the format for your current user locale (the current setting in the Windows Regional Settings control panel on your computer.) For this reason, the data may not actually be separated by commas. For example, in a German locale, items are separated by semicolons.

If you have [joined data](#) (page 507) to geospatial features whose data you are exporting, the exported data will include the joined properties.

NOTE You can also copy cells from the Data Table and paste them into a spreadsheet program, such as Microsoft Excel.

See also:

- [Overview of the Data Table](#) (page 1125)

To export from the Data Table

- 1 In [Map Explorer](#) (page 2068), click the feature layer whose data you want to export.
- 2 Click Table.
- 3 Filter the display to see the data you want.
- 4 Select the data to export. To select all the data currently displayed, click Select in the upper right corner.
- 5 Click Options ► Export (at the bottom of the Data Table window).
- 6 Specify a name and location for the comma-separated file, and click Save.

Printing from the Data View

Data you linked to drawing objects from an external source appears in the Data View. You can print all or part of the active table. If you have filters in effect, only the records that match the filter are printed. You can set print options for margins, titles, grid lines, header, and footer.

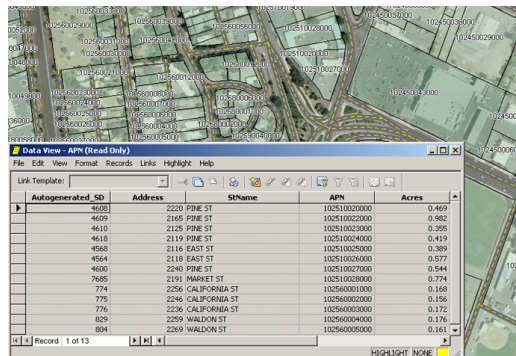

You can print from a Data View table.

NOTE You can also copy cells from the Data View and paste them into a spreadsheet program, such as Microsoft Excel.

See also:

- [Opening a Database Table](#) (page 1052)
- [Finding Records in the Data View Based on Record Data \(SQL Queries\)](#) (page 1230)
- [Finding Data View Records Based on Object Location](#) (page 1233)
- [Freezing and Hiding Data View Columns](#) (page 1059)
- [To print a database table](#) (page 1475)
- [To set print options](#) (page 1476)
- [To specify the header and footer](#) (page 1476)
- [To apply a filter](#) (page 1476)

To print a database table

- 1 Open a database table in the [Data View](#) (page 1146).
- 2 Specify print options, header, footer, or filters.
- 3 In the Data View, click File menu ► Print.
- 4 Click OK.

To set print options

- 1 In the Data View, click File menu ► Page Setup.
- 2 In the [Page Setup dialog box](#) (page 1686), select the print options you want. Click OK.

To specify the header and footer

- 1 In the Data View, click File menu ► Header And Footer.
- 2 In the [Header/Footer dialog box](#) (page 1685), set options for headers and footers. Click OK.

If you have applied a filter to the table, only the filtered records print.

To apply a filter

- See [Finding Records in the Data View Based on Record Data \(SQL Queries\)](#) (page 1230).
- See [Finding Data View Records Based on Object Location](#) (page 1233).

Quick Reference

(Data View) Header and Footer

Specifies header and footer for printing in the Data View

Menu	In the Data View: File ► Header and Footer
Dialog Box	Header/Footer dialog box

(Data View) Page Setup

Sets the print options for Data View

Menu	In the Data View: File ► Page Setup
Dialog Box	Page Setup dialog box

(Data View) Print

Prints the current view of the database table

Menu	In the Data View: File ► Print
-------------	--------------------------------

Icon



Creating a Drawing Object Report (DWG)

To create a drawing object report

- [To run a query in Report mode](#) (page 1477)
- [To create a report template](#) (page 1479)

Running a Query in Report Mode

You can run a special query on objects in attached drawings to retrieve information about the object properties and object data. You can use Report mode to save the results of the query to a comma-separated file, which you can use in a spreadsheet program or database.

For example, you can create a list of pipes and their diameters (when the diameters are stored in object data).

You use a report template to control the information that is included in the report. Depending on your use of blocks, layers, object data, links to external databases, block attributes, color, and other data, you can create various printed reports.

NOTE Queries in Report mode retrieve objects from layers that are Off or Frozen.

See also:

- [Defining Queries](#) (page 1219)
- [Altering Properties of Defined Queries](#) (page 1259)
- [Saving Queries](#) (page 177)
- [Creating a Report Template](#) (page 1478)

To run a query in Report mode

- 1 Click Home tab ► Data panel ► Define Query. 
- 2 Define or load a query.

- 3 Under Query Mode, select Report.
- 4 Click Options.
- 5 In the [Output Report Options dialog box](#) (page 1852), [To create a report template](#) (page 1479). Click OK.
- 6 Click Execute Query.

Quick Reference

ADEQUERY

Controls defining, modifying, saving, loading, and executing a query

Menu	In the Classic workspace, click Setup menu ► More DWG Options ► Define Query
Icon	 Define Query
Command Line	ADEQUERY
Task Pane	In Map Explorer, right-click Current Query ► Define -or- Right-click a query ► Edit
Dialog Box	Define Query dialog box

Creating a Report Template

Control the information that is included in a report query by defining a report template.

For example, you can create a report that displays pipe lengths and diameters by querying the feature class PIPES, and defining a report template that includes the property LENGTH and an object data field that contains pipe diameter information.

A template can include variables that represent:

- object properties
- feature classification
- object data

- topology information
- SQL data in an external database table
- block attributes

For a complete listing of variables you can use in a template, see [Variables](#) (page 1546).

TIP Objects that include several elements have multiple entries in the output file. Use the .TYPE dot variable to identify such objects, and edit the output file to remove duplicate references to the object.

The report template is saved when you save the query.

NOTE Report mode queries retrieve objects from layers that are Off or Frozen.

See also:

- [Running a Query in Report Mode](#) (page 1477)
- [Altering Properties of Defined Queries](#) (page 1259)
- [Saving Queries](#) (page 177)

If you run a Report query, the report template specifies the information to write to an external file.

To create a report template

- 1 Click Home tab ► Data panel ► Define Query. 
- 2 In the Define Query dialog box, under Query Mode, click Report.
- 3 Click Options.
- 4 In the [Output Report Options dialog box](#) (page 1852), specify the information to include in the report.
Click Expression and select the item to include.
You can edit the expression box to add a calculation to the variable. For example, you can edit an area dot variable to reflect the scale of a map.
- 5 To associate a range with the expression, select the range table name from the Range list. To [define a range table](#) (page 1272), click Ranges.

- 6 Click Add to add each expression to the Report Template list.
- 7 Select Process Sub-Objects to create a line in the report for each component of an object, for example, polyline vertices or centroids, links, and nodes in a polygon topology.
- 8 Select Apply Transformation to apply a transformation to the values displayed report.
If you have used either a coordinate system transformation or a simple transformation in the current map, you must select this option to apply the transformation to the values in the report.
- 9 Specify a name and location for the output report file.
- 10 Click OK to close the dialog box.

Quick Reference

ADEQUERY

Controls defining, modifying, saving, loading, and executing a query

Menu	In the Classic workspace, click Setup menu ► More DWG Options ► Define Query
Icon	 Define Query
Command Line	ADEQUERY
Task Pane	In Map Explorer, right-click Current Query ► Define -or- Right-click a query ► Edit
Dialog Box	Define Query dialog box

Overview of Working with Metadata

Metadata is data about data. Geospatial metadata describes your GIS data according to an established standard to help others who use your maps to understand them. Organizing your data according to standards helps you manage it more efficiently, enforces data quality, and facilitates data sharing. In AutoCAD Map 3D, you can automatically generate metadata for DWGs; their [resources](#) (page 2072), such as object or feature classes; and non-DWG files.

AutoCAD Map 3D currently supports two standards for geospatial metadata: the [FGDC CSDGM Standard](#) (page 2063) and [ISO 19139](#) (page 1483).

The FGDC Standard (United States)

In 1998, the Federal Geographic Data Committee (FGDC) released the *Content Standard for Digital Geospatial Metadata* (the [FGDC CSDGM Standard](#) (page 2063)). Its goal is to promote electronic, geospatial information-sharing between various agencies and regions around the world. Some agencies in the United States may be required to create geospatial metadata that complies with this standard.

The FGDC standard specifies seven major sections of GIS metadata. Each section has several data elements, and [compound elements](#) (page 2057). Each element must meet one of the following conditions:

- Mandatory
- Optional
- Conditional

Conditional elements are “mandatory if applicable.” For example, if a particular data set does not have or need distribution information as defined by the FGDC,

you need not complete any of the fields in the Distribution Information section, even if some fields in that section are mandatory.

Information Type	Description	Requirement	Related Editor
Identification Information	Basic information about the data	Mandatory	Contact Information Editor (FGDC Metadata) (page 1762)
Data Quality Information	Overall quality of the data	Conditional	Citation Information Editor (FGDC Metadata) (page 1758)
Spatial Data Organization Information	How spatial information is represented in the data	Conditional	Spatial Data Organization Information Editor (FGDC Metadata) (page 1764)
Spatial Reference Information	Details about the spatial reference of the data, such as coordinates	Conditional	Horizontal Coordinate System Definition Editor (FGDC Metadata) (page 1768)
Entity and Attribute Information	The features and constraints of the data	Conditional	Attribute Domain Values Editor (FGDC Metadata) (page 1773)
Distribution Information	Who provides the data, and how it can be obtained	Conditional	Standard Order Process Editor (FGDC Metadata) (page 1774)

Information Type	Description	Requirement	Related Editor
Metadata Reference Information	How current the metadata is, and who maintains it	Mandatory	Time Period Information Editor (FGDC Metadata) (page 1761)

Because GIS data is so general, it remains usable outside the United States when formatted with this standard. For example, the FGDC standard shares many common fields with ISO 19139. To learn more about the FGDC and its GIS metadata standard, visit <http://www.fgdc.gov/metadata>.

ISO 19139

AutoCAD Map 3D supports ISO 19139. If your version of AutoCAD Map 3D is for any country except the United States, it is configured with ISO as the default. If you need to switch to a different standard, you can do so in the [Metadata Options dialog box](#) (page 1756).

Tell me more



Video

- [Show me how to view and interpret metadata.](#)
- [Show me how to create and edit metadata.](#)



Procedure

- [To set metadata options](#) (page 1485)
- [To work with metadata](#) (page 1487)
- [To enter or edit metadata manually](#) (page 1499)



Tutorial

- Lesson 6: Generate Metadata for a Classified Drawing



Workflow

- Create a Feature Map
- Create a CAD Map



GIS Skill

- *View and interpret metadata.*
- *Create metadata for your map.*



Related topics

- [Creating and Viewing Metadata](#) (page 1486)
- [Editing Metadata](#) (page 1498)
- [Sharing Metadata](#) (page 1510)
- [Setting Metadata Options](#) (page 1484)
- [Working with Metadata Templates](#) (page 1490)

Setting Metadata Options

You can select the [metadata](#) (page 2069) standard you want to work with, set template options, specify the precision to which the metadata measures your map's latitude/longitude values, and indicate whether or not you want the metadata for a data source to be updated as soon as you select it in the [Metadata Viewer](#) (page 1751).

Setting your metadata standard

The default standard is [FGDC](#) (page 2063) for AutoCAD Map 3D in the United States, and ISO 19139 for all other countries. You can change the standard in the [Metadata Options dialog box](#) (page 1756).

Keeping your metadata current

When Auto Update is selected, metadata for a data source is updated as soon as you select it in the [Metadata Viewer](#) (page 1751). If you [import](#) (page 1511) metadata from another AutoCAD Map 3D user, and remain connected to the data source, the metadata is updated when the data is updated. For example, if your organization keeps [classified DWGs](#) (page 2057) on a shared network, and someone updates an object in a DWG, the metadata you have imported from that object updates automatically.

If you do not always want to update your metadata automatically (for example, if you want to check it for accuracy first), do not select the Auto Update check box. Instead, click Update All each time you want to refresh your metadata.

Saving time with metadata templates

Using [metadata templates](#) (page 1491) prevents repetitive data entry, saving time to perform your other job functions. You can save frequently used metadata in a template to reuse as often as necessary.

See also:

- [Metadata Options dialog box](#) (page 1756)
- [Updating Metadata](#) (page 1503)

To set metadata options

- 1 Open the [Metadata Viewer](#) (page 1751).
- 2 On the [Metadata Viewer](#) (page 1751) toolbar, click Options.
- 3 In the [Metadata Options dialog box](#) (page 1756), on the Template tab, do any of the following:
 - Under Metadata Standard, select a standard.
 - [Import a template.](#) (page 1492)
 - [Set a default template.](#) (page 1494)
 - [Preview a template.](#) (page 1494)
 - [Deactivate a template.](#) (page 1495)
 - [Export a template.](#) (page 1496)
 - [Rename a template.](#) (page 1493)
 - [Remove a template.](#) (page 1497)
- 4 Click the Preference tab. Set the latitude and longitude precision.
Enter the number of digits (0 - 10) that display after the decimal point for your reported latitude and longitude values. Both values are 6 by default.
- 5 If desired, select the Auto Update check box.
When Auto Update is selected, metadata is updated as soon as you select it in the Metadata Viewer.
- 6 Click OK.

Quick Reference

MAPMETADATAOPTIONS

Displays the Metadata Options dialog box

Command Line MAPMETADATAOPTIONS

Dialog Box Metadata Options

Creating and Viewing Metadata

When you open the [Metadata Viewer](#) (page 1751) for the first time, [metadata](#) (page 2069) is automatically generated and displayed for the current drawing.

When you select a [resource](#) (page 2072) from the Current Drawing tree view, or a file from the Folder Shortcut tree view, the available metadata for that resource is displayed in the Metadata Viewer.

Some metadata information can be generated for the following resources:

DWG files	FDO file-based data	FDO RDBMS-based data	Web Services
DWGs that contain classified drawing objects	SDF files	Oracle Spatial	WFS
DWGs that do not contain classified drawing objects	SHP files	MySQL with spatial	WMS
	Raster files	SDE	
		SQL Server with spatial	

Metadata for resources in the Current Drawing tree view are stored in the drawing file. Metadata for resources in the Folder Shortcut tree view are stored in an automatically generated MTD file. The MTD file is saved in the same directory as the resource.

Tell me more



Video

- *Show me how to view and interpret metadata.*
- *Show me how to create and edit metadata.*



Procedure

- [To work with metadata](#) (page 1487)



Tutorial

- Lesson 6: Generate Metadata for a Classified Drawing



Workflow

- Create a Feature Map
- Create a CAD Map



GIS Skill

- *View and interpret metadata.*
- *Create metadata for your map.*



Related topics

- [Overview of Object Classification](#) (page 981)
- [Updating Metadata](#) (page 1503)
- [Editing Metadata](#) (page 1498)
- [Sharing Metadata](#) (page 1510)
- [Setting Metadata Options](#) (page 1484)
- [Working with Metadata Templates](#) (page 1490)

To do this...

Use this method...

Display the [Metadata Viewer](#) (page 1751)

In the Display Manager, select a layer. Click Tools ► View Metadata.

Create metadata for a drawing

In the Display Manager, right-click a layer ► View Metadata.

To do this...	Use this method...
Create metadata for a resource (page 2072)	In the Metadata Viewer, select the DWG or data source from the Current Drawing tree view.
To create metadata for a non-DWG file	<ol style="list-style-type: none"> 1 In the Metadata Viewer, in the Folder Shortcut area, click Add. 2 Select the file.
To add your own style sheet	<ol style="list-style-type: none"> 1 Import the stylesheet. (page 1489) 2 At the top of the Metadata tab (page 1753) click the Style sheet menu.
To display metadata in XML format	<ol style="list-style-type: none"> 1 At the top of the Metadata tab, click the Stylesheet menu. 2 Select XML.

Quick Reference

MAPMETADATAVIEWER

Displays the Metadata Viewer

Command Line MAPMETADATAVIEWER

Task Pane In Map Explorer, right-click the current drawing ►
View Metadata.

Dialog Box Metadata Viewer

Working with Metadata Style Sheets

The style of the [metadata](#) (page 2069) in the [Metadata Viewer](#) (page 1751) is controlled by a style sheet. You can use the default style sheet (FGDC Classic for [FGDC](#) (page 2063) metadata or ISO Classic for ISO metadata), one that you import from elsewhere, or no style sheet (unformatted XML).

To import a style sheet into the Metadata Viewer

- 1 Obtain a style sheet in valid XML format.

NOTE The use of stylesheets supplied by parties other than Autodesk is subject to the terms and conditions published by the provider of those stylesheets.

- 2 Save it to the following location:

For FGDC

- *C:\Program Files\AutoCAD Map 3D
2011\Support\Metadata\FGDC\Configuration\Style*

For ISO

- *C:\Program Files\AutoCAD Map 3D
2011\Support\Metadata\ISO\Configuration\Style*

- 3 Open the following file in any text or XML editor:

*C:\Program Files\AutoCAD Map 3D
2011\Support\Metadata\MetadataConfiguration.xml.*

- 4 Inside the `<MetadataStyleSheetSet>` tags, add a `<MetadataStyleSheet>` element. Use the following FGDC example as your guide:

```
<MetadataStandard>
  <Name>FGDC</Name>
  <MetadataProfile>
    <MetadataStyleSheetSet>
      <MetadataStyleSheet>
        <Name>Stylesheet1</Name>
        <Path>Support\Metadata\FGDC\Configuration\Style\Stylesheet1.xsl</Path>
      </MetadataStyleSheet>
    </MetadataStyleSheetSet>
  </MetadataStandard>
```

- 5 Open the [Metadata Viewer](#) (page 1751). (In the Display Manager, select a layer. Click Tools ► View Metadata.)
- 6 Select the new style sheet from the Stylesheet menu at the top of the [Metadata tab](#) (page 1753).

NOTE If your style sheet does not appear in the Stylesheet menu after you perform these steps, restart AutoCAD Map 3D, relaunch the Metadata Viewer, and click Stylesheet again.

Quick Reference

MAPMETADATAVIEWER

Displays the Metadata Viewer

Command Line	MAPMETADATAVIEWER
Task Pane	In Map Explorer, right-click the current drawing ► View Metadata.
Dialog Box	Metadata Viewer

Working with Metadata Templates

Overview of Metadata Templates

Metadata templates allow you to reuse [metadata](#) (page 2069) such as the contact information for your organization, or other common values that rarely change. Templates can be especially useful if your organization must create metadata for large numbers of legacy drawings. You can create new templates from existing metadata, or [import](#) (page 1492) them from other sources to increase your productivity.

See also:

- [Overview of Editing Metadata](#) (page 1498)
- [Updating Metadata](#) (page 1503)

To use metadata templates

- 1 [Create](#) (page 1492) or [import](#) (page 1492) the template you want.
- 2 [Apply the template](#) (page 1492).
- 3 If desired, set a default template:
 - [Preview](#) (page 1494) the templates to see which one you want.

- [Set a default template](#) (page 1494) for all metadata you generate from this point on.

Quick Reference

MAPMETADATAOPTIONS

Displays the Metadata Options dialog box

Command Line MAPMETADATAOPTIONS

Dialog Box Metadata Options

Using Metadata Templates

You can create or import (upload) an existing [metadata](#) (page 2069) template. Metadata templates must be in an XML file, and must comply with the structure of the standard with which you are working.

You can apply imported templates to your metadata. Applying a template overwrites any existing values. However, if they overwrite any values in [forced-update fields](#) (page 2064), those values will revert to the values from their data sources once the metadata is refreshed.

Once you have created or imported templates, you can set the one you use most often as a default.

See also:

- [Setting Metadata Options](#) (page 1484)
- [To create a new template](#) (page 1492)
- [To import a template](#) (page 1492)
- [To set a default template](#) (page 1494)
- [To export a template](#) (page 1496)
- [To deactivate a template](#) (page 1495)
- [To remove a template](#) (page 1497)
- [To create a template](#) (page 1492)

- [To import a template](#) (page 1492)
- [To apply a template](#) (page 1492)
- [To rename a template](#) (page 1493)

To create a template

- 1 In the [Metadata Viewer](#) (page 1751), select the data source from which you want to create a template.
- 2 Click Create Template.
- 3 In the [Create Metadata Template dialog box](#) (page 1758), enter a name for your template.
- 4 Click OK.
Your template is saved as an XML file. If you open the [Metadata Options dialog box](#) (page 1756), your new template will be listed in the Use Template window.

To import a template

- 1 In the Metadata Viewer, click Options.
- 2 In the [Metadata Options dialog box](#) (page 1756), click Import.
- 3 Browse to and select a template (an XML file).
- 4 Click Open.
The template is displayed in the Use Template window.

To apply a template

- 1 In the Metadata Viewer, select the data source to which you want to apply the template.
- 2 Right-click the data source.
- 3 Click Regenerate Metadata from Template.
An additional menu is displayed, listing all your saved metadata templates. If you have a default template already set, it is checked with an orange checkmark.
- 4 Select the template you want to apply.

The template is applied, and the Metadata tab refreshes with the updated metadata.

To rename a template

- 1 On the [Metadata Viewer](#) (page 1751) toolbar, click Options.
- 2 Select a template from the Use Template window.
- 3 Do one of the following:
 - Click Rename. Enter the new name and press ENTER.
 - Right-click a template in the Use Template window and rename it.

Quick Reference

MAPMETADATAOPTIONS

Displays the Metadata Options dialog box

Command Line MAPMETADATAOPTIONS

Dialog Box Metadata Options

Previewing Metadata Templates

You can preview a template to make sure it displays the intended metadata before you select it as a default. The Metadata Preview window behaves similarly to the Metadata tab in the [Metadata Viewer](#) (page 1751). The links are live, and you can collapse and expand levels of metadata to focus on specific areas.

See also:

- [To create a template](#) (page 1492)
- [To import a template](#) (page 1492)
- [To set a default template](#) (page 1494)
- [To apply a template](#) (page 1492)
- [To deactivate a template](#) (page 1495)

- [To export a template](#) (page 1496)
- [To rename a template](#) (page 1493)
- [To remove a template](#) (page 1497)

To preview a template

- 1 On the [Metadata Viewer](#) (page 1751) toolbar, click Options.
- 2 Select the template to preview from the Use Template window.
- 3 Click Preview.

Setting a Default Metadata Template

Once you have created or imported templates, you can set the one you use most often as a default.

See also:

- [To create a template](#) (page 1492)
- [To import a template](#) (page 1492)
- [To preview a template](#) (page 1494)
- [To apply a template](#) (page 1492)
- [To deactivate a template](#) (page 1495)
- [To export a template](#) (page 1496)
- [To rename a template](#) (page 1493)
- [To remove a template](#) (page 1497)

To set a default template

- 1 On the [Metadata Viewer](#) (page 1751) toolbar, click Options.
- 2 From the Use Template window, select the template to set as the default.
- 3 Select the Use Template check box.
- 4 Click OK.
The template you selected is set to be the default.

Deactivating Metadata Templates

If you have applied a template to your [metadata](#) (page 2069), but decide you do not want to use it, you can deactivate it. When you deactivate a metadata template, values that had come from the template are overwritten by values from the data source. Fields that are populated by values from the template, but that do not have corresponding values in the data source are cleared.

See also:

- [To create a template](#) (page 1492)
- [To import a template](#) (page 1492)
- [To apply a template](#) (page 1492)
- [To set a default template](#) (page 1494)
- [To export a template](#) (page 1496)
- [To remove a template](#) (page 1497)

To deactivate a template

- 1 In the [Metadata Viewer](#) (page 1751), click Options.
- 2 If the Use Template check box is selected, clear it.
- 3 Click OK.
- 4 Select the data source.
- 5 Click Update All.
- 6 Click Yes in the warning message that is displayed.

The metadata is updated with values from the data source you selected.

Quick Reference

MAPMETADATAOPTIONS

Displays the Metadata Options dialog box

Command Line MAPMETADATAOPTIONS

Dialog Box Metadata Options

Exporting Metadata Templates

Once you create a [metadata](#) (page 2069) template, you can export it as an XML file to share with others in your organization.

See also:

- [To create a template](#) (page 1492)
- [To import a template](#) (page 1492)
- [To apply a template](#) (page 1492)
- [To set a default template](#) (page 1494)
- [To deactivate a template](#) (page 1495)
- [To remove a template](#) (page 1497)

To export a template

- 1 In the [Metadata Viewer](#) (page 1751), click Options.
- 2 In the [Metadata Options dialog box](#) (page 1756), select a template from the Use Template window.
- 3 Click Export.
- 4 Browse to, and select the location to save the template.
- 5 Optionally, rename the template in the File Name field.

NOTE If a file name is already displayed, rename it unless you are sure that you want to overwrite the existing file with the one you are saving.

- 6 Click Save.

Quick Reference

MAPMETADATAOPTIONS

Displays the Metadata Options dialog box

Command Line MAPMETADATAOPTIONS

Dialog Box Metadata Options

Removing Metadata Templates

If you no longer want a [metadata](#) (page 2069) template to be available for use, you can remove it. If you have applied the template to metadata, removing the template does not cause any of the values in that metadata to change. To remove metadata that came from a template, see [Deactivating Metadata Templates](#) (page 1495).

See also:

- [Editing Metadata](#) (page 1498)
- [To create a template](#) (page 1492)
- [To import a template](#) (page 1492)
- [To apply a template](#) (page 1492)
- [To set a default template](#) (page 1494)
- [To deactivate a template](#) (page 1495)
- [To export a template](#) (page 1496)

To remove a template

- 1 In the [Metadata Viewer](#) (page 1751), click Options.
- 2 In the [Metadata Options dialog box](#) (page 1756), select the template to remove in the Use Template window.
- 3 Click Remove.

Quick Reference

MAPMETADATAOPTIONS

Displays the Metadata Options dialog box

Command Line MAPMETADATAOPTIONS

Dialog Box Metadata Options

Editing Metadata

Overview of Editing Metadata

Although the best practices for creating most [metadata](#) (page 2069) are [auto-generation](#) (page 2056), updating from the data source, using [templates](#) (page 1492), copying and pasting, or [importing](#) (page 1510) from similar sources, some data must be entered manually. [Metadata Editor](#) (page 1754) provides an interface in which to enter and manage your metadata.

Tell me more



Video

- [Show me how to view and interpret metadata.](#)
- [Show me how to create and edit metadata.](#)



Procedure

- [To enter or edit metadata manually](#) (page 1499)



Tutorial

- Lesson 6: Generate Metadata for a Classified Drawing



Workflow

- Create a Feature Map
- Create a CAD Map



GIS Skill

- [View and interpret metadata.](#)
- [Create metadata for your map.](#)



Related topics

- [Creating and Viewing Metadata](#) (page 1486)
- [Metadata Fields](#) (page 1755)



-
- [To enter or edit metadata manually](#) (page 1499)

- [To add a new item to a drop-down menu in the Metadata Editor](#) (page 1500)
- [To select an item from a drop-down menu in the Metadata Editor](#) (page 1501)
- [To edit an item in a drop-down menu in the Metadata Editor](#) (page 1501)
- [To delete an item in a drop-down menu in the Metadata Editor](#) (page 1501)
- [To enter text into a free-form field in the Metadata Editor](#) (page 1501)
- [To edit text in a free-form field in the Metadata Editor](#) (page 1502)
- [To delete text in a free-form field](#) (page 1502)

To enter or edit metadata manually

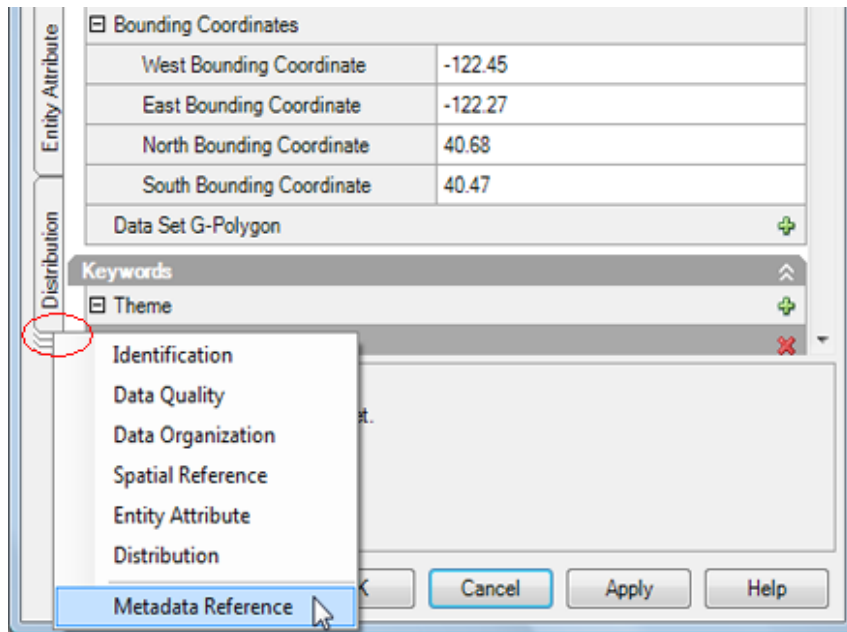
- 1 In the [Metadata Viewer](#) (page 1751), select the file or resource to edit.
- 2 Click Edit.
- 3 On the left side of the [Metadata Editor](#) (page 1754), click the tab for the section you want to edit. If all the tabs do not display on your screen, do one of the following:
 - Stretch the Metadata Editor vertically to make it longer.
 - Click the edges of the lowest tab, and select the tab you want from the menu that is displayed.



- 4 ■ Click 
 - to the left of a field group to reveal additional fields within that group.
 - Click  to contract a field group.
- 5 Enter the required changes in the appropriate fields.
- 6 Click Apply to save your changes and continue editing.
- 7 Click OK to save your changes and close the Metadata Editor.

To add a new item to a drop-down menu in the Metadata Editor

- 1 Click the field. A drop-down arrow is displayed.
- 2 Click the drop-down arrow. A menu is displayed.
- 3 Click New. A [compound element metadata editor](#) (page 1758) is displayed with empty fields.
- 4 Enter the new item.

- 5 Click OK. The item is saved, and will appear in the drop-down menu the next time you click the arrow.

To select an item from a drop-down menu in the Metadata Editor

- Double-click the item.

To edit an item in a drop-down menu in the Metadata Editor

- 1 Click the field. A drop-down arrow is displayed.
- 2 Click the drop-down arrow. A menu is displayed.
- 3 Select the item to edit.
- 4 Click Edit. A [compound element metadata editor](#) (page 1758) is displayed, showing the metadata from your selection.
- 5 Edit the metadata.
- 6 Click OK to save the edits.

To delete an item in a drop-down menu in the Metadata Editor

- 1 Click the field. A drop-down arrow is displayed.
- 2 Click the drop-down arrow. A menu is displayed.
- 3 Select the item to delete.
- 4 Click Delete.

To enter text into a free-form field in the Metadata Editor

- 1 Click the field. A drop-down arrow is displayed.
- 2 Click the arrow. The field expands.
- 3 Select the bottom, right-hand corner of the field, and drag it outward until it is the size and shape that you want.
- 4 Enter text into the field, or paste it in from another source.
- 5 When you are finished, click somewhere else on the screen. The field is no longer displayed.
- 6 Click OK to save the text.

To edit text in a free-form field in the Metadata Editor

- 1 Click the field. A drop-down arrow is displayed.
- 2 Click the arrow. The field expands.
- 3 Select the bottom, right-hand corner of the field, and drag it outward until it is the size and shape that you want.
- 4 Edit the text like you would in a simple text editor.
- 5 When you are finished, click somewhere else on the screen. The field is no longer displayed.
- 6 Click OK to save your edits.

To delete text in a free-form field

- 1 Click the field. A drop-down arrow is displayed.
- 2 Click the arrow. The field expands.
- 3 Select the bottom, right-hand corner of the field, and drag it outward until it is the size and shape that you want.
- 4 Delete text like you would in a simple text editor.
- 5 When you are finished, click somewhere else on the screen. The field is no longer displayed.
- 6 Click OK to save the deletion.

Quick Reference

MAPMETADATAVIEWER

Displays the Metadata Viewer

Command Line	MAPMETADATAVIEWER
Task Pane	In Map Explorer, right-click the current drawing ► View Metadata.
Dialog Box	Metadata Viewer

Updating Metadata

You can specify that your [metadata](#) (page 2069) is updated automatically, or you can update it manually.

Update Automatically

If you select the Auto Update check box in the [Metadata Options dialog box](#) (page 1756), your metadata will be updated as soon as its data source is updated if the drawing is connected to the data source. If the drawing is not connected, the metadata will update the next time you connect to the source.

Update Manually

To update metadata manually, you can use Update Auto in the [Metadata Viewer](#) (page 1751) or in the [Metadata Editor](#) (page 1754). This will update the values for [forced-update fields](#) (page 2064). Forced-update fields are derived directly from their data source. Any manual overrides to values in the fields are updated to those from the data source when you click Update Auto.

The labels for forced-update fields are highlighted in turquoise if you click Highlight in the [Metadata Editor](#) (page 1754).

Fields that are not forced-update fields maintain your manual overrides.

Use Update All to update all fields. This overrides any temporary fields or values you entered manually.

To update metadata for all fields

- In the Metadata Viewer or Metadata Editor, click Update All.

To update metadata for forced-update fields only

- In the Metadata Viewer, click Update Auto.

Quick Reference

MAPMETADATAVIEWER

Displays the Metadata Viewer

Command Line MAPMETADATAVIEWER

Task Pane	In Map Explorer, right-click the current drawing ► View Metadata.
Dialog Box	Metadata Viewer

Copying and Pasting Metadata

You can copy [metadata](#) (page 2069) from one source and paste it into another. You can copy and paste all the metadata from a data source, but not select parts. Because metadata standards require the metadata for [forced-update fields](#) (page 1503) to come directly from their data sources, any pasted metadata that differs from the values in these fields will not be saved.

To copy and paste metadata

- 1 In the [Metadata Viewer](#) (page 1751), right-click the data source from which you want to copy metadata.
- 2 Click Copy Metadata to Clipboard.
- 3 Right-click the data source to which you want to paste the metadata.
- 4 Click Paste Metadata from Clipboard.

The pasted metadata is displayed in the [Metadata Tab](#) (page 1753).

Quick Reference

MAPMETADATAVIEWER

Displays the Metadata Viewer

Command Line	MAPMETADATAVIEWER
Task Pane	In Map Explorer, right-click the current drawing ► View Metadata.
Dialog Box	Metadata Viewer

Adding and Deleting Records in the Metadata Editor

Some metadata elements can have multiple records. You can add or delete these records within the Metadata Editor.

See also:

- [Creating and Viewing Metadata](#) (page 1486)
- [Compound Element Metadata Editors](#) (page 1758)

To add a new record to a metadata element

- Click .

To delete a record from a metadata element

- Click .

Quick Reference

MAPMETADATAVIEWER

Displays the Metadata Viewer

Command Line	MAPMETADATAVIEWER
Task Pane	In Map Explorer, right-click the current drawing ► View Metadata.
Dialog Box	Metadata Viewer

Working with Compound Metadata Elements



Some metadata elements consist of multiple elements. These are called *compound elements*. Some [compound elements](#) (page 2057) have their own editors within the [Metadata Editor](#) (page 1754). These [compound element editors](#) (page 1758) have more detailed field labels, as well as explanations of those fields.

A compound element that has its own editor displays an ellipsis  on the right side of the field when you click it.

See also:

- [Using the Record Navigator](#) (page 1506)

To edit a compound metadata element

- 1 In the [Metadata Editor](#) (page 1754) click a field that displays an ellipsis  on the right side of the field.
- 2 Click the ellipsis  .
- 3 In the [compound element editor](#) (page 1758), make the required edits.
- 4 Click OK.

Quick Reference

MAPMETADATAVIEWER

Displays the Metadata Viewer

Command Line MAPMETADATAVIEWER

Task Pane In Map Explorer, right-click the current drawing ►
View Metadata.

Dialog Box Metadata Viewer

Using the Record Navigator

Some of the [compound element editors](#) (page 1505) have fields or field groups that can save more than one entry. These fields have a small button with four arrows on the right side of the field. If you hover over this button, the Record Navigator is displayed. The Record Navigator is inactive until you enter values into the field or fields for which it stores records. Once a value is saved, you can keep entering values in the same field.

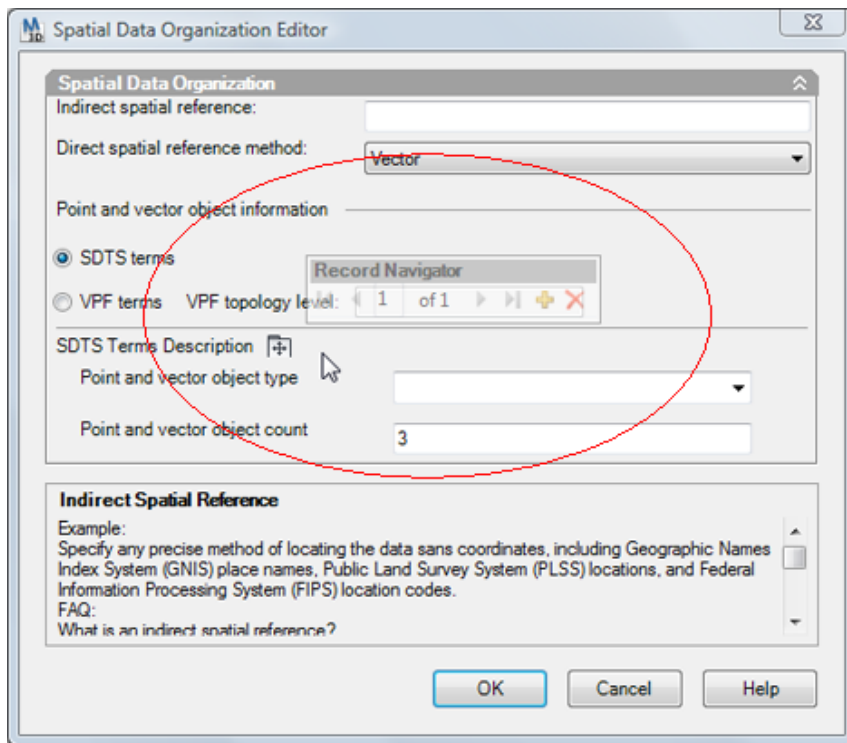

When you hover over the Record Navigator button, the Record Navigator is displayed. Here, the Record Navigator is transparent because it is not yet storing any records.

See also:





- [Creating and Viewing Metadata](#) (page 1486)
- [Editing Metadata](#) (page 1498)
- [To add records using the Record Navigator](#) (page 1507)
- [To locate a record in the Record Navigator](#) (page 1508)
- [To delete a record in the Record Navigator](#) (page 1508)

To add records using the Record Navigator

- 1 If the fields in the [compound element editor](#) (page 1758) are blank, enter values into them as you normally would.

- 2 If the fields are populated, and you want to add more values, hover over the Record Navigator button. The Record Navigator is displayed.
- 3 Click  in the Record Navigator. The related fields in the editor are cleared to accept new entries.
- 4 Enter values into the fields.
- 5 Click anywhere on the screen to hide the Record Navigator.
- 6 Click OK to save the new records.

To locate a record in the Record Navigator

- 1 Hover over the Record Navigator button. The Record Navigator is displayed.
- 2 Hover over the Record Navigator. It is no longer transparent.
 - Click  to go to the first record.
 - Click  to go to the last record.
 - Click  to move one record toward the first.
 - Click  to move one record toward the last.

To delete a record in the Record Navigator

- 1 Locate the record you want to delete.
- 2 Click .

Quick Reference

MAPMETADATAVIEWER

Displays the Metadata Viewer

Command Line	MAPMETADATAVIEWER
Task Pane	In Map Explorer, right-click the current drawing ► View Metadata.
Dialog Box	Metadata Viewer

Auditing Metadata

The [Metadata Editor](#) (page 1754) has an auditor to help you comply with the [metadata](#) (page 2069) standard you are using. The auditor marks empty required fields with auditing symbols that look like caution signs .

These symbols also appear on the tabs along the left side of the Metadata Editor to indicate errors in that section. If no auditing symbol is displayed on a tab, the auditor found no errors in that section.

Once an acceptable value is entered into the field, or other fields in the same field group, the auditing symbol will not be displayed the next time you click Audit.

To audit metadata

- In the [Metadata Editor](#) (page 1754), click .

To view auditing descriptions

- Hover over an auditing symbol .

To clear an auditing symbol

- Enter a valid value into the field.

- Click .

Quick Reference

MAPMETADATAVIEWER

Displays the Metadata Viewer

Command Line	MAPMETADATAVIEWER
Task Pane	In Map Explorer, right-click the current drawing ► View Metadata.
Dialog Box	Metadata Viewer

Sharing Metadata

Overview of Sharing Metadata

The best practice for sharing [metadata](#) (page 2069) within an organization is to store the source data on a server. This ensures that any metadata that you work with on your local machine remains current. If you save a file-based data source to your local machine, the file that keeps the metadata linked to the source data looks for that data on your machine. This can be problematic if you want to share the metadata file. The linking mechanism attempts to locate the data in the same place that you stored it. To work around this, send the data source to the new user. They must either save everything in the exact same locations as you did, or edit the FSD file to point to the new location of the data source.

See also:

- [Importing Metadata](#) (page 1510)
- [Exporting Metadata](#) (page 1512)

To do this...	Use this method...
Print metadata	<ol style="list-style-type: none">1 In the Metadata Viewer (page 1751), select a style sheet.2 Click Print.
Export (page 1513) metadata	■ In the Metadata Viewer, click Export.
Import (page 1511) metadata	■ In the Metadata Viewer, click Import.
Publish (page 1515) metadata	■ In the Metadata Viewer, click Publish.

Importing Metadata

One way to share [metadata](#) (page 2069) is by to import metadata created in AutoCAD Map 3D.

For Object Classes

When you import metadata for an object class (one type of [resource](#) (page 2072)), you can either open the [DWG](#) (page 2061) file containing that class (and its metadata), or append the metadata for the object class to the metadata for an existing object class in your current drawing. To do so, the metadata of the object class you are importing must have the exact same name as the existing object class.

For feature classes

When importing metadata for a feature class (another type of [resource](#) (page 2072)), AutoCAD Map 3D tries to connect to the feature source by launching the Data Connect dialog box with its connection parameter fields filled.

In the [Metadata Viewer](#) (page 1751), you can import a metadata storage (MTD) file.

Import metadata values

In the [Metadata Editor](#) (page 1754), you can import an XML file. As long as the file is structured according to the standard, the metadata values in it overwrite the current ones, except for the values in forced-update fields.

See also:

- [Import Metadata Options dialog box](#) (page 1757)
- [Setting Up Object Classification](#) (page 116)
- [Editing Metadata](#) (page 1498)
- [Exporting Metadata](#) (page 1513)
- [Publishing Metadata](#) (page 1515)

To import metadata for DWGs or their resources

- 1 In the [Metadata Viewer](#) (page 1751), click Import.
- 2 Browse to, and select the MTD file you want to import.
- 3 Click Open.
- 4 In the [Import Metadata Options dialog box](#) (page 1757) elect one of the following:
 - Open the original project DWG file

- Append the source metadata to the current metadata

5 Click OK.

To import metadata for Non-DWG files

- 1 In the [Metadata Editor](#) (page 1754), click Import.
- 2 Browse to, and select the XML file you want to import.
- 3 Click Open.

To import ESRI metadata

- 1 In ESRI, use ArcCatalog to export metadata in an ESRI profile to the FGDC or ISO standard in XML format.
- 2 In the AutoCAD Map 3D [Metadata Editor](#) (page 1754), click Import Metadata Values.
- 3 In the Open dialog box, select the XML file you exported from ESRI, and click Open.

Quick Reference

MAPMETADATAVIEWER

Displays the Metadata Viewer

Command Line	MAPMETADATAVIEWER
Task Pane	In Map Explorer, right-click the current drawing ► View Metadata.
Dialog Box	Metadata Viewer

Exporting Metadata

You can share your [metadata](#) (page 2069) with other AutoCAD Map 3D users by exporting it. If you wish to share metadata with users of other products, see [Publishing and Printing Metadata](#) (page 1514).

For current drawing classified DWGs

For a [classified DWG](#) (page 2057) used as the current drawing, the metadata is stored inside the DWG. Because the DWG file stores the location of the data source, the metadata will be [updated](#) (page ?) with each data update, or each time it connects to updated data.

When you export metadata from a current classified DWG, it is transferred to an MTD file. Although the file has an .mtd extension, its format is XML. A linking file is also created and placed in the same location as the MTD file. If the following conditions are met, the linking file retains the location of the data, and the exported metadata are kept current.

- The MTD file and the linking file are kept together
- The data source remains in the same location
- Auto update is selected in the [Metadata Options dialog box](#) (page 1756)

For non-DWG files and feature classes

An MTD file is also generated when you create metadata for a non-DWG file or a feature class (which is one type of [resource](#) (page 2072)).

When you export metadata for a feature class, a feature source definition (FSD) file is created in addition to the MTD. In this case, it is the FSD file that keeps the metadata linked to its source data.

See also:

- [Updating Metadata](#) (page ?)
- [Importing Metadata](#) (page 1511)
- [Publishing Metadata](#) (page 1515)
- [Setting Up Object Classification](#) (page 116)

To export metadata

- 1 In the [Metadata Viewer](#) (page 1751), click Export.
- 2 In the [Export Metadata dialog box](#) (page 1757), do one of the following:
 - For the current DWG file, click Selected Item.
 - For resources, click All Items In, and select the applicable resources.
- 3 Click Browse to select a location to save the files.

- 4 Click Export.

Quick Reference

MAPMETADATAVIEWER

Displays the Metadata Viewer

Command Line	MAPMETADATAVIEWER
Task Pane	In Map Explorer, right-click the current drawing ► View Metadata.
Dialog Box	Metadata Viewer

Publishing and Printing Metadata

Publishing metadata

You can publish [metadata](#) (page 2069) to the following file formats: XML, HTML, and TXT.

If you publish metadata for an object class or feature source, AutoCAD Map 3D creates an XML file for each object or each feature. If you publish a DWG containing feature sources and object classes, the XML file describes each object and feature in the DWG, but not as thoroughly as it does if you publish them separately.

NOTE It is possible to publish metadata that does not comply with the standard with which you are working. Audit your metadata to check for errors (see [Auditing Metadata](#) (page 1509)).

Printing metadata

When you print [metadata](#) (page 2069), the printout is formatted using the style sheet that is currently selected in the [Metadata Viewer](#) (page 1751).

See also:

- [Importing Metadata](#) (page 1510)
- [Exporting Metadata](#) (page 1512)

To publish metadata

- 1 In the [Metadata Viewer](#) (page 1751), click Publish.
- 2 Optionally, rename the file.
- 3 Select a location to save the file.
- 4 Under Save As Type, select a file type.
- 5 Click OK.

To print metadata

- 1 In the Metadata Viewer, select a style sheet.
- 2 Click Print.

Quick Reference

MAPMETADATAVIEWER

Displays the Metadata Viewer

Command Line	MAPMETADATAVIEWER
Task Pane	In Map Explorer, right-click the current drawing ► View Metadata.
Dialog Box	Metadata Viewer

Reference Guide

This section provides comprehensive information about AutoCAD Map 3D commands, expressions and variables, and the dialog boxes where many of the AutoCAD Map 3D settings can be specified.

Command Reference

11

AutoCAD Map 3D adds its own unique mapping and spatial data management commands to the AutoCAD command set. You get all the power and design capabilities of AutoCAD plus the spatial context needed for mapping.

Commands can be accessed using a variety of methods:

- Enter a command in the drawing area or on the command line.
- Select the command from the menu.
- Click the toolbar icon for the command.
- Right-click an object in the drawing or an item in the Task Pane and select the command from the shortcut menu

This section provides information about the mapping commands in AutoCAD Map 3D.

For information about AutoCAD commands, see the AutoCAD Help.

To learn more about the various ways you can use a command, click the Quick Reference tab of a help topic.

- [Mapping Commands](#) (page 1519)
- [Discontinued Commands](#) (page 1533)
- [MAPWSACTION](#) (page 1536)
- [REFEDIT](#) (page 1536)
- [Wildcard Characters](#) (page 1537)
- [Improving Performance](#) (page 1538)

Mapping Commands

Following is a list of mapping commands. Click a command name for information about how to use it.

For information about AutoCAD commands, see the AutoCAD Help.

Command	Description
AD (page 1033)	Specifies a point based on angle and distance from a given point
ADEATTACHDATA (page 1065)	Attaches object data to objects
ADEDEFCDRDSYS (page 93)	Defines a global coordinate system
ADEDEFDATA (page 201)	Defines object data
ADEDRAWINGS (page 156)	Manages the drawing set
ADEDWGMMAINT (page 1920)	Removes locks from objects
ADEDWGSTAT (page 1926)	Displays drawing statistics
ADEEDITDATA (page 1070)	Edits attached object data
ADEFILLPOLYG (page 939)	Fills a selected polygon
ADEGENLINK (page 523)	Automatically links objects to object data or external database records
ADEQUERY (page 1237)	Controls defining, modifying, saving, loading, and executing a query
ADEQUERYLIB (page 183)	Maintains the library of queries
ADEQVIEWDWGS (page 747)	Performs a quick display of active drawings
ADEREMOBS (page 1885)	Removes objects from the save set so they aren't saved to source drawings
ADERSHEET (page 935)	Performs rubber sheeting on selected objects
ADERUNQUERY (page 179)	Runs queries in the Query Library
ADERUNXQUERY (page 181)	Runs externally saved queries

Command	Description
ADESAVEOBS (page 1887)	Saves objects in the save set back to source drawings
ADESELOBS (page 1886)	Creates a set of objects to be saved to source drawings
ADESETCRDSYS (page 148)	Assigns a global coordinate system code for the current drawing
ADESHOWOBS (page 1887)	Displays the objects in the save set
ADETEXTLOC (page 937)	Redefines the default label point of an object for text
ADETRANSFORM (page 932)	Moves, scales, and rotates a set of objects
ADEWHOHASIT (page 1889)	Displays the current owner of a selected locked object
ADEZEXTENTS (page 745)	Performs a ZOOM command to display the extents of selected active drawings
ATTACHDEF (page 995)	Changes the current object class definition file
BB (page 1037)	Specifies a point using bearings from two given points.
BD (page 1035)	Specifies a point based on bearing and distance from a given point
CLASSIFY (page 990)	Classifies existing objects
DD (page 1039)	Specifies a point based on deflection and distance from a given point
DDIST (page 1041)	Specifies a point based on distances from two other points.
FEATUREDEF (page 122)	Defines a new object class based on an example in the current drawing

Command	Description
MAP2SDF (page 1419)	Exports an SDF 2 file for use with Autodesk MapGuide 6.5 or earlier. Same as MAPEX-PORTMAPGUIDE.
NO LABEL (page 377)	Adds a point cloud from an indexed point cloud data store
MAPABOUT	Gives information about AutoCAD Map 3D
MAPAL (page 881)	Adds a link to a network topology
MAPAN (page 879)	Adds a node to a topology
MAPANBUFFER (page 1348)	Creates a buffer around an existing topology
MAPANDISSOLVE (page 1345)	Dissolves a topology into constituent topologies
MAPANDELETE (page 1109)	Deletes all annotation based on selected template
MAPANNINSERT (page 1574)	Adds annotation to objects based on selected annotation template
MAPANNREFRESH (page 1106)	Refreshes existing annotation
MAPANNTEMPLATE (page 194)	Defines and modifies annotation templates
MAPANNTEXT (page 194)	Creates and edits annotation text
MAPANNUPDATE (page 1108)	Updates existing annotation
MAPANOVERLAY (page 1341)	Overlays one topology with another, and creates a new topology
MAPANTOPONET (page 1322)	Traces through a network topology (shortest path trace, best route analysis, or flood trace)
MAPAP (page 884)	Adds a polygon to a polygon topology

Command	Description
MAPATTACHDB (page 210)	Attaches a data source to a drawing
MAPAUTOCHECKOUT (page 696)	Automatically checks-out features that are edited
MAPBL (page 864)	Breaks a link in a topology at a specified point
MAPBOOKCREATE (page 1389)	Creates a map book to publish your data
MAPBREAK (page 942)	Breaks objects along a selected or defined boundary
MAPBROWSELINK (page 1053)	Opens a database table associated with a specific link template to edit in the Data View
MAPBROWSETBL (page 1053)	Opens a database table to edit in the Data View
MAPCANCELCHECKOUT (page 698)	Discards edits and unlocks the features in the feature source. Edits are not discarded if Update Edits Automatically is enabled
MAPCGADIST (page 1158)	Adds the distances between points
MAPCGANG (page 1160)	Displays the angle between lines or points
MAPCGAZBASE (page 234)	Sets the azimuth base
MAPCGDIST (page 1159)	Displays the distance between points
MAPCGLIST (page 1161)	Displays coordinate geometry information for lines and arcs
MAPCGSETUP (page 234)	Specifies coordinate geometry settings
MAPCGSLIST (page 1162)	Displays the slope between points

Command	Description
MAPCHECKIN (page 694)	Saves modified features back to their feature source and unlocks the features in the feature source
MAPCHECKOUT (page 696)	Makes feature available for editing and if locking is available, sets locks on the source
MAPCLEAN (page 768)	Performs drawing cleanup operations
MAPCLPLINE (page 898)	Creates polylines from a polygon topology
MAPCOGO (page 1029)	Opens the COGO Input dialog box, which allows you to enter coordinate geometry data.
MAPCONFIGDB (page 214)	Configures the connection to an external data source
MAPCONNECT (page 309)	Connects to a feature source
MAPCONNECTDB (page 215)	Connects to an attached data source
MAPCONNECTIONPOOLING (page 89)	Toggles default connection pooling setting.
MAPCREATECENTROIDS (page 887)	Creates a centroid in a polygon and moves data to the centroid
MAPCREATEFEATUREFROMGEOMETRY (page 693)	Converts drawing objects to features to create new features.
MAPDATATABLE (page 1129)	Opens the Data Table, which allows you to view, edit and filter feature data
MAPDEFINELT (page 526)	Defines a link template for a database table
MAPDELETELINKS (page 537)	Deletes database links from objects
MAPDELELET (page 539)	Deletes a link template
MAPDETACHDB (page 215)	Detaches a data source from a drawing

Command	Description
MAPDIGISETUP (page 133)	Sets up user options for digitizing nodes and linear objects
MAPDIGITIZE (page 1082)	Digitizes nodes and linear objects with settings from mapdigisetup
MAPDISCONNECTDB (page 215)	Disconnects an attached, connected database
MAPDISPLAYLIBRARY (page 1621)	Turns on and off the Display Library palette.
MAPDIST (page 1153)	Measures the geodetic distance between points
MAPDL (page 890)	Deletes a link in a network topology.
MAPDN (page 890)	Deletes a node in a topology.
MAPDP (page 890)	Deletes a polygon from a polygon topology.
MAPDOCKWSPACE (page 1908)	Docks and undocks the Task Pane
MAPDVP (page 868)	Divides a polygon in a polygon topology by allowing you to add a link
MAPDWFOPTIONS (page 1366)	Sets AutoCAD Map 3D options for publishing to DWF.
MAPDWGTOSDF	Exports an SDF
MAPEDITDIR (page 848)	Edits direction of a link in a network topology
MAPEDITRES1 (page 850)	Edits direct resistance of a node or link in a network topology
MAPEDITRES2 (page 850)	Edits reverse resistance of a link in a network topology

Command	Description
MAPEDITSETAUTO (page 698)	Updates feature edits automatically
MAPEDITSETAUTODEFAULT (page 88)	Toggles default setting for Update Edits Automatically
MAPFEATUREEDITOPTIONS (page 241)	Specifies options for editing features
MAPEXPORT (page 1410)	Exports data from AutoCAD Map 3D to an external file format
MAPEXPORTMAPGUIDE (page 1419) (Same as MAP2SDF)	Exports an SDF 2 file for use with Autodesk MapGuide 6.5 and earlier. Same as MAP2SDF
MAPEXTRACTFEATUREGEOMETRY (page 716)	Extracts the geometry from a feature to use AutoCAD commands that are not available for features
MAPFDOBUFFERCREATE (page 1309)	Creates a buffer zone around features in your map
MAPFEATUREEDIT (page 701)	Edits a feature.
MAPFEATUREEDITOPTIONS (page 241)	Specifies options for editing features
MAPFEATUREMERGE (page 711)	Merges features and assigns feature property values for the resulting feature
MAPFEATURESPLIT (page 709)	Splits features and assigns feature property values for resulting features
MAPGISOVERLAY (page 1318)	Performs overlay analysis on feature classes
MAPHILLSHADE (page 1201)	Specifies the settings to use for shading 3D raster-based surfaces
MAPIFRAME (page 495)	Makes frames enclosing raster images, visible or invisible
MAPIGNORESPLITMERGERULES (page 1653)	Determines whether or not the rules for split and merge are used

Command	Description
MAPIINFO (page 475)	View file, image, object property, and correlation information about selected images
MAPIINSERT (page 462)	Inserts a raster image
MAPIL (page 881)	Inserts a link in a topology
MAPIMANAGE (page 475)	View list of images in current drawing, change drawing order, erase or zoom to selected images
MAPIMPORT (page 384)	Imports an external file format into AutoCAD Map 3D
MAPIMPORTMAPGUIDE (page 390) (Same as MAPSDFIN)	Imports an SDF 2 file from Autodesk MapGuide 6.5 or earlier. Same as MAPSDFIN.
MAPIN (page 879)	Inserts a node in a topology.
MAPIOPTIONS (page 249)	Specify default image correlation settings, display options, detach options, paths, and memory settings
MAPJL (page 864)	Joins two links in a topology
MAPLINESTRINGCREATE (page 1654)	Creates a new LineString feature
MAPLINESTRINGEDIT (page 1655)	Edits a LineString feature
MAPLINKEDIT (page 864)	Edits a link in a network topology
MAPLINKMANAGER (page 537)	Edits the link data attached to an object
MAPLINKUPD (page 892)	Updates links in a network topology
MAPLOGIN (page 142)	Log in as an AutoCAD Map 3D user
MAPMEL (page 864)	Repositions an end point of a link in a network topology
MAPML (page 864)	Moves a link in a network topology

Command	Description
MAPMN (page 861)	Moves a node in a node topology or moves a node at the end of a link in network or polygon topologies
MAPMP (page 868)	Merges polygons in a polygon topology
MAPMULTILINESTRINGCREATE (page 1656)	Creates a new MultiLineString feature
MAPMULTILINESTRINGEDIT (page 1658)	Edits a MultiLineString feature
MAPMULTIPOINTCREATE (page 1659)	Creates a new MultiPoint feature
MAPMULTIPOINTEDIT (page 1659)	Edits a MultiPoint feature
MAPMULTIPOLYGONCREATE (page 1660)	Creates a new MultiPolygon feature
MAPMULTIPOLYGONEDIT (page 1662)	Edits a MultiPolygon feature
MAPNODEEDIT (page 861)	Edits a node in a topology
MAPNODUPD (page 892)	Updates nodes in a topology
MAPOD2ASE (page 535)	Converts object data tables to linked external database tables.
MAPOPTIONS (page 218)	Sets AutoCAD Map 3D options
MAPPOINTCREATE (page 1663)	Creates a new Point feature
MAPPOLYGONCREATE (page 1663)	Creates a new Polygon feature
MAPPOLYGONEDIT (page 1665)	Edits a polygon feature
MAPPOLYLINETOPOLYGON (page 972)	Converts closed polylines to polygons
MAPPOLYUPD (page 892)	Updates a polygon topology
MAPPROPSLT (page 539)	Edits the database table name or location in a link template

Command	Description
MAPPUBLISHTOMAPGUIDE (page 1378)	Publishes to the new MapGuide technology (Autodesk MapGuide Enterprise 2007 or MapGuide Open Source)
MAPRL (page 848)	Reverses a link in a network topology.
MAPRUNDBQUERY (page 1049)	Runs a database query and opens a database table displaying the results of the query in the Data View
MAPSDFIN (page 390)	Imports an SDF format file from Autodesk MapGuide
MAPSEARCH (page 1215)	Searches for and selects features in your map, based on the location and attribute criteria you specify
MAPSELECTCHECKEDOUT (page 696)	Highlights features in the drawing that are from the selected feature source
MAPSELECTCLASSIFIED (page 994)	Selects all classified objects
MAPSELECTUNCLASSIFIED (page 994)	Selects all objects that have no classification assigned to them
MAPSELECTUNDEFINED (page 994)	Selects all objects whose classification is not defined in the object class definition file
MAPSHOWGEOM (page 912)	Highlights objects in the selected topology
MAPSHOWTOPO (page 912)	Highlights and identifies topologies for the selected object
MAPSTATUSBAR (page 89)	Shows or hides the Map status bar.
MAPTEXTCREATE (page 1115)	Adds text features to an annotation layer
MAPTEXTEDIT (page 1116)	Allows you to edit text features on an annotation layer

Command	Description
MAPTEXTLAYERCREATE (page 1111)	Creates an annotation layer for freestanding text features
MAPTOPOAUDIT (page 921)	Checks that a topology is complete and contains no errors
MAPTOPOCOMP (page 921)	Completes a network or polygon topology
MAPTOPOCREATE (page 825)	Creates a new topology.
MAPTOPODEL (page 926)	Removes topology data from objects, and optionally deletes the objects
MAPTOPOLOAD (page 908)	Loads a topology
MAPTOPOLOGY (page 975)	Converts an existing polygon topology to polygons
MAPTOPOQUERY (page 1354)	Queries topologies
MAPTOPORECR (page 921)	Reestablishes a topology that was edited with nontopology editing commands such as STRETCH, PEDIT, and MOVE
MAPTOPOREN (page 925)	Changes the name, description, or both of a topology
MAPTOPOSTATS (page 916)	Displays detailed information about a topology
MAPTOPOUNLOAD (page 908)	Unloads a topology
MAPTRACKCS (page 1151)	Tracks the coordinates of the cursor in any coordinate system
MAPTRIM (page 946)	Trims objects to a set of edges
MAPUPDATEFEATUREGEOMETRY (page 718)	Merges new or existing drawing object geometry with a feature.
MAPUSEMPOLYGON (page 980)	Enables/disables use of mapping polygons

Command	Description
MAPUSERADMIN (page 84)	Performs administrative functions
MAPVIEWLINK (page 528)	Opens a database table associated with a specific link template to view in the Data View
MAPVIEWTBL (page 1053)	Opens a database table to view in the Data View
MAPWORKOFFLINE (page 721)	Disconnects you from feature sources and caches all your feature data connections, allowing you to work with a local copy of your feature data.
MAPWORKONLINE (page 721)	Reestablishes connections with your feature sources so you are working live again and can check in any changes.
MAPWORKFLOWBATCHRUN	Runs the specified workflow from the command line. Use this in a script file to execute automated workflows.
MAPWORKFLOWCREATE (page 289)	Creates a workflow.
MAPWORKFLOWEDIT (page 289)	Edits a workflow.
MAPWORKFLOWOPEN (page 280)	Opens a workflow.
MAPWORKFLOWRUN (page 280)	Runs a workflow.
MAPWORKFLOWSAVE (page 277)	Saves a workflow.
MAPWORKFLOWSAVEAS (page 277)	Saves a workflow.
MAPWSACTION (page 1536)	Indicates that a shortcut menu command in the Task Pane has no link to an AutoCAD Map 3D command
MAPWSpace (page 1908)	Shows or hides the Task Pane
MAPWSREFRESH (page 1908)	Redisplays the Task Pane

Command	Description
MAPMPEDIT (page 967)	Edits polygons
MPFILL (page 980)	Sets the default fill for polygons
MPOLYGON (page 962)	Creates polygons
MPSPLIT (page 969)	Splits an existing polygon object into two new polygon objects
NEWDEF (page 130)	Creates a new object class definition file
POLYDISPLAY (page 980)	Changes the display of polygon edges and fill
UNCLASSIFY (page 990)	Removes classification from an object
ZD (page 1043)	Specifies a point based on azimuth and distance from a given point

Changed or Replaced Commands

Some commands have been replaced or discontinued in this release. Some of the commands still function, but they may not be available in future releases. You should update any scripts you have to use new commands. For more information, see [Discontinued Commands](#) (page 1533).

Using Wildcard Characters with Commands

Most AutoCAD Map 3D commands are wildcard character-enabled. For more information, see [Wildcard Characters](#) (page 1537).

See also:

- [REFEDIT](#) (page 1536)

Discontinued Commands

The following commands have been discontinued or replaced. Some may still function in this release. However, you should update your scripts to use new commands.

Category	Discontinued Command	Notes
Feature Data Objects (FDO)	FDOATTACH	Discontinued. Not used any more.
	FDOCONFIGURE	Discontinued. Not used any more.
	FDOCONNECT	Discontinued. New command is MAPCONNECT.
	FDODETACH	Discontinued. Not used any more.
	FDISASSOCIATE	Discontinued. Not used any more.
	FDISCONNECT	Discontinued. Not used any more.
	FDOEDITSETADD	Discontinued. New command is MAPCHECKOUT.
	FDOEDITSETREMOVE	Discontinued. New command is MAPCANCELCHECKOUT.
	FDOEDITSETSAVE	Discontinued. New command is MAPCHECKIN.
	FDOEDITSETSHOW	Discontinued. New command is MAPSELECTCHECKEDOUT.
	FDOLOCKS	Discontinued. Not used any more.
	FDOQUERY	Discontinued. Not used any more.

Category	Discontinued Command	Notes
	FDOREFRESH	Discontinued
	FDOSHEMA	Discontinued. Not used any more.
	FDOSHOWOWNER	Discontinued. Not used any more.
	FDOSYSADMIN / SYSADMIN	Discontinued
General	MAPSKINMAP	Discontinued
	MAPPLOTTRANSPARENCY	Discontinued
	MAPDISPLAYMANAGER	Discontinued
Import Export (Release 4)	MAPIMPORT4	Discontinued
	MAPEXPORT4	Discontinued
Drawing Cleanup	ADEDWGCLEAN	Discontinued in Autodesk Map 6. New command is MAP-CLEAN.
Oracle Spatial (Older Method)	ORACONNECT	Discontinued. For information about the new way, see Bringing In Features from Oracle (page 312).
	ORADISCONNECT	Discontinued
	ORAERUPDATE	Discontinued
	ORAEXPORT	Discontinued
	ORAIMPORT	Discontinued
	ORAINDEX	Discontinued

Category	Discontinued Command	Notes
	ORAUPDATE	Discontinued
Topology	MAPBUFFER	Discontinued. New command is MAPANBUFFER
	MAPCREATE	Discontinued. New command is MAPTOPOCREATE
	MAPDISSOLVE	Discontinued. New command is MAPANDISSOLVE
	MAPFLOOD	Discontinued. New command is MAPANTOPONET
	MAPLINKADD	Discontinued. New command is MAPAL
	MAPLINKDEL	Discontinued. New command is MAPDL
	MAPLINKREV	Discontinued. New command is MAPRL
	MAPNODADD	Discontinued. New command is MAPAN
	MAPNODDEL	Discontinued. New command is MAPDN
	MAPNODINS	Discontinued. New command is MAPIN
	MAPOVERLAY	Discontinued. New command is MAPANOVERLAY
	MAPPOLYADD	Discontinued. New command is MAPAP
	MAPPOLYDEL	Discontinued. New command is MAPDP

Category	Discontinued Command	Notes
	MAPTOPOADMIN	Discontinued. There are several new commands, for example, MAPTOPOLOAD and MAPTOPODEL. For a complete list, see Managing Topologies (page 898).
	MAPTOPOEDIT	Discontinued. There are several new commands, for example, MAPAN, MAPDL, and MAPMP. For a complete list, see Editing Topologies (page 851).
	MAPTRACE	Discontinued. New command is MAPANTOPONET

MAPWSACTION

This text represents a shortcut menu command in the Task Pane that has no link to an AutoCAD Map 3D command. For example, some topology commands that you choose from the shortcut menu in the Task Pane do not have corresponding AutoCAD Map 3D commands.

If you right-click in the drawing after completing such an action, you see "Repeat MAPWSACTION" in the menu. If you click this item, nothing will happen, by design. Likewise, if you right-click the command line, you see MAPWSACTION as one of the Recent Commands, but clicking on it will do nothing. The action that MAPWSACTION represents is not repeatable by typing MAPWSACTION on the command line. You must repeat the action from the Task Pane.

NOTE You cannot undo this operation using the UNDO command.

REFEDIT

Use the reference editing command to make modifications to Xrefs and blocks. While in REFEDIT mode, the Task Pane and Data View are grayed-out and some commands are unavailable. If you attempt to use one of these commands,

AutoCAD Map 3D displays a message that the command is not allowed during reference editing

Wildcard Characters

Most dialog boxes and command line entries support the following wildcard characters.

These wildcard characters can be used in object data queries and property queries. To use wildcard characters in SQL queries, refer to your database software for a list of supported characters.

Wildcard	Description
# (pound)	Matches any numeric digit.
@ (at)	Matches any alphabetic character.
. (period)	Matches any nonalphanumeric character.
* (asterisk) or % (percent)	Matches any string, including the null string. It can be used at the beginning, middle, or end of a string.
? (question mark)	Matches any single character.
~ (tilde)	Matches anything but the next pattern.
[] (brackets)	Matches any one of the characters enclosed.
[~] (tilde and brackets)	Matches any character not enclosed.
- (hyphen)	Specifies a range for a single character when inside brackets.
' (reverse quote)	Escape character; reads the next character literally.
, (comma)	Enters a set when used between items.

NOTE Most AutoCAD Map 3D commands are wildcard character-enabled. To use a wildcard character as a literal character, precede the wildcard character with a back quote (`). For example, if you have a layer named "Floor Plan #1," from which you want to query some objects, type Floor Plan `#1 when you create the query. If you select the name from a list box, the back quote is added automatically to the text that appears in any corresponding edit box. The wildcard characters for which this is valid include #, @, .(period), ~.

Improving Performance

You can improve performance in many areas by taking a few steps in advance. For example, creating indexes can greatly speed up queries and save back.

The following table lists some of the steps you can take to improve performance. For more information on an item, click the link.

Feature Layers

Filtering Feature Layers (page 1216)	You can filter a feature layer to reduce the number of features in the layer and improve performance. You can filter data as you bring it into your map (in Data Connect, click Add To Map With Query), or after you bring it in (right-click the layer and choose Query To Filter Data).
--	---

Query Attached Drawings

To turn off a global coordinate system (page 150)	Using the AutoCAD Map 3D global coordinate systems requires many complex calculations and can decrease performance for operations such as querying objects from attached drawings and saving back objects.
---	--

To create a drawing index (page 1294)	To reduce the amount of time it takes to perform a query, create an index. Instead of searching all locations, properties, object data, or database links to find matching data, AutoCAD Map 3D searches only the relevant index. If you created indexes in a previous release of AutoCAD Map 3D, it may help
---	---

Query Attached Drawings

to recreate the indexes in this release to ensure that they include any new features, such as color book names.

Raster Images

[To hide an image](#) (page 485) When you hide an image, the image does not display onscreen, nor does it plot. Only the image boundary displays onscreen. Hiding images is a convenient way to speed regeneration time. You can easily redisplay the image when you are ready to plot.

[To unload an image](#) (page 486) To conserve memory use and enhance performance, you can unload images that you do not currently need to view and/or plot.

[To configure memory for images](#) (page 259) Because memory management can be an issue when working with large images, you can configure the Raster Extension for best performance. Specify the amount of memory reserved for the image swap file. The higher the Memory Limit, the less swapping to hard disk occurs and the faster your images load and display. For best performance, use a local drive for your temporary swap file.

[To change the image display quality](#) (page 254) Display your images in high quality or draft quality. High quality dithers the pixels so that the areas between shading appear more gradual. Draft quality can speed up the performance of your system, but may reduce the quality of how some color and gray scale images appear onscreen.

Topology

Buffering a Topology Improve the performance of buffering operations by increasing the RAM to more than the recommended amount, or by increasing the virtual memory on your system. This is recommended if you are buffering large topologies.

DataView

[To use a SQL filter in the Data View](#) (page 1231) Filter, or limit, the data displayed in the Data View. Filters let you view only the records you want. This can improve

DataView

performance in scrolling through many records or in highlighting records.

Other

[To erase short linear objects](#) (page 796) Using the Erase Short Objects cleanup action, you can locate any objects shorter than the specified tolerance and erase them. This action reduces the number of unnecessary linear objects and nodes in a map.

[To simplify objects](#) (page 814) Simplifying linear objects reduces file size and improves performance but also reduces the resolution of the data.

[To add objects to the save set and lock the objects](#) (page 751) When modifying or working with a large number of objects, you can enhance performance by adding the objects to the EditSet (locking them) prior to working with them.

Expression Evaluator

12

Use expressions and variables to define data based on other information in your drawings or in external databases.

Most places where you can enter an expression, you can use the Expression dialog box to select from a list of available variables. You can combine expressions and variables to create complex expressions.

- [Functions](#) (page 1541)
- [Variables](#) (page 1546)
- [Using Color in Expressions](#) (page 1552)
- [Tips and Suggestions for the Expression Evaluator](#) (page 1553)

Functions

Expressions can include many types of functions.

See also:

- [Variables](#) (page 1546)

Arithmetic Functions

The expression evaluator supports the following arithmetic functions. The words in italics can be replaced by an actual value or a variable.

Expression	Description
(+ <i>number number [number] ...</i>)	Returns the sum of all numbers.

Expression	Description
(- <i>number number</i> [<i>number</i>] ...)	Subtracts the second and following numbers from the first and returns the difference.
(* <i>number number</i> [<i>number</i>] ...)	Returns the product of all numbers.
(/ <i>number number</i> [<i>number</i>] ...)	Divides the first number by the product of the remaining numbers and returns the quotient.
(abs <i>number</i>)	Returns the absolute value of the number.
(atan <i>num1</i> [<i>num2</i>])	Returns the arctangent of the number expressed in radians.
(cos <i>angle</i>)	Returns the cosine of the angle expressed in radians.
(exp <i>number</i>)	Returns the constant e (a real number) raised to a specified power (the natural antilog).
(expt <i>basepower</i>)	Returns a number raised to a specified power.
(fix <i>number</i>)	Returns the conversion of a real number into the nearest smaller integer.
(log <i>number</i>)	Returns the natural log of a number as a real number.
(log10 <i>number</i>)	Returns the base 10 logarithm for a number.
(sin <i>angle</i>)	Returns the sine of an angle as a real number expressed in radians.
(sqrt <i>number</i>)	Returns the square root of a number as a real number.
(tan <i>angle</i>)	Returns the tangent of an angle, measured in radians.

String-Handling Functions

The expression evaluator supports the following string-handling functions. The words in italics can be replaced by an actual value or a variable.

Expression	Description
(strcase <i>string</i> [<i>which</i>])	Returns a string where all alphabetic characters have been converted to uppercase or lowercase.
(strcat <i>string1</i> [<i>string2</i>] ...)	Returns a string that is the concatenation of multiple strings.
(strlen [<i>string</i>] ...)	Returns an integer that is the number of characters in a string.
(substr <i>stringstart</i> [<i>length</i>])	Returns a substring of a string.
(chr <i>integer</i>)	Returns the conversion of an integer representing an ASCII character code into a single-character string.
(LPAD <i>stringlength</i>)	ads the beginning of a string with spaces until the string reaches the length specified.
(RPAD <i>stringlength</i>)	ads the end of a string with spaces until the string reaches the length specified.
(trim <i>string</i> [<i>mode</i>])	Trims strings from the beginning, middle, or end of a string based on the mode. Mode can be B (beginning), M (middle), or E (end), or any combination. If no mode is specified, BE is used.

Equality and Conditional Functions

The expression evaluator supports the following equality and conditional functions. The words in italics can be replaced by an actual value or a variable.

Expression	Description
(= numstr [<i>numstr</i>] ...)	Returns T if all arguments are numerically equal, and returns nil otherwise.

Expression	Description
$(/= \textit{numstr} [\textit{numstr}] \dots)$ or $(<> \textit{numstr} [\textit{numstr}] \dots)$	Returns T if the arguments are not numerically equal, and nil if the arguments are numerically equal.
$(< \textit{numstr} [\textit{numstr}] \dots)$	Returns T if each argument is numerically less than the argument to the right, and returns nil otherwise.
$(<= \textit{numstr} [\textit{numstr}] \dots)$	Returns T if each argument is numerically less than or equal to the argument to the right, and returns nil otherwise.
$(> \textit{numstr} [\textit{numstr}] \dots)$	Returns T if each argument is numerically greater than the argument to the right, and returns nil otherwise.
$(>= \textit{numstr} [\textit{numstr}] \dots)$	Returns T if each argument is numerically greater than or equal to the argument to the right, and returns nil otherwise.
$(\textit{and} \textit{expr} \dots)$	Returns the logical AND of a list of expressions.
$(\textit{or} \textit{expr} \dots)$	Returns the logical OR of a list of expressions.

Symbol-Handling Functions

The expression evaluator supports the following symbol-handling function. The words in italics can be replaced by an actual value or a variable.

Expression	Description
$(\textit{not} \textit{item})$	Verifies that the item evaluates to nil.

Conversion Functions

The expression evaluator supports the following conversion functions. The words in italics can be replaced by an actual value or a variable.

Expression	Description
$(\textit{angtos} \textit{angle} [\textit{mode} [\textit{precision}]])$	Converts an angular value in radians into a string.

Expression	Description
(ascii <i>string</i>)	Returns the conversion of the first character of a string into its ASCII character code (an integer).
(lwtof <i>lineweight</i> [<i>metric</i>])	Converts the lineweight (first argument) to a real. If the optional second argument is non-nil, returns the lineweight as millimeters, otherwise returns it as inches.
(rtos <i>number</i> [<i>mode</i> [<i>precision</i>]])	Converts a number into a string.

Other Functions

The expression evaluator supports the following other functions. The words in italics can be replaced by an actual value or a variable.

Expression	Description
entity <i>.dotvariable</i>	Returns the value of the dot variable for the object as it is stored in the drawing. If the object was queried from a source drawing, returns the value for the object in the source drawing, before any transformations are applied.
style <i>.dotvariable</i>	Returns the value of the dot variable for the object as it is stylized in the Display Manager.
PI	Returns pi (approx. 3.1415926).
(Range <i>expression</i> <i>range_table</i>)	Returns the value of the expression after it has been processed by the specified range table. The range table must be defined in the current drawing.
(viewscale)	Returns the current viewport scale, expressed as the apparent size of a screen pixel in drawing units.
(viewtwist)	Returns the current twist angle for the current viewport. This is equivalent to the viewtwist system variable.

Variables

Expressions can include many types of variables and expressions.

See also:

- [Object Data Variables](#) (page 1549)

Dot Variables

Use dot variables to represent object properties. For example, use the `.LENGTH` variable in a property alteration to have AutoCAD Map 3D add text to all lines specifying their length. In an output report, use the `.TYPE` variable to list the type of objects in your report.

Expression	Description
<code>.ANGLE</code>	For most objects, returns the angle in the XY plane. For ellipse objects, returns the angle of the major axis; for point objects, returns the ECS rotation; for trace objects, returns the angle between the middle points of the start and end edges; for circle objects, returns the angle of the circle normal projected plus $\pi/2$ onto the WCSmdash; if no ECS, returns 0; for objects with 1 or 0 grip points, returns 0; for <code>attdef</code> , <code>text</code> , <code>mtext</code> , <code>insert</code> , <code>shape</code> , and raster images objects, returns rotation.
<code>.AREA</code>	Area of a closed polyline or circle. Topology queries only: Value of AREA object data field for each polygon.
<code>.BLOCKNAME</code>	Name of a block.
<code>.BULGE</code>	Bulge factor for a polyline segment.
<code>.CENTER</code>	Center point of an object's extents. If the object is a polygon (a closed polyline), this coordinate is always inside the closed area regardless of the area's dimension.
<code>.CENTROID</code>	Center point of an object's extents; that is, the intersection of the diagonals of its bounding rectangle.
<code>.CLASSNAME</code>	Object class name.

Expression	Description
.COLOR	ACI color of an AutoCAD Map 3D object. Color BYLAYER evaluates as 256. Color BYBLOCK evaluates as 0.
.DWGNAME	Name of the object's source drawing. Topology queries only: Name of the geometry object's source drawing.
.EANGLE	Ending angle of an arc object, using radians, interpreted from the coordinate space where the object exists.
.EHANDLE	Handle of the queried object.
.ELEVATION	Value for the Z coordinate.
.EWIDTH	Ending width of a polyline. Does not adjust to the ending width of individual polyline segments.
.HEIGHT	Height of a text object.
.LABELPT	Location for text associated with an object.
.LAYER	Layer of an object.
.LENGTH	Length of a line, arc, polyline, or circle. Circle length is given as the circle circumference.
.LINETYPE	Linetype of an object.
.LINEWEIGHT	Lineweight of an object.
.LOCKSTAT	User responsible for the lock.
.PERIMETER	Topology queries only: Value of PERIMETER object data field for each polygon.
.PLOTSTYLE	Plotstyle of an object.
.RADIUS	Radius of a circle.
.ROTATION	Rotation angle of a block or text, using radians.

Expression	Description
.SANGLE	Starting angle of an arc, using radians, interpreted from the coordinate space where the object exists.
.SHAPENAME	Name of an AutoCAD Map 3D shape.
.SIZE	Size of an AutoCAD Map 3D shape.
.STRING	Value of a string (can be the value of an attribute or text).
.STYLE	Style of a text string or attribute.
.SWIDTH	Starting width of a polyline.
.TAG	All AutoCAD Map 3D attribute tags for an object. Usually used with .STRING to return an attribute tag and its string value (that is, .TAG, .STRING).
.THICKNESS	AutoCAD Map 3D thickness of an object.
.TOPONAME	Topology name (Topology queries only).
.TOPOTYPE	Topology type: NODE, NETWORK, or POLYGON (Topology queries only).
.TRUECOLOR	True color or color book value of an AutoCAD Map 3D object.
.TYPE	AutoCAD Map 3D object type.
.URL	<p>URL information linked to an object. An object with no URL link returns nil.</p> <hr/> <p>NOTE An object can take only one URL. URL data can be entered in the following formats:</p> <hr/> <p>http://servername/pathname/filename.dwg ftp://servername/pathname/filename.dwg file://drive/pathname/filename.dwg</p>
.X1, .Y1, .Z1	Components of a line's starting point--X, Y, or Z.
.X2, .Y2, .Z2	Components of a line's ending point--X, Y, or Z.

Expression	Description
.X3, .Y3, .Z3	Third definition point of a shape or three-dimensional face. If used on any other object, returns <i>nil</i> .
.X4, .Y4, .Z4	Fourth definition point of a shape or three-dimensional face. If used on any other object, returns <i>nil</i> .
.XSCALE	Scale factor along the X axis, interpreted using the coordinate space where the object exists.
.YSCALE	Scale factor along the Y axis, interpreted using the coordinate space where the object exists.
.ZSCALE	Scale factor along the Z axis, interpreted using the coordinate space where the object exists.

All numeric return values are in decimals.

Object Data Variables

The syntax for using an object data variable in an expression is

:ObjectDataFieldName@ObjectDataTableName

For example, to retrieve the values in the Diameter field of the Pipes table, enter :diameter@pipes.

Block Attribute Variables

The syntax for using a block attribute variable in an expression is

@BlockTagName

For example, to retrieve the values for the block attribute tag VALVETYPE, enter @VALVETYPE.

SQL Variables and Expressions

The syntax for using a SQL variable in an expression is

&ColumnName@LinkTemplate

For example, to retrieve the values in the PRICE column in the table referenced by the link template HOUSES, enter &PRICE@HOUSES.

To relate a second table to the table specified in the link template and return a value from one of its fields, use this syntax

```
&[ [ [catalog. ] schema. ] colname@LT [.lnka1, lnka2, ..., lnkaN [.lnkb1, lnkb2, ..., lnkbN ] ]
```

The expression must be entered on one line.

- The parameters preceding the @ symbol identify the related table. The LT parameter identifies the primary table. If no schema or catalog is defined, it is assumed the related table exists in the same schema as the primary table.
- The lnk parameter (or lnk1,lnk2,...,lnkN parameter list) identifies the column name (or names) to reference for the relation if you are not using the key or keys identified in the link template. If no lnk column is defined it is assumed that the columns identified in the link template exist in both tables and are referenced for the relation.
- The lnka parameter (or lnka1,lnka2,...,lnkaN parameter list) identifies the column name (or names) to use in the primary table.
- The lnkb parameter (or lnkb1,lnkb2,...,lnkbN parameter list) identifies the column name (or names) to use in the related table if the column name (or names) to reference for the relation are not the same in both tables. The number of lnka parameters and lnkb parameters must be the same.

SQL Expressions and SQL Statements

The expression:

```
&catalog.schema.table.colname  
&linktemplate.lnka1,lnka2,...,lnkaN.lnkb1,lnkb2,...,lnkbN
```

is equivalent to the following SQL statement:

```
SELECT catalog.schema.table.colname FROM catalog.schema.table WHERE  
lnka1 = lnkb1 AND lnka2 = lnkb2 AND ... AND lnkaN = lnkbN AND  
linktemplatekey1 = linktemplatevalue1 AND linktemplatekey2 =  
linktemplatevalue2 AND ... AND linktemplatekeyN = linktemplatevalueN
```

where lnka1,...,lnkaN are columns from the primary table, lnkb1,...,lnkbN are columns from the secondary table, linktemplatekey1,...,linktemplatekeyN are link template key columns from the primary table, and

linktemplatevalue1,...,linktemplatevalueN are the key column values obtained from the object.

Object Classification Variables

The syntax for using an object class property variable in an expression is

#ObjectName.Category.Property

For example, to retrieve the values in the Diameter field of the Pipes table in the PipeRun object class, enter #Piperun.OD:Pipes.Diameter. To retrieve the values in the layer property, which is in the General category, enter #Piperun.General.Layer. To retrieve the values of the end node of the LocalRoads topology in the Roads object class, enter #Road.Topo:LocalRoads."end node". Use quotation marks so the space in the name "end node" is interpreted correctly as part of the property name.

AutoLISP Variables

The syntax for using an AutoLISP variable is

!AutoLISPVariable

For example, to retrieve the values assigned to a variable defined as DIAMETER, enter !DIAMETER.

EED Expressions

The syntax for using an EED expression is

\$EEDFIELD@REGAPP (for string fields)

#\$EEDFIELD@REGAPP (for numeric fields)

\$&EEDFIELD@REGAPP (for SQL fields)

For example, to retrieve the values for the AGE field registered under the application ADE, enter \$#AGE@ADE.

Using Color in Expressions

When specifying color in an expression, you can use any of the following:

- AutoCAD Color Index (ACI) number
- RGB triplet
- color book color

AutoCAD Color Index (ACI)

You can specify the color using an ACI color name (red, yellow, green, cyan, blue, magenta and white), the ACI index number (0-256), BYLAYER (256), or BYBLOCK (0).

Examples:

- `(ade_qrydefine '(" " " " "Property" ("color" "=" "blue"))')`
- `(ade_qrydefine '(" " " " "Property" ("color" "=" "5"))')`
- `(ade_altpdefine "color" "red")`
- `(ade_altpdefine "color" "1")`

RGB Triplet

An RGB triplet specifies the amount of red, green, and blue used to create the color. The values represent the intensity of the red, green, and blue components. The combination of these values can be manipulated to create a wide range of colors. For each component, enter a value between 0 and 255.

To enter an RGB color, enter the value for each of the components separated by commas. Enclose the three numbers in single quotation marks. For example, enter the color Red as '255,0,0' and enter cyan as '0,255,255'.

Only the following operators are valid: = and < >.

Examples:

- `(ade_qrydefine '(" " " " "Property" ("color" "=" "\255,0,0\ " ')))`
- `(ade_altpdefine "color" "255,0,0")`

Color Book and Color Name

You can specify colors using third-party color books (such as Pantone) or user-defined color books.

To specify a color book color, enter the name of the color book and the name of the color separated by a comma. Enclose the entire string in single quotation marks. For example, to specify the Pantone process coated cyan, enter 'Pantone(R) process coated, PANTONE Process Cyan C'. When you enter the color book and color name, be sure to type them exactly.

If you are unsure of the color name or color book name, display the Select Color dialog box. On the Color Books tab, look at the name of the color book and the color name.

For information on adding color books, click Help in the Color Books tab of the Select Color dialog box.

Only the following operators are valid: = and < >.

Examples:

- (ade_qrydefine ('" "" "" "Property" ("color" "=" "\"Pantone,Pantone 647 CVC\"")"))
- (ade_altpdefine "color" "Pantone,Pantone 647 CVC")

Combining Colors

When you specify the range of valid colors, you can combine any of the color specifications. Separate each color with a comma. In addition, for ACI colors, you can specify a continuous range. For example:
1,5,[7,11],255,128,64,'Pantone(R) process coated, PANTONE Process Cyan C'

Tips and Suggestions for the Expression Evaluator

- Not all operators are valid with all types of comparisons. When comparing strings, If, =, /=, >=, <= are valid, but not <. No error results, but the accuracy of the results can be affected.
- For strings, the standard wild-card characters listed in [Wildcard Characters](#) (page 1537) are valid. For example, if the expression (IF (= .LAYER ELEC*) EDISON) is placed in the condition, all objects in the query on layers beginning with ELEC are displayed on the layer EDISON. In addition, the operators = and /= are valid with wild cards.

- For real numbers less than one, enter all decimal values with a leading zero; that is, enter .001 as 0.001.
- When nil is a possible parameter, AutoCAD Map 3D uses zero.
- The expression evaluator deals only in strings; it does not distinguish between strings and numerics. The expression evaluator converts strings to their numeric values for math operations and converts the results back to strings.
- If you use variables set using AutoLISP, you must precede the variable with an exclamation point (!).
- To keep a space within a string, enclose the string in quotation marks. For example, "this string" evaluates as one string, with a space between the two words. Without the quotation marks, this string evaluates as two separate strings. The expression evaluator ignores quotation marks.
- You must enclose named objects with spaces in the name in parentheses when used in evaluator functions. These objects include layers, blocks, hatches, and linetypes.
- The following expressions handle a maximum of three arguments: +, -, *, /, AND, OR, STRCAT, =, and /=. All other expressions handle one or two arguments. If you use +, -, *, or /, you must supply more than one argument. For example, (+ 5 6) evaluates to 11; (+ 5 3 2) evaluates to 10.
- An expression evaluates numbers with scientific notation in compound simple expressions. For example, (+ 1e+001 1) evaluates to 11.0000; 1e+001 evaluates to 10.0.
- AutoCAD Map 3D evaluates pi only in compound expressions; the program treats pi as a string in simple expressions. For example, (STRCAT pi "_%") evaluates to 3.14%; pi by itself evaluates to "pi."
- You can specify **color** (page 1552) using ACI, True Color, or Color Book color values.

Expression Builder

13

Use expressions to filter the geospatial information displayed in your map, to create calculated fields, and to change the styles used for a feature layer based on certain conditions.

Using the Expression Builder

The Expression Builder is displayed when you are doing the following:

- Filtering the Layers You Add to a Map
- Filtering Feature Layers
- Filtering by Location
- Searching to Select Feature Layers
- Creating a Calculation
- Using Expressions to Label Features
- Using Expressions In Split/Merge Rules

Expressions you build with the Expression Builder affect geospatial data only and cannot be used for drawing objects. For help with expressions that affect drawing data, see the [Expression Evaluator](#) (page 1541) section.

Dialog Boxes

Analyzing Data Dialog Boxes

14

Create Buffer dialog box

Use this dialog box to specify the buffer distance and merging options for buffering features in AutoCAD Map 3D.



[To create a buffer](#) (page 1308)



Analyze tab ► Feature panel ► Feature Buffer



NOTE This functionality is for geospatial features only. To create a buffer for drawing objects, see [Buffering a Topology](#) (page 1345).

The Create Buffer dialog box has the following options:

Select Features

If you have not already selected features to buffer, click to select the features interactively on your map.

Buffer Distance

Enter a value, or click  to enter a distance interactively on your map. If you later change the Units setting, the Distance will update to reflect the new units.

Units

Use the measurement units specified by the coordinate system assigned to your map, or choose a different unit from the list.



(Specify buffer distance)

Click to pick the buffer distance interactively on your map.

Output To Layer

Specify the Display Manager layer to contain the buffer. If you created other buffers in this map, you can choose one of their layers from the list. By default, AutoCAD Map 3D creates a new layer for your buffer.

Save To SDF

Specify the name of the SDF file to store the buffered features. By default, the buffer file is saved in the current drawing's saved location.

Merge Results

Select No Merging and overlapping buffers are not merged. Select Merge All Buffers and all overlapping buffers are merged into a single buffer, then combined into a single multi-polygon. Select Merge Overlapping Buffers and only overlapping buffers are merged.

Buffer Warning dialog box

You may have selected too many features to buffer in a reasonable amount of time. Use this dialog box to change your feature selection or merge options to improve performance of the buffer task.



[To change your selection or merge options after receiving a buffer warning](#)
(page 1309)



Analyze tab ► Feature panel ► Feature Buffer 

NOTE This functionality is for geospatial features only. To create a buffer for drawing objects, see [Buffering a Topology](#) (page 1345).

Proceed

Click to use the current options and execute the buffer task. Proceeding after receiving a buffer warning may take a very long time.

Change

Click to change your feature selection or merge options.

Generate Contour dialog box

Use this dialog box to specify the settings for new contour lines for a raster-based surface.



To create contour lines (page 1190)



In [Display Manager](#) (page 2060), right-click a surface layer, and select Create Contour Layer

NOTE This functionality applies only to raster-based surface data brought into AutoCAD Map 3D using Data Connect. You cannot create a surface from other raster data.

The Contour dialog box has the following options:

New Contour Layer Name

Enter the name for the new Display Manager layer that will contain the contour lines.

Contour Elevation Interval

Select the difference in elevation between contour lines, for example, 10, 20, or 50.

Units

Select the units (meters or feet) used to measure the elevation in your surface. AutoCAD Map 3D attempts to get this data from the surface itself, but you can change it.

Major Contour Every

Select the difference in elevation between major (bold) contour lines. For example, if you select 5, every fifth contour line will be bolded.

Label the Elevation

Label the contour lines with the elevations they represent.

Create Contours As

Select the type of feature to use when creating contour lines (polyline or polygon).

Save Contours Into Filename

Enter a name for the new SDF file that will store your contour line features.

Hillshade Settings dialog box

Use this dialog box to specify the settings for shading applied to raster-based surfaces in AutoCAD Map 3D.



[To specify hillshading settings](#) (page 1200)



Click Analyze tab ► Feature panel ► Surface Hillshade.



NOTE This functionality applies only to raster-based surface data brought into AutoCAD Map 3D using Data Connect. You cannot create a surface from other raster data.

The Hillshade Settings dialog box includes the following options:

Direction

Specify the direction from which the light should come, for example, East or West. Enter a direction value into the edit box, drag the yellow disk in the compass to the position you want, or use Settings.

Angle

Specify how high in the sky the light is located, such as near the horizon, directly overhead, or somewhere in between. Enter an angle into the edit box, drag the yellow disk to specify an angle, or use Settings.

Date, Time, Location Settings

Click to specify sun settings in the Sun Properties palette using date, time and location. Then, redisplay the Hillshade Settings dialog box and click Import.

Import

Click to import changes you made using Settings.

Overlay Analysis dialog box

Use this dialog to perform spatial and data analysis by overlaying one set of geospatial features with another set of geospatial features. Overlay results use the split rules set in the [Split and Merge Rules dialog box](#) (page 1669).



To perform an Overlay operation (page 1316)



Analyze tab ► Feature panel ► Feature Overlay



NOTE This functionality is for geospatial features only. To overlay drawing topologies, see [Overlaying Two Topologies](#) (page 1336).

Overlay Analysis dialog box - Source and Overlay Type page

Use this page of the Overlay Analysis dialog box to specify the Source and Overlay features, as well as the type of overlay analysis to perform. Overlay results use the split rules set in the [Split and Merge Rules dialog box](#) (page 1669).



To perform an Overlay operation (page 1316)



Analyze tab ► Feature panel ► Feature Overlay



NOTE This functionality is for geospatial features only. To overlay drawing topologies, see [Overlaying Two Topologies](#) (page 1336).

The Source and Overlay Type page of the Overlay Analysis dialog box includes the following options:

Source

Specify the feature layer or feature class to use as the source.

Overlay

Specify the feature layer or feature class to use as the overlay.

To use a feature layer, you must add it to your map. To use a feature class, you must connect to its data store, but you need not add it to the map. The geometry in the feature classes or layers you select determines the other choices in the dialog box. You can combine only certain types of geometries. For example, Union, Paste, and Symmetric Difference support polygon/polygon comparisons only. Also, you cannot choose point geometries for both Source and Overlay. If you select point geometry for Source, you can select only polygon geometry for Overlay. The available choices for Type depend on the geometry in the Source and Overlay.

If either the Source or the Overlay contains multiple geometries, you can select any feature class or layer in Overlay and any overlay operation in Type. However, the output may be empty if there are no valid geometry combinations.

Type

Select the type of overlay comparison to perform. For more information on the available types, see [Overlaying Two Feature Sources](#) (page 1309).

- **Intersect:** Determines the geometry that overlaps in the Source and Overlay features. Anything that does not overlap is discarded from the output.
- **Union:** Determines the geometry that exists in either the Source or Overlay geometry. Where the geometry intersects, additional features are created. The resulting layer is the sum of the two comparison layers.
- **Erase:** Determines the geometry from the Source that does not intersect with the Overlay. The intersecting pieces are discarded.
- **Identity:** Creates new features where the Source and Overlay features intersect.
- **Clip:** Like Intersect, Clip creates features from the areas of the Source that overlap with the Overlay. However, with Clip, only feature attributes from the Source are included in the resulting layer.
- **Paste:** Creates new features by pasting the Overlay features onto the Source features. All Overlay features become new features in the resulting layer. In addition, areas of the Source that do not fall within the geometry of the Overlay become features in the resulting layer.
- **Symmetric Difference:** Determines geometry of the Source and Overlay that do not overlap. Overlapping areas of the features are discarded in the output, so the resulting layer represents the areas that are mutually exclusive.

Overlay Analysis dialog box - Set Output and Settings page

Use this page of the Overlay Analysis dialog box to specify the information about the output layer, and to set tolerance levels for sliver polygons and the evaluation of points. Overlay results use the split rules set in the [Split and Merge Rules dialog box](#) (page 1669).



To perform an Overlay operation (page 1316)



Analyze tab ► Feature panel ► Feature Overlay



NOTE This functionality is for geospatial features only. To overlay drawing topologies, see [Overlaying Two Topologies](#) (page 1336).

The Set Output And Settings page of the Overlay Analysis dialog box includes the following options:

Output

Specify the name and location of the SDF file that will contain the result of the Overlay operation.

Layer Name

Specify the name of the Display Manager layer that contains the result of the Overlay operation.

Sliver Tolerance

When the Overlay operation splits features to produce the output layer, it eliminates polygons that are smaller than the specified tolerance settings. Some such polygons were present in the sources, and some are produced by the Overlay operation itself. The elimination of slivers affects the output layers only.

Polygons whose areas are larger than the Maximum value become separate features in the output layer.

Polygons whose areas are smaller than the Minimum (and have at least one neighboring polygon) are considered slivers, and are merged with the neighboring polygon that has the longest shared edge.

The Overlay operation checks polygons that fall between the two values to see how wide they are. If they are very narrow, they are merged with a neighboring polygon.

NOTE If the resulting polygons are not as desired, try adjusting the tolerance values and repeating the Overlay operation.

Minimum

Specify a value in the current units. If a polygon is smaller than this value, it merges with a neighboring polygon.

Maximum

Specify a value in the current units. If a polygon is larger than this value, it becomes its own feature.

Suggest

Click to see recommendations for the Sliver Minimum and Sliver Maximum values (if they are not already displayed).

To see recommended values, click Suggest. The default suggested values for sliver tolerances are 1/10 of the smallest input area for the Maximum and 1/100 of the smallest input area for the Minimum. However, the sliver tolerance values will round down to the next power of 10. So, if the smallest polygon has an area of 50, the expected sliver tolerances should be 1 and 0.1 respectively, and not 0.5 and 5.

Units

Specify the units to use for the sliver Minimum and Maximum settings. The available units depend on the Source coordinate system.

Don't Remove Slivers

Select this check box to have the Overlay operation ignore sliver polygons.

Ordinate Tolerance

Specify how far apart two nodes or vertices of a line or polygon must be to be treated as separate points.

Length

Enter a distance in the current units. Any two points that are closer together than this value are treated as a single point in the output layer.

Units

Specify the units to use for the Ordinate Tolerance Lengthsetting. The available units depend on the Source coordinate system.

Output Properties

Specify which properties from the Source and (if applicable) Overlay are included in the resulting layer. "All" adds all properties to the resulting layer. "Identifiers" adds only the primary identifiers (primary keys or unique fields, such as Feature_ID). "Non-Identifiers" adds only the non-key attributes (such as Land_Value or Speed_limit, for example). If you add only non-identifiers, the overlay operation generates primary identifiers for the features in the resulting layer.

Annotation Dialog Boxes

15

Annotation Delete dialog box

Use this dialog box to delete one or more annotation templates from the list of available templates.



To delete all annotation based on a selected annotation template (page 1108)



Click Annotate tab > Map Annotation panel > Delete Annotation.



NOTE This functionality is for drawing objects only. To add annotation to geospatial features, see [Adding Labels to Features](#) (page 1091).

Annotation Refresh dialog box

Use this dialog box to select an annotation template to refresh.



To refresh annotation based on a specific template (page 1105)



Click Annotate tab > Map Annotation panel > Refresh Annotation.



NOTE This functionality is for drawing objects only. To add annotation to geospatial features, see [Adding Labels to Features](#) (page 1091).

The Annotation Refresh operation has two options:

Strings Only

Re-evaluate any expression-based text in the annotation, but change nothing else.

Full Annotation

Re-evaluate any expression-based text in the annotation, as well as other properties of the annotation, such as the insertion point or the layer on which the annotation resides.

Annotation Text dialog box

Use this dialog box to specify each text element in an annotation template, and set its entity properties and text options.



To define an annotation template (page 192)

To change an annotation template (page 196)



At the Command prompt, enter mapanntext.

NOTE This functionality is for drawing objects only. To add annotation to geospatial features, see [Adding Labels to Features](#) (page 1091).

Attribute

Tag

Enter a name for the annotation text object.

Value

Enter the content of the annotation text. Click  to specify an expression.

Object Properties

Layer

Select the layer for the annotation text. Click  to specify an expression.

Color

Select the color for the annotation text. If you select ByBlock, the settings in the Define Annotation Template dialog box will be used. Click  to specify an expression.

Lineweight



Select the lineweight. If you select ByBlock, the settings in the Define Annotation Template dialog box will be used. Click  to specify an expression.

Text Options



Style

Select the style for the annotation text. Click  to specify an expression.

Height

Specify the default height of the annotation text. Click  to pick points in the drawing, or click  to specify an expression.

Rotation

Specify the rotation angle to use when inserting annotation. Click  to pick points in the drawing. These use the AUNITS system variable. Click  to specify an expression. The resulting values use radians. Your expression can include a conversion from degrees to radians (divide the degree value by $360/(2*\pi)$).

Justification

Specify the justification for the annotation text. Click  to specify an expression.

Annotation Update dialog box

Use this dialog box to update an annotation template from the list of available templates.



[To update annotation based on a specific template](#) (page 1107)



Click Annotate tab > Map Annotation panel > Update Annotation.



NOTE This functionality is for drawing objects only. To add annotation to geospatial features, see [Adding Labels to Features](#) (page 1091).

The Annotation Update operation has two options:

Retain

Regenerates all annotation that uses the selected template, maintaining any advanced settings from the original annotation. Text you added or removed in the annotation template is changed in the existing annotations, and any modifications you made to specific annotations remain.

Discard

Regenerates all annotation that uses the selected template, using the default values in the template. Text you added or removed in the annotation template is changed in the existing annotations, but any overrides are lost.

Define Annotation Template dialog box

Use this dialog to define or change the text and graphic elements, default properties, and insertion options of annotation templates.



[To define an annotation template](#) (page 192)

[To delete all annotation based on a selected annotation template](#) (page 1108)



Click Annotate tab > Map Annotation panel > Define Template.



NOTE This functionality is for drawing objects only. To add annotation to geospatial features, see [Adding Labels to Features](#) (page 1091).

Annotation Template

Template Name

Select an annotation template.

New

Create a new annotation template.

Copy

Copy the selected annotation template with a new name.

Rename

Rename the selected annotation template.

Delete

Delete the selected annotation template. You can delete an annotation template only if you first delete all references to that template from the drawing.

Default Properties

Layer

Select a layer for the annotation. Click  to specify an expression.

Linetype

Select a linetype. Click  to specify an expression.

Lineweight

Select a lineweight for the annotation. Click  to specify an expression.



Color

Select a color for the annotation. Click  to specify an expression.



Default Insertion Options

Insertion Point

Specify the annotation insertion location based on the selected template.

Click  to pick a point in the drawing, or click  to specify an expression.

Scale

Specify the scale to use when inserting annotation based on the selected template. Click  to pick points in the drawing, or click  to specify an expression.

Rotation

Specify the rotation angle to use. Click  to pick points in the drawing.

These use the AUNITS system variable. Click  to specify an expression.

The resulting values use radians. Your expression can include a conversion from degrees to radians (divide the degree value by $360/(2*\pi)$).

Edit Template Contents

Display the Block Editor, where you can specify the contents of the selected annotation template.

Edit Expression dialog box

Use this dialog box to edit an expression. For information about the Expression Evaluator, see [Expression Evaluator](#) (page 1541).



[To define an annotation template](#) (page 192)



Click Annotate tab ► Map Annotation panel ► Insert.
At the Command prompt, enter mapanntext.



Click Annotate tab ► Map Annotation panel ► Define Template.



NOTE This functionality is for drawing objects only. To add annotation to geospatial features, see [Adding Labels to Features](#) (page 1091).

Enter an expression or click  to select from a list of variables in your drawing.

Insert Annotation dialog box

Use this dialog box to select an annotation template and specify insert properties.



[To insert annotation](#) (page 1103)



Click Annotate tab ► Map Annotation panel ► Insert.



NOTE This functionality is for drawing objects only. To add annotation to geospatial features, see [Adding Labels to Features](#) (page 1091).

Annotation Template



Select one or more annotation templates to use when inserting annotation into your drawing.

Basic/Advanced



Click Advanced to override the insertion information specified in the annotation template.

Insert Options



Insertion Point

Specify the annotation insertion location. Click  to pick a point in the drawing, or click  to specify an expression.

Scale

Specify the scale to use when inserting annotation based on the selected template. Click  to pick points in the drawing, or click  to specify an expression.

Rotation

Specify the rotation angle to use when inserting annotation. Click  to pick points in the drawing. These use the AUNITS system variable. Click  to specify an expression. The resulting values use radians. Your expression can include a conversion from degrees to radians (divide the degree value by $360/(2*\pi)$).

Insert Properties

Layer

Select a layer for the annotation. Click  to specify an expression.

Linetype

Select a linetype for the annotation. Click  to specify an expression.

Lineweight

Select a lineweight for the annotation. Click  to specify an expression.

Color

Select a color for the annotation. Click  to specify an expression.

Match

Click to copy the insertion options and properties from an annotation already in the drawing.

New Annotation Template Name dialog box

Use this dialog box to specify a name for an annotation template.



[To define an annotation template](#) (page 192)



Click Annotate tab ► Map Annotation panel ► Define Template.



NOTE This functionality is for drawing objects only. To add annotation to geospatial features, see [Adding Labels to Features](#) (page 1091).

Autodesk MapGuide Dialog Boxes

16

Publish to MapGuide dialog box

Use this dialog box to publish the current display map to Autodesk MapGuide Enterprise 2007, a platform that lets you publish map-related data on the web or on an intranet.



[To publish a map for use with MapGuide \(page 1378\)](#)



Click  > Publish > Publish To MapGuide.

Connect To Site

Enter the URL for the target website. If the site requires a password, enter your user name and password in the Connect To MapGuide Site dialog box.

Overwrite Existing Resources Of The Same Name

Select this option to overwrite old files of the same name that already exist in the target folder. Clear this option to cancel the operation when such files are encountered.

Show Map In Web Browser After Publishing

Select this option to review the published map immediately.

Select Destination Folder

Select a folder for the published files.

Publish to MapGuide Results dialog box

Use this dialog box to resolve any errors that result from a Publish To MapGuide operation.



[To resolve MapGuide publishing errors](#) (page 1379)



Click  > Publish > Publish To MapGuide.

View Log

Examine the log file to see which layers failed and why.

Define New Object Data Field dialog box

Use this dialog box to create new fields in existing object data tables when you are importing Autodesk MapGuide SDF 2 files into AutoCAD Map 3D.



[To import SDF 2 files](#) (page 389)



Click Insert tab > Import panel > SDF 2. 

NOTE Data you import becomes AutoCAD drawing objects in your map. To convert the drawing objects to a geospatial format, see [Overview of Converting and Exporting](#) (page 1405).

Field Name

Enter a name for the new field. The name cannot contain any spaces. It must start with an alphanumeric character.

Type

Specify the valid data type of the new field.

Integer

An integer between -2,147,483,648 and 2,147,483,647

Character

Any characters

Point

Three real numbers separated by commas representing the X, Y, and Z values of a point

Real

A real number between -1.7E308 and 1.7E308
If you select Integer, numbers are rounded to the nearest whole number.

Description

Enter a description for the new field. This description appears in the Object Data Fields list.

Default

Enter the value you will use most often when you assign this data field to an object. The value must match the data type you selected above.

New Layer dialog box

Use this dialog box to create layers from imported SDF data.



[To import SDF 2 files](#) (page 389)

[To create centroids for polygons and closed polylines](#) (page 887)



Click Insert tab > Import panel > SDF 2.



Click Create tab > Drawing Object panel > Create Centroids.



NOTE Data you import becomes AutoCAD drawing objects in your map. To convert the drawing objects to a geospatial format, see [Overview of Converting and Exporting](#) (page 1405).

Enter a layer name. It cannot contain any of the following characters: < > / \ : ? * | , = " ` "

Autodesk MapGuide Export dialog box

Use this dialog box to specify settings for exporting DWG data to Autodesk MapGuide SDF 2 files for use with Autodesk MapGuide version 6.5 and earlier.



[To export DWG data to SDF2 format](#) (page 1418)



Click Output tab ► Map Data Transfer panel ► As SDF2.

NOTE Export affects drawing objects only. To convert geospatial data to a different format, see [Migrating GIS Data \(Bulk Copy\)](#) (page 617).

If you previously saved your settings in this dialog box, click Load to reload them. To save the current settings to use later or to use in a script, click Save.

Selection Tab

SDF Type

Select the type of data to export. Objects of other entity types will be filtered out of the export. To export the other entity types, run this operation again. Some objects in an AutoCAD Map 3D drawing may be exported as more than one entity type.

Select Objects Automatically

Select all objects of the specified type. If Filter Selection By Layer is selected, only objects on the specified layers are selected.

Select Objects Manually

Individually select the objects to export. To modify the selection set, click

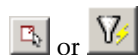

. Selected objects that do not match the filter will not be exported.

Filter Selection

Filter the selected objects based on layer. Select Filter Selection By Layer, click the button, and select from a list of all layers in the drawing. Objects that are not on the selected layers are filtered out of the export. The status line shows how many objects are selected and how many have been filtered out.

Preview Filtered Objects

Preview the objects that will be exported. In the preview, objects that will be exported are highlighted. To leave the preview and return to this dialog, press Esc.

Options Tab

SDF Description

Enter a description for the SDF 2 file.

Data Expression

Key

Enter an expression for the Key field, or click  to open the Expression Chooser dialog box and select an attribute for the Key field.

Name

Enter an expression for the Name field, or click  to open the Expression Chooser dialog box and select an attribute for the Name field.

URL

Enter an expression for the URL field, or click  to open the Expression Chooser dialog box and select an attribute for the URL field.

Coordinate Conversion

To convert the exported objects to a different coordinate system, select Convert To and enter the coordinate system code for the export file, or click



to select one.

If this option is greyed, your current map does not have an assigned coordinate system. You can cancel this dialog box, assign a coordinate system, and then retry this operation.

Create Key Index File

Create a corresponding Key Index File (KIF) for the SDF 2 file.

Autodesk MapGuide Import dialog box

Use this dialog box to specify settings for importing Autodesk MapGuide SDF 2 files into AutoCAD Map 3D.



To import SDF 2 files (page 389)



Click Insert tab > Import panel > SDF 2.



NOTE Data you import becomes AutoCAD drawing objects in your map. To convert the drawing objects to a geospatial format, see [Overview of Converting and Exporting](#) (page 1405).

Import Layer

Import To Layer

Import SDF 2 data to a specified layer. Click the button to create a new layer for the imported SDF 2 data.

Data Elements

Assign To Object Data Table

Assign data from the SDF 2 file to an object data table in the current drawing.

Table

Select the object data table for the imported SDF 2 data. Click the button to define a new object data table for the SDF 2 data.

Key

Select the field in the object data table for the imported SDF 2 Key data. Click the button to define a new field in the object data table for the SDF 2 data.

Name

Select the field in the object data table for the imported SDF 2 Name data. Click the button to define a new field in the object data table for the SDF 2 data.

URL

Select the field in the object data table for the imported SDF 2 URL data.
Click the button to define a new field in the object data table for the SDF 2 data.

Create Hyperlinks From URL Field

Create hyperlinks from the URL expressions in the SDF 2 file.

Coordinate Conversion

Convert From

Enter the coordinate system of the SDF 2 file. This function is available only if the current drawing has an assigned coordinate system. AutoCAD Map 3D converts the data from the SDF 2 coordinate system to the active drawing

coordinate system. Click  to select the coordinate system of the SDF 2 file.

Import by Location

Define an Area to Import From The SDF File

Import a specific area of the SDF 2 file.

X Min

Enter the X coordinate of the lower left corner of the area to import.

Y Min

Enter the Y coordinate of the lower left corner of the area to import.

X Max

Enter the X coordinate of the upper right corner of the area to import.

Y Max

Enter the Y coordinate of the upper right corner of the area to import.

Import Profile

Load

Load previously saved SDF Import Profile (SIP) file containing import settings.

Save

Save the current import settings as an SDF Import Profile (SIP) file.

Cleaning Up Maps Dialog Boxes

17

Cleanup Methods Page

Use this dialog box to specify what to do with the original objects after the cleanup process is complete.



[To specify how to convert the objects after cleanup \(page 776\)](#)

[To save Drawing Cleanup settings as a profile \(page 781\)](#)



Click Tools tab ► Map Edit panel ► Clean Up.



NOTE This functionality is for drawing objects only. There is no equivalent for geospatial features.

Cleanup Method

Modify Original Objects

In the processed drawing, use the original layer and as much of the original data as possible.

Retain Original Objects And Create New Objects

Keep the original objects and put the new objects on a layer you specify.

Delete Original Objects And Create New Objects

Copy existing object data and database links to the new objects.

Use Original Layer

Place new objects on the same layer as the source objects.

Create On Layer

Enter the name of a layer. If the layer does not exist, it will be created. Click Select Layers to select from existing layers.

Convert Selected Objects

Line To Polyline

Convert lines to 2D polylines so you can assign line width to them, use them in thematic maps, or use them in programs that accept only polylines.

Arc To Polyline

Convert arcs to 2D polylines so you can assign line width to them, use them in thematic maps, or use them in programs that accept only polylines. The resulting polyline uses a true arc, not straight line segments.

3D Polyline To Polyline

Convert 3D polylines to 2D polylines so you can assign line width to them, use them in thematic maps, or use them in programs that accept only polylines.

Circle To Polyline

Convert circles to 2D polylines so you can assign line width to them, use them in thematic maps, or use them in programs that accept only polylines. The resulting polyline uses two true arcs, not straight line segments.

Circle To Arcs

Convert circles to arcs.

NOTE Converting objects changes them to different entity types. If classified objects are modified so they no longer meet the object class definition, they will be unclassified. You must re-classify them manually.

Other

Load

Load a profile file that contains drawing cleanup settings you saved previously.

Save

Save your drawing cleanup settings in a profile file for later use.

Next

Move to the next drawing cleanup page.

Displays the [Error Markers Page](#) (page 1587) if you selected Interactive on the previous Select Actions page.

Finish

Perform the drawing cleanup operation using the current settings.

Error Markers Page

Use this dialog box to specify the marker shape and color for each cleanup action. Specify the marker size, and set options for erasing or maintaining markers before and after cleanup.



[To set up markers for interactive mode](#) (page 779)

[To save Drawing Cleanup settings as a profile](#) (page 781)



Click Tools tab ► Map Edit panel ► Clean Up.



NOTE This functionality is for drawing objects only. There is no equivalent for geospatial features.

This page is available only when you select Interactive on the [Select Actions page](#) (page 1588).

In Interactive mode, AutoCAD Map 3D displays each error for you to accept or reject the correction. You can place a markers at error locations to help you find them more easily.

Parameters

Set options for removing markers before and after the drawing cleanup, and specify the size of the markers, relative to the screen size.

Erase Markers When Cleanup Starts

Delete markers from an earlier operation before placing new markers. Clear this check box to display both sets of markers.

Deleting old markers prevents confusion.

Maintain Markers When Command Ends

Keep markers in the drawing after the drawing cleanup operation.

Marker Size

Specify the marker size as a percent of the screen size, usually between 3% and 7%.

Blocks And Colors

For each operation listed, select a marker shape and color.

Other

Load

Load a profile file that contains drawing cleanup settings you saved previously.

Save

Save your drawing cleanup settings in a profile file for later use.

Finish

Perform the drawing cleanup operation using the current settings. You can place markers, review errors, and make correction decisions.

This operation displays the list of detected errors in the [Drawing Cleanup Errors dialog box](#) (page 1593).

Select Actions Page

Use this dialog box to select the cleanup actions to perform and the parameters to use. Specify whether to review errors in Interactive mode or have AutoCAD Map 3D automatically correct errors.



[To select cleanup actions and set options](#) (page 773)

[To save Drawing Cleanup settings as a profile](#) (page 781)



Click Tools tab ► Map Edit panel ► Clean Up.



NOTE This functionality is for drawing objects only. There is no equivalent for geospatial features.

You can perform multiple cleanup actions simultaneously, but it is better to perform only a few at a time so you can track changes. Run the Simplify Objects and Weed Polylines actions by themselves—not with other actions.

Cleanup Actions list

Select a cleanup action and click Add to add it to the Selected Actions list. For more information about each cleanup action, click one of the following links:

[Delete Duplicates](#) (page 793)

[Erase Short Objects](#) (page 795)

[Break Crossing Objects](#) (page 797)

[Extend Undershoots](#) (page 799)

[Apparent Intersection](#) (page 802)

[Snap Clustered Nodes](#) (page 804)

[Dissolve Pseudo Nodes](#) (page 807)

[Erase Dangling Objects](#) (page 809)

[Simplify Objects](#) (page 811)

[Zero-Length Objects](#) (page 815)

[Weed Polylines](#) (page 816)

NOTE Some cleanup actions create a new object or break an object into multiple segments (for example, when you break crossing objects or extend undershoots with the break target option). If the original object was classified, the classification information remains with only the segment that contains the start point of the original object. You must classify the other segments manually.

Add

Add selected actions to the Selected Actions list.

Remove

Remove selected actions from the Selected Actions list.

Selected Actions list

Actions are performed in the order they appear in the list. If you include Simplify Objects and Weed Polylines with other cleanup actions, AutoCAD Map 3D automatically performs Simplify and Weed first, regardless of their position.

Up arrow

Move the selected action up one position in the list.

Down arrow

Move the selected action down one position in the list.

Cleanup Parameters

Select an action in the Selected Actions list to set its parameters. Each action has its own set of parameters. Some cleanup actions have none.

Tolerance

Specify the radial search distance for locating geometric errors. Enter a value or click *Pick* to specify a distance in the drawing area.

For example, if you set the tolerance to 5 units, two nodes within 10 units of each other are within the tolerance and will be corrected.

Rotation

Include rotation in the Delete Duplicates calculation for Blocks, Text, or Mtext.

Z-Values

Include z-values (elevation) in the Delete Duplicates calculation.

Break Target

Break target linear objects at the intersections during the Extend Undershoots operation.

Snap To Node

For Snap Clustered Nodes, snap to an existing node.

Snap To Link

For Snap Clustered Nodes, snap to an existing link endpoint.

Create Arcs

Allow the introduction of arcs during the Simplify Objects operation.

Weeding Distance

For Weed Polylines, enter a value or click *Pick* to select two locations in the drawing. Weeding Factors reduce the number of points generated along 3D polylines. A larger distance and deflection angle weeds a greater number of points. The distance is measured in linear units and must be smaller than the Supplemental Distance.

Weeding Angle

For Weed Polylines, enter the deflection angle, or click *Pick* to select a starting point, a vertex, and an ending point in the drawing. A larger distance and deflection angle weeds a greater number of points. The angle factor is measured in angular units.

Supplemental Distance

For Weed Polylines, enter the maximum distance between vertices. If the distance between vertices on a contour is greater, points are added along the contour at equal intervals that are less than or equal to the Supplemental Distance. The smaller the distance, the greater the number of supplemented points.

Bulge

For Weed Polylines, enter a value, or click Pick to specify it in the drawing. Bulge adds vertices to a polyline curve, creating an approximation of the curve using straight line segments. Bulge is a ratio of the distance from the arc to the chord divided by half the length of the chord.

Options

Interactive

Review errors and decide how to handle them. For example, you can correct the errors, place marker blocks on them, or ignore them.

Automatic

Have AutoCAD Map 3D correct errors automatically. AutoCAD Map 3D corrects Simplify Objects and Weed Polylines errors automatically, no matter what you specify.

Other

Load

Load a profile file that contains drawing cleanup settings you saved previously.

Save

Save your drawing cleanup settings in a profile file for later use.

Next

Move to the next drawing cleanup page.
Displays the [Cleanup Methods page](#) (page 1585).

Finish

Perform the drawing cleanup operation using the current settings.

Drawing Cleanup

Drawing cleanup helps you improve the accuracy of your maps, correct common map errors (resulting from surveying, digitizing, scanning errors, for example), and remove unnecessary detail from complex maps. This is essential when you need accurate and complete maps suitable for defining topologies, performing map analyses, or plotting and presentations.



[To clean up objects in a map](#) (page 767)

[To save Drawing Cleanup settings as a profile](#) (page 781)



Click Tools tab ► Map Edit panel ► Clean Up.



NOTE This functionality is for drawing objects only. There is no equivalent for geospatial features.

Drawing Cleanup is a sequence of pages that guide you through specifying the set of objects to include in a drawing cleanup operation, the objects to anchor, the cleanup actions to perform and the settings to use, how to treat the objects after cleanup, and the error marker settings (for interactive mode only).

Drawing Cleanup includes the following pages:

[Select Objects Page](#) (page 1595)

[Select Actions Page](#) (page 1588)

[Cleanup Methods Page](#) (page 1585)

[Error Markers Page](#) (page 1587)

Other

Load

Load a profile file that contains drawing cleanup settings you saved previously.

Save

Save your drawing cleanup settings in a profile file for later use.

Next

Move to the next drawing cleanup page.
Displays the [Select Actions Page](#) (page 1588).

NOTE Do not use Drawing Cleanup to correct topologies; you might make a topology invalid and not be able to recreate it. To edit topologies, use the [topology editing commands](#) (page 851).

Drawing Cleanup Errors dialog box

Use this dialog box to step through the errors, review them in the map, decide whether to correct the errors, and place markers on errors that you want to review later.



[To set up markers for interactive mode](#) (page 779)
[To review errors before correcting them](#) (page 785)



Click Tools tab ► Map Edit panel ► Clean Up.



NOTE This functionality is for drawing objects only. There is no equivalent for geospatial features.

This dialog box displays the cleanup actions performed on the drawing and the errors detected for each action. This dialog box is displayed only if you select Interactive on the Drawing Cleanup - Cleanup Actions dialog box. If you select Automatic, all errors are corrected automatically.

Cleanup Action

List of cleanup actions

Initially, the first cleanup action with detected errors is selected. The icons next to the cleanup action show you what the error marker for that action will look like (marker shape and color) if you mark errors in the map. Expand a cleanup action to display the list of detected errors (Error 1 of...).

All cleanup actions performed, except Simplify Objects, are listed in the Drawing Cleanup Errors dialog box. AutoCAD Map 3D automatically performs Simplify Objects, even when you select Interactive.

For Erase Short Objects, AutoCAD Map 3D divides the detected errors into three groups: Short Degenerate Objects, Short Line Objects, and Short Polyline Objects. For Zero-Length Objects, AutoCAD Map 3D divides the errors into two groups: Zero Length Line Objects and Zero Length Polyline Objects.

To display the list of errors detected (Error 1 of...) for a cleanup action, click the plus sign (+) next to the cleanup action's name.

Cleanup Action Options

To work with all errors for a cleanup action at once, select the action and click any of the following:

Fix All

Correct all errors for the selected action.

Mark All

Mark all errors for the selected action with error markers, making them easily visible in the map.

Remove All

Skip all errors for the selected action without correcting them, remove any error markers, and go to the next cleanup action in the list.

Next Action

Go to the next cleanup action in which errors are detected, without correcting errors.

Individual Error Options

To step through the errors for a cleanup action one at a time, select its list of errors (Error 1 of...), and then use any of the following:

Fix

Correct the selected error and go to the next error on the list.

Mark

Place an error marker on the selected error.

Remove

Skip the current error without correcting it, remove any error marker, and go to the next error in the list.

Next

Go to the next error on the list without correcting the selected error.

Zoom Settings

Zoom %

Specify the percentage of the drawing that highlighted objects occupy. 100 zooms the display to the extents of the highlighted objects. Less than 100 displays more of the drawing outside the highlighted objects. 0 maintains the current zoom level.

Auto Zoom

Automatically adjust the zoom so the selected error fills the percentage of the screen specified for Zoom %.

Zoom

Zoom to the selected error. Clear Auto Zoom to use this option.

Select Objects Page

Use this dialog box to select the objects to include in the cleanup process and the objects to anchor.



[To select and anchor objects for drawing cleanup](#) (page 770)

[To save Drawing Cleanup settings as a profile](#) (page 781)



Click Tools tab ► Map Edit panel ► Clean Up.



NOTE This functionality is for drawing objects only. There is no equivalent for geospatial features.

If you have previously saved your drawing cleanup settings in a profile file, click Load to reload those settings.

Objects To Include In Drawing Cleanup

Select objects to clean up. In general, you can clean up linear objects only (lines, arcs, circles, and polylines), although a few cleanup actions also support points, blocks, text, and mtext. Unsupported object types are ignored.

Select All

Select all objects.

Select Manually

Specify any layer or feature class filters, select this option, then click  to select objects in the drawing.

Layers

Select the layers used for object selection. Enter the layer names, or click the button to select from a list. You can use wild-card characters. To use all layers, enter an asterisk (*).

Objects that are not on the selected layers are filtered out during objection selection. The status line shows how many objects are selected and how many were filtered out.

Object Classes

Select the object classes used for object selection. Enter the class names, or click the button to select from a list. You can use wild-card characters. To use all object classes, enter an asterisk (*).

Objects that are not in the selected object classes are filtered out. The status line shows how many objects are selected and how many have been filtered out. If your map does not contain object classes, these options are not available.

Objects To Anchor In Drawing Cleanup

Select the objects to anchor. Anchored objects are used as reference points during cleanup and are not altered or moved; objects being cleaned will be moved towards anchored objects. You can anchor linear objects, points, blocks, text, and mtext.

Select Manually

Temporarily close the Select Objects page so you can select the objects to anchor. Press Enter when you are finished.

Layers

Select the layers used for anchor selection. Enter the layer names, or click the button to select from a list. You can use wild-card characters. To use all layers, enter an asterisk (*).

Objects that are not on the selected layers are filtered out during objection selection. The status line shows how many objects are selected and how many were filtered out.

Object classes

Select the object classes used for anchor object selection. Enter the class names, or click the button to select from a list. You can use wild-card characters. To use all object classes, enter an asterisk (*).

Objects that are not in the selected object classes are filtered out. The status line shows how many objects are selected and how many have been filtered out. If your map does not contain object classes, these options are not available.

Other

Load

Load a profile file that contains drawing cleanup settings you saved previously.

Save

Save your drawing cleanup settings in a profile file for later use.

Next

Move to the next drawing cleanup page.
Displays the [Select Actions page](#) (page 1588).

Coordinate Systems Dialog Boxes

18

MAPDIST

Use this command to measure the geodetic distance between points in your map.



[To measure geodetic distance](#) (page 1153)



Click Analyze tab ► Geo Tools panel ► Geo Distance.



The geodetic distance is the actual distance along the ground, taking into account the curvature of the Earth. For example, if you have a Mercator map of the world, use this command to measure how many miles wide Greenland is.

This command is different from the DIST command, which measures the simple Pythagorean distance between two points, not the underlying physical distance. Map distortion (due to the coordinate system), makes the actual distance on the ground considerably different from the distance on the surface of the map.

When prompted, specify the first point and the second point, either by entering the coordinates or by clicking the mouse. AutoCAD Map 3D displays the following information on the command line:

Distance

The geodetic distance from the first point to the second point, expressed in units of the coordinate system assigned to the current drawing.

Azimuth

The angle of the line from the first point to the second point, measured at the first point, and expressed in degrees east of north.

Delta X, Delta Y

These are the same as the DIST command.

Assign Global Coordinate System dialog box

Use this dialog box to assign a coordinate system before you bring objects or features into the current drawing.



[To assign a coordinate system to the current drawing](#) (page 147)



Click Map Setup tab ► Coordinate System panel ► Assign.



When you bring objects and features into the current drawing, AutoCAD Map 3D checks whether the coordinate system assigned to the object or feature matches that of the current drawing. If it does not, AutoCAD Map 3D transforms the object or feature to the current drawing's coordinate system. If you edit and save the object or feature back to its source, AutoCAD Map 3D transforms it back to its original coordinate system.

Current Drawing

You cannot assign a coordinate system to the current drawing if it contains any objects that have been queried from source drawings. If you are using the Canadian National Transformation, you must copy the data files to the Autodesk shared coordinate system directory.

Code

Enter the code for the current drawing, or click Select Coordinate System to select from a list.

Select Coordinate System

Click to select from a list of available coordinate systems.

Source Drawings

Select the attached drawings, then enter the code for these drawings. Click Select Coordinate System to select from a list of available coordinate systems. To assign a different code to other source drawings, use this command again.

You cannot assign a coordinate system to a source drawing if that drawing currently has queried objects in the current drawing.

NOTE For information on using custom coordinate systems you defined in a previous release of AutoCAD Map 3D, look up “coordinate systems, updating” in the help index.

Coordinate system transformations may not work as expected on raster objects.

Select Drawings to Assign Coordinate System dialog box

Use this dialog box to select the file names of drawings to which you want to attach the coordinate system.



To assign a coordinate system to a source drawing (page 146)



Click Map Setup tab ► Coordinate System panel ► Assign.



NOTE This functionality is for drawing files only. To assign a coordinate system to geospatial feature sources to which you are connecting, see [Changing Coordinate Systems](#) (page 311).

Look In

Select a drive alias from the list. AutoCAD Map 3D creates a drive alias for drive C. You must create drive aliases for all other drives that you use.

Create/Edit Aliases



If the drive or folder you want is not listed, click to define a new drive alias.

Preview



Click to display a preview of the selected drawing. If a drawing is locked, the Preview window is blank.

File List

Select a drawing in the current directory.

Filter

Use wild-card characters to filter the display of file names. For example, enter t* to view only file names starting with the letter t.

Add

Add the selected drawing names to the Selected Drawings list. You can change the drive or folder and continue to add files to the Selected Drawings list.

Remove

Remove the selected drawing names from the Selected Drawings list.

Selected Drawings

When you have added all the drawings you want, click OK.

Coordinate Tracker Options Dialog Box

Use this dialog box to set options for the coordinate tracker.



[To specify coordinate tracker options](#) (page 232)



Click Analyze tab ► Geo Tools panel ► Coordinate Track.

General Options

Display Coordinate System Descriptions

View a description of the coordinate system in the [Track Coordinates Dialog Box](#) (page 1601).

Format Lat/Long as D,M,S

Display lat/long coordinates in degrees/minutes/seconds format.

MGRS Options

Set options for Military Grid Reference Systems (MGRS).

Include Square ID

View the square ID when tracking coordinates.

Precision Level

Specify the level of precision to display.

Lettering Scheme

Specify the lettering scheme. AA (MGRS-New) is for use with the WGS84 datum. AL (MGRS-Old) is for use with older datums.

Digitization Location

Specify the digitization location within a given square: left top, center top, right top, left center, center, right center, left bottom, center bottom, or right bottom.

Track Coordinates Dialog Box

Use this dialog box to track coordinates in your map. You can add multiple coordinate trackers to the Track Coordinates dialog box.



[To track coordinates](#) (page 1150)



Click Analyze tab ► Geo Tools panel ► Coordinate Track.

Coordinate Tracker toolbar

You can change the coordinate system of a coordinate tracker in the drop-down list of the coordinate tracker toolbar.



Digitize: create a feature at the coordinates specified in the coordinate tracker.



Options: specify coordinate tracker options.



Add Tracker: add another coordinate tracker to the Track Coordinates dialog box.



Delete Tracker: remove a coordinate tracker from the Track Coordinates dialog box.

Create Reference System Dialog Box

Use this dialog box to create a reference system for a viewport in paper space.



[To track coordinates](#) (page 1150)



Click Layout Tools tab ► Reference System panel ► Create.

Reference System

Select the reference system you want to create: MGRS-AA or MGRS-AL.

Current Map Coordinate System

The coordinate system of the current map.

Current Scale

The view scale of the current map.

Scale

Select or enter the view scale at which the reference system displays.

Precision

Select the precision for the reference system. AutoCAD Map 3D will draw grid lines at the precision level, and tick marks at the next level. For example, a 1000 meter grid will have tick marks at every 100 meters.

Create a Join / Edit a Join dialog box

Use this dialog box to join a table of attribute data to features in your map so they have more properties. You can also edit an existing join.



[To create a join](#) (page 512)



In Display Manager, right-click a feature layer ► Create A Join.
If a join exists, right-click a feature layer ► Manage Joins.

NOTE This functionality is for geospatial features only. To connect drawing objects to an external data source, see [Overview of Linking Database Records to Objects](#) (page 522).

Select the primary table (the feature layer) and the secondary table (the data to join to the primary table, for example, an Access database). Select the columns of data to use to link the tables (often referred to as join keys). Specify the type of join, and the relationship between the primary and secondary records.

Primary Table Initiating The Join

The table to which you are joining secondary data, for example, the layer of features.

Table (Or Feature Class) To Join To

Select the secondary table of attributes to join to the primary table. You must connect to the secondary table before you can join to it.
See [Bringing in GIS Features](#) (page 303)

This Column From The Left Table

Select the column(s) from the primary table that will link the primary table to the secondary table.

Matches This Column From The Right Table

Select the column(s) from the secondary table that will link the tables. This column does not have to have the same name as the column on the left side, but it must have the same data type. Only columns with matching data types are listed.

Type of Join

Select one of the following join types:

Keep All Records On The Left

Display features from the primary table in the map, even if there is no matching value in the secondary table (a left outer join).

Keep Only Left-Side Records With A Match

Do not display features from the primary table in the map if there is no matching value in the secondary table (an inner join).

Relationship With Secondary Records (Cardinality)

Select one of the following:

One-To-One

Join one feature to one record in the secondary table, even if multiple records in the secondary table exist.

One-To-Many

Allow one feature to have multiple secondary records associated with it.

Create Data Store dialog box

Use this dialog box to create a new data store, which is a collection of feature classes in a single storage location.



[To create a data store for a database provider](#) (page 588)



In Display Manager, click Data ► Connect To Data.

NOTE This functionality is for geospatial features only. To set up new data sources for drawing objects, see [Overview of Attaching Data Sources to Drawings](#) (page 205).

Click OK to create the new data store with a default schema. You can edit the resulting schema.

Data Store Name

Enter a name for the new data store.

Password

Enter a password.

Confirm Password

Enter your password again to confirm it.

Description

Enter a description for the new data store.

Data Store Coordinate System

Click [...] to select the coordinate system.

Data Store Extents

Enter the extents.

Storage Resolution

Enter the resolution.

Data Store Tablespace

Enter the tablespace.

Edit Spatial Contexts

Use this dialog box to change the spatial context for a data store, or to remove any changes you made.



To change the coordinate system assigned to the data you are adding to a map (page 311)



In [Display Manager](#) (page 2060), click Data ► Connect To Data.

NOTE This functionality is for geospatial feature data only. To change the coordinate system for attached drawings, see [Assigning a Coordinate System to a Source Drawing](#) (page 146).

Spatial Contexts

Select the entry to change.

Edit

Display the [Select Coordinate System dialog box](#) (page 1609), where you can select a different coordinate system for your map.

Remove

Removes any overrides you applied to the selected entry.

Feature Information dialog box

Use this dialog box to view feature information for the selected object, including feature source, schema, key value, and the current lock status.

Feature Source Scope

Use this dialog box to select the feature sources and classes to include in this query or search.

For example, to limit the query or search to one class, select only that class.

Feature Source Administration dialog box

Use this dialog box to view and release feature source locks.

NOTE This functionality is for geospatial feature data only. To lock or unlock drawings, see [Overview of Sharing Attached Drawings](#) (page 730).

Feature Source

Select the feature source whose locks you want to review.

Feature Locks

Lists locked objects in the selected feature source.

To release a lock, select the object in the list and click Release Selected. You can release locks only if you have appropriate rights in the feature source.

NOTE This dialog does not display objects in the edit set for the current drawing. To remove locks for these objects, remove the objects from the edit set.

Feature Source Connection dialog box

Use this dialog box to connect to an attached feature source.



To bring in features from Oracle (page 314)



In [Display Manager](#) (page 2060), click Data ► Connect To Data.

NOTE This functionality is for geospatial feature data only. To attach drawings to the current drawing, see [Overview of Attaching Drawings](#) (page 154).

Feature Source

Select a feature source to connect. The lists displays feature sources attached to the current drawing.

TIP If the feature source you want is not listed, click Define and attach it to the current drawing.

Properties

In the Value column, enter any connection information required to connect to the selected feature source. Press Enter.

If you do not know the values to enter, contact your database administrator.

Manage Layer Data dialog box

Use this dialog box to modify, edit, and delete joins and calculations for a selected primary table (layer of features).



To modify a join (page 515)



In Display Manager, right-click the feature layer with the join to modify

► Manage Joins or Manage Calculations.

In the Data Table, click Options ► Manage Joins or Manage Calculations .

NOTE This functionality is for geospatial features only. To connect drawing objects to an external data source, see [Overview of Linking Database Records to Objects](#) (page 522).

New

To create a new join, click New ► Join.

To create a new calculation, first select the layer whose properties will be used for the calculation. Use Shift or Ctrl to select multiple layers. Then click New ► Calculation.

Edit

Select the item to modify and click Edit. You can edit only one item at a time.

Delete

Select the items to delete and click Delete. Use Shift or Ctrl to select multiple layers.

Save Features dialog box

Use this dialog box to save modified features back to their feature source.

Objects in the edit set are saved back to their feature source.

If you right-clicked a single feature source and clicked Save, only objects in the edit set for the selected feature source are saved. If you right-clicked the Feature Sources node, all objects in the edit set are saved back to their feature source.

Status

The number of objects that will be saved to the feature source. Click Show to highlight the objects in the drawing.

Save Queried Features

Save edited objects back to the feature source.

Clear this check box to save only newly created objects to the feature source.

Save Newly Created Features

Save new objects to the feature source.

TIP If the status does not list your newly created objects, be sure you have added the objects to the edit set for this feature source.

Clear this check box to save only objects that were queried in from the feature source.

Select Coordinate System dialog box

Use this dialog box to change the coordinate system of data you add to your map. You must specify the original coordinate system for the data. AutoCAD Map 3D automatically converts the data from that coordinate system to the one specified for your map.



To change the coordinate system assigned to the data you are adding to a map (page 311)



In [Display Manager](#) (page 2060), click Data ► Connect To Data.

NOTE This functionality is for geospatial feature data only. To change the coordinate system for attached drawings, see [Assigning a Coordinate System to a Source Drawing](#) (page 146).

Category

Select the set of coordinate systems in which the specific coordinate system is stored.

Search

Search within the category for the coordinate system, using either its code (for example, CA-I) or its description (for example, NAD27 California State Planes, Zone I).

Coordinate Systems In Category

Scroll through the list or use Search to find and select a coordinate system in the current category.

Properties

Display the datum, ellipsoid, projection, false origin, latitude and longitude settings for the selected coordinate system.

User Credentials dialog box

Use this dialog box to log in to data sources that require user credentials. If you do not know your user name and password, check with your System Administrator.



To [access data through FDO](#) (page 308)



In [Display Manager](#) (page 2060), click Data ► Connect To Data.

NOTE This functionality is for geospatial feature data only. For information about a multi-user environment for drawings, see [Overview of Sharing Attached Drawings](#) (page 730).

User Name

Enter your user name for this data source.

Password

Enter your password for this data source.

For SQL Server Spatial data stores, you can use either Windows or SQL Server authentication. If you use Windows authentication, you do not need to enter a user name or password. AutoCAD Map 3D uses your Windows credentials.

Remember Password

Optionally, have AutoCAD Map 3D remember this user name and password and log in whenever you open this map file.

View/Create Query Statement dialog box

Use this dialog box to view the current feature source filter statement.



To [filter feature data when you add it to a map](#) (page 310)



In [Display Manager](#) (page 2060), click Data ► Connect To Data.

NOTE This functionality is for geospatial feature data only. For information about queries for drawings, see [Overview of Finding and Querying Drawing Objects](#) (page 1218).

Query Statement

Enter the expression to use for filtering the data to add to the map.

For information on queries, see [Using the Expression Builder](#) (page 1555)

Data Table Dialog Box

20

Data Table dialog box

Use the [Data Table](#) (page 2059) much as you would a database spreadsheet.



To find and select features (page 1206)



In Display Manager or Map Explorer, click Table.

NOTE You can also access a specialized version of the Data Table from the Survey tab on the Task Pane. For Survey data, the Data Table displays survey point data, and is called the Points Table.

NOTE The Data Table displays geospatial feature data only. To view data connected to drawing objects, see [Viewing External Data Linked to Drawing Objects](#) (page 1146).

- Columns — Resize columns by dragging left or right. Sort columns by clicking the column header. Arrow pointing up or down indicates sort order.
- Rows — Resize rows by dragging up or down.

Data

Select a feature source or data table to view or edit.



Auto-Zoom

Automatically zoom to the map to the selected rows.



Auto-Scroll

Automatically scroll the Data Table to the current selection in your map.

Filter by

Select a property to use to filter the Data Table, then type a value to use for the filter and click Apply Filter .



Clear Filter

Double-click to remove the active filter and show all data for this feature layer.

Row

Enter a row number to scroll the Data Table to that row. Currently selected row numbers appear in this field.

Search to Select

Select features using a query.

Options

- Export—Export the data from the selected row(s) to a text file (.csv).
- Select All—Select all rows in the Data Table.
- Select None—Deselect all rows in the Data Table.
- Zoom To—Zoom the map to the selected row.
- Create A Join/Manage Joins—Add, edit, or delete joins to external data for the current feature layer.

NOTE You cannot create or manage joins for survey point data.

- Create A Calculation/Manage Calculations—Add, edit, or delete calculated properties for this feature layer. A calculated property is based on the current properties. The new property is not added to the original data store, but is available in this map only.

NOTE You cannot create or manage calculations for survey point data.

- Set Split and Merge Rules—Specify how properties will be assigned when you split or merge features.
- Help—Open the Data Table help topic.

Digitizing Dialog Boxes

21

MAPDIGITIZE (Digitize command)

Use this command to digitize nodes and linear objects with settings from MAPDIGISETUP.



To digitize links and nodes (page 1081)



Click Create tab ► Drawing Object panel ► Digitize drop-down ► Digitize.



NOTE This command creates drawing objects. To convert the drawing objects into geospatial feature data, see [Overview of Publishing and Sharing](#) (page 1357).

Digitizing Nodes

Respond to the prompts:

Specify Insertion Point

Specify the location of the first node. Continue to specify nodes. When you finish, press Enter.

Digitizing Linear Objects

Respond to the prompts:

From Point

Specify the starting point of the linear object.

Arc/Close/Halfwidth/Length/Undo/Width/<Endpoint Of Line>

For information on this prompt, look up PLINE command in the help index.
Continue to specify linear objects. When you finish, press Enter twice.

Digitizing Setup

The specified nodes or linear objects are digitized using the settings specified in the [Digitize Setup dialog box](#) (page 1617).

If you selected this in the Digitize Setup dialog box...	Do this...
Attach Data	Enter the data values for each digitized object.
Prompt For Label Point	Specify a label point for each digitized object.
Prompt For Rotation	Enter a rotation in degrees. (Use the UNITS command to view or change the current direction.)
Prompt For Scale	Enter a real number. For example, enter 2 to double the size of the block, or enter .5 to halve the size of the block.

Data to Attach dialog box

Use this dialog box to select the type of data and the source for the data when you attach data to node or linear objects as they are digitized.



[To attach object data as you digitize](#) (page 1083)



Click Create tab ► Drawing Object panel ► Digitize drop-down ► Digitize.

NOTE This process creates drawing objects. To convert the drawing objects into geospatial feature data, see [Overview of Publishing and Sharing](#) (page 1357).

Object Data Type

Select Object Data to use data in an object data table in the current drawing.
Select Database Link to use data in an external database.

Object Data Tables Name

If you are using data from an object data table, select the table.

Link Template

If you are using data from an external database, select the link template associated with that database.

To associate databases to link templates, use the [Define Link Template dialog box \(MAPDEFINELT\)](#) (page 1683).

Record Validation

As AutoCAD Map 3D digitizes your drawing, it prompts you for the key value to associate with each object. Select the validation option to use.

NOTE To attach data to node or linear objects, make sure the Attach Data option is selected on the Digitize Setup dialog box.

Validate

Check the database for the key value you specify. If AutoCAD Map 3D does not find a match, it prompts you for a new key value.

Validate And Create

Check the database for the key value you specify. If AutoCAD Map 3D does not find a match, it creates a new row in the database. You will be prompted to enter information for all the columns in the new row.

No Validation

Associate the specified key value with the object whether or not the key value matches a row in the database.

Digitize Setup dialog box

Use this dialog box to set options for digitizing nodes and linear objects.



[To set digitizing specifications](#) (page 138)

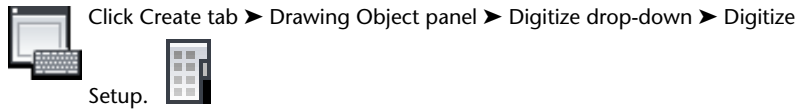

NOTE This process creates drawing objects. To convert the drawing objects into geospatial feature data, see [Overview of Publishing and Sharing](#) (page 1357).

Object Type

Select whether to digitize nodes (points or blocks) or linear objects (polylines).

Attach Data

Attach object data to the digitized objects. Click Data To Attach to select the data source and location.

When you digitize objects, you are prompted for the data for each object.

Prompt For Label Point

Change the default location of the label point for digitized objects. The label point determines the location of text associated with the object during queries.

As the objects are digitized, you are prompted for the new label point.

Node Object Settings

Specify settings for the node objects that are created during the digitizing process.

Create On Layer

Specify the layer for new node objects. To select from a list of layers in the drawing set, click Layers. To create a new layer, enter the layer name.

Block Name

Specify the block to reference when creating node objects. To select from a list of block definitions in the drawing set, click Blocks. To use point objects, use ACAD_POINT.

Prompt For Rotation

Specify the rotation for each block as it is digitized. If this option is not selected, objects are not rotated. ACAD_POINT objects cannot be rotated.

Prompt For Scale

Specify the scale for each block as it is digitized. If this option is not selected, the scale is set to 1. ACAD_POINT objects cannot be scaled.

Object Snap To End

Snap the location of the node object to the closest endpoint of an arc, elliptical arc, line, mline, polyline segment or ray, or the closest corner of a trace, solid, or 3D face.

For more information about the OSNAP command, see the AutoCAD help.

Linear Object Settings

Specify settings for the linear objects that are created during the digitizing process.

Create on Layer

Specify the layer for new linear objects. To select from a list of layers in the drawing set, click Layers. To create a new layer, enter the layer name.

Linetype

Specify the linetype for the linear objects. To select from a list of linetypes in the drawing set, click Linetypes.

Elevation

Select 3D to have the linear objects support three dimensions.

Width

Enter the width of the polyline for 2D linear objects. You cannot specify a width for 3D linear objects.

Object Snap To Insert

Snap the location of the new linear object to the insertion point of an attribute, block, shape, or text.

For more information about the OSNAP command, see the AutoCAD help.

Link Template Data Entry dialog box

Use this dialog box to add information to your external database as you attach external database information to digitized objects. This dialog box appears only if you selected the Validate And Create validation method. The Link Template area lists the full path and table associated with the link template.



[To convert object data to a linked database table](#) (page 534)



At the Command prompt, enter mapod2ase.

NOTE This process creates drawing objects. To convert the drawing objects into geospatial feature data, see [Overview of Publishing and Sharing](#) (page 1357).

Link Template

To edit an entry, highlight it, enter new value in the Column Value box, and press Enter. When you finish updating values for an object, click OK. To attach no additional data to the current object, click Cancel.

Link Template Key Column Entry dialog box

Use this dialog box to review or modify the external data that is attached to digitized objects. The Link Template area lists the full path and table associated with the link template, as well as the current validation method.



To convert object data to a linked database table (page 534)



At the Command prompt, enter mapod2ase.

NOTE This process creates drawing objects. To convert the drawing objects into geospatial feature data, see [Overview of Publishing and Sharing](#) (page 1357).

Link Template

To edit an entry, highlight it, enter new value in the Key Value box, and press Enter. When you finish updating values for an entry, click OK. To cancel the digitize operation, click Cancel.

Display Manager Dialog Boxes

22

MAPDISPLAYLIBRARY (Display Library command)

Use this command to turn on and off the display of the Display Library palette.

MAPDISPLAYMANAGER (Display Manager command)

Use this command to load a display map, update the display, or turn on and off the stylization of maps.

Respond to the prompts:

Display Manager [?/Load/Update/Stylization/eXit]

Do one of the following:

Enter ? to display the current settings for the Display Manager.

Enter l to load a display map.

Enter u to update the display of the current map.

Enter s to turn stylization on/off.

Enter x to exit the command.

Alter Block Insertion dialog box

Use this dialog box to control how blocks are inserted for a specific range of entities or for a specific value in a theme.



To create a theme for a drawing layer (page 1181)



In Display Manager, right-click a drawing layer. Click Add Style ► Theme.

NOTE This functionality applies only to drawing objects. To theme geospatial features, see [Theming Features](#) (page 1165).

Name

Select a block from those already defined in the current drawing or click



to go to the Select Drawing File dialog box.

Layer

Select a layer for the block, or click  to go to the Layer Properties Manager dialog box.

Scale

Specify the scale for the block. Use positive numbers. For example, 2 doubles the size, 0.5 halves it.

Angle

Specify the angle to rotate the blocks.

Alter Line Format dialog box

Use this dialog box to control the line formatting for a specific range of entities or for a specific value in a theme.



To create a theme for a drawing layer (page 1181)



In Display Manager, right-click a drawing layer. Click Add Style ► Theme.

NOTE This functionality applies only to drawing objects. To theme geospatial features, see [Theming Features](#) (page 1165).

Linetype

Select a line type to represent the data values or click to go to the Select Linetype dialog box.

Layer

Select a layer for the new lines, or click to go to the Layer Properties Manager dialog box.

Width

Specify the width of the polylines in the thematic map.

To assign line width to circles, arcs, or lines, convert the objects to polylines with the drawing cleanup tools. See [Cleaning Up Drawing Data](#) (page 765).

Alter Linetype dialog box

Use this dialog box to select a linetype for a specific range of entities or for a specific value in a theme.



[To create a theme for a drawing layer](#) (page 1181)



In Display Manager, right-click a drawing layer. Click Add Style ► Theme.

NOTE This functionality applies only to drawing objects. To theme geospatial features, see [Theming Features](#) (page 1165).

Alter Lineweight dialog box

Use this dialog box to select a lineweight for a specific range of entities or for a specific value in a theme.



[To create a theme for a drawing layer](#) (page 1181)



In Display Manager, right-click a drawing layer. Click Add Style ► Theme.

NOTE This functionality applies only to drawing objects. To theme geospatial features, see [Theming Features](#) (page 1165).

Alter Plotstyle dialog box

Use this dialog box to select a plotstyle for a specific range of entities or for a specific value in a theme from those already defined in the current drawing.



[To create a theme for a drawing layer](#) (page 1181)



In Display Manager, right-click a drawing layer. Click Add Style ► Theme.

NOTE This functionality applies only to drawing objects. To theme geospatial features, see [Theming Features](#) (page 1165).

Copy Scale dialog box

Use this dialog box to copy all the styles from an existing scale.



[To create a theme for a drawing layer](#) (page 1181)



In Display Manager, right-click a drawing layer. Click Add Style ► Theme.

NOTE This functionality applies only to drawing objects. To theme geospatial features, see [Theming Features](#) (page 1165).

Define Hatch dialog box

Use this dialog box to control the addition of hatching for a specific range of entities or for a specific value in a theme.



[To create a theme for a drawing layer](#) (page 1181)



In Display Manager, right-click a drawing layer. Click Add Style ► Theme.

NOTE This functionality applies only to drawing objects. To theme geospatial features, see [Theming Features](#) (page 1165).

Pattern

Select a hatch pattern from those already defined in the current drawing or click to go to the Select Pattern dialog box.

Layer

Select a layer for the new hatch, or click to go to the Layer Manager dialog box.

Color

Specify the color of the hatch or click to go to the Select Color dialog box.

Scale

Specify the scale for the hatch pattern. Use positive numbers. For example, 2 doubles the size, 0.5 halves it.

Angle

Specify the angle to rotate hatch created for the thematic map.

For standard-scale hatch patterns (those that do not have an AR- prefix), the density of the hatching varies according to the hatch scale and plot scale you use, as shown in the following table and figure

Plot Scale	Hatch Scale	Result
1:2000	1 to 500	Solid
2000	Lines clearly visible	
15000	Sparse, occasional lines	
20000	No hatch or one line only	
1:10000	1 to 2500	Solid
10000	Lines clearly visible	
75000	Sparse, occasional lines	
100000	No hatch or one line only	

You can use solid fills at any scale to fill an enclosed area.

Define Text dialog box

Use this dialog box to control the addition of text for a specific range of entities or for a specific value in a theme.



[To create a theme for a drawing layer](#) (page 1181)



In Display Manager, right-click a drawing layer. Click Add Style ► Theme.

NOTE This functionality applies only to drawing objects. To theme geospatial features, see [Theming Features](#) (page 1165).

Style

Select a style for the text from those already defined in the current drawing or click to go to the Text Style dialog box.

Layer

Select a layer for the new text, or click to go to the Layer Manager dialog box.

Insert Point

Select the point on objects to create new text. The default is labelpt.

Justification

Select the justification (left, right, center, middle) for text created for the thematic map. The default is center.

Color

Specify the color of the text or click to go to the Select Color dialog box.

Height

Specify the height of the text.

Angle

Specify the angle to rotate text created for the theme.

Scale and height values for fill patterns, text height, and symbol size vary according to the plotting scale you intend to use. The following table shows suitable text heights for different plot scales.

Plot Scale	Required Text Height on Plot	(Text Height)
1:2000	1	2000
0.5	1000	
1:10000	1	10000
0.5	5000	

Edit Text Instance dialog box

Specifies the text and style for individual text feature instances on annotation layers.



[To edit a text instance](#) (page 1116)



In the map, select the text feature, right-click it, and click Edit Text Instance.

NOTE This functionality applies only to drawing objects. To annotate geospatial features, see [Adding Labels to Features](#) (page 1091).

Style changes made in this dialog box supersede the base style of the annotation layer. To revert to the base style, you must remove the style overrides. For more information about styling annotation layers, see [Style Text Layer dialog box](#) (page 1640)

Specifies the text and the following text styles: font, bold, italic, underline, overline, font size, and color.

Import Old Theme dialog box

Use this dialog box to import a theme or an entire thematic map definition from the old thematic wizard into the Display Manager.

NOTE This functionality applies only to drawing objects. To theme geospatial features, see [Theming Features](#) (page 1165).

Map

Select the map definition.

Themes

If you are importing a single theme, select the theme. The theme is imported as an element in the current Display Manager map.

After you import a theme into the Display Manager, you can edit it:

- To edit the query used to select objects for the element, select the element in the Display Manager. In the Properties palette, under Element Source,

select the Query field and click



- To edit the theme style, right-click an element in the Display Manager. Click Edit Theme.

New Scale dialog box

Use this dialog box to create a new scale.



To create a theme for a drawing layer (page 1181)



In Display Manager, right-click a drawing layer. Click Add Style ► Theme.

NOTE This functionality applies only to drawing objects. To define scale ranges for geospatial features, see [Defining Scale Ranges](#) (page 643).

Range of Values dialog box

Use this dialog box to specify the source of thematic data and partition it into ranges.



To create a theme for a drawing layer (page 1181)



In Display Manager, right-click a drawing layer. Click Add Style ► Theme.

NOTE This functionality applies only to drawing objects. To define scale ranges for geospatial features, see [Defining Scale Ranges](#) (page 643).

Data Values area

Obtain From



Click . In the Choose Data Expression dialog box, select the data source from the lists under Properties, Link Templates, Blocks, or Object Data.

Ignore

Select data values to exclude from the thematic display. These values, while present in the data, may be inappropriate for use in the thematic map. Examples include null or empty data values.

Normalize By

Enter a value or an expression if you want to normalize the data values relative to some other data value. Click  to display the Choose Data Expression dialog box.

Read Data

Reads the data from the data source according to the expression you defined.

Data Ranges area

Group Value By

Select a method for partitioning data values.

Optimal The optimal method groups data values based upon a determination of the natural breaks in the data. Because the calculations are iterative, this method quite literally finds the optimal sets of values in a group based upon the position of values upon a number line. It is most useful for complex non-uniform distributions where calculation time is less important than the accuracy of grouping. This is the default method.

Quantile Divides the data so that each range contains an equal number of values. Also known as equal count, this method is most appropriate where the data values are linear (equally distributed).

Equal Interval Divides the data into a specified number of groups from the minimum value to the maximum. Also known as equal step, this method has the disadvantage that it may over generalize the data and place too many values in one range and too few in another.

Standard Deviation This method calculates how far data values differ from the arithmetic mean. It is most effective when the data approximates a normal distribution (bell-shaped curve). This is rarely the case with geographical data, but is fairly common when considering demographic data. Because of this curve preference, standard deviations are best used with an even number of groups. Standard deviations are often used to emphasize how far a specific value is above or below the mean value.

Number

Select the number of ranges to create.

Precision

Specify the numeric precision. This option rounds the values up or down to the decimal point you specify. Rounding only affects the range value calculations and resulting range divisions. It does not affect the actual data values stored in the data source. For more information, see Notes About Precision below.

Use Thousands Separator

Adds a punctuation mark to separate the thousands in values such as population data.

Find Ranges

Divides the data into ranges according to the parameters you entered.

Ranges Area

This area displays the data divided into ranges according to the parameters you entered.

Notes About Precision

When numeric data is read into the AutoCAD Map 3D as part of thematic mapping, it is stored as an eight byte floating point number. You may fine-tune the formatting of these numbers by selecting a decimal precision or integer rounding up.

For instance, suppose you have a number that was originally entered into a database or into an object data field with the value 12.34. This number could be displayed in several ways depending upon the format specified. Formats that contain a decimal point will generate the specified number of digits to the right of the decimal point. Formats without a decimal point will round up. The following table will make this more clear.

Format	Explanation	Ouput
.01	use two decimal points	12.34
.1	use one decimal point	12.4
1	nearest whole number	13
10	nearest ten	20
100	nearest hundred	100

Select Display Element dialog box

Use this dialog box to select drawing elements on the Display Manager.



To bring in drawing objects based on object classes in the current drawing
(page 357)

[To bring in drawing objects from AutoCAD layers in the current drawing](#) (page 356)

[To bring in drawing objects based on topology](#) (page 367)

[To add a raster image to the map](#) (page 440)

[To add a point cloud to your mapIn the Display Manager, click Data Add Point Cloud Data From Index F...](#) (page 376)

NOTE This functionality applies only to drawing objects. To work with geospatial feature layers in the Display Manager, see [Overview of the Display Manager](#) (page 634).

When you select an item, such as a layer or a object class, a new layer is added to the Display Manager and all objects in that item are added to the new layer. If you select multiple items, for example two layers, then multiple layers are added to the Display Manager.

List of Items

Select the items whose objects you will include in this element.

Feature Class

Lists all feature classes in the active Feature Definition file.

Layer

Lists all the layers in the current drawing. To select from layers in attached drawings, create a [property query](#) (page 362).

Topology

Lists all topologies in the current drawing. If the selected topology is unloaded when you view the display map, it will be loaded.

Image

Lists all images in the current drawing. If the selected image is unloaded when you view the display map, it will be loaded.

Point Cloud

Lists all point cloud objects in the current drawing.

Group Selection

If you choose more than one item, you can select this option to group all the new elements under one heading in the Display Manager. When elements are grouped, you can easily turn off all the elements by turning off the group.

Source Drawing Scope dialog box

Use this dialog box to specify which drawings to include in the query.



[To bring in drawing objects based on object data or external \(SQL\) data](#) (page 364)

[To bring in drawing objects based on location](#) (page 359)

[To bring in drawing objects based on object properties](#) (page 362)

[To create a drive alias](#) (page 161)



Click Map Setup tab ► Map panel ► Attach.



NOTE This functionality applies only to drawing objects. To filter geospatial feature layers when you add them to your map, see [Filtering Features When You Add Them to a Map](#) (page 309).

Click a drawing to select it. The icon is grayed out for unselected drawings.

- If you select a nested drawing, its parent drawing is automatically selected.
- If you deselect a parent drawing, all nested drawings are automatically deselected.
- You can select a parent drawing and deselect a child, but you cannot deselect a parent and select a child.
- If the drawing is attached using a drive alias, the drive alias name appears in the file path.

Style Band dialog box

Use this dialog box to specify the first and last color of the color ramp for styling or theming your feature data. The color ramp will smoothly transition from the first to last color.



[To set styling options for polygon features](#) (page 1172)



In Display Manager, right-click a feature layer ► Edit Style.

NOTE This functionality applies only to features. To style drawing objects, see [Creating a Style](#) (page 658).

Style Label dialog box

Use this dialog box to add and style labels for features.



[To label features](#) (page 1093)



In Display Manager, right-click a feature layer ► Edit Style.

NOTE This functionality applies only to features. To add labels to drawing objects, see [Overview of Annotation](#) (page 1100).

Create A Label

Select the check box to turn on the labels.

NOTE If you are creating a theme, this check box does not appear. Instead, check the Create Feature Labels check box in the Theme dialog box.

Multiline

Specifies that the label can have multiple lines of text, but no advanced placement functionality. For all geometry types but lines, this is the only option available.

Advanced Placement

For line features, specifies a single-line label which follows a path and shrinks to fit. A single label is used for feature segments that have the same property value.

Property To Display

Select a property or select Expression to define an expression for the label text. For more information, see [Using the Expression Builder](#) (page 1555).

Font

Select a font from the list.

Size Context

Select Device Space to specify label widths and heights in screen units. Available units are Points, Inches, Millimeters, or Centimeters. Select Map Space to specify label widths and heights in Mapping Coordinate System (MCS) units. Available units are Inches, Feet, Yards, Miles, Millimeters, Centimeters, Meters, and Kilometers.

Units

Select the type of units to use.

Size

Enter the text size or specify the size using an expression. For more information, see [Using the Expression Builder](#) (page 1555).

Format

To apply bold, italic, or underlining, click one or more of the Format options.

Text Color

Select a text color.

Background Style

Select one of the following background styles:

- **Ghosted:** Draws an opaque border around each character. Use Background Color to specify a color for the outline.
- **Opaque:** Draws a background behind the labels. They are displayed as rectangles with text inside. Use Background Color to specify a color for the rectangles.
- **Transparent:** No background is applied to the labels, which are displayed only as text on the map.

Background Color

For Ghosted and Opaque background styles, click a color in the Background Color list.

Horizontal Alignment

Horizontal alignment is available for point layers with fixed labels instead of symbols.

Vertical Alignment

Vertical alignment is available for labels on polyline layers. Select one of the available positions or select a layer property that contains alignment information for each feature.

Rotation

Do one of the following:

- Enter the amount to rotate the text.
- Click Any Angle. Specify the angle using the slider or enter an angle in the box. Click OK.
- Click Expression. Specify the rotation using an expression. For more information, see [Using the Expression Builder](#) (page 1555).

NOTE Horizontal and vertical alignment settings are not available for area layers. Only the vertical alignment setting is available for line layers. Horizontal and vertical alignment settings are available for point layers that display fixed labels instead of symbols. For more information, see [Displaying Fixed Labels at Point Locations](#) (page 1098).

Style Line dialog box

Use this dialog box to create styles for line geometry.



[To apply styles to lines](#) (page 649)



In Display Manager, right-click a feature layer ► Edit Style.

NOTE This functionality applies only to features. To style drawing objects, see [Creating a Style](#) (page 658).

Apply Styles To The Line

Select to apply styles to lines.

NOTE If you are creating a theme, this check box does not appear. Instead, check the Theme The Lines check box in the Theme Lines dialog box.

Create Composite Lines/Reset To Single Line

Click to build up a composite line style. Style the first line in the composite. Click New to add a new component to the line. Style the new component as desired. Control the position of the selected component in the overall

composite line by clicking the up and down arrows. Click Reset To Single Line to style a single line.

Units (Device Space)

Select the type of units to measure line thickness. Lines are specified in Device Space units.

Thickness

Specify polyline thickness. Select 0 thickness to draw the line as thinly as possible.

Color

Select a color.

Pattern

Select a pattern.

Style Point dialog box

Use this dialog box to specify symbols to represent and display point features.



[To apply styles to points](#) (page 646)

[To place fixed labels at points](#) (page 1099)

[To allow labels to obscure points on the selected layer](#) (page 1097)



In Display Manager, right-click a feature layer ► Edit Style.

NOTE This functionality applies only to features. To style drawing objects, see [Creating a Style](#) (page 658).

Style A Point Symbol

Select the check box to apply styles to points.

NOTE If you are creating a theme, this check box does not appear. Instead, check the Create Feature Labels check box in the Theme Points dialog box.

Symbol

Symbols are AutoCAD blocks stored in drawings. Click  and navigate to the drawing that contains the symbol to use.

Size Context

Select Device Space to specify label widths and heights in screen units. Available units are Points, Inches, Millimeters, or Centimeters.
Select Map Space to specify label widths and heights in Mapping Coordinate System (MCS) units. Available units are Inches, Feet, Yards, Miles, Millimeters, Centimeters, Meters, and Kilometers.

Units

Select the type of units to use.

Width

Enter the symbol width or specify the width using an expression. For more information, see [Using the Expression Builder](#) (page 1555).

Height

Enter the symbol height or specify the height using an expression. For more information, see [Using the Expression Builder](#) (page 1555).

Maintain Aspect Ratio checkbox

To maintain width-to-height proportions when you change the width or height of the symbol, select the Maintain Aspect Ratio checkbox.

Fill Color

To override the fill color of the symbol, select a color. If you do not specify an override, the default fill color from the symbol is used.

Edge Color

To override the edge color of the symbol, select a color. If you do not specify an override, the default edge color from the symbol is used.

Rotation

Do one of the following:

- Enter the amount to rotate the text.
- Click Any Angle. Specify the angle using the slider or enter an angle in the box. Click OK.
- Click Expression. Specify the rotation using an expression. For more information, see [Using the Expression Builder](#) (page 1555).

Style Polygon dialog box

Use this dialog box to create styles for polygon geometry.



[To apply styles to areas](#) (page 650)



In Display Manager, right-click a feature layer ► Edit Style.

NOTE This functionality applies only to features. To style drawing objects, see [Creating a Style](#) (page 658).

Apply Fill To The Area

Apply Fill To The Area

Select this check box to fill polygons.

NOTE If you are creating a theme, this check box does not appear. Instead, check the Theme The Polygons check box in the Theme Polygons dialog box.

Fill Pattern

Select Solid or a pattern.

Foreground Transparency

For solid fills, specify Foreground Transparency if desired.

Foreground Color

For a non-thematic style, specify the Foreground Color for solid or pattern fills.

Foreground Color Range

For themes, instead of a single foreground color, select one of the following:

- **Generated Between Two Colors:** Select the first and last color for the foreground. Intermediate colors are interpolated automatically.
- **Color Palette:** Select a set of predefined color ranges.

Background Color

For non-thematic pattern fills, specify Background Color. If you do not want a background color for the pattern, click Transparent.

NOTE In polygons with transparent backgrounds, the colors you see on the map may differ from the colors displayed in the Preview frame because the Preview frame uses a white background, which may differ from the color beneath the transparent objects in your map.

Background Color Range

For themes, instead of a single background color, select the first and last color for the background. Intermediate colors are interpolated automatically.

Apply A Border To The Polygons

Apply A Border To The Area

Select to apply a border to polygons.

Line Pattern

Specify the pattern for the area border

Units (Device Space)

Select the type of units to use to measure border thickness.

Line Thickness

Specify border thickness. Select 0 thickness to draw the border as thinly as possible.

Line Color

Specify border color.

Style Text Layer dialog box

Specifies how text on the selected annotation is displayed.



[To style a text layer](#) (page 1112)



In Display Manager, right-click an annotation layer. Click Edit Style ► Style field.

Size context

Select one of the following:

- Device Space. Symbol widths and heights are in screen units. Available units are Points, Inches, Millimeters, or Centimeters.

- Map Space. Symbol widths and heights are in Mapping Coordinate System (MCS) units. Available units are Inches, Feet, Yards, Miles, Millimeters, Centimeters, Meters, and Kilometers.

Units

Specify the units for the annotation layer.

Text Type

Select one of the following:

- Plain—Formats annotation text uniformly using the settings specified for the layer in this dialog box. The text has no formatting information itself.
- Mtext—Formats annotation text as multiline. The settings specified for the layer in this dialog box define the base formatting style. You can override this formatting when you insert individual annotative text features.

Click Edit Expression to specify an expression for this setting. Do not use expressions for Text Type.

Text

Displays the name of a property in the feature source. Text for the annotation is what you specify in the [Edit Text Instance dialog box](#) (page 1627) when you create the annotation. Click Edit Expression to specify an expression for this setting.

For more information on inserting annotations, see [Adding Text to a Text Layer](#) (page 1113).

Font Name

Specify the font for the annotation layer.

Font Size

Specify the font size for the annotation layer. Leave the "NullValue(SIZE,number)" expression. The initial setting for font height is in mapping units and is based on the existing view. Try the suggested height and adjust the number as needed. If individual instances need a different height, adjust the value in the SIZE column in the Data Table after you insert the annotation instances.

Horizontal Alignment

Specify the horizontal alignment of the text. Click the expression to edit it. Click Delete Expression to choose a value from a drop-down list.

Vertical Alignment

Specify the vertical alignment of the text. Click the expression to edit it. Click Delete Expression to choose a value from a drop-down list.

Rotation

Specify the rotation of the text. Click the expression to edit it. Click Delete Expression to choose a value from a drop-down list.

Preview

Displays a preview of the text with the specified styles applied.

Thematic Mapping dialog box

Use this dialog box to specify the data you will use for the theme and the ways in which you want to stylize the objects.



[To create a theme for a drawing layer](#) (page 1181)



In Display Manager, right-click a drawing layer. Click Add Style ► Theme.

NOTE This functionality applies only to drawing objects. To theme geospatial features, see [Theming Features](#) (page 1165).

Data Values

Specify whether the data for this theme is a set of distinct, specific values, or whether it is a set of values that can be broken into ranges. Then specify the data to use.

Theme Type

Select one of the following:

- **A Set of Specific Values:** Choose this option if each item in this element has a distinct value, for example, different types of pipe material or land use designations. This option is appropriate for string and integer data.
- **A Range of Numeric Values:** Choose this option if the values can be grouped into ranges, for example, property values, temperature, or population. This is appropriate for numeric data only.

Values

Displays either the [Thematic Values dialog box](#) (page 1644) or the [Range of Values dialog box](#) (page 1629), where you specify the data source to use for the values and the specific values to use.

Thematic Details

Specify the properties to style and the styles for each range or value in this theme.

Table

Select ways to style the objects.

- In the column heading, select the check boxes for the properties to style.
- Click a cell in a style column to edit the style for a specific value.
- Click a cell in the Legend column to edit the text for each value in the map legend.
- To reverse the order of rows in the selected column, right-click a column heading and click Flip. Flip is available for all columns except Values and Legend.
- To change the value of a particular range, click a cell in the Values column and edit the number. To redefine all of the values, click the Values button.

Hide Unused Columns

Hide any columns that are not selected.

Ramps

Select from a list of pre-built style sequences, for example a set of color gradations, hatch patterns, or linestyles.

Scale Ramp to Fit

Divides the selected ramp sequence into equal intervals according to the number of values. If you do not select this option, the ramp styles are applied in sequence, up to the number of values that you have.

Thematic Values dialog box

Use this dialog box (from the [Thematic Mapping dialog box](#) (page 1642)) to specify the source of thematic data and then select one or more discrete values from that data.



To create a theme for a drawing layer (page 1181)



In Display Manager, right-click a drawing layer. Click Add Style ► Theme.

NOTE This functionality applies only to drawing objects. To theme geospatial features, see [Theming Features](#) (page 1165).

Data Values area

Obtain From



Click . In the Choose Data Expression dialog box, select the source of the data to use.

Ignore

Select data values to exclude from the thematic display. These values, while present in the data, may be inappropriate for use in the thematic map. Examples include null or empty data values.

Normalize By

Enter a value or an expression if you want to normalize the data values

relative to some other data value. Click  to display the Choose Data Expression dialog box.

Read Data

Reads the data from the data source according to the expression you defined.

Select Specific Values area

Shows the values read from the data source, together with the number of occurrences (Count). Select the value(s) to appear in the thematic map. To quickly select all the values, right-click and choose Select All.

Theme dialog box

Use this dialog box to create a theme for a feature source layer, based on a range of conditions. The title of the dialog box changes, depending on the type of geometry in the feature you are theming.



[To create a theme for a feature layer](#) (page 1168)



In Display Manager, right-click a feature layer ► Edit Style.

NOTE This functionality applies only to geospatial features. To theme drawing objects, see [Overview of Theming Drawing Data](#) (page 1176).

A theme is a collection of rules. Each rule specifies a style and feature label for the features that meet the specified condition. You can add a legend label to provide a description of a rule's condition.

Create Thematic Rules Based On A Property

Property

Select the property on which to base the theme.

Minimum Value

Specify the minimum value for the range.

Maximum Value

Specify the maximum value for the range.

The first rule includes the Minimum Value and the last rule includes the Maximum Value. Styles are interpolated across the range.

Distribution

Select a method. For more information, see [Theming Features](#) (page 1165).

Number of Rules

Specify the number of ranges to create if Distribution Method is Equal, Quantile, or Jenks (Natural Breaks). Properties containing strings use an Individual Values distribution that does not allow the number of rules to be edited. Adjust the number of rules to control the coarseness of the theme. For more information about distribution methods, see [Theming Features](#) (page 1165).

Replace Existing Rules

Specify whether new ranges replace existing rules (ranges) or are added before or after existing rules.

Theme The Polygons/Lines/Points

Select the Theme The Polygons/Lines/Points check box to use a different style for each rule of the theme. The first rule uses the From style and the last rule uses the To style. Styles are interpolated across the range.

Style Range

Click . The [Style Point dialog box](#) (page 1637), [Style Line dialog box](#) (page 1636), or [Style Polygon dialog box](#) (page 1639) is displayed, depending on the type of data associated with the layer.

Create Legend Labels

Select the Create Legend Labels check box to label the theme in the legend.

Legend Text

Enter the text to appear next to each rule in the legend

Legend Format

Specify how to display the legend label.

If you theme a layer on a property that contained area information and you used the label text Area:, the label formats might look like the following examples:

<Label Text> <Min> to <Max>

Area: 100 to 200

<Label Text> <Min> - <Max>

Area: 100 - 200

<Min> <= <Label Text> <<Max>

100 <= Area < 200

Create Feature Labels

Select the Create Feature Labels check box to add labels to the features in your theme. The label is placed near the line, point symbol, or polygon.

Label Ramp

Click  to specify the property to display, font, size, format, color, background style and color, alignment, and rotation of the labels. For more information, see the [Style Label dialog box](#) (page 1634).

ADEFILLPOLYG (Fill Closed Polyline command)

Use this command to fill a closed polyline with a color.



To fill a closed polyline with a solid-looking hatch (page 939)

NOTE This command is for drawing objects only. To style polygonal geospatial features, see [Styling Area Features](#) (page 650).

Respond to the prompts:

Select/<Layer>:

Enter s to select individual objects, or l to fill all objects on a layer.

Select objects/Layer to fill:

Select the individual objects you want to fill, or enter the name of a layer.

Color to fill <Bylayer>:

Enter the name of a color, such as RED.

The selected closed polylines are filled with a solid hatch. To display text or other objects on top of the hatch, use the DRAWORDER command.

You can set an option to determine whether the hatch object created by this command is associative.

ADERSHEET (Rubber Sheet command)

Use this command to get two or more data sets from different sources to align geographically: for example, when stretching a new subdivision map into a preexisting parcel map.



To rubber sheet two maps (page 935)



Click Tools tab ► Map Edit panel ► Rubber Sheet.



WARNING Use rubber sheeting only when it is absolutely necessary because it can severely compromise the accuracy of your data.

NOTE This command is for drawing objects only. To edit geospatial features, see [Extracting Feature Geometry](#) (page 715).

Respond to the prompts:

Base point 1:

Specify a point.

Reference point 1:

Specify the new location for the first point.

Base point 2:

Specify another point. When you finish specifying points, press Enter. Keep in mind that the more points you enter, the more accurate the results will be.

Select objects by <Area>/Select:

Enter a to select all objects in the polygon, or enter s to select objects individually.

Objects wholly within the original polygon are modified to fit the new shape and location of the polygon.

When selecting points for rubber sheeting, select points in order around the perimeter of the object or region to be rubber sheeted.

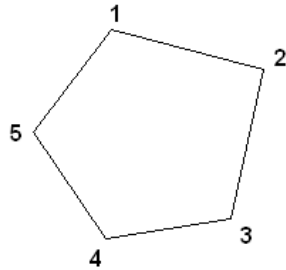

correct

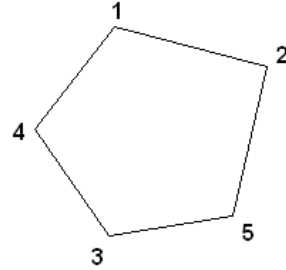

incorrect

The selected points are treated as the vertices of a polygon, so you will get better results if you select the points sequentially around the perimeter.

ADETRANSFORM (Transform command)

Use this command to move, rotate, and scale a single object or a group of objects. (To transform an entire source drawing while it is active, use the transformation options in the [Drawing Settings dialog box](#) (page 1923).



To move, rotate, or scale an object (page 931)



Click Tools tab ► Map Edit panel ► Transform.



NOTE This command is for drawing objects only. To edit geospatial features, see [Extracting Feature Geometry](#) (page 715).

Respond to the prompts:

Select/<Layer>:

Enter S to select objects or enter L to choose all objects on a layer.

Select objects:

Use any AutoCAD selection method to select the objects you want to transform. If you chose Layer, enter the names of the layers you want to transform. You can use “wild-card characters” such as * and ? to select a set of layers.

First source point:

Select a point in your drawing or enter the coordinates of the point.

First destination point:

Select a point in your drawing or enter the coordinates of the point. Objects are translated the relative distance between the first source point and this new point.

Second source point:

Select a point in your drawing or enter the coordinates of the point.

Second destination point:

Select a point in your drawing or enter the coordinates of the point.

Source and Destination Points

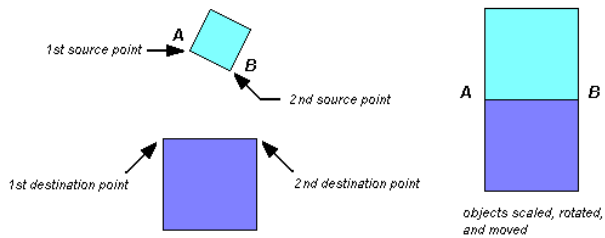

The difference between the first source point and the first destination point is the offset for the selected objects.

The difference in angle between the two source points and the two destination points is the rotation.

The ratio of the length between the two destination points to the length between the two source points is the change in scale.

MAPCOGO

The MAPCOGO command calls the [COGO Input dialog box](#) (page 1668), which allows you to create points using coordinate geometry data.



To create a point using the [COGO Input dialog box](#) (page 1028)

MAPFEATUREMERGE

NOTE This command must be used with at least one feature.

Use this command to merge features and assign feature property values for resulting features.

When you merge features, the resulting feature property values are determined by rules you specify in the [Split and Merge Rules dialog box](#) (page 1669).



To merge features (page 710)



Click Feature Edit tab ► Split/Merge panel ► Merge Feature.



NOTE This command is for geospatial features only. To edit polygonal drawing objects, see [Working with Polygon Objects](#) (page 954).

Respond to the prompts:

Select features to merge:

Select at least two objects to merge, one of which must be a feature. Press ENTER when you are done selecting the feature or features you want to merge.

Specify Feature ID for use [Select/New] <Select>:

Specify whether you want to select the feature that has the feature ID you want to use or you want to create a new feature ID.

Select

Select the feature that has the ID to use for the merged feature.

New

Create a new feature ID for the merged feature.

MAPFEATURESPLIT

Use this command to split geospatial features and assign feature property values for resulting features.

When you split a feature, the resulting feature property values are determined by rules you specify in the [Split and Merge Rules dialog box](#) (page 1669).

You can set defaults for the split prompts in the [Feature Editing Options dialog box](#) (page 1929). You can also turn off two of the prompts, so that split operations use the values set in that dialog box instead.



To split a feature (page 708)



Click Feature Edit tab ► Split/Merge panel ► Split Feature.



NOTE This command is for geospatial features only. To split polygonal drawing objects, see [Splitting Polygon Objects](#) (page 968).

Respond to the prompts:

Select one or more linear or polygonal features to split:

Select one or more linear or polygonal features in your map to split. Press ENTER when you are done selecting the feature or features you want to split.

Create a new or multi-part [New/Multipart] feature:

Specify whether you want the feature or features split into two or more than two features.

New

Creates two new features.

Multipart

Creates multiple features.

Generate new feature ID or use existing [New/Existing] <New>:

Specify whether you want the new feature to use the existing feature ID or a new one.

Would you like to Draw or Select the line for split? [Select/Draw]:

Select or draw a split line. If you use a polyline as your split line, make sure it intersects with feature geometry you are splitting. You can also use a closed polyline.

If you use a polygon (or mpolygon) to split a feature, the part that falls outside of the polygon becomes one feature, and the part that falls inside the polygon becomes another feature.

MAPIGNORESPLITMERGERULES

Use this command to specify whether or not feature property values are calculated based on the rules specified in the [Split and Merge Rules dialog box](#) (page 1669).



To turn Ignore Split And Merge Rules on or off (page 708)



In the Data Table, click Options ► Set Split and Merge Rules.

Click Feature Edit tab ► Split/Merge panel ► Split Feature.



Click Feature Edit tab ► Split/Merge panel ► Merge Feature.



NOTE This command is for geospatial features only. To split polygonal drawing objects, see [Splitting Polygon Objects](#) (page 968).

The rules affect the following commands:

- Split ([MAPFEATURESPLIT](#) (page 1652))
- Merge ([MAPFEATUREMERGE](#) (page 1651))
- [Overlay](#) (page 1563)
- JOIN
- Join option of PEDIT

- BREAK
- TRIM

Even when `MAPIGNORESPLITMERGERULES` is set to Yes, the following default rules are applied when splitting or merging features. For more information about these rules, see [Split and Merge Rules dialog box](#) (page 1669)

Property Type	Default Split Rule	Default Merge Rule
String	Copy	First Selected
Integer (Int)	Copy	Sum
Double	Copy	Sum

MAPLINESTRINGCREATE

Use this command to create a new LineString geospatial feature on a layer that contains LineString feature data.



To create a new LineString or MultiLineString feature (page 691)

NOTE This command is for geospatial features only. To create linear drawing objects, see [Overview of Working with Drawing Objects](#) (page 727).

The MAPLINESTRINGCREATE command is based on the PLINE command. For more information about the prompts, see PLINE in the AutoCAD Help.

Respond to the prompts:

Specify start point:

Specify a starting point for the LineString.

Specify next point or [Arc/Length/Undo]:

Specify the next point or enter an option.

Next Point

Draws a line segment. The previous prompt is repeated.

Arc

Adds arc segments to the polyline.

Specify endpoint of arc or [Angle/Center/Direction/Line/Radius/Second pt/Undo]:

Specify the endpoint of the arc or enter an option. If you have already created one arc, you have the option to close the LineString. For more information about the prompts, see PLINE in the AutoCAD Help.

Length

Draws a line segment of a specified length at the same angle as the previous segment. If the previous segment is an arc, the new line segment is drawn tangent to that arc segment.

Specify length of line:

Specify a distance.

Undo

Removes the most recent segment added to the LineString.

MAPLINESTRINGEDIT

Use this command to edit a LineString geospatial feature.



[To edit a feature using feature editing commands](#) (page 705)

NOTE This command is for geospatial features only. To edit linear drawing objects, see [Overview of Working with Drawing Objects](#) (page 727).

The MAPLINESTRINGEDIT command is based on the PEDIT command. For more information about the prompts, see PEDIT.

Respond to the prompts:

Enter an option [Close/Join/Edit vertex/Undo/eXit] <eXit>:

Enter an option. For more information about the prompts, see PEDIT.

Close

Creates the closing segment of the LineString, connecting the last segment with the first. The LineString is considered open unless you close it using the Close option. If the LineString is closed the first option is Open.

Open

Removes the closing segment of the polyline. The polyline is considered closed unless you open it using the Open option. If the LineString is open the first option is Closed.

Join

Joins two open LineStrings into one. The ends must be touching.

Select objects:

Select the two LineStrings to be joined.

Edit Vertex

Marks the first vertex of the LineString by drawing an X on the screen. If you have specified a tangent direction for this vertex, an arrow is also drawn in that direction.

Next/Previous/Insert/Move/eXit] <Next>:

Enter an option. For more information about the prompts, see PEDIT.

Undo

Reverses operations as far back as the beginning of the edit session.

Exit

Ends the MAPLINESTRINGEDIT command.

MAPMULTILINESTRINGCREATE

Use this command to create a new MultiLineString feature on a layer that contains line feature data. A MultiLineString is a set of LineStrings that behave as one feature. When you complete the first LineString you are prompted to begin another one until you have created the set.



[To create a new LineString or MultiLineString feature \(page 691\)](#)

NOTE This command is for geospatial features only. To create linear drawing objects, see [Overview of Working with Drawing Objects \(page 727\)](#).

The MAPMULTILINESTRINGCREATE command is based on the PLINE command. For more information about the prompts, see PLINE.

Respond to the prompts:

Specify start point

Specify a starting point for the first LineString.

Specify next point or [Arc/Length/Undo]

Specify the next point or enter an option.

LineString/eXit <eXit>:

Create another LineString or exit the command.

Next Point

Draws a line segment. The previous prompt is repeated.

Arc

Adds arc segments to the polyline.

Specify endpoint of arc or [Angle/CEnter/Direction/Line/Radius/Second pt/Undo]:

Specify the endpoint of the arc or enter an option. If you have already created one arc, you have the option to close the LineString. For more information about the prompts, see PLINE.

Length

Draws a line segment of a specified length at the same angle as the previous segment. If the previous segment is an arc, the new line segment is drawn tangent to that arc segment.

Specify length of line:

Specify a distance.

Undo

Removes the most recent segment added to the LineString.

LineString

Begins the MAPLINESTRINGCREATE command so you can create another LineString.

Exit

Ends the MAPMULTILINESTRINGCREATE command.

MAPMULTILINESTRINGEDIT

Use this command to edit a MultiLineString geospatial feature.



To edit a feature using feature editing commands (page 705)

NOTE This command is for geospatial features only. To edit linear drawing objects, see [Overview of Working with Drawing Objects](#) (page 727).

The MAPMULTILINESTRINGEDIT command is based on the PEDIT command. For more information about the prompts, see PEDIT in the AutoCAD Help.

Respond to the prompts:

Enter an option [Add/Delete/Move/Edit/Undo/eXit] <eXit>:

Enter an option.

Add

Adds a new LineString to the MultiLineString. For more information, see [MAPLINESTRINGCREATE](#) (page 1654).

Delete

Deletes a LineString from the MultiLineString.

Move

Moves a LineString in the MultiLineString.

Select Objects:

Select the object to move.

Specify base point:

Specify a base point for the Move operation.

Specify second point:

Specify the second point for the Move operation. The two points you specify define a vector that indicates how far the selected LineStrings are to be moved and in what direction.

Edit

Edits a LineString in the MultiLineString. For more information, see [MAPLINESTRINGEDIT](#) (page 1655).

Undo

Undoes the last step in the MAPMULTILINESTRINGEDIT operation.

Exit

Ends the MAPMULTILINESTRINGEDIT operation.

MAPMULTIPOINTCREATE

Use this command to create a new MultiPoint geospatial feature on a layer that contains point feature data. A MultiPoint feature is a set of points that behave as one feature. When you complete the first point you are prompted to begin another one until you have created the set.



To create a new Point or MultiPoint feature (page 688)

NOTE This command is for geospatial features only. To create drawing objects, see [Overview of Working with Drawing Objects](#) (page 727).

Respond to the prompts.

Specify a point:

Specify the location of the new MultiPoint feature.

Specify a point or [Undo]:

Specify the location of the next point or undo the last point.

MAPMULTIPOINTEDIT

Use this command to edit a MultiPoint geospatial feature.



To edit a feature using feature editing commands (page 705)

NOTE This command is for geospatial features only. To edit drawing objects, see [Overview of Working with Drawing Objects](#) (page 727).

Respond to the prompts:

Add

Adds a new point to the MultiPoint feature. For more information, see [MAPPOINTCREATE](#) (page 1663).

Delete

Deletes a point from the MultiPoint feature.

Move

Moves a point in the MultiPoint feature.

Select Objects:

Select the object to move.

Specify base point:

Specify a base point for the Move operation.

Specify second point:

Specify the second point for the Move operation. The two points you specify define a vector that indicates how far the selected points are to be moved and in what direction.

Undo

Undoes the last step in the MAPMULTIPOINTEDIT operation.

Exit

Ends the MAPMULTIPOINTEDIT operation.

MAPMULTIPOLYGONCREATE

Use this command to create a new MultiPolygon geospatial feature on a layer that contains polygon feature data. A MultiPolygon is a set of polygons that behave as one feature. When you complete the first polygon you are prompted to begin another one until you have created the set.

NOTE You cannot create a non-planar polygon. Every ring of a polygon must be planar and all parts and all rings must be in the same plane.



To create a new Polygon or MultiPolygon feature (page 689)

NOTE This command is for geospatial features only. To create drawing objects, see [Overview of Working with Drawing Objects](#) (page 727) and [Working with Polygon Objects](#) (page 954).

The MAPMULTIPOLYGONCREATE command is based on the PLINE command. For more information about the prompts, see PLINE in the AutoCAD Help.

Respond to the prompts:

Specify start point:

Specify a starting point for the MultiPolygon.

Specify next point or [Arc/Length/Undo]:

Specify the next point or enter an option.

Next Point

Draws a line segment. The previous prompt is repeated.

Arc

Adds arc segments to the polygon.

Specify endpoint of arc or [Angle/Center/Direction/Line/Radius/Second pt/Undo]:

Specify the endpoint of the arc or enter an option. If you have already created one arc, you have the option to close the polygon. For more information about the prompts, see PLINE.

Length

Draws a line segment of a specified length at the same angle as the previous segment. If the previous segment is an arc, the new line segment is drawn tangent to that arc segment.

Specify length of line:

Specify a distance.

Undo

Removes the most recent segment added to the polygon.

Ring

Creates a polygon inside a polygon. This is considered a hole. Additional rings are islands. Repeats the MAPPOLYGONCREATE command.

Polygon

Begins the MAPPOLYGONCREATE command so you can create another polygon.

Exit

Ends the MAPMULTIPOLYGONCREATE command.

MAPMULTIPOLYGONEDIT

Use this command to edit a MultiPolygon feature.

NOTE You cannot perform edits that would create a non-planar polygon. Every ring of a polygon must be planar and all parts and all rings must be in the same plane.



To edit a feature using feature editing commands (page 705)

NOTE This command is for geospatial features only. To edit drawing objects, see [Overview of Working with Drawing Objects](#) (page 727) and [Working with Polygon Objects](#) (page 954).

The MAPMULTIPOLYGONEDIT command is based on the PEDIT command. For more information about the prompts, see PEDIT.

Respond to the prompts:

Enter an option [Add/addRing/Delete/Move/Edit/Undo/eXit] <eXit>:

Enter an option.

Add

Adds a new polygon to the MultiPolygon. For more information, see [MAPPOLYGONCREATE](#) (page 1663).

Addring

Creates a polygon inside a polygon. This is considered a hole. Additional rings are islands. Specify the polygon to which you will add the ring. Repeats the MAPPOLYGONCREATE command.

Delete

Deletes a polygon from the MultiPolygon.

Move

Moves a polygon in the MultiPolygon.

Select objects:

Select the polygon to move.

Specify base point:

Specify a base point for the Move operation.

Specify second point:

Specify the second point for the Move operation. The two points you specify define a vector that indicates how far the selected polygons are to be moved and in what direction.

Edit

Edits a polygon in the MultiPolygon. For more information, see [MAPPOLYGONEDIT](#) (page 1665).

Undo

Undoes the last step in the MAPMULTIPOLYGONEDIT operation.

Exit

Ends the MAPMULTIPOLYGONEDIT operation.

MAPPOINTCREATE

Use this command to create a new point feature on a layer that contains point feature data.



To create a new Point or MultiPoint feature (page 688)

NOTE This command is for geospatial features only. To create drawing objects, see [Overview of Working with Drawing Objects](#) (page 727).

Respond to the prompt.

Specify a point:

Specify the location of the new point feature.

MAPPOLYGONCREATE

Use this command to create a new polygon feature on a layer that contains polygon feature data.

NOTE You cannot create a non-planar polygon. Every ring of a polygon must be planar and all parts and all rings must be in the same plane.

The MAPPOLYGONCREATE command is based on the PLINE command. For more information about the prompts, see PLINE.



To create a new Polygon or MultiPolygon feature (page 689)

NOTE This command is for geospatial features only. To create drawing objects, see [Overview of Working with Drawing Objects](#) (page 727) and [Working with Polygon Objects](#) (page 954).

Respond to the prompts.

Specify start point:

Specify a starting point for the polygon.

Specify next point or [Arc/Length/Undo]:

Specify the next point or enter an option.

Next Point

Draws a line segment. The previous prompt is repeated.

Arc

Adds arc segments to the polygon.

Specify endpoint of arc or [Angle/CEnter/Direction/Line/Radius/Second pt/Undo]:

Specify the endpoint of the arc or enter an option. If you have already created one arc, you have the option to close the polygon. For more information about the prompts, see PLINE.

Length

Draws a line segment of a specified length at the same angle as the previous segment. If the previous segment is an arc, the new line segment is drawn tangent to that arc segment.

Specify length of line:

Specify a distance.

Undo

Removes the most recent segment added to the polygon.

Ring

Creates a polygon inside a polygon. This is considered a hole. Additional rings are islands. Repeats the MAPPOLYGONCREATE command.

Exit

Ends the MAPPOLYGONCREATE command.

MAPPOLYGONEDIT

Use this command to edit a polygon geospatial feature.

NOTE You cannot perform edits that would create a non-planar polygon. Every ring of a polygon must be planar and all parts and all rings must be in the same plane.



To edit a feature using feature editing commands (page 705)

NOTE This command is for geospatial features only. To edit drawing objects, see [Overview of Working with Drawing Objects](#) (page 727) and [Working with Polygon Objects](#) (page 954).

The MAPPOLYGONEDIT command is based on the PEDIT command. For more information about the prompts, see PEDIT.

Respond to the prompts:

Enter an option [Add/Delete/Move/Edit/Undo/eXit] <eXit>:

Enter an option.

Add

Adds an outer polygon or a ring or island to the selected polygon. For more information, see [MAPPOLYGONCREATE](#) (page 1663).

Delete

Deletes the outermost polygon or rings or islands from the selected polygon.

Move

Moves the outermost polygon or rings or islands in the selected polygon.

Select objects:

Select the polygon to move.

Specify base point:

Specify a base point for the Move operation.

Specify second point:

Specify the second point for the Move operation. The two points you specify define a vector that indicates how far the selected polygons are to be moved and in what direction.

Edit

Edits a vertex on the outer ring or an island or hole. For more information, see [MAPLINESTRINGEDIT](#) (page 1655).

Undo

Undoes the last step in the MAPPOLYGONEDIT operation.

Exit

Ends the MAPPOLYGONEDIT operation.

Break Objects at Boundary dialog box

Use this dialog box to create a clean map edge by cutting lines, 2D polylines, arcs, and circles that cross a specified edge.



[To break objects at a boundary](#) (page 941)



Click Tools tab ► Map Edit panel ► Boundary Break.



NOTE This command is for drawing objects only. To split geospatial features, see [Splitting Features](#) (page 705).

Before

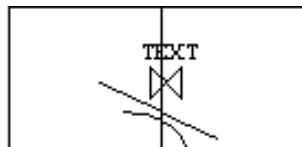

After

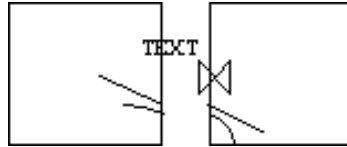

Boundaries

Specify what to use as the boundary.

Use Save Back Extents Of Active Source Drawings

Use the save back extents specified by the drawing settings for the current drawing. To change the save back extents, use the Drawing Settings dialog box.

In Map Explorer, right-click Drawings ► Define/Modify Drawing Set. In the [Define/Modify Drawing Set dialog box](#) (page 1918), click Drawing Settings.

Select Boundaries

Use existing objects as the boundary. Click Select to select the objects to use.

Define Boundary

Use selected points to specify the boundary. Click Define to select points to delineate the boundary.

Objects to Break

Select the objects to break.

Select Automatically

Use all objects within or crossing the boundary.

Select Manually

Use only selected objects. Click Select to select the objects to break.

Filter Selected Objects

Select only objects that are on the specified layers or blocks. These filters are used for both automatic and manual selection of objects.

Filter On Layers

Break only objects on the selected layers. Click Layers to select from a list of all available layers in the current drawing.

Break Method

Select the objects to skip or object data to retain during a break operation.

Skip Topology Objects

Protect topology data. Objects with topology data are not broken.

Retain Object Data

Save object data from the original object. The data is duplicated on each new piece.

COGO Input dialog box

The COGO Input dialog box allows you to create points using coordinate geometry data. It also allows you to run an inverse report to determine the relationship between two points.



To create a point using the COGO Input dialog box (page 1028)



Click Create tab ► Drawing Object panel ► COGO Input.

Routines

Select the COGO routine to use:

- Angle/Distance: specify a point by specifying an angle and a distance from another point.
- Azimuth/Distance: specify a point by specifying azimuth and distance from another point. Azimuth is the clockwise angle from the North(or South) meridian.
- Bearing/Bearing: specify a point using the projections from two existing lines or points and two bearings.
- Bearing/Distance: specify a point by specifying a bearing and a distance from another point.
- Deflection/Distance: specify a point by specifying a deflection angle and a distance from another point.
- Distance/Distance: calculated a new point using two points and two distances to the new point. You must select one of the two calculated points.

- **Inverse Report:** An inverse report gives you information about the relationship between two points.
- **Orthogonal/Offset:** specify a point using distance and offset from an existing line.

Input

Enter the required input for your chosen routine.

Calculate

Calculates the point based on the selected coordinate geometry routine and input.

Result

Displays the coordinates of the new point.



Zoom to the created point in the drawing window.

Report

For Inverse Report only: view the results of the inverse report.

Create Point

Create the point and close the COGO Input dialog box.

OK

For Inverse Report only: close the COGO Input dialog box.

Cancel

Close the COGO Input dialog box without creating a point.

Split and Merge Rules dialog box

Use this dialog box to specify how class property values are calculated when you use the following commands on features.

- Split ([MAPFEATURESPLIT](#) (page 1652))
- Merge ([MAPFEATUREMERGE](#) (page 1651))
- **Overlay** (page 1563)
- JOIN

- Join option of PEDIT
- BREAK
- TRIM



To create split/merge rules using expressions



In the Data Table, click Options ► Set Split And Merge Rules.

Click Feature Edit tab ► Split/Merge panel ► Merge Feature.



Click Feature Edit tab ► Split/Merge panel ► Split Feature.



NOTE This command is for geospatial features only. To split polygonal drawing objects, see [Splitting Polygon Objects](#) (page 968).

Feature Properties

Click a property to see its attributes and set its rules. Right-click a property to select multiple properties or property types. You cannot set rules for properties that are read-only.

Property Attributes

Attribute information for the selected property or properties.

Split and Merge Rules

Specifies how class property values will be calculated when features are split or merged.

Split Rule

Specify the rule for calculating class property values when you split features.

- **Calculation.** For numeric properties, set the property value based on a custom calculation specified in the Expression field.
- **Copy.** Copy the property values to each new feature. (Default)
- **Divide.** Divide the property values equally into each new feature. (Numeric properties only)
- **Empty.** Set the property values to “empty” or a default for new features. The original feature retains the original property values.

- **Expression.** Specify an expression.
- **Proportional.** Distribute the property values proportionally into each new feature based on the numeric value in the Based On field.

Expression

Specify a custom calculation. Enter the expression for the calculation, or

click  to use the Split Rule Expression dialog box.

This option is displayed when the Split Rule is set to Calculation or when the selected property is a string. For more information, see Overview of Expressions for Geospatial Features.

Based On

Specify the value the Proportional rule uses to distribute the property values. This option is displayed when Split Rule is set to Proportional.

Merge Rule

Specify the rule for calculating class property values when you merge features.

- **Average.** Average the property values from the merged features. (Numeric properties only)
- **Calculation.** Set the property value based on a custom calculation specified in the Expression field.
- **Concatenation.** Join the values to form a single string separated by the text in the Separator Text field.
- **Count.** Gives the property the value of the total number of features merged to produce it. This option is for numeric values only.
- **Empty.** Set the property value to “empty” or a default for the merged feature.
- **Expression.** Specify an expression.
- **First Selected.** Use the value of the first selected feature.
- **Last Selected.** Use the value of the last selected feature.
- **Maximum.** Use the maximum property value of the merged features.
- **Median.** Use the median value of the merged features.
- **Minimum.** Use the minimum value of the merged features

- **Standard Deviation.** Use the standard deviation of the merged features.
- **Sum.** Use the sum of the values of the merged features.

Expression

Specify a custom expression. Enter the expression, or click  to use the Split Rule Expression dialog box.

This option is displayed when the Merge Rule is set to Calculation or when the selected property is a string. For more information, see [Overview of Expressions for Geospatial Features](#).

Separator Text

Specify the text that separates the property values when you select the Concatenation merge rule.

Trim Objects At Boundary dialog box

Use this dialog box to trim objects at a specified boundary, excluding either what is inside the boundary (Trim Inside Boundary), or what is outside (Trim Outside Boundary). The trimmed objects are created new in the current drawing and do not retain links to their source drawings.



[To trim objects inside a boundary](#) (page 945)



Click Tools tab ► Map Edit panel ► Boundary Trim.



NOTE This command is for drawing objects only. To edit geospatial features, see [Extracting Feature Geometry](#) (page 715).

Trim Inside / Trim Outside

Given some drawing data...

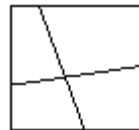

Trim Inside / Trim Outside

And a trim boundary...

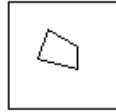

Trim Inside looks like this...



And Trim Outside looks like this...

**Boundary**

Specify what to use as the boundary.

Reference Last Query Boundary

Use the last spatial boundary that was referenced in a query.

Select Boundary

Use an existing object as the boundary. Click Select to select a closed polyline or circle for the boundary.

Define Boundary

Use selected points to specify the boundary. Click Define to select at least three points for the boundary. The boundary cannot cross itself.

Objects to Trim

Select the objects to trim.

Select Automatically

Trim all objects within or crossing the boundary.

Select Manually

Trim only selected objects. Click Select to select the objects to trim.

Filter Selected Objects

Select only objects that are on the specified layers or blocks. These filters are used for both automatic and manual selection.

Filter On Layers

Trim only objects on selected layers. Click Layers to select from the layers in the current drawing. If circle objects cross the selected boundary, they are converted to arcs before they are trimmed.

Trim Method

Set rules for the trim operation.

Trim Inside/Outside Boundary

Specify whether to trim all objects inside the specified boundary and cut a hole in the drawing, or whether to trim all objects outside the boundary and create a neat border.

Skip Topology Objects

Protect topology data. Objects with topology data are not trimmed.

Retain Object Data

Duplicate object data and external database links on each piece of the trimmed object. If you clear this option, the data remains attached only to the original location.

Objects That Cannot Be Trimmed

Specify what to do with objects that cannot be trimmed, such as text.

Ignore

Do not delete the objects.

Delete

Delete the objects.

Reference Insertion Point

Delete an object only if its insertion point is inside the area to trim.

External Databases Dialog Boxes

24

Associate Database Versions dialog box

Use this dialog box to set options related to database versions and file extensions.



[To associate database versions with files extensions](#) (page 243)



Click Map Setup tab ► Map panel ► angle-arrow.

NOTE This functionality applies only to an attribute data source that you use with drawing objects. For information about attribute data for geospatial features, see [Overview of Joins](#) (page 507).

You can associate a database file extension with the version of the database software that you use to edit the file. When you drop a database file on the Map Explorer tab of the Task Pane, AutoCAD Map 3D checks the file extension and uses the specified version of the database software.

Always Prompt

Select this option if you use more than one type of database. Each time you drop a database file onto the Map Explorer tab, AutoCAD Map 3D will prompt for the version of the database software to use with the file.

Always Use

Select this option if you always use one type of database. When you drop a database file onto the Map Explorer, AutoCAD Map 3D uses the specified version of the database software.

For example, if all your dBASE files are in dBASE III format, select Always Use, and then select dBASE III from the list. If you have files in both dBASE III and dBASE IV format, select Always Prompt under dBASE/FoxPro.

For files created with Excel 95, select the Excel 7.0 driver.

Column dialog box

Use this dialog box to specify column display options for Data View.



To change the formatting of cells in a column in Data View (page 1058)



Click Map Setup tab ► Map panel ► angle-arrow.

NOTE Data View displays attribute data linked to drawing objects. For information about viewing attribute data for geospatial features, see [Overview of the Data Table](#) (page 1125).

By default, your formatting changes are saved with the current drawing. Whenever you open this table from this drawing, the table uses the saved formatting. If you do not want to save the formatting, clear the Save Format And Style Changes With Drawing option on the Data Source tab of the [AutoCAD Map Options dialog box](#) (page 1908). If this option is cleared, AutoCAD Map 3D erases formatting information when you close a table. When you detach a data source, AutoCAD Map 3D erases formatting information for all tables in that data source.

If you modify table column order outside of the Data View, the Data View formatting may no longer be correct. To clear the formatting for a single table, close the table when the Save Format And Style Changes With Drawing option is cleared. To clear the formatting for all tables in a data source, detach the data source.

Use the Font tab to specify text options for the selected column.

Use the Interior Pattern tab to specify the background of cells in the selected column.

Use the Borders tab to specify borders for the selected column.

Use the Align tab to specify text alignment for the selected column.

Font tab

Font

Select a font from the list of fonts installed on your system. Row height adjusts automatically for the font size.

Outline

Select a font style. Available styles are determined by the selected font.

Size

Select a font size. Available sizes are determined by the selected font.

Effects

Select Strikeout to print hyphens through the text. Select Underline to underline the text.

Text Color

Select a color for the text.

Preview

Preview your font options.

Color tab

Interior Pattern

Select a pattern. For no pattern, select the asterisks.

Foreground

Specify the color for the foreground of the pattern. Select a color that doesn't hide the text.

Background

Specify the color for the background of the pattern. Select a color that doesn't hide the text.

3D-Effect

Select a 3D effect for the cell.

Preview

Preview your pattern and 3D effects options.

Borders tab

Border

Click in a box to select a border for the Left, Right, Top, or Bottom of each cell in the column. The border uses the currently selected line type.

Type

Click a line type to select it.

Color

Select a color for the border.

Align tab

Horizontal

Align text on the left of the cell, the right of the cell, or in the horizontal center of the cell. Select Standard to right-align numeric fields and left-align all other fields.

Vertical

Align text with the top of the cell, the bottom of the cell, or in the vertical center of the cell.

Wrap Text

Allow text to wrap in the cell. If this option is not selected, text that is too long is not displayed or printed.

Allow Enter

Specify that pressing Enter clears the cell. If this option is not selected, pressing Enter moves to the next cell.

Auto Size

Automatically adjust the column width to the longest value in the column.

Column Values dialog box

Use this dialog box to specify values for a SQL filter in the Data View.



[To use a SQL filter in the Data View](#) (page 1231)



Click Home tab ► Data panel ► Define Query.



NOTE Data View displays attribute data linked to drawing objects. For information about viewing attribute data for geospatial features, see [Overview of the Data Table](#) (page 1125).

Scroll through the list, select the value you want, and click OK. The new value is inserted into the Value field.

Configure Data Source dialog box

Use this dialog box to enter a name for a new data source or select an existing data source from the list.



To [configure a data source automatically](#) (page 213)



Click Map Setup tab ► Attribute Data panel ► Configure Data Source.



NOTE This functionality applies only to an attribute data source that you use with drawing objects. For information about attribute data for geospatial features, see [Overview of Joins](#) (page 507).

Click OK to define or modify a data link file for the data source in the Microsoft Windows Data Link Properties dialog box. If the data source you want is not listed, it may not be in the data sources folder.

For more information on configuring a data source, refer to your Microsoft Windows documentation.

NOTE If you modify a data source that is currently connected, the changes will not take effect until you reconnect the data source.

Connect Data Source dialog box

Use this dialog box to select a data source to connect.



To [attach a data source by dragging the database file to the Task Pane](#) (page 209)

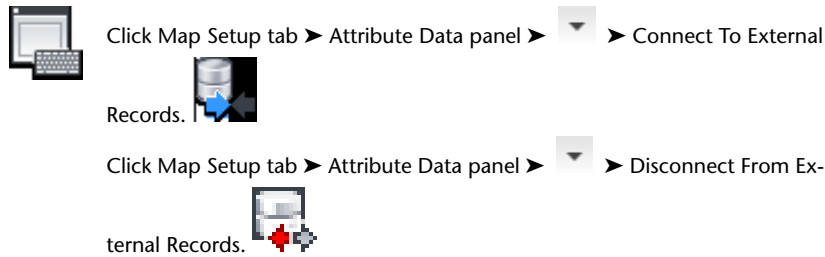



NOTE This functionality applies only to an attribute data source that you use with drawing objects. For information about attribute data for geospatial features, see [Overview of Joins](#) (page 507).

These data sources are attached to the current drawing but are currently disconnected. Select data sources from the list. Click Connect. If the data source you want is not listed, it may not be attached to this drawing.

Convert Object Data to Database Links dialog box

Use this dialog box to convert object data in your drawing to external data.

- 
- [To convert object data to a linked database table](#) (page 534)
 - [To link records to objects using object data automatically](#) (page 531)
 - [To attach a data source by dragging the database file to the Task Pane](#) (page 209)



At the Command prompt, enter mapod2ase.

NOTE This functionality applies only to an attribute data source that you use with drawing objects. For information about attribute data for geospatial features, see [Overview of Joins](#) (page 507).

NOTE Before you run this command, you must attach the data source to the current drawing. In Map Explorer, right-click Data Sources > Attach.

Do either of the following:

- Create a database table from an existing object data table, using the same structure.

AutoCAD Map 3D reads each selected object and creates a new record in the external database table. If an object has multiple records from the object data table, AutoCAD Map 3D creates multiple records in the external database table. AutoCAD Map 3D also generates a database link to connect the object to the record in the new database table.

- Use object data in your drawing that matches information in an external database table and automatically create links based on the matched information.

You can leave the object data in the drawing or remove the object data from the objects as each record is created.

When you are finished with this dialog box, click Proceed.

Source Object Data Table

Select the object data table to convert or link. Select an object data table defined in the current drawing. To work with object data tables in attached drawings, open those drawings directly.

Name

Select the object data table from the list.

Remove Data From Objects Processed

Delete the object data currently associated with the object.

Target Link Template

Select an option and click Define to specify the link template.

Convert Object Data To Database

Convert object data to records in a database and link objects to the new data.

Link Object Data To Database

Link objects with attached object data to records in a database table using key fields.

Define

Specify the link template to identify the database table.

Object Selection

Specify how to select objects, and whether to select all objects or only objects on specific AutoCAD layers.

Select Automatically

Use all objects, unless Filter On Layers is selected.

Select Manually

Select individual objects. Click Select to pick them in the map.

Filter On Layers

Search all layers, or click Layers to select from a list of AutoCAD layers in the current drawing.

Define Link Template dialog box (MAPOD2ASE)

Use this dialog box to specify the table name for the new database table and to define the link template that identifies the database table.



To create a link template (page 526)



At the Command prompt, enter mapod2ase.

NOTE This functionality applies only to an attribute data source that you use with drawing objects. For information about attribute data for geospatial features, see [Overview of Joins](#) (page 507).

Data Source

Select a data source from the list. If it is checked, you are connected to the data source. If you are not connected, click Connect.

Catalog/Schema

Select a catalog and schema from the list, if required by this data source.

Table Name

Specify a unique name for the link template.

Key Columns

Specify the columns to use as key columns. Separate multiple names with commas. To select from a list of field names in the object data table, or to rename the fields, click Select.

Clicking Select displays the [Select Link Template Key dialog box](#) (page 1797).

Link Template

Specify a unique link template name.

Define Link Template dialog box (MAPDEFINELT)

Use this dialog box to define the location of a table and the columns to use as key columns for a link template.



[To convert object data to a linked database table](#) (page 534)



Click Map Setup tab ► Attribute Data panel ► Define Link Template.



NOTE This functionality applies only to an attribute data source that you use with drawing objects. For information about attribute data for geospatial features, see [Overview of Joins](#) (page 507).

If you use the same table and key columns for multiple drawings, specify a consistent naming scheme for link templates.

Data Source list

Select one of the attached and connected data sources in the current drawing. If you open the dialog box from an existing table, you can select the data source for the table.

Table Name list

Select a table for the selected data source. If you open the dialog from an existing table, you can select the table name.

Link Template box

Enter a new name. Link templates defined for the selected table are listed.

Key Selection area

To select a column as a key column, click a box in the Key column. The values in the key column identify records in the table, so select a column or set of columns that has a unique value for each record.

NOTE If the link template does not immediately appear on the Map Explorer tab of the Task Pane, right-click a blank space in the Map Explorer tab. Click Refresh.

Source dialog box

Use this dialog box to view all data sources attached to the current drawing.



To attach a data source by dragging the database file to the Task Pane (page 209)



Click Map Setup tab > Attribute Data panel > Attach Data Source.



NOTE This functionality applies only to an attribute data source that you use with drawing objects. For information about attribute data for geospatial features, see [Overview of Joins](#) (page 507).

Select the data sources. Click Detach. The selected data sources are disconnected and removed from the current drawing.

Disconnect Data Source dialog box

Use this dialog box to view data sources that are attached to the current drawing and are currently connected.



To disconnect a data source (page 215)



Click Map Setup tab > Attribute Data panel >  > Disconnect From Ex-

ternal Records.



NOTE This functionality applies only to an attribute data source that you use with drawing objects. For information about attribute data for geospatial features, see [Overview of Joins](#) (page 507).

Select the data sources. Click Disconnect. Disconnected data sources remain attached to the current drawing. If the data source you want is not listed, it may not be attached to this drawing or it may not be currently connected.

Header/Footer dialog box

Use this dialog box to define the header and footer for a Data View report.



To specify the header and footer (page 1476)



In the Data View: File ► Header and Footer

NOTE Data View displays attribute data linked to drawing objects. For information about viewing attribute data for geospatial features, see [Overview of the Data Table](#) (page 1125).

Select the Header or Footer tab and enter the text. To change the font, select a cell and click Font. In the Font dialog box, select formatting options for all text in the cell.

You can also enter certain variables.

Variable	Replaced with at print time
\$A	Application name
\$P	Current page number
\$N	Total number of pages
\$D	Current date

Distance to Frame

Dimensions are in centimeters if your Windows system-wide measurement system is set to Metric, in inches if it is set to U.S. To view or set the measurement system, from the Windows Control Panel choose Regional Settings ► Number tab ► Measurement System.

Header

Specify the distance from the top margin to the bottom of the header text.

Footer

Specify the distance from the bottom margin to the top of the footer text.

First Page No.

Enter the starting page number. Additional pages are numbered consecutively.

Link Template Properties dialog box

Use this dialog box to change the width of the Column Name or Data Type columns.



[To edit the database path in a link template](#) (page 539)



Click Map Setup tab ► Attribute Data panel ►  ► Edit Link Template

Properties.



NOTE This functionality applies only to an attribute data source that you use with drawing objects. For information about attribute data for geospatial features, see [Overview of Joins](#) (page 507).

Drag the column divider to the desired width.

Page Setup dialog box

Use this dialog box to specify margins, headers, grid, print order, and centering options for printing from Data View.



[To set print options](#) (page 1476)



In the Data View: File ► Page Setup

NOTE Data View displays attribute data linked to drawing objects. For information about viewing attribute data for geospatial features, see [Overview of the Data Table](#) (page 1125).

Margins

Margin dimensions are in centimeters if your Windows system-wide measurement system is set to Metric, in inches if it is set to U.S. To view or set the measurement system, from the Windows Control Panel choose Regional Settings ► Number tab ► Measurement System.

Left

Enter the distance from the left edge of the paper to the beginning of each line.

Right

Enter the distance from the right edge of the paper to the end of the printable area.

Top

Enter the distance from the top of the paper to the top of the first line.

Bottom

Enter the distance from the bottom of the paper to the bottom of the last line.

Titles and Grid Lines

Row Headers

Print row headers.

Column Headers

Print column headers.

Print Frame

Print a frame around the table.

Vertical Lines

Print vertical lines between each column.

Horizontal Lines

Print horizontal lines between each row.

Only Black And White

Print using only black and white. Text that has a color assigned to it will be printed using a pattern.

Page Order

If a table extends beyond the limits of a single page, it is divided into page-size tiles. This setting governs the order of printing the tiles.

First Rows, Then Columns

Print tiles from left to right by rows, top row first.

First Columns, Then Rows

Print tiles from top to bottom by columns, left column first.

Center on Page

Vertical

Center the table between the specified top and bottom margins.

Horizontal

Center the table between the specified left and right margins.

Select Database Version dialog box

Use this dialog box to select the database to use with this file from the list of available databases.



[To set data source options](#) (page 236)



Click  Options.

Click Map Setup tab ► Map panel ► angle-arrow.

NOTE This functionality applies only to an attribute data source that you use with drawing objects. For information about attribute data for geospatial features, see [Overview of Joins](#) (page 507).

Always Use This Database For Files Of This Type

Use the selected database version for all databases with this extension. You will not be prompted again. To turn prompting back on, change the setting on the Data Source tab of the Autodesk Map Options dialog box.

To specify default database versions for other extensions, use the Data Source tab of the [AutoCAD Map Options dialog box](#) (page 1908).

Select Existing Link Template dialog box

Use this dialog box to select the appropriate link template, specify the key fields in the object data to use, and then select a database validation option.



[To open a linked database table](#) (page 527)



At the Command prompt, enter mapviewlink.

NOTE This functionality applies only to an attribute data source that you use with drawing objects. For information about attribute data for geospatial features, see [Overview of Joins](#) (page 507).

The list of link templates include those available for the current drawing.

Link Template

Select a link template for the database table containing the data matching your object data table. In the OD Column, specify the fields in the object data table to use for key fields.

Database Validation

Select a validation option.

None

Create links without checking the database.

Record Must Exist

Create a link only where the text or attribute tag value matches an existing record's key field value.

Create If New

Create a new record in the table if no existing record matches. If you choose this option, you can use the grid below to map data from fields in the object data table to non-key fields in the database.

Select Link Template dialog box

Use this dialog box to select the appropriate data source and then select the link template.



To open a linked database table (page 527)



At the Command prompt, enter mapviewlink.

NOTE This functionality applies only to an attribute data source that you use with drawing objects. For information about attribute data for geospatial features, see [Overview of Joins](#) (page 507).

Select from the data sources and link templates available for the current drawing

Select Link Templates dialog box

Use this dialog box to select link templates to delete.



To delete links for a group of objects (page 537)



Click Map Setup tab > Attribute Data panel >  > Link Manager.



NOTE This functionality applies only to an attribute data source that you use with drawing objects. For information about attribute data for geospatial features, see [Overview of Joins](#) (page 507).

If you are deleting links or link templates for selected objects, the list includes link templates for records linked to the selected objects. Once you select the link templates and click OK, link data associated with the selected link templates is removed from the selected objects.

Select Query dialog box

Use this dialog box to select the query whose records you want to view.



To open a table using the Task Pane (page 1053)



Click Map Setup tab > Attribute Data panel >



> Execute Query.



NOTE This functionality applies only to an attribute data source that you use with drawing objects. For information about attribute data for geospatial features, see [Overview of Joins](#) (page 507).

Select the appropriate data source and then select the query. A Data View window displays the records that match the query.

NOTE You cannot edit the data resulting from a database query.

Data Source

Select from the data sources currently attached and connected to the current drawing.

Query

Select from the queries associated with the selected data source. These queries were defined in the external database program.

Select Table dialog box (MAPBROWSETBL)

Use this dialog box to select a data table to view or edit.



To open a table using the Task Pane (page 1053)



Click Map Setup tab > Attribute Data panel >



> Edit Table.



NOTE This functionality applies only to an attribute data source that you use with drawing objects. For information about attribute data for geospatial features, see [Overview of Joins](#) (page 507).

Select the appropriate data source and then select the table.

Data Source

Select from data sources currently attached and connected to the current drawing.

Table

Select from tables in the selected data source.

Sort dialog box

Use this dialog box to sort the Data View.



[To use the Data View](#) (page 1047)



In the Data View: View ► Sort ► Multiple Columns

NOTE Data View displays attribute data linked to drawing objects. For information about viewing attribute data for geospatial features, see [Overview of the Data Table](#) (page 1125).

Before you begin sorting, note the following:

- Records are sorted based on the value in the column selected in the Sort By box.
If multiple records have the same value in this column, those records are further sorted by the column specified in the first Then By box.
- If you do not specify a sort column, records are sorted in database order.
- To sort the table by additional columns, use the remaining Then By lists.
- You can sort up to five columns simultaneously.
You cannot sort columns that have binary or user-defined data types, and these columns do not appear in the sort lists.
- To clear all the lists, click Reset.

Sort By

Click the down arrow and select the column in the table to sort by. Columns with binary or user-defined data types are not listed.

Ascending

Sort from the beginning of the alphabet, the lowest number, or the earliest date.

Descending

Sort from the end of the alphabet, the highest number, or the latest date.

Table Filter dialog box

Use this dialog box to select records from the database table.



[To use a SQL filter in the Data View](#) (page 1231)



In the Data View: Records ► SQL Filter

NOTE Data View displays attribute data linked to drawing objects. For information about viewing attribute data for geospatial features, see [Overview of the Data Table](#) (page 1125).

When you apply the filter, the Data View searches the current database table and displays only records that match the specified conditions.

To edit an existing condition, select the line in the SQL Filter list. Edit the information in the Where Condition area. When you finish editing, click Update.

To add a new line, select a joining operator (And/Or/Not). Select a column and an operator and specify a value. When you finish, click Add.

SQL Filter area

View the current filter. If lines in the filter were grouped, the group is indented.

Group

Group the selected conditions. Conditions in the group are evaluated before other conditions.

Ungroup

Delete the parentheses from the selected line and from the matching ending or beginning line of the group.

Delete

Delete the selected condition.

Clear All

Delete all conditions.

Where Condition area

Use the Where Condition area to edit an existing condition in the filter or to add a new condition.

And

Specify that both conditions must be met for the object to be included in the query.

Or

Specify that either condition can be met for the object to be included in the query.

Not

Specify **And Not** if the first condition must be met and the second condition must not be met for the object to be included in the query. Specify **Or Not** if either the first condition can be met or the second condition cannot be met for the object to be included in the query.

For the very first condition in the list, do not specify **And** or **Or**. You can select **Not**.

Column

View columns from the current table.

Operator

Specify how to test the values in the column.

Operator	Description
=	The value of the selected column is equal to the value you enter in the Value box.
>	The value of the selected column is greater than the value you enter in the Value box.
>=	The value of the selected column is greater than or equal to the value you enter in the Value box.

Operator	Description
<	The value of the selected column is less than the value you enter in the Value box.
<=	The value of the selected column is less than or equal to the value you enter in the Value box.
<>	The value of the selected column is not equal to the value you enter in the Value box.
IN	The selected column is linked to the object and contains the specified value. If you specify multiple values, separate each value with a comma. Enclose values in single quotes, for example, '1','2','3'.
IS NULL	The selected column is linked to the object and is empty. Do not enter a value in the Value box.
LIKE	The selected column is linked to the object and contains part of the value specified. Applies to string (character) data types only. Use the percent sign (%) as a wild-card character in the Value box.

For information on the wild-card characters supported by your database system, refer to the documentation for your database system software.

Value

Specify the value to search for. To select from a list of existing values in the

column, click . To use wild-card characters for string values, select LIKE.

For example, type B% to find all values that begin with the letter B.

Add

Add the condition line to the SQL Filter list.

Update

Replace the selected condition in the SQL Filter list with the new condition.

To use a filter you previously defined for this table, click History at the bottom of the screen. Select the filter from the list.

Table Filter History dialog box

Use this dialog box to manage the filters you previously defined for this table.



To use a SQL filter in the Data View (page 1231)



In the Data View: Records ► SQL Filter

NOTE Data View displays attribute data linked to drawing objects. For information about viewing attribute data for geospatial features, see [Overview of the Data Table](#) (page 1125).

To use a filter, select it in the list and click OK, or double-click the filter. To erase a filter, select it in the list and click Delete. To erase all filters, click Delete All.

The maximum number of filters stored on this list is determined by the value for Number Of SQL Conditions To Keep In History List on the Current Drawing tab of the [AutoCAD Map Options dialog box](#) (page 1908).

Table Properties dialog box

Use this dialog box to view information about the selected table or query in Data View.



To view external data linked to drawing objects (page 1147)



Click the Highlight Linked Objects icon.

NOTE Data View displays attribute data linked to drawing objects. For information about viewing attribute data for geospatial features, see [Overview of the Data Table](#) (page 1125).

To change the width of the Column Name or Column Type columns, drag the column divider to the desired width.

Name

View the name of the selected table or query.

Structure

View the column name and column type for each column.

Zoom Scale dialog box

Use this dialog box to specify the percentage of the display area that highlighted objects will fill.



[To set other Data View highlighting options](#) (page 1227)



In the Data View: Highlight ► Zoom Scale

NOTE Data View displays attribute data linked to drawing objects. For information about viewing attribute data for geospatial features, see [Overview of the Data Table](#) (page 1125).

Specify 100% to zoom the display to the extents of the selected objects. Specify a smaller number to display more of the drawing outside the highlighted objects.

Specify 0% to maintain the current zoom level.

Import Export Dialog Boxes

25

Attribute Data dialog box

Use this dialog box to specify the attribute data to import for the selected input layer. This is sometimes called a theme, level, or file.



To specify the data to import (page 426)



Click Home tab ► Data panel ► Import From Files.



NOTE Data you import becomes AutoCAD drawing objects in your map. To connect to the data in its original format, see [Overview of Bringing In GIS Features](#) (page 305). To convert the drawing objects to a geospatial format, see [Overview of Converting and Exporting](#) (page 1405).

Do Not Import Attribute Data

Do not add data attached to the objects in the source drawing.

Create Object Data

Import data attached to the objects in the source drawing into an object data table.

Object Data Table To Use

Select an object data table or enter a name for a new one. A table name can include the characters A-Z, a-z, 0-9, \$ and _. It cannot include spaces. It must start with an alphanumeric character.

For a new object data table name, AutoCAD Map 3D creates a new object data table with fields that match the fields you're importing. To change these defaults, click Select Fields.

For an existing object data table, incoming fields are imported into object data fields with the same name by default. If no object data field exists with the same name, the incoming field is not imported. To change these defaults, click Select Fields.

When the data is imported, it will be converted to the following object data types:

- Integer32, Integer16, and Boolean data types are converted to the Integer data type. For Boolean data, false is converted to 0 and true is converted to 1.
- Float, Double, and Decimal data types are converted to the Real data type.
- Char and Date data types are converted to the Character data type.

Incoming data is converted to the data type of the matching object data field. If this conversion fails, AutoCAD Map 3D uses 0 for integers, 0.0 for real numbers, and "" for characters.

Select Fields

Select the fields to import and specify names for the object data fields.

Add Unique Key Field

Automatically create a field with a unique entry for each imported object. You can edit the field name.

The unique ID numbers increment within a single AutoCAD Map 3D session, but restart when you restart AutoCAD Map 3D. To extend the unique key across multiple imported files, import them all during the same AutoCAD Map 3D session.

Add To Database Table

Append data attached to the objects in the source to an external database table. The links to the data are imported with the objects. Select the link template to use. Optionally, import only the link data.

If no link templates are defined in the current drawing, the option is not available.

Link Template

Select a link template from the list.

Select Fields

Select fields to import from the source drawing. If you select only key fields, they are imported as link data, and the database table is not updated.

Create Link Only

Import link data only. Links are maintained from the imported objects to their appropriate row in the table, but no changes are made to the database table.

If you import only the key field, this option is automatically selected.

Block Mapping dialog box

This dialog box was used to list all values in the import file for the specified Control Data Element and the block name to which they were mapped. It has been discontinued. Instead, use one of the following procedures or commands.



[To import data from other formats](#) (page 381)

[To import from Arc/INFO](#) (page 396)

[To import from MapInfo MIF/MID](#) (page 401)

[To import SHP data](#) (page 399)



Click Home tab ► Data panel ► Import From Files.



Conflict Resolution dialog box

Use this dialog box to resolve conflicts during import.



[To specify the data to import](#) (page 426)



Click Home tab ► Data panel ► Import From Files.



NOTE Data you import becomes AutoCAD drawing objects in your map. To connect to the data in its original format, see [Overview of Bringing In GIS Features](#) (page 305). To convert the drawing objects to a geospatial format, see [Overview of Converting and Exporting](#) (page 1405).

You can map incoming attribute data to target data fields in the AutoCAD Map 3D drawing using both the Data and Object Class columns. This may result in mapping two different incoming data fields to the same target data field. Before proceeding with the import, you must resolve such conflicts.

For example, the Object Class field can specify that a AutoCAD Map 3D object data field called "Wire_Data" stores an imported attribute "Voltage," while the Data column specifies that the same "Wire_Data" object data field stores another imported attribute, "EMF." You cannot store two data values in one target field. The Conflict Resolution dialog box lets you specify which incoming data values to use.

Conflicts Detected For Input Layer <Layer Name>

Conflicts between the attribute mapping specified in the Data and Object Class columns have been found for the specified layer.

Conflict List

Specify which of the incoming attributes (the one defined in the Object Class or the one specified in the Data column) should be stored in the AutoCAD Map 3D data field.

Class Input Field

Click in this column to use the value specified by the Object Class.

Data Input Field

Click in this column to use the value specified by the Data column.

Target

View the target attribute data field in the AutoCAD Map 3D drawing. The syntax used for the Target field is

CATEGORY:TABLE.FIELD

Where

CATEGORY	Type of data, for example "OD" for object data, or "LT" for link template (linked external database).
TABLE	Object data table name or database table name.
FIELD	Data field name.

Use Class

Resolve all conflicts using the Class Input Field definitions.

Use Data

Resolve all conflicts using the Data Input Field definitions.

OK

Accept the current settings and return to the Import dialog box.

Coordinate System Translation dialog box

This dialog box was used to convert the file from one coordinate system to another. It has been discontinued. Instead, use one of the following procedures or commands.



[To export drawing objects to MicroStation Design \(DGN\)](#) (page 1438)

[To export to MapInfo MIF/MID](#) (page 1432)

[To export drawing objects to SHP](#) (page 1428)

[To export drawing objects to ESRI Arc/INFO](#) (page 1421)



In the Tool-based Ribbon Workspace, click Output tab ► Map Data Transfer

panel ► Map 3D Export.



If the coordinate system you want is not listed in any category, you can [create a new coordinate system](#) (page 90).

Input Settings area

From the Coordinate System list, select the coordinate system code for the existing file. This list displays all codes in the selected category. To display the codes for a different category, select the new category from the Category list.

Output Settings area

From the Coordinate System list, select the coordinate system code you want for the new file. This list displays all codes in the selected category. To display the codes for a different category, select the new category from the Category list.

Define Link Template dialog box (MAPIIMPORT4)

This dialog box was used to define a new link template when importing an external map file into AutoCAD Map 3D format. It has been discontinued. Instead, use one of the following procedures or commands.



[To import data from other formats](#) (page 381)

[To import from Arc/INFO](#) (page 396)

[To import from MapInfo MIF/MID](#) (page 401)

[To import SHP data](#) (page 399)



Click Home tab ► Data panel ► Import From Files.



OK

When you click OK, a link template is created for the table using the key columns in the Key Selection area that have been set to On.

Table Specification Area

Select a data source, catalog, and schema. Enter the name of a table. To select from a list of table names, click List.

Link Template Area

Enter a name for the link template. Link template names can be up to 31 alphanumeric characters.

Key Selection Area

Specify a key column by selecting the column and clicking On.

Export dialog box

Use this dialog box to select the drawing objects to export, and specify export options. You cannot export feature data.



[To export drawing objects to other file formats](#) (page 1408)



In the Tool-based Ribbon Workspace, click Output tab ► Map Data Transfer

panel ► Map 3D Export.



NOTE Export affects drawing objects only. To convert geospatial data to a different format, see [Migrating GIS Data \(Bulk Copy\)](#) (page 617).

If you have previously saved your settings in this dialog box, click Load to reload those settings. To save the current settings for use later or to use in a script, click Save.

The dialog box has the following tabs:

- [Selection Tab](#) (page 1705)
- [Data Tab](#) (page 1707)
- [Options Tab](#) (page 1708)

If you export to SDF, Oracle, or ArcSDE, the Export dialog box substitutes [Feature Class Tab](#) (page 1706) for the Data Tab.

Selection Tab

Specify the objects to export.

Object Type

For some formats, select the object type to export. Objects of other types are filtered out of the export. To export the other object types, run Export again. Some objects may be exported as more than one type.

Select Objects To Export

Select the objects to export.

Select All

Select all objects.

Select Manually

Individually select the objects to export. To modify the selection set, click

Select Objects  or Quick Select .

Filter Selection area

Filter the selected objects based on layer or object class. Enter the names of the layers or object classes to include, or click the button to select from a list. Objects that are not on the selected layers and in the selected object classes are filtered out of the export. The status line shows how many objects are selected and how many have been filtered out.

Select Polygon Topology To Export

Name

Select the polygon topology to convert to polygon objects and export. These objects are in addition to any objects selected above.

Group Complex Polygons

Group nested polygons into a single balanced polygon. Each nested polygon must have a centroid.

If you do not select this option, AutoCAD Map 3D will create separate polygons, one for each centroid.

Preview Filtered Selection

See which objects will be exported. Objects that will be exported are highlighted. To leave the preview and return to this dialog, press ESC.

Feature Class Tab

Choose a method for organizing the selected drawing objects into logical feature classes.

DWG to Feature Class Mapping

Specify how DWG objects map to FDO feature classes.

Create A Single Class From All Selected Objects

Create a single FDO feature class for all selected DWG objects. This is the default selection.

Create Multiple Classes Based On A Drawing Object

Create multiple feature classes based on a drawing object. Select the drawing object on which to base the feature classes from the Drawing Object To Use list.

Select Attributes

Select specific attributes to export. You can select attributes for both single-class and multiclass export operations. For multiclass export operations, these attributes will be added to every feature class.

Drawing Object

Select the drawing objects to export.

Feature Class

The feature class to which you are exporting your data. If you are exporting to an existing FDO data store, use the drop-down list to map your data to existing fields. Existing feature classes are in blue text. You can map more than one drawing object to a single feature class.

To map drawing properties to feature class properties, click  in the Feature Class field.

Geometry

Select the geometry data to export for each drawing property. Click in the appropriate field, then click the down arrow. For pre-existing classes, this field displays the geometry type already associated with that class.

Show Schema Names

Display the schemas of the feature class to which you are mapping your data.

Data Tab

Data

To include data with the exported objects, select the data fields to export. The selected fields appear in the table. You can also enter an expression.

NOTE If you are exporting to SHP format using object classification to create feature classes, you may not want to specify attributes here, as all feature classes will then receive all attributes you check on this tab. If you don't select attributes here, properties for those feature classes are defined by the original object classes.

Select Attributes

Select properties, object properties, topology information, object class information, or fields from link template data, object data, or block attributes.

TIP To export only key values, select the fields in the Link Templates section. Since the key values are stored in the drawing as link data, selecting only key fields improves performance.

In the list of attributes, Object Data is map-specific and includes the attributes of any objects in the map that have object data tables associated with them. Object Properties are the properties of each entity type. These are the same attributes that appear in the Properties palette. Properties are attributes that apply to every DWG object in the map.

Source Field

Lists the data you selected to export. Click Select Attributes to select additional data, or enter an expression.

Output Field

Enter a name for the field in the output file for the associated field. Output field names can use any alpha-numeric character and the underscore symbol ("_").

Create Unique Key Field

Create a unique value for each exported object. You can specify a name for this field.

The unique ID numbers increment within a single AutoCAD Map 3D session, but restart when you restart AutoCAD Map 3D. To extend the unique key across multiple files you are exporting, export all the files in the same AutoCAD Map 3D session.

Options Tab

Coordinate Conversion

To convert the exported objects to a different coordinate system, check Convert Coordinates To. Enter the coordinate system code for the export

file or click  to select one from a list.

If the conversion controls are not available, there is no coordinate system assigned to your current drawing. Click Cancel, assign a coordinate system to the current drawing, and re-run Export.

Other

The options that appear in this section depend on your choice of export format.

Treat Closed Polylines as Polygons

Export closed polylines as polygons. If this check box is not selected, only polygon objects will be exported as polygons.

NOTE If you export a polygon topology that includes closed polylines and those closed polylines are part of the selection set, selecting this check box may create duplicate polygons in the exported file.

Additional Settings

The Options tab may include more settings for the format you chose. For some formats, the Driver Options button is also available.

For information about the options for a particular format, see [Supported Formats](#) (page 1412).

Additional Notes

- AutoCAD Map 3D exports original object properties regardless of any map stylizations, except for some text. Text entities created by text stylizations are exported. To avoid exporting text entities, turn off any text stylization before exporting your data. To export stylized drawing objects, first save the stylizations to a linked output drawing, and then export the linked objects. You can export stylized feature layers using Display Manager. For more information, see [Saving or Exporting a Display Manager Layer](#) (page 1469).
- Settings saved with the MAPEXPORT command from version 4.0 or earlier of AutoCAD Map 3D cannot be loaded in this dialog box.

Export to LandXML dialog box

The Export to LandXML dialog box specifies settings for exporting a Survey Data Store Project to LandXML. To select a specific element within the project, check the appropriate checkbooks for that element.



[To export survey points to a LandXML file](#) (page 1471)



On the Survey tab of the Task Pane, click Data ► Export LandXML.

NOTE Export affects drawing objects only. To convert geospatial data to a different format, see [Migrating GIS Data \(Bulk Copy\)](#) (page 617).

File

Displays the file name and LandXML version. Click in a field to edit the file information. Constrained fields will displayed valid options in a drop-down list.

Project

Displays information about the Project, such as Name, File Name, LandXML version, and so on. Click in a field to edit the Project information. Constrained fields will displayed valid options in a drop-down list.

Units

Displays information about a Project's units of measure. Click in a field to edit the measurement unit information. Constrained fields will displayed valid options in a drop-down list.

Coordinate System Assignment

Enter the coordinate system code for your new Survey Data Store. Click



to select the coordinate system from a list.

Object Class Attribute Mapping dialog box

Use this dialog box to specify how to map attribute data from the incoming file to object classes in the AutoCAD Map 3D drawing.



To assign an object class to an input layer (page 421)



Click Home tab ► Data panel ► Import From Files.



NOTE Data you import becomes AutoCAD drawing objects in your map. To connect to the data in its original format, see [Overview of Bringing In GIS Features](#) (page 305). To convert the drawing objects to a geospatial format, see [Overview of Converting and Exporting](#) (page 1405).

Select An Object Class

Click an object class defined in the current drawing.

Input Fields

Click an incoming attribute data field to map to a Target Field in the object class.

Target Fields

Click the attribute in the selected object class that the selected Input Field will map to. Map as many Target Fields as possible.

Once you map a target field, it no longer appears in the Target Fields list. This ensures that each target field is mapped to only one incoming data field.

If you don't map a target field, the default object class value will be used.

The syntax for the Target Field is

CATEGORY:TABLE.FIELD

Where

CATEGORY	Type of data, for example "OD" for object data, or "LT" for link template (linked external database).
TABLE	Object data table name or database table name.
FIELD	Data field name.

Import dialog box

Use this dialog box to specify options and settings for imported files.



[To import data from other formats](#) (page 381)

[To specify an area to import](#) (page 418)

[To specify an AutoCAD layer during import](#) (page 419)

[To assign an object class to an input layer](#) (page 421)

[To assign a coordinate system to the current drawing](#) (page 147)

[To specify the data to import](#) (page 426)

[To specify how to import points](#) (page 428)



Click Home tab ► Data panel ► Import From Files.



NOTE Data you import becomes AutoCAD drawing objects in your map. To connect to the data in its original format, see [Overview of Bringing In GIS Features](#) (page 305). To convert the drawing objects to a geospatial format, see [Overview of Converting and Exporting](#) (page 1405).

In the table, you can specify properties for each input layer (sometimes called a schema, level, or file).

To import an input layer, select its check box. To change other settings for an input layer, click in the field to change. Click the down arrow to choose from a list of choices, or click  for additional choices.

To sort on a specific column, right-click the column heading. Click Sort Ascending or Sort Descending.

To copy the contents of a field, right-click in the field. Click Copy. Right-click in the target field. Click one of the Paste options. To copy the contents of a

field to all other layers, right-click in the field. Click one of the Paste To All Layers options. When pasting into Object Class fields, the object class name and data mappings are pasted separately, and if data mapping conflicts are detected, the pasted data mappings options will not be available.

Current Drawing Coordinate System

Displays the global coordinate system for the current drawing. To change this coordinate system, or to assign a coordinate system, click .

Driver Options

If Driver Options is available, click it to specify additional options. Some formats do not have driver options. For more information about the options for a format, see [Supported Import Formats](#) (page 387).

NOTE If you import from DGN Version 8, there may be more than one model in the drawing. If so, you will see input layers reflecting each one. Each model corresponds roughly to a model space in AutoCAD Map 3D (for example, Layout 1 or Layout 2). The input layers are named using the syntax `ModelName_LevelNumber`, `ModelName_LevelName`, or `ModelName_GeometryType`, depending on the settings you choose in Driver Options.

Set driver options before you modify the table. Changing driver options may reset settings in the table.

Spatial Filter

Specify the area to import data into.

None

Place no area limit on the incoming file and import the entire incoming file.

Current Display

Limit the import to the area shown in the current drawing window.

Define Window

Limit the import to a rectangular area you define in the drawing. Click . Drag your cursor from right to left to define the area. Objects that cross or are enclosed by the rectangular window are imported.

Notes:

- AutoCAD Map 3D does not display a preview of the incoming data.

- If the coordinate system assigned to the current drawing differs from the coordinate system specified in the Input Coordinate System column, AutoCAD Map 3D will perform a reverse transformation to determine the correct coordinate space (area) for the incoming data.

Import Properties Table

Input Layer

Select the check box for an input layer name to import objects from that layer. All layers for the selected file or folder are listed.

Drawing Layer

Specify the target layer in the current drawing for the incoming objects.

Click the down arrow to select an existing layer. Click  to select an existing layer, create a new one, or use a layer stored in a data field.

Object Class

Specify the name of the object class to use for the incoming data. For example, objects on an incoming Shapefile input layer can be classified and included in the "LAND USE" object class in Map.

Click the down-arrow to select from a valid object class. Click  to map the incoming data attributes to the object class definition. If you don't map the attributes, AutoCAD Map 3D populates the object class with the default object class values.

NOTE This column is available only if you have object classes defined in your map. For more information about setting up object classes, see [Setting Up Object Classification](#) (page 116).

Input Coordinate System

Click  to specify the coordinate system of the incoming layer. Objects will be converted from the input coordinate system to the coordinate system assigned to the current drawing.

NOTE This column is available only if the current drawing has an assigned coordinate system. To assign a coordinate system to the current drawing, click



under Current Drawing Coordinate System.

Data



Click  to specify a name for the object data table or link template to use for incoming data. Select the incoming fields to include in the object data table.

Data is imported only if it is associated with an imported object. If no imported objects are associated with the incoming data, the table is not created.

Points

Select ACAD_POINT or a block name from the list to use for point objects.

To create text or get block names from incoming data, click  and select the data field.

Saved Profiles

To save your settings as a profile, click Save. To use settings that you've previously saved, click Load. You can use your saved setting to help automate scripts.

NOTE Settings saved with the MAPIMPORT command in version 4.0 or earlier of AutoCAD Map 3D cannot be loaded in this dialog box.

Import Polygons As Closed Polylines

If this option is not selected, polygons are imported as polygon objects. Importing polygons as closed polylines is useful if you plan to use the polygons in a polygon topology. To change the default state of this option, use the MAPUSEMPOLYGON command.

Use Class Defaults For Out Of Range Values

Use object class default values for incoming data values that are not within the specified object class range. This ensures that the incoming data will be accurately classified, but may require AutoCAD Map 3D to modify some of the incoming data values.

Import Data Options dialog box (MAPIMPORT4)

This dialog box was used to specify how objects and data in the import file are imported into AutoCAD Map 3D. It has been discontinued. Instead, use one of the following procedures or commands.



[To import data from other formats](#) (page 381)

[To import from Arc/INFO](#) (page 396)

[To import from MapInfo MIF/MID](#) (page 401)

[To import SHP data](#) (page 399)



Click Home tab ► Data panel ► Import From Files.



Proceed

Convert the selected file.

OK

Close the dialog box but keep the current import options.

Import Graphics Area

Perform Coordinate Conversion

Convert the file from one coordinate system to another. Click Define to display the Coordinate System Translation dialog box.

Map Data Element To Layers

Use the attribute data in the import file to determine the target layer for the AutoCAD Map 3D objects that are created.

Click Layers to display the Map Data Elements to Layers dialog box, where you can map the values for a selected data element to specific layers in the output file.

Map Data Element To Block Name

Use the attribute data in the import file to determine the target block name for point and polygon centroid objects that are created.

Click Blocks to display the Map Data Elements to Block Name dialog box, where you can map the values for a selected data element to specific block names in the output file.

Import Data Elements Area

Ignore Data Elements

Ignore attribute data in the import file (other than data that is used in layer and block name mapping).

Select this option if you do not want to convert the attribute data to object data or create links to SQL tables. Only the graphical objects in the file will be converted.

Map Data Elements To Object Data

Convert the attribute data in the import file to object data.

Click Data to display the Object Data Table dialog box, where you can select the name of an existing object data table or create a new one.

Map Data Elements To SQL Table

Use the attribute data in the import file to create links to existing SQL tables or to create new tables.

Click SQL to display the Map Data Elements to SQL dialog box, where you can map specific data elements to specific columns in an external database.

Options Area

Load

Use import settings that you previously saved.

Save

Save the current settings so you can use them again.

Import ASCII Points dialog box

The Import ASCII Points dialog box allows you to specify settings for bringing in ASCII survey point data.



[To bring ASCII point data into a Survey Data Store](#) (page 373)



Right-click any node in the Survey Tree on the Survey tab of the Task Pane, then click Import ASCII Points.

File Location

Click  to select an ASCII file to import.

Select Formatting

Select the format of the source data using the Format drop-down list. Formats describe the layout of the data in your source files using the following convention:

- P is point ID
- E is Easting, or longitudinal values
- N is Northing or latitudinal values
- Z is elevation values
- D is description

Make sure that you select the correct format plus delimiter type (comma or space) for your data source.

The Autodesk Uploadable File format is as follows: User-Defined (point ID, description, or any other type of data), X, Y, Z. It is a comma-separated format, and uses the # character for comment text.

Z-Unit

Select the unit of measure for elevation (US Feet, International Feet, Meters, or Chains)

Preview

The Preview window shows you a sample of the ASCII data. You can use the Preview to verify that you have selected the desired file.

Coordinate System Assignment

Enter the coordinate system code for your new Survey Data Store. Click



to select the coordinate system from a list.

LandXML Coordinate System dialog box

The LandXML Coordinate System dialog box allows you to view and assign a coordinate system to LandXML data you are importing.



[To bring LandXML data into a Survey Data Store \(page 371\)](#)



On the Survey tab of the Task Pane, click Data ► Import LandXML.

NOTE Data you import becomes AutoCAD drawing objects in your map. To connect to the data in its original format, see [Overview of Bringing In GIS Features](#) (page 305). To convert the drawing objects to a geospatial format, see [Overview of Converting and Exporting](#) (page 1405).

LandXML Reports for Coordinate System

Displays any coordinate system information associated with the LandXML file you are importing.

LandXML Coordinate System Assignment

Enter the coordinate system code for your new Survey Data Store. Click



to select the coordinate system from a list.

Layer Mapping dialog box (MAPIMPORT4)

This dialog box was used to specify all values in the import file for the specified Control Data Element and the layer they are mapped to. It has been discontinued. Instead, use one of the following procedures or commands.



[To import data from other formats](#) (page 381)

[To import from Arc/INFO](#) (page 396)

[To import from MapInfo MIF/MID](#) (page 401)

[To import SHP data](#) (page 399)



Click Home tab ► Data panel ► Import From Files.



Layer Mapping dialog box (Import)

Use this dialog box to specify a target layer in the current drawing for the selected layer in the incoming file. This is sometimes called a schema, level, or file.



To specify an AutoCAD layer during import (page 419)



Click Home tab ► Data panel ► Import From Files.



NOTE Data you import becomes AutoCAD drawing objects in your map. To connect to the data in its original format, see [Overview of Bringing In GIS Features](#) (page 305). To convert the drawing objects to a geospatial format, see [Overview of Converting and Exporting](#) (page 1405).

Create on Existing Layer

Put incoming objects on an existing layer in the drawing. Click the down arrow to select the layer.

If you assigned the incoming layer to an object class with a layer property, the default is the layer specified in the object class.

Create on New Layer

Put incoming objects on a new layer. Enter a name for the new layer.

Use Data Field For Layer Name

Put incoming objects on a layer based on data attached to the objects. Click the down arrow and select the field to use for layer names. For each object, AutoCAD Map 3D will read the value in the specified field and put the object on a layer with the same name. If the layer does not exist, it will be created. If an object does not have a value in the specified field, it will go on Layer 0.

AutoCAD Map 3D uses only the first 255 characters of the value in the field. If the incoming file has longer field values, change the values before you import the file.

NOTE If a conflict between the layer specified by the Drawing Layer setting and an Object Class with a layer property is found, AutoCAD Map 3D uses the Drawing Layer setting, except when Drawing Layer is set to <None>. In that case, the Object Class setting is used. When Use Class Defaults is checked, AutoCAD Map 3D forces the data to the correct Drawing Layer.

Link Template to Export dialog box

This dialog box was used to select the link template to use in the export operation. It has been discontinued. Instead, use one of the following procedures or commands.



[To export drawing objects to MicroStation Design \(DGN\)](#) (page 1438)

[To export to MapInfo MIF/MID](#) (page 1432)

[To export drawing objects to SHP](#) (page 1428)

[To export drawing objects to ESRI Arc/INFO](#) (page 1421)



In the Tool-based Ribbon Workspace, click Output tab ► Map Data Transfer

panel ► Map 3D Export.



If you select the Map SQL Data To Data Element option, the data from the referenced table will be exported.

If you select the Map Database Link To Data Element option, the key column value that links the object to the table will be exported.

Map Data Elements to Block Name dialog box (MAPIIMPORT4)

This dialog box was used to specify which data element to use for determining the block for points or polygon centroids. It has been discontinued. Instead, use one of the following procedures or commands.



[To import data from other formats](#) (page 381)

[To import from Arc/INFO](#) (page 396)

[To import from MapInfo MIF/MID](#) (page 401)

[To import SHP data](#) (page 399)



Click Home tab ► Data panel ► Import From Files.



When the file is converted, the value of the selected data element for each object determines the block to use.

To map a value to a block name, select the value in the Values Available list and select a block from the Target Block Name list. Click >>.

Control Data Element area

Select the data element to use to determine the target block.

Values Available list

Displays all the values in the import file for the selected data element.

Target Block Name area

Select a block name. To load a block, click Load.

>>

Move the selected values from the Values Available list to the Values Assigned list for the selected block name.

<<

Remove the selected values from the selected block name and return them to the Values Available list.

Values Assigned list

Displays the values assigned to the current block name.

Auto Block

Assign each value to a block name of the same name.

List

Display the Block Mapping dialog box, which lists the block name assignment for each value in the selected data element.

Map Data Elements to Layers dialog box (MAPIMPORT4)

This dialog box was used to specify the data element to use when determining the target layer for objects. It has been discontinued. Instead, use one of the following procedures or commands.



[To import data from other formats](#) (page 381)

[To import from Arc/INFO](#) (page 396)

[To import from MapInfo MIF/MID](#) (page 401)

[To import SHP data](#) (page 399)



Click Home tab ► Data panel ► Import From Files.



When the file is converted, the value of the selected data element for each object will determine its layer.

To map a value to a layer, select the value in the Values Available list and select a layer from the Target Layer list. Click >>.

Control Data Element area

Select the data element to use to determine the target layer.

Values Available list

Displays all the values in the import file for the selected data element.

Target Layer area

Select a layer. To create a new layer, click New.

>>

Move the selected values from the Values Available list to the Values Assigned list for the selected layer.

<<

Remove the selected values from the selected layer and return them to the Values Available list.

Values Assigned list

Displays the values assigned to the current layer.

Auto Layer

Assign each value to a layer of the same name. If a layer does not exist, one will be created.

List

Display the Layer Mapping dialog box, which lists the layer assignment for each value in the selected data element.

Map Data Elements to SQL dialog box (MAPIMPORT4)

This dialog box was used to map data elements in the import file to specific columns in external database tables. It has been discontinued. Instead, use one of the following procedures or commands.



[To import data from other formats](#) (page 381)

[To import from Arc/INFO](#) (page 396)

[To import from MapInfo MIF/MID](#) (page 401)

[To import SHP data](#) (page 399)



Click Home tab ► Data panel ► Import From Files.



Database Link Method area

Specify whether to link objects to an existing database table or to create a new database table and link objects to the new table.

When the file is imported, each object in the import file is linked to the record in the external database table with the matching key column value. Or a new table is created using the values from the data elements, and links are created to the new table.

To link a data element to a key value, select the data element in the Import Data Elements list and select the key value in the Link Template list. Click >>.

Import Data Elements area

Displays all data elements in the import file.

Link Template area

Select a link template from the list.

To create a new link template, click Define to display the Define Link Template dialog box.

>>

Link the selected import data element to the selected key in the link template.

<<

Remove the selected link from the Link Template list and return the data element to the Import Data Elements list.

Map Export dialog box

This dialog box was used to export data from AutoCAD Map 3D to an external file format. It has been discontinued. Instead, use one of the following procedures or commands.



[To export drawing objects to MicroStation Design \(DGN\) \(page 1438\)](#)

[To export to MapInfo MIF/MID \(page 1432\)](#)

[To export drawing objects to SHP \(page 1428\)](#)

[To export drawing objects to ESRI Arc/INFO \(page 1421\)](#)



In the Tool-based Ribbon Workspace, click Output tab ► Map Data Transfer

panel ► Map 3D Export.



Proceed

When you have set options, click Proceed to display the Map Export Options dialog box, where you can specify how to export graphics and data.

OK

Click OK to close the dialog box but keep the current import options.

Export File area

Format

Select the format to export to.

Name

Enter a name and location for the new file or directory.

If you are not sure of the location, click Browse to view existing files and directories. If you are creating a coverage, the parent directory for the new directory must be a "workspace" directory, containing only other coverage directories, and the new directory must be empty of all files. The default coverage format is UNIX ArcInfo. If the workspace directory contains an existing PC ArcInfo coverage, the new coverage will be in PC ArcInfo format.

File Type area

Select the file type for the information you are exporting. This option is not necessary for all file formats.

Object Selection area

Select Automatically

Use all objects on the specified layers and of the specified file type.

Select Manually

Select individual objects. Click Select to select objects.

Objects will be filtered for the specified layers and file type.

Filter Selected Objects

If this option is selected, only objects that are on the specified layers or blocks are selected. The filters are used for both automatic and manual selection of objects.

If this option is not selected, the filters are ignored.

Filter On Layers

Specify the layers to search. The default is all layers. To select from a list of layers in the current drawing, click Layers.

Map Export Options dialog box

This dialog box was used to specify how objects and data in the current drawing are exported. It has been discontinued. Instead, use one of the following procedures or commands.



- [To export drawing objects to MicroStation Design \(DGN\) \(page 1438\)](#)
- [To export to MapInfo MIF/MID \(page 1432\)](#)
- [To export drawing objects to SHP \(page 1428\)](#)
- [To export drawing objects to ESRI Arc/INFO \(page 1421\)](#)



In the Tool-based Ribbon Workspace, click Output tab ► Map Data Transfer

panel ► Map 3D Export.



Proceed

Click Proceed to export to the selected file format.

OK

Click OK to close the dialog box but keep the current export options.

Export Geometry area

Select Perform Coordinate Conversion to convert the objects from one coordinate system to another. Click Define to display the Coordinate System Translation dialog box.

Export Object Properties area

Map Layer Name To Data Element

Transfer the layer name for each object to the specified data element name in the export file.

Map Block Name To Data Element

Transfer the block name for each object to the specified data element name in the export file.

Map Linetype To Data Element

Transfer the linetype name for each object to the specified data element in the export file.

Export Data Elements area

No Data Mapping

Export only graphical objects. No data is exported.

Map Object Data To Data Element

Export object data for each object.

Click Data to display the Object Data Table dialog box where you can select the object data table to export.

Map SQL Data To Data Element

Export data from an external database that is linked to the objects.

Click SQL to display the Link Template To Export dialog box, where you can select the link template that defines the external table.

Map Database Link To Data Element

Export information about the database link. This option exports the key column value that links the object to the table.

Click Link to display the Link Template To Export dialog box, where you can select the link template that defines the external table.

Options area

Load

Use export settings that you previously saved.

Save

Save your current export settings so you can use them again.

New Property Data Type dialog box

Use this dialog box to specify a property type for a new property when you export data to a geospatial format.

For example, if you export the .COLOR property to a new feature class in the target data store, you can specify the data type for that feature class as STRING.

Once the property type has been selected, it cannot be edited. To change the property type, you must create a new property.



[To export drawing objects to other file formats \(page 1408\)](#)



In the Tool-based Ribbon Workspace, click Output tab ► Map Data Transfer

panel ► Map 3D Export.



NOTE Export affects drawing objects only. To convert geospatial data to a different format, see [Migrating GIS Data \(Bulk Copy\)](#) (page 617).

New Property Data Type is available for only three AutoCAD properties: .COLOR, LINETYPE, and LINEWEIGHT.

Data Type

Select the data type for the new class property from the drop-down list.

Feature Class Property Mapping dialog box

Use this dialog box to map data to existing feature classes in the target data store when you export to a geospatial format.



To export drawing objects to other file formats (page 1408)



In the Tool-based Ribbon Workspace, click Output tab ► Map Data Transfer

panel ► Map 3D Export.



NOTE Export affects drawing objects only. To convert geospatial data to a different format, see [Migrating GIS Data \(Bulk Copy\)](#) (page 617).

Drawing Attributes

Select the drawing attributes to map to FDO feature classes. This field is not editable.

For .COLOR, LINETYPE, and LINEWEIGHT attributes, click  to display the Property Value Mapping dialog box.

Feature Class Properties

Enter or select the feature class property to which to map your drawing attributes. If you are exporting to an existing FDO feature class, you can select feature class properties from a drop-down list. Existing properties are displayed in bold blue text.

Select Attributes

Select attributes to map to this feature class only.

Entries in this dialog box include both the global attributes selected from the Export dialog box and the attributes that apply to this feature class only.

Property Value Mapping

Use this dialog box to map specific drawing attribute properties to specific feature class properties when you export to a geospatial format. For example, you could map the color RED to the string CLAY.



[To export drawing objects to other file formats](#) (page 1408)



In the Tool-based Ribbon Workspace, click Output tab ► Map Data Transfer

panel ► Map 3D Export.



NOTE Export affects drawing objects only. To convert geospatial data to a different format, see [Migrating GIS Data \(Bulk Copy\)](#) (page 617).

Property value mapping is available for three AutoCAD properties only: .COLOR, LINETYPE, and LINEWEIGHT.

... Value

The AutoCAD drawing attribute property value (left column) displays as COLOR Value, LINETYPE Value, or LINEWEIGHT Value, as appropriate. Select the check box next to each property value to map.

... Value

The target feature class property value (right column) displays the feature class property name you entered in the Feature Class Property Mapping dialog box.

Select Attributes dialog box

Use this dialog box to select attributes for Map Export.



[To export drawing objects to other file formats](#) (page 1408)



In the Tool-based Ribbon Workspace, click Output tab ► Map Data Transfer

panel ► Map 3D Export.



NOTE Export affects drawing objects only. To convert geospatial data to a different format, see [Migrating GIS Data \(Bulk Copy\)](#) (page 617).

Expression

Check the attributes you wish to export in the tree view.

Map Import dialog box

This dialog box was used to translate an external map file into AutoCAD Map 3D format. It has been discontinued. Instead, use one of the following procedures or commands.



[To import data from other formats](#) (page 381)

[To import from Arc/INFO](#) (page 396)

[To import from MapInfo MIF/MID](#) (page 401)

[To import SHP data](#) (page 399)



Click Home tab ► Data panel ► Import From Files.



You can import coverages in both UNIX ArcInfo and PC ArcInfo format. If you are importing a coverage, you must have the coverage subdirectory and the associated INFO subdirectory before using the MAPIMPORT4 command. To set a text size for coverages, set the TEXTSIZE variable before using the MAPIMPORT4 command.

NOTE If a SHP file is located on a read-only drive or directory, you cannot import the file if the name contains any of the following characters: pound sign (#), exclamation point (!), comma (,), or accent grave (`). To import the file, either rename the file or move it to a directory to which you have write access.

When you have set options, click Proceed to display the Import Data Options dialog box, where you can specify how to import graphics and data.

Click OK to close the dialog box but keep the current import options.

Format

Select the format of the file to import.

Name

Enter the name of the existing file or coverage.

If you are not sure of the name or location, click Browse to view existing file names and directories.

New Layer dialog box

This dialog box was used to specify a name for a new imported layer. It has been discontinued. Instead, use one of the following procedures or commands.



[To import data from other formats](#) (page 381)

[To import from Arc/INFO](#) (page 396)

[To import from MapInfo MIF/MID](#) (page 401)

[To import SHP data](#) (page 399)



Click Home tab ► Data panel ► Import From Files.



New layers are created with color number 7 and the CONTINUOUS linetype.

Object Data Table dialog box (Export)

This dialog box was used to select the object data table to export. It has been discontinued. Instead, use one of the following procedures or commands.



[To export drawing objects to MicroStation Design \(DGN\)](#) (page 1438)

[To export to MapInfo MIF/MID](#) (page 1432)

[To export drawing objects to SHP](#) (page 1428)

[To export drawing objects to ESRI Arc/INFO](#) (page 1421)



In the Tool-based Ribbon Workspace, click Output tab ► Map Data Transfer

panel ► Map 3D Export.



Click the down arrow to select from a list of object data tables in the current drawing.

You can select only one object data table. To export data from multiple tables, repeat the export command for each table.

Object Data Table dialog box (Import)

This dialog box was used to select the object data table to import data into. It has been discontinued. Instead, use one of the following procedures or commands.



[To import data from other formats](#) (page 381)

[To import from Arc/INFO](#) (page 396)

[To import from MapInfo MIF/MID](#) (page 401)

[To import SHP data](#) (page 399)



Click Home tab ► Data panel ► Import From Files.



To create a table, exit the import operation and use the ADEDEFDATA command.

During the import operation, data elements in the import file are transferred to a matching field name.

Table box

Displays the target object data table name. If you enter a value in this box that does not reference an existing object data table, AutoCAD Map 3D creates a new table that includes all data elements in the import file.

Tables

Display a list of all defined object data tables in the current drawing.

Selecting an existing table populates only fields whose names exactly match the name of a data element.

Object Data/External Database Mapping dialog box

Use these dialog boxes to specify which fields from the incoming file should be mapped to fields in an object data table or external database when you import.



To specify the data to import (page 426)



Click Home tab ► Data panel ► Import From Files.



NOTE Data you import becomes AutoCAD drawing objects in your map. To connect to the data in its original format, see [Overview of Bringing In GIS Features](#) (page 305). To convert the drawing objects to a geospatial format, see [Overview of Converting and Exporting](#) (page 1405).

Input Fields

Select the fields to import from the incoming file.

Target Fields

Specify the fields in the object data table or external database to import the input fields to.

- If you are importing to an external database:
 - To select a Target Field, click in its box. Click the down arrow to select from a list of existing fields.
 - If you selected Create Link Only in the Attribute Data dialog box, or if you select only the key field in this dialog box, AutoCAD Map 3D will import the key field as link data and will not modify the external database.
- If you are importing to an object data table:
 - To import into an existing field in the table, click in its box. Click the down arrow to select from a list of existing fields.
 - To import into a new field, type the name of the new field in the box.
 - To change a target field, click in the box and select or type a field name.

Point Mapping dialog box

Use this dialog box to specify how to import points for the selected layer. This is sometimes called a schema, level, or file.



To specify how to import points (page 428)



Click Home tab ► Data panel ► Import From Files.



NOTE Data you import becomes AutoCAD drawing objects in your map. To connect to the data in its original format, see [Overview of Bringing In GIS Features](#) (page 305). To convert the drawing objects to a geospatial format, see [Overview of Converting and Exporting](#) (page 1405).

Create As Points

Convert points using ACAD_POINT.

Create As Text From Data

Convert points as text. Select the data field in the incoming file that contains the value to use for the text. If an object does not have a value in the selected data field, the point will be imported using ACAD_POINT.

Text will use the text style for the current drawing. To change the text style for the current drawing, click Text Style.

Create As Blocks

Convert points as blocks. Select the block to use.

Get Block Name From Data

Convert points as blocks and uses a block name stored in attribute data.

Select the data field in the incoming file that contains the value to use for the block name. If the block does not exist, the point will be imported using ACAD_POINT.

Get Attribute Values From Fields

Import attribute values attached to the incoming points. If an attribute name on the block that is being created matches a field name on the incoming point, the data for that attribute will be imported with the point.

This option is available only if you select either Create As Blocks or Get Block Name From Data.

Design File Input Settings

Use this dialog box to set options when you import data from Microstation Design. Options differ for importing DGN7 or DGN 8, and the order of the items in the dialog may also change by version.



[To import DGN files](#) (page 409)



Click Home tab ► Data panel ► Import From Files.



NOTE Data you import becomes AutoCAD drawing objects in your map. To convert the drawing objects to a geospatial format, see [Overview of Converting and Exporting](#) (page 1405).

Group Elements By

Level

Group incoming objects by their DGN level. Only levels that contain elements are imported.

Level Names

Group incoming objects by their DGN level name. Only levels that contain elements are imported. This option is available for DGN 8 only.

Geometry

Group incoming objects by entity type.

Linkage Extraction

Extract MSLinks and FRAMME attribute linkage values from the DGN 7 file.

MSLink

Import up to three links per object for DGN 7. For each link, two fields are added to the object data table: `mslinks_n`, which specifies the key value, and `entity_num_n`, which specifies the table.

FRAMME

Add the following fields to the object data table: `comp_count`, `comp_num`, `dgnfile`, `feat_num`, `state_num`, and `ufid`.

Coordinate Units

Master/Sub

Select Master or Sub to specify which of these units in the DGN 7 file matches the default unit in the AutoCAD Map 3D map.

Each DGN 7 file defines a UOR (unit of resolution); in addition, it can define Sub units and Master units. For example, if the default unit in your AutoCAD Map 3D map is meters, and meters are the Sub unit in the imported file, select Sub. If you select Sub or Master, the UORs in the DGN 7 file are converted to Sub or Master units according to the conversion factor in the DGN file header.

When you import the file, one Master or Sub unit (whichever you choose) will become one drawing unit in your AutoCAD Map 3D map.

Unit Ratio

View the ratio between the Master and Sub units. For example, if the ratio is 1:12 (as it would be for Feet/Inches), imported object coordinates will be scaled 12 times bigger if you select Sub.

Element Expansion

Explode Multi Text

Explode multi-text objects into their component parts.

Create Text From Tags

Convert the contents of tags to text.

Explode Complex Chains

Return each component of a complex chain as its own feature (no feature is returned for the complex chain as a whole). Otherwise, all elements of the complex chain merge into a single linear feature, any arcs in the complex chain become linestrings, and any linkages on the component elements themselves are lost.

Cell Expansion

Create blocks From Cells

Expand cells into blocks, maintaining the cell grouping structure. This is the default.

Explode Cells

Expand the contents of the DGN cells into their component parts. The expansion is a single level deep. It does not expand all sublevels.

Create As Points

Expand the contents of the DGN cells into points instead of blocks, maintaining the cell grouping structure.

Reference Files

Ignore

Ignore all external reference files (xrefs) attached to the source data set.

Create DWG

Read all external reference files (xrefs) attached to the source data set. If the reference file has nested references, they are also imported, but circular references are not.

If you select this option, specify a location for the folder for these files. If the folder already exists, you can replace it (overwrite its contents) or cancel and specify a different location. The default folder location is the same as the selected DGN file location.

Design File Output Settings

Use this dialog box to set options when you export data to Microstation Design (DGN7).



To export drawing objects to MicroStation Design (DGN) (page 1438)



In the Tool-based Ribbon Workspace, click Output tab ► Map Data Transfer

panel ► Map 3D Export.



NOTE Export affects drawing objects only. To convert geospatial data to a different format, see [Migrating GIS Data \(Bulk Copy\)](#) (page 617).

Coordinate Units

Master/Sub Select the coordinate units of the features: Master or Sub.

Select the unit that matches the default unit in your AutoCAD Map 3D drawing. For example, if the default unit in your AutoCAD Map 3D drawing is meters, and you are using a seed file that defines meters as the Master unit, then select Master (the default).

Seed File

Select the seed file, which controls whether or not the output DGN file is two-dimensional or three-dimensional, sets the coordinate units, sets global origin, and more. For DGN version 7, you must use a version 7 DGN seed file.

Override Global Origin (DGN 7 only)

Override the global origin setting in the seed file. Specify the global origin to use.

Compute Parameters (DGN 7 only)

Override all seed file settings and have AutoCAD Map 3D calculate the settings for you. AutoCAD Map 3D determines the largest dimension for the set of exported objects and sets the appropriate range and precision. It sets the UOR per Sub to 10, and sets the Global Origin to the center of the bounding rectangle of the exported objects.

Managing Data Dialog Boxes

26

Schema Editor

Use the Schema Editor to view or change settings for an entire schema hierarchy: schemas, feature classes, and properties.



[To create a schema](#) (page 598)
[To edit a schema](#) (page 612)



In Map Explorer, select the [feature source](#) (page 2063) in the connection tree (at the top of the pane) and click Schema ► Edit Schema.

NOTE This functionality is for geospatial feature data only. To structure data linked to drawing objects, see [Overview of Object Classification](#) (page 981) and [Overview of Entering and Editing Object Data](#) (page 1061).

You cannot control every aspect of a schema from the Schema Editor. For example, you cannot create object or association properties, or specify that the system auto-generate a value for a property. However, if you have set up these attributes for a schema, the Schema Editor will display the current settings.

The settings you see depend on what the provider supports. For example, Long Transactions will not appear if the provider doesn't support versioning.

Import Schema

Import an XML schema that you exported, and use it to define a new schema for another data store. This is useful for creating multiple data stores based on the same schema

Export Schema

Export the selected schema as an XML file to share a schema you created in the Schema Editor with other AutoCAD Map 3D or GIS-software users; to back up a schema you created in the Schema Editor as an XML file; or to save your work in progress if the original data source or directory becomes unavailable.

New Schema

Define a new schema in a new or existing feature source for a database FDO provider (Microsoft SQL Server, MySQL, or Oracle) or for an SDF data store. You cannot create a schema for an existing SHP feature source, but you can create a new file-based data store and create a new schema for it during the creation process. You must use ESRI tools to create an ArcSDE schema—you cannot use AutoCAD Map 3D to create a schema for ArcSDE.

New Feature Class

Select a schema entry on the right and click New Feature Class, and specify the information for the new feature class on the left side of the window.

New Property

Select the feature class entry for the property on the right and click New Property. Specify the information for the property on the left side of the window.

Schema Settings

Enter A Schema Name

Enter the name that will appear in the Schema tree. It must follow the naming rules of the provider.

NOTE You cannot change the schema name for a SQLite data store. The schema name must be "Default." Also, for SQLite schemas, you cannot add comments in the Schema or Feature Class Description fields.

Description

Enter an optional description of the schema.

Feature Class Settings

Name

Enter the feature class name that will appear in the Schema tree. It must follow the naming rules of the provider.

Description

Enter an optional description of the feature class.

Type

Select Feature Class for a class with associated geometry. Select Non-feature Class for non-spatial data that can be used as a standalone or contained class.

For most providers, a *feature class* requires a unique identifier to distinguish it from other features (unless the feature class has a base class from which it inherits an identifier).

A *non-feature class* has no association with another class and requires a unique identifier. As a contained class, it defines a property of another non-feature or feature class. For example, Sidewalk could be a property of a Road feature class; the Sidewalk class defines the Road.Sidewalk property. In this case, the Sidewalk class does not need an identity property, although it could have one.

Base Feature Class

If this feature class inherits from another feature class, select that superclass; otherwise select None. This setting applies only to feature classes (not non-feature classes) and is available only if the provider supports inheritance.

Abstract

Click Yes if this feature class is an abstract class. You can't create features for an abstract class, but you can use it as a base class. This setting applies only to feature classes (not non-feature classes) and is available only if the provider supports inheritance.

Specify Identifier Propert(ies) And The Order

Select the properties that comprise the unique identifier (for non-null primary-key values) for this feature class. Select one property for a simple identifier or multiple properties for a compound identifier. (Some providers support only simple identifiers). Create these properties before you create any others. Use the arrow buttons to reorder the properties.

You must specify a value for any non-null property of a feature before you check that feature into the data store. If you do not, you will not be able to check the feature in.

Ordinarily, identifier properties use an auto-generated integer. This means that when you add new features to this feature class, they automatically

receive an auto-generated, unique identifier. If you do not specify an auto-generated integer for this property, you must manually enter a unique identifier for each new feature that uses it.

Specify Unique Constraint(s) And The Order

Specify the criteria features must meet in order to be added to this feature class. Enter a constraint for this feature class in the Constraints box and click New to apply it. Create additional constraints if necessary. Use the arrow buttons to reorder the constraints. To remove a constraint, select it and click Delete. This setting is available only if the provider supports constraints. Constraint syntax is provider-specific.

Locking

Specify whether the user who checks out a feature controls that feature to the exclusion of other users, until it is checked back in. This setting applies only to providers that support locking.

Long Transaction

Specify whether to enable long transactions. A long transaction groups conditional changes to one or many features. Long transactions create different versions of a feature or set of features. This setting applies only to providers that support versioning.

Property settings

Name

Enter the name of the property that will appear in the Schema tree. It must follow the naming rules of the provider.

Each property is a single attribute of a feature class. For example, a Road feature class may have properties called Name, DateConstructed, and Location.

Type

Select Data for non-spatial data. Select Geometry for a property that defines an object's shape.

A **Data** property data type is either boolean, byte, date/time, decimal, single, double, Int16, Int32, Int64, or string. For example, a Road feature can have a data property called DateConstructed whose data type is date/time.

The default **Geometry** property specifies one of four shapes: point (0 dimensions), curve/line (1 dimension), surface/polygon (2 dimensions), and solid (3 dimensions). A feature class has one main geometry property, but can have additional geometry properties. A geometry property is associated with a spatial context. All instances of a geometric property must have the same ordinate dimension. Not all providers support all geometry types or all dimensionalities; SHP supports only XY points, for example,

whereas Oracle supports XY, XYZ, XYZM, and XYM points. The default is XY. Additionally, it can have attributes that describe elevation and measure: HasElevation for Z and HasMeasure for M.

A feature class has one main geometry property, but can have additional geometry properties. A geometry property is associated with a spatial context. All instances of a geometric property must have the same ordinate dimension. Not all providers support all geometry types or all dimensionalities; SHP supports only XY points, for example, whereas Oracle supports XY, XYZ, XYZM, and XYM points. The default is XY. Additionally, it can have attributes that describe elevation and measure: HasElevation for Z and HasMeasure for M.

The **association** property may appear in the list, but it is not supported by AutoCAD Map 3D. Choose this property type only if existing data uses it and you want to maintain that data after it is moved to a different data store.

Description

Enter an optional description of the property.

System Generated

You cannot set this option, which indicates the current setting for this property in an existing schema. Yes indicates that the system will auto-generate values for this property. Generally, identifier properties whose values identify each feature uniquely are auto-generated.

Data Attributes

Click an attribute name in the schema tree to display its description. If you can change or specify the value for a property, a down-arrow or a blinking cursor appears in its field and you can select or enter a value.

The list changes dynamically to show the different attributes that are available for the selected property type.

NOTE The following caveats apply to certain providers:

- You can constrain the default length of a string property in a SQLite schema. However, AutoCAD Map 3D will not generate an error if the constraints are violated. Such validation slows down the performance of the data store. For example, you can constrain a string field to 2 characters and enter 3 characters without producing an error message. AutoCAD Map 3D maintains the constraint information so that, for example, bulk copying to another data provider will produce the desired constraint.
- You cannot make SQLite properties read-only.

- The Decimal data type actually uses a Double data type. For this reason, many providers will not check the number of decimal places when the data is checked in.
-

Bulk Copy

Use Bulk Copy to copy a Display Manager layer or a feature source. Bulk Copy uses the current definition of the layer (including any filters you applied, any joins you created, and any calculated properties). For feature sources, you can specify a subset based on specified schemas, feature classes, or properties.



To copy data from one feature source to another (page 621)



In Map Explorer, click Tools ► Bulk Copy.

NOTE This functionality is for geospatial feature data only. To convert drawing objects to a geospatial format, see [Overview of Converting and Exporting](#) (page 1405).

From

Connection Name

Select a Display Manager layer or connected feature source in the Connection Name list as feature source from which the data will be copied. Filtered layers display a filter icon in the list.

If you select a survey data store, you can select only a survey point group as the source. To copy multiple point groups, copy them one by one.

Version

If the selected feature source supports versioning, select a version from the list to use for copying.

Select Items To Copy

Select the individual schemas, features classes, and properties to copy to the destination feature source.

Selecting any schema element automatically selects all its child elements (selecting a feature class also selects all its properties, for example). A square

(instead of a check) in a check box means that only some of that element's children are selected.

Calculated fields are appended after the native properties. If there are joined fields, they are grouped under a node representing the join. If there are multiple joins, they appear as they do in the [Manage Layer Data dialog box](#) (page 1607).

To

Connection Name

Select a feature source in the top list as the destination feature source.

Version

If the destination feature source supports versioning, select a version from the list as the version to use for copying.

Click On An Item To Select A Different Input Name

Click the arrow for each item whose counterpart you selected in the left-hand tree to map the source item to its destination item.

Info

The Info area displays information about the selected connection or feature class.

Connection (or Class)

If you select the schema node, this area is blank.

Source Coordinate System

If there are multiple coordinate systems for the classes under the selected connection, this field displays "VARIES."

Filter Info

If the selected item is a filtered layer, this area will display "Filter," "Spatial Filter," "Property Filter," or "Spatial And Property Filter."

Target Coordinate System

If there are multiple coordinate systems for the classes under the selected connection, this field displays "VARIES."

Ignore The Following Errors During The Copy Process

Select the error types to ignore during processing. If you leave error types unselected, Bulk Copy stops processing and reports these errors when they occur.

Insert Errors

Select this option to continue Bulk Copy if there is an error inserting an object. Objects that fail are skipped. Errors can occur if there are any anomalies in the object data being copied.

Anomalies can include an unmatched feature ID, a value that is outside the range allowed for a property, a constraint violation (for example, each item must be unique and the source is trying to copy over an object that already exists in the target), or an inappropriate value (for example, a string value that is too long).

Unmatched Data Or Geometric Type Errors

Select this option to skip association and object properties that the target data store does not support.

NOTE AutoCAD Map 3D does not support either association or object properties, but they may be present in existing schemas created outside AutoCAD Map 3D.

Some dimension properties are also skipped. For example, if you copy 3D data to a 2D target, the z-coordinate is silently removed. Some fields can be converted, for example, from int32 to int64, from int32 to double, or from int32 to string. However, if a target does not support a data type (for example, blob or polygon geometry), the data cannot be converted and the object is skipped. For information about how fields are converted, see [Understanding How Bulk Copy Converts Data Types](#) (page 623).

When the geometry coordinate system is Lat/Long, SQL Server Spatial considers the inside of a polygon to be to the left of the outer boundary. If a polygon with a clockwise boundary is inserted, the polygon actually covers the rest of the world, excluding what appears to be inside the polygon from an onscreen perspective. If you check Unmatched Data Or Geometric Type Errors as an error type to ignore, the geometry and orientation are adjusted when the target is SQL Server Spatial. If you do not check this option and you copy a polygon with the wrong orientation to SQL Server Spatial, that object will fail to copy.

Coordinate System

Select this option to copy the geometry without performing a coordinate system transformation, for example, if information for the source or target coordinate systems is missing, but you are sure that the geometry coordinate systems are the same. If you are not sure of one of the coordinate systems, this option can produce undesired results.

For example, if you are missing the .PRJ file for the .SHP file you are copying, but you know that the coordinate system is the same as the target, use this option.

Schema Mapping

Load/Save

To save the current settings in an XML mapping file, click Save. Click Load to open a saved mapping file.

NOTE Before loading a mapping file, connect to the source and destination feature sources.

Copy Now

Copy the data for the specified schema elements. Bulk Copy reports warnings and errors depending on the data formats of the two feature sources, and the copying options you selected.

Click View Log to see [details](#) (page 626).

Create Data Store Dialog Box

Use this dialog box to create a new data store in a database data source. The available settings in the dialog box vary by provider.



To create a data store for a database provider (page 588)

To create a data store for a file-based data provider (page 589)



For a database data store, connect to and log into the data store in the Data Connect window. In the Data Store list, select Add New Data Store (or type a name that does not appear in the list already) and press *Enter*

For an SDF or SHP data store, in Map Explorer, click Schema ► Create SDF or ► Create SHP.

NOTE This functionality is for geospatial feature data only. To link external attribute data to drawing objects, see [Overview of Linking Database Records to Objects](#) (page 522).

Data Store Name Enter the name of the new data store or accept the default name. This name will appear in the Data Connections by Provider list in Data Connect.

Password Enter the user password (Oracle only).

Confirm password Re-enter the user password (Oracle only).

Description Optionally enter a description of the new feature source.

Data store coordinate system Enter the coordinate system code for the new data store. If you don't know the code, click  to select a coordinate system. In the Select Global Coordinate System dialog box, select a category. Select from a list of available coordinate systems. Click Properties to view the properties of the selected coordinate system. Click OK. Choose a coordinate system that both the provider and AutoCAD Map 3D support.

Data store extents Enter the new data store's minimum and maximum X and Y spatial extents or accept the default values. You can't add objects that are outside these extents.

For SQL Server, you must specify the extents of the data store or Bulk Copy will fail when copying data from any other provider source to SQL Server.

MySQL and Oracle support expanding the extents automatically if incoming data are beyond the scope of the extents.

Storage resolution Enter the new data store's X and Y tolerance or accept the default value. If the distance between two points is smaller than the resolution, the points are considered to be equivalent for most spatial tests.

Data store tablespace Enter the new data store's tablespace name (Oracle only).

Use FDO Enabled Schema Specify whether the new data store will be FDO-enabled or not. FDO-enabled data stores include additional FDO metadata, but otherwise use native SQL Server schema capabilities.

Manage Versions dialog box

Use this dialog box to add, activate, merge, or drop versions for a data store to which you are currently connected. When you save or discard a version, all features in the drawing that were queried from that version are removed from the drawing. You cannot undo saving or discarding a version.

If an error occurs during a version-management operation, the affected item in the dialog box displays an error indicator. To see the cause of the error, hold your cursor over this indicator. If you create a version and the operation fails, you will see a new version with an error indicator. The version has not really been created. It is a placeholder to display the error. Errors remain visible until you close the dialog box, fix the errors, and redisplay the dialog box.

For more information about versions, see [Managing Versions](#) (page 723).



[To create a new version](#) (page 725)

[To activate a version](#) (page 725)

[To commit changes back to the data store](#) (page 726)

[To discard a version](#) (page 726)



In Map Explorer, right-click a connection that supports versioning and click Manage Versions.

NOTE This functionality is for geospatial feature data only. To link external attribute data to drawing objects, see [Overview of Linking Database Records to Objects](#) (page 522).

Add

Create a new child version under the selected version in the Version tree.

Activate

Make the selected version the active one. Switching versions can take some time to execute, because the data store may need to flush and reload the feature cache.

Merge

Commit your edits to the selected version. This option is available for child versions only. If you merge the active version, its parent version is activated and then the selected version is merged and removed from the Version tree. You cannot merge a version if it has children or if it has checked-out features. Unlock any checked-out features by checking them in or cancelling check out.

Drop

Discard the selected version. When you drop a version, all edits saved to that version are discarded. This option is available for child versions only. If you drop the active version, its parent version is activated and then the selected version is dropped and removed from the Version tree. You cannot drop a version if it has children or if it has checked-out features. Unlock any checked-out features by checking them in or cancelling check out.

Version Tree

View and select versions in the current data store. Each entry displays the date and time it was created, its creator, and any comments entered at

creation time. Right-click any version entry to add, activate, merge, or drop it.

Resolve Feature Conflicts dialog box

Use this dialog box to specify how to handle changed objects when the object has been changed in both the parent and the child version.



To [commit changes back to the data store](#) (page 726)



In Map Explorer, right-click the feature source and click Manage Versions.

NOTE This functionality is for geospatial feature data only. To link external attribute data to drawing objects, see [Overview of Linking Database Records to Objects](#) (page 522).

Choose The Parent Version

Keep the object in the parent version and discard changes in the child version.

Choose The Child Version

Overwrite the object in the parent version with the changes from the child version.

Cancel

Stop the Save operation. Determine which version of the objects to keep and modify the child version accordingly.

Metadata Dialog Boxes

27

Metadata Viewer

Use the Metadata Viewer to view metadata for the current drawing or for other resources.



[To view metadata](#) (page 1487)



In the Display Manager, select a layer. Click Tools ► View Metadata.

From the Metadata Viewer you can also perform the following actions:

- Import metadata
- Export metadata
- Print metadata
- Publish metadata to an XML, HTML, or TXT file
- Update forced-update fields
- Update all fields
- Edit metadata (through the [Metadata Editor](#) (page 1754))
- Create a template from the current metadata
- Specify [metadata options](#) (page 1756)

- Specify the metadata stylesheet
- Display additional metadata that is not part of the standard (FGDC or ISO) specified in the Metadata Options dialog box

Metadata Viewer Toolbar

Use the Metadata Viewer toolbar to perform the following actions.

Toolbar Button	Action
Import	Imports metadata from another program
Export	Exports metadata to be read by another program
Print	Prints metadata
Publish	Publishes metadata to an XML, HTML, or TXT file
Update Auto	Updates forced-update fields
Update All	Updates all fields (assumes that the automatic update option is turned off)
Edit	Opens the Metadata Editor
Create Template	Creates a template from the currently-displayed metadata
Options	Opens the Metadata Options dialog box
Learn More	Opens the New Features Workshop
Help	Displays help for the Metadata Viewer

Current Drawing

The Current Drawing tree view lists the current drawing [DWG](#) (page 2061), and any feature classes or object classes ([resources](#) (page 2072)) associated with it.

Show All Feature Classes

View metadata for all feature classes from connected feature sources.

Folder Shortcut

Use the Folder Shortcut tree view to display metadata for other files on your local machine or on a server.

If you add or remove files from a folder that you uploaded to the Folder Shortcut tree view, right-click in the tree view, and click Refresh.

Add

Create and view metadata for additional files.

Remove

Remove files you added to the Folder Shortcut tree view.

Metadata Tab

Display all the metadata related to the selected data source.

When you select a data source, AutoCAD Map 3D automatically identifies all the relevant metadata that it can, categorizes it according to the selected standard, and displays it in the Metadata Viewer. This tab is like a web browser, with links and levels you can expand or contract.

The Summary tab

If the selected data source is a file, use this tab to view basic information such as file type, size, and location.

Stylesheet

Control the display of the metadata.

FGDC Classic/ISO Classic

Specify a standard for displaying the metadata.

XML

Display the metadata in freeform XML format.

Text

Display the metadata as text.

More Metadata

View metadata that is not part of the standard (FGDC or ISO) specified in the [Metadata Options dialog box](#) (page 1756).

Metadata Editor

Edit and update metadata.



[To edit metadata](#) (page 1499)



In the Display Manager, select a layer. Click Tools ► View Metadata.

Metadata Editor Toolbar

Use the Metadata Editor toolbar to perform the following actions:

Toolbar Button	Action
Template: <input type="text" value="None"/>	Apply a template (page 1492) to your metadata.
	Update (page ?) fields with values from the current data source.
	Audit (page ?) metadata for compliance with the selected metadata standard.
	Import (page 1511) metadata values from an XML file that complies with the selected metadata standard.
	Highlight the field labels of forced-update fields (page 2064).
	Create a template (page 1492) from the metadata you are working with.



Expand fields and field groups.



Collapse fields and field groups.

Metadata Fields

Enter metadata in the fields. A description and additional information are displayed in the bottom area of the Metadata Editor when a field name or field is selected.

Required fields are marked with a `<Required>` placeholder. Some fields accept only certain types of data. For example, on the Identification tab, under Spatial Domain, you cannot enter a text string in the North Bounding Coordinate field because the [domain](#) (page 2060) of that field is a number.

Some fields store past entries. If a list of past entries is displayed, you can do one of the following:

- [Select](#) (page ?) the entry
- [Add](#) (page 1500) a new entry
- [Edit](#) (page 1501) a past entry
- [Delete](#) (page 1501) an entry

For fields with predefined values, you can choose a value from the list or enter a new one. However, your entries will not display the next time you click the drop-down arrow.

NOTE For ISO date fields, use one of the following formats: YYYY-MM-DD, YYYY-MM, or YYYY. For ISO date and time fields, use the following format: YYYY-MM-DDThh:mm:ss.

Apply

Saves changes to the metadata without closing the Metadata Editor.

Attribute Editor

Edit ISO element attributes. The title and fields of the Attribute Editor change, depending on the attribute.



[To enter or edit metadata manually](#) (page 1499)



In the Metadata Editor, right-click an element field name and select Edit Attribute.

Metadata Options dialog box



[To set metadata options](#) (page 241)

[To import a template](#) (page 1492)

[To export a template](#) (page 1496)

[To remove a template](#) (page 1497)

(page 1503)

[Using Metadata Templates](#) (page 1491)



In the Display Manager, select a layer. Click Tools ► View Metadata.

Template Tab

Metadata standard

Specify the metadata standard.

The default metadata standard depends on your version of AutoCAD Map 3D.

Use template

Use the selected metadata template in the window below as the default.

Import

Import a metadata template.

Export

Export a metadata template.

Rename

Rename the selected metadata template.

Remove

Remove the selected metadata template.

Preference Tab

Latitude/Longitude Precision

For latitude and longitude, set the number of digits to display after the decimal point. The default is 6.

Auto Update

Update metadata as soon as the data source is updated (or as soon as the metadata is reconnected to its updated data source).

Import Metadata Options dialog box



To import metadata for DWGs or their resources (page 1511)



In the Display Manager, select a layer. Click Tools ► View Metadata.

Open the original project DWG File

Open the original DWG as the current project. Any [resources](#) (page 2072) for the imported DWG are displayed in the [Current Drawing](#) (page 1752) tree view. Edit the metadata for those resources, or save the metadata as a template.

Append the source metadata to the current metadata

Overwrite the current metadata with the source metadata.

Export Metadata dialog box



To export metadata (page 1513)



In the Display Manager, select a layer. Click Tools ► View Metadata.

Select The Source Data Type For The Exported Metadata

Selected items

Export metadata only for the items selected in the [Metadata Viewer](#) (page 1751) .

All items in

Select Feature Source to export metadata for all features in the selected source. Select Object Class to export metadata for all objects in the selected class. Select both to include all features and objects.

Create Metadata Template dialog box

Create a template from the current metadata.



To create a template (page 1492)



In the Display Manager, select a layer. Click Tools ► View Metadata.

Template

The name of the template.

Compound Element Metadata Editors

Citation Information Editor (FGDC Metadata)

NOTE Information about each field is displayed at the bottom of the dialog box when you click in the field.

Use the Citation Information Editor to enter information about published geospatial data using the United States [FGDC CSDGM Standard](#) (page 2063) field definitions.



[To edit a compound metadata element](#) (page 1506)



In the Display Manager, select a layer. Click Tools ► View Metadata.

The Citation Information Editor has the following sections:

General Information

Title

Enter a title. The NOAA Coastal Services Center suggests including a topic, time period, and place. You can also include the file name, data source, and data resolution (if applicable). AutoCAD Map 3D populates the field with the name of the selected resource in the [Metadata Viewer](#) (page 1751).

Originator

Enter the originator, generally the organization that created the resource. For example, specify a county planning department. You can include more than one originator. Put “ed.” after the name of an editor, and “comp.” after the name of a compiler. Use [the Record Navigator](#) (page 1506) to locate a previous entry, delete an entry, or add a new one.

Publication date

Enter a date in one of the following formats:

- YYYYMMDD
- bcYYYYMMDD
- ccYYYYYY
- cdYYYYYY

If you do not know the date, select an option in the drop-down list.

Publication time

Enter a time in one of the following formats:

- HHMMSSSS
- HHMMSSSSshhmm

■ HHMMSSSSZ

Edition

Enter the version of the publication.

Geospatial data presentation form

Specify the format or media used to present the data. Select an option from the drop-down list or enter an FGDC-approved alternative. If you enter an alternative, it is saved in the current field but is not added to the list.

Other citation details

Enter additional information to help users access and use your data.

Online linkage

Specify the URL of the online resource where the data is published. Use [the Record Navigator](#) (page 1506) to locate, add, or delete URLs.

Series Information

Series name

If the data is part of a series, enter the name of the series.

Issue identification

If the data is part of a series, enter the issue number.

Publication Information

Publication place

Enter the city in which the data was published. If the name is not unique, include the state or province and country.

Publisher

Specify the person or organization that published the data.

Large Work Citation

Larger work citation

If the data is part of a larger work with several data sets that require their own citation information, click Detail to launch an empty Citation Information Editor. Do this for as many data sets as needed.

FGDC Field ID	Field Title	Short Name	Data Type
8.4	Title	title	String
8.1	Originator	origin	String

FGDC Field ID	Field Title	Short Name	Data Type
8.2	Publication date	pubdate	Date/time
8.3	Publication time	pubtime	Date/time
8.5	Edition	edition	String
8.6	Geospatial data presentation form	geoform	String
8.9	Other citation details	othercit	String
8.10	Online linkage	onlink	URL
8.71	Series name	sername	String
8.72	Issue ID	issue	String
8.81	Publication place	pubplace	String
8.82	Publisher	publish	String
8.11	Larger work citation	lworkcit	Various

Time Period Information Editor (FGDC Metadata)

NOTE Information about each field is displayed at the bottom of the dialog box when you click in the field.



[To edit a compound metadata element](#) (page 1506)



In the Display Manager, select a layer. Click Tools ► View Metadata.

FGDC Field ID	Field Title	Short Name	Data Type
9.1	Single date/time	sngdate	Compound
9.1.1	Calendar date	caldate	Date
9.1.2	Time of day	time	Time
9.2	Multiple dates/times	mdattim	Compound
9.3	Range of dates/times	rngdates	Compound
9.3.1	Beginning date	begdate	Date
9.3.2	Beginning time	begtime	Time
9.3.3	Ending date	enddate	Date
9.3.4	Ending time	endtime	Time

Contact Information Editor (FGDC Metadata)

NOTE Information about each field is displayed at the bottom of the dialog box when you click in the field.



[To edit a compound metadata element](#) (page 1506)



In the Display Manager, select a layer. Click Tools ► View Metadata.

Contact information is part of the Distribution section of the FGDC specification. The Distribution section is conditional (mandatory if applicable).

The requirements for individual elements and [compound elements](#) (page 2057) assume you will include contact information in your metadata. It is mandatory if you include contact information.

FGDC Field ID	Field Title	Short Name	Data Type
10.1	Primary contact	cntperp	Select one of two choices
10.1.1	Person name	cntper	String
10.1.2	Organization	cntorg	String
10.3	Contact position	cntpos	String
10.4.1	Address type	addrtype	Menu choice
10.4.2	Address	address	String
10.4.3	City	city	String
10.4.4	State or province	state	String
10.4.5	Postal code	postal	String
10.4.6	Country	country	String
10.5	Contact voice phone	cntvoice	String
10.6	TDD/TTY tele-phone	cnttdd	String
10.7	Facsimile tele-phone	cntfax	String
10.8	E-mail address	cntemail	String
10.9	Hours of Service	hours	String
10.10	Contact instructions	cntinst	String

Spatial Data Organization Information Editor (FGDC Metadata)

NOTE Information about each field is displayed at the bottom of the dialog box when you click in the field.

Access the Spatial Data Organization Information Editor from the [Metadata Editor](#) (page 1754). Describe the methods you used to represent spatial information in the data set, and how the data is organized, including direct and indirect spatial references. The fields in the Spatial Data Organization Information Editor accept metadata about the number and type of objects in your data set, the terminology set you use to describe the data, and other information about the nature of the data.



[To add records using the Record Navigator](#) (page 1507)
[To edit a compound metadata element](#) (page 1506)



In the Display Manager, select a layer. Click Tools ► View Metadata.

Spatial Data Organization

Describe the methods you use for your data. Indirect data describes the location of the spatial data, while direct data tells users how you visually represented the data in your resource.

Indirect spatial reference

Specify the methods you used to identify geographic locations, for example, formal methods (such as the Geographic Names Index system place names, Public Land Survey System locations, or Federal Information Processing System location codes); or less formal methods such as the name of a county, or a street address. These references do not include coordinates.

Direct spatial reference method

Select the direct method you used to represent objects:

- Point
- Vector
- Raster

Point and vector object information

Specify the type of vector or non-gridded point objects used in the data set, and how many there are. If the direct spatial reference method is either Point or Vector, select whether you use SDTS terms or VPF terms.

If you select either Point or Vector, the following fields are displayed:

- SDTS Terms
- VPF Terms
- VPF Topology Level
- Point And vector Object Type
- Point And Vector Object Count

SDTS Terms/VPF Terms

This field name changes depending on the terminology set you select.

SDTS terms description

Select the appropriate point or vector information that uses terminology and concepts from Spatial Data Concepts, Part 1, Chapter 2, in Department of Commerce, 1992, Spatial Data Transfer Standard (SDTS) (Federal Information Processing Standard 173): Washington, Department of Commerce, National Institute of Standards and Technology. The reference to the SDTS is used only as a name for the method used to describe the point and vector objects. This method is selected by default in the dialog box.

NOTE If you select one of the options, but later decide to select the other, close the Spatial Data Organization Information Editor and re-open it to reset the fields.

If you select SDTS terms, complete the following fields:

SDTS point and vector object type

Select the type of point or vector objects you use to identify zero-, one-, and two-dimensional locations in the data set.

Point and vector object count

Specify the number of point or vector objects in your data set.

VPF terms description

If you select VPF terms, complete the following fields as many times as necessary. Use the Record Navigator to add new fields.

VPF topology level

Indicate how completely the topology is represented in the data set. This field becomes available if you select VPF terms. These levels are defined in the following publication: Department of Defense, 1992, Vector Product Format (MIL-STD-600006): Philadelphia, Department of Defense, Defense Printing Service Detachment Office. The reference to the VPF is used only as a name for the method used to describe the point and vector objects.

VPF point and vector object type

Select one of the following:

- Node
- Edge
- Face
- Text

This is point or vector information that uses the terminology and concepts defined in: Department of Defense, 1992, Vector Product Format (MIL-STD-600006): Philadelphia, Department of Defense, Defense Printing Service Detachment Office.

VPF point and vector object count

Specify the number of point or vector objects in your data set.

Raster object information

If you select Raster as the direct spatial reference method, the following fields are displayed:

- Raster object type
- Row count
- Column count
- Vertical count

This describes the types of raster objects in the data set, and how many rows and columns they have for flat, rectangular objects; or the number of objects along the Z-axis (verticals) for three-dimensional, rectangular objects.

Raster object type

Select the type of raster objects you use to identify zero-, one-, and two-dimensional locations in the data set.

If you selected Point, Pixel, or Grid Cell, complete the following fields:

Row count

Enter the number of object rows along the Y-axis of the raster.

Column count

Enter the number of object rows along the X-axis of the raster.

If you selected Point, Pixel, or Grid Cell and the data is three-dimensional, complete the Vertical Count field.

Vertical count

Enter the number of objects along the vertical Z-axis.

FGDC Field ID	Field Title	Short Name	Data Type
3.1	Indirect spatial reference	indspref	String
3.2	Direct spatial reference method	direct	Menu choice
3.3	Point and vector object information	ptvctinf	Compound
3.3.1.1	SDTS point and vector object type	sdtstype	Menu choice
3.3.1.2	Point and vector object count	ptvctcnt	Integer
3.3.2	VPF terms description	vpfterm	Compound
3.3.2.1	VPF topology level	vpflevel	Integer
3.3.2.2	VPF point and vector object information	vpfinfo	Compound
3.3.2.2.1	VPF point and vector object type	vpftype	Integer

FGDC Field ID	Field Title	Short Name	Data Type
3.4	Raster object information	rastinfo	Compound
3.4.1	Raster object type	rasttype	String
3.4.2	Row count	rowcount	Integer
3.4.3	Column count	colcount	Integer
3.4.4	Vertical count	vertcount	Integer

Horizontal Coordinate System Definition Editor (FGDC Metadata)

NOTE Information about each field is displayed at the bottom of the dialog box when you click in the field.

The Horizontal Coordinate System Definition section is conditional overall. The requirements for elements and [compound elements](#) (page 2057) within the definition assume you will include it.



[To edit a compound metadata element](#) (page 1506)



In the Display Manager, select a layer. Click Tools ► View Metadata.

FGDC Field ID	Field Title	Short Name	Data Type
4.1	Horizontal coordinate system	horizsys	Compound
4.1.1	Geographic	geograph	Compound
4.1.1.1	Latitude resolution	latres	Real number

FGDC Field ID	Field Title	Short Name	Data Type
4.1.1.2	Longitude resolution	longres	Real number
4.1.1.3	Geographic coordinate units	geogunit	Menu choice
4.1.2	Planar	planar	Compound
4.1.2.1.1	Map projection name	mapprojn	Menu choice
4.1.2.1.23.1	Standard parallel	stdparll	Real number
4.1.2.1.23.2	Longitude of central meridian	longcm	Real number
4.1.2.1.23.3	Latitude of projection origin	latprjo	Real number
4.1.2.1.23.4	False easting	feast	Real number
4.1.2.1.23.5	False northing	fnorth	Real number
4.1.2.1.23.6	Scale factor at equator	sfequat	Real number
4.1.2.1.23.7	Height of perspective point above surface	heightpt	Real number
4.1.2.1.23.8	Longitude of projection center	longpc	Real number
4.1.2.1.23.9	Latitude of projection center	latprjc	Real number
4.1.2.1.23.10	Scale factor at center line	sfctrln	Real number
4.1.2.1.23.11	Oblique line azimuth	obqlazim	Compound

FGDC Field ID	Field Title	Short Name	Data Type
4.1.2.1.23.11.1	Azimuthal angle	azimangl	Real number
4.1.2.1.23.11.2	Azimuth measure point longitude	azimptl	Real number
4.1.2.1.23.12	Oblique line point	obqlpt	Compound
4.1.2.1.23.12.1	Oblique line latitude	obqllat	Real number
4.1.2.1.23.12.2	Oblique line longitude	obqllong	Real number
4.1.2.1.23.13	Straight vertical longitude from pole	svlong	Real number
4.1.2.1.23.14	Scale factor at projection origin	sfprjorg	Real number
4.1.2.1.23.15	Landsat number	landsat	Integer
4.1.2.1.23.16	Path number	pathnum	Integer
4.1.2.1.23.17	Scale factor at central meridian	sfctrmer	Real number
4.1.2.2	Grid coordinate system	gridsys	Compound
4.1.2.2.1	Grid coordinate system name	gridsysn	Menu choice
4.1.2.2.2	Universal transverse mercator (UTM)	utm	Compound
4.1.2.2.2.1	UTM zone number	utmzone	Integer

FGDC Field ID	Field Title	Short Name	Data Type
4.1.2.2.2.3	Universal polar stereographic (UPS)	ups	Compound
4.1.2.2.2.3.1	UPS zone identifier	upszone	Menu choice
4.1.2.2.4	State plane coordinate system (SPCS)	spcs	Compound
4.1.2.2.4.1	SPCS zone identifier	spcszone	String
4.1.2.2.5	ARC coordinate system	arcsys	Compound
4.1.2.2.5.1	ARC system zone identifier	arczone	Integer
4.1.2.2.6	Other grid system's definition	othergrd	String
4.1.2.3	Local planar	localp	Compound
4.1.2.3.1	Local planar description	localpd	String
4.1.2.3.2	Local planar georeference information	localpgi	String
4.1.2.4	Planar coordinate information	planci	Compound
4.1.2.4.1	Planar coordinate encoding method	plance	Choose one of three
4.1.2.4.2	Coordinate pair	coordrep	Compound

FGDC Field ID	Field Title	Short Name	Data Type
4.1.2.4.2.1	Abscissa resolution	absres	Real number
4.1.2.4.2.2	Ordinate resolution	ordres	Real number
4.1.2.4.3	Distance and bearing	distbrep	Real number
4.1.2.4.3.1	Distance resolution	distres	Real number
4.1.2.4.3.2	Bearing resolution	bearres	Real number
4.1.2.4.3.3	Bearing units	bearunit	Menu choice
4.1.2.4.3.4	Bearing reference direction	bearrefd	Menu choice
4.1.2.4.3.5	Bearing reference meridian	bearrefm	Menu choice
4.1.2.4.4.	Planar distance units	plandu	Menu choice
4.1.3	Local	local	Compound
4.1.3.1	Local description	localdes	String
4.1.3.2	Local georeference information	localgeo	String
4.1.4	Geodetic model	geodetic	Compound
4.1.4.1	Horizontal datum name	horizdn	Menu choice
4.1.4.2	Ellipsoid name	ellips	Menu choice
4.1.4.3	Semi-major axis	semiaxis	Real number

FGDC Field ID	Field Title	Short Name	Data Type
4.1.4.4	Denominator of flattening ratio	denflat	Real number

Attribute Domain Values Editor (FGDC Metadata)

NOTE Information about each field is displayed at the bottom of the dialog box when you click in the field.



To edit a compound metadata element (page 1506)



In the Display Manager, select a layer. Click Tools ► View Metadata.

FGDC Field ID	Field Title	Short Name	Data Type
5.1.2.4	Attribute domain values	attrdomv	Choose one of four
5.1.2.4.1	Enumerated domain	edom	Compound
5.1.2.4.1.1	Enumerated domain value	edomv	String
5.1.2.4.1.2	Enumerated domain value definition	edomvd	String
5.1.2.4.1.3	Enumerated domain value definition source	edomvds	String
5.1.2.4.2	Range domain	rdom	Compound
5.1.2.4.2.1	Range domain minimum	rdommin	String

FGDC Field ID	Field Title	Short Name	Data Type
5.1.2.4.2.2	Range domain maximum	rdommax	String
5.1.2.4.2.3	Attribute units of measure	attrunit	String
5.1.2.4.2.4	Attribute measurement resolution	attrmres	Real
5.1.2.4.3	Codeset domain	codesetd	Compound
5.1.2.4.3.1	Codeset name	codestn	String
5.1.2.4.3.2	Codeset resource	codesets	String
5.1.2.4.4	Unrepresentable domain	udom	String

Standard Order Process Editor (FGDC Metadata)

NOTE Information about each field is displayed at the bottom of the dialog box when you click in the field.



[To edit a compound metadata element](#) (page 1506)



In the Display Manager, select a layer. Click Tools ► View Metadata.

FGDC Field ID	Field Title	Short Name	Data Type
6.4.3	Fees	fees	String
6.4.4	Ordering instructions	ordering	String

FGDC Field ID	Field Title	Short Name	Data Type
6.4.5	Turnaround	turnaround	String
6.4	Standard order process	stdorder	Choose one of two
6.4.1	Non-digital form option	nondig	String
6.4.2.1.1	Format name	formname	Menu choice
6.4.2.1.4	Specification	formspec	String
6.4.2.1.2	Format version number	formvern	String
6.4.2.1.3	Format version date	formverd	Date
6.4.2.1.7	Transfer size	transize	Real number
6.4.2.2.1	Online option collection	onlinopt	Compound
6.4.2.2.1.1	Computer contact information	computer	Choose one of two
6.4.2.2.1.1.1	Network address	networka	Compound
6.4.2.2.1.1.1.1	Network resource name	networkr	String
6.4.2.2.1.2	Dialup instructions	dialinst	Compound
6.4.2.2.1.1.2.1	Lowest bps	lowbps	Integer
6.4.2.2.1.1.2.2	Highest bps	highbps	Integer
6.4.2.2.1.2.3	Number databits	numdata	Integer
6.4.2.2.1.1.2.4	Number stopbits	numstop	Integer

FGDC Field ID	Field Title	Short Name	Data Type
6.4.2.2.1.1.2.5	Parity	parity	Menu choice
6.4.2.2.1.1.2.6	Compression support	compress	Menu choice
6.4.2.2.1.1.2.7	Dialup telephone	dialtel	String
6.4.2.2.1.1.2.8	Dialup file name	dialfile	String
6.4.2.2.1.2	Access instructions	accinstr	String
6.4.2.2.1.3	Online computer and operating system	oncomp	String
6.4.2.2.2	Offline option collection	offoptn	Compound
6.4.2.2.2.1	Offline media	offmedia	Menu choice
6.4.2.2.2.2.1	Recording density	recden	Real number
6.4.2.2.2.2.2	Recording density units	recdenu	String
6.4.2.2.2.3	Recording format	recfmt	String
6.4.2.2.2.4	Compatibility information	compat	String

Responsible Party Editor (ISO Metadata)

Enter metadata for the Responsible Party compound element.

Related procedures:

- [To edit a compound metadata element](#) (page 1506)

The Citation Editor (ISO Metadata)

Enter metadata for the Citation compound element



[To edit a compound metadata element](#) (page 1506)



In the Display Manager, select a layer. Click Tools ► View Metadata.

Object Classification Dialog Boxes

28

MAPSELECTCLASSIFIED (Select Classified Objects command)

Use this command to select all drawing objects that were classified with specific object classes.



To select objects in your current map, based on their object class (page 993)



Click Create tab > Drawing Object panel > Select Classified.



NOTE This functionality applies only to drawing objects. For information on the classification systems used by geospatial feature data, see [Overview of Geospatial Data](#) (page 551).

Respond to the prompts:

Select objects

Do one of the following:

- Press Enter to select all classified objects.
- Enter the name of the object class whose objects you want to select. You can use wildcards to select multiple object classes. For example, enter r* to specify all object classes whose name begins with "r". For more information on using wildcards, see [Wildcard Characters](#) (page 1537).

Objects classified with the specified object classes are selected.

MAPSELECTUNCLASSIFIED (Select Unclassified Objects command)

Use this command to select all drawing objects that have not been classified.



To select objects in your current map, based on their object class (page 993)



Click Create tab > Drawing Object panel > Select Unclassified.



Unclassified objects are selected.

NOTE This functionality applies only to drawing objects. For information on the classification systems used by geospatial feature data, see [Overview of Geospatial Data](#) (page 551).

MAPSELECTUNDEFINED (Select Undefined Objects command)

Use this command to select all drawing objects that have been classified, but whose object class definition is not included in the object class definition file attached to the drawing.



To select objects in your current map, based on their object class (page 993)



Click Create tab > Drawing Object panel > Select Undefined.



NOTE This functionality applies only to drawing objects. For information on the classification systems used by geospatial feature data, see [Overview of Geospatial Data](#) (page 551).

An object can be classified but not included in the object class definition file attached to the drawing if you classify the objects using one object class

definition file, and then attach a different object class definition file that does not include a definition for this object class.

Undefined objects are selected.

Attach Object Class Definition File dialog box

The object class definition file includes the set of object classes you will use with this drawing.

NOTE If the FILEDIA variable is set to 0, then this dialog box is not displayed and you can type the name of the file that you want to insert on the command line. For more information, see the AutoCAD help.



[To attach an object class definition file](#) (page 995)

[To use object classification](#) (page 981)



Click Map Setup tab ► Object Class panel ► Attach Definition.



NOTE This functionality applies only to drawing objects. For information on the classification systems used by geospatial feature data, see [Overview of Geospatial Data](#) (page 551).

Look In

Select the drive and folder that contains the object class definition file.

File Name

Type or select the name of the object class definition file.

Files Of Type

Leave this set to Object Definition File.

Classified Property List dialog box

Use this dialog box to review the properties included in this object class definition and the settings for those properties.



[To define an object class](#) (page 120)



Click Map Setup tab ► Object Class panel ► Define.



NOTE This functionality applies only to drawing objects. For information on the classification systems used by geospatial feature data, see [Overview of Geospatial Data](#) (page 551).

To change any settings, return to the [Define Object Classification dialog box](#) (page 1785) and select the property you want to edit.

Classify dialog box

Assign an object class to selected objects.



[To assign an object class to an existing object](#) (page 989)

[To create a classified drawing object](#) (page 988)



Click Create tab ► Drawing Object panel ► Classify.



NOTE This functionality applies only to drawing objects. For information on the classification systems used by geospatial feature data, see [Overview of Geospatial Data](#) (page 551).

Classification Name

Lists the object classes and the object types to which they can be assigned. Select the object class you want to assign to the objects.

Include Objects...

Classifies objects even if their property values do not meet the classification rules for this object. Property values that are out of range will be reset to

the default value for the property. If you clear this option, objects with out-of-range values are not classified.

Exclude Objects...

Does not classify objects that have another object class already assigned. If you clear this option, the existing object class is removed and the new one is assigned.

Classify Objects dialog box

Apply the specified object class to the selected drawing objects.



[To assign an object class to an existing object](#) (page 989)

[To create a classified drawing object](#) (page 988)



In Map Explorer, under Current Drawing, right-click an object class ► Create Classified Object.

NOTE This functionality applies only to drawing objects. For information on the classification systems used by geospatial feature data, see [Overview of Geospatial Data](#) (page 551).

Include Objects...

Classifies objects even if their property values do not meet the classification rules for this object class. If you clear this option, objects with out-of-range values are not classified.

Exclude Objects...

Does not classify objects that have another object class already assigned. If you clear this option, the existing object class is removed and the new one is assigned.

Color Range Editor dialog box

Use this dialog box to specify which colors to allow for this object class.



[To specify a default value and a range for a property](#) (page 125)



Click Map Setup tab ► Object Class panel ► Define.



NOTE This functionality applies only to drawing objects. For information on the classification systems used by geospatial feature data, see [Overview of Geospatial Data](#) (page 551).

Click Add below the List Of Colors following your selection. All colors listed in the List Of Colors are valid colors for this object class.

Color Range

Allow Any Color

Accepts any color as valid for this object class.

Add A Specific Color

Adds a specific color to the List Of Colors.

In the Color list, select the color to include, or choose Select Color to display the Select Color dialog box, where you can select an index color, a true color, or a color book color.

Add A Range Of Colors

Adds a range of colors to the List Of Colors.

In the First Color list, select the color at the beginning of the range. In the Last Color list, select the color at the end of the range.

All colors whose index color number falls between the two selected colors are considered valid for this object class.

List Of Colors

Lists the colors currently included in the object class.

- To delete a color from the list, select the color and click Remove.
- To add a color to the list, choose Add A Specific Color or Add A Range Of Colors, and select the colors you want to add.
- To modify a color in the list, select the color in the list, choose Add A Specific Color or Add A Range Of Colors, and select the colors you want to add. Click Update.

Define Object Classification dialog box

Use this dialog box to create a new object class definition or edit an existing definition.



[To define an object class](#) (page 120)
[To set up object classification](#) (page ?)



Click Map Setup tab ► Object Class panel ► Define.



NOTE This functionality applies only to drawing objects. For information on the classification systems used by geospatial feature data, see [Overview of Geospatial Data](#) (page 551).

The new object class definition is added to the current object class definition file. Users can use these object class definitions to create objects that automatically have the properties you define in this dialog box.

Class Name

Specifies the name for the object class. The name can include spaces, and is not case sensitive.

Description

Specifies the description for the object class.

Based On

Specifies that this object class will be based on an existing object class definition. All of the settings for the base object class are automatically included in this object class definition, and if you modify the base class, the modifications are included in this object class definition. You can add additional settings to this object class definition.

To select a base class, the base class must have the same create method as the class you are defining.

Use As Base Object Classification Only

Specifies that the current class can be used only as a base class. You will not be able to create an object using this object class.

The dialog box has the following tabs:

[Applies To](#) (page 1786)

[Properties List](#) (page 1786)

[Class Settings](#) (page 1788)

[Feature Source Settings](#) (page 1788)

Applies To

Object Types

Specifies the object types that may be tagged with this definition. Available object types are determined by the base class, if there is one, and the selected example objects.

TIP Select the most specific object type that applies to all objects in this object class. For example, if all the objects will be circles, select AcDbCircle.

Properties List

Available Properties

Specifies the properties that will apply to all objects created with this object class. Available properties are based on the objects selected in the drawing, the base class, if one is selected, and the object types selected on the Applies To tab.

If no properties appear, select an object type on the Applies To tab.

Select a check box to include the property in the object class. Highlight a property to view or change its attribute values.

If this object class is based on another object class, you cannot clear a check box for a property that is assigned in the "based on" class.

Property Attributes

Specifies the settings for each property.

To change the value for Type, Range, Default, Visible, or Read Only, click on the value.

Type

For properties that you've created, set the data type. Specify Integer, Real, Text String, 3D Point, or Yes/No. For other properties, the type is set automatically and cannot be changed. (For information on creating a new property, see [New Property](#) (page ?) below.)

Range

Specify the allowable values for this property. This allowable range is used in the following situations:

- When users classify an existing object with this object class definition.
- When users use the Object Class tab of the Properties palette to edit property values for an object classified with this object class definition.

In each case, the value for the property must fall within this range. For many properties, such as color, lineweight, line type, plot style, and layer, you can select from a list of available values. To display the list, click on the value you want to change. Click [...] to display a dialog where you can specify the range.

When specifying the range values, keep these points in mind:

- To enter a list of values for the range, separate each value with a comma, for example, 15,25,35, or Paved,Gravel,Dirt. To enter a continuous range, use square brackets around the first and last value, for example, [2,8].
- When specifying integers, you can specify values between -2147483628 and +2147483627 (32-bit signed integer).
- To specify a lineweight, enter the decimals as integers. For example, to specify a lineweight of 0.13, enter 13.
- To delete a range, enter two dashes ("--").

Default

The default is used when an object has a value assigned that is out of the range. This can happen if the value is assigned before the object is classified or if the object is edited outside the Object Class tab. As soon as the object is selected when the Object Class tab is active, the value will be reset to the default.

When specifying the default for properties such as color, lineweight, line type, plot style, and layer, you can select from a list of available values. To display the list, click on the value you want to change. Click the down arrow to display a list of available value, or click [...] to see additional choices.

Visible

Specify whether the property should appear on the Object Class tab of the Properties palette. You may want to turn visibility off if you want a property set to a single value that users can't edit. In this case, set both the range and the default to the same value.

Read Only

Controls whether the property of a classified object is editable on the Object Class tab. If this is set to Yes, the value is displayed in gray.

To view attribute settings for all selected properties, click Show List.

New Property

Displays the [New Property dialog box](#) (page 1791), where you can add a new property to the Available Properties list.

The new property appears in the Properties palette and can be edited in the same way as other properties.

Show List

Displays the [Classified Property List dialog box](#) (page 1782), which lists all the selected properties and their attribute settings. This is a convenient way to check your properties before you save the definition.

Class Settings

Show Object Class In Map Explorer

Displays the object class name in Map Explorer. When this option is cleared, this object class name is hidden in Map Explorer.

Class Icon

Selects the bitmap to use for this object class in Map Explorer.

Be sure the location you specify is available to everyone who will use this object class definition file. If you store the object class definition file on the network, store the bitmaps in the same location.

Use Standard Icon

Displays the standard icon for the object class in Map Explorer. When this option is cleared, choose the icon to display.

Create Method

Specifies the object to create when creating a new object in this object class. You can select only objects that are appropriate for the object type you selected on the Applies To tab.

Select None if you do not want to specify a create method for this object class. This is useful for base classes, where each subclass may specify a different create method.

In the Geometric Settings table, specify any additional parameters to set when creating objects in this object class.

Feature Source Settings

Specify how to treat linked data when you add an object to a feature source.

Move my linked data to Feature Source

When you add an object with linked data to a feature source, the data from the linked data source is copied to the feature source.

Keep my data linked in Feature Source

When you add an object with linked data to a feature source, the link is copied to the feature source.

Layer Range Editor dialog box

Use this dialog box to specify which AutoCAD layers to allow for this object class.



To specify a default value and a range for a property (page 125)



Click Map Setup tab > Object Class panel > Define.



NOTE This functionality applies only to drawing objects. For information on the classification systems used by geospatial feature data, see [Overview of Geospatial Data](#) (page 551).

You can choose from a list of all AutoCAD layers in the current drawing.

Layer Range

Allow Any Layer

Accepts any AutoCAD layer as valid for this object class.

Choose Specific Layers

Accepts only specific AutoCAD layers for this object class. In the Layer list, select the AutoCAD layers to include.

Linetype Range Editor dialog box

Use this dialog box to specify which linetypes to allow for this object class.



To specify a default value and a range for a property (page 125)



Click Map Setup tab > Object Class panel > Define.



NOTE This functionality applies only to drawing objects. For information on the classification systems used by geospatial feature data, see [Overview of Geospatial Data](#) (page 551).

You can choose from a list of all linetypes in the current drawing.

Linetype Range

Allow Any Linetype

Accepts any linetype as valid for this object class.

Choose Specific Lintypes

Accepts only specific linetypes for this object class. In the Linetype list, select the linetypes to include.

Lineweight Range Editor dialog box

Use this dialog box to specify which lineweights to allow for this object class.



[To specify a default value and a range for a property](#) (page 125)



Click Map Setup tab > Object Class panel > Define.



NOTE This functionality applies only to drawing objects. For information on the classification systems used by geospatial feature data, see [Overview of Geospatial Data](#) (page 551).

Lineweight Range

Allow Any Lineweight

Accepts any lineweight as valid for this object class.

Choose Specific Lineweights

Accepts only specific lineweights for this object class. In the Lineweight list, select the lineweights to include.

New Object Class Definition File dialog box

Use this dialog box to create an object definition file.



[To create a new object classification file](#) (page 129)
[To set up object classification](#) (page 118)



NOTE This functionality applies only to drawing objects. For information on the classification systems used by geospatial feature data, see [Overview of Geospatial Data](#) (page 551).

The object class definition file includes information on how to create each of the object classes you defined. Only definitions in the object class definition file attached to a drawing can be assigned to objects in the drawing or used to create new objects.

NOTE To create a new object class definition file, you must have [Alter Object Class privileges](#) (page 83).

Look In

Select the drive and folder where you want to store the object class definition file.

File Name

Type a name for the new object class definition file.

Files Of Type

Leave this set to Object Definition File.

NOTE If the FILEDIA variable is set to 0, then this dialog box is not displayed and you can type the name of the object class definition file that you want to create on the command line. For more information, see the AutoCAD help.

New Property dialog box

Use this dialog box to create a new property for the object class.

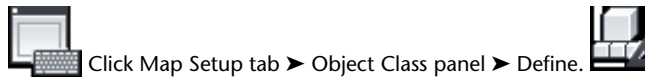
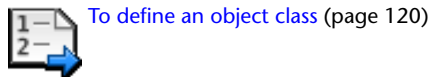

NOTE This functionality applies only to drawing objects. For information on the classification systems used by geospatial feature data, see [Overview of Geospatial Data](#) (page 551).

Property Heading Category

Specify a category for the new property.

Property Name

Specify a name for the new property.

When you close this dialog box, the new property will appear in the Properties List of the Define Object Classification dialog box. If you add this new property to the current object class definition file, the property will appear on the Object Class tab of the Properties palette.

Plotstyle Range Editor dialog box

Use this dialog box to specify which plotstyles to allow for this object class.



To specify a default value and a range for a property (page 125)



Click Map Setup tab ► Object Class panel ► Define.



NOTE This functionality applies only to drawing objects. For information on the classification systems used by geospatial feature data, see [Overview of Geospatial Data](#) (page 551).

You can choose from a list of all plotstyles in the current drawing.

Plotstyle Range

Allow Any Plotstyle

Specify any plotstyle that is valid for this object class.

Choose Specific Plotstyles

Specify a specific plotstyle for this object class. In the plotstyle list, select the plotstyles to include.

Object Data Dialog Boxes

29

Attach Object Data dialog box

Use this dialog box to view the fields in the table and to view or edit the values for those fields.



[To attach data to an object](#) (page 1064)



Click Create tab ► Drawing Object panel ► Attach/Detach Object Data.



NOTE This functionality applies only to attribute data that you use with drawing objects. To see information about a feature source or attribute data you use with a feature source, see [Overview of the Data Table](#) (page 1125) and [Overview of Joins](#) (page 507).

The Object Data Field area lists the fields in the table and the values for those fields. To change any value, highlight it in the Value box, type the new value, and press Enter. When you finish updating values, click OK.

Attach/Detach Object Data dialog box

Use this dialog box to add data to an object data table and attach that data to an object, or to detach existing data from an object.



[To attach data to an object](#) (page 1064)



Click Create tab ► Drawing Object panel ► Attach/Detach Object Data.



NOTE This functionality applies only to attribute data that you use with drawing objects. To see information about a feature source or attribute data you use with a feature source, see [Overview of the Data Table](#) (page 1125) and [Overview of Joins](#) (page 507).

Table

View all the tables in the current drawing. Select the table containing the data fields to attach.

Object Data Field

View all the data fields in the selected table and the current value for each field.

If two attached drawings have a table with the same name, AutoCAD Map 3D recognizes only the fields defined in the first drawing you activate.

To change the value to attach, highlight the field and type a new value in the Value box.

Value

View the default value for the selected field.

To specify a different value, type a new one.

Attach to Objects <

Return to your map, where you can select the objects to attach the data to.

Detach from Objects

Return to your map, where you can select the objects to detach.

All data from the selected table is removed from the objects.

Overwrite

Overwrite any existing values for this table with the new values.

If the box is not selected, the object will have two values assigned for the data fields in the table.

Select the box when you want only one set of values attached to the object, as when specifying a pipe diameter or a desk height. Clear the box when the object can have multiple sets of values assigned to it, as when specifying software installed on a computer or types of plants in a landscape section.

Define

Display the Define Object Data dialog box, where you can create new tables or modify existing tables.

To attach data to an object, select a table and review or change the default values. Click Attach To Objects. When you finish selecting objects in your drawing, AutoCAD Map 3D creates a record for each object and attaches the records to the objects.

If you selected Overwrite, the new record replaces any existing record from this table. If you don't select Overwrite, the object can have more than one record from the table.

To detach data, select a table. Click Detach From Objects. When you return to your map, select all the objects you want to detach the data from.

Edit Object Data dialog box

Use this dialog box to view and edit object data.



[To modify an object data table](#) (page 203)



Click Modify menu ► Edit Object Data.

NOTE This functionality applies only to attribute data that you use with drawing objects. To see information about a feature source or attribute data you use with a feature source, see [Overview of the Data Table](#) (page 1125) and [Overview of Joins](#) (page 507).

- To view data from a different table, select the table from the list.
- To view data for a different object, click Select Object.

- To change a value, enter a new value in the box and press Enter. You must have Edit Drawing privileges to edit object data. See [User Administration dialog box](#) (page 1934)

Table

View all tables with data attached to the selected object.
Select a table to view or edit.

Object Data Field/Value

View the field values for the selected object.
If the object has more than one record from the selected table, use Next, Prior, First, and Last to view the other records.

Nested Data

Determine whether the values displayed are for the nested object, or only for its parent object.

- If the box is selected, the Object Data Field/Value list shows information for just the selected object.
- If the box is not selected, the Object Data Field/Value list shows information for the parent object. If the object has more than one parent object, select one from the list.

Value

View the current value for the selected field.
To change the value, enter a new value in the box and press Enter.

Select Object

To view and edit data for another object, click Select Object and select a new object.

Insert Record

Attach a new record from this table to the object. The record contains the current values for each field.

Delete Record

Remove the record from the object.

Rename Table dialog box

Use this dialog box to rename the selected table.



[To modify an object data table](#) (page 203)



Click Map Setup tab ► Attribute Data panel ► Define Object Data.



NOTE This functionality applies only to attribute data that you use with drawing objects. To see information about a feature source or attribute data you use with a feature source, see [Overview of the Data Table](#) (page 1125) and [Overview of Joins](#) (page 507).

The table name cannot include spaces.

Before you rename a table:

- All source drawings that use the table should be attached and active.
If a drawing is not attached and active, the table will not be renamed for that drawing.
- Do not perform a Draw mode query.
If you have already performed a Draw mode query since you opened the current drawing, you must save the objects back to their source drawings or close the current drawing and reopen it.

If you change a table name, be sure to update any queries that reference the table.

Select Link Template Key dialog box

Use this dialog box to select the fields from the current object data table to use as key fields in the database table.



[To open a linked database table](#) (page 527)



At the Command prompt, enter mapviewlink.

NOTE This functionality applies only to attribute data that you use with drawing objects. To see information about a feature source or attribute data you use with a feature source, see [Overview of the Data Table](#) (page 1125) and [Overview of Joins](#) (page 507).

Method area

Select the method for setting key fields.

Reference Existing Fields

Use existing fields as key fields.

If you select this option, select the fields to use in the Existing Fields area.

Generate Key Field

Create a new field to use as the key field.

If you select this option, specify a name for the field in the Generate Key area. When the database table is created, this field will contain a unique number for each record.

Existing Fields area

If you select Reference Existing Fields, select the fields to use as key fields.

- To specify a key field, select the field and click On.
- To deselect a key field, select the field and click Off.
- To change the name of a field, select the field, type a new name in the Rename box. Click Rename.

Generate Key area

If you select Generate Key Field, specify a name for the new field. The name must be different from other fields in the table.

Other Dialog Boxes

30

ADETEXTLOC (Map Labelpoint Location command)

Use this command to specify a new label point for an object.

An object's label point is used as the reference point when you add text to an object during property alteration. By default, the label point is the centroid of the object. Use this command to specify a different label point.

Respond to the prompts:

Select object:

Use any object selection method.

Pick new text location <X,Y>:

Enter new X and Y coordinates, separated by a comma.

To use this label point when inserting text during a property alteration, choose LABELPT from the Insert Point list in the Define Text dialog box.

AutoCAD Map Messages dialog box

Use this dialog box to view information and error messages. To view additional information about a message, select the message and click Show Log File.

The dialog box has the following windows:

Messages

View brief explanations of the error.

Message details

View additional details about the error, and the code associated with it.

Browse/Search dialog box

Use this dialog box to display preview images of drawings, open drawings, and search for files. Use the browser to search for files across multiple directories on a single drive or on multiple drives.

The Browse tab displays small bitmap images of drawings in the specified directory. You can sort the preview images by file type.

Browse tab

File Name

The name of the currently selected drawing.

Directories

The names of the directories on the current drive.

Drives

The names of the available drives.

List Files of Type

Select file types to browse for, including drawing files (DWG), drawing interchange format files (DXF), and drawing template files (DWT).

Size

Change the size of the preview images. The options are Small, Medium, and Large.

Network

Use the Map Network Drive dialog box (a Windows system window) to connect to networked drives.

Search tab

Files

View a list of files that meet the search criteria.

Search Pattern

Enter a pattern to search for in file name, based on file type. For example, enter floor* to search for all files that begin with "floor" and are of the file type specified.

If you use wild-card characters, and if the search string does not contain path separators, the search attempts to match either the full path or just the file name portion of the path.

File Types

Select the types of files to search for.

Date Filter

Search forward or backward from the specified time or date.

Time

Enter the time from which the system searches forward or backward.

Date

Enter the date from which the system searches. The specified date must be 1/1/80 or later.

Search Location

Specify which drives and paths the system searches.

Drive

View all currently attached drives.

All Drives

View all local hard drives, including removable and network drives.

Path

View directories.

Open

Open the selected file.

Search

Begin searching for the named file according to the search location information. This option changes to Stop Search once the search begins.

Create Centroids dialog box

Use the Create Centroids dialog box to create centroids in the middle of selected closed polylines or polygons, and move any object data or SQL link data from the closed object to the centroid.

When you use this feature, AutoCAD Map 3D checks that the selected polygons and closed polylines are clean; that is, that the lines do not intersect each other, and that the closed object has an area greater than 0. Centroids are created with a Z value of 0.

If the closed object has holes, the centroid will be placed in the center of the enclosed area, regardless of whether it falls within a hole or not. For a 'figure eight' polygon, AutoCAD Map 3D will create one centroid.

Create Centroids In

Select the polylines or polygons for which you want to create centroids.

All Closed Objects

Create centroids for all polygons and closed polylines.

Selected Only

Create centroids only for selected polygons and polylines. Click Select Objects or Quick Select to select the polylines and polygons.

Creation Options

Specify where to create the centroids and what point or block to use for centroids.

Create on Layer

Specify the layer for the new centroids. Click the down arrow to select from a list of layers in the drawing. If the layer you want is not listed, it may be frozen or locked. To create the centroids on a new layer, click Create On Layer.

Create Using

To create centroids as points, select ACAD_POINT. To create centroids using an existing block, click the down arrow and select the name of the block.

Related procedures:

- [To create centroids for polygons and closed polylines](#) (page 887)

Data Expression dialog box

Select a data location.

Attribute

To use data in an attribute, select Attribute. Select the attribute from the Attributes list. To view attributes in a different block, select the block from the Blocks list.

Object Data

To use data in an object data table, select Object Data. Select the field from the Object Data Fields list. To view fields in a different table, select the table from the Tables list.

Database Link

To use data in link data stored on an object, select Database Link. Select the column from the Key Columns list. To view columns in a different link template, select the link template from the list.

Define New Object Data Table dialog box

Use this dialog box to create a new object data table or to modify an existing table.

- To add a data field, enter a new Field Name in the Field Definition section. Enter the information for the new data field. When you finish, click Add.
- To edit an existing field, select it from the Object Data Fields list. Edit the information in the Field Definition section. When you finish, click Update.

Table Name

If you are modifying an existing table, the name of the table appears in the box.

If you are creating a new table, enter a name for the table. A table name cannot include spaces. It must start with an alphanumeric character.

NOTE Do not use a table name that is already used in another drawing, unless this table will have the same field definitions as that table. If two source drawings have tables with the same name but different definitions, AutoCAD Map 3D uses the table definition in the first drawing that is activated, and data from the second table is not available.

Object Data Fields

Select a data field to update or to delete a field.

The Object Data Fields list displays all data fields in the selected table.

If two source drawings have a table with the same name, AutoCAD Map 3D recognizes only the fields defined in the first drawing you activate.

- To edit a data field, select its name in the list. Information about the field appears in the Field Definition section. Change any information. Click Update.
- To delete a field, select its name in the list. Click Delete.

- To delete all the fields in the list, click Delete All.

Field Definition

Change information about an existing field or specify information for a new field.

To change information about an existing field, select its name in the Object Data Fields list. Information about the field appears in the Field Definition area. Change any information. Click Update.

To add a new field, enter a new name in the Field Name box. Enter information about the field. Click Add.

NOTE Before you add a field to an existing object data table, be sure all drawings that use this table are attached and active. Objects in active drawings are automatically updated to include the new field and are assigned the default value for the field. If an object that uses this table is not in an active drawing when the table is modified, the data attached to the object is not modified.

Field Name

Enter a name for the data field.

The name cannot contain any spaces. It must start with an alphanumeric character.

Type

Select a data type.

Integer

An integer between -2,147,483,648 and 2,147,483,647

Character

Any characters, up to 132 characters

Point

Three real numbers separated by commas representing the X, Y, and Z values of a point

Real

A real number between -1.7E308 and 1.7E308

If you select Integer, numbers are rounded to the nearest whole number.

Description

Enter a description for the data field.

This description appears in the Object Data Fields list.

Default

Specify a default value for the data field.

The value must match the data type you selected above.

Enter the value you will use most often when you assign this data field to an object.

Before you modify a table

- All source drawings that use the table should be attached and active. If a drawing is not attached and active, the table definition will not be updated for that drawing. If two source drawings have tables with the same name but different definitions, this operation affects the table definition in the first drawing that is activated, and data from the second table is not available.
- Do not perform a Draw mode query. If you have already performed a Draw mode query since you opened the current drawing, you must save the objects back to their source drawings or close the current drawing and reopen it.

You can modify newly defined tables until you perform a save operation (either saving objects back to source drawings or saving the current drawing). Once you perform a save operation, the table can be modified only by a Superuser. Use the [User Login dialog box](#) (page 1937) command to log in as a Superuser, or contact your system administrator.

Related procedures:

- [To create an object data table](#) (page 201)

Define Object Data dialog box

Use this dialog box to create object data tables and data fields. Object data tables store information about the objects in your drawings.

Create an object data table by entering a name for the table and defining the fields in the table.

Table list

View all tables in the current drawing.

To view the object data fields in a table, select the table name from the list.

Object Data Fields

View the fields in the selected table.

If two source drawings have a table with the same name, AutoCAD Map 3D recognizes only the fields defined in the first drawing you activate. To view Field Definition information for a field, select the field.

Field Definition

Displays the values for the selected field.

Field Name

The name of the field.

Data Type

The type of information that can be entered in the field.

Description

The description assigned to the field.

Default

The default value assigned to the field.

To change any values, click Modify.

New Table

Display the Define Object Data Table dialog box, where you can create a new table and define new object data fields.

Modify

Display the Modify Object Data Table dialog box, where you can modify the selected table and define or delete object data fields.

You can modify newly defined tables until you perform a save operation (either saving objects back to source drawings or saving the current drawing). Once you perform a save operation, the table can be modified only by a Superuser. Use the MAPLOGIN command to log in as a Superuser, or contact your system administrator.

Rename

Display the Rename Table dialog box, where you can enter a new name for the selected table.

NOTE If you rename a table, be sure to update any queries that call that table.

Delete

Delete the selected table.

NOTE If any data from this table is attached to objects, the data is deleted from those objects when you remove the table.

Before you delete a table

- All source drawings that use the table should be attached and active. If a drawing is not attached and active, the object data from the table is not removed from that drawing.
- Do not perform a Draw mode query.

If you have already performed a Draw mode query since you opened the current drawing, you must save the objects back to their source drawings or close the current drawing and reopen it.

This dialog box displays information about the tables in your drawing.

Some of the tables on this list contain information that AutoCAD Map 3D needs. If you select one of these needed tables, you cannot change the information or remove or rename the table. You can view the information.

Related procedures:

- [To create an object data table](#) (page 201)

Expression dialog box

Use this dialog box to add attributes to an expression.



[To define an expression](#) (page 1275)

Select an item from the list and click OK to add the item to your expression. For example, expand Object Data Tables to see the list of tables in the current drawing. Expand again to see the list of fields in the table. For more information about expressions for drawing objects, see [Expression Evaluator](#) (page 1541).

Generate Data Links dialog box

If you have text in your drawing that matches information in a table, use this dialog to automatically create links based on the matched information. You can create links to an external database table or to an object data table stored with the current drawing.

Select a linkage type. Set options for that type. After you click OK, you are prompted to select the blocks, text, enclosed blocks, or enclosed text.

NOTE You cannot create links to objects on layers that are locked, frozen, or turned off.

Block

If you are creating links to blocks or enclosed blocks, select the name of the block.

Keys and Tags

For each key field in the link template, select a tag from the block attribute. You can assign a tag to only one key field. (If you are creating links to enclosed text, skip this step.)

Use Insertion Point as Label Point

Use the insertion point of the text or block as the default label point for the object.

Table/Link Template

Select the table or the link template for the database table containing the matching data. The complete record is linked to the object.

- If you link data from blocks or enclosed blocks to an object data table, the attribute data is linked only if attribute tags match field names in the table.
- If you link data from blocks or enclosed blocks to an external table, use the Data Links area to specify which attribute tags correspond to the key fields.
- If you link data to text or enclosed text, you must select a table with only one field or a link template with only one key field. The remaining controls are grouped in the following areas:

Data Links

Specify whether you are linking to object data or an external database.

Create Object Data Records

Create records in an object data table stored with the current drawing. These new records are attached to the objects.

Create Database Links

Create links to an external database table. Select a Database Validation option to specify whether to link only to existing records or to create new records.

Linkage Type

Select a linkage type.

After you click OK, you are prompted to select the blocks, text, enclosed blocks, or enclosed text.

Blocks

Create links from block attribute data. The links are created on the blocks themselves.

Text

Create links from text. The link data is stored on the text object.

Enclosed Blocks

Create links from block attribute data. The links are created on the polyline that encloses the block. Blocks that are not enclosed by a polyline are not linked.

Enclosed Text

Create links from text that lies within a closed polyline. The links are created on the closed polyline that encloses the text. Text that is not enclosed by a polyline is not linked.

Database Validation

If you are creating links to an external table, select a validation option.

None

Create links without checking the database.

Link Must Exist

Create a link only where the text or attribute tag value matches an existing record's key field value. If you are creating links to an Excel spreadsheet, the selected link template must point to a named range and not to a worksheet.

Create If New

Create a new record in the table if no existing record matches. The new record will have the key field values filled in, but other fields will be blank.

Related procedures:

- [To attach data to objects automatically](#) (page 1067)
- [To link records to objects using text or block attribute data automatically](#) (page 532)

New Layer dialog box

The new layer name may not contain any of the following characters.

< > / \ : ? * | , = " ` "

Related procedures:

- [To import SDF 2 files](#) (page 389)
- [To create centroids for polygons and closed polylines](#) (page 887)

Select dialog box

- To select an item, click the item.
- To select a group of items, click the first one. Hold down the Shift key while you click the last one.
- To select additional items, hold down the Ctrl key while you click each item.

When you finish selecting items, click OK.

Select Block dialog box

Click the block to select it.

Click OK.

Select Blocks dialog box

Select the blocks you want by clicking them.

When you finish selecting blocks, click OK.

Select Data dialog box - Query

This dialog box lists data in the current drawing. Select the type of data to include:

Attribute

The Attribute Tags list displays the attributes for the current block. To see the attribute tags for a different block, select the block from the Block list.

Object Data

The Object Data Fields list displays the data fields for the current table. To see the fields for a different table, select the table from the Table list.

If two source drawings have a table with the same name, AutoCAD Map 3D uses only the fields defined in the first drawing you activate.

Database Link

The Key Columns list displays the key columns for the current link template. To see the key columns for a different link template, select the link template from the link template list.

Select the data value and click OK.

Related procedures:

- [To find sliver polygons when overlaying two topologies](#) (page 843)

Select dialog box

Select from the list of available values.

Some types of values are available only if they are in an active drawing.

Related procedures:

- [To retrieve drawing objects based on their properties](#) (page 1244)
- [To select an image by pressing Shift + left-click](#) (page 493)
- [To find sliver polygons when overlaying two topologies](#) (page 843)

Select Drawings to Attach dialog box

Use this dialog box to add source drawings to your current drawing set.

Select the file names of drawings to attach. Click Add. You can change the drive or folder and continue to add files to the Selected Drawings list. When you finish, click OK.

Look In

Select a drive alias from the list. AutoCAD Map 3D creates a drive alias for drive C. You must create drive aliases for all other drives that you use.



If the drive or folder you want is not listed, click Create/Edit Aliases to display the Drive Alias Administration dialog box where you define a new drive alias.



To open a preview window that displays a preview of the selected drawing, click Preview. In some instances, such as if a drawing is locked, the Preview window is blank.

File List

View all drawings in the current directory.

Filter

Use wild-card characters to filter the display of file names. For example, enter t* to view only file names starting with the letter t.

Add

Add the selected drawing names to the Selected Drawings list.

Remove

Remove the selected drawing names from the Selected Drawings list.

Selected Drawings

To use these drawings, click OK.

You must have Alter Drawing Set privileges to attach and detach drawings. Change privileges using the [User Administration dialog box](#) (page 1934).

Related procedures:

- [Attaching Drawings](#) (page 154)

Select Object Classes dialog box

Select the classes you want by clicking them.

When you finish selecting classes, click OK.

Select Classified Objects dialog box

Select the objects you want by clicking them.

When you finish selecting, click OK.

Select Layer dialog box

Select the layer you want by clicking it

Click OK.

Select Layers dialog box

Select the layers you want by clicking them.

Select Property dialog box

Select the property and click OK.

Related procedures:

- [To alter retrieved objects based on their properties](#) (page 1265)

Select SQL Column dialog box

To see the columns for a different link template, select the link template from the list.

Select the column you want and click OK.

Select Table Dialog Box (MAPIMPORT: Object Data)

This dialog box was used to select an object data table from the list of all object data tables in the current drawing during an import procedure. It has been discontinued. Instead, use one of the following procedures or commands.

■ **Related procedure:**

[To import data from other formats](#) (page 381)

[To import from Arc/INFO](#) (page 396)

[To import from MapInfo MIF/MID](#) (page 401)

[To import SHP data](#) (page 399)

■ **Related command:**

Click Home tab ► Data panel ► Import From Files.



Select Table Dialog Box (MAPIMPORT: Database Table)

This dialog box was used to select a database table from the list of all tables in the current drawing during an import procedure. It has been discontinued. Instead, use one of the following procedures or commands.

■ **Related procedure:**

[To import data from other formats](#) (page 381)

[To import from Arc/INFO](#) (page 396)

[To import from MapInfo MIF/MID](#) (page 401)

[To import SHP data](#) (page 399)

■ **Related command:**

Click Home tab ► Data panel ► Import From Files.



SQL Expression dialog box

Select a column in an external database.

To see columns from a different database table, select the link template for the table from the Link Templates list.

In most cases, the Link Templates list includes only link templates for active source drawings. If the link template you want is not listed, be sure it is defined in the source drawing, and the appropriate data source is attached and connected.

If you are using a command that involves topology, the Link Templates list includes only link templates for the drawing where the topology is loaded. If you loaded the topology from source drawings, the list displays link templates defined in the source drawing; if you loaded the topology from the current drawing, the list displays link templates in the current drawing.

Polygon Object Dialog Boxes

31

MAPPOLYLINETOPOLYGON (Convert Polylines to Polygons command)

Use this command to convert an existing closed polyline to a polygon.



[To convert polylines to polygons](#) (page 971)

Respond to the prompts:

Select objects:

Select the polylines to convert. Press Enter.

NOTE This functionality applies only to drawing objects. It does not apply to features from a feature source.

Each closed polyline in the selection set is converted into a polygon. If the polyline belongs to a group, only the first (outermost) polyline in the group is converted. Other polylines in the group are copied into the polygon as additional boundaries. The polygon is automatically rebalanced.

When objects are converted to polygons, they use the default color or hatch set by the [To change the default setting for importing polygons](#) (page 978).

MAPUSEMPOLYGON

Use this command to change the default setting for how polygons are imported.



[To change the default setting for importing polygons \(page 978\)](#)

NOTE This functionality applies only to drawing objects. It does not apply to features from a feature source.

Respond to the prompts:

Enter new value for MAPUSEMPOLYGON:

Do one of the following:

- Enter ON to turn on the use of mpolygons. Polygons imported into AutoCAD Map 3D are created using the polygon object.
- Enter OFF to turn off the use of mpolygons. Polygons imported into AutoCAD Map 3D are created using the polyline object.

MAPMPEDIT (Edit Polygon command)

Use this command to modify a polygon object.



[To add boundaries \(page 963\)](#)

[To edit nodes on a boundary \(page 965\)](#)

[To edit the fill property for the polygon object \(page 966\)](#)

[To edit nodes on a boundary \(page 965\)](#)



At the Command prompt, enter mapmpedit.

NOTE This functionality applies only to drawing objects. It does not apply to features from a feature source.

You can add, delete, and move polygon boundaries, edit nodes, convert a boundary to an object, change a boundary type, change the fill color or pattern, and rebalance the polygon.

Respond to the prompts:

Select polygon:

Use any object selection method.

Enter an option [Add/Delete/Move/Edit/disConnect/Boundary type/Fill/Rebalance/eXit]:

Enter the letter of the option you want.

Add

Enter a to add a boundary to the polygon. Respond to the prompt:

Select new boundary:

Select the object to use as the new boundary. The object can be a polygon, rectangle, circle, or another mpolygon.

The new boundary is added to the polygon.

Delete

Enter d to delete a boundary from the polygon. Respond to the prompt:

Select boundary:

Select the boundary to delete from the current polygon. If it is a complex polygon, you can select additional boundaries. When you finish, press Enter.

The selected boundaries are deleted from the polygon. Enter r to rebalance the polygon.

Move

Enter m to move a boundary. Respond to the prompts:

Select boundary:

Select the boundary to move. If it is a complex polygon, you can select additional boundaries. When you finish selecting boundaries, press Enter.

Select Basepoint or displacement:

Select the starting point for the move.

Specify second point of displacement or <use first point as displacement>:

Select the ending point for the move.

The selected boundaries are moved according to the distance and direction between the basepoint and the second point of displacement.

Edit

Enter e to edit a boundary. Respond to the prompts:

Select boundary:

Select the boundary to edit.

Enter a node editing option [Next/Previous/Remove/Insert/Move/eXit]:

Enter the letter of the option you want.

- Enter n to move to the next node.
- Enter p to move to the previous node.
- Enter r to remove the current node. You cannot remove a node if the resulting new line would cross another boundary in the current polygon.
- Enter i to insert a node before the current node. Note that you cannot insert a node if the resulting new line would cross another boundary in the current polygon.
- Enter m to move the current node. You cannot move a node so that the current boundary crosses another boundary in the current polygon.
- Enter x to exit node-editing mode.

disConnect

Enter c to disconnect a boundary from the polygon, but preserve the boundary object. Respond to the prompt:

Select boundary:

Select the boundary to disconnect.

The boundary is deleted from the polygon, but remains in the drawing as a polyline or circle object.

If you disconnect a boundary that has nested boundaries, all the nested boundaries are also disconnected.

Boundary type

Enter b to change the boundary type for a boundary. Respond to the prompts:

Select boundary:

Select the boundary whose type you want to change.

Enter boundary type [Outer/Inner/Annotation] <Outer>:

Enter o to make the selected boundary an outer boundary, enter i to make it an inner boundary, or enter a to make it an annotation boundary. Annotation boundaries behave the same as inner boundaries, but have no effect on area calculations.

Fill

Enter f to change the fill for the polygon. This displays the [Polygon Fill Properties dialog box](#) (page 1824), where you can select a hatch pattern or a gradient fill.

Rebalance

Enter r to rebalance the polygon. The polygon is rebalanced so the nesting order follows an alternating outer/inner/outer order.

Undo

Enter u to undo the last action.

eXit

Enter x to exit the mapmpedit command.

MPSPLIT (Split Polygon command)

Use this command to split an existing polygon object into two new polygon objects. The original polygon object is deleted.



[To split a polygon object](#) (page 969)

NOTE This functionality applies only to drawing objects. To split a polygonal geospatial feature, see [Splitting Features](#) (page 705).

You can draw a new line to split the polygon, or you can selecting an existing line.

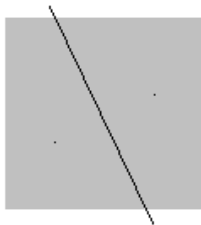

The existing polygon is split into two new polygons.

If the polygon has internal boundaries, your split line must not cross one of the internal boundaries, nor can it touch one of the vertices of an internal boundary.

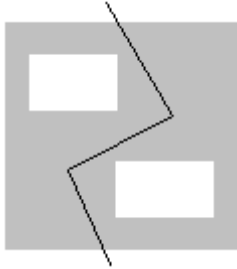

This split is allowed.

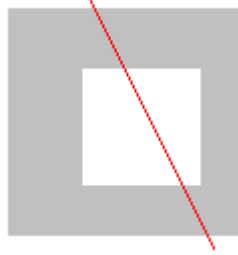

This split is *not* allowed because it crosses an internal boundary.

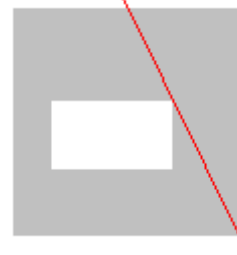

This split is *not* allowed because it touches one of the vertices of the internal boundary.

You can choose to copy data from the original mpolygon to the two new mpolygons, or you can delete the data.

Respond to the prompts:

Select the mpolygon to split:

Use any object selection method.

Would you like to Draw or Select the line for split? [Draw/Select]:

Enter the letter of the option you want.

Draw

Enter d to draw the line. Respond to the prompts:

Specify start point or [eXit] <eXit>:

Select the starting point for the divider line.

Specify next point or [Arc/Undo]:

Do one of the following:

- Select the next point for the divider line.
- Enter a to draw an arc. For more information on drawing arcs, see the AutoCAD help.
- Enter u to undo the last action.

When you finish drawing the line, press Enter.

Select

Enter `s` to select an existing polyline to use as the dividing line. Respond to the prompts:

Select objects:

Select the polyline you want. When you finish selecting polylines, press Enter.

Would you like to copy data from the original mpolygon to the split mpolygons? [Yes/No]:

Do one of the following:

- Enter `y` to copy object data or external database links from the original mpolygon to both of the new mpolygons.
- Enter `n` to delete the data.

Create Polygons From Topology dialog box

Use this dialog box to create polygons directly from a polygon topology.



[To convert a polygon topology to polygons](#) (page 974)



At the Command prompt, enter `maptopologytopolygons`.

NOTE This functionality applies only to drawing objects. It does not apply to features from a feature source.

Name

Select the topology to convert. Click Load Topology to select and load the topology if you need to.

Layer

Select the layer on which you want to place the converted polygon(s). Click Layer Settings to create a new layer and set its properties.

Group Complex Polygons

Create a single polygon from nested polygons in the topology.

Copy Object Data From Centroid

Copy object data from the topology polygons to the new polygon objects.

Copy Database Links From Centroid

Copy database links from the polygons to the new mpolygon objects.

Polygon Fill Properties dialog box

Use this dialog box to specify the fill color and pattern to use for polygon objects. You can choose from a variety of colors including true colors and colors from imported color books. You can also define the pattern type, pattern properties, and attributes for hatch, solid, and gradient fill.



[To edit the fill property for the polygon object](#) (page 966)



At the Command prompt, enter mapmpedit.

NOTE This functionality applies only to drawing objects. To style polygonal geospatial features, see [Styling Area Features](#) (page 650).

The dialog box has the following tabs:

The Hatch tab defines the appearance of the hatch pattern (or solid color) to be used to fill polygons.

The Gradient tab defines the appearance of the gradient fill to be used to fill polygons.

Hatch tab

Pattern Type

Select a pattern type from the following:

- Predefined — Specifies a predefined pattern.
- User Defined — Creates a pattern of lines based on the current linetype in your drawing.
- Custom — Specifies a pattern that is defined in any custom PAT file that you have added to the search path.

Pattern Name

Select from the available predefined patterns. AutoCAD Map 3D stores the selected pattern in the HPNAME system variable. The Pattern Name option is available only if you set Pattern Type to Predefined. Click  to display preview images for all predefined patterns at once.

Angle

Specify an angle for the hatch pattern relative to the X axis of the current UCS.

Scale

Expand or contract a predefined or custom pattern.

Relative To Paper Space

Scale the hatch pattern relative to paper space units to display hatch patterns at an appropriate scale for your layout. This option is available only from a layout.

Fill Color

Click the down arrow to select from a list of colors. To choose from a greater variety of colors, including true colors and colors from imported color books, click Select Color.

Gradient tab

One Color

Specify a fill that uses a smooth transition between darker shades and lighter tints of one color.

Two Color

Specify a fill that uses a smooth transition between two colors.

Color Swatch

Specify the color for the gradient fill. Click  to display the Select Color dialog box, where you can select an AutoCAD Index color, true color, or color book color.

Shade and Tint Slider

Specify the tint (the selected color mixed with white) or shade (the selected color mixed with black) of a color to be used for a gradient fill of one color.

Centered

Specify a gradient configuration that is symmetrical. If this option is not selected, the gradient fill is shifted up and to the left, creating the illusion of a light source to the left of the object.

Angle

Specify the angle of the gradient fill. The specified angle is relative to the current UCS.

Gradient Patterns

Select one of the nine fixed patterns for gradient fills.

For more information on setting hatch options, see the AutoCAD help.

Printing and Publishing Dialog Boxes

32

Create Map Book/Edit Map Book dialog box

Use this dialog box to specify the data to use to create or edit a [map book](#) (page 2067).



[To create a map book](#) (page 1390)
[To edit map book settings](#) (page 1396)



On the Map Book tab of the Task Pane, click New ► Map Book.

Expand a node in the left pane of the dialog box to specify the necessary information on the right

Source node

Create a map book from a display or model space. If your map contains drawing objects, select Model Space to include all the objects, or Map Display to include only objects you added in Display Manager.

- If you select Map Display, enter a name for the map book, select the display map to use, and select a defined scale.
- If you select Model Space, enter a name for the map book.

Sheet Template node

Click Settings to select a template file and layout to use. Indicate whether to include a title block and adjacent sheet links. (You can include these only if you defined placeholders for them.) By default, the scale factor is 1, meaning a scale ratio of 1:1.

If you include a title block, specify its name. If it isn't in the list, click  to find it. If you include adjacent sheet links, specify the name of the file that represents the adjacent sheet.

Tiling Scheme node

Select how to specify the area to publish.

- Click By Area to calculate the number of tiles based on the map scale and the size of the main viewport in the layout template. Select a layer for the grid that forms the tile in your map book. If you defined a grid layer, choose it in the list. Otherwise, enter a name for a new layer to contain the grid. Click Select Area To Tile and draw a rectangle for the area to include in the map book. Enter the percentage to overlap between tiles, and specify whether to skip tiles with no contents.
- Click By Number to calculate the number of tiles based on the map scale, the size of the main viewport in the layout template, and the specified number of rows and columns. Specify the upper left corner and how many columns and rows to create. Enter the percentage to overlap between tiles, and specify whether to skip tiles with no contents. Preview the map book to see how much of the map is included when you use this tiling scheme.
- Click Custom to generate the tiles from the closed polylines you select. Click Select Tiles and define the tiles. If you have already defined the tiles in a separate layer, you can use the layer manager to turn off other layers and window-select the tiles on your grid layer. Enter the percentage to overlap between tiles, and specify whether to skip tiles with no contents.

Naming Scheme node

Select how to name the tiles.

- Click Columns And Rows to name each tile with a column indicator and a row indicator, for example, A1.
- Click Grid Sequential to number the first tile with a digit and augment each subsequent tile number by the increment you enter. Specify the order to go in and the increment between tile numbers.

- Click Sequential for custom tiling schemes. This option numbers only the tiles you specified in your custom tiling scheme. Specify the order to go in and the increment between tile numbers.
- Click Data Driven to choose an expression for your naming scheme based on data in the map.

Key node

If you defined a keyview viewport, optionally specify what to display in it. If you select Linked Drawing or External Reference, specify the drawing or file to display in this viewport. If you select Layers, specify which layers will appear in the keyview thumbnail. To use a new grid layer you created under Tiling Scheme, click the layer icon at the top of the dialog box and type that name in the list.

If you specify Layers, choose a small subset of layers that help the viewer identify a specific area of the map. Too many layers will result in a crowded and hard-to-read thumbnail.

Legend node

Optionally specify the source for a legend. If you created a display legend in Display Manager, select Map Display. To use an area of your map as a legend, select User Defined and click Select Modelspace Bounds to select that area.

Sheet Set node

Create a new sheet set for this map book or make it a subset of an existing sheet set.

Map book sheet sets are based on AutoCAD sheet sets. For more information about AutoCAD sheet sets, type “create and manage a sheet set” on the Search tab of the help.

Identify Map Book Template Placeholders dialog box

Use this dialog box to specify the viewport and element placeholders in the sheet template layout for a [map book](#) (page 2067).



To identify layout placeholders (page 1388)



On the Map Book tab of the Task Pane, click Tools ► Identify Template Placeholders.

Layout Placeholders

Select the viewport or element to identify.

Select Placeholders

In your layout, select the viewport or element that corresponds to the item you selected in the Layout Placeholders list.

Map Book Properties dialog box

Use this dialog box to view basic properties of a [map book](#) (page 2067).



To view [map book or tile properties](#) (page 1399)



On the Map Book tab of the Task Pane, right-click the map book name. Click Properties.

NOTE Except for the name, these properties are strings used as field values in sheets. They do not change the actual properties of the map book. For example, if you change a property in this dialog box, the corresponding map book property does not change. However, if your layout template contains a text element with a field that references the property you changed, that text element will change.

Name

Enter a map book name.

Scale

Enter the scale used for the selected map book.

Orientation

Enter the rotation orientation of the selected map book.

Coordinate System

Enter the coordinate system, if one was specified.

Tile Count

The number of tiles in the selected map book.

Tile Properties dialog box

Use this dialog box to view basic properties of a [map book](#) (page 2067) tile.



[To view map book or tile properties](#) (page 1399)



On the Map Book tab of the Task Pane, right-click a tile name. Click Properties.

NOTE These properties are strings used as field values in sheets. They do not change the actual properties of the tile. For example, if you change a property in this dialog box, the corresponding tile property does not change. However, if your layout template contains a text element with a field that references the property you changed, that text element will change.

Name

Enter the tile name.

Adjacent Tiles

All tiles that are immediately adjacent to the selected tile.

Select Plot Set to Convert dialog box

Use this dialog box to select a plot map set to convert to a [map book](#) (page 2067).



[To import a plot map set](#) (page 1392)



On the Map Book tab of the Task Pane, click New ► Map Book From Plot Set.

Map Information dialog box

Use this dialog box to specify the types of information to include when publishing to [DWF](#) (page 2061)[™].



To publish attribute data to DWF (page 1367)



In the Tool-based Ribbon Workspace, click Output tab ► Export To DWF/PDF panel ► DWF/PDF Options (MAPDWFOPTIONS).



Publish Map Information

Select this option to include checked items in the list in the publish operation. If you clear the Publish Map Information box, the options remain checked, but they are not included in the publish operation. Check Publish Map Information again to include them.

Properties tree

Select items to include in the publish operation. Expand a category to see its layers, and expand a layer to see its objects. If you select an item with sub-items, all the sub-items are automatically checked. Categories listed here vary, depending on the contents of your map.

File icon

Specify the file for the properties.

Folder icon

Find a saved properties file to load.

NOTE If you assigned a coordinate system to your map, it is always included for each sheet in your published DWF file, unless you clear the Export Map Properties check box.

Plot Map Set dialog boxes

The Plot Map Set functionality has been replaced with the Map Books feature. While you can continue to use your existing map plot sets, we recommend that you import your plot sets into map books.



[To import a plot map set](#) (page 1392)



On the Map Book tab of the Task Pane, click New ► Map Book From Plot Set.

Query Dialog Boxes

33

NOTE Query functionality applies only to drawing objects.

Alternate Font dialog box

Use this dialog box to specify a different font for the queried drawing object.



Use these procedures to bring drawing objects into your map (page 354)



Click Home tab > Data panel > Define Query.



The font specified for a queried drawing object cannot be found. Select an alternate font to use.

Change Category dialog box

Use this dialog box to assign queries to categories.



To add a category to the query library (page 182)



Click Create tab > Object Query panel > Library.



Current Category displays the name of the category the query is currently assigned to. (If you are changing the category for multiple queries, this area may be blank.) Select a category from the New Category list, and click OK. The query is reassigned to the new category.

You can assign a query to only one category.

Data Condition dialog box

NOTE This functionality applies only to drawing objects.

Use this dialog box to create or modify a data condition in a query.



[To retrieve drawing objects based on their object data](#) (page 1248)



Click Home tab ► Data panel ► Define Query.



A data condition searches data that you have attached to drawing objects.

Object Class / Object Properties / Database Link / Object Data / Attribute options

Select the data to query.

- To search data associated with a object class, select Object Class. Select an object class from the Class list. Select the property. To search all subclasses of the selected object class, select Include Subclasses. If this option is not selected, only data in objects tagged with the selected object class is searched.
- To search data stored in custom objects, select Object Properties. When selected, you can choose from a list of all object types and properties defined either in all source drawings or in the current drawing, depending on whether the source or current drawing is queried. To search all subclasses of the selected object type and/or property, select Include Subclasses. If this checkbox is cleared, the query will be limited. Select Include Subclasses when running an Object Properties query.
- To search data in link data stored on an object, select Database Link. Select the link template from the Link Templates list. Select the key column. This option searches only the link data stored on objects. To search the database table, use a SQL condition.

- To search data in an object data table, select Object Data. Select a table from the Tables list. Select the object data field.
If two source drawings have a table with the same name, AutoCAD Map 3D recognizes only the fields defined in the first drawing you activate.
- To search data in a block attribute, select Attribute. Select a block from the Blocks list. Select the attribute tag.

NOTE The lists you select from (for example the Link Templates list and the Object Data list) display only the information available in the sources you are querying. For example, if you are querying database links in your source (attached) drawings, the Link Templates list displays only the link templates in your source drawings.

Operator list

Select an operator from the list.

Operator	Description
=	The value of the selected property or data is equal to the value you enter the Value box.
>	The value of the selected property or data is greater than the value you enter the Value box.
>=	The value of the selected property or data is greater than or equal to the value you enter the Value box.
<	The value of the selected property or data is less than the value you enter the Value box.
<=	The value of the selected property or data is less than or equal to the value you enter the Value box.
<>	The value of the selected property or data is not equal to the value you enter the Value box.

NOTE If you are querying database link data, only the = (equals) operator is available.

Value box

Specify the value to search for. You can use [Wildcard Characters](#) (page 1537).

To enter a value that includes a comma, such as an RGB color or a Colorbook color, enclose the value in double quotes, for example, "255,255,255" or "PANTONE(R) process coated,PANTONE Process Cyan C".

Define New Category dialog box

Use this dialog box to create a new category in the Query Library.



To add a category to the query library (page 182)



Click Create tab > Object Query panel > Library.



Enter a new name in the New Category Name box. Click OK. Category names cannot contain any spaces.

Define Query dialog box

NOTE This functionality applies only to drawing objects.

Use this dialog box to define, modify, save, load, or execute queries.



To create a query to retrieve information from attached drawings (page 1237)



Click Home tab > Data panel > Define Query.



The dialog box settings reflect the properties of the current query. If you change a setting, you modify the current query. If you load a query from the query library or from a file, you replace the current query.

Press either Execute Query or OK:

Execute Query

Save dialog box settings and execute the current query.

OK

Save dialog box settings without executing. Click OK to create an element for the Display Manager.

NOTE You can set several query options. See the Query tab of the [AutoCAD Map Options dialog box](#) (page 1908).

Current Query

This area shows the conditions in your current query. You can edit, group, or delete the conditions.

Current Query List

View all conditions in the current query. If conditions have been grouped, the group is indented and enclosed within parentheses. (Conditions in a group are evaluated before conditions outside the group.)

- To edit a condition, select it. Click Edit.
- To group conditions, select the first and last condition that you want in the group. Click Group.
- To delete a condition, select it. Click Delete.

Edit

Edit the selected condition.

If you select more than one condition, Edit is unavailable.

You can also edit a condition by double-clicking it in the list.

Group

Group the selected conditions.

When you run the query, conditions inside the group are evaluated before conditions outside the group.

The easiest way to specify a group is to select the first and last conditions in the group and click Group. All conditions between the first and the last selected conditions are included in the group and enclosed within parentheses.

You can nest groups.

Ungroup

Ungroup the selected group.

To ungroup conditions, select the first or last condition in the group. Click Ungroup.

Delete

Deletes the selected query condition.

Clear Query

Delete all conditions in the list.

Clearing the query does not remove settings from the Set Property

Alterations dialog box or from the Output Report Options dialog box.

Query type

Use this area to create conditions for your query.

And/Or/Not options

Determine how the condition is combined with other conditions.

And specifies that both conditions must be met for the object to be included in the query.

Or specifies that either condition can be met for the object to be included in the query.

And Not specifies that the first condition must be met and the second condition must not be met for the object to be included in the query.

Or Not specifies that either the first conditions can be met or the second condition cannot be met for the object to be included in the query.

Location

Display the [Location Condition dialog box](#) (page 1849), where you can define a condition based on the location of the object in relation to points you specify.

For example, search for all objects that fall inside a circle or that cross a line.

Property

Display the [Property Condition dialog box](#) (page 1855), where you can define a condition based on the object's properties.

For example, search for all objects on a specified layer, all objects of a certain color, or all text in a certain text style.

Data

Display the [Data Condition dialog box](#) (page 1836), where you can define a condition based on object data attached to an object.

For example, if you attach a field named Pipe Diameter to several objects, you can search for all objects where that field has a value of 10" or more.

For more information on defining and attaching data, see [Creating an Object Data Table](#) (page 200) and [Entering and Editing Object Data](#) (page 1061).

SQL

Display the [SQL Link Condition dialog box](#) (page 1866), where you can define a condition based on the external data linked to an object.

For example, if you are trying to determine the best location for a new park and you have linked data from a table containing information about the households, you can search for all parcels where the household has young children.

NOTE Before you execute a query with a SQL condition, be sure the appropriate data source is attached and connected.

Query mode

Specify the type of query to run. If you are creating an element for the Display Manager, Draw is the only available option.

Preview

Preview the objects that match the query conditions, but don't actually pull the objects into the current drawing.

When you redraw the screen, the objects will be gone. Property alterations do not appear in a Preview mode query.

Draw

Get the objects that match the query and bring them into the current drawing. If you are creating an element for the Display Manager, this option gets the objects and adds them to the element.

If a property alteration has been defined, objects are modified as they are copied into the current drawing.

You must have Draw Query privileges to perform a draw query. See [To add a new user](#) (page 83).

Report

Execute the query and save the results in a report file.

To specify a template for the report, click Options to display the [Output Report Options dialog box](#) (page 1852).

Property alterations are not reflected in the report.

Options

Display the [Output Report Options dialog box](#) (page 1852), where you specify a template for the report. The Options button is available only if Report query mode is selected.

NOTE For topology queries, the Options button is available with both Draw and Report query modes.

Options

Set property alterations, save the query to execute later, load a query you previously saved, redraw the screen, or set options.

If you are creating a element for a display map, not all of the options are available.

Alter Properties check box

Determines whether the query executes the property alteration. If this is not selected, property alterations are ignored when you execute the query.

Alter Properties button

Display the [Set Property Alterations dialog box](#) (page 1863), where you specify how to modify objects that are found by the query.

Save

Display the [Save Current Query dialog box](#) (page 1862), where you save the current query so you can run it later.

Load

Display the [Load Internal Query dialog box](#) (page 1848), where you load a query that you previously saved.

Redraw <

Redraw the screen to clear any previews.

Zoom Ext <

Display the [Zoom Drawing Extents dialog box](#) (page 2014), where you select any active drawings in your drawing set. AutoCAD Map 3D then zooms the screen to the extents of the selected drawings.

Drawings

Display the [Define/Modify Drawing Set dialog box](#) (page 1918), where you can change which drawings are attached to the current drawing, and which drawings are active for queries.

More

Display the Query tab of the [AutoCAD Map Options dialog box](#) (page 1908), where you change query options such as whether searches are case sensitive and whether to preview text as an insertion point.

Define Range Table dialog box

NOTE This functionality applies only to drawing objects.

Use this dialog box to create, rename, or delete range tables.



[To create a range table](#) (page 1272)



Click Home tab ► Data panel ► Define Query.



A range table specifies a range of actions to take depending on the actual value of object data or properties associated with drawing objects.

- For property alteration, specify different alterations for a property depending on the value of the property. For example, you could specify that all buildings under two stories be colored blue, all buildings two stories to ten stories be colored green, and all buildings above ten stories be colored red.
- For an output report, specify different actions to take depending on the value of the data. For example, you could specify that if a lot is valued at less than \$10,000, report the value in the Land Value A column of your database; if the lot is valued at over \$10,000, report the value in the Land Value B column.

Create range tables and save them with the current drawing to use again.

Range Table area

Select an existing table, rename a table, create a new table, or delete a table.

Range Table list

View all tables in the current drawing.

To view tables, click the down arrow. Select a table.

Rename

Display the [Rename Range Table dialog box](#) (page 1860), where you can specify a new name for the current range table.

New

Display the New Range Table dialog box, where you can save the current table definitions to a new range table.

Remove

Remove the current range table.

Do not delete a range table used by your queries.

Current Range Table Definition area

Use this area to view, edit, or delete rows in the range table.

Current Range Table Definition list

View all rows in the current range table.

To edit or delete a row, select the row and click Edit or Delete.

Edit

Copy the selected row to the Condition section of the dialog box, where you can modify it.

When you finish modifying the condition, click Add To List to update the row in the Current Range Table Definition list.

Delete

Delete the selected row.

Clear List

Delete all rows from the current range table.

Expressions in the Current Range Table Definition list are evaluated from top to bottom, that is, in the order you enter them. As soon as one condition is evaluated as TRUE, AutoCAD Map 3D stops evaluating, ignores the remaining expressions, and returns the value associated with the TRUE condition in the range table.

For example, assume you enter the following expressions:

If < 0 Return: Low

If < 15 Return: Medium

If < 30 Return: High

If < 45 Return: Very High

With a value of 20, the first condition evaluates to FALSE because 20 is not less than 0. The second condition also evaluates to FALSE since 20 is not less than 15. However, the third condition evaluates to TRUE since 20 is less than 30, and the value returned by the range table is High. The last condition, although TRUE, is ignored.

Condition area

Edit an existing row, or create a new one.

- To edit an existing row, select the row in the Current Range Table Definition list and click Edit. When you finish, click Update.
- To create a new condition, select an operator, specify an expression and a return value, and click Add.

Operator list

Select an operator from the list.

Operator	Description
=	The value of the selected property or data is equal to the value you enter the Value box.
>	The value of the selected property or data is greater than the value you enter the Value box.
>=	The value of the selected property or data is greater than or equal to the value you enter the Value box.
<	The value of the selected property or data is less than the value you enter the Value box.
<=	The value of the selected property or data is less than or equal to the value you enter the Value box.
/=	The value of the selected property or data is not equal to the value you enter the Value box.
OTHERWISE	Specify the action to take none of the preceding conditions are met.If you include an OTHERWISE condition, it must be at the end of the list.

Expression Value box

Enter a simple expression.

If an object matches the value of this expression, the object is affected by the return value.

Return Value box

Specify a return value for this condition.

The return value specifies what happens if the object matches the expression.

Enter a value or a simple expression. Do not enter a compound expression.

Add

Add the current condition to the Current Range Table Definition list.

Update

Update the selected condition in the Current Range Table Definition list with the current condition.

Define Text dialog box

Use this dialog box to specify text to add to all drawing objects found by the query.



[To add text to retrieved drawing objects](#) (page 1278)



Click Home tab ► Data panel ► Define Query.



Text Value

Specify the text to add.

Enter the text, or choose a variable by clicking Expression.

- If you enter text in the box, that text is added to each object.
- If you choose a variable, the text for each object is based on the value of the variable.

For example, if you choose the property Elevation, the elevation is added as text to each retrieved object.

If select a field from an object data table, the value in that field is added to each object. If an object does not have a record attached from the selected table, no text is added to the object.

Text Height

Specify a text height.

If none is specified, text uses the AutoCAD Map 3D default text height.

Insert Point

Specify an insertion point for the text.

Centroid

Insert text at the centroid of the object.

Labelpt

Insert text at the label point of the object.

The default location for the label point is the centroid of the object. To change the location of the label point, use the ADETEXTLOC command.

Justification

Specify the justification for the text. The list displays options for center, middle, and right, or combinations of these with top (T), middle (M), and bottom (B).

Text Style

Enter a text style, or click Styles to select from a list of styles in the active drawings.

Layer

Enter a layer for the text, or click Layers to select from a list of layers in the active drawings. If you enter a new layer name, the layer is created. To easily hide or delete text, insert it on its own layer.

Color

Specify a color for the text.
Enter a color name, or click Color Palette to select a color.

Rotation

Enter a rotation value. Enter 0 for no rotation.
For example, enter 90 to rotate objects 90 degrees in the current direction.
(Use the DDUNITS command to view or change the current direction.)

For each option, enter a value in the box, enter an expression or variable, or select a value. For information on expressions and variables, see [Expression Evaluator](#) (page 1541).

Hatch Options dialog box

Use this dialog box to add a hatch pattern to drawing objects found by the query.



To fill queried drawing objects with a hatch pattern (page 1283)



Click Home tab ► Data panel ► Define Query.



Pattern

Enter a hatch pattern, click Patterns to select from a list of hatch patterns defined in the active drawings, or click Expression to use an expression to

specify the hatch pattern. If you leave the box empty, AutoCAD Map 3D uses a solid fill.

The box displays the selected hatch option. ISO hatch patterns are not displayed.

Scale

Specify a scale for the pattern. A small scale creates a smaller pattern and takes longer to display and print.

Rotation

Enter the rotation. Enter 0 for no rotation.

For example, enter 90 to rotate objects 90 degrees in the current direction. (Use the DDUNITS command to view or change the current direction.)

Layer

Enter a layer for the hatch, or click Layers to select from a list of layers in the active drawings. If you enter a new layer name, the layer is created.

To easily hide or delete the hatch, insert it on its own layer.

Color

Specify a color for the hatch.

Enter a color name, or click Color Palette and select a color.

For each option, enter a value in the box or enter an expression or variable. For example, to use a hatch pattern specified in the Hatch field of the Design object data table, enter :hatch@design. For information on expressions and variables, see [Expression Evaluator](#) (page 1541).

You can set an option to determine whether the hatch object created by this command is associative. See the Query tab of the [AutoCAD Map Options dialog box](#) (page 1908) and [To have hatch created by property alteration be associative](#) (page 247).

NOTE Use the DRAWORDER command to display objects on top of the hatch.

Load Internal Query dialog box

NOTE This functionality applies only to drawing objects.

Use this dialog box to load a previously saved query.



[To create a query to retrieve information from attached drawings](#) (page 1237)

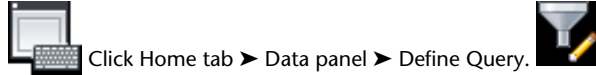

The definition of the loaded query appears in the Define Query dialog box. Depending on the options you specified when you saved the query, it may change the active drawings or load property alteration settings. You can modify the query or click Execute Query to execute the query.

Category list

Select a category to save your query in.

Use categories to organize queries. (When you run a query, you first select a category, and then see all the queries in that category.)

If you have only a few queries, you can save them all in the same category.

Queries list

View all the queries assigned to the selected category.

To load a query, choose it from the list. Click OK.

Selected Query display

View the name and description of the selected query.

Location Condition dialog box

NOTE This functionality applies only to drawing objects.

Use this dialog box to create or modify a location condition in a query.



[To retrieve drawing objects based on their location](#) (page 1241)



A location condition finds drawing objects based on location relative to a specified boundary. You can specify whether objects must be completely inside the boundary or have any part inside the boundary.

For blocks or text objects, you can specify if their location is determined by their insertion point or their bounding box. For hatch, solid, and raster objects,

you can specify if their location is determined by their area or their boundary. See the Query tab of the [AutoCAD Map Options dialog box](#) (page 1908).

Location Coordinates

View the coordinates for the current location condition.

Define <

View your current drawing, where you can specify the points to define the boundary.

Show <

View the boundary of the condition you are editing.

To change the colors used to display the boundaries, use the Query tab on the AutoCAD Map Options dialog box.

Boundary Type

Select a boundary type.

All

Retrieve all objects in the active drawings.

Buffer Fence

Retrieve all objects within a specified distance from a fence.

Select a selection type. Click Define to define the fence and the distance.

First Point Enter the X,Y coordinates of the first point of the buffer fence, or select the point.

Next Point Enter the X,Y coordinates of the next point of the buffer fence, or select the point. Press Enter when done entering points.

Bufference Width Enter the width of the buffer fence in the current unit.

Circle

Retrieve all objects in a defined circle.

Select a selection type. Click Define to define the circle.

Center point Enter the X,Y coordinates of the center of the circle, or select the point.

Radius Enter a number in the current unit.

Fence

Retrieve all objects that cross a defined line.

Select a selection type. Click Define to define the fence.

A fence does not need to be closed and can cross itself.

First Point Enter the X,Y coordinates of the first point of the fence, or select the point.

Next Point Enter the X,Y coordinates of the next point of the fence, or select the point. Press Enter when done entering points.

Point

Retrieve all areas that surround a selected point.

Click Define to select the point.

Coordinates of Point Enter the X,Y coordinates of the point, or select the point.

Polygon

Retrieve all objects in a defined polygon.

The polygon can be any shape, but cannot cross or touch itself. If you do not close the polygon, AutoCAD Map 3D connects the final point to the first point to create a closed polygon.

Select a selection type. Click Define to define the polygon.

First Point Enter the X,Y coordinates of the first point of the polygon, or select the point.

Next Point Enter the X,Y coordinates of the next point of the polygon, or select the point. Press Enter when done entering points.

Polyline

Retrieve all objects that cross an existing polyline.

Select a selection type, select a polyline mode. Click Define to select the polyline.

Select Polyline Select a polyline, line, or arc. If you selected the Polygon polyline mode, you can select only a polyline.

Bufference Width Enter the width of the buffer fence in the current unit. (This prompt appears only if you select the Buffer Fence polyline mode.)

Window

Retrieve all objects in a specified window.

Select a selection type. Click Define to define the window.

First Corner Enter the X,Y coordinates of the first corner of the window, or select the point.

Other Corner Enter the X,Y coordinates of the opposite corner of the window, or select the point.

Selection Type

Inside

Find only objects that are completely within the boundary.

Crossing

Find objects that are completely within or crossing the boundary.

NOTE When you perform location queries close to blocks or text objects, be aware that the bounding box for these objects can extend significantly beyond the extents of the objects. You can set an option to retrieve objects based on

their bounding box or their insertion point. See [AutoCAD Map Options dialog box](#) (page 1908).

Polyline Mode

If you select a polyline boundary, select the mode to define the polyline border.

Polygon

Close the polyline to create a polygon. If the polyline contains arcs, AutoCAD Map 3D connects the ends of the arcs with a straight line.

Fence

Retrieve all objects that cross the polyline.

Buffer Fence

Retrieve all objects within a specified distance from the polyline.

New Range Table dialog box

Use this dialog box to name a new range table.



[To create a range table](#) (page 1272)



Click Home tab ► Data panel ► Define Query.



Enter a name for the new range table.

Output Report Options dialog box

NOTE This functionality applies only to drawing objects. Reports will include information about drawing objects only.

Use this dialog box to specify the name for your report file, and to define a template for the file.



[To create a report template](#) (page 1479)



Click Home tab ► Data panel ► Define Query.



An output report lists information about drawing objects that were found by a query of an attached drawing file. This information can include properties (such as layer, color, or object type), data attached to the object, or data linked to the object from an external database. You set up expressions to limit the objects found to those that match specific criteria. For example, you can create a query that finds all structures larger than a certain size, and then prints a report listing the object type and size. You can also include information from sub-objects.

To specify which information you want in the report, create a template.

Report Template area

Report Template list

View all expressions in the current template. New expressions are added to the bottom of the list, unless an expression in the list is selected, and then the new expression is added above that expression.

Edit

Select an expression in the Report Template list and click Edit to copy it to the Expression box, where you can modify it. When you finish modifying the expression, click Update.

Delete

Select an expression in the Report Template list and click Delete to remove it.

Clear List

Erase the entire report template.

Expression area

Create a new expression or modify an existing one.

Expression box

Enter an expression to add to the template or edit an existing expression. To create an expression, specify the variable that represents the information to include in the report and click Add. To select from a list of available variables, click Expression.

Expression

Display the [Expression dialog box](#) (page 1807), which lists all drawing object properties, object classes, object data, and external data in the drawing you are querying.

Range list

View the current range table.

To see a list of all range tables defined in the drawing you are querying, click the down arrow.

Ranges

Display the [Define Range Table dialog box](#) (page 1842), where you can create a new range table.

Add

Add the current expression to the Report Template list.

Update

Update the edited expression in the Report Template list.

Output File Name area

Enter the path and file name for the report or click Browse to choose one.

Unless you specify otherwise, the file name extension is *.txt*. The output file is in text format regardless of the file name extension you use.

Process Sub-Objects

If you do not select this option, the output report contains information about the selected object, but not its component parts.

For example, select this option to print information for all points in a polygon. If the option is not selected, the output report will contain information for only the first point.

The following table shows the information included in a topology query, depending on whether you select Process Sub-Objects or not.

Topology type	Not selected	Selected
Node topology	Nodes	Nodes, objects, and object data
Network topology	Links	Links, start and end node data
Polygon topology	Centroids	Centroids, links, and nodes

Apply Transformation

If objects from the drawing you are querying have been transformed using a coordinate system transformation or a simple offset, scale, or rotate

transformation, check this option to have the report query evaluate the transformed objects.

If you do not select this option, the report query evaluates only the untransformed objects in the drawing.

Property Condition dialog box

NOTE This functionality applies only to drawing objects.

Use this dialog box to create or modify a property condition in a query.



[To retrieve drawing objects based on their properties](#) (page 1244)



Click Home tab > Data panel > Define Query.



A property condition finds drawing objects based on a property, such as color, layer, length, or text style.

Select Property Area

Specify the property to search for.

Area

Retrieve objects based on their area.

Area only works on circles, ellipses, polylines, splines, regions, and solids. It does not work on objects created from line segments. For example, Area will not work on a rectangle created of four separate lines.

Block Name

Retrieve objects based on their block name.

To select from a list of block names in the active drawings, click Values.

Color

Retrieve objects based on their color.

To select a color, click Values.

Elevation

Retrieve objects based on their elevation.

Elevation is the Z value from the XY plane where the object is defined.

Object Type

Retrieve objects based on their type.

To select from a list of types in the active drawings, click Values.

If an object type, does not appear on the list, it may be a custom object. To add a custom object to the list, run a command that will load the object's dbx.

NOTE To specify a polyline object type, enter 2Dpolyline or 3Dpolyline.

Group

Retrieve objects based on the groups they are members of.

To select from a list of groups in the active drawings, click Values.

The group is not maintained in the current drawing.

Layer

Retrieve objects based on their layer.

To select from a list of layers in the active drawings, click Values.

Length

Retrieve objects based on their length.

Linetype

Retrieve objects based on their linetype.

To select from a list of linetypes, click Values.

If the linetype is not loaded in the current drawing, the objects will appear with a CONTINUOUS linetype.

Text Style

Retrieve objects based on their text style.

To select from a list of text styles, click Values.

Text Value

Retrieve objects based on their text value.

To set an option for case-sensitive match for text values, use the Query tab of the [AutoCAD Map Options dialog box](#) (page 1908).

Thickness

Retrieve objects based on their thickness.

Thickness is the distance an object is extruded above or below its elevation.

Object Class

Retrieve objects based on their object classification.

To select from a list of object classes, click Values.

Select Include Subclasses to return all objects tagged with the selected object class and all objects tagged with any subclasses of the selected object class.

If the option is not selected, the query returns only objects tagged with the selected object class.

Lineweight

Retrieve objects based on their lineweight.
To select from a list of lineweights, click Values.

Plotstyle

Retrieve objects based on their plot style.
To select from a list of plot styles, click Values.

Operator list

Select an operator from the list.

=	The value of the selected property or data is equal to the value you enter the Value box.
>	The value of the selected property or data is greater than the value you enter the Value box.
>=	The value of the selected property or data is greater than or equal to the value you enter the Value box.
<	The value of the selected property or data is less than the value you enter the Value box.
<=	The value of the selected property or data is less than or equal to the value you enter the Value box.
<>	The value of the selected property or data is not equal to the value you enter the Value box.

If you selected Layer, Object Classname, or Plotstyle as the property, = (equal) is the only available operator.

Value box

Specify the value to find.
To specify more than one value, separate each value with a comma. The query will find objects that match any of the values.
You can use wild-card characters for: Block Name, Object Type, Group, Layer, Linetype, and Text Style.
To select values from a list, click Values.

Values

Display a list of values defined for the property in any of the active drawings attached to this drawing.
Select values from the list.

NOTE For topology queries, some of the options are different. For more information on querying a topology, see [To query a topology](#) (page 1353).

Query Library Administration dialog box

NOTE This functionality applies only to drawing objects.

Use this dialog box to rename, create, or delete query categories, to move a query from one category to another, to change a query description, to attach queries from external files, or to delete queries you no longer use.



To add a category to the query library (page 182)



Click Create tab > Object Query panel > Library.



Category

Use this area to select, rename, create, or delete a category.

Category list

View all query categories in the current drawing.

Select a category. The Available Queries list updates to show all queries in the selected category.

Rename

Display the [Rename Category dialog box](#) (page 1860), where you rename the current category.

New

Display the [Define New Category dialog box](#) (page 1838), where you create a new category.

Remove

Delete the current category.

You can remove a category only if it has no queries assigned to it. To delete a category that still has queries in it, you must first delete the queries or assign them to new categories (by clicking Category).

Available Queries

Delete queries or assign them to new categories.

Available Queries list

View all queries in the current category.

To view additional queries, select a different category from the Category list.

Delete

Delete the selected queries.

Select All

Highlight all queries in the list.

Clear All

Remove the highlighting from all queries in the list.

Category

Display the Change Category dialog box, where you move the query to a different category.

A query can be assigned to only one category.

Selected Query

Use this area to add an external query to the current drawing, or to view information about the selected query in the Available Queries list.

To add an external query, select External from the Query Type list. (You may need to erase the query Name first.) Specify the path and file name for the external query in the File Name box. Once the external query is found, you can modify its name or description. Click Add to add the query to the current category.

To modify information about an existing query, select it in the Available Queries list and change any information you want. When you finish, click Update. To assign a query to more than one category, copy the query by selecting it in the Available Queries list. Enter a new name for the query, click Add and assign the new query to a different category.

Name box

Specify a name for the query.

A query name must be unique in the current drawing.

Description box

Specify a query description.

File Name box

If the query is external, specify the path and file name for the file where the query is stored.

Query Type list

Specify internal (the query is stored with the current drawing) or external (the query is saved in a separate file).

Add

Add the query to the Available Queries list for the current category.

Update

Update the existing query in the Available Queries list.

Rename Category dialog box

Use this dialog box to rename a category in a Query Library.



[To add a category to the query library](#) (page 182)



Click Create tab ► Object Query panel ► Library.



The Current Category Name area displays the current name of the category. Enter a new name and click OK. Category names cannot contain any spaces.

All queries assigned to the previous category name are assigned to the new name. The old category name no longer exists.

Rename Range Table dialog box

Use this dialog box to rename a range table.



[To create a range table](#) (page 1272)

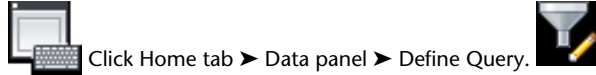

The Current Range Table Name area shows the current name for the range table. Enter a new name in the New Range Table Name box.

NOTE If you have any queries that use the current table name, edit those queries to use the new table name.

Run Library Query dialog box

Use this dialog box to run a query you saved to the Query Library.



Select a query from the query library. Click Run Query. To view queries from a different category, select the category from the Category list. You can run queries that have been saved with the current drawing or external queries that have been added to the library.

Category list

Select a category to save your query in.

Use categories to organize queries. (When you run a query, you first select a category, and then see all the queries in that category.)

If you have only a few queries, you can save them all in the same category.

Queries list

Lists all the queries assigned to the selected category.

To load a query, choose it from the list. Click OK.

Selected Query display

View the name and description of the selected query.

Save Current Query dialog box

NOTE This functionality applies only to drawing objects.

Use this dialog box to save your current query. Once a query is saved, you can run it again later.



[To save a query](#) (page 177)



Click Create tab ► Object Query panel ► Library.



Category List

Select a category to save your query in.

Use categories to organize queries. (When you run a query, you first select a category, and then see all the queries in that category.)

If you have only a few queries, you can save them all in the same category.

New Category

Display the Define New Category dialog box where you can create a new query category.

Name

Enter a name for the query. Query names cannot contain any spaces. Each query name must be unique.

Description

Enter a description for the query. Use a description that will help you remember the query when you look for it later.

Save to External File

Save the query to an external file instead of in the current drawing.

Specify a name for the file.

If you want the query description to appear in the current drawing query library, select Keep Reference In Library.

File name

Specify a name for the external file where you want to save the query. To

select a different directory, click .

Each external query must be saved in a separate file.

Keep Reference In Library

If you save the query to an external file, select this check box to list the query description along with other queries in this drawing's query library.

Save List of Active Drawings

If this box is selected, the saved query specifies which drawings in the drawing set will be active when the query is executed.

If the box is not selected, the query searches whatever drawings are active when you execute the query.

Save Location Coordinates

If this box is selected, the coordinates for any location conditions are saved with the query.

If the box is not selected, you will need to specify the coordinates when you execute the query.

Save Alter Properties

If this box is selected, property alteration specified in the Set Property Alterations dialog box are saved with the query.

If the box is not selected, the property alterations are not saved with the query.

Auto Execute

If this box is selected, when you run the saved query, it is automatically executed.

If the box is not selected, the query is loaded as the active query, but is not executed until you click Execute Query in the Define Query dialog box.

If you save the query to an external file and do not keep a reference in the current drawing library, you do not need to provide a name or description for the query.

Set Property Alterations dialog box

NOTE This functionality applies only to drawing objects.

Use this dialog box to specify how drawing objects found in a query will be modified as they are brought into the current drawing.



To modify objects as they are retrieved by a query (page 1259)



Click Home tab ► Data panel ► Define Query.



You can alter object properties such as color, layer, block name, or thickness, or you can add text to objects. In addition, you can create a range table that modifies objects in different ways based on where they fall in a range of values.

Property alteration is a fast way to modify a group of objects. For example, make objects stand out in their source drawings by adding color or hatch, move a group of objects to a new layer, or add informational text.

NOTE To have a property alteration take effect, execute a Draw mode query. Property alterations do not work in Preview or Report mode queries.

To save property alterations back to source drawings, add the objects to the save set.

Current Property Alterations list

View all expressions in the property alteration list.

Edit

Copy the selected expression to the expression section of the dialog box, where you can modify it.

Delete

Delete the selected expression.

Clear List

Remove all expressions from the Current Property Alterations list.

Select Property area

Select the property to alter.

To change the color of retrieved blocks, the color of the components of the source drawing block must be BYBLOCK. Otherwise, the block retains its original colors.

Color alterations on a bitonal raster image affect both the image and the boundary. On multiple color raster images, the alteration affects only the boundary.

Properties

Select the property to alter.

Text

Display the Define Text dialog box, where you specify text to add, and its height, insertion point, justification, text style, layer, color, and rotation.

Hatch

Display the Hatch Options dialog box, where you specify the hatch to add.

Expression area

Use this area to create or modify an expression that defines how you want to alter a property on objects that are found by the query.

To modify an existing expression, select it in the Current Property Alterations list. Click Edit. When you finish modifying the expression, click Update.

To create a new expression, enter the expression in the Expression box. Use Values, Property, Data, and SQL to help you create the expression. When you are done, click Add.

Each expression must list the property to modify, and how to modify it. To modify objects based on where they fall in a range of values, select an existing range table from the Range list, or create a new table using the Ranges.

Expression box

Enter the expression to add to the Current Property Alterations list.

Range list

Display the current range table.

To see a list of all range tables defined in the current drawing, click the down arrow.

Ranges

Display the [Define Range Table dialog box](#) (page 1842), where you can create a new range table.

Add

Add the current expression to the Current Property Alterations list.

Update

Update the edited expression in the Current Property Alterations list.

Values

For the property selected in the Select Property area, display all values in the active drawings.

Expression

Display the [Expression dialog box](#) (page 1807), which lists all properties, object data fields, and SQL link template fields in the active source drawings.

SQL Condition History dialog box

Use this dialog box to copy a condition to your current SQL query.



To retrieve drawing objects based on linked SQL data (page 1253)



Click Home tab > Data panel > Define Query.



This dialog box lists the SQL conditions specified in this drawing. Each line includes the link template and the condition.

To copy a condition from this list to your current SQL query, select the condition. Click OK.

Clear History

Remove all SQL conditions from the list.

To specify a maximum length for this list, use the Data Source tab of the [AutoCAD Map Options dialog box](#) (page 1908).

SQL Link Condition dialog box

NOTE This functionality applies only to drawing objects.

Use this dialog box to create or modify a SQL condition in a query.



To retrieve drawing objects based on linked SQL data (page 1253)



Click Home tab > Data panel > Define Query.



A SQL condition searches for objects based on data in an external database. (Use the Map Database commands to link external data to objects.)

NOTE Before you execute a query with a SQL condition, be sure the appropriate data source is attached and connected.

To create a SQL condition, specify the link template. Specify the column to check and the value for the column.

Build a SQL condition using this dialog box, or type a condition by choosing Type It.

Current SQL Condition area (SQL Link Condition)

This area displays the current SQL condition. You can add, delete, or edit any line in the condition.

Current SQL Condition list

View the current SQL condition.

If lines in the condition have been grouped, the group is indented. (Lines in a group are evaluated before lines outside the group.)

Edit

Copy the selected line to the Condition section so you can edit it.

Group

Group the selected lines.

Select the first and last lines that you want in the group. Click Group.

When you run the query, lines inside the group are evaluated before the rest of the condition.

Ungroup

Delete the parentheses from the selected line and from the matching ending or beginning line of the group.

Delete

Remove the selected line from the condition.

Clear All

Remove all lines from the current SQL condition.

Condition area (SQL Link Condition)

Edit an existing line in the condition or add new lines.

To edit an existing line, select the line in the Current SQL Condition list. Edit the information in the Condition area. Click Update.

To add a new line, select the operator (And/Or/Not). Select a column and an operator and specify a value. Click Add Condition.

And/Or/Not options

Determine how the condition is combined with other conditions.

And specifies that both conditions must be met for the object to be included in the query.

Or specifies that either condition can be met for the object to be included in the query.

And Not specifies that the first condition must be met and the second condition must not be met for the object to be included in the query.

Or Not specifies that either the first conditions can be met or the second condition cannot be met for the object to be included in the query.

Column list

Select a column from the list.

The list displays columns from the current table.

Operator list

Select an operator from the list.

Operator	Description
=	The value of the selected property or data is equal to the value you enter in the Value box.
>	The value of the selected property or data is greater than the value you enter in the Value box.
>=	The value of the selected property or data is greater than or equal to the value you enter in the Value box.
<	The value of the selected property or data is less than the value you enter in the Value box.
<=	The value of the selected property or data is less than or equal to the value you enter in the Value box.
<>	The value of the selected property or data is not equal to the value you enter in the Value box.
IN	The value of the selected property or data matches any of the values you enter in the Value box. When you use the IN operator, you must enclose each value in single quotation marks, separate the values with commas, and enclose the entire list in parentheses, for example, ('1','2','3').
IS NULL	The value of the selected property or data is empty. Do not enter a value in the Value box.

Operator	Description
LIKE	The value of the selected property or data contains the value you enter in the Value box. Applies to string (character) data types only. Use the percent sign (%) as a wild-card character. For example, to retrieve all objects that have a value starting with B, choose the LIKE operator and enter B% in the Value box. For information on the wild-card characters supported by your database system, refer to the documentation for your database system software.

Value box

Specify the value to search for.

The value must match the data type of the column.

If the string contains a single quotation mark, precede the single quotation mark with another single quotation mark.

For dates, use the format `TIMESTAMP'YYYY-MM-DD 00:00:00'`, for example, `TIMESTAMP'1993-06-20 11:24:00'`.

To use wild-card characters with string values, use the LIKE operator. For example, to retrieve all objects that have a value starting with B, choose the LIKE operator and enter B%. Refer to the documentation for your database software to see which wild-card characters are supported.

Add Condition

Add the condition line to the Current SQL Condition list.

The new line is added to the bottom of the list. If any line in the list is selected, the new line is added above it.

Update

Update the selected condition in the Current SQL Condition list.

Other Controls

Link template list

Select the link template that specifies the table containing the data to use for this query condition.

This list displays only the link templates available in the source(s) you are querying. For example, if you are querying source (attached) drawings, the list will display only the link templates in your source drawings. If you are querying the current drawing, the list will display only the link templates in the current drawing.

You can query only one link template in a SQL condition. To query a different link template, create a new SQL condition.

History

Display the [SQL Condition History dialog box](#) (page 1866), where you select from a list of SQL conditions you previously added.

Type It

Display the [Type SQL Condition dialog box](#) (page 1870), where you enter your SQL condition.

Type SQL Condition dialog box

NOTE This functionality applies only to drawing objects.

Use this dialog box to create or modify a SQL condition, if you are familiar with SQL.



To retrieve drawing objects based on linked SQL data (page 1253)



Click Home tab ► Data panel ► Define Query.



History

To modify a condition you used previously, select it from the list. The condition is copied to the Enter SQL Condition area, where you can modify it.

Link Template

Select the link template that specifies the table to use with this condition. The SQL condition tests information linked from this table to the queried objects. Because queries apply only to objects in active source drawing, this list displays only link templates in your source drawings.

Enter SQL Condition

To create a new condition, enter it in the box.

SQL Condition Syntax

SQL has a strict grammatical structure and syntax. Here are some rules to follow when you define SQL statements.

- Character values (data type CHAR) must be enclosed in single quotation marks ('XXX').
- If the column has a data type of string or data, enclose the column name in double quotes. If the column has a numeric data type, do not enclose the column name in double quotes.
- Database values are case sensitive, but field (column) names are not.
- Do *not* end each statement with a semicolon (;) as in standard SQL syntax.
- For dates, use the format `TIMESTAMP'YYYY-MM-DD 00:00:00'`. For example: `"DATE">TIMESTAMP'1993-06-20 11:24:00'`
- Do *not* use AutoCAD Map 3D or DOS wild cards such as * or ? as part of column values or names.
- Do not use SQL keywords as identifiers. Examples of keywords are SQL commands and data types such as CHAR, GROUP, SQL, TABLE, USER, SECTION, BY, and CURRENT. Examples of identifiers are table and column names. For example, if you try to create a table with a column name of CURRENT, AutoCAD Map 3D displays an error message.

AutoCAD Map 3D supports standard SQL syntax as formally defined in the ANSI X3.135-1989 SQL standard.

Raster Image Dialog Boxes

34

MAPIFRAME (Image Frame command)

Use this command to turn on or off the display of frames.



[To display image frames](#) (page 495)

NOTE This option does not affect images you inserted with Data Connect. See [Overview of Adding Rasters and Surfaces](#) (page 437)

Image Correlation dialog box

Use this dialog box to correlate an image within the drawing when you insert it.



[To insert a raster image](#) (page 460)

[To correlate an image during insertion](#) (page 464)



Click Home tab > Data panel > Insert An Image.



NOTE This option does not affect images you inserted with Data Connect. See [Overview of Adding Rasters and Surfaces](#) (page 437)

The Source tab displays correlation information from the selected correlation source. The Insertion tab shows how these settings apply to the current drawing.

Correlation Source list

Select a correlation source for the image. If a resource or world file exists for the image, it is in this list.

Insertion Point area

View the insertion point (X, Y, and Z coordinates) for the lower-left corner of the image frame. On the Source tab, this information is in the units specified in the Units area at the bottom of the tab. On the Insertion tab, this information is in current drawing units.

Rotation box

Enter the amount of rotation in current drawing angle units for the image. This value uses the lower-left corner as the base point.

Scale box

Enter a scale factor for the image. A scale factor greater than 1 enlarges the image. For example, to make the image twice as large, enter 2.

Density box

Enter the dots (or pixels) per unit for the image.

Units list

Select the units for the insertion point and density. For example, if your image was scanned at 300 dpi, select Inches.

Apply

Apply your changes.

Pick

Click Pick (on the Insertion tab) to draw a frame for the image. For more information, see [To adjust the image frame manually during insertion](#) (page 465).

Frame Color box

View the current color for the image frame and for the foreground of a bitonal image. Usually, this is the current AutoCAD Map 3D color. However, when you insert a bitonal image, AutoCAD Map 3D first looks for the foreground color in the image header file or in a resource file. If it cannot find the color information, then the foreground color defaults to the current AutoCAD Map 3D color. To change the color, click Select (on the Insertion tab).

Image Information dialog box

Use this dialog box to view data about the selected images in your drawing.



To display the Image Information dialog box (page 475)



Click Insert tab > Image panel > Information.



File area

View the image name, location, file type, size, and date it was created and modified.

Image area

View the image density, depth, width, height, and color type.

Object area

View the linetype and layer of the image frame.

Correlation area

View the insertion point, scale, and rotation of the selected image.

NOTE If you select more than one image, and the information varies for different images, then “Varies” is displayed.

Image Management dialog box

Use this dialog box to view information about images in your drawing.



To display the Image Management dialog box (page 474)



Click Insert tab > Image panel > Image Management.



View the names of the images that were inserted into the drawing, the current display order, and other image information. Each image in your drawing, even

if it is unnamed or a copy, is listed. To indicate copies, the dialog box numbers them in the following format: imagename:1, imagename:2.

The images are listed in display order. The image at the top of the list is displayed on top and drawn last. To modify the image display order, click an image name and drag it up or down in the list.

Image

The name of the image file.

File

The full path name for the image file.

Layer

The layer on which the image is located.

Created

The date that the file was created.

Density

Dots per inch that the image was scanned at. Synonymous with resolution.

Depth

Every pixel of an image has information associated with it that defines its color. The amount of information stored with each pixel is referred to as depth. The more information that is stored with each bit, the greater the number of colors that can be represented.

Type

The format type of the image.

Visible

The display status of the image.

Last Modified

The date that the image was last modified.

File Size

The file size of the image in bytes.

Layout

Click Layout to display the [Image Management Layout dialog box](#) (page 1877), where you can determine which topic columns are displayed and their order.

To view additional information about an image, select the image and right-click. Click Information to display the Image Information dialog box.

NOTE You can change the size and position of this dialog box. Any changes you make will be retained in future sessions.

Image Management Layout dialog box

Use this dialog box to control which topic columns are displayed and the order in which they are displayed in the Image Management dialog box.



To display the Image Management dialog box (page 474)



Click Insert tab > Image panel > Image Management.



Image Topics list

Select or clear the check box next to a topic to display or remove that topic column. You can drag a selected topic up or down.

Description area

Provide a brief description of the selected topic in the Image Topics list.

Image Select dialog box

Use this dialog box to control the selection of multiple images in your drawing.



To select an image by pressing Shift + left-click (page 493)



Click Home tab > Data panel > Insert An Image.



NOTE This option does not affect images you inserted with Data Connect. See [Overview of Adding Rasters and Surfaces](#) (page 437)

You can select images by placing your cursor over them and pressing Shift + left-click. If you select more than one image, the Image Select dialog box is displayed.

List of images

View each image you inserted into the drawing. Selected images are highlighted. Click an image name to select or deselect it.

Select All

Click to select all the images in your drawing.

Select None

Click to remove all selected images from the selection set.

Insert Image dialog box

Use this dialog box to insert raster images whose formats are not supported by [Data Connect](#) (page 437)



To insert a raster image (page 460)



Click Home tab ► Data panel ► Insert An Image.



Select one or more images to insert into a drawing. You can view information about an image and preview the image before you insert it.

NOTE If the FILEDIA variable is set to 0, then this dialog box is not displayed and you can type the name of the image to insert on the command line.

Look In

Select the drive and folder that contains the image.

File Name

Type or select the name of the image or images to insert.

Files Of Type

From the list of available image formats, select the type of file to display in the list.

Show Frame(s) Only

Select this option to insert only a frame placeholder for the image. The image is not loaded into memory and not displayed. This is useful if you are inserting a group of images and don't want to wait for each image to

display. (To display the image later, select the image frame. Right-click the image frame ► Image ► Show Image.)

If this option is not selected, the image is loaded into memory and displayed as it is inserted.

Modify Correlation

Display the [Image Correlation dialog box](#) (page 1873) when you click Open. The Image Correlation dialog box lets you review and modify the correlation settings for the image. This option is not available if multiple images are selected. If you do not select this option, the image is inserted using its default correlation settings. Default settings are determined by searching for correlation data in the following order.

- 1 World file
- 2 Resource file (.res extension)
- 3 Tab files (.tab extension)
- 4 Image file
- 5 Defaults set in the Raster Extension Options dialog box

Information >>

Display information about the image file and preview the image.

Raster Extension Options dialog box

Use this dialog box to configure options for raster images you insert with the Insert An Image dialog box.



[Setting Raster Image Options](#) (page 249)



Click Insert tab ► Image panel ► angle-arrow.

NOTE This option does not affect images you inserted with Data Connect. See [Overview of Adding Rasters and Surfaces](#) (page 437)

Configure raster image options using the following tabs:

Paths

Use the Paths tab to set the directory for resource files. Resource files store information about an image insertion point, scale, rotation, and density. Resource files have the same base name as the raster image with an *.res* extension.

Resource File Directory

Specify the directory where AutoCAD Map 3D searches for resource files.

Click  to locate a directory. This directory applies only to resource (*.res*) files and not to other correlation sources.

When you insert an image, AutoCAD Map 3D looks for a resource file associated with the image in the Resource File Directory path. If it locates a resource file, you can select it as the source of correlation information. If you leave the resource file path blank, AutoCAD Map 3D searches the directory or directories the images were inserted from.

Use Resource File Directory Before Using Image Directory

Informs AutoCAD Map 3D to search for resource files in the resource file directory before searching the image path stored in the drawing.

General

Use the General tab to set how frames are displayed, the display quality of images, image detach options, and the Shift + left-click setting.

Display Preferences

Image Frame list

Specify how AutoCAD Map 3D displays the image frames in your drawing. Hide the frames by selecting Frames Off, display frames in front of the images by selecting Frame Drawn Above Image, or display frames behind the images by selecting Frame Drawn Below Image.

Display Quality High

Dither the pixels onscreen so that the changes between shades and colors are more gradual. This setting is recommended for color and grayscale images.

Display Quality Draft option

Do not dither the pixels. This setting is recommended for bitonal images.

Image Detach Preferences

Ask Before Detach

Have AutoCAD Map 3D prompt you to detach an image if there are no more frames in the drawing that reference the image.

Always Detach

Automatically detach an image when you erase the image frames.

Never Detach

Keep the image attached, even if you erase the frames.

Shift + Left Click

Shift + Left Click Image Select

Enable selection of images by placing your cursor over them and clicking the left mouse button while pressing Shift. This feature is useful when you are zoomed in to the image and cannot see the image frame.

Image Defaults

Use the Image Defaults tab to set correlation defaults. Most images have correlation data that is stored in the image file header, or in a resource file, World file, or tab file. However, some images may not have any correlation data. For those cases, you can specify default correlation data. In addition, if the correlation source does not include information on the scale or the density, AutoCAD Map 3D uses the default values on this tab when inserting the image.

TIP Setting the correlation defaults can save you time if you have multiple images that require the same insertion point, scale, rotation, and density.

Insertion Values

X

Enter the default AutoCAD Map 3D X coordinate to define the lower-left corner of images.

Y

Enter the default AutoCAD Map 3D Y coordinate to define the lower-left corner of images.

Z

Enter the default AutoCAD Map 3D Z coordinate to define the lower-left corner of images.

Rotation

Enter a default rotation for images.

Scale

Enter a default numeric scaling factor for images. For example, to make the image twice as large, enter 2 in the Scale box.

Density

Density

Type a default density (or resolution) for images. You should set the this value to the most common density value at which your images are scanned.

Insertion Point and Density Units list

Select the default insertion point and density units for the images. For example, a common North American scanning resolution is 300 dpi (300 dots per inch). To set this value as your default density, type 300 in the Density edit box and select inches as the Units. If you insert images that have density value and density unit information stored in the correlation source, then these defaults are not used.

For an illustration of how to set the density value and units for an image, see [Setting Image Density](#) (page 467).

Memory

Use the Memory tab to specify the amount of memory (RAM) that AutoCAD Map 3D can use for images before using a temporary swap file. You can also define the location of the temporary swap file.

Temporary File Location

Temporary File Location

The location to use for your temporary swap file. Click  to locate a drive and directory. AutoCAD Map 3D uses this temporary swap file when the memory limit has been exceeded.

NOTE Close and restart AutoCAD Map 3D to put these settings into effect.

RAM Settings

Physical RAM

View the amount of physical RAM in your system.

Memory Limit

View the amount of RAM that AutoCAD Map 3D will use before creating a swap file.

NOTE Increasing the default amount may degrade your system's performance. Be sure to leave enough RAM for your operating system and other applications.

Default

Restore the memory setting to the default RAM amount, 25% of the total physical memory.

MB, KB, and Bytes

Specify the units (megabytes, kilobytes, or bytes) for defining the Memory Limit.

Transparency Color dialog box

Use this dialog box to specify the color that should appear transparent in the image.



[To change the color that is transparent](#) (page 500)



Click Insert tab ► Image panel ► angle-arrow.

NOTE This option does not affect images you inserted with Data Connect. See [Overview of Adding Rasters and Surfaces](#) (page 437)

Click Select and pick a color on the image. When transparency is turned on, the selected color is transparent.

Setting transparency color is available only if the image is loaded and the Raster Extension is loaded. To load the image, select the image, then right-click the image frame ► Image ► Show Image. To load the Raster Extension, choose a Raster Extension command.

NOTE The transparency color is stored in the drawing as an AutoCAD Map 3D custom object. If you send the drawing to other users, they can see the transparency color only by opening the drawing in AutoCAD Map 3D or Autodesk Raster Design. If they open the drawing in AutoCAD, they see a message that AutoCAD cannot reference the custom object and will not display the transparent color.

Saving Objects Dialog Boxes

35

ADEREMOBS (Remove Objects from Save Set command)

Use this command to unlock selected locked objects in the current drawing and remove them from the save set.



To remove objects from the save set and unlock the objects (page 759)



Click Home tab > Data panel >  > Remove Objects From Save Set.



NOTE This command affects drawing objects only. For information about saving changes to geospatial feature data, see [Updating Edits Automatically](#) (page 698).

Respond to the prompts:

Erased/<Select>:

Enter e to remove all objects that have been erased from the current drawing.
Enter s or press Enter to select individual objects.

Select objects:

Use an object selection method to select the objects to unlock and remove from the save set. Press Enter when you finish.

Press Enter to confirm.

Objects that are locked in their source drawings are unlocked so that other users can edit them. They are removed from the list to be saved back to source drawings.

Any changes made to the objects in the current drawing still exist in the drawing. To save these changes to a new file, click  ► Save As ► AutoCAD Drawing.

Objects that were erased from the current drawing remain erased from the drawing, but they will not be erased from source drawings.

ADESELOBS (Select Objects for Save Back command)

Use this command to add objects to the save set and lock the objects.



To add objects to the save set and lock the objects (page 751)



Click Home tab ► Data panel ►



► Add To Save Set.



NOTE This command affects drawing objects only. For information about saving changes to geospatial feature data, see [Updating Edits Automatically](#) (page 698).

If object locking is on, adding an object to the save set locks the object to prevent anyone else from editing it while you are using it. When an object is locked, other users can view it, but they cannot edit it.

Respond to the prompts:

Add objects to save set: Select/<allNew>:

Enter s to individually select objects, or press Enter to add all objects created since opening the current drawing.

Select objects:

Use an object selection method.

If you plan to edit more than one object, lock them all at the start of your editing session. That way, no other users can modify or lock them before you get to them.

If an object is on a locked layer in the source drawing, you cannot add it to the save set. If you are working in paper space, you cannot add objects to the save set.

Objects in the save set are saved to source drawings when you use the [Save Objects to Source Drawings dialog box](#) (page 1887) command.

ADESHOWOBS (Show Objects in Save Set command)

Use this command to highlight all objects in the current drawing that are marked to be saved to source drawings.



[To view objects in the save set](#) (page 752)



Click Home tab > Data panel >  > Show Objects In Save Set.



NOTE This command affects drawing objects only. For information about saving changes to geospatial feature data, see [Updating Edits Automatically](#) (page 698).

To remove the highlighting, press Enter.

Save Objects to Source Drawings dialog box

Use this dialog box to save the objects that are currently in the save set back to source drawings.



[To save queried objects back to attached source drawings](#) (page 754)



Click Home tab > Data panel >  > Save To Source.



NOTE This command affects drawing objects only. For information about saving changes to geospatial feature data, see [Updating Edits Automatically](#) (page 698).

If you are saving new objects, specify the source drawings to save objects to and the method used to save objects. Queried objects are saved back to their original layer in their original source drawing.

You must have Edit Drawing privileges to save objects to source drawings. See the [User Administration dialog box](#) (page 1934).

Status area

View the number of queried objects and the number of newly created objects that are in the save set.

Save Queried Objects

Save queried objects to source drawings. Queried objects are saved back to their original layer in their original source drawing.

If you have redefined a block, layer, or text style definition and you want to save the new definition, be sure the option to save the definition is selected on the Save Back tab of the [AutoCAD Map Options dialog box](#) (page 1908).

Save Newly Created Objects

Save objects created in the current drawing to source drawings.

Under Save Order For Newly Created Objects, specify the source drawings to save objects to and the method used to save objects.

Save Order for Newly Created Objects

Specify the method to use when saving objects created in the current drawing. Objects are saved by the first method that applies to them.

Area

Save objects to the first source drawing in the list within whose boundary they lie. This is useful for tiled drawings. This method does not save objects outside the boundary of the source drawings.

You can specify the drawing boundary by setting save back extents in the [Drawing Settings dialog box](#) (page 1923). If no save back extents are set, the drawing extents are used as the boundary. If an object lies partially outside the save back extents, the drawing extents are modified to include the object, but the save back extents are not changed.

Layer

Save objects to the first source drawing in the list that includes a layer of the same name as the layer the object is on in the current drawing. This is useful for stacked drawings. This method does not save objects on layers in the current drawing that have no corresponding layer in the source drawings.

Selective

Specify which objects to save and which drawings to save them in. Objects are saved to the same layer as they are on in the current drawing. If the source drawing does not have a layer of the same name, one is created. This method applies to all objects, so you cannot specify other save back methods after this one.

Drawings to Save New Objects to list

Specify which drawings to save objects to. If you use the Selective method, AutoCAD Map 3D prompts for the objects to save to each selected drawing.

Select All

Highlight all drawings in the list.

Clear All

Remove the highlighting from all drawings in the list.

Filter

Turn on the current drawing filter.

When the filter is on, only drawings that match the filter are displayed. If the parent drawing of a nested drawing is filtered, the nested drawing is not displayed, even if it matches the filter.

To create or change the filter, click Filter. In the [Drawing Set Display Filter dialog box](#) (page 1922), you can create separate filters for file names and descriptions.

Who Has It Information dialog box

Use this dialog box to find out who has an object locked, what source drawing and current drawing it comes from, and the date and time it was locked.



To find out who locked an object (page 735)



Click Home tab > Data panel >



> Show Who Has It.



NOTE This command affects drawing objects only. For information about locking geospatial feature data, see [Checking Out Features](#) (page 695).

Survey Dialog Boxes

36

New Data Store dialog box

Use the New Data Store dialog box to create a specialized data store for survey data.



[To create a survey data store](#) (page 1000)



On the Survey tab of the Task Pane, click Data ► New Survey Data Store.

NOTE This dialog box creates a specialized survey data store only. To create other types of geospatial data stores, see [Creating a Data Store](#) (page 586). To create a data store for external data that you will attach to drawing objects, see [Setting Up Data Sources for Drawings](#) (page 204).

File Location



Click  to enter a file name and save location for your new Survey Data Store. Survey Data Stores are always in SDF format.

Coordinate System Assignment



Enter the coordinate system code for your new Survey Data Store. Click  to select the coordinate system from a list.

Project Properties dialog box

Use the Project Properties dialog box to view and edit properties for a project in the Survey Data Store.



[To view or edit project properties](#) (page 1002)



On the Survey tab of the Task Pane, right-click a project ► Properties.

NOTE This functionality is for geospatial survey data only.



Click the Categorized View button to view project properties by category.



Click the Alphabetized View button to view project properties in alphabetical order.

Project

Display information about the Project, such as Name, File Name, LandXML version, and so on. Click in a field to edit the Project information.

Constrained fields display valid options in a drop-down list.

Application

Display information about the application that created the data. Click in a field to edit the Application information. Constrained fields display valid options in a drop-down list.

CoordinateSystem

Display information about the coordinate system of the Project. Click in a field to edit the coordinate system information. Constrained fields display valid options in a drop-down list.

Units

Display information about a Project's units of measure. Click in a field to edit the measurement unit information. Constrained fields display valid options in a drop-down list.

Survey Properties dialog box

Use the Survey Properties dialog box to view information about a specific survey in a Survey Data Store.



To view or edit survey properties (page 1004)



On the Survey tab of the Task Pane, right-click a survey ► Properties.

NOTE This functionality is for geospatial survey data only.



Click the Categorized View button to view survey properties by category.



Click the Alphabetized View button to view survey properties in alphabetical order.

Survey

Display properties for a given survey, such as Name, Description, Start Time, End Time, Surveyor, and so on. Click in a field to edit the survey information. Constrained fields display valid options in a drop-down list.

Equipment

Display information about the equipment used to collect the survey data. Click in a field to edit the equipment information. Constrained fields display valid options in a drop-down list.

FieldNotes

Display any field notes entered by the surveyor, such as coordinate geometry data. Click the FieldNotes field to display the Field Note Editor.

Units

Display information about a survey's units of measure. Click in a field to edit the measurement unit information. Constrained fields display valid options in a drop-down list.

Point Group Properties dialog box

Use the Point Group Properties dialog box to view information about a point group in a Survey Data Store.



[To view or edit point group properties](#) (page 1005)



On the Survey tab of the Task Pane, right-click a point group ► Properties.

NOTE This functionality is for geospatial survey data only.



Click the Categorized View button to view point group properties by category.



Click the Alphabetized View button to view point group properties in alphabetical order.

Point Group

Display information about the point group, such as Name, State, Zone Number, and so on. Click in a field to edit the point group information. Constrained fields display valid options in a drop-down list.

Field Note Editor

Use the Field Note Editor to view and edit field notes entered by a surveyor at the time of a survey. Field notes may contain measurements for calculating unreachable points using coordinate geometry, for example.



[To view or edit survey properties](#) (page 1003)



On the Survey tab of the Task Pane, right-click a survey ► Properties. In the Survey Properties palette, click the Field Notes entry.

NOTE This functionality is for geospatial survey data only.

Field Notes

View and edit the field notes for a survey.

Create Surface dialog box

Use this dialog box to create raster surfaces from survey data.



To create a surface from a source file, see [surface:create surface from file](#) in the Tool-based Ribbon Works... (page 1009)



Click Create tab ► 3D Surface panel ► Create From Points.

Source



Click to add source data. To add data from a source file, click File. To add data from a data connection, click Connection. To add point data from AcDb points already in your map, click Points in Drawing.



Click to remove source data.



Click to move source data down the order list. If you have not specified a coordinate system for your map, AutoCAD Map 3D uses the first valid coordinate system in the source data list.



Click to move source data up the order list. If you have not specified a coordinate system for your map, AutoCAD Map 3D uses the first valid coordinate system in the source data list.

Formatting

Select Format

Select the format of the source data. Formats describe the layout of the data in your source files using the following convention:

- P is point ID
- E is Easting, or longitudinal values
- N is Northing or latitudinal values
- Z is elevation values
- D is description

Make sure that you select the correct format plus delimiter type (comma or space) for your data source.

The Autodesk Uploadable File format is as follows: User-Defined (point ID, description, or any other type of data), X, Y, Z. It is a comma-separated format, and uses the # character for comment text.

Z-Unit

Select the vertical (Z) unit of your data: meters, US feet, or international feet.

Preview

An excerpt from your data source. Check the Preview pane to confirm that you are adding or connecting to the proper data file or source.

Coordinate System Assignment

Enter Code

Specify the coordinate system of the source data. Click  to choose the coordinate system from a list. You must specify a coordinate system for each data source individually.

Destination

Output File Name

Enter the save name and location of the GeoTIFF file. Click  to browse to a save location.

Layer Name

Enter a name for the new Display Manager raster layer.

Source Data dialog box

Use this dialog box to select the data connection source for creating a surface. You must first connect to your data using Data Connect. For FDO data, only point and line data are supported. Surface features such as parcels are not supported, and will not appear in this dialog box. If you are connecting to an SDF file that contains point data and line data, both points and lines will be added as source data.



[To create a surface from a data connection](#) (page 1010)



Click Create tab ► 3D Surface panel ► Create From Points.

Point Cloud Manager

Use the Point Cloud Manager to manage LiDAR data and create indexed point cloud data store (.isd) files.



[To specify a coordinate system for your point cloud data store in the , click the Coordinate System f...](#) (page 1016)



Click Create tab ► Point Cloud panel ► Create Index

Add File Add a LAS, ASCII, or ISD file to the Point Cloud Manager for processing.

Create Group Create a merge group to assign multiple source files to a single output file.

Remove From Group Remove a file from a merge group. The file remains in the Point Cloud Manager.

Remove Group Remove a merge group from the Point Cloud Manager. Files that are in the merge group remain in the Point Cloud Manager.

Remove File Remove a file from the Point Cloud Manager.

Cancel Processing Cancel the current conversion process.

Source Display the name of the source file or merge group. Click  to select a new source file. Click the merge group Source field to rename a merge group.

Output The file name and save location for the indexed point cloud data store to be generated. Click the Output field to change the output file name and save location.

Coordinate System Set the coordinate system for the point cloud data store. By default, this field displays the coordinate code for the source file. To select

another coordinate system for your point cloud data store, click  and select the appropriate code from the list.

Filter The filter type applied to the source data. To filter your source data, click the Filter field to display the [Filter Point Cloud dialog box](#) (page 1900).

Date Created The date and time that the point cloud data store was created. This field is not editable.

Generate Index Generate an indexed point cloud data store file for the selected source files or merge group.

Add to Map Add a point cloud to the map, and a point cloud layer to the Display Manager, for an indexed point cloud data store.

Surface Manager

Use the Surface Manager to create raster-based surfaces from point cloud data.



To create a surface from a point cloud in the Display Manager, right-click a point cloud layer and se... (page 1022)



Click Create tab ► 3D Surface panel ► Create From Point Cloud.

Add File Add a point cloud data store (.isd) file to the Surface Manager for processing.

Create Group Create a merge group to assign multiple source files to a single surface.

Remove From Group Remove a file from a merge group. The file remains in the Surface Manager.

Remove Group Remove a merge group from the Surface Manager. Files that are in the merge group remain in the Surface Manager.

Remove File Remove a file from the Surface Manager.

Cancel Processing The current surface creation process.

Source Display the name of the source file or merge group. Click  to select a new source file. Click the merge group Source field to rename a merge group.

Filter The filter type applied to the source data. To filter your source data, click the Filter field to display the [Filter Point Cloud dialog box](#) (page 1900).

Parameters Specify the type of surface that AutoCAD Map 3D will create (GeoTIFF or ESRI ASC). To specify parameters for your surface, click the Parameters field to display the [Grid Parameters dialog box](#) (page 1901).

Output The file name and save location for the generated surface file. Click the Output field to change the output file name and save location.

Date Created The date and time that the surface was created. This field is not editable.

Generate Grid Generate a surface file for the selected source files or merge group.

Add to Map Add a surface to the map and a raster layer to the Display Manager.

Filter Point Cloud dialog box

Use the Filter Point Cloud dialog box to filter your LiDAR or point cloud data by classification, elevation, intensity, or location on your map.



To filter point cloud data in the Display Manager, right-click a point cloud layer and select Filter ... (page 1025)



Click Create tab ► Point Cloud panel ► Create Index

Filter By Select a filter type from the drop-down list. You can filter by classification, elevation, intensity, or location on your map.

Define Filter Define the filter to apply to your data:

- **Classification:** select the classified values you want to include in your data. Shift-click or control-click to select multiple values.
- **Elevation:** type the elevation ranges you want to display in your map. Use hyphens to define ranges and commas to separate them; for example, 150-200, 350-400, 1200-2000.
- **Intensity:** filter data based on LiDAR intensity values. Use hyphens to define ranges and commas to separate them; for example, 0.25-2.00, 3.50-4.00, 120.00-200.00.
- **Spatial:** Click the Locate on Map button to create a spatial filter. You can create a spatial filter based on a circle, rectangle, polygon, or proximity to an object on your map.

Clear Filter Clear the values for the filter that you have applied.

Apply Filter Apply the filter you have defined to your data.

Cancel Cancel the filter operation and closes the Filter Point Cloud dialog box.

Grid Parameters dialog box

Use the Grid Parameters dialog box to specify the surface type, name, save location, resolution, and gap filling parameters for a surface.



To create a surface from a point cloud in the Display Manager, right-click a point cloud layer and select [Create From Point Cloud](#). (page 1022)



Click Create tab ► 3D Surface panel ► Create From Point Cloud.

Surface Type Specify whether AutoCAD Map 3D creates a GeoTIFF or ESRI ASC surface.

File Name The name and save location of your surface file. To change the file name and save location, click .

Parameters

Cell Size Specify the number of point cloud units per output cell (raster pixel). This parameter determines the output size of the raster surface. For a 300 x 500 meter point cloud, setting the cell size to 0.5 results in a 600 x 1000 pixel raster image.

Cell Units The unit of measurement for your point cloud cell size. Cell units can be measured in meters, feet, US survey feet, and international feet. By default, cell units are measured in meters.

Search Radius Specify the input point weight. The vertical (Z) value for each cell is calculated from the Z-values of all points in the cell. Those closest to the center are weighted highest, while those at the search radius limit are weighted half as much as the center points. Increase the search radius to give more weight to Z-values for remote points. Decrease the search radius to give less weight to Z-values for remote points.

Fill Gaps Fills gaps in your surface. Check the Fill Gaps box, and select the appropriate method: Nearest Neighbor, Normal Distribution, Normal Distribution Smooth, Square Distance, or Square Distance Smooth.

Point Cloud Style dialog box

Use the Point Cloud Style dialog box to style your point cloud data based on classification, elevation, or LiDAR intensity value.



To style point data by classification In the Display Manager, right-click the point cloud layer to st... (page 677)



Click Point Cloud tab ► Style panel ► Set Style.

Classification Tab

Classification AutoCAD Map 3D assigns a default color to each point class. To change the color for a point class, select a new color from the drop-down list. If you do not see the color that you want in the drop-down list, click More Colors. The Select Color dialog box appears. You can select an Index Color, True Color, or Color Book.

Elevation Tab

Minimum Value The minimum elevation value of your point cloud data. This field is not editable.

Maximum Value The maximum elevation value of your point cloud data. This field is not editable.

Number of Rules Enter the number of rules for the elevation scale range. The default number of rules is five. Rules are distributed evenly over the range of elevation data in your point cloud.

Style Range The From and To values for the colors in your style range. To change a color for your style range, select a new color from the drop-down list. If you do not see the color that you want in the drop-down list, click More Colors. The Select Color dialog box appears. You can select an Index Color, True Color, or Color Book.

Intensity Tab

Minimum Value The minimum intensity value of your point cloud data. This field is not editable.

Maximum Value The maximum intensity value of your point cloud data. This field is not editable.

Number of Rules Enter the number of rules for the intensity scale range. The default number of rules is five. Rules are distributed evenly over the range of intensity data in your point cloud.

Style Range The From and To values for the colors in your style range. To change a color for your style range, select a new color from the drop-down list. If you do not see the color that you want in the drop-down list, click More Colors. The Select Color dialog box appears. You can select an Index Color, True Color, or Color Book.

Setting Map Options Dialog Boxes

37

MAPABOUT (About AutoCAD Map 3D command)

Use this command to display the About AutoCAD Map 3D screen, which shows the version number and date of AutoCAD Map 3D.

MAPAUTOCHECKOUT

Use this command to specify whether or not geospatial features are automatically checked out when edited.



To check out features automatically (page 696)



In the Tool-based Ribbon Workspace, click Feature Edit tab ► Edit Set panel

► Auto Checkout.

NOTE This command affects geospatial feature data only. For information about locking drawing objects in a multi-user environment, see [Turning On Object Locking](#) (page 733).

MAPDOCKWSPACE (Dock Task Pane command)

Use this command to dock or undock the Task Pane.



Use these techniques for the Task pane



Double-click the title bar (floating) or the double bar at the top of the pane (docked).

MAPEDITSETAUTO

Use this command to specify whether or not edits to features are automatically reflected in the feature source.

NOTE You cannot undo this operation.



To update edits automatically (page 700)



In the Tool-based Ribbon Workspace, click Feature Edit tab ► Edit Set panel

► Automatic Update.

NOTE This command affects geospatial feature data only. For information about updating attached drawing objects, see [Setting Save Back Options](#) (page 763).

MAPFEATUREEDITTOOLS

Use this command to specify whether geospatial features are checked out as AutoCAD drawing objects or as features.



To specify Feature Edit Options (page 240)



[Feature Editing Options dialog box](#) (page 1929)

These settings determine how you work with your data.

Features checked out as AutoCAD drawing objects	Features checked out as geospatial features
Allows you to use many common ACAD editing commands	Allows you to use some common ACAD editing commands in addition to geospatial feature-specific editing commands (for example, MAPFEATURESPLIT (page 1652) and MAPFEATUREMERGE (page 1651))
Edited features represented as AutoCAD geometries (for example, closed polylines are used to represent polygonal features)	Edited features are represented as geospatial geometries (for example, MAPPOLYGONS).
Most existing custom or third-party editing applications (LISP, VB or ObjectARX) should continue to work. Some may require minor updates.	Supports multipart (multipolygons, multilines, and multipoints) geospatial features and editing, such as the Hawaiian islands.
Some existing AutoCAD Map 3D editing commands will continue to work on features (for example, rubbersheeting [ADER-SHEET (page 1648)]).	Preserves and allows you to edit M and Z values.
Allows you to use feature styling.	Allows you to use feature styling.

MAPWSFOCUS

Use this command to set the keyboard or mouse focus to the Task Pane. You can also set the focus by clicking in the Task Pane.

To return the focus to the command line, press ESC or click in the command line area. Whenever you return to AutoCAD Map 3D after using another application, the focus is reset to the command line.

MAPWSPACE (Task Pane command)

Use this command to hide or show the Task Pane.



[To hide or display the Task Pane within your current session](#) (page 221)



In the Tool-based Ribbon Workspace, click View tab ► Palettes panel ► Map Task Pane.

MAPWSREFRESH

Use this command to refresh the Task Pane. This is sometimes necessary if Map Explorer does not reflect your recent changes to the drawing or if the icons in the Display Manager need to be refreshed.



[To refresh Map Explorer](#) (page 221)



Right-click a clear area in Map Explorer, and click Refresh.

AutoCAD Map Options dialog box

Use this dialog box to define options for the Task Pane, drawings, drawing queries, save options for drawing objects, drawing data sources, coordinate systems, and the system.



[To use the AutoCAD Map Options dialog box](#) (page 218)



In the Tool-based Ribbon Workspace, click Map Setup tab ► Map panel ► angle-arrow.

[Task Pane](#) (page 1909)

[Current Drawing](#) (page 1909)

[Query](#) (page 1911)

[Save Back](#) (page 1913)

[Data Source](#) (page 1914)

[Multi-User](#) (page 1915)

[System](#) (page 1916)

[Coordinate Systems tab](#) (page 1916)

Task Pane

Specify Task Pane options.

Map Explorer Categories To Display

Select the categories to display in Map Explorer. When you turn off the display of the category, all functionality associated with the category is still available.

TIP To reduce screen clutter, turn off the display of categories you don't use.

These settings are user-specific and will affect any drawing that you open. These settings will take effect the next time you start AutoCAD Map 3D.

Show Task Pane on startup

Show or hide the Task Pane at startup.

Show Properties Palette on startup

Show or hide the Properties palette at startup.

Current Drawing

Specify options for attached drawings, coordinate transformations, and drawing-specific data sources.

Activate Attached Drawings

Specify the default active/inactive status for drawings you attach to the current drawing and whether the active status is saved with the current drawing.

Coordinate Transformation Adjustments

Specify how AutoCAD Map 3D performs coordinate transformations.

NOTE These options affect attached drawings only. For information about changing the coordinate system for geospatial data, see [Changing Coordinate Systems](#) (page 311).

Adjust Sizes And Scales - For Changes In Units

Specify whether the units used in the coordinate system of an attached drawing are scaled to the units used in the coordinate system of the current drawing.

For example, if an attached drawing uses meters and the current drawing uses U.S. Survey Feet, you can scale text and blocks so that their size or scale measures in feet rather than meters.

If you do not set the For Changes In Units option, AutoCAD Map 3D doesn't size or scale text and block objects. In that case, a block that is five meters long in an attached drawing will be five feet long when you bring it into the current drawing.

Do not change this setting after you bring objects into the current drawing, or you may introduce unintended changes to text and blocks when you save them back to their source drawings.

Adjust Sizes And Scales - For Map Distortion

Adjust the size and scale of text and blocks to correct for map distortion introduced when you represent a spherical object (earth) in a Cartesian coordinate system.

For example, two objects, located at the northern and southern extremes of a map, of equal length in coordinate system X will remain the same length when transformed to coordinate system Y.

If you don't select this option, the two objects will be scaled to different lengths in coordinate system Y according to the relative map distortion (or grid scale factor).

This option is not available if For Changes In Units under Adjust Sizes And Scales is not selected.

Adjust Rotations - For Map Distortion

Adjust the angle of text and blocks to correct for map distortion due to the convergence angle (the deviation of the Y axis of a Cartesian coordinate system from true north).

Adjust Rotations - For Zero-Rotation Objects

Specify that text and blocks that have a rotation value of zero in the source drawing are adjusted to correct distortion due to the convergence angle (the deviation of the Y axis of a Cartesian coordinate system from true north).

If you set this option, AutoCAD Map 3D calculates the convergence angle for text and blocks with a zero rotation value. If you don't set this option,

AutoCAD Map 3D does not rotate text and blocks with a zero rotation value even if there is a convergence angle.

This option is not available if For Map Distortion under Adjust Rotations is not selected.

Adjust Elevations

Adjust the elevation (Z axis) of objects when you select For Changes In Units and For Map Distortion under Adjust Sizes And Scales.

Data Source Options

Specify drawing-specific data source options.

NOTE These options affect data stores linked to drawing objects only. For information about filtering geospatial feature data, see [Filtering Features When You Add Them to a Map](#) (page 309).

Number Of SQL Conditions To Keep In History List

Specify the maximum number of SQL conditions that are stored in the SQL Condition History dialog box and in the Table Filter History dialog box.

Once the history list is full, the oldest, or first added, condition is removed from the list to make room for a new condition. If memory is limited on your system, keep this number low.

Query

Query Options

Use the Query tab to specify query options and default settings for queries.

NOTE These options affect queries for drawing objects only. For information about filtering geospatial feature data, see [Filtering Features When You Add Them to a Map](#) (page 309).

Save Current Query With Drawing

Save the current query definition with the current drawing, even if you have not saved the query. When you next open this drawing, the query loads as the current query definition.

Use Case Sensitivity When Matching Text Values

Specify whether text values in Property Condition queries must match the case used in the query definition.

Create Selection Set From Queried Objects

Specify whether the selection set contains the items retrieved by the query. To use this selection set when editing, enter p (to use the previous selection set) when prompted to select objects. (As soon as you select other objects,

AutoCAD Map 3D clears this selection set and replaces it with your new selection.)

If your query finds a large number of objects, this feature can take time. If you do not need to put the objects into a selection set, clear this check box to save time during queries.

Create Associative Hatch Objects

Specify whether AutoCAD Map 3D creates associative hatch objects for hatch objects created by the ADEFILLPOLYG, ADEQUERY (using alter properties), MAPTOPOQUERY, and MAPTHEMATIC (using fill) commands. If this box is not selected, hatch objects created by these commands are non-associative hatch objects.

Preview Queries

Set options to use when displaying blocks and raster images in Preview Query mode.

Show Insertion Point Only

Specify whether to show only the insertion point of inserted blocks in a Preview query and not the objects. An insertion point is represented as an X.

Show Image Clipping Boundary Only

Specify whether a Preview query displays only the clipping boundary of raster images.

Preview Definitions From

Specify the location to use for definitions of layers, linetypes, blocks, etc. when running a query in Preview mode.

Select Current to speed up the preview, though some items may not display exactly as they will when the query is executed in Draw mode.

Location Queries

Set options to use when creating Location queries.

Boundary Color For And/Or Conditions

Specify the boundary color for And and Or conditions when you edit a Location query and click Show.

Boundary Color For Not Conditions

Specify the boundary color for Not conditions when you edit a Location query and click Show.

Reference Entire Bounding Area For Objects

Specify whether Location queries reference the entire bounding area of hatch, solid, and raster objects or only the bounding edge. (The bounding edge for raster objects is the clipping boundary.)

When you select this option, a hatch boundary is treated as an area. If the query location is on any part of the hatch object, even if it touches only a hatch boundary, the whole hatch object (the hatch and the hatch boundary) is included in the selection.

When you clear this option, the hatch boundary is treated as an edge. The query location must intersect or enclose the boundary edge of the hatch object to include the object in the selection. If the query selects only the space inside the hatch area, but not the hatch boundary, the hatch object (the hatch and the hatch boundary) is not selected.

This setting affects the ADEQUERY, MAPTOPOQUERY, and MAPTHEMATIC commands.

Determine Block Locations Using

Specify whether AutoCAD Map 3D uses the block's insertion point or its bounding box as its location to determine whether a block meets a Location condition.

Determine Text Locations Using

Specify whether AutoCAD Map 3D uses the text's insertion point or its bounding box as its location to determine whether text meets a Location condition.

Default Joining Operator

Specify the default joining operator to use in the Define Query dialog box.

And

Specify that both conditions must be met for the object to be included in the query.

Or

Specify that either condition can be met for the object to be included in the query.

Save Back

Use the Save Back tab to specify options for saving queried objects back to attached drawings.

NOTE These options affect save back options for drawing objects only. For information about saving changes to geospatial feature data, see [Updating Edits Automatically](#) (page 698).

Save Set

Set options for adding objects to the save set.

Save Back To Source Drawings

Specify the behavior of objects when you save them back to their source drawings.

Redefine Block Definitions On Save Back

Save changes to block definitions back to attached drawings.

Redefine Layer Definitions On Save Back

Save changes to layer definitions back to attached drawings.

Redefine Text Style Definitions On Save Back

Save changes to text style definitions back to attached drawings.

Create History File Of Changes

Create a file of all changes made to each source drawing. The history file has the same name as the source drawing file, but has the extension *.hst*.

Create Backup File Of Source Drawing

Create a back up file of attached drawings before saving changes. Backup drawing files have the extension *.bak*.

Data Source

Display Of Multiple Tables

Use the Data Source tab to set options for Data View behavior, data source path name display, and database file associations.

NOTE These options affect Data View, which is available for drawing objects only. For information about the Data Table, which displays geospatial feature properties, see [Overview of the Data Table](#) (page 1127).

Specify the number of Data Views to use when displaying tables.

Show Each Table In A Separate Data View

Open a new Data View window for each open table. Move between tables by clicking on the window you want.

Show All Tables In One Data View

Open only one Data View window. When you open a new table, the previous table is automatically closed.

Data Views

Specify the behavior of the Data View.

Open In Read-Only Mode

Open the Data View in read-only mode. When this option is selected, you cannot edit data in the Data View.

Save Format And Style Changes With Drawing

Save all formatting changes, such as column width, font, color, or borders, that you make in the Data View.

Keep On Top

Specify whether the Data View window remains on top of all other windows, even when it is not the active window.

Associate Database Versions With File Extensions

Click Associate to display the Associate Database Versions dialog box where you specify the database version to use for each database file extension. When you drop a database file on the Map Explorer tab, AutoCAD Map 3D checks the file extension and uses the specified version of the database software.

Default Provider For Microsoft Access Databases

Select the default driver to use when you drop an MDB file onto the Map Explorer tab.

Multi-User

Multi-User Options

Use the Multi-User tab to specify options for user login and object locking. You must have Superuser privileges to modify multi-user options.

NOTE These options affect multi-user options for drawing objects only. For information about locking and sharing geospatial feature data, see [Checking Out Features](#) (page 695).

Set options that apply to all users in a multi-user environment.

Force User Login

Require users to log in before using AutoCAD Map 3D.

Enable Object Locking

Lock objects that are selected for the save set. If an object is locked, other AutoCAD Map 3D users can view it, but cannot edit it. AutoCAD users who do not have AutoCAD Map 3D cannot open a drawing that an AutoCAD Map 3D user has open. You cannot disable object locking while drawings are active.

System

If you enabled Force User Login on the Multi User tab, you must log in as a Superuser to edit System options.

Log File Options

Use the System tab to specify system settings.

Log files keep track of error messages and other AutoCAD Map 3D system messages. If the log file is active, it is updated each time you use AutoCAD Map 3D. To save space on your disk, you can delete or archive the log file and start a new one.

Log File Active

Store error messages and other AutoCAD Map 3D system messages in the log file.

Log File Name

Specify a name for the log file. Click Browse to search through existing names or to change the drive or directory. If you do not specify a name, AutoCAD Map 3D creates the *acadmap.log* file in the current directory.

Message Level

Specify which kind of error messages to store in the log file.

Number Of Drawings Loaded In Memory At Once

Specify the number of drawings that AutoCAD Map 3D can have open in memory at the same time. This number does not limit the number of active drawings. AutoCAD Map 3D opens and closes files in memory as it needs them.

If your system has a lot of memory, you can enter a larger number (up to 200) to make queries faster.

Default Query File Directory

Specify the default directory for queries saved to external files.

Default Cache File Directory

Specify the default directory where your cache files are stored. Click Clear Cache to enhance performance of AutoCAD Map 3D.

Coordinate Systems tab

Coordinate System Definitions Stored In Drawing

Specify the program behavior when opening drawings that contain coordinate system definitions. For more information about coordinate systems, see [Assigning Coordinate Systems](#) (page 149).

Ignore Definitions

Have the program ignore coordinate system definitions when opening drawing files.

Prompt User To Add Definitions to Dictionaries

Have the program prompt you for action when opening drawing files that contain coordinate system definitions.

Automatically Add Definitions To Dictionary

Specify that, when opening drawing files that contain coordinate system definitions, the program will automatically add the coordinate system definitions from the drawing file to your coordinate system dictionary.

Geodetic Distance

Units For Display

Specify the units to use to display geodetic distances.

Coordinate Geometry Setup dialog box

Use this dialog box to specify settings to use with the Coordinate Geometry functions.



To set coordinate geometry options (page 234)



Click Home tab ► Draw panel ► COGO drop-down ► COGO Options.



Set North Direction

Direction From Y Axis If North on your map is not on the Y axis, specify the direction from the Y axis to North on your map. Enter a number that represents the angular distance measured clockwise from the Y axis. This option sets the ANGBASE system variable.

Elevation Settings

Prompt For 3D Data Input Select this option to have AutoCAD Map 3D prompt for 3D data, such as elevation, grade, or slope. If this option is not selected, all elevations are assumed to be 0.

Input Units Settings

Set the units for coordinate geometry input. **Linear Units** are US Feet, International Feet, Meters, or Chains. **Angle Formats** are Decimal Degrees, Degrees/Minutes/Seconds, Grads, Radians, and Surveyor's Units.

Azimuth Measurements

Define Bearings Relative To North Select this option if bearings in your map are relative to North.

Define Bearings Relative to South Select this option if bearings in your map are relative to South. This is most often the case for maps of the southern hemisphere.

Create Text Log

When you select this option, AutoCAD Map 3D writes the content of the [COGO Input dialog box](#) (page 1668) to the AutoCAD Text Window when you create a point using that dialog box.

Define/Modify Drawing Set dialog box

Use this dialog to define or modify the drawing set for the current drawing. Attach drawings that you will use with the current drawing. Activate only those drawings you want to search for the current query.



[To attach drawings](#) (page 158)



Click Home tab > Data panel >



> Define Drawing Set.



NOTE These options affect drawing objects only. For information about filtering geospatial feature data, see [Filtering Features When You Add Them to a Map](#) (page 309).

In addition, you can change drawing settings such as description, simple transformation, or save back extents.

AutoCAD Map 3D stores the changes you make to the drawing set with the current drawing. The next time you open this drawing, your new settings will be in effect.

Attached Drawings list

View all drawings attached to the current drawing.

The first column specifies if the drawing is active. Only active drawings are searched during queries.

- Yes indicates the drawing is active.
- Locked indicates the drawing is inactive, and you have locks on objects in the drawing.
- No indicates the drawing is inactive.

If the drawing has a description assigned to it, that description appears in the list instead of the file name. For information on how to assign a description to a drawing, see Drawing Settings dialog box.

Activate

Activate all selected drawings.

Queries search only active drawings; they do not search inactive drawings.

Deactivate

Deactivate all selected drawings.

Queries do not search deactivated drawings. Queries search only active drawings.

If you deactivate a drawing that contains objects you've locked, the status of the drawing changes to Locked.

Select All

Highlight all drawings in the list.

Clear All

Remove the highlighting from all drawings in the list.

Drawing Settings

Display the [Drawing Settings dialog box](#) (page 1923), where you can change the drawing description, simple transformation settings, or save back extents.

Show Nested

When selected, the Attached Drawings list displays nested drawings attached to active drawings. Nested drawings attached to inactive drawings are not displayed.

If a drawing has nested drawings, a plus sign (+) appears before the drawing name.

A nested drawing is a drawing that is not attached directly to the current drawing, but is attached to a drawing in the drawing set.

When not selected, only top-level drawings appear in the Attached Drawings list.

Filter

Select Filter to turn on the current drawing filter.

When the filter is on, only drawings that match the filter are displayed. If the parent drawing of a nested drawing is filtered, the nested drawing is not displayed, even if it matches the filter.

To create or change the filter, click Filter. In the [Drawing Set Display Filter dialog box](#) (page 1922), you can create separate filters for file names and descriptions.

Attach

Display the [Select Drawings to Attach dialog box](#) (page 1811), where you can attach additional source drawings to the current drawing.

To attach drawings to a source drawing, open the source drawing directly, and then attach the drawings.

To open the source drawing, click  > Open > AutoCAD Drawing.

Detach

Detach the selected drawings from the current drawing.

If you detach a parent drawing, all nested drawings attached to that drawing are also detached.

Drawing Maintenance dialog box

Use this dialog box to remove locks from drawings and create drawing indexes.



To create a drawing index (page 1294)

To release all locked objects (page 736)



Click Map Setup tab > Map panel >  > Drawing Maintenance.



NOTE These options affect drawing objects only. For information about locking and sharing geospatial feature data, see [Checking Out Features](#) (page 695).

Use the options in the Active Drawings area to see which drawings currently have locks.

Use the options in the Locks area to see which users have objects locked, and to remove those locks. This feature is useful if a system goes down while objects are locked.

To display information in the Locks area, click User List.

Active Drawings

Use this area to see which drawings currently have locks.

Active Drawings list

View all attached active drawings for the current drawing.

- To display information about locked objects in a drawing, select the drawing in the list. Click User List. The area at the bottom of the screen updates to show the names of users who have locks on objects in the drawing, and the number of objects they have locked.
- To update indexes for a drawing, select the drawing in the list, click Drawing Index.

Select All

Highlight all drawings in the list.

Clear All

Remove the highlighting from all drawings in the list.

Filter

Select Filter to turn on the current drawing filter.

When the filter is on, only drawings that match the filter are displayed. If the parent drawing of a nested drawing is filtered, the nested drawing is not displayed, even if it matches the filter.

To create or change the filter, click Filter. In the [Drawing Set Display Filter dialog box](#) (page 1922), you can create separate filters for file names and descriptions.

Drawings Index

Display the [Index Maintenance dialog box](#) (page 1931), where you can specify which types of indexes to create for the selected drawings.

User List

Update the display of users that have locks on objects in source drawings.

Locks

Use this area to see which users have objects locked, and to remove those locks. This feature is useful if a system goes down while objects are locked.

To display information in this area, click User List.

User Name list

View all users who have locks on objects in the selected drawings. The Number Of Objects Locked column shows how many locked objects each user has.

To update this list, select an active drawing. Click User List.

Select All

Highlight all drawings in the list.

Clear All

Remove the highlighting from all drawings in the list.

Remove Locks

Unlock objects locked by the selected users. Be careful not to unlock objects that other users are currently editing, as this may cause work to be lost. Only Superusers can remove locks for other users.

Drawing Set Display Filter dialog box

Use this dialog box to specify separate filters for file names and for descriptions.



[To attach drawings](#) (page 158)



Click Home tab > Data panel >  > Define Drawing Set. 

Filters can include wild-card characters:

Asterisk (*) represents any set of letters.

Question mark (?) represents any single letter.

For example, if you enter `*\ch*` in the file name filter field, the drawing list displays all file names that start with the letters ch in all directories.

To display drawings in a specific directory, enter the path to that directory. For example, enter `c:\office1*` to view all drawings in the *office1* directory. When specifying drives, use the drive aliases assigned in the [Drive Alias Administration dialog box](#) (page 1928)

Nested drawings are also filtered. If the parent drawing is filtered out, none of its nested drawings appear in the list. If the parent drawing appears in the list, the filter applies to the nested drawings.

To display all drawings, enter `**.dwg` in the File Name box. To display all descriptions, enter `*` in the Description box.

Drawing Settings dialog box

Use this dialog box to change the drawing description, specify simple transformation settings, or define save back extents.



[To create a drawing description](#) (page 166)

[To set transformation options](#) (page 169)

[To set save back extents](#) (page 170)



Click Home tab > Data panel >  > Define Drawing Set.



NOTE These options affect drawing objects only. For information about saving changes to geospatial feature data, see [Updating Edits Automatically](#) (page 698).

To change settings for a drawing, select the drawing in the list. Enter the new information in the fields in the dialog box. When you finish, click Apply. You can then select a new drawing.

Specify the transformation of objects in the source drawing as they are brought into the current drawing. AutoCAD Map 3D stores this information with the current drawing. The source drawing does not change. This feature is useful if you want to overlay drawings or tile them.

Active Drawings list

Select the drawing to change.

This list displays all the active drawings in the drawing set. If a coordinate system code is assigned to the drawing, that code is displayed in the left column.

Filter

Select Filter to turn on the current drawing filter.

When the filter is on, only drawings that match the filter are displayed. If the parent drawing of a nested drawing is filtered, the nested drawing is not displayed, even if it matches the filter.

To create or change the filter, click Filter. In the [Drawing Set Display Filter dialog box](#) (page 1922), you can create separate filters for file names and descriptions.

Drawing Description box

Enter a new description for the selected drawing.

Descriptions make it easy for you to remember what is in a drawing. If a description is assigned to the drawing, it appears in the drawing list instead of the file name.

Simple Transformation area

Specify the transformation of objects in the source drawing as they are brought into the current drawing. AutoCAD Map 3D stores this information with the current drawing. The source drawing does not change. This feature is useful if you want to overlay drawings or tile them.

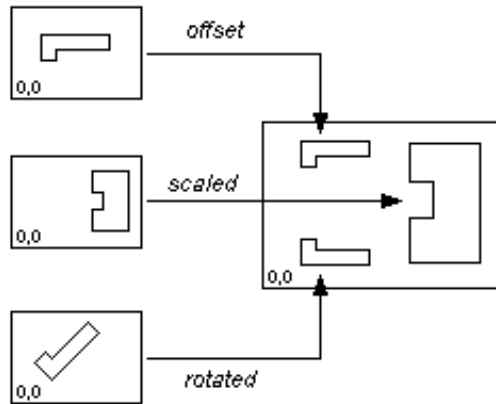

If the document has a coordinate system code assigned to it, you cannot use the simple transformation section.

When objects are saved back to their source drawings, their original scale, offset, and rotation are restored. To permanently transform an object, use the [ADETRANSFORM \(Transform command\)](#) (page 1649) command.

Simple Transformation

Turn the simple transformation settings on and off.

When cleared, the settings are not used.

If the document has a global coordinate system code assigned to it, you cannot use the simple transformation option.

Simple transformations let you tile, scale, or overlay drawings.

Scale box

Specify the change in scale of objects from the source drawing to the current drawing.

Enter a real number. For example, enter 2 to double the size of objects, or enter .5 to halve the size of objects.

Rotation box

Specify the rotation of objects from the source drawing to the current drawing.

Enter an angle. For example, enter 90 to rotate objects 90 degrees in the current direction. (To view or change the current direction, open the source drawing and use the DDUNITS command.)

Offset (X,Y) box

Specify the offset of objects from the source drawing to the current drawing.

Enter two real numbers (one for X and one for Y), separated by a comma. For example, enter 5,-4 to offset objects 5 units to the right and 4 units down. (To view or change the current unit, open the source drawing and use the DDUNITS command.)

If you specify save back extents for the drawing, those extents are also offset.

Pick <

Display the drawing, where you can specify points to determine the scale, rotation, and offset.

- The difference between the old base point and the new base point is the offset for objects in the source drawing.
- The difference in angle between the two old points and the two new points is the rotation. 0,0 is the base point for the rotation.
- The ratio of the length between the two new points to the length between the two old points is the change in scale.

Save Back Extents area

Specify the area that is saved back to the source drawing. By specifying save back extents, you can prevent boundaries from expanding and intruding on the boundaries of adjacent drawings. These save back extents are stored with the source drawing.

Save Back Extents list

View the coordinates of the current save back extents.

Define <

Display your drawing, where you can select points to specify the save back extents.

NOTE This displays the current window. To view or change the extents for the entire drawing, zoom to drawing extents before starting this command. To

zoom drawing extents, click View tab ► Navigate panel ► Zoom

drop-down ► Extents. 

Show <

Display the current save back extents in the current drawing. Save back extents are indicated by a dotted line.

NOTE This shows only the extents displayed in the current window. To view the extents for the entire drawing, zoom to drawing extents before starting this command. To zoom drawing extents, click View tab ► Navigate panel ► Zoom

drop-down ► Extents. 

Reset

Reset the values to the original drawing extents adjusted for simple transformations.

The default save back extents are the extents of the source drawing adjusted for simple transformation.



Drawing Statistics dialog box

Use this dialog box to view information about the active source drawings in the current drawing.



To view information about attached drawings (page 172)



Click Map Setup tab ► Map panel ►  ► Drawing Statistics. 

NOTE This option is for drawings only. To view information about geospatial feature data, see [Viewing Data for a Selected Layer, Join, Unfiltered Feature Class, or Non-Spatial Data Table](#) (page 1134). To see the currently connected feature sources, use Map Explorer.

Select the drawings you want information about. Click an information button. AutoCAD Map 3D searches the selected source drawings and displays the information in the box at the bottom of the screen.

Active Drawings list

View all the active attached drawings in the current drawing.

- Use Select All to select all drawings.
- Use Clear All to remove the highlighting from all items.
- Use Filter to filter the list of drawings.

Filter

Select Filter to turn on the current drawing filter.

When the filter is on, only drawings that match the filter are displayed. If the parent drawing of a nested drawing is filtered, the nested drawing is not displayed, even if it matches the filter.

To create or change the filter, click Filter. In the [Drawing Set Display Filter dialog box](#) (page 1922), you can create separate filters for file names and descriptions.

Object Counts

View the number and type of objects in the source drawing.

Symbol Tables

View symbol tables and their values for each of the selected drawings.

Symbol tables include Blocks, Layers, Linetypes, Text Styles, and Regapps, which are registered applications that contain xdata (extended data) within the drawing.

Object Data

For the selected drawings, view

- Link Templates
- Object Data tables
- Attributes

Object Classes

View object classes used in the selected drawings and the number of features in each feature class.

Drive Alias Administration dialog box

AutoCAD Map 3D creates a drive alias for drive C. You must create drive aliases for all other drives that you use.



To create a drive alias (page 161)



Click Home tab > Data panel >



> Define Drawing Set.



NOTE This option is for attached drawings only. For information about connecting to geospatial feature data, see [Overview of Bringing In GIS Features](#) (page 305).

Drive aliases are useful as typing shortcuts or as a reminder of what drawings are contained in the directory. In addition, they make it easy for multiple users to share drawings.

The alias you assign appears in the Drive list whenever you select drawings.

To modify an existing drive alias, select it in the list, enter a new Actual Path, and click Update.

To create a new drive alias, enter a new Drive Alias, enter an Actual Path, and click Add.

Drive List

View aliases you created.

Drive Alias box

Enter the alias to use.

The name must be unique, use only alphanumeric characters (including hyphen and underscore), contain no spaces or colons, and start with a character.

Actual Path box

Enter the path, including drive or server name and directories.

If you are not sure of the drive or directory, click Browse.

Xrefs and raster objects use their assigned paths and are not affected by drive aliases.

Feature Editing Options dialog box

Use this dialog box to set options for automatically checking out features and updating feature sources, whether features are checked out as drawing objects or geospatial features, how to split polygonal features, and how often you are prompted to check in features.



[To specify Feature Edit Options](#) (page 240)



[MAPFEATUREEDITTOOLS](#) (page 1906)

NOTE These options are for geospatial feature data only. For information on working with attached drawings in a multi-user environment, see [Overview of Sharing Attached Drawings](#) (page 730).

Check Out And Update Features

Specify options for automatically checking out features and updating feature source.

Automatically Check Out Features When Edited.

Specify that features are automatically checked out when you edit them.

Automatically Update Feature Source With Edits

Specify that edits to features are automatically reflected in the feature source

Feature Checkout Options

Specify whether features are checked out as drawing objects or geospatial features.

AutoCAD Drawing Objects

Specify that features are checked out as AutoCAD drawing objects.

NOTE Features checked out as AutoCAD drawing objects will be listed as custom features when you use the LIST command. In addition, custom LISP applications may not work with custom features.

Geospatial Features

Specify that features are checked out as geospatial features.

This setting determines the way you work with your data.

Features checked out as AutoCAD drawing objects	Features checked out as geospatial features
Allows you to use many common ACAD editing commands	Allows you to use some common ACAD editing commands in addition to geospatial feature-specific editing commands (for example, MAPFEATURESPLIT (page 1652) and MAPFEATUREMERGE (page 1651))
Edited features represented as AutoCAD geometries (for example, closed polylines are used to represent polygonal features)	Edited features are represented as geospatial geometries (for example, MAPPOLYGONS).
Most existing custom or third-party editing applications (LISP, VB or ObjectARX) should continue to work. Some may require minor updates.	Supports multipart (multipolygons, multilines, and multipoints) geospatial features and editing, such as the Hawaiian islands.
Some existing AutoCAD Map 3D editing commands will continue to work on features, for example, rubbersheeting (ADERSHEET (page 1648)).	Preserves and allows you to edit M and Z values.
Allows you to use feature styling.	Allows you to use feature styling.

Split Prompt Options

Specify how features are created after a split and whether these prompts display during the split operation.

Feature Geometry

Select Create New to split features into two parts. Select Create Multi-Part to split features into more than two parts.

Feature ID

Select Generate New Feature ID to create a new unique ID for each feature that results from the split. Select Use Existing to use the ID of the original feature for all resulting features.

Do Not Show These Prompts When Executing Split

Select this option to use the settings in this dialog box for all split operations. When you split a feature, you will see only the prompt for drawing a new

line for the split or selecting an existing line or polygon within the feature to define the split.

If you do not select this option, all prompts will appear, but the default values for the prompts will be what you specify in this dialog box.

Other Options

Specify whether or not you are prompted to check in features and how often.

Prompt To Check In Every

Specify that you will be prompted to check in features at intervals of the specified value.

Generate Object Data Index dialog box

Use this dialog box to select the tables and fields to include in the index.



To create a drawing index (page 1294)



Click Map Setup tab > Map panel >  > Drawing Maintenance.



NOTE This option is for drawing object data only. For information about geospatial feature properties, see [Overview of the Data Table](#) (page 1125).

In the Object Data Tables list, select a table. In the Fields list, select the object data fields to include in the index. If a table has fields selected for the index, the table is checked in the list.

Index Maintenance dialog box

Use this dialog box to specify which types of indexes to create for the selected source drawings.



To create a drawing index (page 1294)



NOTE This option is for drawing object data only. For information about filtering geospatial feature data, see [Filtering Feature Layers](#) (page 1216).

Indexes speed up queries, but they add to the size of your source drawings. If size is an issue, create indexes for just the types of queries you perform most often. For example, if you mostly perform queries based on location, create just a location index.

- To create an index, select the check box for the type of index you want. To create an object data index, click Object Data. At the [Generate Object Data Index dialog box](#) (page 1931) select the tables and fields to index. To improve the performance of object data and SQL queries, create object data and SQL indexes for all drawings in the data set, even if they do not contain object data or SQL link information.
- To remove an existing index, select the check box for that type of index. To remove an object data index, click Object Data. At the [Remove Object Data Index dialog box](#) (page 1933) select the tables and fields to remove from the index. Removing an index reduces the size of the drawing, and reduces the time it takes to save the drawing.

Because indexes are saved in the source drawing, you can create indexes only if the drawing is not in a read-only directory and you have Edit Drawing privileges. See [User Administration dialog box](#) (page 1934).

Once you create an index, AutoCAD Map 3D automatically updates the index each time you change the drawing and save the changes back. However, you will need to recreate the index in the following circumstances:

- If you notice that queries are taking longer. Over time, automatic updates can cause degeneration of an index. It is a good idea to periodically use this command to recreate the indexes.
- If you modify a drawing with AutoCAD or with AutoCAD Map 3D when the drawing is not attached, you need to use this command to recreate the indexes.

NOTE To check if a source drawing has an index created, select the drawing in the Drawing Maintenance dialog box. Click Drawing Index to display the Index Maintenance dialog box. If the source drawing contains a usable index, the check box for that index is not selected. If the drawing does not contain an index, or if the index is out of date, the check box for the index is selected.

Remove Object Data Index dialog box

Use this dialog box to remove object data fields from an index.



[To remove a drawing index](#) (page 1294)



Click Map Setup tab > Map panel >  > Drawing Maintenance.



NOTE This option is for drawing object data only. For information about filtering geospatial feature data, see [Filtering Feature Layers](#) (page 1216).

In the Object Data Tables list, select a table. In the Fields list, select the object data fields to remove. If a table has fields selected to be removed from the index, the table is checked in the list.

Select Alias dialog box

Use this dialog box to select the alias to use with this drawing.



[To create a drive alias](#) (page 161)



Click Home tab > Data panel >  > Define Drawing Set.



NOTE This option is for attached drawings only. For information about connecting to geospatial feature data, see [Overview of Bringing In GIS Features](#) (page 305).

More than one alias is associated with the path to the file you selected. Select the alias to use with this drawing

Undefined Alias Referenced dialog box

Use this dialog box to resolve problems with undefined drive aliases.



[To attach drawings](#) (page 154)



Click Home tab > Data panel >



> Define Drawing Set.



NOTE This option is for attached drawings only. For information about connecting to geospatial feature data, see [Overview of Bringing In GIS Features](#) (page 305).

The drawing you are activating or attaching has an alias assigned to it that is not defined.

- To attach this drawing without defining an alias, click Skip. You cannot activate the drawing until you define a path for the alias. To define the alias later, see [To create a drive alias](#) (page 161).
- To define a path for the alias now, click Define. In the [Drive Alias Administration dialog box](#) (page 1928), define a drive alias.

User Administration dialog box

Use this dialog box to add or delete users or modify user settings



[To add a new user](#) (page 83)



Click Map Setup tab > Map panel >



> User Administration.



Do any of the following:

- To add a user, enter information in the User Profile section. Click Add.
- To delete a user, select the name and click Delete.

- To modify a user, select the name and change information in the User Profile section. Click Update.

User List

View all users set up for AutoCAD Map 3D.

Login Name box

Specify the login name for the user.

- Each login name must be unique.
- Login names are not case-sensitive.
- The login name cannot contain spaces or any of the following characters.
" / \ [] ; : | = , + ? < >

Password box

Specify the password for the user.

- Passwords are case-sensitive.
- Passwords cannot contain spaces.

For a new user, you can set the password to PASSWORD and have the user change it.

To be effective, passwords should have a combination of numbers and uppercase and lowercase letters.

Privileges

Select privileges for the user.

Superuser

Let the user perform user administration tasks, set system options, and perform any other AutoCAD Map 3D operation.

Alter Drawing Set

Let the user attach and detach drawings. If this option is not selected, the user can activate and deactivate drawings, but cannot attach and detach them.

Alter Object Class

Let the user define and edit object class definitions. If this option is not selected, users can only assign object classes and change the current feature definition file.

Edit Drawing

Let the user edit objects and save them back to source drawings. If this option is not selected, the user can edit objects but cannot save them back to source drawings.

Draw Query

Let the user execute Draw mode queries, which copy objects into the current drawing. If this option is not selected, users can do Preview and Report mode queries only.

User Information dialog box

This dialog box displays information about the current AutoCAD Map 3D user.

To change your privileges, see your system administrator.

Login Name

View the name used to log in to AutoCAD Map 3D.

Privileges

View the privileges of the current user.

Superuser

Let the user perform user administration tasks, set system options, and perform any other AutoCAD Map 3D operation.

Alter Drawing Set

Let the user attach and detach drawings. If this option is not selected, the user can activate and deactivate drawings, but cannot attach and detach them.

Alter Feature Class

Let the user define and edit feature class definitions. If this option is not selected, users can only assign feature classes and change the current feature definition file.

Edit Drawing

Let the user edit objects and save them back to source drawings. If this option is not selected, the user can edit objects but cannot save them back to source drawings.

Draw Query

Let the user execute Draw mode queries, which copy objects into the current drawing. If this option is not selected, users can do Preview and Report mode queries only.

User Login dialog box

Log in to AutoCAD Map 3D on this computer. If you do not know your login name or password, check with your system administrator



[To log in to AutoCAD Map 3D \(page 142\)](#)



Click Map Setup tab > Map panel >  > User Login.



Some actions, such as modifying object data tables and removing locks for other users, require Superuser access. To log in as a Superuser, enter the login name Superuser. Enter the password SUPERUSER. In offices where the system administrator reserves the Superuser login name, contact your system administrator to gain access to object data tables, object locks, or system options.

If user login is not required, you can log in at any time, even if you did not log in at the beginning of your current AutoCAD Map 3D session. For example, you can log in under your own name, or as a different user, while working in a drawing with active source drawings.

Topology Dialog Boxes

38

NOTE Topology functionality applies only to drawing objects.

MAPEDITDIR (Edit Direction command)

NOTE This functionality applies only to drawing objects.

Use this command to edit the direction of a selected linear object in an existing topology while maintaining the integrity of the topology information.



To edit the direction of a link (page 873)

Respond to the prompts:

Enter topology name (? for list) <toponame>:

Enter the name of the topology for which you want to modify direction. To display a list of all loaded topologies, enter ?.

Select objects:

Use any selection method to select the objects.

Enter new value (Bi-directional/From->To/To->From):

Enter B for bi-directional, F for From->To, or T for To->From.

MAPEDITRES1 (Edit Direct Resistance command)

NOTE This functionality applies only to drawing objects.

Use this command to edit the direct resistance of a selected link or node in an existing topology while maintaining the integrity of the topology information.



[To edit the resistance of a link or node in a network topology \(page 875\)](#)

Respond to the prompts:

Enter topology name (? for list) <toponame>:

Enter the name of the topology for which you want to modify resistance.

To display a list of all loaded topologies, enter ?.

Edit resistance of (Links/Nodes) <L>:

Enter L for Links or N for Nodes.

Select objects:

Use any selection method to select the objects.

Enter new direct resistance <1.000>:

Enter a new value.

MAPEDITRES2 (Edit Reverse Resistance command)

NOTE This functionality applies only to drawing objects.

Use this command to edit the reverse resistance of a selected link an existing topology while maintaining the integrity of the topology information.



[To edit the resistance of a link or node in a network topology \(page 875\)](#)

Respond to the prompts:

Enter topology name (? for list) <toponame>:

Enter the name of the topology for which you want to modify resistance.

To display a list of all loaded topologies, enter ?.

Select objects:

Use any selection method to select the objects.

Enter new reverse resistance <1.000>:

Enter a new value.

MAPLINKADD (Add Topology Link command)

NOTE This functionality applies only to drawing objects.

WARNING This command will not be supported in future releases. This is the old command for adding a link to a topology. The new command is MAPAL.

Use this command to add a link to an existing network or polygon topology while maintaining the integrity of the topology information.



To create a link and add it to a topology (page 880)



MAPAL

Respond to the prompts:

Enter topology name (? for list) <toponame>:

Enter the name of the topology to add the link to. To display a list of all loaded topologies, enter ?.

Enter first point:

Enter the coordinates for the first point of the line, or select the point.

Arc/Close/Halfwidth/Length/Undo/Width/<Endpoint of line>:

For information about this prompt, see the PLINE command in the AutoCAD help.

You can use MAPLINKADD to add a link in three ways:

- In space (connecting no existing nodes). Two new nodes are created at the link endpoints in space.
- From one existing node to a point in space. A new node is created at the end point in space.
- From one existing node to another existing node.

A topology must have a node at the end points of all link objects. This node is part of the topology data structure and is assigned a topology ID. However, a node can be implicit (referenced in the topology data structure) or explicit (a physical object in the drawing). Use the [MAPNODADD \(Add Topology Node command\)](#) (page 1944) or [MAPNODINS \(Insert Topology Node command\)](#) (page 1947) command to create a new node.

When you add a link to a topology, AutoCAD Map 3D creates a node when necessary. If the link joins two existing nodes, no new nodes are created. Remember these features of nodes and links:

- A node can reference many links.
- A link can reference only two nodes.
- Only one node can exist at a specific point.

If the new link splits an existing area in a polygon topology into two areas, AutoCAD Map 3D creates a new centroid and updates the existing centroid.

MAPLINKDEL (Delete Topology Link command)

NOTE This functionality applies only to drawing objects.

WARNING This command will not be supported in future releases. This is the old command for deleting a link in a network topology. The new command is MAPDL.

Use this command to delete a link from an existing network or polygon topology while maintaining the integrity of the topology information.



To delete a link, node, or polygon (page 889)



MAPDL

Respond to the prompts:

Enter topology name (? for list) <toponame>:

Enter the name of the topology to delete the link from. To display a list of all loaded topologies, enter ?.

Select object:

Use any selection method to select the object to delete.

MAPLINKEDIT (Edit Topology Link command)

NOTE This functionality applies only to drawing objects.

Use this command to edit a link in an existing network or polygon topology while maintaining the integrity of the topology information.



[To reposition a node at the end point of a link](#) (page 863)

Respond to the prompts:

Enter topology name (? for list) <toponame>:

Enter the name of the topology to modify. To display a list of all loaded topologies, enter ?.

Select link to edit:

Select the object using any selection method.

For information about the prompts, see the PEDIT command in the AutoCAD help.

You cannot delete the first or last vertex of a polyline.

MAPLINKREV (Reverse Direction of Topology Link command)

NOTE This functionality applies only to drawing objects.

WARNING This command will not be supported in future releases. This is the old command for reversing a link in a network topology. The new command is MAPRL.

Use this command to reverse the direction of a link in an existing network topology while maintaining the topology information.



[To edit the direction of a link](#) (page 873)



Respond to the prompts:

Enter topology name (? for list) <toponame>:

Enter the name of the topology to modify. To display a list of all loaded topologies, enter ?.

Select link to edit:

Use any selection method to select the object whose direction you want to reverse.

MAPLINKUPD (Update Topology Link command)

NOTE This functionality applies only to drawing objects.

When you modify a link using standard editing commands, the topology information associated with the link is not updated. Use this command to have the topology relationship information on the link updated. (If you modified the link using an AutoCAD Map 3D topology command, such as MAPLINKEDIT, the topology information was automatically updated and you do not need to use this command.)



[To update a topology](#) (page 892)

Respond to the prompts:

Enter topology name (? for list) <toponame>:

Enter the name of the topology to modify. To display a list of all loaded topologies, enter ?.

Select link to update:

Use any selection method to select the object to update.

MAPNODADD (Add Topology Node command)

NOTE This functionality applies only to drawing objects.

WARNING This command will not be supported in future releases. This is the old command for adding a node to a topology. The new command is MAPAN.

Use this command to add an existing block or point to a topology while maintaining the integrity of the topology information.



To create a node on an existing link (page 878)



MAPAN

Respond to the prompts:

Enter topology name (? for list) <toponame>:

Enter the name of the topology to add the node to. To display a list of all loaded topologies, enter ?.

Select block or point to add:

Select an existing block or point.

You can use this operation to create a new block object at the location of an existing implicit node. MAPNODADD prompts you to select the new block or point object.

You cannot add a new node to a topology with this command. To insert a node on an existing link, use the [MAPNODINS \(Insert Topology Node command\)](#) (page 1947) command.

MAPNODEL (Delete Topology Node command)

NOTE This functionality applies only to drawing objects.

WARNING This command will not be supported in future releases. This is the old command for deleting a node in a topology. The new command is MAPDN.

Use this command to delete a node from an existing topology while maintaining the integrity of the topology information.



To delete a link, node, or polygon (page 889)



MAPDN

Respond to the prompts:

Enter topology name (? for list) <toponame>:

Enter the name of the topology to delete the node from. To display a list of all loaded topologies, enter ?.

Select node to delete:

Use any selection method to select the node to delete.

If the node has only one link, choose whether to delete the dangling link.

If the node has two links, the two links are combined. Choose which set of object data to preserve.

You cannot delete a node that has more than two links.

MAPNODEEDIT (Edit Topology Node command)

NOTE This functionality applies only to drawing objects.

Use this command to move a node in an existing topology while maintaining the integrity of the topology information.



To edit a node (page 860)

Respond to the prompts:

Enter topology name (? for list) <toponame>:

Enter the name of the topology to modify. To display a list of all loaded topologies, enter ?.

Select node to update:

Use any selection method to select the object to edit.

Specify new insertion point:

Enter the coordinates of a point or select a point onscreen. If a node already exists in the new location, you are prompted to delete one of the nodes.

The node is moved to the new location, and all associated links move their endpoints.

MAPNODINS (Insert Topology Node command)

NOTE This functionality applies only to drawing objects.

WARNING This command will not be supported in future releases. This is the old command for inserting a node in a topology. The new command is MAPIN.

Use this command to insert a node on an existing link while maintaining the integrity of the topology information.



[To create a node on an existing link](#) (page 878)



MAPIN

Respond to the prompts:

Enter topology name (? for list) <toponame>:

Enter the name of the topology to modify. To display a list of all loaded topologies, enter ?.

Specify insertion point:

Enter the coordinates of a point or select a point on the screen. If any block definitions exist in the drawing, you are prompted for a block to reference. The default block name is the last block name referenced in the drawing.

To add a node at the end of a dangling link, or to add a node not on a link, use the [MAPNODADD \(Add Topology Node command\)](#) (page 1944) command.

MAPNODUPD (Update Topology Node command)

NOTE This functionality applies only to drawing objects.

Use this command to have the topology relationship data on the node updated.



[To update a topology](#) (page 892)

When you modify a node using standard editing commands, the topology data associated with the node is not updated. (If you modified the node using an AutoCAD Map 3D topology command, such as MAPNODEEDIT, the topology data was updated automatically and you do not need to use this command.)

Respond to the prompts:

Enter topology name (? for list) <toponame>:

Enter the name of the topology to modify. To display a list of all loaded topologies, enter ?.

Select node to update:

Use any selection method to select the object to update.

MAPPOLYADD (Add Topology Polygon command)

NOTE This functionality applies only to drawing objects.

WARNING This command will not be supported in future releases. This is the old command for adding a polygon to a polygon topology. The new command is MAPAP.

Use this command to add a centroid in an existing topology while maintaining the integrity of the topology information.



[To add a polygon to a polygon topology using existing linework](#) (page 884)



MAPAP

Respond to the prompts:

Enter topology name (? for list) <toponame>:

Enter the name of the topology to modify. To display a list of all loaded topologies, enter ?.

Select objects:

Enter the coordinates of a point or select a point on screen. The point must be in a defined area that does not currently contain a centroid.

MAPPOLYDEL (Delete Topology Polygon command)

NOTE This functionality applies only to drawing objects.

WARNING This command will not be supported in future releases. This is the old command for deleting a polygon from a polygon topology. The new command is MAPDP.

Use this command to delete a polygon from an existing topology while maintaining the integrity of the topology information.



[To delete a link, node, or polygon](#) (page 889)



MAPDP

Respond to the prompts:

Enter topology name (? for list) <toponame>:

Enter the name of the topology to modify. To display a list of all loaded topologies, enter ?.

Select objects:

Use any selection method to select the centroid of the polygon to delete.

MAPPOLYUPD (Update Topology Polygon command)

NOTE This functionality applies only to drawing objects.

Use this command to have the topology data on the polygon updated.



[To update a topology](#) (page 892)

When you modify a polygon using standard editing commands, the topology data associated with the polygon is not updated. (If you modified the polygon using an AutoCAD Map 3D topology command, such as MAPPOLYADD, AutoCAD Map 3D updated the topology for you.)

Respond to the prompts:

Enter topology name (? for list) <toponame>:

Enter the name of the topology to modify. To display a list of all loaded topologies, enter ?.

Select object:

Use any selection method to select the centroid of the polygon to update.

AutoCAD Map Confirmation dialog box - MAPTOPOADMIN Delete

NOTE This functionality applies only to drawing objects.

Use this dialog box to confirm the deletion of topology objects.



[To delete a link, node, or polygon](#) (page 889)



MAPDL
MAPDN
MAPDP

If you select Delete Topology Objects, the referenced objects are deleted from the current drawing, if either of the following conditions exist:

- It was loaded from the source and all objects were created when loaded.
- It was loaded from the current drawing.

AutoCAD Map Confirmation dialog box - MAPTOPOEDIT

NOTE This functionality applies only to drawing objects.

Use this dialog box to confirm the change to an object shared by multiple topologies.



[To edit a topology](#) (page 854)



MAPTOPOEDIT

The object you are modifying is referenced by more than one topology. If you modify the object in the selected topology, the other topologies may be invalid. You must [To update a topology](#) (page 892) the other topologies.

AutoCAD Map Confirmation dialog box - MAPTOPOADMIN

Rename

Use this dialog box to confirm the renaming of a topology.



[To change the name, description, or both of a topology](#) (page 925)



Click Map Setup tab > Topology panel > Rename.



Before you rename a topology:

- Attach all source drawings that are referenced by the topology. If the source drawings are not attached, you could corrupt your data set.
- Load the topology. The topology needs to be completely represented, either in source files or in the current drawing.
- You cannot rename a topology if there are any queried objects in the current drawing. You must save all queried objects back to their source

drawings or detach them from their source drawings before you can rename any topology.

- Be sure the Create Backup File Of Source Drawing option is not selected on the Save Back tab of the [AutoCAD Map Options dialog box](#) (page 1908).

You cannot undo this rename operation using the UNDO command.

Centroid Objects dialog box

NOTE This functionality applies only to drawing objects.

Use this dialog box to select the centroids to include when you create a topology.



[To create a topology](#) (page 825)



Click Create tab ► Topology panel ► New.



Centroid information is stored as object data and saved with the map. Each centroid is given a unique ID number, which is automatically processed whenever you use a topology command.

Object Selection

Select Automatically / Manually options

- Select Automatically selects all objects that meet the object type and filter criteria.
- Select Manually lets you manually select objects for the topology. Click Select < to select objects.

Filter Selected Objects

If this option is selected, only objects that are on the specified layers or blocks are selected. The filters are used for both automatic and manual selection of objects. If this option is not selected, the filters are ignored.

Layer Filters box

Specify which layers to search for objects to be used for the topology. Enter an asterisk (*) to search all layers. To select from a list of layers, click Layers.

Block Filters box

Specify which blocks to search for objects to be used for the topology.

- To search all blocks, enter an asterisk (*).
- To select from a list of block definitions in the drawing set, click Blocks.
- To select point objects, enter ACAD_POINT.

Object Creation

Create on Layer box

If new nodes or centroids are created, specify on which layer they should be placed. To select from a list of layers, click Layers.

Create Using box

If new nodes or centroids are created, specify what block to use to create them.

- To select from a list of block definitions in the drawing set, click Blocks.
- To create nodes or centroids as a point, leave the box blank or enter ACAD_POINT.

Create Closed Polylines dialog box

NOTE This functionality applies only to drawing objects.

Use this dialog box to create polylines from a polygon topology.



[To create closed polylines from a polygon topology](#) (page 898)



Click Create tab > Topology panel > Create Closed Polylines.



Topology Name

Name box

Select the topology you want.

The list displays topologies loaded from the current drawing. If the topology you want is not listed, click Load and load it.

Type

Displays the type of the selected topology.

Description

Displays the description of the selected topology.

Number of Polygons Referenced

Displays the number of polygons referenced by the selected topology. If the topology is loaded as partial, this is the number of polygons in the partial subset.

How to Close

Create on Layer box

Specify a layer for the new plines.

Click Layers to select from a list of layers in the current drawing or enter a new layer name.

Group Complex Polygons

Select this option to group all closed plines that make up the original complex topology polygon. A complex polygon is one that includes islands. If the islands themselves have nested islands or other polygons, these nested polygons will form a separate grouping automatically, creating different levels of grouping. If two or more inner polygons are not nested but share the same outer boundary, they will be treated as one group.

Copy Object Data from Centroid to Pline

Select this option to copy object data from the centroid to the closed pline that is created.

Object data on islands are copied to the outer polygon edge.

Copy Database Links from Centroid to Pline check box

Select this option to copy database links from the centroid to the closed pline that is created.

Database links on islands are copied to the outer polygon edge.

Create Network Topology - Create New Nodes dialog box

NOTE This functionality applies only to drawing objects.

Use this dialog box to create node objects at the endpoint of links when you create a network topology.



[To create a network topology](#) (page 831)



Click Create tab ► Topology panel ► New.



Create New Nodes

Specify whether or not to create nodes in the current object to complete the topology. (Nodes are optional.)

Layer

If new nodes are created, you can specify a new layer or click the down arrow to select from a list of layers in the drawing set.

Point Object for Node Creation

If new nodes are created, specify what block to use to create them.

- To create nodes using a block defined in the drawing set, click the down arrow and select from the list.
- To create nodes using a block saved as a DWG file, click Browse, and select the file you want to use. Selecting this file will insert the entire DWG as a single block.
- To create nodes as a point, select ACAD_POINT.

Cancel

Close the dialog box without creating the topology.

Back

Display the previous dialog box in the list.

Next

Disabled because this is the last dialog box in the list.

Finish

Create the topology using the current settings. Enter a unique name for the topology and click Finish.

Create Network Topology - Select Links dialog box

NOTE This functionality applies only to drawing objects.

Use this dialog box to select the links for a network topology.



To create a network topology (page 831)



Click Create tab ► Topology panel ► New.



Select the links to include in the topology. You can select all links in the map or select them manually. You can also filter (restrict) link selection to a subset of links, in which you include only the links that are on specified layers and in specified object classes.

Link information is stored as object data and saved with the map. Each link is given a unique ID number, which is automatically processed whenever you use a topology command.

Select All

Include all links that meet the filter criteria.

Select Manually

Include only the links that you manually select in the map. Click Select Objects to select the links. Only links that meet the filter criteria will be selected.

Layers

Specify the layers to use to filter (restrict) link selection to a subset of links, in which you include only the links that are on the specified layers. This filter is used for both automatic and manual selection of objects. To select from a list of layers in the map, click Select Layers. To use all layers, enter an asterisk (*) or leave the box blank.

Object Classes

Specify the object classes to use to filter (restrict) link selection to a subset of links, in which you include only the links that are in the specified object classes. To select from a list of object classes in the map, click Select Object Classes. To use all object classes, enter an asterisk (*) or leave the box blank.

Cancel

Close the dialog box without creating the topology.

Back

Display the previous dialog box in the list.

Next

Click to display the [Create Network Topology - Select Nodes dialog box](#) (page 1957).

Finish

Create the topology using the current settings. Enter a unique name for the topology and click Finish.

Create Network Topology - Select Nodes dialog box

NOTE This functionality applies only to drawing objects.

Use this dialog box to select the nodes to include in a network topology.



[To create a network topology](#) (page 831)



Click Create tab ► Topology panel ► New.



Nodes are useful when performing some types of analysis. You can select all nodes in the map or select them manually. You can also filter (restrict) node selection to a subset of nodes, in which you include only the nodes that are on specified layers, are of specified block types, or in specified object classes.

Node information is stored as object data and saved with the map. Each node is given a unique ID number, which is automatically processed whenever you use a topology command.

Select All

Include all nodes that meet the filter criteria.

Select Manually

Include only the nodes that you manually select in the map. Click Select Objects to select the nodes. Only nodes that meet the filter criteria will be selected.

Layers

Specify the layers to use to filter (restrict) node selection to a subset of nodes, in which you include only the nodes that are on the specified layers. This filter is used for both automatic and manual selection of objects. To select from a list of layers in the map, click Select Layers. To use all layers, enter an asterisk (*) or leave the box blank.

Block Names

Specify which blocks to search for nodes to be used in the topology. To search all blocks, enter an asterisk (*) or leave the box blank. To select from a list of block definitions in the drawing set, click Select Blocks. To select point objects, select ACAD_POINT from the list.

Object Classes

Specify the object classes to use to filter (restrict) node selection to a subset of nodes, in which you include only the nodes that are in the specified object classes. To select from a list of object classes in the map, click Select Object Classes. To use all object classes, enter an asterisk (*) or leave the box blank.

Cancel

Close the dialog box without creating the topology.

Back

Display the previous dialog box in the list.

Next

Click to display the [Create Network Topology - Create New Nodes dialog box](#) (page 1955).

Finish

Create the topology using the current settings. Enter a unique name for the topology and click Finish.

Create Node Topology - Select Nodes dialog box

NOTE This functionality applies only to drawing objects.

Use this dialog box to select the nodes to include in a node topology.



To create a node topology (page 827)



Click Create tab ► Topology panel ► New.



You can select all nodes in the map or select them manually. You can also filter (restrict) node selection to a subset of nodes, in which you include only the nodes that are on specified layers, are of specified block types, or in specified object classes.

Node information is stored as object data and saved with the map. Each node is given a unique ID number, which is automatically processed whenever you use a topology command.

Select All

Include all nodes that meet the filter criteria.

Select Manually

Include only the nodes that you manually select in the map. Click the Select Objects to select the nodes. Only nodes that meet the filter criteria will be selected.

Layers

Specify the layers to use to filter (restrict) node selection to a subset of nodes, in which you include only the nodes that are on the specified layers. This filter is used for both automatic and manual selection of objects. To select from a list of layers in the map, click Select Layers. To use all layers, enter an asterisk (*) or leave the box blank.

Block Names

Specify which blocks to search for nodes to be used in the topology. To search all blocks, enter an asterisk (*) or leave the box blank. To select from a list of block definitions in the drawing set, click Select Blocks. To select point objects, select ACAD_POINT from the list.

Object Classes

Specify the object classes to use to filter (restrict) node selection to a subset of nodes, in which you include only the nodes that are in the specified object classes. To select from a list of object classes in the map, click Select Object Classes. To use all object classes, enter an asterisk (*) or leave the box blank.

Cancel

Close the dialog box without creating the topology.

Back

Display the previous dialog box in the list.

Next

Disabled because this is the last dialog box in the list.

Finish

Create the topology using the current settings. Enter a unique name for the topology and click Finish.

Create Polygon Topology - Create New Centroids dialog box

NOTE This functionality applies only to drawing objects.

Use this dialog box to create centroids for any areas that are missing centroids and to specify the layer and block to use for the new centroids.



[To create a polygon topology](#) (page 836)



Click Create tab ► Topology panel ► New.



If you do not select the Create Missing Centroids option, and an area is missing a centroid, you are notified that the topology has not been created. The areas that are missing centroids are marked or highlighted using the error markers you specify in the [Create Polygon Topology - Set Error Markers dialog box](#) (page 1967).

Create Missing Centroids

Creates centroids where needed.

Layer

Specify the layer on which to place the new centroids. Enter a layer name or click the down arrow to select from a list of layers in the drawing set. If a layer you want is not listed, it may be frozen or locked.

Point Object for Centroid Creation

Specify the block to use to represent the new centroids. To create centroids using an existing block, click the down arrow and select the name of the block from the list. To use a point instead of a block, select ACAD_POINT. To use a block saved as a DWG file, click Browse, and select the file.

Cancel

Close the dialog box without creating the topology.

Back

Display the previous dialog box in the list.

Next

Click to display the [Create Polygon Topology - Set Error Markers dialog box](#) (page 1967).

Finish

Create the topology using the current settings. Enter a unique name for the topology and click Finish.

Create Polygon Topology - Create New Nodes dialog box

NOTE This functionality applies only to drawing objects.

Use this dialog box to specify whether to create explicit node objects at the endpoints of links when creating a polygon topology. If so, specify the layer on which to place the new nodes and the block to use to create the nodes.



[To create a polygon topology](#) (page 836)



Click Create tab ► Topology panel ► New.



Create New Nodes

Specify whether nodes that are not present in the current object selection should be created to complete the topology. (Explicit nodes are optional.)

Layer

If new nodes are created, specify on which layer they should be placed. You can specify a new layer or click the down arrow to select from a list of layers in the drawing set.

Point Object for Node Creation

If new nodes are created, specify what block to use to create them.

- To create nodes using a block defined in the drawing set, click the down arrow and select from the list.
- To create nodes using a block saved as a DWG file, click Browse, and select the file you want to use. Selecting this file will insert the entire DWG as a single block.
- To create nodes as a point, select ACAD_POINT.

Cancel

Close the dialog box without creating the topology.

Back

Display the previous dialog box in the list.

Next

Click to display the [Create Polygon Topology - Select Centroids dialog box](#) (page 1962).

Finish

Create the topology using the current settings. Enter a unique name for the topology and click Finish.

Create Polygon Topology - Select Centroids dialog box

NOTE This functionality applies only to drawing objects.

Use this dialog box to select the point and block objects to use as centroids for the polygons.



To create a polygon topology (page 836)



Click Create tab > Topology panel > New.



Each polygon in a polygon topology has a centroid, which is a point or block element within the polygon, and contains information about the area it encloses. Centroid information is stored as object data and saved with the map. Each centroid is given a unique ID number, which is automatically processed whenever you use a topology command.

You can select all point or block elements in the map or select them manually. You can also filter (restrict) object selection to a subset of objects, in which you include only the objects that are on specified layers, are of specified block types, or in specified object classes.

Select All

Use all point or block objects that meet the filter criteria as centroids.

Select Manually

Include only the point or block objects that you manually select in the map. Click Select Objects to select the objects. Only objects that meet the filter criteria will be selected.

Layers

Specify the layers to use to filter (restrict) object selection to a subset of objects, in which you include only the objects that are on the specified layers. This filter is used for both automatic and manual selection of objects. To select from a list of layers in the map, click Select Layers. To use all layers, enter an asterisk (*) or leave the box blank.

Block Names

Specify the point or block objects to use to filter object selection. To use all points and blocks, enter an asterisk (*) or leave the box blank. To select from a list of block definitions in the drawing set, click Select Blocks. To select point objects, select ACAD_POINT.

Object Classes

Specify the object classes to use to filter (restrict) object selection to a subset of objects, in which you include only the objects that are in the specified object classes. To select from a list of object classes in the map, click Select Object Classes. To use all object classes, enter an asterisk (*) or leave the box blank.

Cancel

Close the dialog box without creating the topology.

Back

Display the previous dialog box in the list.

Next

Click to display the [Create Polygon Topology - Create New Centroids dialog box](#) (page 1960).

Finish

Create the topology using the current settings. The Finish is available after you enter a valid, unique name for the topology.

Create Polygon Topology - Select Links dialog box

NOTE This functionality applies only to drawing objects.

Every area forms a polygon; and each polygon in a polygon topology consists of a set of links. When you create polygon topology, use this dialog box to select the links to include in the topology.



[To create a polygon topology](#) (page 836)



Click Create tab ► Topology panel ► New.



You can select all links in the map or select them manually. You can also filter (restrict) link selection to a subset of links, in which you include only the links that are on specified layers and in specified object classes.

Link information is stored as object data and saved with the map. Each link is given a unique ID number, which is automatically processed whenever you use a topology command.

Select All

Include all links that meet the filter criteria.

Select Manually

Include only the links that you manually select in the map. Click the Select Objects to select the links. Only links that meet the filter criteria will be selected.

Layers

Specify the layers to use to filter (restrict) link selection to a subset of links, in which you include only the links that are on the specified layers. This filter is used for both automatic and manual selection of objects. To select from a list of layers in the map, click Select Layers. To use all layers, enter an asterisk (*) or leave the box blank.

Object Classes

Specify the object classes to use to filter (restrict) link selection to a subset of links, in which you include only the links that are in the specified object classes. To select from a list of object classes in the map, click Select Object Classes. To use all object classes, enter an asterisk (*) or leave the box blank.

Cancel

Close the dialog box without creating the topology.

Back

Display the previous dialog box in the list.

Next

Click to display the [Create Polygon Topology - Select Nodes dialog box](#) (page 1965).

Finish

Create the topology using the current settings. Enter a unique name for the topology and click Finish.

Create Polygon Topology - Select Nodes dialog box

NOTE This functionality applies only to drawing objects.

When you create a polygon topology, use this dialog box to select the nodes you want to be part of the topology.



[To create a polygon topology](#) (page 836)



Click Create tab > Topology panel > New.



Nodes are useful when performing some types of analysis. You can select all nodes in the map or select them manually. You can also filter (restrict) node selection to a subset of nodes, in which you include only the nodes that are on specified layers, are of specified block types, or in specified object classes.

Node information is stored as object data and saved with the map. Each node is given a unique ID number, which is automatically processed whenever you use a topology command.

Select All

Include all nodes that meet the filter criteria.

Select Manually

Include only the nodes that you manually select in the map. Click the Select Objects to select the nodes. Only nodes that meet the filter criteria will be selected.

Layers

Specify the layers to use to filter (restrict) node selection to a subset of nodes, in which you include only the nodes that are on the specified layers. This filter is used for both automatic and manual selection of objects. To select from a list of layers in the map, click Select Layers. To use all layers, enter an asterisk (*) or leave the box blank.

Block Names

Specify which blocks to search for nodes to be used in the topology. To search all blocks, enter an asterisk (*) or leave the box blank. To select from a list of block definitions in the drawing set, click Select Blocks. To select point objects, select ACAD_POINT from the list.

Object Classes

Specify the object classes to use to filter (restrict) node selection to a subset of nodes, in which you include only the nodes that are in the specified object classes. To select from a list of object classes in the map, click Select

Object Classes. To use all object classes, enter an asterisk (*) or leave the box blank.

Cancel

Close the dialog box without creating the topology.

Back

Display the previous dialog box in the list.

Next

Click to display the [Create Polygon Topology - Create New Nodes dialog box](#) (page 1961).

Finish

Create the topology using the current settings. The Finish is available after you enter a valid, unique name for the topology.

Create Polygon Topology - Set Error Markers dialog box

NOTE This functionality applies only to drawing objects.

Use this dialog box to specify how to mark errors in your polygon topology. If you mark errors with blocks, specify the size, shape, and color of the marker blocks.



[To create a polygon topology](#) (page 836)



Click Create tab > Topology panel > New.



AutoCAD Map 3D automatically checks for missing centroids and intersections. These are considered serious errors and if detected, prevent topology creation. You can choose whether you want Map to check for other potential problems, including duplicate objects, incomplete areas, and sliver polygons.

Marker Parameters

Specify whether or not to highlight errors and/or mark them with blocks. Also specify the marker size.

Highlight Errors

Highlight errors in red (nodes or centroids are highlighted with a red X). To remove the highlighting, use the REDRAW, REGEN, or SAVE command.

Mark Errors With Blocks

Mark errors with blocks of the shape and color you specify below. To remove a marker block, select it and then press Delete.

Marker Size

Specify the marker size as a percent of the screen size. A value between 3% and 7% is usually suitable.

Missing Centroids

Mark each area with a missing centroid with a block of the shape and color you specify. This option is disabled if you selected the Create Missing Centroids option on the previous dialog box.

Intersections

Mark each duplicate object with a block of the shape and color you specify.

Duplicate Centroids

Select the check box to mark each area in the drawing with more than one centroid. If you don't select the check box, AutoCAD Map 3D creates a topology even if an area contains more than one point object which qualifies to be a centroid. The topology data is added to only one of the centroid objects.

Incomplete Areas

Select the check box to detect links that are not part of a closed area. If you don't select this option, AutoCAD Map 3D ignores links that are not part of a closed area and they do not receive any topology data.

Highlight Sliver Polygons

Select the check box to check for sliver polygons and mark their centroids with red Xs. Sliver polygons are long, thin polygons, which can occur if data is digitized or drawn inaccurately. Map will create your topology regardless of the sliver polygons, but you should check that your data is accurate.

Cancel

Close the dialog box without creating the topology.

Back

Display the previous dialog box in the list.

Next

Disabled because this is the last dialog box in the list.

Finish

Create the topology using the current settings.

Create Topology - Select Topology dialog box

NOTE This functionality applies only to drawing objects.

Use this dialog box to select the type of topology to create and to specify the topology name and description.



To create a polygon topology (page 836)



Click Create tab ► Topology panel ► New.



Before you create network or polygon topologies, you should clean up your map to make sure it doesn't have certain types of errors. Node topologies do not usually require cleanup. Click Tools tab ► Map Edit panel ► Clean Up.



For more information, see [Cleaning Up Drawing Data](#) (page 765).

Topology Type

Select the type of topology to create: node, network, or polygon.

- Node topologies involve independent points. Some examples of node topologies are street lights, city-maintained trees, or drill holes for core samples. [Cleaning Up Maps](#) (page 767)

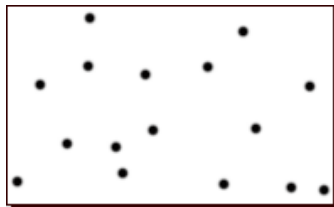

- Network topologies involve linear objects, and can have nodes where linear objects connect. In addition, linear objects can have direction or resistance. Some examples of network topologies are a water distribution network, a river network, or a street network.

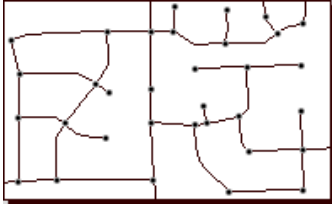

- Polygon topologies involve polygons that define areas. Some examples of polygon topologies are city blocks, land parcels, and political boundaries.

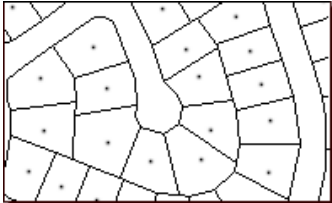

Topology Name

Enter a unique name for the topology. Names can contain letters, numbers, and the underscore, hyphen, and dollar characters. Always use unique names for a topology; topologies with the same name may become corrupt if you insert one drawing with a topology into another.

Topology Description

Enter a description for the topology. Providing a description can help you and other users identify the topology more easily.

Cancel

Close the dialog box without creating the topology.

Back

Disabled because this is the first dialog box in the list.

Next

Display the next dialog box. This varies, depending on the type of topology you are creating.

Finish

Create the topology using the current settings. Enter a unique name for the topology and click Finish.

Create Topology Warning dialog box

NOTE This functionality applies only to drawing objects.

Use this dialog box to indicate whether you want to continue creating the topology.



To create a polygon topology (page 836)



Click Create tab > Topology panel > New.



You selected 25,000 links for your topology. Creating a topology of this size may take longer to create.

- To continue creating the topology, click OK.
- To return to the previous dialog box without creating a topology, click Cancel.

If you don't want to see this warning again, select Do Not Warn Me Before Creating A Large Topology.

Delete Topology dialog box

NOTE This functionality applies only to drawing objects.

Use this dialog box to delete an entire topology.



To delete a topology (page 926)

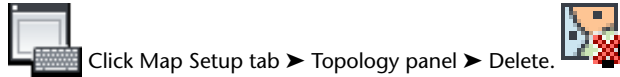

When you delete a topology, the topology relationship data is automatically deleted from objects referenced by the selected topology.

Select Delete Geometry to delete the referenced objects from the current drawing.

You can delete a topology under the following conditions:

- It was loaded from source and all objects were created at load.
- It was loaded from the current drawing and completed.

Edit Direct Resistance dialog box

NOTE This functionality applies only to drawing objects.

Use this dialog box to edit the direct resistance of a selected link or node in an existing topology while maintaining the integrity of the topology information.



[To edit the resistance of a link or node in a network topology](#) (page 850)



[MAPEDITRES1 \(Edit Direct Resistance command\)](#) (page 1939)

[MAPEDITRES2 \(Edit Reverse Resistance command\)](#) (page 1940)

Value box

Displays the direct resistance for the object. Enter a new value and click OK.

The value must be numeric.

Edit Direction dialog box

NOTE This functionality applies only to drawing objects.

Use this dialog box to edit the direction of a selected linear object in an existing topology while maintaining the integrity of the topology information.



To specify the direction for a link (page 847)



MAPEDITDIR
MAPRL

Direction box

Select the direction for the link from the list and click OK. You can choose Bi-Directional, From -> To , or To -> From.

Edit Reverse Resistance dialog box

NOTE This functionality applies only to drawing objects.

Use this dialog box to edit the reverse resistance of the selected link in an existing topology while maintaining the integrity of the topology information.



To edit the resistance of a link or node in a network topology (page 850)



MAPEDITRES1
MAPEDITRES2

Value box

Displays the reverse resistance for the object. Enter a new value and click OK.

The value must be numeric.

Edit Topology dialog box

NOTE This functionality applies only to drawing objects.

WARNING This command will not be supported in future releases. This is the old command for editing geometry, direction, and resistance in a topology. There are several new commands for editing topologies, such as MAPAN, MAPDL, MAPMP. For a complete list, see [Editing Topologies](#) (page 851).

Use this dialog box to modify objects in a topology without damaging the topology relationship data. If you modified objects using standard editing commands, use the Update option to correct the topology relationship data for that object.



[To edit a topology](#) (page 854)

Topology Name area

Select a topology from the list of loaded topologies. When you modify the selected object, the topology data for that object will be updated in the selected topology.

NOTE If the object is referenced by more than one topology, you will need to use the update option to modify the other topologies.

If the topology you want is not loaded, click Load.

Object Type

Select the object type to edit. Object options are unavailable if they do not match the topology type you are choosing.

Edit Operation

Specify the edit operation to perform on the selected object type.
Click OK to perform the specified operation and make your selections.
To cancel the topology edit operation, click Close.

Link Objects	Polygon Objects	Node Objects
MAPLINKEDIT (Edit Topology Link command) (page 1943)	MAPPOLYDEL (Delete Topology Polygon command) (page 1949)	MAPNODEEDIT (Edit Topology Node command) (page 1946)
MAPLINKADD (Add Topology Link command) (page 1941)	MAPPOLYADD (Add Topology Polygon command) (page 1948)	MAPNODADD (Add Topology Node command) (page 1944)
MAPLINKDEL (Delete Topology Link command) (page 1942)	MAPPOLYUPD (Update Topology Polygon command) (page 1949)	MAPNODINS (Insert Topology Node command) (page 1947)

Link Objects	Polygon Objects	Node Objects
MAPLINKREV (Reverse Direction of Topology Link command) (page 1943)		MAPNODDEL (Delete Topology Node command) (page 1945)
MAPLINKUPD (Update Topology Link command) (page 1944)		MAPNODUPD (Update Topology Node command) (page 1948)
MAPEDITDIR (Edit Direction command) (page 1939)		MAPEDITRES1 (Edit Direct Resistance command) (page 1939)
MAPEDITRES1 (Edit Direct Resistance command) (page 1939)		
MAPEDITRES2 (Edit Reverse Resistance command) (page 1940)		

Link Objects dialog box

NOTE This functionality applies only to drawing objects.

When you create a topology, use this dialog box to select the links to include in the topology.



[To create a topology](#) (page 825)

Link information is stored as object data and saved with the map. Each link is given a unique ID number, which is automatically processed whenever you use a topology command.

Select Automatically/Manually options

- Select Automatically selects all objects that meet the object type and filter criteria.
- Select Manually lets you manually select objects for the topology. Click Select < to select objects.

Filter Selected Objects

If this option is selected, only objects that are on the specified layers or blocks are selected. The filters are used for both automatic and manual selection of objects.

If this option is not selected, the filters are ignored.

Layer Filters box

Specify which layers to search for objects to be used for the topology.

Enter an asterisk (*) to search all layers.

To select from a list of layers, click Layers.

Load Topology Conflict dialog box

NOTE This functionality applies only to drawing objects.

Use this dialog box to load the topology from either the source drawing or the current drawing.



To load a topology (page 907)



Click Analyze tab ► Drawing Object panel ► Load Topology.



This dialog box is displayed when AutoCAD Map 3D detects duplicate topology names in a source drawing and the current drawing.

Click OK.

Load Topology dialog box

NOTE This functionality applies only to drawing objects.

Use this dialog box to load a topology.



To load a topology (page 907)



Click Analyze tab ► Drawing Object panel ► Load Topology.



Topology Location options

Select whether to load a topology that is in a source drawing or in the current drawing.

Name

Select the topology to load. If the list does not display the topology you want, be sure you have selected the correct in the Topology Location area. The list of topology names comes from the object data tables. These tables may exist in the current drawing but the topology objects may only exist in the source drawings.

Type

Displays the type of the selected topology.

Description

Displays the description of the selected topology.

Create Topology Objects When Loaded

If the selected topology is from a source drawing, select this check box to copy the topology objects into the current drawing as the topology is loaded. If this option is not selected, the objects are loaded but are not copied into the current drawing.

Select Topology Objects For Save Back

Select this option to add objects in the current drawing to the save back set if they are referenced by the selected topology.

Audit Geometry Of Topology Objects

Select this option to verify that objects for the selected topology are geometrically correct. Any objects that are not correct are highlighted.

Complete Existing Topology Objects

If the selected topology is from the current drawing, select this option to complete any incomplete objects in the topology. Use this option to ensure that the objects in the current drawing are available for topology editing. Map queries all the objects from the source drawings that are required to create a self-contained subset of the topology objects.

Load Topology From Source Drawing dialog box

NOTE This functionality applies only to drawing objects.

Use this dialog to set options when loading a topology from a source drawing.



[To load a topology](#) (page 907)



Click Analyze tab > Drawing Object panel > Load Topology.



Topology Objects

Create Topology Objects When Loaded

If the selected topology is from a source drawing, select this check box to copy the topology objects into the current drawing as the topology is loaded. If this option is not selected, the objects are loaded but are not copied into the current drawing.

Select Topology Objects For Save Back

Select this option to add objects in the current drawing to the save back set if they are referenced by the selected topology. This means that the objects will be saved back to their source drawings and replace the original objects.

Topology Verification

Audit Geometry of Topology Objects

Select this option to verify that objects for the selected topology are geometrically correct. Any objects that are not correct are highlighted.

Network Topology Analysis - Choose Locations dialog box

NOTE This functionality applies only to drawing objects.

Use this dialog box to specify the locations to use for your network analysis.



[To perform a shortest path trace](#) (page 1326)

[To perform a best route analysis](#) (page 1330)

[To perform a flood trace](#) (page 1334)



Click Analyze tab ► Drawing Object panel ► Network Analysis.



When you choose points, AutoCAD Map 3D locates the closest node to the point you select.

- Shortest path — Specify a starting point and ending point.
- Best route — Specify a starting point and one or more visit points.
- Flood trace — Specify a start point only.

Start Point

Select a start point. Click Select Point to select a point in the map. Press Enter to return to this dialog box. All three forms of network analysis require a start point.

Visit Point

Select one or more visit points for best route analysis. Click Select Point to select points in the map. While in the map, click a point to select it. Accept the point, cancel the selected point, or select additional points:

- To accept the point and return to the dialog box, press Enter, or right-click and click Enter.
- To discard the point and return to the dialog box, press ESC, or right-click and click Cancel.
- To accept the point and specify another point, right-click. Click Next Point.

End Point

Selects an end point for a shortest path analysis. Click Select Point to select a point in the map. Press Enter to return to this dialog box.

List of Locations

The points you specify are displayed in the list.

- To see the location of a point in the map, select the coordinates in the list. Click Preview.
- To remove a point from the list, select the coordinates. Click Delete.

Load

Use settings that you previously saved.

Save

Save the current settings so you can use them again.

Cancel

Close the dialog box without performing the network analysis.

Back

Display the previous dialog box.

Next

Display the [Network Topology Analysis - Resistance and Direction dialog box](#) (page 1981).

Finish

Perform the network analysis using the current settings. For a shortest path trace, the Finish is available after you select a start point and an end point. For a flood trace, the Finish is available after you select a start point.

Network Topology Analysis - Output dialog box

NOTE This functionality applies only to drawing objects.

Use this dialog box to view the results of the network analysis onscreen.



[To perform a shortest path trace](#) (page 1326)

[To perform a best route analysis](#) (page 1330)

[To perform a flood trace](#) (page 1334)



Click Analyze tab ► Drawing Object panel ► Network Analysis.



You can specify a name and description for the new topology.

Highlight

Show the results of the analysis on screen using the color specified in the Color.

Color

Select the color you want to use to highlight the results of the analysis in the map. To clear the color when you finish viewing the results in the map, at the Command prompt, enter redrawall.

Create Topology

Create a new topology using the results of the analysis.

Name

Enter a unique name for the new topology. Topology names can contain letters, numbers, and the underscore and hyphen characters.

Description

Enter a description for the new topology.

Load

Use settings that you previously saved.

Save

Save the current settings so you can use them again.

Cancel

Close the dialog box without performing the network analysis.

Back

Display the previous dialog box.

Next

Disabled because this is the last dialog box in the list.

Finish

Perform the network analysis using the current settings. For a shortest path trace, the Finish is available after you select a start point and an end point. For best route analysis, the Finish is available after you select a start point and at least one visit point. For a flood trace, the Finish is available after you select a start point.

Network Topology Analysis - Resistance and Direction dialog box

NOTE This functionality applies only to drawing objects.

Use this dialog box to specify how to determine resistance for links and nodes and to specify how to determine the direction of link objects for the network analysis.



To perform a [shortest path trace](#) (page 1326)

To perform a [best route analysis](#) (page 1330)

To perform a [flood trace](#) (page 1334)



Click Analyze tab ► Drawing Object panel ► Network Analysis.



Direction

Specify how to determine the direction of link objects for the analysis.

Link Direction

Enter a value or enter the location of the data to use to determine the direction of the links. To select the location of the data from a list, click Expression Builder. Select the data to use. You can also enter any valid expression. See [Expression Evaluator](#) (page 1541). If you leave the box blank, bi-directional (0) is used.

If the expression evaluates to...	Link Direction is...
0 or a character	Bi-directional>
A positive number	The physical direction
A negative number	The reverse of the physical direction

Reverse

Select this option to use the reverse of the direction indicated in the Link Direction field.

Resistance

Specify how to determine resistance for links and nodes. Enter the location of the data to use to determine the direct resistance and reverse resistance of link objects and the resistance of nodes. To use values in an object data table or external database, click Expression Builder. Select the data to use. You can also enter any valid expression.

- **Link Direct Resistance** — Specify the resistance to travel in the direction that a link was created. If you leave the box blank, the length of the line (.LENGTH) is used.

- Link Reverse Resistance — Specify the resistance in the opposite direction along a link. If you leave the box blank, the length of the line (.LENGTH) is used.
- Node Resistance — Specify the resistance to cross the node, for example, resistance for a valve in a pipe network, or a junction in a road network. If you leave the box blank, zero (0) is used.
- Specify a minimum and maximum resistance for the trace.

TIP The best route cannot be calculated if the network topology contains negative resistance values or if *all* resistance values equal zero (or use expressions that evaluate to zero). If all resistance values equal zero, every route is as good as another, and there is no "best route."

Load

Use settings that you previously saved.

Save

Save the current settings so you can use them again.

Cancel

Close the dialog box without performing the network analysis.

Back

Display the previous dialog box.

Next

Click to display the [Network Topology Analysis - Output dialog box](#) (page 1980).

Finish

Perform the network analysis using the current settings.

Network Topology Analysis - Select Method dialog box

NOTE This functionality applies only to drawing objects.



Use this dialog box to specify the type of network analysis to perform.



[To perform a shortest path trace](#) (page 1326)

[To perform a best route analysis](#) (page 1330)

[To perform a flood trace](#) (page 1334)

 Click Analyze tab ► Drawing Object panel ► Network Analysis. 

Shortest Path

Calculates the optimal route between two nodes. For example, you could find the shortest distance between an accident site and a hospital. A path trace between the start and end points must have a total resistance of more than the minimum and less than the maximum.

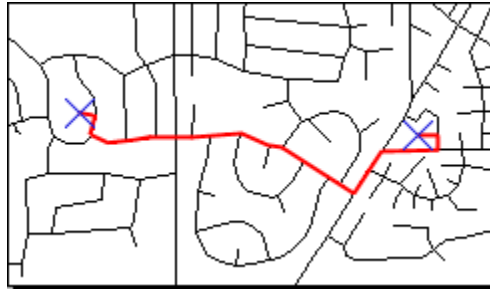

Best Route

Finds the optimal route from a start point, to one or more intermediate points, and back to the start point. The distance between nodes takes into consideration the direction and resistance of intermediate links and nodes.

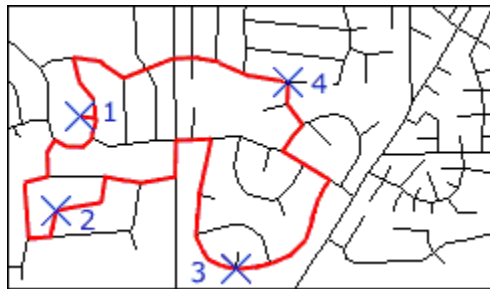

Flood Trace

Shows all possible routes from a chosen node, summing the resistance value of each link and node it travels through. The path stops when the sum reaches the maximum resistance set for the trace. For example, you could create a flood trace of a fifteen-minute travel time from a start point by referencing street length and speed limit.



Load

Use settings that you previously saved.

Save

Save the current settings so you can use them again.

Cancel

Close the dialog box without performing the network analysis.

Back

Disabled because this is the first dialog box in the list.

Next

Click to display the [Network Topology Analysis - Choose Locations dialog box](#) (page 1978).

Finish

Perform the network analysis using the current settings. For a shortest path trace, the Finish is available after you select a start point and an end point. For best route analysis, the Finish is available after you select a start point and at least one visit point. For a flood trace, the Finish is available after you select a start point.

Node Objects dialog box - Network and Polygon Topologies)

NOTE This functionality applies only to drawing objects.

Use this dialog box to select the nodes to include in the topology when you create a topology.



[To create a topology](#) (page 825)



Click Create tab ► Topology panel ► New.



Node information is stored as object data and saved with the map. Each node is given a unique ID number, which is automatically processed whenever you use a topology command.

Select Automatically/Manually options

- Select Automatically selects all objects that meet the object type and filter criteria.
- Select Manually lets you manually select objects for the topology. Click Select < to select objects.

Filter Selected Objects

If this option is selected, only objects that are on the specified layers or blocks are selected. The filters are used for both automatic and manual selection of objects.

If this option is not selected, the filters are ignored.

Layer Filters box

Specify which layers to search for objects to be used for the topology.

Enter an asterisk (*) to search all layers.

To select from a list of layers, click Layers.

Block Filters box

Specify which blocks to search for objects to be used for the topology.

- To search all blocks, enter an asterisk (*).
- To select from a list of block definitions in the drawing set, click Blocks.
- To select point objects, enter ACAD_POINT.

Create Node Objects

Specify whether nodes that are not present in the current object selection should be created to complete the topology. (Nodes are optional.)

Create on Layer box

If new nodes or centroids are created, specify on which layer they should be placed.

To select from a list of layers, click Layers.

Create Using box

If new nodes or centroids are created, specify what block to use to create them.

- To select from a list of block definitions in the drawing set, click Blocks.
- To create nodes or centroids as a point, leave the box blank or enter ACAD_POINT.

Node Objects dialog box (Node topology)

NOTE This functionality applies only to drawing objects.

Use this dialog box to select the nodes to include in the topology when you create a topology.



[To create a topology](#) (page 825)



Click Create tab ► Topology panel ► New.



Node information is stored as object data and saved with the map. Each node is given a unique ID number, which is automatically processed whenever you use a topology command.

Select Automatically/Manually options

- Select all objects that meet the object type and filter criteria automatically.
- Select objects for the topology by hand. Click Select to select objects.

Filter Selected Objects

If this option is selected, only objects that are on the specified layers or blocks are selected. The filters are used for both automatic and manual selection of objects.

If this option is not selected, the filters are ignored.

Layer Filters box

Specify which layers to search for objects to be used for the topology. Enter an asterisk (*) to search all layers.

To select from a list of layers, click Layers.

Block Filters box

Specify which blocks to search for objects to be used for the topology.

- To search all blocks, enter an asterisk (*).
- To select from a list of block definitions in the drawing set, click Blocks.
- To select point objects, enter ACAD_POINT.

Rename Topology dialog box

NOTE This functionality applies only to drawing objects.

Use this dialog box to rename a topology.



To change the name, description, or both of a topology (page 925)



Click Map Setup tab > Topology panel > Rename.



Before you rename a topology, check the following:

- Attach all source drawings that are referenced by the topology. If the source drawings are not attached, you could corrupt your data set.
- Make sure the topology is loaded. The topology needs to be completely represented, either in source files or in the current drawing.
- You cannot rename a topology if there are any queried objects in the current drawing. You must save all queried objects back to their source drawings or detach them from their source drawings before you can rename any topology.
- Be sure the Create Backup File Of Source Drawing option is not selected on the Save Back tab of the [AutoCAD Map Options dialog box](#) (page 1908).
- You cannot undo this rename operation using the UNDO command.

New Name

Enter a new name for the topology. Names can contain letters, numbers, and the underscore and hyphen characters. Names cannot contain spaces.

New Description

Enter a description for the topology.

Select Data dialog box - Topology Overlay

NOTE This functionality applies only to drawing objects. To perform an overlay analysis for geospatial feature data, see [Overlaying Two Feature Sources](#) (page 1309).

Use this dialog box to select the data to attach to the result topology when performing a topology overlay.



[To find sliver polygons when overlaying two topologies](#) (page 843)



Click Analyze tab ► Drawing Object panel ► Object Overlay.



The selected fields and columns are incorporated into a new object data table that is attached to the result topology.

Source Data Area

Select fields and columns. You can combine data from different tables.

To select a field from an object data table, select the Object Data option, and then select the table from the list. In the Available Fields/Columns list, select the fields to use. Click >>.

To select a column from an external database, select the SQL Data option, and then select the link template from the list. In the Available Fields/Columns list, select the columns to use. Click >>.

The Link Template list includes only link templates for the drawing where the topology is loaded. That is, if you loaded the topology from source drawings, the list displays link templates defined in the source drawing; if you loaded the topology from the current drawing, the list displays link templates in the current drawing. In addition, be sure the appropriate data source is attached and connected in the current drawing.

Destination Data Area

Specify a table name and description for the new object data table that will be created for the result topology.

A table name cannot include spaces. It must start with an alphanumeric character. The table name must be unique.

Available Fields/Columns List

Lists the fields in the selected object data table or the selected external database.

To add fields or columns to the new object data table, select them from the list. Click >>.

Selected Fields/Columns List

Lists the fields that will be created in the new object data table. This table can include values from more than one object data table and external database.

Topology Buffer - Create New Centroids and Nodes dialog box

NOTE This functionality applies only to drawing objects. To do a buffer analysis for geospatial feature data, see [Buffering Features in Your Map](#) (page 1306).

Use this dialog box to specify the block to use to create nodes and centroids in the resulting buffer topology.



[To buffer a topology](#) (page 1347)



Click Analyze tab > Drawing Object panel > Object Buffer.



Point Object for Centroid Creation

Specify the block used to represent centroids.

- To select from a list of block definitions in the drawing set, click the down arrow.
- To create centroids from a block saved as a DWG file, click [...] and select the file to use.
- To create centroids as a point, leave the box blank or enter ACAD_POINT.

Point Object for Node Creation

Specify the block used to represent nodes.

- To select from a list of block definitions in the drawing set, click the down arrow.
- To create nodes from a block saved as a DWG file, click [...] and select the file you want to use.
- To create nodes as a point, leave the box blank or enter ACAD_POINT.

Finish

Creates the buffer using the current settings after you specify the buffer distance and enter a valid topology name.

Topology Buffer - New Topology dialog box

NOTE This functionality applies only to drawing objects. To do a buffer analysis for geospatial feature data, see [Buffering Features in Your Map](#) (page 1306).

Use this dialog box to specify settings for viewing the resulting buffer topology onscreen.



[To buffer a topology](#) (page 1347)



Click Analyze tab > Drawing Object panel > Object Buffer.



You can specify the name, description, and layer for the new topology.

Highlight

Show the results of the analysis on screen using the color specified in the Color.

Color

Select the color you want to use to highlight the results of the analysis in the map. To clear the color when you finish viewing the results in the map, at the Command prompt, enter redrawall.

Name

Enter a unique name for the new topology. Topology names can contain letters, numbers, and the underscore and hyphen characters.

Description

Enter a description for the new topology.

Layer

Specify a layer for the new topology. To select from a list of layers in the current drawing, click the down arrow. To create a new layer, type the name in the box.

NOTE Do not specify a locked layer. If you do, AutoCAD Map 3D can complete only part of the buffer process (it can create the buffer geometry but not the buffer topology). To use a locked layer, unlock it first.

Cancel

Close the dialog box without creating a buffer.

Back

Display the previous dialog box.

Next

Click to display the [Topology Buffer - Create New Centroids and Nodes dialog box](#) (page 1990).

Finish

Creates the buffer using the current settings. The Finish is available after you specify the buffer distance and enter a valid topology name.

Topology Buffer - Set Buffer Distance dialog box

NOTE This functionality applies only to drawing objects. To do a buffer analysis for geospatial feature data, see [Buffering Features in Your Map](#) (page 1306).

Use this dialog box to specify the distance from the object to the buffer. The buffer will extend the specified distance from the objects. You can enter a number, an expression, a field in an object data table, or an external database.



[To buffer a topology](#) (page 1347)



Click Analyze tab ► Drawing Object panel ► Object Buffer.



A buffer is a zone that is drawn around a topology. Using a buffer, you can easily identify objects within a specified offset of elements in node, network, and polygon topologies.

Buffer Distance

Enter distance from the object to the buffer. The buffer will extend the specified distance from the objects. To create a buffer inside an existing polygon, enter a negative value for the buffer offset. The buffer offset can be any of the following:

- Numeric value. To decrease the size of existing polygons, enter a negative value.
- An expression that evaluates to a numeric value. For information on valid expressions, see [Expression Evaluator Functions and Variables](#).
- A value in an object data table. Click [Expression Builder](#) to select the table and field.
- A value in an external database. Click [Expression Builder](#) to select the link template and column.

NOTE If you are creating a buffer around a polygon and want to use a value in an object data table or an external database, the data must be attached to the centroid of the polygon.

Expression Builder

Click to select a field in an object data table or an external database from a list of available data.

Next

Click to display the [Topology Buffer - New Topology dialog box](#) (page 1991).

Finish

Creates the buffer using the current settings after you specify the buffer distance and enter a valid topology name.

Topology Dissolve - Create New Centroids and Nodes dialog box

NOTE This functionality applies only to drawing objects.

Use this dialog box to specify the block to use to create nodes and centroids in the resulting dissolve topology.



[To dissolve a composite topology](#) (page 1343)



Click Analyze tab ► Drawing Object panel ► Dissolve.



Point Object for Centroid Creation

Specify the block used to represent centroids.

- To select from a list of block definitions in the drawing set, click the down arrow.
- To create centroids from a block saved as a DWG file, click Browse. Select the file to use.
- To create centroids a point, leave the box blank or enter ACAD_POINT.

Point Object for Node Creation

Specify the block used to represent nodes.

- To select from a list of block definitions in the drawing set, click the down arrow.
- To create nodes from a block saved as a DWG file, click Browse. Select the file to use.
- To create nodes as a point, leave the box blank or enter ACAD_POINT.

Cancel

Close the dialog box without performing the dissolve.

Back

Display the previous dialog box.

Next

Disabled because this is the last dialog box in the list.

Finish

Dissolves the topology using the current settings. The Finish is available after you specify the dissolve parameter and enter a valid topology name.

Topology Dissolve - Create Nodes dialog box

NOTE This functionality applies only to drawing objects.

Use this dialog box to specify whether or not to create new nodes at the endpoints of links where they are missing in the resulting dissolve topology. If so, you specify the block to use to create the nodes.



To dissolve a composite topology (page 1343)



Click Analyze tab > Drawing Object panel > Dissolve.



Create New Nodes For Topology

Select this check box to create new nodes as needed at the endpoints of links in the resulting topology. This is optional, but can be useful if you are going to analyze the resulting topology later on.

Point Object for Node Creation

Specify the block used to represent nodes.

- To create nodes using a block defined in the drawing set, click the down arrow and select a block from the list.
- To create nodes using a block saved as a DWG file, click Browse. Select the file to use. This inserts the entire DWG as a single block.
- To create nodes as a point, select ACAD_POINT.

Cancel

Close the dialog box without performing the dissolve.

Back

Display the previous dialog box.

Next

Disabled because this is the last dialog box in the list.

Finish

Dissolves the topology using the current settings. The Finish is available after you specify the dissolve parameter and enter a valid topology name.

Topology Dissolve - New Topology dialog box

NOTE This functionality applies only to drawing objects.

Use this dialog box to specify settings for viewing the resulting dissolve topology onscreen.



[To dissolve a composite topology](#) (page 1343)



Click Analyze tab ► Drawing Object panel ► Dissolve.



You can specify the name, description, and layer for the new topology.

Highlight

Show the results of the analysis on screen using the color specified in the Color.

Color

Select the color you want to use to highlight the results of the analysis in the map. To clear the color when you finish viewing the results in the map, at the Command prompt, enter redrawall.

Name

Enter a unique name for the new topology. Topology names can contain letters, numbers, and the underscore and hyphen characters.

Description

Enter a description for the new topology.

Layer

Specify a layer for the new topology. To select from a list of layers in the current drawing, click the down arrow. To create a new layer, type the name in the box.

Cancel

Close the dialog box without performing the dissolve.

Back

Display the previous dialog box.

Next

Click to display the [Topology Dissolve - Object Data dialog box](#) (page 1997).

Finish

Dissolves the topology using the current settings. The Finish is available after you specify the dissolve parameter and enter a valid topology name.

Topology Dissolve - Object Data dialog box

NOTE This functionality applies only to drawing objects.

Use this dialog box to create or specify the result table (the object data table that will store the dissolve result field data).

You can reference an existing object data table or define a new one. The dissolve field can be an object data variable or any expression.



[To dissolve a composite topology](#) (page 1343)



Click Analyze tab > Drawing Object panel > Dissolve.



The dissolve operation starts with a single item and "joins" all adjacent objects that share the same value for this item. The resulting topology data includes only the field used to perform the dissolve.

For example, you could perform a dissolve operation on a map of zip code boundaries that reference a county name as a data field. Dissolving the zip codes by county results in the county boundaries as a geometry. The result data holds the county name. In that case, the result table stores the result field consisting of the county name.

Object Data Table

Select an object data table from the list of tables in the current drawing.

Object Data Field

Select a field from the list of fields in the selected table. To add a new field, click Define.

Define

Click to add a new object data field.

Finish

Dissolves the topology using the current settings after you specify the dissolve parameter and enter a valid topology name.

Topology Dissolve - Set Parameter dialog box

NOTE This functionality applies only to drawing objects.

Use this dialog box to select the data on which to base the dissolve.



[To dissolve a composite topology](#) (page 1343)



Click Analyze tab ► Drawing Object panel ► Dissolve.



When you perform a dissolve, you create a new topology by combining polygons that share the same data value in a specified field. This field is called the dissolve field. The dissolve field can be an object data field or a column in a linked external database.

Dissolve By

Select the data on which to base the dissolve. This is often referred to as the dissolve field.

- To use object data or data in an external data base, click Expression Builder. Select the data to use.
Note that the Dissolve command uses only data that is attached or linked to the centroid of the polygon. It does not use data attached to a polygon border.
- You can also enter any valid expression. See [Expression Evaluator](#) (page 1541).

Any two adjacent polygons or connected lines that have the same value for this field are combined into a single polygon or line.

Cancel

Close the dialog box without performing the dissolve.

Back

Disabled because this is the first dialog box in the list.

Next

Click to display the [Topology Dissolve - New Topology dialog box](#) (page 1996).

Finish

Dissolves the topology using the current settings. The Finish is available after you specify the dissolve parameter and enter a valid topology name.

Topology Overlay Analysis - Analysis Type dialog box

NOTE This functionality applies only to drawing objects. To do an overlay analysis for geospatial feature data, see [Overlaying Two Feature Sources](#) (page 1309).

Use this dialog box to select the type of overlay analysis to perform: Intersect, Union, Identity, Erase, Clip, or Paste.



[To find sliver polygons when overlaying two topologies](#) (page 843)



Click Analyze tab ► Drawing Object panel ► Object Overlay.



To overlay topologies, both must be loaded into the current drawing. Click

Analyze tab ► Drawing Object panel ► Load Topology.



Overlay Analysis Operations

Select an overlay operation:

- Intersect – Only areas that appear in both the source and overlay topologies are in the result topology.

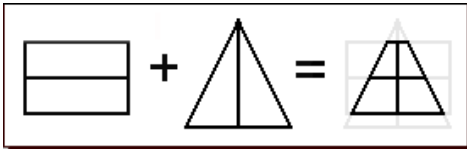

Source Overlay Result

- Union – Areas that appear in either the source or the overlay topologies are in the result topology.

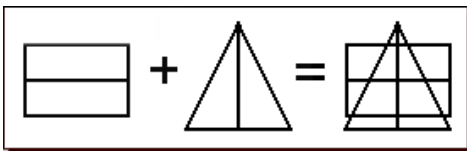

Source Overlay Result

- Identity – The result topology includes areas that appear in the source topology and areas in the overlay topology that are within the source topology boundary.

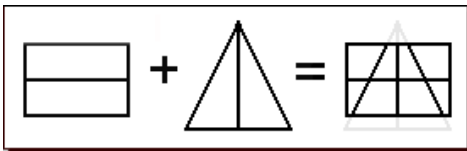

Source Overlay Result

- Erase – The result topology includes areas that appear in the source topology except where it is covered by the overlay topology. The area covered by the overlay topology is erased from the source topology area.

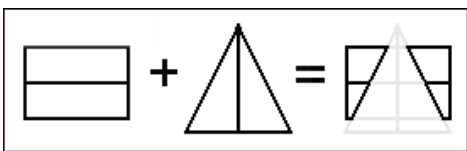

Source Overlay Result

- Clip – The result topology includes areas that appear in the source topology except where they are outside the boundary of the overlay topology. The source topology is clipped to the outer boundary of the overlay topology.

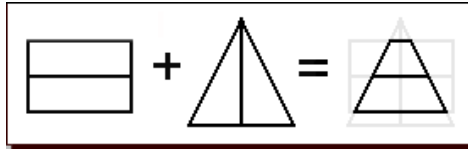

Source Overlay Result

- Paste – The overlay topology is "pasted" on the source topology. The result topology includes the overlay topology and any areas of the source topology that extend beyond the boundaries of the overlay topology.

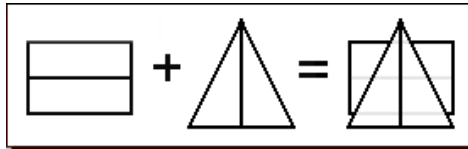

Source Overlay Result

Load

Use settings that you previously saved.

Save

Save the current settings so you can use them again.

Cancel

Close the dialog box without performing the topology overlay analysis.

Back

Disabled because this is the first dialog box in the list.

Next

Click to display the [Topology Overlay Analysis - Select Overlay Topology dialog box](#) (page 2007).

Finish

Perform the topology overlay using the current settings. The Finish is available after you select the overlay topology and enter a valid topology name for the resulting topology.

Topology Overlay Analysis - Create New Centroids and Nodes dialog box

NOTE This functionality applies only to drawing objects. To do an overlay analysis for geospatial feature data, see [Overlaying Two Feature Sources](#) (page 1309).

Use this dialog box to specify the block to use to create nodes and centroids in the resulting overlay topology.



To find sliver polygons when overlaying two topologies (page 843)



Click Analyze tab ► Drawing Object panel ► Object Overlay.



Point Object for Centroid Creation

Specify the block used to represent centroids.

- To create centroids using a block defined in the drawing set, click the down arrow and select a block from the list.
- To create centroids using a block saved as a DWG file, click Browse. Select the file to use. This inserts the entire DWG as a single block.
- To create centroids as a point, select ACAD_POINT.

Point Object for Node Creation

Specify the block used to represent nodes.

- To create nodes using a block defined in the drawing set, click the down arrow and select a block from the list.
- To create nodes using a block saved as a DWG file, click Browse. Select the file to use. This inserts the entire DWG as a single block.
- To create nodes as a point, select ACAD_POINT.

Load

Use settings that you previously saved.

Save

Save the current settings so you can use them again.

Cancel

Close the dialog box without performing the topology overlay.

Back

Display the previous dialog box.

Next

Disabled because this is the last dialog box in the list.

Finish

Perform the topology overlay using the current settings. The Finish is available after you select the overlay topology and enter a valid topology name for the resulting topology.

Topology Overlay Analysis - Create Nodes dialog box

NOTE This functionality applies only to drawing objects. To do an overlay analysis for geospatial feature data, see [Overlaying Two Feature Sources](#) (page 1309).

Use this dialog box to specify whether or not to create new nodes at the endpoints of links where they are missing in the resulting overlay topology. If so, you specify the block to use to create the nodes.



[To find sliver polygons when overlaying two topologies](#) (page 843)



Click Analyze tab ► Drawing Object panel ► Object Overlay.



Create New Nodes For Topology

Select this check box to create new nodes as needed at the endpoints of links in the resulting topology. This is optional, but can be useful if you are going to analyze the resulting topology later on.

Point Object for Node Creation

Specify the block used to represent nodes.

- To create nodes using a block defined in the drawing set, click the down arrow and select a block from the list.
- To create nodes using a block saved as a DWG file, click Browse. Select the file to use. This inserts the entire DWG as a single block.
- To create nodes as a point, select ACAD_POINT.

Load

Use settings that you previously saved.

Save

Save the current settings so you can use them again.

Cancel

Close the dialog box without performing the topology overlay.

Back

Display the previous dialog box.

Next

Disabled because this is the last dialog box in the list.

Finish

Perform the topology overlay using the current settings. The Finish is available after you select the overlay topology and enter a valid topology name for the resulting topology.

Topology Overlay Analysis - Output Topology dialog box

NOTE This functionality applies only to drawing objects. To do an overlay analysis for geospatial feature data, see [Overlaying Two Feature Sources](#) (page 1309).

Use this dialog box to specify settings for viewing the resulting overlay topology onscreen.



[To find sliver polygons when overlaying two topologies](#) (page 843)



Click Analyze tab ► Drawing Object panel ► Object Overlay.



You can specify the name, description, and layer for the new topology.

Highlight

Show the results of the analysis on screen using the color specified in the Color.

Color

Select the color you want to use to highlight the results of the analysis in the map. To clear the color when you finish viewing the results in the map, at the Command prompt, enter redrawall.

Name

Enter a unique name for the new topology. Topology names can contain letters, numbers, and the underscore and hyphen characters.

Description

Enter a description for the new topology.

Layer

Specify a layer for the new topology. To select from a list of layers in the current drawing, click the down arrow. To create a new layer, type the name in the box.

Load

Use settings that you previously saved.

Save

Save the current settings so you can use them again.

Cancel

Close the dialog box without performing the topology overlay.

Back

Display the previous dialog box.

Next

Click to display the [Topology Overlay Analysis - Output Attributes dialog box](#) (page 2006)

Finish

Perform the topology overlay using the current settings. The Finish is available after you select the overlay topology and enter a valid topology name for the resulting topology.

Topology Overlay Analysis - Output Attributes dialog box

NOTE This functionality applies only to drawing objects. To do an overlay analysis for geospatial feature data, see [Overlaying Two Feature Sources](#) (page 1309).

Use this dialog box to select the data to attach to the result topology when performing a topology overlay.



To find sliver polygons when overlaying two topologies (page 843)



Click Analyze tab > Drawing Object panel > Object Overlay.



The selected fields and columns are incorporated into a new object data table that is attached to the result topology.

Source Attributes for New Topology

To copy data from the source topology to the result topology, click Expression Builder. In the Expression Chooser dialog box, select the object data fields or external database columns to copy.

Overlay Attributes for New Topology

To copy data from the overlay topology to the result topology, click Expression Builder. In the Expression Chooser dialog box, select the object data fields or external database columns to copy.

Expression Builder s

Click to display the Expression Chooser dialog box, where you can select the data to include in the resulting topology.

New Object Data Table Name

Enter a name for the object data table that will store the data in the new topology. The Table Name should be a new name.

New Table Description

Enter a description for the new object data table in the resulting topology.

Load

Use settings that you previously saved.

Save

Save the current settings so you can use them again.

Cancel

Close the dialog box without performing the topology overlay.

Back

Display the previous dialog box.

Next

Click to display the next dialog box. Next is disabled if your source topology is a node topology.

Finish

Perform the topology overlay using the current settings. The Finish is available after you select the overlay topology and enter a valid topology name for the resulting topology.

Topology Overlay Analysis - Select Overlay Topology dialog box

NOTE This functionality applies only to drawing objects. To do an overlay analysis for geospatial feature data, see [Overlaying Two Feature Sources](#) (page 1309).

Use this dialog box to select the polygon topology to use as the overlay topology.



To find sliver polygons when overlaying two topologies (page 843)



Click Analyze tab > Drawing Object panel > Object Overlay.



Polygon Topology to Overlay

Select the polygon topology to use as the overlay topology.

Load

Use settings that you previously saved.

Save

Save the current settings so you can use them again.

Cancel

Close the dialog box without performing the topology overlay.

Back

Display the previous dialog box.

Next

Click to display the [Topology Overlay Analysis - Output Topology dialog box](#) (page 2004).

Finish

Perform the topology overlay using the current settings. The Finish is available after you select the overlay topology and enter a valid topology name for the resulting topology.

Topology Query dialog box

NOTE This functionality applies only to drawing objects.

Use this dialog box to execute topology relationship queries using the following tools.



[To query a topology](#) (page 1353)



Click Create tab ► Topology panel ► Define Query.



Query Topology area

Select the topology to query.

If the topology is not loaded, click Load and select the topology you want.

Result Topology area

Select a result topology type.

None

Objects are retrieved into the current drawing, but no topology data is created.

Temporary

Objects are retrieved into the current drawing, and the topology data is loaded into memory. This data is not saved to the objects.

You can use a temporary topology with the following commands: Buffer, Dissolve, Overlay, Trace, Unload, Rename, Statistics, and Delete. You cannot edit a temporary topology.

As soon as you close the current drawing, the temporary topology is removed from memory.

Click Map Setup tab ► Topology panel ► Rename.  Specify a name without an asterisk.

Permanent

Objects are retrieved into the current drawing, and a new topology is created. If you create a temporary or permanent topology, specify a name and description for the topology.

Topology names can contain letters, numbers, and the underscore and hyphen characters. For temporary topologies, the name must begin with an asterisk (*).

Define Query

Display the [Define Query dialog box](#) (page 1838), where you can create a query by defining conditions.

The dialog box you use for a topology query is the same as for a standard query using the ADEQUERY command, except for the Property option in the Query Type area.

Load Query

Display the [Load Internal Query dialog box](#) (page 1848), where you can select an existing query to load.

When you choose Define Topology Query, you use the same dialog boxes as you do for a standard query. The dialog box options are the same for topology queries and standard queries using the ADEQUERY command, except for choices in the Property option in the Query Type area.

Topology and standard queries differ in the following ways:

- Topology queries work with only one topology, while standard queries work with all objects in the attached drawings. Use a topology query when working only with topologies, or when to select one topology or query.

- You can base topology property queries on polygon values of Area, Length, Perimeter, and Direction. Linear objects also have predefined object data for Direct Resistance and Direction.
- Property alterations work differently with polygon topologies.
- For Report mode, additional dot variables, .TOPONAME, and .TOPOTYPE, are available for topology queries. The dot variables .DRAWING, AREA, and .PERIMETER yield different results in topology queries.

Topology Query Result dialog box

NOTE This functionality applies only to drawing objects.

Use this dialog box to specify the type of topology to create with the queried objects. If you create a temporary or permanent topology, specify a name and description for the topology.



[To query a topology](#) (page 1353)



Click Create tab ► Topology panel ► Define Query.



Topology names can contain letters, numbers, and the underscore and hyphen characters. For temporary topologies, the name must begin with an asterisk (*).

None

Objects are retrieved into the current drawing, but no topology data is created.

Temporary

Objects are retrieved into the current drawing, and the topology data is loaded into memory. This data is not saved to the objects.

You can use a temporary topology with the following commands: Buffer, Dissolve, Overlay, Trace, Unload, Rename, Statistics, and Delete. You cannot edit a temporary topology.

As soon as you close the current drawing, the temporary topology is removed from memory.

Click Map Setup tab ► Topology panel ► Rename.  Specify a name without an asterisk.

Permanent

Objects are retrieved into the current drawing, and a new topology is created.

Topology Selection dialog box

NOTE This functionality applies only to drawing objects.

Use this dialog box to select a topology.



[To load a topology](#) (page 907)

[To unload a topology](#) (page 908)

[To audit, recreate, or complete a topology](#) (page 920)

[To delete a topology](#) (page 926)



Click Analyze tab ► Drawing Object panel ► Load Topology.



Click a topology and click OK.

If the topology you want is not listed, check the following:

- If you are selecting a topology to rename, unload, view statistics, audit, etc., it may not be listed because it has not been loaded yet.
- If you are selecting a topology to load, it may not be listed because it's already loaded.

Topology Statistics dialog box

NOTE This functionality applies only to drawing objects.

Use this dialog box to view information about the selected topology.



[To view topology statistics](#) (page 916)



Click Map Setup tab ► Topology panel ► Statistics.



Selected Topology area

Name

Displays the name of the current topology.

Description

Displays the description of the topology.

Type

Displays the type of topology. Topologies can be Node, Network, or Polygon.

Extents area

This area displays the coordinates of the lower-left corner and upper-right corner of the bounding rectangle for the selected topology.

Object Counts area

This area displays the total number of nodes, links, and polygons in the selected topology.

Details area

This area displays area and perimeter information for polygon topologies, and length information for network topologies. It does not apply to node topologies.

Perimeter is the sum of all of the edges in a polygon topology (not just the outer edge of the topology).

Variance is the average of the squares of any given area, perimeter, or length minus the square of the average.

Deviation is the square root of variance.

Viewing Dialog Boxes

39

Quick View Drawings dialog box

Use this dialog box to select drawings to include in the Quick View.



To view objects in source drawings (page 746)



Click Map Setup tab > Map panel > Quick View Drawings.



NOTE This functionality is for drawing objects only. To bring geospatial feature data into your map, see [Overview of Bringing In GIS Features](#) (page 305).

Quick View displays all objects in the selected active source drawings. You can zoom and pan, but you cannot edit the objects. When you regenerate or redraw, the objects are cleared from the current drawing.

Select Active Drawings to Quick View

Lists all active drawings attached to the current drawing. Click the drawing to view. Use Select All and Clear All to quickly highlight or remove highlighting from all drawings in the list.

Filters

Turns the current drawing filter on or off. When the filter is on, only drawings that match the filter are displayed. If the parent drawing of a nested drawing is filtered, the nested drawing is not displayed, even if it matches the filter.

Filters

Displays the Drawing Set Display Filter dialog box, where you can create or change the filters for file names and descriptions.

Zoom to the Extents of Selected Drawings

Zoom the current drawing to the extents of the selected source drawings.

Zoom Drawing Extents dialog box

Use this dialog box to zoom to the extents of a set of drawings.



To zoom to the extents of selected drawings (page 745)



Click Map Setup tab ► Map panel ► Zoom Drawing Extents.



NOTE You can also zoom to the extents of the current drawing from the View tab on the ribbon, or to the extents of a specific Display Manager layer by right-clicking the layer and clicking Zoom To Extents.

Select the drawings you want. Click OK. The display zooms to the extents of the selected drawings. Drawing extents are the bounds of the area occupied by objects.

Select Active Drawings to Zoom list

Lists all active drawings attached to the current drawing.

Select the drawings to use to define the extents.

Select All

Highlight all drawings in the list.

Clear All

Remove the highlighting from all drawings in the list.

Filter

Select Filter to turn the current drawing filter on or off.

When the filter is on, only drawings that match the filter are displayed. If the parent drawing of a nested drawing is filtered, the nested drawing is not displayed, even if it matches the filter.

To create or change the filter, click Filter. In the [Drawing Set Display Filter dialog box](#) (page 1922), you can create separate filters for file names and descriptions.

Define Document View dialog box

Use this dialog box to define a document view to view external documents attached to an object.



At the Command prompt, enter adedefdocview.

NOTE This functionality is for drawing objects only. To see database information linked to geospatial features, see [Overview of Joins](#) (page 507).

To create a new document view, enter a new name in the Name field. Specify the location of the document name, the document type, and the application to use to display the document, and click Add.

To modify an existing document view, select it in the list. Enter new information in the Document View Definition section, and click Update.

Document view definitions are stored in the current drawing and not in the source drawings.

Document View Definitions

Displays the document views defined in this drawing.

To modify a view, select it and edit the information that appears in the Document View Definition section.

Delete

Delete the selected document view definition.

NOTE If you have associated documents that use this view, be sure to define a new view for those documents.

Delete All

Delete all document views in the list.

NOTE If you have associated documents that use these views, be sure to define new views for those documents.

Name

Enter a name for a new document view.
Names cannot contain spaces.

Description

Enter a description for the document view.

Expression

Enter information on where to find the name of the document associated with an object:

- If the name of the associated document is stored in an object data table, click Expression and select the table and field that contains the document name.
When you attach a record from this object data table to an object, the document listed in the specified field will be associated with the object.
- If the name of the associated document is stored in an external database, click Expression and select the link template and column.
When you attach a record from this database to an object, the document listed in the specified column will be associated with the object.
- If the name of the associated document is stored elsewhere, for example, by giving the document the same name as the layer the object is on, enter an expression that specifies the location of the document name. For information on valid expressions, see [Expression Evaluator](#) (page 1541).
- You can type the name of a specific file. This file is then associated with every object.

Directory

Enter the directory where documents for this view are stored.
If you are unsure of the location, click [...] to locate the directory.

Ext

Enter the three-letter file extension for documents using this view.
For example, if you are creating a view for Word documents, enter doc. If the data attached to an object specifies a file name and extension, the extension in this field is ignored. If the data attached to the object does not specify the extension, AutoCAD Map 3D uses the extension in the field when searching for the document.

Command Line

Enter the command to run the associated application.

For example, if you are creating a view for a Word document, enter the path and file name for the Word program file.

If you are unsure of the location, click [...] to search your directories and locate the application file.

Launch Method

Select a launch method.

- Select Default if the application specified for Command Line is a Windows application.
- Select User if the application specified for Command Line is an ARX application. Enter the name of the viewing function. The function must be defined in the ARX application and made available through the use of `acedDefun()`. AutoCAD Map 3D uses `acedInvoke()` to access the user-defined function. For more information about `acedDefun()`, `acedInvoke()`, or on how to create ARX applications, refer to the AutoCAD Object ARX online help.

If you are unsure, select Default.

Define Key View dialog box

Use this dialog box to specify which layers are displayed at different key view zoom levels. For example, you can display fewer layers when zoomed out, but display complete details when zoomed in.



At the Command prompt, enter `adedefkeyview`.

NOTE This functionality is for drawing layers only. To specify styling options at different zoom levels for geospatial feature layers, see [Defining Scale Ranges](#) (page 643).

To add a new condition, enter a drawing window width and specify the layers to display at that width. Click Layers to select from a list of the layers in the active drawings. When you finish, click Add.

To modify an existing condition, select the condition to modify and click Edit. Add or delete layers. When you finish, click Update.

Key views are saved with the current drawing and apply to layers in the current drawing and all active drawings.

Current Key View Definition List

Display the drawing window width conditions defined in this drawing.

Edit

Copy the selected condition to the bottom of the screen, where you can change the width and add or remove layers.

Delete

Delete the selected condition.

Clear List

Delete all conditions.

Width > box

Enter the width to define.

The width is the distance across the drawing window as measured in drawing units. The more you zoom in, the smaller this number is.

TIP Before you use the ADEDEFKEYVIEW command, use the DISTANCE command to measure the width of the window at the zoom magnifications you want to define.

Show Only These Layers box

Specify the layers to display when the drawing window displays a greater width than specified in the Width box. Separate layer names with a comma. Click Layers to select from a list of layers in the active drawings. You can use wild-card characters to specify a set of layers.

Layers

Display a list of layers in the active drawings. Select the layers to display at the specified window width.

Whenever the number of drawing units displayed in the drawing window becomes greater than a defined key view condition, AutoCAD Map 3D displays the layers specified for that condition.

When you use key views, AutoCAD Map 3D previews the specified layers from source drawings. Objects already in the current drawing are not affected by key views.

Document View dialog box

More than one document is associated with the object you selected. Select the document type you want from the list. Click View.



At the Command prompt, enter adedocview.

NOTE This functionality is for drawing objects only.

Select Document View list

Lists the document types for this object. Select a document type. Click View to start the associated application and view the associated document.

Select Object

Select a new object and view its associated documents.

View

View the document associated with the selected document type.

Key View dialog box

Select a zoom level or pan the current zoom. AutoCAD Map 3D previews objects from source drawings for only the key view layers specified for the selected magnification. Objects already in the current drawing are not affected by key views.



At the Command prompt, enter adekeyview.

NOTE This functionality is for drawing layers only. To specify styling options at different zoom levels for geospatial feature layers, see [Defining Scale Ranges](#) (page 643).

Zoom Window

Zoom to a window that you specify onscreen, showing only the key layers for that magnification.

Zoom Previous

Zoom to the previous view, showing only the key layers for that magnification.

Zoom Extents

Zoom to the extents of all active drawings, showing only the key layers for that magnification.

Zoom Out

Zoom out .8x, showing only the key layers for that magnification.

Pan

Pan the current view using one of these methods:

Displacement

At the first prompt, specify the displacement. At the second prompt, press Enter. The drawing moves by the amount you specified.

Points

At the first prompt, specify a point. At the second prompt, specify a new point. The drawing moves so the first point is moved to the location of the second point.

Redisplay

View the selected layers for the current magnification.

MAPWORKFLOWOPEN

Opens the specified saved workflow for the current map. Open workflows appear in the list in the Workflow panel on the Tools tab. Workflows in this list are available to run or edit.



[To create a workflow](#) (page 287)

MAPWORKFLOWRUN

Runs the specified workflow. You must save the current workflow to run it. If the workflow has already been saved, you must open it to run it. To open a workflow, click its name in the list in the Workflow panel on the Tools tab. Click Open Workflow From File in this list to open a workflow that does not already appear in the list.



[To run a workflow](#) (page 278)

NOTE Use the MapWorkflowBatchRun command to open and run a workflow file from within a script file. This is useful for executing automated workflows.

Workflow Designer

Use the Workflow Designer to create or edit a workflow. The name of the current workflow appears in the title bar.



[To edit a workflow](#) (page 284)

[To create a workflow](#) (page 287)



Click Tools tab ► Workflow panel ► Edit.



Workspace Controls

The tools at the top of the Workflow Designer control the appearance of the design space. They provide clipboard functions for activities, and let you open, save, and print workflows.



New

Create a workflow definition.

Open

Open an existing workflow. The Open dialog box displays the location of the most recently opened workflow.

Save

Save the current workflow. Workflows are saved with a *.xoml* extension. You must save a workflow before you can run it.

Save As

Save the current workflow with a new name. You can alter some activity parameters to save different versions of a workflow, for example, to overlay different features.

Print

Print the diagram for the current workflow as it appears in the design space. Expand any activities that are closed if you want them to appear in the printout.

Undo/Redo

Reverse or reinstate changes you have made to workflow activities. You can undo back to the first change you made during the current workflow editing

session. However, you cannot undo changes to parameter settings in input editors.

Cut/Copy/Paste

Use a workflow clipboard to cut, copy, and paste activities. You can copy an activity from one workflow and paste it into another workflow.

Run

Run the current workflow. If you have unsaved changes, you are prompted to save them. Running a workflow from within Workflow Designer validates each step. A green check mark appears if the activity is successful. An exclamation mark appears if a parameter is missing or invalid. A red X appears if the activity fails.

Pan/Magnify/Show The Entire Workflow

Change the display of the workflow within the Workflow Designer design space.

You can also click  to fit the workflow in the design space.

Show/Hide Activities Panel

Display or hide the panel that lists the activities you can add to a workflow.

Show/Hide Properties Panel

Display or hide the panel that shows the parameter values for the selected activity.

Refresh Design Surface

Redisplay the workflow.

Help

Display this Help topic.

Activities Panel

The panel at the right side of the Workflow Designer window contains all activities that you can add to a workflow. For a list of these activities, see [Workflow Activity Input dialog boxes](#) (page 2025).

Workflow Design Space

The area containing the activities for the current workflow is the design space.



Place activities below this icon. It is the starting point for the workflow.

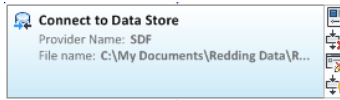

Workflow Activities

Double-click an activity box to see its parameters. Each activity box displays the following:

- An icon indicating whether it is a command, a layer, a description, or a link to another workflow.
- The activity title (by default, the name of the activity in the Activities Panel). All activities have an optional Display Name property. If you change that property, the new name appears.
- Parameters. To change the parameters, double-click the activity box or click . See [Workflow Activity Input dialog boxes](#) (page 2025).
- Command panel. Hover over an activity box to see its command panel. You can delete, disable, or enable any activity. You can edit parameters and toggle the prompt that allows you to replace parameters at run time.

NOTE Drag and drop activities to rearrange them. To move multiple activities at a time, hold down the Shift key and drag a selection box around the activities. Then hold down the Shift key and drag to the new location.



Place activities above this icon. It is the end point for the workflow.

Settings Panel

In the Settings panel, you can view and edit values for the parameters of the current activity. To show or hide the Settings panel for the selected activity,

click .

Status Area

The area at the bottom of the Workflow Designer window is the status area.

Workflow Status

While a workflow is running, the Workflow Status displays the command that is executing and any errors that occur. When the workflow is finished executing, click the Workflow Status link to open the log window.

Workflow Activity Input dialog boxes

Use the workflow activity input dialog boxes to specify or change the parameters for a workflow activity.



[To edit a workflow](#) (page 284)
[To create a workflow](#) (page 287)



Click Tools tab ► Workflow panel ► Edit.



The Workflow Designer includes activity dialog boxes for the following activities. For detailed information about utility activities, see the Windows Workflow Foundation documentation.

Utility Activities

Insert activities that are not AutoCAD Map 3D-specific. These activities include:

Describe Directory

Loops through all the files in a specified folder, allowing you to execute an operation on each one. You can include a filter definition to select a subset of files.

For Each

(Beta) Loops through a set of retrieved objects to perform an operation on each of them. For example, save each retrieved feature layer to an SDF file. In the Windows Workflow Foundation, this activity is called Replicator. Do not use this option unless you have experience in C# programming or Microsoft workflow technology. To set parameters for this activity, click



in the Workflow Designer toolbar. In the Properties palette that displays, click the cell for the parameter to set. Click the browse button that appears to select parameters from a list, if available.

If Else

(Beta) Selects a statement for execution based on the value of a Boolean expression. Do not use this option unless you have experience in C# programming or Microsoft workflow technology. To set parameters for this

activity, click  in the Workflow Designer toolbar. In the Properties palette that displays, click the cell for the parameter to set. Click the browse button that appears to select parameters from a list, if available.

Parallel

Activities that enclose sets of serial activities. Each set can run independently of the other. For example, when adding connection activities, add them inside a parallel activity. That way, if one connection fails, others can still execute.

Prompt User

Specifies a Yes/No dialog box to display at this point in the run-time workflow. For example, you can create a prompt whose title bar reads “Warning,” and contains the text: “The workflow will now convert your SHP files to SDF format. Continue?”

Sequence

Activities that enclose sets of activities. Each set is performed in sequence, and if one activity in the sequence fails, the others cannot execute. For example, if a connection fails, a subsequent layer-creation activity that requires that connection cannot execute.

While

(Beta) Executes a statement or a block of statements until a specified expression evaluates to false. Do not use this option unless you have experience in C# programming or Microsoft workflow technology. To set

parameters for this activity, click  in the Workflow Designer toolbar. In the Properties palette that displays, click the cell for the parameter to set. Click the browse button that appears to select parameters from a list, if available.

AutoCAD Map 3D Activities

Insert AutoCAD Map 3D-specific activities. Click the activity name listed here to see a full description of its parameters.

- [Add Feature Layer](#) (page 2028): Creates a Display Manager layer using the specified data store connection. For an overlay that specifies feature layers, you must include this activity.
- [Add Group](#) (page 2029): Creates a group with the specified name.
- [Add Map](#) (page 2030): Adds the specified display map to the current map file. You can change the display to show the new map.
- [Change Feature Layer Properties](#) (page 2030): Changes certain properties for the specified layer.

- [Change Feature Layer Symbol](#) (page 2031): Sets the styling parameters for the specified feature layer.
- [Change Group Properties](#) (page 2033): Changes the visibility, name, and parent group of a specified group in the Display Manager.
- [Connect To Data Store](#) (page 2034): Connects to the specified data store but does not add data to the map. For an overlay that specifies feature classes, rather than layers, this activity is sufficient (you do not have to create a layer).
- [Create Buffer Layer](#) (page 2036): Analyzes features by proximity. Specify a geospatial feature in your map and the distance for the buffer. AutoCAD Map 3D creates a polygon around the feature or features you have selected at the distance you specify. It saves the buffer polygon to a new layer.
- [Display Feature Attributes](#) (page 2037): Displays the Data Table for the specified feature and selection set.
- [Highlight Features/Remove Highlighting](#) (page 2038): Highlights specified features in the map (or removes highlighting from any features that are already highlighted).
- [List Current Connections](#) (page 2039): Lists the names of connections in the current map. You cannot specify parameters for this activity, other than a Display Name.
- [List Feature Classes](#) (page 2039): Lists the feature classes for the specified data store connection in the current map.
- [List Feature Layer Properties](#) (page 2040): Lists the name of the specified layer in Display Manager, as well as any group it belongs to.
- [Load Layer File](#) (page 2040): Adds a saved *.layer* file to the map. When you load a *.layer* file, AutoCAD Map 3D adds the source file to Map Explorer, creates the connection, adds the feature layer to the Display Manager, and styles the layer correctly.
- [Perform Overlay](#) (page 2041): Compares the spatial relationship of two layers or feature classes.
- [Remove Connection](#) (page 2043): Removes the specified connection to a data source.
- [Remove Feature Layer](#) (page 2044): Removes the specified feature layer.
- [Remove Group](#) (page 2044): Removes the specified group.

- **Remove Map:** Deletes the specified display map from the current map file.
- **Rename Map:** Specifies a different name for the specified display map.
- **Run AutoCAD Command** (page 2046): Executes any AutoCAD command-line instruction supported by AutoCAD Map 3D. If the command requires a selection set or displays a dialog box, the workflow pauses (during run time) to allow for selection or input.
- **Run Workflow** (page 2047): Invokes another workflow at this point in the current workflow.
- **Save Layer File** (page 2048): Saves a Display Manager layer to a *.layer* file. You can save layers from all display maps in your map file.
- **Select Features** (page 2049): Selects individual features in the current display map. You can select the features by layer, by location, or by prompting for a manual selection at workflow run time.
- **Switch Map** (page 2050): Changes the current display to the specified display map.
- **Zoom To Extents** (page 2050): Zooms to the extents of the specified target.

Add Feature Layer

This [Workflow Designer activity](#) (page 2025) creates a Display Manager layer using the specified data store connection. For an overlay that specifies feature layers, you must include this activity.



[To edit a workflow](#) (page 284)

[To create a workflow](#) (page 287)



Click Tools tab ► Workflow panel ► Edit.



The output of this activity is a Display Manager layer name.

Connection ID

Enter a connection ID for the data store that this layer represents, or click



to use the ID property of a preceding activity.

Optional Parameters

- Display Name: Enter a title for this activity.
- Feature Class: Click  and select a feature class or layer from a preceding activity.

NOTE For WMS feature sources, feature classes are displayed as WMS_Schema:0 0, WMS_Schema:0 1, and so on, rather than with descriptive names. For descriptions of the feature classes, examine the connection information in the Data Connect window

- Group: Specify a group for this layer to use in Display Manager.
- Layer Name: Specify the name of the Display Manager layer for this feature class.
- Zoom To Extents: Select this option to zoom to the layer extents after the feature is added.

Prompt For Parameters At Run Time

Select this option to pause for input at run time.

Add Group

This [Workflow Designer activity](#) (page 2025) creates a group with the specified name. For information about groups, see [Organizing Layers in Your Map](#) (page 300).



[To edit a workflow](#) (page 284)
[To create a workflow](#) (page 287)



Click Tools tab > Workflow panel > Edit.



The output of this activity is a Display Manager group name.

Name

Enter a name for this group.

Optional Parameters

- Display Name: Enter a title for this activity.

Prompt For Parameters At Run Time

Select this option to pause for input at run time.

Add Map

This [Workflow Designer activity](#) (page 2025) adds the specified display map to the current map file. You can change the display to show the new map.



[To edit a workflow](#) (page 284)

[To create a workflow](#) (page 287)



Click Tools tab ► Workflow panel ► Edit.



The output of this activity is a Display Manager map name.

Name

Enter a name for this map.

Optional Parameters

- Display Name: Enter a title for this activity.
- Switch To New Map: Change the display to the new map.

Prompt For Parameters At Run Time

Select this option to pause for input at run time.

Change Feature Layer Properties

This [Workflow Designer activity](#) (page 2025) changes certain properties for the specified layer.



[To edit a workflow](#) (page 284)

[To create a workflow](#) (page 287)



Click Tools tab ► Workflow panel ► Edit.



This activity does not produce any outputs that can be bound to subsequent activities. However, it can change a layer or group name, which can affect subsequent activities.

Name

Enter the name of the layer to change.

Visible

Specify whether to make the layer visible or not, or to leave its visibility unchanged.

Name

Specify the name of the layer.

Group

Move the layer into a different parent group, or select No Change to leave it in the current one. The parent group must exist, or must be created by a previous activity in the workflow. To place the group at the root level, specify the Root Group (Map) parameter.

Selectable

Specify whether to make the layer selectable or not, or to leave its selectability unchanged.

Draw Order Position

Change the position of this layer, relative to other layers in Display Manager. To leave the layer in its current position, specify -1.

Optional Parameters

- Display Name: Enter a title for this activity.

Prompt For Parameters At Run Time

Select this option to pause for input at run time.

Change Feature Layer Symbol

This [Workflow Designer activity](#) (page 2025) sets the styling parameters for the specified feature layer.



[To edit a workflow](#) (page 284)

[To create a workflow](#) (page 287)



Click Tools tab ► Workflow panel ► Edit.



This activity does not produce any outputs that can be bound to subsequent activities.

Layer Name

Enter the name of the layer to change. To see the current values for this layer (if it is already in the map), click Current Values.

Style Point

If the geometry of this layer is a point, specify and style the point symbol that represents it in Display Manager. You can specify a particular parameter or specify that the point maintain its original parameter for any setting except the symbol itself. For information about these settings, see [Style Point dialog box](#) (page 1637).

Style Line

If the geometry of this layer is a line, style the line that represents it in Display Manager. You can specify a particular parameter or specify that the line maintain its original parameter for any setting. For information about these settings, see [Style Line dialog box](#) (page 1636).

Style Polygon

If the geometry of this layer is a polygon, style the polygon that represents it in Display Manager. You can specify a particular parameter or specify that the polygon maintain its original parameter for any setting. For information about these settings, see [Style Polygon dialog box](#) (page 1639).

Optional Parameters

- Display Name: Enter a title for this activity.

Prompt For Parameters At Run Time

Select this option to pause for input at run time.

Change Group Properties

This [Workflow Designer activity](#) (page 2025) changes the visibility, name, and parent group of a specified group in the Display Manager. For information about groups, see [Organizing Layers in Your Map](#) (page 300).



To edit a workflow (page 284)
To create a workflow (page 287)



Click Tools tab ► Workflow panel ► Edit.



This activity does not produce any outputs that can be bound to subsequent activities. However, it can change the group name, which can affect subsequent activities.

Group

Enter the name of the group to change.

Visible

Specify whether to make the group visible or not, or to leave its visibility unchanged.

Name

Specify a new name for the group, or select No Change to leave it as currently named.

Group

Move the group into a different parent group. The parent group must exist, or must be created by a previous activity in the workflow. To place the group at the root level, specify the Root Group (Map) parameter.

Optional Parameters

- Display Name: Enter a title for this activity.

Prompt For Parameters At Run Time

Select this option to pause for input at run time.

Connect To Data Store

This [Workflow Designer activity](#) (page 2025) connects to the specified data store but does not add data to the map. For an overlay that specifies feature classes, rather than layers, this activity is sufficient (you do not have to create a layer).

NOTE The parameters vary according to the type of data store you connect to. For example, a database requires login information, while a file requires a file name. All users must provide login credentials when running the workflow, even if you enter your own credentials when you create it.



[To edit a workflow](#) (page 284)

[To create a workflow](#) (page 287)



Click Tools tab ► Workflow panel ► Edit.



The output of this activity is a Connection ID.

Provider

Select the provider type for this connection.

File-based Data Stores

For more information about these options, see [Bringing In Features from SHP](#) (page 335), [Bringing In Features from SDF](#) (page 337), and [Bringing In Features From SQLite](#) (page 330).

File Name

Enter or navigate to the data store file.

ArcSDE Data Stores

For more information about these options, see [Bringing In Features from ArcSDE](#) (page 316).

Server Name

Enter the name of the server where this data store is located.

Instance Name

Enter the name of the instance to connect to.

Data Store

Enter the data store name for this service. For Oracle and MySQL data stores, you can display all data stores if desired.

Version

Enter the version of the data store to connect to.

Other Database Data Stores

For more information about these options, see [Bringing In Features from Oracle](#) (page 312), [Bringing In Features from SQL Server](#) (page 323), [Bringing In Features from SQL Server Spatial](#) (page 326), and [Bringing In Features from MySQL](#) (page 332).

Service Name

Enter or navigate to the data store file or folder.

Data Store

Enter the data store name for this service. For Oracle and MySQL data stores, you can display all data stores if desired.

Version

Enter the version of the data store to connect to. (Oracle only)

ODBC Data Stores

For more information about these options, see [Accessing Data from ODBC](#) (page 342).

Service Name

Enter or navigate to the data store file or folder.

Source Type

Specify whether this data store is a Data Source Name (DSN) or a connection string.

Source

Enter or navigate to the ODBC source.

Raster Data Stores

For more information about these options, see [Adding Raster-Based Surfaces to Your Map](#) (page 441).

Source File or Folder

Enter or navigate to the data store file or folder.

WMS Data Stores

For more information about these options, see [Adding an Image from a WMS \(Web Map Service\)](#) (page 445).

Server Name Or URL

Enter or navigate to the server where this data store is located, or enter its URL.

Version

Choose a supported version from the list.

WFS Data Stores

For more information about these options, see [Bringing In Features from WFS](#) (page 346).

Server Name

Enter or navigate to the server where this data store is located.

Optional Parameters

- Display Name: Enter a title for this activity.

Prompt For Parameters At Run Time

Select this option to pause for input at run time.

Create Buffer Layer

This [Workflow Designer activity](#) (page 2025) analyzes features by proximity. Specify a geospatial feature in your map and the distance for the buffer. AutoCAD Map 3D creates a polygon around the feature or features you have selected at the distance you specify. It saves the buffer polygon to a new layer. For more information about buffers, see [Buffering Features in Your Map](#) (page 1306).



[To edit a workflow](#) (page 284)

[To create a workflow](#) (page 287)



Click Tools tab ► Workflow panel ► Edit.



The output of this activity is a Display Manager layer that represents a buffer. You can also create an SDF file containing this layer.

Selection Set

Specify the feature to base the buffer analysis on.

Distance

Specify the buffer distance or prompt for a distance when the workflow is run.

Unit

Specify the measurement unit for the distance.

Save To SDF

To save the resulting buffer layer as an SDF file, specify a name and location for the file.

Merge Results

Select from the following:

- No Merging: Overlapping buffers are not merged. The number of resulting buffers is equal to the number of features being buffered.
- Merge All Buffers: All overlapping buffers are merged into a single buffer and then combined into a single polygon.
- Merge Overlapping Buffers: Only the overlapping buffers are merged.

Optional Parameters

- Display Name: Enter a title for this activity.

Prompt For Parameters At Run Time

Select this option to pause for input at run time.

Display Feature Attributes

This [Workflow Designer activity](#) (page 2025) displays the Data Table for the specified feature and selection set.



[To edit a workflow](#) (page 284)
[To create a workflow](#) (page 287)



Click Tools tab ► Workflow panel ► Edit.



This activity does not produce any outputs that can be bound to subsequent activities.

Source Type

Specify how to select the features whose attributes you will display. You can display an entire feature source or a selection set.

If you choose to select by feature source, specify the connection ID and a feature class name for that feature source. If you choose to select by selection set, indicate which features to select.

Optional Parameters

- Display Name: Enter a title for this activity.

Prompt For Parameters At Run Time

Select this option to pause for input at run time.

Highlight Features/Remove Highlighting

This [Workflow Designer activity](#) (page 2025) highlights specified features in the map (or removes highlighting from any features that are already highlighted).



[To edit a workflow](#) (page 284)

[To create a workflow](#) (page 287)



Click Tools tab ► Workflow panel ► Edit.



This activity does not produce any outputs that can be bound to subsequent activities.

Selected Features

Specify the features affected by the highlighting change. For example, you can specify all features added or produced by a previous activity.

Optional Parameters

- Display Name: Enter a title for this activity.
- Highlight: Select this option to highlight the features; clear this option to remove highlighting from the features.

Prompt For Parameters At Run Time

Select this option to pause for input at run time.

List Current Connections

This [Workflow Designer activity](#) (page 2025) lists the names of connections in the current map. You cannot specify parameters for this activity, other than a Display Name.



[To edit a workflow](#) (page 284)

[To create a workflow](#) (page 287)



Click Tools tab > Workflow panel > Edit.



The output of this activity is the Connection IDs for all current connections.

Optional Parameters

- Display Name: Enter a title for this activity.

List Feature Classes

This [Workflow Designer activity](#) (page 2025) lists the feature classes for the specified data store connection in the current map.



[To edit a workflow](#) (page 284)

[To create a workflow](#) (page 287)



Click Tools tab > Workflow panel > Edit.



The output of this activity is the feature class names and connection IDs for the specified data store.

Connection ID

Enter a connection ID for the data store whose feature classes you want to list, or click  to use the ID property of a preceding activity.

Optional Parameters

- Display Name: Enter a title for this activity.

Prompt For Parameters At Run Time

Select this option to pause for input at run time.

List Feature Layer Properties

This [Workflow Designer activity](#) (page 2025) lists the name of the specified layer in Display Manager, as well as any group it belongs to.



[To edit a workflow](#) (page 284)

[To create a workflow](#) (page 287)



Click Tools tab ► Workflow panel ► Edit.



The output of this activity is the layer and group names for the specified Display Manager layer.

Layer Name

Enter the name of the layer.

Optional Parameters

- Display Name: Enter a title for this activity.

Prompt For Parameters At Run Time

Select this option to pause for input at run time.

Load Layer File

This [Workflow Designer activity](#) (page 2025) adds a saved *.layer* file to the map. When you load a *.layer* file, AutoCAD Map 3D adds the source file to Map Explorer, creates the connection, adds the feature layer to the Display Manager,

and styles the layer correctly. For information about layer files, see [Saving and Loading Styled Feature Layers](#) (page 651).



To edit a workflow (page 284)
To create a workflow (page 287)



Click Tools tab ► Workflow panel ► Edit.



The output of this activity is a Display Manager layer that displays the specified *.layer* file.

File Name

Enter the name of the *.layer* or browse to it.

Optional Parameters

- Display Name: Enter a title for this activity.

Prompt For Parameters At Run Time

Select this option to pause for input at run time.

Perform Overlay

This [Workflow Designer activity](#) (page 2025) compares the spatial relationship of two layers or feature classes. For information about the overlay operation, see [Overlaying Two Feature Sources](#) (page 1309).



To edit a workflow (page 284)
To create a workflow (page 287)



Click Tools tab ► Workflow panel ► Edit.



The output of this activity is a new Display Manager layer that is the result of the Overlay operation.

Data Type

Specify whether the overlay compares feature classes or Display Manager layers. Both the source and overlay must be the same type (you cannot compare a feature class to a layer).

Source/Overlay

If you select Layers as the Data Type, select the Source Layer and Overlay Layer. These layers are the output of preceding Add Feature Layer activities. If you select Feature Classes as the Data Type select a Source Feature Class ID (the output of a preceding activity). Then select the Source Feature Source for that feature class (if it is not selected automatically). Do the same for the Overlay Feature Class.

Output File

Enter a location and file name for the output (overlay) SDF file. Click  to navigate to a location.

Overlay Type

Select the type of comparison to do. For a complete description of these options, see [Overlaying Two Feature Sources](#) (page 1309).

Optional Parameters

- Display Name: Enter a title for this activity.
- Sliver Tolerance: Specify when small polygons resulting from the overlay operation become separate features and when they are added to larger polygons.
 - Units: Select the units used in determining the sliver Minimum and Maximum settings. The coordinate system determines the available choices for the source layer. If the sliver roundness is higher than the Maximum value, it becomes a separate polygon in the output. If the sliver roundness is lower than the Minimum value, it merges with its neighbor polygon in the output. To see reasonable values for the selected data set, click Suggest. To ignore slivers, click Don't Remove Slivers.
- Ordinate Tolerance: Specify when two nodes or vertices of a line or polygon are treated as separate points.
 - Units: Select the units used in determining the Length setting. The coordinate system determines the available choices for the source layer.

- Length : Set the minimum distance at which two nodes or vertices of a line or polygon are treated as separate points. The default value is determined from the spatial context for the sources.
- Output Properties: Specify which properties from the source and (if applicable) overlay inputs are included in the output. “Identifiers Only” writes the primary identifiers to the output. “Non-Identifiers” writes only the non-key attributes (creating auto-generated primary identifiers for the output features). The default value is “All”.

Prompt For Parameters At Run Time

Select this option to pause for input at run time.

Remove Connection

This [Workflow Designer activity](#) (page 2025) removes the specified connection to a data source.



[To edit a workflow](#) (page 284)

[To create a workflow](#) (page 287)



Click Tools tab ► Workflow panel ► Edit.



This activity does not produce any outputs that can be bound to subsequent activities. However, the removal of a connection can affect subsequent activities.

Connection ID

Select an existing connection or the outcome of a previous activity.

Optional Parameters

- Display Name: Enter a title for this activity.

Prompt For Parameters At Run Time

Select this option to pause for input at run time.

Remove Feature Layer

This [Workflow Designer activity](#) (page 2025) removes the specified feature layer.



[To edit a workflow](#) (page 284)

[To create a workflow](#) (page 287)



Click Tools tab ► Workflow panel ► Edit.



This activity does not produce any outputs that can be bound to subsequent activities. However, the removal of a layer can affect subsequent activities.

Layer Name

Enter the name of an existing layer, or select a layer created by a previous activity.

Optional Parameters

- **Display Name:** Enter a title for this activity.

Prompt For Parameters At Run Time

Select this option to pause for input at run time.

Remove Group

This [Workflow Designer activity](#) (page 2025) removes the specified group.



[To edit a workflow](#) (page 284)

[To create a workflow](#) (page 287)



Click Tools tab ► Workflow panel ► Edit.



This activity does not produce any outputs that can be bound to subsequent activities. However, the removal of a layer can affect subsequent activities.

Group Name

Enter the name of an existing group, or select a group created by a previous activity.

Optional Parameters

- Display Name: Enter a title for this activity.

Prompt For Parameters At Run Time

Select this option to pause for input at run time.

Remove Map

This [Workflow Designer activity](#) (page 2025) removes the specified display map.



[To edit a workflow](#) (page 284)
[To create a workflow](#) (page 287)



Click Tools tab ► Workflow panel ► Edit.



This activity does not produce any outputs that can be bound to subsequent activities. However, the removal of a map can affect subsequent activities.

Map

Enter the name of an existing display map, or select a map created by a previous activity.

Optional Parameters

- Display Name: Enter a title for this activity.

Prompt For Parameters At Run Time

Select this option to pause for input at run time.

Rename Map

This [Workflow Designer activity](#) (page 2025) changes the name of the specified display map.



[To edit a workflow](#) (page 284)
[To create a workflow](#) (page 287)



Click Tools tab ► Workflow panel ► Edit.



This activity does not produce any outputs that can be bound to subsequent activities. However, the removal of a map can affect subsequent activities.

Map

Enter the name of an existing display map, or select a map created by a previous activity.

New Name

Enter a new name for the specified map, or select a map created by a previous activity.

Optional Parameters

- Display Name: Enter a title for this activity.

Prompt For Parameters At Run Time

Select this option to pause for input at run time.

Run AutoCAD Command

This [Workflow Designer activity](#) (page 2025) executes any AutoCAD command supported by AutoCAD Map 3D that can be run from the command line. If the command requires a selection set or input from a dialog box, the workflow pauses (during run time). The person running the workflow must specify a selection set (or dialog box input) during run time.



[To edit a workflow](#) (page 284)

[To create a workflow](#) (page 287)



Click Tools tab ► Workflow panel ► Edit.



This activity does not necessarily produce any outputs that can be bound to subsequent activities.

Command

Type the command-line entry for the AutoCAD command to execute.

Optional Parameters

- Display Name: Enter a title for this activity.
- Parameters: Enter any parameters for the command, or prompt for them at run time.

NOTE If the command displays dialog boxes or requires a selection set, you must provide this input manually at run-time. You cannot automate these responses.

Prompt For Parameters At Run Time

Select this option to pause for input at run time.

Run Workflow

This [Workflow Designer activity](#) (page 2025) invokes another workflow at this point in the current workflow.



To edit a workflow (page 284)
To create a workflow (page 287)



Click Tools tab ► Workflow panel ► Edit.



This activity does not necessarily produce any outputs that can be bound to subsequent activities. However, the workflow you run may contain activities that produce outputs.

File Name

Enter or navigate to the file containing the workflow to run. By default, the Workflow Designer looks for the workflow in the same folder as the current workflow.

NOTE To preview the workflow, specify its file name in the activity and then click  in the Workflow Designer toolbar. In the Properties palette that displays, click the Preview cell containing the name of the workflow, then click the browse button that appears. The referenced workflow appears in a separate window.

Optional Parameters

- Display Name: Enter a title for this activity.

Prompt For Parameters At Run Time

Select this option to pause for input at run time.

Save Layer File

This [Workflow Designer activity](#) (page 2025) saves a Display Manager layer to a *.layer* file. You can save layers from all display maps in your map file. For information about layer files, see [Saving and Loading Styled Feature Layers](#) (page 651).



[To edit a workflow](#) (page 284)

[To create a workflow](#) (page 287)



Click Tools tab ► Workflow panel ► Edit.



The output of this activity is a *.layer* file.

Map

Select the display map that contains the layer to save. Select an existing display map or a display map that results from a previous activity.

Layer Name

Select an existing layer or a layer that results from a previous activity to save.

Output Folder

Enter or navigate to the folder for the new layer file.

Optional Parameters

- Display Name: Enter a title for this activity.
- Map: Select the display map in which this layer is located.

Prompt For Parameters At Run Time

Select this option to pause for input at run time.

Select Features

This [Workflow Designer activity](#) (page 2025) selects individual features in the current display map. You can select the features by layer, by location, or by prompting for a manual selection at workflow run time.



[To edit a workflow](#) (page 284)

[To create a workflow](#) (page 287)



Click Tools tab ► Workflow panel ► Edit.



The output of this activity is a selection set.

Selection Method

Choose one of the following:

- Prompt: The workflow will pause at run time to allow manual selection of features.
- Select By Layer: Selects all features on the specified layer.
- Select By Location: Selects features that either cross or are contained by the intersection of the two layers you specify.

Optional Parameters

- Display Name: Enter a title for this activity.
- SetPickFirst: Select this option to store the data in the selection (no matter it was selected) into the AutoCAD PICKFIRST cache for further use.

Prompt For Parameters At Run Time

Select this option to pause for input at run time.

Switch Map

This [Workflow Designer activity](#) (page 2025) changes the current display to the specified display map.



[To edit a workflow](#) (page 284)

[To create a workflow](#) (page 287)



Click Tools tab ► Workflow panel ► Edit.



The output of this activity is a new current map.

Map Name

Enter the name of an existing display map, or a map created by a previous activity.

Optional Parameters

- Display Name: Enter a title for this activity.

Prompt For Parameters At Run Time

Select this option to pause for input at run time.

Zoom To Extents

This [Workflow Designer activity](#) (page 2025) zooms to the extents of the specified target.



[To edit a workflow](#) (page 284)

[To create a workflow](#) (page 287)



Click Tools tab ► Workflow panel ► Edit.



This activity does not produce any outputs that can be bound to subsequent activities.

Target

Specify what to zoom to: a map, a layer, a selection set, or an extent. Then specify which map, layer, selection set, or extent to zoom to.

Optional Parameters

- Display Name: Enter a title for this activity.

Prompt For Parameters At Run Time

Select this option to pause for input at run time.

Programming Interfaces

41

Learn how to use the AutoCAD Map 3D Application Programming Interfaces (APIs), including:

- ActiveX
- AutoLISP
- Feature Data Objects (FDO)
- Geospatial Platform
- .NET
- ObjectARX

For more information, click [Help > Additional Resources > Developer Help](#).

Glossary

.layer file Layer definition file. In AutoCAD Map 3D, a file that saves all of the information required to recreate a layer, that is, the references to the source data and the styles that have been applied to it.

adjacent sheet block An [annotation](#) (page 2055) block used to indicate adjacent tiles.

anchor point The location on a drawing object that determines the position of any annotation attached to that object.

annotation A way to display related values on a drawing object. To annotate geospatial features, use a [label](#) (page 2066).

annotation definitions Specially created [blocks](#) (page 2056) containing attributes with Map [expression](#) (page 2062) assigned to the attribute properties. Used with drawing data.

annotation template The information to display in an annotation and the layout of that information. Annotation templates are stored as specially named blocks within your drawing. They can include text and graphics.

as-built Data that depicts the final installed configuration (physical or functional). As-built data incorporates any field markups on the original construction drawings.

as-designed Data that depicts the original plan for construction or installation, for example, the design for a new electric service or a new pipe installation.

aspect Direction of ground slope.

attributes or attribute data Tabular data that describes the characteristics of [feature](#) (page 2063) or [drawing objects](#) (page 2061), for example, the number of lanes and pavement-type belonging to a road. For features, attributes can be stored with the geometry, or stored in a database and joined to feature data. For drawing objects, attributes are stored in a database and linked to selected drawing objects. See also [property](#) (page 2071), [external data](#) (page 2062) and [object data](#) (page 2070).

auto-generated field (metadata) A type of field in the Metadata feature, the value of which is derived from the data source, and populated automatically by AutoCAD Map 3D. Metadata auto-generation is triggered by selecting the resource in the Metadata Viewer. See also: [forced-update field](#) (page 2064)

AutoCAD layer A layer in AutoCAD. An AutoCAD layer differs from a map layer you create in [Display Manager](#) (page 2060). See also [layer](#) (page 2066), [drawing layer](#) (page 2060), [feature layer](#) (page 2063), or [surface layer](#) (page 2076).

Autodesk Design Review The free viewer and editor for the DWF file format (formerly DWF Viewer).

azimuth A clockwise angle measured from a reference meridian. Also known as north azimuth. It can range from 0 to 360 degrees. A negative azimuth is converted to a clockwise value.

bearing An angle measured from North or South, whichever is nearest, with the added designation of East or West. The angle is always less than 90 degrees (PI/2 radians or 100 grads) and is usually referenced by a quadrant number.

best route analysis Calculates the shortest path or optimal route from a start point in a drawing, one or more intermediate points, and back to the start point. For example, the best route to follow on a street map when visiting multiple customer sites.

blocks In AutoCAD or AutoCAD Map 3D, compound objects that have been saved for reuse in the drawing or in multiple drawings, for example, a North arrow. In MapGuide Studio, blocks are converted into symbols when they are loaded. See also [symbol](#) (page 2076).

buffer A zone of a specific radius created around a selected feature. Used to select features within a specific distance of another feature. In AutoCAD Map 3D, you can define buffers for drawing topologies and for features, but you define them differently.

buffer fence A fence, or line, at a specified distance from a center line. Used to define a selection boundary.

bulge For contours that contain curves, the bulge value is a maximum mid-ordinate distance along a polyline curve. If the mid-ordinate distance is longer than specified, then points are added to better define the shape of the curve.

The bulge factor can add more vertices to a polyline curve, making it appear more curve-like. The smaller the value, the more vertices are added.

Cartesian coordinate system A [global coordinate system](#) (page 2065) defined using three perpendicular axes (X, Y, and Z) to specify locations in three-dimensional space. Compare with [spherical coordinate system](#) (page 2075).

cartographic coordinate system A [global coordinate system](#) (page 2065) that is referenced directly to an [ellipsoid](#) (page 2062). Compare with [geodetic coordinate system](#) (page 2064).

centroids Points or [blocks](#) (page 2056) that are part of a polygon in a drawing topology. The centroid holds information about the area and perimeter of the polygon.

chained join An advanced type of join, where two or more secondary tables are joined to a primary table in a chain-like fashion, that is primary linked to secondary linked to another secondary, and so on.

checkout The action of locking features in a data store before editing them. See also [explicit checkout](#) (page 2062), [implicit checkout](#) (page 2065).

class See [feature class](#) (page 2063) and [object class](#) (page 2069).

classified DWG An AutoCAD Map 3D DWG (drawing) file that contains object classes, and uses them to represent real-world objects in the drawing. A DWG file that contains object class definitions, but does not have any objects to which these definitions are applied, is not considered a classified DWG.

clustered nodes Nodes within a specified tolerance of one another.

COGO Short for Coordinate Geometry. COGO inquiry commands extract geometric information from drawing objects such as lines, curves, closed polylines, and polygons. This information is useful if you want to verify the accuracy of your data, or send the data to the field. Inquiry commands are specific to drawing objects. They do not work on features.

column A specific category of information in a table, such as Address or Diameter, also called a [FGDC CSDGM Standard](#) (page 2063). See also [table](#) (page 2076).

compound element (metadata) A group of data elements in the [FGDC CSDGM Standard](#) (page 2063). A compound element can consist of individual data elements, other compound elements, or both.

conformal projection, conformality Conformal projections maintain local angles. A map projection is conformal when the scale is the same in every direction at any point. Meridians and parallels intersect at right angles; the shape of small areas and angles with very short sides are preserved. Most larger area sizes are distorted.

conic projection A map projection in which the surface of the Earth is drawn as it would appear if projected on a cone wrapped around the earth. The Lambert Conformal Conic is often used for maps of the continental United States, France, and other countries.

constraint In a database, a restriction specified for a certain [feature class](#) (page 2063), which is validated when a new feature is added to that class. For example, a "minor road" feature class may have a constraint that specifies that the speed attribute must always be 25, 30, or 50 miles per hour.

continuous data Data that can fall anywhere in a broad range. When creating a theme, continuous data is usually organized into smaller ranges that show data trends. For example, property value is continuous data that can be placed into the ranges 0 to \$50,000, \$50,000 to \$100,000, and over \$100,000, with each range displayed in a different color. Compare with [discrete data](#) (page 2060).

contour lines A line that connects points of the same elevation or value relative to a specified reference datum. The lines can help you determine the elevation at a specific location on a surface, help clarify and analyze the 3D surface terrain, and help with things like navigation.

control points Locations with established latitude and longitude, and often elevation, used for accuracy and precise location of maps. A system of geodetic control points covers the entire United States. Similar systems exist for all countries, such as Bench Marks and Trigonometry Points in the United Kingdom. See also [monuments](#) (page 2069), [geodetic coordinate system](#) (page 2064).

coordinate geometry commands See [COGO](#) (page 2057).

coordinate system See [global coordinate system](#) (page 2065).

Create Surface Manager The main user interface for creating grid surfaces from point cloud data.

credentials The user ID and password required to connect to a database.

cylindrical projection A map projection, in which the surface of the Earth is drawn as it would appear if projected on a cylinder wrapped around the earth in a north-south direction. Compare with [transverse cylindrical projection](#) (page 2078). See also [Mercator projection](#) (page 2068) and [conic projection](#) (page 2058).

dangle A link or line, one end of which lacks a connection to another link or node.

Data Connect The window you use to connect a geospatial [data store](#) (page 2059) to your map. You specify each [feature class](#) (page 2063) from that data store to add to your map.

data element (metadata) A single piece of data that can be entered directly, as a value in a field. In the Metadata feature, single data elements are expressed as fields to be completed with values defined in the [FGDC CSDGM Standard](#) (page 2063). See also: [compound element \(metadata\)](#) (page 2057).

data provider A recognized [FDO](#) (page 2062) feature source provider, used to connect to geospatial data.

data source A UDL (universal data link) file that points to a collection of data and provides information on how to access the data.

data store In [FDO](#) (page 2062), a collection of feature classes contained in a single storage location. The data store consists of an integrated set of objects, which are modeled by classes or feature classes defined within one or more schemas. Data stores can be either file-based, such as SDF, or a database, such as Oracle Spatial. See also [FDO provider](#) (page 2063) and [feature class](#) (page 2063).

Data Table In AutoCAD Map 3D, a grid based on [FDO](#) (page 2062) data, in which you can view and edit attributes of selected map features, perform searches, and work with selection sets.

Data View In AutoCAD Map 3D, the grid in which you can view and edit external database tables that are linked to drawing objects.

database query A set of conditions for specifying the selection of records from a database. External database queries, also called views, are created using your database software and can be run from the [Map Explorer](#) (page 2068) tab of the [Task Pane](#) (page 2076). See also [map query](#) (page 2068).

datum A mathematical model that provides a smooth approximation of the earth's surface. Each datum includes both an ellipsoid, which specifies the size and shape of the earth, and a base point for latitude and longitude. If two maps use different datums, points on the map may not line up. Also called a [geodetic coordinate system](#) (page 2064).

DEM Digital Elevation Model. A file that contains a representation of surface terrain. The surface is stored as a grid in which each cell can have any one of several different meanings, such as elevation, color, density, and so on.

digitize To convert existing data from paper maps, aerial photos, or raster images into digital form by tracing the maps on a digitizer. Object locations are recorded as X,Y coordinates.

discrete data Data that falls into explicit categories. For a [feature layer](#) (page 2063) that uses a [theme](#) (page 2077), each value is displayed differently. For example, an agricultural thematic map might show each crop in a different color. Compare with [continuous data](#) (page 2058).

display information A description of the appearance of a drawing object: includes items such as layer, color, hatch pattern, and line type.

Display Manager A view of the [Task Pane](#) (page 2076) that shows each [Display Manager layer](#) (page 2060) in your current display map, and has commands for styling and managing those layers. To view Display Manager, select its tab in the Task Pane.

Display Manager layer A set of objects in [Display Manager](#) (page 2060). The set could be all the objects on a layer or in a [feature class](#) (page 2063), or objects that share a certain property. Each layer can be styled or themed individually.

display map A set of map presentations, consisting of Display Manager layers, that can be stored in a DWG file. See [Display Manager layer](#) (page 2060).

display properties Same as [display information](#) (page 2060).

dissolve To remove the boundaries that exist between polygons sharing a specific attribute.

dither To use a pattern of solid dots to simulate more colors than are available when displaying images.

domain (metadata) In the Metadata feature, the domain refers to element values that are defined as valid within the [FGDC CSDGM Standard](#) (page 2063). A domain can be a list of pre-defined values in a menu, a range of numbers, free-form text, or any other type of value that can be assigned to a given field.

dot variable Variable that refers to an object property. It consists of a period (.) followed by the variable name for that property. Dot variables can be entered in expressions used for building a template file for Report mode queries and for property alteration. See also [query](#) (page 2072) and [expression](#) (page 2062).

draping The process of overlaying [feature](#) (page 2063) or a [raster](#) (page 2072) image on a surface so that the features or the image reflect the underlying terrain.

draping The process of overlaying a set of [feature](#) (page 2063) or a [raster](#) (page 2072) image on a surface so that the features or the image reflect the underlying terrain.

drawing layer A layer in [Display Manager](#) (page 2060) that contains [drawing objects](#) (page 2061) from a DWG file. See also [AutoCAD layer](#) (page 2056), [feature layer](#) (page 2063), [layer](#) (page 2066), [surface layer](#) (page 2076).

drawing layer A layer in [Display Manager](#) (page 2060) that contains drawing objects from a DWG file. See also [AutoCAD layer](#) (page 2056), [drawing layer](#) (page 2060), [feature layer](#) (page 2063), and [surface layer](#) (page 2076). **drawing object** Objects that exist in a drawing (DWG) file or come from an attached drawing. Compare to features. **drawing source** In AutoCAD Map 3D, a drawing source is a drawing (DWG) file and also its associated information, such as attached drawing files, drawing-based feature classes, linked template data, and topologies.

drawing objects Objects that exist in a drawing file (DWG) or come from an attached drawing. Compare to [feature](#) (page 2063).

drawing set The set of source drawings attached to a drawing. See [source drawing](#) (page 2074).

drawing source In AutoCAD Map 3D, a drawing source is a drawing (DWG) file and also its associated information, such as attached drawing files, drawing-based feature classes, linked template data, and topologies. Compare with [feature source](#) (page 2063).

drive alias The mechanism that points to the folder where attached DWG files are stored.

drive alias In AutoCAD Map 3D, the mechanism that points to the folder where attached DWG files are stored.

DTED Digital Terrain Elevation Data.

duplicate objects Objects that share the same start and end points. Object types that can be considered duplicate include linear objects, points, blocks, text, and mtext.

DWF An Autodesk file format for sharing 2D, 3D, and spatially enabled design data. DWF files are easy to publish and view on the web. See also [georeferenced DWF](#) (page 2064), [Autodesk Design Review](#) (page 2056).

DWG Drawing file. The Autodesk file format for storing 2D, 3D, and spatially enabled design data.

edge matching A DWG cleanup function available in AutoCAD Map 3D that allows for distortion between adjacent maps, and produces a true match of drawing objects at the edges of maps.

EditSet When users decide to lock objects in Oracle Spatial, those objects are immediately locked. Edits of locked objects are put into an EditSet. You can then update the database, which updates the locked records with the contents of the EditSet.

element (Oracle Spatial database) The basic building block of an Oracle Spatial [geometry \(Oracle Spatial database\)](#) (page 2064). The supported spatial element types are points, line strings, and polygons. For example, elements might model water wells (point clusters), roads (line strings), and county boundaries (polygons).

elevation The vertical distance from a datum to a point or object on the surface of the Earth. The datum is generally considered to be at sea level. Equivalent to the Z coordinate in an XYZ coordinate system.

ellipsoid An approximation of the shape of the Earth that does not account for variations caused by the nonuniform density of the earth. Synonymous with [spheroid](#) (page 2075). See also [geoid](#) (page 2064).

equal area A map projection in which every part, as well as the whole, has the same area as the corresponding part on the earth, at the same reduced scale. No flat map can be equal area and represent true shape.

equidistant projections Projections showing true distances only from the center of the projection or along a special set of lines. No flat map can be both equidistant and equal area.

exaggeration See [vertical exaggeration](#) (page 2078).

explicit checkout The action of checking out features using the Check Out Features command. See also [checkout](#) (page 2057), [implicit checkout](#) (page 2065).

export profile A file with a *.epf* extension that stores settings for an export operation.

expression An automatic calculation used to specify values for URL, tooltip, and feature labels. For example, you might create a text expression that specifies a state name and population for a label. To express the population in millions, you might apply a number expression that divides the population value by 1,000,000.

expression evaluator The mechanism that analyzes the statement you enter in the Expression box in the Output Report Options dialog box or the Property Alteration dialog box.

external data Attribute data linked to a drawing object but contained in a database apart from the drawing file. See also [attributes or attribute data](#) (page 2055) and [object data](#) (page 2070).

FDO Feature Data Objects (FDO) data access technology. An Autodesk software standard and general purpose API for accessing features and geospatial data regardless of the underlying data store. See also [feature](#) (page 2063), [feature class](#) (page 2063).

FDO provider An implementation of the [FDO](#) (page 2062) API that provides access to data in a particular data store, such as an Oracle or ArcSDE database, or to a file-based data store, such as SDF or SHP.

feature An abstraction of a natural or man-made real world object. A spatial feature has one or more geometric properties. For example, a road feature might be represented by a line, and a hydrant might be represented by a point. A non-spatial feature does not have geometry, but can be related to a spatial feature that does. For example, a road feature may contain a sidewalk feature that is defined as not containing any geometry. In AutoCAD Map 3D, features are accessed and added to maps using Data Connect ([FDO](#) (page 2062)). See also [attributes or attribute data](#) (page 2055). Compare to [drawing objects](#) (page 2061).

feature class For feature data, a schema element that describes a type of real-world object. It includes a class name and property definitions. Commonly used to refer to a set of features of a particular class, for example, the feature class "roads" or the feature class "hydrants." See also [FDO](#) (page 2062), [property](#) (page 2071), [schema](#) (page 2073).

Feature Data Objects See [FDO](#) (page 2062).

feature layer A layer in [Display Manager](#) (page 2060) containing [feature](#) (page 2063) from a feature source such as SDF, ESRI SHP, or ArcSDE. Feature layers are brought in using Data Connect. See also [AutoCAD layer](#) (page 2056), [layer](#) (page 2066), [drawing layer](#) (page 2060), or [surface layer](#) (page 2076).

feature source In AutoCAD Map 3D, any source of feature data that has been connected by means of [FDO](#) (page 2062). In MapGuide Studio, one of the two types of resources created either by loading file-based data or by connecting to a spatial database. Feature sources are stored in the repository either in SDF 3 format or as database connections and contain raw geometry only. Compare with [drawing source](#) (page 2061).

FGDC CSDGM Standard Content Standard for Digital Geospatial Metadata. A standard XML schema for publishing and sharing GIS [metadata](#) (page 2069), released by the United States Federal Geographic Data Committee (FGDC) in 1998. The schema is comprised of seven major sections, each of which contains several individual data elements and compound elements. Depending upon the nature of the GIS data, each section, element, and compound element is mandatory, optional, or conditional (mandatory if applicable).

field A specific category of information in a data file, such as Address or Diameter. Also called a [column](#) (page 2057). See also [table](#) (page 2076).

filtered record A record that matches the conditions of an SQL filter or spatial filter and is therefore available for selection.

flood trace For a [network topology](#) (page 2069), a trace that begins at a specified point and traces out in all directions for a specified distance or resistance.

forced-update field A type of [auto-generated field \(metadata\)](#) (page 2056) in the Metadata feature, the value of which is required to be derived from the data source within a GIS [resource \(metadata\)](#) (page 2072), according to the rules of the [FGDC CSDGM Standard](#) (page 2063). Forced-update fields are updated each time metadata is updated.

generalization A method of reducing the number of vertices in the source data by a specific percentage.

geodetic coordinate system A coordinate system that is referenced directly to a datum. Compare with [cartographic coordinate system](#) (page 2057).

geographic analysis Analytical techniques that identify existing conditions of a geographic location, a spatial area, or a linear network, and predict the effects of certain future events on these features.

geographic data Information about geographic features. See [feature](#) (page 2063).

geoid An ellipsoid with a highly irregular surface used to describe the shape of the earth. See also [ellipsoid](#) (page 2062).

geometry (Oracle Spatial database) The representation of a spatial [feature](#) (page 2063), modeled as an ordered set of primitive elements. See [element \(Oracle Spatial database\)](#) (page 2062).

geometry mapping The process of transforming the geometry elements of AutoCAD Map 3D objects to Oracle Spatial geometry, and transforming the geometry elements of the records back to AutoCAD Map 3D objects.

georeferenced DWF A DWF file published by AutoCAD Map 3D or AutoCAD Civil 3D 2008 that contains a global coordinate system and defined latitude and longitude coordinates based on the WGS84 datum. See also [DWF](#) (page 2061), [Autodesk Design Review](#) (page 2056).

georeferenced image An image that references real-world coordinates in its correlation source. Example: Georeferenced images include GeoSPOT, GeoTIFF, and images that use world files as their correlation source.

GeoTIFF A type of tagged image file format (TIFF) that supports georeferencing information.

GIS (Geographic Information System) A computerized decision support system that integrates geographic data, attribute data, and other spatially

referenced data. A GIS is used to capture, store, retrieve, analyze, and display spatial data.

global coordinate system A method that converts the spherical coordinates of the Earth representing latitude and longitude into an AutoCAD Map 3D drawings Cartesian coordinate system, and accounts for the curvature of the surface of the Earth with a projection. A coordinate system is usually defined by a projection, an ellipsoid definition, a datum definition, one or more standard parallels, and a central meridian.

graticule A network of geographic lines, such as latitude and longitude lines. See also [grid reference system](#) (page 2065).

grid reference system A grid-based Cartesian coordinate system. The [Universal Transverse Mercator \(UTM\)](#) (page 2078) coordinate system is a grid reference system.

grid surface See [surface](#) (page 2076).

Grid Zone Designator (GZD) The first part of a [grid reference system](#) (page 2065) coordinate. The grid zone designator specifies the 6 by 8 degree UTM zone number and latitude letter.

hatch A regular pattern used to fill an area with a series of cross-angled lines.

hillshading The addition of shading to a surface to suggest three-dimensionality, shadow, or degrees of light and dark. Hillshading adds shading by casting the light of the sun across a surface from the direction and angle you specify.

implicit checkout The action of checking out features by selecting them, without using the Check Out Features command. See also [checkout](#) (page 2057), [explicit checkout](#) (page 2062).

index file A point cloud data store file created by the [Point Cloud Manager](#) (page 2071). Index files allow AutoCAD Map 3D to access point cloud data more quickly and efficiently.

inner join A type of join where records in the primary table are displayed only if there is a matching record in the joined secondary table. See also join, left outer join.

intersection (expression) Two or more conditions joined with the logical operator And. An item is selected only if the item meets all specified conditions. Compare with [union](#) (page 2078).

intersection (geometry) The location where one line, surface, or solid crosses another so as to have one or more points in common.

join A relationship that is established between attribute data and feature sources for the purposes of creating a new view of the data or for ad-hoc analysis.

JPG2000 An advanced raster image format from Joint Photographic Experts Group, featuring options for lossless compression, wavelet compression, incremental decompression, and support for up to 48-bit color.

key column One or more columns in a table whose values are used to uniquely identify a record. To provide useful links, a key column should contain a unique value for each record. Also called a key field.

key value A value stored on an object that specifies that value to match in the key field of a table.

key view In a map book, an overview of the entire map with the current tile boundaries displayed.

label Text placed on or near map [feature](#) (page 2063) to describe or identify them.

LAS LiDAR Aerial Survey. LAS is an industry standard file format defined by the American Society of Photogrammetry and Remote Sensing. The LAS standard includes LiDAR point classification.

latitude The first part of a spherical coordinate system used to record positions on the earth's surface. Latitude indicates the angular distance north or south of the equator. See also [longitude](#) (page 2067).

layer A resource that references a feature source or a drawing source. The layer contains styling and theming information, and optionally a collection of scale ranges. You add a layer to your map using [Display Manager](#) (page 2060). Specific types of layers are [drawing layer](#) (page 2060), [feature layer](#) (page 2063), and [surface layer](#) (page 2076).

layout template In a map book, a named composition of viewports and [annotation](#) (page 2055) in paperspace. It includes the intended paper size and output scale for plotting and publishing. See also [map book template](#) (page 2067).

left outer join A type of join where all records in the primary table are displayed, whether they have a matching record in the joined secondary table or not.

LiDAR Light Detection And Ranging. A remote-sensing method that can be used to generate an image of a surface.

link (external databases) The connection between a drawing object and its related database data. The link data is stored on the linked drawing object and contains the name of the link template and the key value used to identify the associated record in the linked table. An object may have more than one link.

link (geometry) An element of geometry that connects nodes. In a polygon topology, a link defines a polygon edge. Links can contain vertices and true arcs, and can be represented as a line, polyline, or arc. See also [node](#) (page 2069).

link template A data structure that contains the path information to a database table and specifies one or more key fields in that table.

lock To make all or part of a disk file read-only so that it cannot be modified by other users on a network. Object locking applies to objects that are being edited by another user. File locking applies to entire files, for example when an AutoCAD user wants to open a file while the file is being edited in AutoCAD Map 3D.

logical operator A symbol such as And, Or, Not, =, >, >=, <, and <= used to define logical relationships.

long transaction Transactions that extend over hours, days, or months, unlike the more typical database transactions that last for only seconds. Long transactions support atomicity, consistency, and durability, and can be committed or rolled back.

longitude The second part of a spherical coordinate system used to record positions on the earth's surface. Longitude measures angular distance east or west of the prime meridian, which runs through Greenwich, England. See also [latitude](#) (page 2066).

main viewport The viewport that represents a map tile in a sheet. See also [viewport \(paper space\)](#) (page 2078).

map A collection of layers displayed within a consistent coordinate system and extents. See also [layer](#) (page 2066).

Map Book Manages your [map book](#) (page 2067) and contains commands for creating, editing, and publishing them. To view Map Book, click its tab in the [Task Pane](#) (page 2076).

map book A publishing option that divides a map into tiles and formats them into pages with a legend and an index/key. Create and edit map books from the Map Book tab in the [Task Pane](#) (page 2076).

map book template A special type of sheet set template used by a map book to generate sheets. The map tiles are generated based on the layout and viewport placeholder properties.

Map Explorer Manages your mapping resources. To view Map Explorer, click its tab in the [Task Pane](#) (page 2076).

map projection A systematic representation of a spherical body, such as the earth, in a flat (planar) surface. Each map projection has specific properties that make it suitable for specific mapping needs.

map query A set of conditions that specify the selection of drawing objects from source drawings. Conditions in a Map query can be based on the location or properties of an object or on data stored in the drawing or in a linked database table. See also [topology query](#) (page 2077) and [database query](#) (page 2059).

map tile A specific region of a map (model space view) for use on an individual sheet.

MapGuide Enterprise A software platform for distributing spatial data over the Internet or on an intranet. MapGuide Enterprise is supported by Autodesk.

MapGuide Open Source A software platform for distributing spatial data over the Internet or on an intranet. MapGuide Open Source is supported by the community (www.mapguide.osgeo.org)

MapGuide Server The component of MapGuide Open Source or MapGuide Enterprise that hosts services and responds to requests from client applications through TCP/IP protocol.

MapGuide Viewer (AJAX viewer) The version of the MapGuide Viewer component that does not need a download (also known as “zero-client viewer”). It works with Microsoft Internet Explorer, running on Windows, or with browsers such as Firefox on other operating systems, such as MacOS or Linux.

MapGuide Viewer (DWF Viewer) The version of the MapGuide Viewer component that is based on a Microsoft ActiveX Control and has full support for the DWF format. It works with the Microsoft Internet Explorer browser only.

MapGuide Web Server Extensions The MapGuide component that exposes the services offered by the MapGuide Server to client applications over the Internet or on an intranet using HTTP protocol.

Mercator projection A map projection, designed by Gerhardus Mercator, in which the surface of the Earth is drawn as it would appear if projected on a cylinder wrapped around the earth. See also [cylindrical projection](#) (page 2058).

meridian A great circle passing through both poles, corresponding to a line of longitude.

metadata Data about data. In the GIS context, metadata consists of information that describes the essential characteristics of geospatial data sets. See also [FGDC CSDGM Standard](#) (page 2063).

Military Grid Reference System (MGRS) A [Universal Transverse Mercator \(UTM\) projection](#) (page 2078)- and Universal Polar Stereographic (UPS)-based [grid reference system](#) (page 2065) used by the United States military and NATO.

monuments Features with known coordinates, used to establish accurate and precise location on a map. See also [control points](#) (page 2058).

Mpolygon A polygon object. A polygon differs from a closed polyline in that it stores information about its inner and outer boundaries.

naming scheme The method of determining an individual map tile name. Examples include column/row, sequential, and data driven.

network analysis, network flood trace See [flood trace](#) (page 2064).

network topology A description of the spatial relationship between linear drawing objects (links and, sometimes, nodes). For example, a network topology can represent pipelines, streets, electrical transmission lines, and rivers.

node A single point or a link end point or intersection in a topology. A node can be represented as a block or point object.

node topology A description of the spatial relationship between geographic point objects in a drawing. Examples of node topologies include point sources of pollution and road signs.

normalizing In a theme, the scaling of data values relative to another data value. A common example is adjusting the thematic value based on the area, length, or perimeter of the entity.

object class All the drawing objects that have been created using a specific object class definition. Use object classification to organize objects in your drawing based on the real-world features they represent, such as roads. Object classes allow you to create new objects that automatically have the appropriate properties and values for objects in your drawing. See also [feature class](#) (page 2063).

object class definition A definition of how to create a classified drawing object in a drawing. An object class definition can include information about the object type, default properties of the object, or default data that should be attached to the object.

object data Attribute data attached to an object and stored in the drawing file. Compare with [external data](#) (page 2062).

OGC Open Geospatial Consortium. A non-profit, international, voluntary consensus standards organization that leads the development of standards for geospatial and location based services. (www.opengeospatial.org)

one-to-many join A join in which one record in the primary table corresponds to more than one record in the secondary table.

one-to-one join A join in which one record in the primary table corresponds to one record in the secondary table.

OpenGIS Agent The component of the MapGuide Server Web Extensions that implements several OpenGIS Web-mapping protocols to expose the services offered by the MapGuide Server to standards-based OpenGIS clients.

Oracle schema See [schema](#) (page 2073).

Oracle Spatial (OSE) feature An earlier version of the Feature Data Objects (FDO (page 2062)) feature, used to store maps in Oracle Spatial.

OSGeo Open Source Geospatial Foundation. A foundation created to support and build the highest-quality open source geospatial software. The goal of the foundation is to encourage the use and collaborative development of community-led projects. (www.osgeo.org)

overlay To create a new topology by combining elements of two distinct topologies. At least one of the original topologies must be a polygon topology.

overlay analysis In AutoCAD Map 3D, a tool that provides spatial and data analysis capabilities for two sets of geospatial features.

package In MapGuide, a compressed file that can speed up the process of loading data onto the server. Large source-data files can be zipped up in this file format and saved to a network location or copied to a CD.

parallel A degree of latitude that circles the earth parallel to the Equator.

path trace For a network topology, a trace begins at a specified point, finds the shortest distance to another point and is based on resistance (the length by default).

persistent locking The ability to edit checked-out objects while you are offline, and then save your changes back to the data source when you return online.

placeholder Specifies location and size of elements (viewports, scale bar, north arrow, legend) in a map sheet.

plot template block An AutoCAD block that contains plotting information such as title page text, plot layouts, legend, and other map [annotation](#) (page 2055).

point cloud A collection of points represented as an AutoCAD object.

Point Cloud Manager The main user interface for converting LiDAR data to a point cloud database file format.

polygon A polygon is a closed area that stores information about its inner and outer boundaries, and about other polygons nested within it or grouped with it. In a polygon topology, the polygon can be enclosed by any lines or arcs in the drawing. In addition, AutoCAD Map 3D supports a polygon object, sometimes called an [Mpolygon](#) (page 2069) or mapping polygon.

polygon topology A description of the spatial relationship between geographic area features. Polygon topologies contain geometric links, nodes, and centroids. Examples of polygon topologies are land use and land cover maps, political boundaries, parcels, and soil types.

primary key The property whose value uniquely identifies each feature within a feature class. Many feature classes use a single property for this purpose, for example, FeatureId. However, a feature class could have a list of properties such as street number, street name, and street type to uniquely identify a house address. You cannot edit primary key values for joined data.

prime meridian The line of longitude drawn through Greenwich, England, used as the origin for longitude measurements.

profile User-defined settings specific to a given drawing.

property For [feature](#) (page 2063) data, a single attribute of a class. A class is described by one or more property definitions. For example, a Road [feature class](#) (page 2063) may have properties called Name, NumberLanes, or Location. See also [attributes or attribute data](#) (page 2055).

property alteration definition The definition of properties you want to change during a query.

property data Values associated with a geographic object, such as river depth, road width, or pipe diameter. In AutoCAD Map 3D, these items are represented as block attributes, values in object data tables, or values in a linked external database.

pseudo node An unnecessary node in a geometric link. A pseudo node can be used to store information about geographic point location or to represent change from one link to another.

publish To generate output from a map book.

purge To remove all unused object definitions from an open drawing.

query A set of executable statements that retrieve specific objects. For example, a layer-based query that displays only the objects on the layers that contain state and district boundaries. See [map query](#) (page 2068), [topology query](#) (page 2077), and [database query](#) (page 2059).

Query Library The set of queries saved in a drawing. You can add, delete, and modify queries in the Query Library.

ramp A sequence of display properties used to render a theme; for example, a sequence of colors, line styles, or hatch patterns.

range of values In a theme, a segment of data along a continuum, such as property value, temperature, or population.

raster Images containing individual dots (called pixels or cells) with color values, arranged in a rectangular, evenly spaced array. Aerial photographs and satellite images are examples of raster images used in mapping. Compare with [vector](#) (page 2078).

raster-based surface layer See [surface layer](#) (page 2076).

reference point For a symbol, the point that controls the position of a symbol over a feature in a map. The default reference point is the center of the symbol.

registration The preparation of a map for digitizing by calibrating a digitizing table to convert an analog source to a digital file. See [digitize](#) (page 2059).

resistance Resistance is a measure of how hard it is to travel a link. The default measure of resistance is the length of the link. You can set the resistance to be related to what the link represents, such as pipe diameter or traffic speed.

resolution In a raster image, the density of pixels-per-inch (PPI) or dots-per-inch.

resource In MapGuide, a feature source, drawing source, or application component that is stored in the resource repository and can be reused and shared.

resource (metadata) In the Metadata feature, a resource is a generic term meaning any type of data set for which AutoCAD Map 3D can generate [metadata](#) (page 2069). A resource could be a feature class, an object class, a schema, or a file.

resource repository In MapGuide, an XML database that stores the resources created either by loading file-based data or by connecting to databases.

rubber sheeting An editing method, used only when necessary, that attempts to correct errors by stretching a map to fit known control points or monuments.

rule (for feature themes) A feature theme consists of a collection of rules. Each rule specifies a style and feature label for the features that meet the specified condition. You can add a legend label to provide a description of the condition of a rule. As a layer is drawn, each [feature](#) (page 2063) is compared to the rules in the order that they are listed. The first rule for which the feature meets the condition is used to specify the style and feature label for that feature.

save set Objects that have been created or modified in the current drawing and are marked to be saved back to source drawings.

scale The ratio of the distance on a paper map to the distance on the ground. If a paper map has a scale of 1:100,000 (also represented as 1/100000), then a distance of 1 unit on the paper map corresponds to 100,000 units on the ground. On a digital map, scale represents the scale of the map from which the digital map was derived.

scale threshold You can define different stylizations at different scale thresholds. For example, turn on the display of road names only when the drawing scale factor is below 1:5000.

schema The definition of multiple feature classes and the relationships between them. A schema is the logical description of the data types used to model real-world objects, and does not reference the actual data instances (a particular road or land parcel). Rather, it is metadata. See also [feature class](#) (page 2063).

SDF Spatial Data File. An open source file-based geodatabase that can contain multiple feature classes or types of data stored in tables with attributes and geometry. See [SDF 2](#) (page 2073), [SDF 3](#) (page 2073).

SDF 2 The previous version of the SDF file format. It was the native file format for Autodesk MapGuide (the last release was Autodesk MapGuide 6.5). Each SDF 2 file generally contained one [feature class](#) (page 2063) or type of data, for example points, lines, polygons, or text.

SDF 3 The current version of the SDF format. It is the native format for MapGuide Enterprise and MapGuide Open Source. Each SDF 3 file can contain multiple feature classes or types of data stored in tables with attributes and geometry. See [feature class](#) (page 2063).

service An Oracle database.

shading See [hillshading](#) (page 2065).

sheet An individual named object in a sheet set that can be published. References a layout. In a DWF file, a plot layout containing a specific view of the original data.

sheet set A named collection of sheets and subsets for publishing.

sheet subset A named collection of sheets within a sheet set. An individual sheet can only be a member of a single subset.

sheet template A drawing file that defines a title block and a layout for use in sheets. Can be specified for sheet sets and sheet subsets.

shortest path trace See [path trace](#) (page 2070).

site The collection of servers that process MapGuide requests.

Site Administrator A web-based application, installed with MapGuide Server, for managing a site and its servers.

Site Explorer The tree view in MapGuide Studio that displays the resources stored in the resource repository.

site server In a site, the server that contains the resource repository.

slope A method of reporting surface inclination as a ratio that expresses the horizontal distance in which the elevation changes by one linear unit. For example, if the ground rises 3 units over a horizontal distance of 15 linear units (meters or feet), the slope is 5:1 (5 to 1).

source drawing A drawing file attached to another drawing. The set of all source drawings attached to a drawing is called the drawing set. Use a query to retrieve selected objects from multiple source drawings.

spatial A generic term used to reference the mathematical concept of n -dimensional data.

spatial analysis The process of understanding, extracting, or creating information about a set of objects. Spatial analysis includes techniques used to determine the distribution of objects over a network or area, and the relationships between those objects. The location of, proximity to, and orientation of objects can be analyzed with spatial analysis. It is useful for evaluating suitability and capability, for estimating and predicting, and for interpreting.

spatial context The general metadata or parameters within which the geometry for a collection of features resides. In particular, the spatial context includes the definition of the coordinate system, spheroid parameters, units, spatial extents, and so on, for a collection of geometries owned by features.

spatial data Information about the location and shape of geographic features, and the relationships between those features. See also [feature](#) (page 2063).

Spatial Data File See [SDF](#) (page 2073).

spatial database A database containing information indexed by location.

spatial filter A selection of objects that specify which records to display in the active table or query. When a spatial filter is active, the Data View displays only those records linked to selected objects. Compare with [SQL filter](#) (page 2075).

spatial index An index created in an Oracle Spatial database by dividing the extents of the drawings in the database into rectangular tiles. AutoCAD Map 3D uses the index to locate the geometry to be imported.

spherical coordinate system A coordinate system measured on the surface of a sphere and expressed as angular distances. Compare with [Cartesian coordinate system](#) (page 2057).

spheroid See [ellipsoid](#) (page 2062).

SQL filter A series of SQL expressions that specify which records to select in the active table or query. When an SQL filter is active, the Data View displays only those records that match the filter criteria. Compare with [spatial filter](#) (page 2075).

style Settings that specify how to display the [feature](#) (page 2063) or drawing objects in a Display Manager layer. For example, a polygon style that makes parcel polygons 50% transparent and which appears at a scale of 1:50000. One or more styles can be applied to a single element.

style library Use the style library to store the styles you use frequently. You can drag and drop these styles onto any element in any other display map.

styling The process of assigning display characteristics (such as line color, line pattern, fill color, fill pattern, and so on) to [feature](#) (page 2063) (points, polylines, polygons). See also [theming](#) (page 2077).

stylization Visually or textually changing the display of drawing objects according to the assigned styles, rather than displaying them with their native object properties. See also [style](#) (page 2075).

superuser A user who controls user IDs, passwords, and access to sensitive procedures.

supplementing distance The maximum distance between 3D polyline vertices. If the distance between vertices is greater than specified, then points are added

along the 3D polyline in equal increments that are less than or equal to the supplementing distance.

supplementing factors Add vertices along 3D polylines that are long and contain few vertices. The supplementing distance is the maximum distance between vertices. If the distance between vertices is greater than specified, then points are added along the 3D polyline in equal increments that are less than or equal to the supplementing distance. The smaller the distance, the greater the number of supplemented points.

surface A network of elevation data. AutoCAD Map 3D supports raster-based grid surfaces, such as DEM, DTED, and ESRI Grid. In these types of surfaces, the points of a surface are connected into a grid, which are then used to interpolate contours, and to generate profiles and cross-sections. A surface represents the ground condition at a particular time or event.

surface layer A layer in [Display Manager](#) (page 2060) containing a raster-based surface such as a Digital Elevation Model (DEM), an ESRI Grid file, or Digital Terrain Elevation Data (DTED). A surface layer is brought in using Data Connect. See also [feature layer](#) (page 2063), [drawing layer](#) (page 2060), [AutoCAD layer](#) (page 2056).

swing tie A type of measurement taken by a surveyor using a known distance plus an angular offset. A tie is a direct measurement, made with a tape or chain. Swing refers to the angle offset of the tie.

symbol A bitmap or vector image that is used to represent a point.

symbol library In MapGuide Studio, a collection of related symbols. Image files are converted into symbols when they are brought into the symbol library. The symbol library is stored in the resource repository.

symbol table A term referring to the storage of named objects, including linetypes, layers, text styles, and blocks.

table A set of data arranged in records (rows) and fields (columns). When a table is displayed in a grid, records display in horizontal rows and fields display in vertical columns. Each field value in the table displays in a cell.

Task Pane A AutoCAD Map 3D window that provides the tools you require to accomplish your main mapping tasks: creating, displaying, styling, analyzing, and publishing maps. The Task Pane contains tabbed views: [Map Explorer](#) (page 2068), [Display Manager](#) (page 2060), Survey, and [Map Book](#) (page 2067). Map Explorer enables you to manage the resources you use to create your maps. Display Manager provides tools to create maps, and create styles and themes. With Map Book, you can print, publish and share maps. You can resize and move the Task Pane palette.

task workflow An overview of the steps to perform common GIS tasks.

template file A file that formats another file, such as a text file for saving information from queried objects. See also [dot variable](#) (page 2060), [query](#) (page 2072), and [link template](#) (page 2067).

text layer Static text stored as a separate SDF data store, independent from the current map. You can precisely position text on the layer, and style and rotate the text.

thematic map See [theme](#) (page 2077).

theme A theme is a special style used to vary the stylization based on some property of the objects. For example, instead of just coloring the lakes blue, you could vary the shade of blue based on the depth of the lake. Instead of just altering the line width of the roads, you could vary the line width based on traffic flow.

theming The process of styling [feature](#) (page 2063) according to an attribute value. See also [styling](#) (page 2075).

tiling scheme The method of breaking a large map into multiple smaller tiles. Options include by area, by number, and custom.

tolerance A radius around a node or linear object used to search for drawing errors.

tolerance (drawing cleanup) The minimum distance allowed between linear objects or nodes during drawing cleanup. If two linear objects or nodes are separated by a distance less than the tolerance, AutoCAD Map 3D corrects the error.

Topobase An Autodesk data management solution for utility companies, municipalities, and engineering firms. Autodesk Topobase consists of a set of industry-specific modules built on AutoCAD Map 3D and MapGuide, all of which use Oracle as the central data store.

topology A set of geometric relationships between drawing objects, including links, nodes, and centroids. Topology describes how lines, nodes, and polygons connect and relate to each other, and forms the basis for advanced GIS functions such as network tracing, spatial analysis, buffer analysis, overlay analysis, and dissolving a polygon topology.

topology query An extension to a Map query that applies to a loaded topology. See also [map query](#) (page 2068).

transparent command A command started while another is in progress. Precede transparent commands with an apostrophe.

transverse cylindrical projection A map projection, in which the surface of the Earth is drawn as it would appear if projected on a cylinder wrapped around the earth in an east-west direction. Compare with [cylindrical projection](#) (page 2058).

UDL (Universal Data Link) File with .udl extension that includes the name and location of the database table and the software used to create the file. Windows uses a UDL file to identify a data source. Using the information in this file, programs such as AutoCAD Map 3D can view and update data from external databases.

undershoot Two or more lines within a specified tolerance of each other that do not meet.

union Two or more conditions joined with the logical operator Or. An item is selected only if the item meets at least one of the specified criteria. Compare with [intersection \(expression\)](#) (page 2065).

United States National Grid (USNG) A [Universal Transverse Mercator \(UTM\) projection](#) (page 2078)-based [grid reference system](#) (page 2065) for the United States.

Universal Transverse Mercator (UTM) projection A specific implementation of the Mercator projection, designed for use around the world. See also [Mercator projection](#) (page 2068).

vector A mathematical calculation of an object with precise direction and length. Vector data is stored as X,Y coordinates that form points, lines, and areas. Compare with [raster](#) (page 2072).

versioning A database function that allows multiple copies of a spatial dataset to be stored and tracked by date of creation, data of change, and so on.

vertical exaggeration An increase of vertical scale relative to horizontal scale, used to make elevation changes easier to differentiate.

viewport (paper space) A view of model space from a layout.

wavelet A multiple resolution image file compressed using a lossy compression that enables large graphics to load much faster due to the reduction in file size. Wavelet compression is based on a mathematical algorithm in which graphic images can be reduced to a small fraction of their original size.

weeding The removal of points along a selected 3D polyline, which may represent a contour. The weeding factors determine the number of points removed. You can use weeding to reduce the amount of point information taken from the contours that may not be necessary to generate an accurate surface.

weeding factors You can use the weeding factor settings to reduce redundant points along 3D polylines by ignoring vertices that are close together or along a straight line. A larger distance and deflection angle will weed a greater number of points. Distance is an absolute measure and the angle is measured in degrees. The larger the distance value, the greater the number of weeded points. The weeding factors must be less than the supplementing factors.

A point is weeded by calculating its location in relation to the vertices before and after it. If the length between these three points is less than the weeding length value, and the deflection angle is less than the weeding angle value, then the middle point is not added to the contour data file.

WFS Web Feature Service. A web service based on the specification defined by the OGC. Acts as a source of [feature](#) (page 2063) data.

WMS Web Map Service. A web service based on the specification defined by the OGC. Produces an image (for example, a PNG or JPG image) of geospatial data.

workflow An automated set of tasks that can be arranged to run in series or parallel. The output of one task can be used as the input of another task. The user can configure the sequence and parameters for execution graphically.

workflow activity A single step in a workflow that executes a command or set of commands.

workflow binding A relationship between activities such that the output of one activity is used as the input of another.

workspace Contains the commands and tools for specific tasks. The Tool-based Ribbon workspace is tailored to those familiar with the AutoCAD ribbon, while the Task-based Ribbon workspace is optimized for working with AutoCAD Map 3D.

To change your workspace, click the name of the current workspace in the status bar and select a different workspace from the list.

zero-client viewer See [MapGuide Viewer \(AJAX viewer\)](#) (page 2068).

zoom To change the display magnification so that it focuses on progressively smaller areas (when you zoom in) or larger areas (when you zoom out) of an image.

zoom extents To magnify a drawing based on its extents so that the view shows the largest possible view of all spatial objects.

Index

- .bmp files
 - inserting with Raster Extension 455
- .ddf files (SDTS format) 413
 - importing 414
- .dgn files 405, 408, 1435
 - exporting to 1435
 - importing 405, 408
- .dib files
 - inserting with Raster Extension 455
- .dpf files 781
- .dwg files
 - exporting maps to 1460
- .dwk files 227, 730, 735
- .dxf files 391
 - exporting 1459
 - importing 391
- .eoo files
 - exporting 396
 - importing 396
- .gml files 412
 - exporting to 1429
 - importing 412
- .ini files 249
 - and drive aliases 161
 - customizing 264
 - for import and export 269
- .jpg files
 - adding with Data Connect 443–444
- .mif files 400
 - exporting to 1431
 - importing 400
- .mil files
 - inserting with Raster Extension 455
- .pct files
 - inserting with Raster Extension 455
- .pcx images
 - inserting with Raster Extension 455
- .png files
 - adding with Data Connect 443–444
- .rst files
 - inserting with Raster Extension 455
- .sdf files 338, 387, 1413
 - exporting 1413, 1417
 - importing 387
 - saving Display Manager layers as 1470
 - using as a data source 338
- .shp files 335–336, 399
 - adding feature data to maps 336
 - converting to drawing objects 335
 - importing 399
- .sif files 1417
- .sqlite files 331
 - exporting 1447
 - using as a data source 331
- .sys files 249
- .tab files 402, 404, 1433
 - exporting to 1433
 - importing 402, 404
- .tga files
 - inserting with Raster Extension 455
- .tif files
 - adding with Data Connect 443–444
- .vml files 1449
 - exporting to 1449
- .vpf files 416–417
 - importing 416–417
- 2D
 - adding rasters to maps 444
 - draping over 3D surfaces 1193
 - viewing 1193
- 3D
 - orbit options 1196
 - surfaces 1192
 - viewing 1193, 1196
- 3D surfaces
 - draping 2D data on 1193
 - video 1194
 - walkthroughs 1196

A

- abstract classes
 - in Schema Editor 1739
- acadmap.ini file 161, 249
- acadmap.sys file 249
- ACADOPTIONS command 89
- ACADPUBLISH command 1371, 1373
- ACADSAVE command 742
- ACADSAVEAS command 1459
- accessing 314, 319, 324, 331, 333, 336, 338, 341, 344, 378
 - ArcSDE data in maps 319
 - Autodesk SDF data in maps 338
 - Microsoft Access data in maps 344
 - MySQL data in maps 333
 - ODBC data in maps 344
 - Oracle data in maps 314
 - PostGIS data in maps 341
 - SHP files in maps 336
 - SQL Server data in maps 324
 - SQLite data in maps 331
 - vs importing data for maps 378
 - WFS data in maps 348
- activating source drawings 160
- activities
 - for workflows 281
- Add Class Property dialog box (Export) 1726
- Add Feature Layer activity
 - for workflows 2028
- Add Group activity
 - for workflows 2029
- Add Map activity
 - for workflows 2030
- Add To Map With Query 310
- adding 314, 319, 324, 331, 333, 336, 338, 341, 444, 751, 764, 878, 880, 884, 937, 1056
 - 2D rasters to maps 444
 - annotation to maps 1103
 - ArcSDE data to maps 319
 - Autodesk SDF data to maps 338
 - database records in Data View 1056
 - digital elevation models to maps 442
 - digital terrain elevation data to maps 442
 - distances 1157
 - drawings to save sets for maps 751
 - drawings to the current map 158
 - ESRI grid files to maps 442
 - ESRI SHP data to maps 336
 - linear objects to topology 880
 - MySQL data to maps 333
 - nodes to topology 878
 - objects to save set 764
 - Oracle data to maps 314
 - polygons to topology 884
 - PostGIS data to maps 341
 - raster images to maps 442
 - raster-based surfaces to maps 442
 - SHP data to maps 336
 - SQL Server data to maps 324
 - SQLite data to maps 331
 - surfaces to maps 442
 - text to drawing objects 1278
 - text to objects 937
 - WFS (Web Feature Service) data to maps 348
 - WMS (Web Map Service) data to maps 447
- ADEATTACHDATA command 1062, 1065, 1794
- ADEDEFCDRDSYS command 91
- ADEDEFDATA command 200–201, 1456, 1805
- ADEDRAWINGS command 156, 159, 1918
- ADEDWGCLEAN command (discontinued) 1533
- ADEDWGMMAINT command 736, 1295, 1920
- ADEDWGSTAT command 166, 173, 1926
- ADEEDITDATA command 1070, 1795
- ADEFILLPOLYG command 940, 1647
- ADEGENLINK command 533, 1063, 1068, 1457, 1807
- ADEQUERY command 1238, 1262, 1289, 1478, 1480, 1838

- ADEQUERYLIB command 181, 183, 1858
- ADEQVIEWDWGS command 747, 2013
- ADEREMOBS command 742, 760, 1885
- ADERSHEET command 935, 1648
- ADERUNQUERY command 180, 1861
- ADERUNXQUERY command 180
- ADESAVEOBS command 742, 749, 754, 756, 1887
- ADESELOBS command 742, 752, 1886
- ADESETCRDSYS command 147–148, 1296, 1598
- ADESHOWOBS command 753, 1887
- ADETEXTLOC command 937, 1799
- ADETRANSFORM command 932, 1649
- ADEWHOHASIT command 735
- ADEZEXTENTS command 745, 2014
- adjacent arrows
 - for map books 1385
- aerial imagery
 - purchasing 72
 - samples 63
- affine transformation
 - and digitizing 133
- aliases for drives 161
- aligning 154, 931
 - attached drawings 154
 - drawing objects in maps 931
 - drawings 169
 - maps 154
- Alter Block Insertion dialog box 1622
- Alter Line Format dialog box 1622
- Alter Linetype dialog box 1623
- Alter Lineweight dialog box 1624
- Alter Plotstyle dialog box 1624
- Alternate Font dialog box (drawing queries) 1835
- analyzing data
 - overview 1121
- anchoring 770
 - objects for Drawing Cleanup 770
- angle information 1160
 - displaying 1160
- ANGLE variable 1546
- annotating
 - maps (video) 1089
- annotation 186, 1100, 1103, 1105–1108
 - adding for drawing layers 660, 1176
 - applying for drawing layer themes 1176
 - attaching to drawing objects in maps 1103
 - changing templates 196
 - defining templates 192
 - deleting in maps 1108
 - deleting references to templates 197
 - deleting templates 197
 - editing on an annotation layer 1116
 - for drawing layer themes 1186
 - inserting in maps 1103
 - legends (video) 1117
 - refreshing in maps 1105
 - templates 186
 - templates from xrefs 186
 - text layers (video) 1109, 1111, 1113, 1115
 - updating in maps 1107
- Annotation Delete dialog box 1569
- annotation layers
 - adding text to 1114
 - creating 1110
 - styling 1112
- Annotation Refresh dialog box 1569
- Annotation Text dialog box 1570
- Annotation Update dialog box 1571
- apostrophe 1027
 - and coordinate geometry commands 1027
- apparent intersection 773, 779, 803
 - and Drawing Cleanup 803
 - marking for cleanup 779
 - selecting 773
 - tolerance for extending 773
- appending 1413, 1424
 - when exporting to SDF 1413
 - when exporting to SHP 1424
- Arc/INFO Coverages 381, 394, 1419
 - export defaults 269
 - exporting 1405
 - exporting to 1419
 - importing 381, 394

- arcs 776, 1032, 1034, 1036, 1038, 1040, 1042, 1044
 - converting to polylines during Drawing Cleanup 776
 - displaying COGO information for 1161
 - specifying with angle and distance 1032
 - specifying with azimuth and distance 1042
 - specifying with bearing and distance 1034
 - specifying with deflection and distance 1038
 - specifying with distance and offset 1044
 - specifying with two bearings 1036
 - specifying with two distances 1040
- ArcSDE 316
 - adding feature data to maps 319
 - exporting drawing data to 1423
 - importing data from 392
 - moving DWG data to 629
 - provider capabilities in maps 316
 - schemas 579
 - setting up for 318
 - working with data 581
- ArcView ShapeFile 381
 - exporting as folder 269
 - exporting to 1424
 - importing 381
 - importing as folder 269
- area
 - altering drawing objects based on 1265
 - finding drawing objects by 1244
 - specifying save back extents 170
 - style options for 650
- AREA variable 1546
- arithmetic functions 1541
- aspect
 - and theming 1202
 - theming surfaces for 1203
- Assign Global Coordinate System dialog box 1598
- Associate Database Versions dialog box 1675
- associating 507, 512
 - data with map features 512
- association properties
 - in Schema Editor 1739
- associations
 - data and map features 507
- associative hatch 247
- Attach Object Class Definition File dialog box 1781
- Attach Object Data dialog box 1793
- Attach/Detach Object Data dialog box 1794
- ATTACHDEF command 996, 1781
- attached drawings
 - querying (video) 24, 1235, 1238, 1242, 1245, 1249
- attaching 158, 523
 - data sources for drawings 209
 - data to drawing objects in maps 523
 - drawings to the current map 158
 - external data to maps 209, 523
 - queries to the current drawing 180
 - text to drawing objects 1278
- attribute data 291, 364, 426, 434–435, 507, 509, 512, 532
 - adding drawing objects to maps by 364
 - adding to features 509
 - adding using joins 507, 512
 - altering drawing objects based on 1267
 - and maps 291
 - and queries 1300
 - displaying as text 435
 - exporting 1405, 1473
 - exporting text enclosed in a polyline 1455
 - finding drawing objects by 1248
 - importing 426, 434
 - including when publishing to DWF 1367
 - joining to features (video) 37
 - linking records to drawing objects 532

- linking to drawing objects in maps 1067
 - overview 27
 - reports 1473
 - viewing (video) 27
 - viewing for features 1125
 - Attribute Data dialog box 1699
 - Attribute Domain Values Editor 1773
 - Attribute Editor (metadata) 1756
 - auditing
 - metadata 1509
 - topology 920
 - Australian coordinate systems 109
 - changes 110
 - grid data files 109
 - AutoCAD Civil 3D 545
 - bringing data into AutoCAD Map 3D 545
 - AutoCAD Color Index 1552
 - AutoCAD commands 701
 - editing features with 701, 715–716
 - AutoCAD layers 356, 419, 421
 - adding drawing objects to maps 356
 - adding to Display Manager (video) 352, 634
 - assigning object classes during import 421
 - importing into AutoCAD Map 3D 419
 - AutoCAD Map 3D 77, 84, 142
 - checking version 1905
 - coordinate system files 113
 - customizing 84, 216–217
 - logging in as Superuser 142
 - opening display maps in previous versions 1460
 - sample data 62
 - setting options 216–217
 - setting up 77
 - templates 62
 - tutorials 58
 - user interface tour 2
 - user privileges 142
 - AutoCAD Map Confirmation dialog box (drawing topology) 1950–1951
 - AutoCAD Map Messages dialog box 1799
 - AutoCAD Map Options dialog box 1908
 - AutoCAD Raster Design images
 - inserting with Raster Extension 455
 - AutoCommitting changes in the Data View 1056
 - Autodesk Design Review 1365, 1369, 1372
 - Autodesk digital animation
 - inserting with Raster Extension 455
 - Autodesk DWF Viewer 1365
 - Autodesk MapGuide 389
 - exporting to version 6.5 and earlier 1417–1418
 - exporting to version 6.5 or earlier (video) 1376
 - importing from 389
 - publishing to current Enterprise version 1378
 - Autodesk MapGuide Export dialog box 1580
 - Autodesk mapGuide Import dialog box 1582
 - Autodesk SDF 337–338, 388
 - about file format 387
 - adding feature data to maps 338
 - and Bulk Copy 617
 - provider capabilities for maps 337
 - AutoLISP variables 1551
 - automatic checkout
 - video 713
 - automatic drawing cleanup 783
 - automatic save file 757
 - automatic update 698
 - changing default setting 88
 - for feature data 698
 - automating tasks 278, 281
 - autox.sv\$ file 757
 - azimuth base 234
 - setting to South 234
- B**
- backup files 764
 - balancing polygon boundaries 955
 - base feature classes
 - in Schema Editor 1739

- base object classes 123
- base or abstract classes (inheritance)
 - setting in schemas 612
- BB 1036
- best route analysis 845, 849, 1328, 1330
 - and direct resistance 849
 - and direction 845
- BIL images
 - inserting with Raster Extension 455
- bitonal images
 - inserting with Raster Extension 455
- block attributes 532
 - and queries 1300
 - finding drawing objects by 1248
 - linking data to drawing objects in maps 532
 - linking to drawing objects in maps 1067
 - variables 1549
- Block Mapping dialog box 1701
- block names
 - altering drawing objects based on 1265
 - finding drawing objects by 1244
- block queries 1296
 - and property queries 1296
 - in preview mode 1296
- BLOCKNAME variable 1546
- blocks 225, 428, 532, 761, 764, 1067, 1296
 - adjusting for map distortion 225
 - altering name with queries 1261
 - and property alteration 1296
 - exploding when saving back from maps 761
 - for drawing layers 660
 - importing into AutoCAD Map 3D 428
 - linking to data for maps 532
 - linking to records
 - automatically 1067
 - options 225
 - querying 1300
 - redefining on save back 764
 - saving to source drawings from maps 761
 - scaling for drawing layer
 - themes 1176
 - specifying color 1285
 - specifying for digitized nodes 138
 - theming for drawing layers 1176
 - units 225
- BMP files
 - inserting with Raster Extension 455
- boundaries 756, 941, 945, 955, 963, 978
 - breaking drawing objects at 941
 - changing for polygons in maps 963
 - displaying for polygons 978
 - inner and outer for polygons 955
 - query location 1241
 - trimming objects at 945
 - using to save drawing objects 756
- Boundary Break command 941
- boxes
 - Responsible Party Editor (ISO Metadata) dialog box 1776
- Break Objects at Boundary dialog box 1666
- breaking 941
 - drawing objects at boundaries 941
- brightness
 - for drawing layers 660
- Browse/Search dialog box 1800
- Buffer Warning dialog box 1560
- bufference boundary for query location 1241
- buffers
 - and topology 1347
 - creating (video) 1302
 - for drawing objects 1347
 - for features 1308
 - for geospatial features 1306
 - overlapping (video) 1302
 - using to select features (video) 1302
 - using with location queries (video) 1302, 1306
 - warnings 1306
- buffers (video) 37
- BULGE variable 1546
- Bulk Copy
 - alternatives to 617
 - and Autodesk SDF 617

- and coordinate systems 617
- and geometry issues 625–626
- and SHP files 617
- and SQL Server Spatial 617
- copying data from one feature source to another 621
- copying foreign schemas 621
- data types 623
- ignoring errors 1744
- log files 626
- overview 617
- video 616–617
- widening conversion 623
- Bulk Copy (video) 43
- Bulk Copy dialog box 1744
- Bursa/Wolfe conversion method 94
- buying data 62

C

- caching 722
- calculated fields
 - video 1125, 1132
- calculated properties
 - and joined data 519
 - creating 1133
- calibration
 - and digitizing maps 136
 - options when digitizing 133
- CALS images
 - inserting with Raster Extension 455
- Canadian National Transformation 112
- cancelling check out for features 698
- Cartesian coordinate system 143
 - adjusting for distortion in maps 225
 - and digitizing 133
- categories 97, 101
 - for coordinate systems 97, 101
 - for queries 182
- cells (in database) 1056
 - editing in Data View 1056
- CENTER variable 1546
- central meridian 143
- Centroid Objects dialog box (drawing topology) 1952
- CENTROID variable 1546

- centroids 430, 836, 839, 937
 - creating for closed polylines 950
 - creating for polygon topology 836
 - creating for polygons 433, 887, 950, 977
 - creating if missing 839
 - importing to in AutoCAD Map 3D 430
 - moving data to 430, 887
 - moving label point 937
 - removing duplicates 839
- CG4 images
 - inserting with Raster Extension 455
- Change Category dialog box (drawing queries) 1835
- Change Feature Layer Properties activity
 - for workflows 2030
- Change Feature Layer Symbol activity
 - for workflows 2031
- Change Group Properties activity
 - for workflows 2033
- check out features
 - automatically 696
- checking in
 - features (video) 693
- checking in features 694
- checking out
 - features (video) 695, 701
- checking out features 696, 698
 - and automatic update 698
 - and locking 696
 - and working offline 696
 - cancelling 698
- circles 776
 - boundary for query location 1241
 - converting to 2D polylines during Drawing Cleanup 776
 - converting to arcs during Drawing Cleanup 776
- Citation Editor (ISO Metadata) dialog box 1777
- Citation Information Editor 1759
- Civil 3D 543, 545
 - bringing data into AutoCAD Map 3D 545

- bringing data into AutoCAD Map 3D
 - (video) 9, 43
 - exporting data to SHP 545
 - objects supported by AutoCAD Map 3D 543
 - video 543
- classified DWG 988–989
- Classified Property List dialog box (object classification) 1782
- CLASSIFY command 990
- Classify dialog box (object classification) 1782
- Classify Objects dialog box 1783
- classifying objects 988–989, 993
- cleanup 767, 770, 773, 776, 779, 781–783, 785, 788, 791, 794, 796, 799, 801, 803, 806, 808, 810, 814–815, 819, 838
 - actions 788
 - anchoring objects 770
 - apparent intersection 803
 - breaking crossing objects 799, 838
 - correcting errors automatically 783
 - correcting errors interactively 785
 - correction methods 782
 - dangling objects 810
 - deleting duplicates 794
 - displaying markers 785
 - elevation for new objects 776
 - erasing short linear objects 796
 - extending undershoots 801
 - for topology 788
 - layers for new objects 776
 - line width for new objects 776
 - markers 779
 - order of actions 773
 - order of operations 788
 - overview 766
 - profiles 781
 - pseudo nodes 808
 - reviewing errors before
 - correcting 785
 - selecting actions 773, 791
 - selecting objects 770
 - simplifying objects 814
 - snapping clustered nodes 806
 - tolerance for 773
 - weeding 819
 - zero-length objects 815
- Cleanup Methods dialog box page 1585
- clip overlay 1309
- closed polylines 433, 898
 - creating centroids for 433, 950, 977
 - creating from polygon topology 898
 - creating from polygons during export 1458
- clustered nodes 773, 779, 806
 - marking for cleanup 779
 - snapping 806
 - tolerance for deleting 773
- COGO 1027–1028, 1032, 1034, 1036–1037, 1040, 1042, 1044–1045
 - angle and distance 1032
 - azimuth and distance 1042
 - bearing and distance 1034
 - bearing/bearing 1036
 - deflection and distance 1037
 - distance/distance 1040
 - entering commands 1028
 - input commands 1027
 - inverse report 1045
 - orthogonal/offset 1044
 - transparent commands 1027
- Color Range Editor dialog box (object classification) 1783
- COLOR variable 1546
- colors
 - altering drawing objects based on 1265
 - altering using queries 1261
 - and styles 650
 - changing for blocks 1285
 - digitizing 138
 - finding drawing objects by 1244
 - for drawing layers 660
 - for lines 649
 - for surface themes 1205
 - in expressions 1552
 - list of 1552
 - setting feature default 1552
 - theming for drawing layers 1176

- using to modify thematic objects 1261
- Column dialog box 1676
- Column Values dialog box 1678
- columns (in database tables) 526, 1058–1059
 - for link templates in maps 526
 - formatting in Data View 1058
 - hiding or freezing in Data View 1059
- combining maps 158
- comma-separated files
 - and user locale 1474
 - exporting from Data Table 1142, 1474
- command line 87
 - inserting images 471
 - showing by default in geospatial and drawing workspaces 87
- commands 1519, 1533
 - blocked during refedit 1537
 - changed from previous releases 1519
- committing changes in the Data View 1056
- complete topology 920
- complex linear objects 779, 814, 819
 - marking for cleanup 779
 - simplifying 814, 819
- composite line styles 649
 - for drawing layers 662
- Computer Aided Acquisition images
 - inserting with Raster Extension 455
- conditional functions 1543
- conditions 369
 - using to add drawing objects to maps 369
- conditions for queries (drawing objects) 1237
 - block attribute conditions 1248
 - combining 1256
 - data conditions 1248
 - editing 1258
 - link data conditions 1248
 - location conditions 1241
 - object data conditions 1248
 - overview 1238
 - precedence 1256
 - property conditions 1244
 - SQL conditions 1253
- Configure Data Source dialog box 1679
- configuring
 - data sources 213
 - digitizers 132
- conformal projections 143
- Connect Data Source dialog box 1679
- Connect To Data Store activity
 - for workflows 2034
- connecting 314, 319, 324, 331, 333, 336, 338, 341, 344
 - compared to importing 15
 - data sources for drawings 215
 - to ArcSDE data sources for maps 319
 - to Autodesk SDF data sources for maps 338
 - to Microsoft Access data for maps 344
 - to MySQL data in maps 333
 - to ODBC data for maps 344
 - to Oracle data sources for maps 314
 - to PostGIS data sources for maps 341
 - to SHP files for maps 336
 - to SQL Server data for maps 324
 - to SQLite data sources for maps 331
 - to WFS data 348
 - using Data Connect (video) 3, 9, 13
- connection pooling 88
- constraints
 - in schemas (video) 43
 - setting in schemas 601, 612
 - setting in schemas (video) 599
- Contact Information Editor 1763
- continuous distances 1159
 - base option 1159
- contour layers
 - video 1187
- contour lines 799, 814, 1073, 1189
 - and Drawing Cleanup 799
 - deleting 1191
 - digitizing 1073
 - editing 1191

- overview 1189
 - simplifying with Drawing Cleanup 814
 - video 1189
- control points for digitizing 1073
- conversion functions 1544
- convert
 - DWG data 1405
 - to other format 1405
- Convert DWG To... 1405
- Convert Object Data to Database Links dialog box 1680
- converting 381, 534, 776, 898, 971
 - current map to DWG (video) 628
 - data from one format to another 617
 - drawing objects during Drawing Cleanup 776
 - drawings from other formats 381
 - elevation during Drawing Cleanup 776
 - files from other programs 381
 - geospatial features to DWG format 381
 - layers during Drawing Cleanup 776
 - line width during Drawing Cleanup 776
 - maps to DGN 1438
 - maps to GML 1430
 - maps to MapInfo 1432
 - maps to MapInfo TAB 1434
 - maps to MicroStation Design 1438
 - maps to other formats 1408, 1421
 - maps to SDF 1416
 - maps to Shape Multiclass 1445
 - maps to SHP 1428
 - maps to SQLite 1448
 - maps to Vector Markup Language 1450
 - maps to VML 1450
 - object data to database tables 534
 - overview 1405
 - polygons to polylines during export 1458
 - polygons to polylines in AutoCAD Map 3D 898
 - polylines from 3D to 2D during Drawing Cleanup 776
 - polylines to polygons 971
- coordinate conversion 424
 - during export 1405
 - during import 424
- coordinate geometry 1006, 1027–1028, 1032, 1034, 1036–1037, 1040, 1042, 1044–1045
 - angle and distance 1032
 - azimuth and distance 1042
 - bearing and distance 1034
 - bearing/bearing 1036
 - commands 1148
 - creating survey points using coordinate geometry 1006
 - deflection and distance 1037
 - displaying information for lines and arcs 1161
 - distance/distance 1040
 - inverse report 1045
 - measuring 1154
 - options 234, 1154
 - orthogonal/offset 1044
- Coordinate Geometry Setup dialog box 1917
- Coordinate System Translation dialog box 1703
- coordinate systems 92, 94–95, 97–98, 101, 103–104, 109–110, 112–113, 143, 146, 231, 308, 953
 - and Bulk Copy 617
 - and feature sources in maps 308
 - assigning to current drawing 147
 - assigning to source drawings 146
 - Australia and New Zealand 109
 - basing on datum 92
 - basing on ellipsoid 92
 - categories 97, 101
 - changes to Australian 110
 - converting when adding data 311
 - correcting when adding data 311
 - datum shift issues for North American users 112
 - defining 92
 - defining a datum 94

- defining an ellipsoid 95
- deleting 98
- digitizing points 953
- files 113
- for current drawing (video) 143
- for source drawings 143
- GDC files 104
- geodetic 149
- grid data catalog (GDC) files 103–104
- ignoring in Bulk Copy 1744
- latitude and longitude 92
- measuring geodetic distance 1153
- modifying 98
- options 225, 231
- overriding with Bulk Copy 621
- overview 143
- removing from drawings 150, 1296
- selecting 590
- specifying for export 1405
- tracking coordinates 1150
- transformation options 231
- transforming for a drawing 152
- video 11
- viewing for source drawing 151
- coordinate tracker
 - specifying options 232
- coordinate transformation 146
 - options 231
- coordinate transformation (video) 143
- coordinates 451, 953, 1148
 - changing format for 1150
 - digitizing 953
 - measuring 1148
 - specifying for raster images 451
 - tracking 1148, 1150
- Copy Scale dialog box 1624
- copying
 - data from one feature source to another 621
 - display layers 639
- correcting topology 920
- Coverages 381, 394, 1419
 - export defaults 269
 - exporting to 1419
 - importing 381, 394
- Create A Calculation 1133
- Create a Join dialog box 1603
- Create Buffer dialog box 1559
- Create Buffer Layer activity
 - for workflows 2036
- Create Centroids dialog box 1801
- Create Closed Polylines dialog box
 - (drawing topology) 1953
- Create Data Store dialog box 1605, 1747
- Create Map Book dialog box 1827
- Create Metadata Template dialog box 1758
- Create Network Topology Create New Nodes dialog box 1955
- Create Network Topology Select Links dialog box 1956
- Create Network Topology Select Nodes dialog box 1957
- Create Node Topology Select Nodes dialog box 1959
- Create Polygon Topology Create New Centroids dialog box 1960
- Create Polygon Topology Create New Nodes dialog box 1961
- Create Polygon Topology Select Centroids dialog box 1963
- Create Polygon Topology Select Links dialog box 1964
- Create Polygon Topology Select Nodes dialog box 1966
- Create Polygon Topology Set Error Markers dialog box 1967
- Create Polygons From Topology dialog box 1823
- Create Surface dialog box 1895
- Create Topology Select Topology dialog box 1969
- Create Topology Warning dialog box 1971
- creating 94–95, 97, 687–689, 691, 825, 827, 831, 836, 960, 988
 - classified drawing objects 988
 - coordinate system categories 97
 - datums 94
 - ellipsoids 95
 - feature classes in schemas 598

- features (video) 684, 686, 691
- geospatial features 687
- linestring features 691
- map books 1390
- maps 298
- metadata 1486
- multilinestring features 691
- multipoint features 688
- multipolygon features 689
- network topology 831, 836
- node topology 827
- point features 688
- polygon features 689
- polygons in maps 960
- properties in schemas 598
- query indexes 1294
- schemas 598
- themes for feature layers 1168
- topology 825
- workflows 281
- crossing linear objects 779, 799, 838
 - breaking 799, 838
 - marking for cleanup 779
- customizing 84–85, 225, 229, 269, 764
 - .ini files 264
 - AutoCAD Map 3D 84, 216–217, 249
 - automatically highlighting linked objects 1227
 - coordinate system 231
 - coordinate transformation 225
 - data sources 225, 236, 243
 - Data View 238
 - digitizing 138
 - drawing origin 169
 - drawing settings 225
 - export 269
 - import 269
 - log files 229
 - map books 1394
 - mapexport.ini 269
 - mapimport.ini 269
 - multi-user settings 227
 - overview 216–217
 - queries 245
 - save back settings 764
 - saving options 249

- system settings 229
- Task Pane 221
- workspaces for AutoCAD Map
 - 3D 85

D

- dangling objects 773, 779, 810
 - and Drawing Cleanup 810
 - marking for cleanup 779
 - tolerance for deleting 773
- data 209, 426, 434–435, 507, 523, 827, 831, 836, 914, 1048, 1056, 1064, 1066–1067, 1069, 1083, 1085
 - altering drawing objects based on 1267
 - analyzing 1121
 - and maps 291
 - attaching data sources 209
 - attaching multiple records to drawing objects 1066
 - attaching object data to drawing objects 1064
 - attaching to drawing objects automatically 1067
 - attaching to objects 209
 - attaching while digitizing 138, 1083, 1085
 - configuring data sources 213
 - converting 1405
 - copying from one feature source to another 621
 - displaying as text 435
 - editing external data in Data View 1056
 - editing object data 1069
 - exporting 1405
 - external data 209
 - external data for drawing objects 1048
 - finding drawing objects by 1248
 - finding for features 1212
 - finding patterns 1121
 - for network topology 831
 - for node topology 827
 - for polygon topology 836

- highlighting in Data Table 1139
- importing 426, 434
- joining to features 507
- linking to drawing objects in maps 523
- migrating 617
- modifying object data tables 202
- round-trip from DWG and back 1467
- samples included with AutoCAD Map 3D 62
- saving changes in Data View 1056
- viewing for topology 914
- viewing with Data View 1048
- data access 540–541
 - extending capabilities 540–541
- data attributes
 - for properties in Schema Editor 1739
- Data Condition dialog box (drawing queries) 1836
- data conditions for queries 1248
 - editing 1258
- Data Connect
 - accessing feature sources with 308
 - adding images 440
 - creating feature sources 588, 592
- data formats
 - converting between 617
- data properties
 - in Schema Editor 1739
- Data Source Name (DSN) 209, 213, 344
 - creating in Windows XP 344
- data sources 209, 215, 243, 312, 316, 330, 332, 335, 337, 340, 342, 346, 392, 410
 - ArcSDE 316
 - attaching 209
 - Autodesk SDF 337
 - combining in maps 13
 - configuring automatically 213
 - configuring coordinate geometry 234
 - configuring manually 213
 - connecting 215
 - creating 588, 592
 - customizing 243
 - default database versions 243
 - detaching 209
 - disconnecting 215
 - for maps 291
 - importing ArcSDE data 392
 - importing Oracle data 410
 - Microsoft Access 342
 - MySQL 332
 - ODBC 342
 - options 225, 236, 243
 - Oracle 312
 - PostGIS 340
 - PostgreSQL 340
 - SDF 337
 - SHP 335
 - SQLite 330
 - UDL (Universal Data Link) file
 - for 209
 - WFS 346
- data stores
 - copying data between (video) 616–617
 - creating 588, 592
 - creating for database providers 586
 - creating for file-based providers 586
 - creating for SQLite 565
 - creating with SQL Server Spatial 561
 - definition 551
 - deleting 593
 - overview 551
- Data Table 701, 712, 1127
 - auto-hiding 1127
 - calculated properties 1133
 - dialog box 1613
 - displaying 1127
 - editing features with 701, 712
 - exporting data from 1473
 - exporting from 1142, 1474
 - filtering 1212
 - finding data 1212
 - highlighting areas in map 1137
 - highlighting rows of data 1139
 - making transparent 1127
 - overview 1125
 - removing highlighting in map 1138

- searching feature data 1207, 1210
- selecting data 1212
- selecting data with 1131
- selecting features 1207, 1210
- video 1130, 1136, 1138, 1140–1141
- videos 1125
- viewing data for all feature classes 1135
- viewing feature class data 1135
- viewing joined data 1135
- viewing non-spatial data 1136
- zooming to a view 1141
- Data to Attach dialog box 1616
- data types
 - supported by OSGeo FDO Provider for SQL Server Spatial 562
 - when converting with Bulk Copy 623
- Data View 526–527, 529, 539, 1048, 1053, 1056, 1222
 - adding records 1056
 - and database queries 1053
 - Auto Commit 1056
 - changing alignment 1058
 - changing colors 1058
 - changing columns 1058
 - changing fonts 1058
 - checking records linked to drawing objects 1222
 - copying data to Windows Clipboard 1056
 - customizing 1058–1059
 - deleting records 1056
 - editing records 1056, 1225
 - filtering 1231
 - filtering by location 1234
 - filtering records 1222
 - finding records 1222, 1225
 - hiding and showing columns 1059
 - highlighting objects in drawings 1222, 1227
 - highlighting records linked to drawing objects 1229
 - link template paths 539
 - link templates 526
 - linked tables 527
 - linking records to drawing objects 529
 - navigating 1048
 - opening tables 1053
 - options 238
 - overview 1048
 - printing 1222
 - printing data from 1473
 - printing tables 1475
 - saving changes to data 1056
 - spatial filter 1234
 - SQL queries 1230
 - SQL queries for drawing data 1231
 - viewing external data for drawing objects 1147
- database link index 1294
- database queries 1053
- database tables 213, 215, 434–435, 523, 526–527, 529, 532, 539, 1048, 1053, 1056, 1071
 - adding records 1056
 - altering drawing objects based on 1270
 - and Data View 1048
 - attaching 213
 - attaching to drawing 209
 - connecting 215
 - converting object data to 1071
 - default version 243
 - deleting records 1056
 - disconnecting 215
 - displaying as text 435
 - editing in Data View 1056
 - filtering 1231
 - filtering by location 1234
 - finding records 1222
 - highlighting linked drawing objects 1227
 - highlighting records linked to drawing objects 1229
 - importing links 434
 - key columns for link templates 526
 - link template paths 539
 - link templates for maps 526
 - linked 527

- linking records to drawing objects 529
- linking to drawing objects in maps 523, 532
- navigating in Data View 1048
- opening in Data View 1053
- opening linked 527
- printing from Data View 1475
- querying 1053
- saving changes 1056
- searching 1225
- SQL conditions 1253
- UDL (Universal Data Link) file for 209, 213
- viewing external data 1048
- database views
 - accessing from native schemas 603
 - exposing in AutoCAD Map 3D 603
 - mapping to feature classes 603, 605
- databases 209, 215, 291, 523, 529, 532–534, 1048, 1056, 1085
 - adding records 1056
 - altering drawing objects based on 1270
 - and Data View 1048
 - and maps 291
 - and object data 533
 - attaching 209
 - attaching to maps 206
 - configuring 213
 - connecting 215
 - converting from object data 534
 - default version 243
 - deleting records 1056
 - detaching 209
 - disconnecting 215
 - editing in Data View 1056
 - filtering 1231
 - filtering by location 1234
 - finding records 1222
 - highlighting linked drawing objects 1227
 - highlighting records linked to drawing objects 1229
 - linking records to drawing objects 529
 - linking to drawing objects in maps 523, 532
 - linking to while digitizing 1085
 - navigating in Data View 1048
 - opening queries for 206
 - saving changes 1056
 - searching 1225
 - setting up users for AutoCAD Map 3D 584–585
 - SQL conditions 1253
 - UDL (Universal Data Link) file for 209, 213
 - viewing for drawing objects 1048
 - viewing in Data View 1147
 - viewing properties 206
- DATAVIEWHEADERANDFOOTER command 1476
- DATAVIEWPAGESSETUP command 1476
- DATAVIEWPRINT command 1477
- datum (for coordinate system) 94, 99, 110
 - changes to Australian 110
 - defining 94
 - deleting 99
 - geodetic coordinate systems 149
 - modifying 99
 - shift issues 112
- DB files
 - attaching to drawing 209
 - setting default version 243
- dBASE
 - attaching database to drawing 209
 - setting default version 243
- DBF files
 - attaching to drawing 209
 - setting default version 243
- DDIST 1040
- defaults
 - database versions 209
 - for object classes 125
 - for object data fields 201
- Define Annotation Template dialog box 1572
- Define Hatch dialog box 1625

- Define Link Template dialog box 1682–1683
- Define New Category dialog box (drawing queries) 1838
- Define New Object Data Field dialog box 1578
- Define New Object Data Table dialog box 1803
- Define Object Classification dialog box 1785
- Define Object Data dialog box 1805
- Define Query dialog box (drawing queries) 1838
- Define Range Table dialog box (drawing queries) 1843
- Define Text dialog box 1626
- Define Text dialog box (drawing queries) 1846
- Define/Modify Drawing Set dialog box 1918
- defining 92, 94–95
 - coordinate systems 92
 - datums 94
 - ellipsoids 95
 - object classes 119–120
- definition file 995
 - for object classes 995
- Delete Topology dialog box 1971
- deleting 889, 899, 1056
 - annotation from maps 1108
 - coordinate system assignment 150
 - coordinate system categories 101
 - coordinate systems 98
 - data stores 593
 - database links 537
 - database records 1056
 - datums 99
 - ellipsoids 100
 - feature classes in schemas 614
 - feature sources 593
 - joins 515
 - links (linear objects) from
 - topology 889
 - map book tiles 1403
 - map books 1403
 - nodes from topology 889
 - object data tables 202
 - points (nodes) from topology 889
 - polygons from topology 889
 - properties from schemas (video) 610
 - properties in schemas 614
 - schemas in feature sources 614
 - topology 899, 926
- DEM (Digital Elevation Model) 437, 440–441
 - adding to maps 437
 - adding with Data Connect 440, 442
- density 451
 - specifying for raster images 451
- Describe Directory activity
 - for workflows 2025
- descriptions
 - for object data fields 201
 - for source drawings 166
- Design File Input Settings dialog box (Import) 1734
- Design File Output Settings dialog box (Export) 1736
- Design Web Format
 - publishing map books to 1401
 - publishing maps to 1365, 1369, 1372
- Detach Data Source dialog box 1684
- detaching 751
 - data sources 209
 - drawings from maps 751
- deviation
 - and calibration 133
- DGN files 381, 405, 408, 1435
 - changing export default to imperial units 269
 - changing the default seed file 269
 - exporting 1405
 - exporting to 1435
 - importing 381, 405, 408
 - seed file for 1435
 - units of measurement 269
- dialog boxes 1559
 - Add Class Property (Export) 1726
 - Alter Block Insertion 1622
 - Alter Line Format 1622
 - Alter Linetype 1623

Alter Lineweight 1624
 Alter Plotstyle 1624
 Alternate Font (drawing queries) 1835
 Annotation Delete 1569
 Annotation Refresh 1569
 Annotation Text 1570
 Annotation Update 1571
 Assign Global Coordinate System 1598
 Associate Database Versions 1675
 Attach Object Class Definition File 1781
 Attach Object Data 1793
 Attach/Detach Object Data 1794
 Attribute Data 1699
 Attribute Domain Values Editor 1773
 Attribute Editor (metadata) 1756
 AutoCAD Map Confirmation (drawing topology) 1950–1951
 AutoCAD Map Messages 1799
 AutoCAD Map Options 1908
 Autodesk MapGuide Export 1580
 Autodesk MapGuide Import 1582
 Block Mapping 1701
 Break Objects at Boundary 1666
 Browse/Search 1800
 Buffer Warning 1560
 Bulk Copy 1744
 Centroid Objects (drawing topology) 1952
 Change Category (drawing queries) 1835
 Citation Editor (ISO Metadata) 1777
 Citation Information Editor 1759
 Classified Property List (object classification) 1782
 Classify (object classification) 1782
 Classify Objects 1783
 Cleanup Methods page 1585
 Color Range Editor (object classification) 1783
 Column 1676
 Column Values 1678
 Configure Data Source 1679
 Connect Data Source 1679
 Contact Information Editor 1763
 Convert Object Data to Database Links 1680
 Coordinate Geometry Setup 1917
 Coordinate System Translation 1703
 Copy Scale 1624
 Create a Join 1603
 Create Buffer 1559
 Create Centroids 1801
 Create Closed Polylines (drawing topology) 1953
 Create Data Store 1605, 1747
 Create Map Book 1827
 Create Metadata Template 1758
 Create Network Topology Create New Nodes 1955
 Create Network Topology Select Links 1956
 Create Network Topology Select Nodes 1957
 Create Node Topology Select Nodes 1959
 Create Polygon Topology Create New Centroids 1960
 Create Polygon Topology Create New Nodes 1961
 Create Polygon Topology Select Centroids 1963
 Create Polygon Topology Select Links 1964
 Create Polygon Topology Select Nodes 1966
 Create Polygon Topology Set Error Markers 1967
 Create Polygons From Topology 1823
 Create Topology Select Topology 1969
 Create Topology Warning 1971
 Data Condition (drawing queries) 1836
 Data Expression 1802
 Data to Attach 1616
 Define Annotation Template 1572
 Define Hatch 1625

Define Link Template 1682–1683
 Define New Category (drawing queries) 1838
 Define New Object Data Field 1578
 Define New Object Data Table 1803
 Define Object Classification 1785
 Define Object Data 1805
 Define Query (drawing queries) 1838
 Define Range Table (drawing queries) 1843
 Define Text 1626
 Define Text (drawing queries) 1846
 Define/Modify Drawing Set 1918
 Delete Topology 1971
 Design File Input Settings (Import) 1734
 Design File Output Settings (Export) 1736
 Detach Data Source 1684
 Digitize Setup 1617
 Disconnect Data Source 1684
 Drawing Cleanup 1585, 1587–1588, 1591, 1595
 Drawing Cleanup Errors 1593
 Drawing Maintenance 1920
 Drawing Set Display Filter 1922
 Drawing Settings 1923
 Drawing Statistics 1926
 Drive Alias Administration 1928
 Edit a Join 1603
 Edit Direct Resistance (drawing topology) 1972
 Edit Direction (drawing topology) 1973
 Edit Expression 1574
 Edit Object Data 1795
 Edit Reverse Resistance (drawing topology) 1973
 EditText (text layers) 1628
 Error Markers page 1587
 Export 1704
 Export Metadata 1757
 Expression 1541, 1807
 External Database Mapping 1732
 Feature Class Mapping (Export) 1727
 Feature Editing Options 1929
 Feature Information 1606
 Feature Source Administration 1606
 Feature Source Connection 1607
 Feature Source Scope 1606
 Generate Contour 1561
 Generate Data Links 1807
 Generate Object Data Index 1931
 Hatch Options (drawing queries) 1847
 Header/Footer 1685
 Hillshade Settings 1562
 Horizontal Coordinate System Definition Editor (FGDC Metadata) 1768
 Identify Map Book Layout Placeholders 1829
 Image Correlation (Insert Image command) 1873
 Image Information 1875
 Image Management (Insert Image command) 1875
 Image Management Layout (Insert Image command) 1877
 Image Select (Insert Image command) 1877
 Import 1711
 Import Data Mapping 1732
 Import Metadata Options 1757
 Import Old Theme 1628
 Index Maintenance 1931
 Insert Annotation 1574
 Insert Image 1878
 Layer Mapping (Import FDO) 1719
 Layer Range Editor (object classification) 1789
 Linetype Range Editor (object classification) 1789
 Lineweight Range Editor (object classification) 1790
 Link Objects (drawing topology) 1975
 Link Template Data Entry 1619

Link Template Key Column
 Entry 1620
 Link Template Properties 1686
 Load Internal Query (drawing
 queries) 1848
 Load Topology 1976
 Load Topology Conflict 1976
 Load Topology From Source
 Drawing 1978
 Location Condition (drawing
 queries) 1849
 Manage Joins 1607
 Map Book Properties 1830, 1832
 Metadata Editor 1754
 Metadata Options 1756
 Metadata Viewer 1751
 Network Topology Analysis Choose
 Locations 1978
 Network Topology Analysis
 Output 1980
 Network Topology Analysis Resistance
 and Direction 1982
 Network Topology Analysis Select
 Method 1983
 New Annotation Template
 Name 1576
 New Layer 1579, 1810
 New Object Class Definition
 File 1790
 New Property (object
 classification) 1791
 New Range Table (drawing
 queries) 1852
 New Scale 1629
 Node Objects (drawing
 topology) 1985, 1987
 Object Class Attribute
 Mapping 1710
 Object Data Mapping 1732
 Output Report Options (drawing
 queries) 1852
 Overlay Analysis, Set Output And
 Settings 1565
 Overlay Analysis, Source and Overlay
 Type 1563
 Page Setup 1686
 Plotstyle Range Editor (object
 classification) 1792
 Point Mapping 1733
 Polygon Fill Properties 1824
 Property Condition (drawing
 queries) 1855
 Property Value Mapping
 (Export) 1728
 Publish to Autodesk
 MapGuide 1577
 Publish to MapGuide Results 1379
 Publish To MapGuide results 1578
 Query Library Administration
 (drawing queries) 1858
 Quick View Drawings 2013
 Range of Values 1629
 Raster Extension Options (Insert
 Image command) 1879
 Remove Object Data Index 1933
 Rename Category (drawing
 queries) 1860
 Rename Range Table (drawing
 queries) 1860
 Rename Table 1797
 Rename Topology 1988
 Responsible Party Editor (ISO
 Metadata) 1776
 Run Library Query (drawing
 queries) 1861
 Save Current Query (drawing
 queries) 1862
 Save Features 1608
 Save Objects to Source
 Drawings 1887
 Save Version 1750
 Schema Editor 1739
 Select Actions page 1588
 Select Alias 1933
 Select Block 1810
 Select Coordinate System 1609
 Select Data 1811
 Select Data (drawing topology) 1989
 Select Database Version 1688
 Select Display Element 1631
 Select Drawings to Assign Coordinate
 System 1599

Select Drawings to Attach 1811
 Select Existing Link Template 1689
 Select Feature Classes (Display Manager) 1631
 Select Images (Display Manager) 1631
 Select Layers (Display Manager) 1631
 Select Link Template 1690
 Select Link Template Key 1797
 Select Link Templates 1690
 Select Objects page 1595
 Select Plot Set to Convert 1831
 Select Query 1691
 Select Table 1691
 Select Topologies (Display Manager) 1631
 Set Property Alterations (drawing queries) 1863
 Sort (records) 1692
 Source Drawing Scope 1633
 Spatial Data Organization Editor 1764
 Split and Merge Rules 1669
 SQL Condition History (drawing queries) 1866
 SQL Expression (link templates) 1814
 SQL Link Condition (drawing queries) 1866
 Standard Order Process Editor 1774
 Style Band 1633
 Style Label 1634
 Style Line 1636
 Style Point 1637
 Style Polygon 1639
 Style Text Layer 1640
 Table Filter 1693
 Table Filter History 1696
 Table Properties 1696
 Thematic Mapping 1642
 Thematic Values 1644
 Theme (features) 1645
 Tile Properties 1831
 Time Period Information Editor 1761
 Topology Buffer Create New Centroids and Nodes 1990
 Topology Buffer New Topology 1991
 Topology Buffer Set Buffer Distance 1992
 Topology Dissolve Create New Centroids and Nodes 1994
 Topology Dissolve Create Nodes 1995
 Topology Dissolve New Topology 1996
 Topology Dissolve Object Data 1997
 Topology Dissolve Set Parameter 1998
 Topology Overlay Analysis Analysis Type 1999
 Topology Overlay Analysis Create New Centroids and Nodes 2002
 Topology Overlay Analysis Create Nodes 2003
 Topology Overlay Analysis Output Attributes 2006
 Topology Overlay Analysis Output Topology 2004
 Topology Overlay Analysis Select Overlay Topology 2007
 Topology Query 2008
 Topology Query Result 2010
 Topology Selection 2011
 Topology Statistics 2011
 Transparency Color (Insert Image command) 1883
 Trim Objects at Boundary 1672
 Type SQL Condition (drawing queries) 1870
 Undefined Alias Referenced 1934
 User Administration 1934
 User Credentials 1610
 User Information 1936
 User Login 1937
 using wild-card characters 1537
 View Query Statement 1610
 Who Has It Information 1889
 Workflow Designer 2022

- Workflow Designer activity
 - input 2025
 - Workflow Designer parameters 2025
 - Zoom Drawing Extents 2014
 - Zoom Scale 1697
- DIB images
 - inserting with Raster Extension 455
- Digital Elevation Model 437, 440–441
 - adding to maps 437
 - sample images 63
- digital elevation models 1188
 - adding contour lines 1190
 - analyzing 1188
 - applying hillshading 1200
 - applying vertical exaggeration 1200
 - changing theme colors 1205
 - draping vector data on 1193
- Digital Terrain Elevation Data 437, 440–441
 - adding to maps 437
- digital terrain modeling 1009
- DigitalGlobe 62
- Digitize Setup dialog box 1617
- digitizing 131–132, 767, 841, 1073, 1080–1081, 1083, 1085
 - and alignment 1073
 - and external data 1085
 - and LABELPOINT 1081
 - and object data 1080, 1083
 - and registering maps 136
 - and rotation 1081
 - and sliver polygons 841
 - calibration options 133
 - configuration 132
 - correcting errors 767
 - drawings 1073
 - layers 138
 - maps 131, 1073
 - options 138
 - overview 1073
 - setting up 130
 - tablet 130–131
 - transformation types 133
 - using coordinates 953
 - width 138
 - with MAPDIGITIZE 1080–1081
- dimensions 761
 - saving to source drawings from maps 761
- direct resistance 849
 - for links in network topology 849
- direction 845, 863
 - changing for links in topology 873
 - editing for topology 863
 - for links in network topology 845
- directories
 - drive aliases for 161
 - for external queries 229
- Disconnect Data Source dialog box 1684
- Display Feature Attributes activity
 - for workflows 2037
- Display Manager 350, 352, 440
 - adding drawing objects to maps 352
 - adding images to maps 440
 - and drawing layers 350
 - and Properties palette 1124
 - combining styles 662
 - controlling display order 637
 - creating styles for drawing layers 660
 - creating themes 1168
 - displaying 221, 635
 - draw order 300
 - exporting layers 1470
 - groups 300
 - layers 300
 - legend 1117
 - Map Base layer 352
 - modifying styles for drawing layers 663
 - multiple display maps 639
 - overview 634
 - refreshing 635
 - repairing broken connections 350
 - saving layers 1470
 - scale threshold 668
 - sharing maps 1460
 - Style Library 665–666
 - styles for drawing objects 652
 - themes for drawing layers 1181
 - thumbnails for drawing layers 1181

- thumbnails for layers 300
 - updating 635
 - using 641, 654
 - using layers in MapGuide
 - 2007 1470
 - video 634, 636
- display maps
 - and map files 7
- display order 300
 - controlling in the Display Manager 637
 - for layers in maps 300
- display styles
 - combining 662
 - controlling display order 637
 - for drawing layers 660
 - legend 1117
 - modifying 663
 - modifying for scale thresholds 668
 - referencing 666
 - saving 665
 - viewing at all scales 670
- displaying 474
 - angle information 1160
 - COGO information for lines and arcs 1161
 - map draw order 637
 - raster image information 474
 - save back extents 170
 - source drawing information 172
- dissolving 808
 - pseudo nodes 808
 - topology 1343
- distances
 - adding 1157
 - and buffers 1308
 - best route 1330
 - buffering a topology by 1347
 - continuous 1159
 - finding shortest 1326
 - flood trace 1334
 - horizontal between points 1162
 - measuring geodetic distance 1153
- distortion in maps 934
- distribution methods 1165
 - equal 1165
 - individual values 1165
 - Jenks (natural breaks) 1165
 - quantile 1165
 - standard deviation 1165
- dot variables 937, 1264, 1546
 - LABELPT 937
- Draw mode queries 1287–1288, 1291
- draw order 302
 - and Display Manager 300
 - changing for map layers 302
 - in Display Manager 637
 - video 634, 636
- Drawing Cleanup 766–767, 770, 773, 776, 779, 781–783, 785, 788, 791, 794, 796, 799, 801, 803, 806, 808, 810, 814–815, 819, 838–839
 - actions 788
 - anchoring objects 770
 - and sliver polygons 839
 - apparent intersection 803
 - Automatic mode 783
 - breaking crossing objects 799, 838
 - correcting errors automatically 783
 - correcting errors interactively 785
 - correction methods 782
 - dangling objects 810
 - deleting duplicates 794
 - displaying markers 785
 - elevation for new objects 776
 - erasing short linear objects 796
 - extending undershoots 801
 - for topology 788
 - Interactive mode 785
 - layers for new objects 776
 - line width for new objects 776
 - markers 779
 - order of actions 773
 - order of operations 788
 - overview 766
 - profiles 781
 - pseudo nodes 808
 - reviewing errors before
 - correcting 785
 - selecting actions 773, 791
 - selecting objects 770

- simplifying objects 814
- snapping clustered nodes 806
- tolerance for 773
- using 767
- video 727, 766
- weeding 819
- zero-length objects 815
- Drawing Cleanup dialog box 1585, 1587–1588, 1591, 1595
- Drawing Cleanup Errors dialog box 1593
- drawing data 681
 - combining with feature data for maps 291
 - overview of editing in AutoCAD Map 3D 681
- drawing layers 350, 419
 - creating themes for 1178, 1181
 - importing into AutoCAD Map 3D 419
 - styles for 657
 - styling with annotation 1186
 - styling with hatch patterns 1184
 - styling with ramps 1183
 - styling with text height 1185
 - themes for 1176
 - vs. AutoCAD layers 350
- Drawing Maintenance dialog box 1920
- drawing objects 291, 352, 356–357, 359, 362, 364, 367, 369, 381, 523, 529, 531–532, 534, 537, 692, 717, 727, 730, 733, 735–736, 738, 746, 748, 751–752, 754, 756–759, 764, 770, 776, 794, 796, 799, 801, 803, 806, 808, 810, 814–815, 819, 836, 838, 852, 892, 911, 931, 937, 939, 941, 945, 947, 988–989, 991, 993, 1064, 1066–1067, 1069, 1073, 1083, 1085
 - adding distances 1157
 - adding hatch during a query 1283
 - adding text with queries 1278
 - adding to a map (video) 9
 - adding to Display Manager layers 356
 - adding to maps by attribute data 364
 - adding to maps by location 359
 - adding to maps by object class 357
 - adding to maps by property 362
 - adding to maps by topology 367
 - adding to maps with multiple conditions 369
 - adding to save sets 751
 - aligning 931
 - altering based on queries 1267, 1270
 - altering with queries 1261, 1263, 1265
 - anchoring for cleanup 770
 - and labels 937
 - and maps 291, 350
 - apparent intersection 803
 - associative hatch 247
 - attaching external data while digitizing 1085
 - attaching multiple records to 1066
 - attaching object data automatically 1067
 - attaching object data manually 1064
 - attaching object data while digitizing 1083
 - attributes in Properties palette 1146
 - breaking at a boundary edge 941, 943
 - breaking crossing objects 799, 838
 - centroids and topology 836
 - classified properties 991
 - classifying 120, 988–989
 - combining query conditions 1256
 - combining with geospatial features 9
 - converting during Drawing Cleanup 776
 - converting to features in AutoCAD Map 3D 692
 - counting 172
 - creating using object classes 988
 - dangling objects 810
 - database links 1222

- defining expressions for 1275
- defining label point 1280
- deleting duplicates 794
- digitizing 1073
- Display Manager styles for 654
- displaying thematically 1261
- dissolving pseudo nodes 808
- editing for topology 852
- editing in map source drawings 748
- editing in maps 947
- editing in source drawings 163
- editing links to external data 537
- editing object class data 991
- editing object data 1069
- editing query conditions 1258
- entering geometry when
 - creating 1027
- erasing on save back 764
- erasing short linear objects 796
- executing queries 1287
- exporting 1405
- exporting Oracle 1462–1463
- exporting styled (video) 1453
- exporting to ArcSDE 1423
- exporting to DGN 1438
- exporting to GML (Geography Markup Language) 1430
- exporting to MapInfo 1432
- exporting to MapInfo TAB 1434
- exporting to MicroStation Design 1438
- exporting to other file
 - formats 1408, 1421
- exporting to SDF 1416
- exporting to SDF (video) 1405
- exporting to SDF or Oracle and back again 1467
- exporting to Shape Multiclass 1445
- exporting to SHP 1428
- exporting to SQLite 1448
- exporting to Vector Markup Language 1450
- exporting to VML 1450
- extending undershoots 801
- filling 939
- filtering records by location 1234
- filtering with SQL queries 1231
- finding 1219
- finding by location 1241
- finding by property 1244
- finding with queries 1237
- grips in maps 947
- highlighting in Data View 1227
- highlighting linked records in Data View 1229
- highlighting locked objects 752
- highlighting topology associated with 911
- importing 381
- including in maps 352
- linking to data using object data 531
- linking to external data for maps 534
- linking to external data in maps 532
- linking to external database records 523, 529
- listing for queries 1477
- locking 751
- locking in AutoCAD Map 3D 730, 733
- merging with existing features 717
- moving 931
- multi-user editing (video) 727, 730, 734, 738
- object properties and layer properties 1242
- overview for AutoCAD Map 3D 727
- overview of editing in AutoCAD Map 3D 681
- previewing in map source drawings 746
- querying 1237
- querying (video) 1235, 1238, 1242, 1245, 1249
- Quick Select 1219–1220
- releasing locks in AutoCAD Map 3D 736
- removing from save set 759
- retrieving by groups 1296
- retrieving during queries 1288
- retrieving hatched areas 1296

- rotating 931
- saving as DXF 1459
- saving in AutoCAD Map 3D 738
- saving to new drawings 758
- saving to source drawings 754, 756
- saving to the current map 757
- scaling 931
- selecting 1219
- selecting by properties 1219
- selecting for cleanup 770
- selecting with object
 - classification 993
- sharing 730
- simplifying complex objects 814
- snapping clustered nodes 806
- SQL conditions 1249
- SQL queries 1230
- styles for 652
- styling on import 385
- text insertion point 937
- transforming 931
- trimming at a boundary edge 945
- updating for topology 892
- using topologies (video) 1319
- viewing information for 1144
- viewing locked objects 752
- viewing locks in AutoCAD Map 3D 735
- weeding 819
- zero-length objects 815
- drawing origin
 - modifying for source drawings 169
- drawing set 83, 154
 - activating drawings 160
 - adding drawings 158
 - creating 156
 - modifying settings 164
 - options 225
 - overview 154
 - privileges 83
- Drawing Set Display Filter dialog
 - box 1922
- Drawing Statistics dialog box 1926
- drawing workspace 84
 - showing command line by
 - default 87
- drawings 83, 154, 157–158, 169, 209, 215, 381, 730, 735, 738, 745–746, 748, 751, 754, 756–758, 761, 767, 822, 934, 1073
 - activating 160
 - activating automatically 225
 - adding queries 180
 - aligning 154, 169
 - and xrefs 157
 - assigning coordinate system 146–147
 - attaching databases to 206
 - attaching to maps 158
 - attributes in Properties Palette 1146
 - backup files 764
 - cleaning 767
 - connecting data sources 215
 - coordinate systems 152
 - correcting errors 767
 - creating from existing drawings 738
 - creating with saved drawing
 - objects 758
 - descriptions 166
 - detaching 751
 - detaching data sources 209
 - digitizing 1073
 - disconnecting data sources 215
 - distorting 934
 - distortion 225
 - dragging onto the Task Pane 158
 - drawing set 154
 - drive aliases for 161
 - editing in AutoCAD Map 3D 748
 - global coordinate systems 146–147, 152
 - importing 381
 - indexing 1294
 - nested 157, 160
 - offset for source drawings 169
 - opening source drawings 163
 - options 225, 249
 - previewing 746
 - problems saving 761
 - querying 1237
 - Quick View 746

- removing coordinate system
 - assignment 150, 1296
- retrieving objects from 1237
- rotating source drawings 169
- rubber sheeting 934
- save back extents 170, 756
- saving 738, 751, 1460
- saving objects to 757
- saving queried objects to 754, 756
- scaling source drawings 169
- settings 164
- sharing 161, 730, 751
- stretching 934
- tiled 756
- tiles 154
- topology 822
- transforming 169
- transforming coordinate system 152
- updating 754, 756
- user privileges for 83
- viewing coordinate systems 151
- viewing information 172
- viewing locks 735
- zooming to extents in AutoCAD Map 3D 745
- Drive Alias Administration dialog
 - box 1928
- drive aliases 161, 1928
 - creating 161
- driver options 397, 1424, 1443
 - DGN version 7 and 8 405, 1435
 - ESRI Arc/INFO Coverages 394, 1419
 - MapInfo MIF/MID files 1431
 - setting default 236
 - SHP files 397, 1424
 - SHP Multiclass 1443
 - when importing 381
- DSN (Data Source Name) 209, 213, 344
 - creating in Windows XP 344
- DTED (Digital Terrain Elevation Data) 437, 440–441
 - adding to maps 437
- DTM (digital terrain modeling) 1009
- DTM layer 1009
- duplicate objects 773, 779, 794
 - deleting 794
 - marking for cleanup 779
 - tolerance for deleting 773
- DWF
 - publish map book as (video) 46
 - publishing map books to (video) 1360, 1366, 1381, 1389
 - publishing map books to (video)) 1400
- DWF (Design Web Format)
 - and attribute data 1367
 - publishing map books to 1401
 - publishing maps to 1365, 1369, 1372
 - setting publishing options 1367
- DWG
 - exporting current map to (video) 1405
 - exporting maps to (video) 1459
 - exporting styled objects (video) 628
 - exporting to GIS (video) 628
- DWG files
 - querying (video) 352, 358
- DWG format
 - converting data to 377–378, 381
 - exporting maps to 1460
 - moving data to geospatial formats 629
- DWGNAME variable 1546
- DWK files 227, 730, 735
- DXF files 391
 - exporting drawing data to 1459
 - importing 391
- E**
 - EANGLE variable 1546
 - ECW images
 - adding with Data Connect 443–444
 - edges 941, 945, 951, 978
 - breaking drawing objects at 941
 - displaying for polygons 978
 - matching for maps 951
 - trimming objects at 945
 - Edit a Join dialog box 1603

- Edit Direct Resistance dialog box (drawing topology) 1972
- Edit Direction dialog box (drawing topology) 1973
- Edit Expression dialog box 1574
- Edit Object Data dialog box 1795
- Edit Reverse Resistance dialog box (drawing topology) 1973
- Edit Text Layer dialog box (text layers) 1628
- editing 83, 712, 748, 852, 860, 863, 867, 894, 947, 963, 991, 1056, 1069
 - attached drawings 748
 - coordinate system categories 101
 - coordinate systems 98
 - data in Data View 1056
 - datums 99
 - drawing descriptions 166
 - drawing objects in map source drawings 748
 - drawing objects in maps using grips 947
 - ellipsoids 100
 - external data in Data View 1056
 - feature classes in schemas 612
 - features (video) 684, 701
 - features with Data Table 712
 - linear objects in topology 863
 - map books 1397
 - metadata 1499
 - nodes in topology 860, 863
 - object class data 991
 - object data 1069
 - object data tables 202
 - partial topology 894
 - polygons in maps 963
 - polygons in topology 867
 - privileges 83
 - properties in schemas 612
 - property alteration definition 1286
 - queried objects 1261
 - queries 184
 - query conditions 1258
 - schemas in feature sources 612
 - source drawings 748
 - topology 852, 894
- EED expressions 1551
- EED index 1294
- EHANDLE variable 1546
- electric symbols
 - samples 69
- elements (Display Manager) 352, 356, 359, 362, 364, 367, 369
 - adding drawing objects to maps by attribute data 364
 - adding drawing objects to maps by property 362
 - adding drawing objects to maps by topology 367
 - bringing in drawing objects 352
 - combining styles 662
 - controlling display order 637
 - creating styles 660
 - drawing objects by location 359
 - grouping drawing objects by layer 356
 - modifying styles 663
 - scale thresholds 668
 - using multiple conditions to add drawing objects to maps 369
 - viewing styles at all scales 670
- elevation 776
 - altering drawing objects based on 1265
 - altering with queries 1261
 - coloring surfaces by (video) 37
 - displaying with contour lines 1189–1190
 - finding drawing objects by 1244
 - for objects created during Drawing Cleanup 776
 - purchasing data 72
- ELEVATION variable 1546
- ellipsoid 95, 100
 - defining 95
 - deleting 100
 - modifying 100
- emergency response symbols
 - samples 69
- Enhanced Compressed Wavelet images
 - adding with Data Connect 443–444

- enlarged map sections 943
- EOO files
 - exporting 396
 - importing 396
- EPSG numbers
 - and SRID numbers 590
- EPSG values
 - for Web Map Service (WMS) 447
- equal distribution 1165
- equality functions 1543
- ER Mapper images
 - inserting with Raster Extension 455
- erase overlay 1309
- erasing
 - saved back drawing objects 758
- Error Markers dialog box page 1587
- errors 767, 782–783, 785
 - cleaning up 767
 - correcting automatically 783
 - correcting in maps 927
 - correcting interactively 785
 - correction methods in Drawing Cleanup 782
 - displaying cleanup markers 785
 - resolving for Publish to MapGuide 1379
 - reviewing during Drawing Cleanup 785
- ESRI Arc/INFO Coverages 381, 394, 1419
 - export defaults 269
 - exporting 1405
 - exporting to 1419
 - importing 381, 394
- ESRI ArcSDE
 - exporting to 1422
 - importing from 392
 - schemas 579
 - working with data 581
- ESRI data 540
- ESRI grid files 440–441, 1188
 - adding contour lines 1190
 - adding to maps 437
 - adding with Data Connect 440, 442
 - analyzing 1188
- ESRI Personal Database 540
 - accessing 541
- ESRI ShapeFiles 336, 1443–1444
 - adding feature data to maps 336
 - converting to drawing objects 335
 - exporting 1405
 - exporting multiclass 1444
 - exporting to 1424
 - importing 397, 399
 - multiclass 1443
 - provider capabilities for maps 335
- EWIDTH variable 1546
- exaggeration 1199
 - applying to surfaces 1200
- Excel
 - attaching spreadsheet to drawing 209
 - setting default version 243
 - setting up database ranges 578
- explicit nodes 1339
- Export dialog box 1704
- Export Metadata dialog box 1757
- export settings 269
- exporting 269, 396, 401, 1429
 - .gml files 1429
 - .ini file for 269
 - and profiles 263
 - Arc/INFO Coverages 396
 - Arc/INFO Coverages and line segments 269
 - ArcView ShapeFiles as folder 269
 - attribute data 1405, 1473
 - coordinate conversion 1405
 - Coverages 396
 - current map to DWG (video) 1459
 - drawing objects in maps 1408, 1416, 1421, 1430, 1432, 1434, 1438, 1448, 1450
 - drawing objectsto Shape Multiclass 1445
 - drawing objectsto SHP 1428
 - DWG to GIS (video) 628
 - DWG to SDF or Oracle and back 1467
 - DXF files 1459
 - EOO files 396
 - ESRI Arc/INFO Coverages 396
 - external data 1405

- feature data from Data Table
 - (video) 1141
- from Data Table 1142, 1474
- Geography Markup Language 1429
- GML 1429
- GML (Geography Markup Language) 1405
- layers (video) 1469
- layers as SDF (video) 1469
- layers from Display Manager 1470
- layers to SDF (video) 1376, 1405
- line segmentation 269
- MapGuide SDF 2 files 1417
- MapInfo MIF/MID 401, 1405
- MapInfo TAB 1405
- maps to DWG format 1460
- metadata 1513
- MicroStation DGN 1405
- MicroStation DGN (in imperial units) 269
- multiple layers to a single feature class 1442
- multiple feature classes 1440
- object data 1405
- object properties 269
- Ordinance Survey of Great Britain
 - GML v2 1429
- overview 1405
- polygons 1458
- procedure overview 1408, 1421
- queries 180
- saving settings for 1405
- schemas 608
- SDF 2 files 1417
- SQLite 1405
- styled drawing objects (video) 1453
- styled DWG objects (video) 628
- supported formats 1412
- supported object types 1411
- text as points 1405
- text enclosed in a polyline 1455
- to ArcSDE 1423
- to DGN 1438
- to GML (Geography Markup Language) 1430
- to image files 1465
- to MapInfo 1432
- to MapInfo TAB 1434
- to MicroStation Design 1438
- to Oracle 1462–1463
- to SDF 1416
- to SQLite 1448
- to Vector Markup Language 1450
- to VML 1450
- toSQLite 1447
- VML 1449
- VML (Vector Markup Language) 1405
 - vs. saving as SDF 1469
- Expression dialog box 1807
- expression evaluator 1541
- expressions
 - arithmetic 1541
 - AutoLISP 1551
 - block attributes 1549
 - conditional functions 1543
 - conversion 1544
 - defining for drawing objects 1275
 - dot variables 1546
 - EED 1551
 - entity 1545
 - equality 1543
 - object classification 1551
 - object data variables 1549
 - pi 1545
 - range 1545
 - reusing in queries 1541
 - SQL 1549
 - string-handling 1543
 - style 1545
 - symbol-handling 1544
 - tips on using 1553
 - using as labels 1093
 - using colors in 1552
 - using to select features 1130
 - variables 1546
- extending 779, 801, 803
 - to apparent intersection 803
 - undershoots 779, 801
- extents 745, 756
 - setting save back extents 170
 - using to save drawing objects 756

- zooming to for drawings 745
- external data 209, 215, 364, 434, 523, 529, 532, 534, 537, 1048, 1056, 1071, 1085
 - adding drawing objects to maps
 - by 364
 - adding text to queried objects 1278
 - altering drawing objects based
 - on 1270
 - attaching 209
 - attaching while digitizing 138, 1085
 - committing changes in Data
 - View 1056
 - configuring 213
 - connecting 215
 - converting from object data 534
 - converting object data to 1071
 - database links 1222
 - detaching 209
 - disconnecting 215
 - editing in Data View 1056
 - exporting 1405
 - for drawing objects 1048
 - importing 434
 - lediting links 537
 - linking to drawing objects 532
 - linking to drawing objects in
 - maps 523, 534
 - linking to objects manually 529
 - options 236, 238, 243
 - printing using report queries 1477
 - saving changes 1056
 - SQL conditions 1253
 - using to dissolve topology 1343
 - viewing for drawing objects 1144
 - viewing in Data View 1147
- External Database Mapping dialog
 - box 1732
- external queries
 - adding to library 180
 - default directory 229
- extracting feature geometry 716

F

- fade
 - for drawing layers 660
- false origins 91
- FDO
 - overview of schemas 554
- FDO and non-FDO-enabled schemas 561
- FDO developer help 59
- FDO features 308, 507, 512, 686–687, 698
 - and automatic update 698
 - and joins 507
 - and maps 303
 - bringing into maps 308
 - creating and editing 686
 - creating joins 512
 - creating new 687
 - defining scale for layers 644
 - labeling 1093
 - loading styles 652
 - managing 551
 - overview 551
 - overview of editing 681
 - provider capabilities 305
 - saving styles 652
 - styles for 641
- FDO providers 312, 316, 330, 332, 335, 337, 340, 342, 346, 540–541
 - adding 541
 - ArcSDE 316
 - Autodesk SDF 337
 - creating data stores 588
 - deleting data stores 593
 - Microsoft Access 342
 - MySQL 332
 - ODBC 342
 - Oracle 312
 - overview 547
 - PostGIS 340
 - PostgreSQL 340
 - Schema Editor 596
 - SDF 337
 - SHP 335
 - SQLite 330
 - WFS 346

- FDO-enabled data stores
 - and Bulk Copy 617
- FDOATTACH command
 - (discontinued) 1533
- FDOCONFIGURE command
 - (discontinued) 1533
- FDOCONNECT command
 - (discontinued) 1533
- FDODETACH command
 - (discontinued) 1533
- FDODISASSOCIATE command
 - (discontinued) 1533
- FDODISCONNECT command
 - (discontinued) 1533
- FDOEDITSETADD command
 - (discontinued) 1533
- FDOEDITSETREMOVE command
 - (discontinued) 1533
- FDOEDITSETSAVE command
 - (discontinued) 1533
- FDOEDITSETSHOW command
 - (discontinued) 1533
- FDOLOCKS command 1606
- FDOLOCKS command
 - (discontinued) 1533
- FDOSHEMA command
 - (discontinued) 1533
- FDOSHOWOWNER command 1606
- FdoUserManager utility 584–585
- Feature Class Mapping dialog box
 - (Export) 1727
- feature classes
 - appending features to (video) 43
 - appending to schemas (video) 594, 610
 - creating in schemas 598
 - definition 551
 - deleting in schemas 614
 - editing in schemas 612
 - exporting multiple 1440
 - exporting multiple layers to 1442
 - mapping to database views 603, 605
 - metadata for 1486
 - overview 551
 - querying (video) 24
 - setting physical configuration 612
 - settings in Schema Editor 1739
 - undoing schema changes 615
- feature data 686, 725
 - and maps 291
 - combining with drawing data for maps 291
 - creating and editing 686
 - exporting to DWG format 1460
 - understanding 681
 - versioning 725
- feature editing options
 - setting 240
- Feature Editing Options dialog box 1929
- Feature Information dialog box 1606
- feature layers
 - repairing broken connections 350
- Feature Overlay 1316
- Feature Source Administration dialog box 1606
- Feature Source Connection dialog box 1607
- feature source layers
 - overview 551
- Feature Source Scope dialog box 1606
- feature sources 291, 305, 308, 312, 316, 330, 332, 335, 337, 340, 342, 346, 392, 410, 700, 725
 - accessing in maps 308
 - and coordinate systems in maps 308
 - and locking 305
 - and maps 291
 - and persistent locking 305
 - and schema editing 305
 - and versioning 305
 - ArcSDE 316
 - Autodesk SDF 337
 - connecting to (video) 305
 - copying from one to another 621
 - copying from one to another (video) 616–617
 - creating 588, 592
 - deleting 593
 - importing ArcSDE data 392
 - importing Oracle data 410
 - Microsoft Access 342
 - MySQL 332

- ODBC 342
- Oracle 312
- overview 19, 305
- PostGIS 340
- PostgreSQL 340
- removing highlighting in map 1138
- Schema Editor 596
- SDF 337
- setting up 583
- SHP 335
- SQLite 330
- updating automatically 700
- versioning 723, 725
- viewing data for all 1135
- WFS 346
- FEATUREDEF command 122, 124, 126, 1785
- features 308, 314, 319, 324, 331, 333, 336, 338, 341, 344, 507, 512, 681, 684, 686–689, 691–692, 694, 696, 698, 700–701, 705, 712, 716–717, 722, 725, 1008
 - accessing WFS data 348
 - adding (video) 9
 - adding ArcSDE data to maps 319
 - adding Autodesk SDF data to maps 338
 - adding Microsoft Access data to maps 344
 - adding MySQL data to maps 333
 - adding ODBC data to maps 344
 - adding Oracle data to maps 314
 - adding PostGIS data to maps 341
 - adding properties 512
 - adding SHP data to maps 336
 - adding SQL Server data to maps 324
 - adding SQLite data to maps 331
 - and automatic update 698
 - and generated IDs 686
 - and joined properties 507
 - and joins 507
 - and locking 684
 - and maps 303
 - and multiuser environment 684
 - and persistent locking 698
 - and revision numbers 698
 - appending features (video) 31
 - appending to feature classes (video) 43
 - bringing into maps 308
 - buffering 1308
 - cancelling check out 698
 - checking in 694
 - checking in (video) 693, 721
 - checking out 696
 - checking out (video) 721
 - checking out automatically 696
 - checking out(video) 695, 701
 - copying from one feature source to another 621
 - create from DWG objects (video) 19
 - creating (video) 684, 686, 691
 - creating and editing 686
 - creating from geometry 692
 - creating geospatial features from survey points 1008
 - creating joins 512
 - creating linestring 691
 - creating multilinestring 691
 - creating multipoint 688
 - creating multipolygont 689
 - creating new 687
 - creating point 688
 - creating polygon 689
 - creating themes for 1168
 - creation methods 686
 - defining scale for layers 644
 - editing (video) 19, 684, 701, 721
 - editing commands 705
 - editing offline 722
 - editing with AutoCAD
 - commands 715–716
 - editing with Data Table 712
 - editing with Properties palette 718
 - filtering 1210
 - filtering by conditions 1217
 - finding 1207, 1210
 - finding and selecting 1209
 - finding in Data Table 1212
 - highlighting in map 1137
 - joining attributes to (video) 37
 - labeling 651, 1093

- labeling (video) 185–186, 190, 194, 640, 645, 648, 1091, 1096, 1098
- loading styles 652
- merging 710
- overview 551
- overview of editing 681
- provider capabilities in maps 305
- saving styles 652
- searching for 1214
- selecting 1207
- selecting (video) 1130
- selecting checked out 694
- selecting in Data Table 1131, 1212
- selecting with queries 1130
- splitting 708
- splitting (video) 706
- styles for 641
- styling (video) 34
- theming (video) 37
- updating automatically 700
- updating geometry 717
- versioning 723, 725
- viewing attribute data 1125
- viewing attributes (video) 27
- viewing data for 1135
- features classes
 - appending features to (video) 31
- Federal Geospatial Data Committee standard for metadata 1481
- fence boundary for query location 1241
- FGDC CSDGM Standard
 - downloading 1481
 - for metadata 1481
- fields (in records) 426, 434–435, 1071
 - adding to tables 202
 - creating for object data 201
 - displaying as text 435
 - exporting with objects 1405
 - finding drawing objects by 1248
 - importing 426, 434
 - modifying for object data 202
 - SQL conditions 1253
 - when converting object data to database tables 1071
- file formats
 - for exporting 1405
 - for exporting from AutoCAD Map 3D 1412
 - for importing data to maps 378
 - for raster files outside Data Connect 455
 - SDF 2 files 1417
 - SIF files 1417
- file sharing 730
- file-based data sources 291
 - and maps 291
- files 381
 - for query results 1477
 - grid data catalog (GDC) 103–104
 - importing 381
- fill 939, 960, 963, 978
 - adding to closed polylines 939
 - adding to queried drawing objects 1283
 - changing default for polygons in maps 963
 - changing for polygons in maps 963
 - default for polygons in maps 978
 - for areas 650
 - gradients for polygons in maps 960, 978
 - specifying for polygons in maps 960
- filtering
 - features using conditions 1217
 - geospatial features when adding to maps 310
- filters
 - conditions for features in maps 1217
 - spatial (Data View) 1234
- finding
 - drawing objects 1219
 - features 1207
- fixed screen area
 - for digitizing 132
- FLC images
 - inserting with Raster Extension 455
- FLI images
 - inserting with Raster Extension 455

- floating screen area
 - for digitizing 132
- flood trace analysis 1334
 - and direct resistance 849
 - and direction 845
- fly through for surfaces 1196
- folders
 - drive aliases for 161
- fonts
 - setting for export and import 269
- For Each activity
 - for workflows 2025
- formats
 - for importing data to maps 378
 - supported for map export 1412
- FoxPro
 - attaching database to drawing 209
 - setting default version 243
- frame color 451
 - specifying for raster images 451
- FSD files 1513
- functions 1541
 - arithmetic 1541
 - conditional 1543
 - conversion 1544
 - entity 1545
 - equality 1543
 - pi 1545
 - range 1545
 - string-handling functions 1543
 - style 1545
 - symbol-handling 1544

G

- GDAL provider 540
- GDC files 104
- Generate Contour dialog box 1561
- Generate Data Links dialog box 1807
- Generate Object Data Index dialog box 1931
- geodata 62
- geodata portal 72
- geodatabase 540–541
 - accessing ESRI data 541

- geodetic coordinate systems 590
 - determining 149
- geodetic distance
 - measuring 1153
- geographic analysis
 - video 1319
- geography data types 562
- Geography Markup Language (GML) 381, 412–413, 608, 1429
 - exporting 1405, 1429
 - exporting as schema 608
 - exporting to 1429
 - importing 381, 412–413
 - importing as schema 608
- geometry 692, 705, 716–717, 1027
 - and Bulk Copy 625–626
 - creating features from 692
 - editing for features 705, 716
 - entering when creating objects 1027
 - properties in Schema Editor 1739
 - updating for features 717
- geometry data types 562
- geometry types
 - supported by OSGeo FDO Provider for SQL Server Spatial 562
- georeferencing 455
 - and publishing to DWF 1365, 1369, 1371–1372
 - and raster images 455
 - with rubber sheeting (video) 932
- geospatial data
 - understanding hierarchy 551
- geospatial feature layers
 - repairing broken connections 350
- geospatial features 687, 698, 1137
 - buffering 1308
 - combining with maps 9
 - converting to DWG format 377–378, 381
 - creating new 687
 - creating themes for 1168
 - defining scale for layers 644
 - definition 551
 - exporting data for 1474
 - filtering 1210
 - filtering using conditions 1217

- filtering when adding to maps 310
 - finding 1207, 1210
 - finding and selecting 1209
 - finding in Data Table 1212
 - labeling 1093
 - loading styles 652
 - managing 551
 - overview 551
 - overview of providers 547
 - overview of schemas 554
 - saving styles 652
 - searching for 1214
 - selecting 1207
 - selecting in Data Table 1212
 - selecting with queries 1130
 - styles for 641
 - viewing attribute data 1125
 - viewing data for 1135
 - geospatial workspace 84
 - showing command line by default 87
 - GeoSpot images
 - inserting with Raster Extension 455
 - GeoTIFF images
 - inserting with Raster Extension 455
 - GIS features 308, 507, 512, 681, 686–687, 698
 - and automatic update 698
 - and joins 507
 - and maps 303
 - bringing into maps 308
 - creating and editing 686
 - creating joins 512
 - creating new 687
 - overview of editing 681
 - provider capabilities 305
 - global coordinate systems 91
 - GML (Geography Markup Language) 381, 412, 608, 1429
 - exporting 1429
 - exporting as schema 608
 - exporting maps 1405
 - exporting to 1429
 - importing 381, 412–413
 - importing as schema 608
 - GP4 images
 - inserting with Raster Extension 455
 - GPS data 342
 - and ODBC 342
 - grade 1162
 - displaying 1162
 - graticule 1362
 - reference system 1362
 - grid
 - Military Grid Reference System (MGRS) 1362
 - reference grid 1362
 - reference system 1362
 - grid data catalog (GDC) files 103–105, 108–109
 - Australia 109
 - New Zealand 109
 - setting up for US 108
 - United States 105
 - grips in maps 947
 - grouping layers in maps 301
 - groups 301, 764
 - altering drawing objects based on 1265
 - and Display Manager 300
 - changing for layers 301
 - finding drawing objects by 1244
 - querying 1300
 - removing on save back 764
 - unused 764
 - Groups button 301
- ## H
- hatch 761, 939, 978
 - adding to closed polylines 939
 - adding to queried drawing objects 1283
 - and queries 247
 - associative 247
 - boundaries when saving 761
 - default for polygons 978
 - displaying for polygons 978
 - for drawing layers 660
 - querying 1300

- saving to source drawings from maps 761
 - scaling for drawing layer themes 1176
 - theming for drawing layers 1176, 1184
 - Hatch Options dialog box (drawing queries) 1847
 - Header/Footer dialog box 1685
 - height
 - altering with queries 1261
 - and theming 1202
 - theming surfaces for 1203
 - HEIGHT variable 1546
 - help 61
 - printing 61
 - hiding
 - Data Table 1127
 - Data View columns 1059
 - map books 1398
 - map status bar 87
 - Task Pane 221
 - Highlight Features activity
 - for workflows 2038
 - highlighting 752, 911
 - drawing objects linked to external data 1227
 - features in maps 1137
 - locked objects 752
 - records linked to drawing objects 1229
 - removing from features in maps 1138
 - rows in Data Table 1139
 - topology associated with objects 911
 - highlighting features
 - video 1136, 1138
 - Hillshade Settings dialog box 1562
 - hillshading
 - applying to surfaces 1200
 - video 1199
 - Horizontal Coordinate System Definition Editor (FGDC Metadata) dialog box 1768
 - horizontal distance 1162
 - displaying 1162
 - hyperlinks 389
 - exporting to SDF 2 files 1417
 - importing from SDF 1 or 2 files 389
- I**
 - Identify Map Book Layout Placeholders dialog box 1829
 - identity overlay 1309
 - If Else activities
 - for workflows 2025
 - IG4 images
 - inserting with Raster Extension 455
 - IGS images
 - inserting with Raster Extension 455
 - IKONOS images
 - adding to maps 437
 - Image Correlation dialog box (Insert Image command) 1873
 - image formats
 - exporting drawing data to 1465
 - Image Information dialog box 1875
 - Image Insertion dialog box 451
 - Image Management dialog box (Insert Image command) 1875
 - Image Management Layout dialog box (Insert Image command) 1877
 - Image Select dialog box (Insert Image command) 1877
 - Image Systems Gray Scale images
 - inserting with Raster Extension 455
 - Image Systems Group 4 images
 - inserting with Raster Extension 455
 - ImageConnect 62
 - images
 - adding to a layer (video) 437
 - adding with Data Connect 440
 - inserting (video) 437, 459
 - inserting at command line 471
 - inserting with Raster Extension 455
 - imperial units
 - for exported MicroStation DGN files 269
 - implicit nodes 1339

- Import Data Mapping dialog box 1732
- Import dialog box 1711
- Import Metadata Options dialog box 1757
- Import Old Theme dialog box 1628
- importing 269, 377–378, 381, 388–389, 391–392, 396, 399, 401, 404, 408, 410, 413–415, 417–419, 421, 424, 426, 428, 434–435
 - .ddf files (SDTS format) 414
 - .gml files 413
 - .ini file for 269
 - .shp files 399
 - .tab files 404
 - .vpf files 417
 - and assigning object classes 421
 - and coordinate conversion 424
 - and profiles 263
 - and styling drawing objects 385
 - Arc/INFO Coverages 381, 396
 - ArcSDE data 392
 - ArcView ShapeFiles 381
 - ArcView ShapeFiles as folder 269
 - areas 418
 - attribute data 426, 428, 434–435
 - AutoCAD layers into AutoCAD Map 3D 419
 - Autodesk MapGuide files 389
 - blocks 428
 - compared to connecting 15
 - data 377, 435
 - data types for AutoCAD Map 3D 426, 434
 - databases 209
 - DGN files 408
 - driver options 381
 - DXF files 391
 - EOO files 396
 - ESRI Arc/INFO Coverages 396
 - ESRI ShapeFiles 399
 - external data 381, 426, 434–435
 - file-based 269
 - folder-based 269
 - GML (Geography Markup Language) 381, 413
 - layers into AutoCAD Map 3D 419
 - limiting area 418
 - MapGuide files 389
 - MapInfo MIF/MID as folder 269
 - MapInfo MIF/MID files 381, 401
 - MapInfo TAB 381, 404
 - metadata 1511
 - MicroStation DGN 381, 408
 - MIF/MID files as folder 269
 - object data 426, 434–435
 - object properties 269
 - Oracle data 410
 - Ordnance Survey of Great Britain
 - GML v2 381, 413
 - overview 381
 - plot map sets for map books 1392
 - point data as text 428
 - preparation for maps 378
 - queries 180
 - schemas 608
 - schemas (video) 43, 606
 - SDF 1 or 2 files 389
 - SDF 1, 2, or 3 388
 - SDTS (Spatial Data Transfer Standard) 381, 414
 - ShapeFiles 399
 - SHP files 399
 - SHP files as folder 269
 - Spatial Data Transfer Standard 414
 - spatial filters for 418
 - SQLite 381, 415
 - SQLite files 414
 - supported formats for maps 378
 - TAB files 404
 - TAB files as folder 269
 - Vector Product Format as folder 269
 - Vector Product Format files 417
 - VPF (Vector Product Format) 381, 417
 - VPF as folder 269
 - vs. accessing data for maps 378
- incomplete topology 920
- Index Maintenance dialog box 1931
- indexes
 - creating for drawings 1294
- individual values distribution 1165

- information 474, 916
 - for raster images 474
 - printing using report queries 1477, 1479
 - specifying type for tables 201
 - viewing for raster images 474
 - viewing for source drawings 172
 - viewing for topology 916
- inheritance (base or abstract classes)
 - setting in schemas 612
- Insert Annotation dialog box 1574
- insert errors
 - ignoring in Bulk Copy 1744
- Insert Image dialog box 1878
- insertion point 451, 937
 - for labels 937
 - for text in maps 937
 - specifying for raster images (Data Connect) 451
- insets for maps 943
- installing
 - sample data 63
- integers 426, 434
 - importing 426, 434
- Intermap 62
- internal queries
 - executing 178, 1288
- international coordinate systems 143
- intersect overlay 1309
- intersecting lines 1160
 - displaying acute angles 1160
 - displaying obtuse angles 1160
- invalid geometry
 - and SQL Server Spatial 326
- islands 836, 920, 955, 963, 971, 974
 - adding to polygons in maps 963
 - converting to polygons 974
 - creating from grouped polylines 971
 - creating in polygons 955
 - for topology 836, 898, 920
 - rebalancing in maps 963
 - when exporting polygons 1458
 - within boundaries 836
- ISO 19139 metadata 1483

J

- Jenks distribution 1165
- Jet provider for Microsoft Access 209
- JFIF images
 - adding to maps 437
 - inserting with Raster Extension 455
- join keys 509
- joins 507
 - about 507, 509
 - advanced techniques 509
 - and calculated properties 519
 - and non-matching data 509
 - creating 512
 - deleting 515
 - editing joined data 517
 - exporting data 520
 - managing 515
 - modifying 515
 - publishing data 520
 - removing 515
 - saving 520
 - sharing data 520
 - video 37, 507, 509, 514
 - viewing in Data Table 1135
- Joint Photographic Experts Group
 - images 437
 - adding with Data Connect 440
- JPEG images 437
 - adding with Data Connect 440, 443–444
- JPEG2 images 437
 - adding with Data Connect 440, 443–444
- justification
 - setting for export and import 269

K

- key columns for link templates 526
- keyview viewport
 - for map books 1385
- KIF files
 - exporting 1417

L

- L74 images
 - adding to maps 437
- label point 937, 1280
 - changing 937
 - defining 937
 - defining for drawing objects 1280
 - specifying while digitizing 138
- labeling
 - features 651
 - features (video) 640, 645, 648
- LABELPT variable 937, 1546
- labels 937
 - adding to features (video) 1089, 1091
 - allowing to obscure points 1097
 - for contour lines 1191
 - for features (video) 185–186, 190, 194, 1096, 1098
 - insertion point 937
 - on features 1093
 - on points 1099
- Lambert Conformal Conic projection 143
- land cover map 840
- land use map 840
- LANDSAT FAST images
 - adding to maps 437
- latitude
 - when digitizing 133
- layer CS code
 - for Web Map Service (WMS) 447
- Layer Mapping dialog box (Import FDO) 1719
- Layer Range Editor dialog box (object classification) 1789
- LAYER variable 1546
- layers 300–301, 350, 357, 359, 362, 419, 421, 764
 - adding drawing objects to by property 362
 - altering drawing objects based on 1265
 - altering with queries 1261
 - and map styles 300
 - and scale ranges (video) 648
 - assigning object classes during import 421
 - changing draw order 302
 - changing groups for 301
 - changing thumbnail 302
 - changing thumbnail styles in Display Manager 301
 - copying 639
 - creating for drawing objects in maps 356
 - defining scale for 644
 - display order in maps 300
 - draw order 637
 - drawing vs. AutoCAD layers 350
 - exporting 1405
 - exporting to a feature class 1442
 - exporting to SDF (video) 1376, 1405, 1469
 - finding drawing objects by 1244
 - for drawing objects in maps by location 359
 - for drawing objects in maps by object class 357
 - for styled drawing objects 652
 - grouping in maps 301
 - importing 381
 - importing into AutoCAD Map 3D 419
 - managing (video) 634, 636
 - redefining on save back 764
 - saving to .layer files (video) 1405, 1469
 - specifying for digitized objects 138
 - updating in Display Manager 635
 - using wild-card characters 1537
 - viewing data for 1135
- layout
 - for map books 1388
- LDF files
 - loading 652
 - saving 652
- legends
 - adding to maps (video) 1089
 - creating 1117–1118, 1181
 - samples 62, 71

- viewport for map books 1385
- legends (video) 185–186, 190, 194
- legends(video) 1117
- length
 - altering drawing objects based on 1265
 - finding drawing objects by 1244
- LENGTH variable 1546
- levels
 - importing 381
- library for queries 174, 178
- LiDAR
 - ASCII format 1012
 - data
 - bringing in 374
 - filtering 1016
 - importing 374
 - managing 1015
 - overview 1012
 - supported versions 374
 - file types 1012
 - LAS file format 1012
- LIDAR data 342
 - and ODBC 342
- line features
 - theming 1174
- line width 776
 - assigning for drawing layer themes 1176
 - for objects created during Drawing Cleanup 776
- linear objects 767, 773, 779, 794, 796, 799, 801, 803, 806, 808, 814–815, 819, 831, 838, 847, 850, 863, 873, 875, 880, 889, 892, 1073
 - adding to topology 880
 - breaking crossing 799, 838
 - changing direction in topology 873
 - changing resistance in topology 875
 - cleaning up 767
 - dangling objects 810
 - deleting duplicates 794
 - digitizing 1073
 - dissolving 1343
 - dissolving pseudo nodes 808
 - editing 863
 - erasing short 796
 - extending to apparent intersection 803
 - extending undershoots 801
 - marking for cleanup 779
 - removing from topology 889
 - segmentation during export 269
 - simplifying 814
 - snapping clustered nodes 806
 - specifying direction 847, 850
 - tolerance for deleting duplicates 773
 - topology 831
 - updating for topology 892
 - weeding 819
 - zero-length objects 815
- lines 808, 815, 1032, 1034, 1036, 1038, 1040, 1042, 1044
 - digitizing 138
 - displaying COGO information for 1161
 - dissolving pseudo nodes 808
 - scale ranges for 649
 - segmentation during export 269
 - specifying with angle and distance 1032
 - specifying with azimuth and distance 1042
 - specifying with bearing and distance 1034
 - specifying with deflection and distance 1038
 - specifying with distance and offset 1044
 - specifying with two bearings 1036
 - specifying with two distances 1040
 - styles for 649, 662
 - zero-length 815
- linestring features 691
 - creating 691
- linetypes 1176
 - theming for drawing layers 1176
- Linetype Range Editor dialog box (object classification) 1789
- LINETYPE variable 1546

- linetypes
 - altering drawing objects based on 1265
 - altering with queries 1261
 - finding drawing objects by 1244
 - for drawing layers 660
 - setting for export and import 269
 - specifying for digitized objects 138
 - theming for drawing layers 1176
- Lineweight Range Editor dialog box (object classification) 1790
- lineweights 381
 - finding drawing objects by 1244
 - for drawing layers 660
 - for imported lines 381
 - setting for export and import 269
 - theming for drawing layers 1176
- link data 434
 - altering drawing objects based on 1267
 - importing 434
- link index 1294
- Link Objects dialog box (drawing topology) 1975
- Link Template Data Entry dialog box 1619
- Link Template Key Column Entry dialog box 1620
- Link Template Properties dialog box 1686
- link templates 526–527, 539
 - about 525
 - creating for maps 526
 - deleting 539
 - editing paths 539
 - opening linked database tables 527
- linking 507, 512, 523, 529, 531–532, 534, 537, 1064, 1085
 - data sources to drawings 209
 - data to drawing objects 1064
 - drawing objects to object data 531
 - records to drawing objects 529
 - records to drawing objects in maps 523, 532, 534, 537
 - records to drawing objects while digitizing 1085
 - using joins 507, 512
- links (database) 435, 1085
 - altering drawing objects based on 1270
 - creating while digitizing 1085
 - Data View 1222
 - deleting 537
 - displaying as text 435
 - editing 537
 - filtering by location 1234
 - importing 434
 - overview 1222
 - to external data 523, 529, 532, 534
- links (linear objects) 796, 799, 801, 803, 806, 808, 814–815, 838, 847, 850, 863, 873, 875, 880, 889, 892
 - adding to topology 880
 - breaking crossing 799, 838
 - changing direction in topology 873
 - changing resistance in topology 875
 - cleaning up 767
 - dangling objects 810
 - deleting 794
 - digitizing 1073
 - dissolving 1343
 - dissolving pseudo nodes 808
 - editing 863
 - erasing short 796
 - extending to apparent intersection 803
 - extending undershoots 801
 - marking for cleanup 779
 - removing from topology 889
 - simplifying 814
 - snapping clustered nodes 806
 - specifying direction 847, 850
 - topology 831
 - updating for topology 892
 - weeding 819
 - zero-length objects 815
- List Current Connections activity for workflows 2039
- List Feature Classes activity for workflows 2039
- List Feature Layer Properties activity for workflows 2040

- lists
 - for schema property values 599
- LizardTech images
 - inserting with Raster Extension 455
- Load Internal Query dialog box (drawing queries) 1848
- Load Layer File activity
 - for workflows 2041
- Load Topology Conflict dialog box 1976
- Load Topology dialog box 1976
- Load Topology From Source Drawing dialog box 1978
- loading 899
 - feature styles 652
 - queries 184
 - schemas 608
 - topology 899, 907
- location 359, 539
 - adding drawing objects to maps by 359
 - for source drawings 169
 - link templates 539
- Location Condition dialog box (drawing queries) 1849
- location conditions for queries 1241
 - editing 1258
- location index 1294
- location queries
 - using with buffers (video) 1302, 1306
- locking 305, 684, 696, 730, 733, 735–736, 751, 759, 764
 - and working offline 696
 - drawing objects 730, 733, 751
 - drawings 730
 - enabling in schema 612
 - features 684
 - for feature sources in maps 305
 - in Schema Editor 1739
 - removing locks from drawing objects 759
 - removing locks on save back 764
 - viewing lock owners 735
 - viewing locked drawing objects 752
- LOCKSTAT variable 1546

- log files
 - for Bulk Copy 626
 - for MapGuide publishing 1379
 - options 229
- logging in 142
 - forcing 227
- long transactions 323
 - and SQL Server 323
 - in Schema Editor 1739
 - versioning 612
- longitude
 - when digitizing 133

M

- M dimensions 562, 610
- Manage Joins dialog box 1607
- managing
 - FDO data 551
 - joins 515
 - versions 723
 - versions of data 725
- Map Base (Display Manager) 352
- Map Book Properties dialog box 1830, 1832
- map books
 - adjacent arrows 1385
 - and sheet sets 1381
 - creating 1390
 - creating (video) 1360
 - creating from saved settings 1395
 - deleting 1403
 - editing 1397
 - editing settings 1396
 - hiding 1398
 - importing plot map sets 1392
 - keyview viewport 1385
 - layout placeholders 1388
 - legend viewport 1385
 - MBS files 1394
 - overview 1381, 1383
 - printing 1402
 - publishing (video) 1381, 1389
 - publishing to DWF 1401
 - publishing to DWF (video) 46, 1360, 1366

- publishing to DWF with
 - attributes 1400
- publishing to plotter 1402
- rebuilding 1391
- renaming 1402
- saving settings 1394
- setting up templates 1385–1386
- sheet templates 1386
- video 46, 1381
- viewing 1397–1398
- viewing layouts 1400
- viewing properties 1399
- viewing tiles 1399
- Map Books
 - sample templates 63, 66
- map files
 - and data stores 3
 - and display maps 7
- map status bar
 - hiding 87
- MAP2SDF command 1419
- MAPABOUT command 1905
- MAPAL command 881
- MAPAN command 879
- MAPANBUFFER command 1348
- MAPANDISSOLVE command 1345
- MAPANNINSERT command 1570, 1574
- MAPANNTEMPLATE command 1572
- MAPANOVERLAY command 1341
- MAPANTOPONET command 1322, 1328, 1332, 1336
- MAPATTACHDB command 210
- MAPAUTOCHECKOUT command 1905
- MAPBL command 864
- MAPBOOKCREATE command 1383, 1391
- MAPBOOKCREATEFROMSETTINGS
 - command 1384, 1394–1395
- MAPBOOKEDITSETTINGS
 - command 1384, 1394, 1396
- MAPBOOKIMPORTPLOTSET
 - command 1384, 1392
- MAPBOOKPLACEHOLDER
 - command 1384, 1389
- MAPBOOKSAVESETTINGS
 - command 1385, 1393, 1395
- MAPBREAK command 942, 1666
- MAPBROWSELINK command 1054
- MAPBROWSETBL command 1054, 1691
- MAPBUFFER command
 - (discontinued) 1533
- MAPCLEAN command 769
- MAPCLPLINE command 1953
- MAPCOGO command 1651
- MAPCONFIGDB command 214, 1679
- MAPCONNECTDB command 215, 1679
- MAPCONNECTIONPOOLING
 - command 89
- MAPCREATE command
 - (discontinued) 1533
- MAPCREATECENTROIDS
 - command 887, 977
- MAPDATAGRID command 712, 1613
- MAPDEFINELT command 527, 1682–1683, 1690
- MAPDELETEDLINKS command 538, 1690
- MAPDELETED command 540
- MAPDETACHDB command 210, 1684
- MAPDIGISETUP command 131, 139, 1617
- MAPDIGITIZE command 138, 1080–1082, 1615
 - setting options 138
- MAPDISCONNECTDB command 215, 1684
- MAPDISPLAYLIBRARY command 1621
- MAPDISPLAYMANAGER command 1621
- MAPDISSOLVE command
 - (discontinued) 1533
- MAPDIST command 1153, 1597
- MAPDL command 890
- MAPDN command 890
- MAPDOCKWSPACE command 1906
- MAPDP command 890
- MAPDVP command 868
- MAPDWFOPTIONS command 1368
- MAPEDITDIR command 848, 874, 1939, 1973
- MAPEDITRES1 command 1940, 1972
- MAPEDITRES2 command 1940, 1973
- MAPEDITSETAUTO command 1906

MAPEDITSETAUTODEFAULT
 command 89
 MAPEXPORT command 261, 264, 1410,
 1457, 1704
 mapexport.ini 269
 customizing 264
 MAPFDOBUFFERCREATE
 command 1302, 1306, 1309
 MAPFEATUREEDITTOOLS
 command 1906
 MAPFEATUREMERGE command 1651
 MAPFEATURESPLIT command 1652
 MAPFIGNORESPLITMERGERULES
 command 1653
 MAPFLOOD command
 (discontinued) 1533
 mapforeignfileproperties.ini
 customizing 264
 mapgisoverlay 1309
 MapGuide 389
 exporting to version 6.5 and
 earlier 1417–1418
 importing from 389
 publishing to (video) 3, 1376
 publishing to current Enterprise
 version 1378
 publishing to Open Source
 version 1378
 resolving publishing errors 1379
 video 46, 1360
 viewing log file after
 publishing 1379
 MAPIFRAME command 492, 495, 1873
 MAPIINFO command 475, 1875
 MAPIINSERT command 459, 1873, 1878
 MAPIL command 881
 MAPIMANAGE command 475, 478,
 481, 1875, 1877
 MAPIMPORT command 262, 264, 384,
 387, 389, 394, 397, 400, 402,
 404, 409, 412–414, 416–417, 1711
 mapimport.ini 269
 customizing 264
 MAPIN command 879
 MapInfo MIF/MID 381, 400, 1431
 exporting 1405
 exporting to 1431
 importing 381, 400
 importing as folder 269
 MapInfo TAB 381, 402, 404
 exporting 1405
 exporting to 1433
 importing 381, 402, 404
 importing as folder 269
 MAPIOPTIONS command 253, 1879
 MAPJL command 865
 MAPLINESTRINGCREATE
 command 1654
 MAPLINESTRINGEDIT 705
 MAPLINESTRINGEDIT command 1655
 MAPLINKADD command
 (discontinued) 1533, 1941
 MAPLINKDEL command
 (discontinued) 1533, 1942
 MAPLINKEDIT command 1943
 MAPLINKMANAGER command 538
 MAPLINKREV command
 (discontinued) 1533, 1943
 MAPLINKUPD command 892, 1944
 MAPLOGIN command 142, 1937
 MAPML command 865
 MAPMN command 861
 MAPMP command 868
 MAPMPEDIT command 1818
 MAPMULTILINESTRINGCREATE
 command 1656
 MAPMULTILINESTRINGEDIT
 command 1658
 MAPMULTILINESTRNGEDIT 705
 MAPMULTIPOINTCREATE
 command 1659
 MAPMULTIPOINTEDIT 705
 MAPMULTIPOINTEDIT command 1659
 MAPMULTIPOLYGONCREATE
 command 1660
 MAPMULTIPOLYGONEDIT 705
 MAPMULTIPOLYGONEDIT
 command 1662
 MAPNODADD command
 (discontinued) 1533, 1945
 MAPNODDEL command
 (discontinued) 1533, 1946

MAPNODEEDIT 1946
 MAPNODINS command
 (discontinued) 1533, 1947
 MAPNODUPD command 892, 1948
 MAPOD2ASE command 533–534, 536,
 1680, 1689
 MAPOPTIONS command 88, 216–218,
 222, 226, 228, 230, 232, 237,
 239, 244, 246, 249, 743, 765,
 1908
 MAPOVERLAY command
 (discontinued) 1533
 MAPPLOT command 1364
 MAPPOINTCREATE command 1663
 MAPPOLYADD command
 (discontinued) 1533, 1948
 MAPPOLYDEL command
 (discontinued) 1533, 1949
 MAPPOLYGONCREATE command 1663
 MAPPOLYGONEDIT 705
 MAPPOLYGONEDIT command 1665
 MAPPOLYLINETOPOLYGON
 command 972, 1817
 MAPPOLYUPD command 892, 1950
 MAPPROPSLT command 540, 1686
 MAPPUBLISHTOMAPGUIDE
 command 1379, 1381
 MAPRL command 865, 874
 MAPRUNDBQUERY command 1054,
 1691
 maps 147, 298, 300, 302, 308, 381, 746,
 758, 767, 822, 852, 927, 932,
 934, 941, 943, 951, 1073
 adding GIS features 308
 aligning 169
 and data 291
 and GIS features 303
 and Quick View 746
 annotating (video) 1089
 assigning coordinate system 146–
 147
 attaching drawings 154, 158
 breaking drawing objects at
 boundaries 941, 943
 changing draw order for layers 302
 changing thumbnail for layers 302
 cleaning 767
 contents of 3
 converting to DWG (video) 628
 coordinate system 143
 creating 298
 creating and editing overview 19
 creating map books 1390
 creating multiple display maps 639
 creating with saved drawing
 objects 758
 digitizing 1073, 1080–1081
 discontinuous edges 951
 distorting 934, 951
 distortion 225
 draw order for layers 637
 editing tools 927
 editing topology 852
 enlargements 943
 exporting to DWG (video) 1459
 exporting to DWG format 1460
 importing data for 381
 insets 943
 irregular 951
 joining at seams 951
 layer display order 300
 legends 1117
 matching 934
 matching edges 951
 on web sites 46
 options 216–217
 output formats 1360
 overview 3
 overview of map creation 296
 overview of printing 1357
 previewing 746
 publishing 1360
 publishing as web pages 1374
 publishing in HTML format 1374
 publishing overview 1357
 publishing to Autodesk MapGuide
 Enterprise 1378
 publishing to MapGuide Open
 Source 1378
 publishing to plotter 1364
 publishing to DWF format 1372
 rebuilding map books 1391

- registering for digitizing 136
 - rubber sheeting 932, 934
 - sample data for AutoCAD Map
 - 3D 62, 71
 - scale 169, 638
 - sections 169
 - sharing 46, 1357, 1460
 - styles 631
 - tiling 951
 - topology 822
 - transforming 169
 - transforming coordinate system 152
 - trimming drawing objects at
 - boundaries 945
- MAPSDFIN command 390
- MAPSELECTCLASSIFIED command 994, 1779
- MAPSELECTUNCLASSIFIED
 - command 994, 1780
- MAPSELECTUNDEFINED
 - command 995, 1780
- MAPSHOWGEOM command 903, 912
- MAPSHOWTOPO command 903, 912
- MAPSTATUSBAR command 89
- MAPTOPOADMIN command
 - (discontinued) 1533
- MAPTOPOADMIN Delete
 - command 1950
- MAPTOPOADMIN Rename
 - command 1951
- MAPTOPOAUDIT command 904, 921
- MAPTOPOCOMP command 904, 921
- MAPTOPODEL command 906, 926
- MAPTOPOEDIT command 1951
- MAPTOPOEDIT command
 - (discontinued) 1533, 1974
- MAPTOPOLOAD command 902, 908
- MAPTOPOLOGYTOPOLYGONS
 - command 975, 1823
- MAPTOPOQUERY command 1354, 2008
- MAPTOPORECR command 904, 921
- MAPTOPOREN command 906, 925
- MAPTOPOSTATS command 903, 916
- MAPTRACE command
 - (discontinued) 1533
- MAPTRACKCS command 1152
- MAPTRIM command 946, 1672
- MAPUSEMPOLYGON command 980, 1818
- MAPUSERADMIN command 84, 1934
- MAPVIEWLINK command 1054, 1797
- MAPVIEWTBL command 1055
- MAPWORKFLOWBATCHRUN
 - command 2021
- MAPWORKFLOWOPEN command 2021
- MAPWORKFLOWRUN command 2021
- MAPWSACTION command 1536
- MAPWSFOCUS command 1907
- MAPWSpace command 1908
- MAPWSREFRESH command 1908
- markers 785
 - for Drawing Cleanup 779, 785
- matching 951
 - map edges 951
- maximum speed for links and nodes 850
- measuring 1148
 - continuous distances 1159
 - coordinate geometry 1154
 - coordinates 1148
 - distances 1157
 - geodetic distance 1153
- Mentor coordinate systems 590
- Mercator projection 143
- merge rules
 - ignoring 708
- merging
 - features 710
- metadata
 - about 1481
 - adding records 1505, 1507
 - applying templates 1492
 - Attribute Domain Values
 - Editor 1773
 - auditing 1509
 - boxes
 - Responsible Party Editor (ISO) 1776
 - Citation Editor (ISO) 1777
 - Citation Information Editor 1759
 - Contact Information Editor 1763
 - copying and pasting 1504
 - creating 1486

- creating templates 1492
- deactivating templates 1495
- default template 1494
- deleting records 1505
- editing 1499
- exporting 1513
- exporting templates 1496
- free-form fields 1501–1502
- Horizontal Coordinate System
 - Definition Editor (FGDC Metadata) 1768
- importing 1511
- importing templates 1492
- ISO 19139 1483
- previewing templates 1494
- printing 1515
- publishing 1515
- record navigator 1507
- removing templates 1497
- renaming templates 1493
- samples 63
- setting options 1484–1485
- setting options for 241
- sharing 1510
- Spatial Data Organization
 - Editor 1764
- Standard Order Process Editor 1774
- standards for 1481
- stylesheets for 1489
- templates 1490
- Time Period Information
 - Editor 1761
- updating automatically 1484
- video 1481, 1486, 1498
- viewing 1486
- viewing a summary 1753
- metadata (video) 30
- Metadata Editor 1754
- Metadata Options dialog box 1756
- Metadata Viewer 1751
 - exporting data from 1473
 - importing stylesheets 1489
 - Summary tab 1753
- MGRS 1362
- Microsoft Access 342, 344
 - adding feature data to maps 344
 - provider capabilities for maps 342
- Microsoft Excel
 - attaching spreadsheet to drawing 209
 - setting default version 243
 - setting up database ranges 578
- Microsoft Jet 4.0 provider 209
- Microsoft Visual FoxPro
 - attaching database to drawing 209
 - setting default version 243
- MicroStation DGN 381, 405, 408, 1435
 - changing export default to imperial units 269
 - changing the default seed file 269
 - exporting 1405
 - exporting to 1435
 - importing 381, 405, 408
 - seed file for 1435
 - units of measurement 269
- MIF/MID files 269, 381, 400, 1431
 - exporting 1405
 - exporting to 1431
 - importing 381, 400
 - importing as folder 269
- migrating data
 - overview 617
- MIL images
 - inserting with Raster Extension 455
- Military Grid Reference System (MGRS) 1362
- model space
 - queries in 1235
- modifying
 - coordinate system categories 101
 - coordinate systems 98
 - datums 99
 - ellipsoids 100
 - object data tables 202
- monuments for digitizing 1073
- motion path animation 1196
- MPEDIT command (See MAPMPEDIT) 1818
- MPFILL command 968, 980
- MPOLYGON command 962
- MPSPLIT command 969, 1821

- MrSID images 437
 - adding with Data Connect 440, 443–444
- MTD files 1513
- multi-page DWF 1365
- multi-polygon
 - and SHP files 572
- multi-polygons
 - and SHP files 335, 397
 - creating 689
- Multi-Resolution Seamless Image Database
 - images 437
 - adding with Data Connect 440
- multi-user editing
 - for drawing files (video) 727, 730, 734, 738
 - video 19
- multilinestring features 691
 - creating 691
- multiple features 1444
 - exporting from AutoCAD Map 3D 1444
- multiple user options 216
- multipoint features 688
 - creating 688
- multipolygon features 689
 - creating 689
- multiuser environment 684
 - and editing 684
 - locking drawings 730
 - options 227, 249
- MySQL 332–333
 - adding feature data to maps 333
 - provider capabilities for maps 332
 - schemas 567
 - working with data 569

N

- naming
 - object data tables 201
- naming restrictions 610
- natural breaks distribution 1165
- NAVTEQ 62
- nested drawings 157
 - activating 160

- network topologi
 - video 829
- network topology 829, 831, 847, 849–850, 873, 875, 1073
 - and object data 829
 - best route 1330, 1334
 - changing link direction 873
 - changing resistance 875
 - creating 831
 - creating (video) 727
 - digitizing objects for 1073
 - direct resistance 849
 - editing 852
 - overview 829
 - path trace analysis 845
 - shortest path 1326
 - specifying link direction 847, 850
 - testing integrity 1334
 - travel time 1326
 - video 822
- Network Topology Analysis Choose
 - Locations dialog box 1978
- Network Topology Analysis Output dialog
 - box 1980
- Network Topology Analysis Resistance and
 - Direction dialog box 1982
- Network Topology Analysis Select Method
 - dialog box 1983
- New Annotation Template Name dialog
 - box 1576
- New Layer dialog box 1579
- New Object Class Definition File dialog
 - box 1790
- New Property dialog box (object
 - classification) 1791
- New Range Table dialog box (drawing
 - queries) 1852
- New Scale dialog box 1629
- New Zealand grid data files 109
- NEWDEF command 130, 1790
- NITF images
 - adding to maps 437
- Node Objects dialog box (drawing
 - topology) 1985, 1987
- node topology 826–827, 1073
 - and object data 826

- creating 827
 - digitizing objects for 1073
 - overview 826
 - nodes (Map Explorer)
 - displaying 221
 - nodes (topology) 138, 773, 779, 806, 808, 810, 814–815, 827, 860, 863, 870, 875, 878, 889, 892, 953, 1073
 - adding 878
 - changing appearance 870
 - changing resistance in topology 875
 - clustered 806
 - creating 827
 - dangling objects 810
 - digitizing 138, 1073
 - digitizing by coordinates 953
 - dissolving pseudo nodes 808
 - dissolving psuedo nodes 779
 - editing 860
 - explicit 1339
 - implicit 1339
 - importing 428
 - marking for cleanup 779
 - pseudo 808
 - query location 1241
 - removing from topology 889
 - repositioning 863
 - simplifying lines 814
 - snapping clusters 779, 806
 - styling 870
 - tolerance for deleting clusters 773
 - updating for topology 892
 - weeding 814
 - zero-length objects 815
 - non-feature classes
 - in Schema Editor 1739
 - non-planar polygons 689, 704
 - non-spatial data
 - viewing in Data Table 1136
 - North American datum shift issues 112
 - north arrows
 - samples 62, 71
 - not-null
 - for schema property values 599
 - notes
 - adding to maps 1089
 - numbers
 - specifying type for tables 201
 - numeric ranges
 - for property queries 1244
 - for queries 1242
- O**
- Object Class Attribute Mapping dialog
 - box 1710
 - object classes 357, 421, 991, 995
 - adding drawing objects to maps
 - by 357
 - adding text to queried objects 1278
 - assigning during import 421
 - defining 119–120, 123
 - defining range of values 125
 - definition file 995
 - editing data 991
 - files 129
 - finding drawing objects by 1244
 - hierarchies 122–123
 - metadata for 1486
 - modifying definitions 127
 - range of allowable values 124
 - renaming 120
 - setting property ranges 125
 - using to modify thematic
 - objects 1261
 - viewing information about 1144
 - object classification 83, 117, 981, 983, 988–989, 991, 993, 995
 - and export 1440
 - assigning to existing drawing
 - objects 989
 - base classes 123
 - creating files 129
 - creating objects using 988
 - defining objects 120, 123, 125
 - definition file 995
 - editing data 991
 - files 128
 - general procedure 983
 - modifying definitions 127

- overview 117, 981
- privileges 83
- removing from drawing objects 989
- selecting objects using 993
- setting up 118
- variables 1551
- object data 364, 426, 430, 434–435, 531, 533–534, 826, 829, 833, 887, 913–914, 1061, 1064, 1066–1067, 1069, 1071, 1080, 1083
 - adding drawing objects to maps
 - by 364
 - adding text to queried objects 1278
 - altering drawing objects based on 1267
 - and database links 533
 - and digitizing 1080
 - and network topology 829
 - and node topology 826
 - and polygon topology 833
 - attaching multiple records 1066
 - attaching to drawing objects 1064
 - attaching to drawing objects
 - automatically 1067
 - attaching while digitizing 138, 1083
 - converting to a linked database table 1071
 - converting to external data 534, 1071
 - creating tables 201
 - displaying as text 435
 - editing 1069
 - exporting 1405
 - exporting text enclosed in a polyline 1455
 - finding drawing objects by 1248
 - for polygon topology 1064
 - for topology 913
 - importing 426, 434
 - indexing 1294
 - linking automatically to records 531
 - linking to enclosed blocks and text 1067
 - listing tables in source drawings 172
 - modifying tables 202
 - moving to polygon centroids 430, 887
 - overview 1061
 - printing using report queries 1477
 - using to dissolve topology 1343
 - variables 1549
 - viewing for drawing objects 1144
 - viewing for topology 914
 - viewing in Properties palette 1146
- Object Data Mapping dialog box 1732
- object locking 730, 733, 735–736
 - enabling 227
 - overview 730
 - releasing locks 736
 - turning on 733
 - viewing lock owners 735
- object type
 - altering drawing objects based on 1265
 - finding drawing objects by 1244
- ODBC 342, 344
 - adding feature data to maps 344
 - compliant databases 209
 - provider capabilities for maps 342
 - schemas 576
 - setting up 577
 - video 305, 342
 - viewing data in Data Table 1136
 - working with data 577
- offline
 - editing features 722
- offset
 - for source drawings 169
- OGC Basic Web Map Service 447
 - using with maps 447
- OGR provider 540
- one-to-many joins 509
- one-to-one joins 509
- online
 - returning 722
- open source providers 540–541
 - adding 541
- opening 527, 1053
 - attached drawings 163
 - database tables in Data View 1053
 - linked database tables 527

- source drawings 163
- options 169, 225, 229, 249, 764, 781, 922
 - acadmap.ini file 249
 - acadmap.sys file 249
 - AutoCAD Map 3D 216–217, 249
 - coordinate system 231
 - coordinate transformation 225
 - data sources 225, 236, 243
 - Data View 238
 - digitizing 138
 - drawing origin 169
 - drawing scale 169
 - feature editing 240
 - for coordinate geometry 234
 - for drawings 225
 - log files 229
 - map books 1394
 - metadata 241
 - multi-user 227
 - overview 216–217
 - queries 245
 - Raster Extension 249
 - rotation 169
 - save back 764
 - save back extents 170
 - saving 249
 - saving for Drawing Cleanup 781
 - saving for topology 922
 - setting while attaching drawings 158
 - split prompts 709
 - system 229
 - Task Pane 221
 - transformation 169
- Oracle 312, 410
 - adding feature data to maps 314
 - exporting drawing data to 1462–1463
 - exporting from DWG and back 1467
 - importing data from 410
 - moving DWG data to 629
 - provider capabilities for maps 312
 - schemas 554
 - version-enabling 554, 557
 - working with data 558
- ORACONNECT command
 - (discontinued) 1533
- ORADISCONNECT command
 - (discontinued) 1533
- ORAERUPDATE command
 - (discontinued) 1533
- ORAEXPORT command
 - (discontinued) 1533
- ORAIMPORT command
 - (discontinued) 1533
- ORAINDEX command
 - (discontinued) 1533
- orbiting 1196
 - surfaces in 3D 1196
- Order button 301
- Ordnance Survey of Great Britain
 - exporting GML v2 1429
 - exporting to 1429
 - importing 412
 - importing GML v2 381, 413
- origin
 - modifying for source drawings 169
- orthogonal transformation
 - and digitizing 133
- osgeo 540–541
 - downloading providers from 541
- OSGeo FDO Provider for SQL Server Spatial
 - and Schema Editor 610
 - supported data types 562
 - supported geometry types 562
- OSNAP
 - and AutoCAD Map 3D 688, 713
- Output Report Options dialog box
 - (drawing queries) 1852
- output reports for queries 1477, 1479
- overlay analysis
 - for DWG topology (video) 822, 829, 841, 1319
 - for feature classes(video) 1309
 - using drawing topologies (video) 1336
- Overlay Analysis dialog box, Set Output And Settings 1565

- Overlay Analysis dialog box, Source and Overlay Type 1563
- overlay topology 843
 - to find sliver polygons 843
- overlays
 - creating 1316
 - overview 1309
 - types 1309
- overposting 1097
- overshoots 773, 810
 - and dangling objects 810
 - tolerance for deleting 773

P

- Page Setup dialog box 1686
- PAGESETUP command 1388
- panning
 - surfaces in 3D 1196
- paper space
 - and map topology 822
 - queries in 1235
- Paradox
 - attaching database to drawing 209
 - setting default version 243
- Parallel activities
 - for workflows 2025
- parameters
 - for Workflow activities 2022, 2025
- parcel data
 - samples 63
- parcels 836, 969
 - creating polygon topology for 836
 - splitting polygons for 969
- passwords 83, 142
 - default 142
 - for AutoCAD Map 3D users 83
- paste overlay 1309
- path trace analysis 1326
 - and direct resistance 849
 - and direction 845
- paths 539
 - for link templates 539
- patterns
 - filling areas with 650
 - finding in data 1121
- PCT images
 - inserting with Raster Extension 455
- PCX images
 - inserting with Raster Extension 455
- Perform Overlay activity
 - for workflows 2041
- performance 1538
 - improving 1538
 - improving by working offline 722
 - improving for queries 150, 1292, 1294, 1296
- PERIMETER variable 1546
- persistent locking 305, 684, 698
 - and automatic update 698
 - for feature sources in maps 305
- personal geodatabase 540
 - accessing ESRI data 541
- photographs 440
 - adding with Data Connect 440
- physical configuration
 - setting for feature classes 612
 - setting for properties 612
- PICT images
 - inserting with Raster Extension 455
- pipes 831, 847, 873, 875
 - changing direction in topology 873
 - changing resistance in topology 875
 - creating network topology 831
 - specifying direction 847
 - tracing in topology 1334
- plot map sets
 - importing for map books 1392
- plot styles
 - finding drawing objects by 1244
 - theming for drawing layers 1176
- Plotstyle Range Editor dialog box (object classification) 1792
- plotters
 - publishing map books to 1402
 - publishing maps to 1364
- PNG images 437
 - adding with Data Connect 440, 443–444
- point boundary for query location 1241
- point cloud
 - adjusting display density 375

- bringing in point cloud data 375
- creating a Display Manager layer from a point cloud object 375
- creating a new data store from filtered point cloud data 1024
- creating a point cloud data store 1019
- creating a point cloud group in Display Manager 1019
- creating surfaces from point cloud data 1021
- exporting point cloud data
 - to ASCII format 1451
 - to LAS format 1451
 - to SDF format 1451
- filtering point cloud data 1024
- importing point cloud data 375
- index file 1013, 1019
- overview 1012–1013
- point cloud data store 375, 1013, 1019
- point cloud drawing object 375, 1013
- point cloud groups 1019
- styling point cloud data
 - by classification 675
 - by elevation 675
 - by LiDAR intensity value 675
 - by RGB value 675
- working with AutoCAD Civil 3D point cloud objects 375
- working with point cloud data 1013
- point cloud manager 374, 1015
 - adding a file 374
 - creating a merge group 1015
 - filtering data 1016
 - merging files 1017
 - removing a merge group 1016
 - specifying coordinate systems 1015
- point data 342
 - and ODBC 342
- point features 688
 - creating 688
 - theming 1175
- point groups
 - deleting 1005
 - renaming 1004
- Point Mapping dialog box 1733
- points 1006–1008, 1032, 1034, 1036, 1038, 1040, 1042, 1044, 1046
 - and fixed labels 1099
 - and symbols (video) 645
 - assigning survey points to point groups 1006
 - creating geospatial features from survey points 1008
 - creating raster surfaces from 1009
 - creating survey points 1006
 - creating survey points using coordinate geometry 1006
 - deleting survey points 1007
 - determining relationships
 - between 1046
 - displaying angles between 1160
 - displaying grade between 1162
 - displaying horizontal distance
 - between 1162
 - displaying slope between 1162
 - obscuring with labels 1097
 - removing survey points from a point group survey points 1007
 - scale ranges for 646
 - specifying with angle and distance 1032
 - specifying with azimuth and distance 1042
 - specifying with bearing and distance 1034
 - specifying with deflection and distance 1038
 - specifying with distance and offset 1044
 - specifying with two bearings 1036
 - specifying with two distances 1040
 - styles for 646
 - styling 1637
 - styling with symbols (video) 640
 - symbols for 646
 - viewing survey point data in the points table 1008
 - viewing survey points 1008

- points (geometric) 428, 953
 - boundary for query location 1241
 - digitizing by coordinates 953
 - importing as text 428
 - query location 1241
- points (nodes) 767, 773, 779, 806, 808, 810, 814–815, 827, 850, 860, 870, 875, 878, 889, 892, 953, 1073
 - adding to topology 878
 - and topology 827
 - changing appearance in topology 870
 - changing resistance in topology 875
 - cleaning up 767
 - clustered 806
 - dangling objects 810
 - digitizing 1073
 - digitizing by coordinates 953
 - editing in topology 860
 - explicit 1339
 - implicit 1339
 - importing as text 428
 - marking for cleanup 779
 - pseudo 808
 - removing from topology 889
 - simplifying lines 814
 - specifying resistance 850
 - tolerance for deleting clusters 773
 - updating for topology 892
 - weeding 814
 - zero-length objects 815
- points of interest symbols 70
- POLYDISPLAY command 980
- polygon boundary for query location 1241
- polygon features 689
 - creating 689
 - splitting 708
 - theming 1172
 - theming (video) 1171
- Polygon Fill Properties dialog box 1824
- polygon topology 833, 836, 840, 843, 1073
 - and Drawing Cleanup 838
 - and missing centroids 839
 - and object data 833
 - and sliver polygons 839, 843
 - creating 836
 - digitizing objects for 1073
 - exporting 1458
 - for land cover map 840
 - for land use map 840
 - overlying 1339
 - overview 833
- polygons 430, 836, 841, 867, 884, 887, 889, 892, 898, 920, 955, 960, 963, 969, 971, 974, 978, 1064
 - adding boundaries 963
 - adding fill 650
 - adding holes 963
 - adding islands 963
 - adding to topology 884
 - and gradient fill 960, 978
 - and islands 955
 - attaching object data 1064
 - boundaries for 955
 - changing fill 963
 - converting polylines to 971
 - converting to polylines during export 1458
 - converting to polylines from topology 898
 - converting topology to 974
 - creating centroids 433
 - creating centroids for 836, 887, 950, 977
 - creating in maps 960
 - default fill 978
 - disabling for maps 978
 - displaying boundaries 978
 - displaying edges 978
 - dissolving 1343
 - dividing 867, 969
 - editing 963
 - editing in topology 867
 - exporting 1458
 - exporting polylines as 1405
 - filling 960
 - finding drawing objects by 1244
 - importing into AutoCAD Map 3D 430

- incomplete in topology 920
 - inner and outer boundaries 955
 - merging in topology 867
 - nested 971, 974
 - overview of using in maps 955
 - query location 1241
 - rebalancing 963
 - removing from topology 889
 - slivers 841
 - splitting 969
 - splitting in topology 867
 - topology 836
 - updating for topology 892
- polyline segments 814–815, 819
 - simplifying 814
 - weeding 819
 - zero-length 815
- polylines 776, 808, 814–815, 819, 863, 898, 920, 939, 971
 - and Drawing Cleanup 776
 - converting 3D to 2D 776
 - converting drawing objects to 776
 - converting to polygons 971
 - creating from polygon topology 898
 - creating from polygons during export 1458
 - digitizing 138
 - dissolving pseudo nodes 808
 - editing in topology 863
 - exporting as polygons 1405
 - exporting text enclosed in 1455
 - filling 939
 - incomplete in topology 920
 - simplifying 814
 - supplementing 819
 - weeding 819
 - zero-length 815
- Portable Network Graphic images 437
 - adding with Data Connect 440
- PostGIS 340–341
 - adding feature data to maps 341
 - provider capabilities for maps 340
 - using as a data source 341
- PostgreSQL/PostGIS
 - provider capabilities for maps 340
- Preview mode queries 1287–1288, 1290
- previewing 746
 - drawing objects in attached drawings 746
 - queries 178, 1288, 1290
 - source drawings for maps 746
- previous releases of AutoCAD 754
 - updating source drawings 754
- primary key (identifier properties)
 - setting in schemas 612
- printing
 - Data View tables 1475
 - map books 1402
 - metadata 1515
 - overview 1357
 - query reports 1477
- privacy 56
- privileges for users 83
- problem-solving 761
 - saving drawings 761
- profiles 781, 922
 - compatibility across product versions 263
 - for Drawing Cleanup 781
 - for import/export 263
 - for topology 922
- projections 143
- projective transformation
 - and digitizing 133
- Prompt User activities
 - for workflows 2025
- prompts
 - for splitting features 709
- properties 362, 507, 512
 - adding drawing objects to maps by 362
 - altering drawing objects based on 1265
 - and joins 507, 512
 - constraining 601
 - constraining (video) 599
 - creating in schemas 598
 - deleting in schemas 614
 - editing for features 718
 - editing in schemas 612
 - finding drawing objects by 1244
 - for attached databases 206

- map books 1399
- setting identifier (primary key) in schemas 612
- setting physical configuration 612
- undoing schema changes 615
- using as labels 1093
- viewing for drawing objects 1146
- viewing for features 1127
- PROPERTIES command 992
- Properties palette
 - and Display Manager 1124
 - drawing attributes 1146
 - editing feature data 718
- property alteration 1296
 - adding hatch to objects 1283
 - adding text to objects 1278
 - based on external data 1270
 - based on object data 1267
 - based on object properties 1265
 - modifying 1286
 - overview 1261
 - text insertion point 937
 - topology queries 1353
 - with queries 1263
- Property Condition dialog box (drawing queries) 1855
- property conditions for queries 1244
 - editing 1258
- property index 1294
- property settings
 - in Schema Editor 1739
- Property Value Mapping dialog box (Export) 1728
- providers
 - capabilities in maps 305
- pseudo nodes 808
 - dissolving 808
- Publish to Autodesk MapGuide dialog box 1577
- Publish to MapGuide Results dialog box 1379
- Publish To MapGuide Results dialog box 1578
- publishing
 - attribute data 1367
 - map books to DWF format 1401

- map books to plotters 1402
- maps 1360
- maps as web pages 1374
- maps to plotters 1364
- metadata 1515
- options for DWF 1367
- overview for maps 1357
- to MapGuide 1378
- purchasing data 62

Q

- QSELECT command 1220
- quantile distribution 1165
- queries 83, 369, 756, 894, 1053
 - adding drawing objects to maps with 369
 - adding hatch to retrieved drawing objects 1283
 - adding text to retrieved objects 1278
 - altering properties of retrieved objects 1261, 1263, 1265, 1267, 1270
 - and numeric ranges 1242
 - and raster images 1296
 - and topology 894
 - block attribute conditions 1248
 - boundary for 1241
 - categories 182
 - combining conditions 1256
 - database 1053
 - default directory 229
 - defining for drawing data 1237
 - Draw mode 1287–1288, 1291
 - drawings with xrefs 1296
 - editing after saving 184
 - editing conditions 1258
 - executing 1287
 - external 177, 180
 - for attached databases 206
 - for features 1207
 - improving performance 150, 1292, 1294, 1296
 - indexes for 1294
 - issues with groups 1300

- issues with hatch 1300
 - joining conditions 1258
 - library 174, 178
 - link data conditions 1248
 - loading 184
 - location and buffer (video) 1302, 1306
 - location conditions 1241
 - model space 1235
 - modes 1288
 - modifying property alterations 1286
 - object data conditions 1248
 - operators 1256
 - options 245
 - overview 1235
 - paper space 1235
 - precedence of conditions 1256
 - Preview mode 1287–1288, 1290
 - previewing 1290
 - privileges for 83
 - problem solving 1300
 - property conditions 1244
 - Report mode 1287–1288, 1477, 1479
 - rerunning 178
 - running 1477
 - saving 177
 - saving objects back to source
 - drawings 754, 756
 - selecting feature data with 1130
 - SQL conditions 1249, 1253
 - storing 174
 - topology 1353
 - using expressions 1541
 - using wild-card characters 1537
 - video 1235, 1238, 1245, 1249
 - with blocks of same name 1296
 - writing results to file 1477
 - xrefs 1300
 - query library
 - adding external queries 180
 - categories 182
 - overview 174
 - running stored queries 178
 - saving queries 177
 - Query Library Administration dialog box
 - (drawing queries) 1858
 - querying
 - drawings (video) 24
 - features (video) 24
 - querying features
 - video 305
 - Quick Select 1219
 - for drawing objects 1219–1220
 - Quick View 746
 - redrawing the screen 746
 - Quick View Drawings dialog box 2013
 - Quickbird images
 - adding to maps 437
- ## R
- RADIUS variable 1546
 - ramps
 - for drawing layer themes 1183
 - Range of Values dialog box (for theming) 1629
 - range table 1272
 - creating 1272
 - ranges
 - finding drawing objects using 1244
 - for object classes 125
 - for schema property values 599
 - for themes (video) 1163
 - Raster Design 451
 - and image location 451
 - inserting images with Raster Extension 455
 - Raster Extension 454
 - correlation defaults 257
 - correlation source 251
 - detaching images 255
 - display quality 254
 - frame options 253
 - inserting images with 455
 - memory use 259
 - options 249
 - resource file directory 251
 - selection methods 256
 - Raster Extension Options dialog box
 - (Insert Image command) 1879

- raster images 291, 437, 440–442, 449–451, 453–455, 465, 468, 471, 473–475, 478–479, 481–482, 485–490, 493–494, 496, 498–499, 501, 503–504
- 2D 444
- adding contour lines 1190
- adding to maps 437
- adding with Data Connect 440, 442
- adjusting brightness 673
- adjusting contrast 673
- analyzing 1188
- and maps 291
- and REGEN 459
- and transparency 449
- changing transparency 450
- displaying extents 674
- displaying in color or greyscale 674
- exporting drawing objects to 1465
- formats not supported by Data Connect 453–455, 459, 462, 465, 467–468, 471, 473, 475, 478–479, 481–482, 485–490, 493–494, 496, 498–499, 501, 503–504
- formats supported by Data Connect 443, 445
- information for 474
- inserting from the command line 471
- inserting manually 451
- metadata for 1486
- resampling 674
- setting insertion point 451
- setting single-color transparency 673
- styles for 672
- viewing information 474
- web-based 445
- Raster Object Enabler 453
- raster surface 1009
- raster-based surfaces 437, 440–442
 - adding to maps 437
 - adding with Data Connect 440, 442
- Rebuild Sheet Set 1381
- records
 - viewing for drawing objects 1144
- records (database records) 426, 434–435, 523, 529, 532, 534, 537, 1056, 1064, 1067, 1069, 1083, 1085
 - adding in Data View 1056
 - altering drawing objects based on 1270
 - attaching multiple to drawing objects 1066
 - attaching to drawing objects automatically 1067
 - attaching while digitizing 138, 1083, 1085
 - copying 1056
 - deleting in Data View 1056
 - displaying as text 435
 - editing in Data View 1056
 - editing in object data 1069
 - editing links 537
 - exporting with objects 1405
 - filtering 1231
 - filtering by location 1234
 - finding drawing objects by 1248
 - finding in Data View 1222, 1225
 - importing 426, 434
 - linking automatically to drawing objects 532
 - linking to drawing objects 523, 529, 1064
 - linking to drawing objects in maps 534
 - object data 201
 - printing 1475
 - SQL conditions 1253
- records (metadata) 1507
- redrawing the screen 746
 - after Quick View 746
- REFEDIT command 1537
 - commands blocked during 1537
- reference systems
 - adding 1362
 - Military Grid Reference System (MGRS) 1362
- registering maps 136

- relational database tables 342
 - and feature classes 342
 - setting up users for AutoCAD Map 3D 584
- relational databases
 - setting up users for AutoCAD Map 3D 585
- releasing locks for drawing objects 736
- Remove Connection activity
 - for workflows 2043
- Remove Feature Layer activity
 - for workflows 2044
- Remove Group activity
 - for workflows 2044–2045
- Remove Highlighting activity
 - for workflows 2038
- Remove Object Data Index dialog box 1933
- removing
 - coordinate system assignment 150
- Rename Category dialog box (drawing queries) 1860
- Rename Range Table dialog box (drawing queries) 1860
- Rename Table dialog box 1797
- Rename Topology dialog box 1988
- renaming 899, 925
 - map books 1402
 - object data fields 202
 - object data tables 202
 - topology 899, 925
- Report mode queries 1287–1288, 1477, 1479
- reports
 - creating during a query 1477, 1479
 - for attribute data 1473
 - template for 1479
 - topology 1353
- residual calibration 133
- resistance 850, 860, 863, 875
 - and network topology 850
 - editing for topology 860, 863
 - for links and nodes in topology 875
 - using in best route analysis 1330
 - using in flood trace analysis 1334
 - using in path trace analysis 1326
- resource file directory
 - Raster Extension 251
- resources
 - copying metadata 1504
- reusing
 - expressions in queries 1541
 - layers from Display Manager 1470
- revision numbers 698
 - and automatic update 698
- RGB color system
 - importing objects using 269
- rights 83
- RLC 1 and 2 images
 - adding to maps 437
- RLC images
 - inserting with Raster Extension 455
- RLE images
 - inserting with Raster Extension 455
- RMS error 133
- roads 831, 847, 873, 875
 - changing direction in topology 873
 - changing resistance in topology 875
 - creating network topology 831
 - specifying direction 847
 - tracing in topology 1334
- rotating 931
 - drawing objects in maps 931
 - drawings 169
- rotation
 - altering with queries 1261
 - using to specify image location 451
- ROTATION variable 1546
- routes
 - finding best 1330
 - finding shortest 1326
 - flood trace 1334
- RST images
 - inserting with Raster Extensions 455
- rubber sheeting 932, 934
 - maps 934
 - video 927, 932
- Run AutoCAD Command activity
 - for workflows 2046
- Run Library Query dialog box (drawing queries) 1861

- Run Workflow activity
 - for workflows 2047
- running
 - workflows 278

S

- sample data
 - downloading 63
 - for AutoCAD Map 3D 62
 - on product CDs 63
 - symbol libraries 70
- SANGLE variable 1546
- satellite imagery
 - purchasing 72
 - samples 63
- save back 761, 764
 - improving performance 1296
 - options 764
 - problem-solving 761
- save back extents 170, 756
 - resetting 170
 - using to save drawing objects 756
 - viewing 170
- Save Current Query dialog box (drawing queries) 1862
- Save Features dialog box 1608
- Save Layer File activity
 - for workflows 2048
- Save Objects to Source Drawings dialog box 1887
- save sets 730, 750–752, 754, 756, 759, 761, 764
 - adding drawing objects
 - automatically 764
 - adding objects to 751
 - for maps 750
 - object locking 730
 - options 764
 - problem-solving 761
 - removing drawing objects from 759
 - saving queried objects to source drawings 754, 756
 - turning off prompt 764
 - viewing objects in 752
- Save Version dialog box 1750

- saving 738, 751, 754, 756–758, 761, 917
 - drawing objects 738
 - drawing objects as raster images 1465
 - drawing objects to new drawing 758
 - drawing objects to source drawings 754, 756
 - drawings 738
 - drawings and exploding blocks 761
 - feature styles 652
 - layers as SDF (video) 1469
 - layers from Display Manager 1470
 - new drawing objects to drawings 751
 - objects to the current map 757
 - options for drawings 764
 - problem-solving 761
 - queries 177
 - schemas 608
 - topology 917, 1354
 - vs. exporting as SDF 1469
- scale 451
 - setting for map 638
 - specifying for raster images 451
- scale bars
 - samples 62, 71
- scale factors
 - altering with queries 1261
 - for drawing objects 931
 - for source drawings 169
 - for text 225
- scale ranges
 - defining for layers in Display Manager 644
 - understanding 643
 - video 640, 643
- scale reduction factor 91
- scale thresholds (Display Manager)
 - creating 668
 - modifying 668
 - viewing all styles 670
- scaling 931
 - drawing objects in maps 931
 - drawings 169
- Schema Editor 608
 - abstract classes (inheritance) 612

- and OSGeo FDO Provider for SQL Server Spatial 610
- backing up schemas 608
- base classes 612
- constraints 612
- creating schemas 598
- deleting schemas 614
- editing schemas 612
- enabling long transactions 612
- exporting schemas 608
- identifier properties (primary key) 612
- importing schemas 608
- overview 596
- physical configuration 612
- undoing schema changes 615
- versioning 612
- viewing schemas 609
- Schema Editor dialog box 1739
- schemas 608
 - and Bulk Copy 1744
 - appending feature classes (video) 610
 - appending feature classes to (video) 594
 - ArcSDE 579
 - backing up 608
 - constrained properties (video) 594
 - constraints 601
 - constraints (video) 599
 - copying foreign 621
 - creating 598
 - defintiion 551
 - deleting 614
 - deleting properties (video) 594, 610
 - editing 612
 - exporting with Schema Editor 608
 - importing 381
 - importing (video) 582, 586, 594, 606
 - importing with Schema Editor 608
 - MySQL 567
 - ODBC 576
 - Oracle 554
 - overview 551, 554
 - overview of procedures 595
 - Schema Editor 596
 - SDF 569
 - SHP 572
 - SQL Server 559
 - SQL Server Spatial 561
 - SQLite 565
 - undoing changes to 615
 - using native views 603
 - viewing 609
 - WFS (Web Feature Service) 581
- screen pointing area
 - for digitizing 132
- SDF 44, 388
 - creating files (video) 43
 - exporting layers to (video) 1376
 - viewing contents (video) 1453
- SDF 1 or 2 files
 - importing 389
- SDF 2 files
 - exporting 1417–1418
- SDF data stores 586
- SDF files
 - creating 588
 - creating (video) 582, 586, 594
 - exporting from DWG and back 1467
 - exporting to 1413
 - exporting vs. saving 1469
 - importing 387
 - moving DWG data to 629
 - provider capabilities for maps 337
 - saving Display Manager layers as 1470
 - schemas 569
 - working with data 571
- SDTS (Spatial Data Transfer Standard) 381, 413–414
 - importing 381, 414
 - overview 413
- Search To Select 1131
- searching
 - DataTable 1131
 - for features 1214
- seed file
 - default for exporting DGN files 269
 - for DGN files 1435

- Select Actions dialog box page 1588
- Select Alias dialog box 1933
- Select Coordinate System dialog box 1609
- Select Data dialog box 1811
- Select Data dialog box (drawing topology) 1989
- Select Database Version dialog box 1688
- Select Display Element dialog box 1631
- Select Drawings to Assign Coordinate System dialog box 1599
- Select Drawings to Attach dialog box 1811
- Select Existing Link Template dialog box 1689
- Select Feature Classes dialog box (Display Manager) 1631
- Select Features activity
 - for workflows 2049
- Select Images dialog box (Display Manager) 1631
- Select Layers dialog box (Display Manager) 1631
- Select Link Template dialog box 1690
- Select Link Template Key dialog box 1797
- Select Link Templates dialog box 1690
- Select Objects dialog box page 1595
- Select Plot Set to Convert dialog box 1831
- Select Query dialog box 1691
- Select Table dialog box 1691
- Select Topologies dialog box (Display Manager) 1631
- selecting 694, 770, 993
 - checked out features 694
 - classified objects 993
 - drawing objects 1219–1220
 - features 1207
 - objects for Drawing Cleanup 770
 - records in databases 1225
- selecting features
 - using buffers (video) 1302
- Sequence activities
 - for workflows 2025
- server CS code
 - for Web Map Service (WMS) 447
- Set Property Alterations dialog box (drawing queries) 1863
- SETELEMENTS command 1829
- setup 77
 - overview 77
- Seven Parameter Transformation
 - conversion method 94
- Shape Multiclass 1443–1444
 - exporting 1405, 1444
 - exporting to 1443
- ShapeFile 335–336, 381, 1424
 - adding feature data to maps 336
 - converting to drawing objects 335
 - exporting as folder 269
 - exporting multiclass 1444
 - exporting to 1424
 - folder option 1424
 - importing 381, 397
 - importing as folder 269
 - importing vs. adding to maps 335
 - provider capabilities for maps 335
- SHAPENAME variable 1546
- sheet sets
 - and map books 1381
- short linear objects 773, 779, 796
 - erasing 796
 - marking for cleanup 779
 - tolerance for deleting 773
- shortest path analysis
 - video 1319, 1324
- shortest path trace 1326
- Show Foreign Data Stores 314, 324, 333
- SHP data stores 586
- SHP files 335–336, 397, 1424
 - adding feature data to maps 336
 - and Bulk Copy 617
 - creating 588
 - exporting data from Civil 3D 545
 - exporting multiclass 1444
 - exporting to 1424
 - importing 381, 397, 399
 - importing vs. adding 335
 - multiclass 1443
 - provider capabilities for maps 335

- schemas 572
 - working with data 574
- SID images
 - inserting with Raster Extension 455
- SIF files
 - exporting 1417
- SIZE variable 1546
- SL King Provider 540
- sliver polygons 839, 841, 843
 - finding when creating topology 843
 - finding when overlaying
 - topologies 843
 - removing 839
- slope 1162
 - and theming 1202
 - displaying 1162
 - theming surfaces for 1203
- snapping nodes 806
- soil drawings
 - samples 63
- solid fill 939
 - adding to closed polylines 939
- Sort dialog box (records) 1692
- Source Data dialog box 1897
- Source Drawing Scope dialog box 1633
- source drawings 730, 738, 745–746, 748, 754, 756, 764, 852, 917, 951
 - activating 160
 - aligning 169
 - assigning coordinate system 146
 - attaching to the current
 - drawing 158
 - backup files 764
 - descriptions 166
 - drive aliases for 161
 - editing in AutoCAD Map 3D 748
 - editing topology 852
 - global coordinate systems 146
 - indexing 1294
 - locking 730
 - matching edges 951
 - offset for 169
 - opening 163
 - previewing objects in 746
 - querying 1237
 - Quick View 746
 - retrieving objects from 1237
 - rotating 169
 - save back extents 170, 756
 - saving objects to 738
 - saving queried objects to 754, 756
 - saving topology to 917
 - scaling 169
 - settings 164
 - symbol table information 172
 - tiled 154, 756
 - transforming 169
 - viewing coordinate systems 151
 - viewing information 172
 - zooming to extents 745
- source files
 - for maps 3
- spatial analysis
 - video 1319
- spatial contexts
 - editing 311
 - selecting coordinate systems for 590
- spatial data
 - metadata for 1486
- Spatial Data File 44, 388
- Spatial Data Organization Editor 1764
- Spatial Data Transfer Standard files 381
 - importing 381, 414
 - overview 413
- spatial databases
 - overview 551
- spatial filters 418
 - during import 418
- spatial filters (Data View) 1234
- spatial indexes
 - and Bulk Copy 625–626
- speed 875
 - for links and nodes in
 - topology 850, 875
- Split and Merge Rules dialog box 1669
- split prompts
 - setting options 709
- split rules
 - ignoring 708
- splitting
 - features (video) 706
 - polygon features 708

- SPOT images
 - inserting with Raster Extension 455
- SQL Condition History dialog box
 - (drawing queries) 1866
- SQL conditions 364
 - dates 1253
 - editing 1258
 - for drawing queries 1249
 - maximum number in history
 - list 225
 - operators 1253
 - quotation marks 1253
 - selecting drawing objects for maps
 - by 364
 - strings 1253
 - troubleshooting 1253
- SQL Expression dialog box (link
 - templates) 1814
- SQL Link Condition dialog box (drawing
 - queries) 1866
- SQL links index 1294
- SQL queries
 - for drawing data in Data View 1231
 - for drawing objects 1230
- SQL Server 323–324
 - adding feature data to maps 324
 - and long transactions 323
 - provider capabilities for maps 323
 - schemas 559
 - working with data 561, 564, 566
- SQL Server Spatial 326
 - and Bulk Copy 617
 - authentication options 326
 - creating data stores 561, 592
 - geography type for geodetic
 - coordinate system 326
 - invalid geometry 326
 - provider capabilities for maps 326
 - schemas 561
- SQL variables 1549
- SQLite 330
 - adding feature data to maps 331
 - creating data stores 565
 - exporting to 1405
 - importing 381, 415
 - provider capabilities for maps 330
 - schemas 565
- SQLite data stores 586
- SQLite files
 - creating 588
 - exporting to 1447
 - importing 414
- SRID numbers
 - and EPSG numbers 590
- standard deviation 1165
 - and digitizing 133
- Standard Order Process Editor 1774
- state plane coordinate systems 143
- statistics 474, 916
 - for raster images 474
 - for source drawings 172
 - for topology 916
 - printing using report queries 1477, 1479
 - viewing for raster images 474
- street centerline data
 - samples 63
- stretching drawings 934
- STRING variable 1546
- string-handling functions 1543
- Style Band dialog box 1633
- Style Label dialog box 1634
- Style Library 665–666
- Style Line dialog box 1636
- Style Point dialog box 1637
- Style Polygon dialog box 1639
- Style Text Layer dialog box 1640
- STYLE variable 1546
- styles 300
 - and map layers 300
 - and symbols 660
 - combining 662
 - composite styles for drawing
 - layers 662
 - composite styles for lines 649
 - for areas 650
 - for contour lines 1191
 - for display elements 665
 - for drawing layers 657, 660, 662
 - for drawing objects 652, 654
 - for features 641
 - for lines 649

- for maps 631
 - for points 646
 - modifying for drawing layers 663
 - referencing 666
 - saving in library 665
- stylesheets
 - for metadata 1489
- styling
 - and scale ranges (video) 643, 648
 - drawing objects on import 385
 - features (video) 3, 7, 34
 - using themes (video) 1163
- Superuser 83, 142, 202, 227, 730, 733, 736
 - default password 142
 - forcing user login 227
 - logging in as 142
 - modifying object data tables 202
 - options 227
 - releasing locks 736
 - setting up privileges 83
 - turning on object locking 730, 733
- surface
 - connecting to raster surfaces through Data Connect 1021
 - create surface from data connection 1010
 - create surface from file 1009
 - create surface from point data 1009, 1011
 - creating surfaces from point cloud data 1021
 - ESRI ASC 1021
 - GeoTIFF 1021
 - raster surface 1009
 - viewing surfaces 1021
- surfaces 437, 440–442
 - 3D (video) 1187, 1192, 1194
 - adding contour lines 1190
 - adding to maps 437
 - adding with Data Connect 440, 442
 - analyzing 1188
 - and contour lines 1189
 - applying hillshading 1200
 - applying vertical exaggeration 1200
 - changing theme colors 1205
 - coloring by elevation (video) 37, 1187, 1199, 1204
 - coloring surfaces based on elevation (video) 1204
 - draping 2D data on 1193
 - draping layers on (video) 1192
 - draping layers on (video) slope analysis
 - video 1187
 - fly through 1196
 - hillshading (video) 1199
 - motion path animation 1196
 - orbiting 1196
 - panning 1196
 - slope analysis (video) 1202
 - swiveling 1196
 - theming to display height, slope, or aspect 1203
 - vertical exaggeration (video) 1199
 - video 1187
 - viewing in 3D 1196
 - walk through 1196
 - zooming in 3D 1196
- survey 371, 373, 998, 1000–1008, 1471
 - adding a point group 1003
 - point groups 1003–1005
 - project 1001–1003
 - adding a point group 1001
 - removing a project from a survey data store 1002
 - removing a survey 1003
 - renaming 1002
 - removing a survey from a project 1003
 - renaming 1003
 - survey data store 1000
 - connecting to 1000
 - creating 1000
 - editing 612
 - viewing active data store only 1000
 - working with survey data 998
- survey data store
 - importing ASCII point data 373
 - importing LandXML data 371

- survey points 342, 1003–1008
 - and ODBC 342
 - assigning survey points to point groups 1006
 - creating geospatial features from survey points 1008
 - creating survey points 1006
 - creating survey points using coordinate geometry 1006
 - deleting survey points 1007
 - exporting to a LandXML file 1471
 - importing ASCII point data 373
 - importing LandXML data 371
 - point groups 1003–1005
 - removing survey points from a point group 1007
 - viewing survey point data in the points table 1008
 - viewing survey points 1008
- WIDTH variable 1546
- Switch Map activity
 - for workflows 2050
- swiveling surfaces in 3D 1196
- symbol libraries
 - samples 69
- symbol tables
 - viewing for source drawings 172
- symbol-handling functions 1544
- symbols 62
 - adding to point layers 646
 - combining styles 662
 - for drawing layers 660
 - for point features (video) 640, 645
 - general use 70
 - samples 69
- symmetric difference overlay 1309
- system-generated properties
 - in Schema Editor 1739

T

- TAB files 381, 402, 404
 - exporting 1405
 - exporting to 1433
 - importing 381, 402, 404
 - importing as folder 269

- Table Filter dialog box 1693
- Table Filter History dialog box 1696
- Table Properties dialog box 1696
- tables (database tables) 209, 215, 523, 526–527, 529, 532, 534, 537, 539, 1048, 1053, 1056, 1085
 - adding records in Data View 1056
 - and Data View 1048
 - attaching to drawings 209
 - connecting 215
 - converting from object data 534
 - deleting link templates 539
 - deleting links 537
 - deleting records in Data View 1056
 - detaching from drawings 209
 - disconnecting 215
 - editing database path 539
 - editing in Data View 1056
 - editing links 537
 - filtering records 1231
 - filtering records by location 1234
 - finding records 1222
 - key columns 526
 - link templates 526
 - linked 527
 - linking records to drawing objects 529
 - linking to drawing objects in maps 523, 532
 - linking to while digitizing 1085
 - navigating in Data View 1048
 - opening 527
 - opening in Data View 1053
 - options 238
 - printing 1475
 - querying 1053
 - saving changes in Data View 1056
 - searching 1225
 - SQL conditions 1253
 - UDL (Universal Data Link) file
 - for 209, 213
 - viewing for drawing objects 1048
- tables (object data) 202, 435, 534, 827, 831, 836, 914, 1064, 1066–1067, 1069, 1083
 - adding fields 202

- attaching multiple records to drawing objects 1066
- attaching records to drawing objects 1064
- attaching to drawing objects automatically 1067
- converting to database tables 534
- creating 201
- creating while digitizing 1083
- deleting 202
- displaying as text 435
- editing 202, 1069
- exporting 1405
- for network topology 831
- for node topology 827
- for polygon topology 836
- importing 426, 434
- modifying fields 202
- renaming 202
- viewing for topology 914
- tablet for digitizing 130, 132
- TABLET mode 1080
 - and digitizing 1080
- TAG variable 1546
- Tagged Image File Format images 444
 - adding with Data Connect 440, 443–444
- TARGA images
 - inserting with Raster Extension 455
- Task Pane
 - data source options 236
 - Display Manager tab 634–635, 654
 - hiding 221, 1908
 - making transparent 221
 - options 221
 - refreshing 221
 - showing 1908
- templates 62
 - and annotation 1105, 1107–1108
 - applying for metadata 1492
 - creating for metadata 1492
 - deactivating for metadata 1495
 - exporting from metadata 1496
 - for map books 66, 1386
 - for metadata 1484–1485, 1490
 - for query reports 1479
 - for styling drawing objects 385
 - importing for metadata 1492
 - installed location for 66
 - previewing for metadata 1494
 - removing from metadata 1497
 - renaming for metadata 1493
 - samples 66
 - setting default for metadata 1494
- text 428, 435, 532, 937
 - adding for drawing layers 1176
 - adding to annotation layers 1114
 - adding to queried objects 1278
 - adjusting for map distortion 225
 - altering drawing objects based on 1265
 - altering with queries 1261
 - attaching to objects in maps 937
 - displaying data as 435
 - exporting as points 1405
 - exporting when enclosed in a polyline 1455
 - finding drawing objects by 1244
 - for drawing layers 660
 - height for drawing layer themes 1176
 - importing points as 428
 - insertion point 937
 - label point 937
 - linking to external data for maps 532
 - options 225
 - specifying type for tables 201
 - units 225
- text layers
 - creating 1110
- text layers (video) 1109, 1111, 1113, 1115
- text styles 764
 - altering drawing objects based on 1265
 - altering with queries 1261
 - finding drawing objects by 1244
 - for drawing layer themes 1185
 - redefining on save back 764
 - when importing points into maps 428

- texture maps 1192
- TGA images
 - inserting with Raster Extension 455
- Thematic Mapping dialog box 1642
- thematic maps
 - legend 1117
- Thematic Values dialog box 1644
- Theme dialog box (features) 1645
- themes
 - based on height, slope, or aspect 1202
 - by layer type 1163
 - changing colors for 1205
 - creating for drawing layers 1176, 1181
 - creating for feature layers 1168
 - distribution methods 1165
 - for drawing data 1178
 - methods to use 1165
 - ranges for (video) 1165
 - transparency 1172, 1174–1175
 - using for analysis 1163
 - video 1163, 1165, 1171
- theming
 - features (video) 7, 37
- thickness
 - altering drawing objects based on 1265
 - altering with queries 1261
 - finding drawing objects by 1244
- THICKNESS variable 1546
- third party providers 540–541
 - adding 541
- thumbnail 302
 - changing for map layers 302
- TIFF images
 - adding with Data Connect 440, 443–444
- Tile Properties dialog box 1831
- tiled drawings 756, 951
 - matching edges 951
 - saving back to 756
- tiles
 - deleting from map books 1403
 - renaming for map books 1402
- viewing and editing in map books 1397
- viewing in map books 1399
- Time Period Information Editor 1761
- tolerance for Drawing Cleanup 773
- topographic map 1189
- topology 367, 430, 788, 806, 808, 810, 814–815, 822, 825–827, 829, 831, 833, 836, 838, 840–841, 847, 850, 852, 860, 863, 867, 870, 873, 875, 878, 880, 884, 887, 889, 892, 894, 899, 907, 911, 913–914, 916–917, 920, 922, 925–926, 974, 1073
 - adding drawing objects to maps by 367
 - adding linear objects 880
 - adding links 852
 - adding nodes 852, 878
 - adding polygons 852, 884
 - analysis settings 922
 - analyzing (video) 1319
 - and clip operations 1336
 - and Drawing Cleanup 788, 838
 - and erase operations 1336
 - and identity 1336
 - and paste operations 1336
 - and union operations 1336
 - auditing 920
 - best route 1330
 - buffering 1347
 - changing appearance of nodes 870
 - changing link direction 873
 - changing resistance 875
 - clustered nodes 806
 - combining 1339
 - completing 920
 - converting to polygons 974
 - correcting 920
 - creating 825, 827, 831, 836
 - creating centroids for polygons 430, 836, 887
 - dangling objects 810
 - deleting 899, 926
 - deleting objects 852
 - digitizing objects for 1073

- dissolving 1343
- dividing polygons 867
- editing 852, 860, 873
- editing partial 894
- editing polygons 867
- errors 920
- exporting 1458
- flood trace 1334
- highlighting objects 911
- islands 920
- land cover map 840
- land use map 840
- left-right relationships 836
- links 831
- loading 899, 907
- managing 899
- merging polygons 867
- network topology 829, 831
- node topology 827
- object data for 913
- object data stored for best route 1328
- overlay analysis (video) 1336
- overlying 1339
- overview 822
- polygon topology 836
- profiles for 922
- pseudo nodes 808
- querying 894, 1353
- removing objects 889
- renaming 899, 925
- repositioning nodes 863
- result 1354
- saving 1354
- saving to source drawings 917
- shortest path trace 1326
- simplifying lines 814
- sliver polygons 841
- specifying link direction 847, 850
- splitting polygons 867
- temporary 1354
- testing integrity 920
- unloading 907
- updating manually 892
- video 822, 899, 906
- viewing object data 914
- viewing statistics for 916
- weeding nodes 814
- zero-length objects 815
- Topology Buffer Create New Centroids and Nodes dialog box 1990
- Topology Buffer New Topology dialog box 1991
- Topology Buffer Set Buffer Distance dialog box 1992
- Topology Dissolve Create New Centroids and Nodes dialog box 1994
- Topology Dissolve Create Nodes dialog box 1995
- Topology Dissolve New Topology dialog box 1996
- Topology Dissolve Object Data dialog box 1997
- Topology Dissolve Set Parameter dialog box 1998
- Topology Overlay Analysis Analysis Type dialog box 1999
- Topology Overlay Analysis Create New Centroids and Nodes dialog box 2002
- Topology Overlay Analysis Create Nodes dialog box 2003
- Topology Overlay Analysis Output Attributes dialog box 2006
- Topology Overlay Analysis OutputTopology dialog box 2004
- Topology Overlay Analysis Select Overlay Topology dialog box 2007
- Topology Query dialog box 2008
- Topology Query Result dialog box 2010
- Topology Selection dialog box 2011
- Topology Statistics dialog box 2011
- TOPONAME variable 1546
- TOPOTYPE variable 1546
- trace analysis
 - best route 1330
 - flood trace 1334
 - shortest path 1326
- tracking coordinates 1148–1150
 - setting coordinate tracker options 232

- using coordinate system for attached drawing 1150
- transactions
 - long (versioning) 612
- transforming 931
 - coordinates 225, 231
 - drawing objects in maps 931
 - entire source drawing 169
- transparency
 - and styles 650
 - and themes 1172, 1174–1175
 - for polygon features (video) 1171
 - for raster images 449
 - for Task Pane 221
 - in themes 1171
 - video 640
- Transparency Color dialog box (Insert Image command) 1883
- transparent commands 1027–1028
 - using 1028
- Transverse Mercator projection 143
- Trim Objects at Boundary dialog box 1672
- trimming objects 945
- troubleshooting
 - broken connections in Display Manager 350
 - buffers 1308
 - Bulk Copy 625–626
 - data stores from previous versions of AutoCAD Map 3D 325
 - drawing queries 1296, 1300
 - error messages when editing schemas 610
 - invalid data for SQL Server Spatial 326
 - SQL conditions 1249, 1253
- True Colors
 - importing objects using 269
- TrueVision images
 - inserting with Raster Extension 455
- tutorials
 - AutoCAD Map 3D 58
- Type SQL Condition dialog box (drawing queries) 1870
- TYPE variable 1546

U

- UDL (Universal Data Link) file
 - editing 213
 - overview 209
- UNCLASSIFY command 990
- Undefined Alias Referenced dialog box 1934
- undershoots 773, 779, 801
 - extending 801
 - marking for cleanup 779
 - tolerance for extending 773
- undoing
 - feature class changes in schemas 615
 - property changes in schemas 615
 - schema changes in feature sources 615
- union overlay 1309
- uniqueness
 - for schema property values 599
- United States grid data files 105
- units
 - default 225
- units of measurement
 - converting for text 225
 - default for exporting DGN files 269
- Universal Transverse Mercator System 143
- unloading topology 907
- unlocking drawing objects 736, 759
- unmatched data or geometric type errors
 - ignoring in Bulk Copy 1744
- Update Edits Automatically 722
 - changing default setting 88
 - enabling 700
 - turning off 722
- updating topology 892
- URL variable 1546
- URLs 389
 - exporting to SDF 2 files 1417
 - importing from SDF 1 or 2 files 389
- Use FDO Enabled Schema 561
- User Administration dialog box 1934
- User Coordinate System (UCS) 1154

- User Credentials dialog box 1610
- User Information dialog box 1936
- user interface in AutoCAD Map 3D 85
- User Login dialog box 1937
- users 83
 - database and AutoCAD Map 3D 585
 - rights 83
 - valid usernames 83

V

- validation
 - and SQL Server Spatial 326
- variables 937, 1541, 1546
 - AutoLISP 1551
 - block attributes 1549
 - dot variables 1546
 - LABELPT 937
 - object class properties 1551
 - object data 1549
 - SQL 1549
- vector data 1193
 - draping on 3D surfaces 1193
 - purchasing 72
- Vector Markup Language (VML) files
 - exporting 1405
 - exporting to 1449
- Vector Product Format (VPF)
 - importing as folder 269
- Vector Product Format (VPF) files
 - importing 381, 416–417
- version-enabling
 - Oracle 557
- versioning 305, 723, 725
 - and Bulk Copy 1744
 - for feature data 725
 - for feature sources in maps 305
 - long transactions 612
- versions 725
 - activating for feature data 725
 - creating for feature data 725
 - discarding for feature data 725
- vertical exaggeration
 - video 1187, 1199
- videos
 - adding AutoCAD layers to Display Manager 352, 634
 - adding multiple images to a single layer 437
 - analyzing topologies 1319
 - appending feature classes to a schema 594
 - appending feature classes to schemas 610
 - appending features to a feature class 31
 - appending features to feature classes 43
 - automatic checkout 713
 - bringing in a subset of data 305
 - bringing in data from Civil 3D 9, 43, 543
 - bringing in data from ODBC 305, 342
 - bringing in data from web servers 305, 346, 437, 445
 - bringing in drawing objects 9
 - bringing in features 9
 - buffers 37, 1302
 - Bulk Copy 43, 616–617
 - calculated fields 1125, 1132
 - checking in features 693, 721
 - checking out features 695, 701, 721
 - coloring surfaces by elevation 37, 1187, 1199, 1204
 - complete list of 51
 - connecting to data 13
 - connecting to data sources 3, 9
 - connecting to feature sources 305
 - constrained properties 599
 - constraining fields in a schema 43
 - constraints 594
 - contour layers 1187
 - contour lines 1189
 - converting a map to DWG format 628
 - coordinate system 143
 - coordinate systems 11
 - coordinate transformation 143

- copying data between data stores 616–617
- creating data stores 582, 586, 594
- creating features 684, 686, 691
- creating features from AutoCAD objects 19
- creating SDF files 43
- Data Table 1125, 1130, 1136, 1138, 1140–1141
- deleting properties from schemas 594, 610
- Display Manager 634, 636
- draping layers on surfaces 1187, 1192
- draw order 634, 636
- drawing cleanup 727, 766
- editing features 684, 701, 721
- editing features in a database 19
- exporting current map to DWG 1405
- exporting DWG data to GIS 628
- exporting DWG to SDF 1405
- exporting feature data 1141
- exporting layers to SDF 1376, 1405, 1469
- exporting styled DWG data 628
- exporting styled DWG objects 1453
- exporting the current map to DWG 1459
- georeferencing 932
- highlighting features 1136, 1138
- how exported maps look in DWG 1459
- importing schemas 43, 582, 586, 594, 606
- inserting images 437, 459
- joining attributes to features 37
- joins 507, 509, 514
- labeling features 185–186, 190, 194, 640, 645, 648, 1089, 1091, 1096, 1098
- layers and scale ranges 640
- legends 185–186, 190, 194, 1089, 1117
- making features transparent 640
- managing layers 634, 636
- map books 46, 1360, 1381
- MapGuide 46, 1360, 1376
- metadata 30, 1481, 1486, 1498
- multi-user editing for drawing files 727, 730, 734, 738
- multi-user editing of drawings 19
- network topology 727, 822, 829
- overlay analysis using drawing topologies 1336
- overlay analysis using feature classes 1309
- overlay analysis using topologies 1319
- overlying two topologies 822, 829, 841
- publishing map books 1389
- publishing map books to DWF 46, 1360, 1366
- publishing map books with attributes to DWF 1381, 1389, 1400
- publishing to MapGuide 3
- queries 1235, 1238, 1242, 1245, 1249
- querying attached drawings 24
- querying attached DWG files 352, 358
- querying feature classes 24
- raster-based surfaces 1187
- replacing points with symbols 640, 645
- rubber sheeting 927, 932
- saving layers to .layer files 1405, 1469
- scale ranges 643, 648
- scale ranges for styles 640
- selecting features 1130
- shortest path analysis 822, 829, 1324
- slope analysis 1187, 1202
- splitting polygonal features 706
- styling and scale ranges 643, 648
- styling features 3, 7, 34
- surfaces 1187
- text layers 1109, 1111, 1113, 1115
- themes 1165, 1171
- theming data 1163

- theming features 7, 37
 - theming polygons 1171
 - topologies 1319
 - topology 822, 899, 906
 - using 3D view 1187, 1192, 1194
 - vertical exaggeration 1187, 1199
 - viewing attribute data for
 - features 27
 - viewing the contents of SDF files 1453
 - zooming to features 1140
 - View Query Statement dialog box 1610
 - viewing 474, 746, 914, 916, 1048
 - coordinate system assignment 151
 - database tables 1048
 - drawing objects in attached drawings
 - for maps 746
 - external data for drawing
 - objects 1048
 - in 3D 1196
 - map book properties 1399
 - map book tiles 1399
 - map books 1397–1398
 - metadata 1486
 - raster image information 474
 - save back extents 170
 - schemas 609
 - source drawing information 172
 - source drawings for maps 746
 - statistics for source drawings 172
 - topology data 914
 - topology statistics 916
 - using Quick View 746
 - views
 - database 603
 - viewscale expressions 1545
 - viewtwist expressions 1545
 - Visual FoxPro
 - attaching database to drawing 209
 - setting default version 243
 - VML (Vector Markup Language)
 - files 1449
 - exporting 1405
 - exporting to 1449
 - VPF (Vector Product Format)
 - importing as folder 269
 - VPF (Vector Product Format) files
 - importing 381, 416–417
- ## W
- walk through for surfaces 1196
 - water data
 - samples 63
 - water symbols
 - samples 69
 - watersheds 836
 - creating polygon topology for 836
 - weather data
 - purchasing 72
 - Web Feature Service (WFS) 346
 - adding feature data to maps 348
 - metadata for 1486
 - provider capabilities for maps 346
 - Web Map Service (WMS)
 - adding images to maps 447
 - specifying version 447
 - making background transparent 447
 - metadata for 1486
 - provider capabilities 445
 - specifying format 447
 - web pages
 - exporting to 1449
 - publishing maps as 1374
 - web-based raster images 445
 - weeding 814, 819
 - and bulge 816
 - and supplementing factors 816
 - defined 816
 - lines with Drawing Cleanup 814, 819
 - polylines 819
 - wells
 - creating topology for 827
 - WFS
 - video 346
 - WFS (Web Feature Service) 346
 - adding feature data to maps 348
 - metadata for 1486
 - provider capabilities for maps 346
 - schemas 581
 - working with data 582

- While activities
 - for workflows 2025
 - Who Has It Information dialog box 1889
 - widening conversion
 - and Bulk Copy 623
 - width
 - altering with queries 1261
 - digitizing 138
 - wild-card characters 1537
 - using in dialog boxes 1537
 - using in expressions 1553
 - windows
 - finding all objects in 1241
 - Windows authentication
 - and SQL Server Spatial 326
 - WKT
 - and coordinate systems 590
 - WMS
 - video 305, 437, 445
 - WMS (Web Map Service)
 - adding images to maps 437, 447
 - adding surfaces to maps 441
 - adding with Data Connect 440
 - metadata for 1486
 - provider capabilities 445
 - Workflow Designer
 - changing the display 289
 - Workflow Designer parameter dialog box 2022, 2025
 - Workflow Designer window 2022
 - workflows
 - activity dialog boxes 2025
 - activity parameters 281
 - Add Feature Layer activity 2028
 - Add Group activity 2029
 - Add Map activity 2030
 - binding parameters 281
 - Change Feature Layer Properties activity 2030
 - Change Feature Layer Symbol activity 2031
 - Change Group Properties activity 2033
 - Connect To Data Store activity 2034
 - Create Buffer Layer activity 2036
 - creating 281, 284, 287
 - Display Feature Attributes activity 2037
 - editing 284
 - for automating activities 275
 - Highlight Features activity 2038
 - List Current Connections activity 2039
 - List Feature Classes activity 2039
 - List Feature Layer Properties activity 2040
 - Load Layer File activity 2041
 - overview 275
 - parallel and sequenced activities 281
 - Perform Overlay activity 2041
 - Remove Connection activity 2043
 - Remove Feature Layer activity 2044
 - Remove Group activity 2044–2045
 - Remove Highlighting activity 2038
 - Run AutoCAD Command activity 2046
 - Run Workflow activity 2047
 - running 278
 - Save Layer File activity 2048
 - Select Features activity 2049
 - settings 289
 - Switch Map activity 2050
 - utility activities 2025
 - Workflow Designer 2022
 - Zoom To Extents activity 2050
 - working offline 696, 722
 - and checking out features 696
 - workspaces 84–85
 - creating for AutoCAD Map 3D 85
 - in AutoCAD Map 3D 84
 - World Coordinate System (WCS) 1154
- X**
- XLS files
 - attaching to drawing 209
 - setting default version 243
 - XMI files
 - importing as schemas 608
 - XML files 608
 - exporting schemas as 608

- for object class definitions 129
- importing as schemas 608
- xrefs 157
 - and drawings 157
 - querying 1300
- XSCALE variable 1546

Y

- YSCALE variable 1546

Z

- Z dimensions 562, 610

- zero-length objects 815
 - identifying and removing 815
- Zoom Drawing Extents dialog box 2014
- Zoom Scale dialog box 1697
- Zoom To Extents activity
 - for workflows 2050
- zooming 745
 - Display Manager 670
 - surfaces in 3D 1196
 - to drawing extents 745
 - to raster image extents 674
 - using Data Table 1141
- zooming to features
 - video 1140
- ZSCALE variable 1546

