

# OPERATING GUIDE

BECKER

<b>Contents</b>	<b>2</b>	Operating instructions	15	Adjusting the unit holder's position	26
24-month warranty	6	Registration	15	Attaching the Navigation device	26
<b>Warranty</b>	<b>6</b>	Repairs	15	Removing the Navigation device	26
<b>Safety instructions</b>	<b>7</b>	Emissions and disposal	15	Devices with magnetic holders	26
<b>The Navigation device</b>	<b>9</b>	<b>Overview of the scope of Delivery</b>	<b>16</b>	Switching the Navigation device on/ off (model dependent)	26
Operating manual contents	9	<b>Overview of the navigation device</b>	<b>17</b>	Switching on	27
Use of the product	9	<b>General operation</b>	<b>19</b>	Switching off (depending on model)	27
Navigation	9	Maintenance and care	19	Basic information about the touch screen	28
Images*	9	Battery quality declaration	20	Operation	28
Telephone (selected models)	10	Display quality declaration	20	Calibration	28
Unpacking the Navigation device	10	Start-up	20	Basic information about the menus	29
Checking the contents	10	Power supply	20	The main menu	29
Overview of functions	11	Using the battery	21	Entries made with the entry menu	30
Scope of delivery	13	Connection for the cigarette lighter	21	Entering characters	30
Complaints	13	Connection to the mains outlet	22	Accepting proposals	30
Handling the packaging	13	Connecting to power supply	22	Scrolling through the lists	31
Description of the device	13	TMC antenna (depending on the model)	22	Special characters and accent marks	31
The basic unit	14	GPS antenna	22	Other character sets	32
Cable for power supply from cigarette lighter	14	Unit antenna	22	Entering numbers	32
Battery	14	Cable for vehicle integration		Switching between upper and lower case:	32
USB connection cable	14	(depending on model, optional)	23	Deleting characters	33
Unit bracket	14	Cable for rear view camera		Inserting spaces	33
Accessories	14	(depending on the model, optional)	23	The back button	33
Mains power supply unit	14	Memory card	23	Content Manager	33
Cable for vehicle integration (for certain models only)	15	Inserting the memory card	24	Installing the Content Manager	34
Information about the documentation	15	Ejecting the memory card	24	Starting the Content Manager	34
Quick Start Guide	15	Unit bracket	24		
		Fitting the unit bracket	24		
		On the windscreen	25		

Transferring pictures	35	route guidance	45	Selecting Info box data fields	65
Faults	36	Entering address by speech (selected models)	50	3D city view	66
<b>Navigation Mode</b>	<b>37</b>	Speech Dialogue System (selected models)	51	The Route overview button	66
What is navigation?	37	Explanation of symbols	51	The Guidance info button	67
Selecting Navigation	38	Objective	51	The Route options button	68
Home address	38	Route	52	Selecting the vehicle profile (depending on model)	69
Smart Guess	39	More...	52	Truck and mobile home functions (depending on model)	70
Last destinations list	39	Live POI Search (model dependent)	52	Setting truck profiles	71
The destination list	39	Points of interest	52	Selecting vehicle category and name	72
Icons used	40	Point of interest in the vicinity	53	Selecting the route type	73
Operating the last destinations list	40	Point of interest near to an address	54	Time-dependent route guidance	73
Start with existing destination	40	Point of interest near to destination	55	Avoiding particular types of road	74
Scrolling through stored destinations	40	POI on route	55	The TMC button	74
Displaying or editing a destination	40	Entering a point of interest directly	55	The Traffic Button (model dependent)	75
Personal destinations	41	Calling special destination phone number (depending on the model)	56	The Voice guidance button	75
Contacts	41	Additional point of interest information	56	Setting the Voice	76
Selecting a destination from Personal destinations	41	Travel Guide (model dependent)	56	Setting the Volume	76
Editing Personal destinations	42	Selecting a destination from the map	57	The Warnings button	77
Selecting a destination from Contacts	42	Coordinate entry	58	Setting Driver alerts	78
The New destination menu	43	Route planning	58	Setting environmental zones (depending on model)	78
Layout of the New destination menu	44	Simulation of the route	60	Truck warnings (depending on model)	78
Enter address	44	Creating a new route	60	Setting Speed info	79
Select Point of Interest	44	Editing a route	61	The Blocked roads button	80
Travel Guide (model dependent)	44	Optimising a route	62	The Vehicle data button	81
Select on map	44	Navigation settings	62	The Format button	82
Enter geo-coordinates	44	The Map view button	63	The Time button	82
Route planning	44	Auto zoom	64	The Reset button	83
Entering the address	44	Select POI categories	65		
Selecting a country	45				
Selecting an address and starting					

Traffic announcements using TMC (depending on the model)	83	SituationScan	95	Calling up the telephone mode (only selected models)	107
Live Traffic - Traffic Announcements via Data		The detour assistant	95	Telephone menu (only selected models)	108
Connection (model dependent)	84	The Park Assistant	95	Dialing a number	108
Displaying TMC messages on the map	84	The departure assistant	96	Phonebook	109
Using TMC	85	Map display options	96	Call list	111
Reading a message	86	Displaying the whole route	97	Icons used	111
Taking announcements into consideration when calculating routes	86	Move route (model-dependent)	97	Scrolling through the call list	111
Automatic recalculation	86	Selecting alternative routes	99	Dialing an available number	112
Manual recalculation	86	Change route options	99	Displaying or editing entries	112
The map display	87	Canceling route guidance	99	Lists loaded from cell phone	112
Calling up the map display	87	Entering/deleting a stopover	100	Connecting Bluetooth® telephones	113
Structure of the map display	87	Blocking route temporarily	100	Calling up a device list	113
Map display without route guidance	87	Setting day/night display	101	Automatic connection	114
Map display with route guidance	88	Displaying current position (Where am I?)	101	Searching for cell phones	114
The Information box	88	Entering the destination	103	Connect new devices	115
Split screen with route guidance	89	Skipping a destination	103	Connecting a mobile phone	115
Route guidance with arrow display	90	<b>Supplementary functions for trucks and mobile homes (selected models only)</b>	<b>104</b>	Disconnecting a connected telephone	115
Lane Assistant Pro 3D (model dependent)	90	Feedback after route calculation	104	Telephone calls	116
Map display with Junction view	91	Zooming in on the map	104	Establishing a call	116
Tunnel view	91	Warnings with planned route	104	Accepting a call	116
Using the map display	92	Warnings without planned route	105	Ending a call	117
Repeating the last announcement	92	Show route	105	During a call	117
Changing the announcement volume	92	<b>Other additional functions (only selected models)</b>	<b>106</b>	Telephone settings	118
Map zooming	93	Display height profile	106	Bluetooth®	119
Moving the map	93	<b>Telephone mode</b>	<b>107</b>	Automatic connection	119
Map orientation	93			Automatic call acceptance	119
The Route overview	94			Telephone volume	119
				Updating the phonebook	120
				Bluetooth® name	120

<b>Tools</b>	<b>121</b>	Design by day	132
Travel Guide (model dependent)	121	Design by night	132
Rear View camera	121	Setting the colour	133
Displaying Rear view camera (depending on the model)	121	Language	133
Image viewer*	121	Keyboard layout	134
The image viewer menu	122	Sounds	134
Selecting an image	122	Rear view camera (depending on the model)	134
Enlarging the image	123	Screen animations	134
Rotating the picture	123	Driver profiles (depending on model)	135
Displaying image information	123	Renaming driver profile	135
Slide show	124	Deleting driver profile	136
Settings	124	Driver profile Pro (model dependent)	136
Where am I?	124	Service information	137
Traffic forecast (depending on model)	124	Factory settings	137
Country information	125	Calibration (model dependent)	137
Blocking a section of the road permanently	126	<b>WiFi settings (model dependent)</b>	<b>138</b>
Trip computer (depending on model)	127	<b>Technical terminology</b>	<b>139</b>
<b>Settings</b>	<b>129</b>	<b>index</b>	<b>141</b>
Selecting system settings	129	<b>Model overview and technical   specifications</b>	<b>144</b>
The system settings menu	129	<b>NOTICE</b>	<b>146</b>
Operation	129	EU Declaration of Conformity	146
Selection options	129	Disposal of the unit	147
Closing the settings menu	129	Disposal of the battery	148
The individual menu items	130	Duty to supply information according to battery legislation (BattV)	148
Battery	130	Removing the battery	148
Automatic on/off	130		
Day/night display	131		
Brightness	131		

The information and data contained in these documents are subject to change without prior notice.

No part of these documents may be duplicated or transmitted for any purpose whatsoever without express written permission of United Navigation GmbH. All technical information, drawings etc. are subject to copyright law.

© Copyright 2014, United Navigation GmbH  
All rights reserved.

The Bluetooth® word mark is a registered trademark owned by Bluetooth SIG, Inc. and any use of such marks by United Navigation GmbH is under license.

## 24-month warranty

**The company United Navigation GmbH, Marco-Polo-Str. 1, 73760 Ostfildern, Germany, provides a world-wide, 24-month warranty (battery: 6 months) for BECKER units, beginning on the day of delivery to the final customer (buyer).**

Within the framework of the warranty, functional defects will be eliminated free-of-charge, provided that these can be shown to be the result of material or manufacturing faults and this shall be effected either by elimination of the fault or by provision of a new unit, at the discretion of the manufacturer. Warranty claims must be registered by the buyer immediately after defects are discovered and must be accompanied by the initial buyer's purchase contract.

The warranty expires after 24 months (battery: 6 months); neither warranty claims nor fulfilment shall effect an extension of the warranty period.

Faults resulting from improper handling, incorrect installation of the unit, improper noise suppression of the vehicle, static charge or mechanical damage are excluded from the warranty.

The warranty is invalidated in the case of repairs or tampering on the part of the buyer or unauthorised third parties.

Repairs may only be performed by persons and service centres expressly authorised by the manufacturer or by the manufacturer himself.

**This warranty does not affect or restrict the legal warranty rights of the buyer.**

### **Safety instructions**

- Use of the device is only permitted if the traffic conditions are suitable and you are absolutely sure that its use presents no risk, distraction or inconvenience to you, your passengers or other road users.  
Traffic laws and regulations will apply in each and every case. Destinations may only be entered when the vehicle is stationary.
- The navigation system is merely an aid, data/information may in select cases be incorrect. The driver must decide in each situation by him- or herself if he or she will follow the directions. No liability will be assumed for incorrect directions provided by the navigation system. Imprecise or incorrect directions may be provided due to changing traffic patterns or deviations in data. Therefore, you must always observe the actual road signs and traffic regulations. In particular, the navigation system must not be used as an orientation aid at times of poor visibility.
- The device must only be used for its intended purpose. The volume of the navigation system should be adjusted so that noises external to the vehicle are still well audible.
- Turn the unit off immediately if a defect occurs (e.g. emission of smoke or odors).
- For reasons of safety and security, the device must only be opened by a professional. In case of needed repair please consult your dealer.
- Navigation devices from Becker could contain magnets. Do not bring them near magnetic data carriers (notebooks) or cards (EC cards, credit cards etc.). These could get damaged or be rendered unusable if brought into contact. Magnets can impair the function of cardiac pacemakers! Persons with cardiac pacemakers should not carry the device too close to their bodies.

- It is forbidden to exceed the supply voltages (Volts) specified for the mains adapter, the motor vehicle charging adapter and the product. In case of non-observance, the product or the charger may be damaged, or the battery may explode.
- Do not open the product or the battery under any circumstances. No modifications of the product are permitted, any such modification leads to the loss of the operating permission.
- Only use original BECKER accessories. This way it is ensured that all relevant provisions will be met and that health risks and damages to the product are avoided. Dispose of the used product or the battery according to the legal regulations in effect.
- Improper use excludes all warranties! The safety instructions are also valid for any original BECKER accessories.
- Allowed temperature range: -20 °C – 60 °C storage / 0 °C – 45 °C operation



## Operating manual contents

This operating manual contains the description of your Becker navigation equipment.

This manual contains descriptions for different model versions in a single document. Therefore, some of the functions described here might not be available for your equipment under certain circumstances.

All pictures are similar.

## Use of the product

This product is a high performance PND (**P**ersonal **N**avigation **D**evice) for use in vehicles. Protect the product and the accessories from moisture and dirt.

## Navigation

The use of the GPS = **G**lobal **P**ositioning system eliminates the tedious process of looking in street maps.

The receiver antenna integrated into the product allows constant access to the navigation services outside buildings. Within buildings, it is currently not possible to access any navigation functions. When using in vehicles, it might not possible to receive sufficient GPS data depending on the installation position of the Navigation device.

### Images\*

The Navigation device has a Picture Viewer with a lot of image display functions.

**Telephone (selected models)**

Your Navigation device is equipped with Bluetooth® wireless technology. Via Bluetooth®, you may connect to a cell phone equipped with Bluetooth® wireless technology.

Your Navigation device can then be used as a very comfortable hands-free unit. You also have the option to read out the address book or phonebook of the cell phone and to read any received short messages.

**Unpacking the Navigation device****Note:**

Your Navigation device is delivered in a stable packaging. If the packaging or its contents show the signs of serious damages, you must not continue to unpack the product. In such case, please contact your dealer.

**Checking the contents**

Before you start using the Navigation device, the scope and condition of the contents must be thoroughly checked (see also page 16).

- > Unpack the contents carefully and check them thoroughly.

## Overview of functions

- : standard
- : not available
- : optional

	Navigation system									
	active.5 CE LMU BE B00	active.5 LMU BE B00	transit.5 LMU BE B02	active.5 LMU plus BE B10	active.6 CE LMU BE B30	active.6 LMU plus BE B40	professional.5 LMU BE B20	professional.6 LMU BE B50	transit.6 LMU BE B50	ready.5 BE B60
TMC	●	●	●	●	●	●	●	●	●	●
Becker Speech Dialogue System	-	-	-	-	-	-	●	●	●	-
Becker OneShot speech control	-	-	-	-	-	-	●	●	●	-
Speed camera warning	○	○	○	○	○	○	○	○	○	-
Driver warnings	-	-	●	-	-	-	-	-	●	○
Telephone	-	-	-	●	-	●	●	●	●	-
Trip computer	-	-	-	●	-	●	●	●	●	-
Environmental zones	●	●	●	●	●	●	●	●	●	-
Truck & Camper Navigation Pro	-	-	●	-	-	-	-	-	●	●
Display height profile	-	-	●	-	-	-	●	●	●	-
Move route	-	-	-	-	-	-	●	●	●	-
ADAC Camping Guide	○	○	○	○	○	○	○	○	●	-
Traffic forecast	-	-	-	-	-	-	-	-	-	-
Driver profiles	-	-	-	-	-	-	-	●	●	-
Driver profile Pro	-	-	-	-	-	-	-	-	-	-
Lane assistant Pro 3D	●	●	●	●	●	●	●	●	●	-
Reversing camera	-	-	-	-	-	-	-	●	●	-
Connection for vehicle integration	-	-	-	-	-	-	-	●	●	-
WiFi	-	-	-	-	-	-	●	●	●	-
Becker Link2Live	-	-	-	-	-	-	●	●	●	-
Live Traffic	-	-	-	-	-	-	●	●	●	-
Live POI Search	-	-	-	-	-	-	●	●	●	-

- : standard
- : not available
- : optional

	Navigation system									
	Ready 70 LMU BE J00	Transit 70 LMU BE J10	Transit 70 LMU Pro BE J11	Professional 70 LMU BE J12						
TMC	●	●	●	●						
Becker Speech Dialogue System	-	-	-	-						
Becker OneShot speech control	-	-	●	●						
Speed camera warning	-	-	●	●						
Driver warnings	○	○	○	○						
Telephone	-	●	●	●						
Trip computer	-	-	-	-						
Environmental zones	-	●	●	●						
Truck & Camper Navigation Pro	●	●	●	●						
Display height profile	-	●	●	-						
Move route	-	-	●	●						
ADAC Camping Guide	-	-	●	●						
Traffic forecast	-	-	●	○						
Driver profiles	-	-	-	-						
Driver profile Pro	-	●	●	●						
Lane assistant Pro 3D	-	-	-	-						
Reversing camera	●	●	●	●						
Connection for vehicle integration	●	●	●	●						
WiFi	-	●	●	●						
Becker Link2Live	-	●	●	●						
Live Traffic	-	●	●	●						
Live POI Search	-	○	●	●						

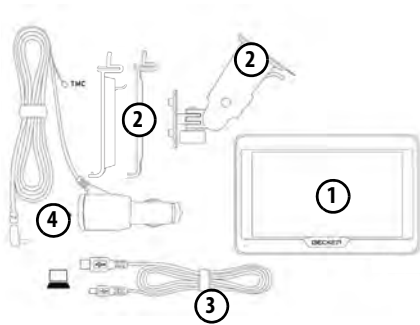
**Scope of delivery**

- ① Navigation device
- ② Device console with carrier plate (depending on model)
- ③ USB cable
- ④ Motor vehicle adapter power supply 12/24 V for cigarette lighters with built-in TMC antenna (depending on model)

In the case of devices with magnetic holders, the carrier plate ② and car adapter cable ④ form one unit.

**Complaints**

In case of complaints, please consult your dealer. The equipment may be sent directly to United Navigation in its original packaging.

**Handling the packaging**

Keep the original packaging in a dry place, at least for the warranty period.

**Note:**

The disposal must be performed in a professional manner, according to the country-specific regulations. The packaging must not be combusted. Depending on the country of delivery, it might be possible to return the packaging to the dealer.

**Description of the device**

The navigation device consists of the basic unit and the accessories included in the scope of delivery.

For descriptions of the individual parts, see:

- "Overview of the scope of Delivery" on page 16

**Note:**

The basic unit and accessories must not be opened or modified in any way.

**The basic unit**

The basic unit consists of the complete electronic unit:

- Integrated antenna
- a TMC receiver for receiving traffic messages (depending on the model),
- Touchscreen
- an integrated loudspeaker
- a microphone (depending on the model).

On the side of the unit, there are also various connections and ports.

You will find more details of the unit under:

- "Model overview and technical specifications" on page 144

**Cable for power supply from cigarette lighter**

This cable allows the unit to be connected up to the car's cigarette lighter.

The power supply must satisfy the following requirements:

- DC current 12/24 volts  
1 amps

**Battery**

When depleted, the integrated rechargeable battery can be recharged by connecting the Navigation device to the power supply.

For this purpose, connect the unit via a car power adapter to a 12/24 V socket in a vehicle or via the optional mains power supply unit to the 230 V mains.

**Note:**

You can charge the Navigation device via the car charger cable included in the scope of delivery or via the optionally available mains power supply unit.

When the Navigation device is connected to a PC, it is supplied with power via the PC and does not consume battery power.

**USB connection cable**

With the USB connection cable provided, it is possible to connect the Navigation device to a standard PC with a USB interface. The integrated flash memory of the navigation device and a micro SD card that may eventually be inserted can then be addressed by the PC like a removable storage device.

**Note:**

Switch the navigation device completely off, see "Devices with magnetic holders" on page 26, before connecting the navigation device to the computer.

**Unit bracket**

The Navigation device can be mounted in the vehicle using the unit bracket.

**Accessories****Mains power supply unit**

This power supply allows connection of the Navigation device to a mains outlet.

The power supply must satisfy the following requirements:

- Alternating current 100-240 volts  
50-60 Hertz

### **Cable for vehicle integration (for certain models only)**

With a 4-pin 3.5mm jack cable you can integrate your Navigation device seamlessly into your vehicle. Details of the connection can be found under "Cable for vehicle integration (depending on model, optional)" on page 23.

## **Information about the documentation**

### **Quick Start Guide**

The Quick Start Guide is designed to provide a brief introduction to operating your Navigation device. The most important basic functions of the Navigation device are explained in the Quick Start Guide.

### **Operating instructions**

A comprehensive explanation of the Navigation device functionalities is contained in these operating instructions.

## **Registration**

You can register your product using our software service. We will then inform you of any new updates and other news.

Registration is performed in the "Content Manager" - see page 33.

## **Repairs**

The unit must not be opened if damaged. Please contact your dealer.

## **Emissions and disposal**

You will find details on emissions and electromagnetic compatibility and disposal in "NOTICE" on page 146.

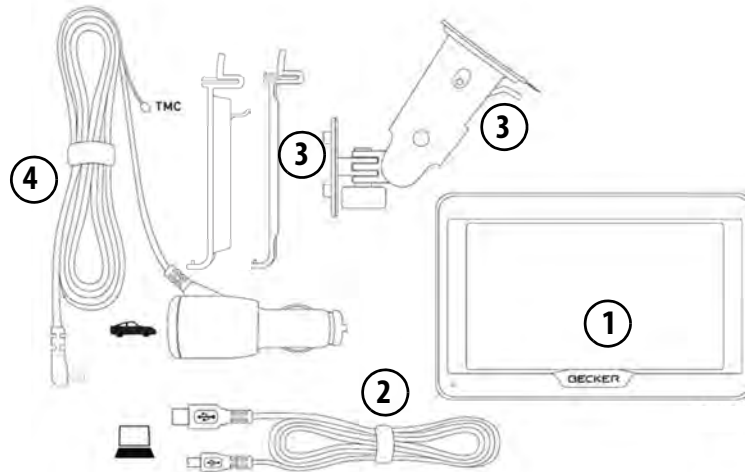

### Scope of delivery

- 1 Basic device – PND (**P**ersonal **N**avigation **D**evice)
- 2 USB connection cable
- 3 Unit holder with carrier plate (the design depending on the model)
- 4 Cable for power supply via the vehicle cigarette lighter (12/24 Volt) with integrated TMC-antenna (depending on the model)

In the case of devices with magnetic holders, the carrier plate ② and car adapter cable ④ form one unit.





### Front of unit with controls and displays

#### 1 Back button

Model dependent: either on the left bottom side of the screen or in the left top corner of the housing.

Press = Back function in most applications

Press and hold = Open the main menu

#### 2 Touch screen showing the main menu selected

#### 3 Touch screen key

Press = activates the corresponding key command

#### 4 Microphone (depending on the model, sometimes in the right top corner, too)

Model dependent, the arrangement of the connections can differ on the bottom side of the device.

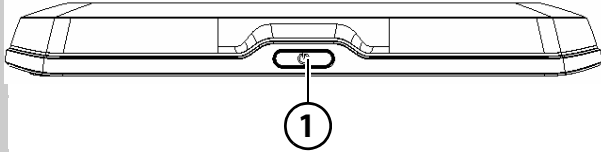

**Top of the unit**

- 1 ON/OFF switch

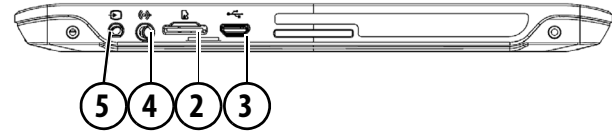

**Underside of the unit**

- 2 Slot for Micro SD card
- 3 Mini USB connection / connection for power supply
- 4 Connection for reversing camera
- 5 Connection for vehicle integration

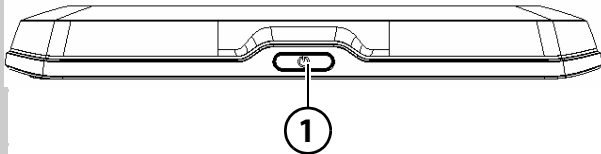

**Top of the unit**

- 1 Standby switch (sleep mode)

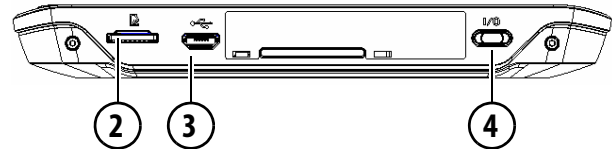

**Underside of the unit**

- 2 Slot for Micro SD card
- 3 Mini USB connection / connection for power supply
- 4 On/Off switch (I/O)

## Maintenance and care

The unit is maintenance-free.

For proper care, a commercially available cleansing fluid for electrical devices may be applied using a soft damp cloth.

### **Danger!**

**Danger to life by electrocution.**

**Always switch off the unit and disconnect the mains power supply unit before cleaning the unit, supplied components, or accessories.**

### **Note:**

Do not use any aggressive or abrasive substances or cloths which may damage the surface.

A micro-fibre cloth is particularly suitable for the display.

The unit must not be exposed to water.

Your mobile navigation system was designed and manufactured with great care and should be treated with equal care. You will enjoy your mobile navigation system for a long time to come if you observe the recommendations listed in the following:

- Protect your mobile navigation unit and the accessories from water and moisture. If your unit has been exposed to moisture, switch it off immediately and disconnect the power supply. Allow to dry at room temperature.
- Do not operate your mobile navigation system in a dusty or dirty environment and do not store it in such an environment.
- Do not store your mobile navigation system in hot environments. High temperatures can shorten the service life of electronic components in your unit, damage the rechargeable batteries and cause certain plastics to warp or melt.

- Do not store your mobile navigation system in cold environments. During operation, when the unit warms up to operating temperature, moisture may form internally, causing damage to electronic components.

- Do not drop your mobile navigation system unit, protect it from shocks and do not shake it. Improper handling can damage components within the unit.
- Never use corrosive or aggressive chemicals, cleaning solutions or aggressive detergents for cleaning.

All the above information applies equally to the mobile navigation system, the rechargeable battery, the mains charging and car power adapters as well as all accessories. Should one of these parts not work properly, please contact your authorised dealer.

## Battery quality declaration

The capacity of the rechargeable battery in your mobile navigation system decreases with every charging/ discharging cycle. Improper storage at excessively high or low temperatures may also cause a gradual deterioration of capacity. Consequently, the operating time may be substantially reduced even in the case of a fully charged battery.

## Display quality declaration

In some cases, for technical reasons, a few discoloured dots (pixels) may be visible on the display. Some pixels may also appear brighter or darker. However, such instances do not represent a product flaw.

## Start-up

Once the Navigation device has been unpacked and checked for damage, the unit can be started up. The individual start-up steps are:

- connect to power supply.
- switching on the unit.
- ensuring antenna reception (if navigation is desired)

## Power supply

### Note:

You can charge the Navigation device via the car charger cable included in the scope of delivery or via the optionally available mains power supply unit. When the Navigation device is connected to a PC, it is supplied with power via the PC and does not consume battery power.

## Using the battery

The internal power supply is via the integrated rechargeable battery. The rechargeable battery is maintenance-free and does not require any particular care.

You are alerted by a warning message when the battery should be recharged. After the alert, the device can still be used for approximately 10 minutes before switching off automatically.

### Note:

Note that if the battery is completely discharged, it may take up to a minute before the device can be switched on again.

### Note:

In the event of a defective battery, please contact your authorised dealer. Please do not attempt to remove the battery yourself.

## Connection for the cigarette lighter

### Note:

If the cigarette lighter has recently been used and is still hot, wait until the lighter socket has cooled down.

Connect the power supply via the vehicle battery and the cable provided for the cigarette lighter as follows:

- > Grasp the connector of the connection cable and insert it gently without force into the connector socket of the navigation device up to the stop, or in the case of a device with an active cradle, on the underside of the supporting plate. (Model dependent, this step is not required on navigation devices with magnetic holders)

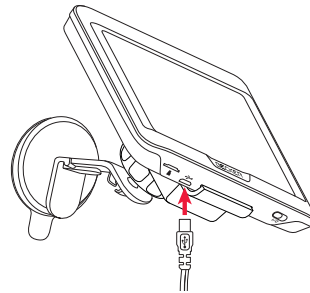

- > Insert the adapter into the cigarette lighter.

### Note:

When the engine is switched off, the power supply slowly discharges the vehicle battery via the cigarette lighter! Do not therefore operate the Navigation device for long periods with the engine switched off.

To receive TMC messages (depending on the model), the power supply must be connected to the supporting plate in the case of a device with an active cradle.

## Connection to the mains outlet

### **Danger!**

**Make sure that your hands are not wet and that the power supply unit is dry. Only connect the power supply unit to a permissible mains power supply.**

### **Connecting to power supply**

Connection to the public mains grid is achieved using the optionally available mains power supply unit. Please proceed as follows to connect to the mains:

- > Hold the connector and push it all the way into the connecting socket in the Navigation device without using excessive force.
- > Insert the plug of the power supply unit into the socket.

### **Note:**

Remove the power supply unit when not using the Navigation device for longer periods of time.

## TMC antenna (depending on the model)

The supplied TMC antenna is integrated into the cable for power supply.

The TMC antenna runs in parallel with the the cigarette lighter cable in the delivered condition.

If the TMC reception is poor, you must remove the cable of the TMC antenna from the cable for the cigarette lighter.

(Model dependent, the cable cannot be disconnected on navigation devices with magnetic holders)

### **Note:**

The TMC antenna must be installed in such a way that it does not distract you while driving.

## GPS antenna

### **Unit antenna**

The GPS antenna is integrated into the housing.

### **Note:**

The integrated GPS antenna is not suitable for use in vehicles with anti-glare windows (metalised thermo-glass or metal foil, indicated by the window label - SIGLA SOL, SIGLA CHROM, SIGLA, KOOL-OF, SUNGATE, etc.) and vehicles with fine-meshed heating wires in the windows.

## Cable for vehicle integration (depending on model, optional)

With a 4-pin 3.5mm jack cable you can integrate your Navigation device seamlessly into your vehicle.

- connect your Navigation device to the phone mute function of your audio system. If the cable is connected correctly, your audio system will mute the car radio during navigation announcements.
- connect your Navigation device to your audio system for output of the audio signal.

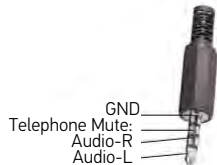

- > Plug the cable into the designated 3.5 socket on the underside of the device.

### Note:

Once the cable is connected, the loudspeaker of the basic device is switched off.

## Cable for rear view camera (depending on the model, optional)

You can connect your rear view camera to your navigation device using a 4-pin 2.5mm AV cable. Insert the cable into the socket provided on the back of the basic unit, also see page 18.



You can make the necessary settings in the chapter “Rear View camera” on page 121.

## Memory card

Your Navigation device has a slot for a micro SD memory card.

As the map data is stored in an internal memory on the Navigation device, the slot for a micro SD memory card is used for updates and for viewing images.

The memory card can also be used for supplementing the map data.

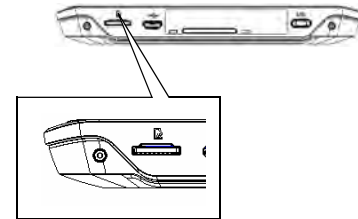

The card slot is located on the bottom side of the device. The card slot is equipped with a spring-actuated locking and ejector mechanism.

### Inserting the memory card

- > Remove the memory card from its packaging without touching or soiling the contact bar.
- > Hold the memory card so that the contact strip is facing towards the rear of the unit.
- > Guide the memory card into the card slot.
- > Exert a little pressure and slide the memory card into the card slot until it snaps in.

### Ejecting the memory card

The card slot ejects the card so that you can pull it out with two fingers.

- > Use your finger to gently press the memory card against the spring force into the card slot and then release it.

The card is ejected.

- > Remove the memory card and place it in the packaging while ensuring not to touch contact bar.

### Unit bracket

The Navigation device can be attached directly to the windscreen with the unit holder.

#### Note:

The Navigation device and unit bracket must not be exposed to long periods of direct sunlight. Temperatures inside the vehicle of +70 °C and higher may damage parts of the bracket.

### Fitting the unit bracket

#### Note:

Fasten the unit holder such that your field of vision is not impaired when the Navigation device is installed and ensure that the unit is outside the deployment area of the airbag.

Ensure that the electrical connection cable does not hamper you from accessing the vehicle's controls.

Clean the attachment surface on the windscreen to ensure that it is clean and free of grease. Do not use greasy or soapy cleaning agents.



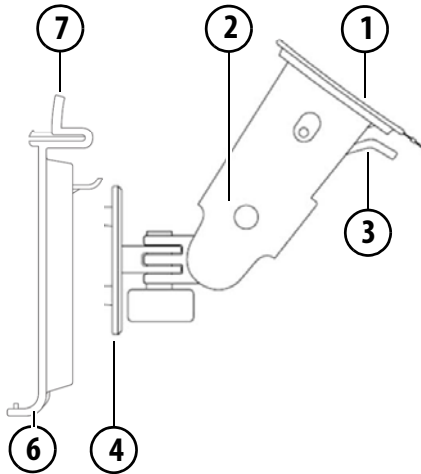

- ① Suction surface
- ② Base
- ③ Lever
- ④ Fastening screw
- ⑥ Carrier plate
- ⑦ Release button

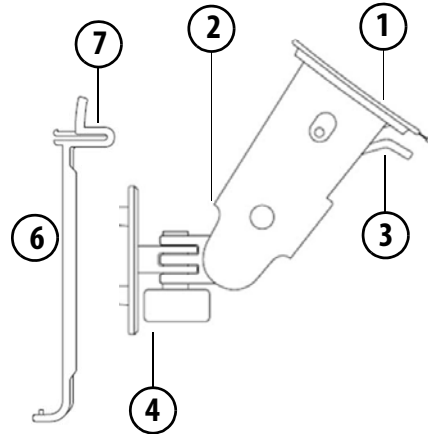

Similar to figure, on devices with magnetic holders no unlocking button is present ⑦.

### On the windscreen

The unit holder can be attached directly to the windscreen using the suction mechanism.

- > Press the carrier plate onto the four retaining lugs of the unit holder.
- > Select a suitable spot to attach.
- > Loosen the fastening screw ④ slightly.
- > Press the base ② with its suction surface ① against the windscreen. Turn the unit holder such that the carrier plate is positioned roughly in the desired viewing direction.
- > Press the lever ③ down.

The holder has attached itself firmly to the windscreen. It can now be adjusted with precision. In order to remove it, operate the ③ lever again.

### Adjusting the unit holder's position

- > Loosen the fastening screws (4) and (5) until the carrier plate (6) can be moved without using excessive force.
- > Move the carrier plate (6) to the required position and hold it in this position.
- > Tighten the fastening screws (4) and (5) sufficiently so that the Navigation device is held securely in place when the vehicle is in motion.

### Attaching the Navigation device

- > Position the Navigation device with the attachment point on the bottom of the housing, onto the carrier plate (6).
- > Without using excessive force, press the Navigation device onto the carrier plate (6). The Navigation device locks into place.

### Removing the Navigation device

Press the button (7) on the top of the carrier plate (6). This unlocks the Navigation device which can be removed from the carrier plate.

### Devices with magnetic holders

The unlocking button (7) is not present. First place the navigation device with the upper mounting point onto the carrier plate (6) and fold down the navigation device. The magnet holds the navigation device securely on the carrier plate. To remove the navigation device, first take it off from the carrier plate at the bottom.



### Switching the Navigation device on/off (model dependent)

With the ON/OFF switch (I/O) (1) you can switch the Navigation device on or off completely.

With the (2) button on the upper side of the Navigation device you can switch the device to sleep mode or switch it from sleep mode again.

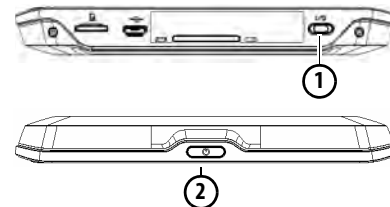

For devices without the (1) button on the underside (model dependent): With the (2) button you can switch the device off, on or to the sleep mode.

## Switching on



> Press the button on the top of the Navigation device.

The unit is switched on. The manufacturer's logo appears on the touchscreen.



When the Navigation device is started for the first time, the language selection is displayed automatically.



Using the   buttons or the scroll wheel, it is possible to scroll through the list in the direction of the relevant arrow.

> Press the button for the required language.

> The selection is confirmed by pressing **OK**.



> Then select the desired voice.

### Note: for models with TTS

Voices with a (TTS) tag support the text-to-speech function (e.g. announcing roads and reading out text messages).

A short example announcement is given.

> Confirm your selection by pressing the **OK** button.

The following prompt appears shortly afterwards:

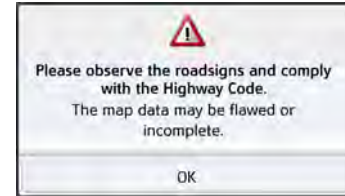

> If you agree to the request contained in this prompt, press the **OK** button.

### Note:

Use of the Navigation device is only permitted in accordance with the national road traffic regulations applicable at the time.

## Switching off (depending on model)

You can switch the unit off at any time.

> Press the button on the top of the Navigation device.

The Navigation device switches to sleep mode.

> Before finally switching off the navigation device, press the I/O switch on the underside of the device to 0.

For devices without the I/O switch on the underside:

- > Press the switch on the top of the navigation device for longer than 3 seconds to finally switch it off.

**Note:**

We recommend that you place the Navigation device in sleep mode in the event of short interruptions to operation (of up to a week).

This significantly reduces the switch-on time and the Navigation device finds the satellites required for navigation much faster.

If route guidance was active when sleep mode is activated, it is automatically resumed if the Navigation device is switched back on again within approx. 4 hours.

If the device cannot be switched off anymore or no longer works reliably, it is possible to switch off devices without I/O switches completely by pressing the button on the top for longer than 7 seconds.

## Basic information about the touch screen

The Navigation device is fitted with a touch screen.

**Note:**

To ensure that the display's surface is not damaged, you may only touch it with your fingers or a blunt, non-smearing object.

## Operation

When you touch a button on the touch screen, the button in question is briefly shown outlined in red to confirm the selection.

If you touch a button that is not active at the moment, a short signal tone sounds.

## Calibration

If the touch screen starts responding imprecisely, calibration should be undertaken.

The calibration function is started from the  menu (see also page 137).

## Basic information about the menus

During operations, you are assisted by various menus and entry windows.

### The main menu

The top menu level is the main menu. The individual applications are started from the main menu.

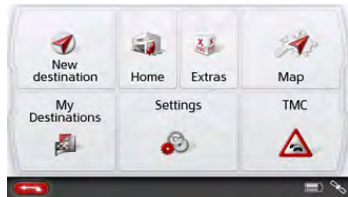

You will find information about the individual applications in the corresponding main chapters.

In addition to the individual applications, the main menu also contains further information and operating options.

You can tell whether a telephone is already connected by the symbol on the **Phone** button.



- ① Telephone connected
- ② Telephone not connected

A satellite symbol at the right of the status line shows you whether there is currently GPS reception or not.



- ① GPS reception
- ② No GPS reception

If route guidance is already active, the current destination address and a button for cancelling route guidance will be displayed between the two rows of buttons.



Press the button ① to cancel route guidance to the displayed destination directly in the main menu.

### Entries made with the entry menu

Some applications require entries to be made via the entry menu. The entry menu is operated in a similar way to a keypad.

The keyboard layout can be switched between ABC and QWERTZ, see page "Keyboard layout" on page 134



The character entered on the keypad is displayed in the top line of the entry menu. The central area is used to enter characters. Help functions are provided in the right line. Descriptions of how to operate the menu are provided below.

### Entering characters

Characters are entered by pressing the keys in the central area.

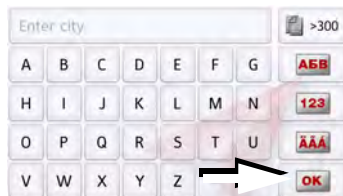

Once the entry is complete, the process is concluded by pressing the **OK** key and the entry passed on to the Navigation device for processing.

When a navigation destination is entered, the Navigation device compares the data with the stored data.

Only those letters that are still possible area available for selection.

Characters that cannot be selected are displayed greyed out.

### Accepting proposals

During entry, the Navigation device makes proposals in the uppermost line.

The proposals take into account your usage habits. For example, if you enter the city of Hamburg often, then after you enter the letter "H" the proposal "Hamburg" is automatically displayed.

If no preferences are known for the letter entered, then cities/locations suitable for the entry are displayed as proposals.



> To accept the proposal, you may press either the input field or the **OK** button.

### Scrolling through the lists

If you have already entered some of the letters of the selection you want, you can use the selection list to display all the destinations containing the combination of letters in question.

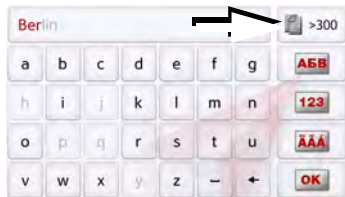

> To call up the selection list, press the  >300 key.



#### Note:

The quantity of selection options is displayed in the form of the number on the button. When there are more than 300 options, the precise number is not displayed.

In the list, all the entries corresponding to the letters already entered are displayed. The letters entered are coloured red in the case of the individual entries.

The selection list appears.



> Press the   arrow keys on the right hand side of the screen to scroll through the list.

> Press the destination you want.

The destination is adopted and the selection list is closed.

### Special characters and accent marks

Special characters and accent marks do not have to be used when entering the names of towns and streets. The Navigation device will change entries from AE, OE and UE if necessary.

> If, for example, you are looking for the location "Würzburg", then simply press "WUERZBURG" or "WURZBURG".

Special characters can be useful when naming destinations and routes.

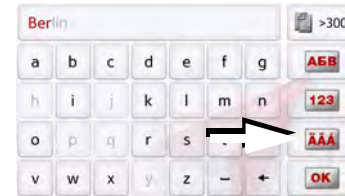

> In order to switch to the special characters keyboard, press the button marked with an arrow.

The special characters keyboard is displayed.

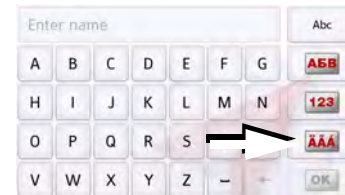

> Enter the desired special character.

After you enter a character, the Navigation device automatically switches to the normal input menu.

To exit the special character keypad without an entry, press the button marked with the arrow.

**Other character sets**

Different character sets can be selected for the keyboard of the Navigation device.

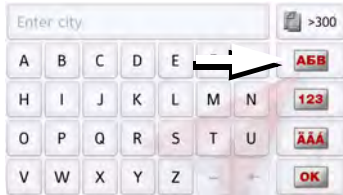

> Press the button marked with an arrow repeatedly until the desired character set is selected.

**Entering numbers**

Switch to the numbers keyboard in order to enter figures.

> Press the **123** button.

The numbers keyboard is displayed.

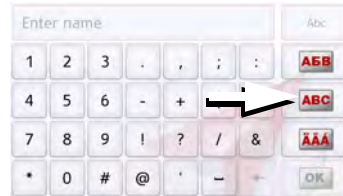

> In order to return again to the keyboard for entering letters, press the button marked with an arrow.

**Switching between upper and lower case:**

During free text entry, it is possible to switch between upper/lower case and the automatic function.

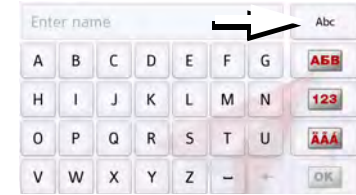

> Press repeatedly on the button in the top right-hand corner of the display until the desired method of entry is activated.

The inscription on the button symbolises the method of entry.

- The **Abc** button represents automatic mode. This means that, on entry, the first letter is automatically in upper case and subsequently changes automatically to lower case.
- The **ABC** button represents the entry of upper case letters.
- The **abc** button represents the entry of lower case letters.



### Deleting characters

To delete the last character, use the back key.

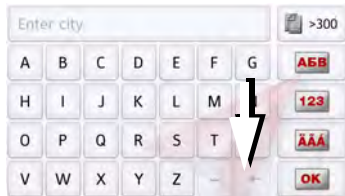

> To delete the character to the left of the cursor, press the  key.

### Inserting spaces

If you have an entry with two words, e.g. for names of towns, the words should be separated by a space.

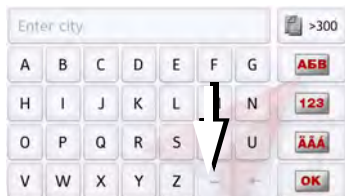

> To enter a space, press the  key.

### The back button

The  button is located on the bottom left of the device.

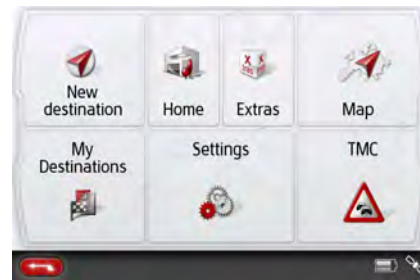

It has various functions:

- Depending on the menu context, if pressed briefly, you will be returned to the previous entry level.
- The main menu is displayed by pressing and holding the button.

### Content Manager

The Content Manager is a PC-based application containing a number of important functions to help you manage the content on your Navigation device.

With the Content Manager you can:

- back up the content saved on the Navigation device to your PC and restore it later to your Navigation device,
- download current content from the Internet and install it on the Navigation device.

To use the Content Manager, you will need the USB cable provided as well as a computer that meets the following minimum requirements:

	Minimum
Operating system	Windows
Processor	300 MHz clock frequency
Main memory	256 MB
Free storage space	2 GB

### Installing the Content Manager

You can install the Content Manager on your computer with the following steps:

- > Switch the navigation device completely off, see "Devices with magnetic holders" on page 26.
- > Connect the USB interface of the device directly to a USB port of the computer using the USB cable supplied.
- > Switch on the navigation device.
- > If the application does not start automatically, please start the file "CONTENT-MANAGER" manually in the folder "Becker\_Content\_Manager\_Setup".
- > Select a language from the list and then click on **OK**.
- > Read the welcome page and click on **Next** to continue.
- > Select the installation folder. A default installation folder is already specified. To select another folder, either type in the path name or click on **Browse** and define another folder.

> Click on **Install** to start the copying procedure. Click on **Details** to see the details during copying.

The Content Manager is automatically started immediately after installation. Remove the check mark from the box if you do not want this.

This completes the installation procedure.

> Click on **Finish** to exit the installation program.

### Starting the Content Manager

Execute the following actions to start the Content Manager:

- > Switch the navigation device completely off, see "Devices with magnetic holders" on page 26.
- > Connect the USB interface of the device directly to a USB port of the computer using the USB cable supplied. Switch on the Navigation device.

#### Note:

When you connect the Becker Navigation device to the PC for the first time, the PC installs all the necessary drivers and then displays the message "Your unit is now ready to use".

After a short time, the Navigation device is displayed as a removable storage medium on the computer.

- > Click on **Start** > **All Programs** on the computer.
- > Select **Becker**.
- > Click on **Content Manager**.

When the Content Manager is started, the program executes a number of steps before you can start to manage your navigation software content.

Each time the program is called, a connection is established to the Internet to check whether a new version of the ContentManager is available. If a new software version is found, the Content Manager gives you the option of installing it. We recommend that you always agree to the upgrade, if one is available. If a new software version is found, you have the following options:

- Click on **Yes** to accept the new software version. The new version is downloaded and installed before you can start the Content Manager.

- Click on **No** to start the Content Manager with the version already installed.
- If the new version is a critical update, the **Exit** button will be shown instead of the **No** button. You must install the new version, otherwise you have to exit the application.

If you have not yet made a backup of the navigation unit, the Content Manager will ask you each time it starts whether you would like to make a complete or partial backup copy.

**Note:**

We recommend that you always create the backup. Otherwise you will not be able to restore the content in the event of loss of data.

## Transferring pictures

Images\*, music\* and videos\* can be stored on a separate Micro SD memory card (not included in the scope of delivery) or in the internal memory of the Navigation device in the "Media" folder. Files can be transferred via a card reader or a USB connection.

**Note:**

Switch off the navigation device completely, see "Devices with magnetic holders" on page 26, before connecting the navigation device to the computer. We recommend that you give files and directories self-explanatory names so that it is simpler to find these again, if needed.

## Faults

Malfunctions in the operating system or in the unit are displayed accordingly. If the function you want cannot then be executed, you should restart the Navigation device using the On/Off switch.

If the messages reappear or the unit doesnot function correctly for any other reason, please contact your local dealer. You can also try to find a solution to your problem in the FAQ in the Support area on the Becker homepage ([www.mybecker.com](http://www.mybecker.com)).

**Note:**

Never attempt to open the unit yourself. Please contact your authorised dealer if you are unable to remedy the fault.

## What is navigation?

The term "navigation" (lat. navigare = to travel by sea) is generally understood to mean the determination of a vehicle's location, the determination of its direction and its distance from the desired destination and the required route to get there. Stars, prominent landmarks, compasses and satellites etc. are used as navigation tools.

With the Navigation device, the location is determined by the GPS receiver. The **Global Positioning System (GPS)** was developed during the 1970s by the US military as a weapons guiding system.

GPS is based on a total of 24 satellites which orbit the Earth and transmit signals. A GPS receiver receives these signals and calculates its distance to the individual satellites based on the signal travel times, and then determines your current geographical position.

Signals from at least three satellites are required to determine your position; your height above sea level can be calculated if signals are received from four or more satellites.

The Navigation device determines the direction and distance from the destination using a navigation computer and a digital street map held in its internal memory.

For safety reasons, route guidance **is given predominantly in spoken form.** This is supported by a direction indicator and a map display on the touch screen.

### Safety instructions

- Road traffic regulations always take priority. The navigation system is merely an aid, data/information may in select cases be incorrect. The driver must decide in each situation by him- or herself if he or she will follow the directions.  
No liability will be assumed for incorrect directions provided by the navigation system.
- When first put into use it can take up to 30 minutes to fix the position.
- Observation of traffic signs and local traffic regulations must always take priority.
- Traffic guidance is restricted to passenger vehicles. Special driving recommendations and regulations for other vehicles (e.g. commercial vehicles) are not included.
- Destinations may only be entered when the vehicle is stationary.

## Selecting Navigation

Navigation mode is called up from the main menu. New destinations can be entered in the menu "**New destination**". Destinations that have already been visited or saved can be selected in the menu **My destinations**.

> In the main menu, press the button **My destinations**.

### Note:

If an address is displayed in the lower edge of the main menu, this means that route guidance has already been started to the displayed address.

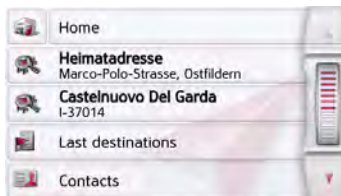

### Home address

When you press the **Home** button you will be asked to enter an address if no home address has yet been entered.



> Press the **Yes** to enter the address. You can then enter a destination as described under "The New destination menu" on page 43.

### Note:

The menu items **Set current position** and **Select from last destinations** (fast access mode) can also be used to select a destination.

If you have already entered your home address, you can start route guidance to your home address in the first line. A home address once entered can be modified later. In the "**My destinations**" menu, next to the **Home** option press the  button.



> Press the **Change** button to enter a new home address. The menu for selecting the destination appears.

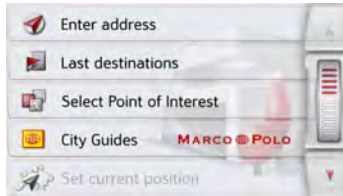

Here you can set the new home address for example using an intelligent text entry field.

### Smart Guess

The two addresses that can be selected with the button,  is a selection of the addresses last visited. Depending on the time of day and your current position, the two most likely destinations are displayed and can be selected directly.

## Last destinations list

The last destinations visited and saved destinations are displayed in the Last destinations list and can be selected directly. The menu for entering destinations can also be called up using the fast access function.

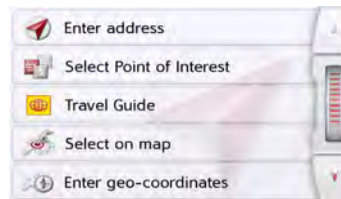

## The destination list



The destination list displays, line by line, all destinations available for fast dialling. Each line of the destination list is divided into two fields. Each list field is designed as a button. The destination is shown on the right-hand button and the properties of the destination are displayed using the left icon.

### Note:

Up to 200 of the most recent destinations are automatically stored in the destination list. If the storage capacity is reached, the oldest destination in the list is automatically deleted to make room for each new destination. However, important destinations may be protected. If you select your home address and it has not yet been defined, you will be requested to enter the address.

**Icons used**

The following icons are used in the destination list:

Icon	Meaning
	This destination is a standard destination with no special features.
	This destination is protected. If the destination memory is full, this destination will not automatically be deleted. This can be performed manually, if required. In the case of a protected entry, you can also determine the position using the fast access function.

**Operating the last destinations list****Start with existing destination**



The existing destinations are listed in the destinations list.

> Press the button for the desired destination to start route calculation.

The calculation begins.

When the calculation is complete, the map appears and the route guidance begins.

**Scrolling through stored destinations**

Using the   buttons or the scroll wheel, it is possible to scroll through the list.

**Displaying or editing a destination**

Any destination stored in fast access mode can be displayed and edited.

> Press the button to the left of the desired destination.

> A selection menu appears.

Option	Meaning
<b>Show details</b>	The data for the destination are displayed. From this screen you can display the destination on the map, display the route or start the route guidance.
<b>Name entry</b>	The destination can be renamed. If the destination is given a name it is automatically protected.
<b>Protect entry</b>	The destination is protected from automatic deletion. This function is only available for unprotected destinations.



Option	Meaning
<b>Remove protection</b>	The protection is removed from the destination. This function is only available for protected destinations.
<b>Move up</b>	The destination is moved forwards by one position. If the destination is moved it is automatically protected.
<b>Move down</b>	The destination is moved back by one position. If the destination is moved it is automatically protected.
<b>Delete entry</b>	The destination is deleted from the fast access mode.
<b>Delete all entries</b>	All destinations (except for the protected destinations and your home address) are deleted from the list.

**Personal destinations**

Using the **Personal destinations** button you can call up Google™ points of interest that have been imported into the Navigation device and start route guidance to one.

- See "Selecting a destination from Personal destinations" on page 41.

**Contacts**

Using the **Contacts** button you can call up Microsoft® Outlook® contacts that have been imported into the Navigation device and start route guidance to the address listed in the contact.

- See "Selecting a destination from Contacts" on page 42.

**Selecting a destination from Personal destinations**

You can call up Google™ points of interest that have been imported into the Navigation device and start route guidance to one.

**Note:**

To display custom Google™ points of interest, the Google™ KML files must be stored in the **Navigator\content\userdata\mydest** directory of the Navigation device.

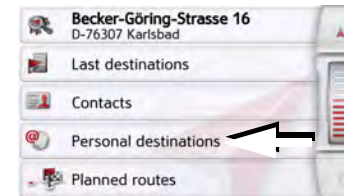

- > In the main menu, press the button **My destinations**.



- > Press the **Personal destinations** button.



A list of the available destinations will be displayed.

Using the   buttons or the scroll wheel, it is possible to scroll through the list.

#### Note:

If the list contains numerous entries, it may be a good idea to search for the desired destination by selecting **Search entry** and using the input menu.

A maximum of 1000 destinations can be imported.

Newly imported destinations are filed at the start of the list.

> Select the desired destination. Route guidance to the selected destination will be initiated.

#### Editing Personal destinations

> In the list of your own destinations, press the  button in front of the destination that you wish to edit.

Select **Delete entry** if you wish to delete the destination from the list. Select **Delete all entries** if you wish to delete the entire list.

Select **Show details** if you wish to display details about the destination.



Press the **Start** button to begin route guidance to the destination straight away.

You can also display your chosen destination on the map (**On map**), store it in fast access mode (**Save**), display the route to the destination (**Show route**) or call the number if a telephone is connected and a phone number is available by pressing the button with the  symbol.

#### Selecting a destination from Contacts

You can call up Microsoft® Outlook® contacts that have been imported into the Navigation device and start route guidance to one.

#### Note:

The Microsoft® Outlook® contacts are imported via the Content Manager.

> In the main menu, press the button **My destinations**.

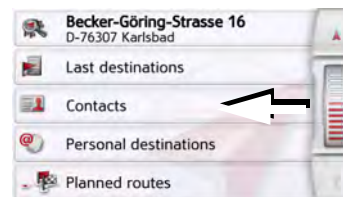

> Press the **Contacts** button.

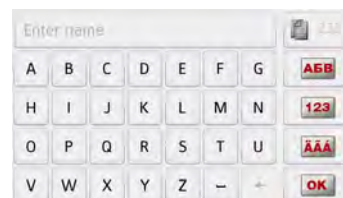

An input menu appears if there are more than 10 contacts. If there are fewer than

10 entries, a list of contacts is displayed straight away.

> In the input menu, select the first letters of the entry you are looking for.

> Press the **OK** button when the name you want is displayed in the top line.

If there are 5 or fewer entries available with the letter combination entered, a list containing these entries will automatically be displayed.

#### Note:

You may also first have a list displayed that corresponds to the letter combination entered. For this purpose, press the  button in the input menu.

> Select the desired entry in the list.



Press the **Start** button to begin route guidance to the address displayed for this contact straight away.

You can also display the address shown for the contact on the map (**On map**), store itin fast access mode (**Save**), display the route to the destination (**Show route**) or call the number displayed if a phone number is provided (button with the  symbol).

If there are a number of addresses provided for the chosen contact, you can select one of them after pressing the button **1**.

If there are a number of phone numbers provided for the chosen contact, you can select one of them after pressing the button **2**.

## The New destination menu



> In the main menu, press the button **New destination**.

The menu for new destinations appears.

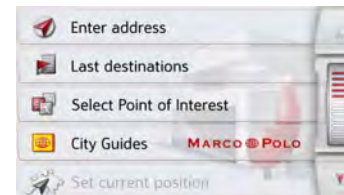

## Layout of the New destination menu

### Enter address

The various steps from selecting an address to starting route guidance can be carried out using the **Enter address** button.

- See "Entering the address" on page 44.

### Select Point of Interest

Points of interest such as airports and ferryports, restaurants, hotels, petrol stations or public buildings can be selected and route guidance started using the **Select Point of Interest** button.

- See "Points of interest" on page 52.

### Travel Guide (model dependent)

With the travel guide, you can select, for example, MARCO POLO Top-Highlights or MARCO POLO Insider Tips and start the guide destination there. See "Travel Guide (model dependent)" on page 56.

### Select on map

With the button **Select on map**, you can select a destination directly on the map and start route guidance.

- See "Selecting a destination from the map" on page 57.

### Enter geo-coordinates

The geographic coordinates for a destination can be entered and route guidance started via the **Enter geo-coordinates** button.

- See "Coordinate entry" on page 58.

### Route planning

A route with several waypoints can be planned using the **Route planning** button.

- See "Route planning" on page 58.

## Entering the address

The **Enter address** button in the destination input menu opens the menu for entering addresses.

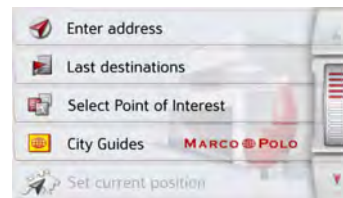

> In the destination input menu, press the **Enter address** button.

The menu for entering addresses appears.



### Note:

By pressing the **Clear form** button (top right) you can delete all entered data apart from the country.

### Selecting a country

You can select a country from those available using the button for the country of destination. A country is adopted automatically in the address input menu after selection. If a country of destination has already been entered it will remain until you select a different country.





> Press the button containing the country of destination to access the country selection list.

The selection list appears.



> Press the button for the desired country.

### Note:

If required, press the arrow keys   or use the scroll wheel on the right of the screen to scroll through all available countries of destination.

The  symbol indicates the countries for which an address can be entered using speech. (depending on the model)

### Selecting an address and starting route guidance

You can enter the exact destination address in the address input menu.



The following settings can be made in the address input menu:

- Town
- Zip code (or postal code)
- Street and house number
- Junctions as an orientation aid

It is also possible to:

- search for a point of interest near to the address entered (**POI search**). This can be entered as described under "Point of interest near to an address" on page 54.
- save the destination in fast access mode,
- show the route on the map. For details please see page 97.
- start the route guidance straight away.

### Selecting a town

The destination can be entered by either using the name or ZIP code.

When you enter the letters of a place, the navigation device displays suggestions (See "Accepting proposals" on page 30). If you do not want to accept the proposal, just enter the other letters of the location you want.

The Navigation device excludes all impossible letter combinations and ZIP codes and activates only letter fields or numerical fields that lead to an existing location or ZIP code.

> Select the option of entering the town or postcode.



> Enter the letters of the destination town or the numbers of the postcode consecutively.

#### Note:

If two words need to be entered you must separate them with the character

–

When sufficient letters have been entered it will automatically switch to a list from which you can select the town. However, you can switch to the list before this by pressing the  >300 button.

#### Note:



If you have entered a postcode, the name of the town will be hidden in the input menu to start with. If you then enter the street name, the name of the town will then also be displayed.

### Using the town list

Once a few letters of the desired town have been entered you can display a list of all the towns with the relevant letter combinations or this list will be displayed automatically.

> Press the  >300 button on the right of the screen to call up the list.



Using the   buttons or the scroll wheel, it is possible to scroll through the list.

> Press the button for the required town.

### Selecting the street

In the **Street** menu field the street and house number can be entered separately using a letter and number field.

The Navigation device excludes all impossible letter combinations and activates only those letters that could give an existing street name.

A house number can only be chosen once the street has been selected and if house numbers are included in the data.

> Enter the letters of the destination street consecutively.



When sufficient letters have been entered it will automatically switch to a list from which you can select the street. However, you can switch to the list before this by pressing the  >300 button.

### Using the street list

Once a few letters of the desired street have been entered you can display a list of all the streets with the relevant letter combinations or this list will be displayed automatically.

> Press the  >300 button on the right of the screen to call up the street list.



You can scroll through the displayed list using the   buttons.

> Press the button for the desired street.

### Selecting the Intersection

After entering the destination town and street, you can enter a junction so as to further limit the choice.

#### Note:

Instead of entering a junction, you can also enter a house number. However, it is not possible to enter both at the same time.

> Press the **Intersection** button.

The input menu for the name of the junction will appear.

> Enter the name of the junction.

Once a few letters of the desired street have been entered a list will automatically be displayed.

> Press the button for the desired street.

### Selecting a house number

After entering the destination town and street, you can enter a house number so as to further limit the choice.

#### Note:

Instead of entering the house number, you can also enter a junction. However, it is not possible to enter both at the same time.

> Press the **No.** button.

The input menu for the house number will appear.

> Enter the house number and then press the **OK** button.

### Displaying the route

Once the address has been entered, the address input menu allows the route to the destination to be displayed on the map.

> Press the **Show route** button to display the route on the map.

The route is calculated.

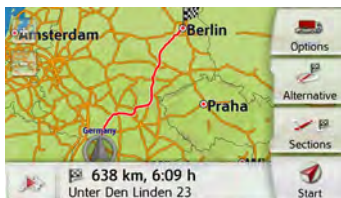

You can start the route guidance directly from this screen using the **Start** button.

The other options on this screen are described under "Displaying the whole route" on page 97.

### Storing a destination

In the address input menu, the **Save** button opens a menu where a name can be entered for the specified destination. If the desired name has been entered and **OK** has been pressed to accept it, the destination is transferred to fast access mode and protected.

### Starting navigation

The **Start** button starts the route guidance.

All data entered thus far is processed when calculating the route.

> Press **Start** to start the route guidance.



The route is calculated. The map will then be displayed and the route guidance will begin.



**Note:**

The symbols above the progress bar refer to restrictions that you may have activated (e.g. unpaved roads, toll roads).

If the route guidance is already running you will be asked whether the new destination should replace the old destination or if the new destination should be regarded as a waypoint.

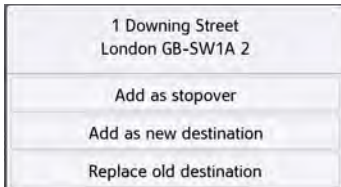

> Select between **Add as stopover**, **Add as new destination** or **Replace old destination**.

If the route guidance is already running and a waypoint has already been entered you will be asked whether the new destination should replace the old destination or the waypoint.



> Select **Replace stopover** or **Replace old destination**.

**Note:**

If there is no GPS signal when the route is calculated, the following will be displayed:

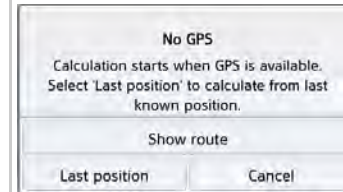



When a GPS signal is available, the route calculation will start automatically.

When the **Last position** button is pressed, the last known position is used and the route calculated from this position.

**Entering address by speech (selected models)**

You can start the spoken address entry from the address entry menu by pressing the  button.

**Notes:**

- Only one address can be entered using the voice entry function. Lists for more precise selection cannot be operated using speech.
- The destination country cannot be entered using speech.
- The  symbol in the list of countries indicates the countries for which address entry using speech is possible.  
If entry using speech is not possible, the  button will be displayed greyed out.
- An address and the street number must be spoken in the language of the destination country.

After pressing the  button, a menu that shows you how to say an address will be displayed.



You can say the address as soon as you see the lines next to the stylised face.

**Notes:**

- If a number of languages are spoken in the destination country (as is the case in Switzerland, for example), you can set another language by pressing the **Change language** button.
- You can say the complete address or just a part of it.  
Possible entries include:
  - street number - street - town
  - street - town
  - town

> Say the address.

If your entry is unique, after a short time the menu for entering addresses will be displayed with your entry filled in.



If the address displayed does not match the address you said, you can make appropriate changes.

If the address is correct, you can start route guidance, display the route or store the address as described on page 48.

If your entry was not unique or the Navigation device was not able to uniquely assign your entry, you will be shown appropriate lists. You can then select the address you want from these lists.

Depending on your entry, lists with town names, lists with street names or combined lists with town and street names can be displayed.

**Note:**

Voice entry can be restarted at any time in the lists by pressing the  button.

The following example shows a list in which a town can be selected.



Entries identified with the  symbol open up a further list when they are selected. This can be necessary if, for example, the same town name occurs a number of times in the set country.

Once you have selected the town or street you want in the lists, the menu for entering addresses is displayed after a short time with your entry filled in. You can then start route guidance, display the route or store the address as described on page 48.

**Speech Dialogue System (selected models)**

The Speech Dialogue System is an extension of the spoken address entry. As well as entering addresses directly, selected device functions can be operated via speech dialogue. This function is available in the following languages: German, English, Italian, Spanish and French.

**Explanation of symbols**

The following symbols are displayed on the left-hand side of the screen:

	Please speak
	Please listen
	Please click (to start voice control)

**Objective**

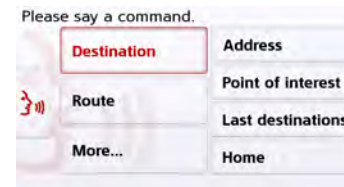

You can enter the following destinations via speech entry:

- Address
- Point of Interest
- Last destinations
- Home

To enter an address, see page 58.

If you have not yet entered a destination,

or you have not set a home address (because this is the first time you have used the device), these fields are greyed out.



Points of interest are divided into different categories. Route guidance is also activated in the screenshot above, so the device asks if the petrol station should be located on the route or near the destination.

## Route

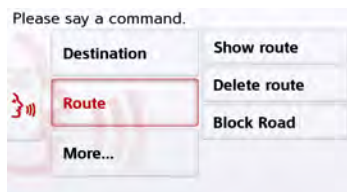

When you enter a destination, the following options are available:

- Show route
- Delete route

- Block road
- If there is not currently a route activated, this field is greyed out.

## More...

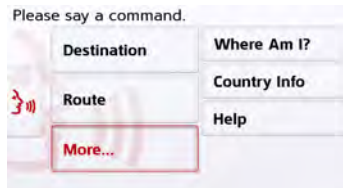

When you click on **More...**, you can choose between three menu items.

Under **Where Am I?**, you can determine the current GPS position.

If you select **Country info**, you will be given information about the country you are currently in.

**Help** gives you useful information about speech entry. For example, it lists all phrases which can be used as soon as the speech dialogue is started. As well as these global commands, you will also find help for entering addresses or for points of interest.

With the Live POI Search your Becker navigation device establishes a connection to our live Server. You have access to millions of addresses in Europe. You can choose between:

- A Live POI Search in the vicinity,
  - A Live POI Search near to an address
  - A Live POI Search near to a destination
- Subsequent operation is similar to how it is described in the chapter entitled Points of interest on page 52, except that no categories can be selected.

## Points of interest

Points of interest (POI) are included in the map and can be displayed there. Points of interest include airports and ferry ports, restaurants, hotels, petrol stations, public buildings. You can use points of interests as navigation destinations.

## Live POI Search (model dependent)

**Note:**

You can only select points of interest in the area in question if the GPS reception is adequate for determining a position. Otherwise, the last position stored will be used.

You can extend the places of interest stored on the device by installing additional POIs in KML format on your device via the Content Manager.

- > In the main menu, press the button **New destination**.

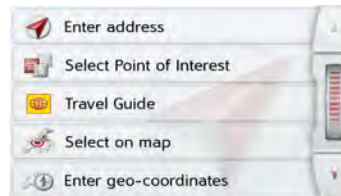

- > Press the **Select Point of Interest** button.





You can choose between:

- a point of interest in the vicinity,
- a point of interest near to an address,
- a point of interest near to a destination,
- a point of interest along the route or
- entering a point of interest directly.

**Point of interest in the vicinity**

- > Press the **POI nearby** button.



Press the arrow keys   or use the scroll wheel to scroll through the list displayed.

- > Select one of the available categories.

**Note:**

You can also press the **All categories** button. An input menu will then open and you can enter the name of a point of interest directly and confirm it.

For some categories, e.g. petrol stations, a further selection menu is displayed in which you can narrow down the choice further, e.g. by brand.

If you have selected the category, any points of interest belonging to the relevant category and available within the area in question will now be displayed.



The name, distance as the crow flies and the address is displayed for each entry.

> Select the desired point of interest.

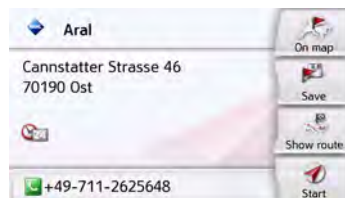

You will now receive additional information about your chosen destination.

> Press the **Start** button to begin route guidance to the point of interest directly.

In addition, the selected point of interest can be:

- displayed on the map (**On map**),
- saved in fast access mode (**Save**),
- used for displaying a route to the POI (**Show route**),
- if a telephone is connected and a phone number is available by pressing the button with the  symbol. (depending on the model)

### Point of interest near to an address

> Press **POI near location**.



> Select the desired country.

> In the **City** or **Code** field, enter the town where you wish to search for a point of interest.

#### Note:

If you have already entered an address, this address will appear by default.

> Press the **Select category** button.

The available Points of interest categories for the city entered will be displayed.

> Select the desired point of interest as described under "Point of interest in the vicinity" on page 53.

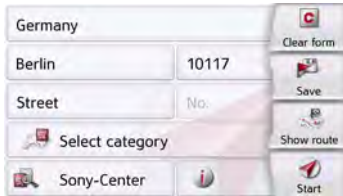

> Press the **Start** button to begin route guidance to the point of interest directly.

However, you can also store your chosen point of interest in fast access mode (**Save**) or display the route to the point of interest (**Show route**).

**Note:**

Your can also press the **Select Point of Interest** button. An input menu will then open and you can enter the name of a point of interest directly and confirm it.

By pressing of the **i** button next to the selected POI, you can display the additionally available information for the destination.

**Point of interest near to destination**

> Press the **POI near destination** button.



The categories available near to the destination are displayed.

> Select the desired point of interest as described under "Point of interest in the vicinity" on page 53.

**POI on route**

> Press the **POI on route** button

The available Point of Interest categories available on the whole route will be displayed.

> Select the desired point of interest on the route as described under "Point of interest in the vicinity" on page 53.

**Entering a point of interest directly**

> Press the **POI search by name** button.



> Enter the desired point of interest or part of the name.

> Press the **OK** button.

The Navigation device displays in a list all the points of interest corresponding to the name entered.

> Select the desired destination in the list.



You will now receive additional information about your chosen destination.

> Press the **Start** to begin route guidance to the point of interest straight away. However, you can also display your chosen point of interest on the map (**On map**), store it in fast access mode (**Save**) or display the route to the point of interest (**Show route**).

### Calling special destination phone number (depending on the model)

You can dial directly phone numbers specified in the information on a point of interest

The prerequisite here is that a cell phone is connected via Bluetooth® wireless technology with the Navigation device.

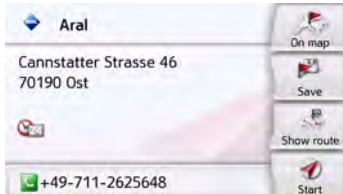

> Press the button with the  symbol shown at the bottom of the point of interest information screen.

The call will be initiated.

### Additional point of interest information

Any additional information that is provided for a point of interest can also be displayed.



To display the additional information, press the **More** button shown at the bottom of the point of interest information screen.

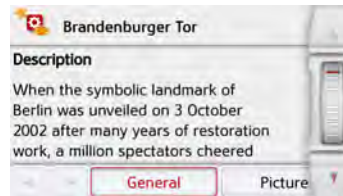

You can scroll through the displayed text using the arrow buttons or the scroll wheel.

### Travel Guide (model dependent)

The Travel Guide acts in a similar fashion to the "Enter point of interest" function (see also page 44).

The Travel Guide for Berlin is already pre-installed. All travel guides are available in 5 languages (D, E, I, S, F). Other languages are represented in English. Additional cities can be purchased from the ContentManager (see also page 33).



### Selecting a destination from the map

You may also select a destination directly from the displayed map.

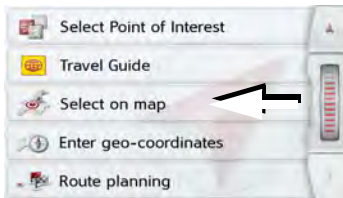

> Press the **Select on map** button.  
The map display appears.

**Note:**

You may need to make the area larger using the zoom buttons **+** and **-** in order to find the desired point. You can also move the map to the desired point.



> Press the desired point lightly on the surface of the screen.  
A flashing red cross will be displayed at this point.

**Note:**

By pressing the **GPS Position** you can display your current position again.

> Press the **Select** button.



Where available, the address of your chosen point is displayed.

> Press the **Start** button to begin route guidance to the destination straight away.

You can also search for points of interest in the vicinity of your chosen point using the POI nearby button.

However, you can also store your chosen point in fast access mode (**Save**) or display the route to the point of interest (**Show route**).

You can select a new destination by touching the map even during the route guidance in progress, in order to insert a stopover or to replace the old destination. When touching the display, a compass appears with arrows to adjust the horizontal display and the vertical display angle of the map. This function is described on page 93.

## Coordinate entry

You can also enter your destination using geographic coordinates.

> In the main menu, press the button **New destination**.

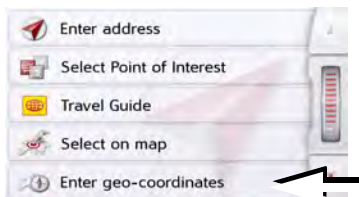

> Press **Enter geo-coordinates**.

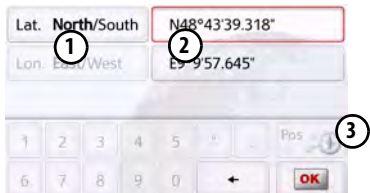

> Using (2) select the value you wish to change.

> Using the two buttons indicated by (1) select the direction required for the geographic longitude and latitude (east/west or north/south).

> Then enter the desired values using the buttons **1** to **0**.

The entry field at the beginning may be displayed greyed out. Delete any entries in the field with the backspace button, in order to use the entry field. You can enter coordinates in three different ways.

The following formats can be used:

- Degrees Minutes Seconds.Decimal seconds e.g. 42°52'46.801"
- Degrees Minutes.Decimal minutes e.g. 48° 53.56667'
- Decimal degrees e.g. 48.89277778

### Notes:

- The coordinates entered must correspond to WGS84 (World Geodetic System 1984).
- If you press button (3) your current geographic position will be entered into the fields.

> Press the **OK** button.

Where possible, an address matching the coordinates will be displayed. You can view the destination on the map, store it, display the route to the destination or start the route guidance straight away.

## Route planning

The route planning menu allows you to create and select individual routes. To do this, enter the individual destination points for the desired route. It is then possible to travel to these points consecutively without having to enter any further information. You can also optimise the destination points entered and in so doing change their order.

> In the main menu, press the button **New destination**.



> Press the **Route planning** button.

In the route menu you can create a new route by pressing the **Create new route** button. Previously stored routes are shown in a list below this.



**Note:**  
If no routes have yet been stored, the route menu is empty.

**Scrolling through stored routes**

> Press the arrow keys or use the scroll wheel on the right of the screen to scroll through the stored routes.

**Editing stored routes**

You can add additional stages to a stored route, change the name of the route or delete it.

> Press the button in front of the route you wish to edit.

By pressing **Add stage** you can now add a stage to the route.

After pressing **Rename route** you can give the route a new name.

Pressing **Delete route** will allow you to delete the route from the stored routes.

**Selecting and starting a route**

> Press a route to select it. The route is loaded and displayed in the stage menu.



> Press the top button.

**Note:**  
You can also select a leg of the route. The route is started as of this leg.

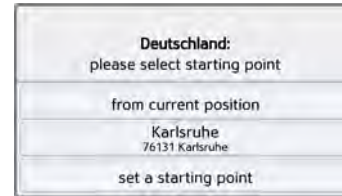

> Select the start point or your current position as the start point for route guidance.

**Note:**  
If a start point is selected, this is only used to view a route.

The individual stages are calculated. A map of the stages will then be displayed.

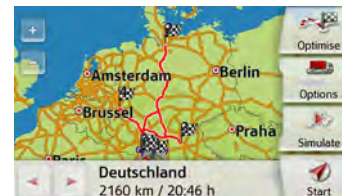





> Press the **Start** button to start guidance for this route.

You can call up the route options using the **Options** button.

**Simulation of the route**

There is a play button  on the left under the map, used to start a simulation of the route.

If you touch the display after starting, a control bar is displayed at the top with control buttons for the simulation. You can pause the simulation with the  button, and continue it with the  button. The  button allows you to fast forward the simulation by a 16x speed. You can move from route section to route section with the  and  buttons.

If there is no further action, the control bar disappears after a few seconds.

**Creating a new route**

> Drücken Sie in der Routenplanung die Taste **Create new route**.

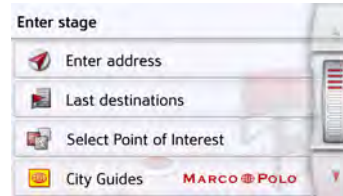

You can now enter an intermediate destination as described under "The New destination menu" on page 43 (**Enter address, Select from last destinations, Select Point of Interest, Travel Guide, Contacts, Personal destinations, Select on map or Enter geo-coordinates**). You also have the option of quickly selecting a destination using the **Select from last destinations** button.

> In the input menu, press the **OK** button to accept the relevant intermediate destination.

**Notice (depending on model):**

Here you can define a loading time. This, in turn, has an impact on the calculations of the arrival time for the subsequent destinations of the route.

> Enter the loading time in hours and minutes using the buttons.

If you do not want to set any loading time, press the **No loading time** button.

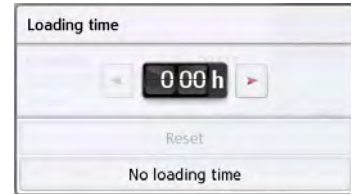

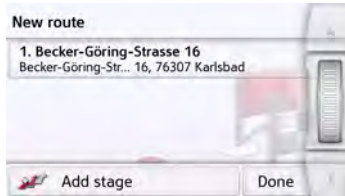

- > Press **Add stage** to enter further intermediate destinations as described above.
- > When you have entered all intermediate destinations, press the **Done** button.

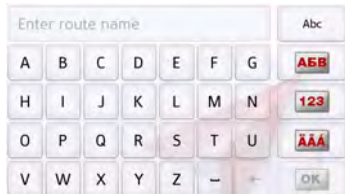

- > Give the route a name of your choice. The stage menu for the new route will be displayed.

**Editing a route**

- > Select the route you wish to edit.
- > Press the  button in front of the stage you wish to edit.

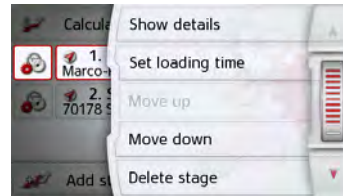

The edit menu will be displayed. The following options are available:

Option	Meaning
<b>Show details</b>	The data relating to the intermediate destination is displayed. From this screen, you can display the intermediate destination on the map.
<b>Entering loading time</b>	You can define the expected loading time. This is necessary in order to display the most accurate expected arrival time possible.
<b>Move up</b>	The stage is moved forwards by one position.

Option	Meaning
<b>Move down</b>	The stage is moved backwards by one position.
<b>Delete stage</b>	The stage is deleted from the route.
<b>Replace stage</b>	You can replace the selected stage with another intermediate destination.

### Optimising a route

If you have entered several destinations for a route, you can use the Navigation device to optimise the order of the destinations for the journey distance. The route stored is retained even after optimization, however.

Call up the map display for the stages of the route.

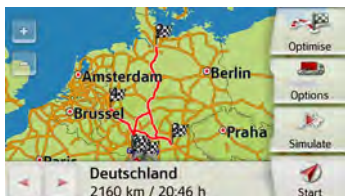

> Press **Optimise**.

The route is optimised and recalculated.

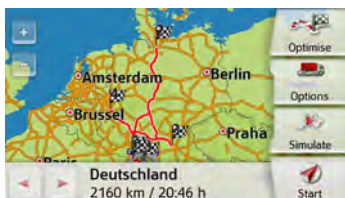



The optimised route is displayed.

### Navigation settings

The navigation settings contain all the settings that are relevant to the navigation functions.

#### Note:

All your settings must be confirmed by pressing the  button. Only in a few cases it is possible to confirm selections in the menu using the **OK** button or the **Yes** button.

> In the main menu, press the  button.

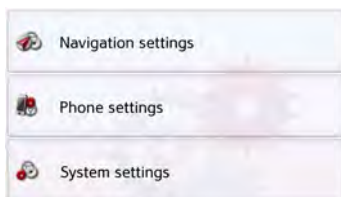



> Press the **Navigation settings** button.

This will take you to the navigation settings menu.

### Configuration

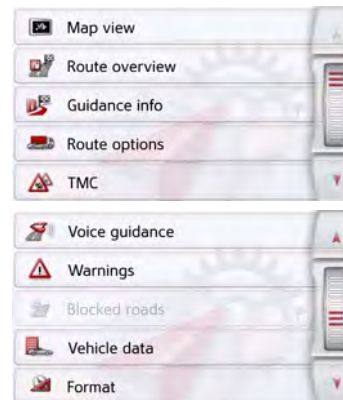
Various pages containing functions are available in the menu:



You can go to the next or previous page of the settings by pressing the  and  buttons or the scroll wheel.

### The Map view button

You can select whether the map is to be displayed in 3D or 2D mode, in a split screen with 3D or 2D display or in arrow mode.

You can also select whether or not 3D buildings available in towns should be displayed in 3D mode.

Further setting options are available to you in the extended settings.

> Press the **Map view** button in the settings menu.

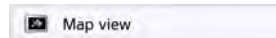

The **Map view** settings window appears.

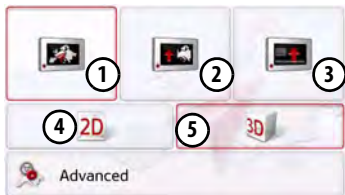

- > Press the button (4) or (5) to select whether to use 2D or 3D mode.
- > Press the button (1) to select the entire map.



> Press the button (2) for a split screen.

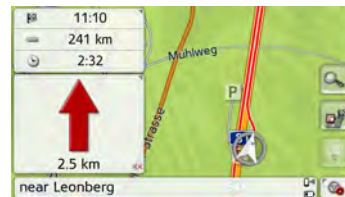

> Press the button (3) for arrow mode.



To call up the extended settings, press the **Advanced** button.

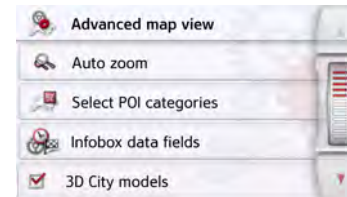

The following setting options are available in the extended settings:

- **Auto zoom**

You can select how the map changes when approaching an action point or at different speed.

- **Select POI categories**

You can select which symbols are displayed for points of interest on the map.

- **Infobox data fields**

In this menu you can define the data to be displayed in the Info box in the top left corner of the map view. You can select between Speed, Speed limit, Time and Height.

- **3D City models**

You can select whether or not 3D buildings available in towns should be displayed in 3D mode  or not . This option is only available with the 3D view active.

- **Street names 2D/Street names 3D**

You can select whether the street names should be displayed () or not () in 3D or 2D mode.

- **2D heading up**

You can select whether the map should always be orientated to the direction of travel () or to the north () in 2D mode. This option is only available with the 2D view active.

### Auto zoom

> Press the **Auto zoom** button in the extended settings.

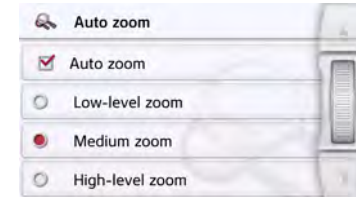

Pressing the **Auto zoom** button switches the zoom function on () or off ()

When the zoom function is switched on, you can select whether the autozoom action should be weak, medium or strong.



### Select POI categories

You can select which POI symbols are to be displayed on the map.

> Press the **Select POI categories** button in the extended settings.

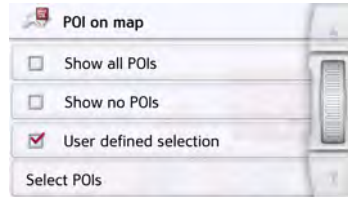

Selecting **Show all POIs** displays all points of interest on the map.

Selecting **Show no POIs** displays no points of interest on the map.

Selecting **User defined selection** and then pressing the **Select POIs** button allows you to determine for yourself in the menu which then appears whether each individual points of interest category is displayed or not.

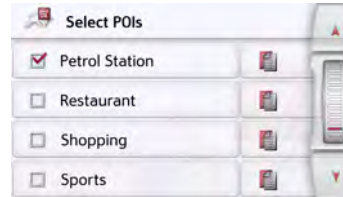

> You can then switch the display of entire categories on (✓) or off (□).

After pressing the [icon] button beside a category you can switch subcategories in further menus on or off.

> Confirm all your settings by pressing the [back] button.

### Selecting Info box data fields

In this menu you can define the data to be displayed in the Info box in the top left corner of the map view.

> Press the Info box data fields button.

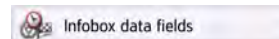

The Info box data field selection window appears.

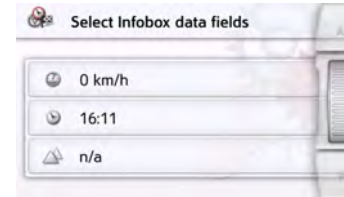

Touch the first field to select one of the possible options.

An options list appears on the right side over the window.

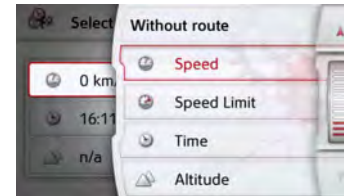

After selecting a route (cell with route), the following display options are available: Distance, Remaining time, Arrival time, Speed, Speed limit, Time and Height.

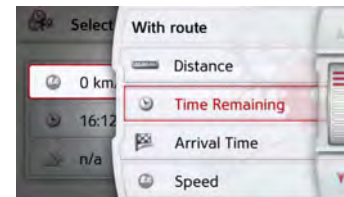

## NAVIGATION MODE

Under these options, you can select displays for the travel without a selected route. Here you can only select between Speed, Speed limit, Time and Height.

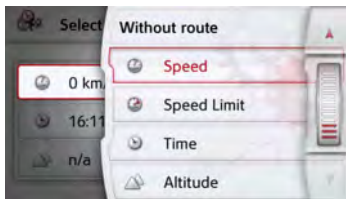

### 3D city view

With this option, you can select whether or not 3D buildings available in towns should be displayed in 3D mode or not. In the Advanced menu, press the 3D city view button to turn the function on or off.



> Confirm your setting in the Advanced menu by pressing the  button.

#### Note:

This setting is only available in the 3D view.

### The Route overview button

With the options in this setup menu you can select the Points of Interest to be displayed and whether TMC reports are displayed in the map view when pressing the Route overview  button.

> Activate the option All Destinations.

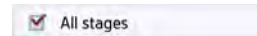

The Route Overview displays the Points of Interest selected in the POI Categories menu. The display is recalculated every two minutes.

> Activate the option TMC On Route.

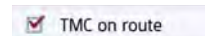

The Route Overview in the map view displays TMC announcements.

> Press the Select POI Categories button.

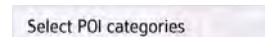

The Select POI Categories window is opened. Three point of interest categories can be selected.

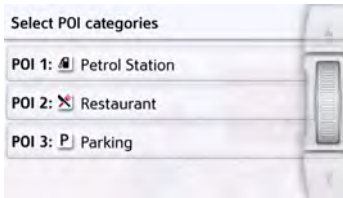

If you touch the preset option of one of the POI Categories (POI 1, 2 and 3), a selection list with 20 POI types appears.

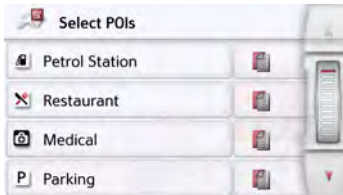

### The Guidance info button

In the **Guidance info** settings window you can select which additional information you would like displayed during route guidance.

> Press the **Guidance info** button in the settings menu.

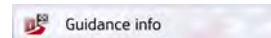

The **Guidance info** settings window appears.



The following settings are available:

Setting	Meaning
<b>Lane info</b>	When this function is enabled, a small arrow indicates which lane you should move into in the case of multi-lane roads.

Setting	Meaning
<b>Signposts</b>	When this function is activated, you receive additional important information at traffic junctions about the sign you should follow.
<b>Detour Assistant</b>	If this function is activated, the Assistant will help you to avoid traffic jams or traffic disruptions. The responsiveness can be adjusted with 3 sensitivity settings.
<b>Parking Assistant</b>	If this function is activated, the Assistant will help you to choose a car park at the destination.
<b>ExitAssistant</b>	If this function is activated, the Assistant will help you if you leave the motorway unexpectedly.

Setting	Meaning
<b>Country info</b>	When this function is enabled, you will automatically receive generally applicable traffic information for the relevant country when you cross a national border (e.g. speed limits).
<b>Lane Assistant Pro 3D</b>	If this function is activated, you will see an animated, realistic representation of your lane at many junctions if available.
<b>Junction view</b>	If this function is activated, you will see realistic views of the current lane situation, if available, at many motorway intersections.

Setting	Meaning
<b>Tunnel View</b>	If this function is activated, you will see a three-dimensional tunnel view when entering a longer tunnel.

**Note:**

This information can only be displayed if it is contained in the map material.

- > Press the relevant button to switch the required function on  or off .
- > Confirm your selection by pressing the  button.

**The Route options button**

You can edit your driving profile in the **Route options** settings window. The settings made here have an effect on the route selection and on the calculation of the estimated journey times.

- > In the settings menu, press the **Route options** button.

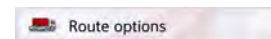

The **Route options** settings window appears.

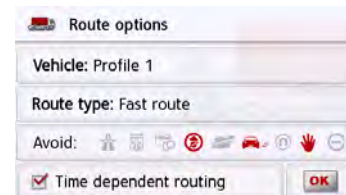

**Selecting the vehicle profile (depending on model)**

This setting influences the calculation of the expected time of arrival and blocks e.g. motorways for the bicycle setting.

> Select the mode of travel or the required vehicle profile after pressing the **Vehicle** button.



The different profiles are displayed and you can select the desired profile by pressing the appropriate button.

- ① Saved profile truck with trailer
- ② Saved bus profile
- ③ Saved mobile home profile
- ④ General truck profile
- ⑤ Car profile
- ⑥ Motorcycle profile
- ⑦ Bicycle profile
- ⑧ Pedestrian profile

After selecting the desired profile, it is displayed.

You can now change the selected profile, as described under "Truck and mobile home functions (depending on model)" on page 70 (only for selected models).

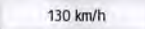

> Press the settings button  or  button.

The window for selecting the maximum speed is displayed.

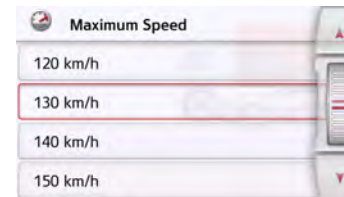

Select a speed and exit the speed menu with the back button .

> Exit the vehicle selection menu, too, with the back button .

The selected vehicle type is now displayed.

The required profile is displayed once selected.

**Truck and mobile home functions (depending on model)**

You can select or set the vehicle profile. For the truck profiles (depending on the model), you can define or select dimensions, weight, number of axles etc.

Once the appropriate profile is set, a route is calculated on the basis of these settings.

See also the chapter on supplementary functions for trucks and mobile homes on page 104.

**! Danger of accident!**

The information in the map material could be incorrect on account of sudden changes (e.g. construction sites)! The traffic situation and the signposts on site have priority over the information given by the navigation system.

**Notes:**

In the map display, roads are displayed with a light red contour if no specific information for trucks is available. You must therefore be particularly careful here.

With the GPS navigation activated the  symbol displays that there is no specific truck information available before the current road or the road to which the next driving manoeuvre is leading.

> Call up the option menu for the map screen.

 Route options

> Press the **Route options** button (depending on model).

> Press the **Vehicle** button

**Vehicle:** Car

Different menus are now displayed depending on the vehicle profile previously set.

> Confirm the profile currently set by selecting **OK** or select **Change profile** to change the profile.

You have different operation options in the car or truck profile menus displayed. You do not have any further setting options for all other profiles.

For the car profile:

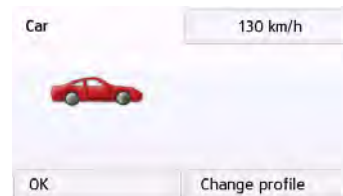

For the general truck profile or saved truck profiles (depending on the model):

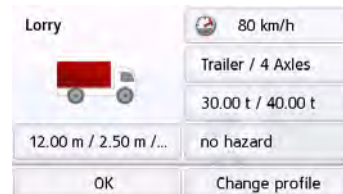

Here you can set the profile settings directly by pressing the buttons in the right-hand area as described on the following pages.

### Setting truck profiles

#### Notes:

This function is only available with models with optimized route navigation for trucks, busses and mobile homes.

> Select one of the saved truck profiles or the general truck profile.

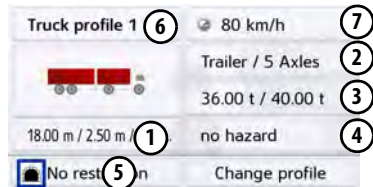

You can now set the selected profile:

- ① With this button you can set the size of the truck.
- ② With this button you can set whether the truck has a trailer and how many axles there are.
- ③ With this button you can set the maximum permissible weight as well as the actual weight.
- ④ With this button you can set the hazardous materials class of the truck.
- ⑤ Use this button to select tunnel restrictions. ADR tunnel categories B to E are available for selection.

With the three saved truck profiles you have the option to customize the truck symbol ⑤ and name ⑥

⑦ The window is displayed for selecting the maximum speed

#### Setting size

> In the profile settings, press the button for setting the size.



> Press the button next to the dimension to be entered.

An entry menu will appear.

> Enter the desired dimension.

> Confirm the entry in the entry menu by pressing **OK**.

Once you have made all the required settings, confirm your settings by selecting



#### Setting trailer and axles

> In the profile settings, press the button for the trailer and axle settings.

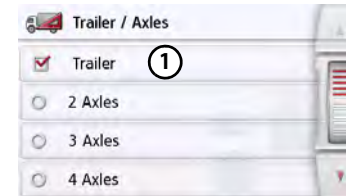

> Use the ① button to select whether there is a trailer () or not ()

> Select the total number of axles.

> Confirm your settings by selecting

#### Setting weight

> In the profile settings, press the button for setting the weight.



> Press the button next to the weight to be entered.

An entry menu will appear.

> Enter the desired weight.

> Confirm the entry in the entry menu by pressing .

Once you have made all the required settings, confirm your settings by selecting .

Setting hazardous materials class

> In the profile settings, press the button for setting the hazardous materials class.

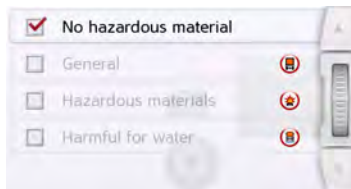

> Select the required hazardous materials class.

Set tunnel category (ADR)

> In the profile settings, press the button for setting the tunnel categories .

> Select the required tunnel category.

If you do not select any of the available restrictions (B to E), all tunnels will be used for your route.

Once you have made all the required settings, confirm your settings by selecting .

### Selecting vehicle category and name

Once you have changed one of the truck profiles, you have the option to enter the displayed truck symbol and name.

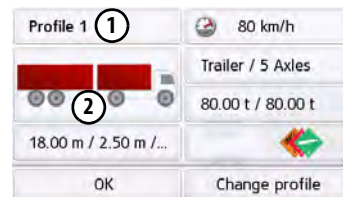

> Press the  button to enter another name.

The entry menu will appear.

> Enter the desired name.

> Confirm the entry in the entry menu by pressing .

The name is changed.



> Press the ② button to change the displayed symbol.



> Select the desired symbol. The new vehicle category is displayed in the profile.

**Selecting the route type**

> After pressing the **Route type** button, select one of the following options.

Option	Meaning
<b>Fast route</b>	With this option, the fastest route in terms of travel time is calculated.
<b>Economical route</b>	With this option, the most economical route in terms of travel time and mileage is calculated taking into consideration further parameters such as gradients, for example.
<b>Short route</b>	With this option, the shortest route in terms of mileage is calculated.
<b>Easy route</b>	With this option, a route with as few manoeuvres as possible is calculated. This may result in larger detours.



**Time-dependent route guidance**

If this function is switched on (☑), information (statistical information) on the possible speed on certain segments at certain times of the day is also taken into account in the route calculation, provided this is available. This provides a more accurately calculated arrival time and may even result in a different route being selected.

**Avoiding particular types of road**

After pressing the button **Avoid** you can exclude various types of road (e.g. **motorways**, **ferries** and **toll roads**), from the route calculation.

You can set one of the following options for each of these road types.

Option	Meaning
	Permitted With this option, the road type in question is included in calculating the route.
	Prohibited With this option, the road type in question is not included in calculating the route.

> Confirm your selection in the **Route options** window by pressing the **OK** button.

**The TMC button**

You can configure settings for the reception of traffic announcements in the **TMC** settings window.

> Press **TMC** in the settings menu.



The **TMC** settings window appears.

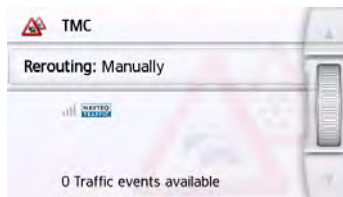

Setting	Meaning
<b>Rerouting</b>	This button allows you to choose whether the route change should be made <b>Never</b> , <b>Automatically</b> or <b>Manually</b> . (See "Taking announcements into consideration when calculating routes" on page 86.) The setting <b>Never</b> is equivalent to switching off the TMC function.

> Confirm your settings by pressing the  button.

An automatic search procedure presets the transmitter with the best reception. The currently received TMC-transmitter appears on the display.

The TMC announcements can be spoken by the voice, if the navigation settings in the **Voice guidance** menu the **Announce TMC events** option is activated.

### The Traffic Button (model dependent)

When the navigation device has access to the server, the heading **Traffic** and another icon are displayed instead of TMC. The traffic announcements will always then be retrieved updated from the server. The settings are the same as described in the chapter entitled TMC.



#### Notice:

The data transmission via your mobile phone may involve additional costs depending on the mobile phone contract. Please find out from your mobile phone provider before activating. If a connection to the server is not possible, e.g. because no mobile phone network is available for a longer period of time, then the system switches over automatically to TMC until a connection to the server is possible again.

### The Voice guidance button

In the **Voice guidance** settings window you can make settings relating to the voice guidance of the Navigation device.

> Press the **Voice guidance** button in the settings menu.

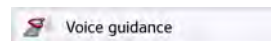

The **Voice guidance** settings window appears.

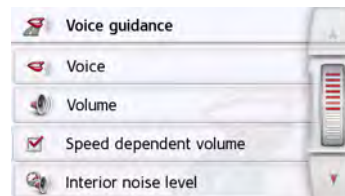

The following setting options are then available:

- **Voice**  
You can select the voice that will make the navigation announcements for the language that has been set.

- **Volume**

You can select the standard volume for voice announcements for each start of the Navigation device, or switch off voice announcements completely.

- **Interior noise level**

With the **Interior noise level** button, you can adjust the speed-dependent volume control. To do this, select the interior volume level suitable for your vehicle.

With the **Dynamic** setting (selected models), the interior noise is measured with the aid of the integrated microphone, the volume is then continually adjusted depending on the noise level.

#### Notice:

If the announcements of your navigation device are too loud at high speed, you should select a quieter interior noise. If the announcements are too quiet, you should select a louder interior noise.

- **Announce streets**

Using the **Announce streets** button you can switch the announcement of the names of streets into which you are to turn on () or off ()

- **Announce time of arrival**

Using the **Announce time of arrival** button you can switch the automatic announcement of the expected arrival times on () or off ()

**Note:**

The **Announce streets** and **Announce time of arrival** functions are only supported by speakers with the TTS function.

**Setting the Voice**

In the **Voice** settings window you can set the voice that will make the navigation announcements for the language that has been set.

> In the **Voice guidance** settings window, press the **Voice** button.

The **Voice** settings window appears.

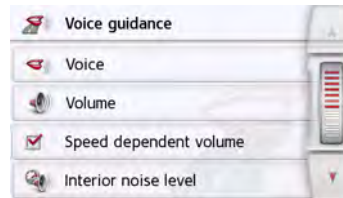

> Select the desired voice.

**Note:**

Voices with a (TTS) tag support the text-to-speech function (e.g. announcing roads and reading out text messages).

A short example announcement is given.

> Confirm your selection by pressing the  button.



**Setting the Volume**

With the **Volume** settings window, you can set the standard volume for voice announcements for each start of the Navigation device, or switch off voice announcements completely. Depending on the situation, this setting can be fitted into the map display.

> In the **Voice guidance** settings window, press the **Volume** button.

The **Volume** settings window appears.



> Select the desired volume with the  and  buttons or the scroll wheel.

> The voice output can be switched off completely or turned back on by pressing the Mute button.

> Confirm your settings by pressing the  button.

## The Warnings button

In the **Warnings** settings window you can select which warnings are to be displayed by the Navigation device or which warning sounds are to be output.

> In the settings menu, press the **Warnings** button.

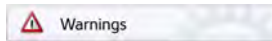

The **Warnings** settings window appears.

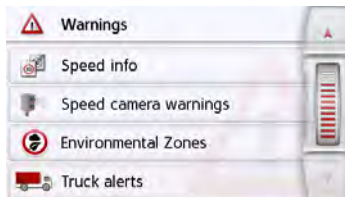

The following setting options are then available:

- **Driver alerts (depending on the model)**

You can have signs displayed, for example for dangerous curves or steep gradients, provided this information is stored in the map data.

- **Speed info**

You can select whether speed limits are displayed in parallel to the navigation.

You can also receive an audible warning about exceeding the speed limit.

- **Speed camera warnings\***

You can receive a warning about permanent speed checks.

- **Environmental zones (depending on model)**

You can let yourself be warned about environmental zones.

- **Truck Navigation (depending on model)**

You can let yourself be warned about loading and vehicle-specific restrictions (e.g. height, weight, restrictions for hazardous materials).

### Note:

There is no standardised rule in Europe on the use of this function (warning about speed checks). Please check the legal situation in the respective country. In Germany, for example, it is an offence to use this function while driving.

**Setting Driver alerts**

If this information is saved in the map material and is supported by your navigation device, you can display information signs, e.g. for dangerous bends or descending gradients. In addition, you can define whether the display of the sign is also to be accompanied by a warning sound.

> In the **Warnings** settings window, press the **Driver alerts** button.

The **Driver alerts** settings window appears.





The available driver alerts are divided into 4 categories. The four categories can be enabled  or disabled  individually. The warning sound can be set individually for each of the four categories by pressing the symbol with the bell ( warning sound switched on).

The following signs are available in the individual categories:

- **Curve warnings**  
This category includes warning signs that relate to sharp curves.
- **Traffic regulations**  
This category includes other traffic regulations, such as no passing zones.
- **General warnings**  
This category includes all other warning signs, such as steep gradients, falling rocks.
- **Informatory road signs**  
This category contains the available information signs.

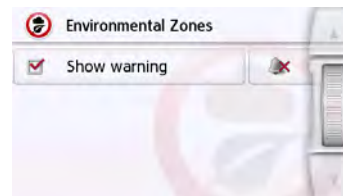
> Confirm your settings by pressing the  button.

**Setting environmental zones (depending on model)**

You can let yourself be warned about environmental zones provided that this information is saved in the card material and is supported by your navigation system. This function can be activated  or deactivated . By pressing the symbol with the bell, you can set the audible warning signal ( audible warning signal activated).

> Confirm your settings by pressing the  button.

**Truck warnings (depending on model)**

You can let yourself be warned about environmental zones provided that this information is saved in the card material and is supported by your navigation system. The function can be adjusted separately for journeys with and without active navigation. The function can be activated  or deactivated  respec-

tively. By pressing the symbol with the bell, you can set the audible warning signal (  audible warning signal activated).

> Confirm your settings by pressing the  button.

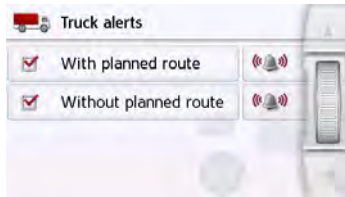

### Setting Speed info

The **Speed info** settings window allows to select whether speed limits are displayed in parallel to the navigation. You can also receive an audible warning about exceeding the speed limit.

#### Note:

This information can only be displayed if it is contained in the map material.

#### Risk of accident!

**The information in the map material may be incorrect as a result of short-term changes (road works, for example).**

**The traffic situation and the local road signs take precedence over the navigation system information.**

> In the **Warnings** settings window, press the **Speed info** button. The **Speed info** settings window appears.



The following settings are available.

Setting	Meaning
Show signs	Select whether speed limits are never displayed, always displayed or only displayed if the limit is exceeded. Furthermore, you can select whether the sign should blink when exceeding the speed limit, by selecting <b>Always</b> or <b>If speed limit is exceeded</b> .
In city	Select the amount over the speed limit at which you would like to receive an acoustic warning within built-up areas.

Setting	Meaning
<b>Out of city</b>	Select the amount over the speed limit at which you would like to receive an acoustic warning within built-up areas.
<b>Alert</b>	An audible signal is to sound when exceeding speed limits.
<b>Voice output</b>	A speaker's voice warns you of exceeding the speed limit.

> Confirm your selection by pressing the  button.

### The Blocked roads button

In the **Blocked roads** settings window you can unblock previously permanently blocked roads (See "Blocking a section of the road permanently" on page 126) or modify the block (time and days of week of block).

> In the settings menu, press the **Blocked roads** button.

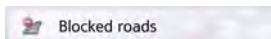

A window is displayed containing the roads that have previously been blocked.





#### Note:

To delete all blocked roads from the list, press the **Delete all blockings** button followed by the **Yes** button in the display that then appears.

> Select the blocked road you want.



The road is currently blocked for all days of the week, for the whole day . You can now set whether or not the road should be blocked for each day of the week.

> Press the buttons with the days on which the road should not be blocked .

> Press the clock symbol under one of the days and limit the block of this day to the required time of the day.

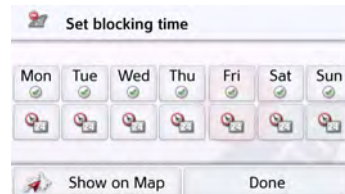



You can now set whether or not the road should be blocked for each day of the week.

> Confirm your settings by pressing the back button .

or

> Press the  button under one of the days and set up to two times when the road should be blocked.

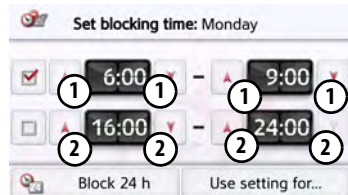

> Using the buttons ① set the first period when the road is to be blocked on this day.

> Using the buttons ② set the second period when the road is to be blocked on this day if necessary.

**Note:**

Press the **Block 24 h**, button to set a block for an entire day.

Press the **Use setting for...** button to also use the block on other days.

> Confirm your settings by pressing the back button .

**The Vehicle data button**

This menu allows the calculation of an economic route by using the fuel consumption of the vehicle.

> Press the **Vehicle data** button.

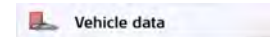

The **Vehicle data** window is displayed.

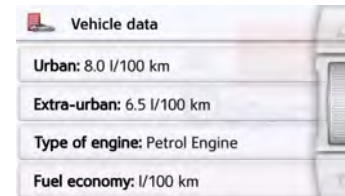

The following settings can be made:

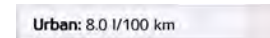

> Press the **Urban** button to enter the average fuel consumption of the vehicle within cities. The input menu for numbers appears. Any existing inputs can be deleted with the arrow buttons. Enter the fuel consumption value with the number keys. The value can be given to one decimal point. Confirm your entry by pressing the **OK** button.

**Extra-urban:** 6.5 l/100 km

- > Press the **Extra-urban** button to enter the average fuel consumption of the vehicle outside cities. This can be entered as described for the In city value.

**Type of engine:** Petrol Engine

- > Press the **Type of engine** button to set your engine type. The display changes by pressing the button repeatedly. You can select Petrol, Diesel and Hybrid as the engine type.

**Fuel economy:** l/100 km

- > Press on the **Fuel economy** button to change to the consumption unit. Pressing this button repeatedly will change the display. You can choose from the consumption units l/100 km, MPG (UK) and MPG (US).

### The Format button

In the **Format** settings window you can set the measurement units to be used for times and distances.

- > In the settings menu, press the **Format** button.



The **Format** settings window appears.

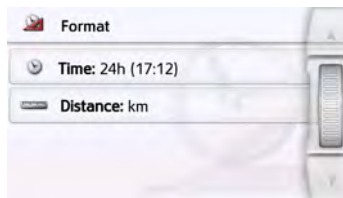

- > Press the **Time** button to switch between the 12 hour clock and the 24 hour clock.
- > Press the **Distance** button to switch between kilometres and miles.
- > Confirm your settings by pressing the  button.

### The Time button

You can select the time zone relevant for your location in the **Time** settings window. This setting is important for the correct calculation of the estimated time of arrival.

- > Press **Time** in the settings menu.



The **Time** settings window appears.

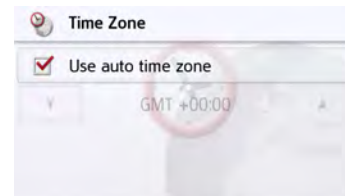

Using the **Time zone** you can set whether the time zone should be set automatically by the Navigation device or not (**Use auto time zone** on  or **Use auto time zone** off ).

If the automatic function is switched off, you can select the desired time zone by pressing the button below **Use auto time zone**.

## The Reset button

You can reset the navigation settings to their factory settings.

The settings will then be reset. The fast access mode data, stored routes, blocked routes, voice and home address are retained.



> Press the **Reset** button.

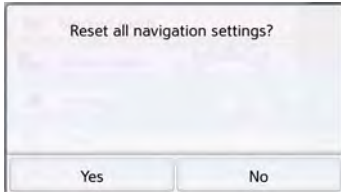

> Press the **Yes** button.

The navigation settings are reset to their factory settings.

## Traffic announcements using TMC (depending on the model)

Your Navigation device can receive traffic announcements (TMC messages) from radio stations. The power supply with the integrated TMC antenna must be connected to the carrier plate for this function.

### Note:

TMC is not available in all countries.

Traffic announcements are transmitted by radio stations via the TMC (Traffic Message Channel) in addition to the radio programme and are received and analysed by the navigation system. Receiving traffic announcements is free of charge.

### Note:

As the traffic announcements are transmitted by radio stations, we cannot assume responsibility for the completeness or accuracy of the announcements.

Austria: The location and event code was made available by ASFINAG and BMVIT.

The Navigation device constantly checks whether there are any relevant announcements for the route that has been set. All traffic problems that have been received are shown on the map.

If the continuous checks determine that a traffic announcement is relevant to route guidance, the unit can automatically recalculate a new route to the destination (See "The TMC button" on page 74).

## Live Traffic - Traffic Announcements via Data Connection (model dependent)

Your navigation device can receive traffic announcements from a server via a data connection. These announcements are more up-to-date than data received via TMC and are also available more quickly. There must also be an appropriate data connection. Subsequent use of the traffic announcements is the same as described below for TMC.

If a connection to the server is not possible, the system then tries to switch over to TMC traffic announcements (model dependent). As soon as TMC is displayed, there is no connection to the Live Traffic server.

In the Chapter entitled WiFi Settings on page 138 we describe how to create a data connection.

### Notice:

The data transmission via your mobile phone may involve additional costs depending on the mobile phone contract. Please find out from your mobile phone provider before activating. If a connection to the server is not possible, e.g. because no mobile phone network is available for a longer period of time, then the system switches over automatically to TMC until a connection to the server is possible again.

## Displaying TMC messages on the map

Current TMC messages are displayed on the map graphically. Sections of the route where there are traffic problems are highlighted blue. Arrows indicating the traffic direction which is affected by the traffic problem continue to be displayed.

In addition to the coloured mark, a warning sign is displayed on the stretch of road affected.



## Using TMC

When the Navigation device has been attached to the carrier plate (power supply with the integrated TMC antenna connected), your Navigation device will receive up-to-date traffic announcements. It is then possible to calculate dynamic routes (traffic jam diversion).

You can also view traffic announcements directly.



Settings for TMC can be made as described under "The TMC button" on page 74.

> In the main menu, press the  button.

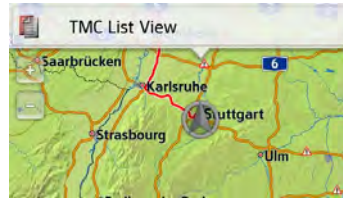
The map overview appears.



The message list appears when you press  **TMC List view**.

You can scroll through the list using the arrow keys   or the scroll wheel on the right-hand edge of the screen.

The following is displayed for each traffic announcement:

- ① The type of problem and the street number (motorway, A-road or district road)
- ② The distance as the crow flies from the current position, and the length and duration of the problem if applicable

③ The part of the route with the travel direction

④ If a TMC message lies on your route, the message is indicated by the sign



Traffic announcements received via Premium-TMC are indicated by the symbol.

⑤ A red twisted arrow next to the traffic report  warns for traffic jams that need to be avoided. If the arrow is crossed out in grey and red



, the route does not go around the traffic jam.





**Reading a message**

> Press on the desired message in the list. The message display appears on the top of the screen, while a map is displayed below it with the related route section. Press on the message again to display more information on the traffic obstruction. By pressing it again, the extra information disappears.

The message display appears.



- > Press the arrow buttons   to scroll in the messages.
- > Press the  button to return to the message list.

**Taking announcements into consideration when calculating routes**

Your Navigation device can take traffic announcements into consideration when calculating a route. You have the option of setting this function to automatic, manual or never in the  menu in the navigation settings with the TMC option (see "The TMC button" on page 74).

**Automatic recalculation**

If the traffic on your route is obstructed, the Navigation device checks whether an expedient detour of the obstruction is possible. If an expedient detour is possible, then an alternative route is calculated and you are guided via the alternative route.

**Manual recalculation**

If a traffic announcement affects your route, a window with detailed information on the traffic announcement appears.



If, after displaying the traffic message, the navigation system detects that a sensible alternative route is possible, the following display appears.

**Note:**

This display may also appear if, for example, a previously obstructed route is now free again.



The display provides you with an overview of the alternative route calculated.

The red route or route marked blue for an obstruction shows the previous route.

The route marked yellow displays the alternative route calculated.

In the right section of the display, you can see how much the route changes and how much time you will likely save if you use the alternative route.

> Now either press the **OK** button to use the alternative route or press the **Reject** button to continue using the existing route.

## The map display

The map display is used primarily for route guidance. However, you can also use the map display without route guidance to show your current position and, for example, to receive warnings about exceeding the speed limit.

### Calling up the map display

The map display is called up automatically when you start route guidance.

Without route guidance, you can call up the map display from the main menu.

The map display will then appear and, if GPS reception is available, will show your current position.

If route guidance is already active, the map will be displayed with route guidance.

## Structure of the map display

The structure depends on the settings made in "Map display options" on page 96 or in "The Map view button" on page 63 and whether route guidance is active or not.

### Map display without route guidance



If the navigation is not active, almost the whole area of the touch screen will be taken up by the map.

## NAVIGATION MODE

- ① Speed limit on the road currently being driven on (display not available for all roads), signs for the driver alerts will also be displayed
- ② Zoom buttons
- ③ Power level/telephone status (depending on the model)
- ④ Button for calling up the options
- ⑤ Vehicle position
- ⑥ Current road
- ⑦ Information box (if displayed) showing vehicle speed and altitude above sea level

### Map display with route guidance

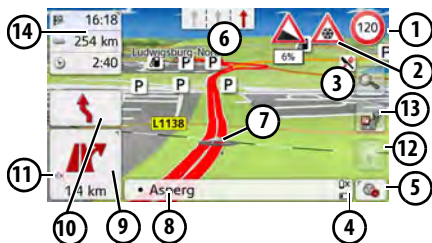

- ① Speed limit of the street currently being driven on (display is not available for all streets)
- ② Driver alerts (depending on the model)
- ③ Zoom buttons

- ④ Power level/telephone status (depending on the model)
- ⑤ Button for calling up the options
- ⑥ Traffic lane recommendation (only appears on some multi-lane roads; green arrows = recommended lanes)

#### Note:

If you follow the lane recommendation, the next driving maneuver is possible without changing lanes.

- ⑦ Vehicle position
- ⑧ Current street or street to which the next driving maneuver leads
- ⑨ Distance to the next driving maneuver
- ⑩ Next driving maneuver
- ⑪ Calls up volume settings
- ⑫ Button for **SituationScan**
- ⑬ Button for Route overview (only with the selected route active. If TMC announcements are activated on the route, a traffic jam warning sign appears on the button.)
- ⑭ Information box

Your current position is displayed on the map via the position icon.



### The Information box

During route guidance you can have information displayed in the Info box.

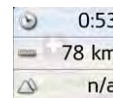

①

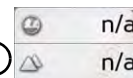

②



If you press the Info box again, more or less fields are displayed. At least one field and a maximum of three fields can be displayed. The information displayed depends on the settings that are selected in the **Navigation settings in the map view menu > Advanced > Info box data fields**. The following can be selected:

- With selected route **1**: Remaining distance to destination, remaining travel time, arrival time at the destination, speed, speed limit, time and and height above sea level.
- Without selected route **2**: Speed, Speed limit, Time and Positionheight



Information is also displayed in the bottom left corner in the preview area.

The next manoeuvre is displayed as an arrow, with a distance indication underneath it. If two driving manoeuvres are to be performed in succession within a short time, another smaller arrow indicating the second driving manoeuvre is displayed above the first arrow. You can adjust the volume of the navigation announcements by pressing the button with the speaker symbol in the preview area (See "Changing the announcement volume" on page 92).

**Split screen with route guidance**

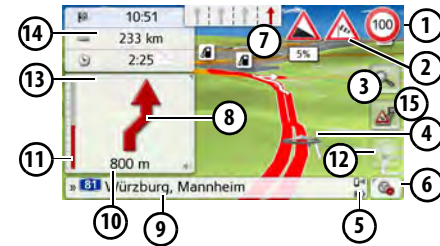

- 1** Speed limit on the road currently being driven on (display not available for all roads), signs for the driver alerts will also be displayed
- 2** Driver alerts (depending on the model)
- 3** Zoom buttons
- 4** Vehicle position
- 5** Power level/telephone status (depending on the model)
- 6** Button for calling up the options
- 7** Traffic lane recommendation (only appears on some multi-lane roads; green arrows = recommended lanes)

**Note:**

If you follow the lane recommendation, the next driving maneuver is possible without changing lanes.

- ⑧ Next driving maneuver
- ⑨ Current street or street to which the next driving maneuver leads
- ⑩ Distance to the next driving maneuver
- ⑪ Bar display to illustrate the distance to the next driving maneuver
- ⑫ Button for **SituationScan**
- ⑬ Calls up volume settings
- ⑭ Information box
- ⑮ Button for Route overview (only with the selected route active. If TMC announcements are activated on the route, a traffic jam warning sign appears on the button.)

**Route guidance with arrow display**

- ① Vehicle speed and altitude above sea level
- ② Information box
- ③ Button for **SituationScan**
- ④ Power level/telephonestatus (depending on the model)
- ⑤ Button for calling up the options
- ⑥ Button for Route overview (only with the selected route active. If TMC announcements are activated on the route, a traffic jam warning sign appears on the button.)
- ⑦ Driver alerts (depending on the model)
- ⑧ Speed limit of the street currently being driven on (display is not available for all streets)
- ⑨ Next driving maneuver

- ⑩ Traffic lane recommendation (only appears on some multi-lane roads; green arrows = recommended lanes)

**Note:**

If you follow the lane recommendation, the next driving maneuver is possible without changing lanes.

- ⑪ Current street or street to which the next driving maneuver leads
- ⑫ Distance to the next driving maneuver
- ⑬ Calls up volume settings

**Lane Assistant Pro 3D (model dependent)**

You can display an animated realistic representation of the lane at many junctions. To do this, switch on the function **Lane Assistant Pro 3D** as described under "The Guidance info button" on page 67. At selected complex junctions you will be shown exactly which lane you have to change to. You can leave the Lane Assistant Pro 3D again by touching the display.



**Map display with Junction view**

You can display a detailed and realistic view of the lane situation at many motorway junctions.

To do this, switch on the **Junction view** function as described under "The Guidance info button" on page 67.

If you are then directed through a motorway junction by the Navigation device, you will see a corresponding display.



> Follow the lanes indicated with the arrows.

**Tunnel view**

When you enter a longer tunnel, a three dimensional tunnel view appears. If there is no manoeuvres performed in the next 1000m in the tunnel, the lane of the current road section is displayed. An overview of the tunnel is displayed in the bottom on the right. When you touch the display, the tunnel view disappears. If any manoeuvres are performed in the tunnel, or if the next manoeuvre is performed outside the tunnel, a tunnel view is displayed in full image mode with the coming manoeuvre.

**Note:**

The tunnel view and the intersection view can be deactivated by touching the display. The map view is displayed again. If you would like to deactivate the tunnel view permanently, de-select the "Tunnel view" option in the **"Settings > Navigation settings > Route guidance"** menu.

**Note:**

The tunnel view provides a schematic view of the route layout of the tunnel. The whole tunnel layout, the first route section and the vehicle position are displayed. Since there is no GPS signal during the travel through the tunnel, the displayed position is only calculated.

## Using the map display

### Repeating the last announcement

During route guidance, the system announces important information, e.g. the next driving manoeuvre. The last announcement can be repeated with updated information.





> Press the speaker symbol in the preview area while route guidance is active.

The last announcement is repeated with updated information. The volume is also displayed. If the preview area is reduced and no speaker symbol is displayed, the announcement can be spoken again if you press the preview area.

### Changing the announcement volume

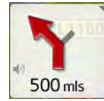

The volume of announcements can be adjusted.





> Press the speaker symbol in the preview area while route guidance is active. On the top edge of the image, the Mute button is displayed with a speaker symbol. A bar diagram and the  and  buttons are displayed on the right.



The bar diagram represents the volume.

> Press  or  or pull your finger over the scroll strip to increase or decrease the volume.  
> Press **Mute** in order to mute the announcements.

An **x** now appears next to the speaker symbol . With pressing the  button, you can make the volume control elements disappear.

> Press again the speaker symbol in the preview area to mute the voice again.

### Warning!

**Always adjust the volume so that you can still hear any ambient noise while driving.**

The bar display disappears again automatically after a short while if no button is pressed.

### Map zooming

The map can be zoomed into in steps by using the zoom buttons.



> Press the  button. The zoom buttons are displayed.





> Press zoom in  to "zoom in on the map" and therefore to get closer to the details displayed.

> Press zoom out  to "zoom out from the map" and therefore to obtain a larger overview.

> Press the  button to switch back to the set zoom step after a change.

**Note:**  
The zoom steps are altered in quick succession by pressing and holding the  or  button.

If you change the zoom step, a button with two red lenses  are displayed.

> Press the  button to restore the originally set zoom step.

### Moving the map

You can move the map to any point.

> To do this, press the map briefly.



> Then press any point on the map and move it in the required direction.

The map is then moved accordingly.

**Note:**  
By pressing the **GPS Position** you can display your current position again.

You can also select a point as a destination as described under "Selecting a destination from the map" on page 57.

### Map orientation



When a route is activated, the map view can be oriented in different ways.

If you have selected a 2D view in the Navigation settings in the map view (see page 64), this pertains to the compass direction only.

> Press the 2D map view on the display a little longer.



Apart from the pulsating point, a compass and two arrow buttons pointing to the left and right appear on the top edge of the screen.

> Press the  and  buttons to rotate the map towards the desired compass direction.



You can orient the map for example in the direction of travel.

If you have selected a 3D display for the map view, the vertical display angle can be adjusted, too.

> Press the 3D map view on the display a little longer.



Apart from the pulsating point, a compass and two arrow buttons pointing to the left and right appear on the top edge of the screen, and on the left edge of the screen, two arrow buttons pointing up and down are displayed.

> Press the button.



The viewing angle will be lower and the horizon is moved back after a while into the image.

> Press the button.



The viewing angle will be steeper. If the angle is exactly 90°, you are viewing the map in the 2D view from the top.

## The Route overview

With the Route overview, you can have Points of Interest (POIs) and, if the TMC on route option is activated in the **Navigation settings > Route overview** menu, TMC events displayed on the selected route.

> Press the button.

A list of POIs and traffic events are displayed. In the top edge of the screen, four single buttons are displayed for TMC announcements on the route and the three selected POI Categories are also displayed. Apart from the symbols, the

number of TMC announcements and POIs are displayed.

> Press one or more buttons to display TMC events or POIs.

A list of POIs and, if applicable, TMC events is displayed with the expected arrival time and distance from the current vehicle position.

> Press the desired Point of Interest or TMC event.

Information such as the address and the telephone number of the POIs or the type of traffic obstruction are displayed. From this view, all actions already described in the chapter Points of Interest on page 52 can be accessed, such as displaying POIs on the map, inserting or storing stopovers on routes.



2	11	28	P 43
207 km/2:02 h		234 km/2:23 h	
92 km/0:58 h		206 km/2:02 h	
48 km/0:32 h		67 km/0:43 h	
9.5 km/0:11 h		13.1 km/0:15 h	
1600 m/0:02 h		4.3 km/0:06 h	

The red line in the middle of the screen represents your route. If this line ends with two points, then the list continues and you can scroll through the complete list by moving your finger.

 2	 11	 28	 43
235 km/2:25 h		16:22, Chur	
		235 km/2:25 h	
207 km/2:02 h		234 km/2:23 h	
		206 km/2:02 h	
92 km/0:58 h		206 km/2:02 h	
48 km/0:32 h		67 km/0:43 h	

At cross-border destinations, the border crossing is displayed with the appropriate national flag. If you select the petrol station button, a petrol station is displayed before and after the border if available.

### Note:

If there is a traffic jam announcement on the route, the TMC symbol  appears on the  button. If there are no traffic jams reported on the route, the POI symbol  is displayed instead.

## SituationScan

If this function is activated  in the Navigation settings in the Route guidance menu, three assistants support the driver during the travel with useful information and help in case of unexpected traffic situations.

### The detour assistant

This function reacts to the reduction of the speed. If there are no POIs such as resting places or filling stations in the vicinity, the assistant assumes that the driver is in a traffic jam. If the  symbol is displayed in colour and begins to blink, the assistant suggests a detour.

> Press the  symbol.

A message is displayed with the question "You are probably standing in a traffic jam. Would you like to avoid the jam using a detour?". Now you can have the suggested detours displayed and select or reject them.

If the vehicle is not on a motorway, the detour assistant calculates possible alternative routes before the next crossing in case of strong stop-and-go traffic to get you there faster. If the assistant can calculate an alternative route before the vehicle passes the crossing, the  symbol is blinking. The alternative routes can be displayed and selected similar to the identically named function described on page 84.

### The Park Assistant

This assistant will be activated when you are near the destination or passed by the destination. In the case when the driver is looking for a parking place, the  symbol is activated as soon as it is possible to park in the given point of interest. Up to eight parking possibilities may be displayed, where the route to there and the footpath from the parking

lot to the destination are governing for the selection.

> Touch a parking possibility on the map to select it.

You can then have the route leading there displayed and the route guidance started. You can have the device lead you to the destination in pedestrian mode at the arrival at the parking place.

### The departure assistant

This assistant reacts when you leave the suggested route, and asks your intentions with a list of options. Depending on whether you are looking for a resting place or a parking place, or would like to avoid a visual traffic obstruction, a tunnel or a toll road, the assistant displays the appropriate POIs in the vicinity or calculates a detour that supports the driver in avoiding the given route section. If the assistant has calculated a detour, the  symbol is activated and blinking.

### Map display options



In the map display options, you can change the settings for route guidance, the map display and the route.



On the map display, press the button on the bottom right.



This opens the options menu for the map display.

You can go to the next or previous page of the options by pressing the  and  buttons or by using the scroll wheel.

#### Note:

The scope of the displayed functions depends on whether route guidance or a route with several destinations is active.

The options menu is exited either by selecting a function or by pressing the  button.



### Displaying the whole route

(Only available when route guidance is active.)

You can have the whole route to the destination displayed on the map. Additionally, you can have a complete route description displayed. As a further option, you can display and, if needed, select the different routes that can be set in the Route options.

> Call up the options menu for the map display.

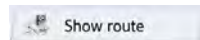



> Press the **Show route** button.



The complete route is displayed.

### Move route (model-dependent)

Becker RouteMove allows you to move your route with a single movement of your finger, providing a rapid means of adjusting your current route guidance with just one hand. After you switch to the Show route screen, the  icon is displayed on the left-hand side. It takes just a short time for the function to become available and the icon to change. As soon as this icon  is displayed and you select it, the route displayed can be moved.

Press and hold your finger down anywhere on the route displayed on the screen and drag the route to where you want it to be. The device will immediately calculate the updated route.

Original route





New route



The distance and journey time of the new route are displayed immediately underneath.

You can set the route options using the **Options** button.



By pressing the Play  button, the whole route can be simulated. The control elements, that are displayed by touching the screen shortly, allow you to play the simulation in up to 16x speed, or to step from route section to route section. The simulation can be stopped by pressing the back  button.

### Route description

> When the whole route is displayed, press the **Sections** button.



The first point of the route description is displayed on the map.

You can scroll through the whole route description with the **Next**  and **Back**  buttons.

You can also display a list version of the route description. For this press the **List view** button. The simulation is continued by pressing the **Resume**  button.





> Press the   arrow keys on the right hand side of the screen to scroll through the list.

If you press an entry in the route description, it is displayed on the map.

### Blocking route sections/roads

You can block individual route sections/roads. The Navigation device then calculates a sensible diversion to avoid the blocked section.

> Use the  and  buttons in the route directions to select the section of the route to be blocked.

> Press the **Block** button.

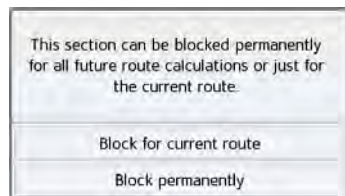

> Select **Block for current route** to block the section of the route for the current route guidance session only.

#### Note:

If the route section is more than 10 kilometres long, you can choose, in another menu, whether to block the entire section or just part of it.

> Select **Block permanently** to block the section of the route for future route guidance sessions too.

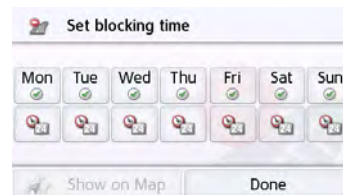

Changing of the blocking times is described on page 127.

## Selecting alternative routes

You can have the different routes displayed by the navigation device.

> When the whole route is displayed, press the Alternative routes button.

(This function can be selected in the Route overview, too.)

After a short time, the map is displayed. Each route is calculated after each other and displayed on the map. On the right-hand side, you can see the coloured list of the single routes, according to the kilometres to be travelled and the expected duration of the travel.

You can select the desired route by pressing the buttons on the right.

## Change route options

(Only available when route guidance is active.)

You can change the route options (route selection etc.) during route guidance.

> Call up the options menu for the map display.

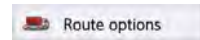

> Press the **Route options** button.

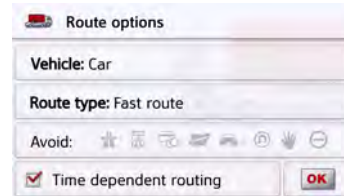

> Set the route options as described under "The Route options button" on page 68.

After a modification, the route is recalculated.

## Canceling route guidance

(Only available when route guidance is active.)

You can cancel the active route guidance.

> Call up the options menu for the map display.

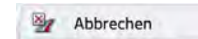

> Press the **Stop guidance** button.

This cancels route guidance to all destinations.

### Note:

You can also cancel route guidance as described in "The main menu" on page 29.

## Entering/deleting a stopover

(Only available when route guidance is active.)

With this function, you can enter a stopover, or you can delete an entered stopover.

> Call up the options menu for the map display.

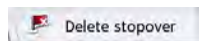

> Press the **Add stopover** button.



You can now enter a stopover as described under "The New destination menu" on page 43 (**Enter address, Select Point of Interest, Personal destinations, Contacts, Select on map** or **Enter geo-coordinates**). You also have the option of quickly selecting a destination using the **Select from last destinations** button.

If you have entered the desired stopover, the route is recalculated.

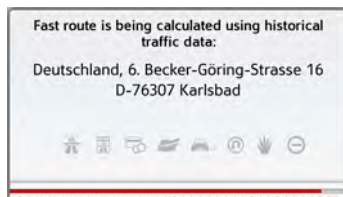

The stopover is indicated on the map by a red flag.

## Deleting a stopover

> Call up the options menu for the map display.

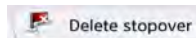

> Press the **Delete stopover** button.



> Press the **Yes** button.  
The stopover is deleted.

## Blocking route temporarily

Using the **Block road ahead** option, you can block a stretch of road ahead temporarily. This determines a certain stretch of road that should not be used. The Navigation device will now try to calculate a detour.

### Notes:

- The selected length of the block is only an approximation since the actual distance blocked depends on the availability of an exit.

> Call up the options menu for the map display.

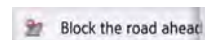

> Press the **Block the road ahead** button.

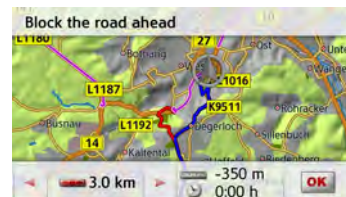

> Select the length of block you want by pressing the arrow buttons.

If route guidance is active, you can select a road length between 200 m and 50 km. As soon as you selected the stretch, a new route will be calculated. Furthermore, the distance and time difference are also displayed in the lower part of the display.

#### Notes:

- If route guidance is not active, you can only select between 200 and 500 m (250 and 500 yards). You can then define directly the days and times when the route should be blocked.
- After the temporary blocking of a section, the Clear blockings option appears in the option menu of the map view. Press this button to delete all temporary blockings. If a route guidance is active, the former route is restored.

### Setting day/night display

You can switch the Navigation device display from day to night and vice versa.

> Call up the options menu for the map display.

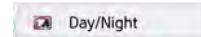

> Press the **Day/Night** button.

The display changes from day to night and vice versa.

### Displaying current position (Where am I?)

You can display your current position, make an emergency call (depending on model), select a hospital or filling station and save this position. Furthermore, you can display information regarding the current GPS reception and the current country.

> Call up the options menu for the map display.

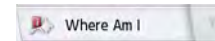

> Press the **Where Am** button.

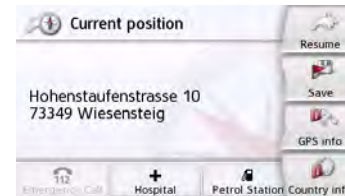

The current position is displayed. If possible, an address is displayed. If no address is available for the current position, the geographic coordinates are displayed.



With the **Emergency call** button you can make an emergency call under the Europe-wide standard emergency call

number 112 (depending on model) if a mobile telephone is connected to your navigation system and has reception. Before dialling the emergency call number, you must confirm this once again.



The **emergency** call number is dialled using the call button.



An address or the GPS position will be displayed depending on availability. If possible, you can change between the views using the buttons  Show GPS position or  Show address. In addition, you have other telephone functions at

your disposal. Also see chapter "Telephone calls" on page 116. With the Hospital button, you can change directly to the places of interest category Hospital in the current vicinity. Also see chapter "Points of interest" on page 52. With the Petrol Station button, you can change directly to the places of interest category Filling station in the current vicinity. Also see chapter "Points of interest" on page 52.

You can return to the map using the **Resume** button. By pressing **Save** you can store your current position in the fast access list. By pressing the **Country info** button you can display country-specific information such as the maximum permitted speed for the country you are currently in. Click on the relevant icon to display additional information.

By pressing **GPS info** you can view information regarding the GPS reception.

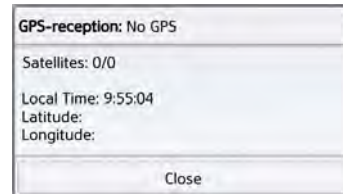

You can see how many satellites are being received, and whether the satellite reception is good enough for navigation. The current time and the geographic position are also displayed.

### Entering the destination

(Only available when route guidance is not active.)

You can enter a destination.

> Call up the options menu for the map display.

> Press the **Enter destination** button.

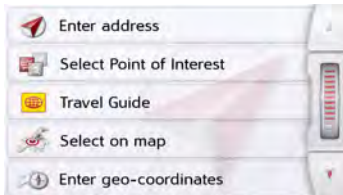

You can now enter a destination as described under "The New destination menu" on page 43 (**Home, Enter address, Select Point of Interest, Personal destinations, Contacts, Route planning, Select on map** or **Enter geo-coordinates**).

### Displaying/selecting different routes

You can use the Navigation device to display various routes.

> With the entire route displayed, press the **Alternative** button. This function can also be selected in the options of the map display, See "Map display options" on page 96.

After a short time, the map is displayed. Each route is calculated after each other and displayed on the map.

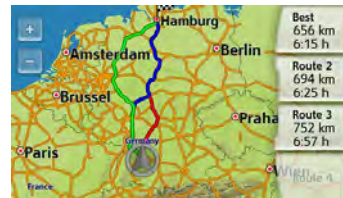

The area on the right-hand side shows the colour key for the individual routes, the mileage for each route and the estimated driving time.

You can select the desired route by pressing the buttons on the right.

### Skipping a destination

If a planned route with several destinations is active, you may delete the current destination of the route. Route guidance to the next destination is then started.

This may be necessary if a destination was not driven to directly. The Navigation device otherwise tries to guide you to the current destination.

> Call up the options menu for the map display.

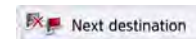



> Press the **Next destination** button.

Route guidance to the next destination is started.

Depending on the selected settings (see page 71 onwards), a number of helpful supplementary functions are made available to you.

### Feedback after route calculation

When calculating the route, the best possible route is selected by taking the vehicle or loading specifications into consideration if possible. The route might vary considerably from the car route as regards distance, journey time or routing. If a destination cannot be reached without taking the predefined restrictions into consideration, this will be displayed after the route calculation.

You can scroll through the list using the arrow key   or scroll wheel on the right-hand side of the screen.

Press the **Cancel** button or  to return to the last entry.

Press the **Next** button to start the navigation.

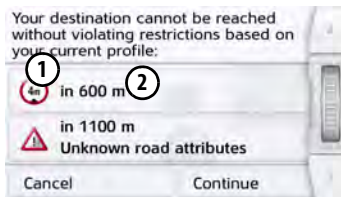

The following is displayed for each restriction:



- ① A graphic for the restriction
- ② The distance from the current position

When you select a restriction, the corresponding section will be displayed on the map.



### Zooming in on the map

You can gradually zoom in and out of the map using the Zoom buttons.

- > Press Zoom in  to "zoom into the map" and thus zoom in closer to the displayed details.
- > Press Zoom out  to "zoom out from the map" and thus get a greater overview.
- > Press the  button to display the entire section of the route.

### Warnings with planned route

When the driver warnings function is activated in the navigation settings, you will be warned about road sections where there are relevant restrictions.



If there are road sections on your route that are subject to a restriction, your navigation system will warn you shortly before reaching the road sections affected. The layout of the message is similar as



described in the chapter "Feedback after route calculation".

You have the following options:

- ① Press the  button to close the message.
- ② enlarge the display area if another restriction lies ahead of you.

The message will close automatically once you have left the critical area. In addition, the message closes automatically when you approach a new road section with a restriction.

### Warnings without planned route

When the driver warnings function is activated in the navigation settings, you will be warned about road sections where there are relevant restrictions.

The function is similar as described in the chapter "Warning with planned route".

Furthermore, the navigation system will display in which direction you can or cannot drive at intersections, provided that the information is available.



### Show route

You can display the route on the screen once you have entered a destination. If a different route has been selected on the basis of a profile setting (vehicle dimensions, weight, dangerous goods), the section of road being avoided because of this is shown in blue.

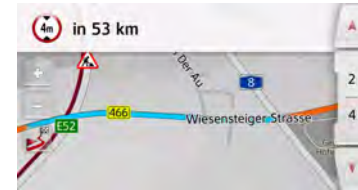

On the avoided (blue) route, the restrictions are displayed with signs. Select a traffic sign on the map to display a detailed view of the section of road concerned.



If there are further restrictions on your route, you can use the arrow keys   to scroll through the list of restrictions that are being avoided because of the vehicle settings you have made.



## OTHER ADDITIONAL FUNCTIONS (ONLY SELECTED MODELS)

**Display height profile**

You can display a height profile from the Show route or Alternative routes view. To do this, select the  button.

Height profile for a route:





You can use the  and  buttons to adjust the zoom level and move to the left or right to shift the height profile.

If you select a point by touching the profile, the corresponding height and distance from the starting point are displayed for it.

Press the  button to go back to the route view.

Height profile for alternative routes:



Yet more functions are available for alternative routes. Press the **Next**  and **Previous**  buttons to highlight the individual height profiles. The height profiles and their associated alternative routes on the right-hand side of the screen are displayed in the same colour. Once you have decided on a route, use the buttons on the right to select it.

If your navigation device has an integrated Bluetooth® wireless technology interface, you can connect it to a mobile phone equipped with Bluetooth® wireless technology. Your Navigation device can then be used as a very comfortable hands-free unit.

**Note:**

- For some cell phones equipped with Bluetooth® wireless technology, it is possible that some of the functions described are not available.
- The following descriptions assume that Bluetooth® is activated on the cell phone. You can find out how to activate Bluetooth® wireless technology on your cell phone in the cell phone's description.
- This function must also be activated on the mobile phone for an automatic connection to the mobile phone.

## Calling up the telephone mode (only selected models)

You can call the telephone mode from the main menu.

- > To call the telephone mode, press the **Phone** button in the main menu.

If Bluetooth® wireless technology is activated and the Navigation device is already connected to a cell phone, the telephone menu is displayed.

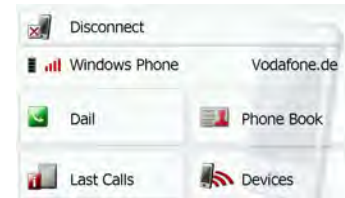

If Bluetooth® wireless technology is not activated upon calling up the telephone function, the system will prompt you to switch Bluetooth® wireless technology on.

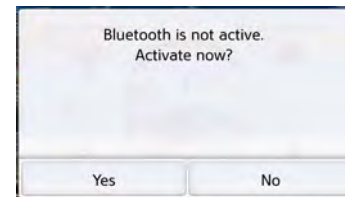

- > Press the **Yes** button to activate Bluetooth® wireless technology.

The Navigation device now attempts to reconnect the cell phone last connected. When the connection is established, the telephone menu is displayed after a short period.

If no cell phone has been connected yet or if the device last connected is not available, the following display is generated.

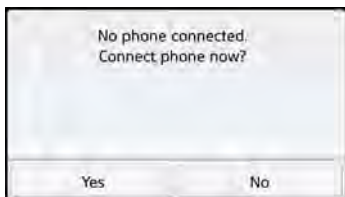

> Press the **Yes** button to find Bluetooth® cell phones as described in "Searching for cell phones" on page 114.

## Telephone menu (only selected models)

From the telephone menu, you have the option:

- Numbers to be dialed or selected from the phonebook,
- to display the telephone book
- to call up the call list,
- To search for Bluetooth® telephones
- To disconnect the connection to a cell phone.

If Bluetooth® is activated and the Navigation device is already connected to a cell phone, the telephone menu is displayed after the telephone function is called up.



In the upper area of the telephone menu, the signal strength of the cell phone, the charging level of the cell phone, the telephone name and the network provider are displayed, if available.

## Dialing a number

You can enter a telephone number and start a call to this number or select a number from the phonebook.

> In the telephone menu, press the **Dial** button.



> Use the buttons displayed to enter the phone number you want.

**Note:**

Press the  button to delete the characters entered.

> Press the **Dial** button.

The Navigation device then attempts to establish a connection to the phone number entered. You can find out how to continue operation in "Telephone calls" on page 116.

**Phonebook**

In the phonebook, the system displays the phonebook entries loaded from the SIM card and from the memory of the cell phone. After selecting the desired entry, you can call the respective phone number.

**Note:**

- Be aware that it may take several minutes to transfer the phonebook.
- If the cell phone whose phonebook was already loaded is reconnected, the phonebook is not loaded again. If entries were changed or entered while the cell phone was not connected, then the phonebook of the Navigation device must be loaded manually for the update. See "Updating the phonebook" on page 120.

> In the telephone menu, press the **Dial** button.



> Press the **Phone book** button.

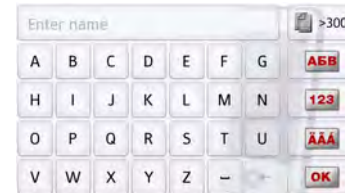



If there are more than 10 entries in the phonebook, an input menu is displayed. If there are less than 10 entries, a list with the entries will be displayed directly.

# TELEPHONE MODE

> In the input menu, select the first letters of the entry you are looking for.

### Note:

- For example, if you entered the letters "M" and "I", the entries are displayed whose last names or first names start with "MI". That means, "Miller John" or "Bauer Michael".
- You may enter the first letter of the last name and then enter the first letter of the first name separately using a space (button ).

> Press the  button when the name you want is displayed in the upper line. As soon as just 5 or fewer hits are available, a list is displayed from which you can select the correct entry.

### Note:



You may also first have a list displayed that corresponds to the letter combination entered. For this purpose, press the  button in the input menu.

> Select the desired entry in the list.

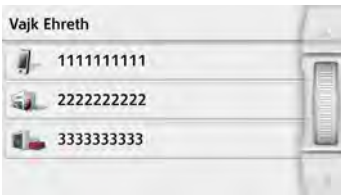
If there is more than one phone number available for the entry selected, you may then select the respective number.



The different numbers are indicated by icons.

Icon	Meaning
	Private phone number
	Business phone number
	Cell phone number

> Select the desired phone number. The Navigation device then attempts to establish a connection to the phone number selected. You can find out how to continue operation in "Telephone calls" on page 116.

## Call list

In the call list, the last dialed, answered or unanswered numbers or names are displayed in chronological order. If possible, the numbers or names of the list stored in the cell phone are also displayed in different lists.

> In the telephone menu, press the **Last calls** button.

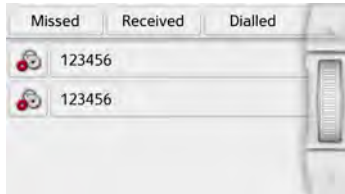

Using the buttons **Missed**, **Received** and **Dialled**, you may retrieve the lists loaded from the cell phone.

The call list of the dialed, answered or unanswered numbers or names on the Navigation device is displayed in the rows below.

Each row of the call list is divided into fields. Each list field is designed as a button. On the right button, the number/name is displayed and the features of the entry are displayed with the left icon.

### Notes:



- The last 100 numbers/names are saved automatically in the call list. If the storage capacity of 100 numbers is reached, the oldest number is automatically deleted for each new number. Using the buttons **Missed**, **Received** and **Dialled**, you may retrieve the lists loaded from the cell phone, if available.

## Icons used

The following icons are used in the call list.

Icon	Meaning
	This entry is a standard entry without any special features.

## Scrolling through the call list

Using the   buttons, you can scroll through the call list in the corresponding direction of the arrow.

**Dialing an available number**

You can dial the numbers/names in the call list directly.

> To initiate the call, press the button with the entry you want.

The call will be initiated.

**Displaying or editing entries**

Each entry contained in the call list can be displayed or edited.

> Press the button field on the left next to the entry you want.

A selection menu appears.

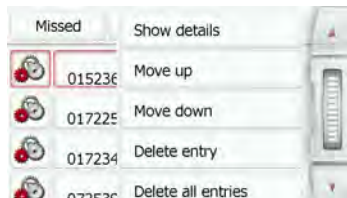



Selection	Meaning
<b>Show details</b>	The data for the entry is displayed (number and name, time and date of call, if available).
<b>Move up / Move down</b>	The entry is moved one position forwards/backwards.
<b>Delete entry</b>	The entry is deleted from the call list.
<b>Delete all entries</b>	All entries (even the protected ones) are deleted from the call list.

**Lists loaded from cell phone**

> In the call list, call up the corresponding list using the **Missed**, **Received** and **Dialled** buttons.



Using the   buttons, you can scroll through the list in the corresponding direction of the arrow.

> To initiate a call, press the button with the entry you want.

**Note:**

Press the  button in front of an entry to display the data for that entry (number and name, time and date of call, if available).



## Connecting Bluetooth® telephones

So that you may make and receive calls with your Navigation device, a cell phone that is equipped with Bluetooth® wireless technology must be connected to the Navigation device. The following describes the various options for establishing a connection.

### Calling up a device list

> In the main menu, press the **Telephone** button.

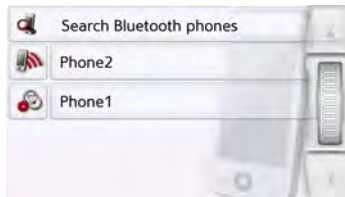



The device list is displayed. From the device list, you may search for or connect cell phones.

#### Note:

If you have not yet established any connections to cell phones, then the list is empty.

The device list shows line by line all cell phones that were already connected to the Navigation device.

Each line of the device list is divided into two fields. Each list field is designed as a button. On the right button, the device is named and its features are displayed with the left icon.

Icon	Meaning
	This device is a standard device without any special features.
	This device is the cell phone currently connected.

You can call up a menu by pressing the icon.

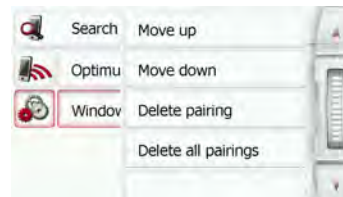

Selection	Meaning
<b>Move up / Move down</b>	The device is moved one position forwards/backwards.
<b>Delete pairing</b>	The device is deleted from the device list.
<b>Delete all pairings</b>	All entries (even the protected ones) are deleted from the call list.

**Automatic connection**

After activation, your Navigation device attempts to establish a connection to the cell phone last connected.

You can switch this function on or off as described in "Automatic connection" on page 119.

Prerequisites for a successful connection are:

- On your Navigation device, Bluetooth® wireless technology is switched on. (See "Bluetooth®" on page 119.)
- The cell phone is switched on, is within range, and Bluetooth® wireless technology is activated.

**Searching for cell phones****Note:**

Prior to a search, switch on Bluetooth® on the cell phone to be searched for.

> Call up the device list.

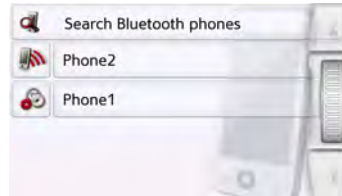

> Press the **Search Bluetooth® phones** button.

The search starts.

During the search, any devices found are displayed and you may cancel the search by pressing the **Stop search** button.

After the search or after you press the **Stop search**, a list of the devices found is displayed.



> Then select the name of the cell phone to be connected.

The Navigation device will then attempt to establish the connection. On the cell phone, the password prompt should then occur. This password is fixed by Navigation device.



> Enter the password displayed on the cell phone.

The connection will be established. With a successful connection, the telephone menu will be displayed.

### Connect new devices

You can initiate a connection to another mobile phone using the **Devices** button located in the telephone menu at the lower right hand corner of your screen. If a cell phone is already connected, that connection is automatically disconnected and the new device is connected.

> Click on **Devices**

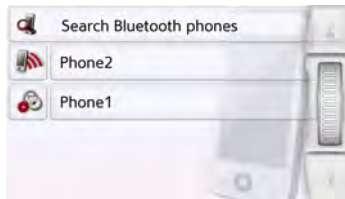

> Select the cell phone you want in the list.

The connection is established to the cell phone selected. With a successful connection, the telephone menu will be displayed.

### Connecting a mobile phone

You can also attempt to establish a connection to the Navigation device from the mobile phone.

If a request is received from a mobile phone that has not yet been connected, you will be asked whether you wish to allow the connection.

> Press the **Yes** button to permit the connection.

> Enter the displayed password (four zeros) on the mobile phone.

The connection will be established. With a successful connection, the telephone menu will be displayed.

### Disconnecting a connected telephone

You may disconnect the connection to a cell phone currently connected via Bluetooth® wireless technology.

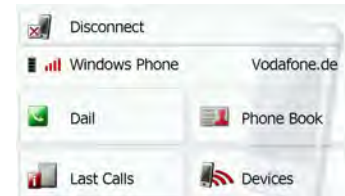

> Press the **Disconnect** button.

The connection to the cell phone currently connected is disconnected.

## Telephone calls

In the telephone calls section, you can find a summary of the control options that are available for establishing a call, accepting a call, and ending a call.

### Establishing a call

> Enter the telephone number or select an entry from the call list or telephone book.

If the call is accepted by the party called, the display changes and you are connected to the other party.

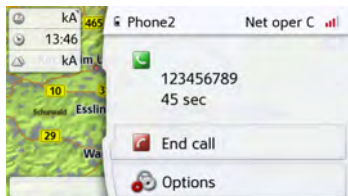

### Accepting a call

For an incoming call, a ringing tone will sound. Also the following is displayed.

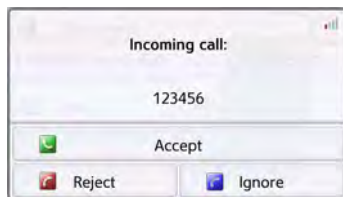

If available, the phone number and name of the caller are displayed.

For incoming calls, you have several operating options:

Selection	Meaning
<b>Accept</b>	The call is accepted. The call screen is displayed.
<b>Reject</b>	The call will be declined. The caller hears the busy signal. The screen last active is displayed.
<b>Ignore</b>	The ringing tone is switched off. The screen last active is displayed. The call is ended if the caller hangs up.

If you have switched on the automatic call acceptance as described in "Automatic call acceptance" on page 119, the time to call acceptance is also displayed for the **Accept** button.

## Ending a call

You can end an active call.

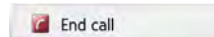

> In the call screen, press the **End call** button.

The call is ended. The screen last active is displayed.

### Note:

The call is also ended if the other party hangs up. The screen last active is also displayed.

## During a call

During a call, you have various control options.

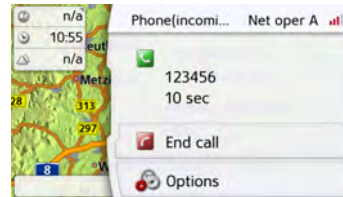

In the call display, the signal strength of the cell phone, the charging level of the cell phone, the telephone name and the network provider are displayed if available in the upper area.

Beneath, the call time and, if available, the phone number or name the name of the other party are displayed.

If route guidance is active, then you will receive the navigation instructions with arrows on the call screen.

> To call the options menu of the call screen, press the **Options** button.



- **Volume**

By pressing the **Volume**, you can call the volume adjustment. See "Telephone volume" on page 119.

- **Microphone off/Microphone on**

For a private conversation in a vehicle, you can switch off the microphone of the Navigation device. The other party on the phone will not hear anything. Press the **Microphone off** button to switch off the microphone. Press the **Microphone on** button to switch the microphone back on.

- **Private mode/Hands free**

You can transfer a call back to the cell phone. The hands-free function is then ended.

After the call is ended, the connection to the cell phone is automatically re-established.

Press the **Private mode** button. The hands-free function is ended.

Press the **Hands free** button to make and receive calls again via the Navigation device prior to ending the call.

## Telephone settings

The telephone settings include all the settings relevant for the telephone mode.

> In the main menu, press the  button.

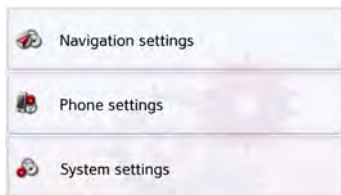



> Press the **Phone settings** button. You will branch to the menu for the telephone settings.

## Start

In the menu, various pages with the functions are available:



You can access the next or previous page of the settings by pressing the  and  buttons.

## Bluetooth®

With the **Bluetooth®** button, you can switch Bluetooth® on or off.

## Automatic connection

With the **Auto-connect** button, you can switch on or off whether an automatic connection to a cell phone is attempted after switching on the Navigation device.

> In the settings menu, press the **Auto-connect** button.

Depending on the previous setting, you can switch the function on or off.

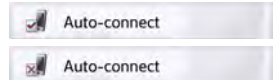

- Top icon: function on
- Bottom icon: function off

## Automatic call acceptance

With this function, you can set whether or not or after which time an incoming call is accepted automatically.

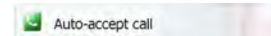

> In the settings menu, press the **Answer call automatically** button.

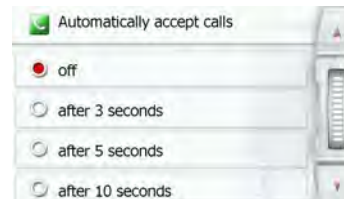

> Select whether incoming calls will be accepted automatically after 3, 5 or 10 seconds.

If you select **Off**, the function is switched off.

## Telephone volume

With this function, you can set the volume of the ringtone and the volume of the call.

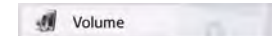

> In the settings menu, press the **Volume** button.

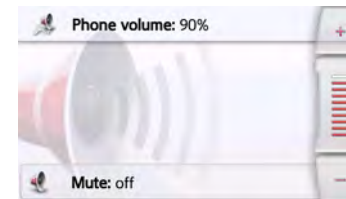

> Select the desired volume with the **-** and **+** buttons.

> Press the **Mute** button to mute the volume. By pressing the button again, the telephone volume is switched back on.

> Confirm your settings by pressing the back button .

### Updating the phonebook

With this function, you can update or retransfer the stored phonebook entries in the Navigation device.



> In the settings menu, press the **Refresh** button.

Be aware that it may take several minutes to load the phonebook.

### Bluetooth® name

With this function, you can assign a name for your Navigation device. This assigned name will then be displayed by other Bluetooth® devices.

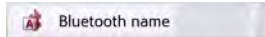

> In the settings menu, press the **Bluetooth® name** button.



> Enter the desired name.  
> Confirm the name entered by pressing the **OK** button.



Under Tools, the following functions are grouped together, depending on the model:

- Marco Polo City Guides
- Image viewer
- Country information
- Overview of functions
- Blocking a section of the road
- Trip computer

The Tools menu is called up from the main menu.

> In the main menu, press **Extras**.



This displays the extras menu.

> Select the desired function by pressing one of the buttons.

## Travel Guide (model dependent)

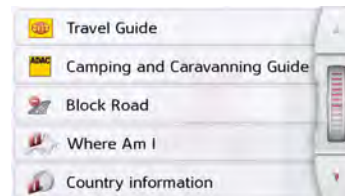

With the travel guide, you can select, for example, MARCO POLO Top-Highlights or MARCO POLO Insider Tips and start the guide destination there. See "Travel Guide (model dependent)" on page 56.

## Rear View camera



## Displaying Rear view camera (depending on the model)

When a reversing camera is connected to your navigation system, and the reversing camera setting is set to **Manual** (see "Rear view camera (depending on the model)" auf Seite 134) you can display the image of the reversing camera on your navigation system via the button **Show rear view camera**.

Press the  button and then return to the screen last viewed. Depending on the model, the  button will be on the map.

## Image viewer\*

### Note:

The image viewer cannot be called up when route guidance is active.

The Image Viewer can display pictures saved on an inserted micro SD memory card or on the internal memory.

The jpg and bmp image formats are supported.



> Press the **Pictures** button.

\*depending on model, this must be activated via the Content Manager.

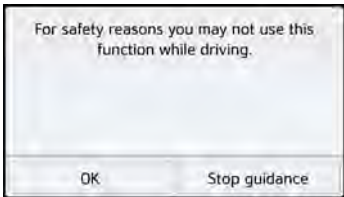

A message is displayed stating that the image viewer must not be used when driving. Please observe this warning.

> Confirm the message by pressing the **OK** button.

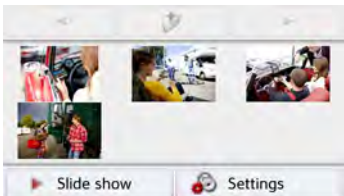

The image viewer menu appears.

### The image viewer menu

In the image viewer menu, you can select images, start a slide show and call up the settings.

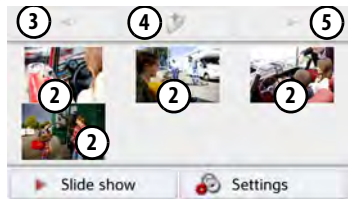

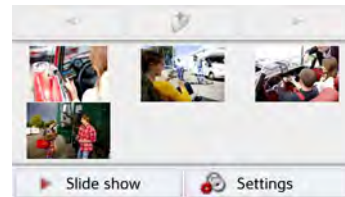

- ① Folder containing images
- ② Thumbnails of the images in the current folder
- ③ View the previous page of images/ folders
- ④ Go up one level in the directory hierarchy
- ⑤ View the next page of images/ folders

### Selecting an image



> In the image viewer menu, select the desired folder, and then the desired image.

You can use the  and  buttons to scroll through the pages of images and folders.

The selected image is displayed along with an image menu.

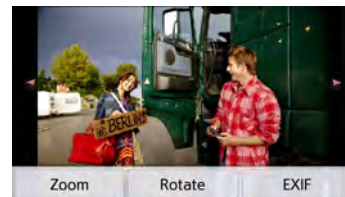

You can use the menu buttons to rotate or enlarge the image or to display information.

Press the buttons to the left and right of the image to move to the next or previous image.

Press the centre of the image to hide the image menu.



Press the right- or left-hand side of the screen to move to the next or previous image.

Press the centre of the image to show the image menu again.

### Enlarging the image

- > Show the image menu.
- > Press the **Zoom** button.



- > Move the control on the top of the screen to the desired level of magnification.

The image can then be moved around. Press the centre of the image to cancel the enlargement.

### Rotating the picture

- > Show the image menu.
  - > Press the **Rotate** button until the image is in the desired orientation.
- Press the centre of the image to hide the image menu again.

### Displaying image information

- > Show the image menu.
- > Press the **EXIF** button.



Information on the current image is displayed.

- > Press the  button to close the information.

## Slide show

In the slide show, all the pictures in the current folder level are automatically displayed sequentially.

> Press **Slide show** in the image viewer menu.

The image display changes to full screen display and initiates the slide show according to the settings made, with the first image in the current folder level.

The slide show will end once all images have been displayed.

Press the  button to stop the show before the end.

## Settings

In the settings, you can choose the speed at which the images are displayed, whether certain effects are used when a new image is shown, and whether the images should be loaded at a higher quality.

> Press **Slide show settings** in the image viewer menu.

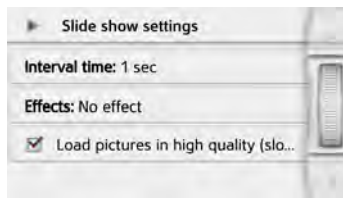

> You can use **Interval time** to set the display duration.

> In **Effects** you can choose the transition effects for the images.

> In **Load pictures in high quality (slower)** you can choose whether images should be loaded at high resolution () or not ()

Loading the images at high resolution makes the display slower.

> Confirm your settings by pressing the back button .

## Where am I?

> See "Displaying current position (Where am I?)" on page 101.

## Traffic forecast (depending on model)

With the traffic forecast, you can observe the expected flow of traffic.

The data is based on historical traffic data collected over a longer period of time.





You can determine the expected flow of traffic by the colour of the road. Green signifies a clear road, red signifies congestion. All possible colours are displayed on the right-hand side of the screen.

If you now change the time of day, you will see how the expected flow of traffic changes.

> Press the **Traffic forecast** button

- With the **1** and **2** buttons you can change the weekday
- With the **3** and **4** buttons you can change the time in hourly increments

- With the  and  buttons you can change the section of the map.
- With the  button you can display the complete route on the screen if available.

You can select another section of the map by dragging.

## Country information

The country information enables you to display country-specific information for numerous countries (maximum permitted speed, alcohol limits, etc.).

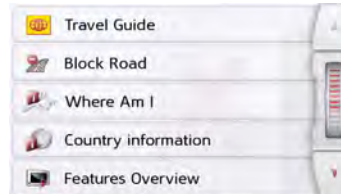

> Press the **Country information** button.



The list of countries is displayed.

> Press the button for the desired country.















The country-specific information is displayed (maximum permitted speed, alcohol limits, etc.). Click on these symbols to display additional information.

### Note:

Please note that the information may not be complete and other regulations may apply in the various countries.

Below you will find a description of the symbols used:

Symbol	Meaning
	Speed limit in built-up areas
	Speed limit outside built-up areas
	Speed limit on motorways
	Speed limit on main roads
	Alcohol limit
	Reflective jacket requirement
	Driving lights requirement during daytime
	Tow rope must be carried
	Spare bulbs must be carried
	Fire extinguisher must be carried
	Winter tyres must be fitted in winter
	Snow chains must be fitted in winter

Press the **OK** button or the  button to exit the menu.

## Blocking a section of the road permanently

With the Block option you can block individual route sections permanently. The Navigation device then calculates a diversion to avoid a traffic obstruction. Furthermore, existing blockages can be removed  (with the Delete blockage button) or be displayed on a map

 Show on Map

> Press the Block button.

A map of the vicinity near your location is displayed.



> Define the start and end point of the section to be blocked by touching the map.

The points will be marked by the letters A and B.

> Define the direction of blockage for the road section (from A to B or from B to A).



Additionally, you can display a list of permanent blockages already defined on the map.



Select the desired blocked road by pressing, in order to set the blockage times.



The road is currently blocked for all days of the week, for the whole day (✓). You can now set whether or not the road should be blocked for each day of the week.

- > Press the buttons with the days on which the road should not be blocked (✗).
- > Press the clock symbol under one of the days and limit the block of this day to the required time of the day.

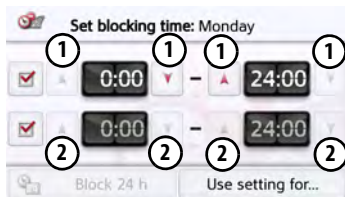

You can set up to two times when the road shall be blocked.

- > Using the buttons (1) set the first period when the road is to be blocked on this day.
- > Using the buttons (2) set the second period when the road is to be blocked on this day if necessary.

Press the **Block 24 h** button to set a block for an entire day. Press the **Use setting for...** button to also use the block on other days.



- > Press again the (↩) back button to confirm the settings and to exit the menu.

**Note:**  
The duration of the blockages can be defined also in the **Blocked roads** menu in the Navigation settings.

## Trip computer (depending on model)

The Trip computer provides a data display with average speeds, maximum speeds, etc. and a stopwatch with the option to record laps.

- > In the main menu, press **Extras**.

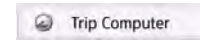

- > Press the **Trip computer** button.



The data display appears. The data display contains the following information:

- (1) Current speed (as a number and in the form of a bar graph)
- (2) Maximum speed
- (3) Average speed without breaks in the journey
- (4) Average speed with breaks in the journey
- (5) Total distance

- ⑥ Travel time without breaks in the journey
- ⑦ Travel time with breaks in the journey
- ⑧ Compass
- ⑨ Calls up the stopwatch with lap recording

Press the **Reset** button to reset the values to zero.

To display the stopwatch with the lap recording, press the button ⑨.



> Press the **Start** button to start the recording.

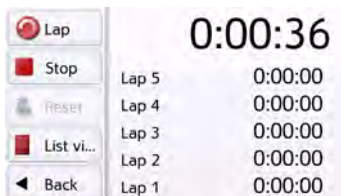

> Press the **Lap** button to stop the current recording and start a new lap recording.

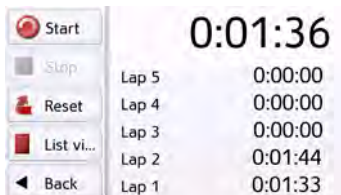

You can record up to 300 laps in the same way.

#### Notes:

- The second value displayed in the top section shows the total time for the laps driven.
- Pressing the **Back** button on the left-hand side of the display or pressing the  button switches back to the data display.

Press the **Stop** button to stop the recording. The time continues if you press the **Start** button again after stopping the recording.

Press the **Reset** button to delete all recordings and reset all times to zero.

You can display the individual laps in list form using the **List view** button.



> Press the **Delete list** button to delete the recorded laps.



## Selecting system settings

You can change various basic settings for all applications on the Navigation device.

> In the main menu, press the  button.

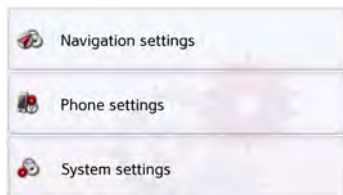

> Press the **System settings** button.  
The system settings menu is displayed.

## The system settings menu

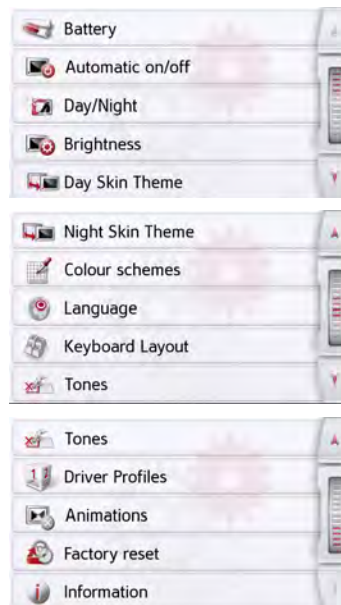

You can select the various settings options from the system settings menu.



## Operation

### Selection options

Select the desired menu item by pressing the appropriate button. The functionality of the buttons varies depending on the selection and is described under "The individual menu items" on page 130.

You can go to the next or previous page of the settings by pressing the  and  buttons.

### Closing the settings menu

Press  to close the settings menu.

## The individual menu items

### Battery

Your Navigation device may be operated using an external power supply unit or an integrated rechargeable battery.

#### Note:

The current charging state is important when operating with a battery. If the battery is low on power, it may not be possible to continue navigation right to the destination.

The energy supply and status are shown on a display.

### Displaying the power supply

You can call up the status display using the following button:



> Press the **Battery** button.

The status display appears and shows the power supply.



The power level is shown in the charge display. In the example, the battery still has around two-thirds charge. The charging operation is indicated by the mains socket symbol in the status display.

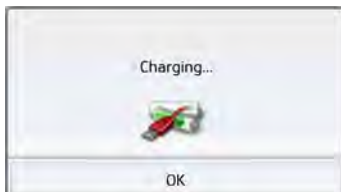

### Closing the status display

Pressing the **OK** button closes the status display and shows the settings menu.

### Automatic on/off

The Navigation device can switch automatically to sleep mode when the vehicle ignition is switched off.

Prerequisite for this:

- The Navigation device must be connected to the vehicle cigarette lighter (see also page 21).
- The cigarette lighter is de-energized after the ignition is switched off.
- The relevant function can be switched on at the Navigation device.

### Switching the function on/off

> Press the **Automatic on/off** button.

Depending on the previous setting, you can switch the function on or off. The current setting is shown by the icon.

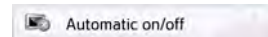
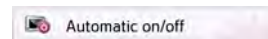

- Top icon: The function is switched on, the Navigation device switches off automatically.

- Bottom icon: The function is switched off, the Navigation device does not switch off automatically.

The following display is shown during automatic switch-off.

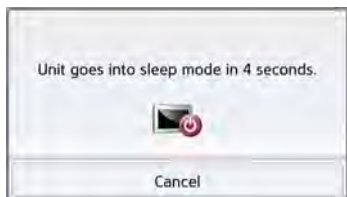

You can cancel the automatic switch-off procedure by pressing the **Cancel** button.

### Day/night display

You can set the Navigation device display to day, night or automatic.

The automatic setting changes automatically between day and night display depending on the time, the current position and the time of year.

With the following button, you can call up the setting:



> Press the **Day/Night** button.

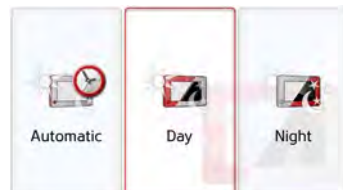

> Select from **Automatic, Day and Night**.

The desired function is activated and the system settings are displayed.

### Brightness

You can set the brightness of the display separately for day and night display.

With the following button, you can call up the setting:

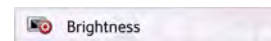

> Press the **Brightness** button.

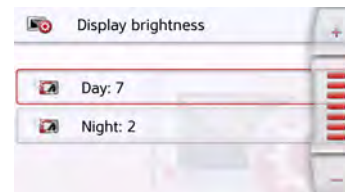

> Use the **-** and **+** buttons to set the desired brightness for the day and night display.

> Confirm your settings by pressing the back button (⏪).

## Design by day

With this option, the menu and map display during the day can be switched to the colours and contrast of night display.

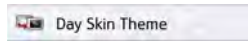

> Press the Design by day button.



> Select the Dark design option for a dark display during the day.

> Select the Normal design option for a normal display during the day.

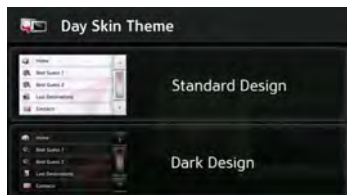

Confirm your selection by pressing the back button

## Design by night

Two schemes with different contrasts are available to select for the map display at night.

Press the Design by night button.

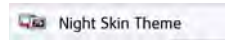

Select the option on the bottom to set a lighter night display for the map view.

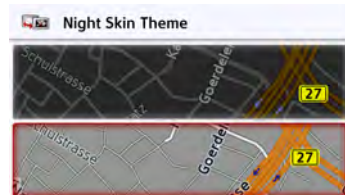

Select the option on the top to reset the darker, standard preset night display for the map view.

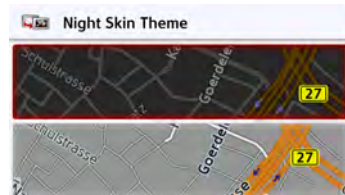

> Confirm your selection by pressing the back button . The new night display will take effect when activating the night mode.

## Setting the colour

You can change the colour of the icons and other design elements.

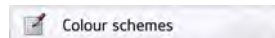

> Press the **Colour schemes** button.

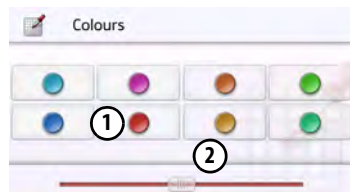

> Select one of the eight predefined colours.

or

> Select the required colour using the slider **2** at the bottom of the display.

### Note:

The colour of the button **1** corresponds to the red colour set at the factory.

> Confirm your settings by pressing the back button .

## Language

The texts on the touch screen can be displayed in a variety of languages.

### Opening language selection

You can choose between the various languages using the following button:

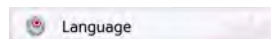



> Press the **Language** button.

The language selection appears.



The language selection shows the available languages in a list several pages long. Each list field is in the form of a button. Each button is labelled with the language name and the associated national flag.

## Scrolling



Using the   buttons or the scroll wheel, it is possible to scroll through the list in the direction of the relevant arrow.

### Selecting the language

> Press the button for the required language.

> The selection is confirmed by pressing the back  button.

The selection list for the voice is displayed.

> Using the   buttons or the scroll wheel, scroll through the selection list.

> Select a voice by touching the button.

> Press the Back  button.

A prompt appears indicating that the software has been re-started, and you are asked whether you really want to change the language.

> Confirm the prompt using **OK**.

### Cancelling the language selection

Pressing the **Cancel** button cancels the language selection and shows the settings menu.

## Keyboard layout

You can switch the sequence of the keyboard layout by selecting the corresponding key.

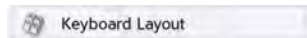

## Sounds

You can switch the Navigation device signal tone on and off. This also includes the clicking of the touch screen buttons.

> Press the **Tones** button.

Depending on the previous setting, the signal tones are switched on or off.

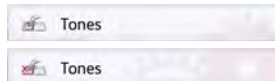

- Top icon: Tones switched on
- Bottom icon: Tones switched off

## Rear view camera (depending on the model)

Once you have connected your navigation system to a rear view camera using a suitable cable, (see "Cable for rear view camera (depending on the model, optional)" on page23) you can display the image of the rear view camera on your navigation system.



> Press the button rear view camera

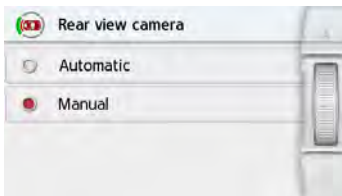

You can choose from the following options:

Selection	Meaning
<b>Automatic</b>	The navigation system switches over to the image of the reversing camera as soon as an image signal is sent. Normally, this is always the case once the reverse gear has been engaged

Selection	Meaning
<b>Manual</b>	It is possible to manually switch over to the reversing camera. In the <b>Tools</b> menu, a corresponding menu item is then available

## Screen animations

You can switch the animated screen changes on and off.

> Press the animations key

Depending on the previous setting, you will either switch the animated screen changes on or off.

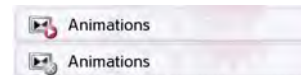

- Top icon: animations switched on
- Bottom icon: animations switched off

## Driver profiles (depending on model)

You can select 4 different driver profiles.

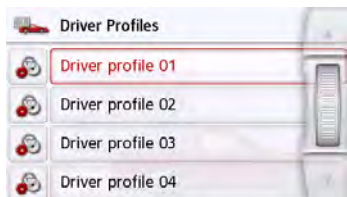

You select the corresponding profile by pressing the **Profile 1 – Profile 4** button. You must then restart the navigation system.

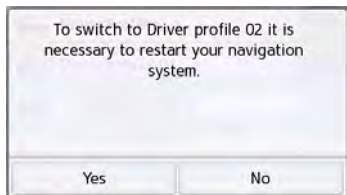

You restart the system by pressing on the **Yes** button.

The driver profiles can now be named individually. This function can be useful, for example, if several drivers use the same navigation system.

Many settings and regular destinations are stored in the driver profiles.

The following .. are stored in the driver profiles:

- Home address
- Last destinations
- Planned routes
- Blocked roads
- Last calls
- Data in the journey computer
- Last GPS position
- Navigation settings
- Phone settings
- System settings

## Renaming driver profile

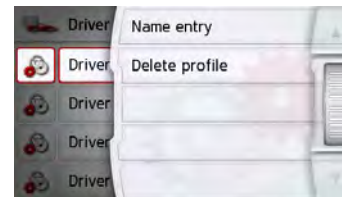

You can rename the selected profile by pressing the **Name entry** button.

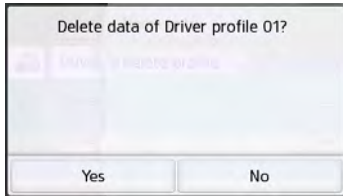

**Deleting driver profile**

You can delete the saved profile data by pressing the **Delete profile** button. The profile itself will still remain. If the profile was renamed previously, it will then be renamed to the original name again (Profile 1 – Profile 4).

**Driver profile Pro (model dependent)**

Besides the functions described in the previous chapter, a Bluetooth® telephone can be used for automatically changing the profile on devices with Driver Profile Pro. Whenever the navigation device is switched on and the last connected phone is not found, your navigation device checks whether another telephone is within reach that was selected as a trigger for changing the profile.

**Notice:**

In order to use a telephone as a trigger for changing to another driver profile, you must first connect the telephone in the profile to the navigation device in which the telephone is to be used as a trigger, (also see "Connecting Bluetooth® telephones" on page 113).

Furthermore, the Auto-connect setting must be activated, see "Automatic connection" on page 119.

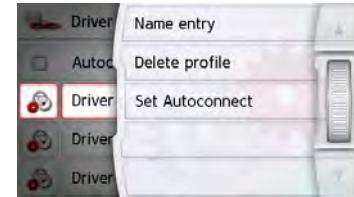

Press the Set Auto-connect button. A list of possible telephones is displayed that you can use as a trigger for this profile, select the corresponding telephone by pressing the appropriate button.



### Service information

The following button displays information regarding the Navigation device.

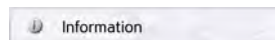

> Press the **Information** button.

The information display appears with the software version number.



By pressing the **Service information** button, you can display further information such as used licences, installed contents and map material. Always quote these details in enquiries to the service provided by United Navigation GmbH.

### Factory settings

You can reset your Navigation device to the factory settings.

The following updated data is deleted: saved destinations, saved routes, the home address, telephone data, images, videos etc. saved on the internal memory.

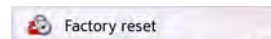

> Press the **Factory reset** button.



> Press the **Yes** button.

The Navigation device is reset to the factory settings.

### Calibration (model dependent)

If the touch screen responds incorrectly when buttons are pressed, it needs to be calibrated.

#### Starting the calibration

You can start the calibration using the following button:

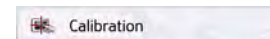

> Press the **Calibration** button.

The calibration procedure will be started. You will be guided through the procedure by means of text instructions.

## WIFI SETTINGS (MODEL DEPENDENT)

You can establish a data connection to a WiFi network (a telephone, for example) from your navigation system. This function requires that there is a mobile device in range which can be used as a WiFi hotspot.

Please refer to the operating instructions for your smartphone to see if/how you can use your smartphone as a mobile hotspot.

Press the WiFi settings button in the Settings menu.

Press the  button to activate and deactivate the WiFi function.

Press the  button to display the list of available networks. Select the network you wish to access from the list. Networks belonging to other people which you cannot access without a corresponding password might also appear in the list.

If you are connecting to a network for the first time, you must enter a password for this device. Enter the correct password for your WiFi hotspot here.

If you have previously connected to a

network, you can select it from this list without having to enter a password again.

If you have previously connected with a WiFi hotspot, the system will automatically try to re-establish the connection the next time you activate WiFi.

If you select the  button in this menu, you can establish or disconnect a connection, delete this network from the list or delete all networks displayed from the list.

The  button is used to modify or display specific settings.

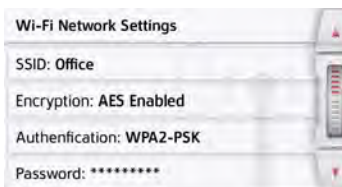

You can view the encryption, authentication and name of the WiFi network, for example, or enter the password for your WiFi hotspot.

### Notice:

The data transmission via your mobile phone may involve additional costs depending on the mobile phone contract. Please find out from your mobile phone provider before activating. If a connection to the server is not possible, e.g. because no mobile phone network is available for a longer period of time, then the system switches over automatically to TMC until a connection to the server is possible again.

**GMT**

(Greenwich Mean Time)

Central European Time standard

Standard time at 0 degree longitude (the longitude intersecting Greenwich, Great Britain). This time is used worldwide for synchronization of data collection.

**Bluetooth® wireless technology**

Technology for wireless data transmission at short range up to 10 metres.

**GPS**

(Global Positioning System)

GPS determines your actual geographical position by the use of satellites. It is based on a total of 24 satellites which orbit the Earth and transmit signals. The GPS receiver receives these signals and calculates the distance to each satellite from the running time differences and thus evaluates its actual current position in terms of geographical length and width. In order to determine the position, signals from at least three satellites are required, and the fourth one allows the height to be determined.

**JPG/JPEG**

(Joint Photographic Experts Group)

The JPEG is the most common type of storage format for dissipating picture compression, i.e. when compressing, details of the picture are lost. Still provides good picture quality despite compression, compression stages are selectable. It is the most common format for representation and exchange of pictures on the internet.

**SD card**

(Secure Digital)

The Secure Digital Card was developed in 2001 by SanDisk on the basis of the older MMC standard. An SD card is a rewritable change-over storage card.

**Stylus**

A stylus is an input pointer which is used for the operation of touch-screens, mobile phones or PDAs.

The stylus consists basically of a plastic pointer with a softer plastic core. The sleeve is hard and can be gripped and the softer core emerges at the tip and is designed to touch the screen as softly as possible (i.e. without the danger of scratching the screen).

The stylus is more accurate than operation using the fingers, since only the thin tip touches the screen. In addition, dirty marks on the screen caused by fingerprints are avoided.

**TMC**

(Traffic Message Channel)

Traffic announcements transmitted by most FM stations via RDS. Basis for dynamic navigation.

**USB**

(Universal Serial Bus)

The Universal Serial Bus (USB) is a bus system for interconnection of a computer with external USB peripherals for the exchange of data.

**Numerics**

3D display .....63

**A**

Adjusting the map view .....63

Announce streets .....76

Automatic call acceptance .....119

Automatic connection ..... 114, 119

**B**

Block .....100

Blocked roads .....80

Blocking a section of the road .....100

Blocking a section of the road

permanently .....126

Bluetooth® wireless technology ... 113,

139

Switching on/off .....119

**C**

Call

Accept .....116

End ..... 116, 117

Ignore .....116

Reject .....116

Call list .....111

scrolling .....111

selecting number .....112

Call lists .....111

Connecting a telephone .....113

Content Manager .....33

telepítése .....34

Coordinate entry .....58

Country information ..... 68, 125

Current position .....101

**D**

Destination from map .....57

Destination input menu

Start .....44

Destination list .....39

Destination memory

changing .....40, 111

Scroll .....40

Destinations

Entering .....44

Protected .....40

Standard .....40, 113

Storing .....48

Dial .....108

Dialing a number .....108

Display position .....57

Display street names .....64

Displaying information signs .....78

Displaying the route ..... 48, 97

Driver warnings .....78

**E**

Easy route .....73

Economical route .....73

Eco-route .....73

Entering address by speech .....50

Entering an address .....45

Entering the town .....46

**F**

Factory settings .....83

Fast access .....40

Icons .....40

Fast route .....73

Ferries .....74

**G**

Geo coordinates .....58

GMT ..... 139

Google™ points of interest .....41

GPS ..... 139

GPS reception ..... 102

**H**

Hazardous materials class .....72

Home address .....38

House number .....48

**I**

- ID3 tag ..... 139
- Image viewer ..... 121
- Intended purpose .....7
- Intersection ..... 47

**J**

- JPG/JPEG ..... 139

**L**

- Lap recording ..... 128
- Last announcement ..... 92
- Lists
  - List of towns ..... 46
  - Street list ..... 47
  - telephone numbers ..... 111

**M**

- Map
  - showing ..... 87
  - Zoom in ..... 57, 93, 104
  - Zoom out ..... 57, 93, 104
- Map display ..... 87
- Map orientation ..... 64
- Memory card ..... 23
- Micro SD Card ..... 23
- Microphone on/off ..... 117
- Motorways ..... 74

**N**

- Navigation ..... 37
  - starting ..... 48
  - terminating .....29, 99
- Number list
  - Dialing a number ..... 112
- Number lists ..... 111

**P**

- Phonebook ..... 108, 109
  - Update ..... 120
- Photo ..... 121
- Point of Interest on the route ..... 55
- Points of interest
  - Call ..... 56
  - entering directly ..... 55
  - in the vicinity ..... 53
  - near the destination ..... 55
  - near to an address ..... 54

**Q**

- Quick access
  - Icons ..... 111

**R**

- Restrictions
  - Ferries ..... 74
  - Motorways ..... 74
  - Toll roads ..... 74
- Route calculator ..... 127
- Route description ..... 97
- Route guidance
  - starting ..... 48
  - terminating .....29, 99
- Route options .....68, 99
- Route planning .....44, 58
- Route types ..... 103

**S**

- Safety instructions .....7, 37
- Satellites ..... 102
- SD card ..... 23
- Searching for a telephone ..... 114
- Selecting a country ..... 45
- Selecting a town ..... 46
- Selecting destination
  - Entering an address ..... 45
- Selecting the street ..... 47
- Setting the volume ..... 92, 119
- Settings
  - Navigation ..... 62
  - System ..... 129
  - Telephone ..... 118

Short route .....73  
Slide show .....124  
Speed limit .....79  
Stopover .....100  
    Deleting .....100  
Stylus .....140  
Switching on the navigation device ..27  
System settings .....129

**T**

Telephone menu .....108  
The main menu .....29  
Time of day format .....82  
Time zone .....82  
TMC .....74, 83  
    Displaying TMC messages on the  
    map .....84  
    Route recalculation .....86  
TMC antenna .....22  
Toll roads .....74  
Traffic information .....68, 125  
Truck profile .....71

**U**

Units .....82  
USB .....140

**V**

Vehicle profile  
    selecting .....69, 70  
    setting .....70  
Voice .....76  
Voice commands .....50

**W**

Warnings  
    Speed limit .....79

## MODEL OVERVIEW AND TECHNICAL SPECIFICATIONS

- : standard
- : not available
- : optional

	Navigation system									
	active.5 CE LMU BE B00	active.5 LMU BE B00	transit.5 LMU BE B02	active.5 LMU plus BE B10	active.6 CE LMU BE B30	active.6 LMU plus BE B40	professional.5 LMU BE B20	professional.6 LMU BE B50	transit.6 LMU BE B50	ready.5 BE B60
Weight	200 g	200 g	200 g	200 g	300 g	300 g	220 g	330 g	330 g	200 g
Processor in MHz	800	800	800	800	800	800	800	800	800	800
Flash memory	4 GB	4 GB	8 GB	4 GB	4 GB	4 GB	8 GB	8 GB	8 GB	4 GB
SD-RAM	256 MB	256 MB	256 MB	256 MB	256 MB	256 MB	256 MB	256 MB	256 MB	128 MB
Li-polymer battery	1250 mAh	1250 mAh	1250 mAh	1250 mAh	1550 mAh	1550 mAh	1300 mAh	1550 mAh	1550 mAh	1250 mAh
TMC	●	●	●	●	●	●	●	●	●	●
Holder for vehicle integration	-	-	-	-	-	-	-	-	-	-
Bluetooth® hands-free device	-	-	-	●	-	●	●	●	●	-
Dimensions in mm (W x H x D):	138x85x16	138x85x16	138x85x16	138x85x16	167x103x16	167x103x16	138x85x16	167x103x16	167x103x16	138x85x16
Screen size	12.7 cm	12.7 cm	12.7 cm	12.7 cm	15.8 cm	15.8 cm	12.7 cm	15.8 cm	15.8 cm	12,7cm
Display resolution	800 horizontal and 480 vertical									480 x 272
Resistive touch display	●	●	●	●	●	●	-	-	-	●
Capacitive touch display	-	-	-	-	-	-	●	●	●	-
Micro SD card reader	Support class 6 SDHC max. 32 GB; format FAT32									
USB interface	USB Client 2.0, Micro-USB									
1 Internal loudspeaker	1.5 Watt max.									
Supply voltage LPS (Limited Power Source)	5V, 1,3A	5V, 1,3A	5V, 1,3A	5V, 1,3A	5V, 2A	5V, 2A	5V, 2A	5V, 2A	5V, 2A	5V, 1,3A
Compatible with HR holders	●	●	●	●	●	●	●	●	●	●



- : standard
- : not available
- : optional

	Navigation system								
	Ready 70 LMU BE J00	Transit 70 LMU BE J10	Transit 70 LMU Pro BE J11	Professional 70 LMU BE J12					
Weight	311 g	320 g	320 g	320 g					
Processor in MHz	800	800	800	800					
Flash memory	4 GB	4 GB	8 GB	8 GB					
SD-RAM	256 MB	256 MB	256 MB	256 MB					
Li-polymer battery	1500 mAh	1500 mAh	1500 mAh	1500 mAh					
TMC	●	●	●	●					
Holder for vehicle integration	-	-	-	-					
Bluetooth® hands-free device	-	-	-	-					
Dimensions in mm (W x H x D):	184x115x15	184x115x15	184x115x15	184x115x15					
Screen size	17,8 cm	17,8 cm	17,8 cm	17,8 cm					
Display resolution	800 horizontal and 480 vertical								
Resistive touch display	-	-	-	-					
Capacitive touch display	●	●	●	●					
Micro SD card reader	Support class 6 SDHC max. 32 GB; format FAT32								
USB interface	USB Client 2.0, Micro-USB								
1 Internal loudspeaker	2.5 Watt max.								
Supply voltage LPS (Limited Power Source)	5V, 2A	5V, 2A	5V, 2A	5V, 2A					
Compatible with HR holders	●	●	●	●					

**Dear customer,**

In conformance with current EC guidelines, any person may operate this unit. This unit conforms to the current valid European or harmonized national regulations. This designation is your guarantee that the unit conforms to the applicable specifications concerning electromagnetic compatibility. Interference caused by your unit affecting other electrical/electronic devices, as well as interfering influences on your unit from other electrical/electronic devices are largely prevented.

**EU Declaration of Conformity**

The **United Navigation GmbH** hereby declares that the navigation device described here is in compliance with the essential requirements of the EC directives and in particular is in compliance with the essential requirements and other relevant regulations of the R&TTE directive 1999/5/EG.

You can find a comprehensive EU Declaration of Conformity on our website <http://www.mybecker.com> under the "Downloads" area for the respective product.

## Disposal of the unit

### Customer information on the disposal of electrical and electronic devices (private households)

According to the self-proclaimed corporate principles of United Navigation GmbH, your product has been developed and manufactured from high-quality, recyclable materials and components.

This symbol on the product and/or accompanying documentation means that electrical and electronic products must be disposed of separately from the household garbage at the end of its service life. Please bring this product to the appropriate collection sites for processing and recycling. The units will be accepted there free of charge.

The proper disposal of this product serves the purpose of environmental protection and prevents the harmful effects to persons and the environment that may be caused by improper disposal.

For further information on the nearest collection points, please contact your local municipal authorities.

### For commercial customers in the European Union

Please contact your dealer or supplier if you wish to dispose of this electrical/electronic device.

### Information on disposal in countries outside the European Union

This symbol is only valid within the European Union.



## Disposal of the battery

### Duty to supply information according to battery legislation (BattV)

Batteries must not be disposed of in household waste. It is the duty of the user to return used batteries. Please only dispose of batteries via specialised dealers or at battery collection points. In this way, you make a positive contribution to environmental protection.

Since 1998, German battery legislation obligates all citizens to dispose of used batteries exclusively via the retail or at collection points specially equipped for this purpose (statutory obligation to return). It is the duty of the retail and of manufacturers to take back these batteries free of charge and to correctly recycle them or to dispose of them as hazardous waste (statutory obligation to take back).

The lithium ion battery in the Navigation device is marked with the adjacent symbol, consisting of a crossed-out waste bin, and the type of battery used.



### Removing the battery

Before you hand in your old unit for disposal, the battery must first be removed.

#### Note:

Please note that in following the removal instructions for the battery described here, your unit may be **destroyed**. You should only remove the battery if your unit is old and is to be handed in for disposal.

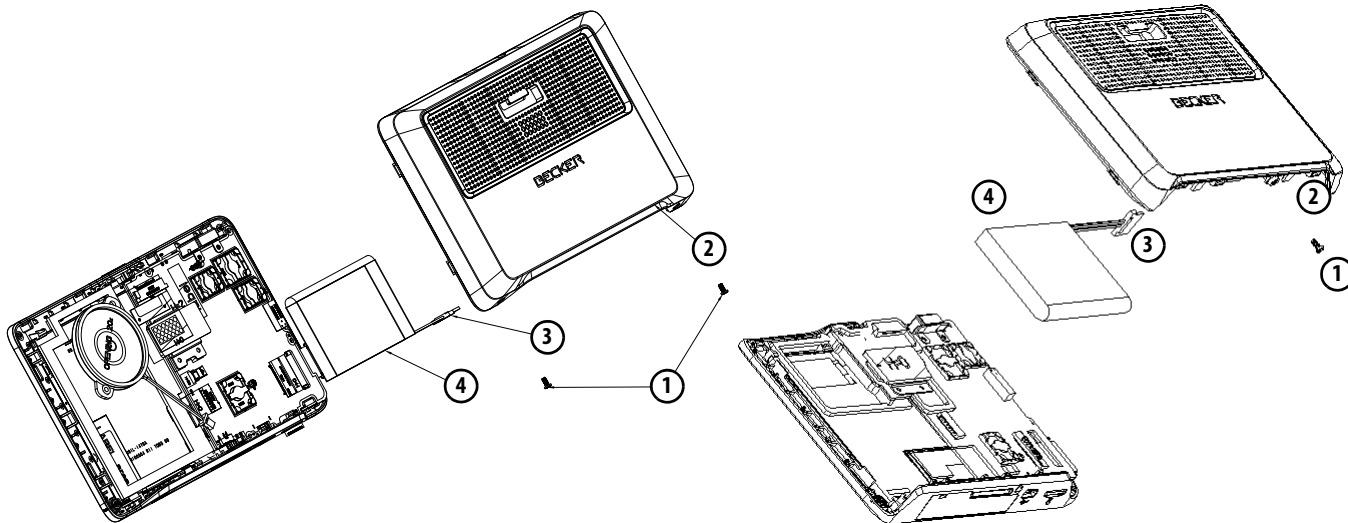

- > Completely discharge the battery (leave the unit switched on with no power supply until it automatically switches off).
- > Unscrew and remove the housing screws ① (model dependent) using a small screwdriver.
- > Lever off the rear of the housing ② using a flat-blade screwdriver (placed at the slits on the sides of the housing).
- > Remove the circuit board if necessary; to do this, you first have to remove the screws of the circuit board (model dependent).
- > Pull out the connector of the battery connecting cable ③.
- > Remove the battery ④.

**Note:**

Do not reconnect a unit that you have opened to the power supply.

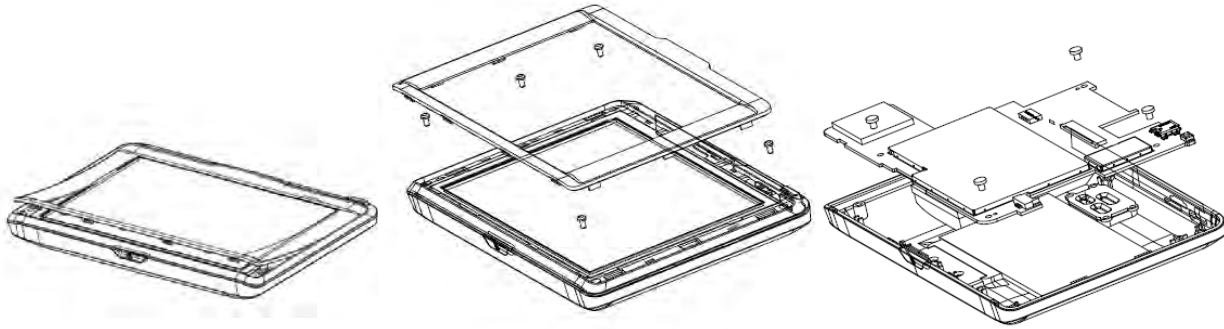

For devices without screws on the bottom side of the device (model dependent):

- > Completely discharge the battery (leave the unit switched on with no power supply until it automatically switches off).
- > Lever off the front cover using a flat-headed screw driver (placed between the display and display frame).
- > Remove the 5 screws.
- > You can now lever off the front of the device from the back panel using a flat-headed screw driver.
- > Then remove the circuit board; to do this, you first have to remove the screws of the circuit board.
- > Disconnect the plug of the battery connection cable.
- > Remove the battery.

**Note:**

Do not reconnect a unit that you have opened to the power supply.

**United Navigation GmbH**

Marco-Polo-Str. 1

73760 Ostfildern - Germany

[www.mybecker.com](http://www.mybecker.com)

**BECKER**