



bryton®



Rider
40

User's Manual



Table of Contents

Getting Started	4	Stopwatch	19
Your Rider 40	4	Countdown	19
Accessories	5	Timer	20
Turn On/Off Rider 40.....	5	Settings	21
Reset Rider 40.....	5	Altitude	21
Initial Setup	5	Personalize Bike Profile	22
Connect, Sync, and Charge.....	5	Display	23
Status Icons	6	View GPS Status	25
Ready for Training.....	6	Sensors.....	26
Sharing and Managing Data	7	Change System Settings.....	27
Train & Test	8	Personalize User Profile.....	30
Simple Workouts	8	View Firmware Version	30
Interval Workouts	10	Appendix	31
Lap Workouts.....	11	Specifications	31
My Workout	12	Battery Information	32
My Schedule Workouts	13	Install Rider 40	33
Bryton Workout.....	13	Install the Speed/Cadence Sensor (Optional).....	34
Test Workouts	14	Install Heart Rate Belt (Optional).....	35
Stop Training	15	Wheel Size and Circumference	36
Follow Track	16	Basic Care For Your Rider 40.....	37
Navigate Rides from History	16		
Navigate Rides from Planned Trip	16		
My POI.....	17		
Data Recording.....	17		
Stop Navigating	17		
Save POI	18		
View History	18		



WARNING

Always consult your physician before you begin or modify any training program. Please read the details in Warranty and Safety Information guide in the package.

Product Registration

Help us better support you by completing your device registration using Bryton Bridge. Go to <http://support.brytonsport.com> for more information.

Bryton Software

Go to <http://brytonsport.com> to download free software to upload your personal profile, tracks and analyze your data on the web.

Australian Consumer Law

Our goods come with guarantees that can not be excluded under the New Zealand and Australian Consumer Laws. You are entitled to a replacement or refund for a major failure and for compensation for any other reasonably foreseeable loss or damage. You are also entitled to have the goods repaired or replaced if the goods fail to be of acceptable quality and the failure does not amount to a major failure.

Getting Started

This section will guide you on the basic preparations before you start using your Rider 40.

Your Rider 40

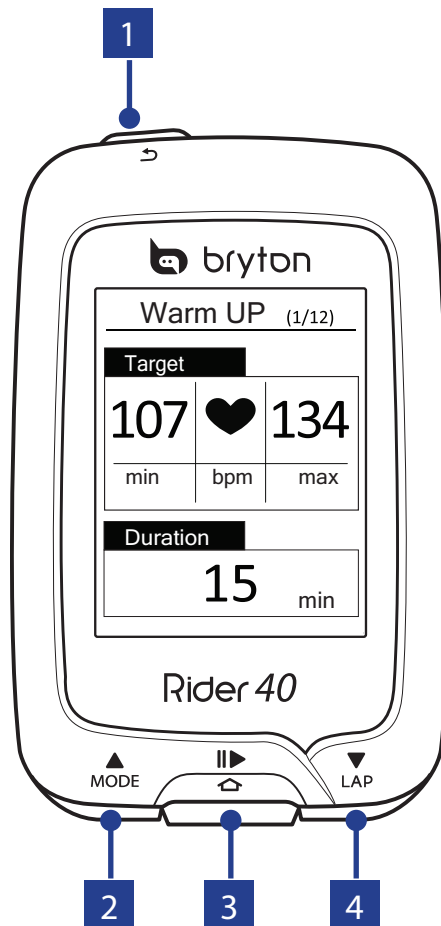

1 POWER/BACK (⏻/↶)

- Press to return to the previous page or cancel an operation.
- Press and hold to turn the device on/off.

2 MODE/UP (▲)

- In meter view, press to switch meter screen page.
- In Menu, press to move up to scroll through menu options. Press and hold to fast scroll up through menu options.
- In altitude view, press and hold to see altitude whole view.

3 ENTER/RECORD (⏏/||▶)

- In Menu, press to enter or confirm a selection.
- In free cycling, press to start recording. Press it again to stop recording.

4 LAP/DOWN (▼)

- In Menu, press to move down to scroll through menu options. Press and hold to fast scroll down through menu options.
- When riding and recording, press to mark the lap.
- In Meter mode, press and hold to enter Shortcut page.

Accessories

The Rider 40 comes with the following accessories:

- mini USB cable
- Bike mount

Optional items:

- Heart rate belt
- Speed sensor
- Cadence sensor
- Combo sensor

Turn On/Off Rider 40

Press and hold  to turn Rider 40 on or off.

Reset Rider 40

To reset the Rider 40, long press all three keys (//) at the same time.

Initial Setup

When turning Rider 40 on for the first time, the setup wizard appears on screen. Follow the instructions to complete setup.

1. Select the display language.
2. Select the daylight saving time.
3. Select the unit of measurement.
4. Enter your “user profile”.

The “user profile” includes the following data settings:

- Gender
- Age
- Height
- Weight
- Max HR (Maximum HR)
- LTHR (Lactate threshold heart rate)

It is recommended to input the data. Data accuracy highly affects your training analysis.

5. Select the exercise type.
6. Read and accept the Safety Agreement.

NOTE: If you want to change the language on the device, please connect your device to [Brytonsport.com](https://www.brytonsport.com) and change the setting via **My Device > Manage Device Data** or go to **Settings > System > Language**.

Connect, Sync, and Charge

Warning:

This product contains a lithium-ion battery. See the Warranty and Safety Information guide in the package for important battery safety information.

1. Connect Rider 40 to a PC using the supplied mini USB cable.

- Download the *Bryton Bridge 2* application from bb.brytonsport.com and sync with Rider 40.





















Keep Rider 40 connected to the PC to charge the battery.

Use a mini USB cable to connect to a PC.

NOTE: For first time use, charge the battery for about 4 hours.

Status Icons

Icon	Description
Bike in use	
	Bike 1
	Bike 2
GPS Signal Status	
	No signal (not fixed)
	Weak signal
	Strong signal
Power Status	
	Full battery
	Half battery
	Low battery

Icon	Description
	Heart Rate Sensor Active
	Cadence Sensor Active
	Speed Sensor Active
	Power Meter Active
	Combo Sensor Active
	Train & Test mode
	Meter mode
	Follow Track mode
	Log Record in Progress
	Pause log recording

NOTE: Only the active icons are displayed on the screen.

Ready for Training

- Turn on Rider 40.
- Press ▼ to select **Train & Test** and press 🏠 to enter the Train & Test menu.
- To set a simple workout, select **To Plan > Simple > By Time, By Distance, or By Calories**.

4. Set the necessary exercise/training settings and go for a ride.

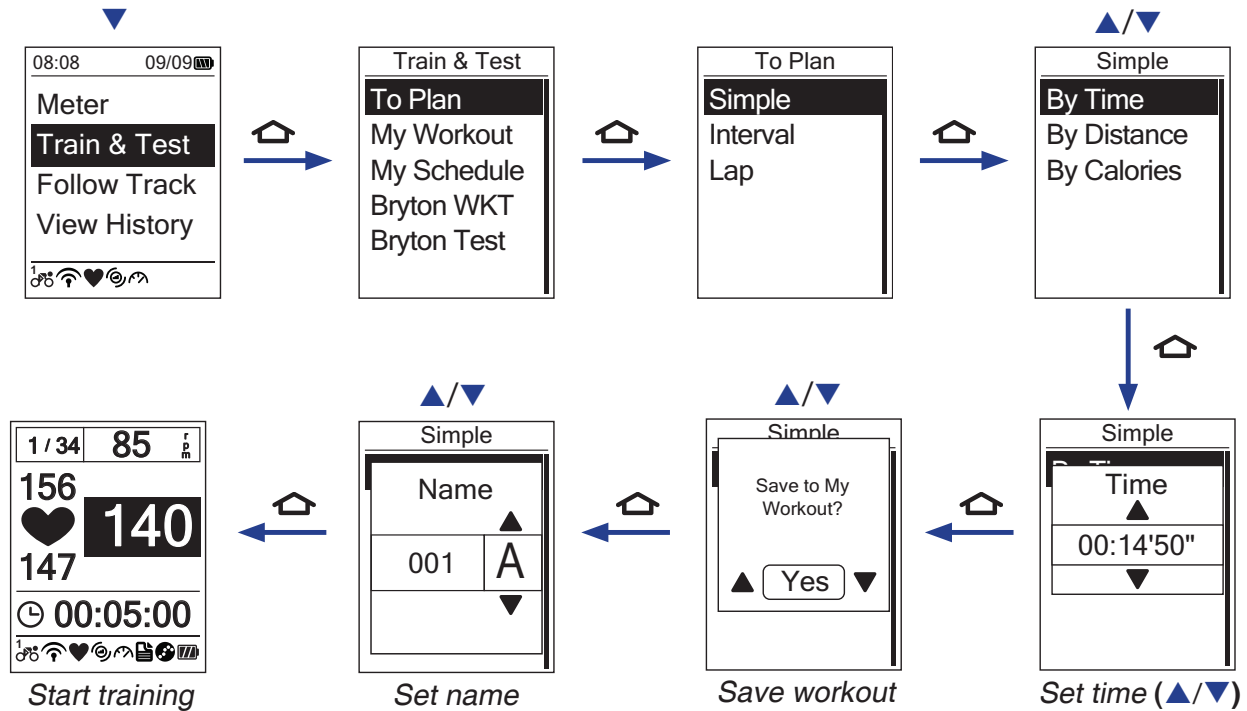

NOTE:

- *By Calories* will only be displayed on the screen if HR sensor is linked to Rider 40.
- Displayed information and available options vary on exercise/training mode.

Sharing and Managing Data

Manage Rider 40 Data via Your Computer

1. Connect your Rider 40 to your computer by using the mini USB cable.
2. Install the *Bryton Bridge 2* application. You can download the application from <http://bb.brytonsport.com>.
3. Follow the on-screen instructions to transfer data to your computer.

NOTE: Do not unplug the USB cable during the file transferring process. Otherwise, the files may be damaged or corrupted.

Share Your Experience With Other Bikers

To share your experiences and training result with other bikers around the world, visit <http://www.brytonsport.com>.

Train & Test

Bicycling is one of the best types of exercise for your body. It helps you to burn your calories, lose weight, and increase your overall fitness. With the Rider 40 Train & Test feature, you can set simple/zone based workouts and use the Rider 40 to track your training or workout progress.

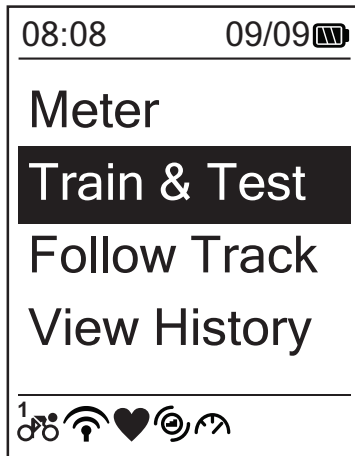

1. In the main screen, press ▲/▼ to select **Train & Test**.
2. Press 🏠 to enter the Train & Test menu.

Simple Workouts

You can set simple workouts by entering your time or distance goals.

The Rider 40 offers you with three types of simple workouts:

- By Time
- By Distance
- By Calories

Time

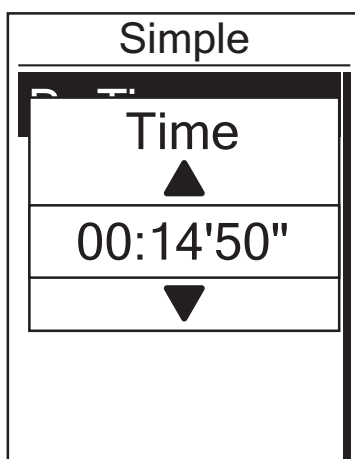

1. In the Train & Test menu, press ▲/▼ to select **To Plan > Simple > By Time** and press 🏠.
2. Press ▲/▼ to set your time and press 🏠 to confirm.
3. A "Save to My Workout?" message appears on the screen. To save the data, press ▲/▼ to select **Yes** and press 🏠 to confirm.
4. Enter the workout name using the on-screen keyboard.
5. Go for a ride.
Press 🏠 to start training and record log.

Distance

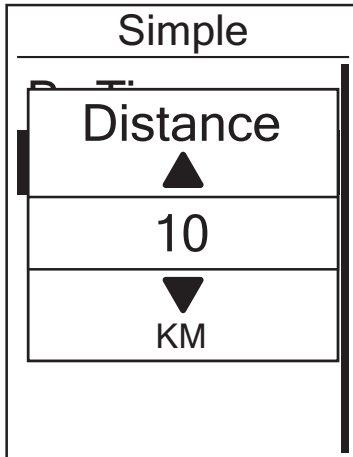

1. In the Train & Test menu, press ▲/▼ to select **To Plan > Simple > By Distance** and press 🏠.
2. Press ▲/▼ to set your distance and press 🏠 to confirm.
3. A "Save to My Workout?" message appears on the screen. To save the data, press ▲/▼ to select **Yes** and press 🏠 to confirm.
4. Enter the workout name using the on-screen keyboard.
5. Go for a ride.
Press 🏠 to start training and record log.

Calories

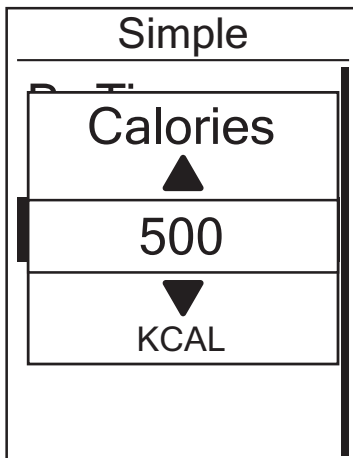

1. In the Train & Test menu, press ▲/▼ to select **To Plan > Simple > By Calories** and press 🏠.
2. Press ▲/▼ to set your calories that you want to burn and press 🏠 to confirm.
3. A "Save to My Workout?" message appears on the screen. To save the data, press ▲/▼ to select **Yes** and press 🏠 to confirm.
4. Enter the workout name using the on-screen keyboard.
5. Go for a ride.
Press 🏠 to start training and record log.

NOTE: *By Calories* will only be displayed on the screen if HR sensor is linked to Rider 40.

Using the On-screen Keyboard

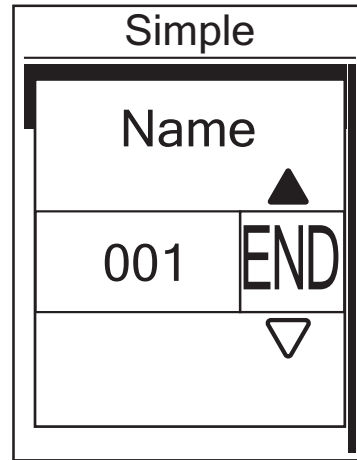
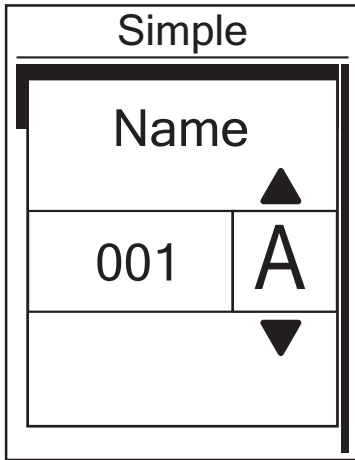

1. Press ▲/▼ to select the input character.
 - Select **DEL** to erase the data.
2. Press 🏠 to confirm the selection.
3. When finished, press ▲/▼ to select **END** and press 🏠 to confirm or press ⏻ to save.

Interval Workouts

You can create a customize interval workouts with your Rider 40.

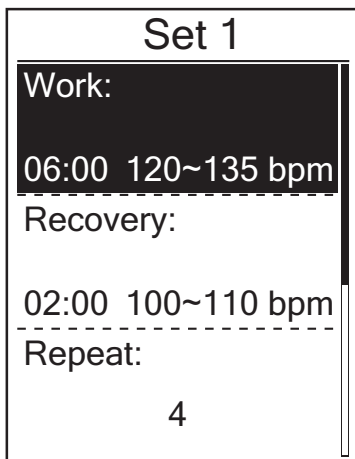

1. In the Train & Test menu, press ▲/▼ to select **To Plan > Interval** and press 🏠.
2. Set the customize workout settings.
 - Work • Recovery • Repeat time
3. When finished, press ▲/▼ to select **Next** and press 🏠 to continue.
4. A "Create a new main set?" message is displayed on the screen. To create another set of interval workout, select **Yes** and press 🏠 to confirm. Follow step 2~3.

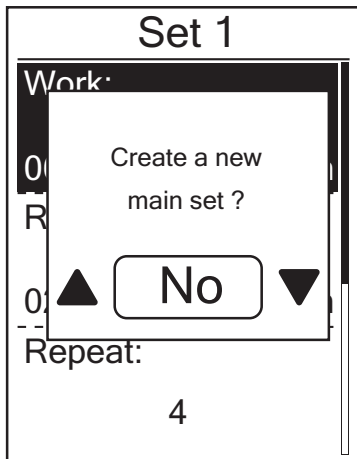

- To continue with “Warm & Cool” setting, select **No** and press to confirm.
- Set the “Warm up” and “Cool Down” settings.
 - When finished, press to select **OK** and press to continue.
 - A “Save to My Workout?” message appears on the screen. To save the data, press to select **Yes** and press to confirm.
 - Enter the workout name using the on-screen keyboard.
 - Go for a ride.
Press to start training and record log.

Lap Workouts

With the Lap feature, you can use your Rider 40 to automatically mark the lap at a specific location or after you have traveled a specific distance.

Lap by Location

- In the Train & Test menu, press to select **To Plan > Lap > By Location** and press .
- Go for a ride.
Press to start training and record log.

NOTE: If the GPS signal is not fixed, a “NO GPS” message appears on the screen.

Lap by Distance

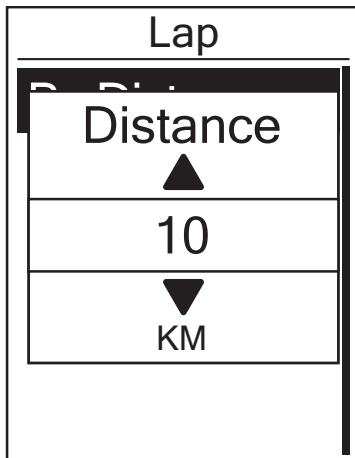

1. In the Train & Test menu, press ▲/▼ to select **To Plan > Lap > By Distance** and press 🏠.
2. Press ▲/▼ to select your desired distance and press 🏠 to confirm.
3. Press ▲/▼ to select **Continue** and press 🏠 to continue.
4. A "Save to My Workout?" message appears on the screen. To save the data, press ▲/▼ to select **Yes** and press 🏠 to confirm.
5. Go for a ride.
Press 🏠 to start training and record log.

My Workout

With My Workout feature, you can start your workout using the training plan that you have saved earlier.

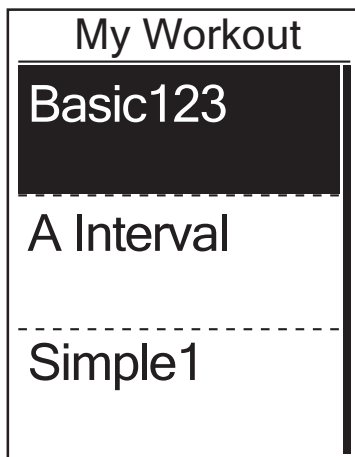

1. In the Train & Test menu, press ▲/▼ to select **My Workout** and press 🏠.
2. Press ▲/▼ to select your desired training plan and press 🏠 to confirm.
3. Go for a ride.
Press 🏠 to start training and record log.

NOTE: If the selected workout includes several interval settings, a workout details appear on the screen. Select **Start** and press 🏠 to proceed with the workout.

My Schedule Workouts

You start a workout based on the preset interval workouts data.

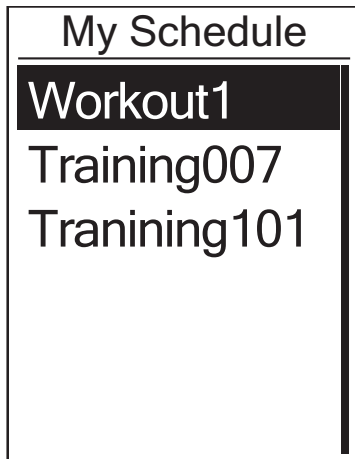

1. In the Train & Test menu, press ▲/▼ to select **My Schedule** and press 🏠.
2. Press ▲/▼ to select your desired schedule workout and press 🏠 to confirm.
3. The selected workout details appear on the screen. Select **Start** and press 🏠 to continue.
4. Go for a ride.
Press 🏠 to start training and record log.

Bryton Workout

With Bryton Workout feature, you can start your workout using the training plan that you have downloaded to your Rider 40 from the Bryton Bridge application.

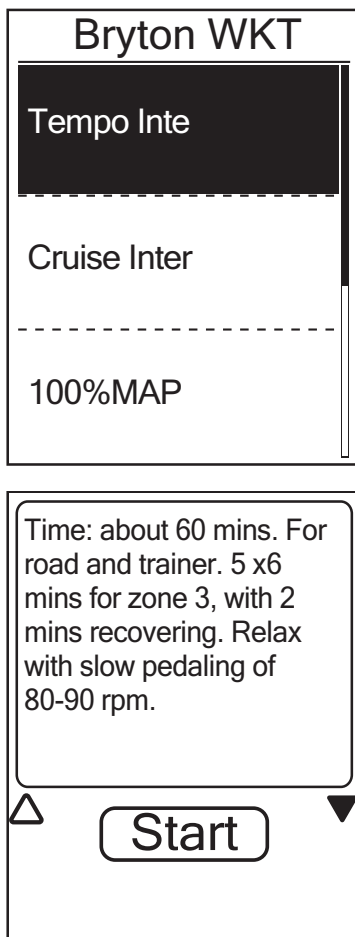

1. Connect your Rider 40 to the computer using the mini USB cable.
2. Download the available workout via brytonsport.com and Bryton Bridge application. Follow the on-screen instructions to transfer data to your Rider 40.
3. Unplug the mini USB cable and your Rider 40 will automatically restart.
4. In the Train & Test menu, press ▲/▼ to select **Bryton WKT** and press 🏠.
5. Press ▲/▼ to select your desired workout and press 🏠 to confirm.
6. The selected workout details appear on the screen. Select **Start** and press 🏠 to continue.
7. Go for a ride.
Press 🏠 to start training and record log.

Test Workouts

With Bryton Test workout, you can measure your MHR (Maximum Heart Rate), LTHR (Lactate Threshold Heart Rate), FTP (Functional Threshold Power), and MAP (Maximum Aerobic Power).

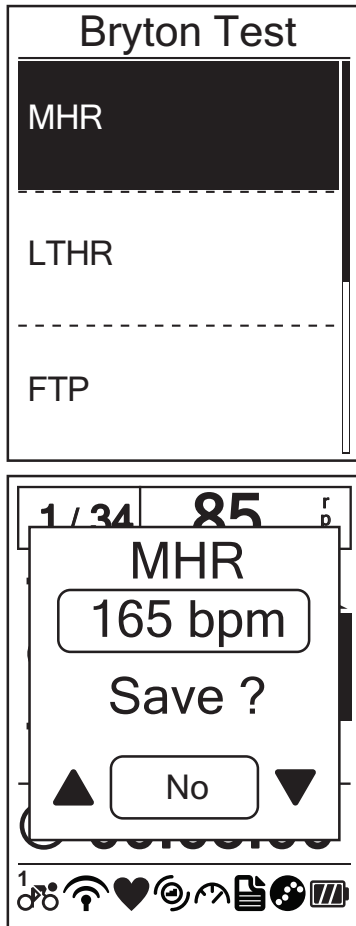







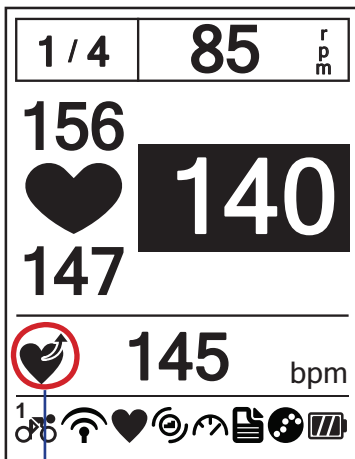

1. In the Train & Test menu, press ▲/▼ to select **Bryton Test** and press 🏠.
2. Press ▲/▼ to select your desired test workout and press 🏠 to confirm.
 - MHR: a test workout for measuring your maximum heart rate.
 - LTHR: a test workout for measuring your lactate threshold heart rate.
 - FTP: a test workout for measuring your functional threshold power.
 - MAP: a test workout for measuring your maximum aerobic power.
3. The selected workout details appear on the screen. Press 🏠 to continue.
4. Go for a ride.
5. After the test workout is complete, a "Save?" message appears on the screen. To save the test data, press ▲/▼ to select **Yes** and press 🏠 to confirm.

Icon indicators

During the test workout, the displayed icon varies depending on the sensor type and the current status.







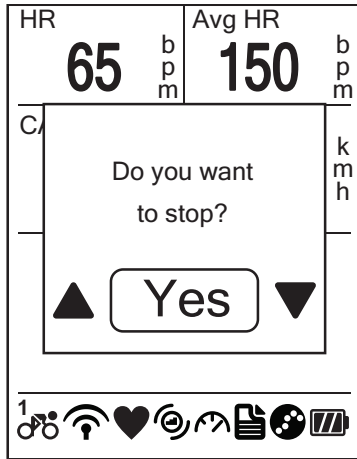

current status

Icon	Description
	Increasing Heart Rate
	Increasing Max Heart Rate percentage
	Decreasing Heart Rate
	Decreasing Max Heart Rate percentage
	Increasing Cadence
	Decreasing Cadence
	Increasing Speed
	Decreasing Speed

Stop Training

You can stop the current training after you have reached your goal, or you decide to end the current training.



1. Press  or .
2. A "Do you want to stop?" message appears on the screen. To stop the current training, press / to select **Yes** and press  to confirm.

Follow Track

With the Follow Track feature, you can navigate rides from History, Planned Trip, and My POI list.



1. In the main screen, press ▲/▼ to select **Follow Track**.
2. Press 🏠 to enter the Follow Track menu.

Navigate Rides from History

You can navigate any trip saved in your Rider 40 history.

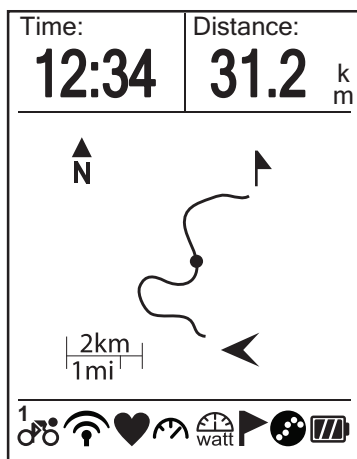

1. In the Follow Track menu, press ▲/▼ to select **History** and press 🏠.
2. Press ▲/▼ to select a ride from the list and press 🏠 to confirm.
3. Press 🏠 to record log.
A track appears on the screen, showing you the direction to your destination.

Navigate Rides from Planned Trip

You can navigate a ride uploaded to your Rider 40 from the Bryton Bridge application.

1. Prepare and download your trip via brytonsport.com and Bryton Bridge application.
2. Connect your Rider 40 to the computer using the mini USB cable.
3. Follow the on-screen instructions to transfer data to your Rider 40.
4. Unplug the mini USB cable and your Rider 40 will automatically restart.
5. Press ▲/▼ to select **Follow Track > Planned Trip** and press 🏠.
6. Press ▲/▼ to select a ride from the list and press 🏠 to confirm.
7. Press 🏠 to record log.

My POI

You can navigate any POI saved in My POI.



1. In the Follow Track menu, press ▲/▼ to select **My POI** and press 🏠.
2. Press ▲/▼ to select a place from the list.
3. Press 🏠 to start navigating the ride.

Data Recording

The Rider 40 can record points of your ride.

- In training mode, press 🏠 to start training and recording log. Press 🏠 again to stop training and recording log.
- In free cycling or direction mode, press 🏠 to start recording log and press it again to stop recording.

Stop Navigating

You can stop the navigation mode at anytime.

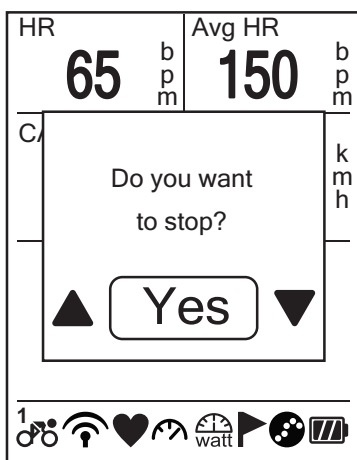

To stop your ride:

1. Press 🏠 or 🔌.
A "Do you want to stop?" message appears on the screen.
2. To stop the current training, press ▲/▼ to select **Yes** and press 🏠 to confirm.

Save POI

You can add the current place into My POI list.

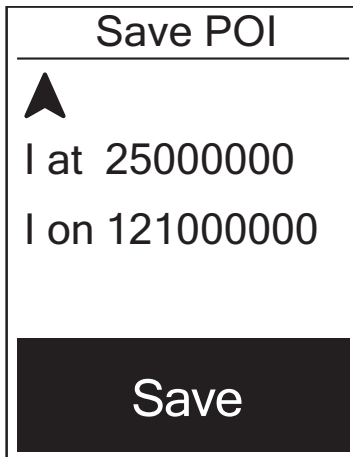

To add a POI data:

1. In the main screen, press ▲/▼ to select **Save POI** and press 🏠.
2. Press 🏠 to save the current POI data.
3. Enter the POI name using the on-screen keyboard.

NOTE: You can also save a POI after you have stopped the current training. Press and hold ▼ to enter Shortcut page and select **Save POI**.

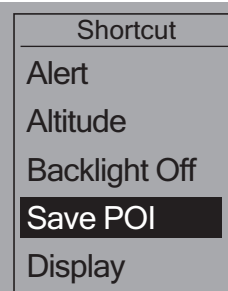

View History

The Rider 40 automatically saves the history as the timer starts. After you have finished a ride, you can view the history data on the Rider 40.



To view your history:

1. In the main screen, press ▲/▼ to select **View History** and press 🏠.
2. Press ▲/▼ to select a ride history from the list and press 🏠 to view your history.

NOTE: You can also upload your history to brytonsport.com to keep track of all your ride data.

Stopwatch

With the Stopwatch feature, you can measure the amount of time elapsed from the time the Rider 40 is activated and deactivated. You can switch between two modes: Countdown and Timer. Countdown is used to notify you when a set amount of time has passed. Timer is used to measure how long something takes.

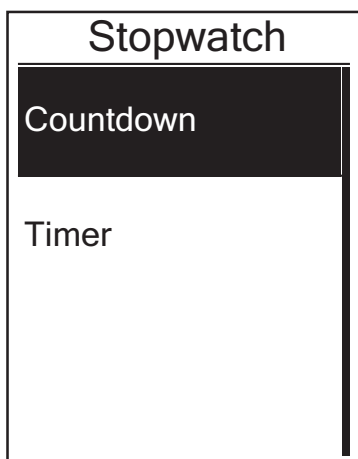

1. In the main screen, press ▲/▼ to select **Stopwatch**.
2. Press 🏠 to enter the Stopwatch menu.

Countdown



1. In the Stopwatch menu, press ▲/▼ to select **Countdown** and press 🏠.
2. Press ▲/▼ to select the time field that you want to adjust and press 🏠.
3. Press ▲/▼ to set your time and press 🏠 to confirm.
4. To start the countdown, press ▲/▼ to select **Start** and press 🏠 to confirm.
5. To stop the countdown, select **Stop** and press 🏠 to confirm.
6. Press ⏻ to exit this menu.

Timer

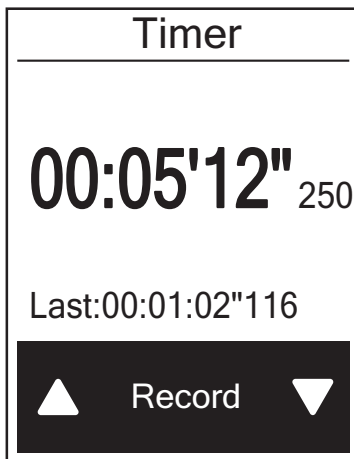

1. In the Stopwatch menu, press ▲/▼ to select **Timer** and press 🏠.
2. To start the timer running, press 🏠 to confirm.
3. To record a lap while the watch is running, press ▲/▼ to select **Record** and press 🏠 to confirm. It displays the first lap time.
 - Repeat this step to create a new lap.
4. To stop the watch, press ▲/▼ to select **Stop** and press 🏠 to confirm.
 - To reset the timer, press ▲/▼ to select **Reset** and press 🏠 to confirm.
5. To view the timer history, press ▲/▼ to select **History** and press 🏠 to confirm.

Settings

With the Settings feature, you can customize altitude settings, display settings, sensor settings, system settings, bike and user profiles, GPS setup, and view device information.

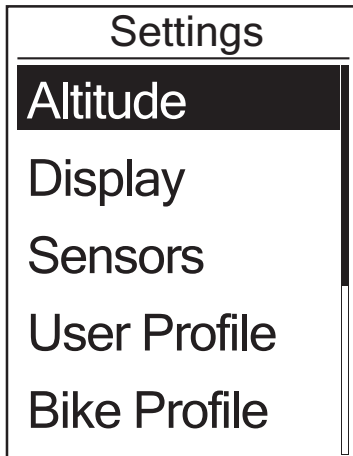

1. In the main screen, press ▲/▼ to select **Settings**.
2. Press 🏠 to enter the Settings menu.

Altitude

You can set the altitude setting for the current location and the other 4 locations.

Current Altitude

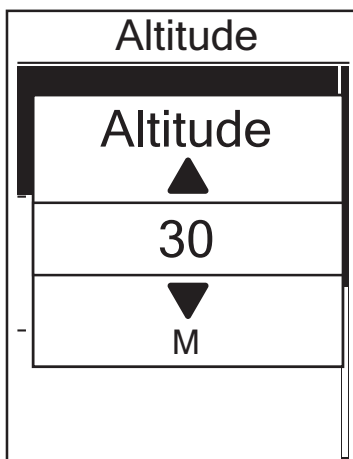

1. In the Settings menu, press ▲/▼ to select **Altitude > Altitude** and press 🏠.
2. Press ▲/▼ to adjust the desired altitude and press 🏠 to confirm the setting.
3. Press ⏻ to exit this menu.

Other Location Altitude

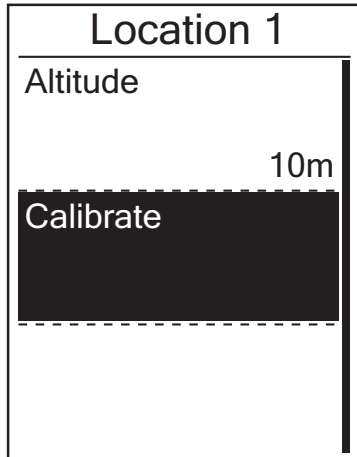

1. In the Settings menu, press ▲/▼ to select **Altitude** > **Location 1**, **Location 2**, **Location 3**, or **Location 4** and press 🏠.
2. To set the altitude, use ▲/▼ to select **Altitude** and press 🏠 to confirm.
3. Press ▲/▼ to adjust the desired altitude and press 🏠 to confirm the setting.
4. To calibrate the set altitude, use ▲/▼ to select **Calibrate** and press 🏠 to confirm.
5. Press ⏻ to exit this menu.

Personalize Bike Profile

You can customize and view your bicycle(s) profile.

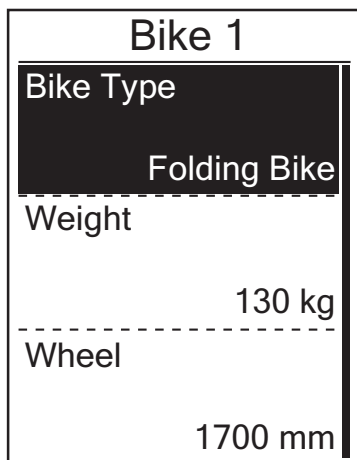

1. In the Settings menu, press ▲/▼ to select **Bike Profile** > **Bike 1** or **Bike 2** and press 🏠.
2. Press ▲/▼ to select the desired setting and press 🏠 to confirm.
 - Bike Type: select the bike type.
 - Weight: set the bike weight.
 - Wheel: set the bike wheel size.
 - Activate: select to activate the bike.
3. Press ⏻ to exit this menu.

NOTE: For details on wheel size, see "Wheel Size and Circumference" on page 37.

View Bike Profile

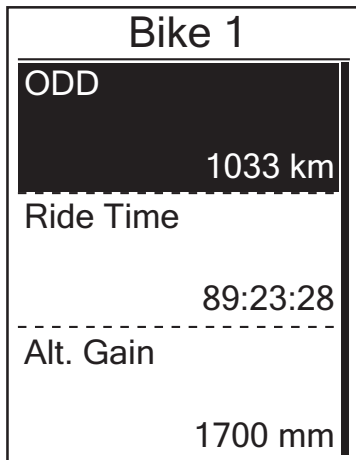

1. In the Settings menu, press ▲/▼ to select **Bike Profile > Overview** and press .
2. Press ▲/▼ to select the desired bike and press to confirm.
3. Press ▲/▼ to view more data of the selected bike.
4. Press to exit this menu.

Display

You can set the display settings for the Meter, Follow Track, Altitude, Lap, and Auto Switch. You can also set the Auto Switch interval setting.

Meter Display

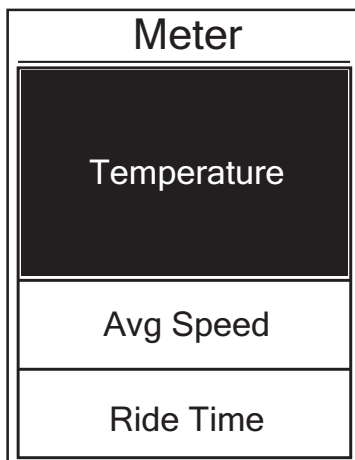

3-grid display

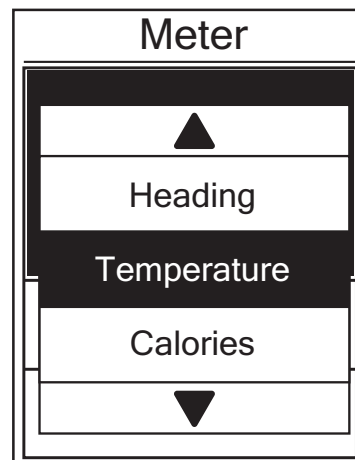





Item selection

1. In the Settings menu, press ▲/▼ to select **Display > Meter > Meter 1, Meter 2, or Meter3** and press .
2. Press ▲/▼ to select the number of data fields and press to confirm.
3. Press ▲/▼ to select the item field that you want to customize, and press to confirm the selection.
4. Press ▲/▼ to select the desired setting and press to confirm.
5. Press to exit this menu.

NOTE:

- The number of data fields shown on the screen depends on the “Data fields” selection:

<p>Time: 12:34:56</p> <hr/> <p>Avg HR: 65 <small>b p m</small></p> <hr/> <p><small>1</small> </p> <p><i>2-grid display</i></p>	<p>Avg HR: 65 <small>b p m</small></p> <hr/> <p>Avg Cadence: 60 <small>r p m</small></p> <hr/> <p>Time: 12:34:56</p> <hr/> <p><small>1</small> </p> <p><i>3-grid display</i></p>	<p>Avg HR: 65 <small>b p m</small></p> <hr/> <p>Avg Cadence: 60 <small>r p m</small></p> <hr/> <p>Max HR: 180 <small>b p m</small></p> <hr/> <p>Max Cadence: 81 <small>r p m</small></p> <hr/> <p><small>1</small> </p> <p><i>4-grid display</i></p>	<p>Avg HR: 65 <small>b p m</small></p> <hr/> <p>Max HR: 180 <small>b p m</small></p> <hr/> <p>Avg Cadence: 60 <small>r p m</small></p> <hr/> <p>Max Cadence: 81 <small>r p m</small></p> <hr/> <p>Time: 12:34:56</p> <hr/> <p><small>1</small> </p> <p><i>5-grid display</i></p>	<p>Time: 12:34</p> <hr/> <p>Distance: 31.2 <small>k m</small></p> <hr/> <p>Avg HR: 65 <small>b p m</small></p> <hr/> <p>Max HR: 180 <small>b p m</small></p> <hr/> <p>Avg Cadence: 60 <small>r p m</small></p> <hr/> <p>Max Cadence: 81 <small>r p m</small></p> <hr/> <p><small>1</small> </p> <p><i>6-grid display</i></p>
---	--	---	---	---

- There are five types of Power meter information that can be displayed on the screen: Power Now (current power), 3s Power (3 seconds average power), 30s Power (30 seconds average power), Max Power (maximum power), and Avg Power (average power).

Follow Track / Altitude / Lap Display

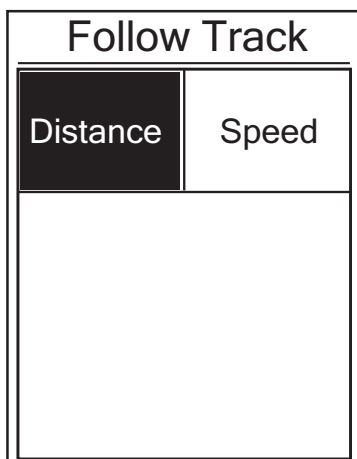

Follow Track (2-grid display)

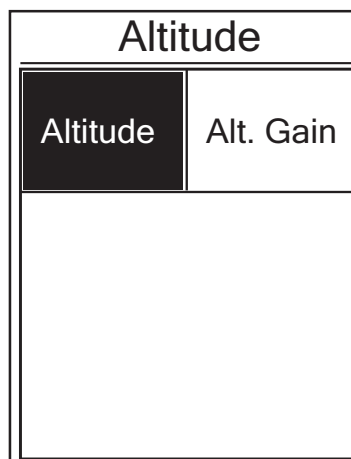

Altitude (2-grid display)

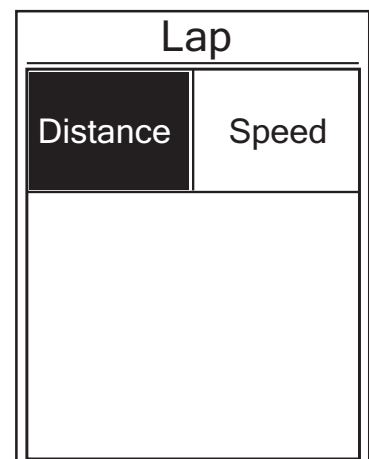

Lap (2-grid display)

- In the Settings menu, press ▲/▼ to select **Display > Follow Track, Altitude, or Lap** and press 🏠.
- Press ▲/▼ to select the number of data fields and press 🏠 to confirm.
- Press ▲/▼ to select the item field that you want to customize, and press 🏠 to confirm the selection.
- Press ▲/▼ to select the desired setting and press 🏠 to confirm.
- Press ⏻ to exit this menu.

Auto Switch

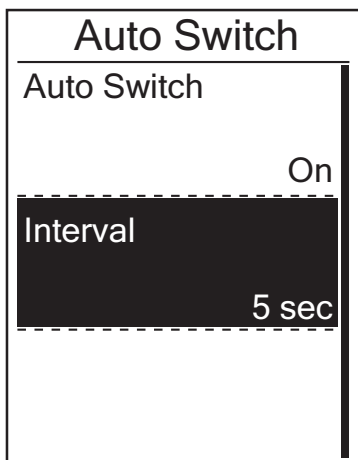

1. In the Settings menu, press ▲/▼ to select **Display > Auto Switch** and press .
2. Press ▲/▼ to select the desired setting and press to confirm.
 - Auto Switch: enable/disable the auto switch.
 - Interval: set the interval time.
3. Press to exit this menu.

View GPS Status

You can view the information about the GPS signal the Rider 40 is currently receiving.

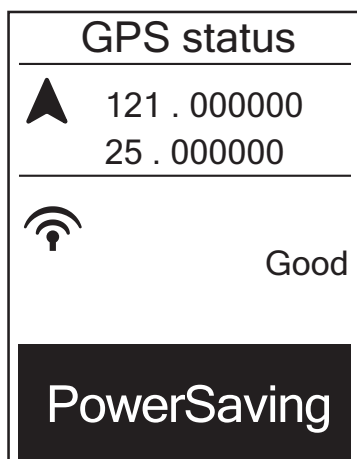

1. In the Settings menu, press ▲/▼ to select **GPS Status** and press .
2. To set the signal search mode, press to confirm.
3. Press ▲/▼ to select the desired setting and press to confirm.
 - Off: Turn-off GPS functions. Choose this to save power when GPS signal is not available, or when GPS information is not required (such as indoor use).
 - Full Power: maximum position and speed accuracy, consumes more power.
 - PowerSaving: Achieves longer battery life when used in good GPS signal condition, but less accurate.

Sensors

You can customize the respective sensor settings such as enable/disable the function or rescan the sensor for the Rider 40.

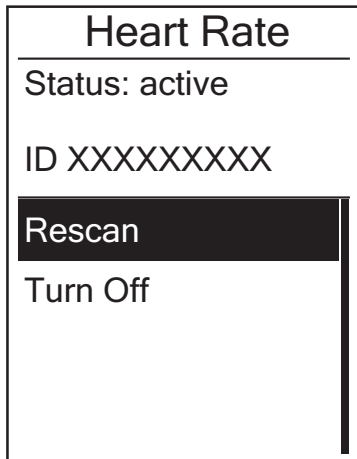

Heart Rate

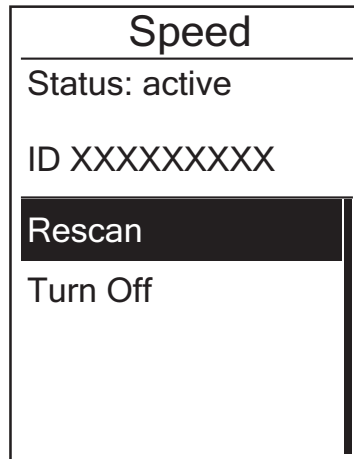

Speed

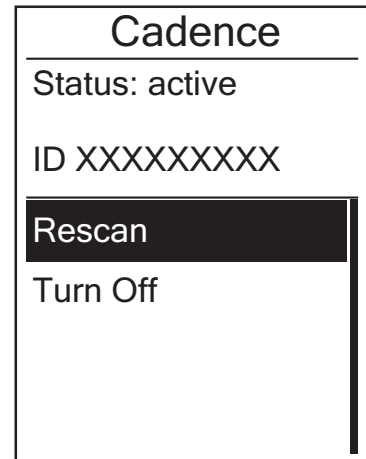

Cadence

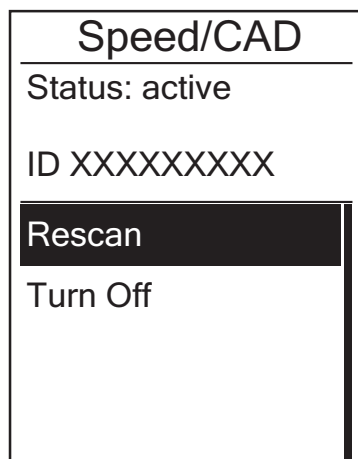

Speed/Cadence

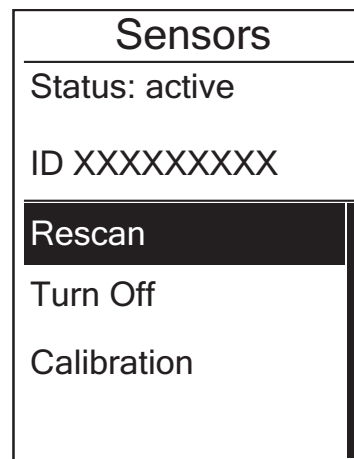

Power

1. In the Settings menu, press ▲/▼ to select **Sensors > Heart Rate, Speed, Cadence, Speed/CAD, or Power** and press 🏠.
2. Press ▲/▼ to select the desired setting and press 🏠 to confirm.
 - Rescan: rescan to detect the sensor.
 - Turn on/Turn off: enable/disable the sensor.
 - Calibration (**only with paired Power meter sensor*): calibrate the Power meter.
3. Press 🔌 to exit this menu.

NOTE: When pairing with the Power meter sensor, select **Rescan** and pedal the wheel to provide power to the Power meter.

Calibrating the Power meter

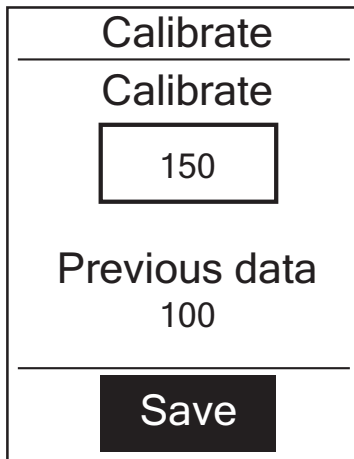

1. In the Settings menu, press ▲/▼ to select **Sensors > Power** and press 🏠.
2. Pedal the wheel to provide power to the Power meter.
3. When the wheel stops, press ▲/▼ to select **Calibration**.
4. Press 🏠 to automatically calibrate the Power meter.
5. When the calibration process is complete, press 🏠 to save the setting.

NOTE:

- When the heart rate monitor is paired, the ❤️ heart rate icon appears on the main screen.
- While pairing your speed/cadence sensor and the heart rate belt, please make sure there is no other cadence/speed sensor within 5 m. When the cadence sensor is paired, the 🌀 cadence sensor icon appears on the main screen.
- When the Power meter sensor is paired, the ⚡ watt power meter icon appears on the main screen.

Change System Settings

You can customize the Rider 40 system settings such as backlight off, alert, time/unit data format, on-screen display language, and data reset.

Backlight Off



1. In the Settings menu, press ▲/▼ to select **System > Backlight Off** and press 🏠.
2. Press ▲/▼ to select the desired setting and press 🏠 to confirm.
3. Press ⏻ to exit this menu.

NOTE: **Auto** depends on the sunrise and sunset time to automatically adjust the backlight off setting.

Alert

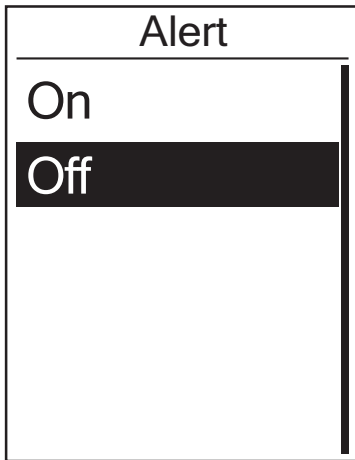

1. In the Settings menu, press ▲/▼ to select **System > Alert** and press 🏠.
2. Press ▲/▼ to select the desired setting and press 🏠 to confirm.
3. Press ⏻ to exit this menu.

Time/Unit



Daylight Save

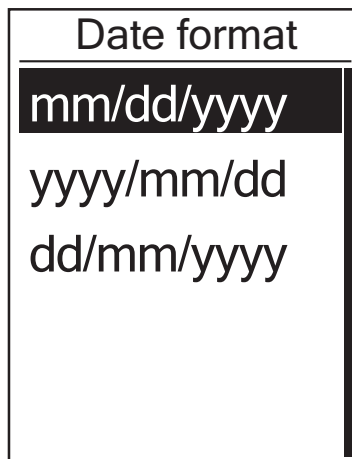

Date format

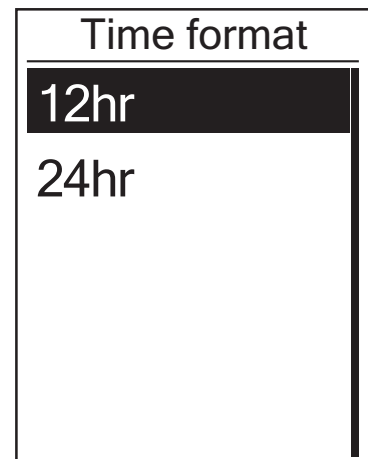

Time format

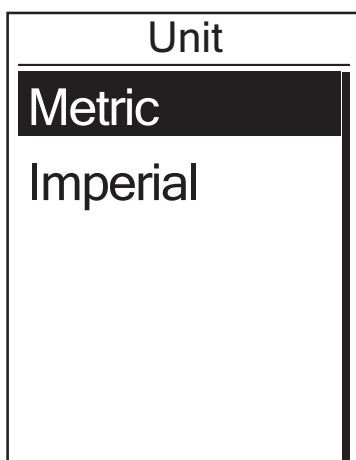



Unit

1. In the Settings menu, press ▲/▼ to select **System > Time/Unit > Daylight Save, Date format, Time format, or Unit** and press 🏠.
2. Press ▲/▼ to select the desired setting/format and press 🏠 to confirm.
3. Press ⏻ to exit this menu.

Language





1. In the Settings menu, press ▲/▼ to select **System > Language** and press .
2. Press ▲/▼ to select the desired setting and press  to confirm.
3. Press  to exit this menu.

NOTE:

- If you want to change the language on the device, please connect your device to Brytonsport.com and change the setting via **My Device > Manage Device Data** or go to **Settings > System > Language**.
- **Erase data** will delete all the history data and record logs, except the user profile.

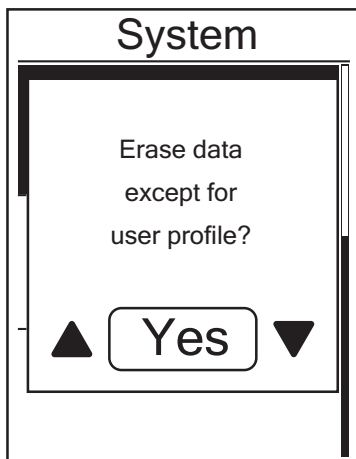
Erase Data



1. In the Settings menu, press ▲/▼ to select **System > Erase data** and press .
2. An "Erase data except for user profile?" message appears on the screen. To erase all data in the device, press ▲/▼ to select **Yes** and press  to confirm. The device will automatically restart.

Personalize User Profile

You can change your personal information.

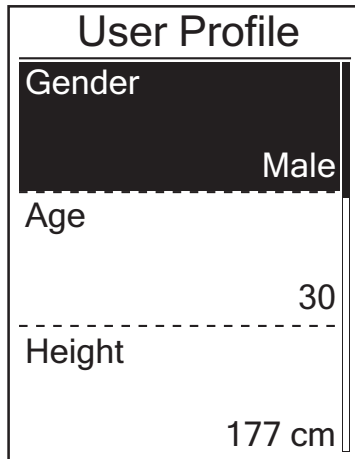

1. In the Settings menu, press ▲/▼ to select **User Profile** and press 🏠.
2. Press ▲/▼ to select the desired setting and press 🏠 to confirm.
 - Gender: select your gender.
 - Age: set your age.
 - Height: set your height.
 - Weight: set your weight.
 - Max HR: set your maximum heart rate.
 - LTHR: set your lactate threshold heart rate.
 - FTP: set your functional threshold power.
 - MAP: set your maximum aerobic power.
3. Press ⏻ to exit this menu.

View Firmware Version

You can view your Rider 40 current firmware version.

1. In the Settings menu, press ▲/▼ to select **About**.
2. Press 🏠 to confirm.

The current firmware version is displayed on the screen.
3. Press ⏻ to exit this menu.

Appendix

Specifications

Rider 40

Item	Description
Display	1.8" TN Positive transreflective dot-matrix LCD
Physical Size	39.6 x 58.9 x 17 mm
Weight	40g
Operating Temperature	-10°C ~ 50°C
Battery Charging Temperature	0°C ~ 40°C
Battery	700mAh rechargeable Li-ion battery
Battery Life	30 hours in open sky (may vary depending on condition of use)
GPS	Integrated high-sensitivity U-blox receiver with embedded antenna
RF Receiver	2.4GHz ANT+ Receiver
Water Resistant	IPX7 waterproof rating
External Storage	2M Byte

Speed/Cadence Sensor

Item	Description
Physical size	34.2 x 46.7 x 13.2 mm
Weight	14 g
Water Resistance	IPX7
Transmission range	5 m
Battery life	1 hour per day for 16 months
Operating temperature	-10°C ~ 60°C
Radio frequency/protocol	2.4GHz / Dynastream ANT+ Sport wireless communications protocol

Accuracy may be degraded by poor sensor contact, electrical interference, and receiver distance from the transmitter.

Heart Rate Monitor

Item	Description
Physical size	67~100 x 26 x 15 mm
Weight	14 g (sensor) / 35g (strap)
Water Resistance	20 m
Transmission range	5 m
Battery life	1 hour per day for 24 months
Operating temperature	5°C ~ 40°C
Radio frequency/protocol	2.4GHz / Dynastream ANT+ Sport wireless communications protocol

Accuracy may be degraded by poor sensor contact, electrical interference, and receiver distance from the transmitter.

Battery Information

Heart Rate Monitor and Cadence Sensor Battery

The heart rate monitor/cadence sensor contains a user-replaceable CR2032 battery.

To replace the battery:

1. Locate the circular battery cover on the back of the heart rate monitor/cadence sensor.
2. Use a coin to twist the cover counter-clockwise so the arrow on the cover points to OPEN.
3. Remove the cover and battery. Wait for 30 seconds.
4. Insert the new battery, with the positive connector first into the battery chamber.
5. Use a coin to twist the cover clockwise so the arrow on the cover points to CLOSE.

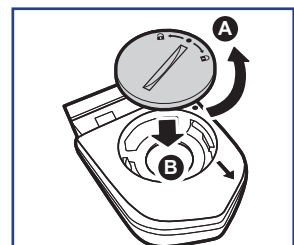
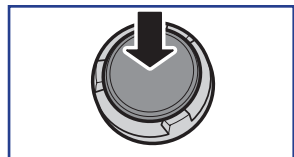
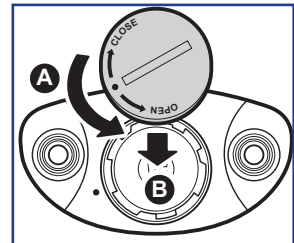

NOTE:

- When installing a new battery, if the battery is not placed with the positive connector first, the positive connector will easily deform and malfunction.
- Be careful not to damage or lose the O-ring gasket on the cover.
- Contact your local waste disposal department to properly dispose of used batteries.

Install Rider 40

Mount Rider 40 to the Bike

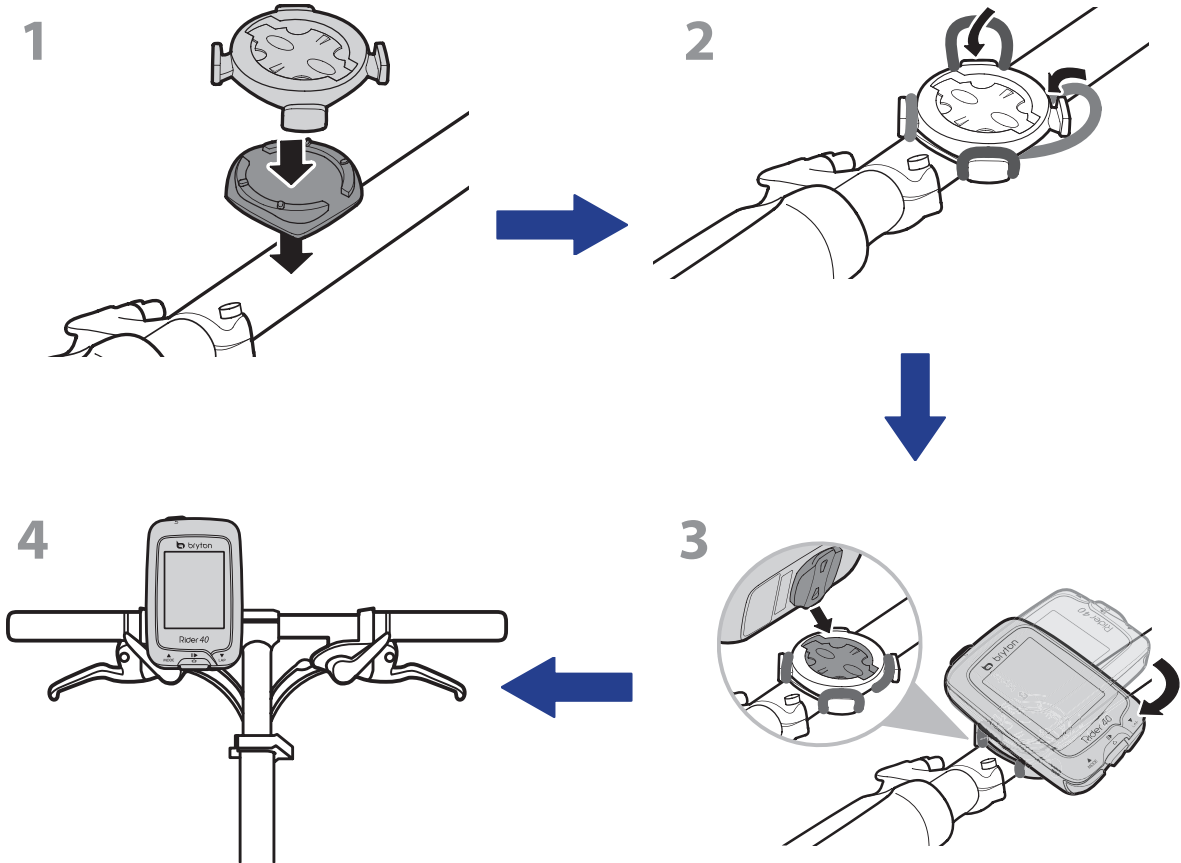

Install the Speed/Cadence Sensor (Optional)

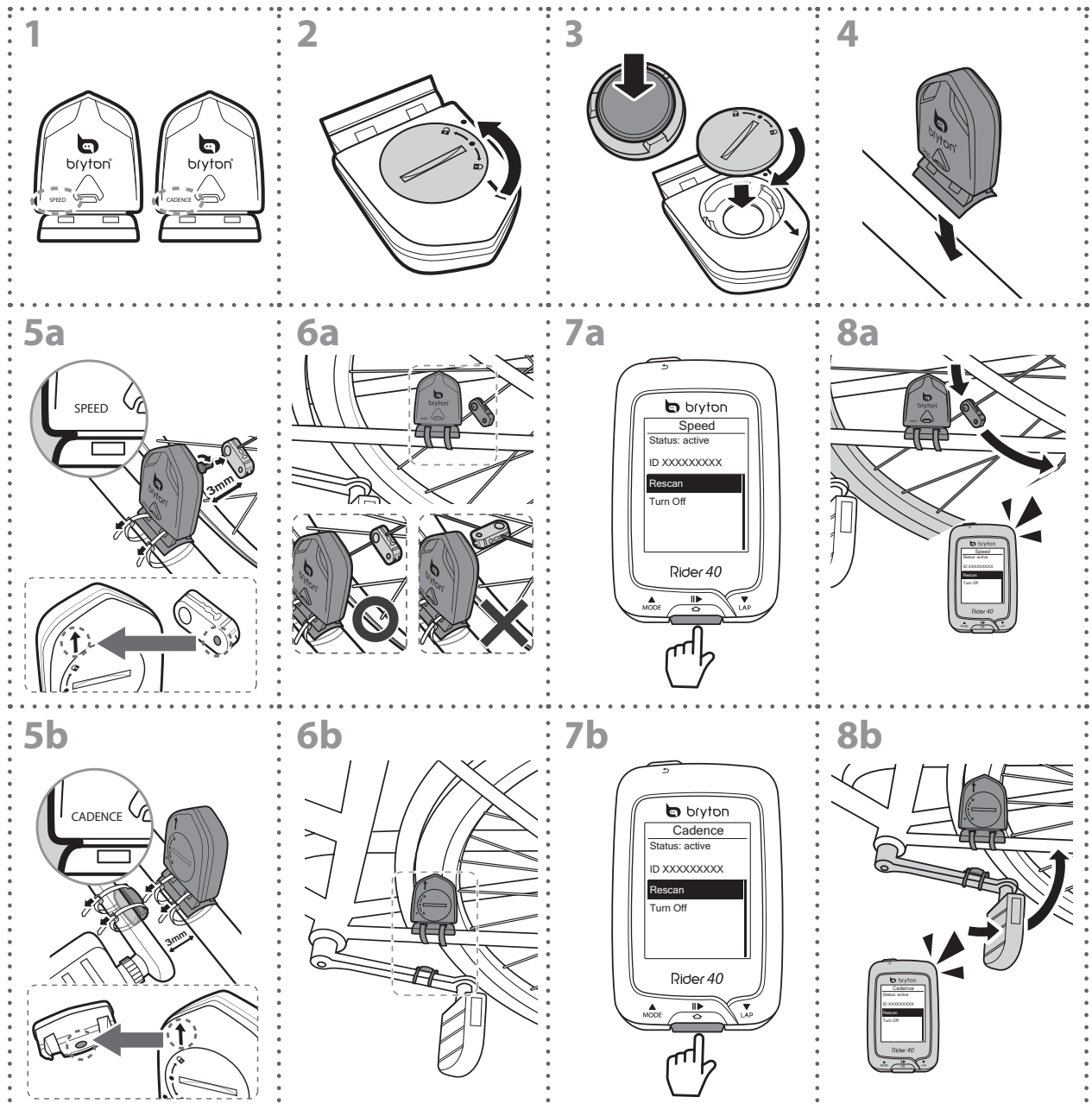

NOTE:

- To ensure optimum performance, do the following:
 - Align both sensor and magnet as shown in the illustration (5a / 5b). Pay attention on the alignment points.
 - Ensure the distance between the sensor and the magnet must be within 3 mm.
- Ensure that both Speed sensor and Speed magnet are installed and aligned horizontally, not vertically.
- On the initial usage, press the front button to activate the sensor and start pedaling. When the sensor detects the magnet, the LED blinks once to indicate the alignment is correct (the LED blinks only for the first ten passes after pressing the button).

Install Heart Rate Belt (Optional)

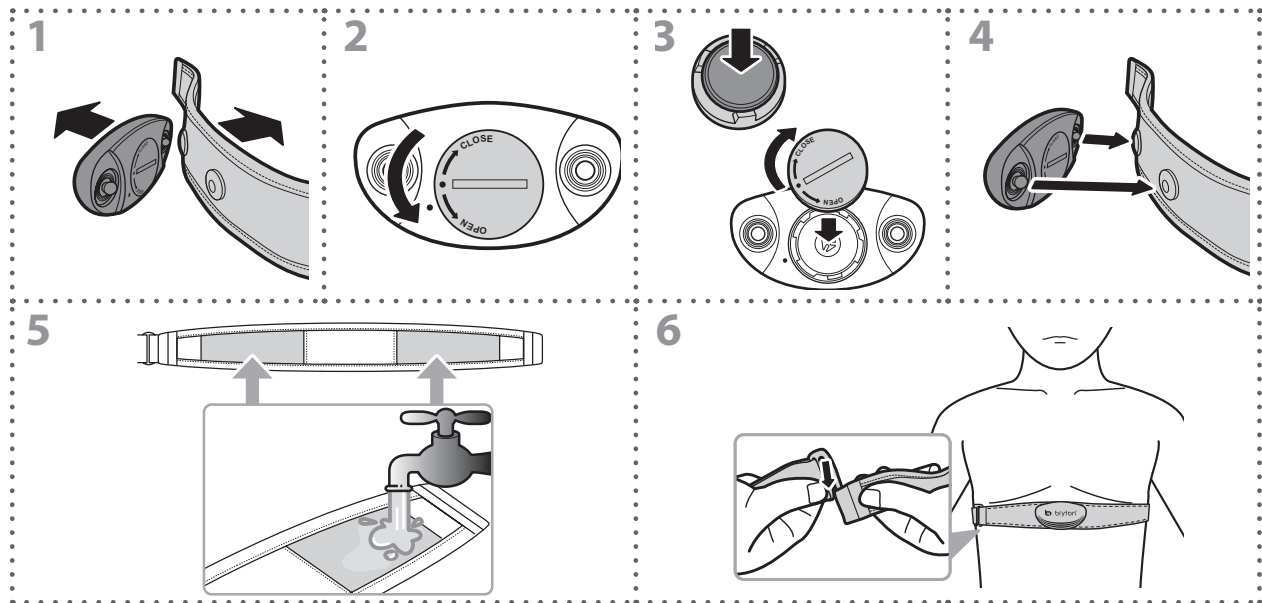
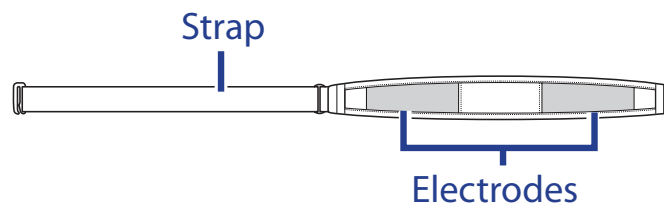

NOTE:

- In cold weather, wear appropriate clothing to keep the heart rate belt warm.
- The belt should be worn directly on your body.
- Adjust the sensor position to the middle part of the body (wear it slightly below the chest). The Bryton logo shown on the sensor should be facing upward. Tighten the elastic belt firmly so that it will not turn loose during the exercise.
- If the sensor cannot be detected or the reading is abnormal, please warm up for about 5 minutes.
- If the heart rate belt is not used for a period of time, remove the sensor from the heart rate belt.

Wheel Size and Circumference

The wheel size is marked on both sides of the tires.

Wheel Size	L (mm)
12 x 1.75	935
14 x 1.5	1020
14 x 1.75	1055
16 x 1.5	1185
16 x 1.75	1195
18 x 1.5	1340
18 x 1.75	1350
20 x 1.75	1515
20 x 1-3/8	1615
22 x 1-3/8	1770
22 x 1-1/2	1785
24 x 1	1753
24 x 3/4 Tubular	1785
24 x 1-1/8	1795
24 x 1-1/4	1905
26 x 2.10	2068
26 x 2.125	2070
26 x 2.35	2083
26 x 3.00	2170
27 x 1	2145
27 x 1-1/8	2155
27 x 1-1/4	2161
27 x 1-3/8	2169
650 x 35A	2090
650 x 38A	2125
650 x 38B	2105
700 x 18C	2070

Wheel Size	L (mm)
24 x 1.75	1890
24 x 2.00	1925
24 x 2.125	1965
26 x 7/8	1920
26 x 1(59)	1913
26 x 1(65)	1952
26 x 1.25	1953
26 x 1-1/8	1970
26 x 1-3/8	2068
26 x 1-1/2	2100
26 x 1.40	2005
26 x 1.50	2010
26 x 1.75	2023
26 x 1.95	2050
26 x 2.00	2055
700 x 19C	2080
700 x 20C	2086
700 x 23C	2096
700 x 25C	2105
700 x 28C	2136
700 x 30C	2170
700 x 32C	2155
700C Tubular	2130
700 x 35C	2168
700 x 38C	2180
700 x 40C	2200

Basic Care For Your Rider 40

Taking good care of your Rider 40 will reduce the risk of damage to your Rider 40.

- Do not drop your Rider 40 or subject it to severe shock.
- Do not expose your Rider 40 to extreme temperatures and excessive moisture.
- The screen surface can easily be scratched. Use the non-adhesive generic screen protectors to help protect the screen from minor scratches.
- Use diluted neutral detergent on a soft cloth to clean your Rider 40.
- Do not attempt to disassemble, repair, or make any modifications to your Rider 40. Any attempt to do so will make the warranty invalid.

