



REGAL®

— Follow no one.



2300/2500/2550

OWNER'S MANUAL



REGAL®

— Follow no one.

OWNER'S MANUAL

2300/2500/2550





Table Of Contents

INTRODUCTION

Your Regal Owner's Manual	Int-8
General Information	Int-8
Regal Limited Warranty	Int-18

1 SAFETY ON BOARD

Safety Labels	1-1
General Boating Safety	1-3
Required Safety Equipment	1-7
Fire Extinguishers	1-10
Visual Distress Signals	1-12
Sound Protecting Devices	1-15
Navigation Lights	1-15
Pollution Requirements	1-17
Marine Sanitation Devices	1-17
Exhaust & Carbon Monoxide	1-21
Boating Under The Influence	1-25
Boating Accidents	1-27
Water Sports	1-29
Weather & Water Conditions	1-34

2 RULES OF THE ROAD

Navigation Rules Defined	2-1
Navigation Rules	2-2
Navigation Aids	2-6
Night Running	2-9
Bridge Clearance	2-10

3 ENGINES & CONTROLS

Engines	3-1
Propulsion	3-3
Controls	3-5
Remote Control	3-16

4 SYSTEMS

Electrical	4-1
Fuel	4-13
Pressurized Fresh Water	4-16
Waste	4-17

5 VESSEL OPERATION

Getting Underway	5-1
Fueling	5-3
Starting & Stopping	5-6
Steering	5-8
Fenders	5-11
Dock Line Basics	5-12
Steps-Stern Drive Docking	5-15
Stern Drive Maneuvering	5-17
Trim Angle	5-20
Anchoring	5-25
Towing	5-26
Law of Salvage	5-27
Knots	5-28
Emergencies	5-29
First Aid	5-30
Hypothermia	5-31
Environmental Awareness	5-32



Table Of Contents

6 EQUIPMENT OPERATION

Air Compressor	6-2
Automatic Fire Extinguisher	6-3
Battery	6-7
Battery Switch Circuitry	6-8
Bilge Pump/Automatic Switch	6-10
Canvas	6-11
Cockpit Carpet/Table	6-18
Cockpit Refreshment Center	6-19
Drain Plug	6-20
Depth Finder/Sounder	6-21
Doors/Walk-Thru Bow	6-24
Engine Hatch	6-25
Gas Vapor Detector	6-26
Grill	6-29
Gray Water	6-34
Ladder	6-35
Lighting-Docking	6-36
Lighting-Stern	6-37
Power Tower	6-38
Pressurized Fresh Water	6-40
Regal Vue	6-42
Seating-Bucket Operation	6-44
Seating-Bow Filler	6-46
Seating-Bow Arm Rests	6-47
Seating-Cabin w/Berth	6-48
Ski Pylon/Ski Tow	6-50
Stereo/CD Player	6-51
Stereo Performance Package	6-62
Stereo iPod	6-63
Swim Platform	6-64
Toilet	6-66
Trim Switch	6-74
Underwater Lights	6-74
Wide-Angle Mirror	6-75
Wakeboard Racks	6-76
Windshield-Center Latch	6-101

7 COSMETIC CARE & MAINTENANCE

Cosmetic Care	7-1
Maintenance	7-12

8 TROUBLESHOOTING

Diagnostic Charts	8-1
-------------------	-----

9 STORAGE & WINTERIZATION

Decommissioning Checklist	9-2
Recommissioning Checklist	9-5

10 TRAILERING

Before Towing	10-1
Driving	10-7
Launching	10-8
Loading	10-10

11 GLOSSARY & INDEX

Glossary	11-1
Index	11-5

12 TECHNICAL INFORMATION/ DRAWINGS



Welcome To Regal

Dear Regal Owner,

I know I speak for everyone at Regal when I welcome you to the ever-growing family of Regal boat owners. You've chosen a boat that is recognized worldwide for its standard of excellence. Each step in construction has been carefully scrutinized to assure comfort, performance, reliability and safety for both your passengers and yourself.

Your boat is certified by the National Marine Manufacturers Association. It also complies with the applicable standards set by the United States Coast Guard and American Boat and Yacht Council. Your Regal boat was built with the same attention to detail and quality of construction that we would expect in a boat we would purchase ourselves.

Whether you're a veteran boater or a newcomer, we strongly urge you to read this boat owner's manual thoroughly. Familiarize yourself with the various components of your boat, and heed the safety precautions noted herein.

If you have questions that are not covered in this manual, please consult your authorized Regal dealer for assistance or phone the Regal factory at 407-851-4360.

Thank you, and welcome to the "World of Regal!"

*Duane Kuck
President & CEO
Regal Marine Industries, Inc.*



Mission Statement

*With God's help
and a steadfast commitment
to integrity,
we will develop a team
of exceptional people
and relationships
to provide exceptional
customer satisfaction.*



THIS PAGE IS LEFT INTENTIONALLY BLANK.



Introduction



Boating is becoming more popular every year. There are numerous types of recreational vessels on our waterways today involved in an every growing number of activities. Therefore, as a new boat owner it is of the highest priority to learn about general boating

practices before operating your craft.

Your Regal dealer will answer many questions and provide valuable “hands on” information during the completion of the new boat delivery process. In addition, your dealer has received special factory training on the product line and his services should be employed to solve technical problems and periodic maintenance beyond the scope of this manual. Also, your Regal dealer carries a line of factory approved parts and accessories.

Your Regal dealer can provide information regarding national training organizations such as the U.S. Power Squadron and United States Coast Guard Auxiliary. Along with other organizations and literature, they can help build your “boating savvy” by developing the necessary skills and awareness to be a safe and competent skipper. Your local library can also help in providing recommended boating literature such as Chapman Piloting (Seamanship & Boat Handling by Elbert S. Maloney).

Remember, the waterways can change from normal to abnormal conditions in a heartbeat. Knowing how to react quickly comes from experience and knowledge which can be gained through boating education.

Welcome Aboard!



YOUR REGAL OWNER'S MANUAL

Your Regal owner's manual has been developed to assist you in operating your vessel with safety and pleasure. Be sure to read and become familiar with the contents before operating your craft. Your owner's manual has been divided into general chapters to assist you in becoming more knowledgeable with your Regal boat. Also, we have added a special technical drawing chapter which can be valuable in maintenance and troubleshooting. **This manual is not intended to be a complete source of boating maintenance, boat handling techniques, boating safety or seamanship. These skills require education and experience levels beyond this manual.**

In keeping with its commitment to continued improvement, **Regal Marine Industries Inc. notes that all drawings, specifications, models, standard and optional equipment referred to in this manual are subject to change without notice.**

OWNER'S INFORMATION PACKET

Your Regal boat features an information pouch with vessel and engine owner's manuals. In addition, this packet contains valuable literature on your propulsion package, standard and optional equipment systems, along with various care and cleaning instructions. Be sure to store the information pouch in a clean dry area aboard your vessel.

GENERAL INFORMATION

Hull Identification Number (HIN) ---

The United States Coast Guard has established a universal system of numerically identifying vessels by using a hull identification number or "HIN." This number identifies your Regal boat's model, hull number, month and year of manufacture. The HIN is normally found on your boat's transom, on the starboard side, just below the rub rail.



Introduction

The HIN consists of 12 alpha or numeric characters imprinted on a metal band. Also, another location for the HIN could be under the extended swim platform on the transom.

It is recommended that you locate and write down the HIN for future reference in the owner's manual. It can be especially useful when ordering parts from your Regal dealer. A second HIN number is found in a hidden location. This second HIN is useful to authorities if the vessel is stolen and the original transom HIN is modified or eliminated.

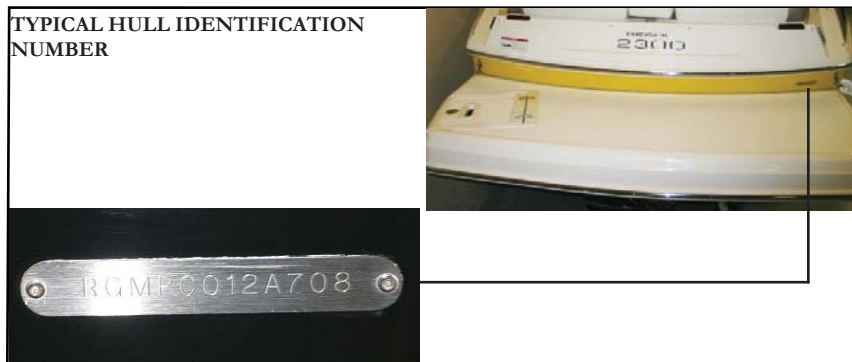

Vessel Information Sheet

It is recommended that you fill out the information on the following page. It will supply vital statistics on your vessel. Make a copy of the data for safe keeping.

Vessel Float Plan

Fill out the float plan on the following page before departing. Leave it with a responsible person who will notify the United States Coast Guard or local law enforcement authorities if you do not return as planned. If you change your plans be sure to notify this person. Make copies of the float plan and use one each time you go boating. This will help people know where to find you should you not return on schedule. Do not file the float plan with the United States Coast Guard.



VESSEL INFORMATION SHEET

Owner: _____

Address: _____

City & State: _____

Home Phone: _____ Business Phone: _____

In Case Of Emergency Notify: _____

Address: _____

City: _____ State: _____

Phone: _____

Insurance Agent's Name: _____

Policy#: _____

USCG Phone: _____ Local Police: _____

Marina Phone: _____ Slip (Dock#): _____

Hull Serial #: RGM _____

Key #: _____ Engine Serial #: _____

Outdrive Serial #:

Key #: _____ Cabin Door: (If Applicable) _____

Selling Dealer: _____

Address: _____

City & State: _____

Phone: _____ Fax: _____

Servicing Dealer: _____

Address: _____

City & State: _____

Phone: _____ Fax: _____



Introduction

FLOAT PLAN

Owner: _____ Safety Equipment Aboard:

Address: _____ Life Jackets

City & State: _____ First Aid Kit

Telephone#: _____ Flares

Cell Phone#: _____ Flashlight
 VHF Radio

Person Filing Report: _____ Anchor

Name: _____ Compass

Home Telephone#: _____ Food

Cell Phone #: _____ Water

Boat Make: _____ Destination: _____

Registration#: _____

Leave From: _____

Length: _____ Time Left: _____

Boat Name: _____

Gel Color: _____

Fuel Level: 1/4, 1/2, 3/4, F

Trim Color: _____ Est. Time Of Arrival: _____

Inboard/Outboard: _____

Hull I.D.#: _____

Fuel Capacity: _____ Est. Time of Arrival: _____

If not back by, call local authorities

Other Information: _____

Name Of Person(s) Aboard	Age	Address	Phone#
--------------------------	-----	---------	--------

_____	_____	_____	_____
_____	_____	_____	_____
_____	_____	_____	_____



LAUNCH & CRUISE CHECKLIST

- Obtain a current weather report.
- Inspect the hull and propeller for damage/foreign objects.
- Check all electrical system switches for proper operation.
- If your boat has been in the water, run the bilge pump until the water flow stops.
- If your boat has been out of the water, check to see that all bilge water has drained out. Install the drain plug.
- Check that all required safety equipment is on board and in good working condition.
- Check that all other equipment is on board such as basic gear, tool kit and extra parts (See next page).
- Open engine compartment. Inspect for fuel odors and visible leaks in the fuel, oil, exhaust & power steering.
- Visually inspect engine for cracked hoses, defective belts, loose fasteners such as bolts, nuts and hose clamps.
- Check fuel level. Fuel tanks should be filled to near full capacity.
- Make sure all navigation charts and vessel registration paperwork is onboard and weatherproofed.
- Check operation of bilge blower, steering system, navigation lights and horn.
- Make sure passengers and crew know how to operate safety equipment and react to an emergency.
- File a float plan with a responsible party ashore.



Introduction

SUGGESTED TOOLS, PARTS & GEAR

SUGGESTED TOOLS

Allen Wrenches
Jack Knife w/ Bottle-Can Opener
Phillips Screwdriver Set
Slotted Screwdriver Set
Regular Pliers
Combination Wrench Set
Ratchet & Socket Set (3/8" drive)
Hammer
Wire Crimpers
Vise Grip Pliers
Floating Flashlight
Nut Driver Set
Oil & Fuel Filter Wrench
Spark Plug Socket (3/8" drive)

BASIC GEAR

Tie Lines
Mooring Lines
Dock Fenders
First Aid Kit
Boat Hook
Foul Weather Gear
VHF Radio, EPRIB
Charts/Handheld GPS w/ extra batteries/12 volt charger
Cell Phone w/ 12 volt charger
Bailer (Bucket) Or Hand Pump
Fire Extinguisher
Personal Flotation Devices
Anchor & Line
Life Raft
Extra Food (Can Goods w/ Can Opener) & Water

SPARE PARTS

Fuel Filter
Spark Plugs
Water Pump Belt
Propellers
Extra Serpentine Belt
Anti-Siphon Set
Propeller Nut & Hardware
Penetrating Oil
Extra Light Bulbs
Extra Batteries
Duct Tape
Electrical Tape
Power Steering Fluid
Water Pump Impeller
Spare Keys On Floater
Clean Rags
Container (for draining fluids)



Capacity Plate

Close to the helm on the 2300 is a capacity plate. This plate represents manufacturers who participate in the National Marine Manufacturer's Association small boat certification program.

Your Regal boat model has been certified by NMMA approved inspectors to be in compliance with their system guidelines along with federal safety regulations.

The 2500 and 2550 are part of the NMMA Yacht certification program. These vessels are built to design compliance in effect on the date the certification was verified. This plate states that your vessel complies with USCG safety standards in effect on the date of certification.

The driver of the craft shall read and understand the plate information before operating the vessel.

The capacity plate data applies under normal conditions. Be sure to read and abide by the capacity limits. Remember, the boat operator is responsible for the vessel and passengers.

Note the following typical capacity plate information below:

- The plate states the maximum number of persons allowed on the boat.
- The total weight of persons, gear and other items under normal conditions that the vessel is capable of carrying.
- Overloading, improper loading and weight distribution are well documented causes of accidents. Provide for an extra margin of safety in rough sea conditions.





Introduction

Owner's Registration & Systems Checklist ---

Please note that your Regal boat requires the proper registration by your authorized Regal dealer. To initiate your Regal express limited warranty the dealer must complete the owner's registration form and systems checklist at the time of delivery. The owner must sign the paperwork to acknowledge that the dealer has reviewed the boat systems and Regal express limited warranty provisions with the owner. The owner should keep the original paperwork that features a temporary Regal express limited warranty registration. A Regal express limited warranty certificate containing all relevant boat and engine serial numbers will be sent after the factory receives the paperwork.

Dealer's Responsibility ---

Your boat has undergone rigid quality assurance inspections before leaving the factory. However, your dealer has been trained to perform final pre-delivery checks and to service your Regal boat prior to your pickup. Your dealer's responsibilities include:

- A complete orientation in the operation of your Regal boat, including matters relating to the safe operation of your craft.
- Completion and mailing of your Regal express limited registration warranty form to the factory.
- Limited warranties, registration materials, owner's manual, operation, installation and maintenance instructions for all auxiliary equipment supplied with or installed on your Regal boat.

Owner's Responsibility ---

You are entitled to all the benefits and services outlined in your Regal express limited warranty. However, you have certain responsibilities to ensure Regal express limited warranty satisfaction. These are:

- To read the Regal express limited warranty materials and understand them fully.



-
- To examine the boat in detail at the time of delivery.
 - Apply the following: boating rules and regulations, safety equipment, environmental regulations, accident reports and Regal express limited warranty regulations terms and conditions.
 - To read thoroughly all literature supplied with your boat, including this owner's manual and to follow the recommendations in the literature.
 - To return the boat after the recommended hours of engine operation for the proper dealer service inspections.
 - To provide proper maintenance and periodic servicing of your boat and equipment as outlined in the various manuals supplied.



Introduction



RUNABOUTS and CUDDY NEW BOAT DELIVERY CHECKLIST

REGAL MARINE INDUSTRIES
2300 JETPORT DRIVE
ORLANDO, FLORIDA 32809
(407) 851-4360

OWNER REGISTRATION INFORMATION

NAME _____ DEALER _____
 ADDRESS _____ HULL # _____
 CITY _____ STATE _____ ZIP _____ MODEL _____
 COUNTRY _____ PHONE # _____ EMAIL _____

INSTRUCTIONS: This checklist is designed to assist dealers in the delivery of a Regal Boat to a new owner. Review the location, operation and maintenance of each item noted below with the owner and acknowledge this by checking the appropriate boxes. Indicate if item is not applicable with "NA". This form must be completed and signed by the dealer's representative and the customer to acknowledge proper receipt of the boat. The warranty will not be activated until a fully completed and signed copy has been received by Regal Marine.

<p>A. NEW BOAT INFORMATION</p> <p>1. Review Regal's warranty _____</p> <p>2. Review Engine warranty _____</p> <p>3. Review Regal's owner manual _____</p> <p>4. Review owner's package _____</p> <p>5. Review dealer's service procedures _____</p> <p>6. Review owner's service responsibilities _____</p>	<p>DEALER OWNER</p> <p>_____</p> <p>_____</p> <p>_____</p> <p>_____</p> <p>_____</p> <p>_____</p>	<p>D. INSTRUMENTATION</p> <p>1. Function of all gauges _____</p> <p>2. Function of all switches _____</p> <p>3. Throttle & shifter _____</p> <p>4. Steering _____</p> <p>5. Ignition _____</p> <p>6. Operation of all optional electronics _____</p>	<p>DEALER OWNER</p> <p>_____</p> <p>_____</p> <p>_____</p> <p>_____</p> <p>_____</p> <p>_____</p>
<p>B. CABIN (IF APP)</p> <p>1. Location of all storage areas _____</p> <p>2. Cabin lighting _____</p> <p>3. Deck hatch _____</p> <p>4. Port hole _____</p> <p>5. Carbon monoxide detector _____</p> <p>6. Dinette table set up _____</p> <p>7. Cabin cushions set up _____</p> <p>8. Electrical panel _____</p> <p>9. Toilet / head _____</p> <p>10. Water system _____</p>	<p>DEALER OWNER</p> <p>_____</p> <p>_____</p> <p>_____</p> <p>_____</p> <p>_____</p> <p>_____</p> <p>_____</p> <p>_____</p> <p>_____</p>	<p>E. ENGINE ROOM</p> <p>1. Engine fluid check _____</p> <p>2. Trim pump location / fluid check _____</p> <p>3. Battery I _____</p> <p>4. Battery switch (may be in cockpit) _____</p> <p>5. Bilge pump _____</p> <p>6. Trim tab pump _____</p> <p>7. Fire extinguisher _____</p> <p>8. Blower _____</p>	<p>DEALER OWNER</p> <p>_____</p> <p>_____</p> <p>_____</p> <p>_____</p> <p>_____</p> <p>_____</p> <p>_____</p>
<p>C. COCKPIT</p> <p>1. Swim ladder _____</p> <p>2. Transom shower _____</p> <p>3. Cockpit seating set up _____</p> <p>4. Engine hatch operation _____</p> <p>5. Cockpit storage areas _____</p> <p>6. Refreshment center _____</p> <p>7. Fishing package _____</p>	<p>DEALER OWNER</p> <p>_____</p> <p>_____</p> <p>_____</p> <p>_____</p> <p>_____</p> <p>_____</p>	<p>F. CANVAS</p> <p>1. Canvas set up _____</p> <p>2. Canvas storage _____</p> <p>3. Canvas care and cleaning _____</p>	<p>DEALER OWNER</p> <p>_____</p> <p>_____</p> <p>_____</p>
		<p>L. CARE & CLEANING</p> <p>1. Vinyl uph. care & cleaning _____</p> <p>2. Windshield care & cleaning _____</p> <p>3. Gel coat care & cleaning _____</p> <p>4. Stainless steel hardware care & cleaning _____</p> <p>5. Toilet system care & cleaning _____</p>	<p>DEALER OWNER</p> <p>_____</p> <p>_____</p> <p>_____</p> <p>_____</p> <p>_____</p>

CAUTION: This checklist is only intended to provide a general overview and does not represent all information necessary for proper operation of the boat. It is very important that persons operating this boat study the various manuals and materials provided with the boat and follow the recommendations contained in these materials. They contain important information including cautions and warnings that are vital to safe and enjoyable operation of the vessel. It is the owner's responsibility to insure that anyone operating the boat has been properly trained.

We have completed a review and orientation of the boat and its systems. The boat is in order and functioning properly with the exception of any items specifically noted above. This confirms that owner has received a copy of the Regal Limited Lifetime Warranty and engine manufacturer's warranty and agrees to these warranty terms and conditions.

DEALER REPRESENTATIVE _____ DELIVERY DATE _____
 OWNER _____ DATE _____



REGAL MARINE INDUSTRIES, INC. LIMITED WARRANTY

Welcome to the Worldwide Family of Regal Owners! We are very pleased that you have chosen a Regal Powerboat!

This document is your Warranty Registration Certificate and Statement of Warranty. Please check the registration information section for accuracy. If this information is not correct or if you change your address at some future date, please notify us at the following address: Regal Marine Industries, Inc. Attention: Warranty Registrations, 2300 Jetport Drive, Orlando, Florida 32809; or E-mail at customer.service@regalboats.com.

Please read the warranty carefully. It contains important information on Regal's claims procedures and your rights and obligations under this warranty.

WHAT IS COVERED: This Limited Warranty applies to Regal boats beginning with model year 2012.

LIFETIME LIMITED STRUCTURAL HULL WARRANTY: Regal Marine Industries, Inc. warrants to the original retail purchaser of this boat if purchased from an authorized Regal dealer that the selling dealer or Regal will, repair or replace the fiberglass hull if it is found to be structurally defective in material or workmanship for as long as the *original* retail purchaser owns the boat. For purposes of this warranty, the hull is defined as the single fiberglass casting which rests on the water. This limited warranty is subject to all limitations and conditions explained below.

FIVE-YEAR TRANSFERABLE LIMITED STRUCTURAL HULL WARRANTY: In addition to the Lifetime Limited Structural Hull Warranty, Regal offers a Transferable Five-Year Limited Structural Hull Warranty. Under the Five-Year Transferable Limited Structural Hull Warranty, the selling dealer or Regal will repair or replace the fiberglass hull if it is found to be structurally defective in material or workmanship within the first (5) years after date of delivery to the *original* retail purchaser. Any remaining term of this Five-Year Limited Hull Warranty may be transferred to a second owner if within 60 days of purchase, the new owner registers the transfer with Regal and pays the established warranty transfer fee. Contact Regal Customer Service at the above address for details.

FIVE-YEAR LIMITED HULL BLISTER WARRANTY: Regal warrants that the selling dealer or Regal will repair any underwater gelcoated surfaces of the hull against laminate blisters which occur as a result of defects in material or workmanship within (5) years of the date of delivery, provided that the original factory gelcoat surface has not been altered. Alternation would include but is not limited to damage repair; excessive sanding, scraping, sandblasting; or from improper surface preparation for application of a marine barrier coating or bottom paint, any of which shall void this Five-Year Limited Hull Blister Warranty. Proper preparation must be applied to the hull bottom if the boat is to be moored in the water for periods in excess of 60 days. Regal Marine shall repair or cause to be repaired any covered laminate blisters based on the following prorated schedule. Less than two (2) years from delivery date - 100%, Two (2) to three (3) years from delivery date - 75%, Three (3) to four (4) years from delivery date - 50%, Four (4) to five (5) years from delivery date - 25%. Reimbursement shall be limited to one repair, not to exceed (\$100.00) dollars per foot of boat length prior to prorating. Regal's prior authorization for the method and cost of repair, must be obtained before repairs are commenced. All costs to transport the boat for repairs are the responsibility of the owner.



Introduction

LIMITED GENERAL WARRANTY: In addition to above hull warranties, Regal warrants to the original purchaser of this boat if purchased from an authorized Regal dealer or Regal that the dealer or Regal will repair or replace any parts found to be defective in materials or workmanship for a period of one (1) year from the date of delivery, subject to all exceptions, limitations and conditions contained herein.

LIMITED EXTERIOR FINISH WARRANTY: Regal warrants that the selling dealer or Regal will repair cosmetic defects in the exterior gelcoat finish including cracks or crazing reported to Regal within 90 days from the date of delivery to the original retail purchaser, subject to all limitations and conditions contained herein. All warranty work is to be performed at a Regal dealership or other location authorized by a Regal Customer Service Manager after it is established to Regal's satisfaction that there is a defect in material or workmanship.

REGISTRATION INFORMATION:

CUSTOMER OBLIGATIONS: The following are conditions precedent to the availability of any benefits under these limited warranties:

- (a) The purchaser must sign and the dealer must submit to Regal the "NEW BOAT DELIVERY CHECKLIST" within fifteen (15) days of the date of delivery and such information must be on file at Regal.
- (b) The purchaser must first notify the dealer from whom the boat was purchased of any claim under this warranty within the applicable warranty period and within a reasonable period of time (not to exceed thirty (30) days) after the defect is or should have been discovered; and (2) if such continued use causes other or additional damage to the boat or component parts of the boat.
- (c) Regal will not be responsible to repair any condition or replace any part, (1) if the use of the boat is continued after the defect is or should have been discovered; and (2) if such continued use causes other or additional damage to the boat or component parts of the boat.
- (d) Based on the dealer's knowledge of Regal's warranty policy and/or consultations with Regal, the dealer will accept the claim and arrange for appropriate repairs to be performed, or deny the claim if it is not within the warranty.
- (e) The dealer will contact the Regal boat owner regarding instructions for delivery of boat or part for warranty repair if it is covered by the limited warranty. ALL COSTS TO TRANSPORT THE BOAT FOR REPAIRS ARE THE RESPONSIBILITY OF THE OWNER.
- (f) If the Regal boat owner believes a claim has been denied in error or the dealer has performed the warranty work in an unsatisfactory manner, the owner must notify Regal's Customer Service Department in writing at the address listed for further consideration. Regal will then review the claim and take appropriate follow-up action.



WARRANTY EXCEPTIONS: THIS LIMITED WARRANTY does not cover and the following are not warranted:

- (a) Engines, metal plating or finishes, windshield breakage, leakage, fading and deterioration of paints, canvas, upholstery and fabrics;
- (b) Gelcoat surfaces including, but not limited to, cracking, crazing, discoloration or blistering except as noted above;
- (c) Accessories and items which were not part of the boat when shipped from the Regal factory, and/or any damage caused thereby;
- (d) Damage caused by misuse, accident, galvanic corrosion, negligence, lack of proper maintenance, or improper trailering;
- (e) Any boat used for racing, or used for rental or commercial purposes;
- (f) Any boat operated contrary to any instructions furnished by Regal, or operated in violation of any federal, state, Coast Guard or other governmental agency laws, rules, or regulations;
- (g) The limited warranty is void if alterations have been made to the boat;
- (h) Transportation of boat or parts to and/or from the REGAL factory or service location;
- (i) Travel time or haul outs, loss of time or inconvenience;
- (j) Any published or announced catalog performance characteristics of speed, fuel and oil consumption, and static or dynamic transportation in the water;
- (k) Any boat that has been repowered beyond Regal's power recommendations;
- (l) Boats damaged by accident and boats damaged while being loaded onto, transported upon or unloaded from trailers, cradles, or other devices used to place boats in water, remove boats from water or store or transport boats on or over land;
- (m) Water damage to, dry rot to, condensation to, or absorption by interior surfaces, wood structures or polyurethane foam; interior wood including, but not limited to, bleeding and/or discoloration as a result of condensation or moisture or water continually contacting the plywood causing staining to upholstery, carpet or other interior surfaces;
- (n) Costs or charges derived from inconveniences or loss of use, commercial or monetary loss due to time loss, and any other special, incidental or consequential damage of any kind or nature whatsoever.



Introduction

NO WAIVER OF THESE ITEMS: The terms, conditions, limitations and disclaimers contained herein cannot be waived except by the Customer Service Manager of Regal. Any such waiver shall be in writing. Neither the dealer, nor the customer, nor any service, sales and/or warranty representative of Regal is authorized to waive and/or to modify these conditions, limitations and/or disclaimers.

GENERAL PROVISIONS: ALL GENERAL, SPECIAL, INDIRECT, INCIDENTAL AND/OR CONSEQUENTIAL DAMAGES ARE EXCLUDED FROM THIS WARRANTY AND ARE TOTALLY DISCLAIMED BY REGAL. IT IS THE INTEREST OF THE PARTIES THAT THE OWNER'S SOLE AND EXCLUSIVE REMEDY IS THE REPAIR OR REPLACEMENT OF THE VESSEL OR ITS ALLEGEDLY DEFECTIVE COMPONENT PARTS AND THAT NO OTHER LEGAL OR EQUITABLE REMEDIES SHALL BE AVAILABLE TO SAID OWNER. SOME STATES DO NOT ALLOW THE EXCLUSION OF INCIDENTAL OR CONSEQUENTIAL DAMAGES SO THE INCLUSION OF INCIDENTAL OR CONSEQUENTIAL DAMAGES MAY NOT APPLY TO YOU. THIS IS A LIMITED WARRANTY; REGAL MAKES NO WARRANTY, OTHER THAN CONTAINED HEREIN;

TO THE EXTENT ALLOWED BY LAW ANY WARRANTIES OF MERCHANTABILITY OR FITNESS FOR A PARTICULAR PURPOSE ARISING IN STATE LAW ARE EXPRESSLY EXCLUDED TO THE EXTENT ALLOWED BY LAW, ANY IMPLIED WARRANTY OF MERCHANTABILITY IS LIMITED TO THE DURATION OF THIS LIMITED WARRANTY. ALL OBLIGATIONS OF REGAL ARE SPECIFICALLY SET FORTH HEREIN. REGAL DOES NOT AUTHORIZE ANY PERSON OR DEALER TO ASSUME ANY LIABILITY IN CONNECTION WITH REGAL BOATS. Some states do not allow limitations on how long an implied warranty lasts, so the above limitation may not apply to you. Regal's obligation with respect to this warranty is limited to making repairs to or replacing the defective parts and no claim for breach of warranty shall be cause for cancellation or rescission of the contract or sale for any boat manufactured by REGAL MARINE INDUSTRIES, INC.

Regal will discharge its obligations under this warranty as rapidly as possible, but cannot guarantee any specific completion date due to the different nature of claims which may be made and services which may be required. Regal reserves the right to change or improve the design of its boats without obligation to modify any boat previously manufactured. This limited warranty gives you specific legal rights, and you may also have other rights which may vary from state to state. Regal shall in no way be responsible for any repairs not **PRE-AUTHORIZED** by a Regal Customer Service Manager or repairs performed by a repair shop not **PRE- AUTHORIZED** by a Regal Customer Service Manager.



Notes



Safety On Board

Safety awareness can't be over emphasized. Safety on board needs to be the skipper's number one priority. In this manual you will find many safety precautions and symbols to identify safety related items. *Heed all safety precaution information and labels.* Remember, the skipper is responsible for the safety of his passengers and crew.

SAFETY LABELS

Safety Precaution Definition

Safety precautions are stated as caution, warning and danger signal words. They are highlighted in this manual by font design and symbol usage. Also, a notice heading is included which provides operation and maintenance information but is not hazard-related.

Become familiar and understand all safety precaution labels!

	DANGER
IMMEDIATE HAZARDOUS SITUATION THAT, IF NOT AVOIDED, WILL RESULT IN DEATH OR SERIOUS INJURY.	

	WARNING
POTENTIALLY HAZARDOUS SITUATION THAT, IF NOT AVOIDED, COULD RESULT IN DEATH OR SERIOUS INJURY.	



CHAPTER 1



CAUTION

Indicates a potentially hazardous situation or unsafe practice that, if not avoided, **may** result in injury or property or product damage.

NOTICE

General or specific information which is important to correct operation or maintenance, **but is not hazard related.**

Precautionary Labels

Read and understand all safety labels affixed to your Regal boat. Most of the safety labels are found close to the helm, aft cockpit and or swim platform. The location of the labels may vary by model and the label list does not cover everything! Use common sense to analyze the result of an action on board your vessel. **Always think safety first!**

NOTICE

DO NOT REMOVE OR COVER ANY
PRECAUTIONARY LABELS.
KEEP HARSH CHEMICALS AWAY FROM LABELS.
IF A LABEL BECOMES ILLEGIBLE,
CONTACT YOUR REGAL DEALER
FOR ORDERING REPLACEMENTS.



Safety On Board

GENERAL BOATING SAFETY

We understand that you are eager to get your Regal boat on the water. However, we strongly suggest that you thoroughly familiarize yourself and friends or members of your family with safe boating practices before setting out.

Remember, that along with the freedom and exhilaration of boating comes the responsibility that you have for the safety of your passengers and other boaters who share the water with you.

Boating regulations vary from state to state. Check with your local state and local authorities for the regulations pertaining to your area.

☐ Check with local weather stations, the U. S. Coast Guard, or weather station broadcasts for the latest conditions. Remember, being caught in severe weather is hazardous. Check weather conditions periodically while you are boating and before your outing. If you are forced to operate your boat in a storm condition, take common sense precautions; wear PFD's, store gear, reduce speed and head for safe refuge.

☐ It is best to avoid operating your boat in foggy weather. When fog sets in, take bearings, log courses and speeds. You are required to emit a five second blast from your horn or whistle once a minute. Also, have your passengers wear PFD's and observe for oncoming vessels.

☐ Operating in shallow water presents a number of hazards including sand bars and water levels influenced by tides. If the vessel strikes an underwater hazard, check for boat and engine damage. If the engine vibrates excessively after striking an underwater obstruction, it may indicate a damaged propeller. If you run aground, seek help by radio or flares.

☐ Make sure your boat and equipment are in top condition. Do this by frequently inspecting the hull, engine and gear.



CHAPTER 1

- You must provide a Coast Guard approved personal flotation device (PFD) for every person on board. These PFD's should be in good condition and easily accessible.
 - Insist that non-swimmers and children on board wear a PFD at all times. Any time you encounter rough weather conditions, make sure everyone on board is wearing a PFD, including yourself. Instruct your passengers in how to put on their PFDs and be sure they know their storage location on the boat. Remember, in an emergency, a PFD that cannot be quickly located and worn is useless.
- Never allow anyone to sit anywhere on the boat not specifically designed a seat. While underway, **ALWAYS** insist passengers remain seated.
- **Use maximum caution when fueling.** Never allow any smoke or flame nearby while you are fueling. **ALWAYS** check for fuel leaks and fumes when fueling is completed.



WARNING

GASOLINE VAPORS CAN EXPLODE.
BEFORE STARTING ENGINE, OPERATE
BLOWER 4 MINUTES AND CHECK
ENGINE COMPARTMENT FOR GASOLINE FUMES
OR LEAKS. RUN BLOWER MOTOR
BELOW CRUISING SPEEDS.



WARNING

USE OF ALCOHOL ENHANCED FUEL, OR ANY FUEL
OTHER THAN GASOLINE,
CAN LEAD TO DETERIORATION OF THE FUEL
SYSTEM COMPONENTS.
CAN RESULT IN FIRE AND POSSIBLE EXPLOSION



Safety On Board



□ **Never drink and drive!** As captain, you are responsible for the safety of your passengers and yourself. Alcohol and boating can be a dangerous combination. **DO NOT** mix them. Alcohol impairs the boat operators ability to make conscious decisions and react to emergency situations quickly.

□ **Never overload your boat!** An overloaded boat, or one with uneven weight distribution, can be difficult to steer.

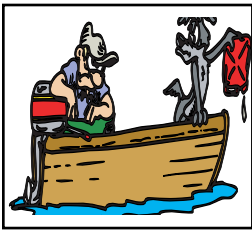

□ **Be certain there is enough fuel aboard for your cruising needs.** Include any reserve that might be needed should you change your plans due to weather or emergency. **Practice the “one-third rule:** (Use one-third of your fuel going out, one-third to return and keep one-third as a reserve).

□ Check the weather before departure. Be particularly cautious of electrical storms and high winds.

□ Keep up-to-date charts aboard. Supplement any chart plotter charts with paper backups. Charts can be obtained at your closest marine outlet or store or by contacting one of three federal government agencies.

□ **File a float plan.** Leave details of your trip with someone responsible who will be remaining on shore. Include expected return, plus name and phone number of a contact person in case of emergency.

□ Use care, courtesy and common sense when launching, docking or operating your boat.



CHAPTER 1

- **Learn and obey the “Rules of the Road”.** A copy of the “Rules of the Road” can be obtained from the U. S. Coast Guard Auxiliary or local Power Squadron organizations.

- In case of emergency: Know the international distress signals if you have a VHF radio aboard. The spoken word **“MAYDAY”** is the international signal of distress and is for emergency use only. Under no circumstances should this word be used, unless there is danger at hand.

- Posted speed limits, swimming areas, “no wake” zones and other restrictions should be red-flagged. They are so noted for a reason. Sensible boat use plus courtesy fosters enjoyable and safe boating.

- It is your responsibility to stay abreast of all federal, state and local rules, as some laws or regulations may change or be different from state to state. Contact your local boating agencies for updated information.

- We can not stress safety enough! Remember, there are no brakes on your boat, and the water current and wind velocity all affect your ability to respond. The driver must use caution at all times to maintain control of his vessel and especially to maintain a safe distance from other boats and obstacles.

- **Always keep all safety gear in optimum condition.** Pay special attention to attached tags and plates indicating expiration dates on equipment such as fire extinguishers, and personal flotation devices. Encourage a periodic maintenance check on all safety equipment. Contact your Regal dealer or marine professional for more information. Again, remember that the captain is responsible for his passengers and vessel.



Safety On Board

REQUIRED SAFETY EQUIPMENT

Personal Flotation Devices



All personal flotation devices (PFD's) must be Coast Guard approved, in good working condition, and must be the correct size for the wearer. All PFD's must be readily accessible. This means being able to wear them in a reasonable amount of time

in case of an emergency (fire, boat sinking, etc.). They should not be stored or locked in closed areas. Also, make sure that all coverings are removed, such as plastic from any PFD's. Throwable devices such as a ring buoys need to be available for immediate deployment. A PFD should be worn at all times when your boat is operating on the water. A PFD may save your life, but it must be worn to do so.

As minimum U. S. Coast Guard requirements all recreational boats must carry one type I, II, III, or V PFD (wearable) for each person aboard. See the explanation following for each type. For type V to be counted they must be used according to the label instructions. In addition, all boats over 16' must carry one Type IV (throwable) PFD. Some states require that PFD's be worn by children of specific ages at all times. Check with state boating agencies for particular requirements in your state before taking children on the water.

Remember PFD's will not necessarily keep you from drowning, even though they are designed to keep a person from sinking. When purchasing PFD's make sure it safely fits the person wearing it. It is a good idea to test PFD's in a shallow pool before trying on the water. Refer to the USCG minimum equipment requirements at the end of this chapter. It is meant to be a guide only. **Contact state and local agencies for additional equipment requirements.** Remember as the captain of your vessel you are responsible for its safe operation.



CHAPTER 1

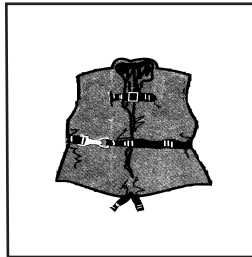

- **TYPE I-** Also known as an offshore jacket, it provides the most buoyancy. It is a PFD for all waters and is especially useful in rough waters where rescue may encompass additional time. It is designed to turn most unconscious users in the water to a face-up position. Type I PFD is available in adult & child sizes.

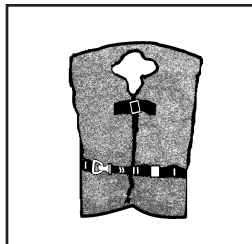

- **TYPE II-** Also known as near-shore buoyant vest, it is recommended for calm, inland water where rescue time will be minimal. It will turn some unconscious people face-up in the water but not as numerous as Type I. They are available in adult, medium child, along with infant and small child sizes.

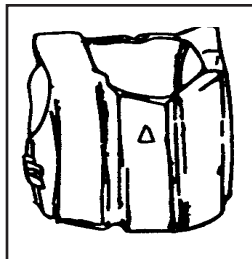

- **TYPE III-** Known as a flotation aid it is good for calm, inland water or where there is a chance for quick rescue. It is designed so wearers can place themselves in a face-up position in the water. The wearer may have to tilt their head back to avoid turning facedown in the water.

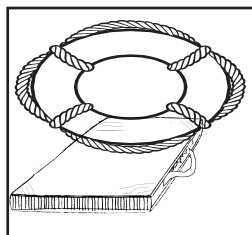

- **TYPE IV-** Intended for calm, inland water with heavy vessel traffic, where help is constantly present. It is designed to be thrown into the water for someone to grab on to and held until rescued. It should *not* be worn. Type IV includes ring buoys, buoyant cushions, and horseshoe buoys.



Safety On Board

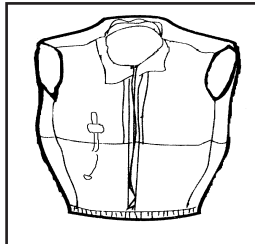

- **TYPE V-** This is the least bulky of all PFD's. It contains a small amount of inherent buoyancy, and an inflatable chamber. It is rated even to a Type I, II, or III PFD (as noted on the jacket label) when inflated. Hybrid PFD's must be worn to be acceptable.

Maintaining your PFD's

A PFD is only useful if it's well maintained. Always be aware of PFD age since it has a life expectancy.

- Do a periodic operation check of all PFD's in shallow water.
- Be sure to air dry all PFD's after each use. Store in a dry, easily accessible location.
- Check periodically for broken zippers, frayed webbing, water soaked kapok bags, missing straps, and sewing that is undone.
- Clean each PFD with mild soap and water only. Again, let dry sufficiently before storing.
- Keep PFD's out of grease and oil since they can deteriorate the jacket inner and outer materials.
- Check any kapok-bagged jackets by squeezing. If jacket loses air the bag is defective and the PFD should be thrown away.
- Grab the cover with the fingers. If the cover material rips, the PFD is rotted and should be thrown away.
- If the kapok bag is hard the PFD should be discarded.



CHAPTER 1

FIRE EXTINGUISHERS

General Information

Fire extinguishers are classified by a letter and numeric symbol. The letter references the type of fire the unit is designed to extinguish. For example, type B extinguishers commonly used on boats are designed to put out flammable liquids such as grease, oil and gasoline. The number indicates the general size of the extinguisher and minimum extinguishing agent weight.

FIRE EXTINGUISHER CONTENTS				
CLASS	FOAM IN GALS.	CO2 IN LBS.	DRY CHEM IN LBS.	HALON IN LBS.
B-I	1.25	4	2	2.5
B-II	2.5	15	10	10

MINIMUM PORTABLE FIRE EXTINGUISHERS REQUIRED		
VESSEL LENGTH	NO FIXED SYSTEM	WITH FIXED SYSTEM
LESS THAN 26' 26' TO LESS THAN 40' 40' TO 65'	1 B-1 2 B-1 OR 1 B-II 3 B-1 OR 1 B-II	0 1 B-1 2 B-1 AND 1 B-1 OR 1 B-II



Safety On Board

U. S. Coast Guard approved fire extinguishers are required on all Regal boats. Besides the **minimum** Coast Guard requirements always check state and local agencies for additional requirements and equipment. Coast Guard approved extinguishers are hand-portable, either B-I or B-II classification. U. S. Coast Guard approved hand-portable and semi-portable extinguishers contain a metal plate that shows the manufacturer's name and extinguisher type, capacity and operating instructions. They have a special marine type mounting bracket which keeps the extinguisher solidly mounted until needed.

The extinguisher needs to be mounted in a readily accessible location but one out of being bumped by people while underway. All approved extinguishers need to feature an indication gauge.

USCG- Approved Fire Extinguisher Types & Features



The dry chemical agent is widely used because of its convenience and low cost. The extinguisher canister is filled with a white dry chemical powder along with a pressurized gas. It is a good idea to shake this type periodically because they tend to "pack" on the canister bottom.

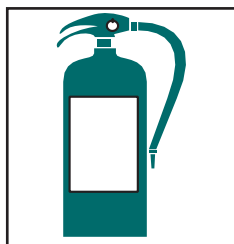

The foam type uses a chemical foaming agent plus water and is best when used for fires involving flammable liquids- solvents, gasoline, oil, grease and various paints. It will work on fires involving rubber, plastics, cloth, wood, and paper. It leaves a messy residue. Not for electric fires.



The carbon dioxide unit uses CO² gas under high pressure, with a funnel discharge hose usually swivel mounted. This extinguisher leaves no residue and does not cause interior engine harm. To ensure workability, weigh the unit annually. 10% maximum weight variance is allowed.



CHAPTER 1

Another type of liquefied gas used today is Halon. This gas is colorless and odorless, heavier than air and sinks to the lower bilge to extinguish fires. Since the year 2000 ingredients for Halon has changed to a more environmental friendly formula. Halon is used in portable-hand units along with making up the majority of boat automatic fire extinguishing systems. The canister shall be weighed once a year. Halon units must feature a dash mount indicator.

Refer to the information regarding fire prevention in this manual.

VISUAL DISTRESS SIGNALS

All vessels used on coastal waters, any of the Great Lakes, territorial seas, and those waters connected directly to them , up to point where a body of water is less than two miles wide, must have Coast Guard approved visual distress signals.

Pyrotechnic Devices

Pyrotechnic visual distress signals must be Coast Guard approved, be ready for service and must be readily accessible. They all display a marking which is the service life, which must not have expired. A minimum of 3 devices are required for the day and night. Some devices meet both day and night requirements. Pyrotechnic devices should be stored in a cool, dry location. Most of these devices can be purchased in an highly visible (orange) watertight container. Types of Coast Guard approved pyrotechnic distress signals and associated devices are:

- Pyrotechnic red flares, hand- held or aerial type.
- Pyrotechnic orange smoke, hand-held or floating type.
- Launchers for parachute flares or aerial red meteors.



Safety On Board

All in all, each distress signal has certain pros and cons. There is no distress signal that is best under all situations. Pyrotechnics are recognized worldwide as superior distress signals. A downfall is they emit a very hot flame that can cause burns and or ignite flammable materials. Pistol launched and hand-held parachute flares operate consistent with firearms and therefore must be carefully handled. Check with local and state regulations since some of these device are considered firearms and are prohibited.

Non-Pyrotechnic Devices

Non-pyrotechnic devices must all be in serviceable condition, readily accessible, and must be certified by the manufacturer to comply with Coast Guard standards. They include:

- Orange distress flag.
- Electric distress flag.

The distress flag is for day use only. It must be 3 x 3 or larger with a black square and ball on an orange background. It can be spotted when attached to a boat hook, long fishing rod, or paddle with the person waving the flag back and forth overhead.

The electric distress flag is for night use only flashing the international SOS distress signal (... _ _ _ ...).

Under Inland Navigation Rules, a high intensity white light that flashes at regular intervals from 50-70 times per minute is considered a distress signal.

Remember that regulations prohibit the display of visual distress signals on the water under any circumstances except when assistance is required to prevent immediate or potential danger to passengers on a vessel.



CHAPTER 1

INTERNATIONAL DISTRESS SIGNALS

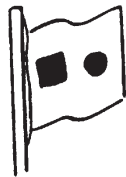

BLACK SQUARE
AND BALL ON
ORANGE
BACKGROUND



CODE FLAGS
NOVEMBER AND
CHARLIE



SQUARE
FLAG AND
BALL



PERSON
WAVING
ARMS



MORSE
CODE
S.O.S.



"MAYDAY"
BY
RADIO

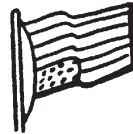

ENSIGN
UPSIDE
DOWN



PARACHUTE
RED
FLAG



RED METEOR
FLARES



SMOKE



FOG HORN
SOUNDED
CONTINUOUSLY



GUN FIRED
AT 1-MINUTE
INTERVALS

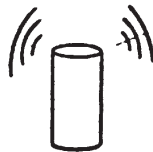

POSITION
INDICATING
RADIO BEACON



DYE MARKER
(ANY COLOR)



HAND-HELD
FLARE



Safety On Board

SOUND PRODUCING DEVICES

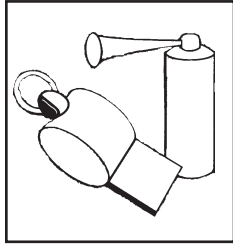

According to both Inland and International Rules, all boats **must** carry some way of producing an efficient sound signal. If your vessel is 12 meters (39' 4") or longer, a power whistle, power horn or bell must be carried. The bell must be 7 7/8" in diameter.

Boats less than 12 meters a horn or whistle is **recommended** to signal intentions or signal position. The sound signal made in all cases must

be capable of a four or six second blast audible for one half mile. See the section discussing bridge and whistle signals.

RADIO COMMUNICATIONS

VHF radios are used for distress and ship to shore and ship to ship communications today. Learn the specialized messages such as **Mayday, Mayday, Mayday** is only used when life or vessel is in imminent danger.

NAVIGATION LIGHTS

The U. S. Coast Guard requires recreational boats operating at night to display navigation lights between sunset and sunrise. Navigation lights help avoid collisions by improving the night visibility of vessels. Red and green directional lights, white stern lights, white masthead lights and white all-around lights must be displayed in specified positions, depending on boat size, and mode of operation.

The configuration of visible lights tells and operator the size, direction of travel and means of propulsion (sail, power, rowing or at anchor) of another vessel.

This helps both operators determine who has the right of way.



CHAPTER 1

NAVIGATION LIGHT RULES

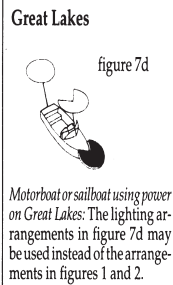
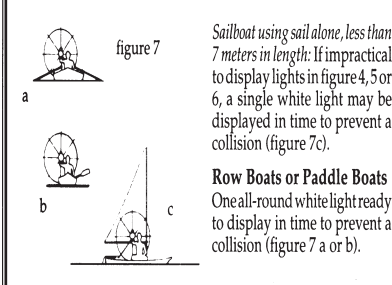
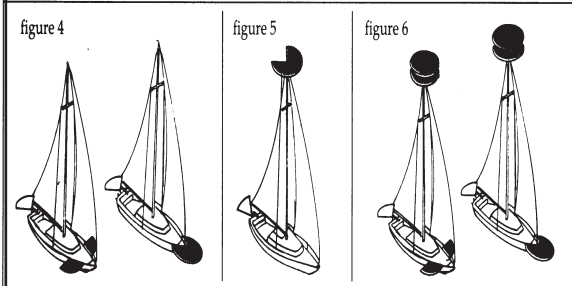
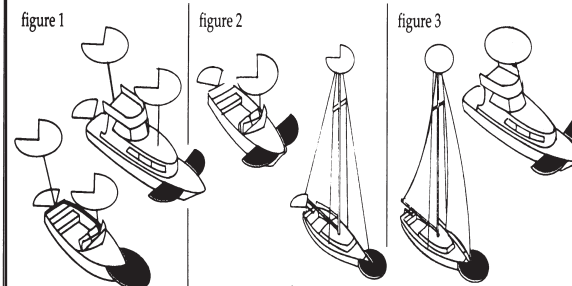
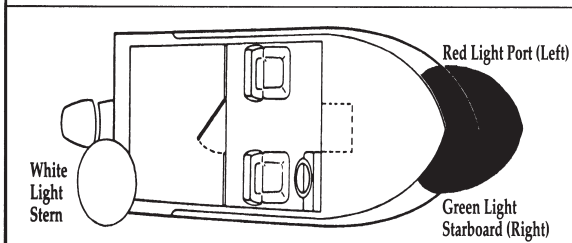

Location of lights on vessel	Visible Range		Degrees of arc lights
	Less than 12 m.	12 m. but less than 20 m.	
Masthead	2	3	225°
All-round	2	2	360°
Side lights	1	2	112.5° each color
Stern light	2	2	135°

Boats less than 12 meters in length
Motorboats or sailboats using power: The lighting arrangements to figure 1, 2 or 3 may be used.
Sailboat using sails alone: The lighting arrangements in figure 4, 5 or 6 may be used.

Boats 12 meters but less than 20 meters in length
Motorboats or sailboats using power: The lighting arrangements to figure 1 or 2 may be used.
Sailboat using sails alone: The lighting arrangements in figure 4, 5 or 6 may be used.

Location of lights
 Lights should be located as shown in the drawings.
 The masthead light (forward white light in figures 1, 2 and 7d) must be at least one meter higher than the colored lights on a boat less than 12 meters in length and at least 2.5 meters above the gunwale on a boat 12 meters but less than 20 meters in length.

Exceptions
Motorboat or sailboat using power, built before December 24, 1980: The lighting arrangement in figure 1, 2 or 3 may be used. However, the arrangement in figure 3 is not acceptable on a boat that is 12 meters or longer on international waters.



MARINE SANITATION DEVICES

Recreational vessels under 65' with installed toilet facilities must have an operable marine sanitation device (MSD) on board. Vessels 65' and under may use Type I, II, or III MSD. All installed MSD's must be U.S. Coast Guard certified. Normally the devices are labeled to show conformity to the regulations.

POLLUTION REGULATIONS

The Federal Water Pollution Control Act prohibits the discharge of oil or hazardous substances which may be harmful into U. S. navigable waters. *Vessels 26' and over* must display a placard at least 5" x 8", made of durable material, fixed in a conspicuous machinery space laocation, stating the following:

NOTICE
DISCHARGE OF OIL PROHIBITED
THE FEDERAL WATER POLLUTION CONTROL ACT PROHIBITS THE DISCHARGE OF OIL OR OILY WASTE INTO OR UPON THE NAVIGABLE WATERS OF THE UNITED STATES, OR THE WATERS OF THE CONTIGUOUS ZONE, OR WHICH MAY AFFECT NATURAL RESOURCES BELONGING TO, APPERTAINING TO, OR UNDER THE EXCLUSIVE MANAGEMENT AUTHORITY OF THE UNITED STATES, IF SUCH DISCHARGE CAUSES A FILM OR DISCOLORATION OF THE SURFACE OF THE WATER OR CAUSES A SLUDGE OR EMULSION BENEATH THE SURFACE OF THE WATER. VIOLATORS ARE SUBJECT TO SUBSTANTIAL CIVIL PENALTIES AND/OR CRIMINAL SANCTIONS INCLUDING FINES AND IMPRISONMENT.



CHAPTER 1

You must immediately notify the U. S. Coast Guard if your vessel discharges oil or hazardous substances in the water. Call toll free 800-424-8802. Report the following information: location, source, size, color, substances and time observed.

Garbage

The Act to Prevent Pollution from Ships places limitations on the discharge of garbage from vessels. It is illegal to dump plastic trash anywhere in the ocean or navigable waters of the United States. Also, it is illegal to discharge garbage in the navigable waters of the United States, including the Great Lakes. The discharge of other types of garbage is allowed outside certain specified distances from shore as determined by the nature of that garbage.

THE DISCHARGE OF PLASTIC OR GARBAGE WITH PLASTIC INTO ANY WATERS IS PROHIBITED . THE DISCHARGE OF ALL GARBAGE IS PROHIBITED IN THE NAVIGABLE WATERS OF THE UNITED STATES AND IN ALL OTHER WATERS, WITHIN THREE NAUTICAL MILES OF THE NEAREST LAND.		
THE DISCHARGE OF DUNNAGE, LINING, AND PACKING MATERIALS THAT FLOAT IS PROHIBITED WITHIN 25 NAUTICAL MILES FROM THE NEAREST LAND.	OTHER UNGROUND GARBAGE MAY BE DISCHARGED BEYOND 12 NAUTICAL MILES FROM THE NEAREST LAND.	OTHER GARBAGE GREATER THAN ONE INCH MAY BE DISCHARGED BEYOND THREE NAUTICAL MILES FROM THE NEAREST LAND.
A PERSON WHO VIOLATES THE ABOVE REQUIREMENTS IS LIABLE FOR A CIVIL PENALTY OF UP TO \$25,000, A FINE OF UP TO \$50,000, AND IMPRISONMENT FOR UP TO FIVE YEARS FOR EACH VIOLATION, FEDERAL, STATE, AND LOCAL RESTRICTIONS ON GARBAGE DISCHARGES MAY ALSO APPLY.		



USCG Minimum Equipment Requirements for Recreational Vessels			
Boat Size in Feet	16'	26'	40'
Personal Flotation Devices ¹	One Type I, II, III, or V per person		65'
Fire Extinguishers ²	One Type I, II, III, or V per person plus one Type IV throwable		165'
No Fixed System	One B-I, any type	One B-II or Two B-I	One or more B-II (vessels 0-50 tons gross) Two or more B-II (vessels 50-100 tons gross)
With Fixed System	No Portables Required	One B-I	Two B-I or one Class B-II
Visual Distress	Night signals required when operating at night	Minimum of three day-use and three night-use (or three day/night combination) pyrotechnic devices ⁵	
Signals	Horn or whistle recommended to signal intentions or signal position		One bell, and one whistle or horn required to signal intentions or position
Sound Producing Devices	One CG-approved device on each carburetor of all gasoline-powered engines built after April 1940, except outboard motors		
Backfire Flame Arrestor	One CG-approved device on each carburetor of all gasoline-powered engines built after April 1940, except outboard motors		
Ventilation	CG standard system required on gasoline powered vessels with enclosed engine compartments built after August 1980		
Navigation Lights	Sidelights, Stern Light and Masthead ^{6,7}		
Under Power ^{3,4}	Same as "Under Sail"		
Rowing	All-round light, 2mm (at night) or black anchoring ball (during the day) when outside a designated anchorage		
At Anchor	1mm Sidelights, 2mm all others		
Visibility Range	"Honor system" (no plaques required)		
Pollution	Vessels with installed toilet facilities must have an operable, CG-certified Type I, II or III Marine Sanitation Device (MSD). Subject to local laws!		
Regulations	Familiarity with the Inland Navigation Rules required		
Marine Sanitation Devices	The Inland Navigation Rules ("Rules of the Road") must be kept on board		
Navigation Rules			

1. PFD's must be CG approved, wearable by the intended user and readily accessible.
2. Fire extinguishers required on boats with enclosed engine compartments (not outboards), enclosed living spaces or permanent fuel tanks.
3. Sailboats operating under engine power are considered power driven and must follow the "Under Power" rules. During the day, motorsailing vessels are required to fly a motoring cone.
4. Power-driven vessels under 23' and under 7 knots can substitute a white lantern or torch in place of the required lights.
5. Non-pyrotechnic substitutes: 1 orange distress flag (day-use) and 1 electric SOS signal light (night-use).
6. All boats under 65' can substitute a single bi-color light for sidelights.
7. Boats under power under 40' can substitute a single all-round light for separate stern and masthead lights.
8. Boats under sail under 40' can substitute a tri-color light for separate sidelights and stern light.

Additions to these requirements are prescribed by some individual state laws. Check your state's Boating Safety Handbook for a complete list.



CHAPTER 1

Communications

EPIRB

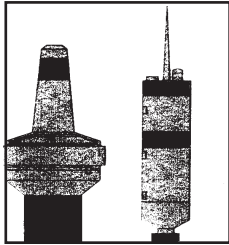

It is a good idea to carry communication gear such as a VHF-FM and/or HF transceivers set up for your operating area. Also, cell phones are useful in many coastal areas. Be sure to carry extra batteries. Also, mainly for offshore vessels, EPIRB's are designed to quickly and accurately alert rescue forces, indicate an accurate distress

position, and guide units to the distress scene. These devices operate from satellite signals sent to a ground station where the signal is downloaded. The downside is that they are relatively expensive but they are reliable even when other communications have been exhausted.

Life Rafts

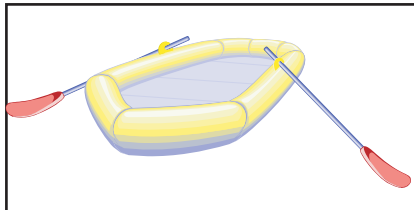

Inflatable life rafts are recommended for oceangoing and operating a vessel in a large body of water like the Great Lakes. They provide a shelter for extended periods. If used, make sure it is large enough for all aboard and contains the proper

emergency equipment pack. Periodically find a professional to service the life raft. Store it on board in an area safe from sharp objects. Make sure the life raft is Coast Guard approved.

Remember the U. S. Coast Guard requirements are minimal standards. They are an excellent starting point. Check with local and state boating agencies for further required safety equipment. You are best prepared for emergencies by a well equipped vessel. Don't skimp when purchasing equipment for your boat.!



EXHAUST & CARBON MONOXIDE

Carbon monoxide (CO) in exhaust can be hazardous. It is important for you and your passengers to be aware of the potential safety hazard created by exhaust gases. Familiarize yourself with the symptoms of carbon monoxide poisoning.

For safety sake avoid the following:

1. Do not allow the boat to remain stationary with the engine idling for an extended period of time.
2. Do not disable the carbon monoxide alarms that come with your Regal boat. Test the unit in accordance with the alarm manufacturers instructions.
3. Do not operate the engine for extended periods of time while in a confined area or where exhaust outlets face a wall or bulkhead.
4. Do not operate the engine for an extended period of time with the canvas in the upright and installed position.
5. Have the engine exhaust system inspected when the boat is in for service.
6. Persons sleeping can easily be overcome by carbon monoxide without realizing it. Do not sleep on board while the engine is running.

	WARNING
AVOID SERIOUS INJURY OR DEATH FROM CO POISONING! DO NOT OPERATE THE BOAT WITH PEOPLE HOLDING ON TO THE SWIM PLATFORM WHILE IN THE WATER	



CHAPTER 1

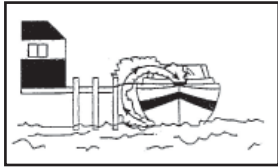

Blockage of exhaust outlets can cause carbon monoxide to accumulate in the cabin and cockpit area even when the hatches, windows, portholes and doors are open.

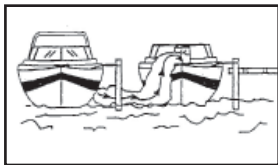

Exhaust from another vessel alongside your boat, while docked or anchored, can emit poisonous CO gas inside the cabin and cockpit areas of your boat.

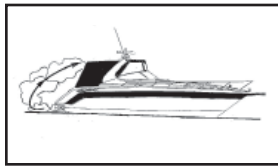

The “station wagon effect” or backdrafting can cause CO gas to accumulate inside the cabin, cockpit or bridge areas when the boat is under-way, using protective weather coverings, high bow angle, improper or heavy loading, slow speeds, or when boat is at rest.

Typical Carbon Monoxide Label At Helm

⚠ WARNING	
	<p>Carbon monoxide (CO) can cause brain damage or death.</p> <p>Engine and generator exhaust contains odorless and colorless carbon monoxide gas.</p> <p>Signs of carbon monoxide poisoning include nausea, headache, dizziness, drowsiness, and lack of consciousness.</p> <p>Get fresh air if anyone shows signs of carbon monoxide poisoning.</p> <p>See Owner's Manual for information regarding carbon monoxide poisoning.</p>

Typical Carbon Monoxide Label At Transom

⚠ DANGER	
	<p>Carbon monoxide (CO) can cause brain damage or death.</p> <p>Engine and generator exhaust contains odorless and colorless carbon monoxide gas.</p> <p>Carbon monoxide will be around the back of the boat when engines or generators are running.</p> <p>Move to fresh air, if you feel nausea, headache, dizziness, or drowsiness.</p>



Safety On Board

Typical Carbon Monoxide Label In Cabin/Head

⚠ WARNING	
	Carbon monoxide (CO) can cause brain damage or death.
	Carbon monoxide can be present in the cabin.
	Signs of carbon monoxide poisoning include nausea, headache, dizziness, drowsiness, and lack of consciousness.
	Get fresh air if anyone shows signs of carbon monoxide poisoning.
	Get fresh air if carbon monoxide detector alarm sounds.
Carbon monoxide detector must be functioning at all times.	

In high concentrations, CO can be fatal in minutes. However, lower concentrations over an extended period of time can be just as lethal.

Symptoms of excessive exposure to carbon monoxide are:

- Dizziness
- Drowsiness
- Nausea
- Headache
- Ringing in the ears
- Throbbing temples
- Watery, itchy eyes
- Flushed appearance
- Inattentiveness
- Incoherence
- Fatigue or vomiting
- Convulsions

Carbon monoxide accumulation requires immediate attention! Thoroughly ventilate cabin and cockpit areas. Determine the probable source of the carbon monoxide and correct the condition immediately. Regal has installed CO detectors on your boat. Have these detectors professionally calibrated at regular intervals.

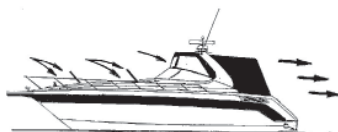

**DESIRED AIR FLOW
THROUGH BOAT**

To help prevent carbon monoxide accumulation, ventilate your cabin and cockpit while underway. Open a forward hatch, porthole or window to allow air to travel through the boat's interior. See the illustration below for desired air flow.



CHAPTER 1

Each Trip

- Make sure all exhaust clamps are in place and secure.
- Look for exhaust leaking from the exhaust system components, indicated by rust and or black streaking, water leaks, or corroded or cracked fittings.
- Inspect all rubber exhaust hoses for burned or cracked areas. All rubber hoses should feel soft and be free of kinks.
- Visually verify that water exits at the engine exhaust outlet.
- Keep an ear tuned for any change in exhaust sound that could indicate an exhaust component malfunction.

DO NOT OPERATE THE VESSEL IF ANY OF THE ABOVE ITEMS EXIST. CONTACT A MARINE PROFESSIONAL!

At Least Annually (To be performed by a marine professional)

- Replace exhaust hoses or mufflers if any evidence of cracking, charring or deterioration is found.
- Replace the engine water pump impeller along with the plate and housing if necessary. This will help prevent cooling system and in turn exhaust system overheating.
- Inspect each of the metallic exhaust components for cracking, rusting, leaking or looseness. Pay detailed attention to the exhaust manifold, cylinder head and water injection elbows. Make sure all exhaust clamps are in place and secure.



Safety On Board

BOATING UNDER THE INFLUENCE



WARNING

FEDERAL LAWS PROHIBIT OPERATING A VESSEL UNDER THE INFLUENCE OF ALCOHOL OR DRUGS. THESE LAWS ARE VIGOROUSLY ENFORCED BY ALL ENFORCEMENT AGENCIES.

Operating a vessel while intoxicated became a specific federal offense



effective in 1988. The ruling set federal standards for determining when an individual is intoxicated. If the blood alcohol content (BAC) is .10% (.08 in some states) or higher for operators of recreational vessels being used only for pleasure are subject to a civil penalty up to \$1,000 or criminal penalty up to \$5,000, one year imprisonment or both.

In some states the fines and imprisonment may increase significantly. The effects of alcohol and drugs account for the highest single cause of marine accidents and deaths. Most deaths in boating accidents occur when someone falls into the water. Balance is one of the first things you lose when drinking alcohol or under the influence of drugs. The problem arises out of not knowing your balance is restricted.

Overall vision is reduced by alcohol especially at night, along with double or blurred vision. Peripheral vision is lessened which restricts seeing vessels or objects on the side. Also, color awareness decreases especially with red and green which happen to be the colors of boat navigation lights, buoys, and channel markers.

Alcohol will greatly increase your heat loss so it increases the effects of hypothermia. Finally, your ability to make correct judgements in emergency situations is greatly reduced. Alcohol takes away the brains ability to process information quickly and delays a persons reaction time. **Don't drink and drive!**



CHAPTER 1

Alcohol Myths And Facts

Myth: Beer is less intoxicating than other alcoholic beverages.

Fact: One 12 oz. can of beer has about the same amount of alcohol as a 5oz. glass of wine or a shot of liquor.

Myth: Black coffee, fresh air, and a shower will sober the effects of alcohol.

Fact: After consuming alcohol time is the only thing that will sober you up. Our bodies average burning 1 oz. of alcohol every hour. If a person is drunk, it will take a person seven or more hours to sober up.

Myth: Telling if a person is too drunk to operate a vessel is easy.

Fact: Many experienced drinkers have learned to compensate for the visual effects of alcohol and can disguise their drunk condition.

Myth: You're the best person to judge if you are fit to operate a boat.

Fact: Judgement is one of the first elements you lose when drinking

BLOOD ALCOHOL CONTENT CHART									
Body Weight In Pounds	Number of Drinks In A 2 Hour Period (12 oz. beer=5 oz. wine=1 oz. 80 proof liquor)								
100	1	2	3	4	5	6	7	8	9
120	1	2	3	4	5	6	7	8	9
140	1	2	3	4	5	6	7	8	9
160	1	2	3	4	5	6	7	8	9
180	1	2	3	4	5	6	7	8	9
200	1	2	3	4	5	6	7	8	9
220	1	2	3	4	5	6	7	8	9
240	1	2	3	4	5	6	7	8	9
BAC to .05%	— — Be Careful- Loss of Judgement & Coordination								
BAC .05% to .10%	==== Abilities Impaired- Accident Chance Increased								
BAX. Over 10%	===== Do Not Operate A Boat- High Accident Risk								



Safety On Board

BOATING ACCIDENTS

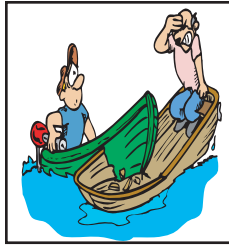

The following is a list of common causes of boating accidents. Be aware of them and take the necessary steps to ensure that your crew and yourself are educated and prepared to act in an emergency.

- Mixing boating and alcohol. Remember the skipper is responsible for his boat and crew.
- Trying to reach the bow by the deck walk-around while the boat is moving too fast.
- Someone sitting on the bow, deck, or swim platform while underway.
- Choosing a boating outing day with inclement weather, especially with high winds and thunderstorms in the forecast or staying out when bad weather is approaching.
- Disembarking without checking all fluids or systems and especially fuel system components.
- Not monitoring the boating traffic or possible obstructions around you.
- Emergency communications equipment, signaling devices, and navigation lights not working.
- Improper boat handling especially high speed turns in rough water. Improper trim.
- Being too far from shore with inadequate fuel supply or navigational aids.



CHAPTER 1

- Passengers, especially children that are not wearing the proper life saving devices.
- Skipper or passengers not seated in the boat.
- Running a craft that is mechanically marginal.

Reporting Boating Accidents

According to the Federal Boat Safety Act of 1971 involving collision, accident or other casualty, the operator must make a formal report within 48 hours to the nearest state boating authority when the incident involves:

1. Death
2. Injury requiring treatment other than first aid
3. The disappearance of someone from a boat under death or injury circumstances.

A formal report must be made within 10 days for accidents involving more than \$500 damage or complete loss of vessel.

For information regarding accident reporting, please call the **Boating Safety Hotline** at 800-368-5647.

Rendering Assistance

The operator of a vessel is obligated by law to provide assistance that can be provided safely to any individuals in dangerous situation on the waterways. The operator is subject to fine and or imprisonment for failure to do so. Move cautiously and think before acting.



WATER SPORTS

Besides learning the safety precautions for safe boating, as well as understanding and knowing required rules and regulations, you are obligated to be particularly careful around other water sportsman, such as scuba divers, water skiers, wakeboarders, and fisherman.

Skin & Scuba Divers

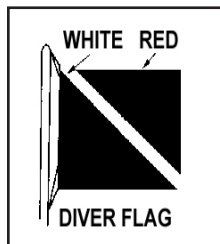

Whenever you see a “Diver Down” flag, maintain a distance of at least 100 feet on inland waters. In bays and open waters stay 300 feet away. The flag indicates a diver in the water. If a diver is operating from your boat, be certain to use this flag and post a lookout on board for a divers air bubbles. Sometimes divers stray from the flag area.

Water Skiers & Wakeboarders



For information on water skiing and how to get started, we recommend you contact the American Water Ski Association, P. O. Box 191, Winter Haven, Florida 33880. They offer pamphlets and instructional materials.

For more wakeboarding information there are numerous training schools, instructional videos available at libraries and the internet.



CHAPTER 1

General safety procedures for towing skiers and wakeboarders include the following:

- Know your hand signals and make sure all your passengers know them. See the illustration.
- Do not allow non-swimmers to ski or wakeboard. You're asking for trouble!
- Always have an observer on board whose sole job is to watch the skier/wakeboarder and communicate with the driver.
- If you plan to do a lot of skiing/wakeboarding, it is advisable to have a ski pylon and driver's rear view mirror installed.
- Acquaint yourself with the ski site before skiing/wakeboarding.
- Follow the speed limits and all posted signs- i.e. no wake, etc.
- Keep the boat away from swimmers or other people in the water.
- Avoid running near the shoreline or in heavily congested areas with skier/wakeboarder in tow.
- Do not allow skier/wakeboarder to spray fisherman or other parties.
- Keep the engine speed steady while towing a skier/wakeboarder.
- Make wide turns with skier/wakeboarder in tow.
- Instruct skier/wakeboarder in case of a fall to raise his ski in the air to ensure his visibility.
- Always turn your engine off when the skier/wakeboarder is near the platform or transom.



Safety On Board

□ If the skier falls, return promptly to retrieve him, circling wide from the starboard side, to bring his rope within easy grasp. See illustration.

Ski Tow



A preferred placement of the line provides a tight fastening for skiing while allowing the line to be readily removed if needed. Check your tow line for abrasion and tow ring for tightness periodically. The same principle applies to PowerTower combo all-around light and tow device.



WARNING

AVOID SERIOUS INJURY OR DEATH!
DO NOT USE SKI TOW FITTING
FOR LIFTING OR PARASAILING.
FITTING COULD PULL OUT OF DECK

Swim Platform

WARNING!
MAXIMUM CAPACITY
OF SWIM PLATFORM
500 POUNDS
226 KG

On integrated or extended swim platforms you should make periodic inspections of the swim ladder and swim platform hardware to ensure that all connectors and fittings are tight and free from corrosion.

Check the laminated fiberglass under platform supports for fatigue and cracks. Never run the boat with someone holding on to or standing/sitting on the platform. Use heed when operating the boat in reverse to insure that water does not accumulate excessively on the platform especially in rough seas or strong currents. Do not exceed the platform recommended maximum capacity **label!**



CHAPTER 1

WATER SKI & WAKEBOARD SIGNALS

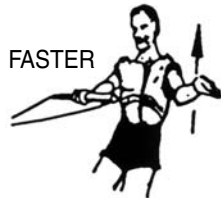

FASTER



SLOWER



SKIER OK
AFTER FALL



CAUTION OR FALLEN
SKIER; PICK ME UP

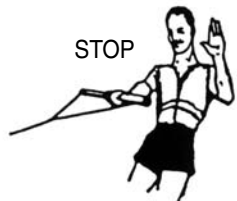

STOP

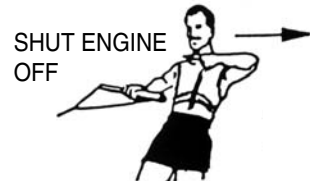

SHUT ENGINE
OFF



RETURN TO DROP
OFF AREA

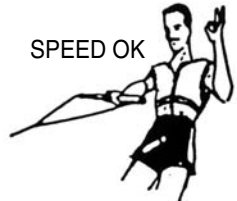

SPEED OK

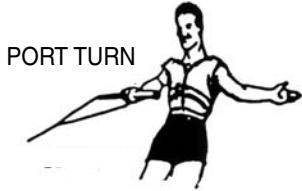

PORT TURN

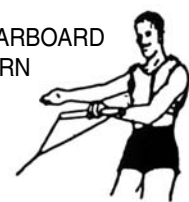

STARBOARD
TURN



Safety On Board



WARNING

AVOID SERIOUS INJURY OR DEATH!
DO NOT OPERATE THE BOAT
WITH PEOPLE IN THE WATER
OR ON TOP OR HOLDING ON TO
THE SWIM PLATFORM STRUCTURE OR HARDWARE.

Fishing



Most boaters fish from time to time. With the propulsion systems of today it is possible to fish in out-of-the-way places. When cruising, stay clear of fisherman. They may have lines or nets out which might be cut or get caught in your propeller if you come too close. Slow down when approaching fishing boats.

Do not return to cruising speed until the boats have been passed. If a fishing boat should be anchored, a large wake could flip or swamp the boat, upset fishing gear, pull the anchor loose from the bottom or worse yet cause someone to fall overboard.

When fishing from your boat, never anchor in shipping channel or tie up to any navigational aids. These must be kept clear of at all times. Be sure to carry a chart of the area and be on the lookout for shallow water and hidden obstructions. Pick up a local tidal chart if appropriate so you do not end up grounded.

Remember, the skipper is responsible for any damage caused by his wake. Use common sense and be a responsible captain!



CHAPTER 1

WEATHER & WATER CONDITIONS

Before a boating outing check the weather conditions. As we all know the weather can change rapidly in many parts of the country. It does so sometimes without being predicted. NOAA weather radio reports are continuously available on designated frequencies installed on VHF radios and various handheld devices. Also, many local radio stations carry weather reports.

Cloud Formations

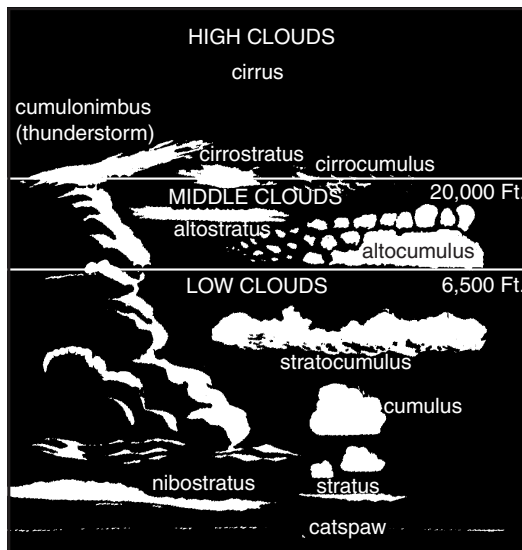

Clouds indicate the type of current weather and upcoming changes in the weather. Knowing the type of cloud formations can assist you in choosing the appropriate boating day or if already on the water will help you understand any upcoming weather changes.

Flat clouds (stratus) normally indicate stable air. Cumulus clouds indicate unstable air.

Many times a “cotton ball” or cumulus cloud builds vertical height in the afternoon and the result is a thunderstorm with increased winds and waves; sometimes these storms are quite violent. You can find additional information on weather (meteorology) at your local library.



Safety On Board

Waves & Fog



As the wind blows across water waves are created. The stronger the wind and increased distance across the water enlarges the wave action.

Other factors that can cause problem situations for vessels are fog, currents, and tidal changes.

Fog can develop inland on clear, calm mornings. Coastal areas see large “blankets” of fog roll in and stay for extended time periods causing sometimes

hazardous navigation conditions. If you are caught in the fog, do not panic. Think of the best plan of action and proceed carefully. If you are limited in navigation equipment at the first sign of fog proceed to the nearest shoreline and wait until the fog lifts.

Boats equipped with navigation equipment, local waterway experience and charts should proceed to a safe harbor. Use extreme caution, signal as needed, and reduce to a speed where you can stop within half of your forward vision range.







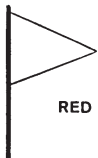

If foul weather catches you at sea do the following:

1. Slow down. Proceed with caution and put on your life vests.
2. Try to reach the nearest safe shoreline.
3. Navigate your vessel slowly into the waves at a 45 degree angle.
4. Passengers should sit low in the center of the vessel.
5. Monitor your bilge pump. Make sure sump stays free of water.
6. Secure loose gear. Make ready emergency equipment.
7. If the engine stops, throw the anchor over the bow. If needed use a sea anchor. Never anchor off the stern.



CHAPTER 1

Marine Weather Symbols

	SMALL CRAFT	GALE	STORM	HURRICANE
DAY FLAGS	 RED	 RED	 RED & BLACK	 RED & BLACK
NIGHT LIGHTS	 RED WHITE RED	 WHITE WHITE RED	 RED WHITE RED	 RED WHITE RED

Although the National Weather Service has discontinued the use of the day flags and night lights, many marinas and ports of call still display them.



Rules Of The Road

NAVIGATION RULES DEFINED

The Navigation Rules set forth actions to be followed by boats to avoid collision. They are referred to as the “Rules of the Road”. There are two main parts referred to as the inland and international rules. The inland rules apply to vessels operating inside the boundaries of the United States. The international rules referred to as 72 COLREGS apply to vessels operating on the high seas and all connected waters outside the established demarcation boundaries. Most navigational charts show the demarcation lines by red dotted lines and are published in the navigation rules. Remember to consult state and local agencies since areas such as “no wake zones”, swimming beaches, “diver down flag” and inland landlocked lakes fall under their jurisdiction. This section is only an introduction to the “rules of the road”. We strongly recommend additional training before getting behind the “wheel” of your boat.

	WARNING
TO AVOID INJURY AND DEATH FOLLOW THE NAVIGATION “RULES OF THE ROAD” TO PREVENT COLLISIONS.	

You can order the Inland & International Navigation Rules from:
Superintendent of Documents
U. S. Government Printing Office
Washington, DC 20402
Telephone: (202-512-1800) Fax: (202-512-2250)



CHAPTER 2

NAVIGATION RULES

Right Of Way

1. Cross waves at right angles.
2. When caught in heavy water or squalls, head either directly into the waves or at a slight angle. Reduce speed, but maintain enough power to maneuver your boat safely.
3. Keep your speed under control. Respect the rights of other boaters engaged in all water sports. Give them a “wide berth”.
4. Whenever meeting a boat head on, keep to the right where possible.
5. When two boats cross, the boat to the right (starboard) has the right of way.
6. When overtaking or passing, the boat being passed has the right of way.

In general, boats with less maneuverability have right-of-way over more agile craft. The skipper must keep his craft clear of the following vessels:

- A vessel not under command or aground; due to their circumstances, these vessels have no maneuverability.
- A vessel restricted in its maneuverability; these vessels usually are performing work which limits their maneuverability such as surveying, dredging, laying pipe or cable, or servicing navigational markers among others.
- A vessel engaged in fishing; these include boats fishing with lines, trawls or nets, but not trolling lines.



Rules Of The Road

- Sailboats; they have the right-of-way over power boats. However, if a sailboat is using a prop to move forward, it is considered a powerboat even if the sails are up.
- Remember the unwritten “rule of tonnage”. Basically a smaller tonnage vessel should take every effort to avoid close quarters with a larger tonnage vessel. One way to accomplish this is to have a designated human lookout to “eyeball” the horizon for any developing collision course.
- Use defensive driving skills on the waterway just as you do on the roadway. The other vessel may not know the “rules of the road” Be alert and ready to take immediate action.
- If a collision course is unavoidable neither boat has the right of way. Both boats must react to avoid an accident according to the rules of the road.

Signals

WHISTLE SIGNALS

- ONE LONG BLAST:** Warning signal
(Coming out of slip)
- ONE SHORT BLAST:** Pass on my port side
- TWO SHORT BLASTS:** Pass on my starboard side
- THREE SHORT BLASTS:** Engine(s) in reverse
- FOUR OR MORE BLASTS:** Danger signal

BRIDGE SIGNALS

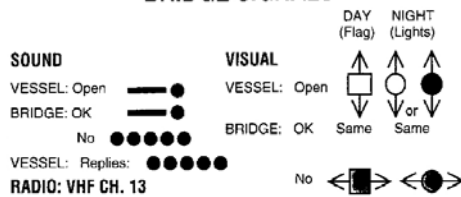



CHAPTER 2

NAVIGATION RULES

The Navigation Rules set forth 3 types of crossing situations- crossing, meeting, and overtaking. In each case, both boats are governed by special procedures.

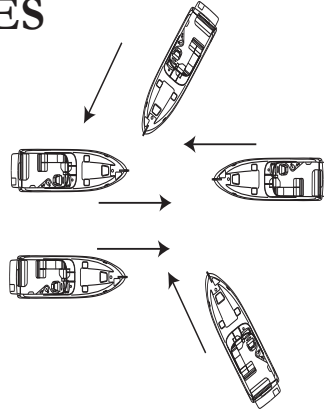

In a head-on meeting, both vessels must sound a single blast to give way toward starboard and pass to port.

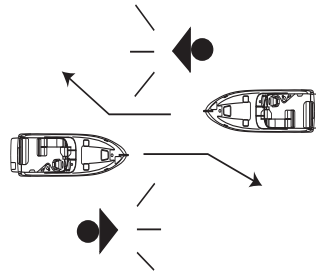

These rules appear when there is a risk of collision. In a crossing situation be aware of the other craft's position. For safety, there should be a noticeable change in the angle, bow or stern; a gradual change in position indicates possible danger.

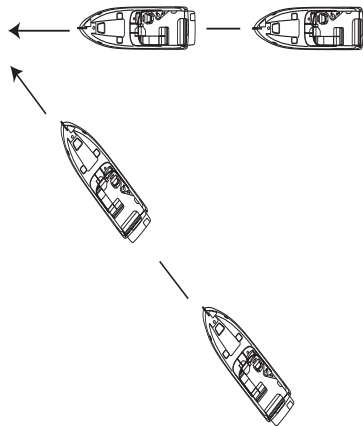



Rules Of The Road

NAVIGATION RULES

An overtaking boat is burdened, and is not the privileged craft, even though it approaches the danger zone of the overtaken boat.

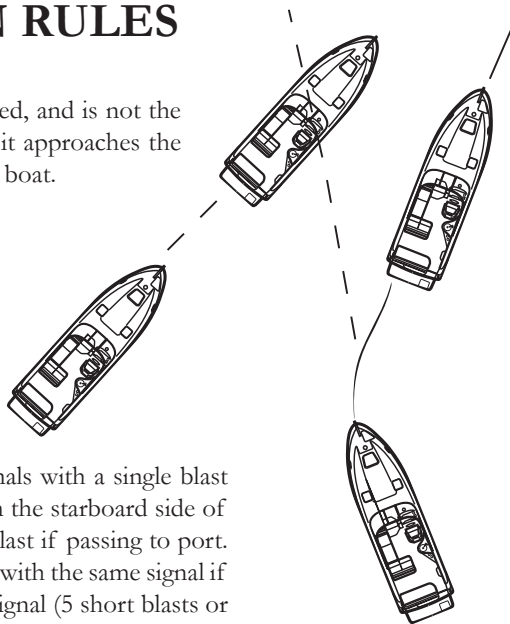

The overtaking boat first signals with a single blast if that boat desires to pass on the starboard side of the boat ahead, or a double blast if passing to port. The overtaken craft responds with the same signal if it is safe, or with the danger signal (5 short blasts or more) if unsafe. The boat overtaking must not pass unless the appropriate signals are sounded.

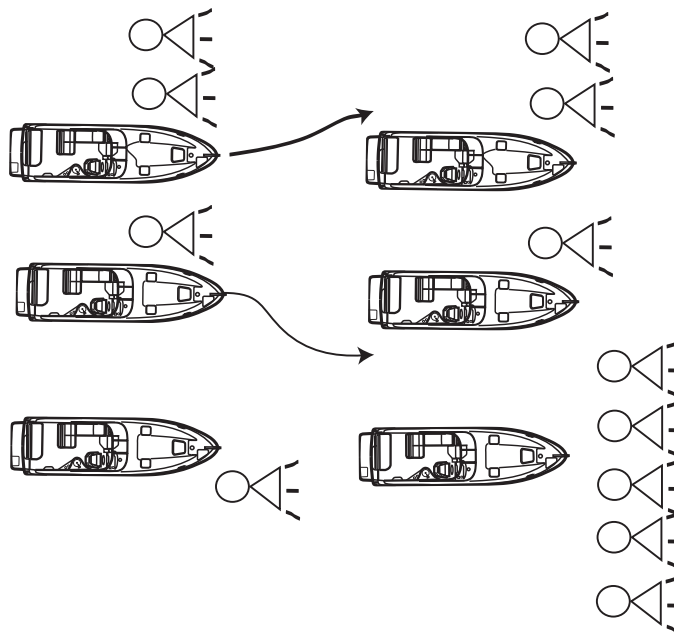



CHAPTER 2

NAVIGATION AIDS

Navigation aids are placed along coasts and navigable waters as a guide for mariners in determining their position in reference to land and hidden danger. Each aid provides specific information. They form a continuous system of charted markers for accurate piloting on paper and on the water.

Nautical charts are provided by the National Ocean Service (NOS) and are distributed nationwide through marinas and outlet stores. These charts show the geography of the coast, water depth, landmarks, navigation aids (buoys and markers), marine hazards, and port facilities. Use only up-to-date charts for navigation. We recommend when purchasing a chart to look for the weather resistant ones.

Buoys provide a road map to keep the skipper on course and to avoid hazards. Buoys are identified by light, shape, color and in severe weather conditions by sound.

Buoys or beacons called lateral markers indicate the port and starboard sides of the waterway to be followed. U. S markers follow the buoy system known as Red Right Returning. When returning from sea or traveling upstream, the green markers are to port (on your left) and the red markers are to the starboard side (on your right). When traveling downstream or out to sea the marker color would be reversed. The Intercoastal waterway uses a different system of lateral markers for port and starboard. Before operating your vessel, learn to identify the various navigational aids such as lateral aids, mid-channel markers, information and regulatory markers.

NOTICE

**SKIPPERS MUST NOT RELY ON BUOYS ALONE
TO MARK THEIR POSITION.
SEVERE WEATHER CONDITIONS
AND WAVE ACTION CAN ALTER A BUOYS POSITION.
NEVER TIE UP TO A BUOY.
IT IS ILLEGAL AND EXTREMELY DANGEROUS.**



Rules Of The Road

LATERAL AIDS

Port Side
Odd Numbers

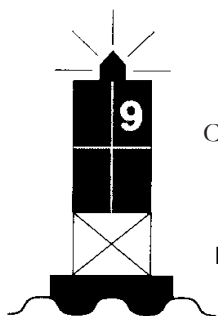

Chart Symbol



G "9"
Fl G 4 sec

Lighted Buoy
(Green Light Only)

Starboard Side
Even Numbers

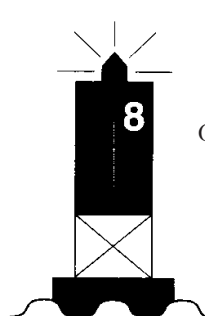

Chart Symbol



R "8"
Fl R 4 sec

Lighted Buoy
(Red Light Only)

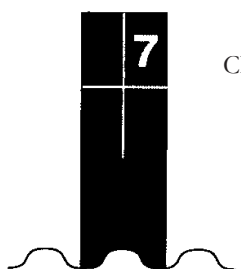

Chart Symbol



C "7"

Can Buoy
(Unlighted)

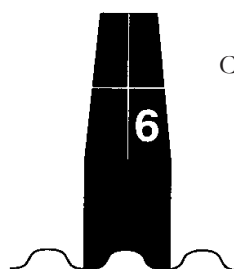

Chart Symbol



N "6"

Nun Buoy
(Unlighted)



Chart Symbol



G "1"

Daymark



Chart Symbol



R "2"

Daymark



CHAPTER 2

MID-CHANNEL MARKERS

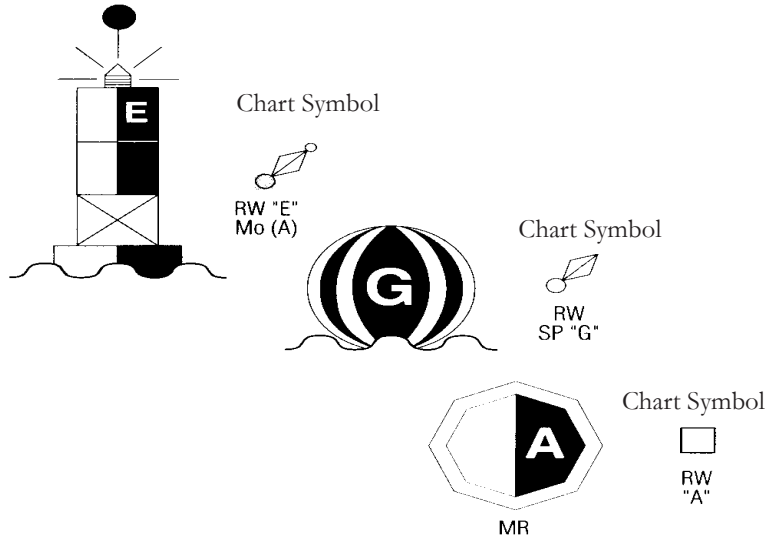

REGULATORY MARKERS

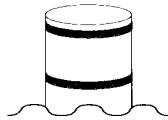

Diamond Shape
Danger Warning



Diamond Shape With Cross-
Boats Keep Out



Circle Marks Area Controlled
As Indicated



For showing information such
as locations, distances and
directions



Rules Of The Road

NIGHT RUNNING

Boats operating between sunset and sunrise (hours vary by state), or in conditions of reduced visibility, must use navigation lights. Nighttime operation, especially during bad weather and fog, can be dangerous. All Rules of the Road apply at night, but it is best to slow down and stay clear of all boats regardless of who has the right-of-way.

To see more easily at night, avoid bright lights when possible. Also, it is helpful to have a passenger keep watch for other boats, water hazards and navigational aids.

To determine the size, speed and direction of other vessels at night, you should use the running lights. A green light indicates starboard side, and a red light indicates port side. Generally, if you see a green light, you have the right-of-way. If you see a red light, give way to the other vessel.

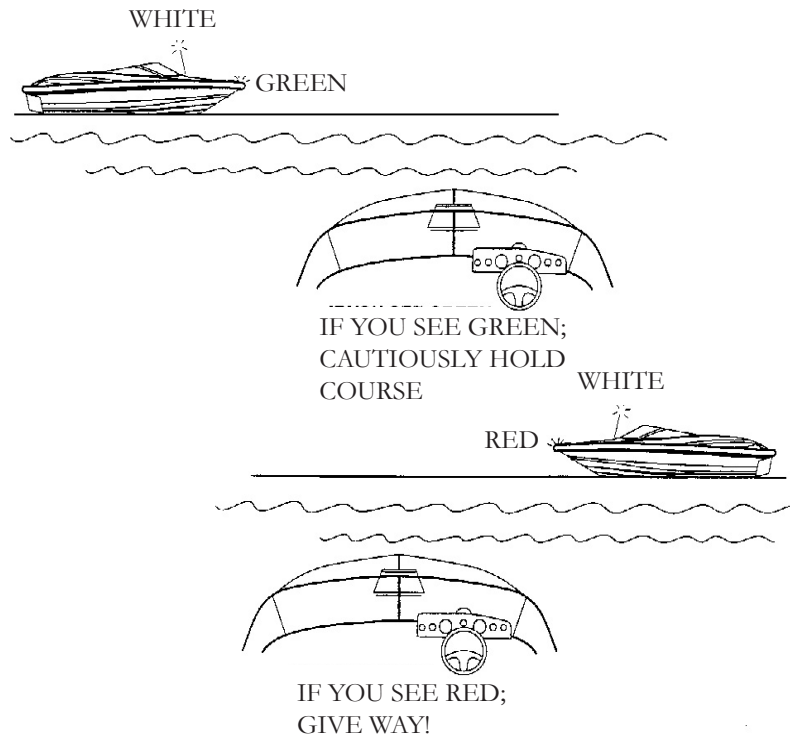



CHAPTER 2

BRIDGE CLEARANCE



Be aware that your vessel requires a specified bridge clearance height. This height is a measured estimate from the waterline to the top of the highest object usually the tower, arch, radar or the masthead light depending on what equipment is installed. All canvas should be in the stored

position. The estimated height can change because of variances in the loaded condition of the vessel. Consult the bridge clearance specifications located in Chapter 12 (technical information section). As an alternative to be carried out at dockside have someone place a long straightedge such as a piece of wood at a 90 degree angle across the highest point of the boat with the boat in the water. Then with a tape rule measure the distance straight down (90 degrees) to the waterline. Take this measurement with the fuel and water tanks 1/2 full and only 1 person besides yourself on board. This will give you a safe measurement. As your boat is loaded down with people the bridge clearance needed will be slightly lower.

Some bridges are tendered. Know and use the proper bridge signals when approaching these bridges (see bridge signals on page 2-3). You can also monitor and communicate bridge information on channel 13 of a VHF radio. Other bridges are marked with a clearance measurement and you are on your own.

If your vessel has a tower with the potential to lower it, be sure it lays forward to a distance that will safely clear the bridge before attempting to proceed under the bridge. After determining your vessel will clear the bridge proceed with caution at a safe idle speed. Keep your eye on vessel traffic at all times in order to react quickly. Resume a safe speed once clear of the bridge structure and acknowledgment of clear visibility.

Use common sense with bridge clearance because bodily injury and/or property damage will result if a mishap occurs with a bridge.

Engines & Controls

ENGINE

Engine Basics



It is important that you read the engine manual carefully and become familiar with the operation as well as necessary maintenance on the engine and propulsion systems. Pay careful attention to the sections on winterization if you live in freezing climates. Extensive damage can result if proper winter storage is not followed. Consult your Regal dealer for further information.



WARNING

**AVOID SERIOUS INJURY!
READ ALL MANUFACTURER'S ENGINE AND
PROPULSION OWNER MANUALS
BEFORE OPERATING YOUR VESSEL.**

Engine Mounts

The engine is set in the boat on a group of metal or wooden platforms called mounts. These rubber isolation mounts keep the engine from moving laterally and athwartships (right angles to the center line). The mounts help reduce the vibration caused by the engine and drive. Periodically, check the mount hardware for tightness.



CHAPTER 3

Engine Alignment

The engine uses a rubber splined hub to which the outdrive drive shaft is attached. This alignment specification between the engine and out drive needs to be checked periodically. It should be checked after each 50 hours of operation or if the vessel has run aground or hit a submerged object. Alignment should be checked by a Regal dealer or marine professional since special tools and procedures are required.

Engine Removal

In the event the engine or outdrive (sometimes referred to as stern drive) requires major service where it needs to be removed, consult your Regal dealer.

Engine Ventilation

Ventilation systems are required for engine compartments. Your boat features a set of deck vent shrouds with mesh covers which supply fresh air constantly to the engine compartment. A powered blower motor connected to ducts in the lower one third of the bilge evacuates air to the atmosphere. **Pay close attention to the following warning.**



WARNING

GASOLINE VAPORS CAN EXPLODE. BEFORE STARTING ENGINE, OPERATE BLOWER 4 MINUTES AND CHECK ENGINE COMPARTMENT FOR GASOLINE LEAKS OR VAPORS. RUN BLOWER BELOW CRUISING SPEED.

All owners are responsible for keeping their boat's ventilation systems in operating condition. This means making sure the ventilation covers are obstruction free, ducts are not blocked or torn, blower operates properly and any worn parts are replaced with approved marine parts.



WARNING

TO PREVENT FIRE OR EXPLOSION
USE ONLY APPROVED MARINE REPLACEMENT
PARTS THAT ARE IGNITION PROTECTED

PROPULSION

Stern Drive

It is important that you read the engine/stern drive manual carefully and become familiar with the operation as well as necessary maintenance on the drive unit components. Pay careful attention to the sections on winterization if you live in freezing climates. Extensive damage can result if proper winter storage is not followed. Refer to the maintenance section of this manual for more information or call your nearest Regal dealer.

Propellers



We have carefully tested and chosen the propellers to give your stern drive boat the best possible performance and have allowed for the additional weight in equipment that might be added to the boat. It is a good idea to carry a spare set of propellers and hand tools in order to handle an emergency propeller change. Refer to the engine manual for proper procedures since each stern drive application is unique. Call a marine professional or your Regal dealer for further information.



DANGER

**PREVENT SEVERE INJURY OR DEATH!
SHUT OFF ENGINE NEAR SWIMMERS
TO AVOID ROTATING PROPELLER BLADES.**

Propeller Checklist

At least twice a year check each propeller for:

- Loose, missing or corroded hardware.
- Nicks, dings or missing propeller material.
- Bent propeller blades.
- Objects wrapped around the prop such as fish line.
- Decomposing propeller blades (electrolysis symptom).
- Aluminum prop with paint coming off near blade tip (ventilation symptom).
- Check the propeller pressed in rubber hub for slippage.

Contact a propeller shop or your closest Regal dealer if any of the above symptoms exist. They have special equipment to refurbish both stainless steel and aluminum propellers. After making any blade alternations the propellers are “repitched” in special prop jigs.

Engines & Controls

CONTROLS

Instrumentation

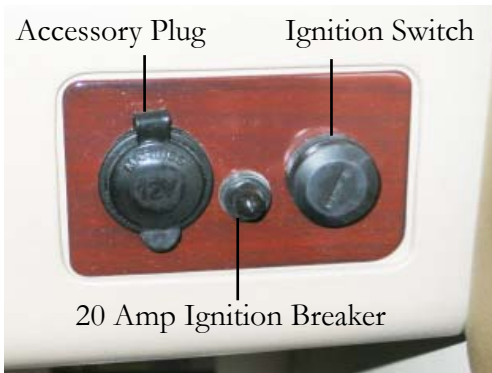

The helm station is equipped with a complete set of instruments that allows you to monitor the condition of the engines. Close observation of the gauges may stop engine damage.

The dash instrument panel is powered and protected by a main breaker located

at the back of the battery switch panel in the bilge. It is connected through the key switch.

If a fuse “blows” find the cause of the problem before replacing it. Always use same type/size fuse.

The engine wiring is protected by a main breaker with a push button reset mounted on the engine. Refer to your specific engine manual for information on type and location. If a breaker “pops” figure out the reason why before resetting it.

Individual dash switches are protected by a breaker or fuse.

NOTICE

WITH BATTERY SWITCH IN THE “OFF” POSITION
THERE IS NO POWER TO THE DASH.



CHAPTER 3

Typical Helm Overview

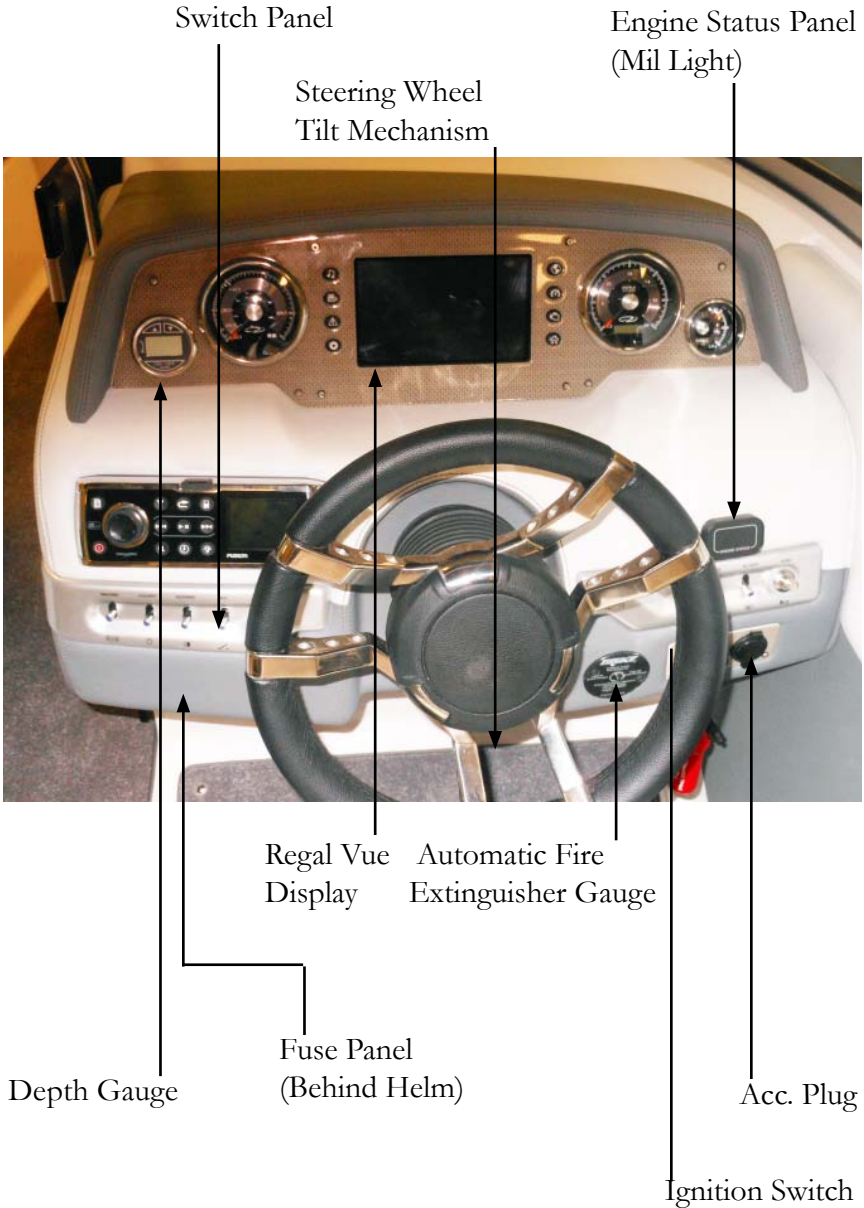

Engines & Controls

Gauge Operation

Following is a general description of typical gauge operations. An alert skipper monitors his gauges constantly for any system malfunctions. The gauges are lighted for night operation. Gauges are an early warning system for marine engines just as for automobiles. For more information, refer to the engine manufacturer's manual in the owner's pouch. Select Regal models use the multi-function gauge versus the single gauge.

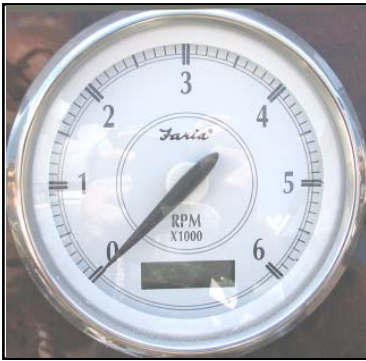

Tachometer:

The tachometer indicates the speed of the engine in revolutions per minute (rpm). The tachometer allows you to monitor the engine speed so you can be sure not to exceed the recommended limits of the engine manufacturer. *Selected* tachometers have built in hour meters.

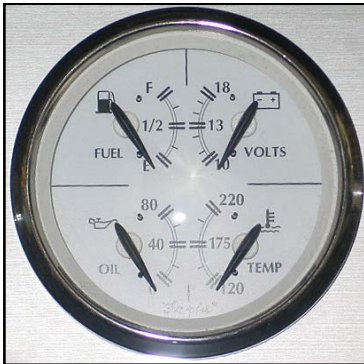

Multi-Function Gauge

The multi-function gauge reads 4 separate engine functions which makes viewing much easier especially when cruising. The parameters covered are fuel, volt, oil, and temperature. Refer to the individual gauges on the next page for a full description of gauge operation.

Note: Later gauges feature a black bezel vs. the white one shown here.



CHAPTER 3

Fuel Gauge:

The fuel gauge indicates the level of fuel inside the fuel tank. It is a good idea to keep the fuel tanks “topped off” when possible to reduce fuel vapors inside the tank. It is also a good idea not to run the fuel level close to empty in order to leave an adequate “safety” factor.

Volt Meter:

The volt meter monitors the battery condition as well as the alternator performance. Normal voltage is between 12.0 and 15.0 volts. Readings outside of this range may indicate a charging system or battery problem.

Oil Pressure:

The oil pressure gauge indicates the pressure of the oil inside the engine lubrication system. A drop in oil pressure may be an indication of a low oil situation or a leak. Continued operation of the engines with low oil pressure could lead to engine damage. Refer to appropriate manufacturer’s engine manual for more information.

Temperature Gauge

The temperature gauge monitors the cooling system of the engine. A sudden increase in the temperature could be a sign that the engine cooling system is malfunctioning. Shut down the engine immediately and investigate the problem. Consult your engine manual for allowable limits.

Engines & Controls

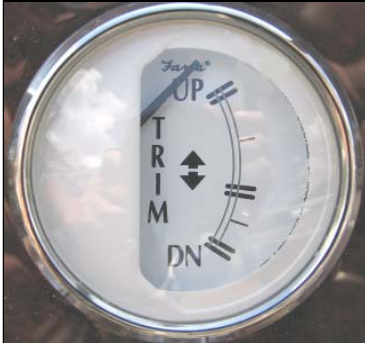

Trim Gauge:

This gauge measures the stern drive tilt and indicates the relative position of the bow, up or down when the boat is on plane. The power trim normally begins in the down position when used to accelerate the boat onto a plane position. The gauge can be helpful in achieving the most economical running condition.



Depth Gauge:

The depth gauge is standard equipment on selected models. The depth gauge indicates the water depth under the keel of the boat. It features an shallow water alarm. By monitoring the water depth closely, damage to props and underwater hardware can be avoided.



Speedometer:

The speedometer used on selected models indicates kilometers per hour and miles per hour by measuring water pressure against a small hole in a device mounted under the boat. Consult the owner's packet for further information.

Note: Later gauges feature a black bezel vs. the white one shown here.



CHAPTER 3

Optional Gauges & Indicators



The **optional** gas vapor detector determines if there is a level of gasoline vapors that is unsafe in the engine room of the boat. If installed, turn on the unit and wait about one minute for it to do its safety test. If all is well it will give you a green light. You must run the test before you start the engines. In the event the detector does not show a green light, you must investigate the bilge of the boat for gas

fumes or signs of a fuel leak before starting the engines. If uncertain, consult a marine service professional.



The automatic fire extinguishing system utilizes an instrument display unit (gauge) that provides the operator with a system status of charged or uncharged condition by an audible alarm. With the ignition turned on the indicator light shows system is charged and operating properly. With

the ignition on and no light indicates the system has discharged. If the system should discharge the ignition system will be instantaneously interrupted. Should this occur shut down the engine, ventilation blower and any electrical system components. Investigate the source of the shutdown immediately and take appropriate action. For more information, refer to the owner's pouch.

Engines & Controls

Audible Alarms

Most Mercruiser and Volvo engines use audible alarms. They are designed to use sensors which pick up deviations from the normal operating parameters. Oil pressure and temperature sensors send a signal to a buzzer under the dash which sounds a high pitched alarm indicating a possible problem. In addition to the dash, some engines use buzzers at the engine itself.

NOTICE

**PREVENT POSSIBLE ENGINE DAMAGE
WHEN AN AUDIBLE ALARM SOUNDS
SHUT DOWN ENGINE IMMEDIATELY,
INVESTIGATE & REPAIR THE PROBLEM**

On start up it is not unusual to hear an audible alarm sound when cranking the engine over. This occurs normally because it takes a second or two to build up the engine oil pressure. Then the alarm will stop. A seasoned skipper monitors his instrument panel often while cruising.



CHAPTER 3

Typical Catalyst Engine Monitoring Panel ---



Shown is a typical dash mounted engine emission status panel used with catalyst engines. It provides a visual and audible (beeping alarm) means of monitoring engine and emission control systems. The panel will show the outline of an engine on the left side and a warning sign on the right.

When an emissions related fault is detected an amber colored light will appear on the left side.

When an engine related malfunction is detected the warning sign will light red on the right side. If the situation is serious enough there may be a significant power reduction of the engine.

If either of the above lights is lighted an audible short beep alarm will be activated.

When the engine is initially started there is a series of self-checks involving the various emission system sensors.

Read the engine manufacturer's operation manual for more detailed information on emission monitoring systems related to the particular engine brand installed on your vessel.

Engines & Controls

Instrument Lighting

Each gauge is designed with a light bulb so it can be seen at night. On most models you activate the instrument lighting by energizing the navigation light switch. Eliminate condensation inside the gauges by activating the gauge lights in high humidity environments.



CHAPTER 3

Ignition Switch

A typical ignition switch features 4 positions. In a clockwise direction they are auxiliary, off, run, and start. The start position is spring loaded and the key should be held in this position to engage the starter. Once the engine has started release the key from the start position. The electrical system will then be energized in the run position. The auxiliary position is counterclockwise from the “off” position. When it is activated the stereo and dash switches can be energized without the instrumentation engine ignition wiring and engine warning buzzers being energized. Be a smart skipper and remove the ignition key from the ignition switch with children aboard and/or when there are people in the water.

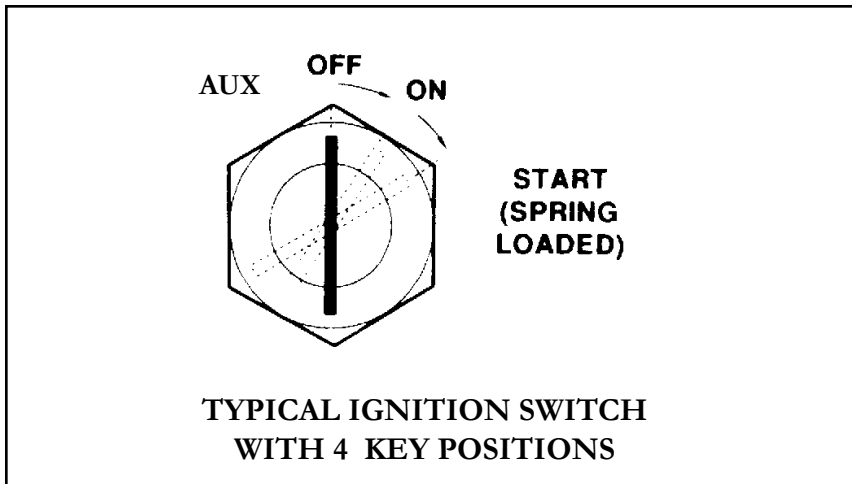

NOTICE

TO AVOID DRAINING THE BATTERY
DO NOT LEAVE IGNITION KEY
IN THE “ON” POSITION
WHEN THE ENGINE IS NOT RUNNING.

Engines & Controls

STD. REMOTE CONTROL OVERVIEW

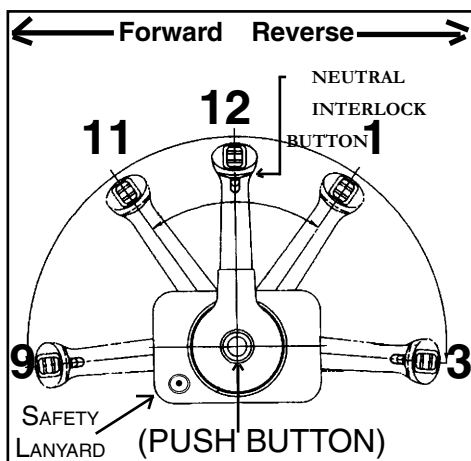

Vessels without EVC or DTS electronic controls use a single lever remote control similar to the illustration.

To help visualize the operating principals we have used a clock mode. The lever in the straight-up or 12 o'clock (neutral) position uses a detent push button (see illustration) which allows advancing the throttle for neutral or starting the engine without engaging the gearshift. This feature is

useful when trying to start a cold engine.

Pushing the throttle lever forward from the neutral 12 o'clock position to the 11 o'clock position will engage forward gear with minimum throttle. From the 11 o'clock position to the 9 o'clock position the vessel is in forward gear with forward throttle selections.

Pulling the throttle back from the neutral 12 o'clock position to the 1 o'clock position will engage reverse gear with minimum throttle. From the 1 o'clock position to the 3 o'clock position the vessel is in reverse gear with reverse throttle selections.

As you shift from neutral to forward or reverse positions, *push up on the neutral interlock button* located under the gearshift knob. This will allow the control to shift into the desired gear.

Neutral Safety Switch

The remote control features a neutral safety switch which ensures the stern drive and control handle are in the detented neutral position for starting the engine.



CHAPTER 3



You will hear a distinct sound and will “feel” the remote control in the detent neutral position. If you turn the key to the “start” position and the engine starter doesn’t crank over the engine make sure the remote control is in the detent neutral position.

Remember these points when shifting :

1. Do not shift quickly from forward to reverse gear position. Drive system damage may occur.
2. Do not “pump” the throttle in neutral or flooding will result. Today’s engines require very little starting throttle.
3. Do not try to shift into forward or reverse gear at high rpm’s as personal injury, drive system or property damage may result.
4. Remember to squeeze the shift interlock button to engage the remote control into forward or reverse.
4. Only use idle throttle positions when docking or maneuvering in tight quarters.
5. Wear your safety lanyard at all times.
6. Never shift the controls with the engine not running. Control, linkage, and/or stern drive damage may occur.
For more information read your engine operator’s manual for more details on controls.

Engines & Controls

Safety Lanyard (Interrupt Switch)

The safety lanyard (**used on selected remote controls**) sometimes called an interrupter switch is attached to the operator and the remote control panel (See the illustrations). Should the operator lose control of the vessel and become dislodged from his seat or fall overboard the lanyard will shut the engine off.

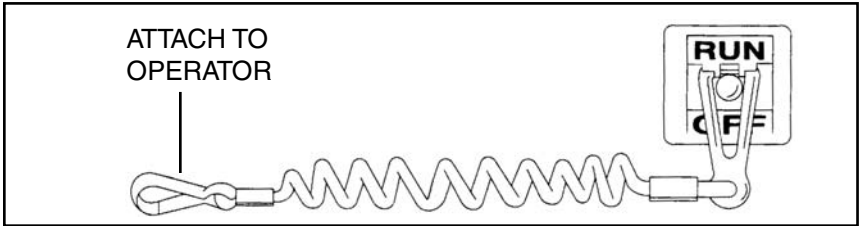

Make sure the lanyard is installed to a part of clothing such as a belt before operating the vessel. Never disconnect the hook from attached clothing while the engine is running.

NOTICE

IF THE INTERRUPT SWITCH
IS IN THE "OFF" POSITION
THE ENGINE WILL CRANK OVER
BUT WILL NOT START.



WARNING

INTERRUPT SWITCH MUST BE ATTACHED TO
OPERATOR WHILE ENGINE IS RUNNING.
QUALIFIED OPERATOR MUST BE IN CONTROL
AT ALL TIMES. READ OWNER'S MANUAL BEFORE USE



Systems

ELECTRICAL

The electrical system on board your vessel is known as direct current (DC for short). It is referred to as DC because electricity flows one-way in the circuit. Most DC circuits identify positive (+) wires as red and negative (-) wires as black.

Direct Current (12 volts)



Storage batteries (often known as a lead-acid cell battery) furnish 12 volts of electricity to boat components. Storage batteries use 2 dissimilar metals immersed in an liquid to carry current (acid). The engines require large reserve amounts of battery power for starting purposes. The automobile battery is charged up by the engine alternator as is the marine battery. The dash volt meter displays the battery voltage. If the volt meter shows less than 12 volts there could be a charging system malfunction. This condition needs to be investigated before the battery(ies) become completely drained. The typical battery is maintenance free and features 650 to 1000 cold cranking amps (CCA). Check chapter 7 for battery maintenance information.

Note: Never disconnect a battery terminal with the engine running as engine/charging system damage may result.



WIRE COLOR CODES (solid color/stripe)

Color	Gauge	Function
Red	00	Battery Cable To Engine
Black	16 to 4	All Grounds
Black/White	16	Halon Fire Extinguisher
Brown	12	Water Pressure Pump
Brown	16	Aft Bilge Pump/Manual
Brown	16	Fwd. Bilge Pump/Manual
Brown/Black	10	Overboard Discharge Pump
Brown/White	16	Aft Auto Bilge Pump
Brown/Red	16	Fwd. Auto Bilge Pump
Brown/Pink	16	CO Detector
Yellow	12	Blower
Yellow/Black	16	Stereo Memory
Orange	12	Refrigerator, Hatch Ram
Orange	16	Windshield Wiper/Run
Orange/White	16	Windshield Wiper/Park
Orange/Black	16	Horn
Orange	10	Spotlight
Blue	14	Interior Lights
Blue/White	14	Cockpit Lights
Yellow/Red	14	Engine Cranking Circuit
Blu/Green	16	Underwater Lights



WIRE COLOR CODES (CON'T.)

Color	Gauge	Function
Blue	10	Cabin Light Main Feed
Blue/White	16	Transom Courtesy Lights
Gray	16	Bow, Navigation Lights
Gray/White	16	Mast Light (Fwd. Running)
Gray/Black	16	Mast Light (Anchor Light)
Red/Black	16	Windlass Up
Red/White	16	Windlass Down
Red	16	Gas Vapor Detector, Stereo Remote, Breaker To Dash Feed Leads
Red	2/0	Main DC Panel Feed
Red	2	Positive Feed, Starter, Battery
Red	4	Positive Feed
Red	6	Positive Feed, Alt. Charge
Red	8	Positive Feed, Alt. Charge
Red	14	Positive Feed, Electronics
Yellow/Black	16	Tank Monitor
Purple	16	Hour Meter
Green	8	Bonding
Green	16	Tank Level Monitor
Pink	16	Fuel Tank Sender Feed



CHAPTER 4

The standard wire color, gauge size and function shown is used throughout the marine industry. The charts are helpful in identifying wire circuitry during troubleshooting or the adding of marine accessories. Never replace a wire with a size other than shown in the chart. This practice could result in fire or component failure.

Typical DC Switches

Following are the direct current switches used on your Regal boat. *Your boat may not use some of the switches mentioned because they represent optional equipment not installed on your vessel.* These switches are located on the dash switch panel. Note: electrical components and specifications may change at any time.

Typical Port Switch Panel



Typical Starboard Switch Panel





Horn

This switch controls the audible horn signal. Your vessel features an electric horn. It is located at the starboard forward hull. It is protected by a stainless grille cover. Be sure to test the horn before each outing and learn horn and bridge signals.

Bilge Blower

This switch controls the bilge ventilation blower. The blower's function is to evacuate any fumes and engine exhaust gases that have accumulated in the lower bilge. *The blower must be activated at least 4 minutes prior to starting the engine.* Check the ventilation ducts and black bilge hose to ensure they are not obstructed. Be careful not to step on the bilge hoses when doing bilge maintenance. *The blower shall be used below cruising speeds.*



WARNING

GASOLINE VAPORS CAN EXPLODE. BEFORE STARTING ENGINE, OPERATE BLOWER 4 MINUTES AND CHECK ENGINE COMPARTMENT FOR GASOLINE LEAKS OR VAPORS. RUN BLOWER BELOW CRUSING SPEED.

Nav/Anc

This switch controls the running and stern lights. It is a two position switch. Activate the forward section and the running lights (navigation and stern lights) are activated along with the instrumentation and switch lights for night running. Activate the aft portion and the stern light (360 degree light) is activated. Remember the navigation lights, sometimes called running lights must be used between sunset and sunrise. Should you anchor or stop the vessel at night the 360 degree light is required to be lit.



CHAPTER 4

Bilge Pump



This switch controls the bilge pump located in the engine compartment. Mechanically, the switch features a manual position forward and an off position. When the switch is manually activated the bilge pump sends the accumulated bilge water overboard. There is an outlet on the starboard aft hull where you can visually monitor the bilge water.

The bilge pump uses an automatic float switch. In the “off” position the float switch activates the bilge pump as needed. This feature is especially useful when the vessel is moored and vacant. There is a built-in lighted icon on the bilge pump switch that illuminates when the automatic mode is activated. The operator should monitor this icon periodically while operating the vessel. If the light activates stop the vessel and investigate the problem. Check the bilge pump before each outing and remove any foreign objects caught in the float switch or bilge pump grating. Never run the bilge pump in a dry mode since it may shorten the pump life. The bilge pump is energized even with the battery switch turned to the “off” position.

Docking Lights

This switch controls the forward hull docking lights. They are very useful for night maneuvering and docking.

Cockpit Lights

This switch controls the courtesy lights in the cockpit area. Using these lights is especially useful for night boarding or exiting.

Accessory (Acc.)

This switch controls any after market equipment installed. Make sure any components are matched to the over current protection (fuse).



Fresh Water Pump

This switch controls the pressurized water system fresh water pump for the head or cockpit refreshment faucet and transom shower. Periodically check and clean the in-line filter on the inlet side of the fresh water pump. Make sure this switch is turned to the “off” position before debarking. Be sure to winterize the fresh water system in colder climates. See the storage chapter.

Sport Tower/Arch



This switch is used to lower the sport tower to a forward position as needed for bridge clearance. *Be sure to read and understand the warning below before operating the (Tower) arch switch.* **Note: The sport tower should be in the “up” position when towing with a travel cover. All sunshades and bimini tops must be in their**

boots with all canvas hardware secure before attempting to tow the vessel. While towing continue to check all canvas boots and top frame hardware.



WARNING

TO AVOID PERSONAL INJURY
KEEP ALL BODY PARTS AWAY
FROM THE SPORT TOWER AND LIFT COMPONENTS
WHILE OPERATING THE SPORT TOWER SWITCH.



CHAPTER 4

DC BREAKER & FUSE LISTING

Function	Breaker/Fuse Size	Fuse Or Breaker
Ignition	20	Breaker
Water Pressure Pump	5	Fuse
Vacuflush	15	Breaker
Cockpit Lights	10	Fuse
Docking Lights	7.5	Fuse
Nav/Anchor Lights	10	Fuse
Stereo Performance	30	Breaker
Bilge Pump	10	Fuse
Bilge Blower	10	Fuse
Horn	10	Fuse
Automatic Fire Ext.	.5	Fuse
Acc. Switch	5	Fuse
12 Volt Outlet	15	Fuse
Main Dash Feed (red)	50/60	Breaker
Stereo Remote	2	Fuse
Underwater Lights	10	Fuse



EVC Relay	20	Fuse
Stereo Memory	15	Fuse
Tower	60	Breaker
Stereo Performance Package	30	Breaker
Tower Speakers	30	Breaker
Windlass	30	Breaker



CHAPTER 4

DC Circuit Protection

As part of the direct current circuitry (DC for short) the engine features a breaker with a reset button. This breaker protects the engine wiring from overloads. Refer to the engine manufacturer's manual for the breaker location and operation.

In addition, there are fuses protecting the individual switches located under the helm accessible at the port bow backrest or found under the dash itself. See page 11. Always find the reason a breaker or fuse fails and repair the problem before replacing the parts. Replace with the same amperage and type breaker or fuse. Carry extra ones which are available at marine supply stores or your closest Regal dealer's parts department.

Battery Switch



The battery switch displays 2 functions; off and on. Turn the knob to the "on" position before cranking over the engine. **Never turn the battery switch to the "off" position with the engine running.**

The battery switch is located under the rear bench seat on the starboard side of the cockpit. Since the automatic bilge pump float switch and stereo memory are wired directly to the battery switch you can leave the vessel and still have the vessel bilge pump energized with the battery switch in the "off" position along with the stereo retaining its pre-set functions and stations.

Main DC Breaker

Near the battery switch are several electrical components. One of the items is a breaker normally 50/60 amps with a red reset button. This breaker protects the main red power lead running up to the dash.



A stereo memory fuse is located near the battery switch or under the dash. Should the batteries be disconnected for a short period of time the stereo memory of selected stations and other functions remains intact.

The aft bilge pump fuse protects the bilge pump. The fuse is normally located under the dash or near the circuit breaker panel.



50 AMP MAIN
BREAKER

30 AMP STEREO
PERFORMANCE
BREAKER

If the vessel features the stereo performance package a 30 amp breaker protects the stereo system wiring. The resettable breaker is normally found near the battery switch beside the main DC breaker.

NOTICE

AVOID DAMAGE TO THE ALTERNATOR
AND OR CHARGING SYSTEM COMPONENTS.
NEVER TURN THE BATTERY SWITCH TO THE "OFF"
POSITION WITH THE ENGINE RUNNING.



Electrical Components Under Helm



Amplifier

Satellite
Tuner

Main Fuse
Block

Woofer

Amplifier

The main DC fuse block is located under the helm or dash. It may be accessible by lifting up the starboard bow backrest. The fuse block offers over protection to on-board equipment components through color coded fuses. Notice that each component protected is labeled. When replacing fuses use the same amperage. Fuses are available from your Regal dealer or automotive parts outlets. Periodically check all electrical connections at the fuse block for tightness.

In addition, a satellite tuner/antenna may be located under the helm. If a stereo performance package is installed one amplifier is normally located under the helm or may be in the cockpit refreshment center cabinet on select models. With tower speakers a second amplifier is added.



FUEL

The fuel system consists of a fuel tank, fuel fill fittings marked “gas” or “diesel”, fuel hoses, fuel vents, anti-siphon valve, fuel filter, fuel gauge and sender. Each one of these components plays an important role in providing an uninterrupted flow of fuel while operating your boat. Refer to the technical drawing section for system specifics.

Fuel Tank ---

Your boat uses an aluminum or polyester fuel tank. These tanks are tested several times along with the fuel system components for safety requirements and dependability in house and inspected independently by National Marine Manufacturers Association personnel.

Fuel Fill ---

The fuel fill is labeled “gas” or “diesel” and is located at the starboard deck for more convenient filling. When fueling the boat keep the fill nozzle in contact with the fuel fill pipe since it decreases static electricity. Always use the recommended fuel octane rating as specified in your engine owners manual. **Extinguish all flame producing agents before fueling!** Read and review the fueling section in chapter 5.



Fuel Vent

Fuel tanks are vented to permit the fumes to escape. While the tank is filled, air displaced by the incoming fuel is relieved through the fuel vent. Once the fuel fill cover is replaced all domestic EPA compliant tanks use a charcoal filter between the tank and vent line. This device

needs no maintenance and lasts the life of the fuel system.

The fuel fill is located at the starboard deck.

Your vessel uses a combo type (internal vent) fuel fill. Both the fuel fill and vent occupy the same cavity under a protective cover. If fuel overflows through the vent the design forces it back into the fuel fill hose and tank.

A seasoned skipper will hear a distinct sound as the tank nears

the “top out” or full mode and may see fuel overflowing back into the fuel hose through the vent. This helps avoid any overboard spills which harm the environment. There is a key that fits the fuel fill. Use it to secure the fitting from leaking fuel. Store the key in a safe place so it can be easily found for fueling. Check the vent fill screen periodically for debris.

Anti-Siphon Valve

The fuel feed line is equipped with an anti-siphon valve. The valve is screwed into the fuel tank fitting at the feed line. The valve is pulled off its seat by fuel pump pressure as the engine is cranking or running. It allows a one-way fuel roadway to the engine fuel pump. It prevents fuel from siphoning out of the tank in the event of a fuel line rupture or disconnected fuel feed hose. See the fuel tank maintenance chapter for more specific information on the anti-siphon valve location. Never remove the anti-siphon valve as it is a fuel system safety item.



To clean or replace a clogged or stuck anti-siphon valve contact your closest Regal dealer or marine professional.

Fuel Gauge & Sender

The dash fuel gauge is an **estimate** of the on board fuel supply. They are not exact reading instruments. Therefore, use the one third rule discussed earlier for monitoring your fuel supply. The fuel sender located in the fuel tank sends a signal to the dash fuel gauge. The signal is shown through a gauge needle movement which indicates estimated fuel. Remember, *there are not many filling stations on the open waterways!*

Fuel Filter

A fuel filter is installed on marine engines. They are of the spin on type similar to an automobile oil filter. Their main purpose is to trap dirt particles and water in fuel. It is a good idea to keep an extra fuel filter on board along with a filter wrench, catch pan and clean rags for emergencies. Dispose of all fuel residue materials in an environmentally safe fashion.

Diesel Fuel System

Diesel boats use special fuel filters. Most of these filters have a thumb screw to drain settled particles via the bottom of the filter. Refer to your engine owner's manual for further information.



CAUTION

ALGAE CAN GROW IN DIESEL FUEL.
PERIODICALLY ADD A CONDITIONER
TO THE DIESEL FUEL SYSTEM.



PRESSURIZED FRESH WATER SYSTEM



If equipped, a fresh water supply system consists of a water tank, fill/vent, head and/or cockpit refreshment sink, drain hose, faucet and transom shower. Water is supplied by a pressurized fresh water fill with an internal vent. When the water tank reaches full capacity water will be seen cycling from the vent into the fill hose. To energize the system there is a dash switch marked fresh water pump. When activated the switch sends power to the pressure pump which supplies on demand fresh water.

DECK WATER FILL



When the water supply line is full a pressure valve switch releases and the fresh water pump stops.

We recommend turning the dash fresh water pressure switch “off” when the vessel is left for extended periods. For initial filling of the freshwater system and winterizing refer to the operation and maintenance sections.



WASTE SYSTEM

Chemical Toilet



The waste system consists of a self-contained sanitation device known as a chemical toilet. It features an upper fresh water tank and a lower deodorized tank. These two components can be separated for waste disposal, cleaning and refilling. The lower tank contains a capacity gauge. Before each outing, check the waste level since it is illegal to dump waste within and extending out to the United States territorial limit.

Be sure to use the proper chemicals and paper in the unit that are biodegradable and environmentally friendly.

Chemical toilet supplies are available at most marine outlet stores and marinas. If installed, a pump out waste fitting is located on the deck that permits a pump out station hookup for removing waste. This procedure saves manually dumping the tank. Pump-out stations can be found at selected marinas.

Vacuum Style Toilet

If a vacuum style toilet is installed on your vessel reference chapter 6 for further information. With this type of toilet the fresh water switch must be activated for the toilet to operate correctly.



CHAPTER 4

TYPICAL CHEMICAL TOILET

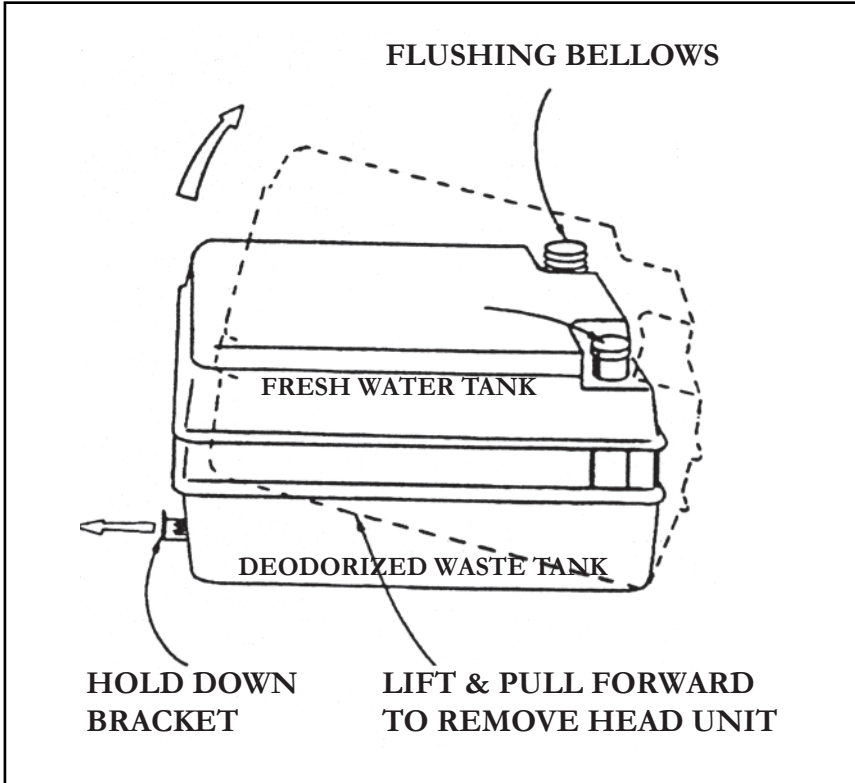



Vessel Operation



This chapter explores the many facets of running your vessel from casting off to docking and handling emergencies. We cover the basics but suggest you read other information on the chapter topics. Also, become familiar with your engine owner's manual since many of the items discussed here are found there in more detail.

GETTING UNDERWAY

Pre-Departure Questionnaire

- Have all fluid levels been topped off?
- Is the fuel tank full?
- Is all safety equipment accounted for and easily accessible?
- Are navigation lights and horn in good working condition?
- Is the bilge free of water and does the bilge pump operate?
- Is the engine, stern drive, and propeller in good working condition?
- Is the drain plug in place ?
- Have all passengers been briefed on emergency procedures and seated for departure? Is the boat load balanced?



CHAPTER 5

- Is the operator sober, alert and ready to skipper the vessel?
- Have all passengers been fitted for life jackets?
- Has a float plan been filed and left with a component person?
- Has the bilge been sniffed and the fuel system leak checked?
- Are the seacocks open (if applicable)?
- Is all communication equipment in good operating condition?
- Has a second person been briefed on operational procedures should the skipper become disabled?
- Are all gauges and electrical switches functioning properly?
- Has weather information been gathered and analyzed?

Underway Questionnaire

- After casting off have all dock lines and fenders been stowed?
- Are all passengers seated and all transom doors closed?
- As skipper are you monitoring the dash gauges for changes?
- As skipper are you on the lookout for changing weather?
- As skipper are you checking for abnormal vibration?
- Is the remote control safety lanyard (if equipped) tightly secured to your belt or clothing?





Vessel Operation

Disembarking Questionnaire

- Have you removed the keys from the ignition and secured them?
- Have all systems been checked for leaks?
- Has the battery switch been turned to the “off” position?
- Are all hatches and portholes secured and seacocks closed?
- Has the fuel tank been filled enough to prevent condensation?
- Is the vessel properly tied and covered with equipment stored?

FUELING

	DANGER
<p>AVOID PERSONAL INJURY OR DEATH! GASOLINE IS A HIGHLY FLAMMABLE AND EXPLOSIVE MATERIAL. PRACTICE “NO SMOKING” AND EXTINGUISH ALL FLAMMABLE MATERIALS WITHIN 75 FEET OF THE FUEL DOCK.</p>	

	WARNING
<p>AVOID SERIOUS INJURY OR DEATH FROM EXPLOSION OR FIRE RESULTING FROM LEAKING FUEL. INSPECT ENTIRE FUEL SYSTEM AT LEAST ONCE A YEAR.</p>	



CHAPTER 5

NOTICE

SINCE GASOLINE IS AVAILABLE IN SEVERAL GRADES INCLUDING ETHENOL & VARIOUS OCTANE LEVELS, REFER TO THE ENGINE MANUFACTURER'S OWNER'S MANUAL FOR THE CORRECT ONE FOR YOUR ENGINE. USING IMPROPER OCTANE FUEL CAN CAUSE ENGINE DAMAGE AND VOID THE WARRANTY.

Before Fueling

- Make sure a working fire extinguisher is at close hand.
- Stop engines and any device that can cause a spark.
- Disembark all passengers and crew not needed for fueling.
- Fuel if possible during the daylight hours.
- Check to ensure nobody is smoking in the boat or near the fueling dock.
- Close all portholes, hatches and doors to keep vapors from blowing aboard and settling in the bilge.
- Tie up your boat securely at the fuel dock.
- Identify the fuel fill. Unfortunately, people have mistakenly filled the water or waste with fuel.
- Visually inspect all fuel system components before each filling.
- Consult engine owner's manual for recommendations when using fuels with alcohol additives.



Vessel Operation

During Fueling

- ☑ Keep the fuel nozzle in contact with the fuel fill to guard against static sparks. The fuel fill pipe is grounded through the fuel system wiring to protect against static electricity.
- ☑ Avoid overfilling the fuel tank. Leave room for expansion. Also, if fuel exits the fuel vent indicating the tank is full, this situation is dangerous and unfriendly to the environment.
- ☑ Avoid spilling any fuel. Clean up any fuel accidentally spilled with a clean rag and dispose of it onshore.

After Fueling

- ☑ Close all fuel fill openings tightly. Use a fuel key if needed.
- ☑ Open all portholes, hatches and doors.
- ☑ Energize the blower for a minimum of 4 minutes.
- ☑ Sniff in the lower bilge and engine compartment for gas fumes. If fumes are detected continue to ventilate until the odor is gone. Look for any traces of fuel droplets or spillage. **Do not start the engines, smoke or run any electrical components except the blower until the fumes can no longer be detected.**



WARNING

AVOID SERIOUS INJURY OR DEATH!
THE OPERATOR OF THE CRAFT MUST HAVE
COMPLETE CONTROL OF THE HELM STEERING
STATION WHILE THE VESSEL IS MOVING.
NEVER LEAVE THE HELM STATION UNATTENDED
WHILE THE VESSEL IS MOVING.



CHAPTER 5

STARTING & STOPPING

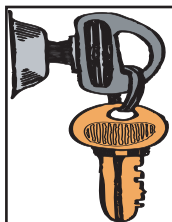

The following general information covers starting and stopping your engine. Read and understand all previous information on remote controls, fueling and operational procedures. Pay particular attention to all labels. Refer to the engine owner's manual for in depth propulsion system information.

Starting Guidelines

Review all pre-departure information. Before starting your engine make sure all canvas is removed and stored. Start engine only in a well ventilated location to avoid CO buildup. Turn the battery switch to the number 1 or 2 position.

Set the remote control handle in the neutral position. Advance the neutral throttle position as instructed in the engine owner's manual. Connect the safety lanyard to a belt or secure to clothing such as a pants belt loop. Keep passengers seated and away from controls.



DANGER

AVOID PERSONAL INJURY OR DEATH!
WHEN ENGINE IS RUNNING TRANSOM DOOR MUST
BE CLOSED AND LOCKED. SWIM PLATFORM
AND LADDER MUST NOT BE IN USE.



WARNING

GASOLINE VAPORS CAN EXPLODE. BEFORE STARTING
ENGINE, OPERATE BLOWER 4 MINUTES AND CHECK
ENGINE COMPARTMENT FOR GASOLINE LEAKS OR
VAPORS. RUN BLOWER BELOW CRUISING SPEED.



Vessel Operation

Turn the ignition key to the momentarily start position. You will hear the starter cranking over the engine. When the engine starts release the key switch. It will automatically align itself in the run position (ignition). If the engine does not start, refrain from cranking the engine over 10-12 seconds. Allow the starter and battery a chance to recover. Advance the remote control in the neutral throttle position as recommended in the engine manual. Do not use excessive remote control throttle in the neutral position.

	CAUTION
<p>TO AVOID ENGINE DAMAGE! CHECK THE OIL GAUGE IMMEDIATELY AFTER STARTING. IF LOW OR NO READING SHUT DOWN ENGINE IMMEDIATELY AND INVESTIGATE THE PROBLEM.</p>	

Shifting Guidelines



Before shifting into reverse or forward gear positions make sure the coast is clear. When shifting to either gear from neutral make sure the throttle is in the idle position. Allow your vessel to lose all headway before shifting into reverse or forward gear. Practice shifting! You will become more familiar with the procedure and self-confidence will build especially in tight docking situations. Stay alert at all times!



CHAPTER 5

Stopping

Before stopping the engine make sure it is in neutral and idle speed. After an outing let the engine cool down at idle speeds for a few minutes before turning the ignition off. Glance at the gauges one last time to monitor their readings. Do not pull on the safety lanyard versus the ignition switch to stop the engine. Never turn off the engine while in forward or reverse gear since water could enter the engine through the exhaust system and cause extensive damage. The same holds true for running the boat in reverse. Above all, use common sense.

STEERING

Your Regal features a rotary or rack style steering system. These systems transfer helm mechanical motion to the engine. There is a hydraulic steering cylinder which with the assistance of a steering pump sends fluid force to the stern drive steering arm changing the course of the boat, depending on the direction the steering wheel is turned.

Since the steering system is the primary link for engine control, it must be periodically inspected and maintained. The hardware at both the helm and engine must be checked periodically for tightness.

Check the steering system for full steering port and starboard before disembarking. Refer to the steering manufacturer's literature in the owner's pouch and the maintenance chapter for more information.



WARNING

**AVOID PERSONAL INJURY AND PROPERTY DAMAGE!
LOOSENING OR LOSS OF ONE OR MORE FASTENERS
MAY CAUSE FAILURE OF THE STEERING SYSTEM
OR DAMAGE TO THE STEERING CABLE,
RESULTING IN LOSS OF STEERING CONTROL.
PERIODICALLY INSPECT THE STEERING SYSTEM.**



CAUTION

AVOID PERSONAL INJURY AND PROPERTY DAMAGE!
ABRUPT TURNS ABOVE 30 M.P.H. MAY RESULT
IN LOSS OF CONTROL.
STEERING RESPONSE AT HIGH SPEEDS
CAN BE VERY SUDDEN.
ABRUPT TURNS MAY CAUSE YOU
TO CROSS YOUR OWN WAKE.
JUMPING A WAKE, SUDDEN TURNS, AND INCREASES
OR DECREASES IN SPEEDS MAY BE DANGEROUS.
THE OPERATOR MUST MAKE SURE THAT ALL
PASSENGERS ARE SEATED SECURELY
BEFORE MAKING SPEED CHANGES.



CHAPTER 5

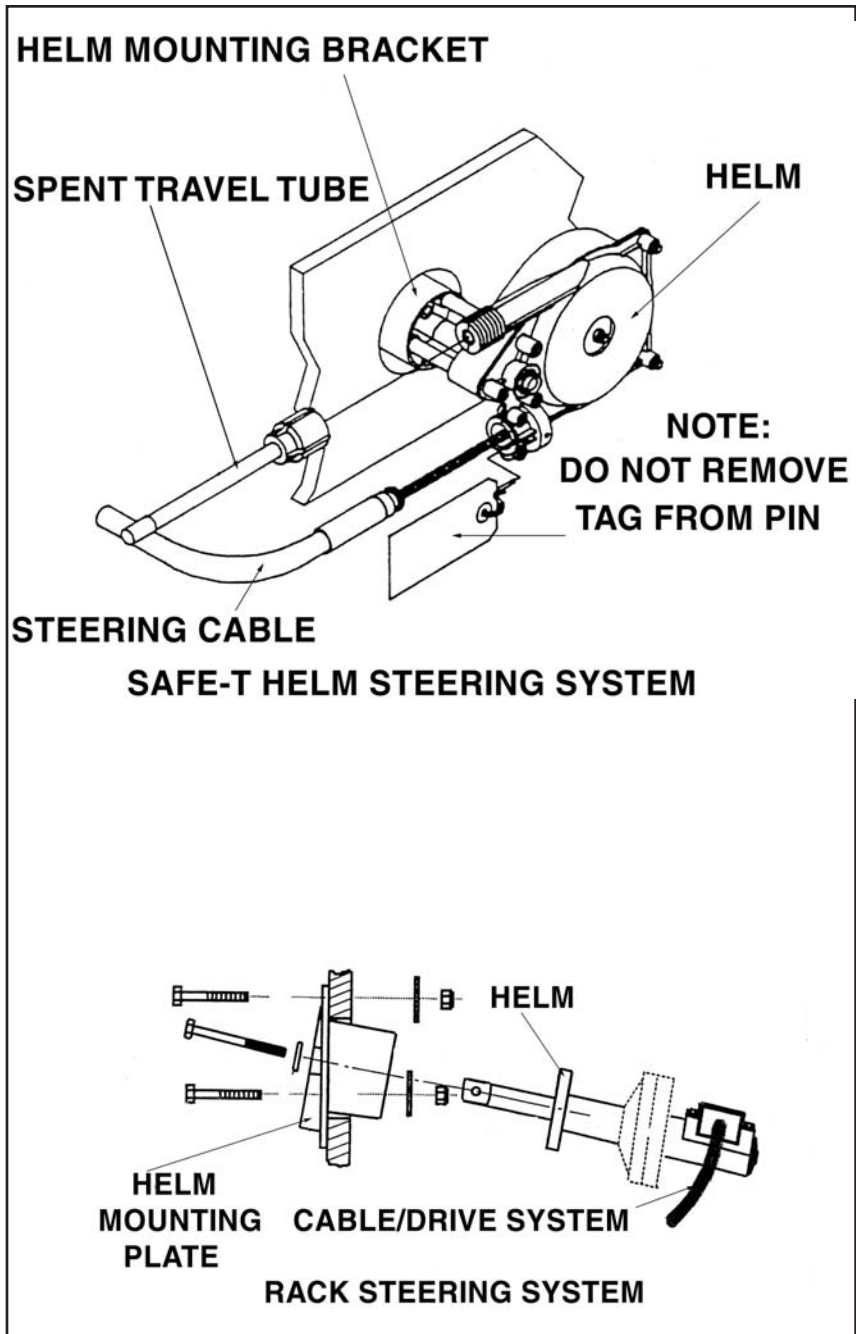



FENDERS

Fender Usage

Fenders are normally made of a rubberized plastic and are usually filled with air. Most have a fitting like a basketball so they can be inflated or deflated. Fenders are available in a wide range of sizes and shapes to fit both small and large vessels. Fenders are normally designated in inches. They are used between piers, docks, sea walls and the boat. They protect the top sides of the boat from rubbing against rough objects. Most fenders have eyes of attachment which allow a line to be inserted vertically or horizontally. This will permit the fender to be tied off to fit a variety of marina, dock and tidal situations. Be sure the fender is correct for the vessel size. It is a good idea to carry extra fenders but half a dozen is normally an acceptable number. Remember to store fenders on board so they can be easily accessed. Some people incorrectly call fenders “bumpers”.

Fender Types



There is a variety of fender styles and types, each selected for specified uses. When choosing fenders, contact a marine dealer or supply house. Explain how you moor and use your vessel so they can recommend the best fender type for you. We suggest the type with a fill plug so you can inflate them with a hand pump like the ones used for bicycles.



CHAPTER 5

DOCK LINE BASICS

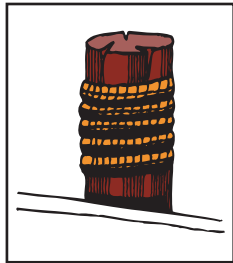

Most skippers use dock line terminology fairly loose but there is more to the basics than just bow or stern lines. There are several lines that can be secured to the bow and stern and depending on their direction and use, can be called other names. Remember that “forward” and “aft” refer to the direction that a spring line runs from the vessel, and not where it is secured on board.

Bow & Stern Lines

There is only one true bow line. It is secured to the forward cleat and run forward along the dock to prevent the vessel from moving to the stern. The stern line leads from a rear cleat to a piling or cleat on the dock astern of the vessel. This line keeps the boat from moving ahead. For small vessels these are the only lines needed for normal wind and current conditions. If located in a tidal environment, keep slack in the lines.

Breast Lines

These lines are attached to the bow and stern that lead to nearly right angles from the center of the vessel to the dock. They help keep larger vessels from moving away from the dock, or are pulled in to help people board the vessel. Larger vessels may use bow or quarter breast lines.

Spring Lines

Most small boats use two spring lines although it is possible to have four. They are called the after bow spring and forward quarter spring.



Vessel Operation

Bow springs are secured at the vessels bow area. Forward spring lines lead forward from the boat to the dock and control movement toward the stern. After springs stem aft from the vessel, and stop movement ahead. Spring lines are used to prevent movement in a berth, ahead or astern. They are really useful in controlling the effects of a real active tidal surge. Spring lines are useful where fenders need to be kept in place against piles.

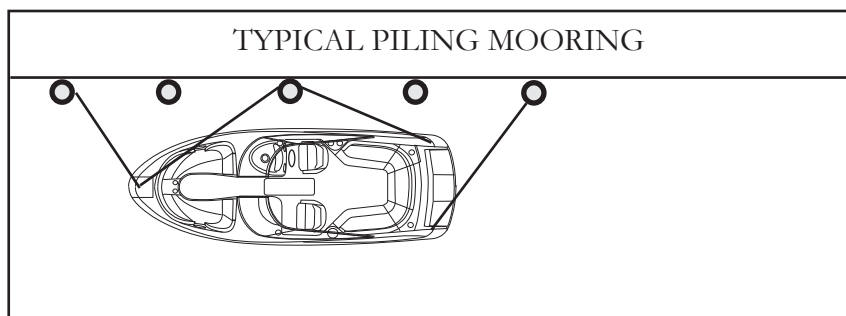
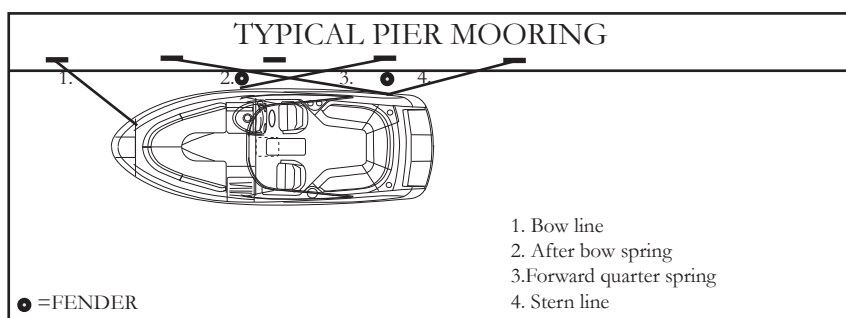

Boat Mooring

Most boats can be secured to a dock using four lines. The after bow spring is crossed with the forward quarter spring and secured to individual dock cleats or pilings. This ensures longer springs and can be snugged up tighter for more efficient tidal control. Remember, if you only have one piling available, position the vessel so this point is opposite admidships. Run both spring lines to it. These lines will be shorter but still useful.



CHAPTER 5

The bow and stern lines should be relatively at a 45 degree angle with the dock. The stern line can be attached to the near-shore quarter cleat, but will work more efficiently to the offshore quarter cleat. The longer line will allow the boat flow with the tide with less time checking the vessel.

Dock Line Sizing

Most dock lines today are made of nylon, either of twisted rope or braided core and cover. The most often used material is nylon because of its stretching abilities absorbing shock loads. It is chafe resistant for extended life and is easier on bare hands.

The line's size varies with the vessel. Normally, a vessel in the 20' to 40' boats will use 1/2" diameter nylon lines. Larger yachts use 5/8" and 3/4" diameter nylon lines. Smaller boats can use 3/8" nylon lines.

Dock lines need to have the strength to hold the vessel and have enough density to resist chafing. They shouldn't be too heavy that they lose their shock-absorbing capabilities. Use the right size line for the vessel since a line too large for the boat will pull hard against the vessel since it won't be forced to stretch. If the line is too small for the vessel, there is no margin for wear and chafe when under strain.

Securing Lines

When mooring your boat, make sure the dock lines are secured at both ends. Depending on your situation you may need to loop the eye splice of the dock line around a piling. Sometimes the mooring line will lead down sharply from the piling to the deck cleat. Loop the eye splice around the piling twice to keep it from being pulled up off the pile. Pull the line through the looped eye if the mooring line is too small to go around the piling twice or too small to fit over once.

If you must drop a line over a piling that already holds another boat's line, run the eye of the line up through the first eye from below, then loop it over the pile. This will allow either line to be removed without disturbing the other. If another line is dropped over yours, simply



reverse the process. Secure a little slack in the other dock line, then slip your eye up through its loop and over the top of the pile. Your line can be dropped through the other eye.

When debarking from a dock, it is easier to release the line from a cleat or piling, from on board the boat, as soon as you leave the dock. Loop a long line around the cleat or pier and leading both ends on board you can release the line easily. Slip one end around the cleat or pile, then pull it back on board. Release the line without the eye splice, so it will run freely from around the pile without hanging up on the splice.

STEPS TO STERN DRIVE DOCKING

Stern drive powered boats are fairly easy to back up and maneuver with a little knowledge and docking practice. One of the most important aspects of the process is to keep your calm in the wake of a busy marina. Basically, the reversing propeller is turned in the direction you want to go by using the wheel.

Some boats tend to be influenced by the wind. When backing down in a crosswind, allow room to maneuver and watch the bow. Try not to overreact or get excited, but use your knowledge and experience. If the wind begins to swing the bow, you need to stop backing, turn the wheel to port and go forward to straighten the boat. Use a quick burst of power but not too much to knock your crew off balance.

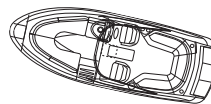

A. Stop the boat by shifting in reverse. Put the wheel over to the port and begin backing in. Slow down your speed by momentarily shifting into reverse.

*** Control in reverse idle position, Outdrive to port.**



CHAPTER 5

B. Continue backing up the boat with the wheel hard to port. Keep an eye on the bow, and begin to straighten the wheel as the boat enters the slip.

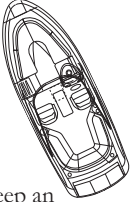

*** Control in reverse idle position, Outdrive to port.**

C. Center the wheel to align the boat parallel with the dock. If the stern is too far from the dock, shift to neutral, then put the wheel hard over to port and then go forward a second or two.

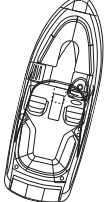

*** Control in neutral idle position. Drive centered.**

D. When the boat is completely into the dock, stop stern movement by shifting into forward. Put the wheel to port to kick the stern over close to the dock if necessary. Shift into neutral and tie up the boat.

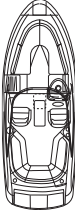

*** Control in forward idle position. Drive to port.**



STERN DRIVE MANEUVERING

Stern drive boats do not have rudders. The boat uses a steering system that directs the propeller thrust, by turning the stern drive unit where the propeller is mounted. Normally maneuvering an I/O boat is easier than a similar single screw vessel.

Directing propeller energy (thrust) makes slower speed maneuvering easier. The propeller discharge current is turned from one side to the other which results in turning forces. Rudder boats need water to flow by the rudder to be efficient. Stern drive units are designed to have reduced shaft angle, so the propeller does not produce as much unequal blade thrust and resistance as does a propeller on a single screw boat. Large horsepower stern drive boats produce more thrust and steering torque but Regal boats use power steering. Below is some basic information on how single stern drive boats handle in normal conditions.

Gathering Headway

When a stern drive is not moving forward or reverse in the water and the propeller is not turning, (shift in neutral) the boat will not react to the helm steering wheel.

As soon as the vessel is shifted into forward gear the propellers action creates a discharge motion and generates energy in the form of thrust. If the stern drive is centered, the discharge motion is directed straight back causing the vessel to advance forward.

You may notice that if you advance the throttle quickly in initial take-off (make sure you have a firm grip on the wheel), the boat has a tendency to pull the stern of the vessel to starboard. There is a trim tab (also serves as a sacrificial anode) located on the vertical drive housing just to the top of the propeller blade. This trim tab helps compensate for the low speed steering torque. Once the boat increases headway the propeller is operating in a faster water flow this torque effect decreases.

Sometimes the trim tab may need adjustment on stern drive models. Contact your Regal dealer for further information or consult your engine manufacturer's manual.



CHAPTER 5

Turning

Once the boat has gathered headway, with the boat planing at the correct bow angle and the stern drive unit and helm straight the boat tends to stay on a uniform course heading. To assure the boat trim angle is correct use the trim gauge as a guide while activating the trim button on the remote control panel.

When the helm wheel is turned to the right or starboard, the stern drive unit is turned in the same direction. The propeller's discharge force is directed to starboard forcing the boats stern to port. Water flowing past the hull strikes the stern drive gear housing in its starboard side, creating additional turning torque. The stern starts a move to port, forcing the bow to starboard.

If the helm is turned to the left or port the stern drive turns to port, the stern of the boat goes starboard as the bow turns to port.

As the vessel operator gains experience, he will better gauge each maneuver and speed situation. In this way he will understand the handling characteristics of his boat. He needs to keep the safety of his passengers in the highest priority.

Backing Down

Stern drive boats do not have rudders. The boat uses a steering system that directs the propeller thrust, by turning the stern drive unit where the propeller is mounted. Normally maneuvering the I/O boat is easier than a similar single screw vessel.

If your boat has the steering wheel and stern drive straight with the control in reverse, the stern will be pushed a bit to port by the reversing propeller thrust. This tendency to back to port can be eliminated by turning the stern drive to starboard.



Vessel Operation

When the vessel begins to gather speed to stern, the water passing by the lower gearcase housing will continue to increase steering torque. If the helm wheel is turned to starboard, it will direct the propeller thrust to port, tracking the stern to starboard.

Wind and current will affect how a vessel backs. Stern drive boats tend to be light displacements and when backing down in a strong crosswind; the bow will tend to fall toward the windward. This may cause steering problems.

Once increased headway is gathered in reverse gear, the force of the lower hull moving through the water is enough to track straight. When backing, the stern will lead as it heads to port or starboard, before the vessel actually starts to turn.

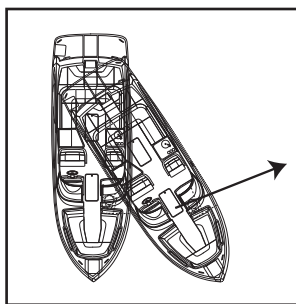

When the control is put in forward gear position, the stern is pushed to starboard; the amount of push depends on the hull design and the amount of throttle advance. See illustration.

Stopping

Remember that your boat does not have any brakes. It uses reverse thrust from the propeller to stop. If the vessel has headway, with the helm and propeller in reverse the propeller thrust is directed backwards, past the lower gearcase of the stern drive.

Depending on how far the throttle is advanced, the discharged thrust may not be strong enough to reverse the water flowing by the gearcase. As the power is increased, the propeller thrust becomes strong enough to stop the flow of water past the lower unit, and, as the throttle is advanced it reverses its flow more completely.

When water is flowing past the gearcase, steering torque is increased, but when the thrust stops the water flow, the boat will not respond to the helm. This is a short lived event and is overcome quickly when the water again flows past the gearcase.



CHAPTER 5

Furthermore, added to the energy of the water hitting the lower gear case, the propeller thrust is directed by turning the stern drive, which can add to the steering torque.

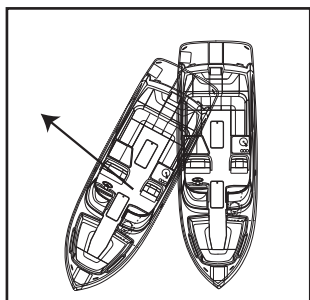

The prop tends to throw the stern to port. This is why experienced skippers undertake a portside landing when wind and current conditions permit. They allow the prop to move the stern to port toward the dock. With a forward motion when the helm wheel is turned hard to one side, the vessel pivots around a point about 1/3 its length abaft to stern. See illustration.

TRIM ANGLE

Stern drive boats have the ability to angle in or out their drive unit in relationship to the transom. This is accomplished by hydraulic shocks located on the stern drive along with an electrical sender unit that reads the drive angle and sends information to the dash trim gauge showing a reading.

Purpose Of Power Trim

The purpose of the power trim/tilt is to enable the operator to change the angle of the drive while at the helm. Changing the angle of the drive or “trimming” provides the following benefits:

1. Improves acceleration onto a plane.
2. Maintains boat on plane at reduced throttle settings.
3. Increases fuel economy.
4. Provides smoother ride in choppy water.
5. Increases top speed.



Vessel Operation

In short, power trim is a way of fine-tuning the ride of your boat and will enable you to get the most efficient and comfortable ride possible, whatever the conditions.

Use Of Power Trim

The power trim is normally used prior to accelerating onto a plane, after reaching the desired RPM or boat speed and when there is a change in water or boating conditions. Position passengers and equipment in the boat so that the weight is balanced correctly fore and aft as well as side to side. Trimming will not compensate for an unbalanced load.

To operate the trim, push the switch until the desired bow position is reached. The trim may be operated at any boat speed or at rest. Avoid operating the trim system when running in reverse. Observe the trim gauge which indicates the boat's bow position achieved by the trim angle of the vertical drive unit. "Bow Up" corresponds to the upper portion of the trim range on the gauge while "Bow Down" corresponds to the lower portion of the trim range on the gauge.

To determine the proper trim angle, experiment a little until you are familiar with the changes in your boat. The vessel will be properly trimmed when the trim angle provides the best boat performance for the particular operating conditions. A trim position that provides a balanced steering load is desirable.

To familiarize yourself with the power trim, make test runs at slower speeds and at various trim positions to see the effect of trimming. Note the time it takes for the boat to plane. Watch the tachometer and speedometer readings as well as the ride action of the boat.



CHAPTER 5

Operation In “Bow Up” Position

The “Bow Up” or out position is normally used for cruising, running with a choppy wave condition, or running at full speed. Excessive “bow up” trim will cause propeller ventilation resulting in propeller slippage. Use caution when operating in rough water or crossing another boat’s wake. Excessive “bow up” trim may result in the boat’s bow rising rapidly, creating a hazardous condition.

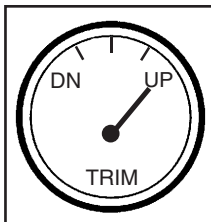

Operation In “Bow Down” Position

The “Bow Down” or in position is normally used for acceleration onto a plane, operating at slow planning speeds, and running against a choppy wave condition. It is also used when pulling water skiers, tubers, kneeboarders, etc. In this position the boats’ bow will want to go deeper into the water. If the boat is operated at a high speed and/or against high waves, the bow of the boat will plow into the water.

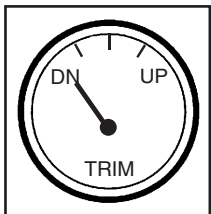

Operation In “Level” Position

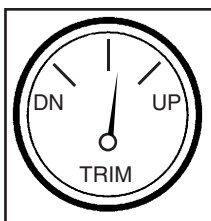

In normal running conditions, distribute passengers and gear so boat is level. At or below cruising speeds, trim the vessel for optimum performance. The trim gauge needle will display somewhere in the center of the gauge. This position will also enhance running visibility and overall stability. Again, each outing provides different wave, load and running conditions. Be prepared to make trim changes as needed.



	CAUTION
<p>THE BOAT TRIM SHOULD BE ADJUSTED TO PROVIDE BALANCED STEERING AS SOON AS POSSIBLE EACH TIME YOU GET UNDERWAY. SOME BOAT/ENGINE/ PROPELLER COMBINATIONS MAY CREATE BOAT INSTABILITY AND/ OR HIGH STEERING TORQUE WHEN OPERATED AT OR NEAR THE LIMITS OF THE “BOW UP” OR “BOW DOWN” POSITIONS. BOAT STABILITY AND STEERING TORQUE CAN ALSO VARY DUE TO CHANGING WATER CONDITIONS. IF YOU EXPERIENCE BOAT INSTABILITY AND/OR HIGH STEERING TORQUE, SEE YOUR AUTHORIZED REGAL DEALER.</p>	

Shallow Water Operation

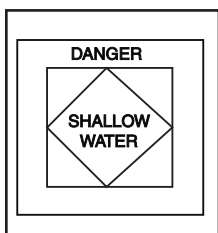

Operating your vessel in shallow water presents various hazards. You are more apt to hit a submerged object such as a rock, sand bar, stump, logs, coral, or other unmarked objects.

Pay close attention to your chart for descriptions of any shallow areas along with marked submerged objects. Always post a lookout when operating in shallow water. Trim your outdrive up as needed to

provide adequate draft. Set the alarm on your depth sounder and travel at a speed that keeps the boat level in these shallow areas.

If your boat strikes a submerged object stop immediately and check for hull, outdrive and propeller damage.



CHAPTER 5

TRIMMED "TO FAR IN" POSITION

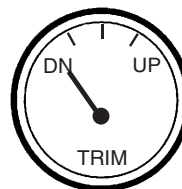

TRIMMED "TOO FAR OUT" POSITION

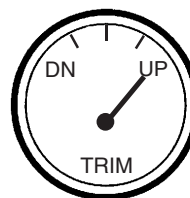
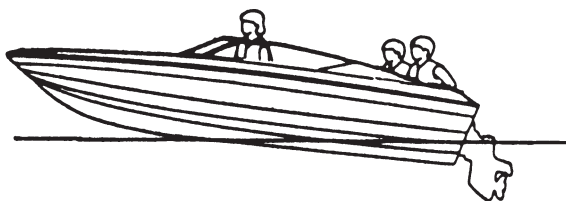

WELL TRIMMED "LEVEL" POSITION

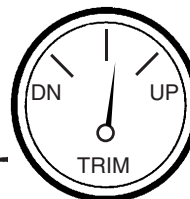
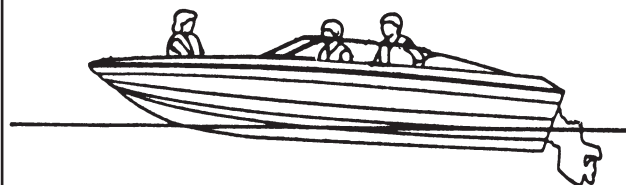

CAUTION

DO NOT RUN ENGINE ABOVE 1000 RPM
WITH THE STERN DRIVE TRIMMED
FOR SHALLOW WATER MANEUVERING SINCE THE
STERN DRIVE IS OUT BEYOND THE GIMBAL RING
SIDE SUPPORT BRACKETS.
OPERATING IN ABOVE MANNER MAY PRODUCE A
DANGEROUS STEERING CONDITION OR MAY
DAMAGE THE STERN DRIVE COMPONENTS.



ANCHORING



Selecting the correct anchor is an important decision. The anchor style in part depends on the usage and boat type. Regal boats designate an anchor type and or model. Some models incorporate chain, line with an optional windlass. Contact an authorized Regal dealer for more information.

Anchoring is easier with another person on board. First be certain that the line for the anchor is properly attached, to avoid losing the anchor and anchor line overboard.

For most anchors to perform more efficiently, you should attach 3 to 6 feet of chain. The chain will stand up to the abrasion of sand, rock, or mud on the bottom much better than a nylon line. It should be galvanized to reduce corrosion. Next, attach a length of nylon line to the other end of the chain.

The nylon will stretch under a heavy strain cushioning the impact of waves or wind on both the boat and the anchor.

To anchor, select a well protected area, preferably with a flat bottom. Contrary to modern belief, you do not throw the anchor over while the boat is making headway, or moving forward. In fact, the bow of the boat should be brought slowly backward, while easing the anchor slowly over the side of the boat until it hits the bottom. To “snub the line” means to stop its outward “pay” or movement. Usually the length of anchor line used should be 5 to 10 times the depth of the water.

After you have anchored, check your position with landmarks if possible. You need to continue to monitor these landmarks to make sure you are not drifting. Since anchoring can also be an emergency procedure, the anchor and line should be readily accessible.

For increased holding power in windy conditions, two anchors are sometimes set. If your primary anchor drags, you can run out your secondary anchor without picking up the primary one. The important thing is to lay them out at an angle. When setting two anchors, make sure they are fastened to separate rodes or cleats. This is done in case you need to adjust one later so the line is accessible.



CHAPTER 5

If two anchors are used ahead of a boat, make sure to set the rodes at an angle than in a straight line to reduce the chances of tangeling as the boat moves in wind and current.

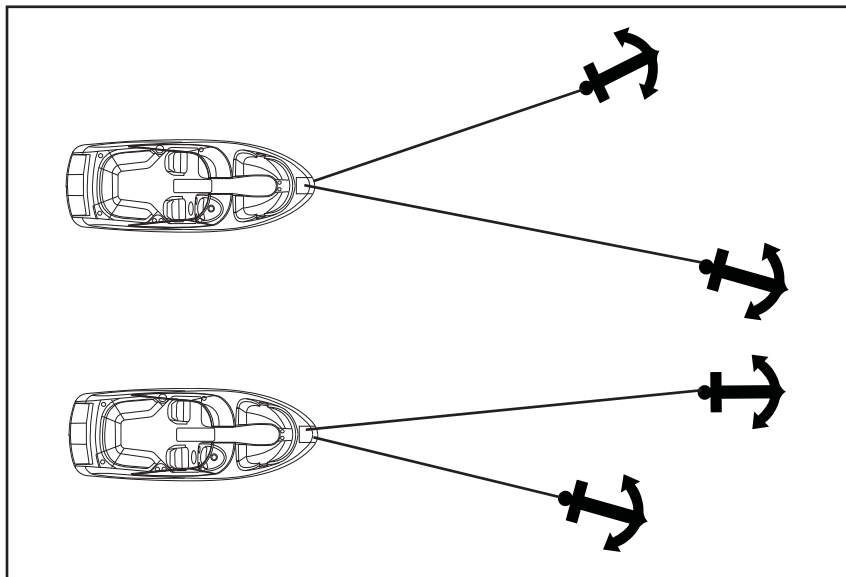

TOWING

In case you find yourself aground or in need of a tow, or should you want to tow another vessel, keep in mind that you **never use deck hardware or cleats to secure lines for towing!**

Deck hardware is intended for mooring and anchoring, and is not designed to withstand the strain and pull of towing. Rather than tie the line to your cleats on deck, it is suggested that you tie a bridle by passing a line completely around the hull of your boat to avoid damage.

When towing, always stand clear of a taut line, as any type of line breaking under stress can be extremely dangerous. The preferred line for towing is double-braided nylon, as it has sufficient elasticity to cushion shock loads. Move slowly and cautiously.



Vessel Operation

Law Of Salvage

The Admiralty Law sometimes referred to as the Salvage Law was founded primarily on English law fundamentals and basically says that a vessel distressed, in danger of flounder, if rendered assistance from a towing company or private agency, can be forced to relinquish a portion of the vessels' worth for the assistance received.

NOTICE

IN THE EVENT YOUR VESSEL IS IN DISTRESS,
PRIOR TO ALLOWING ANY TOWING COMPANY OR
PRIVATE AGENCY THE RIGHT TO PASS A LINE TO
YOUR VESSEL, BE SURE TO ESTABLISH THAT YOU
DO NOT AGREE TO ANY SALVAGE RIGHTS.
ESTABLISH WITH THE CAPTAIN OR OPERATOR
THAT YOU WISH TO BE ASSISTED IN A CONTRACT
BASIS AND ESTABLISH A PRICE.
OF COURSE IN CERTAIN SITUATIONS, YOU MAY
NOT HAVE THIS OPTION.

USE YOUR BEST JUDGEMENT!



CHAPTER 5



DANGER

AVOID DEATH OR SERIOUS BODILY INJURY!
DO NOT USE DECK HARDWARE INCLUDING
CLEATS FOR TOWING.

Knots

Knots are useful in docking, towing and other emergency situations. Learning to tie knots requires practice. As they say “Practice makes perfect”. Some of the knots used in boating are the square, bowline, anchor bend, clove hitch, figure eight and half hitch. There are several periodicals available that explain various knots and how to tie them effectively. An experienced skipper will know the basic nautical knots and will use them when on the water. Take the time to know the basic knots.

**Figure 8 Knot
Tied To Cleat**



A useful knot to learn for general docking is the figure eight with one end reversed. By turning the free end of the line back under, the knot can be released without disturbing the boat. After some practice one person can secure a vessel easily to a dock or pier in a variety of weather conditions. This knot normally is used to tie the bow and stern. Then the vessel can further be fastened by tying the spring line(s) in the figure eight knot. Wrap it around the cleat 2 or 3 times.



EMERGENCIES

Always be ready to help others on the water if possible, but do not take any unnecessary risks. Use equipment to save a life, but do not risk a life to save equipment. Consult earlier information in this manual concerning accidents, etc. Also, read other literature concerning on the water emergencies. Be alert and prepared!

Fire

Fire aboard a vessel can spread quickly and can cause tremendous alarm among everyone. Most fires can be prevented by keeping the bilge free from oil and debris. Keep all equipment stowed and maintained in working order. Carry a backup fire extinguisher on board. If something becomes a possible fire hazard, remove that possibility at once.

Never use water on gasoline, oil or electrical fires. When you dump water on an electrical fire you can be shocked. Follow these instructions if a fire breaks out:

- Fit everyone aboard with a life jacket. Turn off the ignition.
- Try to keep the fire downwind. If the fire is to the stern, head the bow toward the wind. If forward, put the stern to the wind.
- If the engine should catch fire, shut off the fuel supply. Usually there is a fuel tank access that you can crimp the fuel feed line.
- Use a hand fire extinguisher or pull the cable on the automatic fire extinguishing system. Make sure to point it at the base of the flames. Use short bursts and sweep the extinguisher side to side.

Remember : (4 lb. extinguisher discharges in 20 seconds)

These actions help prevent the fire from spreading to other parts of the boat. You can extinguish fires quickly if you act swiftly. Have a plan of action in motion in case a fire breaks out.



CHAPTER 5

FIRST AID

Knowing first aid can save lives. A first aid kit and the ability to use it are important ingredients for the safety of a skipper's passengers, crew and vessel. Having confidence and competence in handling medical emergencies on board is a must for the skipper. Invest your time in a first aid course available at the American Red Cross.

CPR (Basic Life Support)

If someone is seriously injured call for help while the injured person is being attended.

Check for possible danger signs; loss of breathing, unconsciousness, severe bleeding and heartbeat. If you determine the individual is not breathing or unconscious place the victim on their back on a hard surface and do the following:

1. If unconscious, open the airway. Neck lift, head lift or chin head lift.
2. If not breathing, begin artificial breathing. Pinch the nose. Give 4 quick breaths. If airway is blocked, try back blows, abdominal or chest thrusts and finger probe until airway is open.
3. Check for pulse. begin artificial circulation. Depress sternum 2". 15 compressions rate 80 per minute. 2 quick breaths. Continue uninterrupted until advanced medical support is available.

Follow up immediately with medical authorities!



HYPOTHERMIA

Hypothermia is a condition where the body temperature decreases because the body can't generate enough heat to maintain its normal temperature. It can be serious and usually occurs where victims have been immersed in water (under 68 degrees) for extended periods of time. If you encounter a possible hypothermia victim call for help on the radio and get the person out of the water.

Symptoms are:

1. Shivering that if condition is advanced may stop.
2. Confusion, clumsiness or slurred speech.
3. Rigid muscles.
4. Semiconscious to unconscious.

Treat hypothermia by the following:

- Remove wet clothing.
- Monitor the victim's pulse and breathing.
- Rapidly apply heat to the body core by using blankets, naked bodies or warm water.
- Do not give the person any food or drink.
- Do not warm the arms and legs. Warming of these extremities can be fatal.

Follow up immediately with medical authorities!



CHAPTER 5

ENVIRONMENTAL AWARENESS

There are numerous vessels operating on our waterways on a daily basis. Each boat has an impact on our environment. Boat operation habits, marine sanitation, and maintenance all play a role in a delicate battle to keep the ecosystem clean. Each of us has a role in doing our part as environmentally conscious skippers to conserve our waterways.

The National Marine Manufacturer's Association lists their top ten of Eco-Boating Practices as follows:

1. Observe all regulatory agency policies regarding marine toilets.
2. If equipped with a holding tank, use marina pump-out facilities.
3. If used, make sure bottom paints are legal and ecosystem friendly.
4. Use only biodegradable cleaning agents.
5. Dispose of all garbage and litter on shore properly, not on the water.
6. Don't top off fuel tanks. Leave expansion room. Clean up spills.
7. Watch your wake and propeller wash.
8. Make sure your engines are well tuned and maintained.
9. Control your bilge water.
10. When fishing, practice the "catch and release" principle.

Follow these basic practices when on the waterways. Treat the environment in a way that you would like to be treated.



Equipment Operation

INTRODUCTION



This chapter assists the operator in understanding typical standard and optional equipment which may be installed on your vessel.

A portion of the equipment described may not be installed on your boat or the pictorials may not exactly match your components.

A portion of the Regal boat illustrations in the owner's manual may represent typical examples.

Regal is constantly improving its product line and therefore may make changes in vendors, parts and specifications at any time without notice. **For further equipment information, refer to the individual vendor literature provided in the owner's packet. Read and understand all equipment information before attempting to use the components.**



Air Compressor



If equipped on your boat the air compressor/inflater provides 12 volt blower capacity for various aquatic toys, etc. To use, remove the unit from its stand and insert the cord plug into the 12 receptacle located at the ignition panel. Turn on the component.

There are attachments to fit various fittings. After use return the compressor to its stand.



Automatic Fire Extinguisher



The automatic fire extinguishing system is normally located in the bilge at the engine aft end. See the illustration. The system uses an environmentally friendly agent FE-241 which has been approved by the EPA to replace the old Halon agent. This

system is formulated only for use in the engine compartment of your vessel. FE-241 is to be used with gasoline fuel systems only since the agent will not “stall” diesel engines. This could cause a fire to re-flash.

Operation-Automatic

Automatic fire extinguisher systems are not nor are they intended to be explosion suppression devices. **Boat owners still need to take normal precautions for checking gasoline fumes and using blowers.**

Read the information regarding the dash and manual operation portions of the fire extinguisher system. When the system actuation starts you may hear a loud sound similar to that of small arms fire, followed by a rushing air sound.



CHAPTER 6



The system will show actuation whenever the ignition key is ON and the indicator light is OFF. The actual actuation time when a fire occurs is dependent on the severity of the fire.

When the automatic fire extinguisher activates IMMEDIATELY SHUT DOWN ALL ENGINES, POWERED VENTILATION

(BLOWER), ELECTRICAL SYSTEMS AND EXTINGUISH ALL SMOKING MATERIALS. DO NOT OPEN THE ENGINE COMPARTMENT IMMEDIATELY.

Allow the agent to “soak” the compartment for a period of time and wait for hot metals and any fuels to cool before inspecting for the fire cause. Premature opening of the engine compartment allows an in-rushing of oxygen and could result in a flash-back. When the engine compartment is opened have portable fire extinguishers ready.



WARNING

**AVOID SERIOUS INJURY OR DEATH!
DO NOT BREATHE FUMES OR VAPORS
CAUSED BY A FIRE AS THEY ARE
HAZARDOUS AND TOXIC.**



Operation-Manual



If a fire has started in the engine compartment where the automatic fire extinguisher system is located, do not wait for automatic activation. Release the system manually. Close any opened hatches leading to the engine compartment, shut down all forced ventilation devices, engines, and electrical components.

Remove the safety pin from the “Fire” T-handle, and pull firmly on the “FIRE”

cable handle which will activate the fire extinguisher unit in the engine compartment. A loud “rushing” or air” sound may be heard. Complete discharge will take several seconds. Do not open the compartment immediately! Keep the compartment closed for a period of time sufficient to allow the agent to soak all areas of the protected space. This allows hot metals and fuel to cool.

KEEP ADDITIONAL MARINE APPROVED HAND HELD FIRE EXTINGUISHERS ON BOARD AS BACKUPS. THESE UNITS SHOULD BE SERVICED PERIODICALLY.



WARNING

AVOID SERIOUS INJURY!
ACCIDENTAL DISCHARGE COULD OCCUR
DURING HANDLING, INSPECTION,
OR WORKING IN THE ENGINE COMPARTMENT.
WEAR EYE PROTECTION AT ALL TIMES!



CHAPTER 6

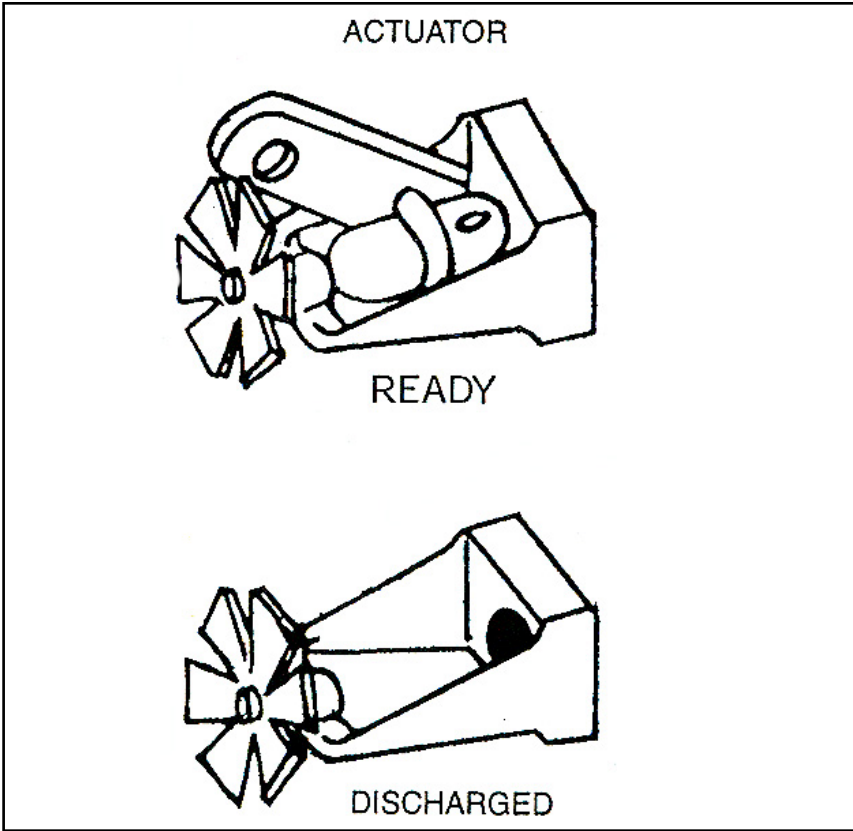

Premature opening of the compartment could cause a reflash. When opening the engine compartment for inspection have hand held portable extinguishers ready.

Inspect the pressure gauge and system before and after each outing. Refer to the maintenance chapter for caring for your fire extinguisher system.

The illustration opposite shows the actuator not discharged at the top and one which has been discharged at the bottom.



Battery



RED OR “+”
BOOT

The battery is the heartbeat of the on-board DC (direct current) electrical system. It supplies the power to crank over the engine (650 or 1000 Cold Cranking Amps) and to operate the electrical equipment through the engine charging system.

The battery is a wet-cell design with maintenance free features. The battery system features red and black boots to protect the terminals and a battery tray with hold downs. Make sure the red (positive) and black

(negative) boot are completely covering their respective terminals of the battery. The boots and the terminal nuts should be checked periodically for tightness and corrosion. In colder climates battery removal for the winter months is to be considered. See chapter 7 for more specific information on the battery system or contact your closest Regal dealer for recommended battery size and amperage requirements.



Battery Switch Circuitry

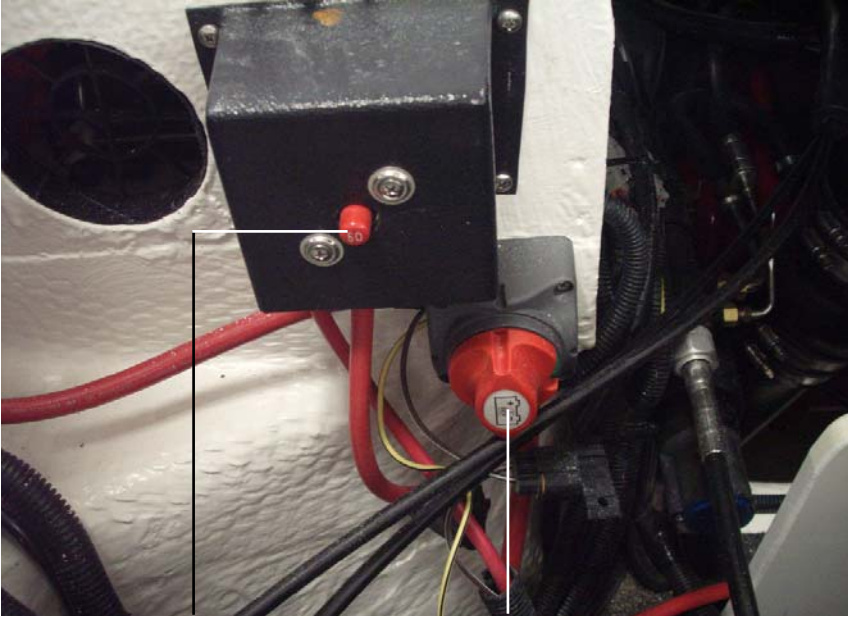

Wiring To Helm
50 Amp Breaker

Battery
Switch

The battery components shown above feature a universal on/off battery switch with an overcurrent protection device (breaker). The battery switch is located in the engine compartment. The 50 amp breaker normally protects the main harness feed wiring (red).

The stereo memory fuse (15 amp) located in the same location protects the memory circuit and holds the stereo settings for a predetermined time frame should the stereo lose power due to a dead battery.

The aft bilge pump fuse (10 amp) protects the aft bilge pump and if the stereo performance package is installed a 30 amp breaker normally protects it.

Note: Should a breaker “pop” or fuse “blow” determine the cause of the problem before resetting the breaker or replacing the fuse. When replacing breakers and fuses use the correct type and amperage.



Equipment Operation

The battery switch features ignition protection technology which makes it safe to use in the engine compartment. It features “on” and “off” positions.

To energize the battery switch simply rotate the knob to the “green” or “on” position. Current will now be available at the helm to start the engine and run the accessories. To deenergize the battery switch rotate the knob to the “red” or “off” position.

Note: **Never** turn off the battery switch with the engine running as damage to the engine charging circuit will occur.

With the battery switch in the “OFF” position (recommended for docking and mooring for extended periods) the aft bilge pump continues to function in the automatic position and the stereo memory continues to function as normal.



Bilge Pump/Automatic Float Switch

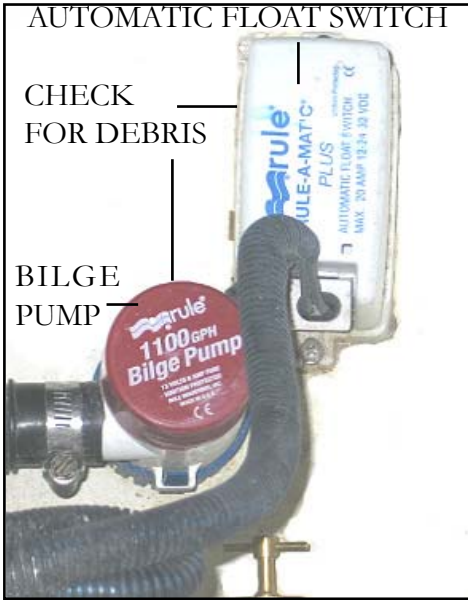

Before each outing check the operation of the bilge pump and automatic switch. With the dash switch in the automatic position manually pick up the automatic switch or you can activate the switch by throwing a bucket of water in the bilge. The automatic switch should energize the bilge pump. Periodically, check for debris around the grates of bilge pump base. The bilge pump and automatic switch are located in the bilge in front of the engine.

By holding up the end of the float switch, you can periodically test the unit. With the automatic float switch held up the bilge pump should activate itself.



Canvas

Canvas packages may include a bimini top with boot, bows and hardware. In addition, canvas may include a tonneau cover for the bow (open bow rider models only) and a cockpit cover which encloses an area from the windshield to the stern.

To install a typical *bimini* top on models without the optional sport tower, unzip the top boot and remove it from the bimini top. Store it



for future use. Unroll the canvas and install both of the front bimini canvas straps. Adjust the straps to make them equal in length. Install the aft support stanchions and place them in the arch mount located on the deck. Lock each stanchion with a pin. Make sure the pin is completely

inserted through the ball and socket mount.

Note: Sometimes canvas straps can make a noise while underway. To help deminish the noise simply twist the straps and relatch.



CAUTION

TO PREVENT BODILY INJURY AND PROPERTY
DAMAGE, TOW BOAT
WITH CANVAS UP ZIPPED IN THE BOOT.
CHECK ALL FASTENERS FOR TIGHTNESS.
FOR WATER CRUISE USE,
PLACE THE BIMINI OR CONVERTIBLE TOP
IN THE CRUISE POSITION.



CHAPTER 6

Canvas-Bimini Top w/Sport Tower

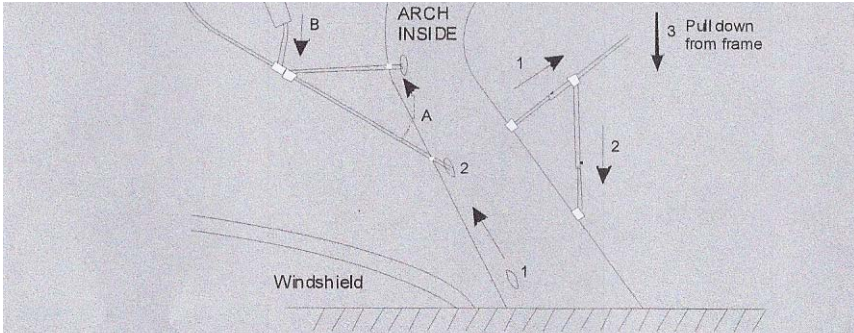

FORWARD TOP INSTALLATION:

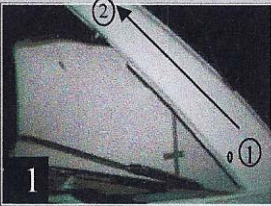

1 Move your main bow from position 1 to position 2.



2 Locate your middle bow in place (Step B).

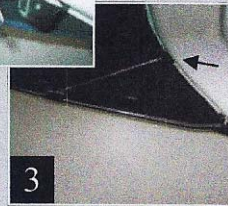

3 Install your support stanchion (Step A).

AFT TOP INSTALLATION:



4 Extend your bow. Release push button and adjust in place (Step 1).



5 Extend your rear stanchion. Then secure in arch-mount (Step 2).

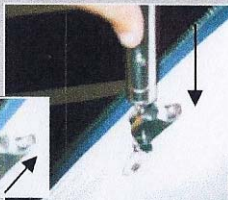

Adjust stanchion in place (Step 3).

TYPICAL INSTALLATION

Note: While cruising the bimini top shall be zipped in the boot to avoid damage due to wind and sea conditions as well as from possible higher cruising speeds.



Canvas Enclosure

To install the optional canvas enclosure to a vessel without the sport tower follow these steps:

1. Install the bimini top per previous page.
2. Zip the windscreen to the bimini top. Then attach the windscreen to the windshield snaps. It may be necessary to unzip a portion of the top to access the snaps.
2. Next, install the port and starboard side curtains. They may be marked for easy identification. If not, a visual inspection will indicate their port or starboard location.
3. Finally, install the aft curtain to the bimini top rear section and zip it in place. Finish installing any remaining snaps as you exit the boat.
4. Do not operate the vessel on the water or highway with the canvas enclosure in place.
5. When breaking down the canvas enclosure make sure each canvas piece is dry especially the clear window glass material. *Roll all canvas parts before stowing them. Folding clear glass canvas parts could permanently damage them.*



CHAPTER 6

Canvas Enclosure w/Sport Tower

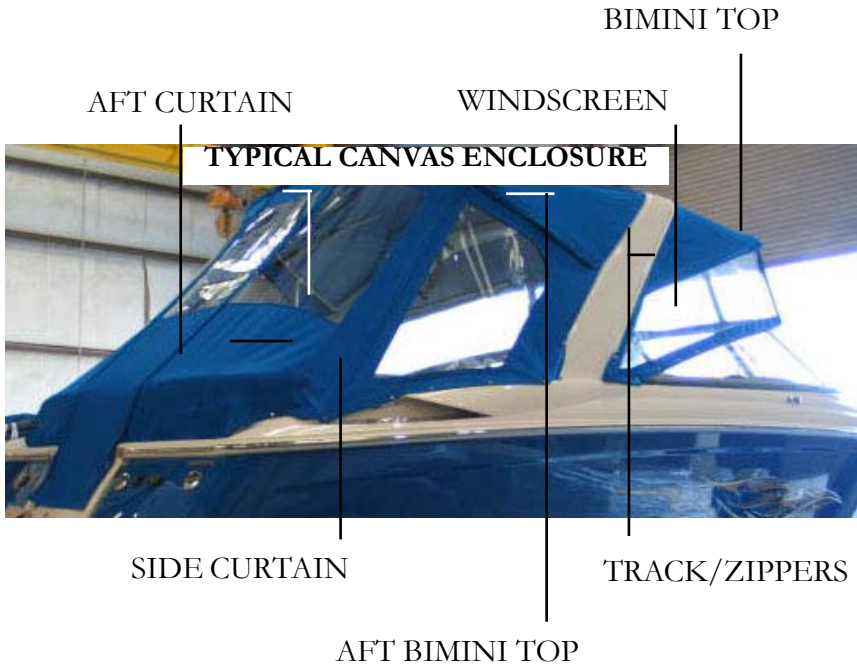

To install full enclosure canvas on vessels with the optional tower follow the process as indicated on the illustration.

1. Find the zippered canvas strips and insert each in the sport tower track. Make sure they line up with the actual zippered counterparts on the front and aft bimini tops. Failure to properly match the ends will be noticed as you will not be able to zip the top to the canvas strip.
2. The front bimini top must be zipped to the canvas piece located in the front track on the sport tower during the installation process.
3. The aft bimini top must be zipped to the canvas piece located in the aft track on the sport tower during the installation process.



Cockpit Cover



COCKPIT COVER

TONNEAU COVER

The cockpit cover installs over the windshield and snaps to the deck. To install the cockpit cover, note that at the bow end of the cover there is a seam on the inside which separates the port and starboard sides. Align this seam with the center snap below the windshield. Complete snapping the canvas to the outside and then down each gunnel to admidships.

This type of canvas cover requires several cockpit poles. Their purpose is to keep the canvas tight and water out of the interior. Notice on the underside of the cover there are areas of reinforced canvas material. These are for the cockpit cover poles. Each pole is adjustable by opening it to the desired length and tightening the thumb screw. You may find it helpful to mark the poles so you can install them in the same location each time.

Note: The cockpit and tonneau covers are not designed to be used at highway speeds. Do not tow your Regal boat with a cockpit cover or tonneau cover installed as personal injury and/or property damage could result. Purchase a suitable travel cover designed for highway use before towing your vessel. They can be ordered from your authorized Regal dealer.



Canvas- Travel/Storage Cover

▲ WARNING: To prevent damage to your boat and/or cover please read and understand instructions before attempting to use cover.

It features:

1. **ON SOME MODELS:** A special anti-pooling system is included to prevent large puddles from ruining your cover.
2. The SurLast® all-weather fabric was chosen to allow stability, water repellency and breathe-ability.
3. The Vacu-Hold™ system allows trailering at highway speeds (65 mph) without billowing or buffeting.
4. The new ratchet and drawstrap type attachment will allow easy, tight and secure installation.

CARE, WARRANTY AND INSTALLATION INSTRUCTIONS

Hint-To properly install ratchet strap system.

1. Pull the webbing through the channeled ratchet cylinder and tension while ratcheting to "start" the webbing.
2. Tension the ratchet with about 5 lbs. of pressure (pinky finger). Pull the sides of the cover to even the webbing throughout. Re-tension about 5 lbs. (the ratchet should be tight on the side of the boat lever, perpendicular to the hull).
3. Crank the ratchet approximately 5 full additional times to add tension (based on an 18' boat).
4. Check boat webbing for tension during stops while trailering. (webbing may stretch during first installation and use **CHECK OFTEN**).

▲ WARNING: Readjust and retighten the cover after trailering and before storage. To prevent pooling do not allow snow and ice to accumulate on the cover. Never trailer at speeds above the speed limit.

CARE INSTRUCTIONS- Wash with warm soapy water (while installed if possible) and allow to air dry. For stubborn stains, mild detergent is recommended.

Storing the boat in constant direct sunlight will shorten the life of the cover and the components used to construct it. We recommend storing the boat in a location that exposes it to some sun and also shades it throughout the day. Preferably morning sun and afternoon shade.

WARRANTY- This cover includes a two-year warranty from date of purchase against any defects in material or workmanship. If you incur any problems or have any comments please contact your dealer or call COMMERCIAL Sewing Customer Service directly at (860) 482-5509.

PROPER INSTALLATION-

A. Pooling System Installation:

Note:

Install anti-pooling system as per illustration putting the front webbing to the cleats, standing pole upright. Pull the other two webbing straps to the two rear cleats. Tighten adjustable buckle strap, until the pole stands upright.

B. Proper Cover Installation:

- Place cover on boat starting at front, use cleats as buttons to keep cover in place, work toward back over pooling system until back cleats are "buttoned" in place.
- Maneuver in place until cover fits over gunwale. Check the symmetry. Connect the confidence straps through the openings on the swim platform to the "U" bolts. Disconnect velcro wrap around ratchet. Begin ratcheting by unzipping ratchet pocket(s) and pulling ratchet(s) handle in right-to-left motion until zippered ratchet pocket no longer sags but rests against the hull.
- Pull on webbing to even the tension around the cover and again tighten the ratchet until it does not sag but rests against the boat. Tighten ratchet four to five more times. The ratchet should be very hard to pull with your pinky finger. Zip ratchet pocket closed and connect velcro wrap around ratchet pocket. **On some models:** Connect the rear strap tiedowns in the back of the boat.

Note: Proper installation and operation of this cover requires that it be very tight at the gunwale. Retighten as necessary before, after and during stops while trailering. **BE SURE** cover is installed below gunwale before final ratchet adjustment. ZIP ratchet pocket closed for final installation.

▲ Warning: Zippered ratchet mechanism should be hand tightened only. Do not pry or attempt to operate ratchet mechanism with any type of tool.

REMOVAL-

- Disconnect velcro wrap & zip open ratchet pocket.
- Follow instructions on ratchet label to release pressure.
- Once pressure is released pull out webbing to allow simple future installation, then close handle and ZIP POCKET closed (this is important to prevent damage in future installation).
- Disconnect holddown straps. Remove and fold cover working from rear to front.

ANTI-POOLING POLE STORAGE-

- Disconnect anti-pooling pole from either the front (colored webbing) or back.
- After disconnecting collapse poles by pushing buttons and telescoping them down.
- Wrap webbing around poles.

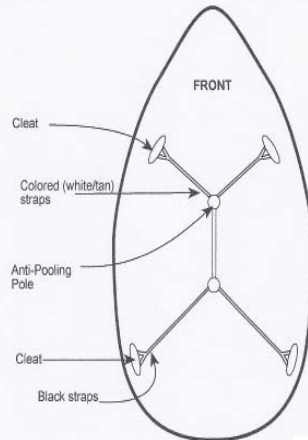

ISBLANKMOORING/RO



Equipment Operation



TYPICAL TRAVEL/STORAGE
COVER



Ensure the ratchet strap is tight and the velcro flap is closed on the travel cover before pulling boat at highway speeds. Tie cover securely to bow and stern eyes. Do not exceed manufacturer's 65 miles per hour speed limit. Once on the road periodically pull over and check cover, ratchet strap and pertinent hardware for tightness.



Cockpit Carpet/Table



Cockpit carpet features a forty ounce weight with a heavy duty backing. As required, snaps are installed.

Note: Before towing roll-up the cockpit carpet and store it in a locker to prevent it from blowing out of the vessel. Do not yank on the carpet to remove it.



A dining table may be installed in the cockpit or cabin. When installing the table ensure the nylon sleeve is installed in the table pedestal located under the table. It locks the table and provides additional stability.

TYPICAL RECEIVER



NYLON SLEEVE

COCKPIT TABLE





Cockpit Refreshment Center



The cockpit refreshment available on select models features a Corian countertop with backsplash, stainless steel sink, strainer, FRP cabinet with under storage. All parts are made to resist the harsh marine environment.

The fresh water tank is activated by a 12 volt

fresh water system helm switch. A fresh water pump features a fresh water filter that needs to be changed periodically. See the section on the fresh water system for further information.

See the winterization chapter for vessels in colder climates. Follow the procedure for “laying up” the system to prevent system and component damage.



Drain Plug



CAUTION

TO PREVENT VESSEL FROM SINKING,
INSTALL DRAIN PLUG!

TIGHTEN-CLOCKWISE

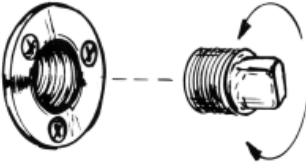

Your boat is equipped with a garboard style drain plug. Make sure it is tightly installed before launching. *Tighten with a wrench.* Do not use your fingers alone. After your outing while the boat is angled on the ramp remove the drain plug to help eliminate any bilge water accumulation or run the

bilge pump. When the water stream is diminished, remove foreign objects stuck in the drain hole. Pull the drain plug if dry storing the boat for extended periods especially in colder climates.



Depth Finder/Sounder



In theory the depth finder picks up a bottom signal sent through a transducer to the helm gauge unit which is converted to readings in feet, meters, or fathoms and displayed on the gauge. The unit features shallow or deep water alarms, both of the audio and visual type, and keel offset.

General Description

If equipped the depth finder will display depths of 2-199 feet, 1-92 meters, or 1-54 fathoms. To accommodate greater depths to be displayed in the “ft” feet mode the depth sounder will automatically change to “F” fathoms mode and continue to display depths to around 54 fathoms.

When the depth decreases below 200 feet the display will return to the “ft” mode. Limits on depth will vary depending on transducers and bottom conditions.

If the reading is less than 19.9 feet, meters, or fathoms, 1/10th increments will be displayed. If the reading is more than 19.9 feet, all readings will be in whole numbers.

The depth finder features an audible and LCD displayed depth alarm with adjustable shallow and deep limits and a depth below keel offset feature. These settings once made are stored in memory and will remain even if the battery is not connected.



Operation

Power On. When the helm is powered up by the key switch 12 volt DC energy is available at the depth gauge along with the remainder of the instrument cluster. You do not need to press the “ON/OFF MODE” keypad.

The LCD will illuminate showing the depth and the type of units selected; feet (FT), meters (M), or fathoms (F). To deactivate the depth sounder, hold the “ON/OFF MODE” keypad for 4 seconds. If you press the “ON/OFF MODE keypad again the unit will be reactivated.

Depth Alarm. *Shallow mode:* If you press the “ON/OFF” MODE” keypad again the “SH” shallow depth alarm setting is displayed. This is the shallowest water that will energize the alarm. Press and hold the up or down arrow keypads to adjust the reading to the desired depth.

Depth Alarm. *Deep Mode:* By pressing the “ON/OFF MODE” keypad displays again the “DP” deep depth alarm setting. This is the deepest water that will energize the alarm.

Press and hold the “UP” or “DOWN” keypads to adjust the reading to the desired depth. When the shallow depth setting is read by the depth finder, the “SH” will flash on the LCD and the audible alarm will sound in a rapid sequence. When the deep depth setting is read by the depth finder the “DP” will flash on the LCD and the audible alarm will sound at 2 beeps per second.

Note: To fully deactivate the alarm, reset it to zero. Pressing the “ON/OFF MODE” keypad temporarily deactivates the alarm. To reactivate the alarm press the “ON/OFF MODE” keypad until the depth reading appears.



Equipment Operation

Keel Offset. By pressing the “ON/OFF MODE” keypad again displays the “KL” keel offset setting. It can be set so the depth finder shows the depth below the transducer or the depth under the keel. Press the “UP” or “DOWN” arrow keypads to adjust the reading to the desired depth no further than 19.9 feet.

An example would be if the keel bottom is 3 feet below the transducer and you desire the depth sounder to read the depth below the keel, the display should be adjusted to read 3.0 FT.

Note: Once the keel offset is programmed, the shallow and deep alarms will be energized by the depth under the keel.

Units. Pressing the “ON/OFF MODE” keypad again displays “UN” on the LCD indicating the units mode.

Press either the up or down arrow keypads to set the units desired to (F’T) feet, (M) meters, or (F) fathoms. Once these units are set, they will remain the same for all modes. By pressing the “ON/OFF MODE” keypad again returns the depth finder to normal operation.

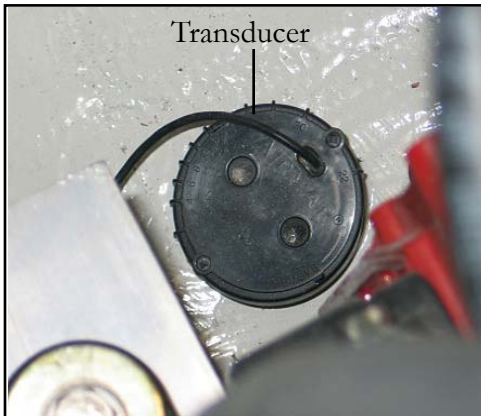

Note: At the step area there is an access plate. Under the plate near the keel is the depth sounder transducer. It bounces a constant signal off the bottom and sends it to the dash head unit. Never use bottom paint on the hull side of the transducer since it will effect the unit’s operation.



Doors/Walk-Thru Bow



Walk-thru bow doors are great for foul weather. With the tonneau cover in place, simply open the doors and pull across the bow opening. Secure shut by lining up the latch and pushing down to catch both doors. Snap the tonneau cover to the fasteners provided on the center windshield frame.

To store, fold against the walk-thru and secure with snaps or latch.



Engine Hatch



Your vessel may feature an engine compartment hatch latch located under the center walk-through cushion on the aft deck hatch or in some cases forward of the engine on the cockpit floor. The hatch utilizes a forward opening design which permits accessing the engine from the swim platform. Accessing the hatch is a real plus when performing pre-cruise and

maintenance inspections.

To open the hatch lift up on the latch and turn it 90 degrees.

To close the engine hatch lower it and then turn the latch and lock it in place.

Note: To aid in opening or closing the hatch, use your hand to push the hatch lid down while turning the latch to the open or closed position.



Gas Vapor Detector

If equipped, a gas vapor detector is a state of the art fume monitoring and alarm system. It is a highly effective detector of engine compartment gasoline fumes from unburned hydrocarbons emitted from faulty exhaust systems and hydrogen battery vapors.

The unit operates with a head unit at the helm, a sensor located in the bilge installed just above the normal accumulation of oily bilge water.

A .5 amp buss fuse (for overcurrent protection) is located behind the helm head unit.

Operation

The display panel at the helm features 3 windows. The left window is a green power on indicator. The right window is an opening for the Var-a-Brite light intensity detector. The center window is the red warning indicator.

To check for fumes, turn the ignition key to the “on” position. The green power on LED will show on and the red warning LED may light momentarily to indicate a warm-up period for the sensor. The alarm horn will not sound during this period.

If a vapor build-up reaches 10-20% of lower explosion limit the red warning LED will light indicating a detection of fumes. Should this condition last for longer than 10 seconds, the alarm horn will sound.

The alarm will continue as long as vapors are present. The alarm horn may be silenced by pressing the “mute” switch, the red warning light will remain on until the vapor problem has been resolved.

NOTE: PROBLEM SHOULD NEVER BE CONSIDERED CORRECTED UNTIL WARNING LIGHT GOES OUT.

If the red LED begins to glow softly and or intermittently, it is an indication that the gasoline vapor build-up is beginning to occur and you can anticipate a full alarm momentarily.



Immediately have all passengers and crew exit the passenger compartment. If an explosion or fire should occur, the probability of injury will be greatly reduced if no one is in a confined area of the vessel.

IN THE EVENT OF AN ALARM:

NOTE: IT IS IMPORTANT TO UNDERSTAND THAT AN ALARM WOULD NOT OCCUR UNLESS A PROBLEM EXISTED. CAREFULLY CHECK ALL FUEL LINES, GAS LINES, AND ANY OTHER POTENTIAL SOURCES OF GAS LEAKS.

Testing System



The head unit can be tested for electrical continuity by pressing the “Test” switch. The Red LED will come on. The light will glow as long as the switch is held down. If the test switch is held down longer than 10 seconds the horn will sound and the “MUTE” switch must be pushed to silence the horn.

Unplug the sensor wire from the helm display head while the unit is powered up. The Red LED will illuminate and within 10-15 seconds the alarm horn will sound. If warning Red LED fails to come on & horn fails to sound, remove display head & return to factory for repair.



WARNING

AVOID INJURY AND DEATH!
GASOLINE VAPORS CAN EXPLODE!
OPERATE BLOWER FOR AT LEAST 4 MINUTES
AND CHECK THE ENGINE COMPARTMENT
AND BILGE FOR GASOLINE VAPORS.
RUN BLOWER BELOW CRUISING SPEEDS.



Grill

The optional marine gas grill uses small bottles of propane as a fuel similar to home units. On selected models the grill receiver is located on the deck. **Read and understand all instructions before using the grill. Make sure grill is mounted securely to rail before using.**

Gas Grill- Barbecue Safety Instructions

1. The unit is designed to cook food like meat, fish or vegetables. Do not use it for any other purpose since it could be improper or dangerous.
2. Do not operate the barbecue in rough seas or while under power.
3. Do not use burning type charcoal bricketts or volcanic stones.
4. Never light the barbecue with the lid closed.
5. Use mitts or gloves when handling a hot barbecue.
6. Keep combustible material away from the barbecue.
7. Keep children away from barbecue hot parts.
8. Do not store propane bottles on board the vessel.
9. Let the unit cool down before attempting to store the grill.
10. Always change propane tank away from any ignition source.
- 11. Turn off the grill after each use.**
12. Do not tamper or modify any parts adjusted or sealed by the manufacturer.
13. Periodically check all components for leaks and wear.



CHAPTER 6

14. When installing a propane bottle make sure it is screwed into the receptacle tightly. Use a spray bottle with soapy water to check for leaks. See the information on gas leaks.
15. Never try to adjust the regulator. It is factory set for best operation.
16. Use common sense around the grill. A fire extinguisher should be readily available.



WARNING

**GASOLINE VAPORS ARE EXPLOSIVE!
OPEN FLAME APPLIANCES CAN IGNITE GASOLINE
VAPORS. TO AVOID INJURY OR DEATH FROM
EXPLOSION OR FIRE,
TURN OFF ALL OPEN FLAME DEVICES**



WARNING

**OPEN FLAME COOKING APPLIANCES CONSUME
OXYGEN AND PRODUCE CARBON MONOXIDE.
TO AVOID ASPHYXIATION, OR INJURY OR DEATH
FROM EXPOSURE TO CARBON MONOXIDE,
MAINTAIN OPEN VENTILATION
WHEN USING THESE APPLIANCES.
DO NOT USE THIS APPLIANCE
FOR COMFORT HEATING.**



Equipment Operation



Screw Propane
Tank Clockwise
To Tighten

Regulator

Fish-On Mount
Thumb Screws

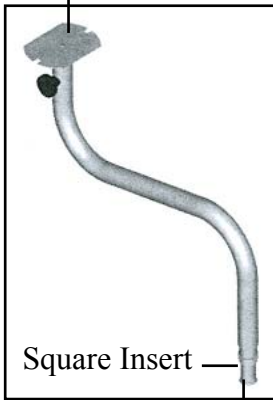

Typical Gas Grill-Operating Instructions

- A universal mount is required to attach the grill to the deck fitting.
- Attach the “fish-on” mount top to the two thumb screws. Tighten securely.
- Fit the grill-mount assembly in the square deck fitting. Make sure the grill is tightened in place.

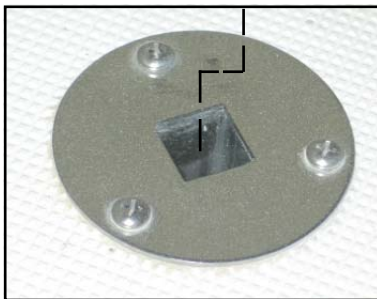

- Screw on the propane bottle until tight.

- With a long match or propane starter apply flame to the burner. Always apply the flame to the burner before turning on the gas. A lighting hole is located below the lid's handle.

- If locked, push the center burner down to unlock. The control knob now can be turned to start the grill.



CHAPTER 6

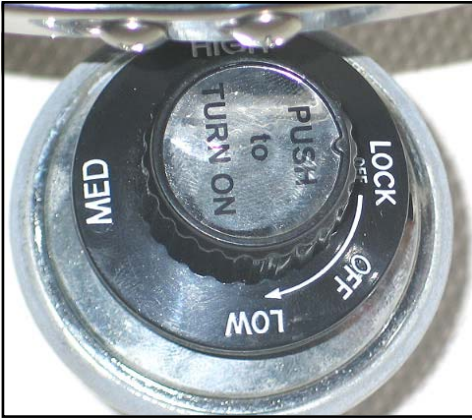

- Turn the grill on high. Make sure there is heat coming from the unit.

If after 10 seconds the burner has not ignited or your flame has gone out turn the unit off and wait 1 minute for the propane to dissipate.

- Once lit, adjust the flame to the desired temperature. No preheating time is necessary.

- Do not operate the grill with the vent shutters and lid completely closed. Keep the vent shutters open a bit to allow adequate combustible air.
- If you close the lid and vents for long periods of time the flame may be extinguished from excess smoke.
- Do not leave the grill operating unattended.
- After cooking , shut off the grill and allow the unit to cool.
- After cooling, clean up any grease build-up. Clean after every use to keep the grill operating correctly.



Gas Leaks

1. Extinguish all flames and smoking materials.
2. Turn off the grill knob.

To determine the source of the gas leak:

1. Ventilate the propane tank storage compartment by opening the locker door.
2. With the locker well ventilated and the burner valve turned off, open the propane container valve.
3. Apply a mixture of liquid detergent and water to all connections checking for bubbles indicating a leak. If a leak is found tighten the connection and verify with soap solution as above that the leak is stopped before attempting to light the barbecue.



Gray Water System

The gray water system option consists of a holding tank along with a deck mounted waste pump out fitting. Water from a cockpit refreshment center or head sink normally exits the boat at a thru hull fitting. With the gray water system any used potable water is stored via the drain hoses to a holding tank. Once the gray water holding tank is full it is pumped overboard by a pumping station vacuum pump much the same way a toilet holding tank is pumped out.

This system is environmentally friendly as it keeps many soap related alkalines and harsh detergents out of the water supply.



Ladder



TYPICAL LADDER

Your vessel features a stainless steel boarding ladder. Use the appropriate hand rails and ladder rungs. Be sure all body parts are clear of the ladder when folding the ladder up or down and repositioning it on the swim platform. Keep body parts clear of any hinged parts. Be sure to read and adhere to any written warnings posted at the helm area or swim platform regarding ladder load limits.

Always turn the engine off and remove the ignition keys while people are in the water near the boat, or using the swim platform and/or the boarding ladder. Also, insist people always use the ladder not the stern drive ventilation plate for entering and exiting the vessel. Again, safety first!



WARNING

**AVOID BODILY INJURY DUE TO MOVING PARTS!
KEEP ALL BODY PARTS CLEAR OF THE LADDER'S
MOVING AND ROTATING PARTS!**



CHAPTER 6

Lighting-Docking

If installed the docking lights are integrated into the hull. They are very useful for night docking and maneuvering. To operate turn on the helm switch marked “docking lights”.

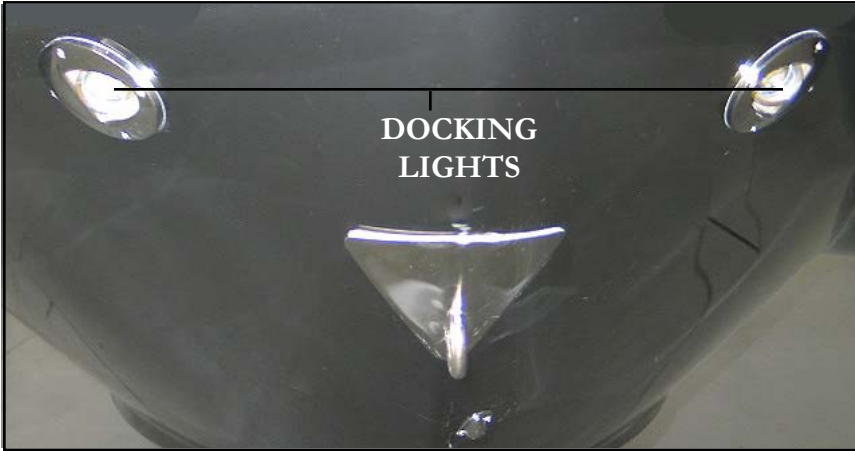

Lighting-Courtesy

LED cockpit courtesy lights are standard equipment on your vessel. They are located along the cockpit at various locations. To operate, turn the “cockpit light” helm switch to the “on” position.



Lighting-Stern



STERN LIGHT

The stern light is normally stored in the ski locker under the starboard side. Selected stern lights are hinged for storage.

It must be used between dusk and dawn. It is controlled by the navigation light switch located at the helm. Simply remove the light from the holders and install it in the stern light receptacle located at the aft starboard deck and activate the top portion of the nav/anchor switch.



CHAPTER 6

PowerTower

The optional PowerTower features a ski pylon roller system located high at the top center of the arch for water sports. As part of the innovative design the tower hinges forward for tight overhead clearances such as bridges and for highway towing.



Tower Shown In Up Position



Tower Shown In Forward Tilted Position



Equipment Operation



The PowerTower can be hinged forward for clearance purposes or for highway towing. There is a single pole switch labeled “arch” at the helm area that connects to a lift motor and a set of hydraulic rams that raise or lower the tower.

Before energizing the switch pay special attention that all passengers maintain a safe



distance from the tower hinge mechanisms located at the base of the tower on the deck. As the operator energizes the arch switch to hinge the tower up or down visually

monitor the port and starboard deck to ensure all passengers are clear of the hinge mechanism.

Note: For highway towing the PowerTower should be in the full upright position and all canvas shall be in their dedicated boots. All attached hardware shall be checked for tightness before and during the towing process.



WARNING

WHEN OPERATING POWERTOWER
KEEP ALL BODY PARTS CLEAR
OF TOWER HINGE MECHANISMS.



CHAPTER 6

Pressurized Fresh Water System

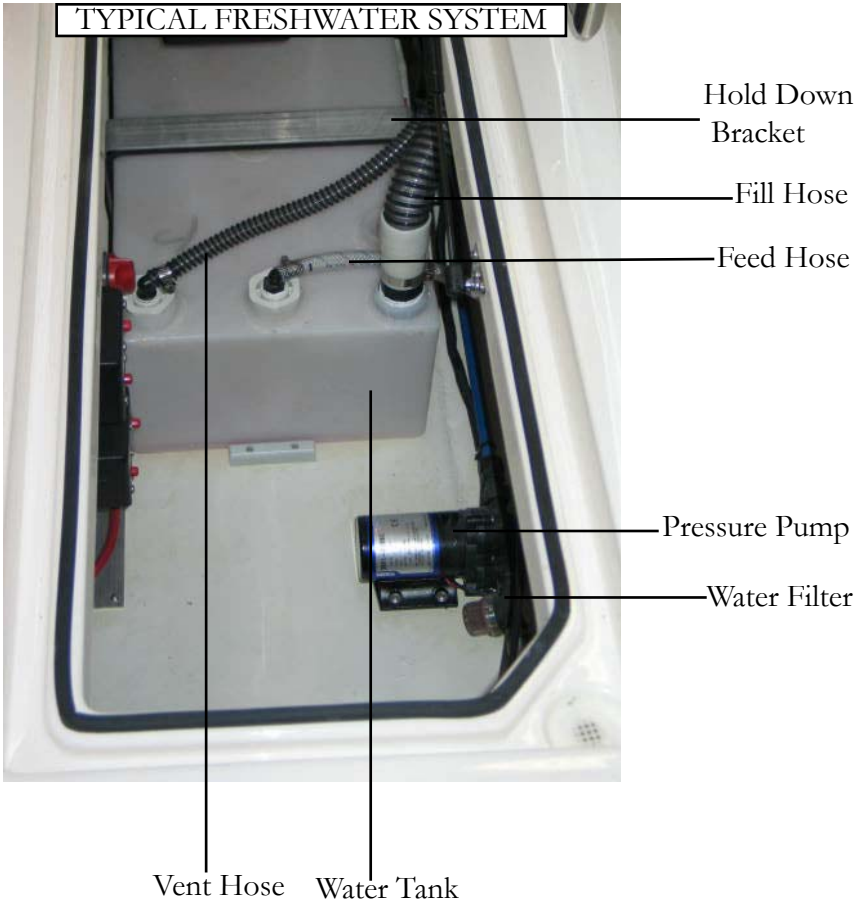

Note: The fresh water tank represented by the one above can be visually monitored for fullness. Monitor the tank level as part of your pre-cruise checklist. It is always a good idea to fill the fresh water tank before an outing.



Equipment Operation

If equipped, the pressurized water system needs to be initially filled to operate properly.

1. Unscrew the “water fill” deck fitting. Fill the fresh water tank with approximately 10 gallons of fresh water with a suitable container or hose. Make sure the water is safe for drinking.
2. Find the helm fresh water pump switch and energize to the “on” position. Pressurized water tank will fill entire system with fresh water.
3. Open the faucet to allow any air to escape. Close the faucet when there is a steady stream of water without air. You will hear the pressure switch shut off the pump indicating the system is full.
4. If equipped with a cold water transom shower and/or bow washdown repeat step #3.
5. After these initial procedures, “top” the system off with fresh water.
6. Check for system leaks as evidenced by the pressure water pump recycling even though no water is being used from the faucet.
7. It is a good idea to turn “off” the fresh water pump switch after each use.



CAUTION

**AVOID PRESSURE PUMP BURN OUT!
DO NOT ACTIVATE THE FRESH WATER
SYSTEM WITH THE WATER TANK EMPTY.**



Regal View Display



The Regal Vue display option is installed as shown. Each unit is outfitted with a memory card with predetermined geographical regions. Should the operator want a different memory card access to the Regal Vue panel is outlined below.

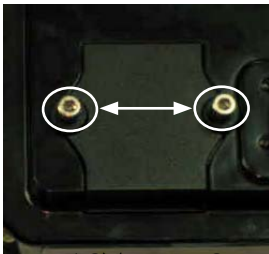

FASTENERS

1. The battery switch should be turned to the “off” position before starting to work behind the dash. At the rear of the Regal Vue display (behind the dash) you will see a small compartment with 2 allen head type fasteners. Remove both fasteners with the panel cover to access the memory card compartment.

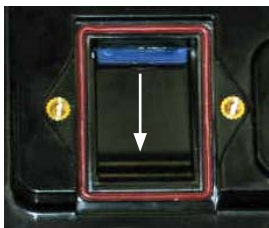

2. Insert a fingernail or small slotted screwdriver into the memory card end tab. Push up to disengage the card. Next, pull down on the card to remove it from the card slot.



Equipment Operation



3. Install the new card with written side out into the card slot. Make sure the memory card seats into the card slot.
4. Reinstall the panel cover and tighten the allen head screws. There must be a small “crush” on the cover gasket to ensure a tight fit but do not over tighten the fasteners.
5. Energize the battery switch and test the display unit.



Seating-Bucket Operation

The bucket seat features a handle mechanism that operates multiple seat functions. The separate handles prevent the seat from rotating and sliding fore and aft during operation of the vessel. This provides the operator with a safety margin. Do not alter the seat slide mechanism. To adjust the seat slider follow the instructions and refer the illustration.

1. To adjust fore and aft seat positions, pull up on handle “A”, slide seat to desired location and release the handle. The slide will lock in position.
2. To rotate seat and adjust the drag control feature for rotation, pull handle “B” up to the horizontal position and release. The handle will maintain the horizontal position. The seat is now able to be rotated 360 degrees. To increase the drag on rotation, turn handle “C” clockwise to desired resistance. To decrease drag, turn handle “C” counterclockwise.
3. To lock the rotational feature, push handle “B” down and the positive quick lock feature locks for the next available locking spline.

Always use the positive lock feature when your vessel is underway.



CAUTION

TO PREVENT BODILY INJURY!
PERIODICALLY CHECK AND TIGHTEN
THE MOUNTING BOLTS
BETWEEN THE SEAT SLIDER
AND THE BUCKET SEAT BOTTOM
ALSO, CHECK THE FLOOR INSERT BOLTS.

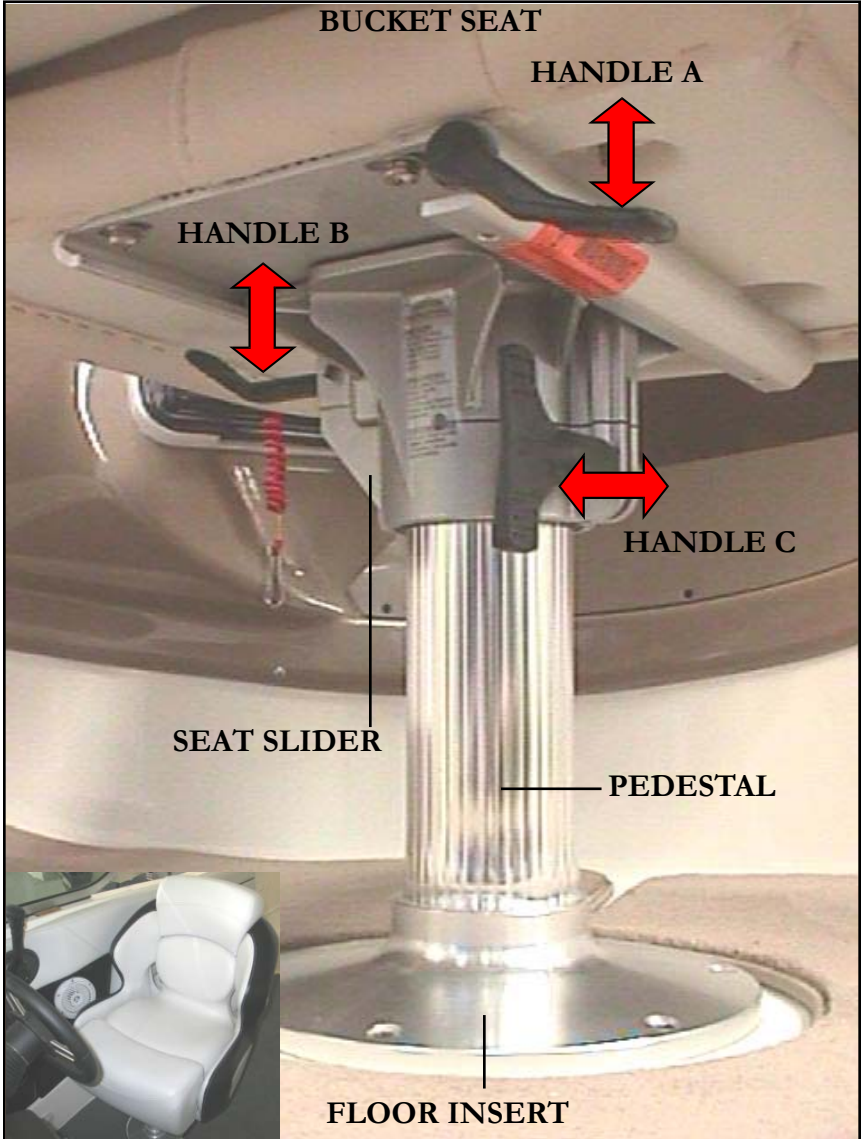

TYPICAL BUCKET SEAT LOCK MECHANISM



CHAPTER 6

Seating/Bow Filler Cushion



If installed the bow filler cushion is supported by s/s bars located under the bow cushions. One is longer than the other. Make sure both bars are seated in the liner detents (Typical bow seating shown).



Place cushion on bars. Make sure the cushion is completely seated on the bars before attempting to sit or lay on it.



Seating/Bow Arm Rests



ARM REST- UP POSITION

On bow rider models the seating features arm rests. On select models arm rests utilize a track system that permit them to slide down. To extend the arm rest simply pull up on the bottom of the arm rest until it snaps in the lock position.



BLACK KNOB

ARM REST- DOWN POSITION

To unlock the arm rest tracking mechanism simply push up on the black knob with one hand and while holding the knob up push down on the front end of the arm rest until it rests in the arm rest-up position. Keep body parts away from the track itself to avoid injury.



Other vessels feature bow seating arm rests where you simply push down on the arm rest to engage.



To fold away, simply pull up on the arm rest.



Seating/Cabin w/Berth Conversion



The 2550 cabin seating serves a dual function. It provides dinette seating with the optional teak cockpit table. Insert the leg into the cabin receiver and insert the table into the leg top. The hatch provides cabin cross ventilation. See the illustration.

The cabin can be converted to a berth. There are detented scallops in the cabin liner to accept a set of support bars. Under the middle starboard cushion berth support bars are stored. Follow these steps to set up the berth once the bars are located.

1. Pull the port aft backrest cushion up to release the cushion from its holder.

This cushion will serve as one of the berth fillers.

2. Pull the starboard backrest cushion up to release the cushion from its holder. This cushion will be used as the other berth filler.

3. Insert one of the two short support bars in the forward most liner detent.

4. Insert the other short support bar in the next liner detent.

5. Place the longer support bar diagonally from the port aft detent to the starboard aft detent.

6. Place the port aft backrest on the support bars with the angle aft.

7. Place the starboard backrest cushion on the support bar with the angle aft which completes the berth conversion.



Equipment Operation

Longest Bar

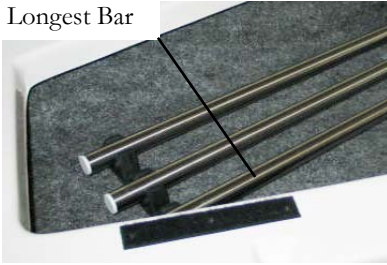

To disassemble the berth reverse the process. Make sure that the backrest cushion clip plates are firmly pushed into the backrest holders.

When storing the support bars the longest bar must be placed in the most inside slots or it will not fit. Push the bars completely down in the rubber holders.

See the illustrations below.





Ski Tow/Pylon



A water sports ski pylon is located center line at the stern deck. Double loop the line first through the hole and then around the ski

pylon and cinch it tightly. This procedure helps to keep the line intact when there is no strain on it.

Always appoint a person to keep their “eye out” for the tow line when the vessel is running to prevent the line from being caught in the propeller.

If your vessel is equipped with a wakesport tower a universal roller type pylon is positioned at the top of the tower. This provides a higher angle to enhance water sport activities.



Stereo/CD Player- Fusion



Regal boats feature Fusion® marine stereo audio systems. Fusion stereo systems are designed and engineered to perform to the highest standards in the harsh marine environment. The head units feature easy to read displays and use oversized rubber buttons and controls for easier operation on a moving vessel. Being at the leading edge in stereo technology the head unit opens to a truly unique internal iPod

dock. The iPod dock handles many generations of iPods through a set of sleeves. These sleeves hold the iPod in position ensuring ease-of-use and protect the iPod from the marine environment.

The standard MS-IP700 provides 70 watts x 4 total output.

All components including the speakers comply with the international IP waterproof standards. Selected optional system components include an amplifier and additional speakers.

The system utilizes a 15 amp automotive style fuse located behind the stereo head unit.

See the amplifier and remote information for vessels equipped with the optional stereo performance package and remote controls.







Note: As standard equipment on Regal sport boats the stereo functions from the auxiliary key switch position which is located to the left of the normally “off” position. Here the stereo can be operated without the typical draw on the ignition circuit which normally occurs when the key switch is in the “on” position.



CHAPTER 6









BUTTON DESCRIPTION

BUTTON	DESCRIPTION
	Power Press to turn the unit ON/OFF
	Menu Press to enter menu system and press again to return to previous screen
	Radio Press to access the Radio source FM - AM - SAT
	CD (MS-CD500 only) Press to access the CD/MP3 source
	AUX (MS-IP500 only) Press to access Auxiliary source
	iPod. Press to access the iPod source Press again to access AUX (MS-CD500)
	Back/Previous. Short Press: To select the previous track in CD/MP3 or iPod mode. Start automatic tuning down the frequency spectrum in the Tuner mode. Press and hold: Rewind in CD/MP3 or iPod mode. Start manual tuning down the frequency spectrum in the Tuner mode.



Equipment Operation

BUTTON	DESCRIPTION
	Forward/Next Short Press: To select the next track in CD/MP3 or iPod mode. Start automatic tuning up the frequency spectrum in Tuner mode. Press and hold: Fast-forward in CD/MP3 or iPod mode. Start manual tuning up the frequency spectrum in the Tuner mode
	Play/Pause Play/ Pause track in CD/MP3 and iPod mode.
	Mute Mutes all sound in all zones
	Clock Displays the clock
	Display Brightness Press to enter display brightness setting. Turn the Rotary Encoder to adjust
	Rotary Encoder The rotary encoder operates similar the click wheel on an iPod. Turn to adjust volume or move up or down a menu structure. Press the Rotary Encoder to select a highlighted option.

RESET BUTTON

- Press the Reset button to reset the unit to the factory settings

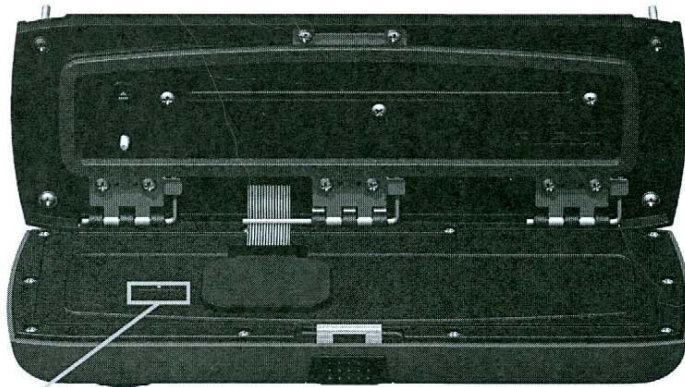

■ Reset Button



CHAPTER 6

OPERATION



The MS-CD500 and MS-IP500 features Clock battery back up and Eprom technology, This allows ti to be completely disconnected from the vessels +12volt Voltage supply [Battery switch] with No settings lost.

Power

Press  to turn the unit ON/OFF

RADIO OPERATION

Region Selection

Press  and turn  to select setup - Press to enter - turn the  to select tuner region
Press to enter and press to select region



Band Selection

Press the  to select band
FM - AM - SAT



Tuning

There are 15 presets available per band.

Seek Tuning

1. Press the  or  to scan to the next station.
2. The selected station will be auto saved into the station presets menu.

Manual Tuning

1. Press and hold the  or  for 3 seconds to enter. The manual tuning icon will flash on screen.
2. The selected station will be Auto saved into the presets menu.

Note: Once the station is selected the station will be stored into the pre-set menu and the manual tuning icon will be removed.

Auto Tuning

Press the  and turn the  to navigate to the "Search Station" function. Then press to search and store.

Note: Automatic tuning mode will erase all other presets already stored for the selected band and will automatically store the station into the Preset menu in numerical order.

Recalling a Preset Station

1. Select the required band. FM - AM - Sat

2. Press the  and then turn the  select the "Presets" option and press to enter.

3. Turn the  to select the desired preset and press to select



SIRIUS SATELLITE RADIO - USA only - SIRIUS TUNER NOT INCLUDED

SIRIUS ACTIVATION

Activating Your Sirius Tuner

You must activate the SIRIUS tuner before you can begin to receive the SIRIUS Satellite Radio Service. In order to activate your radio subscription, you will need the SIRIUS ID (SID) which uniquely identifies your tuner. The 12 digit SID is displayed on the LCD on initialization. MS-CD500 and MS-IP500 will display the SID on Channel 0.

Power on your system and make sure that you are receiving good signal you are able to hear audio on the SIRIUS Preview channel [Ch-1B4]

Note:

Have your credit card handy and contact SIRIUS on the internet at <https://activate.sirius.radio.com/> and follow the prompts to activate your subscription. You can also call SIRIUS toll-free at 1-888-539-SIRIUS (1-888-539-7474) Once activated, you will be able to begin enjoying SIRIUS Satellite Radio's digital entertainment and can tune to other channels.

SIRIUS OPERATION

Press the  to select Sat Radio

SIRIUS NAVIGATION

Press the  and enter the menu, turn the  to navigate the functions and press  to select.

- **Channels**
Select the desired channel (listed in channel order) and music preference
- **Category**
Select the desired genre type. [The unit will only play the selected option]
- **Favourites**
Add your favourite channel to your favourites list by selecting "add favourite".
[Maximum 15 channels]
Remove channels by selecting "Remove Favourite" select "ALL" or the individual channel and

push Enter 

Exit MNU by pressing 

- **Parental Mode**

Pin #

Turn  to select number and press to enter, repeat to enter the 4 digit code. [Default is 0 on 1st time use]

NOTE: Must be entered before the following items are operational.

Mode on/off

Turn On to initiate parental locking of selected channels etc, turn Off for full channel access

Lock / Unlock

Select the channel to be locked or unlocked

Skip / Un-skip

Select the channel to be bypassed from the menu

Change Pin

Personalise your Pin number. [4 digits max]



CHAPTER 6

SELECTING A SOURCE

Press the desired source button:

-  Radio AM/FM/Sat
-  CD CD/MP3 [MS-CD500]
-  iPod/AUX Press once for iPod [MS-IP500]
Press twice for AUX [MS-CD500]
-  AUX Aux direct [MS-IP500]





ADJUSTING THE VOLUME

- Turn the  to adjust the volume (Zone 1 Default)

ZONE VOLUME

- Press the  to select zone. Press again to step through zones.
Zone 1 - All zones - Zone 2 - Zone 3 - Zone 4

GENERAL SETUP

- Press the  and rotate the  to select the Setup menu. Press to enter.
- Turn the  to select the function and press to enter
- Turn the  to adjust and press  to return.

SETTINGS

Treble

Adjusts the treble to the speakers

Bass

Adjusts the bass to the speakers

Balance

Adjusts the audio balance from left to right

Contrast

Adjusts the display contrast.

Key Sound

Press to turn ON / OFF

AUX Configuration

AUX ON/OFF - Select OFF if no auxiliary device is connected, this will remove the AUX feature from the source list.

AUX Name - Select the desired AUX name

AUX - TV - DVD - GAME - PORTABLE - COMPUTER

Clock Adjust

Adjusts the Clock time, 12/24 hour

- Turn the  to adjust the Hour, Press to confirm, repeat to adjust the minutes, Press to confirm.



Equipment Operation

LOADING / EJECTING AN IPOD

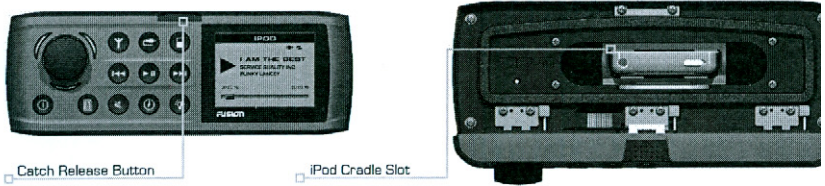

Note:

Failure to correctly insert your iPod will result in damage to your iPod and the FUSION Marine Stereo.

Selecting the correct iPod Sleeve

The MS-IP500 has 8 possible iPod solutions.

A different set of sleeves is used for each iPod model. The different sleeve combinations are outlined in chart below:

iPod	Top sleeve	Bottom sleeve
classic, 5th Gen (30gb)	A	A
classic, 5th Gen (60/80gb)	A	B
classic, 6th Gen (80gb)	B	A
classic, 6th Gen (160gb)	B	B
classic, 7th Gen	B	A
touch, 1st Gen, 2nd Gen	D	D
nano, 2nd Gen	C	C
nano, 3rd Gen, + Adapter	A	A
nano, 4th Gen	E	E

Please note: For the iPod nano (3rd gen), the iPod must be placed inside the adaptor sleeve, and then placed inside Dock sleeve combination A.

Please note: Place the sleeves inside the Stereo Unit before inserting your iPod.

BUTTON	DESCRIPTION
	iPod. Press to access the iPod source
	Play/Pause Play/Pause track in CD/MP3 and iPod mode.
	Forward/Next Short Press: To select the next track in CD/MP3 or iPod mode. Press and hold: Fast-forward in CD/MP3 or iPod mode.
	Back/Previous. Short Press: To select the previous track in CD/MP3 or iPod mode Press and hold: Rewind in CD/MP3 or iPod mode



CHAPTER 6

Press the  to enter the iPod menu, use the  to navigate the functions of your iPod. The rotary encoder operates similar to the click wheel on your iPod. Turn to navigate and press to enter.

Note: Press the  to return to the previous menu screen.

NO iPod Connected

If this appears on the display possible causes are

1. Ensure the iPod is correctly connected
2. Ensure the cable is not excessively bent
3. The iPod's battery remains low [refer to iPod manual and charge the battery]
4. The iPod's software version is not compatible (update software version to be compatible with this



AUX OPERATION

CONNECTING AN AUXILIARY AUDIO DEVICE

1. The Left & Right AUX RCA plugs are located at the rear of the unit.
2. Connect your auxiliary audio device.

Note: You may require an adapter cable to connect your device.

LISTENING TO YOUR AUXILIARY AUDIO DEVICE

1. Press the  on the main unit to select AUX mode (MS-IP500) or press  twice (MS-CD500)
2. Start playback on your auxiliary audio device. Use both the volume control on your auxiliary device (if available) and the volume control on the FUSION Marine Stereo to set the volume level.

AUXILIARY NAMING

See page 9



TYPICAL REMOTE CONTROL.

If equipped, the Fusion remote control is normally mounted at the transom area which makes it easier to use during water activities.









It is a plug and play device and uses the same function buttons and rotary encoder as the helm head unit. It features the ability to select various speaker zones on the vessel.

Refer to the Fusion owner's manual for more detailed information.



CHAPTER 6

BUTTON DESCRIPTION

BUTTON	DESCRIPTION
	Power Press to turn the unit ON/OFF
	Source Press to select the desired source Radio (FM-AM-SAT) - CD/MP3 - iPod - AUX
	Mute Press to Mute/Un-Mute sound in all zones
	Menu Press to enter menu system. Press to return to previous screen
	Play/Pause Play/Pause track in CD/MP3 and iPod mode.
	Back/Previous Short Press: To select the previous track in CD/MP3 and iPod mode. Start automatic tuning down the frequency spectrum in the tuner mode. Press and Hold: Rewind in CD/MP3 and iPod mode. Start manual tuning down the frequency spectrum in the tuner mode.
	Forward/Next Short Press: To select the next track in CD/MP3 and iPod mode. Start automatic tuning up the frequency spectrum in the tuner mode. Press and Hold: Fast forward in CD/MP3 and iPod mode. Start manual tuning up the frequency spectrum in the tuner mode.
	Rotary Encoder The Rotary Encoder operates the same way as the Rotary Encoder on your FUSION Marine Stereo Unit







ALLOCATING ZONES FOR THE REMOTE.

Press and hold the Mute Button for 7-10 seconds then turn the  to select a : [Z1, Z2, Z3, Z4, Z1234]. Press to select. The Remote will then shut down and will need to be turned on.

ZONE VOLUME

Turn the  to adjust the volume in the allocated zone

GENERAL SETUP

1. Press the  and turn the  to select the Setup menu. Press to enter.
2. Turn the  to select the function and press to enter.
3. Turn the  to adjust and press  to return.



Stereo Performance Package



The stereo performance package features extra speakers including a sub-woofer and a 2 channel amplifier to provide leading edge performance in sound and power. The simplicity of design contributes to low distortion and high efficiency. Normally the amp is located under the starboard helm

or may be in the cockpit refreshment center. The circuit is protected by twin 25 amp automobile type fuses. It is a good idea to carry extra fuses which are available at local marine or automotive stores. The amplifier does not require any type of maintenance other than periodic checking of the wiring connectors for tightness. Contact your Fusion owner's manual or closest Regal dealer for additional information.

Vessels with the optional sport arch speakers use an additional 4 channel amplifier located under the helm or the cockpit refreshment center depending on the specific boat model.



Stereo iPod

An iPod adapter is located inside the face of the FUSION stereo as standard equipment. Using a set of top and bottom sleeves it is able to fit most iPod versions.

Refer to the FUSION stereo instruction manual for further information on sleeve specifications.



Swim Platform

On swim platforms follow periodic inspections of the swim ladder and platform support hardware to insure that all connections and fittings are tight and in a non-corrosive state. Never dive off the swim platform. *Do not store or add objects to the swim platform since additional weight will affect steering and maneuvering characteristics of the vessel.*



WARNING

**AVOID SERIOUS INJURY OR DEATH!
DO NOT OPERATE THE BOAT
WITH PEOPLE ON TOP OR HOLDING ON TO
THE SWIM PLATFORM STRUCTURE OR HARDWARE.**

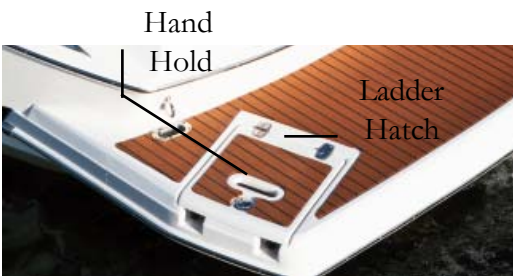

Always close the ladder hatch once the ladder is extended. Remind passengers entering from the water to use the hatch handhold to aid in safe boarding. Never use the stern drive to access the swim platform since

serious injury could result from propeller blades and/or stern drive parts.



Swim Platform- Flexiteek



Flexiteek decking available on selected models features significant advantages over similar wood products. It is made from synthetics. Color is as natural as timber and uniform through the entire thickness adding to its appeal. It sands like wood resulting in a natural wood look and feel. It provides superior grip making it great for boating in general and water sports. It is stain resistant with most washing away with soap and water. The product is UV resistant.

Gentle sanding removes most marks on the decking with a minimum of product loss.



Toilet-Chemical



If installed, make sure the chemical toilet is filled with the proper chemicals, paper is available, and the holding tank is empty.

To fill the toilet follow the manufacturer's recommendations for mixing the solution. Use the fill to pour in the deodorant chemical and water. By pushing down on the bellows the chemical mix is released to rinse and help flush the toilet bowl. When the flush valve is pulled forward the toilet bowl waste water empties

into the holding tank. Close the flush valve after each use.

The chemical toilet features a holding tank level indicator. When full the lower holding tank must be emptied by first separating it from the upper toilet bowl assembly. Before proceeding, ensure the flush valve is completely closed. Find the latches that allow the 2 units to be separated. Once separated, find an environmentally friendly facility to dispose of the waste.



Toilet-Chemical/Pump Out Fittings



As an option chemical toilets feature a deck fitting that permits a marina or waste station to pump out the vessel holding tank. A hose attachment screws into the deck fitting and removes the waste in the vessel toilet holding tank when a land pump is activated. The pump-out fittings eliminate the need to remove the

holding tank manually from the vessel.

After the pump-out procedure rinse the waste hose briefly to eliminate a build-up of debris and odor before closing the pump-out deck fitting. Refurbish the holding tank chemical per the manufacturer's directions immediately after the pump-out procedure. For extended cruising, carry extra holding tank chemical and paper recommended by the manufacturer since household varieties are not usually "friendly" to the environment.

As part of your pre-cruise inspection monitor the chemical toilet by reading the monitor indicator level located on the toilet holding tank.



Toilet-Vacuum Flush



A vacuum flush style toilet is available on select models. This toilet operates in a different way from other marine toilets. The system uses around 16 ounces per flush plus a simple vacuum to complete each flush which is a substantial water savings over other systems. The toilet is connected to a pressurized fresh water supply. Fresh water is the key to an odor-free bathroom compartment. Selected other systems use intake water from wherever the vessel is sitting which may carry an odor. These units are equipped with a special

vacuum breaker which prevents the possible contamination of the potable water system.

Vacuum Tank- This tank stores the vacuum energy used in the system. When a switch senses a drop in the vacuum it automatically energizes the pump to upgrade the vacuum. This process is on-going between flushes.

Vacuum Pump- This unique bellows style pump is designed to handle solids without a problem. It uses two duckbill valves on each side of the pump chamber to prevent back flow of waste and vacuum.

Vacuum Generator- This unit houses the vacuum pump and tank in one unit.

Holding Tank- Unit features polyethylene composition 50% thicker than other holding tanks. A deodorant additive is required to keep the holding tank odor-free.

In-Line Vent Filter- Available on select models the filter uses special a charged filter media to remove odors and sanitize the vent system.

Fresh Water and Waste Monitor- Select vessels offer a monitor panel to display the waste level.

Overboard Discharge Pump- An optional overboard discharge pump vacates waste through the deck waste fitting or a seacock (only used beyond the 3 mile limit in the USA).



TYPICAL VACUUM FLUSH SYSTEM

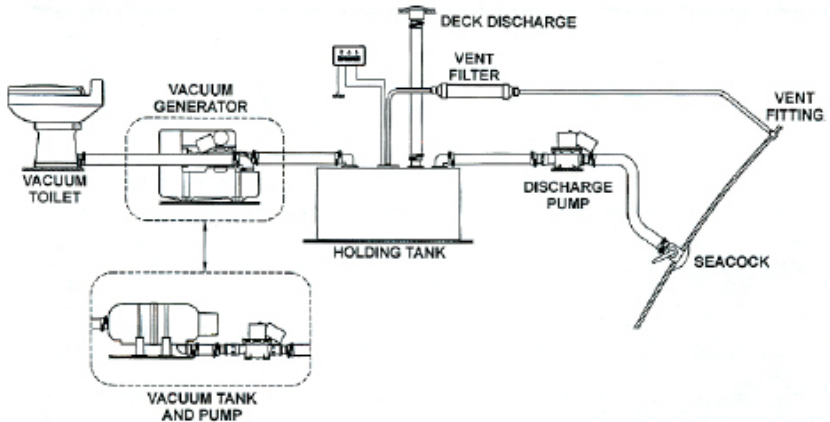

A vacuum style head uses a combination of vacuum suction and water flow from the fresh water tank to clear the head of waste. Before using the system turn the head switch located in the head to the “on” position at the main DC control panel.

Make sure that there is always a small amount of water left in the toilet head bowl. This acts as a trap and will reduce unwanted odors.

Before leaving the boat for an extended period, flush the head for at least 10 seconds. This ensures that waste has cleared the sanitation transfer hose and has entered the holding tank.

Waste left within the transfer hose tends to dry out and harden. This could restrict the internal size of the hose and hamper future operation. The system components including the hose are formulated for the transfer of sanitary waste only. Do not allow the following items in the system: Strong acid or caustics such as drain openers, petroleum solvents or fuels, alcohol based products such as antifreeze and pine oil products along with sanitary napkins and baby diapers.

System vacuum is monitored by a switch located on the outside of the vacuum generator’s tank. When the switch senses a vacuum drop, it automatically signals the pump to energize and bring the vacuum back to the operating level. This is normally a two minute process.



CHAPTER 6

In a properly operating system, the stored vacuum will “leak” down between flushes, causing the vacuum pump to run for a short period. This is normal. The pump should not run for more than once every (3) hours after the last flush.

To operate the vacuum style head:



1. Activate the fresh water system switch at the helm since the fresh water tank is the water source for the operation of the head system.

2. Activate the vacuum pump switch located at the head aft wall. This will activate the vacuum generator pump which diminishes the size of the waste as it enters the holding tank. Remember to tell passengers using the toilet system to activate the vacuum pump switch before flushing the toilet or the waste entering the holding tank will not be diminished in size.

3. Lift the toilet lever until the desired water level is reached. The system requires more water for solid over liquid waste. See figure 1.



4. To flush the toilet, press the flush lever in one swift motion down to the floor until contents in the bowl disappear. A distinct popping noise is normal when flushing action begins and the vacuum seal is broken. Hold the lever down for at least 3 seconds. If flush lever is accidentally released before waste clears the bowl, do not try to flush toilet again until vacuum pump stops running. A small amount of water should remain in the bowl after flushing. See figure 2.



Equipment Operation

Figure 1



Figure 2

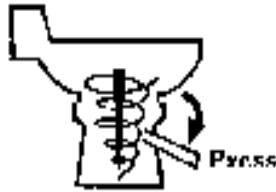

Figure 3



5. Do not dispose of sanitary napkins or other non-dissolving items in the toilet. Do not attempt to flush facial tissue, wet strength tissue, paper towels, or excessive quantities of toilet paper down the toilet. These types of items do not dissolve and cause plugging of the system.

See figure 3.

6. Make sure all passengers are aware of the toilet operation.

7. If using holding tank deodorant, use the approved ones for the system.

8. See the maintenance section for cleaning and routine system inspections.



Overboard Discharge

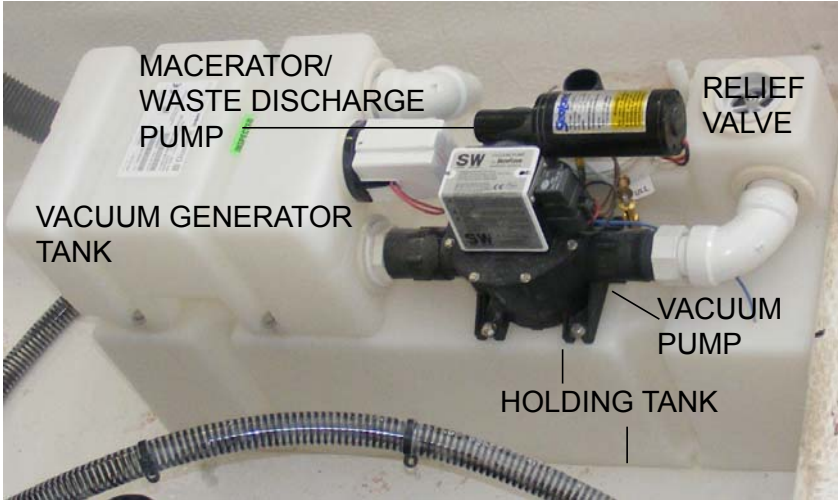

A few notes regarding systems using the vacuum generator tank:

A. The holding tank level can be easily monitored by a visual inspection. Before venturing out on a cruise it is a good idea to have the holding tank pumped out. The tank manufacturer has installed a shutdown relay into the holding tank to prevent overfilling. When the holding tank reaches the “full” level the relay shuts down the vacuum generator and the toilet will not flush.

B. As a safety device there is a relief valve built into the vacuum system. It will activate if the pumping station pump is running too high a vacuum.

C. Since a small amount of water usually remains in the holding tank it is a good idea to rinse the tank especially after cleaning. Add water to the toilet bowl along with 8 ounces of manufacturer’s tank deodorant and cleaner until the discharge is clear. Do not use chlorine based or caustic cleaners along with drain openers as damage to the seals and hoses may occur.



Equipment Operation

Federal regulations prohibit pumping waste overboard within the territorial limits of the United States. Check with authorities regarding specific laws and regulations before attempting to pump waste overboard.



The overboard discharge feature consists of a hull bottom mounted seacock, head key switch, and a macerator (overboard discharge pump) to grind up the waste and deliver it through the sea-

cock overboard.

The seacock is secured in the “closed” position and it must be “opened” before operating the overboard discharge pump. **Damage to system components and/or a potential leak could develop if the seacock is not in the “open” position before activating the pump.**

1. Locate the seacock. Remove the locking mechanism from the seacock and turn the valve to the “open” position by aligning the seacock handle with the valve.



2. The overboard pump key switch is located in the head. To activate the macerator pump turn the switch on and completely to the right. At this point the macerator pump will sound starting the pump out process. It will be required to hold the switch to the right until the tank is emptied. Once empty return the key switch to the “off” position. Have someone monitor the waste tank level visually during the pump out process.

Avoid running the discharge pump “dry”.

3. Close the seacock by repositioning the seacock handle aligning it across the hose. Ensure the seacock is closed completely. Relock the seacock. Failure to relock the seacock within the territorial limits of the United States could result in boat operator fines.



Trim Switch



The trim switch is located on the transom. It permits tilting the stern drive in the “up” or “down” positions from the stern of the boat. Always remove the keys from the ignition switch to prevent the unit from starting in the trailer “up” position. Make sure nobody is near the stern drive when using

the trailer switch. Return the stern drive unit to the “down” position before starting the engine. Failure to do so may result in stern drive component damage.

Underwater Lighting



As an option light bars w/ LED bulbs make up the underwater lighting system. The lights are located on the transom on both port and starboard sides of the stern drive. There is a dash switch for energizing the lights. The un-

derwater lights circuit protection fuse is found in the under dash fuse block and is rated at 10 amp.



Wakeboard Racks



As an option board racks mount on both port and starboard sides of the PowerTower to carry wakeboards, aquatic toys, etc. Strap equipment in place by using the tie downs built into each rack. Periodically check the hardware for tightness.



Wide-Angle Mirror



Select models offer a wide angle windshield mounted water sports mirror. The mirror offers the boat operator a crystal clear view of water sports activities. An observer is still required.

To loosen the mirror from the windshield turn both lock mechanisms counterclockwise.

To adjust the mirror simply move the mirror to the desired location. Clean the mirror with a soft, lint free cloth and rubbing alcohol. Do not use harsh cleaners which can scratch the finish.



Windshield-Center Latch

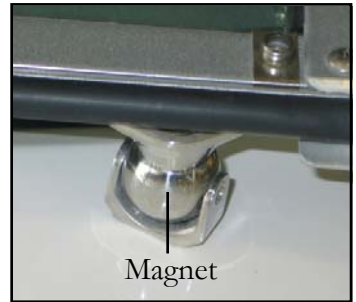

The center windshield shall be closed and locked at all times the boat is moving. Make sure the two locking latches are firmly seated in a horizontal position against the windshield framework.

In the open position at the dock make sure the center windshield is held securely by the magnet. See illustration.



WARNING

AVOID BODILY INJURY!
CLOSE AND SECURE CENTER WINDSHIELD
AT ALL TIMES THE VESSEL IS MOVING!



Cosmetic Care & Maintenance

COSMETIC CARE



This section covers the care and maintenance of your 2300, 2500 or 2550 Regal boat. Many cosmetic care topics including exterior hardware, upholstery, fiberglass and canvas are covered along with major equipment and systems. As always, refer to the owner's information packet and the appropriate engine manufacturer's owner's manuals for further

detailed instructions.

Upholstery

Cockpit and interior vinyl require periodic cleaning to maintain a neat appearance and to prevent the build up of dirt, mildew and contaminants that may stain and reduce the vinyl life if they are not removed. The frequency of cleaning depends on the amount of use and conditions to which the vinyl is subjected.

Most common stains can be cleaned using warm, soapy water and clear rinses. Scrubbing with a soft bristle brush will help loosen soiled material from embossed surfaces and under welting. If the stains are not removed with the above method use a mild cleaner such as Fantastic. This cleaner should be used only as needed and not the normal means.

With more stubborn stains, rubbing alcohol or mineral spirits may be tried cautiously. Widespread solvent use can severely damage or discolor vinyl. Try to remove stains immediately before they have a chance to



CHAPTER 7

penetrate the surface of the vinyl.

Powdered abrasives, steel wool, or industrial strength cleaners are not recommended for cleaning our vinyl. Lacquer solvents will cause immediate damage. Dilute chlorine bleach before using. Do not wax the vinyl as it may cause cracking. Always wear protective gloves and make sure there is sufficient ventilation when cleaning vinyl. Wear eye protection.

Remember that suntan oil will damage vinyl. Use suntan lotion instead of suntan oil. Exposure to the sun is a natural enemy of vinyl upholstery. Keep the vessel covered with a cockpit cover when not in use

Cockpit Carpet

Use approved cleaners on carpet. Always try on a test area first. Many spots and spills can be removed using a cleaner combined with a clean, white terry towel. Try not to soak an area excessively and do not use solvents because most interior carpet is rubber backed and glued in place. Solvents and abrasives will break down the backing and fibers.

Note: Remove cockpit carpet before towing boat without the travel cover.

Plastics

Use plastic cleaners and polishes recommended for marine use only. Use proper applicators. Read all instructions carefully. Test the product in a small area first. Use a soft rag and always rinse the surface with water. Ammonia based cleaners and abrasives will damage plastic parts.

NOTICE

NEVER CLEAN PLASTIC SURFACES WITH A DRY CLOTH OR GLASS CLEANING SOLUTIONS CONTAINING AMMONIA. NEVER USE SOLVENTS OR WIPE WITH ABRASIVES



Cosmetic Care & Maintenance

Interior Fabrics

Clean flat good interior fabrics with dry cleaning fluid style cleaners approved for use with soft fabrics. Allow adequate ventilation and follow the label instructions carefully. Use a soft cleanser with feldspar to clean stubborn marks or stains on wallpaper. Normal interior vinyl such as used on the headliner on cruisers and head clean up with a mild soap and water solution. Rinse immediately with clean water and wipe dry. Always test an area with a cleaner before applying it to a larger area.

Fiberglass & Gelcoat

	CAUTION
<p>AVOID BODILY INJURY! WAXED GELCOAT SURFACES CAN BE VERY SLIPPERY. DO NOT WAX NORMALLY USED AREAS OF THE DECK, LINER, OR GUNWALES. DO NOT WAX ANY TEXTURED OR NONSKID SURFACES SUCH AS FLOORS, WALKWAYS, STEPS, LADDERS OR SWIM PLATFORMS. WEAR NON-SLIP FOOTWEAR WHEN WALKING ON VESSEL SURFACES.</p>	

Routine maintenance is the only practical way to keep the surface of your boat looking shiny and new. Most objects left outdoors will gradually deteriorate from exposure to the sun, water, dust and pollution. Such outdoor exposure can cause your boat's gelcoated surface to change or fade. Darker colors tend to fade more rapidly than lighter colors because they absorb more of the sun's rays (ultraviolet and infrared). Basic maintenance includes monthly washing of the boat's surface to remove normal accumulation of soil and stain.



CHAPTER 7

Use a mild detergent such as dishwasher powder or liquid. Do not use automatic dishwasher detergent. Avoid any kind of alkaline cleaners such as trisodium phosphate (TSP), abrasives, bleaches and ammonia. For best results use cleaners that are recommended for fiberglass.

NOTICE

WIRE BRUSHES, SCOURING PADS, OR OTHER ABRASIVE TYPE MATERIALS AND SOLUTIONS SHOULD NEVER BE USED ON THE HULL OR DECK OF YOUR BOAT. THEY CREATE SMALL SCRATCH MARKS THAT WILL COLLECT MARINE GROWTH AND OTHER FOREIGN MATERIALS.

It is recommended that you wax the gelcoat surface twice yearly to prevent loss of gloss and to protect the finish. Use only waxes for fiberglass and follow the label instructions. Apply a 3' x 3' section at a time using clean applicator cloths or a buffing bonnet. When a haze develops, use a power buffer at low speeds (1200-2000 rpm) to remove the haze. Keep the buffer moving to avoid heat buildup. The power buffer is very efficient at removing contaminants from gelcoat. Never wax gelcoat in the direct sun.

When the washing and waxing as recommended does not restore the shine it may be necessary to use a fine rubbing compound. Do not apply rubbing compound in direct sunlight. A power buffer at low speed does an excellent job to remove impurities from the gel coat that cause dulling. Use light pressure and keep the buffer moving. Re-wax after compounding to buff the surface.

“Hairline cracks” or “spider webbing” could develop in the gelcoat surface of a hull or deck. This can be caused by impact or other factors. Small air pockets or gouges may also occur through **normal** wear.



Cosmetic Care & Maintenance

These do not affect the strength of the hull or deck and can be repaired by yourself, a marine professional or a Regal dealer.

The affected area should be chipped or sanded away and a thin layer of color matched gelcoat applied. This layer is then sanded smooth and buffed to its original luster.

Most minor scratches, nicks, and dents can be removed by compounding the surface. Marine type compounds can be found at most auto body supply stores. Specify a number 25 which is a coarser compound up to a number 55 being less coarse. Various glazes and polishes are available as needed. Ask your marine professional or Regal dealer for more information. Fiberglass hulls are strong but they can be damaged. A fiberglass hull has virtually no internal stresses. Thus when a part is broken or punctured, the rest of the hull retains its original shape. A severe blow will either be absorbed or result in a definite localized break. A break of this nature should be checked and repaired by a marine professional or a Regal dealer.

Minor Repairs

You will need the following materials for minor repairs:

- Gelcoat
- Clear Liquid Catalyst
- Putty Knife
- Razor Blade
- Fine Sandpaper (400,600,1000)
- Wax Paper (to cover repair area)



WARNING

AVOID BODILY INJURY!
GELCOAT & FIBERGLASS RESIN ARE FLAMMABLE.
WORK IN A WELL VENTILATED AREA FREE FROM
OPEN FLAMES. DO NOT SMOKE!



CHAPTER 7

For minor repairs refer to the following procedure:

1. Clean the area to be repaired and get rid of any wax or grease residues.
2. Clean out scratches, chips, and nicks.
3. Sand area to be repaired so gelcoat will bond.
4. In a separate container, measure only the amount of gelcoat you will need. Mix a ratio of 2% ratio of catalyst to the amount of gelcoat being used (a spoonful of gelcoat will require only a drop or two of catalyst). Do not pour any unused portions of the gelcoat/catalyst mixture back into either original container.
5. Apply gelcoat to area leaving a slight lift above the surface.
6. Cover the area with wax paper. It will help the mixture to set up faster.
7. Remove wax paper and shave off any extra gelcoat with a razor blade.
8. After the area is shaved smooth, start with the 400, 600, and finally 1000 grit sand papers.
9. Buff the area with compound, polish and a finish wax. You may notice a difference between the repaired area and the original finish due to the natural weathering process.



Cosmetic Care & Maintenance

Canvas

Boat canvas is in most cases subjected to more severe punishment than practically any other type of material. Moisture, dirt and chemicals from industrial fallout, heat, ultraviolet rays and salt water are all factors which accelerate the deterioration of your boat canvas.

These elements can cause serious damage if left unchecked.

The boat top and other canvas supplied on your Regal boat are manufactured from top quality materials to provide you with years of trouble free service. The following information on the care, cleaning and proper storage of the fabrics and fasteners that make up your marine canvas is being provided to help you maintain the appearance and ease of operation.

Sunbrella is used on most Regal tops, aft curtains, camper enclosures, bow tonneaus and cockpit covers. Sunbrella is a woven fabric made from 100% solution dyed acrylic fiber. It is color fast and will withstand long term exposure to the sun (ultraviolet rays) without excessive fading.

Sunbrella is a woven fabric. Even though it is treated with water repellency some "misting" through the fabric is typical. With new canvas, the greatest potential for leakage is through the sewn seams. Because Sunbrella and the long term thread used is synthetic, the holes created by sewing will not swell up and seal when exposed to water as cotton does. Usually the movement of the fabric in use will move the fibers enough to seal the holes. You may apply Apsel or Uniseal to the seams to speed up this process.

When the canvas is new, the fit will normally be tight. It is designed this way because Sunbrella stretches as it ages. The initial tight fit allows for a suitable fit for the life of the canvas. The Sunbrella fit will vary slightly in the heat, cold, and rain.



CHAPTER 7

Sunbrella Cleaning Instructions

Sunbrella should be cleaned regularly before substances such as dirt, roof particles, etc., are allowed to accumulate on and become embedded in the fabric. The fabric can be cleaned without being removed from the boat. Simply brush off any loose dirt, hose down, and clean with a mild solution of natural soap in lukewarm water. Rinse thoroughly to remove soap. **DO NOT USE DETERGENTS!** Allow to air dry.

For heavily soiled fabric, remove the top from the frame.

Soak the fabric in a solution that has been mixed to the following proportions: 1/2 cup of bleach and 1/4 cup of Ivory or Lux soap (liquid or soap) per each gallon of lukewarm water. Allow the fabric to soak until the bleach has killed the mildew and the stains can be brushed out with a common kitchen scrub brush. Rinse the fabric thoroughly in cold water to remove all the soap. This may require several rinsings. Incomplete rinsing can cause deterioration of sewing threads and prohibit the fabric from being properly retreated. Allow the fabric to dry completely. **DO NOT STEAM PRESS OR DRY IN AN ELECTRIC OR GAS DRYER!** Excessive heat can damage and shrink the fabric since it is heat sensitive.

This method of cleaning may remove part of the water and stain repellent that was applied to the fabric during its manufacture. It is recommended to retreat with such water repellency products as Apeal and Uniseal. We do not recommend any wax based treatments such as Thompson's Water Seal or any of the silicone products such as SC-15 or Aqua-Tite. Wax based products prevent the fabric from breathing, and encourage mildew growth while the silicone products interact with the original fluorocarbon finish and seem to cause a rapid loss of water repellency.



Cosmetic Care & Maintenance

Clear Vinyl, Zipper & Snap Care

Never store canvas wet or in an unventilated, moist area. Always roll the canvas instead of folding. This is of particular importance on side curtains or any other part with the clear vinyl “glass”. Roll the top carefully around the bows and cover with the storage boot provided.

The clear vinyl “glass” used in side curtains, aft curtains, visors, and camper enclosures is very susceptible to heat and cold. Keep vinyl curtains from touching metal tubing to minimize burning the vinyl.

If the boat is stored with top, side curtains and aft curtain in place, heat build up inside the boat may discolor the vinyl.

To clean the clear “vinyl” glass, use a solution of Ivory or Lux soap, liquid or flakes, and lukewarm water. Allow to air dry. Never use any type of abrasive cleaner as it will scratch the “vinyl” glass. There are many cleaners and scratch removers on the market specifically for clear vinyl. Handle the clear curtains carefully. They are soft and prone to scratching.

Canvas parts are designed with zippers. When zippers are new they can be a little difficult to use. Zip carefully without forcing the zipper or the material. They will loosen with use. A zipper lubricant may be used to help new zippers as well as maintaining used ones. The most vulnerable part of the zipper is the starts. Use care when beginning to close the zipper.

Canvas snap fasteners should be unsnapped as close to the button as possible. Never remove canvas by pulling roughly on the edge of the material. This can damage the canvas as well as the fasteners. Use petroleum jelly on snaps to keep them from developing corrosion especially in harsh environments.



CHAPTER 7

Hull Bottom

Never use wire brushes or highly abrasive scouring pads on your hull bottom. It could damage the gel coat surface or the bottom paint. The bottom of your boat needs to be clean since the build up of natural coatings from water or marine life can potentially create drag and affect your boat's performance. Contact a marine professional or Regal dealer for more information.

Metal

Keep all stainless steel and other metal parts rinsed and wiped dry. To maintain their finish annually polish the stainless steel and other bright works at least annually. Use commercially available metal products and read the labels carefully before use. Refer to the flyer in the owners information pouch. Most marinas and boating retail outlets carry metal care products.



Cosmetic Care & Maintenance

FREQUENT STAINS/CLEAN-UP STEPS	1	2	3
Coffee, Tea, Chocolate.....	B		
Permanent Marker*.....	E	B	C
Household Dirt.....	A	B	
Grease.....	D	B	
Ketchup, Tomato Products.....	A	B	
Latex Paint.....	A	B	
Oil Base Paint.....	D	B	
Mustard.....	A	B	C
Suntan Oil.....	A	B	
Asphalt/Road Tar.....	D	B	
Crayon.....	D	B	
Engine Oil.....	B		
Spray Paint.....	B		
Chewing Gum.....	D	A	
Shoe Polish*.....	D	B	
Ballpoint Pen*.....	E	B	A
Lipstick.....	A	B	
Eyeshadow.....	E	B	
Mildew*.....	C	B	A
Wet Leaves *.....	C	B	A

A= Soft brush; warm soapy water/rinse/ dry

B= Fantastik cleaner

C= One tablespoon ammonia, 1/4 cup of hydrogen peroxide, 3/4 cup of warm water/ rinse/dry

D= Scrape off residue (use ice to lift gum)

E= Denatured alcohol/rinse/dry

* These products contain dyes which leave permanent stains.



CHAPTER 7

MAINTENANCE

Engine

Each engine package is unique and quite complex. A select portion of the maintenance items are covered in this chapter. Many times because of the advanced ignition and fuel injection systems used on marine engines it is best to use trained marine professionals. This is especially true with the new DTS and EVC systems. For more detailed information, refer to the manufacturer's engine owner's manual.

Stern Drive

The stern drive unit should be checked before each outing. Tilt up the drive and check for any debris around the intake and any fish line tangled in the propeller. Check your engine manual for stern drive maintenance schedules.

Propellers

Out-of-balance or nicked props will effect performance or cause vibration. Damaged props should be replaced, but those that are chipped or bent can usually be reconditioned by propeller repair facility. When cruising, consider carrying a spare set of props on board because many marinas do not carry a full inventory of replacement propellers. Also, carry an extra set of prop hardware. Refer to the manufacturer's engine manual for appropriate stern drive and inboard propeller replacement.

Be sure to make a note of the propeller diameter and pitch while the vessel is in dry dock. They are pressed into the prop for easy reading. In an emergency a stainless steel propeller blade may be able to be straightened by laying the propeller blade on a 2 x 4 and hammering the bent portion of the blade until straight. This procedure will assist the operator in reaching port so he can have the propeller re-pitched.



Cosmetic Care & Maintenance

VOLVO DUO PROP INSTALLATION

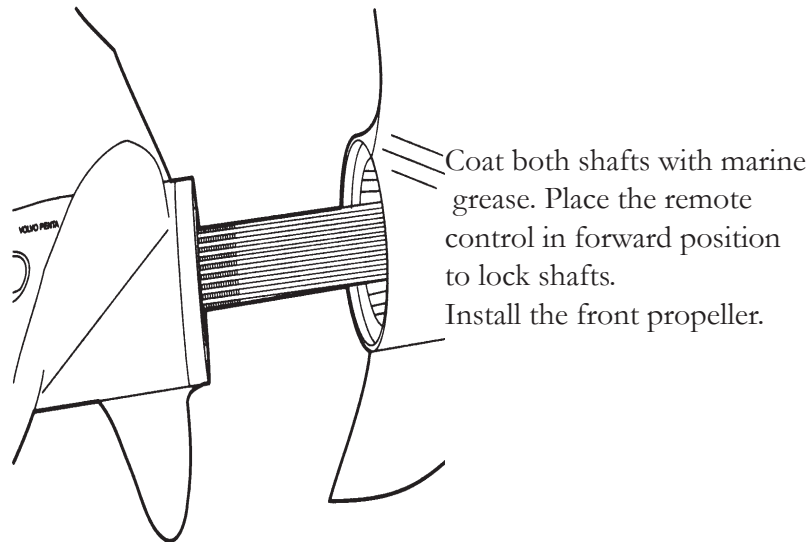

Coat both shafts with marine grease. Place the remote control in forward position to lock shafts. Install the front propeller.

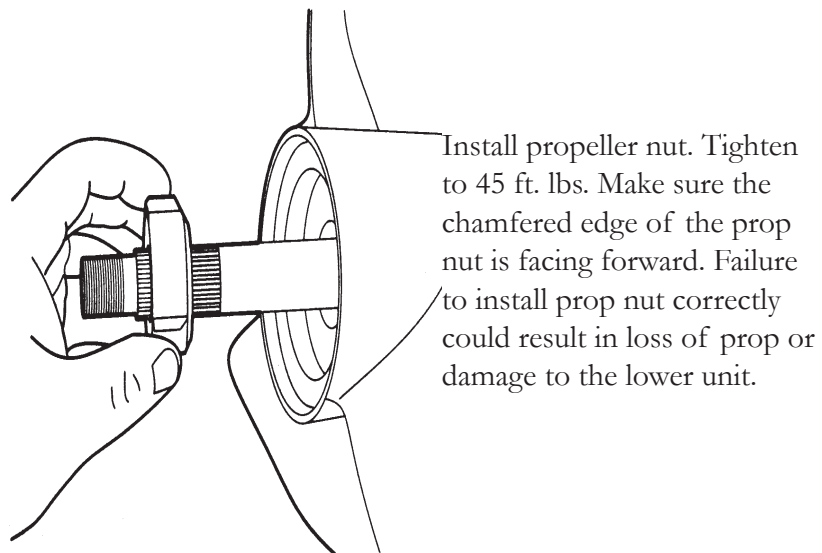

Install propeller nut. Tighten to 45 ft. lbs. Make sure the chamfered edge of the prop nut is facing forward. Failure to install prop nut correctly could result in loss of prop or damage to the lower unit.



CHAPTER 7

VOLVO DUO PROP INSTALLATION

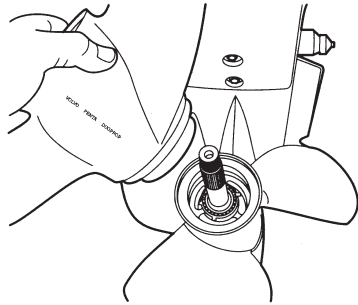

Shift remote control to reverse to lock the propeller shaft. Install the rear propeller.

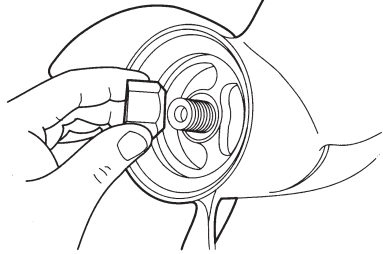

Install the rear propeller nut and tighten it to 50 foot pounds using a torque wrench. Shift the remote control to neutral. The propeller should turn freely.



Cosmetic Care & Maintenance

MERCUISER BRAVO THREE

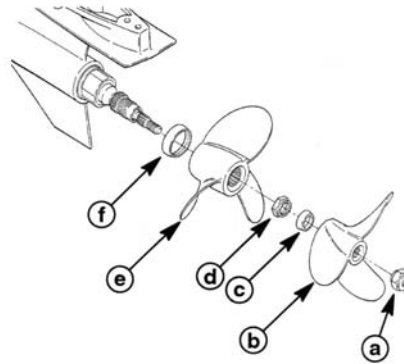

Bravo Three

- a - Rear Propeller Locknut
- b - Rear Propeller
- c - Rear Propeller Thrust Hub
- d - Front Propeller Locknut
- e - Front Propeller
- f - Front Propeller Thrust Hub



CHAPTER 7

Steering

Your boat uses a rack or rotary style steering system featuring a cable that functions with assistance through the engine power steering pump. As you turn the wheel force is applied through the system to a hydraulic cylinder found at the aft end of the engine and attached through the engine power steering pump hoses.

With the engine running, check the engine power steering pump level before each outing. Add the appropriate power steering fluid. Periodically inspect the entire steering system for tightness and signs of wear and leaks including the steering wheel. Lubricate the steering shaft at the engine. Refer to the manufacturer's engine manual in the owner's pouch for additional information along with the maintenance chart in this chapter.

CHECK HOSE CONNECTIONS
FOR LEAKS & TIGHTNESS

CHECK NUT FOR
TIGHTNESS.





Cosmetic Care & Maintenance

Battery

Frequently check your battery terminals for corrosion build-up. If you find a greenish, powdery substance, remove the cable connections and clean both the terminals and the connectors with a wire brush. When the cleaning is finished reconnect the battery cables and coat the terminal with an approved grease or petroleum jelly to help prevent further corrosion. Check the electrolyte level at least every 30 days, more often in hot weather. The level should be maintained between the top of the battery plates and the bottom of the fill cap opening. Add distilled water as needed after charging the batteries or periodically as needed. Do not overfill because sulfuric acid could run over and cause burns or an explosion.

Batteries should be charged outside the boat. Do not smoke or bring flames near a battery that is being or has recently been charged. The hydrogen gas generated by battery charging is highly explosive.

Set batteries on a block of wood rather than concrete since this procedure will help the batteries from losing their charge.

Do not allow a metal object or loose wires to spark across battery posts while working close to the battery. Contact across terminals will cause a short circuit and personal injury may result.

Tighten all battery connectors securely. Check their tightness by pulling on the connectors. They should not move from their tightened position. Be sure to reinstall the positive boot over the battery terminal after tightening the battery post connection. While using the boat, use the volt meter to monitor the charge level of the battery. Monitor the charge with the engines turned off (static condition).

The engine alternators recharge the batteries. A fully charged battery will indicate between 12.3 and 12.6 volts on the voltmeter. Readings below this could indicate a dead battery cell or a charging system malfunction which should be checked by a marine professional.



CHAPTER 7



WARNING

TO PREVENT BODILY INJURY!
BATTERIES CONTAIN SULFURIC ACID (POISON)
WHICH ALSO CAN CAUSE BURNS.
AVOID CONTACT WITH THE SKIN, EYES & CLOTHING.
IF CONTACTED, FLUSH WITH WATER AT LEAST 15
MINUTES. IF SWALLOWED, DRINK LARGE AMOUNTS
OF WATER OR MILK. FOLLOW UP WITH MILK OF
MAGNESIA, BEATEN EGG OR VEGETABLE OIL. GET
MEDICAL ATTENTION IMMEDIATELY!



WARNING

TO PREVENT BODILY INJURY!
WEAR GOGGLES, RUBBER GLOVES
AND A PROTECTIVE APRON
WHEN WORKING WITH A BATTERY.
BATTERY ELECTROLYTE CAUSES SEVERE EYE
DAMAGE AND SKIN BURNS.
IN CASE OF SPILLAGE, WASH AREA WITH
A SOLUTION OF BAKING SODA AND WATER.



Cosmetic Care & Maintenance

Remote Control



Check the helm control box and the cable attachment at the engine for tightness and shifting without binding. This applies to engines with standard remote controls only.

Shift and throttle controls at both the engine and helm areas must be checked on a periodic basis. At the engine end, make sure all control cable hardware is tight and control cable brackets are secure. An application of silicone spray on the cable ends periodically will keep control cables working freely and fights corrosion. At the helm end check to make sure the control box hardware is tightly secured. Contact a marine professional or Regal dealer for further assistance.

Vessels with Mercruiser DTS and Volvo EVC controls require a different type of periodic maintenance. Both of the above systems shift electronically and operate without a control cable in the system. See your closest Regal dealer for maintenance information.



CHAPTER 7

Seating



The bucket seat slider needs periodic inspection and maintenance. Loosen the swivel knob located on the slider and pull the slider off the pedestal. Inspect all fasteners and metal for fatigue. Lubricate the points shown in the illustration with a marine type grease. type of grease will not run off under warm temperatures. Use a paint brush to apply the grease. Also, use silicone spray for areas that can not be accessed with the grease. Reassemble slider to pedestal with the delrin cup positioned correctly.

Reassemble slider to pedestal with the delrin cup positioned correctly.

BUCKET SEAT SLIDER MAINTENANCE

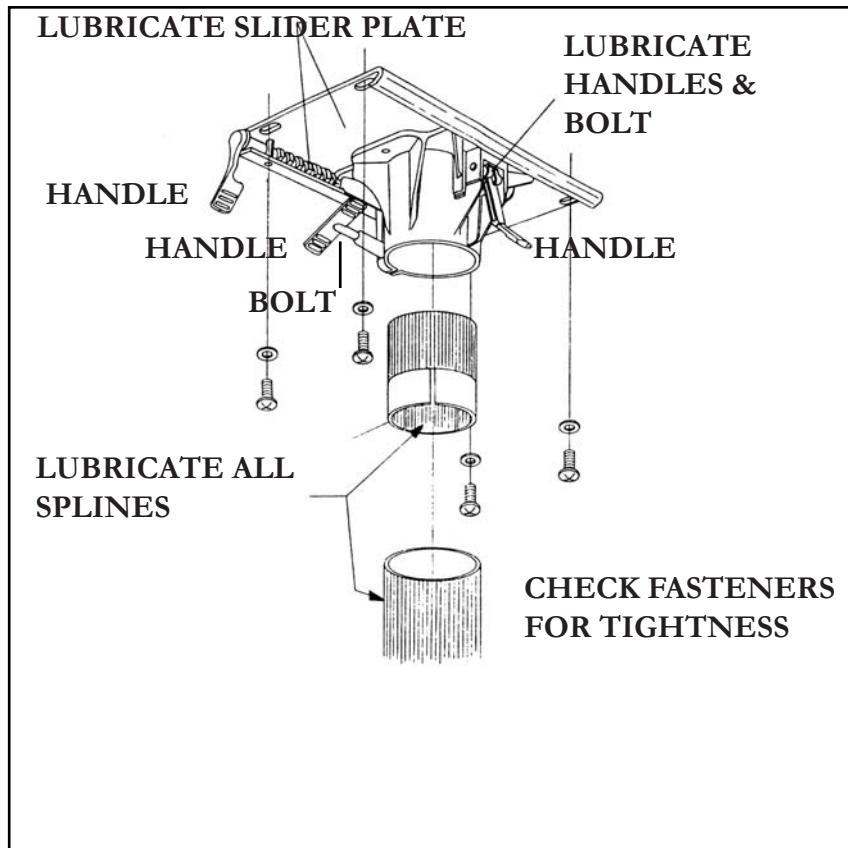



Cosmetic Care & Maintenance

Bilge Pump

The bilge pump is usually installed in the engine compartment just below the engine front. Check for foreign materials stuck in the strainer area or discharge hose.

Check all clamps and electrical connections for tightness. A quick check of the bilge pump automatic float switch is afforded by lifting up on the float and listening for the pump operating. Look around the float area for foreign debris and remove as necessary.

Fuel Tank & Fittings

Periodically inspect the fuel tank components for loose clamps at the vent, fill and feed locations. Examine each hose for signs of deterioration and leakage. Check the fuel sender for loose bolts, nuts, and leaks at all areas of contact. Also, inspect the fuel tank for signs of leakage or abrasion. Tighten all components as needed.

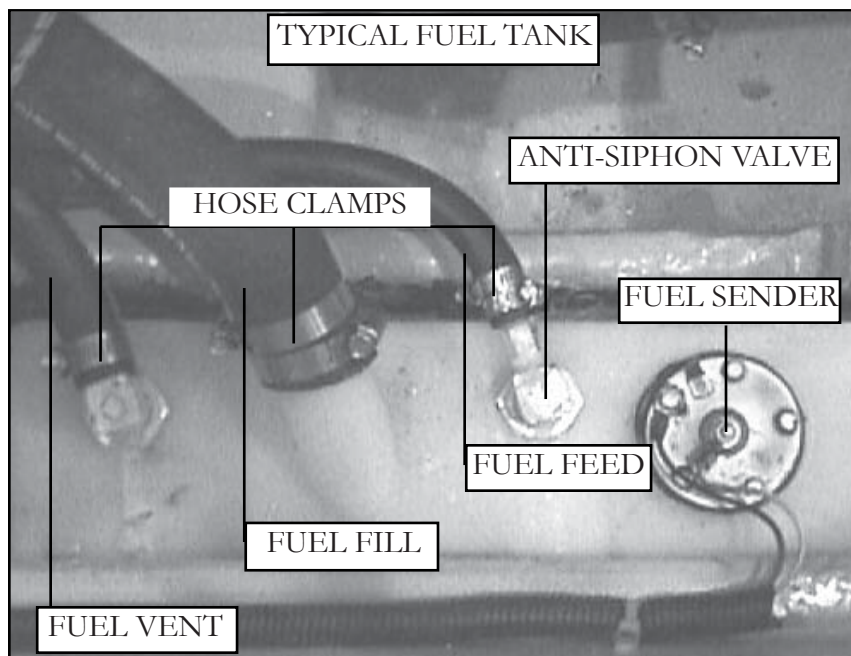



CHAPTER 7

Fuse Panel

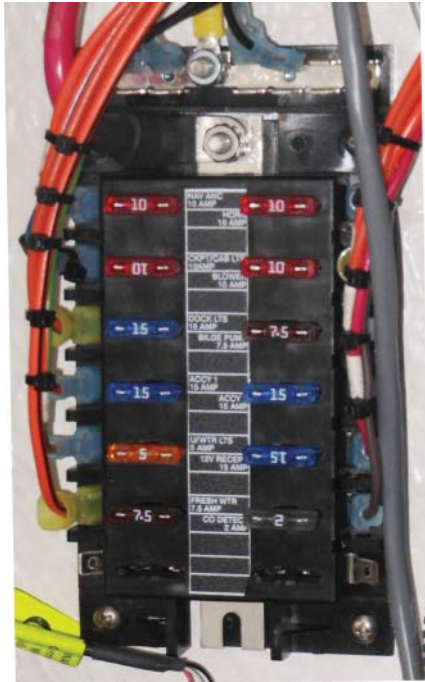

TYPICAL HELM FUSE PANEL

The fuse panel is located under the dash area. On select models the panel can be accessed on the bow side of the helm. Lift the starboard bow seat backrest to access the fuse panel. Fuses are of the automotive type and can be obtained at most auto aftermarket stores or your closest authorized Regal dealer who can order it as a designated fuse pack. It is recommended that you carry all the different amperages. When a fuse “blows” determine the cause before replacing the fuse. Never replace with a higher amperage fuse since the equipment, wiring or even worse a fire could develop due to an overload.



Cosmetic Care & Maintenance

Stereo

The Fusion® stereo head unit requires little maintenance. When washing the cockpit, do not discharge water directly at the stereo unit. Possible damage may result. As with any CD unit clean your CD's to keep them from skipping. This process also aids in keeping dust out of the unit. Never allow water to enter the iPod mechanism behind the head cover.

For further information, refer to your stereo owner's manual located in the owner's packet.



CHAPTER 7

Automatic Fire Extinguisher

Vessels with the automatic fire extinguisher system should check the halon unit for tightness at the engine compartment monthly. At that time the unit itself should be weighed to ensure it is full. If the green dash indicator light is not on when the key is in the ignition position there is a system malfunction that must be investigated immediately. Refer to the manual in the owner's packet

Blower

Check the blower hoses to ensure they are fastened in the bilge properly and there are no holes in them. The hose connected to the blower needs to be positioned about 3/4 of the way down in the bilge to evacuate fumes properly. All vents need to be checked for debris.

Make sure the blower motor is securely fastened and all hose clamps and or tie wraps are tight. Also, check all electrical eyelet connectors for tightness.



Cosmetic Care & Maintenance

Galvanic/Stray Current Corrosion

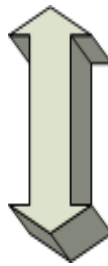
CORROSION TABLE	
Gold	<p>Least Active</p>  <p>Most Active</p>
Stainless Steel	
Bronze	
Copper	
Brass	
Steel	
Aluminum	
Zinc	
Magnesium	

Metal parts underwater can be subjected to two basic styles of electrolysis: galvanic corrosion and stray current corrosion. Both can damage the drive, propeller, underwater parts, boat and motor if not correctly monitored (testing at 2 week intervals) and avoided.

Galvanic corrosion is an electrochemical reaction between two or more metals. Drive systems consist of several different metals. Some are more active than others.

Galvanic corrosion of the more chemically active metals can occur whenever two or more dissimilar metals that are “grounded” (connected by actually touching each other, or through a wire or metal part) are immersed in a conductive solution (any material that can conduct electricity). Anything but pure water is conductive. Saltwater, fresh water with a high mineral content and polluted freshwater are highly conductive. Conductivity increases with temperature. That is why Florida boats experience more corrosion than boats in Maine.

Specifically look at a typical marine drive unit with a stainless steel propeller. The aluminum is the more chemically active metal (called the anode) and the stainless steel propeller is the less chemically active metal (called the cathode).



CHAPTER 7

Typically electrons flow from the anode (the aluminum drive unit), via the external conducting path to the cathode (stainless steel propeller). If there is a very large anode connected to a small cathode, the anode will corrode very slowly. If a very large cathode is connected to a small anode, the anode will corrode very quickly. Obviously, if you do not control galvanic corrosion, over time the aluminum will corrode away.

The first sign of galvanic corrosion is paint blistering (starting on sharp edges) below the water line- a white powdery substance forms on the exposed metal areas. As the corrosion advances, the exposed metal will become deeply pitted as the metal is actually eaten away.

Another condition which will increase galvanic corrosion is the removal or reduction in surface area of the sacrificial anodes. Never add aftermarket products that are connected to the engine ground such as stainless steel steering aids and trim planes.

Zinc connected to aluminum will form a corrosion cell but the aluminum (drive) becomes the cathode and the zinc (anode) corrodes.

Even though your boat may not have shore power aboard current from nearby vessels with shore power can produce stray current galvanic corrosion. Stray current corrosion occurs when metal with an electrical current flowing into it is immersed in water that is grounded (lake, ocean, pond). The current can leave the metal and flow through the water to ground. This will cause rapid corrosion of the metal at the point where the current leaves.

When a vessel nearby is plugged into shore power, they can potentially tie your aluminum drive unit to their boat via the green grounding shore power lead. Your aluminum drive unit could be the receiving end of a large galvanic cell (a battery) interconnected with nearby vessels or even through the marina's metal structures via their electrical system.



Cosmetic Care & Maintenance

The vessel should be tested every couple of weeks to determine the integrity of the anode protection system. If not installed, Volvo and Mercury offer an optional corrosion protection system that utilizes the anode/cathode theory to assist in offsetting galvanic corrosion.

Another way to test the system is to measure the hull potential. This is accomplished by immersing a reference electrode, usually a silver/silver chloride into the water about six inches behind the drive. With leads attached to a digital multi-meter the hull potential is read on the DC scale and compared to recommended specifications for the water body type. See the owner's information vendor packet for more information or contact your nearest authorized Regal dealer.

Tips To Maintaining Galvanic Integrity

1. *Test the galvanic integrity of your vessel every 2 weeks.* Raise the outdrive and inspect anodes/parts for signs of galvanic corrosion, stray current corrosion or loose fasteners. *Contact your closest Regal dealer/marine professional where signs of galvanic corrosion exist.*
2. Never paint over anodes as they will become inoperative. Always leave at least one inch between bottom paint and any underwater fitting such as seacocks, swim platform stanchions and all drive and propulsion related underwater parts.
3. Periodically remove vessel from water and clean/pressure wash all outdrive, anode and hull bottom areas to remove growth.
4. Ensure vessel is using the correct anode metal for the body of water that it is moored. See the engine/drive manufacturer information packets for more information or contact an authorized dealer.
5. Ensure that the drive is completely "in" down to provide more complete anode protection when vessel is moored.
6. Do not attempt to use magnesium anodes in saltwater. They will provide overprotection.



CHAPTER 7

7. If marina moored, contact appropriate personnel if signs of galvanic corrosion appear on your drive system. Ask them to check for stray electrical current which may be arising from a nearby vessel's faulty DC wiring or from a marina pier, piling or dock carrying leaking marina ground wiring.

GALVANIC/STRAY CURRENT CORROSION	
<i>Cause/Observed Condition</i>	<i>Corrective Action</i>
Sacrificial anodes consumed	Replace anodes when 30% consumed
Sacrificial anodes not grounded to drive	Remove anodes, clean contact surface, reinstall, check for continuity
Loss of continuity between underwater parts & ground	Provide good ground connections
Nearby vessel with stray current	Contact appropriate personnel Remove your vessel from water
Paint on drive heavily worn, exposing more metal	Prime and repaint or install additional anodes
Sacrificial anodes painted	Remove paint or replace anodes
Drive tilted/anodes out of water	Leave drive down, install additional anodes below water
Power trim cylinders only corroded	Provide a good ground to drive, all parts must be grounded
Corrosion in area of exhaust outlets	Remove deposits
Corrosion occurring after vessel is removed from saltwater	Wash exterior and flush interior with freshwater
Stainless steel parts corroding	Clean parts, remove foreign material, ensure continuity
Underwater drive parts corroded, sacrificial anodes OK	Oxide film on anode (fresh water only) Replace anode Poor grd. Remove/scrape anode



Cosmetic Care & Maintenance

Zinc Anodes

Sacrificial zinc anodes are located on the stern drive housing, trim cylinders and/or propshaft to protect softer metals exposed to the water. Electrolysis attacks the least noble metals first. Because zinc is a less noble metal, it will decompose before other metals. Check these zinc anodes periodically and have them replaced when they are 30% consumed. Notwithstanding, zinc is the most popular metal used to protect parts that are exposed to saltwater, freshwater or brackish water.

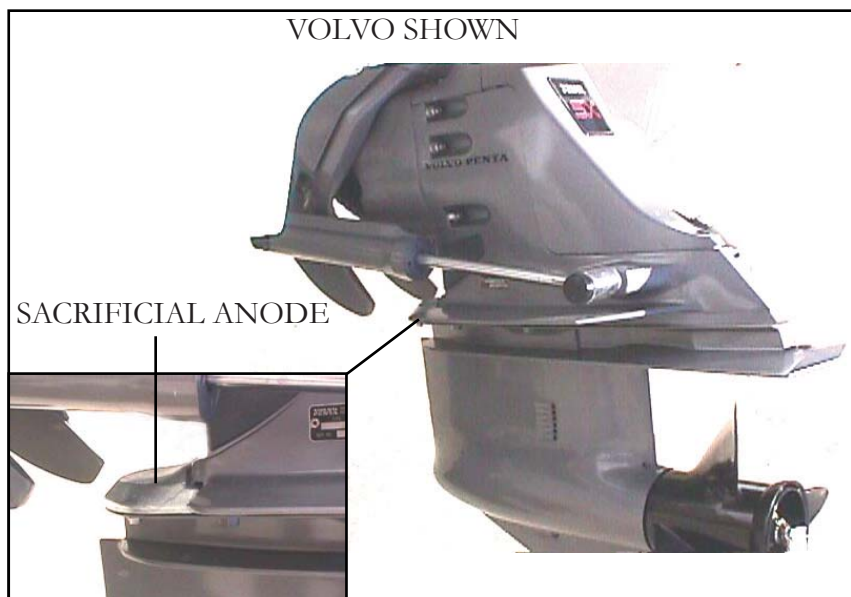

Zinc anodes in brackish or salt water need to be checked more frequently. If the anodes seem to be requiring frequent replacement there may be a boat leaking DC current into the water taxing the anodes. This is especially possible around a marina environment. Contact a marine professional who can measure the galvanic activity with a special electrode and electric VOA meter. Refer to the engine manufacturer's manual for exact anode location and detailed information. **Stern drive or related parts damage due to galvanic or stray current corrosion is not covered under the Regal limited warranty.**



CHAPTER 7

VOLVO MAINTENANCE GUIDE

FUNCTION	ADJUST	CHECK	LUBE	FILL	REPLACE	TIGHTEN
<i>Each Trip</i>						
Anodes		*				
Leaks, Cooling System		*				
Stop Switch		*				
Leaks, Fuel System		*				
Oil, Engine		*		*		
Oil, Drive		*		*		
Safety Equipment		*				
Shift System		*				
Fluid, Power Steering		*		*		
Steering Cable		*				
<i>Monthly</i>						
Battery		*				
Exhaust Sys		*				*
<i>Every 50 Operating Hours</i>						
Battery Connections		*				*
All Belts		*				*
Exhaust System Hoses, Clamps		*				*
Fasteners		*				*
Fuel System		*				
Water Pump Impeller		*			Every 2 years	



Cosmetic Care & Maintenance

VOLVO MAINTENANCE GUIDE CONT.

FUNCTION <i>Per Season</i>	ADJUST	CHECK	LUBE	FILL	REPLACE	TIGHTEN
Bellows & Clamps Drive		*			Every 2 Years	
Exhaust Manifold, Risers		*				
Carb, Fuel Filter					*	
Water Pump Impeller					Every 2 Years	
Leaks, Fuel System		*				
Oil, Engine					See Volvo Engine Operation Manual	
Oil, Drive						
Oil Filter, Engine						
Propeller & Shaft		*	*			
Remote Control Cable		*				
Spark Plugs					*	
Spark Plugs Wires, Boots		*				
Steering System Cable			*			
Throttle Cable		*	*			
Serpentine where applicable		*				
Carb Adj.	*					
Engine Alignment		*				
Gimbal Bearing			*			
Universal Joints & Splines		*				



CHAPTER 7

MERCUISER MAINTENANCE GUIDE

	EACH TRIP	WEEKLY	EVERY 2 MTHS.	EVERY YEAR (100 HRS)	EVERY 3 YRS. (300 HRS)	EVERY 2 YRS.	EVERY 5 YRS.
Oil, Engine	*						
Oil, Drive	*						
Oil, Trim Pump	*						
Fluid, Power Steering	*						
Salt Usage, Flush Cooling	*						
Water Pick-Ups		*					
Anodes		*					
Fuel Pump Site Tube		*					
Battery Connection		*					
Propeller Shaft/Nut			*				
Engine, Corrosion Guard			*				
Touch-Up Paint				*			
Engine Oil & Filter				*			
Drive Oil, Change				*			
Fuel Filter, Replace				*			
Steering & Remote Control				*			



Cosmetic Care & Maintenance

MERCUISER MAINTENANCE GUIDE CONT.

	EACH TRIP	WEEKLY	EVERY 2 MTHS.	EVERY YEAR (100 HRS)	EVERY 3 YRS. (300 HRS)	EVERY 2 YRS.	EVERY 5 YRS.
U-Joints, Splines & Bellows				*			
Lube Gimbal Bearing & Engine Coupler				*			
Test MerCathode Bravo's				*			
Engine Mounts, Retorque				*			
Check ignition parts, timing				*			
PCV Valve, Replace				*			
Flame Arrestor, Clean				*			
Belts, Inspect				*			
Leaks & Tightness, Exhaust Sys.				*			
Disassemble Seawater Pump				*			
Leaks & Tightness, Cooling System				*			
Clean seawater section, cooling system				*			
Replace Coolant						*	
Lube U-joints				*			



CHAPTER 7

Engine

Each engine and stern drive package is unique and quite complex. A select portion of the maintenance items are covered in this chapter including lubrication specifications and general periodic maintenance. Because of the advanced ignition and fuel injection systems used on marine engines it is best to contact your Regal dealer for more of the detailed service procedures.



CAUTION

AVOID ENGINE DAMAGE!
FOLLOW ALL ENGINE BREAK-IN PROCEDURES
AS RECOMMENDED BY THE ENGINE MANU-
FACTURER. FAILURE TO FOLLOW THE BREAK-
IN PROCEDURE MAY VOID THE ENGINE AND
STERN DRIVE WARRANTY.



CAUTION

AVOID ENGINE DAMAGE!
DO NOT RUN ENGINE AT A CONSTANT RPM
FOR PROLONGED PERIODS OF TIME DURING
BREAK-IN PERIOD. CHECK ENGINE OIL OFTEN.



CAUTION

AVOID ENGINE DAMAGE!
DO NOT RUN ENGINE OUT OF WATER UNLESS
YOU HAVE AN OPTIONAL FLUSHETTE.
FOLLOW MANUFACTURER'S ATTACHING &
RUNNING INSTRUCTIONS.



Cosmetic Care & Maintenance

Recommended Lubricant Specifications

Volvo Engine

Checking the Engine Oil

VOLVO ENGINE OIL CHART		
Lowest Anticipated Temperature	Recommended SAE Viscosity Oils	
32 Degrees F & Above	SAE 30* SAE 20W50 SAE 15W50	Volvo 3.0 uses approximately 4 quarts with oil filter. Volvo 4.3 uses approximately 4.5 quarts with oil filter. Volvo 5.0, 5.7 use approximately 6 quarts with oil filter.
0 Degrees To 32 Degrees F	SAE 20W20	Volvo 8.1 uses approximately 9 quarts with oil filter.
Below 0 Degrees F	SAE 10W	

Refer to the Volvo engine operator's manual for oil viscosity and type or contact your closest Regal or Volvo marine authorized dealer.

1. Remove the dipstick. The oil level must lie between the 2 marks on the dipstick. Add the recommended oil to maintain the proper level.
2. Recheck the engine oil dipstick level.

Note: All fluid recommendations are based on this manual's printing date. Regal is not responsible for the accuracy of the information since it can change at any time. For more detailed information and procedures check your engine operator's manual or contact your closest Regal dealer.



CHAPTER 7

NOTICE

PREVENT ENGINE DAMAGE!
DO NOT ALLOW THE CRANKCASE OIL LEVEL TO RECEDE BELOW THE ADD MARK, AND DO NOT FILL ABOVE THE FULL MARK. OVERFILLING RESULTS IN REDUCED ENGINE LIFE, HIGH OPERATING TEMPERATURES, FOAMING & LOSS OF POWER.

Checking the Power Trim/Tilt Fluid Level

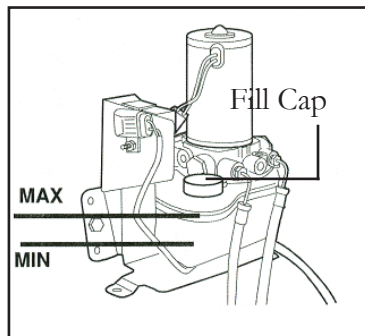

1. At least once annually preferably at the start of the boating season check the system fluid level. Begin with the stern drive trimmed in (down) as far as possible.
2. Remove the fill cap on the power trim pump reservoir.
3. Check the fluid level. It should be between the minimum and maximum marks on the reservoir.
4. Add Volvo Penta DuraPlus Power Trim/Tilt and Steering Fluid as required.
5. Replace the fill cap and tighten cap securely.



Cosmetic Care & Maintenance

Checking Power Steering Fluid

1. Check the power steering fluid before each boating outing. Remove the steering reservoir and check the fluid level. If the engine has not been running use the “COLD” mark. Use the “HOT” mark for engines that have been running at normal operating temperature as indicated by the temperature gauge.
2. The fluid should be between the minimum and maximum marks on the dipstick. If needed, fill to the proper level with Volvo Penta Dura Plus Power Trim/Tilt & Steering Fluid. DO NOT OVERFILL THE STEERING PUMP RESERVOIR.



CAUTION

PREVENT STEERING OPERATION IMPAIRMENT
OR COMPONENT DAMAGE!
NEVER FILL THE POWER STEERING SYSTEM
WITH AN UNKNOWN OIL.

3. Replace the fill cap and tighten securely.

NOTICE

HELPFUL HINT:
TO FILL TRIM, CRANKCASE & POWER STEERING
LEVELS WITHOUT SPILLING FLUID
PURCHASE A FUNNEL AT AN AUTOMOTIVE
STORE WITH A LONGER NECK THAT WILL FIT THE
RESERVOIR OPENINGS.



CHAPTER 7

Volvo Stern Drive

Checking Volvo Stern Drive Oil

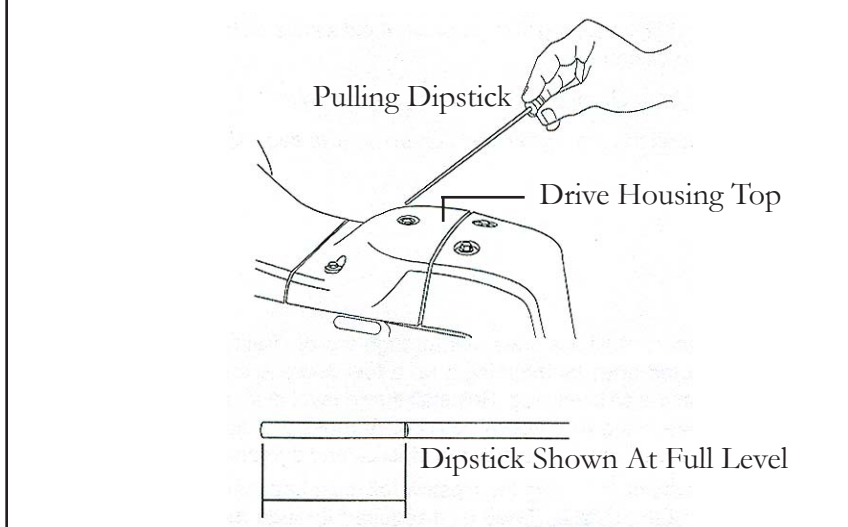

CAUTION

FULLY THREAD OIL DIPSTICK INTO THE OIL LEVEL HOLE IN THE DRIVE UNIT TO PROPERLY CHECK THE OIL LEVEL. IMPROPER OIL LEVELS MAY RESULT IN SERIOUS STERN DRIVE COMPONENT DAMAGE.

It is recommended to check the drive oil level on a weekly schedule. Fully thread the dipstick into the hole. At this point, remove the dipstick and make sure the oil level is at the top of the mark as shown above. If the oil level is low, add enough oil to bring the level to the top of the mark on the dipstick. **DO NOT OVERFILL.** Tighten up the dipstick with a slotted screwdriver.

If the oil color is milky in appearance there probably is water in the unit normally caused by a leaking seal.

No metal flakes should be present in the oil. If the above conditions exist contact a Regal dealer.



Cosmetic Care & Maintenance

MerCruiser Engine

Checking Engine Crankcase Oil

1. Check the engine oil by first allowing the engine to warm up. Stop the engine and allow about 5 minutes for the oil to drain to the oil pan to obtain an accurate reading.
2. Remove the dipstick. Wipe it clean and reinstall it into the dipstick tube. Wait 1 minute to allow any trapped air to vent. (Install dipstick with oil indication marks facing the flywheel end of the engine. Add engine oil type and viscosity as recommended in the engine operator's manual. to the full or OK points on the oil dipstick.
DO NOT OVERFILL!
3. Remove the dipstick and look at the oil level. Level must be between full or OK range and add. Reinstall dipstick into the tube.

NOTICE

ADDING 1 QUART OF ENGINE OIL WILL RAISE
THE OIL LEVEL FROM THE ADD MARK
TO THE TOP OF THE OK RANGE.

4. When checking or filling the engine crankcase oil ensure that the vessel is level in the water or on a trailer.

For changing the engine oil & filter see the MerCruiser maintenance schedule and operation manual or contact your Regal dealer.

Note: Above are basic recommendations. Regal is not responsible for the accuracy of the information since it can change at any time. For more detailed information and procedures check your engine operators manual or call your closest Regal dealer.



CHAPTER 7

Checking MerCruiser Stern Drive Oil



CAUTION

ENVIRONMENTAL HAZARD!
DISCHARGE OF OIL OR OIL WASTE
INTO THE ENVIRONMENT IS RESTRICTED BY
LAW. DO NOT SPILL OIL OR OIL WASTE INTO THE
ENVIRONMENT WHEN USING OR SERVICING
YOUR VESSEL. DISPOSE OF OIL OR OIL WASTE
AS DEFINED BY LOCAL & STATE AUTHORITIES.

1. Drive oil level must be checked with the engine cold before starting.
2. Check the gear oil level in the reservoir located on the engine. Keep the gear oil level at the recommended ranges as marked on the reservoir. If any water is visible at the bottom of the reservoir or there are any metal chips in the drive oil do not run the engine since component damage can result. Contact your Regal dealer for more information.

Filling the Stern Drive

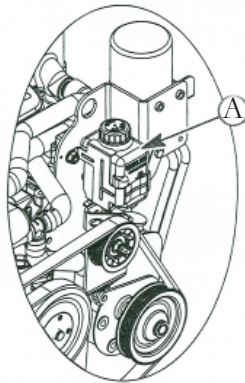

1. If more than 2 ounces of High Performance Gear Lubricant is required to fill the monitor reservoir a seal may be leaking. Contact your Regal dealer.
2. If drive lubricant is free from water and metal chips proceed to fill the reservoir. Remove the gear lube monitor cap. Fill the reservoir with High Performance Gear Lubricant (Merc part # 92-802854A1).

A=Drive Reservoir



Cosmetic Care & Maintenance

3. Fill the reservoir so that drive oil level is in the operating range. Do not overfill reservoir. For changing the drive oil refer to the MerCruiser operation manual or contact a Regal dealer for more information.

Checking Power Steering Fluid

1. Stop the engine and center the sterndrive unit.
2. Remove the combo fill cap/dipstick and observe the level.
 - a. Proper fluid level with engine at normal operating temperature should be within the warm range.
 - b. Proper fluid level with engine cold should be within cold range.
3. Fill to line with Quicksilver Power Trim & Steering Fluid (Merc # 92-802880A1) or Dextron III automatic transmission fluid. If you can not see any fluid in the power steering reservoir contact your Regal dealer since a leak must of developed in the system.

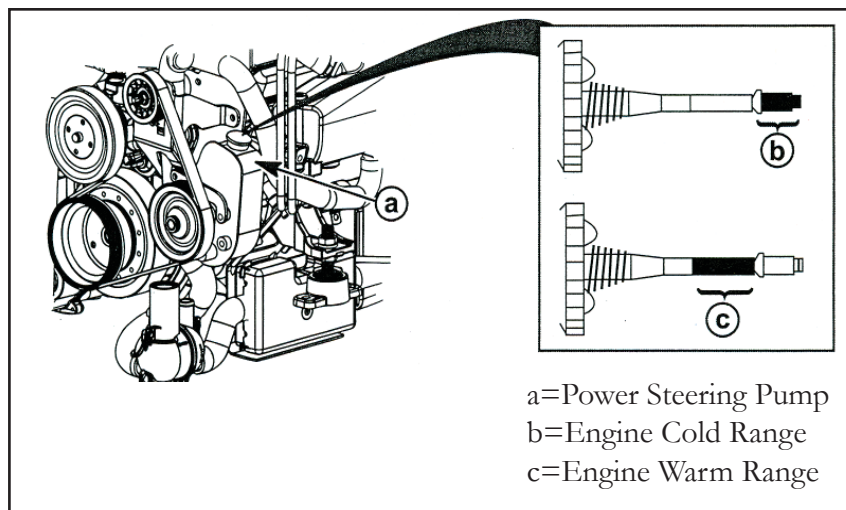



CHAPTER 7

Checking Power Trim Fluid



CAUTION

ALWAYS CHECK THE OIL LEVEL
WITH THE STERN DRIVE
IN THE “FULL” DOWN OR “IN” POSITION.

1. Place the stern drive unit in the full down position.
2. Observe the oil level. Level must be between the “MIN” or “MAX” lines on the reservoir.
3. Fill as necessary with Power Trim & Steering Fluid (Merc part # 92-802880A1).

Refilling The Reservoir

1. Remove the fill cap from the reservoir. Fill cap is vented.
2. Add lubricant to bring level to the within the “MIN” and “MAX” lines on the reservoir. Use Power Trim & Steering Fluid (92- 802880A1).
3. Install the cap.

Changing Power Trim Fluid

1. Power steering fluid does not require changing unless it becomes contaminated with water or debris. Contact a Regal dealer to change the fluid.



Cosmetic Care & Maintenance

Checking Engine Coolant



WARNING

AVOID BODILY INJURY!
ALLOW ENGINE TO COOL DOWN BEFORE REMOVING THE COOLANT PRESSURE CAP. A SUDDEN LOSS OF PRESSURE COULD CAUSE HOT COOLANT TO BOIL AND DISCHARGE VIOLENTLY. AFTER THE ENGINE HAS COOLED, TURN THE CAP 1/4 TURN TO ALLOW PRESSURE TO ESCAPE SLOWLY, THEN PUSH DOWN AND TURN THE CAP COMPLETELY OFF.

1. Remove the cap from the heat exchanger and observe the level of the fluid.
2. The coolant level in the heat exchanger should be at the bottom of the filler neck. A low coolant level means you should contact your Regal dealer.
3. Install the cap onto the heat exchanger.
4. When reinstalling the pressure cap, be sure to tighten it until it seats on the filler neck.
5. With the engine at normal operating temperature, check the coolant level in the coolant recovery canister.

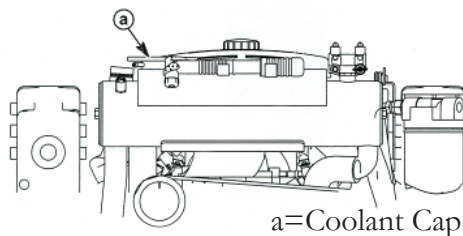



CHAPTER 7

6. The coolant level should be between the “ADD” and “FULL” marks.

7. Add Extended Life Antifreeze/Coolant (Mercury part # 92-877770K1).

	CAUTION
<p>AVOID ENGINE DAMAGE! DO NOT USE ALCOHOL OR METHANOL BASED ANTIFREEZE OR PLAIN WATER IN THE COOLANT SECTION OF THE CLOSED COOLING SYSTEM AT ANY TIME.</p>	

NOTICE
<p>ADD COOLANT ONLY WHEN THE ENGINE IS AT A NORMAL OPERATING TEMPERATURE.</p>

Filling Engine Coolant

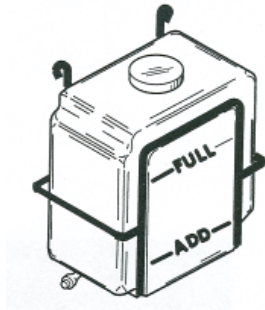

1. Remove the fill cap from the coolant recovery canister.

2. Fill to the “FULL” line with Extended Life Antifreeze/Coolant Mercury part # 92-877770K1.

3. Reinstall the cap onto the coolant recovery canister.

Changing Engine Coolant

Call your Regal dealer to change coolant in the entire system.



Cosmetic Care & Maintenance

Notes

Troubleshooting

DIAGNOSTIC CHARTS

The following diagnostic charts will assist you in identifying minor electrical, fuel, and mechanical problems. Some of the items listed require technical training and tools. Additional assistance is available in the engine manufacturer's manual. Also, you can contact your closest Regal dealer or marine professional for more information. Most problems can be solved by following a logical sequence of elimination.

	CAUTION
TO AVOID BODILY INJURY AND PROPERTY DAMAGE! USE ONLY APPROVED MARINE REPLACEMENT PARTS.	

	WARNING
TO AVOID BODILY INJURY AND DEATH! BEFORE PERFORMING ANY MAINTENANCE WORK TURN OFF THE BATTERY SWITCH AND REMOVE THE KEYS FROM THE IGNITION SWITCH.	



CHAPTER 8

REMOTE CONTROL DIAGNOSTIC CHART		
PROBLEM	POSSIBLE CAUSE	POSSIBLE FIX
Remote control stiff/inoperative	Corroded cable	Clean/lubricate cable
	Kinked cable	Replace cable
	Broken cable	Replace cable
	Remote control box jammed	Repair/Replace box
Throttle only control inoperative (neutral)	Worn throttle cable	Replace cable
	Binding Cable	Follow cable routing; look for pinched cable
	Broken cable	Replace cable
Does not apply to EVC/DTS systems	Control box worn or in need of lubrication	Refer to information supplied by control mfg.

INSTRUMENT DIAGNOSTIC CHART		
PROBLEM	POSSIBLE CAUSE	POSSIBLE FIX
No reading on gauge or gauge reads wrong	Faulty gauge	Replace gauge
	Wiring to gauge faulty	Inspect/repair wiring
	Faulty sender	Replace sender
Gauge reads erratic	Loose ground or hot wire	Repair or replace wire and or connection

Troubleshooting

PERFORMANCE DIAGNOSTIC CHART		
PROBLEM	POSSIBLE CAUSE	POSSIBLE FIX
Excessive vibration	Material obstructing propeller	Remove material by reversing engine
	Bent propeller shaft	Call Regal dealer
	Bent propeller blade	Repair/replace propeller
	Propeller hub slipping	Replace propeller
Poor performance	Engine trim incorrect	Adjust trim
	Uneven load distribution	Adjust boat load
	Engine problem	Call Regal dealer
FUEL SYSTEM DIAGNOSTIC CHART		
PROBLEM	POSSIBLE CAUSE	POSSIBLE FIX
Engine won't start or not running right	Fuel tank vent obstructed	Clean vent hose or and fitting. Check for kinks.
	Fuel line blocked	Check for kinked hose
	Lack of fuel	Clean filter. Check for clogged anti-siphon valve
	Water in fuel	Eliminate water
	Clogged fuel filter	Replace filter element
	No fuel reaching engine	Check fuel pump output. Clean filters. Check fuel tank gauge level.



CHAPTER 8

DC ELECTRICAL DIAGNOSTIC CHART		
PROBLEM	POSSIBLE CAUSE	POSSIBLE FIX
No 12 volt power	Battery switch in "off" position	Turn selector switch to "on" position
	Weak or dead battery	Charge or replace battery
Battery not charging; (Engine running)	Loose belt	Tighten belt
	Faulty alternator	Repair/Replace alternator
	Faulty volt meter	Replace volt meter
Battery will not hold charge	Faulty/Old battery	Replace battery
12 volt equipment not working	Equipment switch "off"	Switch to "on" position
	Circuit breaker blown	Push reset on circuit breaker
	Weak or dead battery	Replace battery
	Corroded connection	Eliminate corrosion
	Loose wire	Tighten connection
	Internal equipment short	Replace equipment

Troubleshooting

REGAL VUE DISPLAY

Troubleshooting

General Troubleshooting Guide

Display appears not to work or doesn't come "ON".

1. Display could be in *sleep* mode. Touch a key on the keypad to activate the display.
2. Check for loose connections at battery and display unit.
3. Check for reversed polarity on the power connections.
4. Verify battery has a minimum voltage of 6 Volts.

Display resets or goes "OFF" when starting engine.

1. Check display supply wires are connected properly to battery.
2. Verify battery is charged properly.
3. Check battery for efficient starter current.

Display has no backlight.

Contact your Regal service center.

Display has no keypad backlight.

Contact your Regal service center.



Storage & Winterization

Storage procedures are outlined in this chapter. These are **general guidelines** to follow before longer periods of storage such as over the winter in colder climates. Be sure to familiarize yourself with all relevant information in the owner's pouch. Special winterization procedures are necessary for the boat equipment and systems. Use the enclosed checklists to help you identify areas of concern and maintenance. These lists cover land stored boats either inside or outside. Call a Regal dealer or marine professional for further information.



WARNING

EXPLOSION, FIRE AND POLLUTION HAZARD!
DO NOT FILL FUEL TANK TO RATED CAPACITY
LEAVE ROOM FOR EXPANSION.



CAUTION

REMOVE BATTERY(IES) WHEN VESSEL
IS IN LONG PERIODS OF STORAGE.



CAUTION

TO PREVENT ENGINE DAMAGE!
USE ONLY ETHYLENE GLYCOL BASE ANTIFREEZE.
DO NOT USE ALCOHOL BASE PRODUCTS.



CHAPTER 9

DECOMMISSIONING CHECKLIST

ENGINE

- Run engine. Pour a fuel stabilizer/conditioner in the fuel tank. Allow time for it to circulate through the fuel system.
- Change all engine fluids as referenced in the engine manufacturer's owners manual. Contact a Regal dealer.
- Drain cooling and exhaust system or have a marine professional "pickle" the engine. Contact a Regal dealer.
- Spray all exterior parts with a rust preventative.

STERN DRIVE

- Remove drive. Perform maintenance as referenced in the manufacturer's owners manual. Contact your Regal dealer.
- Remove propeller. Refurbish as needed.
- Touch up paint on stern drive.
- Apply coat of wax to stern drive.

BOAT

- Check hull bottom for any fiberglass damage.
- Apply a coat of wax to hull and deck surfaces.
- Pour a pint of 50/50 antifreeze into bilge pump.
- Never block up boat bottom. May cause structural damage.*



Storage & Winterization

- Remove battery. Use a trickle charge as needed.
- Remove all loose gear and electronics from boat. Inspect all equipment for wear and damage. Store in a clean, dry environment.
- Remove drain plug. Clean drain plug hole of debris as needed. Enclose drain plug in plastic bag and tie to steering wheel.
- Make sure bow is higher than stern to permit proper drainage.
- Clean all upholstery and store so it breathes.
- Conduct a visual inspection to ensure boat is balanced properly on the trailer, cradle or blocks.
- Cover boat with appropriate cover. Tie down for protection from rain, snow and/or wind. Prop up cover to provide proper ventilation. Do not cover up the fuel vents.
- Drain the fresh water system per instructions in this chapter.

TRAILER

- Repack all wheel bearings per manufacturer's specifications.
- Check all trailer parts for excessive wear. Replace/refurbish as needed.
- Use touch up paint on trailer as needed.
- Lubricate all moving parts as needed.
- Block the trailer up to remove wheel strain.



CHAPTER 9

FRESH WATER SYSTEM

1. Activate the fresh water pump switch.
2. Open all faucets including transom shower (if equipped) and allow tank to empty.
3. Drain the water tank. Shut off fresh water pump switch.
4. Mix nontoxic antifreeze with water in accordance with the manufacturer's recommendations. (Available at marina & RV stores)
5. Pour solution into the fresh water tank.
6. Turn on fresh water pump switch.
7. Open water faucet and purge until a steady stream of nontoxic antifreeze flows from the faucet. If equipped, do the same to the transom shower. Turn the fresh water switch to the "off" position.

WASTE SYSTEM

1. With **chemical** heads, make sure to dump both upper and lower tanks. Rinse well with fresh water.
2. With **vacuum designed** head, pump out holding tank. Add nontoxic antifreeze to toilet and holding tank. Pump from toilet to holding tank to eliminate any water remaining in supply lines.

NOTICE

AVOID VESSEL AND ENGINE DAMAGE!
CONTACT MARINE PROFESSIONAL FOR
WINTERIZATION INSTRUCTIONS. DAMAGE IS
NOT COVERED BY REGAL WARRANTY.



Storage & Winterization

RECOMMISSIONING CHECKLIST

ENGINE/STERN DRIVE

- Check all components per engine manufacturer's owners manual especially fluid levels.
- Run engine on "ear muffs" (flushette) before launching. Check for fuel, exhaust, oil, and water leaks.

BOAT

- Install drain plug.
- Install battery and tighten all terminals.
- Check all equipment, switches, alarms, gauges and breakers for proper operation.
- Add necessary chemicals and water to **chemical** head.
- Add water to fresh water tank. Turn on faucet to purge tank. Refill water tank.
- Make sure all safety gear is on board and in excellent working condition.
- After launching, check controls and gauges for proper operation.

TRAILER

- Make sure all equipment is in excellent working condition.



CHAPTER 9

Notes



Trailering

This chapter covers trailering/towing basics including equipment, maintenance, and techniques of using a trailer. *Check with state and local agencies for detailed information on required equipment, safety issues, and licensing.*

BEFORE TOWING

Before towing your boat, be sure to check the air pressure of your tires for the recommended inflation rating. Also, be certain that your tow vehicle is in good working order.

Stow all gear to be carried properly, especially heavy items such as batteries or anchors. Be sure these items are secured. Don't overload and try to carry excessive weight on your trailer.

Give consideration to the weight distribution of your trailer. If the rear end of your vehicle sags, chances are the load is positioned too far forward on your trailer.

This can make it especially difficult to drive safely, as the hitch may be in danger of striking the road. Also, this situation can be caused by worn vehicle rear shock absorbers. One option is to install a set of air shocks which will assist in supporting the load. As a rule of thumb 5 to 7 percent of the total trailer load should be on the trailer tongue.

Check all lights to ensure they all work properly. You may find it helpful to ask someone to check your turn signals, brake lights, and towing lights while you remain in the vehicle. Be certain that the trailer winch cable is securely attached to the boat's bow eye and the cable lock is engaged. Make sure the bow of the boat is snug against the bow stop at the winch stand.

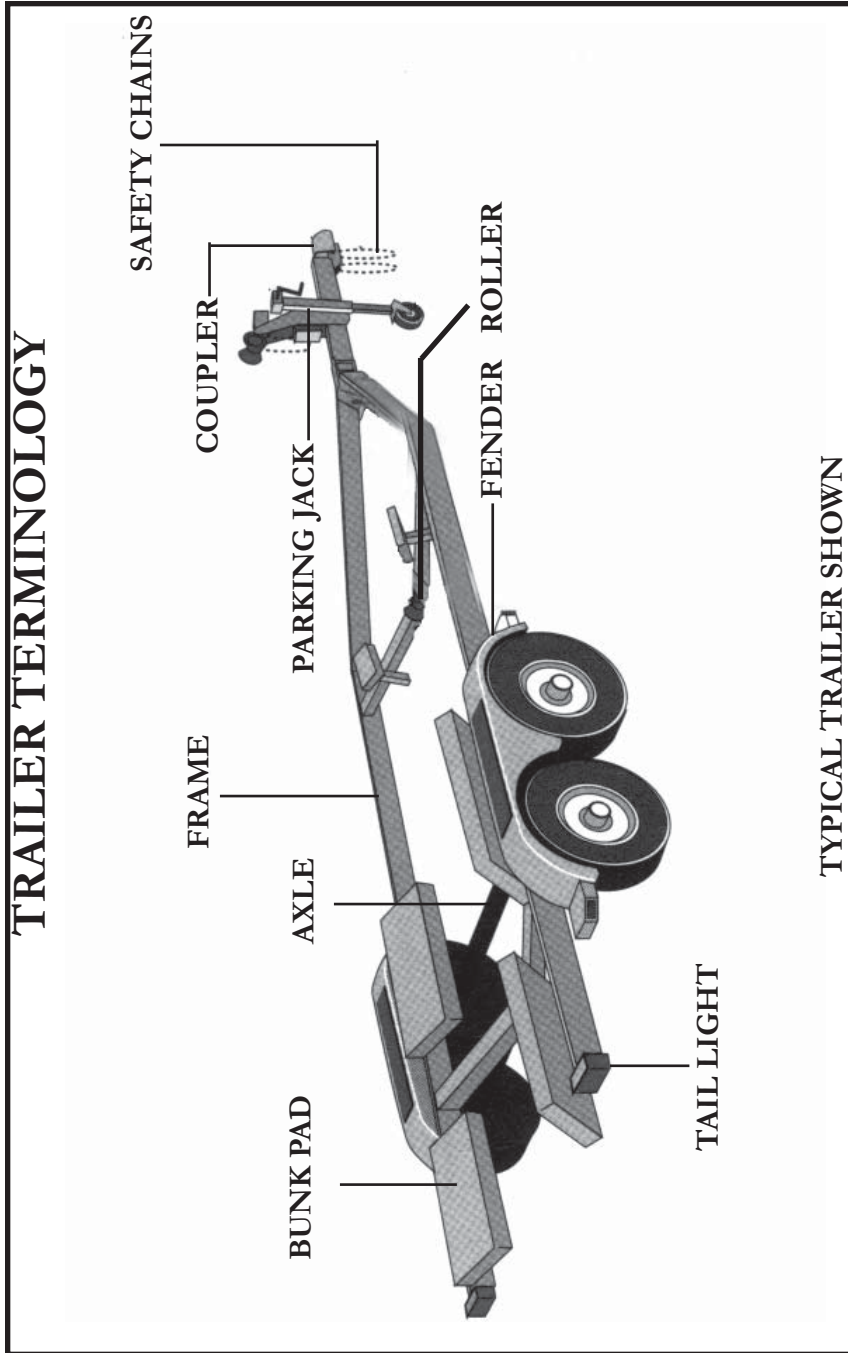

Trailering

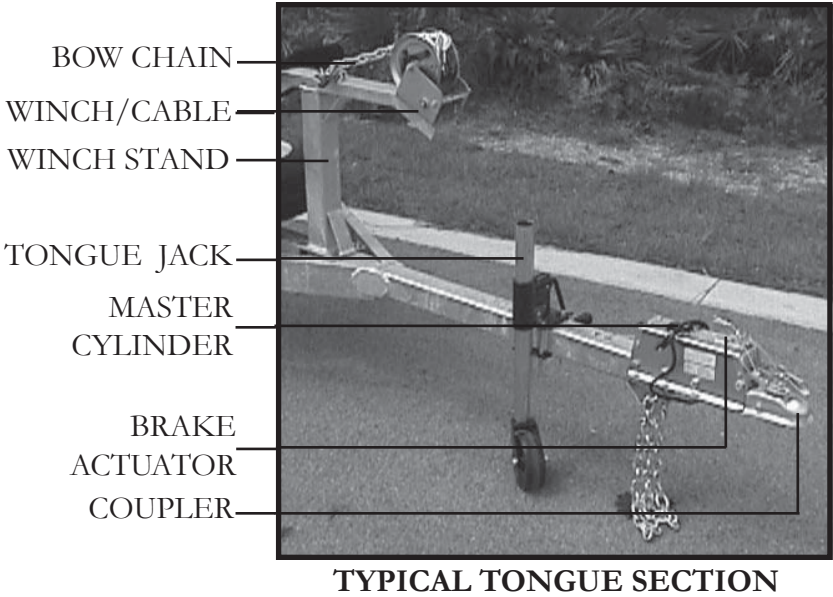
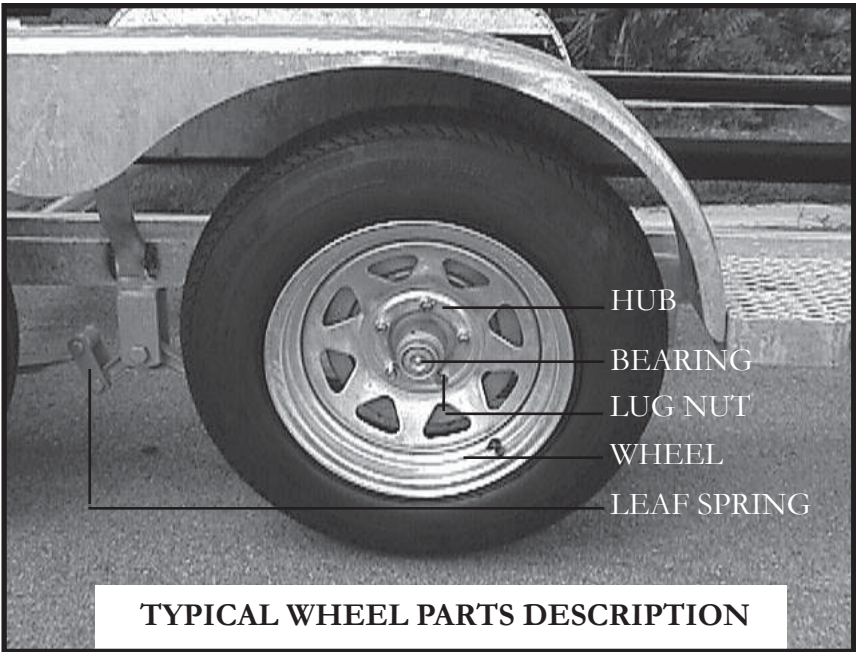



CHAPTER 10

It is a good idea to tie another line or secure an extra cable to the winch stand and boat bow eye as a backup system.

Be certain that your trailer is of rated capacity for the size and weight of your boat, including the weight for all fuel, water and gear. Your authorized Regal dealer can advise you on the proper trailer capacity and tongue weight (the weight exerted on the rear of your vehicle).

Never use a bumper mounted trailer hitch. Always use a bolted or welded frame-mounted hitch, class 2 or 3. Consult your Regal dealer for more information.

Should your trailer be equipped with surge brakes, that is brakes on the trailer that cut in with a very slight delay when your brakes are applied, be sure to follow recommended service and maintenance instructions. Be sure that the trailer master cylinder is filled with the recommended fluid before towing your boat. Inspect the trailer brake lines for any leakage. Also, if you notice brake fluid on the inside of the tires, you may have a wheel cylinder leaking. Consult a professional.

Never place your hands between the trailer hitch coupling and the hitch ball on your towing vehicle while hooking up. Be sure the tongue jack is in the full up position before departure. Be certain safety chains are crisscrossed and secured; do not allow them to drag on the road.

Be sure to buy a suitable set of tie downs which can be attached to the boats' stern eyes and the eyelets provided on most trailers. Tighten them securely and neatly fold up the extra strap material and secure it with tape so it doesn't loosen and dangle on the road.

Check the trailer lug nuts for the proper torque. Use a foot pound wrench and torque in a star sequence to the correct poundage as recommended by the trailer manufacturer. Torque the lug nuts at half the poundage on all nuts. Then set the torque wrench to the full poundage and fasten to the last foot poundage figure.

Check the trailer tires often for voids, excessive wear or out of round tire conditions. If the trailer seems to vibrate you may have a bad tire or one that is unbalanced. These wheels can be rebalanced at most automotive or tire shops. Never pull a boat on a patched tire. Buy a spare tire and wheel including a hub and wheel bearing assembly. Mount it on the trailer for speedy installation should a blow out occur.

SPARE PARTS CHECKLIST

Longer towing trips increase the need for special preparations. Sometimes these extended trips cover areas where it is difficult in locating repair parts due to a breakdown. Following is a checklist of recommended items to add a safety net to your trip.

Trailer-

1. Trailer tire jack
2. Spare hub assembly including wheel bearings
3. Spare tire
4. Lug wrench
5. Jackstand
6. 12 volt air compressor- found at automotive box stores
7. Spare bearing protector
8. Extra tie-down straps
9. Trailer light bulbs
10. Brake pads and brake fluid
11. Grease gun

Tow Vehicle-

1. Tool kit including necessary ratchet and sockets
2. Jumper cables
3. Extra fuses
4. Engine oil
5. Transmission fluid
6. Wheel chocks
7. Highway flares
8. 12 volt spotlight- type that plugs into 12 volt accessory outlet
9. Flashlight & spare batteries
10. Waterless hand cleaner and rags
11. Electrical connectors and crimpers
12. Low voltage electrical tester



CHAPTER 10

Check the trailer harness often for signs of fraying. Check the harness connector for corrosion. Make sure the trailer harness when connected to the trailer has enough slack for turning

Check the wheel bearings for wear periodically by a professional. On most trailers, there is a zerk fitting on the wheel hub to add the proper lubricant to the wheel bearing with a grease gun. These wheel bearing waterproof covers for the bearings can be purchased at retail outlets. Be sure everything is secured in the boat and canvas is down in the towing position with the bimini stored in the boot. Tilt the stern drive up to clear the road and any bumps that might occur while in transit.

DRIVING

Practice maneuvering the vehicle and trailer in a large, empty parking lot or open space. If you practice slowly and cautiously, you will soon develop a feel for maneuvering the trailer .

Test your vehicle and trailer brakes before departure along with the lights. Pack a tool kit with extra bulbs, fuses and fluids.

Drive as smoothly as possible, anticipating your stops and giving yourself plenty of room for turning and stopping. Avoid any quick turns or sudden jerks of the steering wheel.

Remember to maintain safe speed limits. It takes longer to stop your loaded boat. Allow enough room to the front in bad weather.

Keep an eye on your rig through the rear view and side mirrors. If your rear view mirror is obstructed, purchase a set of side mirrors that extend out over the side of the vehicle for increased visibility. In addition, it is a good idea to install a set of round mirrors to the side mirrors as they help identify blind spots.

Plan to stop periodically on your way to check the trailer hitch for tightness, harness connector, tires and wheel bearings. Also, check to make sure the cockpit cover is secure and the load is balanced.



CHAPTER 10

LAUNCHING

Serious accidents can occur at the launching ramp. Therefore, it is imperative you be alert and attentive during launching and docking activities. Study the ramp area and surrounding water for any potential hazards, such as a short ramp or one with a drop off at the end. If you are uncertain of the conditions, ask someone else who has just used the ramp if there are any peculiarities to the area.

Install the drain plug. Attach 2 lines, one each at the bow and stern, to control your boat once it is off the trailer. If you need additional fenders to keep the sides of the boat from banging against the ramp walls, use those as well.

Unhook the stern tie-downs and the winch line to the bow. Unplug the trailer harness connector so the hot trailer light bulbs won't blow out when they come in contact with water.

When backing in, have someone assist, giving the palms up stop signal when the boat is in deep enough water to float off, or when the rear wheels of your vehicle approach the water's edge.

After your boat is floating freely, position it clear of the trailer before pulling out of the water. If there is no one to help you, secure one of the lines you've attached from the boat to the dock and use the other line to pull the boat off trailer. The process is easier with 2 people.



CAUTION

AVOID LOSING VEHICLE TRACTION!
DO NOT ALLOW REAR WHEELS TO ENCOUNTER
SAND OR SLIPPERY CONCRETE CONDITIONS.



WARNING

AVOID BODILY INJURY!
RAMPS ARE VERY SLIPPERY. DO NOT ATTEMPT TO
WALK OR STAND ON AN ANGLED BOAT RAMP.

BACKING A TRAILER

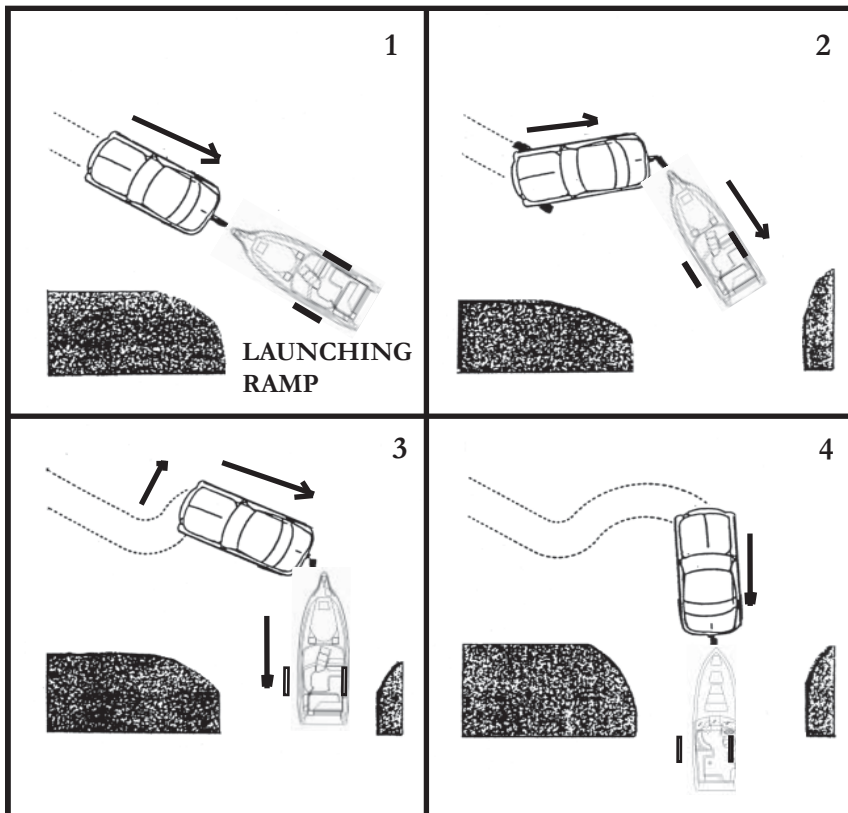

A trailer backs in a direction opposite to an automobile. In 1, driver swings the rig near the launching ramp. In 2, the driver cuts the vehicle toward the driveway. In 3, the driver cuts the vehicle wheels to the left and then backs into the ramp as the trailer moves to the right. In 4, the driver straightens the vehicle wheels to follow the trailer as it backs down the ramp.

NOTICE

ALLOW TRAILER WHEEL BEARINGS AND LIGHTS
TO COOL BEFORE SUBMERGING



CHAPTER 10

LOADING



The most important thing to remember when pulling your boat out of the water is that often the ramp will be crowded. As you approach the ramp, make a visual inspection of the traffic and people, both at the ramp and all around you. This is an important time to use caution,

courtesy, and common sense. While you may feel it's your next turn, another boater may not be as courteous. Don't insist on your rightful place in line; it could lead to disastrous consequences in the confines of a crowded boat ramp. If there is any perceived danger, stand off until you can safely approach the ramp.

Back your trailer down to the water's edge. At this point it is a good idea to let a sufficient amount of line out of the winch to reach the bow eye. Make sure you disconnect the trailer harness to keep the bulbs from blowing out due them being subjected to the cold water.

On roller or bunk style trailers back up until the aft roller is just at the water level. This allows you to hook up the winch cable and to start cranking the boat on to the trailer properly. This method gives you a good starting point and helps keep the boat centered on the trailer as it is reloaded. It may be necessary to further back the trailer into the water. This permits cranking the boat easier on to the trailer.

Once the boat is positioned correctly on the trailer have someone hook up the winch cable hook to the bow eye. Also, this will help keep the boat bow against the trailer roller. Shut down the engine and run the stern drive up to the top of the trailer position.

With the bow snug against the roller, start to crank the boat up on to the trailer. Make sure the hull bottom or keel stays in the center of each roller as it is being cranked on the trailer. On bunk style trailers, watch the bunks to make sure the boat is centered as they usually do not touch any rollers other than the aft one because the boat weight

Trailer

is being supported more by the bunks as it is cranked onto the trailer. Stop cranking the winch when the boat bow contacts the bow roller. Be sure the winch is in the locked position. Stand back and visually check to see that the boat is centered on the trailer.

After pulling your boat away from the ramp, be sure to go through all the checks involved before departure. Reinstall the harness connector and check the lights, brakes, safety chain, winch, hitch, and tie downs.

Double check to ensure the hitch is locked tight on the vehicle ball. Make sure the boat is covered properly and all loose gear is stowed.

Remove the drain plug to exit any excess water in the bilge. Reinstall the hull drain plug and tighten it. For longer storage periods remove the drain plug and keep in a plastic bag tied to the steering wheel.



WARNING

AVOID PERSON INJURY!
DO NOT LET ANYONE STAND NEAR THE WINCH OR
CABLE. THE CABLE COULD BREAK.



CAUTION

HULL BOTTOM DAMAGE COULD RESULT
FROM THE BOAT NOT BEING POSITIONED
ON THE ROLLERS BUT RESTING
ON THE TRAILER FRAME.
AVOID BACKING TRAILER
TOO FAR INTO THE WATER!

Glossary & Index

Below is a brief list of nautical terminology. For more detailed glossaries we recommend you check your local library, book retailer, marine store or internet.

GLOSSARY

Abeam: at right angles to the fore and aft line and off the boat

Aboard: on or in the boat

Above: the part of the boat on a vessel which is above the interior of the boat

Aft, After:: aft is the boat section toward the stern or back of the boat

Admidships: toward the center of the boat from either side to side or rear to front

Beam: the width of a boat at its widest part

Bilge: the lower interior of the hull of the boat

Bitter end: the end of a line also the end of an anchor line

Bow: the front, or forward part of the boat

Bulkhead: the vertical partition or wall of a boat



CHAPTER 11

Cast off: to let go or release

Chine: the line fore and aft formed by the intersection of the side and bottom of the boat

Chock: deck fitting used to secure or guide anchor or tie lines

Cleat: deck fitting with protruding arms around which lines are secured

Cockpit: the seating space used to accommodate passengers

Cuddy: a small cabin in the fore part of the boat

Deck: the open flooring surface on which crew and passengers walk

Draft the depth from the waterline of the boat to the lowest part of the boat, which indicates how much water is required to float the boat

Fathom: a measurement of depth; one fathom equals six feet

Fender: a cushion hung from the side of a boat to prevent it from rubbing against a dock or against other boats

Fend off: to push off to avoid sharp contact with dock or other vessel

Fore: the part of the boat toward the bow or front

Freeboard: the height of the top side from the waterline to the deck at its shortest point. (The distance from the sheer or gunwale to the water)

Galley: cooking area

Gunwale: rail or upper edge of the side of the boat

Glossary & Index

Head: toilet

Hull: the part of the hull from the deck down

Keel: the lowest point of a boat; the backbone of the vessel

Knots: a measurement of speed indicating nautical miles per hour

Lee: the side opposite that from which the wind is blowing; the side sheltered from the wind

Leeward: the direction toward which the wind is blowing

PFD: personal flotation device; required for each person aboard

Port: the left side of the boat when facing forward (an easy way to remember the difference between “port” and “starboard” is that both “port” and “left” have four letters)

Shank: the main body of an anchor

Sheer: the curve of the boat’s deck from fore to aft when seen from the side

Starboard: the right side of the boat when facing forward

Stern: the aft end of the boat

Stern drive: an inboard/outboard (I/O) unit

Stringer: strengthening integral unit fastened from fore to aft inside the hull and fiberglass encapsulated for added strength: much like the skeleton system of our body

Top off: to fill up a tank

Transom: the vertical part of the stern



CHAPTER 11

Trim: the boat's balance when properly loaded

Wake: the path of a boat left astern in the water

Windward: the direction from which the wind blows; opposite of leeward

Glossary & Index

INDEX

A

Accidents	1-27
Accident Reporting	1-28
Air compressor	6-2
Alcohol	1-25
Anchor Light	1-16
Anchoring	5-25
Audible Alarms	3-11
	8-10
Audible Producing Devices	1-15
Automatic Fire Extinguisher	6-3
	7-24

B

Battery	4-1
	6-7
	7-17
Battery Switch Circuitry	4-10
	6-8
Berth Conversion	6-48
Bilge Pump	4-6
	6-10
	7-21
	8-7
Blower	4-5
	5-6
	7-24
Breakers & Fuses	4-8
Breast Lines	5-12
Bridge Clearance	2-10

C

Canvas	6-11
	7-7
Carbon Monoxide	1-21
Capacity Plate	Int-14
Cardiopulmonary Resuscitation	5-29
Cockpit Carpet/Table	6-18
Cockpit Refreshment Center	6-19
Cosmetics	7-1
Controls	3-5

D

Dealer Responsibilities	Int-15
Depth Sounder	3-9
	6-21
Diagnostic Charts	8-1
Direct Current (DC)	4-1
Distress Signals	1-12
Diver's Flag	1-29
Docking	5-15
Dock Lines	5-12
Drain Plug	6-20
Doors-Bow	6-24

E

EPIRB	1-20
Electrical	4-1
	8-6
Emergencies	5-29
Engine	3-1
	7-12
	7-34
	8-2
Engine Hatch	6-25
Environmental Awareness	5-32
Exhaust	1-21



CHAPTER 11

F		I	
Fenders	5-11	Ignition Switch	3-14
Fiberglass Maintenance	7-3	Index	11-5
Fire Extinguishers	1-10	Instruments (Gauges)	3-7
	6-3	Interior Fabrics	7-3
	7-24	International Distress Signals	1-14
First Aid	5-30	Interrupt Switch	3-17
Float Plan	Int-11		
Fresh Water System	4-7	K	
	4-16	Knots	5-28
	6-40		
Fuel	4-13	L	
	5-3	Labels	1-1
	7-21	Ladder	6-35
	8-4	Law of Salvage	5-27
		Lighting-Docking	6-36
		Lighting-Stern	1-16
			6-37
		Loading	5-21
			Int-14
		Lanyard	3-17
		Launch & Cruise Checklist	Int-12
G		M	
Galvanic/Stray Current Corrosion	7-25	Maneuvering	5-17
Garbage Placard	1-18	Maintenance Guides	7-30
Gas Vapor Detector	6-26	Maintaining PFD'S	1-9
Gathering Headway	5-17	Masthead Light	1-16
Gauges (Instrumentation)	3-7		1-19
Gelcoat Maintenance	7-3	Mayday	1-15
General Boating Safety	1-3	MerCruiser	7-39
Getting Underway	5-1	Metal (Cleaning)	7-10
Glossary	11-1	Minimum Required Equipment	1-19
Gray Water	6-34	Mooring	5-13
Grill	6-29		
H			
HIN	Int-9		
Horn	1-19		
	4-5		
Hour Meter	3-7		
Hull Bottom	7-10		
Hypothermia	5-31		

Glossary & Index

N

Navigation Aids	2-6
Navigation Lights	1-15 1-19 2-9
Navigation Rules	2-1
Neutral Safety Switch	3-15
New Boat Delivery Checklist	Int-17
Night Running	2-9

O

Oil Pressure Gauge	3-8
Oil Spills	1-17
Overloading	Int-14
Owner's Information Packet	Int-8
Owner's Registration	Int-15
Owner Responsibilities	Int-15

P

Panel-Engine Status	3-12
Personal Flotation Devices	1-7 1-19
Pollution Regulations	1-17
PowerTower	6-38
Plastics	7-2
Power Trim	5-20
Precautionary Safety Labels	1-1
Pre-departure questionnaire	5-1
Propellers	3-3 7-12
Propulsion	3-3
Pump Out Fittings	6-67

R

Recommissioning	9-5
Regal Vue	3-6 6-42
Remote Control	3-15 5-7 7-19
Right-Of-Way	8-5
Rules Of The Road	2-2 2-1

S

Safety	1-1 Int-14
Seating-	7-20 6-44 6-46 6-48
Shallow Water Operation	5-23
Ski Pylon-Tow	1-31 6-50
Specifications	Tech
Spring Line	5-12
Starting & Stopping	5-6
Stern Line	5-11
Steering	5-8 7-16
Stereo	6-51 8-8
Stereo iPod Adapter	6-63
Stereo Performance Package	6-62
Swim Platform	6-64



CHAPTER 11

Stern Drive	3-3	V	
	5-15		
	5-17	Ventilation	1-22
	7-1		3-2
	7-38	Visibility	2-9
	7-40		5-23
	8-2	Visual Distress Signals	1-12
	9-2	Volt Meter	3-8
	9-5	Volvo	7-35
	7-8		
Sunbrella Cleaning	1-31		
Swim Platform	6-64		
Switches (DC)	4-4	W	
		Wake	1-33
		Wakeboard Racks	6-75
		Warning Labels	1-1
		Warranty	Int-18
		Waste	4-17
		Water Skiing	1-29
		Weather	1-34
		Wide-Angle Mirror	6-76
		Windshield-Center Latches	6-77
		Winterizing	9-1
		Wiring Color Codes	4-2
T		Z	
Tachometer	3-7	Zinc Anodes	7-29
Technical	12-1		
Temperature Gauge	3-8		
Toilet	4-17		
	6-66		
Towing	5-26		
Trailer	10-1		
Trim Switch	6-74		
Trim Angle	5-20		
Trim Gauge	3-9		
Troubleshooting	8-1		
Turning	5-18		
U			
Upholstery	7-1		
Underwater Lights	6-74		



Technical Information

NOTICE

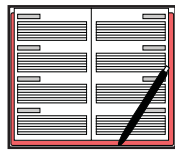

The following technical information and drawings are accurate up to the printing date listed at the beginning of this manual. These drawings can be an aid to troubleshooting electrical and mechanical problems along with the charts located in the troubleshooting chapter.

Note that all product specifications, models, standard and optional equipment, systems, along with the technical information is subject to change without notice.

For more information contact your nearest authorized Regal dealer. For the location of your nearest authorized dealer call 407-851-4360. or visit the web-site at www.RegalBoats.com.

Your Regal dealer has received special factory training on the entire product line and his services should be employed to solve more technical problems.



2300 Specifications		
LENGTH OVERALL W/ SWIM PLAT- FORM	USA 22' 11"	CE 6.95 M
CENTERLINE LENGTH	20' 1"	6.12 M
BEAM	8' 6"	2.60 M
APPROXIMATE DRY WEIGHT W/ VOLVO 5.0 L CATALYST W/DP STERN DRIVE	3870 LBS.	1714.57 KG
APPROX. BRIDGE CLEARANCE-TOP OF TOWER	7' 7"	2.31 M
APPROX. BRIDGE CLEARANCE W/ TOWER IN FULL FORWARD POSI- TION	4' 8"	1.42 M
COCKPIT DEPTH	32 1/2"	.82 M
APPROX. DRAFT- DRIVE DOWN	18"-20"	.45-.50 M
FUEL CAPACITY	56 GALS.	211.9 L
WATER CAPACITY	N/A	N/A
WASTE CAPACITY	N/A	N/A
SLEEPING CAPAC- ITY	N/A	N/A
PERSONS CAPACITY	12	10



Technical Information

2500 Specifications		
LENGTH OVER-ALL W/ EXTENDED PLATFORM	USA 26' 3"	CE 8 M
CENTERLINE LENGTH	24'6"	7.46 M
BEAM	8' 6"	2.60 M
APPROXIMATE DRY WEIGHT W/ 5.0 L	4600 LBS.	2086.52 KG
APPROX. BRIDGE CLEARANCE-TOP OF TOWER	8'	2.43 M
APPROX. BRIDGE CLEARANCE W/ TOWER IN FULL FORWARD POSITION	6' 3"	1.98 M
COCKPIT DEPTH	33.5"	.85 M
APPROX. DRAFT-DRIVE DOWN	18"-20"	.45-.50 M
FUEL CAPACITY	74 GALS.	280.1 L
WATER CAPACITY	11	60.56 L
WASTE CAPACITY	2.5 GAL. W/ CHEMICAL HEAD	41L W/ CHEMICAL HEAD
SLEEPING CAPACITY	N/A	N/A
PERSONS CAPACITY	Yacht Certified	11



2550 SPECIFICATIONS		
	USA	CE
LENGTH OVER-ALL W/ EXTENDED PLATFORM	26' 3"	8.07 M
CENTERLINE LENGTH	24'6"	7.49 M
BEAM	8' 6"	2.50 M
APPROXIMATE DRY WEIGHT W/ 5.0 L	4828 LBS.	2189.44 KG
APPROX. BRIDGE CLEARANCE-TOP OF TOWER	7' 11"	2.31 M
APPROX. BRIDGE CLEARANCE W/ TOWER FULL FORWARD	6'2"	1.98 M
COCKPIT DEPTH	35"	.82 M
APPROX. DRAFT-DRIVE DOWN	18"-20"	.45-.50 M
FUEL CAPACITY	74 GALS.	280.1 L
WATER CAPACITY	11	60.56 L
WASTE CAPACITY	2.5 GAL. W/ CHEMICAL HEAD	41 L W/ CHEMICAL HEAD
SLEEPING CAPACITY	2	2
PERSONS CAPACITY	Yacht Certified	8



Technical Information

TYPICAL LABELS & LOCATIONS

⚠ DANGER

CARBON MONOXIDE IS A TASTELESS, ODORLESS AND INVISIBLE GAS THAT CAN CAUSE DISCOMFORT, SEVERE AND EVEN DEATH. EXERCISE CAUTION WHILE OPERATING GENERATOR OR ENGINES IN CONFINED SPACES OR AT DOCKSIDE. DO NOT ALLOW HULL EXHAUST OUTLETS TO BECOME BLOCKED OR EXHAUST FUMES CAN BECOME TRAPPED IN AND AROUND THE CONFINES OF YOUR BOAT. DURING IDLE AND SLOW CRUISE CONDITIONS, BILGE BLOWERS SHOULD BE USED.

⚠ WARNING

INTERRUPT SWITCH MUST BE ATTACHED TO OPERATOR WHILE ENGINE IS RUNNING. QUALIFIED OPERATOR MUST BE IN CONTROL AT ALL TIMES. READ OWNER'S MANUAL BEFORE USE.

CAUTION: TO AVOID INJURY, WINDOW MUST BE SECURED IN THE CLOSED POSITION WHEN VESSEL IS IN MOTION. USE BOTH WINDOW LOCKS.

TAYLOR MADE SYSTEMS, INC.

WARNING

GASOLINE VAPORS CAN EXPLODE BEFORE STARTING ENGINE. OPERATE BLOWER 4 MIN. AND CHECK ENGINE COMPARTMENT FOR GASOLINE LEAKS OR VAPORS. RUN BLOWER BELOW CRUISING SPEED.

4 MIN.

LIFETIME Plus WARRANTY

REGAL BOATS



WARNING!

MAXIMUM CAPACITY OF SWIM PLATFORM
500 POUNDS
226 KG

⚠ WARNING

LEAKING FUEL IS A FIRE AND EXPLOSION HAZARD. INSPECT SYSTEM REGULARLY. EXAMINE FUEL SYSTEM FOR LEAKS OR CORROSION AT LEAST ANNUALLY

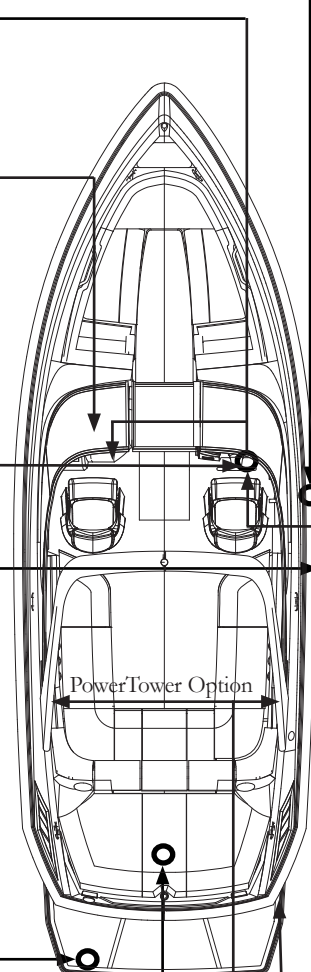

MAXIMUM CAPACITIES

12 PERSONS OR 1724 LBS.

1200 POUNDS, PERSONS, SEAT

THIS BOAT COMPLIES WITH U.S. COAST GUARD SAFETY STANDARDS IN EFFECT ON THE DATE OF CERTIFICATION. MEETS U.S. EPA EVAP STANDARDS USING CERTIFIED COMPONENTS. MANUFACTURED BY: REGAL MARINE, INC., OLANDO, FL.

MEETS U.S. EPA EVAP STANDARDS USING CERTIFIED COMPONENTS

REGAL MARINE INC., OLANDO, FL

YACHT CERTIFICATION

NATIONAL MARINE MANUFACTURERS ASSOCIATION

THIS BOAT COMPLIES WITH U.S. COAST GUARD SAFETY STANDARDS IN EFFECT ON THE DATE OF CERTIFICATION.

REGAL MARINE INC., OLANDO, FL.

2500-2550

⚠ WARNING

ROTATING PROPELLER(S) MAY CAUSE SERIOUS INJURY OR DEATH! DO NOT APPROACH OR USE LADDER WHEN ENGINE IS RUNNING.

⚠ CAUTION

WHEN OPERATING POWERTOWER KEEP ALL BODY PARTS CLEAR OF TOWER HINGE MECHANISMS.

2300 Volvo Deck Harness (1 of 2)

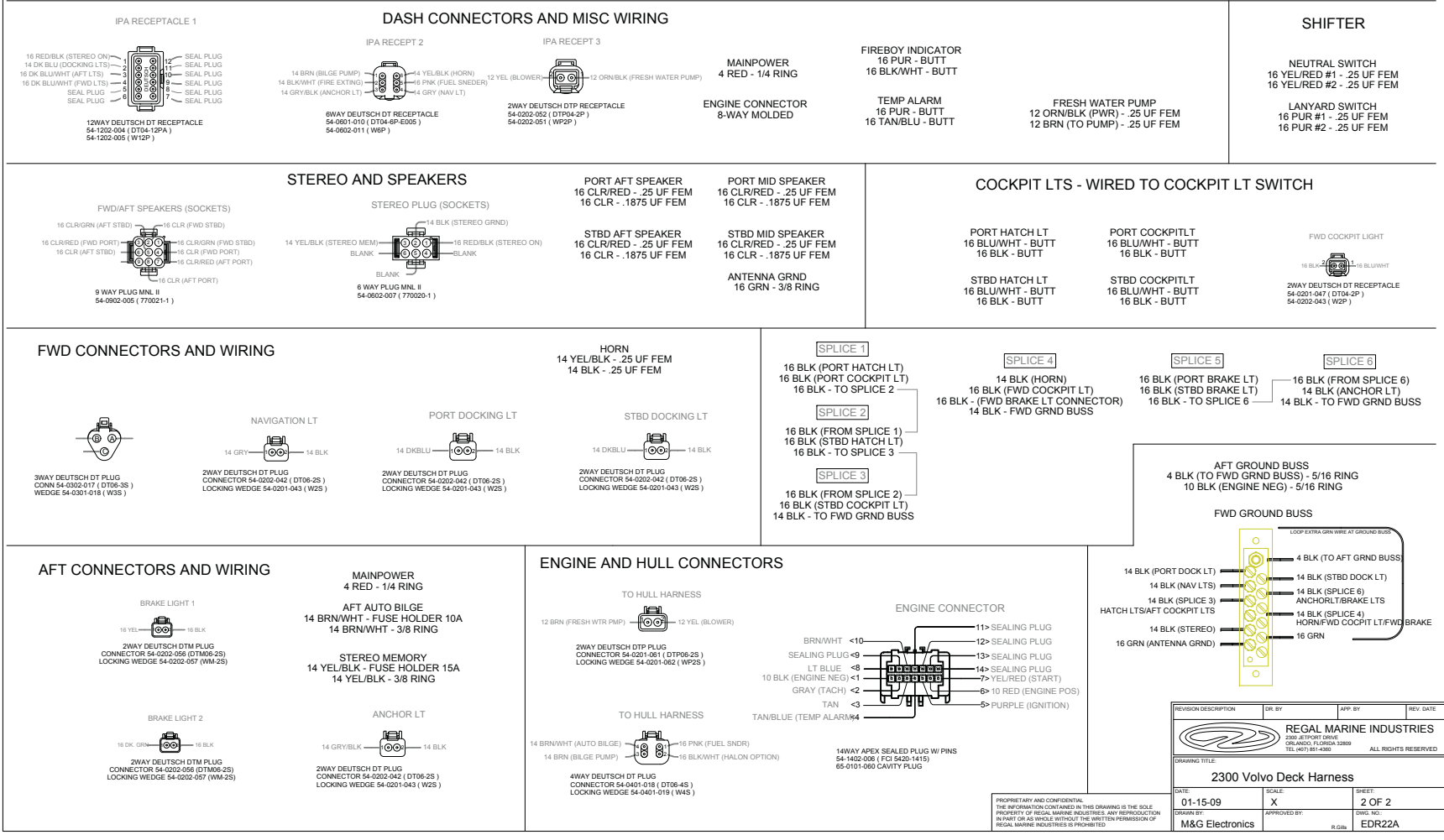

2300 DECK HARNESS LAYOUT (1 OF 2)

2300 Volvo Deck Harness (1 of 2)

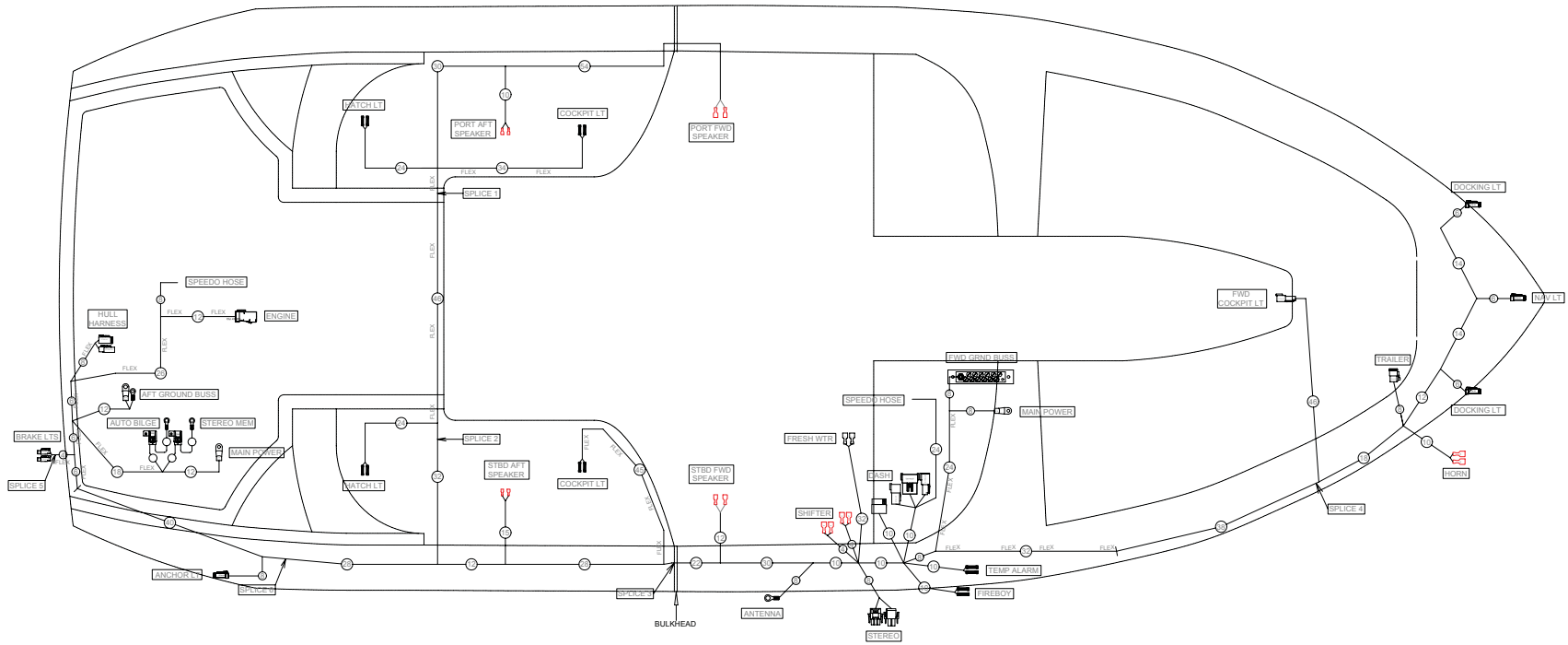

PROPRIETARY AND CONFIDENTIAL.
 THE INFORMATION CONTAINED IN THIS DRAWING IS THE SOLE
 PROPERTY OF REGAL MARINE INDUSTRIES. ANY REPRODUCTION
 IN PART OR AS A WHOLE WITHOUT THE WRITTEN PERMISSION OF
 REGAL MARINE INDUSTRIES IS PROHIBITED.

2300 DECK HARNESS LAYOUT (2 OF 2)

2300 Fuel Plumbing

BILL OF MATERIALS			
ITEM	QTY.	DESCRIPTION	PART #
01	1	1-1/2" FUEL FILL HOSE - 8FT	1769
02	1	5/8" FUEL VENT HOSE- 8FT	1770
03	1	3/8" FUEL CARB - 3FT	1776
04	1	1-1/8" BILGE FLEX HOSE- 8FT	1463

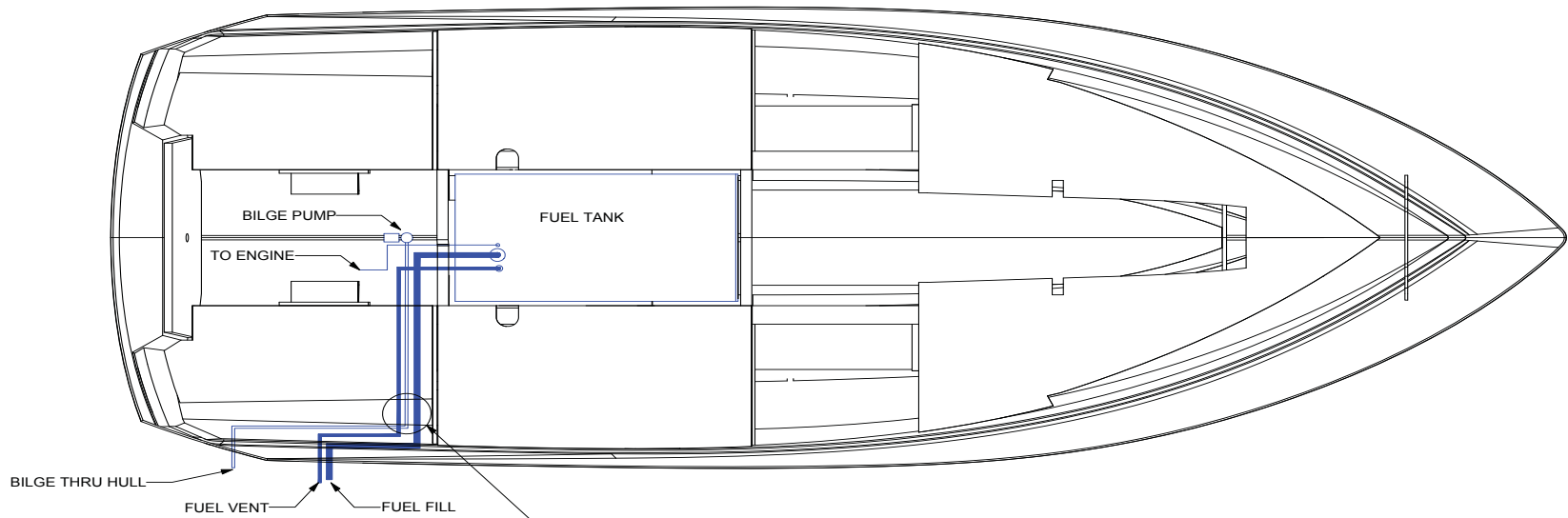

NOTE: DO NOT STRAP HOSES TOGETHER.

REVISION DESCRIPTION	DR. BY	APP. BY	REV. DATE
 REGAL MARINE INDUSTRIES 2300 JEFFERSON DRIVE ORLANDO, FLORIDA 32809 TEL (407) 851-4360 ALL RIGHTS RESERVED			
DRAWING TITLE:			
2300 Fuel Plumbing			
DATE:	12.12.08	Page:	1 of 1
DRAWN BY:	RYAN.WB	APPROVED BY:	D. Lindel
		DWG. NO.:	MDR23A

2300 (NON-EPA) FUEL SYSTEM

2300 Sump Hardware

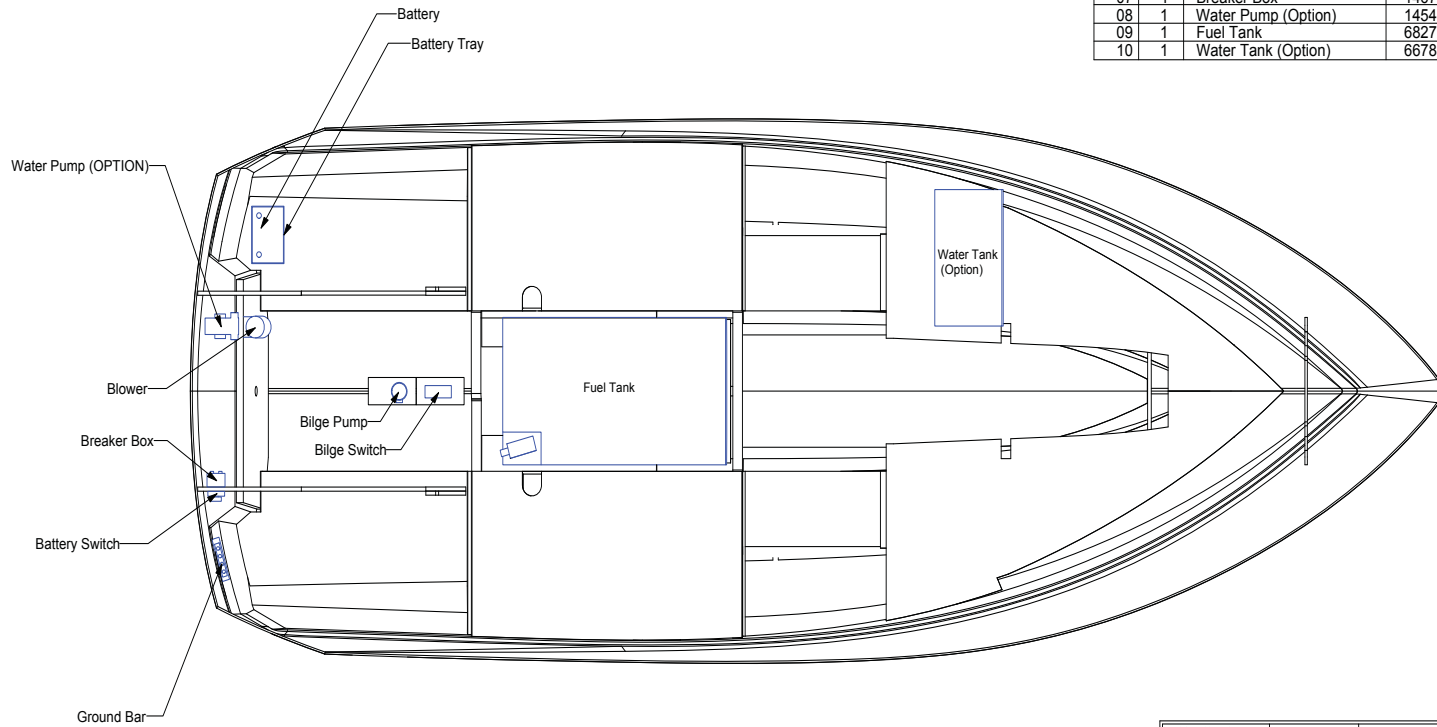

BILL OF MATERIALS			
ITEM	QTY.	DESCRIPTION	PART #
01	1	Battery Tray	1479
02	1	Bilge Pump	57661
03	1	Bilge Switch	57674
04	1	Blower	68312
05	1	Ground Bar	956733
06	1	Battery Switch	147141
07	1	Breaker Box	14670
08	1	Water Pump (Option)	14541
09	1	Fuel Tank	68272
10	1	Water Tank (Option)	66781

REVISION DESCRIPTION	DR. BY	APP. BY	REV. DATE
 REGAL MARINE INDUSTRIES 2300 AIRPORT DRIVE ORLANDO, FLORIDA 32809 TEL (407) 851-4300 ALL RIGHTS RESERVED			
DRAWING TITLE: 2300 Sump Hardware			
DATE: 12.16.08	SCALE: 1 of 1		
DRAWN BY: RYAN.WB	APPROVED BY: D.LINKER	DWG. NO.:	MDR24Q

2300 SUMP HARDWARE

REGAL 2300
 MANUAL DRAWING
 REGAL MARINE INDUSTRIES

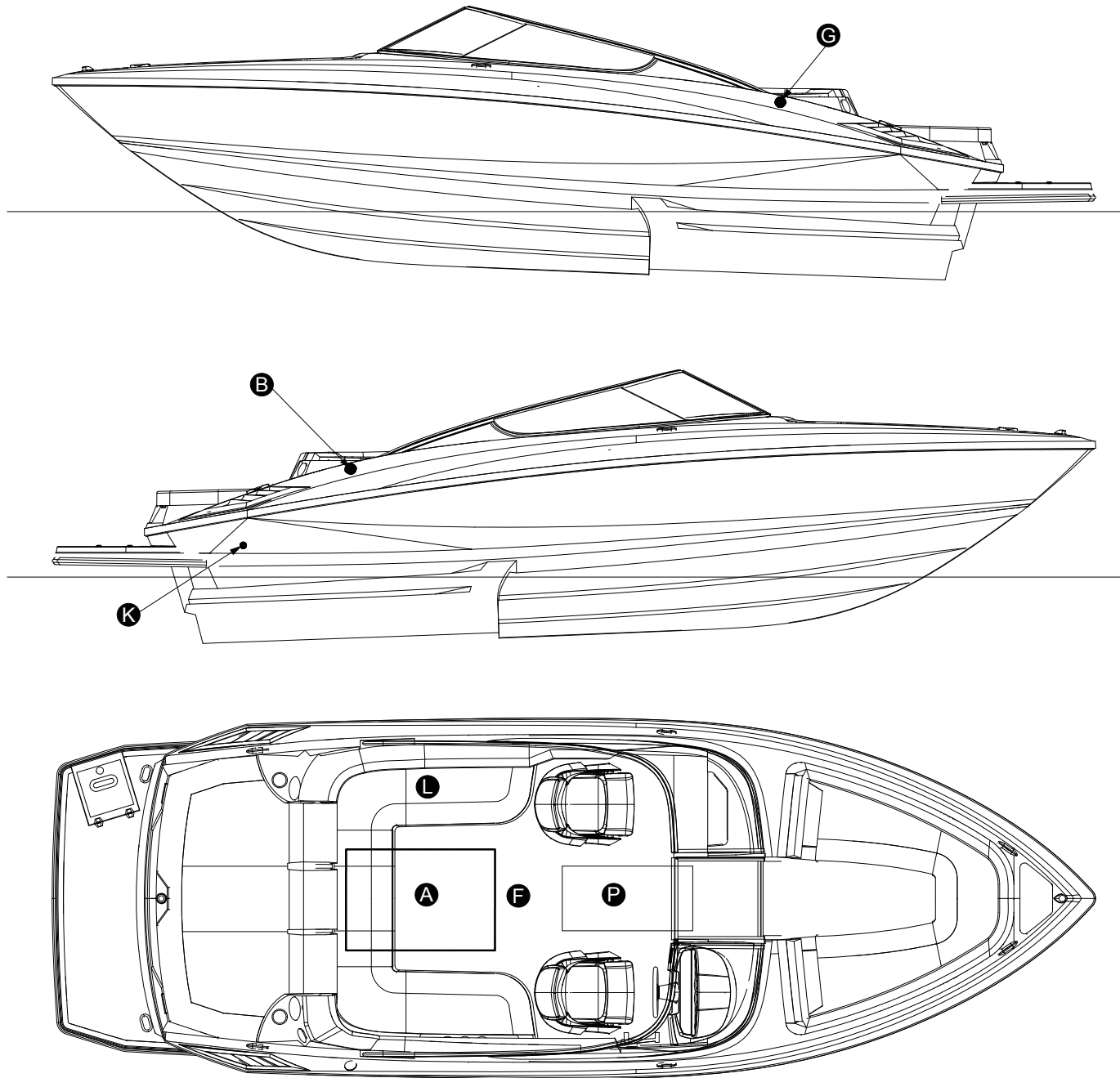

- Key
- A) Fuel Tank
 - B) Fuel Tank Filling Point
 - C) Oil Tank
 - D) Oil Tank Filling Point
 - E) Oil Tank Emptying Point
 - F) Water Tank
 - G) Water Tank Filling Point
 - H) Holding Tank
 - I) Holding Tank Emptying Point
 - J) Seacocks
 - K) Through-Hull Fittings
 - L) Fire Extinguisher
 - M) Carbon Monoxide Detector
 - N) Escape Hatch
 - O) Fire Escapes
 - P) Life Raft Stowage

2300 CE EQUIPMENT LOCATION

2500 ELECTRICAL LAYOUT (1 OF 2)

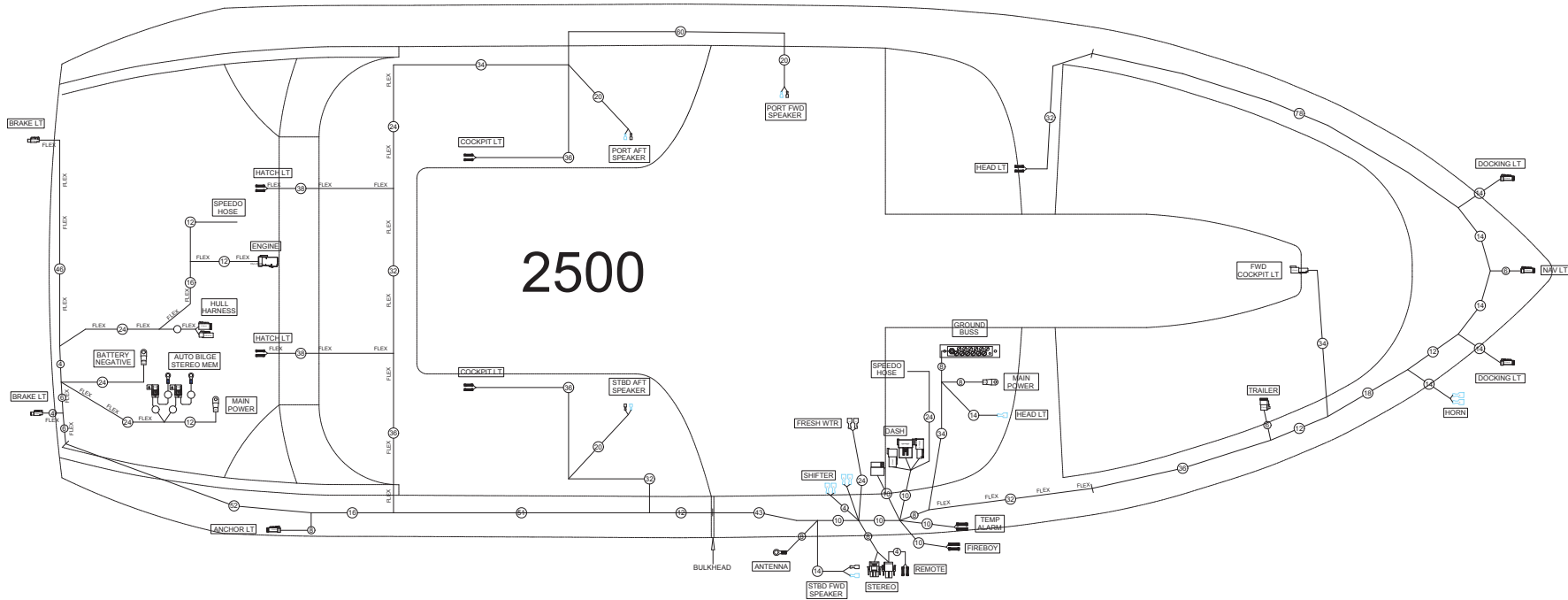

REVISION DESCRIPTION	DR. BY	APP. BY	REV. DATE
 REGAL MARINE INDUSTRIES 2300 JETPORT DRIVE ORLANDO, FLORIDA 32809 TEL: (407) 851-4360 ALL RIGHTS RESERVED			
DRAWING TITLE:			
2500 ELECTRICAL LAYOUT (1 OF 2)			
DATE:		SCALE:	
10-10-08			
DRAWN BY:		APPROVED BY:	DWG. NO.:
C. WOO			EME22D

2500 ELECTRICAL LAYOUT (EARLIER STEREO VERSION)

2500 ELECTRICAL LAYOUT (2 of 2)

IPA RECEPTACLE 1

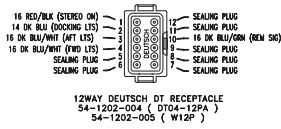

IPA RECEPT 2

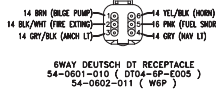

IPA RECEPT 3



MAINPOWER
4 RED - 1/4 RING

ENGINE CONNECTOR
8-WAY MOLDED

FIREBOY INDICATOR
16 PUR - BUTT
16 BLK/WHT - BUTT

TEMP ALARM
16 PUR - BUTT
16 TAN/BLU - BUTT

FRESH WATER PUMP
12 ORN/BLK (PWR) - .25 UF FEM
12 BRN (TO PUMP) - .25 UF FEM

NEUTRAL SWITCH
16 YEL/RED #1 - .25 UF FEM
16 YEL/RED #2 - .25 UF FEM

LANYARD SWITCH
16 PUR #1 - .25 UF FEM
16 PUR #2 - .25 UF FEM

STEREO AND SPEAKERS

FWD/AFT SPEAKERS (SOCKETS)

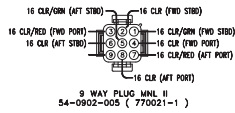

STEREO PLUG (SOCKETS)

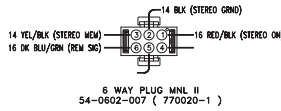

PORT AFT SPEAKER
16 CLR/RED - .25 UF FEM
16 CLR - .1875 UF FEM

STBD AFT SPEAKER
16 CLR/RED - .25 UF FEM
16 CLR - .1875 UF FEM

STEREO REMOTE
16 YEL/BLK (MEM) - BUTT
16 BLK (GRND) - BUTT

PORT MID SPEAKER
16 CLR/RED - .25 UF FEM
16 CLR - .1875 UF FEM

STBD MID SPEAKER
16 CLR/RED - .25 UF FEM
16 CLR - .1875 UF FEM

ANTENNA GRND
16 GRN - 3/8 RING

COCKPIT LTS - WIRED TO COCKPIT LT SWITCH

PORT HATCH LT
16 BLU/WHT - BUTT
16 BLK - BUTT

STBD HATCH LT
16 BLU/WHT - BUTT
16 BLK - BUTT

PORT COCKPITLT
16 BLU/WHT - BUTT
16 BLK - BUTT

STBD COCKPITLT
16 BLU/WHT - BUTT
16 BLK - BUTT

FWD COCKPIT LIGHT



FWD CONNECTORS AND WIRING

FWD BRAKE LIGHT CONNECTOR

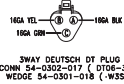

NAVIGATION LT

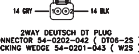

PORT DOCKING LT



STBD DOCKING LT

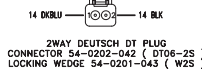

HORN

14 YEL/BLK - .25 UF FEM
14 BLK - .25 UF FEM

HEAD LT
16 BLU/RED - .25 UF FEM
REGAL ATTACH TO COCKPIT LT FUSE

HEAD LT
16 BLU/RED - BUTT
16 BLK - BUTT

BATTERY NEGATIVE
4 BLK - 5/16 RING

GROUND BUSS

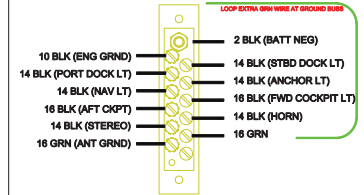

AFT CONNECTORS AND WIRING

BRAKE LIGHT 1



BRAKE LIGHT 2



MAINPOWER
4 RED - 1/4 RING

AFT AUTO BILGE
14 BRN/WHT - .25 UF FEM

STEREO MEMORY
14 YEL/BLK - .25 UF FEM

ANCHOR LT



ENGINE AND HULL CONNECTORS

TO HULL HARNESS

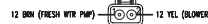

TO HULL HARNESS

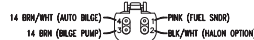

ENGINE CONNECTOR

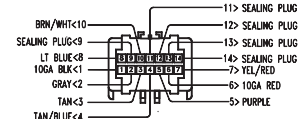

14WAY APEX SEALED PLUG W/ PINS
54-1402-006 (FCI 5420-1415)
65-0101-060 CAVITY PLUG

REVISION DESCRIPTION	DR. BY	APP. BY	REV. DATE
REGAL MARINE INDUSTRIES 2300 JETPORT DRIVE ORLANDO, FLORIDA 32809 TEL (407) 851-4360 ALL RIGHTS RESERVED			
DRAWING TITLE:			
2500 ELECTRICAL LAYOUT (2 of 2)			
DATE:	10-10-08		SCALE:
DRAWN BY:	C. WOO		DWG. NO.:
APPROVED BY:			EME22D

2500 TRANSOM SPEAKER ELECTRICAL

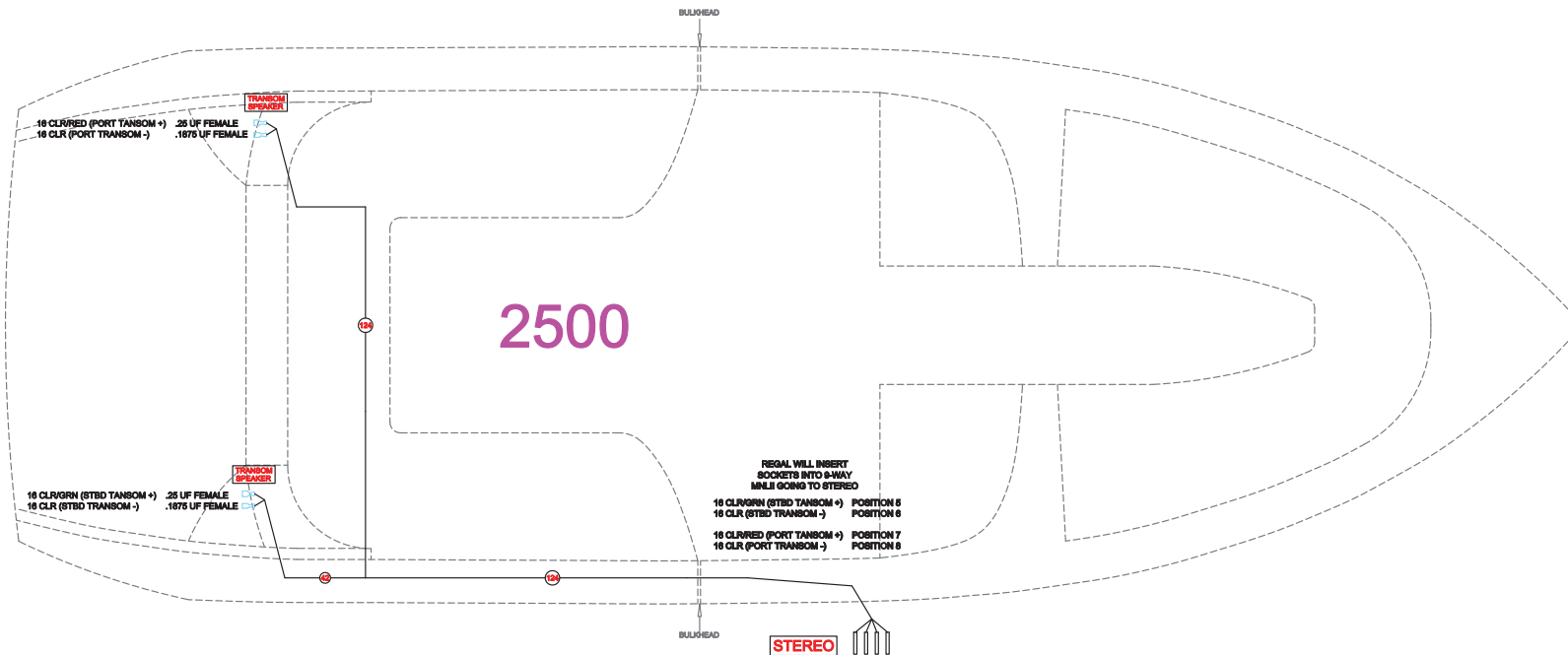

REVISION DESCRIPTION	DR. BY	APP. BY	REV. DATE
 REGAL MARINE INDUSTRIES 2300 JETPORT DRIVE ORLANDO, FLORIDA 32809 TEL (407) 851-4389 ALL RIGHTS RESERVED			
DRAWING TITLE:			
2500 TRANSOM SPEAKER ELECTR.			
DATE:	10-13-08	SCALE:	
DRAWN BY:	C. WOO	APPROVED BY:	DWG. NO.: EME22F

2500 TRANSOM SPEAKER WIRING (EARLIER STEREO VERSION)

2500 SPP ELECTRICAL LAYOUT

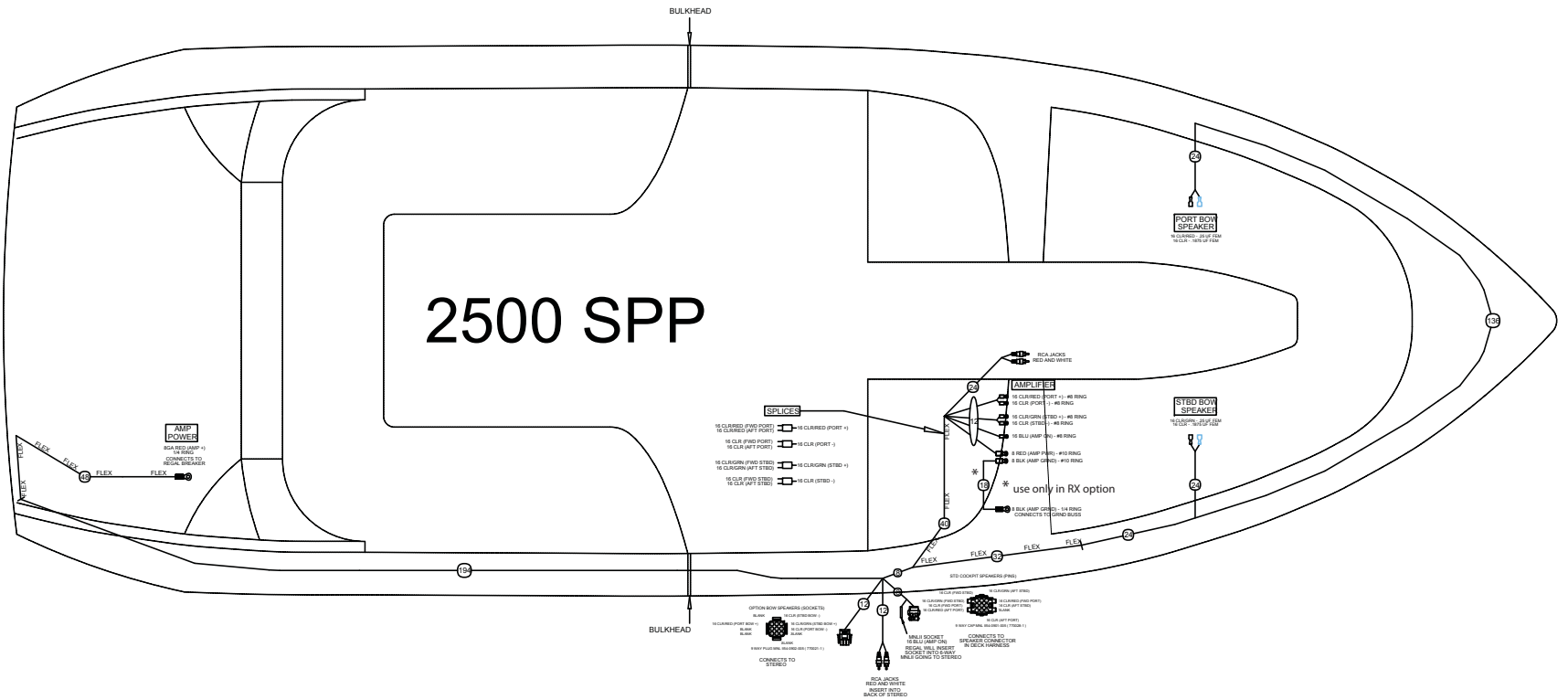

REVISION DESCRIPTION	DR. BY	APP. BY	REV. DATE
 REGAL MARINE INDUSTRIES 2300 JETPORT DRIVE ORLANDO, FLORIDA 32809 TEL (407) 851-4360 ALL RIGHTS RESERVED			
DRAWING TITLE:			
2500 SPP ELECTRICAL LAYOUT			
DATE: 10-20-08		SCALE:	
DRAWN BY: C. WOO	APPROVED BY:	DWS. NO.: EME22G	

2500 STEREO PERFORMANCE PACKAGE (EARLIER STEREO VERSION)

2500 FUEL SYSTEM

BILL OF MATERIALS			
ITEM	QTY.	DESCRIPTION	PART #
01	1	1-1/2" FUEL FILL HOSE - 8FT	1769
02	1	5/8" FUEL VENT HOSE - 8FT	1770
03	1	3/8" FUEL CARB - 3FT	1776
04	1	1-1/8" BILGE FLEX HOSE - 8FT	1463

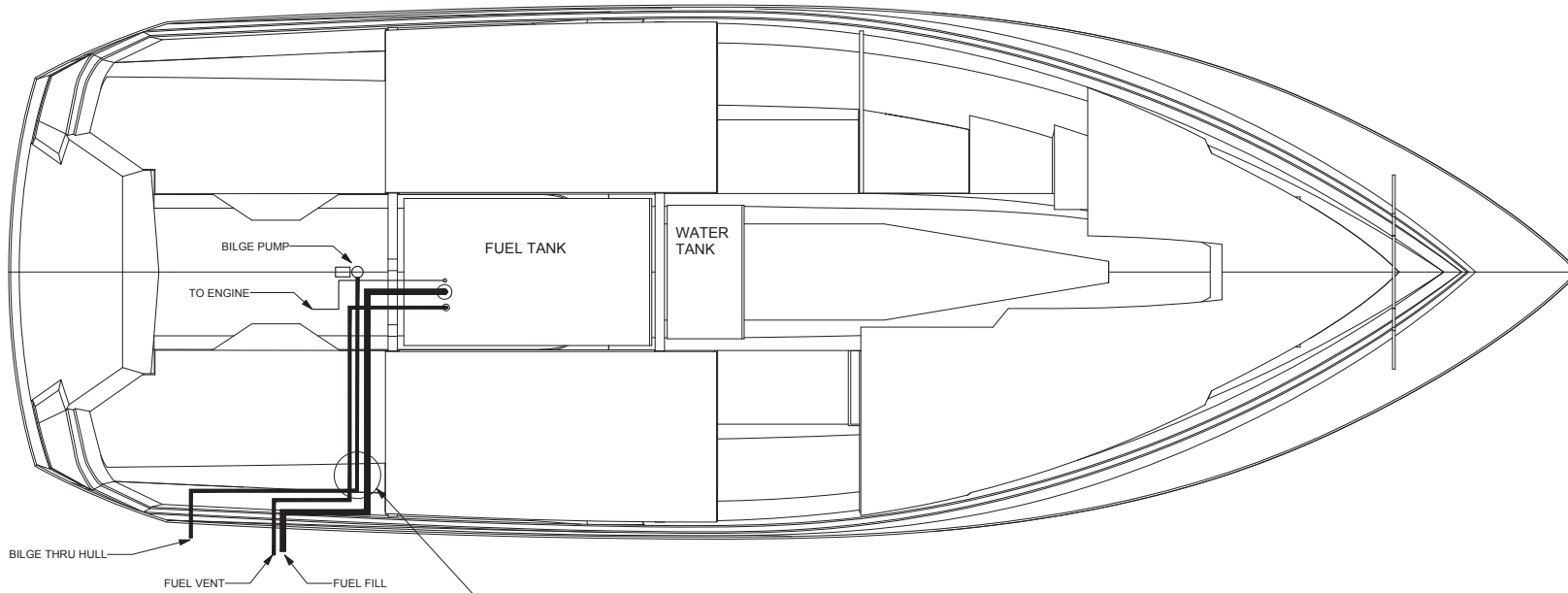

NOTE: DO NOT STRAP HOSES TOGETHER.

REVISION DESCRIPTION	DR. BY	APP. BY	REV. DATE
 REGAL MARINE INDUSTRIES 2350 WESTPORT DRIVE ORLANDO, FLORIDA 32809 TEL (407) 951-4360 ALL RIGHTS RESERVED			
DRAWING TITLE:			
2500 FUEL SYSTEM			
DATE:	10-31-08	SCALE:	
DRAWN BY:	C. WOO	APPROVED BY:	
		DWG. NO.:	MME23A

2500 FUEL (NON-EPA) SYSTEM

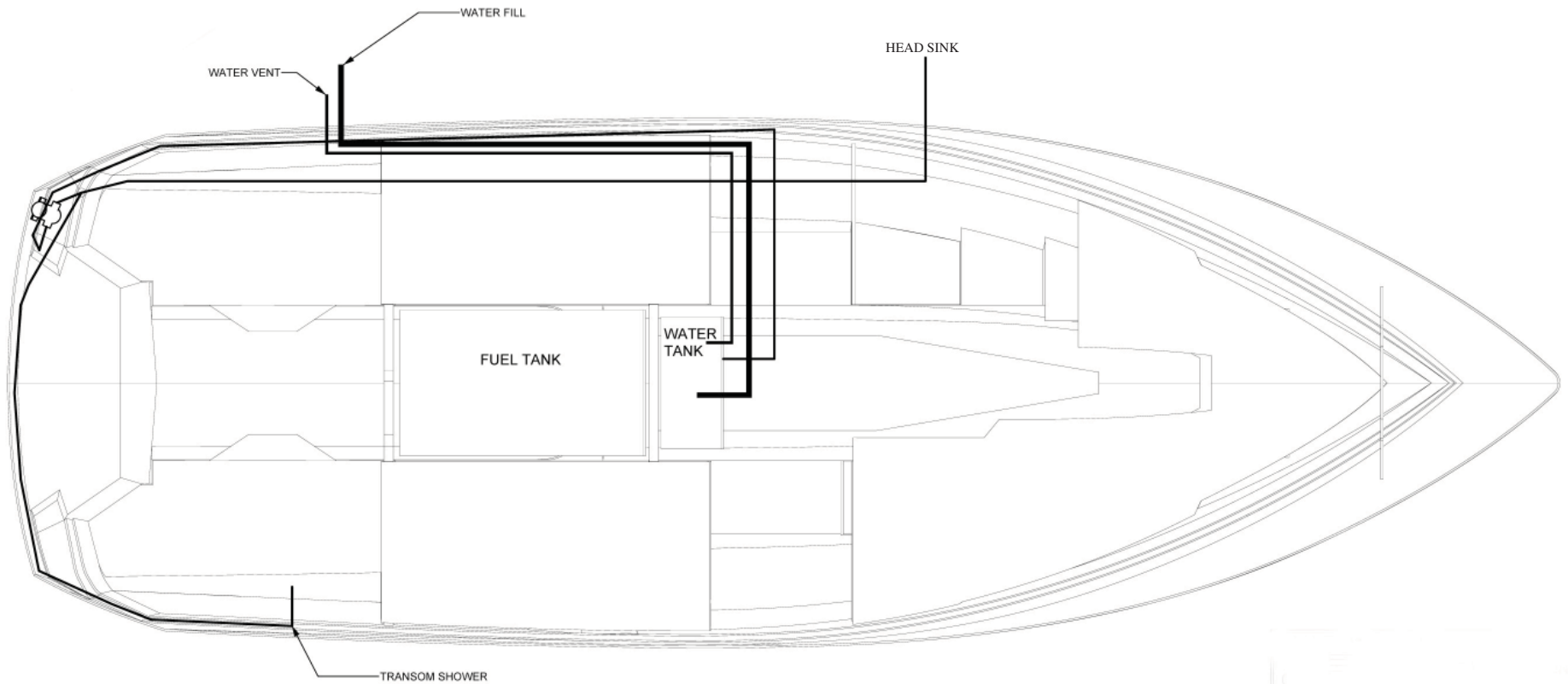

2500 PRESSURE WATER SYSTEM

2500 SUMP LAYOUT

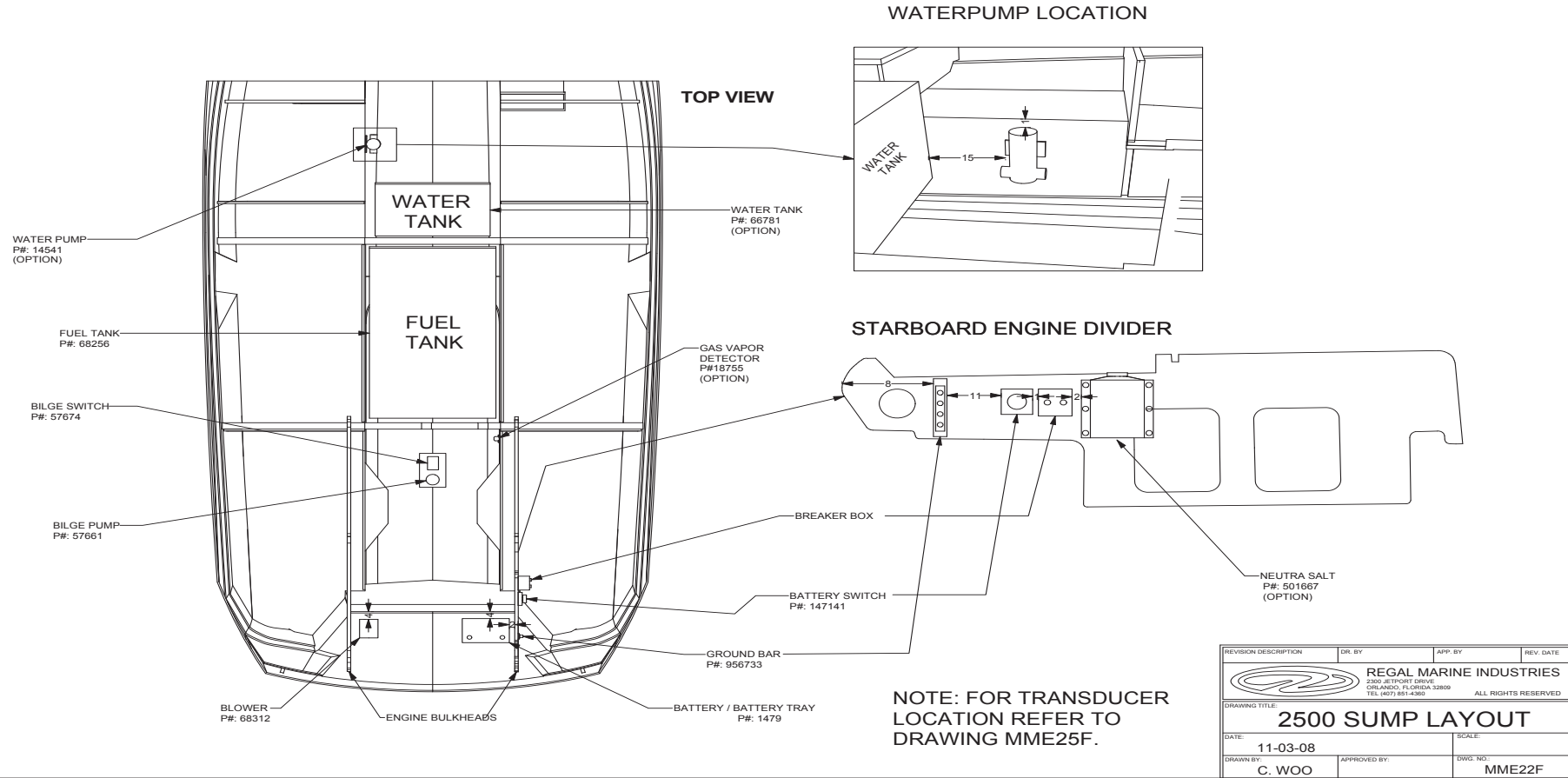

REVISION DESCRIPTION	DR. BY	APP. BY	REV. DATE
 REGAL MARINE INDUSTRIES 2300 ALPHARET DRIVE ORLANDO, FLORIDA 32809 TEL. 407.851.4360 ALL RIGHTS RESERVED			
DRAWING TITLE:			
2500 SUMP LAYOUT			
DATE:		SCALE:	
11-03-08			
DRAWN BY:		APPROVED BY:	DWG. NO.:
C. WOO			MME22F

2500 SUMP EQUIPMENT LAYOUT

2500 DECK PLAN W/ FUEL AND WATER TANKS

Deck Parts & Features Locations

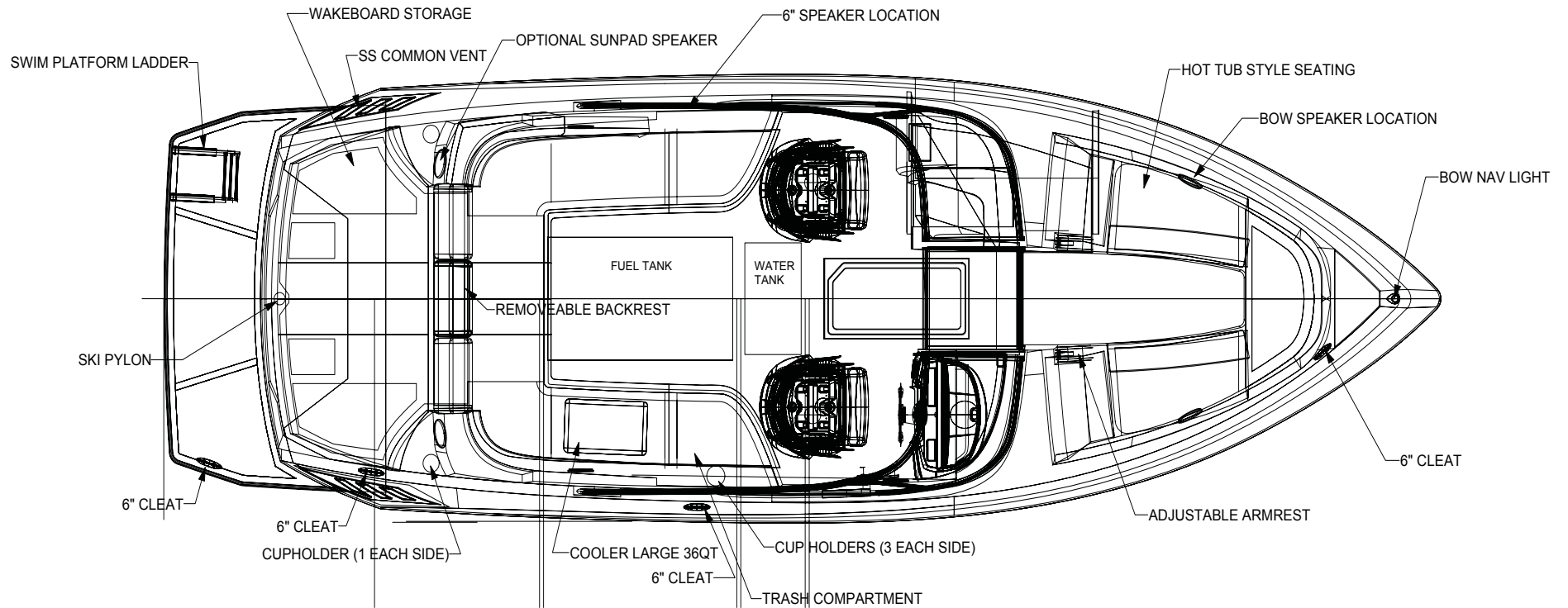

© REGAL MARINE INDUSTRIES
 SCALE: 1/2" = 1' 3-20-2008

2500 DECK HARDWARE

REGAL 2500

MANUAL DRAWING

REGAL MARINE INDUSTRIES

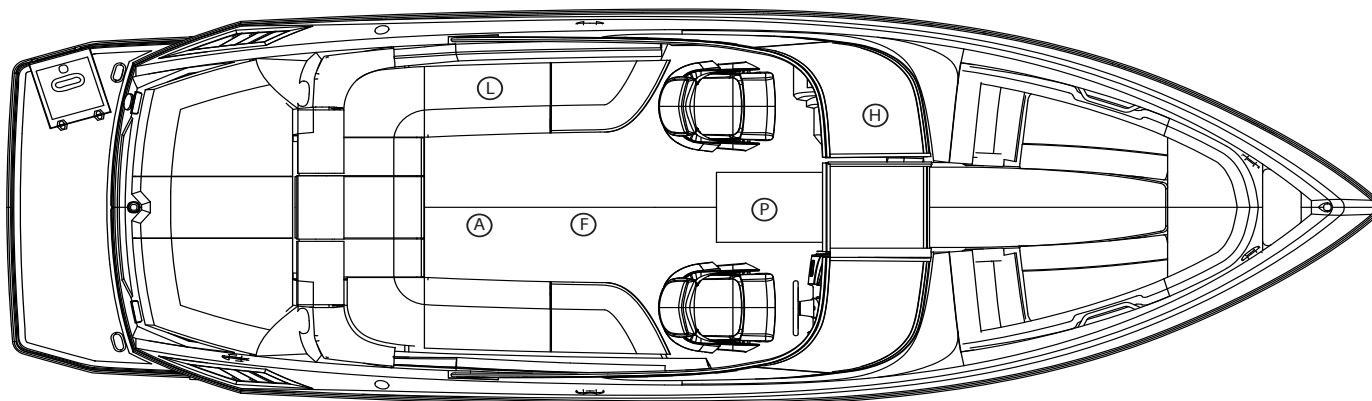
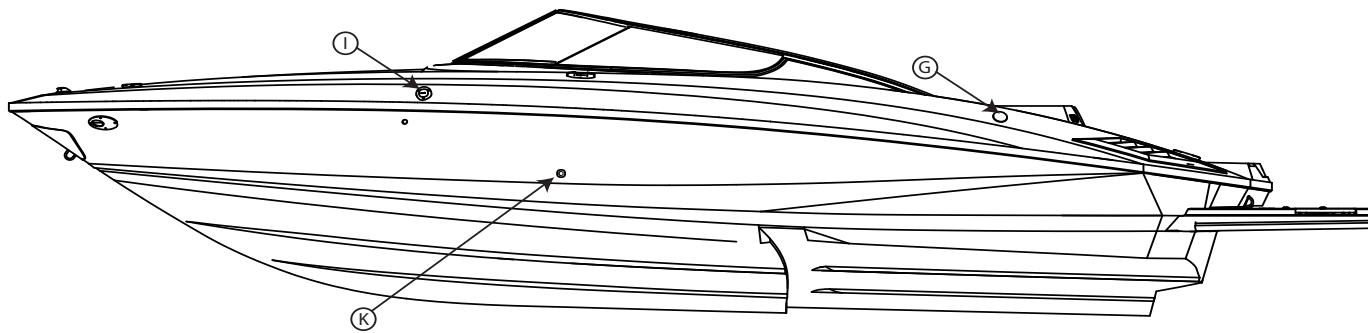
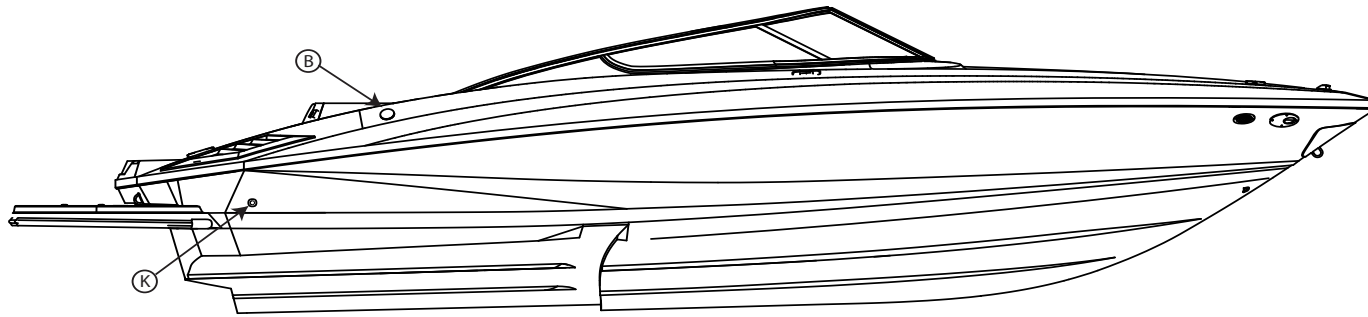

Key

- A) Fuel Tank
- B) Fuel Tank Filling Point
- C) Oil Tank
- D) Oil Tank Filling Point
- E) Oil Tank Emptying Point
- F) Water Tank
- G) Water Tank Filling Point
- H) Holding Tank
- I) Holding Tank Emptying Point
- J) Seacocks
- K) Through-Hull Fittings
- L) Fire Extinguisher
- M) Carbon Monoxide Detector
- N) Escape Hatch
- O) Fire Escapes
- P) Life Raft Stowage

2500 CE EQUIPMENT LOCATION

7-30-09	PROTO X5	MD
9-3-09	A: Release for production w/ changed	md
9-14-09	B: RECN#23097 ADDED ARCH LTS DROP OFF	MD

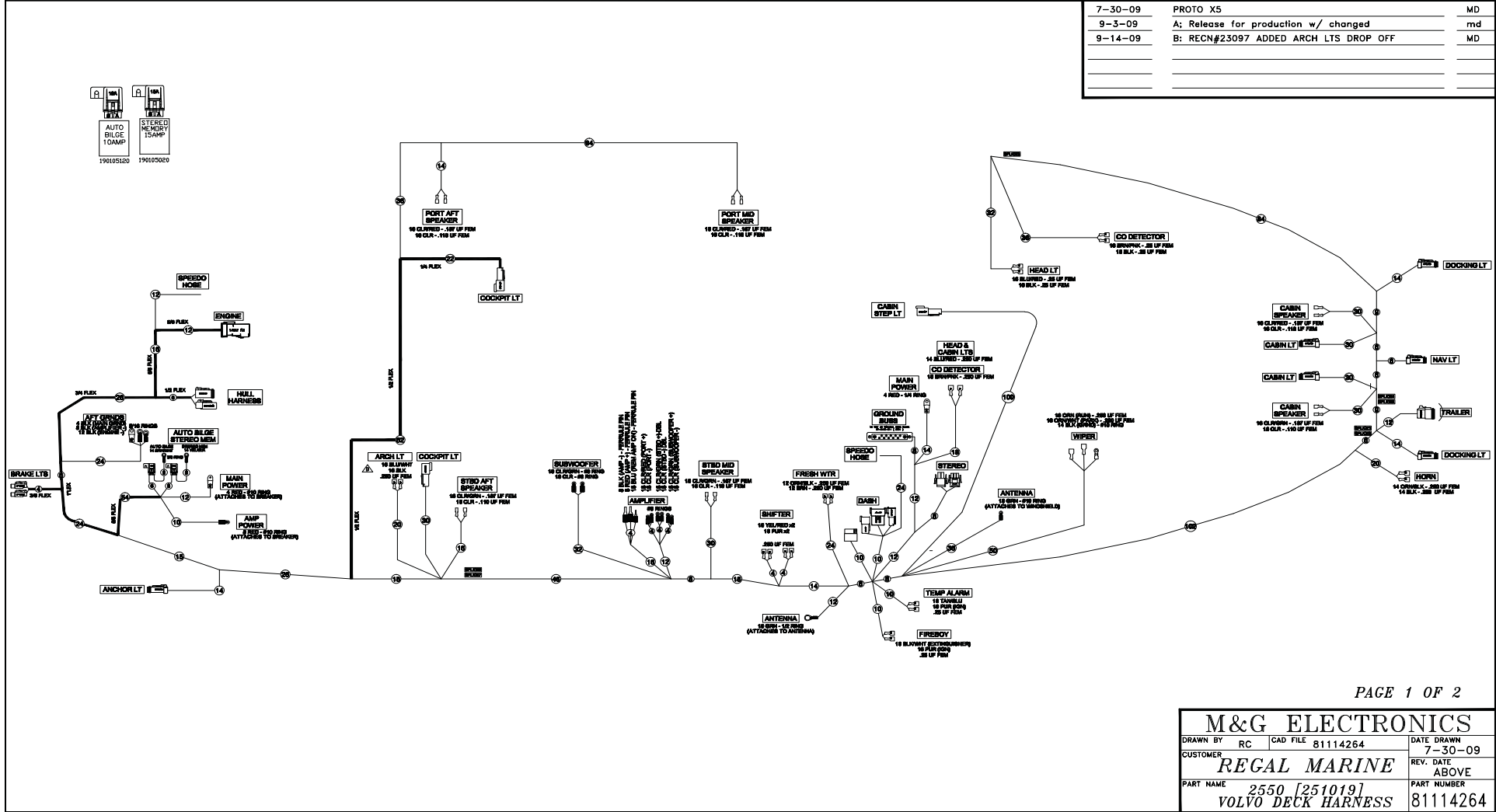

M&G ELECTRONICS		
DRAWN BY	RC	CAD FILE 81114264
CUSTOMER	REGAL MARINE	
PART NAME	2550 [251019]	PART NUMBER
	VOLVO DECK HARNESS	81114264
		DATE DRAWN 7-30-09
		REV. DATE ABOVE

2550 DECK HARNESS LAYOUT

2550 ELECTRICAL LAYOUT (2 of 2)

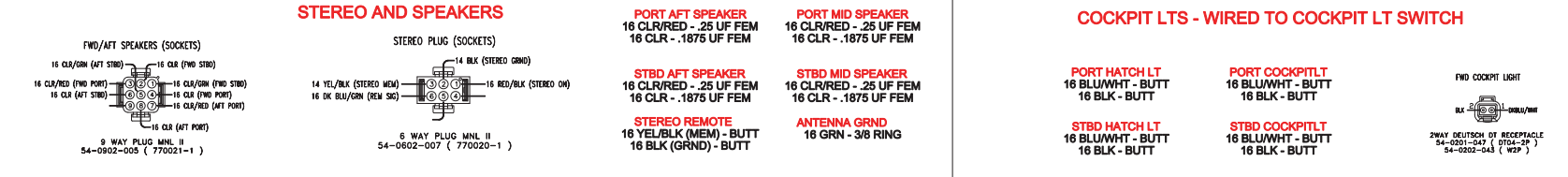
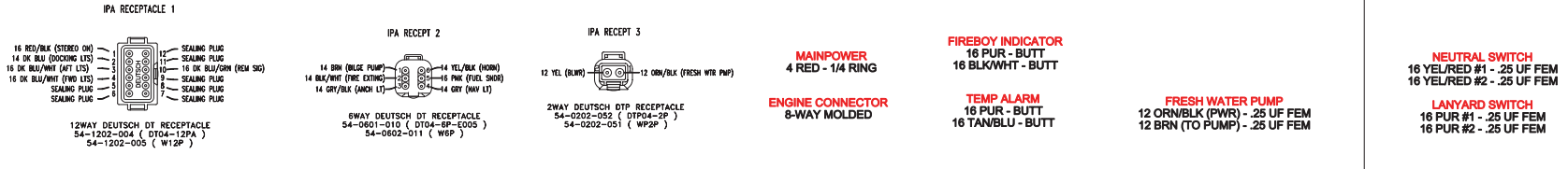

FWD CONNECTORS AND WIRING

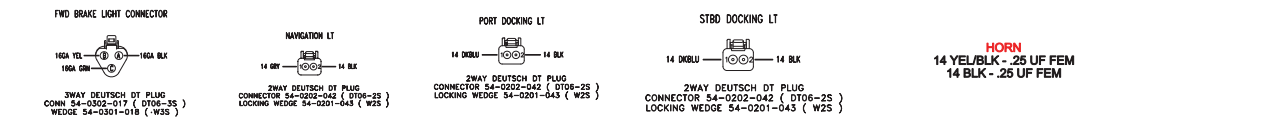

AFT CONNECTORS AND WIRING

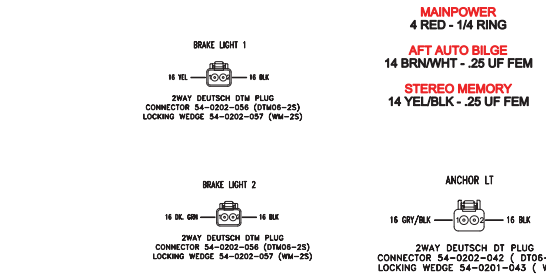

ENGINE AND HULL CONNECTORS

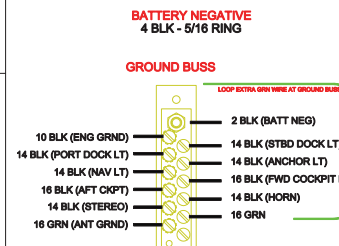
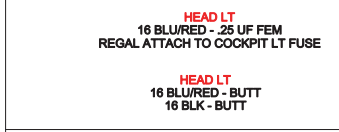
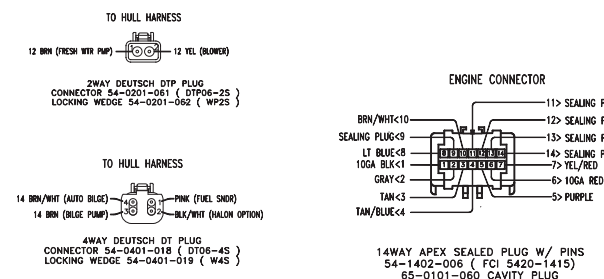

REVISION DESCRIPTION	DR. BY	APP. BY	REV. DATE
 REGAL MARINE INDUSTRIES 2300 JETPORT DRIVE ORLANDO, FLORIDA 32809 TEL 407.854.4360 ALL RIGHTS RESERVED			
DRAWING TITLE: 2550 ELECTRICAL LAYOUT (2 of 2)			
DATE:		SCALE:	
DRAWN BY: C. WOO	APPROVED BY:	DWS. NO.:	

2550 FUEL SYSTEM

BILL OF MATERIALS			
ITEM	QTY.	DESCRIPTION	PART #
01	1	1-1/2" FUEL FILL HOSE - 8FT	1769
02	1	5/8" FUEL VENT HOSE- 8FT	1770
03	1	3/8" FUEL CARB - 3FT	1776
04	1	1-1/8" BILGE FLEX HOSE- 8FT	1463

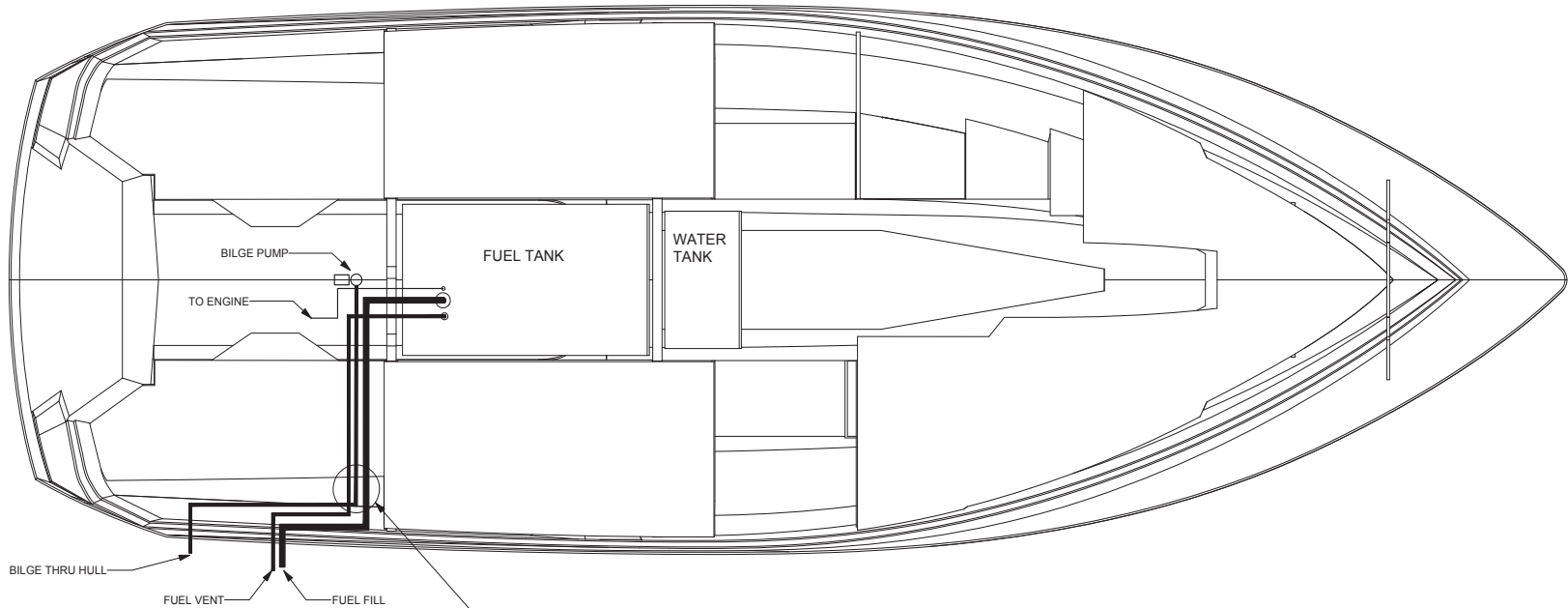

NOTE: DO NOT STRAP HOSES TOGETHER.

REVISION DESCRIPTION	DR. BY	APP. BY	REV. DATE
 REGAL MARINE INDUSTRIES 2300 JEFFERSON DRIVE ORLANDO, FLORIDA 32809 TEL (407) 851-4360 ALL RIGHTS RESERVED			
DRAWING TITLE:			
2550 FUEL SYSTEM			
DATE:	10-31-08	SCALE:	
DRAWN BY:	C. WOO	APPROVED BY:	
		DWG. NO.:	MME23A

2550 (NON-EPA) FUEL SYSTEM

WIRING DIAGRAM

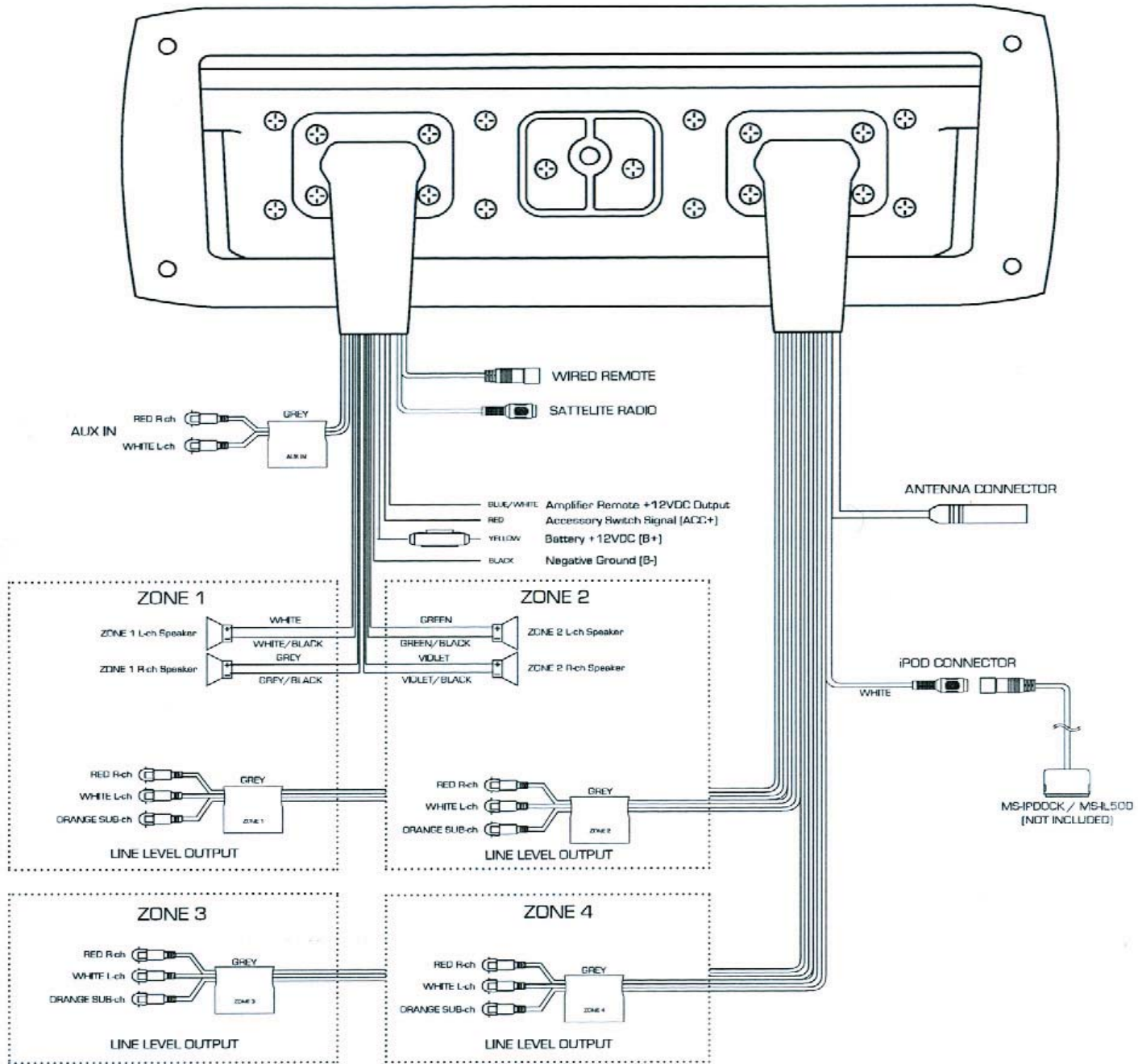

FUSION STEREO WIRING DIAGRAM

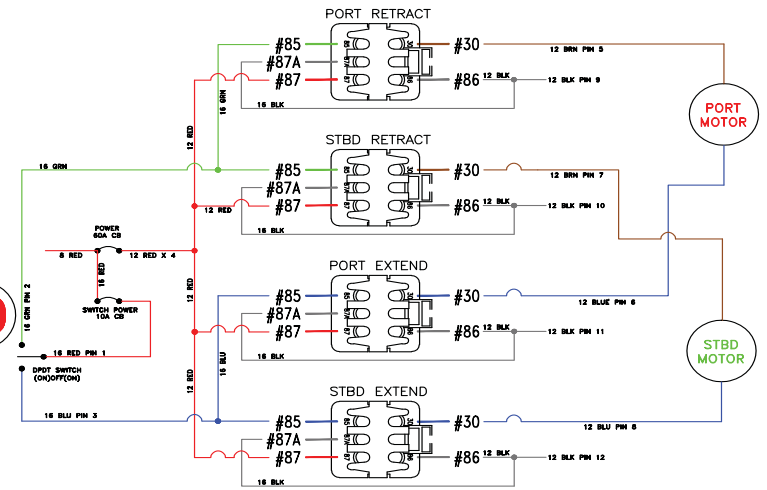
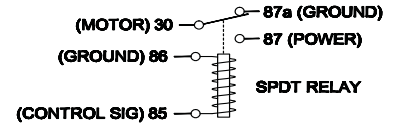
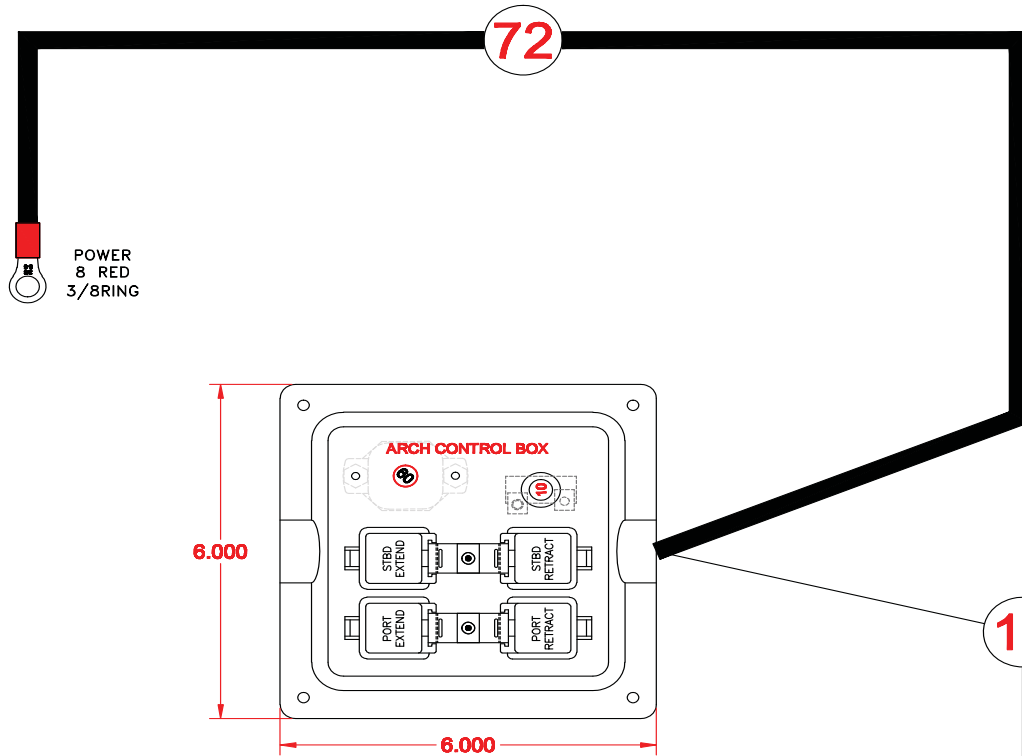

PLUG/PINS

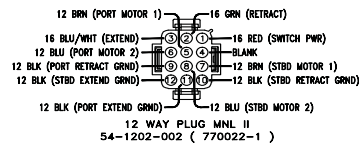

2300,2500,2550 OPTIONAL SPORT TOWER RELAY BOX

QUICK START GUIDE-REGAL SURF SYSTEM



Introduction to Regal Surf System

The following pages outline the **basic operation of the Regal Surf System**. Read and understand the Regal owner's manual and the Regal Vue system before attempting to use the surf system along with any safety labels found in the manual or on board the vessel. Always use an on board spotter to watch and communicate with the surf rider. Remember the captain is responsible for his crew and maintaining his vessel. Safety first!!

The Regal Surf System utilizes Volvo forward drive propulsion along with other integrated components to offer boater's wakesurfing, wakeboarding or cruising options. The components include ballast tanks, wave shaping surf tabs, and a Regal Vue touch screen for full surf control at your fingertips.

Brief Description of Surf Components

Volvo Forward Drive Propulsion-

This cutting edge technology utilizes two-forward-facing counter-rotating propellers which actually pull the vessel through the water rather than push it (old technology). The forward drive delivers a smoother and quieter ride with little vibration. Of course coupled with surf tab technology, the drive unit permits equally shaped wakesurfing on either side of the vessel. By reducing prop ventilation, the Volvo forward drive produces better overall fuel economy and higher top end speeds.

Ballast Bags-

Depending on the Regal surf model, a set of ballast bags (total poundage varies) can be filled automatically or manually to different levels which can affect the type of surf wave produced. Normally the ballast bags are located in the center bow along with the port and starboard stern to maintain stability.

Surf Tabs-

The stainless steel surf tab set (transom mounted near hull bottom edge) are designed to be either fully extended for surf riding or fully retracted for normal cruising as controlled by the Regal Vue surf system touch screen. When the starboard or port positions are chosen on the touch screen the transom light on that side of the boat will initially flash indicating to the surf rider the side of the surf wave. Note that the surf tabs are locked when the engine is “OFF”. There is a red (OFF/ON) tab system activation icon touch control button on the lower left surf screen. In addition, when a speed of 14 mph is achieved the surf tabs will automatically return to the retracted position.

Regal Vue Surf Screen-

Using the full fingertip surf control screen you can consolidate all surf functions in one place. Here you can fill your ballast, choose your speed, and pick your wave direction with just a few taps on the touch screen display. The surf control screen is opened by depressing the second button from the top on the right side (timer).

Setting The Surf Screen Control Screen Display Functions

1. The Regal Vue display is energized by starting the engine or all selections can be made with the key in the “ON” position except for the surf tabs. Once the display is activated it will show REGAL and the HOME screen will appear similar to illustration A below.
2. To activate the surf screen display and to be able to set up the system for surfing depress the timer on the Regal Vue right side. You will see a screen appear that is close to what is shown below.



3. After initial surf display activation you can program the display to accommodate the surf rider. Use illustration B below to fill the ballast bags. Choose FILL all tab at the left hand ballast column and all bags will fill automatically and then shut off. If you want to individualize ballast weight for a rider you can fill them individually by pressing the up arrows to the desired amount. To empty the ballast bags choose the EMPTY all tab at the left hand ballast column.

4. Press the ZERO OFF tab to the ON position to enter the surf mode and set the surf rider speed. Use the arrows to set the speed at 11 mph for most riders. For a steeper wake (more push) choose 10 mph. For a longer wake (easy cruise) choose 10.5 or 11. The wake speed can be adjusted in 1/2 increments.

5. Press the RED icon button at the bottom left of the surf tab control screen display to TURN OFF the surf tab circuit. Activate the PORT or STBD. surf tab at the bottom to choose left or right. Tabs are locked when engine is OFF.

ALL 3 BAGS FILL OR EMPTY AT THE SAME TIME

ON/OFF TO ZERO OFF MUST BE ON TO HOLD SPEED POSITIONS.

B



6. The QUICK LAUNCH tab shown next to the surf tab in illustration B is a factory preset program for surf tab enhancements. The surf tabs in this mode automatically adjust for a loaded boat to aid in improved visibility by assisting in keeping the bow down and a more efficient ride through the entire RPM range. Note that the pre-programmed surf tab positions are factory set and can't be altered by the end user.

7. Notice that it is possible to save an individual's surf riding profile. Just press the PROFILE tab and the unit saves the surf rider's information so the display screen need not be programmed again for that surf rider.