



26 FASDECK

26 OBX

OWNER'S MANUAL

Notes

The information found in this owner's manual may change at any time.

Designated items referred to may not be installed on your vessel. In keeping with its commitment to continued product improvement Regal Marine Industries, Inc. reserves the right to modify the vessel at any time without notice including changes in specifications, colors, fabrics, materials and equipment or to discontinue a model. Regal is not obligated to make similar changes or modifications to models sold prior to the date of such changes.

All specifications are approximate including weights, fuel figures and speeds. Speeds are calculated at sea level with a temperature of 70 to 85 degrees. Increases in altitude and/or temperature will reduce horsepower and thereby reduce the speed of the vessel.

All information is for reference only and should be used as a guideline. Consult local and state guidelines as they may differ in your area. Any decisions relating to safe operation of the vessel are the responsibility of the operator.

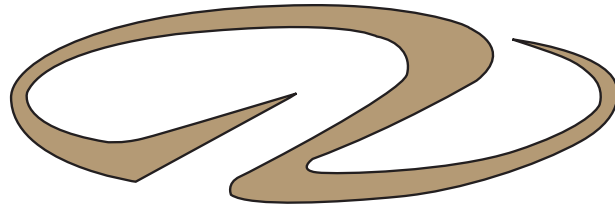

REGAL®

OWNER'S MANUAL

26 FASDECK

26 OBX



Table Of Contents

1 INTRODUCTION

Regal Owner's Manual	12
Owner's Information Packet	12
General Information	13
Regal Marine Warranty	20

2 SAFETY ON BOARD

Safety Labels	24
General Boating Safety	25
Required Safety Equipment	27
Fire Extinguishers	29
Visual Distress Signals	31
Sound Producing Devices	33
Radio Communications	33
Navigation Lights	33
Marine Sanitation Devices	33
Pollution Regulations	35
Garbage Discharge	36
Life Rafts	37
U.S.C.G Minimum Equipment Requirements	37
Exhaust & Carbon Dioxide	38
Boating & Alcohol	41
Boating Accidents/Federal Security Regulation	42
Water Sports	44
Weather & Water Conditions	45

3 RULES OF THE ROAD

Navigation Rules Defined	46
Navigation Rules	48
Bridge Clearance	53



Table Of Contents

4 SYSTEMS

Fire Port	56
Fuel	57
Electrical	64
Fresh Water	78
Waste	82
Trim Tabs	90
Entertainment	92
Electronics	105

5 ENGINE/CONTROLS

Break-In	109
Ventilation	110
Instrumentation	111
Starting Engine	115
Controls	123
Steering	126
Outboard- OBX General Information	127

6 VESSEL OPERATION

Getting Underway	151
Starting & Stopping	154
Fenders	156
Dock Line Basics	157
Knots	159
Docking/Maneuvering	160
Anchoring	167
Towing/Admiralty Law	168
Emergencies	169
Trailerling	173



Table Of Contents

7 AUXILIARY EQUIPMENT OPERATION

Bilge Pump/Float Switch	183
Boarding Ladder	184
Bow Filler Cushion	185
Bow Walk-Thru Doors	186
Canvas	187
Carpet-Cockpit	195
Docking Lights	196
Drain Plug	197
Fender Clips	198
Fire Extinguishing System	199
Markers-Slings	201
Mats-Cockpit Seagrass	202
Port Light	203
PowerTower	204
Pressure Pump-Fresh Water	206
Rod Holders	207
SeaDeck Covering	208
Seat-Ultra Lounge	210
Stereo Performance Package	211
Swim Platform	212
Table-Cockpit	213
Underwater Lighting	214
Water Sports Tow	215



Table Of Contents

AUXILIARY EQUIPMENT OPERATION (Continued)

Water/Waste Monitor	216
Waste Pump	217
Waste Filter-Vent	217



Table Of Contents

8 COSMETIC CARE & MAINTENANCE

Cosmetic Care 218

Maintenance 233

9 TROUBLESHOOTING

Diagnostic Charts 251

10 STORAGE & WINTERIZATION

Checklists 261

11 GLOSSARY & INDEX 268

12 TECHNICAL INFORMATION 274

13 TECHNICAL DRAWINGS 282



Introduction

Note that select information in this manual is shared by both stern drive and outboard vessels. There is a special section in chapter 5 that addresses the OBX outboard exclusively.

More detailed outboard information is found in the outboard vendors operation manual and this document must be read and understood before attempting to operate the OBX.

Boating is becoming more popular each and every year. There are numerous types of recreational vessels on our waterways today involved in an every growing number of activities. Therefore, as a Regal boat owner it is of the highest priority to learn about general boating practices before operating your vessel.

Your Regal dealer will answer many questions and provide valuable “hands on” information during the completion of the new boat delivery process. In addition, your dealer has received special factory training on the product line and his services should be employed to solve any technical problems and periodic maintenance beyond the scope of this manual. Your Regal dealer carries a line of factory approved parts and accessories.



Your Regal dealer can provide information regarding national training organizations such as the U.S. Power Squadron and United States Coast Guard Auxiliary. Along with other organizations and literature, they can help build your “boating savvy” by developing the necessary skills and awareness to be a safe and confident skipper.

Also, your local library can assist in providing recommended boating literature such as Chapman Piloting Seamanship & Boat Handling by Elbert S. Maloney.

Also, boating information is available on the internet. Remember, waterway conditions can change in a heartbeat. Knowing how to react quickly comes from experience and knowledge which can be gained through boating education. Welcome aboard!

It is important that you read the engine operator’s manual carefully and become completely familiar with the operation as well as required maintenance procedures on the engines and related propulsion systems. Also, read the auxiliary equipment manuals found in the owner’s information packet.



Chapter 1

WELCOME TO REGAL

I know I speak for everyone at Regal when I welcome you to the ever-growing family of Regal boat owners. You've chosen a boat that is recognized worldwide for its standard of excellence. Each step in construction has been carefully scrutinized to assure safety, performance, reliability and comfort for both your passengers and yourself.

Your yacht is certified by the National Marine Manufacturers Association. It also complies with the applicable standards set by the United States Coast Guard, American Boat and Yacht Council and the International Marine Certification Institute. Your Regal boat was built with the same attention to detail and quality of construction that we would expect in a craft we would purchase ourselves.

Whether you're a veteran boater or a newcomer, we strongly urge you to read this owner's manual thoroughly. Familiarize yourself with the various components of your vessel, and heed the safety precautions noted herein.

If you have questions that are not covered in this manual, please consult your authorized Regal dealer for assistance, phone the Regal factory at 407-851-4360 or E-mail us at www.regalboats.com.

Thank you, and welcome to the "World of Regal!"

*Duane Kuck
President & CEO*



REGAL MARINE INDUSTRIES, INC.
MISSION STATEMENT

With God's help
and a steadfast commitment to integrity,
we will develop a team
of exceptional people and relationships
to provide exceptional customer satisfaction.



Chapter 1

REGAL OWNER'S MANUAL

Your Regal owner's manual has been compiled with information to assist you in operating your craft with safety and pleasure. This manual targets specific details of Regal related systems and components along with their location, operation and maintenance that normally is not found in the vendor information. In addition, supplier related equipment information is located within the owner's information package.

	WARNING
PREVENT INJURY, DEATH, OR PROPERTY DAMAGE! READ AND UNDERSTAND THE PROPULSION OWNER'S MANUAL BEFORE ATTEMPTING TO OPERATE THE VESSEL.	

The Regal owner's manual is not to be thought of as a complete shop technical document. Beside the system chapters, there is troubleshooting information devoted to select current standard and optional equipment. In addition, refer to the engine and generator (if installed) operator's manuals. More detailed information may exist in the owner's packet associated with that component.

Remember that your Regal dealer has received special factory training and his services should be employed to solve more technical problems. Call 407-851-4360 or go to the internet at www.RegalBoats.com to find the closest Regal dealership.

In keeping with its commitment to improvement Regal Marine Industries, Inc. is continually upgrading the product line. Regal notes that all dimensions, specifications, models, standard and optional equipment is subject to change without notice at any time.

OWNER'S "INFO" PACKET



An owner's information packet (black satchel) is located on the vessel. Read and become familiar with the materials. This packet contains valuable literature on your

propulsion package, standard and optional equipment, systems, various care and cleaning instructions along with component warranty and instructional information. Store the information packet in a clean, dry location.



Introduction

GENERAL INFORMATION

HULL IDENTIFICATION NUMBER (HIN)



TYPICAL HIN

The United States Coast Guard has established a universal system of numerically recognizing vessels by using a hull identification number or "HIN." This number identifies your Regal yacht's

model, hull number, month and year of manufacture. The HIN is normally found on your boat's transom, on the starboard side, just below the rub rail on the transom vertical surface. The HIN is stamped on a plate and reinforced with a special adhesive. The HIN consists of 12 alpha or numeric characters.

It is recommended that you locate and write down the HIN for future reference. It can be especially useful when ordering parts from your Regal dealer. A second HIN number is found in a hidden location. This second HIN is useful to authorities if the vessel is stolen and/or the original transom HIN is modified or eliminated.

VESSEL INFORMATION SHEET

It is recommended that you fill out the information on the following page. It will supply vital statistics on your vessel. Make a copy of the data for safe keeping at home.

VESSEL FLOAT PLAN

Formulate the float plan on the following page before departing. Leave it with a responsible person who will notify the United States Coast Guard or local law enforcement authorities if you do not return as planned. If you change your plans be sure to notify this person. Make copies of the float plan and use one each time you go boating. This will help people know where to find you should you not return on schedule. Do not file the float plan with the United States Coast Guard.

NMMA YACHT CERTIFICATION PLATE

At the helm (dash) area you will notice a metal plate which recognizes that your vessel was built to design compliance in effect on the date the certification was verified. The plate also states that your vessel complies with U. S. Coast Guard safety system standards in effect on the date of certification. Vessels 26' and longer are candidates for the NMMA Yacht Certification Plate.

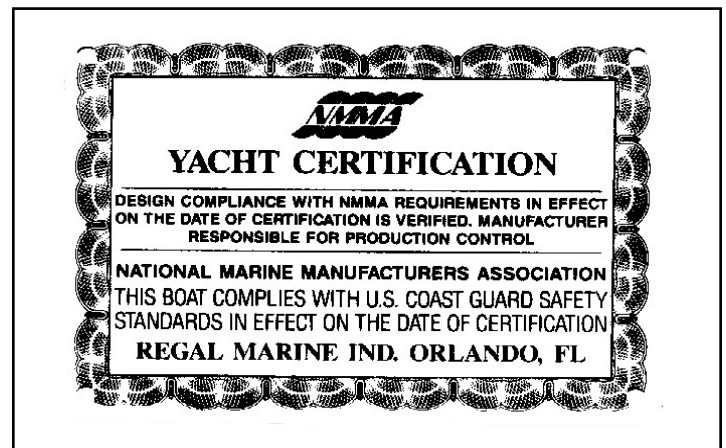



VESSEL INFORMATION

Owner: _____

Address: _____

City & State: _____

Home Phone: _____ Business Phone: _____

In Case Of Emergency Notify: _____

Address _____

City _____ State _____

Phone _____

Insurance Agent's Name: _____

Policy#: _____

USCG Phone: _____ Local Police: _____

Marina Phone: _____ Slip (Dock#): _____

Hull Serial #: RGM _ _ _ _ _

Key #: _____ Engine: _____

Selling Dealer: _____

Address: _____

City & State: _____

Phone: _____ Fax: _____

Servicing Dealer: _____

Address: _____

City & State: _____

Phone: _____ Fax: _____



VESSEL FLOAT PLAN

Fill out this form before departure. Leave it with a responsible person who will notify the Coast Guard or police if you don't return as planned. If you change your plans be sure to notify this person. Make copies of the float plan and use one each time you go on a trip. This will help people know where to find you should you not return on schedule. Do not file this plan with the Coast Guard.

Owner: _____

Address: _____

City & State: _____

Telephone#: _____

Person Filing Report: _____

Name _____

Telephone _____

Make Of Craft: _____

Length _____ Boat Name _____

Color _____ Trim _____ Hp _____

Inboard _____ Stern Drive _____

Hull I.D.# _____

Documented Vessel # _____

Other Information _____

Safety Equipment Aboard: _____

Life Jackets _____

First Aid Kit _____

Flares _____

Flash Light _____

VHF Radio _____

Cell Phone ___#_____

Computer ___Desk Top ___Lap Top___

E-mail address _____

Food _____ Water _____

State Registration# _____

Destination: _____

Leave From _____

Time Left _____

Going To _____

Fuel Capacity _____

Est. Day Of Arrival _____

Est. Time Of Arrival _____

If Not Back By _____ o'clock Call Authorities

Persons Aboard:

Name	Age	Address	Phone
_____	_____	_____	_____
_____	_____	_____	_____
_____	_____	_____	_____
_____	_____	_____	_____
_____	_____	_____	_____
_____	_____	_____	_____
_____	_____	_____	_____
_____	_____	_____	_____
_____	_____	_____	_____
_____	_____	_____	_____

____ See Other Side For Additional Persons



VESSEL CRUISE CHECKLIST

- Obtain a current weather update.
- Periodically hoist the boat & inspect the hull bottom and propellers for damage. Marine growth such as barnacles will affect performance and fuel efficiency. Check sacrificial anodes located on the propulsion unit, transom and engine. Replace anode if less than 2/3 remaining.
- Check the electrical system and all safety related equipment. Carry extra fuses. Ensure they are of the proper capacity and type.
- If your boat has been in the water, run the bilge pump until the flow of water stops.
- If your boat has been out of the water, check to see that all bilge water has drained.
- Check that all required safety equipment is on board and in good working condition. Examples include personal flotation devices (PFD's), horn, bell, hand held fire extinguishers, and visual distress signals.
- Check fuel level. Fuel tanks should be filled to slightly less than capacity. Allow for fuel expansion. Remember the "one third rule".
- Open engine compartment. Inspect for fuel odors and visible leaks in the fuel, oil, coolant, exhaust and power steering systems.
- Check the fuel filters for the presence of water .
- Check fluid levels of engines, drives and generator.
- Visually inspect engine for cracked hoses, worn or loose belts, and loose hardware.



Introduction

RECOMMENDED ON BOARD EQUIPMENT

TOOLS

Allen Wrenches
Jack Knife
Phillips Screwdriver
System
Regular & Needle Nose Pliers
Combination Box & End Wrench Set
Screwdriver Set (One With Various Tips)
Side Cutters
Ratchet & Socket Set
Electrical Crimper,Cutter,Stripper Combo
Hammer
VOA Electrical Tester
Water Pump Pliers
Vise Grip Pliers
Floating Flashlight/Lantern
Oil/Fuel Filter Wrench
Tape Rule

SPARE PARTS

Fuel Filters-Engines & Generator
Poly V- Belt (See Engine Manual)
Coolant For Engine Freshwater
Extra Light Bulbs
Seawater Filter
Fuses
Propeller Set (See Dealer)
Propeller Hardware
Flashlight Batteries
Engine Spare Parts
Generator Spare Parts
Air Filters-Engine & Generator
Oil Filters-Engine, Generator
Drive Oil Filters

BASIC GEAR & SUPPLIES

Tow Line
Mooring Lines
Dock Fenders
Distress Signals
First Aid Kit
Boat Hook
Charts & Plotting Instruments/Back-up Use
Emergency Food & Water
EPIRB
Bailer or Hand Pump
Extra Hand Held Fire Extinguishers
Personal Floation Devices
Clean Rags, Diapers (For Under Engine-Oil Leaks)
Sunscreen (SPF 30+)
Bucket/Pans w/Lids-Draining/Storing Used Fluids
Mirror (For Inspection & Emergency Signaling)
Funnel

BASIC GEAR & SUPPLIES

Lubricating Oil, Liquid Wrench
Duct & Electricians Tape
Coolant (Engine Freshwater Side)
Engine, Drive, Power Steering Oil
Boat Soap (Not Dish Soap)
Woody Wax
Vinyl Cleaner
Hydrogen Peroxide (AC Pans)
Life Raft
Rust Stain Remover (Starbrite)
Corrosion Block
Bilge Cleaner
Nylon Windbreaker Suit
Shop Vac (1 Gal. Cap. Wet-Dry)
Squeegee
Binoculars



Owner's Registration & Systems Checklist

Please note that your boat requires the proper registration by your authorized Regal dealer. To initiate the vessel warranty your dealer must complete the owner's registration form and systems checklist at the time of delivery. The owner must sign the paperwork to acknowledge that the dealer has reviewed the boat systems and warranty provisions with the owner. The owner should keep the original paperwork that features a temporary warranty registration. A warranty certificate will be sent approximately 6 weeks after receipt of the paperwork at Regal World Headquarters.

Dealer's Responsibility

Your vessel has undergone rigid quality assurance inspections before leaving the factory. In addition, your dealer has been trained to perform final pre-delivery checks and to service your Regal boat.

Your dealer's responsibilities include:

1. An orientation in the operation of your Regal boat including matters relating to the safe operation of the vessel.
2. Completion and mailing of your boat registration warranty form to Regal.
3. Location of vendor warranties, registration materials, owner's manual, operation, installation and maintenance instructions for auxiliary equipment supplied with or installed on your Regal boat.



Introduction

Owner's Responsibility

You are entitled to all the benefits and services outlined in your Regal warranty. However, you have certain responsibilities to ensure warranty satisfaction.

These are:

To read the warranty materials and understand them fully.

To examine the vessel in detail at the time of delivery.

Apply the following: boating rules and regulations, safety equipment, environmental regulations, accident reports and warranty regulations terms and conditions.

To read thoroughly all literature supplied with your boat including this owner's manual and to follow the recommendations in the literature.

To provide proper maintenance and periodic servicing of your boat and equipment as set forth in the various manuals supplied.

Customer Service

Take the time to write down your Regal dealer's phone number and E-mail address for future reference. Along with your Regal dealer information is a listing below of other phone numbers and web addresses which may prove useful.

Regal Dealer:

Phone: _____

E-mail: _____

Regal Marine Customer Service:

1-800-US REGAL (1-800-877-3425)

regal@regalboats.com

customer.service@regalboats.com

Volvo Penta Of America (24-Hour Hotline Support):

1-800-522-1959

vpa.consumerrelations@volvo.com



Chapter 1



REGAL MARINE INDUSTRIES, INC. LIMITED WARRANTY

Welcome to the Worldwide Family of Regal Owners! We are very pleased that you have chosen a Regal Powerboat!

This document is your Limited Warranty Registration Certificate and Statement of Limited Warranty. Please check the registration information section for accuracy. If this information is not correct or if you change your address at some future date, please notify us at the following address: Regal Marine Industries, Inc. Attention: Warranty Registrations, 2300 Jetport Drive, Orlando, Florida 32809; or email customerservice@regalboats.com.

Please read the Limited Warranty carefully. It contains important information on Regal's claims procedures and your rights and obligations under this Limited Warranty.

WHAT IS COVERED: This Limited Warranty applies to Regal boats beginning with model year 2017.

LIFETIME LIMITED STRUCTURAL DECK & HULL WARRANTY: Regal Marine Industries, Inc. warrants to the original retail purchaser of this boat, if purchased from an authorized Regal dealer, that the authorized selling Regal dealer or Regal will repair or replace the factory installed fiberglass if it is found to be structurally defective in material or workmanship, for as long as the *original* retail purchaser owns the boat. For purpose of this Limited Warranty, the hull is defined as the single fiberglass casting which rests on the water. This Limited Warranty is subject to all limitations and conditions explained below.

FIVE-YEAR TRANSFERABLE LIMITED STRUCTURAL HULL WARRANTY: In addition to the Lifetime Limited Structural Hull Warranty, Regal offers a Transferable Five-Year Limited Structural Hull Warranty. Under the Five-Year Transferable Limited Structural Hull Warranty, the authorized Regal selling dealer or Regal will repair or replace the fiberglass hull or deck if it is found to be structurally defective in material or workmanship within the first five (5) years after date of delivery to the *original* retail purchaser. Any remaining term of this Five-Year Limited Hull Warranty may be transferred to a second owner if within 60 days of purchase; the new owner registers the transfer with Regal and pays the established Limited Warranty transfer fee. Contact Regal Customer Service at the above address for details.

FIVE-YEAR LIMITED HULL BLISTER WARRANTY: Regal warrants that the authorized Regal selling dealer or Regal will repair any underwater gelcoated surfaces of the hull against laminate blisters which occur as a result of defects in material or workmanship within five (5) years of the date of delivery, provided that the original factory gelcoat surface has not been altered. Alteration would include but is not limited to damage repair; excessive sanding, scraping, sandblasting; or from improper surface preparation for application of a marine barrier coating or bottom paint, any of which shall void this Five-Year Limited Hull Blister Warranty. Proper preparation must be applied to the hull bottom if the boat is to be moored in the water for periods in excess of sixty (60) days. Regal Marine shall repair or cause to be repaired any covered laminate blisters based on the following prorated schedule.

Less than three (3) years from delivery date – 100%, Three (3) to four (4) years from delivery date – 50%, Four (4) to five (5) years from delivery date – 25%

Reimbursement shall be limited to one repair, not to exceed one hundred (\$100.00) dollars per foot of boat length prior to prorating. Regal's prior authorization for the method and cost of repair must be obtained before repairs are commenced. All costs to transport the boat for repairs are the responsibility of the owner.

LIMITED GENERAL WARRANTY: In addition to above hull warranties, Regal warrants to the original purchaser of this boat if purchased from an authorized Regal dealer, that the authorized Regal selling dealer or Regal will repair or replace any parts found to be defective in materials or workmanship for a period of one (1) year from the date of delivery, subject to all exceptions, limitations and conditions contained herein.

LIMITED EXTERIOR FINISH WARRANTY: Regal warrants that the authorized Regal selling dealer or Regal will repair cosmetic defects in the exterior gelcoat finish including cracks, air voids or crazing for one year from the date of delivery to the original retail purchaser reported within the first year, subject to all limitations and conditions contained herein. All warranty work is to be performed



Introduction

at a Regal dealership or other location authorized by a Regal Customer Service Manager after it is established to Regal's satisfaction that there is a defect in material or workmanship.

CUSTOMER OBLIGATIONS: The following are conditions precedent to the availability of any benefits under these limited warranties:

- (a) The purchaser, who is not Regal's sales agent and is otherwise not in any general or sales agency relationship with Regal, must sign and the authorized Regal selling dealer, must submit to Regal the "NEW BOAT DELIVERY and ACCEPTANCE CHECKLIST" within fifteen (15) days of the date of delivery and such information must be on file at Regal.
- (b) The purchaser must first notify the authorized Regal selling dealer from whom the boat was purchased of any claim under this Limited Warranty within the applicable Limited Warranty period and within a reasonable period of time (not to exceed thirty (30) days after the defect is or should have been discovered.)
- (c) Regal will not be responsible to repair any condition or replace any part, (1) if the use of the boat is continued after the defect is or should have been discovered; and (2) if such continued use causes other or additional damage to the boat or component parts of the boat.
- (d) Based on the authorized Regal selling dealer's knowledge of Regal's Limited Warranty policy and /or consultations with Regal, the dealer will accept the claim and arrange for appropriate repairs to be performed, or deny the claim, if it is not within the Limited Warranty policy.
- (e) The authorized Regal selling dealer will contact the Regal boat owner regarding instructions for delivery of boat or part for covered warranty repair if it is covered by the Limited Warranty. **ALL COSTS TO OR FROM THE BOAT AND/OR TRANSPORT OF THE BOAT FOR REPAIRS ARE THE RESPONSIBILITY OF THE OWNER.**
- (f) If the Regal boat owner believed a claim has been denied in error or the authorized Regal selling dealer has performed the covered warranty work in an unsatisfactory manner, the owner must notify Regal's Customer Service Department in writing at the address listed for further consideration. Regal will then review the claim and take appropriate follow-up action.
- (g) Before bringing any action, claim, lawsuit or otherwise seeking relief against Regal based on any alleged breach of any of the Limited Warranties' terms or conditions herein, the Regal Boat owner must contact Regal's Customer Service Department Directly and allow Regal, beyond those efforts made by its authorized Regal selling dealer or other authorized Regal dealer, notice and an opportunity to cure any alleged breach of any of the terms of any of the Regal Limited Warranties.

WARRANTY EXCEPTIONS: THIS LIMITED WARRANTY does not cover, the following are not warranted, are excluded from the terms of the Regal Limited Warranty and the following terms apply to any Regal Limited Warranty:

- (a) Engines, drives, controls, propellers, batteries, metal plating or finishes, windshield breakage, leakage, fading and deterioration of paints, canvas, vinyl, upholstery, and fabrics;
- (b) Gelcoat surfaces including, but not limited to discoloration or blistering except as noted above;
- (c) Accessories and items which were not part of the boat when shipped from the Regal factory or which carry their own individual warranty and /or any damage caused by such accessories and items;
- (d) Damage caused by one or more of the following: misuse, accident, corrosion, galvanic corrosion, negligence, lack of proper maintenance, or improper trailering;
- (e) Any boat used for racing, or used for rental or commercial purposes;
- (f) Any boat operated contrary to any instructions furnished by Regal, including instructions and guidance provided in the Regal Owner's Manual, or operated in violation of any federal, state, Coast Guard or other governmental agency laws, rules, or regulations;
- (g) The limited warranty is void if alterations have been made to the boat;
- (h) Transportation of boat or parts to and/or from a REGAL factory or service location;
- (i) Travel time or haul outs, loss of time or inconvenience;
- (j) Any published or announced catalog performance characteristics of speed, fuel and oil consumption, and static or dynamic transportation in the water;
- (k) Any boat that has been repowered beyond Regal's power recommendations;
- (l) Boats damaged by accident and boats damaged while being loaded onto, transported upon or unloaded from trailers, cradles, or other devices used to place boats in water, remove boats from water or store or transport boats on or over land;
- (m) Any item repaired, replaced or modified under the terms of this warranty does not in any way prolong, extend or change any terms set forth in this limited warranty;



Chapter 1

- (n) Water damage to, dry rot to, condensation to, or absorption by interior surfaces, wood structures or polyurethane foam; interior wood including, but not limited to, mold, bleeding and/or discoloration as a result of condensation or moisture or water continually contacting the plywood causing staining to upholstery, carpet or other interior surfaces;
- (o) Costs or charges derived from inconvenience or loss of use, commercial or monetary loss due to time loss, and any other special, incidental or consequential damage of any kind or nature whatsoever.
- (p) Regal reserves the right to improve the design or manufacture process of Regal boats without obligation to modify previously produced product;

NO WAIVER OF THESE TERMS: The terms, conditions, limitations and disclaimers contained herein cannot be waived except by the Customer Service Manager of Regal. Any such waiver shall be in writing. Neither the authorized Regal dealer, nor the customer, nor any service, sales and/or warranty representative of Regal is authorized to waive and/or modify these conditions, limitations and/or disclaimers.

EXCEPT AS SET FORTH HEREIN OR ON ANY OTHER WRITTEN EXPRESS LIMITED WARRANTIES BY REGAL, THERE ARE NO OTHER WARRANTIES EITHER EXPRESS OR IMPLIED PROVIDED BY REGAL ON THIS BOAT. ALL OTHER WARRANTIES, EXPRESS OR IMPLIED, INCLUDING IMPLIED WARRANTIES OF FITNESS AND MERCHANTABILITY, ARE EXPRESSLY EXCLUDED. REGAL FURTHER DISCLAIMS ANY LIABILITY FOR ECONOMIC LOSS ARISING FROM CLAIMS OF PRODUCT FAILURE, NEGLIGENCE, DEFECTIVE DESIGN, MANUFACTURING DEFECT, FAILURE TO WARN AND/OR INSTRUCT, LACK OF SEAWORTHINESS, AND ANY OTHER THEORY OF LIABILITY NOT EXPRESSLY COVERED UNDER THE TERMS OF THIS LIMITED WARRANTY.

AS SET FORTH ABOVE, REGAL MAKES NO IMPLIED WARRANTY OF MERCHANTABILITY AND EXPRESSLY EXCLUDES ANY SUCH WARRANTY. TO THE EXTENT SUCH EXCLUSION IS NOT ALLOWED BY LAW OR AN IMPLIED WARRANTY OF MERCHANTABILITY IS ALLOWED BY LAW: (1) ANY IMPLIED WARRANTY OF MERCHANTABILITY THAT IS, AS A MATTER OF LAW, NOT PERMITTED TO BE EXCLUDED AS SET FORTH ABOVE, IS LIMITED TO ONE YEAR FROM THE DATE OF DELIVERY TO THE FIRST RETAIL OWNER; (2) NEITHER REGAL, NOR ANY SELLING DEALER SHALL HAVE ANY RESPONSIBILITY FOR LOSS OF USE OF THE BOAT, LOSS OF TIME, INCONVENIENCE, COMMERCIAL LOSS, INCIDENTAL OR CONSEQUENTIAL DAMAGES. SOME STATES MAY NOT ALLOW EXCLUSIONS OF IMPLIED WARRANTIES OR LIMITATIONS ON HOW LONG ANY IMPLIED WARRANTY LASTS, SO THE ABOVE LIMITATION MAY NOT BE APPLICABLE. SOME STATES MAY NOT ALLOW THE EXCLUSION OR LIMITATION OF INCIDENTAL OR CONSEQUENTIAL DAMAGES, SO THE ABOVE LIMITATIONS OR EXCLUSIONS MAY NOT BE APPLICABLE IN THOSE STATES. THIS WARRANTY GIVES THE OWNER SPECIFIC LEGAL RIGHTS, AND THE OWNER MAY ALSO HAVE OTHER RIGHTS WHICH VARY FROM STATE TO STATE.

THE TERMS AND CONDITIONS CONTAINED HEREIN, AS WELL AS THOSE OF ANY DOCUMENTS PREPARED IN CONJUNCTION WITH THE SALE OF THIS VESSEL MAY NOT BE MODIFIED, ALTERED OR WAIVED BY ANY ACTION, INACTION, OR REPRESENTATIONS, WHETHER ORAL OR IN WRITING, EXCEPT UPON THE EXPRESSED, WRITTEN AUTHORITY OF A MANAGEMENT LEVEL EMPLOYEE OF REGAL. Some states do not allow limitations on how long an implied warranty lasts, so the above limitation may not apply to you. Regal's obligation with respect to this warranty is limited to making repairs to or replacing the defective parts and no claim for breach of warranty shall be cause for cancellation or rescission of the contract or sale for any boat manufacturer by REGAL MARINE INDUSTRIES, INC.

Regal will discharge its obligations under this warranty as rapidly as possible, but cannot guarantee any specific completion date due to the different nature of claims which may be made and services which may be required. Regal reserves the right to change or improve the design of its boats without obligation to modify any boat previously manufactured. This limited warranty gives you specific legal rights, and you may also have other rights which may vary from state to state. Regal shall in no way be responsible for any repairs not PRE-AUTHORIZED by a Regal Customer Service Manager or repairs performed by a repair shop not PRE-AUTHORIZED by a Regal Customer Service Manager.

ARBITRATION OF DISPUTES AND WAIVER OF JURY TRIAL

EXCEPT AS SPECIFICALLY EXCLUDED IN THIS LIMITED WARRANTY, PURCHASER, REGAL AND AUTHORIZED REGAL DEALER AGREE TO SUBMIT ANY AND ALL CONTROVERSIES, CLAIMS OR DISPUTES ARISING OUT OF OR RELATING TO THE BOAT AND THIS LIMITED WARRANTY AND ALL OTHER AGREEMENTS EXECUTED BY



Introduction

PURCHASER RELATED TO THE BOAT TO BINDING ARBITRATION. IT IS THE EXPRESS INTENT OF PURCHASER, REGAL AND DEALER THAT THIS ARBITRATION PROVISION APPLIES TO ALL DISPUTES, INCLUDING CONTRACT DISPUTES, TORT CLAIMS, FRAUD CLAIMS AND FRAUD-IN-THE INDUCEMENT CLAIMS, STATUTORY CLAIMS AND REGULATORY CLAIMS RELATING IN ANY MANNER TO THE BOAT AND THIS LIMITED WARRANTY.

IF ANY CONTROVERSY OR CLAIM DESCRIBED IN THIS ARBITRATION PROVISION IS DETERMINED FOR ANY REASON TO BE INELIGIBLE FOR ARBITRATION, AND FOR ANY CONTROVERSIES, CLAIMS, OR DISPUTES SPECIFICALLY EXEMPTED FROM ARBITRATION, THEN THOSE CONTROVERSIES, CLAIMS OR DISPUTES SHALL INSTEAD BE DECIDED BY A JUDGE OF A COURT OF COMPETENT JURISDICTION, IN ORANGE COUNTY, FLORIDA, WITHOUT A JURY. PURCHASER, REGAL AND DEALER KNOWINGLY AND VOLUNTARILY WAIVE THE RIGHT TO A TRIAL BY JURY FOR ALL SUCH CONTROVERSIES, CLAIMS AND DISPUTES. PURCHASER, REGAL AND DEALER UNDERSTAND THAT THERE SHALL BE NO JURY TRIAL, WHETHER THE CONTROVERSY OR CLAIM IS DECIDED BY ARBITRATION OR BY TRIAL BEFORE A JUDGE. NOTWITHSTANDING THE PROVISIONS OF THIS ARBITRATION AGREEMENT, WITH REGARD TO CONTROVERSIES AND/OR ENTITLEMENT TO POSSESSION OF EITHER THE BOAT OR ANY TRADE-IN, ANY PARTY HERETO MAY RESORT TO A JUDICIAL DETERMINATION (BY A JUDGE AND NOT A JURY), OF SUCH CONTROVERSIES, DISPUTES OR CLAIMS WITHOUT WAIVING ANY RIGHT TO DEMAND ARBITRATION WITH RESPECT TO ALL OTHER CONTROVERSIES, DISPUTES OR CLAIMS BETWEEN THE PARTIES AS MORE SPECIFICALLY SET FORTH IN THIS ARBITRATION PROVISION.

ALL ARBITRATIONS SHALL PROCEED THROUGH THE AMERICAN ARBITRATION ASSOCIATION AND BE SUBJECT TO ITS COMMERCIAL ARBITRATION RULES, EXCEPT AS SET FORTH HEREIN. THE ARBITRATORS SHALL HAVE THE AUTHORITY TO AWARD ANY FORM OF RELIEF THAT COULD BE PROPERLY AWARDED IN A CIVIL ACTION IN THE STATE OF FLORIDA FOR THE TYPE OF CLAIMS PRESENTED, SUBJECT HOWEVER, TO ALL LIMITATIONS, PREDICATES, AND CONDITIONS COVERING SUCH REMEDIES OR RELIEF UNDER FLORIDA LAW.

THE PURCHASER, REGAL OR DEALER MAY DEMAND ARBITRATION OF A CLAIM BY FILING A WRITTEN DEMAND FOR ARBITRATION, ALONG WITH A STATEMENT OF THE MATTER IN CONTROVERSY WITH THE AMERICAN ARBITRATION ASSOCIATION, AND SIMULTANEOUSLY SERVING A COPY UPON THE OTHER PARTY. PURCHASER, REGAL AND DEALER AGREE THAT THE ARBITRATION PROCEEDING SHALL BE CONDUCTED IN ORANGE COUNTY, FLORIDA UNLESS OTHERWISE AGREED BY THE PARTIES. EACH PARTY AGREES TO BEAR THEIR OWN ATTORNEY FEES AND COSTS. THE FILING FEES AND ALL OTHER THIRD-PARTY COSTS FOR THE ARBITRATION, INCLUDING THE ARBITRATOR'S FEE SHALL BE PAID BY THE FILING PARTY INITIATING THE ARBITRATION. THE PREVAILING PARTY SHALL BE ENTITLED TO REIMBURSEMENT OF THEIR REASONABLE ATTORNEY FEES AND REASONABLE EXPENSES FROM THE NON-PREVAILING PARTY.

REGISTRATION INFORMATION:



AN ISO-9001:2008 REGISTERED COMPANY



Safety On Board



Safety awareness can not be over emphasized. Safety on board needs to be the skippers number one priority. In this manual you will find many safety precautions and symbols to identify safety

related items. Heed all safety precaution information. Remember, the skipper is responsible for the safety of his passengers and crew.

SAFETY LABELS

SAFETY PRECAUTION DEFINITION

Safety precautions are stated as caution, warning and danger signal words. They are highlighted in this manual by font design and symbol usage. Also, a notice heading is included which provides operation and maintenance information but is not hazard-related. An information label provides tips on a variety of topics. Become familiar and understand all safety precaution labels!

	WARNING
Potentially hazardous situation that, if not avoided, could result in death or serious injury.	

	CAUTION
Indicates a potentially hazardous situation or unsafe practice that, if not avoided, may result in injury, property or product damage.	

NOTICE	
General or specific information which is important to correct operation or maintenance, but is not hazard related.	

	DANGER
Immediate hazardous situation that, if not avoided, will result in death or serious injury.	

	INFORMATION
Educational tips for the skipper and crew.	



PRECAUTIONARY LABELS

Read and understand all safety labels affixed to your Regal boat or found in this manual and the vendor literature. Many of the safety labels are posted close to the helm, aft cockpit, cabin and swim platform. The location of the labels may vary.

Review the helm safety labels with passengers before disembarking.

Use common sense to analyze the result of an action on board your vessel. Always think safety first!

NOTICE

DO NOT REMOVE OR COVER
ANY PRECAUTIONARY LABELS.

KEEP HARSH CHEMICALS
AWAY FROM LABELS.

IF A LABEL BECOMES ILLEGIBLE,
CONTACT YOUR REGAL DEALER
FOR ORDERING REPLACEMENTS.

GENERAL BOATING SAFETY

We understand that you are eager to go boating. However, we strongly suggest that you thoroughly familiarize yourself and friends or members of your family with safe boating practices before setting out.

Remember, that along with the freedom and exhilaration of boating comes the responsibility that you have for the safety of your passengers and other boaters who share the water with you.

Boating regulations vary from state to state. Check with your local state and local authorities for the regulations pertaining to your area.

Check with local FM weather stations, U. S. Coast Guard, or on-line for the latest weather conditions. Remember getting caught in severe weather is hazardous. Check weather conditions periodically while you are boating. If you are forced to operate your boat in a storm condition, take common sense precautions; wear PFD's, store gear, reduce speed and if possible head for safe refuge.

It is best to avoid operating your boat in foggy weather. When fog sets in, take bearings, log courses and speeds. You are required to emit a five second blast from your horn or whistle once every minute. Also, have your passengers wear PFD's and observe for oncoming vessels.

Operation in shallow water presents a number of hazards including sand bars and water levels influenced by tides. If the vessel strikes an underwater hazard, check for boat and engine damage. If the engine vibrates excessively after striking an underwater obstruction, it may indicate a damaged propeller. If you run aground, seek help by radio or flares.

Make sure your boat and equipment are in top condition. Do this by frequently inspecting the hull, engine and propulsion components.



Safety On Board

You must provide a Coast Guard approved personal flotation device (PFD) for every person on board. These PFD's should be in good condition and easily accessible.

Insist that non-swimmers and children on board wear a PFD at all times. If you encounter rough weather conditions, make sure everyone on board is wearing a PFD, including yourself. Instruct your passengers in how to put on their PFDs and be sure they know their storage location on the boat. Remember, in an emergency, a PFD that cannot be quickly located and worn is useless.

Never allow anyone to sit anywhere on the boat not specifically designed as seating. While underway, ALWAYS insist passengers sit in a seat and set an example by doing this yourself.



Never drink and drive! As captain, you are responsible for the safety of your passengers. Alcohol and boating can be a dangerous combination. DO NOT mix them. Alcohol impairs the boat operators ability to make conscious decisions and react to emergency situations quickly.

Never overload your boat! An overloaded boat, or one with uneven weight distribution can be difficult to steer.

CAUTION

READ AND UNDERSTAND THE SEATING ARRANGEMENT DRAWING IN THE TECHNICAL CHAPTER (12-38). THIS DRAWING DISPLAYS THE DESIGNATED SEATING ARRANGEMENT FOR A BALANCED LOAD AND VESSEL MAXIMUM PERSONS CAPACITY.

Use maximum caution when fueling. Never allow any smoke or flame nearby while you are fueling. ALWAYS check for fuel leaks and fumes when fueling is completed.

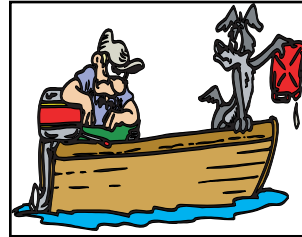

Be certain there is enough fuel aboard for your cruising needs. Include any reserve that might be needed should you change your plans due to weather or an emergency. Practice the "one-third rule: Use one-third of your fuel going out, one-third to return

and retain one- third as a reserve.

Always check the weather before departure. Be particularly cautious of forecasted electrical storms and high winds.

Always have up-to-date charts aboard as a back-up to your plotter and auto pilot option. Charts can be obtained at your closet marina, on-line store or by contacting one of three federal government agencies.

Always file a float plan. Leave details of your trip with someone responsible who will be remaining on shore. Include expected return, plus name and phone number of a contact person in case of emergency.

Use care, courtesy and common sense when launching, docking or operating your boat.

Learn and obey the "Rules of the Road". A weather resistant placard copy of the "Rules of the Road" is included in the on board Regal information packet. Additional information can be obtained from the U.S. Coast Guard Auxiliary or your local Power Squadron organization. In case of emergency know the international distress signals for your VHF radio. The spoken word "MAYDAY" is the international signal of distress and is for emergency use only. Under no circumstances should this word be used, unless there is danger at hand.



Posted speed limits, swimming areas, “no wake” zones and other restrictions should be red-flagged. They are so noted for a reason. Sensible boat use, plus courtesy, equals enjoyable and safe boating.

It is your responsibility to stay abreast of all federal, state and local rules, as some laws or regulations may change or be different from state to state. Contact your local boating agencies for updated information.

We can not stress safety enough! Remember, there are no brakes on your boat, and the water current and wind velocity both affect your ability to respond. The operator must use caution at all times to maintain control of his vessel and especially to keep a safe distance from other boats and obstacles.

Always keep all safety gear in optimum condition. Pay special attention to attached tags and plates indicating expiration dates on equipment such as fire extinguishers, and personal flotation devices. Encourage a periodic maintenance check on all safety equipment. Contact your Regal dealer or marine professional for more information. Again, remember that the captain is responsible for his crew, passengers and vessel.

REQUIRED SAFETY EQUIPMENT

PERSONAL FLOTATION DEVICES



All personal flotation devices (PFD's) must be Coast Guard approved, in good working condition, and must be the correct size for

the wearer. All PFD's must be readily accessible. This means being able to wear them in a reasonable amount of time in case of an emergency (fire, boat sinking, etc.). They should not be stored or locked in closed areas. Also, make sure that all coverings are removed such as plastic from any PFD's. Throwable devices such as a ring buoy need to be available for immediate deployment. A PFD should be worn at all times when your boat is operating on the water. A PFD may save your life, but it must be worn to do so.

As a minimum U. S. Coast Guard requirement all recreational boats must carry one type I, II, III, or V PFD (wearable) for each person aboard. See the explanation following for each type. For type V to be counted they must be used according to the label instructions. In addition, all boats over 16' must carry one Type IV (throwable) PFD.

Some states require that PFD's be worn by children of specific ages at all times. Check with local and state boating agencies for particular requirements in your state before taking children on the water. Child life jackets are classified by the child's weight and should like all life jackets be sized before being purchased.

Remember PFD's will not necessarily keep you from drowning, even though they are designed to keep a person from sinking. When purchasing PFD's make sure it safely fits the person wearing it. It is a good idea to test PFD's in a lifeguarded shallow pool before venturing on the water.



Safety On Board

Refer to the USCG minimum equipment requirements at the end of this chapter. It is meant to be a guide only. Contact state and local agencies for additional equipment requirements. Remember as the captain of your vessel you are responsible for its safe operation.

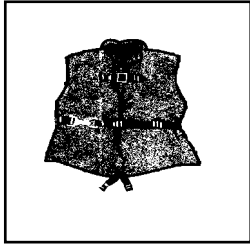

TYPE I- Also known as an off-shore jacket, it provides the most buoyancy. It is a PFD for all waters and is especially useful in rough waters where rescue may encompass additional time. It is designed to turn most unconscious users in the water to

a true face-up position. Type I PFD is available in adult & child sizes Buoyancy minimum poundages are 15.5 adult, 11 medium child, and 7 for small child and infants.

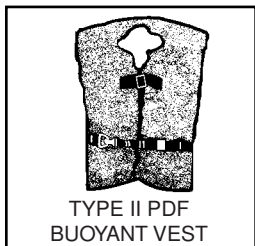

TYPE II- Also known as near-shore buoyant vest, it is recommended for calm, inland water where rescue time will be minimal. It will turn some unconscious people face-up in the water but not as numerous as Type I. They use the same buoyancy minimum poundages as the type I PFD's.

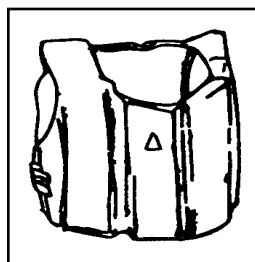

TYPE III- Known as a flotation aid it is good for calm, inland water or where there is a chance for quick rescue. It is designed so wearers can place themselves in a face-up position in the water. The wearer may have to tilt their head back to avoid face-down

positions. Type III offer the same buoyancy minimum poundages as the Type II. They are generally the most comfortable for continuous wear. Float coats, fishing vests, and vests featuring designs for various sport activities are examples of Type III.

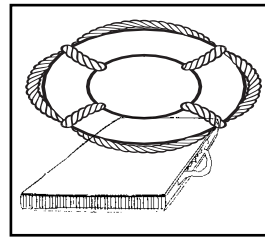

TYPE IV- Intended for calm, inland water with heavy vessel traffic, where help is constantly present. It is designed to be thrown into the water for someone to grab on to and held until rescued. It is not designed to be worn. Type IV includes ring buoys, buoyant cushions, and horseshoe buoys.

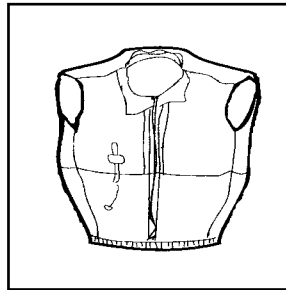

TYPE V- Also known as a special use device this is the least bulky of all PFD's. It contains a small amount of inherent buoyancy, and an inflatable chamber. It is rated even to a Type I, II, or III PFD (as noted on the jacket label) when inflated. Some Type V devices provide significant hypothermia protection. Varieties include deck suits, work vests, board sailing vests and Hybrid PFD's. Remember that this Type V type PFD may be carried instead of another PFD only if used according to the approval condition on the label.

Note: A water skier or wakeboarder is considered on board the vessel and a PFD is required for the purposes of compliance with the PFD carriage requirements. It is advisable and recommended for a skier or wakeboarder to wear a PFD designed to withstand the impact of hitting the water at a high speed. "Impact Class" marking on the label refers to PDF strength, not personal protection. Some state laws require a skier or wakeboarder to wear a PFD.



PFD'S FOR PETS

If you are a skipper who needs to have his pet dog or cat on board or dockside then a PFD is recommended. The PFD will aid you in finding the pet if it should fall overboard. The device must fit the pet properly. Also, it may take a bit of training before the pet is comfortable wearing the PFD. Normally, dogs are easier to train wearing a life vest than a cat.

Marine type retail stores will fit a pet to a PFD by body weight.

MAINTAINING YOUR PFD'S

A PFD is only useful if it is well maintained. Always be aware of PFD age since it has a life expectancy like any other piece of equipment.

✓ Check periodically for broken zippers, frayed webbing, water soaked kapok bags, missing straps, and sewing that has become undone.

✓ Clean each PFD with mild soap and water only. Again, let dry sufficiently before storing.

✓ Keep PFD's out of grease and oil since they can deteriorate the jacket inner and outer materials.

✓ Check any kapok-bagged jackets by squeezing. If you hear air escaping the bag is defective and the PFD should be thrown away.

✓ Grab the cover with the fingers. If the cover material rips, the PFD is rotted and should be thrown away.

✓ If the kapok bag is hard the PFD should be discarded.

FIRE EXTINGUISHERS

GENERAL INFORMATION

Fire extinguishers are classified by a letter and numeric symbol. The letter references the type of fire the unit is designed to extinguish.

For example, type B extinguishers commonly used on boats are designed to put out flammable liquids such as grease, oil and gasoline.

The number indicates the general size of the extinguisher (minimum extinguishing agent weight).

Coast Guard Approved extinguishers are identified by the following marking on the label:

“Marine Type USCG Approved, Size..., Type..., 162.028/.../”, etc.

FIRE EXTINGUISHER CONTENTS				
CLASS	FOAM IN GALS.	CO2 IN LBS.	DRY CHEM IN LBS.	HALON IN LBS.
B-I	1.25	4	2	2.5
B-II	2.5	15	10	10

MINIMUM PORTABLE FIRE EXTINGUISHERS REQUIRED		
VESSEL LENGTH	NO FIXED SYSTEM	WITH FIXED SYSTEM

LESS THAN 26'	1 B-1	0
26' TO LESS THAN 40'	2 B-1 OR 1 B-II	1 B-1
40' TO 65'	3 B-1 OR 1 B-1 & 1 B-II	2 B-1 OR 1 B-2



Safety On Board

U. S. Coast Guard approved fire extinguishers are required on all Regal boats. Besides the minimum Coast Guard requirements always check state and local agencies for additional requirements and equipment.

Coast Guard approved extinguishers are hand-portable, either B-I or B-II classification. U. S. Coast Guard approved hand-portable and semi-portable extinguishers contain a metal plate that shows the manufacturers name and extinguisher type, capacity and operating instructions. They have a special marine type mounting bracket which keeps the extinguisher solidly mounted until needed. The extinguisher needs to be mounted in a readily accessible location but one that will not be bumped by people while underway. All approved extinguishers shall have an indication gauge.

U.S.C.G APPROVED FIRE EXTINGUISHER TYPES & FEATURES



■ The carbon dioxide unit uses CO₂ gas under high pressure, with a funnel discharge hose usually swivel mounted. This extinguisher leaves no residue and does not cause interior engine harm. To ensure workability, weigh the unit annually. A 10% maximum weight

variance is allowed.

Another type of liquefied gas used today is FE-241. This gas is colorless and odorless, heavier than air and sinks to the lower bilge to extinguish fires. Since the year 2000 ingredients have changed to a more environmental friendly formula (Chlorotetrafluoroethane or FE-241). FE-241 is used in portable-hand units along with making up the majority of boat automatic fire extinguishing systems. The canister needs to be weighed once a year. These clean agent units feature a dash mount indicator. Refer to the information regarding fire prevention in this manual.



■ The dry chemical agent is widely used because of its convenience and low cost. The extinguisher canister is filled with a white dry chemical powder along with a pressurized gas. It is a good idea to shake this type periodically because they tend to “pack” on the canister bottom.

Note that a stern drive vessel may utilize a fire port.

The fire port requires a specified portable fire extinguisher size by weight. See chapter 4 for further information or contact your closest dealer or marine professional.



■ The foam type uses a chemical foaming agent plus water and is best when used for fires involving flammable liquids- solvents, gasoline, oil, grease and various paints. It will work on fires involving rubber, plastics, cloth, wood, and paper. It leaves a messy residue. Do not use this extinguisher for electric fires.



PYROTECHNIC DEVICES

Pyrotechnic visual distress signals must be Coast Guard approved, be ready for service and must be readily accessible. They all display a marking which is the service life, which must not have expired. A minimum of 3 devices are required for the day and 3 devices for night. Some devices meet both day and night requirements. Pyrotechnic devices should be stored in a cool, dry location. Most of these devices can be purchased in an highly visible (orange) watertight container. Types of Coast Guard approved pyrotechnic distress signals and associated devices are:

- Pyrotechnic red flares, hand-held or aerial type.
- Pyrotechnic orange smoke, hand-held or floating type.
- Launchers for parachute flares or aerial red meteors.

All in all, each distress signal has certain advantages and disadvantages.

There is no distress signal that is best under all situations. Pyrotechnics are recognized world-wide as superior distress signals. A downfall is they emit a very hot flame that can cause burns and or ignite flammable materials. Pistol launched and hand-held parachute flares operate consistant with firearms and therefore must be carefully handled. Check with local and state regulations since some of these device are considered firearms and are prohibited.

It is best to carry red aerial flares which are visible from a greater distance. Also, the red parachute flares burn for longer periods and therefore are more likely to be seen by another vessel.

NON-PYROTECHNIC DEVICES

.Non-pyrotechnic devices must all be in serviceable condition, readily accessible, and must be certified by the manufacturer to comply with U. S .C. G standards. They include:

- Orange distress flag.
- Electric distress light.

The distress flag is for day use only. It must be 3 x 3 or larger with a black square and ball on an orange background. It can be spotted when attached to a boat hook, long fishing rod, or paddle with the person waving the flag back and forth overhead.

The electric distress light is for night use only flashing the international SOS distress signal (... _ _ _ ...).

Under Inland Navigation Rules, a high intensity white light that flashes at regular intervals from 50-70 times per minute is considered a distress signal.

Remember that regulations prohibit the display of visual distress signals on the water under any circumstances except when assistance is required to prevent immediate or potential danger to passengers on a vessel.



Safety On Board

INTERNATIONAL DISTRESS SIGNALS

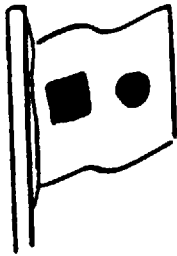

BLACK SQUARE
AND BALL ON
ORANGE BACKGROUND

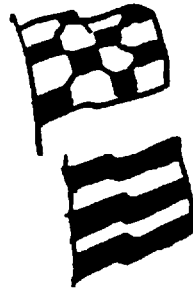

CODE FLAGS
NOVEMBER
& CHARLIE



SQUARE FLAG
& BALL



PERSON
WAVING
HANDS

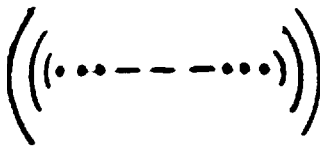

MORSE
CODE S.O.S.



"MAYDAY"
BY
RADIO

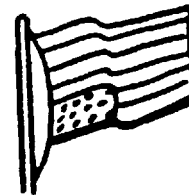

ENSIGN
UPSIDE
DOWN

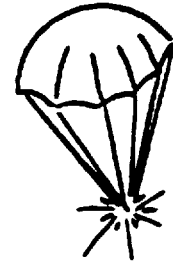

PARACHUTE
RED FLARE



RED METEOR
FLARES



SMOKE



FOG HORN
SOUNDED
CONTINUOUSLY



GUN FIRED AT
1- MINUTE
INTERVALS

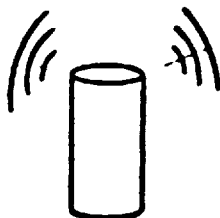

POSITION
INDICATING
RADIO BEACON



DYE MARKER
(ANY COLOR)

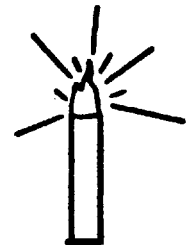

HAND-HELD
FLARE



SOUND PRODUCING DEVICES

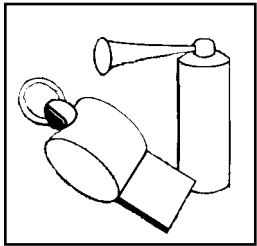

According to both Inland and International Rules, all boats must carry a way of producing an efficient sound signal. If your vessel is 12 meters (39' 4") or longer, a power whistle or power horn and bell must be carried. Bell mouth must be at least 7 7/8"

diameter.

The sound signal made in all cases must be capable of a four or six second blast audible for one half mile. See the section discussing bridge and whistle signals for more information.

RADIO COMMUNICATIONS

VHF radios are used for distress and ship to shore and ship to ship communications today. Learn the specialized messages such as Mayday, Mayday, Mayday. It is only used when life or vessel is in imminent danger.

Many of the more recent VHF's feature DSC capability which offers the ability to place and receive digital calls directly with vessels and shore stations including USA and Canadian Coast Guards. Channel 70 is reserved exclusively for DSC calls. Refer to the VHF owner's information since you need to establish a Mobile Maritime Safety Identity (MMSI) number before using the DSC feature. A MMSI number identifies each DSC radio, like a telephone number. The FCC requires a ship station license for all vessels equipped with a marine VHF radio.

NAVIGATION LIGHTS

The U. S. Coast Guard requires recreational boats operating at night to display navigation lights between sunset and sunrise along with other periods of reduced visibility.

Navigation lights help avoid collisions by improving the night visibility of vessels. Red and green directional lights, white stern lights, white masthead lights and white all-around lights must be displayed in specified positions, depending on boat size, and mode of operation.

The configuration of visible lights tells an operator the size, direction of travel and means of propulsion (sail, power, rowing or at anchor) of another vessel.

This helps both operators determine who has the right of way. Larger boats are required to carry bigger, brighter lights that are visible over longer distances. See the light requirement chart for pleasure craft.

MARINE SANITATION DEVICES

Recreational vessels under 65' with installed toilet facilities must have an operable marine sanitation device (MSD) on board. Vessels 65' and under may use Type I, II, or III MSD's. All installed MSD's must be U.S. Coast Guard certified. The MSD's are labeled to show conformity to the regulations.

NAVIGATION RULES

The navigation rules establish actions to be taken by vessels to avoid collision. They are divided into Inland/International. Operators of vessels 39.4' or more shall have on board and maintain a copy of the Inland navigation rules.



NAVIGATION LIGHT RULES

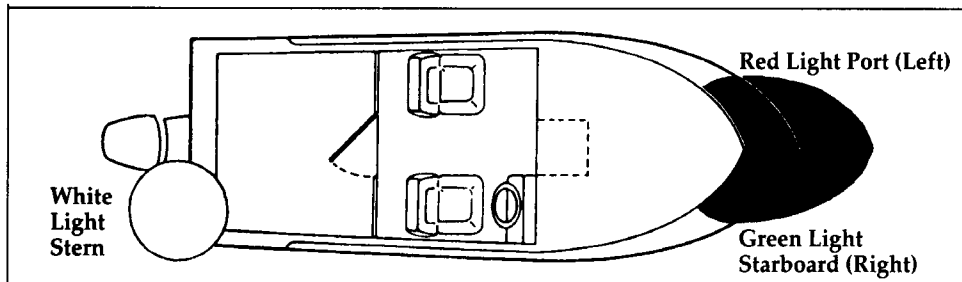

Location of lights on vessel	Visible Range		Degrees of arc lights
	Less than 12 m.	12 m. but less than 20 m.	
Masthead	2	3	225°
All-round	2	2	360°
Side lights	1	2	112.5° each color
Stern light	2	2	135°

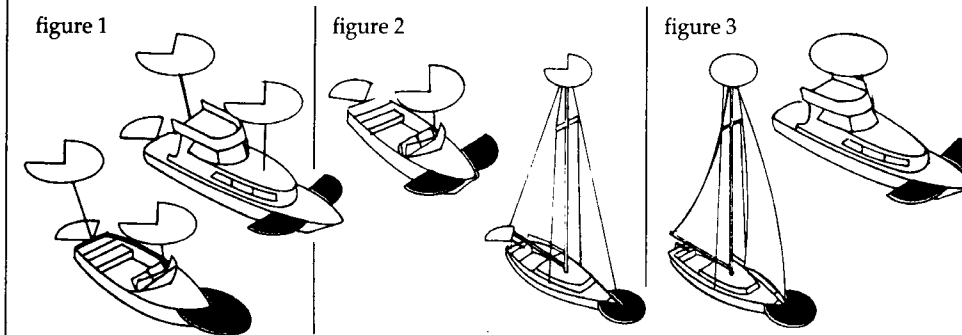

Boats less than 12 meters in length
Motorboats or sailboats using power: The lighting arrangements to figure 1, 2 or 3 may be used.
Sailboat using sails alone: The lighting arrangements in figure 4, 5 or 6 may be used.

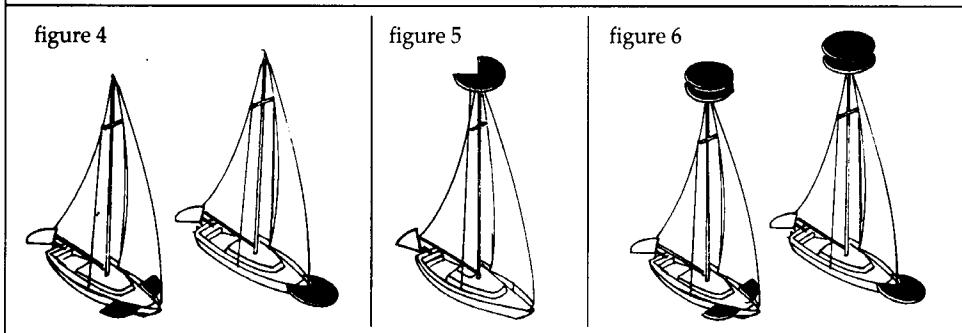

Boats 12 meters but less than 20 meters in length
Motorboats or sailboats using power: The lighting arrangements to figure 1 or 2 may be used.
Sailboat using sails alone: The lighting arrangements in figure 4, 5 or 6 may be used.

Location of lights
 Lights should be located as shown in the drawings.

The masthead light (forward white light in figures 1, 2 and 7d) must be at least one meter higher than the colored lights on a boat less than 12 meters in length and at least 2.5 meters above the gunwale on a boat 12 meters but less than 20 meters in length.

Exceptions
Motorboat or sailboat using power, built before December 24, 1980: The lighting arrangement in figure 1, 2 or 3 may be used. However, the arrangement in figure 3 is not acceptable on a boat that is 12 meters or longer on international waters.

figure 7

Sailboat using sail alone, less than 7 meters in length: If impractical to display lights in figure 4, 5 or 6, a single white light may be displayed in time to prevent a collision (figure 7c).

Row Boats or Paddle Boats
 One all-round white light ready to display in time to prevent a collision (figure 7 a or b).

Great Lakes

figure 7d

Motorboat or sailboat using power on Great Lakes: The lighting arrangements in figure 7d may be used instead of the arrangements in figures 1 and 2.



POLLUTION REGULATIONS

DISCHARGE OF OIL PROHIBITED

THE FEDERAL WATER POLLUTION CONTROL ACT PROHIBITS THE DISCHARGE OF OIL OR OILY WASTE INTO OR UPON THE NAVIGABLE WATERS OF THE UNITED STATES, OR THE WATERS OF THE CONTIGUOUS ZONE, OR WHICH MAY AFFECT NATURAL RESOURCES BELONGING TO, APPERTAINING TO, OR UNDER THE EXCLUSIVE MANAGEMENT AUTHORITY OF THE UNITED STATES, IF SUCH DISCHARGE CAUSES A FILM OR DISCOLORATION OF THE SURFACE OF THE WATER OR CAUSES A SLUDGE OR EMULSION BENEATH THE SURFACE OF THE WATER. VIOLATORS ARE SUBJECT TO SUBSTANTIAL CIVIL PENALTIES AND/OR CRIMINAL SANCTIONS INCLUDING FINES AND IMPRISONMENT.

MARPOL TREATY

The USCG now enforces the International Convention for the Prevention of Pollution from ships, referred to commonly as the MARPOL TREATY (marine pollution). This international treaty prohibits the overboard dumping of all oil, garbage, ship-generated plastic and chemicals. There is a placard on board your boat (typical example shown below) that explains the garbage and plastic dumping laws in detail.

Immediately notify the USCG if your vessel discharges oil or hazardous substances in the water. Call toll free 1-800-424-8802. Report the following information: location, source, size, color, substances and time observed.

No vessel may intentionally drain oil or oily waste from any source into the bilge of any vessel. A bucket or bailer is suitable as a portable means of discharging oily waste. The placard noted above is normally located in the engine or may be attached to the engine hatch.



GARBAGE DISCHARGE

The act to prevent pollution from ships places limitations on the discharge of garbage from vessels. It is illegal to dump plastic trash anywhere in the ocean or navigable waters of the United States. Also, it is illegal to discharge garbage in the navigable waters of the United States, including the Great Lakes. The discharge of other types of garbage is allowed outside certain specified distances from shore as determined by the nature of that garbage. United States vessels of 26 feet or longer must display in a prominent location, a durable placard at least 4" x 9" notifying crew and passengers of discharge restrictions. USA vessels of 26' or longer equipped with a galley and berthing must have a written Management Plan describing the plan for collecting, processing, storing and discharging garbage, and designate the person charged with carrying out the plan.

The placard noted below is usually found near a galley, inside the engine hatch area or close to a receptacle.

THE DISCHARGE OF PLASTIC OR GARBAGE WITH PLASTIC INTO ANY WATERS IS PROHIBITED. THE DISCHARGE OF ALL GARBAGE IS PROHIBITED IN THE NAVIGABLE WATERS OF THE UNITED STATES AND IN ALL OTHER WATERS, WITHIN THREE NAUTICAL MILES OF THE NEAREST LAND.		
THE DISCHARGE OF DUNNAGE, LINING, AND PACKING MATERIALS THAT FLOAT IS PROHIBITED WITHIN 25 NAUTICAL MILES FROM THE NEAREST LAND.	OTHER UNGROUND GARBAGE MAY BE DISCHARGED BEYOND 12 NAUTICAL MILES FROM THE NEAREST LAND.	OTHER GARBAGE GROUND TO LESS THAN ONE INCH MAY BE DISCHARGED BEYOND THREE NAUTICAL MILES FROM THE NEAREST LAND.
A PERSON WHO VIOLATES THE ABOVE REQUIREMENTS IS LIABLE FOR A CIVIL PENALTY OF UP TO \$25,000, A FINE OF UP TO \$50,000, AND IMPRISONMENT FOR UP TO FIVE YEARS FOR EACH VIOLATION, REGIONAL, STATE, AND LOCAL RESTRICTIONS ON GARBAGE DISCHARGES MAY ALSO APPLY.		



LIFE RAFTS

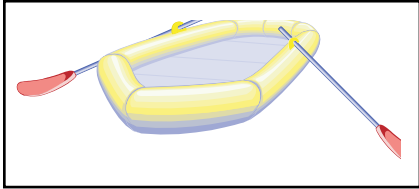

Inflatable life rafts are recommended for ocean going and vessels operating in a large body of water like the Great Lakes.

They provide a shelter for extended periods. If used, make sure it is large enough for all aboard and contains the proper emergency equipment pack. Also, periodically have the unit professionally serviced. Make sure the life raft is Coast Guard approved since it would require meeting a number of stringent material and performance standards.

USCG MINIMUM EQUIPMENT REQUIREMENTS

Use the chart below as a guideline for assuring your vessel is outfitted to meet USCG standards. Remember to check with local and state authorities for additional equipment requirements. Make sure your vessel certificate of numbers are on the boat, updated and displayed properly according to state requirements. Keep the paperwork on board in a watertight and safe environment. Make sure it is quickly accessible.

On documented vessels keep both the original and current certificate on board stored in a safe, dry, and accessible location. Also, on documented vessels make sure the vessel name/hailing port are marked on the hull exterior with letters not less than 4" in height. In addition, the Official Number must be permanently affixed on a clearly visible interior structure part of the boat-block type Arabic numbers not less than 3" in height.

USCG Minimum Equipment Requirements for Recreational Vessels					
Boat Size in Feet	16'	26'	40'	65'	165'
Personal Flotation Devices¹	One Type I, II, III, or V per person		One Type I, II, III, or V per person plus one Type IV throwable		
Fire Extinguishers²	One B-I, any type		One B-II or Two B-I	One B-II and one B-I, or three B-I	One or more B-II (vessels 0-50 tons gross) Two or more B-II (vessels 50-100 tons gross)
No Fixed System	One B-I, any type		One B-II or Two B-I	One B-II and one B-I, or three B-I	One or more B-II (vessels 0-50 tons gross) Two or more B-II (vessels 50-100 tons gross)
With Fixed System	No Portables Required		One B-I	Two B-I or one Class B-II	
Visual Distress Signals	Night signals required when operating at night		Minimum of three day-use and three night-use (or three day/night combination) pyrotechnic devices ⁵		
Sound Producing Devices	Horn or whistle recommended to signal intentions or signal position		One bell, and one whistle or horn required to signal intentions or position		
Backfire Flame Arrestor	One CG-approved device on each carburetor of all gasoline-powered engines built after April 1940, except outboard motors				
Ventilation	CG standard system required on gasoline powered vessels with enclosed engine compartments built after August 1980				
Navigation Lights	Sidelights, Stern Light and Masthead ^{6,7}				
Under Power ^{3,4}	Sidelights and Stern Light ^{6,8}				
Under Sail	Same as "Under Sail"				
Rowing	Same as "Under Sail"				
At Anchor	All-round light, 2nm (at night) or black anchoring ball (during the day) when outside a designated anchorage				
Visibility Range	1nm Sidelights, 2nm all others		3nm Masthead, 2nm all others		5nm Masthead, 2nm all others
Pollution Regulations	"Honor system" (no plaques required)		5" x 8" Oil Discharge placard and 4" x 9" Waste Discharge placard		
Marine Sanitation Devices	Vessels with installed toilet facilities must have an operable, CG-certified Type I, II or III Marine Sanitation Device (MSD). Subject to local laws!				Type II or III MSD only
Navigation Rules	Familiarity with the Inland Navigation Rules required		The Inland Navigation Rules ("Rules of the Road") must be kept on board		

- Pfd's must be CG approved, wearable by the intended user and readily accessible.*
- Fire extinguishers required on boats with enclosed engine compartments (not outboards), enclosed living spaces or permanent fuel tanks.*
- Sailboats operating under engine power are considered power driven and must follow the "Under Power" rules. During the day, motorsailing vessels are required to fly a motoring cone.*
- Power-driven vessels under 23' and under 7 knots can substitute a white lantern or torch in place of the required lights.*
- Non-pyrotechnic substitutes: 1 orange distress flag (day-use) and 1 electric SOS signal light (night-use).*
- All boats under 65' can substitute a single bi-color light for sidelights.*
- Boats under power under 40' can substitute a single all-round light for separate stern and masthead lights.*
- Boats under sail under 40' can substitute a tri-color light for separate sidelights and stern light.*

Additions to these requirements are prescribed by some individual state laws. Check your state's Boating Safety Handbook for a complete list.



Safety On Board

EXHAUST & CARBON MONOXIDE

Carbon monoxide (CO) in exhaust can be hazardous, especially from gasoline engines, gasoline generators, grills, stoves, space heaters and on a much smaller degree diesel engines.

CO is a natural by-product of the gasoline engine using an artificial spark. Diesels on the other hand detonate fuel using pressure and temperature. Looking at the two engines another way, gasoline engines use much more oxygen up in the combustion process which contributes to a much higher CO build-up. Although diesels do produce a small amount of CO the combustion process operates with much greater amounts of oxygen which the end result is a much lower CO level.

Ensure that you read the information and follow all the recommendations regarding CO.

Familiarize your crew, passengers and yourself with the sources, symptoms and possible effects of carbon monoxide poisoning. Remember that boats in the same general vicinity can cause your vessel to accumulate dangerous CO levels in the cabin and or in the cockpit.

For safety sake avoid the following:

1. Do not park by other boats with their engine idling or generator cycling for an extended period of time.
2. Do not disable the carbon monoxide alarms that come with your Regal boat. Test the units in accordance with the alarm manufacturers instructions.
3. Do not operate an engine for extended periods of time while in a confined area or where exhaust outlets face a sea wall or bulkhead.
4. Do not operate the engine for an extended period of time with the canvas in the upright and installed position.
5. Have the engine exhaust system inspected when the boat is in for service.
6. Persons sleeping can easily be overcome by carbon monoxide without realizing it. Do not sleep on board while an engine or generator is running close-by.
7. Do not operate your vessel for extended periods with the bow up in slow cruise conditions especially close behind a vessel being towed or one operating at slow speeds.
8. When underway open all hatches, windshield vents, and main cabin entry door to allow proper airflow from bow to stern.

	WARNING
AVOID SERIOUS INJURY OR DEATH FROM CO POISONING! DO NOT OPERATE THE BOAT WITH PEOPLE HOLDING ON TO THE SWIM PLATFORM OR WITH PEOPLE IN THE WATER.	

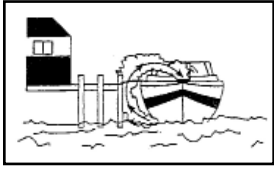

Blockage of exhaust outlets can cause carbon monoxide to accumulate in the cabin and cockpit area even when the hatches, windows, portholes and doors are open. Sea walls and other confined spaces can cause CO levels to be dangerously elevated.

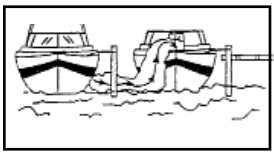

Exhaust from another vessel alongside your boat, while docked or anchored, can emit poisonous CO gas inside the cabin and cockpit areas.

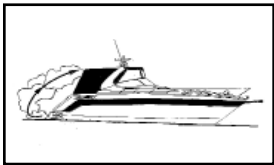

The “station wagon effect” or backdrafting can cause CO gas to accumulate inside the cabin, cockpit/hardtop or bridge areas when the boat is under-way, using protective weather coverings (canvas), high bow angle, improper or heavy loading, slow speeds, or at rest. This can occur when traveling behind another boat.

How does CO affect us?

In high concentrations, CO can be fatal in minutes. However, the effects of lower concentrations over a extended period of time can be just as lethal.

Our blood uses hemoglobin to carry the oxygen we breathe to different body parts. Unfortunately, hemoglobin carries CO more readily than it does oxygen. The result is when we breathe in CO it replaces oxygen in our blood and we begin to suffocate. Also, when we are removed from the CO source it remains in our blood for hours causing long term effects. People have been known to become sick and even lose consciousness hours after exposure.

Carbon monoxide accumulation requires immediate attention! Thoroughly ventilate cabin and cockpit areas. Determine the probable source of the carbon monoxide and correct the condition immediately. Anyone with symptoms of CO poisoning should be placed in a fresh air environment and medical attention found immediately. Regal has installed CO detectors on your boat. Have these detectors professionally calibrated at regular intervals according to the equipment manufacturer’s recommendations.

A Few Notes About Diesel/CO Poisoning

The diesel engine under normal combustion produces much smaller amounts of CO. Therefore, it is far less likely to be fatal to a healthy person. Other factors including weather, temperature and engine condition can greatly affect the unsafe build-up of CO. The best approach is to respect and treat the engine, generator and other vessel components the same way you would a gasoline propulsion system giving particular attention to the sources and possible effects of CO poisoning!

Diesel exhaust in the combustion process produces various components and the captain must be aware that the build-up of these select components over a period of time can cause CO or seasickness like symptoms.

These include carbon dioxide, carbon monoxide (CO), nitrogen dioxide, nitric oxide, sulfur dioxide and others. A healthy person breathing in sulfur dioxide over a period of time through a diesel engine or generator exhaust can develop nausea. This condition is not life threatening but the person may exhibit CO poisoning or seasickness symptoms. Just never rule out that it could be CO poisoning! Immediately find the source of the problem and move the individual to a fresh air environment!



Safety On Board

Symptoms of excessive exposure to carbon monoxide (CO) are:

- Dizziness
- Drowsiness
- Nausea
- Headache
- Ringing in the ears
- Throbbing temples
- Watering, itchy eyes
- Flushed appearance
- Inattentiveness
- Incoherence
- Fatigue or vomiting
- Convulsions

DANGER

CARBON MONOXIDE IS A TASTELESS, ODORLESS AND INVISIBLE GAS THAT CAN CAUSE DISCOMFORT, SEVERE ILLNESS, AND EVEN DEATH. EXERCISE CAUTION WHILE OPERATING GENERATOR OR ENGINES IN CONFINED SPACES OR AT DOCKSIDE. DO NOT ALLOW HULL EXHAUST OUTLETS TO BECOME BLOCKED OR EXHAUST FUMES CAN BECOME TRAPPED IN AND AROUND THE CONFINES OF YOUR BOAT. DURING IDLE AND SLOW CRUISE CONDITIONS, BILGE BLOWERS SHOULD BE USED.

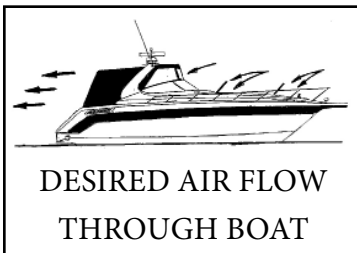

To help prevent carbon monoxide accumulation, ventilate your cabin and cockpit while underway. Open a forward hatch, porthole or window to allow air to travel through the boat's interior and

cockpit. See the illustration for desired airflow.
 NOTE: Never occupy moored boat with engines running and/or canvas completely covering vessel.

WARNING

INSPECT THE EXHAUST SYSTEM. IMMEDIATELY REPAIR OR REPLACE LEAKING, CRACKED AND CORRODED, OR MISSING EXHAUST COMPONENTS.

- Before each trip inspect engine and generator.
- Make sure all exhaust hose clamps are in place and secure.
- Look for exhaust leaking from the exhaust system components, indicated by rust and or black streaking, water leaks, or corroded or cracked fittings.
- Inspect all rubber exhaust hoses for burned or cracked areas. All rubber hoses should feel soft and be free of kinks.
- Visually verify that water exits at the engine exhaust outlet.
- Keep an ear tuned for any change in exhaust sound that could indicate an exhaust component malfunction.

DO NOT OPERATE THE VESSEL IF ANY OF THE ABOVE CONDITIONS EXIST. CONTACT A MARINE PROFESSIONAL!

NOTICE

CARBON MONOXIDE PRECAUTIONARY LABELS ARE LOCATED AT THE HELM, TRANSOM AND CABIN.

ENSURE THAT ALL ABOARD READ AND UNDERSTAND THE SIGNS AND EFFECTS OF CARBON MONOXIDE (CO).



BOATING & ALCOHOL

 **WARNING**

FEDERAL LAWS PROHIBIT OPERATING A VESSEL UNDER THE INFLUENCE OF ALCOHOL OR DRUGS. THESE LAWS ARE VIGOROUSLY ENFORCED BY ALL ENFORCEMENT AGENCIES.



Operating a vessel while intoxicated became a specific federal offense effective in 1988. The ruling set federal standards for determining when an individual is intoxicated. If the blood alcohol content

(BAC) is .10% (.08 in some states) or higher for operators of recreational vessels being used only for pleasure are subject to a civil penalty up to \$1,000 or criminal penalty up to \$5,000, one year imprisonment or both. In some states the fines and imprisonment may increase significantly.

The effects of alcohol and drugs account for the highest single cause of marine accidents and deaths. Most deaths in boating accidents occur when someone falls into the water. Balance is one of the first things you lose when drinking alcohol or under the influence of drugs. The problem arises out of not knowing your balance is restricted.

Overall vision is reduced by alcohol especially at night, along with double or blurred vision. Peripheral vision is lessened which restricts seeing vessels or objects on the side. Also, color awareness decreases especially with red and green which happen to be the colors of boat navigation lights, buoys, and channel markers.

Alcohol will greatly increase your heat loss so it increases the effects of hypothermia. Finally, your ability to make correct judgements in emergency situations is greatly reduced. Alcohol takes away the brains ability to process information quickly and delays a persons reaction time. Don't drink and drive!

ALCOHOL MYTHS AND FACTS

Myth: Beer is less intoxicating than other alcoholic beverages.

Fact: One 12 oz. can of beer has about the same amount of alcohol as a 5oz. glass of wine or a shot of liquor.

Myth: Black coffee, fresh air, and a shower will sober the effects of alcohol.

Fact: After consuming alcohol time is the only thing that will sober you up. Our bodies average burning 1 oz. of alcohol every hour. If a person is drunk, it will take a person seven or more hours to sober up.

Myth: Telling if a person is too drunk to operate a vessel is easy.

Fact: Many experienced drinkers have learned to compensate for the visual effects of alcohol and can disguise their drunk condition.

Myth: You can judge if you are fit to operate a boat.

Fact: Judgement is one of the first elements you lose when drinking.



Safety On Board

BOATING ACCIDENTS



The following is a list of common causes of boating accidents. Be aware of them and take the necessary steps to ensure that yourself and crew are educated and prepared to act in an emergency.

1. Mixing boating and alcohol. Remember, the skipper is responsible for his crew, passengers and vessel.
2. Trying to reach the bow by the deck walk-around at unsafe speeds. Use the center walk-through.
3. Someone sitting on the bow, deck, or swim platform while underway.
4. Choosing a boating outing day with inclement weather, especially in high winds and thunderstorms in the forecast or staying out when bad weather is approaching.
5. Disembarking without checking all the fluids or systems, and especially fuel system components.
6. Not monitoring the boating traffic or possible obstructions around you.
7. Emergency communications equipment, signaling devices, and navigation lights not working.
8. Improper boat handling especially high speed turns in rough water. Using trim improperly.
9. Being too far from shore with inadequate fuel supply or navigational aids.
10. Passengers, especially children that are not wearing the proper life saving devices.
11. Skipper or passengers not seated in the boat.

REPORTING BOATING ACCIDENTS



According to the Federal Boat Safety Act of 1971 involving collision, accident or other casualty, the operator must make a formal report within 48 hours to the nearest state

boating authority when the incident involves:

1. Death
2. Injury requiring treatment other than first aid
3. The disappearance of someone from a boat under death or injury circumstances.

A formal report must be made within 10 days for accidents involving more than \$2000 damage or complete loss of vessel.

For information regarding accident reporting, please call the Boating

Safety Hotline at 800-368-5647.

If there is no state provision for reporting boating accidents a report must be made to the Coast Guard officer in charge, Marine Inspection Unit nearest to the accident site or USCG station.



RENDERING ASSISTANCE

The operator of a vessel is obligated by law to provide assistance that can be provided safely to any individuals in a dangerous situation on the waterway. The operator is subject to fine and or imprisonment for failure to do so.

DANGER

AVOID BODILY INJURY OR DEATH FROM
FALLING OVERBOARD! ALL OCCUPANTS SHALL
STAY SEATED IN THE COCKPIT
WHILE THE BOAT IS RUNNING.

FEDERAL REGULATIONS REGARDING VESSEL SECURITY

Federal maritime regulations contain specific information when operating near naval vessels, oil tankers and cruise ships.

1. You may not approach within 100 yards of any U.S. naval vessel, oil tanker, or cruise ship. When this is impossible to avoid, you must contact either the vessel or the Coast Guard escort vessel on channel 16 of the VHF radio.
2. Also, you must operate at minimum speed within 500 yards of these vessels.

WARNING

Do not approach within 100 yards of any U.S. naval vessel. If you need to pass within 100 yards of a U.S. naval vessel in order to ensure a safe passage in accordance with the Navigation Rules, you must contact the U.S. naval vessel or the Coast Guard escort vessel on VHF-FM channel 16.

OPERATE AT MINIMUM SPEED

You must operate at minimum speed within 500 yards of any U.S. naval vessel and proceed as directed by the Commanding Officer or the official patrol.

Violations of the Naval Vessel Protection Zone are a felony offense, punishable by up to 6 years in prison and/or up to \$250,000 in fines



Safety On Board

WATER SPORTS

Besides learning the safety precautions for safe boating, as well as understanding and knowing required rules and regulations, you are obligated to be particularly careful around other water sportsman, such as scuba divers, water skiers, wake boarders, and fisherman.

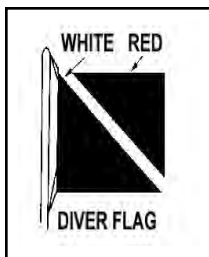

Whenever you see a “Diver Down” flag, maintain a distance of at least 100 feet on inland waters. In bays and open waters stay 300 feet away. The flag indicates a diver in the water. If a diver is operating from your boat, be certain to use this flag and post a lookout on board to observe the

diver’s air bubbles.

SWIM PLATFORM

On integrated or extended swim platforms you should make periodic inspections of the swim ladder and hardware that supports the platform to ensure that all connections and fittings are tight and in good condition. Use heed when operating the boat in reverse to insure that water does not accumulate excessively on the platform or transom, especially in rough seas or strong currents. Do not exceed the recommended maximum capacity label!



Typical label shown.

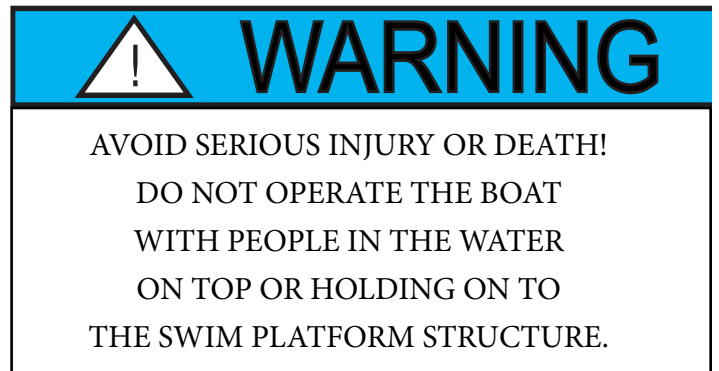

Read and understand the warning label above regarding “teak surfing.”

FISHING



Most boaters fish from time to time. With the propulsion systems of today it is possible to fish in out-of-the-way places. When cruising, stay clear of fisherman. They may have lines or nets out which might be cut or get caught in your propeller if you come too close. Slow down when approaching fishing boats. Do not

return to cruising speed until the boats have been passed. If a fishing boat should be anchored, a large wake could flip or swamp the boat, upset fishing gear, pull the anchor loose from the bottom or worse yet cause someone to fall overboard.

When fishing from your boat, never anchor in a shipping channel or tie up to any navigational aid. These must be kept clear of at all times.

Be sure to carry a local chart of the area to back up your plotter and be on the lookout for shallow water and hidden obstructions. Many times local conditions change and there is a time lag on the plotter chip until the next revision.

Pick up a tidal chart if appropriate so you do not end up grounded.



WEATHER/WATER CONDITIONS

Before a boating outing check the weather conditions. As we all know the weather can change rapidly in many parts of the country. It does so sometimes without being predicted. NOAA weather radio reports are continuously available on designated frequencies installed on VHF radios and various hand held devices. Also, many local radio stations carry weather reports along with on-line information.

CLOUD FORMATIONS

Clouds indicate the type of current weather and upcoming changes in the weather. Knowing the type of cloud formation can assist you in understanding current weather. Flat clouds (stratus) normally indicate stable air. Cumulus clouds indicate unstable air. Many times a “cotton ball” or cumulus cloud builds vertical height in the afternoon and the result is a thunderstorm with increased winds and waves; sometimes these storms are quite violent. Also, water spouts with high vortex winds can develop over water. You can find additional weather information (meteorology) at your local library or on the internet.

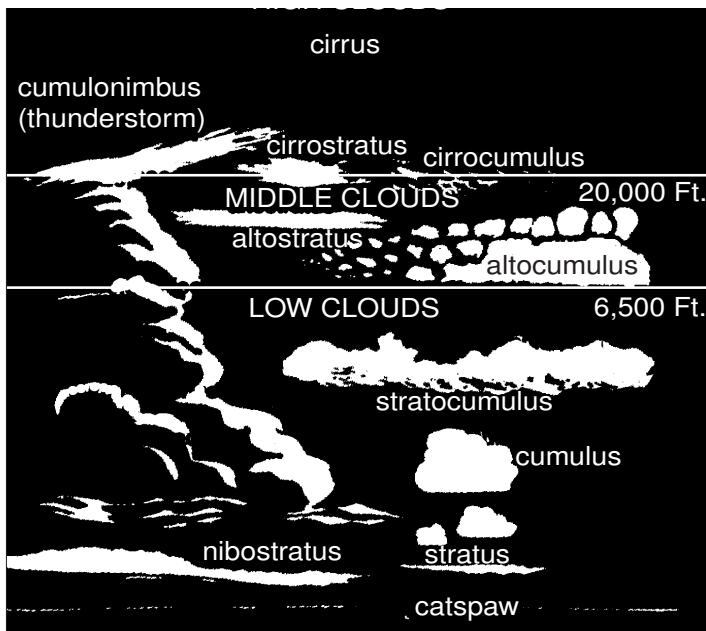

WAVES & FOG



As the wind blows across water waves are created. The stronger the wind and increased distance across the water enlarges the wave action.

Other factors that can cause problem situations for vessels are fog, currents, and tidal changes.

Fog can develop inland on clear, calm mornings. Coastal areas see large “blankets” of fog roll in and stay for extended time periods sometimes causing hazardous navigation conditions. If you are caught in the fog, do not panic. Think of the best plan of action and proceed carefully. If you are limited in navigation equipment at the first sign of fog proceed to the nearest shoreline and wait until the fog lifts.

Boats equipped with navigation equipment, local waterway experience and charts should proceed to a safe harbor. Use extreme caution, signal as needed, and reduce to a speed where you can stop within half of your forward vision range.

If foul weather catches you at sea do the following:

1. Slow down. Proceed with caution and put on your life vests.
2. Try to reach the nearest safe shoreline.
3. Navigate your vessel slowly into the waves at a 45 degree angle.
4. Passengers should sit low in the center of the vessel.
5. Monitor your bilge pump. Make sure sump stays free of water.
6. Secure loose gear. Make ready emergency equipment.
7. If the engine stops, throw the anchor over the bow. If needed use a sea anchor. Never anchor off the stern.



Rules Of The Road

NAVIGATION RULES DEFINED

The Navigation Rules set forth actions to be followed by boats to avoid collision. They are referred to as the “Rules of the Road”.



There are two main parts referred to as the inland and international rules. The inland rules apply to vessels operating inside the boundaries of the United States. The international rules (referred to as 72

COLREGS) apply to vessels operating on the high seas and all connected waters outside the established demarcation boundaries. Most navigational charts show the demarcation lines by red dotted lines and are published in the navigation rules. Remember to consult state and local agencies since areas such as “no wake zones,” swimming beaches, “diver down flag” and inland landlocked lakes fall under their responsibilities. This section is only an introduction to the “rules of the road”. We strongly recommend additional training before getting behind the “wheel” of your boat.

You can order the Inland & International Navigation Rules from:

Superintendent of Documents
U. S. Government Printing Office
Washington, DC 20402
Tel: (202-512-1800) Fax:(202-512-2250

NAVIGATION RULES

RIGHT OF WAY

1. Cross waves at right angles.
2. When caught in heavy water or squalls, head either directly into the waves or at a slight angle. Reduce speed, but maintain enough power to maneuver your boat safely.
3. Keep your speed under control. Respect the rights of other boaters engaged in all water sports. Give them plenty of operating room.
4. Whenever meeting a boat head on, keep to the right where possible.
5. When two boats cross, the boat to the right (starboard) has the right of way.

 **WARNING**

TO AVOID INJURY AND DEATH
FOLLOW THE NAVIGATION “RULES OF THE
ROAD” TO PREVENT COLLISIONS.



6. When overtaking or passing, the boat being passed has the right of way.

In general, boats with less maneuverability have right-of-way over more agile craft. The skipper must keep his craft clear of the following vessels:

- A vessel not under command or aground; due to their circumstances, these vessels have no maneuverability.
- A vessel restricted in its maneuverability; these vessels usually are performing work which limits their maneuverability. Examples are boats surveying, dredging, laying pipe or cable, or servicing navigational markers.
- A vessel engaged in fishing; these include boats fishing with lines, trawls or nets, but not trolling lines.
- Sailboats; they have the right-of-way over powerboats. However, if a sailboat is using a prop to move forward, it is considered a powerboat even if the sails are up.
- Remember the unwritten “rule of tonnage”. Basically a smaller tonnage vessel should take every effort to avoid close quarters with a larger tonnage vessel. One way to accomplish this is to have a designated human lookout to “eyeball” the horizon for any developing collision course.
- Use defensive driving skills on the waterway just as you do on the roadway. The other vessel may not know the rules of the road. Be alert and ready to take immediate action.
- If a collision course is unavoidable neither boat has the right of way. Both boats must react to avoid an accident according to the rules of the road.

LOOKOUTS

International and Inland navigation rules spell out the specifics of establishing a lookout. A lookout is legally defined by the court system as a person who has specifically charged duties on board such as observing sounds, echoes, lights and any inhibitors to navigation with complete thoroughness as permitted by the circumstances.

The term “specifically charged” means that the lookout has no other duties at that time that could prevent him from keeping a proper watch.

Of course the skipper must delegate the lookout duties to a seasoned crew member who can react to events quickly and communicate effectively with the captain with little notice.

As captain of your yacht you are responsible for the vessel and the crew. Choose an experienced individual as lookout and review the navigation rules with this person so he can make the right call quickly as situations develop.

WHISTLE SIGNALS

ONE LONG BLAST: Warning signal
(Coming out of slip)

ONE SHORT BLAST: Pass on my port side

TWO SHORT BLASTS: Pass on my starboard side

THREE SHORT BLASTS: Engine(s) in reverse

FOUR OR MORE BLASTS: Danger signal

BRIDGE SIGNALS

		DAY (Flag)	NIGHT (Lights)
SOUND	VISUAL	↑	↑
VESSEL: Open	VESSEL: Open	□	○
BRIDGE: OK	BRIDGE: OK	↓	↓
No	No	Same	Same
VESSEL: Replies:			or
			Same
RADIO: VHF CH. 13			No
		◀	▶



Rules Of The Road

NAVIGATION RULES

The Navigation Rules set forth 3 types of crossing situations- crossing, meeting, and overtaking. In each case, both boats are governed by special procedures.

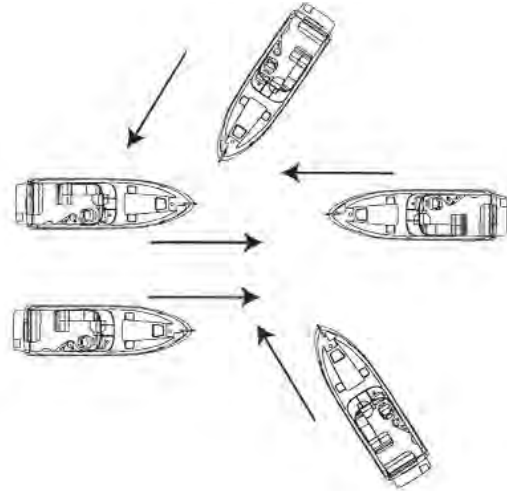

In a head-on meeting, both vessels must sound a single blast to give way toward starboard and pass to port.

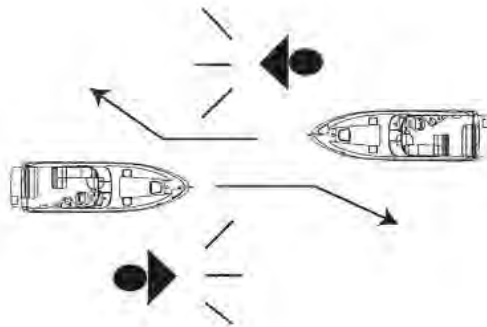

These rules appear when there is a risk of collision. In a crossing situation be aware of the other craft's position. For safety, there should be a noticeable change in the angle, bow or stern; a gradual change in position indicates possible danger.

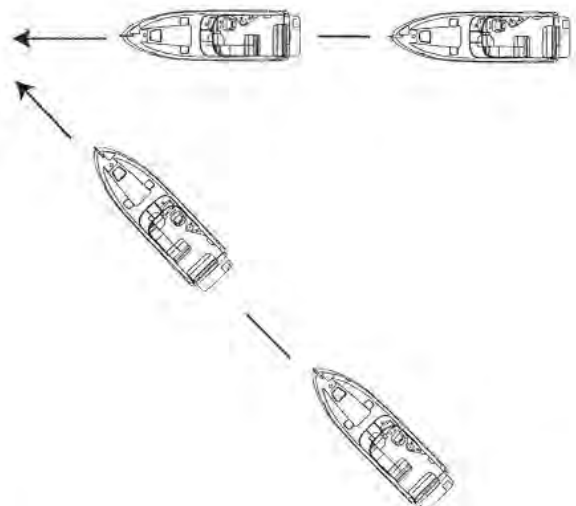



NAVIGATION RULES

An overtaking boat is burdened, and is not the privileged craft, even though it approaches the danger zone of the overtaken boat.

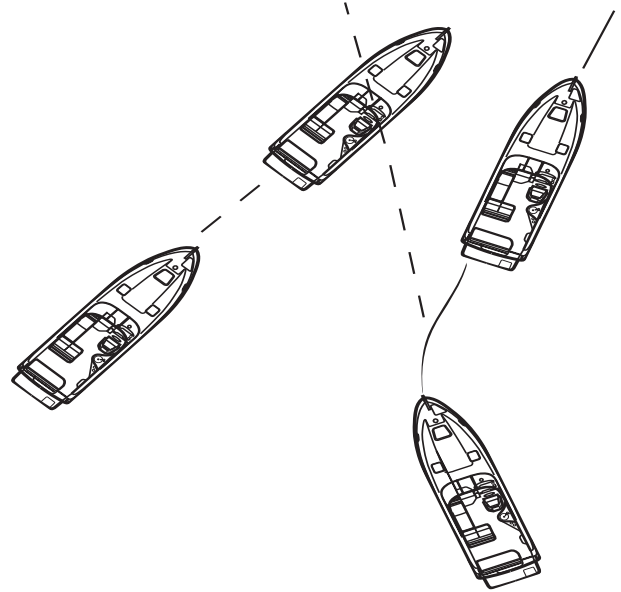

The overtaking boat first signals with a single blast if that boat desires to pass on the starboard side of the boat ahead, or a double blast if passing to port. The overtaken craft responds with the same signal if safe, or with the danger signal (5 short blasts or more) if unsafe. The boat overtaking must not pass unless the appropriate signals are sounded.

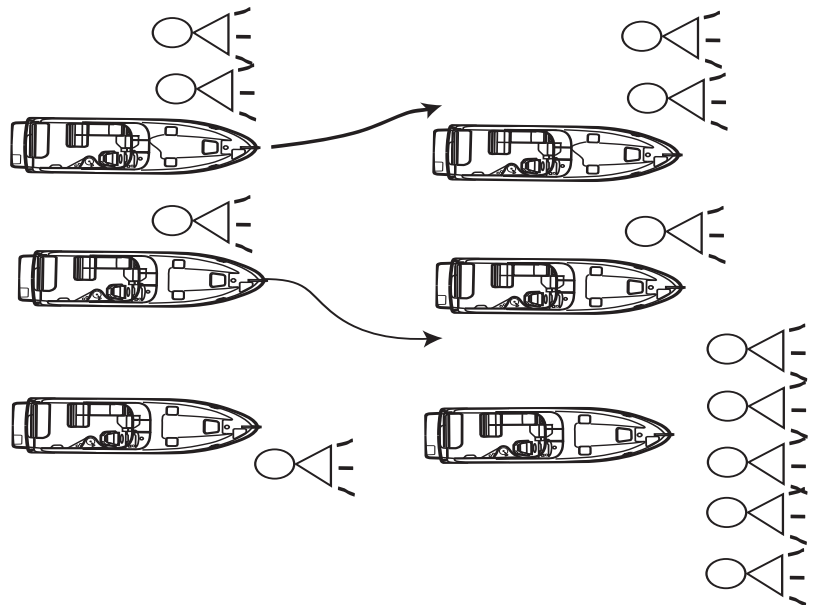



Rules Of The Road

NAVIGATION AIDS

Navigation aids are placed along coasts and navigable waters as a guide for mariners in determining their position in reference to land and hidden danger. Each aid provides specific information. They form a continuous system of charted markers for monitoring on the plotter or providing accurate piloting on paper as a backup.

Your on board plotter provides up to date navigation aids. Besides coastal maps a complete domestic interior waterway grid is featured on the plotter.

If desired, there are hand-held GPS devices that are available as back-up devices. In addition, nautical charts are provided by the National Ocean Service (NOS) and are distributed nationwide through marinas and outlet stores. These charts show the geography of the coast, water depth, landmarks, navigation aids (buoys and markers), marine hazards, and port facilities. Use only up-to-date charts for navigation. We recommend when purchasing a chart to look for the weather resistant ones. Buoys provide a roadmap to keep the skipper on course and to avoid hazards. Buoys are identified by light, shape, color and in severe weather conditions by sound.

Buoys or beacons called lateral markers indicate the port and starboard sides of the waterway to be followed. U. S markers follow the buoyage system known as Red Right Returning. When returning from sea or traveling upstream, the green markers are to port (on your left) and the red markers are to the starboard side (on your right). When traveling downstream or out to sea the marker color would be reversed.

Before operating your vessel, learn to identify the various navigational aids such as lateral aids, mid-channel markers, information and regulatory markers.

NOTICE

SKIPPERS MUST NOT RELY ON BUOYS
ALONE TO MARK THEIR POSITION.
SEVERE WEATHER CONDITIONS
AND WAVE ACTION CAN ALTER
A BUOYS POSITION.
NEVER TIE UP TO A BUOY.
IT IS ILLEGAL AND DANGEROUS.



LATERAL AIDS

Port Side
Odd Numbers

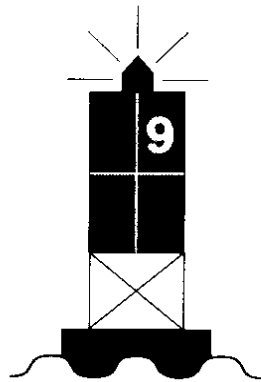

Lighted Buoy
(Green Light Only)

Chart Symbol



Starboard Side
Even Numbers

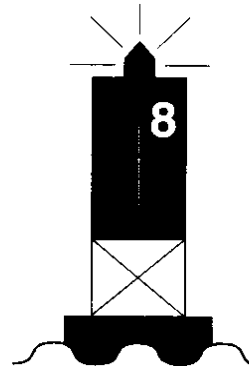

Lighted Buoy
(Red Light Only)

Chart Symbol

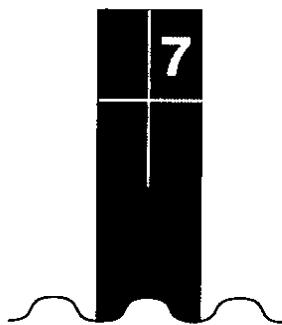

Can Buoy
(Unlighted)

Chart Symbol

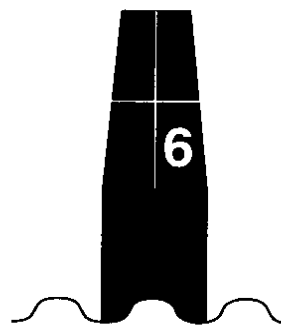

Nun Buoy
(Unlighted)

Chart Symbol



Daymark

Chart Symbol

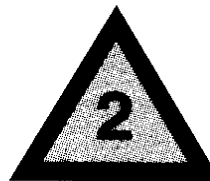

Daymark

Chart Symbol





Rules Of The Road

MID-CHANNEL MARKERS

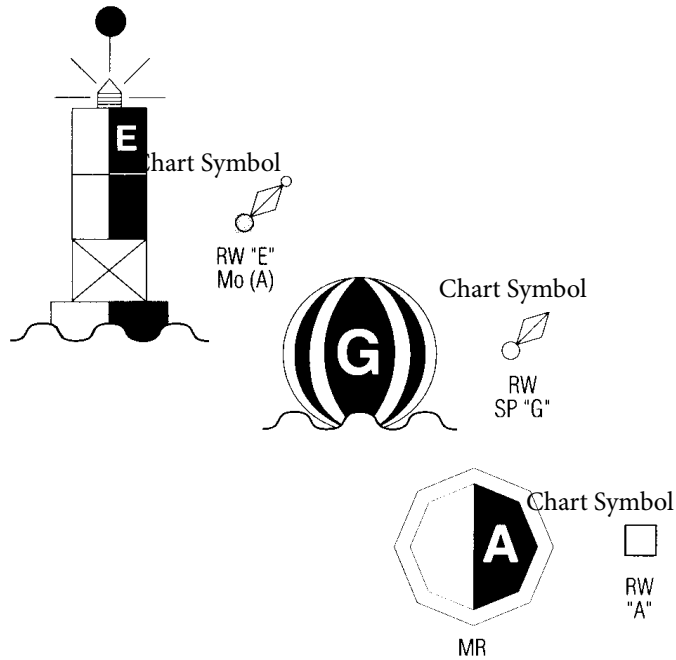

REGULATORY MARKERS

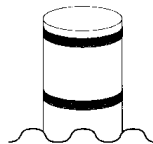

Diamond Shape Warns Of Danger



Diamond Shape With Cross-Boats Keep Out



Circle Marks Area Controlled As Indicated



For showing information such as locations, distances and directions



NIGHT RUNNING

Boats operating between sunset and sunrise (hours vary by state), or in conditions of reduced visibility, must use navigation lights. Night time operation, especially during bad weather and fog, can be dangerous. All Rules of the Road apply at night, but it is best to slow down and stay clear of all boats regardless of who has the right-of-way. To see more easily at night, avoid bright lights when possible. Also, it is helpful to have a passenger (appoint as lookout) keep watch for other boats, water hazards and navigational aids.

To determine the size, speed and direction of other vessels at night, you should use the running lights. A green light indicates starboard side, and a red light indicates port side. Generally, if you see a green light, you have the right-of-way. If you see a red light, give way to the other vessel.

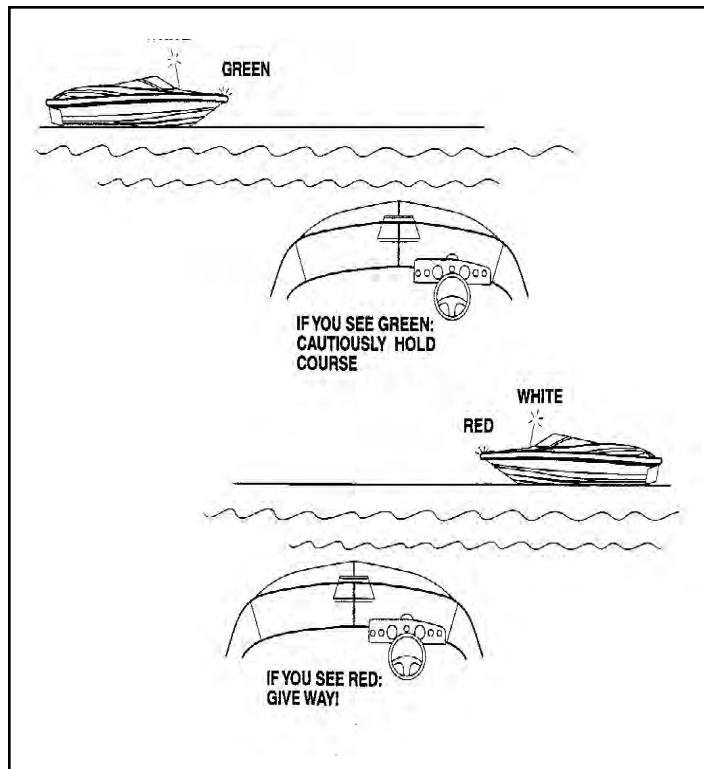

BRIDGE CLEARANCE

Be aware that your vessel requires a specified bridge clearance height. This height is a measured estimate from the waterline to the top of the highest equipment height. The estimated height can change because of variances in the loaded condition of the vessel and equipment variances. Consult the bridge clearance specifications located in Chapter 12 (Technical Information section). Some bridges are tendered. Know and use the proper bridge signals when approaching these bridges (see bridge signals in this chapter). You can also monitor and communicate on channel 13 of a VHF radio for bridge information in most domestic locals. Other bridges are marked with a clearance measurement and you are on your own. It is recommended that you have a look out posted for additional visual assistance when entering a bridge zone.

After determining your vessel will clear the bridge proceed with caution at a safe idle speed. Keep your eye on vessel traffic at all times in order to react quickly. Keep both hands on the helm since you may need to change course because of current and wind conditions. Resume a safe speed once clear of the bridge structure and acknowledgment of clear visibility.

Just use common sense around any type of bridge structure!

BRIDGE LIGHTING

Bridge lighting is maintained by the Department of Homeland Security. On the following pages are 2 typical examples of night-time bridge lighting. As the skipper approaches bascule and fixed bridges light position (arc of visibility) and color will indicate the safe channel through the bridge. Notice green denotes the “safe” entry location on single-span bridges and green or white on multiple-span bridges designates the main channel. In addition, green denotes the “up” position for single and double lift bridges.



Rules Of The Road

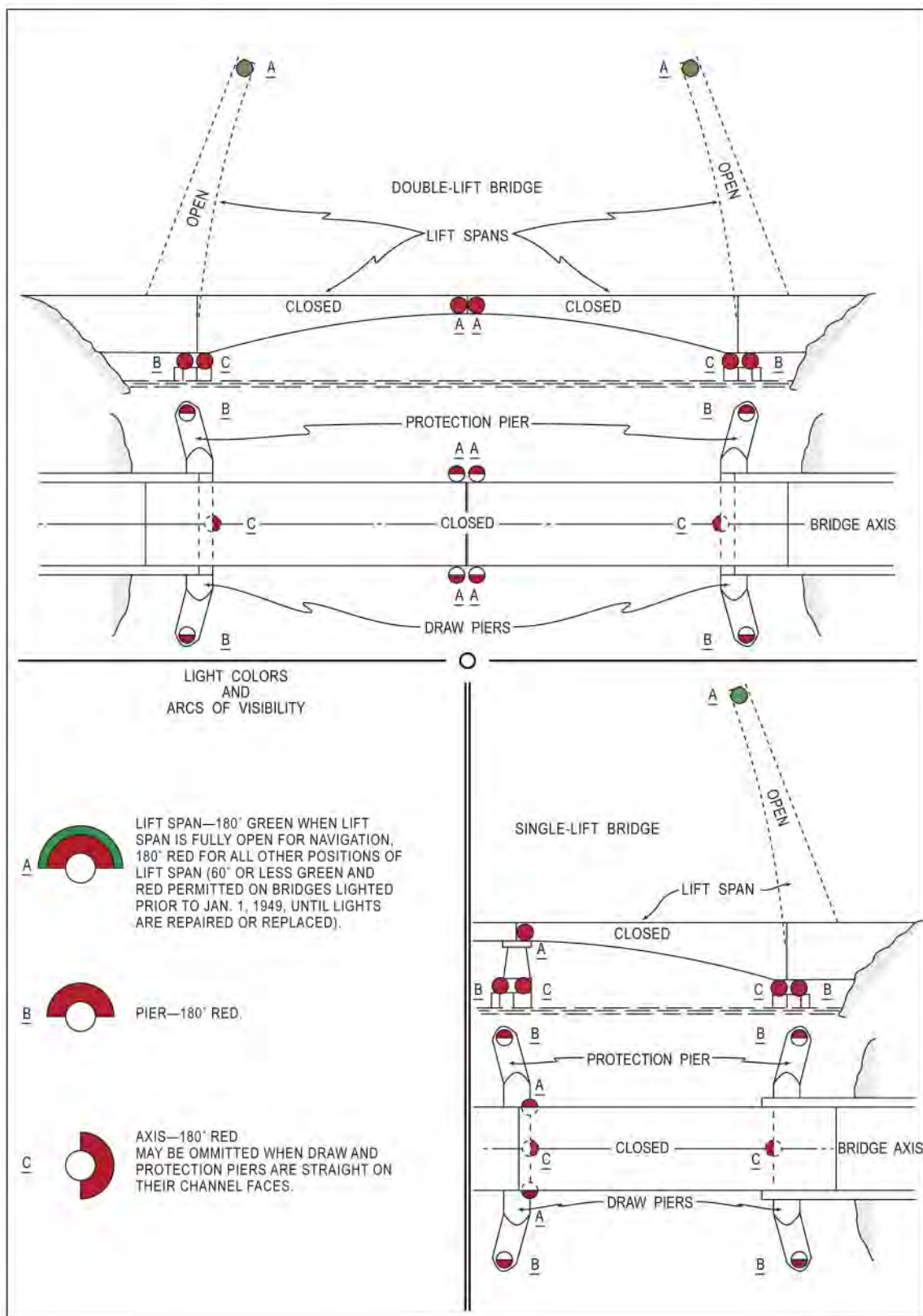

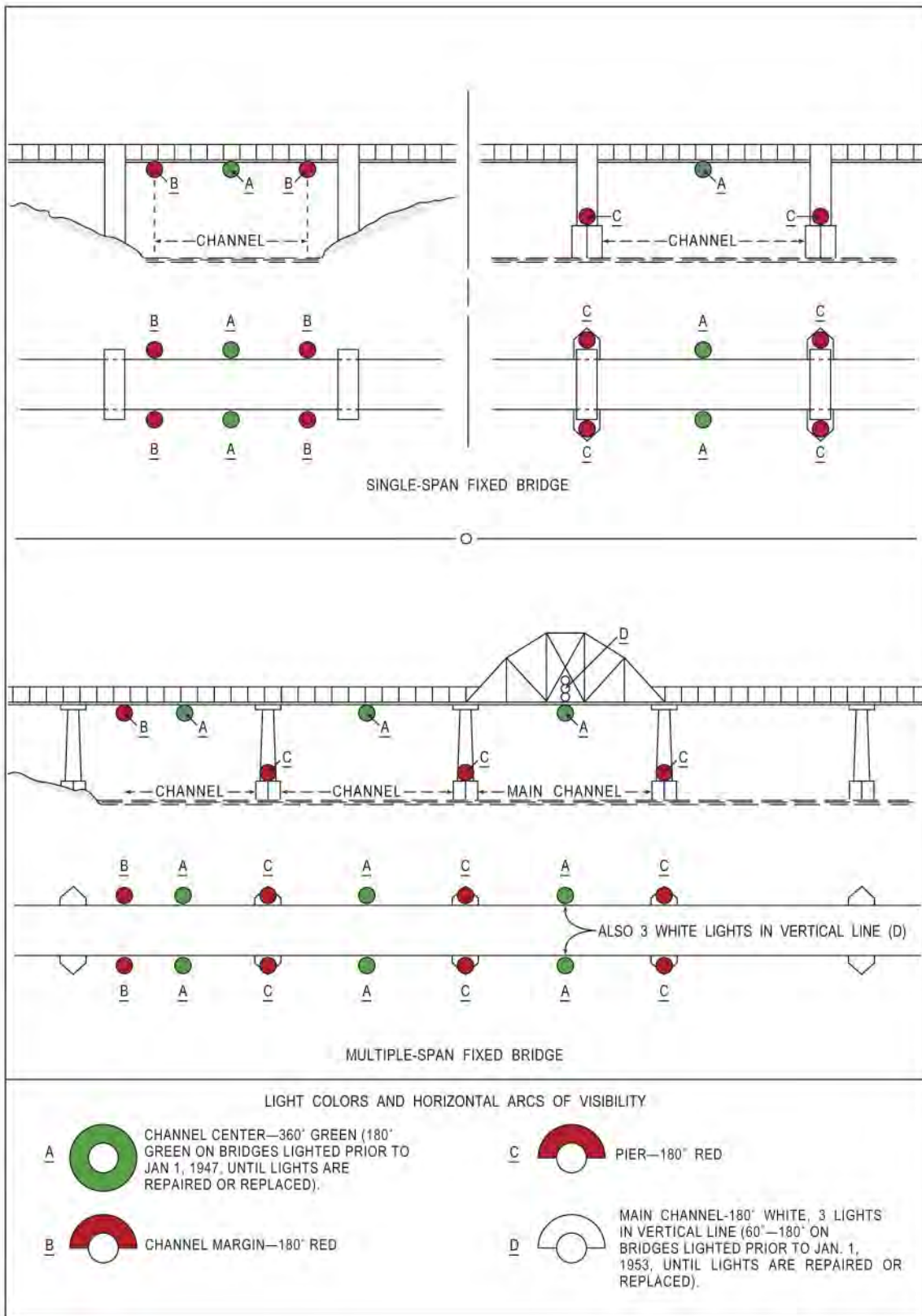



Systems

OVERVIEW

In this chapter Regal on board systems are introduced. Information includes several main systems including fuel, DC electrical, water, waste, electronics, entertainment and trim tabs. Most of these Regal systems are similar for the stern drive and outboard models. Where differences exist notations will be found. This is the “meat and potato” section for equipment operation.

A system description, location of components, operational information along with common problems and solutions are covered with each of the system components. Enhanced vendor component details can be found in the owner’s information packet.

Be sure to read and follow any danger, warning, or caution labels in reference to boat systems or individual equipment components.

Your Regal boat may not contain all of the equipment or systems shown. Regal has the right to modify, update or delete equipment and/or systems at anytime.

Refer to the vendor documentation located in the owner’s information packet for more detailed information of individual system components.

STANDARD FIRE PORT

On stern drive models there may be a fire port in the



aft cockpit near the engine hatch. The plug includes a decal. In a fire emergency place a hand held fire extinguisher in the port and pull the pin to evacuate the agent. See the photo above for typical fire port.

If installed, locate the

fire port on your vessel, point out to passengers and make everyone aware of emergency procedures related to the fire port. Make sure an approved portable fire extinguisher(s) of the correct type and weight is aboard and located for fast access in case of fire. See the *note* information below for choosing the proper clean agent fire extinguisher for fire port usage.

Note that the approved portable fire extinguisher must be a halogenated or clean agent type which includes Halon agents along with newer and less ozone depleting halocarbon agents. These type extinguish the fire by interrupting the chemical reaction of the fire triangle.

Clean agent extinguishers are primarily for Class B and C fires (gasoline is a flammable liquid under the Class B group). The extinguisher should be of the 5 lb. capacity and 2 are recommended based on the maximum capacity of the fuel tank onboard and the boat length. These extinguishers may be available from your dealer, marine speciality stores, or on the internet.

	WARNING
<p>PREVENT INJURY, DEATH, OR PROPERTY DAMAGE! READ AND UNDERSTAND THE PROPULSION OWNER’S MANUAL AND GENERATOR MANUAL BEFORE ATTEMPTING TO OPERATE THE VESSEL.</p>	



GASOLINE FUEL SYSTEM

In this section, a typical EPA approved domestic gasoline fuel system is introduced. The fuel system includes the fuel tank, fuel feed lines, fill and vent fittings along with fuel filters, emission devices natural and powered ventilation systems.

Gasoline today is processed in a different manner than it was a few years ago. As a result it has become more unstable and the product shelf life has been shortened. As part of the Volvo product features the gasoline engine EVC system and transmissions are all protected by a fault handling system should a malfunction develop. A portion of this fault system is used to monitor the gasoline fuel system. Mercruiser propulsion systems offer “Smartcraft” technology which delivers key engine functions.

Select codes warn the captain with a “buzzer” sound while others will display on the helm tachometer, display, or alarm panel. The “pop-up” will alternate between the cause of the fault and a task to perform to aid in eliminating the situation.

It is important to read and understand your Volvo or MercCruiser propulsion owner’s manual in order to react to a fault code should a malfunction display on the instrumentation or an alarm sound.

Note that outboards utilize the same style fuel tank as the stern drive models with slight differences in the fuel system components.

For example a special bulb and hose is supplied by the engine manufacturer to feed the fuel from the tank to the outboard engine. Read and understand the outboard owner’s manual fuel section and safety information before attempting to use the vessel.

On outboard models due to a possible fire or explosion danger never store flammable liquids and/or portable outboard fuel tanks in any onboard storage compartment

GASOLINE SPECIFICATIONS/OCTANE RATINGS

Gasoline Requirements- Use regular non-leaded gasoline with the following minimum octane rating for stern drive engines:

- Inside United States-(R+M)2 (AK)- 87
- Outside United States- (RON) -90

The use of leaded fuels will damage the catalysts and can not be used with catalytic converters.

Gasoline in the United States and other areas is blended with 10% ethanol and is known as E-10 at the pumps. Marine engines used in your Regal boat may be operated with gasoline blended with no more than 10% ethanol and that meets the minimum octane specification.

Do not use ethanol blends greater than 10% such as a newer blend for select motor vehicles called E-15. Your marine engine may be damaged by more than 10% ethanol. A loss of performance may occur and the engine will not be covered by the engine manufacturer’s warranty.

Outboard models depending on the model may require a mid-range octane level verses a lower regular octane level. Refer to your outboard manufacturer’s operation manual for correct information regarding the proper octane level for your outboard model. Using the wrong octane level may cause permanent engine damage. such as piston detonation.

As an option contact your outboard manufacturer’s hot line or text on web with fuel related questions. Also, contact your closest Regal dealer.



TYPICAL EPA FUEL SYSTEM

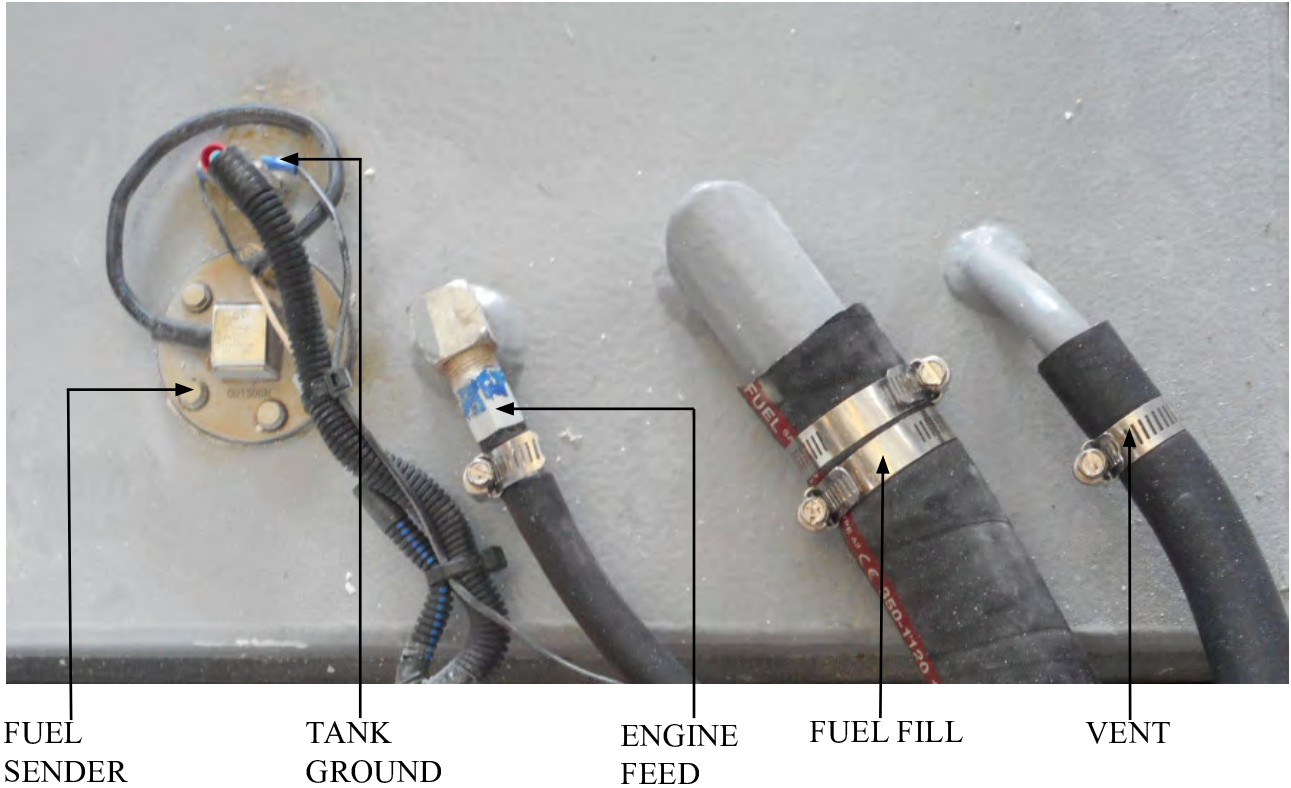

TYPICAL FUEL TANK

Boats manufactured for domestic use are now required to be outfitted with an EPA compliant fuel system using an aluminum tank. This system uses parts such as special valves and baffles located inside the fuel tank. Also, there is a carbon canister which functions much like the one in an automobile. This component is located between the fuel tank and hull side vent. The carbon canister never needs to be replaced and is not a serviceable item. Tanks are initially outfitted to work with gasoline and diesel systems.

These tanks are tested and inspected along with the complete fuel system several times for safety requirements and quality by the fuel tank supplier, in house personnel and independent inspections by National Marine Manufacturers Association personnel.

FUEL FILL FITTING

The fuel fill fitting is labeled “gas” and in addition displays the international symbol (See the next page). When fueling the boat keep the fill nozzle in contact with the fuel fill pipe since it decreases static electricity. Always use the recommended fuel octane rating as specified in your engine owner’s manual.

Extinguish all flame producing agents before fueling!



FUEL VENT FITTING- TYPICAL



COMBO FUEL FILL/
INTERNAL VENT

Currently, domestic EPA compliant fuel tanks vent fumes back into the fuel tank system. While the tank is filled, air displaced by the incoming fuel is vented through the fuel system charcoal canister.

Your vessel uses a combo type (internal vented) fuel fill. Both the fuel fill and vent occupy the same cavity under a protective cover. If fuel overflows through

the vent the design forces it back into the fuel fill hose and tank.

A seasoned skipper will hear a distinct sound as the tank nears the “top out” or full mode and may see fuel overflowing back into the fuel hose through the vent.

DO NOT OVERFILL THE TANK.

This helps avoid any overboard spills which harm the environment.

Note: On select vessels there is a key that fits into the fuel fill cap. Use it to secure the fitting from leaking fuel. Store the key in a safe place so it can be easily found for fueling. Check the vent fill screen periodically for debris.

ANTI-SIPHON VALVE



INTERNAL BALL/SPRING

The gasoline fuel tank feed line that runs from the fuel tank to the engine fuel component use an anti-siphon valve.

The valve is threaded into the fuel tank fitting

at the feed line. The valve is pulled off its seat by fuel pump pressure as the engine is cranking or running. There is a ball and spring assembly inside the valve that is activated by fuel pump impulses. It allows a one-way fuel roadway to the engine fuel system. It prevents fuel from siphoning out of the tank in the event of a fuel line rupture or disconnected fuel feed hose. When the engine fuel components stop the fuel from cycling the spring forces the ball against the valve opening to stop fuel flow. Never remove an anti-siphon valve as it is a fuel system safety component. Also, never remove the ball and spring from the valve assembly. The anti-siphon valve requires no normal maintenance. Symptoms indicating possible valve problems may be fuel starvation at intermediate or high rpm or in extreme cases an engine that will not start. Contact your Regal dealer for further information.



FUEL GAUGE/SENDER

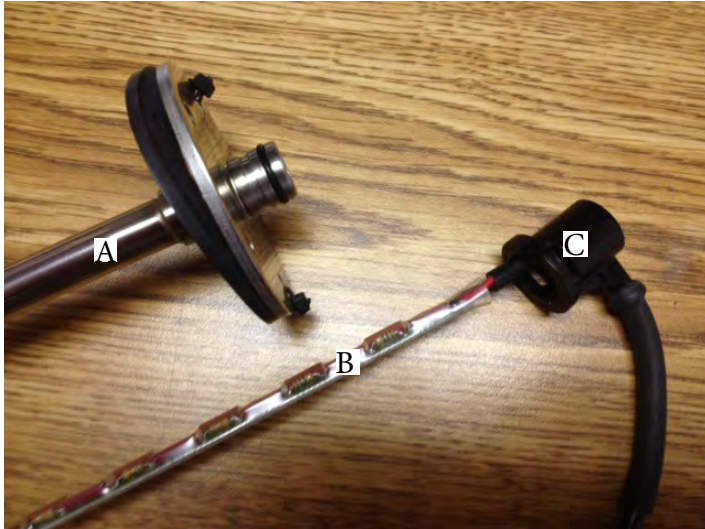

The dash fuel gauge is only an indication of the on board fuel supply. They are not exact reading instruments. Therefore, use the one third rule discussed earlier for monitoring your fuel supply. There are not many filling stations on the open waterways!

The gas sender located in the fuel tank uses a float system which sends a signal to the dash fuel gauge as to the estimated fuel tank level.

The new sending units feature a removable tube (B) which inserts inside the stainless steel sender (A) without having to remove the entire unit found in earlier units. The unit requires as little as 3" height to remove the tube. Also, a liquid-tite strain relief connector protects the harness.

A buna-N type float travels the length of the sender tube (A) as the fuel level changes. The resistors inside the tubing read the float level and send a signal to the dash gauge.

As an emergency tip in the event the fuel gauge shows no gauge activity or reads improperly:

Check the sender by disconnecting the 2 sender leads at the fuel tank and connecting an ohm meter between them. Make sure you zero out the meter by first connecting both red and black leads together and then adjusting the meter knob to zero. This needs to be performed to obtain a correct ohm reading. The actual resistance between the sender leads should be between 30 and 240 ohms.

FUEL FILTERS

Fuel filters are installed on your marine engine. They are of the spin on type similar to an automobile oil filter. Their main purpose is to trap dirt particles and condensation in the fuel system before it reaches the injectors. Impurities can clog up the injection system. It is a good idea to keep an extra set of fuel filters on board along with a filter wrench, catch container and clean rags for emergencies. Never use automotive style fuel filters on your vessel. Dispose of all fuel residue materials in an environmentally safe fashion.

Note that outboard models use a spin on-spin off style fuel filter located in the aft storage compartment. It is recommended to carry extra fuel filters for emergencies. Be sure to store them in a dry area. For more information, refer to your outboard owner's manual or contact your closest Regal dealer to order replacement filters.



CARBON CANISTER



The domestic EPA compliant fuel tank system contains a carbon canister. It is located in the engine room (bilge or sump).

Its environmental mission is to catch and filter any impurities that are attempting to exit the fuel system via the fuel tank vent hose. This component should last the life of the fuel system and requires no periodic maintenance other than periodically checking the hose clamps for tightness.

VENTILATION SYSTEM



Stern drive gasoline propelled engines require a continuous supply of fresh air in order to generate peak horsepower and rpm. To deliver fresh air for the engine a permanently mounted vent system is integrated into the boat's aft deck on both port and starboard sides. This is called the natural ventilation system.

When the engine is started fresh air is drawn through the vent system. As the demand for air increases in relationship to the engine revolutions per minute (rpm's) the engine induction system supplies the

required additional air supply by inhaling more air. As part of the gasoline combustion process fuel vapors can accumulate in the bilge and cause a possible explosion or fire. To offset the possibility of this happening a powered ventilation system exits fuel vapors and possible CO through a blower with hoses that are strategically placed in the lower third of the engine compartment. There is one blower per engine. Gasoline vapors naturally seek the bilge bottom and the blowers evacuate any fuel vapors out the exhaust side of the ventilation system. This is known as the powered ventilation system. If you are working in the sump make sure you do not step on the black 4" blower hoses.

Check the vents periodically for any obstructions or foreign objects such as nests or spider webs. If the propulsion system is running at a lower than normal cruising rpm or seems to lack power or the vessel is slow to plane check the fresh air supply to the engine including the engine air filters.



GASOLINE FUEL SYSTEM-GENERAL LABELS

NOTICE

SINCE GASOLINE IS AVAILABLE IN VARIOUS OCTANE LEVELS, REFER TO THE ENGINE MANUFACTURER'S OWNER'S MANUAL FOR THE CORRECT ONE FOR YOUR ENGINE. USING IMPROPER OCTANE FUEL CAN CAUSE ENGINE DAMAGE AND VOID THE WARRANTY.



DANGER

AVOID PERSONAL INJURY OR DEATH! GASOLINE IS A HIGHLY FLAMMABLE AND EXPLOSIVE MATERIAL. PRACTICE "NO SMOKING" AND EXTINGUISH ALL FLAMMABLE MATERIALS WITHIN 75 FEET OF THE FUEL DOCK.



WARNING

GASOLINE VAPORS CAN EXPLODE!
BEFORE STARTING ENGINE
OPERATE BLOWERS 4 MINUTES AND
CHECK ENGINE COMPARTMENT
FOR GASOLINE LEAKS AND VAPORS.
RUN BLOWERS BELOW CRUISE SPEEDS.



WARNING

AVOID SERIOUS INJURY OR DEATH
FROM EXPLOSION OR FIRE!
NEVER STORE FUEL OR FLAMMABLE
LIQUIDS ON BOARD.



WARNING

AVOID SERIOUS INJURY OR DEATH
FROM EXPLOSION OR FIRE
RESULTING FROM LEAKING FUEL.
INSPECT ENTIRE FUEL SYSTEM AT LEAST
ONCE A YEAR.



GASOLINE FUEL PROBLEMS/SOLUTIONS

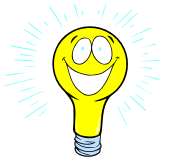

1. Engine is hard to start or idles rough- This problem can be caused by foreign particles or water in the fuel system or a blockage in the fuel supply which causes a lean condition.

Check all fuel system lines, clamps, fittings and filters for tightness. Check the entire system for fuel leaks.

2. The engine hesitates at intermediate speeds or fail to obtain top rpm- Check the fuel system for possible leaks, clogged fuel filters and/or malfunctioning anti-siphon valve.

3. The fuel tank reads low and the engine is running rough. The pick-up tube has possibly picked up some residual water from the bottom of the fuel tank.

Pour dry gas into the fuel fill fitting and fill the gas tank with fresh fuel. Test run the engines to purge impurities from the fuel system.

4. Fuel tank gauge not reading correctly/or not at all- If you disconnect the fuel tank sending wire leading to the dash gauge at the sending unit and ground it momentarily with the key on the dash gauge should show full. Release the wire from the ground position and the gauge should show empty. Normally this would indicate the dash gauge is working properly. The next item to check would be the fuel sender ohms reading which is explained earlier in this section. Also, make sure the sender wires and ground are securely fastened and the ground wire is tight. Many times a loose ground wire will cause a malfunctioning dash gas gauge or the gauge needle moves in an irregular fashion.



ELECTRICAL INTRODUCTION



In this section the basic DC (direct current) electrical system is introduced. Each primary electrical component is reviewed along with its location and function within the Regal electrical system.

For more complicated issues outside the scope of this manual contact your closet Regal dealer. They have undergone extensive training on the Regal boat systems. Be sure to read and follow any danger, warning, or caution labels in reference to the boat's electrical system or individual equipment components.



DIRECT CURRENT (12 VOLTS)

Your Regal boat uses 12 volt DC electricity otherwise known as direct current. It is called DC because it flows only one way in a circuit. Specifically to name a few, helm gauges, batteries, battery cables, engine electrical components, engine wiring harnesses, dash switches, selected lighting, shower sump, bilge pumps, and vacuum toilets are all components using a 12 volt DC system.

In the DC system used in the United States the red wire is designated as the “hot” or conductor wire and the black wire is referred to as the ground wire. At times other current carrying wires are color coded such as blue to identify their use as a low voltage conductor. This is especially helpful in troubleshooting and adding additional equipment. Be sure to review the wiring schematics in the drawing section of the technical chapter.

Direct current is stored in the ship’s batteries and produced through the engine alternator while the engine is running or by the battery charger at dockside.

The alternator charges the batteries by sending current through the main distribution panel relays, battery switches and harnesses to the appropriate battery. Normal DC voltage is between 12 and 15 volts. Lower or higher readings could indicate a charging malfunction or a weak battery.

The engine alternator used on your boat is internally self “excited” and produce DC current at idle. Normal alternator output would be around 105 amps.

TYPICAL BATTERY (12 VOLTS) DESCRIPTION

On board the boats direct current (DC) is stored in the ship’s “wet cell” battery(ies).

As part of the standard equipment package a Type 31 A battery is used for engine cranking and on board equipment. This system uses an “on” and “off” battery switch located under the aft port deck cushion. This battery switch controls a majority of all on board equipment including starting the engine.

Note that stereo memory and auto bilge pump circuits are energized even though the main battery switch is turned off.

More often the on board battery circuit includes one engine starting battery and a “house” type battery. Both batteries are of the Type 31A. The batteries may appear identical but their functions are specific and unique.

Included in this system is a dual battery switch. This permits the operator to select an additional position on this battery switch named “combine batteries”. Let’s say the engine cranks very slow in the battery switch “on” position. When combine batteries position is chosen both batteries operate together for increased engine starting power.

Note that with weak batteries it is necessary to choose the “combine batteries” position on the battery switch in order for both batteries to initiate the charging process.

CAUTION

AVOID POSSIBLE ENGINE DAMAGE!
NEVER TURN THE MAIN BATTERY SWITCH
TO THE “OFF” POSITION
WITH THE ENGINE RUNNING!



TYPICAL ON-OFF BATTERY SWITCH



TYPICAL DUAL BATTERY SWITCH

BATTERY SPECIFICATIONS			
Battery Type	Group	CCA @32 Degrees F.	Reserve Capacity
Engine Cranking	31A	1190	195 min.

BATTERY TERMINOLOGY

Group- Batteries are divided into groups which identify the height, length, and width of the battery. This is useful information should a replacement battery become necessary.

Cold Cranking Amps (CCA)- This rating measures the cranking power a full charged marine battery has available to start at 32 degrees F. Basically, the higher the rating the greater starting power of the battery.

Reserve Capacity (RC)- As usage on the boat increases so does the need for more reserve capacity. The reserve capacity represents the length of time in minutes a new fully charged battery can maintain the boat's electrical needs without the engine running or in the event the alternator fails.



POSSIBLE BATTERY PROBLEMS/SOLUTIONS



1. Weak battery- This battery problem can be caused by low electrolyte cell levels.

Warm engine compartment temperatures will deteriorate a battery's life quicker by evaporating the water from the

electrolyte, thus corroding and weakening the positive grids inside the battery.

With the house battery low electrolyte levels can be monitored by periodic inspection and filling as needed with distilled water. Boaters in higher climate areas with longer stretches of hot weather will need to check their batteries more often.

If installed "maintenance free" engine cranking batteries require no water. They do feature a different chemistry that does consume less water. Inside the cells as gases are released condensation is formed which aids in maintaining the cell electrolyte level. These batteries incorporate a deeper layer of electrolyte over the plates, but eventually it can run dry.

2. Dead Battery- Either the battery will not accept a charge, hold a charge or the charging system is not supplying a charging current through the battery charging system and/or engine alternators.

The battery charger output can be checked by monitoring the lights on the charger front face.

To begin with check the battery post connections for tightness and corrosion.

With the engines running the displayed voltage of the port or starboard engine battery and house battery should be between 12.5 up to 14.6 volts. If less than 12 volts check for voltage across the battery terminals.

Batteries should be removed from the vessel if necessary and trickle charged. If readings after charging are still low replace the battery.



MAIN BREAKER-BATTERY PANEL

POSSIBLE PROBLEMS/SOLUTIONS



As part of the battery circuit protection from the battery to the battery management system and finally to the dash panel a breaker is installed within 40" of the battery. If the breaker would draw excessive amperage it is possible it could

“blow”. At this point it would need to be reset.

Always determine the reason why the breaker blew before resetting it.

To reset the breaker move the lever from the “off” position to the “on” position. These Buss brand breakers are ignition protected which means they are sealed providing protection from spark sources. When replacing breakers ensure they are marketed as being ignition protected

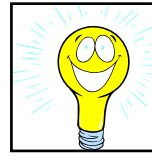

1. It is possible that the battery management system main circuit breaker may trip from long-term arcing and heat. The breaker may need to be reset.

2. Breaker will not reset- Replace the breaker. Contact the nearest Regal dealer for replacement parts.

3. Breaker continues to “trip”. Check the affected equipment to determine if it is responsible for the excessive draw to trip the breaker. If the equipment is determined to be within specifications check for a “short” in the wiring circuit. Also, the breaker may be faulty. Contact the nearest Regal dealer.



TYPICAL ON-OFF BATTERY MANAGEMENT SYSTEM-REAR VIEW

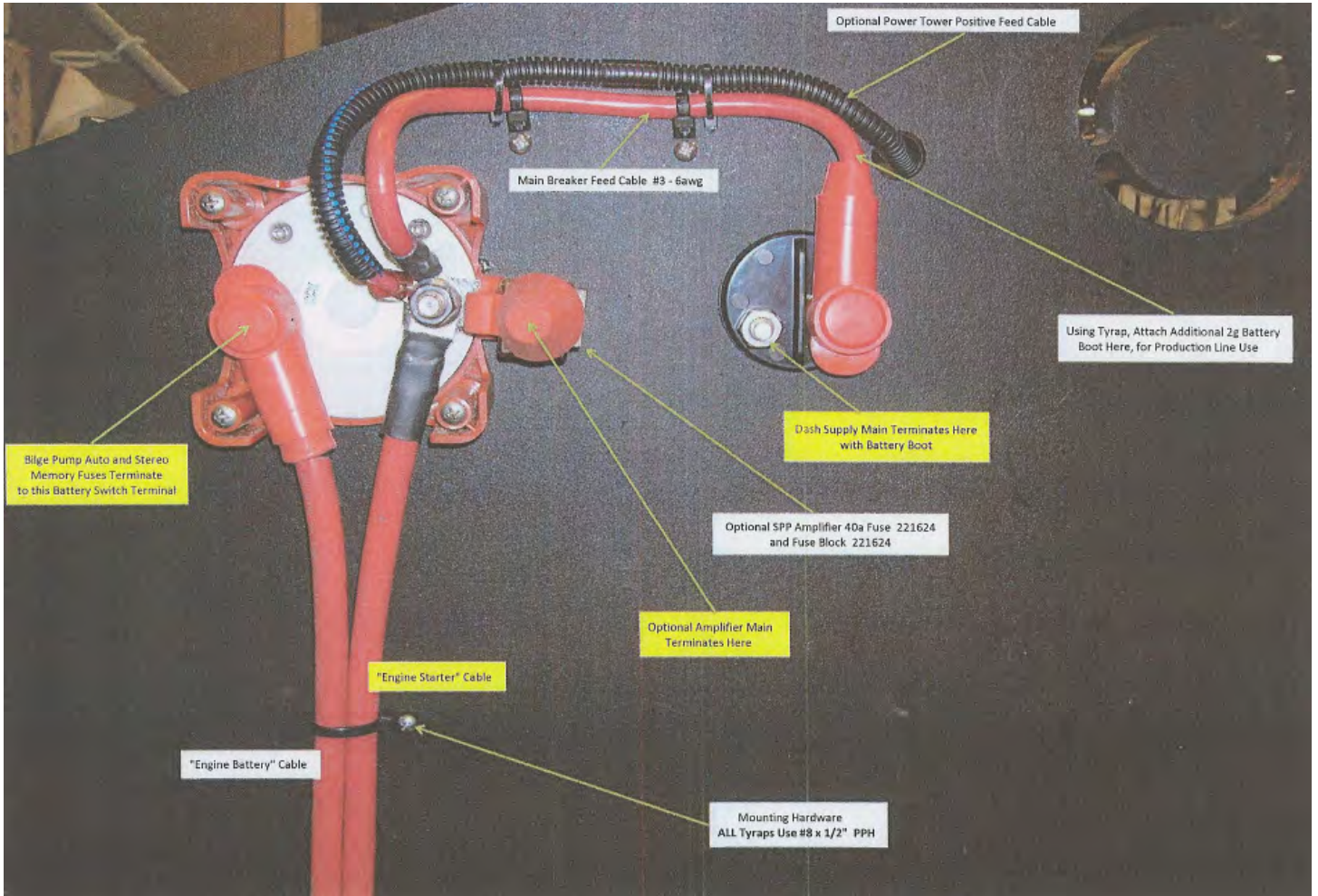

The battery management system is an important ingredient of the 12 volt direct current (DC) system. Refer to the battery management information in this section and the technical chapter for a breaker amperage listing. Be aware that in some cases the breaker protects a component; in other cases it may control a sub-panel or parts of a sub-panel.

Refer to the previous pages to identify the battery switch type found on your vessel. Both systems use two batteries.

Note that select vessels utilize a larger battery box to allow the use of larger batteries that could be used as a cranking battery or a house battery.



TYPICAL DUAL BATTERY SWITCH MANAGEMENT SYSTEM-FRONT VIEW

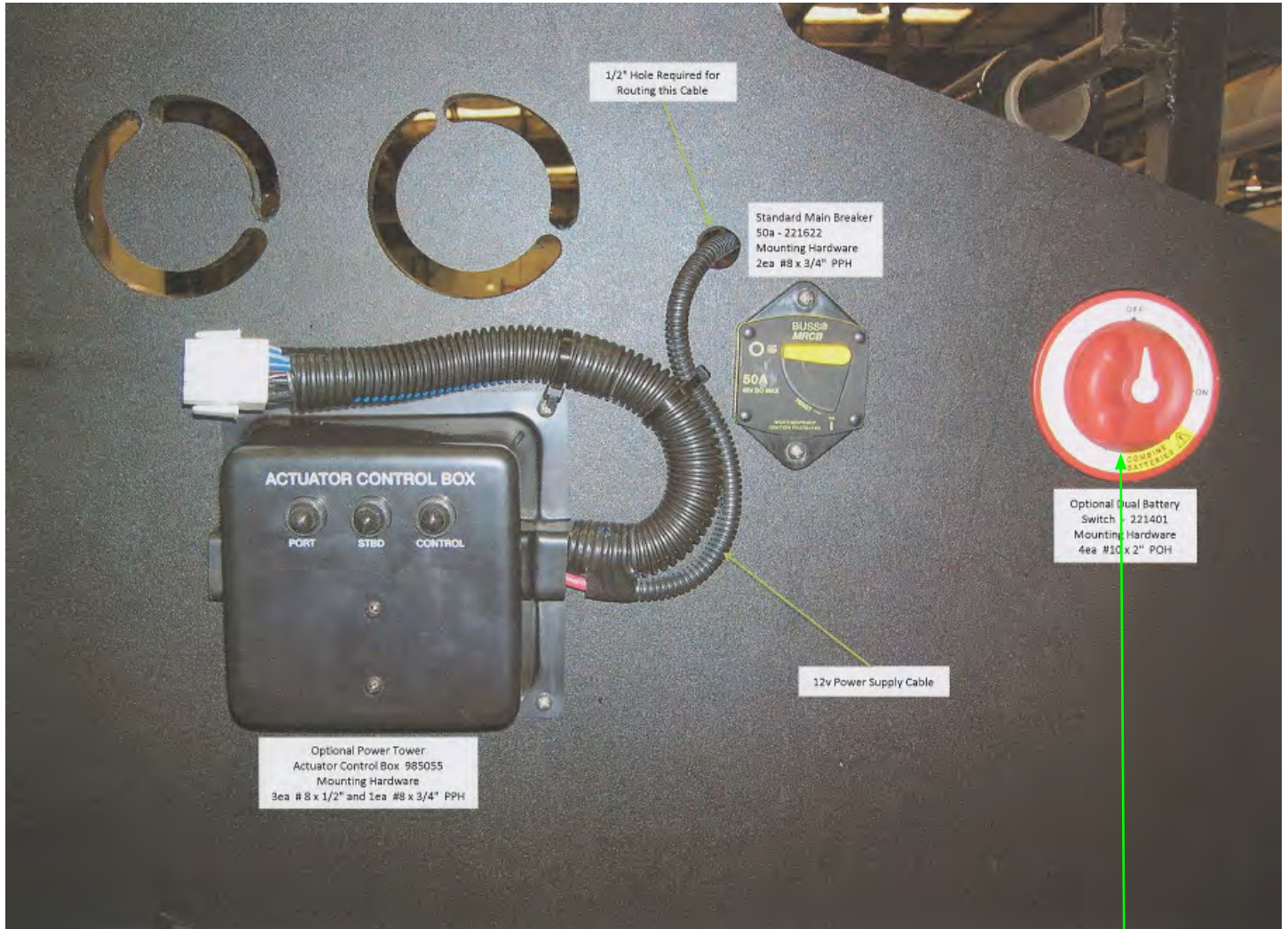

TYPICAL DUAL BATTERY SWITCH SHOWN

Engine Battery- Controls Cranking Engine

House Battery- Dash Main, Dash Breakers/Fuses

Note that the actuator shown above is part of the optional PowerTower and is used in the actuator circuit to drive the tower forward or back to raise or lower it for watersports, low clearances, or land storage.



UNDER HELM FUSE BLOCK

LEFT SIDE

1. NAV/ANCHOR LIGHTS 10 AMP
2. COCKPIT LIGHTS 10 AMP
3. DOCK LIGHTS 15 AMP
4. GARMIN 15 AMP
5. UNDERWATER LIGHTS 10 AMP
6. FRESH WATER 7.5 AMP
7. COCKPIT HEATER 15 AMP

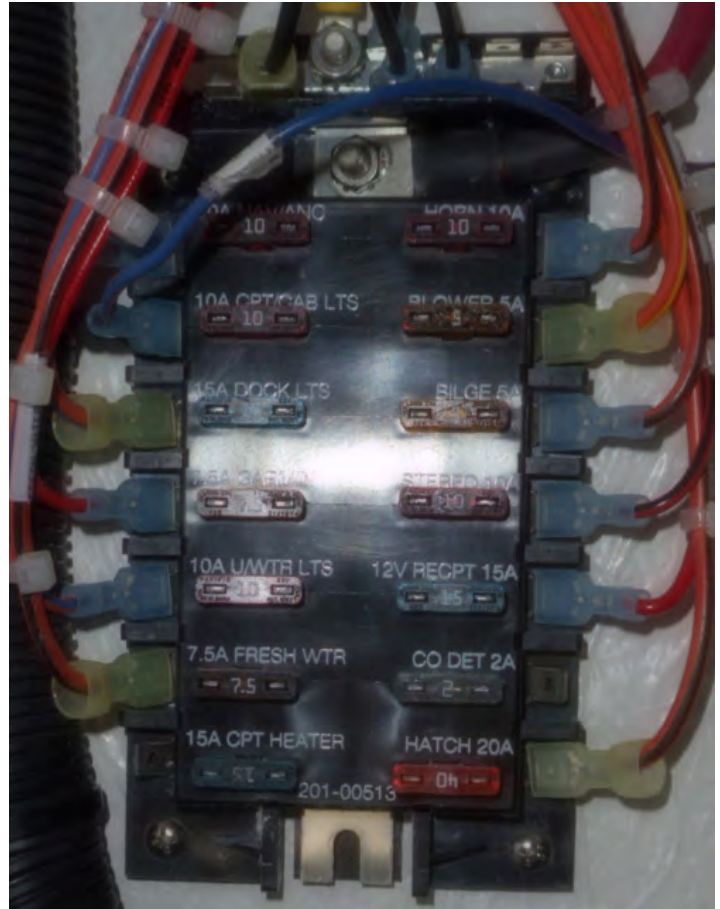

RIGHT SIDE

1. HORN 10 AMP
2. BLOWER 5 AMP
3. BILGE PUMP 5 AMP
4. STEREO 15 AMP
5. 12V DASH RECEPTACLE 15 AMP
6. CO DETECTOR 15 AMP
7. HATCH 20 AMP

Note: A portion of the above system/component fuses may not be found on your vessel since they may be options.



Below are the common breakers that will be “on” or activated when you leave the vessel for extended periods of time with the battery switch off at the bilge located battery switch panel.

1. Bilge pump
2. Stereo memory



WARNING

PREVENT POSSIBLE FIRE/EQUIPMENT
DAMAGE!
NEVER TURN BATTERY SWITCH TO THE “OFF”
POSITION WHILE THE ENGINE IS RUNNING.

NOTICE

AS A SAFETY FEATURE
THE BILGE PUMP CIRCUIT
IS CONTINUOUSLY “ON”
EVEN WITH THE BATTERY SWITCH
IN THE “OFF” POSITION.

Note: As stated above the engine alternator or electronics may be damaged from the current spike created by turning off the battery switch with the engine running.



TYPICAL 12 VOLT HELM SWITCH PANEL



The helm switch panel is controlled by the dash main breaker located on the battery management center panel discussed earlier in this chapter.

The skipper should learn the location of all DC breakers on the vessel and the equipment they protect. For example, a breaker may trip on the sub-panel but may not trip the breaker on the battery management panel. Knowing his breaker location will aid the skipper in troubleshooting problems faster.

Remember, always find why a breaker “blows” before resetting it. Refer to the technical drawing section for additional information.

Note: A portion of the DC circuit protection is provided by the fuse block under the helm as mentioned earlier in this chapter.



TYPICAL 12 VOLT HELM SWITCH PANEL

NAV/ANC.- protects the port and starboard deck navigation and anchor lights.

COCKPIT LTS- activates the LED cockpit lights installed on the deck.

DOCKING LTS.- protects the hull mounted docking light circuitry.

BILGE PUMP- protects the bilge pump circuitry.

BILGE BLOWER- protects the bilge blower that evacuates engine compartment fumes.

HORN- protects the horn circuitry.

TOWER UP & DOWN- controls the PowerTower actuators

UNDERWATER LTS.- protects the transom mounted light (under platform) circuit.

FRESH WATER- protects the pressure fresh water system pump.

HATCH.- protects the engine hatch motor circuitry.

Note: A portion of the helm switch panel protection is for optional items that may not be on board your vessel.



TYPICAL DC (12 VOLT) WIRING COLOR CODE & SIZES		
BLACK	16,14,12,10,8,6,4,2,2/0,40	GROUNDS
BLACK/WHITE	16	HALON INDICATOR
BLACK/YELLOW	10,16	GRD. DIESEL TRANSFER PUMP, MERC DIESEL STOP CIRCUIT
BLACK/WHITE	10	HALON MAIN GRD. FEED
BROWN/BLACK	10	MACERATOR, SUN ROOF
BROWN	10	SUN ROOF
BROWN	14	AFT BILGE PUMP-MANUAL
BROWN/WHITE	14	AFT BILGE PUMP-AUTO
BROWN/RED	14	FWD. BILGE PUMP-AUTO
BROWN/BLUE	14	FWD. BILGE PUMP-MANUAL
BROWN/PINK	16	CO DETECTOR
BROWN/BLACK	16	SHOWER SUMP PUMP
YELLOW	12,10	BLOWER
YELLOW/WHITE	16	HEAD VENT FAN MOTOR
YELLOW/BLACK	16	STEREO MEMORY
YELLOW/RED	14	ENGINE START CIRCUIT

Note: The list above applies to a number of vessels. Vessel components/wiring specifications may vary depending on the model.

TYPICAL DC (12 VOLT) WIRING COLOR CODE & SIZES (CONTINUED)		
ORANGE	10,12	VACUUM TOILET, REFRIGERATOR, HATCH RAM
ORANGE	16	WIPER RUN
ORANGE/WHITE	16	WIPER PARK
ORANGE/BLACK	10,12,16	HORN, HATCH RAM
BLUE	14	INTERIOR LIGHTS, SWITCHED CIRCUIT
BLUE/RED	14	INTERIOR LIGHTS, CONSTANT HOT CIRCUIT
BLUE/BLACK	16	COCKPIT SOFT LIGHTS
BLUE/GREEN	16	INTERIOR SOFT LIGHTS
BLUE	10	CABIN LIGHT MAIN CIRCUIT FEED
GRAY	14	NAVIGATION LIGHTS, RUN- NING, BOW, TRANSOM LIGHTS
GRAY/BLACK	14	NAVIGATION LIGHTS, AFT AN- CHOR, MASTHEAD
GRAY/WHITE	14	NAVIGATION LIGHTS, MAST- HEAD, FWD. RUNNING LIGHTS
RED	16	POSITIVE FEED- ELECTRON- ICS, GAS VAPOR DETECTOR, BREAKER TO DASH SWITCH FEEDS

Note: The list above applies to a number of vessels. Vessel components/wiring may vary depending on the model.



TYPICAL DC (12 VOLT) WIRING COLOR CODE & SIZES (CONTINUED)		
RED/WHITE	16	WINDLASS CONTROL-DOWN
RED/BLACK	16	WINDLASS CONTROL-UP
RED/WHITE	14	BATTERY PARALLEL-LOAD
RED	14	POSITIVE FEED-ELECTRONICS
RED	12	POSITIVE FEED-ELECTRONICS
RED	10	POSITIVE FEED-AUTO PILOT
RED/VIOLET	10	FUEL TANK TRANSFER PUMP AMPLIFIER POWER
RED	8	POSITIVE FEED- MAIN ALTERNATOR CHARGE
RED	6	POSITIVE FEED- MAIN ALTERNATOR CHARGE
RED	4	POSITIVE FEED-MAIN
RED	2	POSITIVE FEED- MAIN STARTER, BATTERY, GENERATOR
RED	2/0	POSITIVE FEED- MAIN, STARTER, BATTERY
PURPLE	16	STBD.IGNITION, HOUR METER- WINDSHIELD VENT
PURPLE/WHITE	16	PORT IGNITION, HOUR METER, WINDSHIELD VENT
PINK	16	STBD. FUEL TANK SENDER
PINK/BLACK	16	PORT FUEL TANK SENDER
TAN/BLUE	16	ENGINE ALARM CIRCUIT
GREEN	16	TANK LEVEL MONITOR, SPOT- LIGHT
GREEN	10	SPOTLIGHT
GREEN	8	BONDING

Note: The list above applies to a number of vessels. Vessel components/wiring may vary depending on the model.



TYPICAL FRESH (POTABLE) WATER SYSTEM

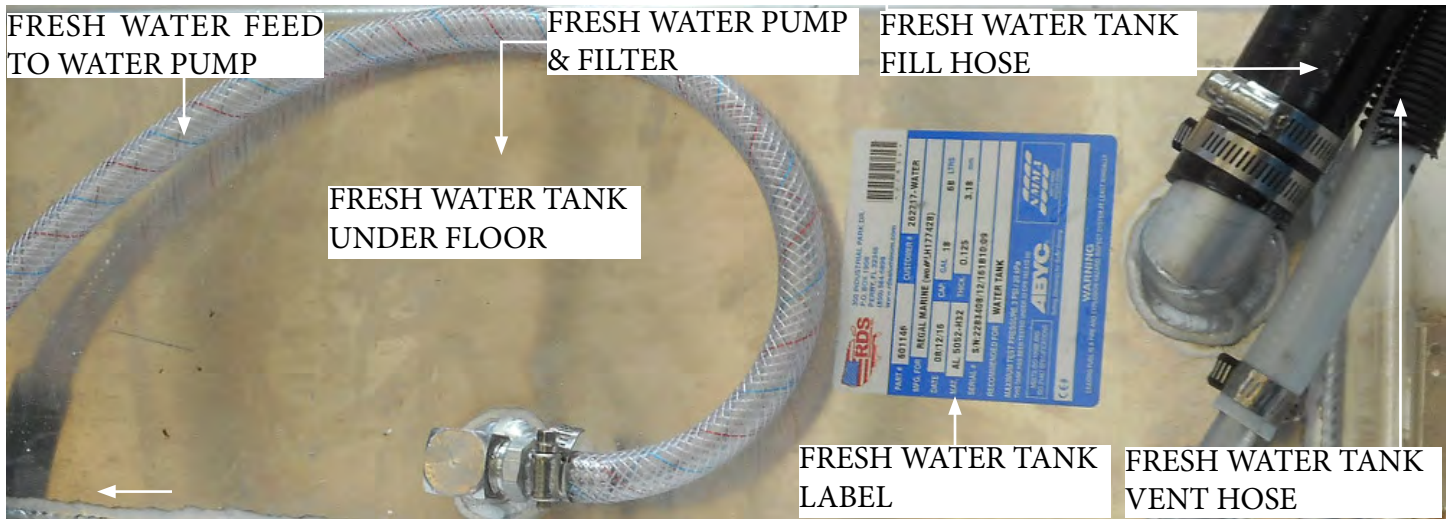

Your vessel is equipped with a fresh water supply system. It consists of a fresh water tank, deck fill/vent fittings, pressure water pump with filter, and distribution system. As needed the pressure demand type pump is energized, water is drawn through the potable water tank.

The system is winterized from the factory utilizing a product called “Freeze Ban”. It is best to completely drain the Freeze Ban before adding any water to the tank in order to minimize the taste of Freeze Ban. Freeze Ban will not harm you but it does have a peculiar taste.

The system requires little maintenance except occasional flushing and disinfecting the system, cleaning of the water filter and winterizing in cold weather climates.

For more specific information on the water system contact your closest Regal dealer.

The fresh water system, also known as the potable water system uses a tank to distribute water on board.

Note: that the system can be filled using the foredeck water fill.

There are special white hoses for potable water system filling that are odorless. Before filling potable water tank disinfect entire fresh water system. Use the Public Health Service Publication information outlined in Chapter 10.

Filling Water Tank At the Deck Fill

Fill with a clean water system approved hose until you see water emerging from the deck vent. Reinstall the fill cap and tighten it securely.



Periodically check the water fill cap for tightness. Tighten the cap until the 2 blue dots line up. On the underside of the water fill cap is an “O ring” which helps to seal the cap properly. The “O ring” should fit

tightly around the cap. If it is loose, cracked or damaged replace it since it helps to keep debris out of the water system.



Using Fresh Water (Potable) System

1. Verify that the dockside water is pure and safe to use.
2. Fill the fresh water tank using the deck fill labeled water until water is seen at the water internal deck fill vent.
3. At the helm switch panel activate the fresh water system breaker. This will energize the water pressure pump to send fresh water from the potable water tank through the cold water lines terminating at the various faucets and related components.
4. Open a faucet. Water pressure should be present. Opening the faucet for a few seconds will purge any air in the system especially in cases where the fresh water tank has run out of water. When water is running at a faucet it is not unusual to hear the water pump activate as it is trying to build up the pressure required in the system. Soon after the faucet is turned off the fresh water pump sound will end indicating the fresh water system is now up to specified system pressure.

Note: If the fresh water pressure pump continues to run long after the faucets are deactivated check for fresh water system leaks.

Note: Do not run pressure water pump with system dry as water pump component damage will occur.



Fresh Water Pressure Pump

In theory the fresh water pump system provides water pressure when dockside water is not available or used. Once energized the pump is automatic. It will shut down once system pressure has built up and will automatically start after a faucet is opened. The fresh water pump and filter are normally located in the engine sump area.

The fresh water pressure pump features a removable strainer basket filter which collects any debris which has entered the fresh water system. The clear strainer cover highlights any debris.

To clean the basket make sure the pressure water pump is off at the ship's DC control panel. Unscrew the clear cover to access the strainer basket. Remove the strainer basket, clean, rinse with fresh water and reinstall basket and cover. Do not overtighten or use tools. Turn on the pressure pump breaker and check for leaks.

For general knowledge a special reinforced fabricated hose is used to feed the fresh water pressure pump. The design prevents hose kinks.

Note: It is recommended that the fresh water pressure pump breaker be flipped to the "off" position when leaving your boat to help prevent damage should a leak develop in the cold water system.

Note: In freezing climates make sure the fresh water system is winterized to prevent damage to hoses and components. Contact your Regal dealer since only special alcohol based products like "Winterban" are to be used in the system.

Never use automotive type antifreeze since it is poisonous to the human body.





POSSIBLE PROBLEMS/SOLUTIONS- FRESH WATER SYSTEM



1. Fresh water pressure pump cycles on and off. Normally this type of action indicates a water leak in the system. Check all fresh water system related equipment on the deck, head, and engine compartment for leaks. Do not forget wash down equipment including spigots. Look for puddled or dripping water.
2. Using potable water system the water pressure is weak. Check the fresh water pressure pump filter for debris.
3. Water at sink faucet is hammering and has air bubbles in it. Check for air leaks in the system along with low water levels in the potable water tank.
5. There is no water at any of the fresh water related equipment. Check to make sure the fresh water pressure pump breaker is energized. Also, check the fresh water monitor for tank levels at the salon monitor panel.
6. The water system has a bad odor. Use the fresh water pressure pump to drain the fresh water system. Do not drink the water as it may be contaminated. Sanitize the water system as explained in this manual.



TYPICAL WASTE SYSTEM

CHEMICAL TOILET

Installed as standard equipment on your vessel is a self-contained sanitation device known as a chemical toilet featuring an upper fresh water tank and a lower deodorized tank. These two components can be separated for waste disposal, cleaning and refilling. The lower tank contains a capacity gauge. Before each outing, check the waste level since it is illegal to dump waste within and extending out to the United States territorial limit. For more information, review the vendor manual supplied in the owner's information packet or visit the vendor on-line location.

TYPICAL CHEMICAL TOILET

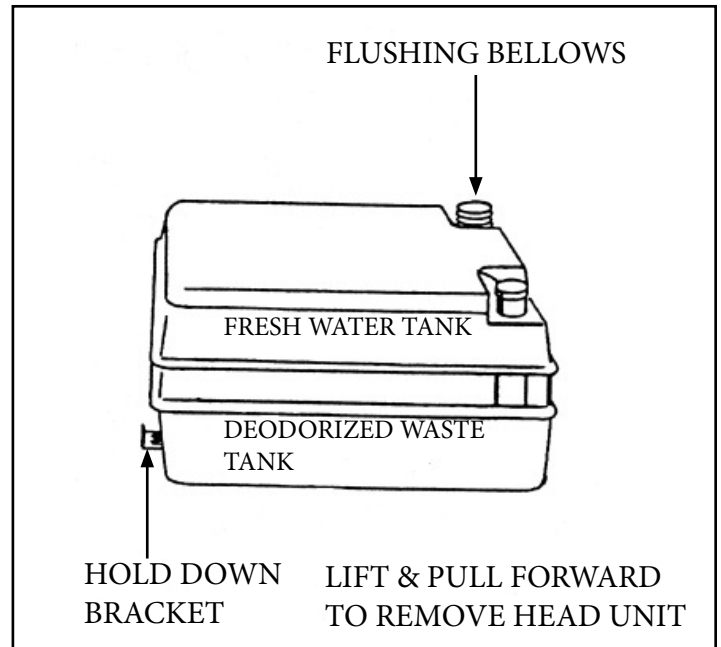

TYPICAL HEAD OVERVIEW WITH CHEMICAL TOILET





Typical Electric Toilet System-(Optional)

The optional on-board electric head system features a toilet taking advantage of minimal water usage. The system features a vitreous china bowl, minimal maintenance, easy cleaning and a wall switch keyboard. The toilet is powered by 12 volt DC electricity and is controlled by a 30 amp breaker located at the ship's main DC control panel.

Under normal conditions, the head system operates from the onboard fresh water tank. If dockside water is being used the toilets still draw water from the freshwater tank. The head breaker is located on the battery management where the battery switch is mounted. See the illustration.

A Few Notations About The Head System:

- Only human waste and toilet paper should be put in the toilet. Never flush foreign materials such as paper towels, pre-moistened wipes, condoms, feminine hygiene products, dental floss or household garbage down the toilet.
- Always disconnect the dockside water system if boat is left unattended to avoid property damage due to leakage.
- Refill the toilet as soon as possible after emptying the bowl to prevent objectionable odors.
- Use only RV-Marine toilet tissues that disintegrate rapidly. Do not use household type tissues.
- If repairs are needed, use only a trained and qualified marine technician or electrician.

Using Electric Vacuum Style Toilet

To use the optional on board toilet first make sure the 12 volt head system breaker is activated at the battery management panel. The wall control switch is used to add water to the bowl and to flush the toilet. Select cycle information is noted below. For more complete information, refer to the toilet vendor information.

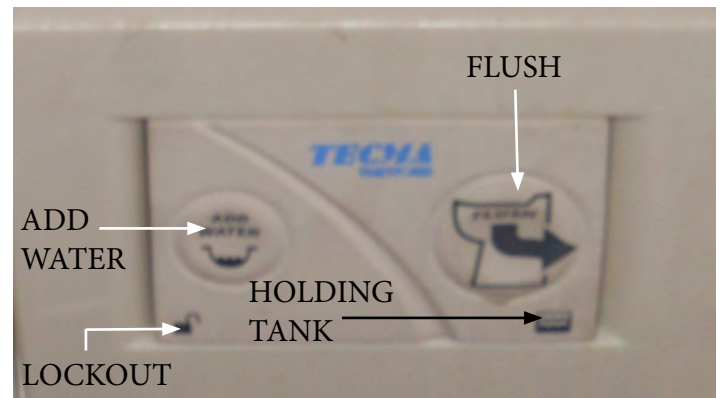

TYPICAL WALL SWITCH

1. To add water (est. 17 ounces each cycle) to the bowl press the add water button momentarily and release. The system prevents overfilling the bowl.
2. To flush the bowl press the flush button momentarily and release. The attached bowl motor will macerate the waste and flush it. The cycle ends with a small amount of water being added to the bowl to help prevent odors. This completes the minimal water usage flush cycle.



Wall Control Panel Blue Backlighting Description:

- The holding tank icon in the lower right hand corner of the control panel is not lighted. Toilet system is off or not receiving power.
- The holding tank icon is normally green. This means the holding tank is less than full.
- The holding tank icon is red. The holding tank is full or near full with the flush lockout (prevents Flush operation when holding tank is full) activated.
- Tank icon flashes
- Sleep mode (non-use for 8 hours) causes the lights to go out. Pushing the fill or flush button momentarily will return lighting cycle.

Single Flush Override of Flush Lockout

1. If the holding tank is full the flush lockout cycle will not allow the bowl to be flushed and the flush button will be lighted red.
2. For emergency use only the flush button can be held for 8 seconds and a flush will occur. This can be accomplished because the full sensor connected to the holding tank is usually placed a bit below the actual full capacity of the tank. Flushing more than 5 times using the override feature may force waste into plumbing system. Regal is not responsible for damage to equipment, or injury or death due to overflow of waste due when flush lockout is overridden. Again, refer to toilet vendor information in the owner's information packet.

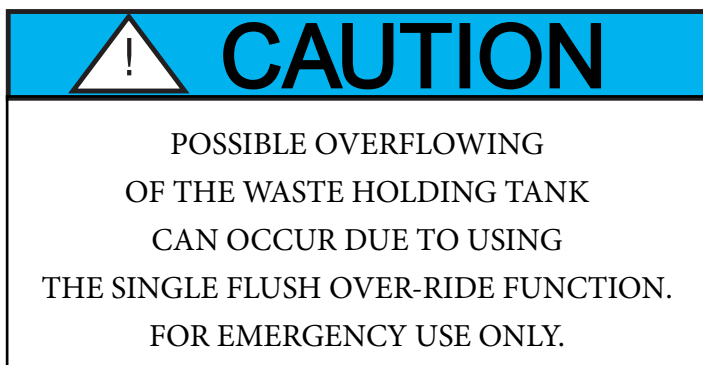



TYPICAL WASTE WATER SYSTEM (OPTIONAL ELECTRIC HEAD ONLY)

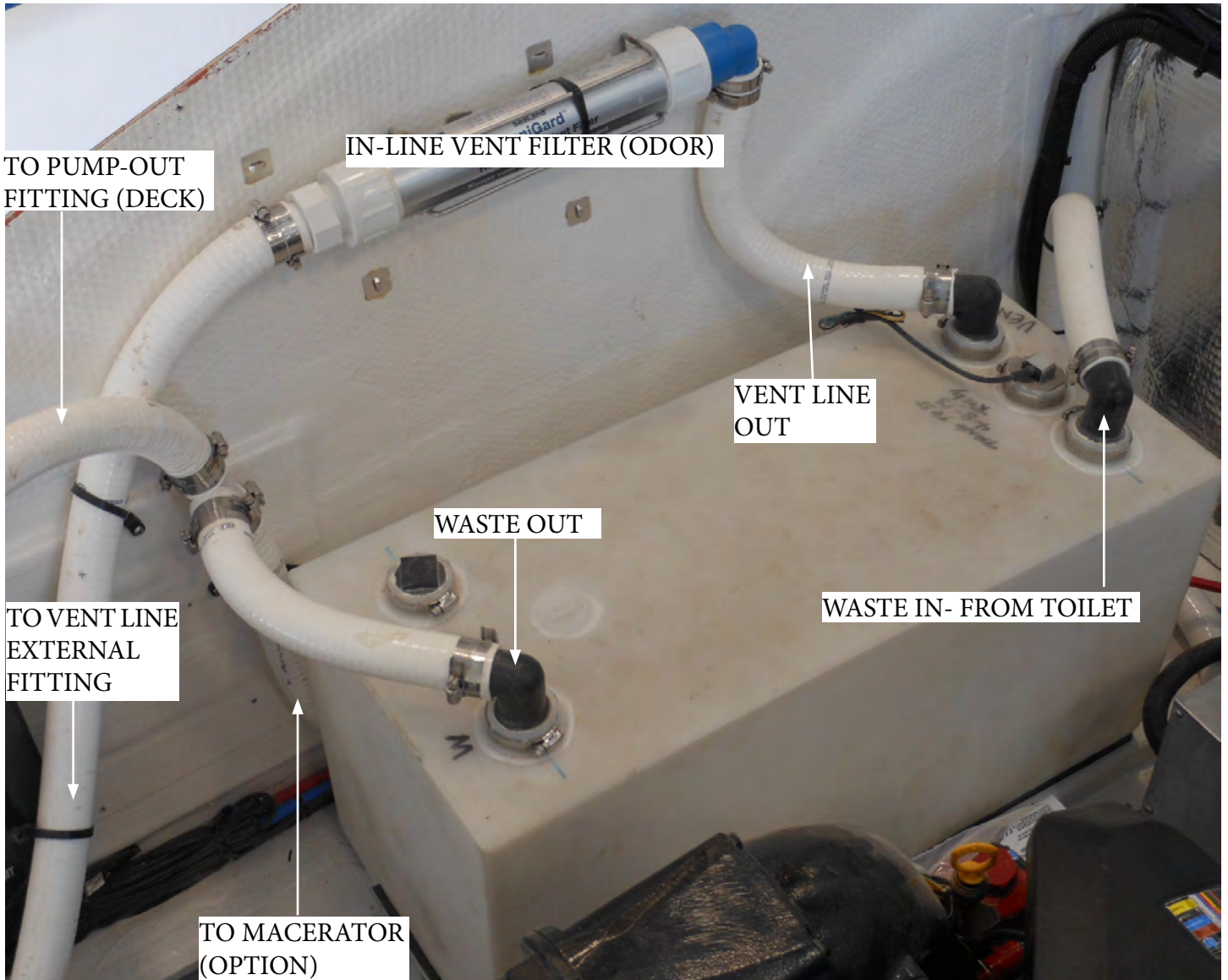

TYPICAL WASTE WATER SYSTEM

Overview

The waste water system on your boat may include a waste tank located in the engine room. Besides the tank the system may include a waste pump-out fitting on the deck. A monitor panel system displays the waste tank level when activated.

If installed, a macerator (overboard discharge pump) diverts waste through a hull bottom seacock (where dumping laws permit).

TYPICAL WASTE TANK HOSE FUNCTIONS	
EQUIPMENT	FUNCTION
Pump Out	To Pump Out Deck Fitting
Vent	To In-Line Vent Filter
Waste-In	From Head
Overboard Discharge	To Macerator (Overboard Discharge Pump) with seacock



Typical Dockside Pump-Out



An optional fitting may be located on the deck labeled “waste.” This fitting is used to pump out the waste tank. Normally a pump out station is found at most marinas. After removing the fitting cover a special hose is inserted into the fitting and the machine then removes the waste. Normally there is a charge for the service. Make sure they connect the hose to the “waste” fitting. Of course when cruising in international waters the overboard discharge pump may be used if installed. See the section on using the macerator.

Typical In-Line Vent Filter



As stated earlier there is a waste filter installed in the vent line between the waste tank and the port thru-hull fitting (see photo. The filter’s purpose is to keep objectionable odors to a minimum from the waste tank. It is recommended that the filter be changed yearly. It can be ordered from your Regal dealer or from marine supply stores. The waste filter is mounted in the sump (engine compartment) near the waste tank.



Typical Macerator (Overboard Discharge Pump)



The macerator (overboard discharge pump) option is located in the engine room. It is connected to a normally closed seacock. In locals where it is approved the seacock is opened and

the macerator is activated through a key switch and button located at the ship's main salon control panel (shown above). At that point waste travels from the waste holding tank through the macerator pump where it is ground up and then exits through the hull bottom at the open seacock. See the photo.

To Use Macerator (If Installed):

- Make sure it is legal to pump waste overboard before starting the operation.
- Locate the overboard discharge seacock in the engine room. Usually this seacock can be identified by the stack of tie wraps next to it. Also, look for the incoming hose that runs from the output side of the macerator to the seacock. It is normally a 1 1/2" diameter white hose. Since the seacock by law must have another means besides the handle to keep it closed. The tie wrap serves that need. Cut the tie wrap to access the seacock handle.

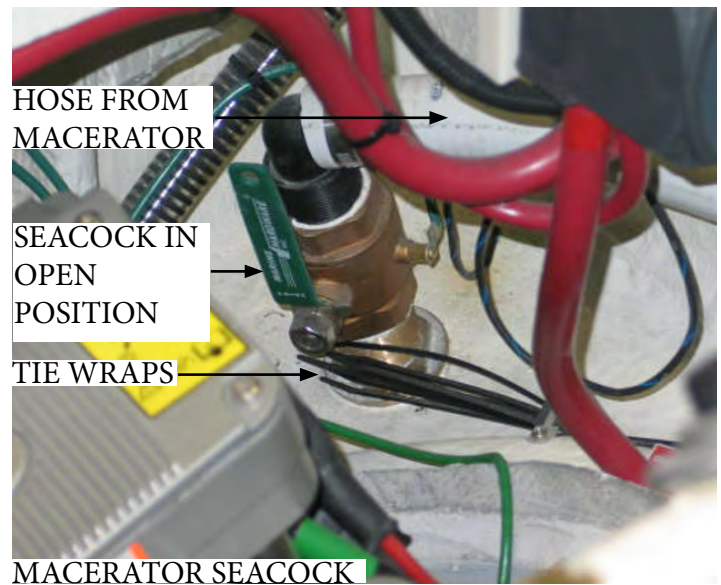

- Turn the seacock handle to the "open" position. It should be positioned in line as shown in the photo.
- Activate the macerator breaker at the 12 volt salon main DC control panel.
- At the level monitor panel shown above turn the key to the "on" position. With the key switch being held in the "on" position push in on the macerator button to start the overboard discharge. Continue to discharge the waste until the monitor panel shows empty for the waste tank. At this point, shut off the macerator switch, deactivate key switch and turn macerator breaker to the "off" position.
- Close the seacock handle. It should now be at a 90 degree angle to the seacock.
- Use a tie wrap and refasten the seacock handle tightly so it can not be moved.
- At this point you may desire to add an approved holding tank deodorant by flushing the recommended amount down the toilet.

Outboard vessels normally install the macerator in the aft storage compartment.



POSSIBLE PROBLEMS/SOLUTIONS-WASTE SYSTEM

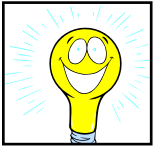

1. Toilet does not flush or flushing performance is poor. The holding tank indicator is lighted red at the toilet control panel wall switch. The holding tank is full and needs to be pumped out. Also, there could be a clog at the water pump inlet.
2. No water in bowl during flush or add water cycle. Check to make sure the main water supply has not been turned off along with the fresh water pressure pump.
3. There is no light on the toilet wall control panel or it does not stay lighted. Check the head breaker at the battery switch panel. Also, the wall panel could of entered the Sleep mode cycle after 8 hours of inactivity.
4. There is an odor of sewage onboard. Check the vent filter. It should be replaced annually at the beginning of the boating season. Also, check the waste tank, fittings,, clamps, and related hoses throughout the vessel.
5. When running the overboard discharge pump it is not pumping out the waste. Check to make sure the deck waste cap is securely fastened and O ring is not missing (Air in system).



TYPICAL WASTE SYSTEM-VACUUM STYLE MODELS

1. Toilet Bowl
2. Solenoid Valve
3. Fresh Water Pressure Pump
4. System Vent
5. Holding Tank
6. Fresh Water Tank (System can also run from dock-side water supply)

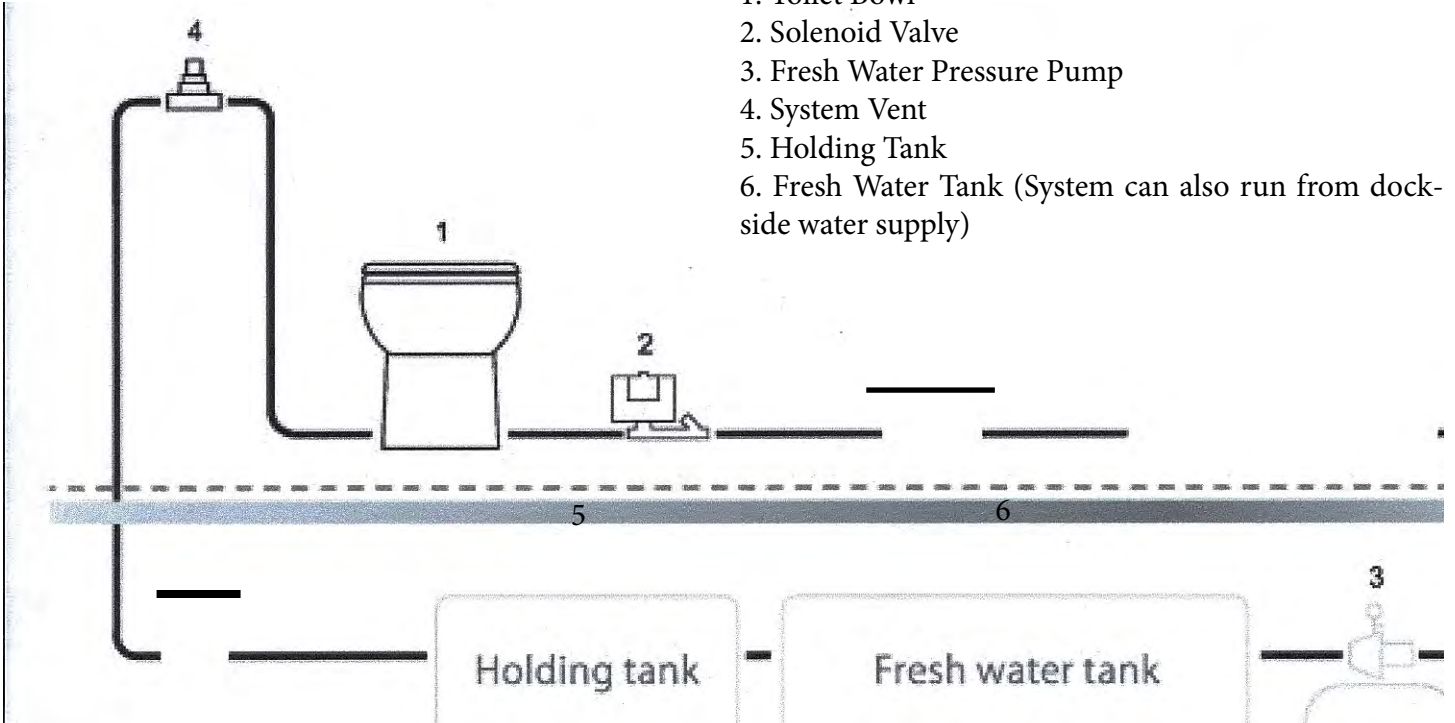



TRIM TABS

If installed, trim tabs would be located on the lower hull at the transom area. Water is deflected and redirected as the trim tabs are raised and lowered from the dash switches. This change in water flow creates upper pressure under the tabs, and raises the stern. When the stern rises, the bow is lowered. Lowering the port tab will cause the port stern to rise, making the starboard bow lower. Lowering the starboard tab will cause the starboard stern to rise, making the port bow lower.



TRIM TAB DASH SWITCH



Obtaining A Trimmed Position

Your boat reaches a planing position at a designated speed. This speed is determined by bottom design, weight distribution, water conditions, and on board equipment. As the throttle is advanced the stern squats and the bow rises initially. The trim tabs allow your boat to plane at a slower speed than natural conditions allow.

In short bursts both trim tab rocker switches are pushed simultaneously in the “bow down” position which causes the trim tabs to move down. As the boat breaks over the bow high attitude the boat speed accelerates and visibility increases.

If the boat is over trimmed, it will plow the bow and the boat will lose maneuverability. If this occurs, simply short burst the “bow up” trim tab rocker switches simultaneously.

In the “learning curve” process, press the tab switches in half second bursts. You will notice a slight delay from the time the switches are pushed until the boat reacts depending on vessel speed. You will know after awhile the optimum planing angle and speed.

When running in heavy seas press the “bow down” position which will assist the vessel to cut through the waves. This will produce a drier and more comfortable ride.

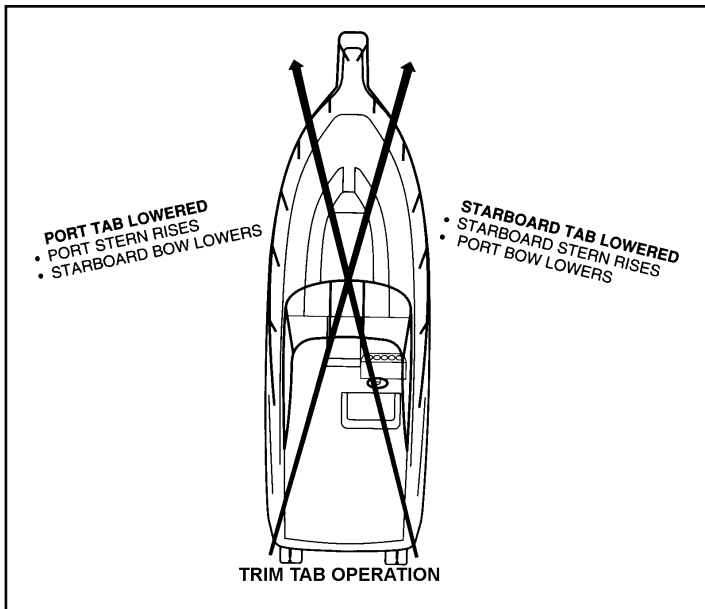

Using trim tabs will compensate for uneven weight distribution, listing, water conditions, wind velocity and other factors that cause inefficient operation.

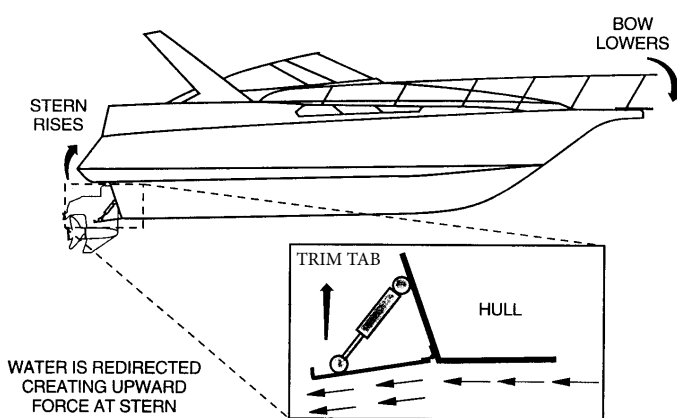



When trimmed or in the bow down position, the bow spray is farther forward, the wake is smaller, and positioned further behind the vessel. Also, when trimmed you will notice that the tachometers show an increase in rpm's.

Rectifying A List

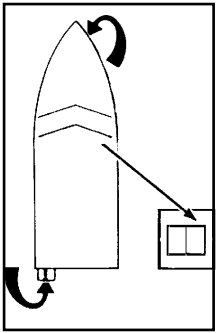

Your vessel can use the trim tabs to rectify a list. The trim tabs adjust the boat's attitude in the direction the helm rocker switch is pushed.

If the port bow is high, push the left-hand "bow down" direction on the dash rocker and the port bow will lower. If the starboard bow is high, push the right-hand "bow down" direction and the starboard bow is

lowered.

Porpoising

Porpoising is a running condition where the bow "bounces" up and down similar to a porpoise motion. Press "bow down" in one-half second bursts. As the trim tabs turn, the porpoising should recede and the vessel speed should increase. Only a small amount of "bow down" is normally necessary to make this change.

Trim Tab Pump



The trim tab pump is located in the bilge. It supplies a special hydraulic fluid to the transom based trim tab cylinders which move up and down with the rocker switches to operate the actual trim tab plates attached to the cylinders at the transom.

Periodically check the pump level. Fill with specified fluids as notated in the vendor trim tab

information. Also, check hose for leaks and ensure all connections are tight.



STEREO-TYPICAL



The stereo is located at the helm. The unit features an undock and bluetooth technology compatible for different brands of cell phones.. See photo above.

An iPod features several adapters to cover an array of earlier and later vintage iPods currently in the marketplace.

Stereo over current protection is located on the fuse block behind the helm. For further information refer to the vendor manual located in the owner's information packet or search the Goggle under FUSION as a key word.

Note: Most modern electronic devices such as smartphones and tablets have a limited operating temperature range and smartphones are optimized to operate in a narrower temperature range than MP3 devices. All electronic devices generate heat during normal day-to-day use and to reduce temperature while they are being used may stop charging, the device may display a temperature warning, and eventually may shut down if the operating temperature exceeds its specified limits.

If you are in an environment where there is a high ambient temperature and the device shuts down while inside the unit, remove it and let it cool down.



TYPICAL FUSION 650 AND 750 STEREO OVERVIEW

Both stereo units mentioned above are used in our vessels. Many of the component related operations are identical in both stereo models. Please refer to the individual stereo vendor owner's manuals and the technical section (schematics) for further entertainment system information along with the internet where further technical data and updates are available. Note that the information below shows a typical stereo similar to the current production model.

MS-IP700

Before inserting your iPod or iPhone into the MS-IP700 you must first insert the correct sleeves to match the iPod or iPhone model. For the iPod nano (6th gen), the iPod must be placed inside the adaptor sleeve, and then placed inside Dock sleeve combination A + B

MS-AV700

Connect your iPod or iPhone via the standard Apple sync cable at the rear of the unit for connectivity. MS-DKIPUSB Portable Media Device Dock will connect to the MS-AV700 stereo and provide iPod or iPhone integration (Refer to the MS-DKIPUSB user manual for iPod/iPhone sleeve combinations and compatibility).

BEFORE INSERTING iPod or iPhone:

- Please ensure iPod dock connector is clean, dry & free from damage.
- Check that unit iPod dock is free from obstructions.
- Insert correct sleeve combination to match your iPod or iPhone
- Never insert an iPod or iPhone without the correct sleeve.
- Ensure your iPod or iPhone is inserted with display facing upwards, Never force your iPod or iPhone into the dock, if the unit does not mate with reasonable ease the sleeve/iPod combination is most likely incorrect.

SELECTING THE CORRECT iPod SLEEVE

(MS-IP700) A different set of sleeves is used for each iPod or iPhone model. The different sleeve combinations are outlined in the chart below:

iPod Model	Top Sleeve	Bottom Sleeve
iPod touch 2nd gen	D	D
iPod touch 3rd gen	D	A
iPod touch 4th gen	D	D
iPod nano 4th gen	E	D
iPod nano 5th gen	G	G
iPod nano 6th gen	A	B + Adaptor
iPod classic, 80GB	B	A
iPod classic, 160GB (2007)	B	B
iPod classic, 120GB	B	A
iPod classic, 160GB (2009)	B	A

iPhone Model		
iPhone 4	A	D
iPhone 3GS	F	F
iPhone 3G	F	F



USER INTERFACE AND CONTROLS

CONTROL PANEL LAYOUT



BUTTON DESCRIPTION



Menu



Tuner source



Auxiliary

PRIMARY SOURCE	
MS-IP700i	MS-AV700i
iPod	DVD



Rewind



Play/Pause



Forward



Power



Mute



Clock



Brightness





ROTARY ENCODER AND MENU KEY

Although the controls of the 700 Series are designed to be intuitive to use, we recommend that you familiarize yourself with the operation of the Encoder and Menu key before using the unit.



ROTARY ENCODER OPERATION

The Encoder can be used in three ways to control the operation of the 700 Series:

1		Rotary Encoder turn
2		Encoder press
3		Encoder press and hold down for at least one second

MENU KEY OPERATION

You can use the Menu key to open or to exit from menus:

	Menu key	Press the Menu key to open a menu.
	Menu exit	<p>In an open menu you can use the Menu key at any time to save changes and exit:</p> <ul style="list-style-type: none">• Press the Menu to exit from the current menu level or control screen.• Press and hold down the Menu key to exit from the menu completely. Or press any other key. <p>Time out feature: After 10 seconds of inactivity, the menu exits and any changes are saved automatically.</p>



USING THE ROTARY ENCODER AND MENU KEY

You can use the Rotary Encoder and Menu key to adjust levels, access menus and open control screens.

Adjusting levels

Use the Encoder and Menu key to adjust levels on the 700 Series. For example, to adjust the volume level:

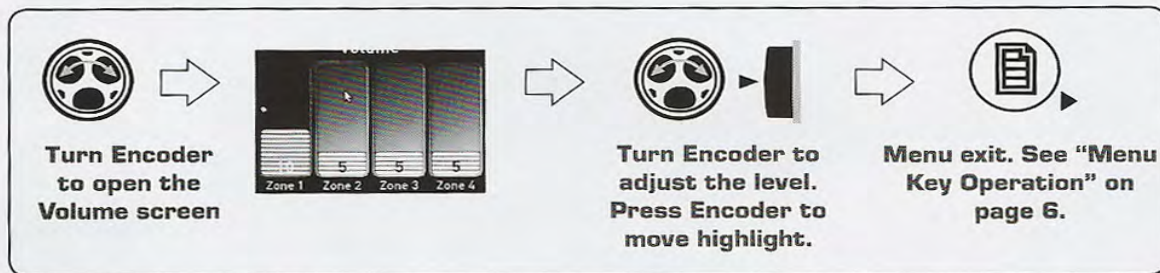

Accessing Menus

Use the Menu key and Encoder to access menus to change settings. For example, to access the Settings menu:

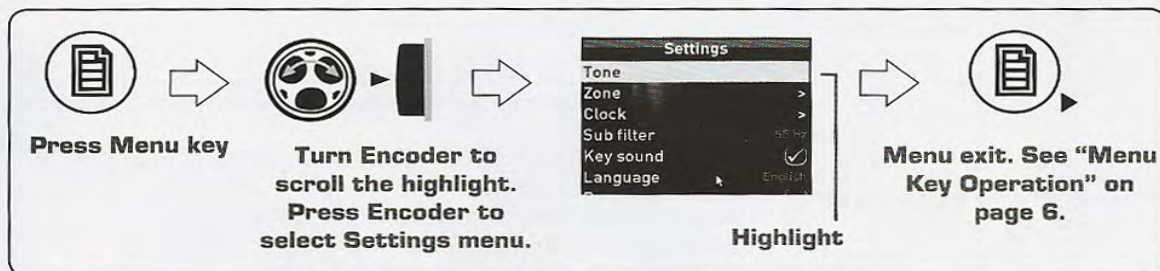



Opening Control Screens

Use the Encoder to open the Sub Level and Tone control screens to adjust levels:

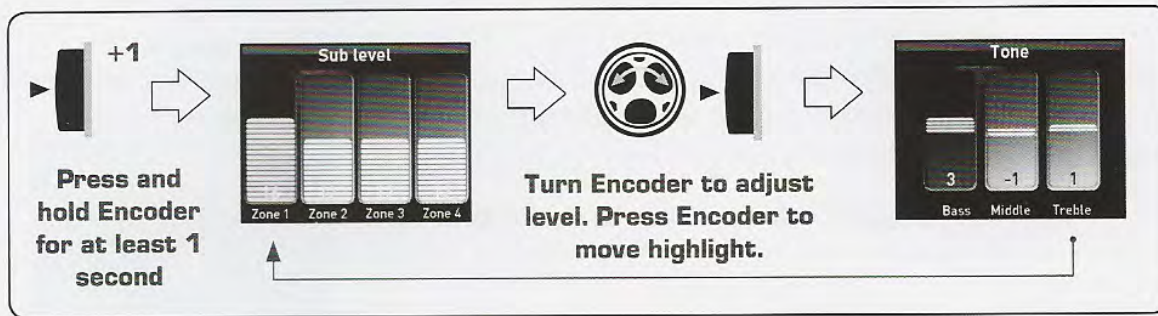

GETTING STARTED

POWERING THE UNIT ON OR OFF

When you power on the 700 Series it will automatically start playing music from the most recently selected input source.

To power the unit on or off.

 Power	<ul style="list-style-type: none">• Momentarily press the Power key to power on the unit. As the unit starts up, a splash screen is displayed for several seconds, followed by the current input source.• When the unit is on, momentarily press the Power key to power off the unit.
---	--

INPUT SOURCE SCREENS

The 700 Series supports a wide range of input source types, depending on model:

- **MS-IP700i** AM/FM/VHF/SiriusXM; iPod/iPhone via internal dock; USB and iPod/iPhone via external dock or cable; auxiliary.
- **MS-AV700i** AM/FM/VHF/SiriusXM; CD/DVD; USB and iPod/iPhone via external dock or cable; auxiliary.



Both models are also SiriusXM-Ready (USA only) requires optional SiriusXM Connect Vehicle Tuner. For further details of setting up SiriusXM options see "SiriusXM Satellite Radio" on page 49.

When you select one of these sources, the 700 Series displays a source screen, similar to the AM source screen shown in Figure 1 below. The title bar always shows the current time and source name. Other information varies depending on the source type you have selected.

Figure 1 – Example source screen (AM input selected)

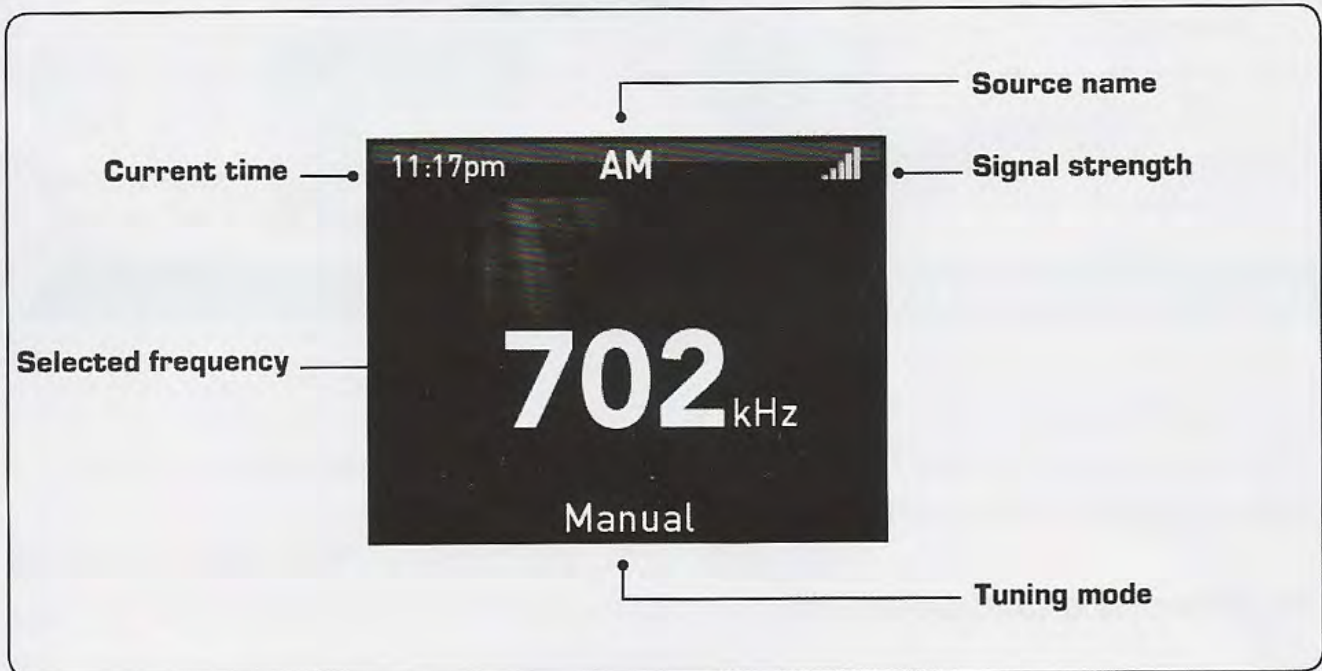

ADJUSTING VOLUME LEVEL

The 700 Series allows you to control speaker output volume level in up to four named areas called Zones. Note: Zone 3 and 4 require additional amplification.

If you wish, you can customize the settings for each Zone by defining a volume limit, a balance setting, a sub-woofer level and a personalized name (such as "Saloon" or "Galley"). For further details see "Zones" on page 40.



To adjust the volume level:

1. Turn the Encoder.
 - The Volume screen is displayed with the Current Zone Selection Highlighted (remembered from previous use).
 - The volume is adjusted in the highlighted Zone (or Zones) only.

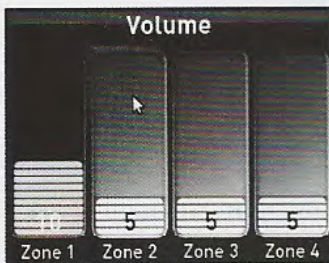

2. If required, press the Encoder to highlight the next Zone to adjust its volume level.

While the Volume screen is displayed, each press of the Encoder will highlight available Zones in the following order:

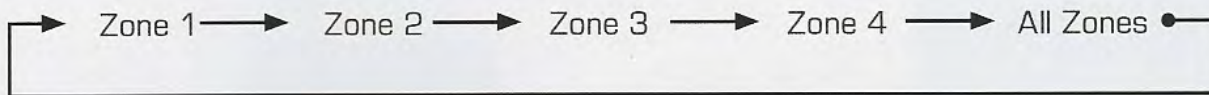

3. When finished, press the Menu key (or leave to time out) to save the current volume level and exit.

MUTING OUTPUT

To mute and unmute the volume:



Mute

- Press the Mute key to mute the audio output. The Mute icon is displayed over the top of the current input source screen.
- Press the Mute key again to unmute the audio output. The volume continues at the previously set level.





iPod

PLAYING CONTENT

Before you can use your iPod as an input source you must first connect the device to the 700 Series. For further details, see “Preparing for iPod or USB Input” on page 43.

To listen to input from your iPod:

MS-IP700i	 iPod	<ul style="list-style-type: none"> • Press the iPod key. The iPod input source screen is displayed. The most recently selected track starts playing at the current play point. • To appear on the iPod source screen the iPod may either be inserted into the internal dock or connected to the external USB connector.
MS-AV700i	 Auxiliary	<ul style="list-style-type: none"> • Press the Auxiliary key. Keep pressing the key until the iPod source screen is displayed.

iPod SOURCE SCREEN

An example of a typical iPod input source screen is shown in Figure 4 below.

Figure 4 – Example iPod input source screen





CONTROLLING iPod PLAYBACK

Selecting tracks from a playlist



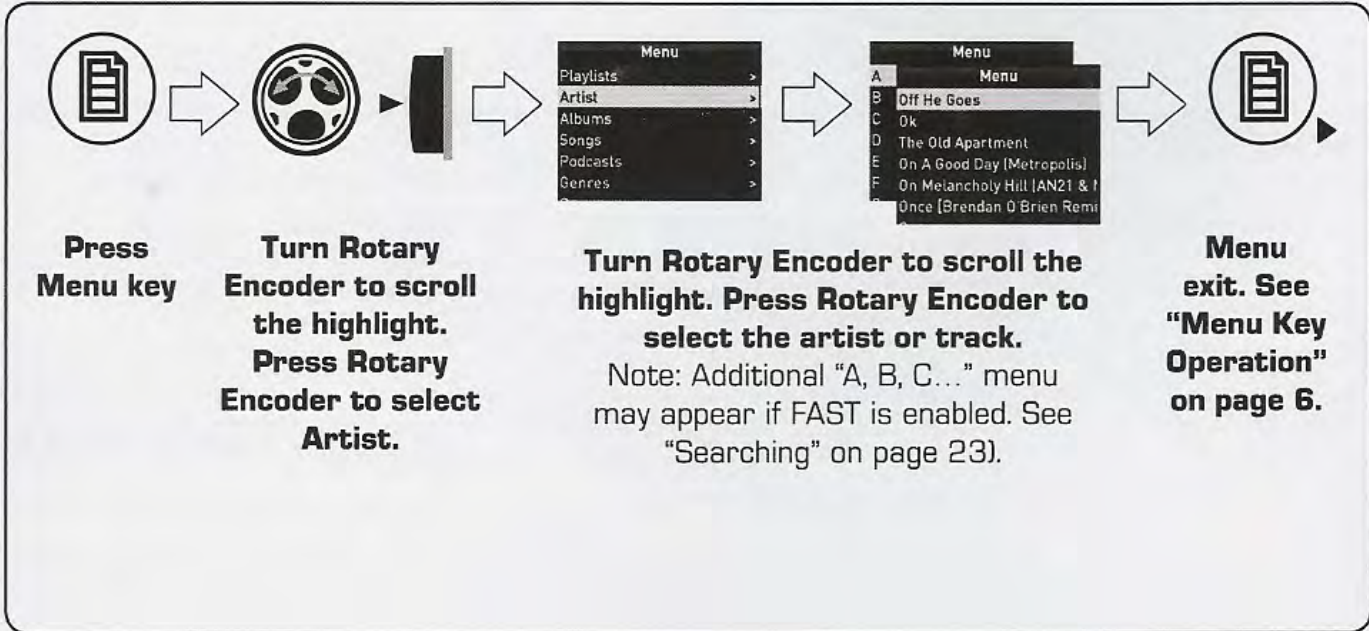





There can be thousands of tracks stored on an iPod, so you need to select the tracks you wish to play from one of the groupings available (such as Playlists, Artists, Albums). For example, to select tracks by artist:





Controlling Playback

You can control iPod playback with the Play / Pause, Forward and Rewind keys. The selected track starts playing automatically.

If you want to:	Use:	Notes:
Play / Pause a track	 Play / Pause	<ul style="list-style-type: none">• Press the key to pause the current track. The pause icon () is displayed top right in the input source screen.• Press the key again to resume play. The play () icon is displayed in the input source screen.
Skip to next track	 Forward	<ul style="list-style-type: none">• Press the key to skip to the start of the next track.
	 Rewind	<ul style="list-style-type: none">• Press the key to skip to the start of the current track.• Press the key twice to skip to the start of the previous track.
Fast forward / rewind	  Forward, or Rewind	<ul style="list-style-type: none">• Press and hold down the key to fast forward (or Rewind) the playback. The fast forward () (or Rewind) icon is displayed in the input source screen.



Subtitles

- **Off.** Subtitles are not displayed when the iPod is playing video
- **Subtitles.** Subtitles are displayed
- **Closed caption.** Provides additional information about the track (if available)

Album artwork

- Display album artwork if available
- Do not display album artwork

MS-IP700i MODEL

Note: If you select iPod or USB input without first connecting the device, the message “Not connected” is displayed on the screen.

Important Note: Connecting Supported iPods and iPhones to a MS-IP700i Stereo

The MS-IP700i provides two connection options for iPod and iPhone users. Supported devices may be either inserted into the internal dock or connected to the external USB connector.

The MS-IP700i Stereo does NOT support multiple iPod or iPhone devices connected simultaneously. Correct operation is only guaranteed with a single iPod/iPhone device connected.

Note; For connection to the external USB connector a Apple sync cable or external FUSION MS-DKIPUSB dock is required.

Before connecting iPod

To avoid damage and ensure safe operation, please read the following information before using your iPod.

- Please ensure iPod dock connector is clean, dry and free from damage.
- Check that the unit's iPod dock is free from obstructions.
- Insert correct sleeve combination to match your iPod (never insert iPod without the correct sleeve).
- Ensure iPod is inserted with display facing upwards.
- Never force your iPod into the dock, if the iPod does not mate with reasonable ease, the sleeve/iPod combination is most likely incorrect.
- Take care when removing iPod from unit as surfaces may be warm.

To insert your iPod:

1. Press the door catch and open the control panel door.

Press the
door catch



Open





- 2.** Insert your iPod in its sleeve (see iPod compatibility sheet supplied separately). Make sure that the device is firmly pushed onto the connector socket.
- 3.** Close the control panel door firmly.
- 4.** Select input from the device, as required.

Note: For further information read the stereo operator's manual in the owner's information packet.



REGALVUE DISPLAY



TYPICAL DISPLAY SHOWN

If installed the RegalVue display features a touch screen for full control of various functions at your fingertips including GPS tracking, multi-media display, speed control, along with many different engine parameters and service codes as the engine is running.

Select units display fuel, engine rpm, speed, temperature and volts.

Normally the unit comes loaded with display information and generic chart.

READ AND UNDERSTAND *the RegalVue display owner's manual before attempting to use or to navigate with the unit. This includes all warning and safety information.*



TYPICAL USB DEVICE

Regional specific waterway charts can be ordered from your Regal dealer at a nominal cost. These region specific water charts arrive in the

form of a USB device sometimes known as a wireless adapter or thumb drive. To download the chart on to the RegalVue display access the rear of the display unit under the helm. There you will see a wire hanging down with a USB connector. Simply plug the wireless adapter into the connector and follow the instructions to download your regional chart into the display unit.



Quick Access Keys

The vertically located access keys permit each of the controls to be accessed and further tweaked. They include beginning on the port side of the display and working downward;

- Stereo
- Video
- Diagnostic Messages
- Settings
- Maps
- Speed Controls
- Engine Statistics
- Home

Touch Point Commands

These commands furnish additional features and navigation shortcuts. The commands may be displayed as icons or a vertical control bar depending on the current screen being displayed.

Touch point commands are used throughout the RegalVue display to;

- Navigate the Screen
- Navigate to More Detailed Layers or Levels
- Edit Settings
- Access Features

Note: Select touch points are graphics or words highlighted with a soft glow,



Typical Chartplotter



If installed, the unit features a touchscreen, NMEA 2000 compatible, multifunction display, pre-loaded with U. S. coastal maps and interfaces with other electronic components. It displays graphics with crisp, video-quality resolution.

Chartplotter Operation

Before operating the chartplotter read and understand the vendor supplied owner's manual including all the warning information.

These chartplotters feature "touch" screens. When you see information groups on the screen use your finger to touch the format desired. With some information in particular it is required that you actually drag an object by using your finger and keeping it on the screen as you move the object.

A. To power the system up make sure the battery switch at the battery panel board is energized.

B. Press and release the chartplotter power key. When the warning screen appears, touch I agree. At this point you will be taken to the home page screen.

Note that the Garmin system is protected by a 15 amp fuse usually located at the helm fuse block accessible by lifting the starboard bow backrest.



Home Screen

Charts- Selects navigational charts and radar overlay functions.

Radar- Sets up and provides sonar information through the optional transducer.

Information- Shows tide conditions, currents, celestial data, information about other vessels, your yacht's instrumentation, and video.

Mark- Marks, edits, or deletes your current location as a waypoint or Man Overboard

WhereTo?- Searches and navigates to service areas, routes and way points.

Combinations- formats screen to view a chart, sonar, radar, and video cameras if installed.

Configure- Permits the editing of chartplotter system settings (Can set a simulator mode where you can practice using most of the chartplotter functions).

Man Overboard- Marks your current position as a way point, and sets a course back to the marked location.



Chapter 4

Once you are able to navigate to the home screen each of the electronic onboard components can be formatted and adjusted to meet individual needs and the finer points of cruising. Continue to read the electronic owner's manuals for adjusting the finer settings on the chartplotter.



Engines & Controls

Note that selected outboard engine and control information will be found in the outboard section at the end of this chapter. Refer to the manufacturer's outboard engine operators manual for more detailed documentation.

Keep in mind that many Regal systems and components are similar between the stern drive and outboard models so becoming familiar with this entire manual is recommended.

STERN DRIVE OVERVIEW

This section introduces the stern drive propulsion system-engine and drive. This is not to be thought of as a complete workshop manual. This manual will highlight a portion of the engine and drive information

Read the Volvo or MercCruiser engine manual carefully and understand the operation as well as the necessary maintenance requirements of the engines and related drive system components before operating the vessel. Contact your closest Regal dealer or repair facility for maintenance or parts needs.

Always begin maneuvering in a controlled environment where you can practice shifting and docking operations at your own pace. Learn how the vessel's engines and propulsion systems behave at different speeds, in varied sea conditions, and under light and heavy loads. Always keep the safety of others in mind as you practice docking. Learn to monitor the helm gauges, electronic equipment, and warning systems as they are your on board friends. Read all safety labels and practices. Review with a crew member all the component operations in case the captain would become unable to carry out his duties as skipper.

Note: Your Regal dealer has been factory trained on the various vessel systems. Consult your Regal dealer for further information regarding technical support and parts.



WARNING

AVOID SERIOUS INJURY OR DEATH!
READ ALL MANUFACTURER'S ENGINE
AND PROPULSION MANUALS
BEFORE STARTING OR OPERATING
THE VESSEL.



CAUTION

NEVER RUN ENGINES WITHOUT WATER.
DAMAGE TO THE WATER PUMP, IMPELLER,
AND OTHER ENGINE PARTS
WILL OCCUR.



ENGINE BREAK-IN: ALL MODELS

All propulsion systems require a pre-determined “break in” period. During this time the engine should not be run at a full load condition for extended periods. Various engine load and speed conditions assist the internal engine parts such as bearings, valves and piston rings to “seat” properly which will help ensure a longer engine life. See operator’s manual for further information.

During the “break in” period it is necessary to check the engine oil more frequently since it is normal that the engine will use more oil. If engine oil is required be sure to check the engine manual for proper grade and viscosity.

Check the maintenance schedule in your engine owner’s manual and contact your Regal dealer to set up the first maintenance inspection. Normally the engine oil, filters, and drive oil inspections and maintenance are performed during this inspection along with other items.

Never exceed a 12 month period between oil changes especially with diesel power since sulfur tends to enter the lubrication system through the fuel combustion process over a period of time.

OIL CHANGES (ENGINE & DRIVE)

Be sure to read the owner’s manual regarding engine oil change recommendations along with stern drive oil. Be sure to follow the engine manufacturer’s recommended oil type and viscosity. The engine oil change is an important factor in obtaining engine longevity since impurities enter the crankcase through the combustion process and build up in the engine oil.

Be sure to check the drive oil on a periodic basis and change it using the recommended type per the engine owner’s manual.



VENTILATION SYSTEM

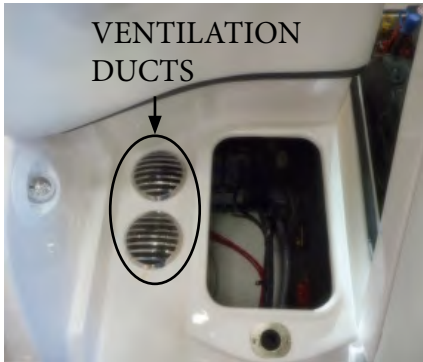

Select amounts of air are required to perform the combustion process. The higher the revolutions per minute of the engine the more air is required to meet the demand.

A natural and powered ventilation system are incorporated with gasoline stern drive engines. **Read and understand the blower warning label instructions found on this page.** As part of periodic maintenance, ensure the cowlings are free of debris including animal nests such as wasps and birds. Check and replace the engine air filters as required. See your nearest Regal dealer or marine professional for replacement filters.

Also, it is recommended that after a cruise you let the engine idle under a 'no load' condition for several minutes. Perform a visual check for exhaust and fluid leaks in the bilge. Since there is a light gelcoat color in the bilge bottom it will be easier to spot any fluid leaks.

 **WARNING**

TO PREVENT FIRE OR EXPLOSION
DO NOT STORE
FLAMMABLE LIQUIDS IN CONTAINERS
ANYWHERE ON THE VESSEL!

 **WARNING**

BEFORE STARTING ENGINE
CHECK ENGINE COMPARTMENT
FOR FUEL LEAKS.

 **WARNING**

AVOID SERIOUS INJURY OR DEATH!
GAS VAPORS CAN EXPLODE!
BEFORE STARTING ENGINE
OPERATE BLOWER 4 MINUTES
AND CHECK ENGINE COMPARTMENT FOR
GASOLINE LEAKS OR VAPORS.
RUN BLOWER BELOW
CRUISING SPEED.



STERN DRIVE INSTRUMENTS AND CONTROLS

Note that the stern drive dash or sometimes called the helm features a variety of instruments (gauges) and controls depending on the engine brand and vessel options selected. We will describe several of these focusing on select gauges and controls along with basic components that overlap on all of the dashes or helms.

Read and understand your particular propulsion package instrumentation and controls found in the engine owner's manual along with this manual before attempting to operate the vessel.

Note that standard and optional equipment may change at anytime along with the appearance of select components.



Engine & Controls

STANDARD HELM LAYOUT WITH ANALOG GAUGES

TRIM
GAUGE

DEPTH
GAUGE

MULTI
GAUGE

SPEEDO
GAUGE

TACHOMETER
GAUGE



STEREO

IGNITION
SWITCH

SWITCH
PANEL

FIREBOY
GAUGE

*See following pages for gauge functions.



TYPICAL HELM LAYOUT WITH REGAL VUE

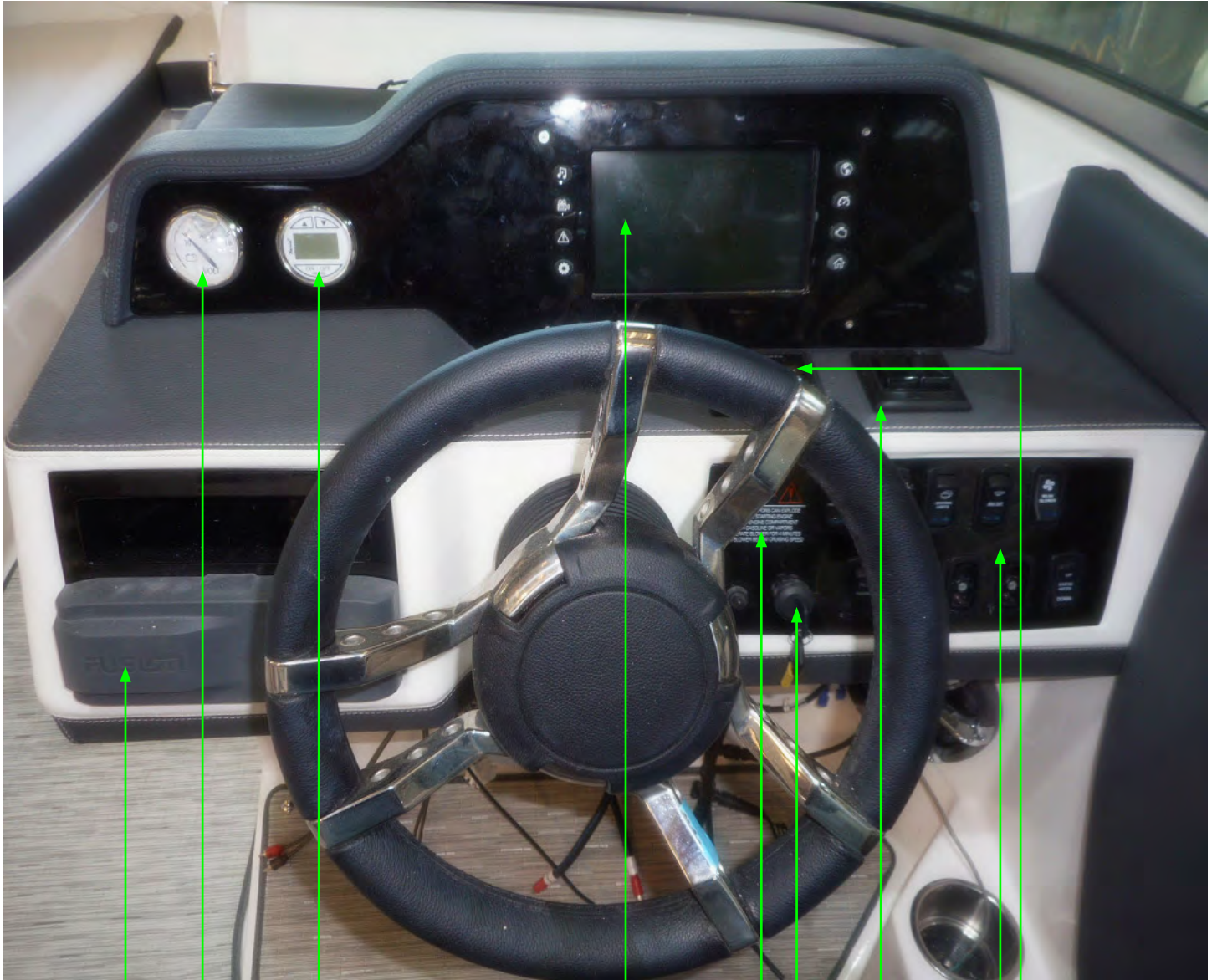

STEREO

DEPTH GAUGE

REGALVUE

SWITCH
PANEL

FUEL GAUGE

IGNITION
SWITCH

TRIM TABS

ENGINE
INFORMATION
PANEL



Engine & Controls

TYPICAL HELM LAYOUT WITH GARMIN CHARTPLOTTER

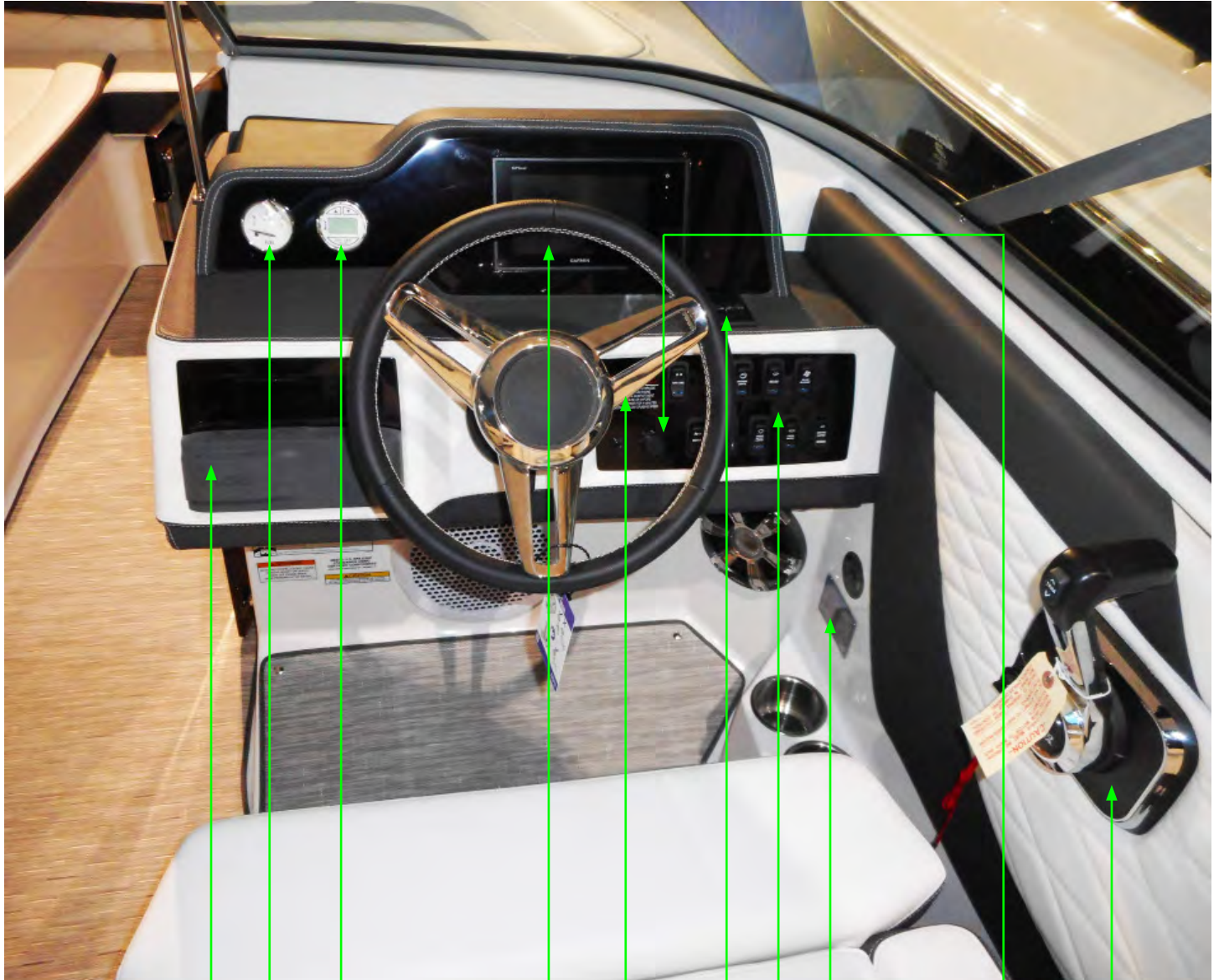

STEREO

DEPTH GAUGE

TRIM TABS

ABYC PLATE

REMOTE CONTROL

FUEL GAUGE

CHARTPLOTTER

BLOWER
WARNING
LABEL

SWITCH PANEL

IGNITION
SWITCH



ENGINES WITH KEY SWITCH PANEL

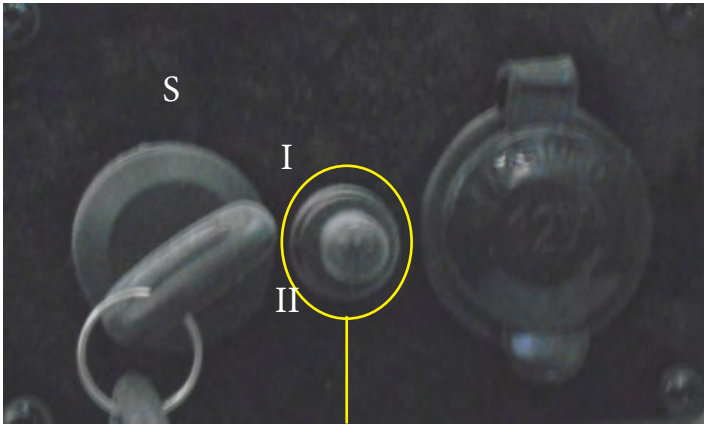

20 AMP BREAKER

Ignition key switches normally feature the following positions to identify key operating functions.

S= Stop

I= Operating Position (Ignition On)

II=Start Position (Spring Loaded)

Note that the key switch above is shown with the key in the “ignition on” position.

Read and understand the blower information on this page before attempting to start the engine. A blower switch is used on all gasoline engines.

Before turning on the blower switch do a sniff test by opening the engine hatch. At the same time check fuel tank components. When assured the bilge is clear of any fumes turn on the blower switch for at least 4 minutes before attempting to start the engine. This will vacate any gasoline fumes that are in the engine room (bilge or sump). Continue to run the powered blower system below cruising speeds after starting the engine.

A 20 amp ignition system breaker protects the ignition circuit (See above). Should a breaker “pop” find the cause of the malfunction before attempting to restart the engine.

STARTING ENGINE-IGNITION SWITCH

To start the engine turn the ignition key clockwise to the right “OPERATING” position and then to the spring loaded “START” position. Hold the key in this position as the engine will crank until it starts. Once the engine starts release the key and it will seek the operating position. To stop the engine, turn the key counterclockwise to the “off” position and remove the key from the ignition.



WARNING

AVOID SERIOUS INJURY OR DEATH!
GAS VAPORS CAN EXPLODE!
BEFORE STARTING ENGINE
OPERATE BLOWER 4 MINUTES
AND CHECK ENGINE COMPARTMENT FOR
GASOLINE LEAKS OR VAPORS.
RUN BLOWER BELOW
CRUISING SPEED.

NOTICE

TO PREVENT ELECTRICAL SYSTEM
DAMAGE, NEVER TURN “OFF”
THE BATTERY SWITCH
BEFORE IGNITION KEY IS REMOVED.

NOTICE

TO PREVENT A POSSIBLE DEAD
BATTERY, NEVER LEAVE THE
IGNITION SWITCH KEY IN THE “ON”
POSITION WITHOUT THE ENGINE RUNNING.



Engine & Controls

INSTRUMENTATION (TYPICAL ANALOG)

The helm (dash) features select gauges specifically designed to monitor the condition of the propulsion components and other onboard equipment. Close observation of the gauges is the responsibility of the captain while cruising. Periodically scan the gauges for the appropriate meter level deflections. Other instruments called displays present digital information verses needle deflection.

Become familiar with all the gauge functions and their normal operating specifications as outlined in this manual and your engine operation manual. Gauge deflection (movement) on boats is very similar to automobiles.

After educating yourself in the functionality of the instruments be sure to train another person as the skipper's backup. This person should know how to read the gauges and how to respond to system "fault" codes should they occur.

Note that the gauges shown in the following pages are typical and may vary in appearance and type depending on helm configuration along with engine and components selected.

AUTOMATIC CHARGING RELAY/ SI-ACR

Note on stern drive dual battery systems there is an automatic charging relay installed on the battery management panel.

The purpose of this device is to protect electronics by temporarily isolating house loads from the engine circuit during the engine cranking cycle.

Also, it automatically combines batteries during charging, isolates batteries when discharging and when in the engine cranking cycle.

This device supports stern drive alternators up to 120 amps. **Remember when charging up a low or dead battery with the ACR and the dual battery switch, you must select the COMBINE BATTERIES section of the dual battery switch for the low battery to recharge.**

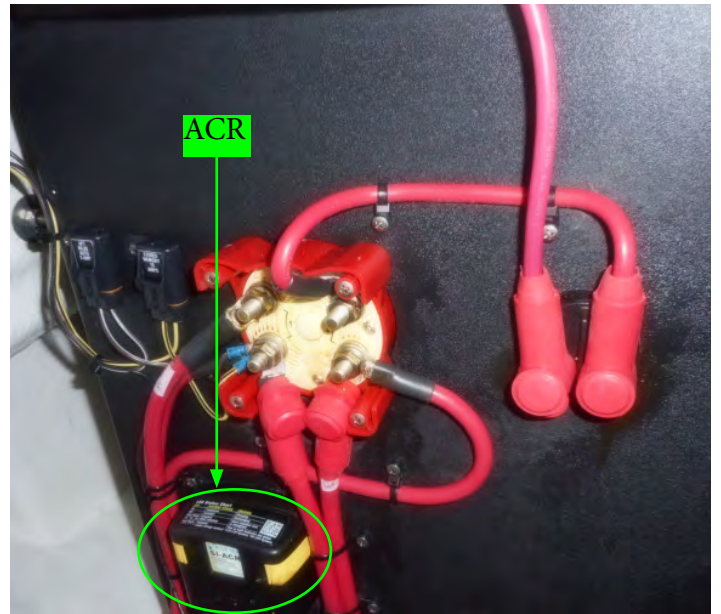



GAUGE OPERATION (TYPICAL)



Multi Gauge

The multi gauge may read fuel, oil, temperature and volt functions. The fuel section indicates the level of fuel inside the fuel tank. It is a good idea to keep the fuel tank “topped off” when

possible to reduce condensation inside the tank. Do not run the fuel level close to empty. Figure in an adequate “safety” factor (1/3 rule) when monitoring fuel gauges since they are not entirely accurate.

The oil pressure display indicates the pressure of the oil inside the engine lubrication system. A drop in oil pressure may be an indication of a low oil situation or a leak. Operation of the engines with low oil pressure could lead to engine damage. Should a low oil pressure situation develop shut down the engine immediately and investigate the problem.

The temperature display monitors the cooling system of the engine. A sudden increase in the temperature could be a sign that the engine cooling system is malfunctioning. Shut down the engine immediately and investigate the problem. Consult your engine manual for allowable limits. Engine water temperature is indicated in degrees of Fahrenheit. Engines today run warmer closer to the 180 degrees to 200 degrees.

The voltage display indicates the battery condition as well as the alternator performance. Normal voltage is between 12.0 and 15.0 volts. Readings outside of this range may indicate a charging system or battery problem.

Volts should be normally over battery voltage indicating the battery is being supplied properly by the engine alternator.

Typical engine alternator output for Volvo stern drive models is 75 amps and for MerCruiser is 70 amps.

Note the following: stator output for outboards with mechanical controls is 50 amps and outboards with digital controls is 70 amps.



Speedometer Gauge

The speedometer indicates the speed of the vessel over water. It is indicated in miles per hour or knots.



Trim Gauge

The trim gauge indicates the relative angle of the engine outdrive in units. Degrees of trim are indicated as the drive unit is trimmed up. Likewise degrees of trim are shown as the drive is lowered.



Tachometer

The digital tachometer (tach) indicates the speed of the engine in revolutions per minute (rpm). Marine engines feature rev limiters to keep the engine rpm's within safe limits. Select tachometers display the engine running hours.

Note that engine hours is the gauge for marine maintenance schedules. Pay close attention to the hours of running displayed on the tachometer and the recommended system maintenance as found in your engine operator's manual.



Automatic Fire Extinguishing System



If installed the system utilizes an instrument display unit light that provides the operator with a system status of a charged or uncharged condition by an audible alarm. With the ignition switch on and a no light condition indicates that

the system has been discharged.

If the system should discharge the ignition system will be instantaneously interrupted. Should this occur shut down the engine and any electrical system components along with closing any open hatches.

If a fire has started in the engine compartment find the system manual cable assembly located in the cockpit. Remove the safety pin from the “Fire T Handle” and pull firmly on the “Fire” handle which will activate the fire extinguisher unit in the engine compartment. A loud “rushing air” sound may be heard. Complete discharge will take several seconds. Keep the compartment closed for a period

of time sufficient to permit the agent to soak all areas of the protected space. This allows hot metals and fuel time to cool. Refer to the automatic fire extinguisher owner’s manual for additional information.



Gas Vapor Detector



If installed the optional gas vapor detector determines if there is a level of gasoline vapors that is unsafe in the engine room of the boat. If installed, turn on the unit and wait about one minute for

it to do its safety test. If all is well it will give you a green light. You must run the test before you start the engines. In the event you don’t get a green light, you must investigate the bilge of the boat for gas fumes or signs of a fuel leak before starting the engines. If uncertain, consult a marine service professional.

NOTICE

BECOME FAMILIAR WITH THE ENGINE FAULT CODE SYSTEM. SHOULD AN ENGINE MALFUNCTION DEVELOP THE OPERATOR WILL BE ABLE TO REACT FASTER TO THE SITUATION.



Depth Gauge

The depth gauge displays bottom signals as read through a transducer installed through the hull bottom. Information can be shown as meters or feet. Read the depth gauge literature found in the following pages and owner's packet for in-

depth settings and operational tips.

In theory the depth gauge picks up a bottom signal sent through a transducer to the helm gauge unit which is converted to readings in feet, meters, or fathoms, and displayed on the gauge. The unit features shallow or deep water alarms, both of the audio and visual type, and keel offset.

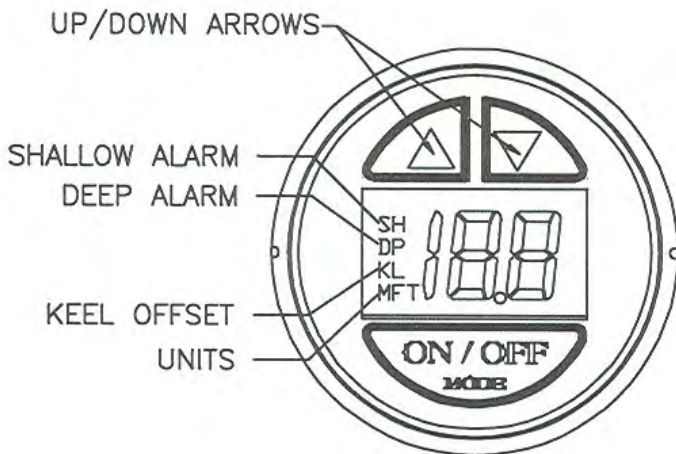

Depth Gauge With Functions

OPERATION

The depth finder will display depths of 2-199 feet, 1-92 meters, or 1-54 fathoms. To accommodate greater depths to be displayed in the feet mode (ft), the depth sounder will automatically change to the fathoms (f) mode and continue to display depths to around 54 fathoms. When the depth becomes larger than 200 feet, the display will return to the feet mode. Limits on depth will vary depending on transducers and bottom conditions.

If the reading is less than 19.9 feet, meters, or fathoms, 1/10th increments will be displayed. If the reading is more than 19.9 feet, all readings will be in whole numbers.

The depth finder features an audible and LCD displayed depth alarm with adjustable shallow and deep limits and a depth below keel offset feature. These settings once made are stored in memory and will remain, even if the battery is not connected.

POWER ON

When the helm is powered up by the key switch, 12 volt DC energy is available at the depth gauge along with the remained of the instrument cluster. You do not need to press the "ON/OFF MODE" keypad.

The LCD will illuminate showing the depth and the type of units selected; feet (FT), meters (M), or fathoms (F). To deactivate the depth sounder, hold the "ON/OFF MODE" keypad for 4 seconds. Pressing the "ON/OFF MODE" keypad again, reactivates the unit.

DEPTH ALARM SHALLOW MODE

If you press the "ON/OFF MODE" keypad again, the shallow depth alarm setting is displayed. This is the shallowest water that will energize the alarm. Press and hold the up or down arrow keypads to adjust the reading to the desired depth.



DEPTH ALARM DEEP MODE

By pressing the “ON/OFF MODE” keypad again, the deep depth alarm setting is displayed. This is the deepest water that will energize the alarm. Press and hold the up or down arrow keypads to adjust the reading to the desired depth.

When the shallow depth setting is read by the depth finder, the “SH” will flash on the LCD and the audible alarm will sound in a rapid sequence. When the deep depth setting is read by the transducer, the “DP” will flash on the LCD and the audible alarm will sound at two beeps per second.

To fully deactivate the alarm, reset it to zero. Pressing the “ON/OFF MODE” keypad temporarily deactivates the alarm. To reactivate, press the “ON/OFF MODE” keypad until the depth reading appears.

KEEL OFFSET

By pressing the “ON/OFF MODE” keypad again, the alarm will display the keel offset setting “KL”. It can be set so the depth finder shows the depth below the transducer, or the depth under the keel. Press the up or down arrow keypads to adjust the reading to the desired depth no further than 19.9 feet.

An example would be if the keel bottom is 3 feet below the transducer, and you desire the depth sounder to read the depth below the keel, the keel offset display should be adjusted to 3.0 FT.

Once the keel offset is programmed, the shallow and deep water alarms will be energized by the depth under the keel.

UNITS

Pressing the “ON/OFF MODE” keypad again displays the units mode “UN”. Press either the up or down arrow keypads to set the units to feet (FT), meters (M), or fathoms (F). Once these units are set, they will remain the same for all modes. By pressing the “ON/OFF MODE” keypad again, the depth finder will return to the normal operations screen.



TRANSDUCER



If you should decide to use a barrier coating on the boat bottom do not paint the transducer as its effectiveness will be compromised. Never cut the main lead to shorten or lengthen it as it is been matched by the electronics manufacturer to the chartplotter.

NOTICE

AVOID EQUIPMENT DAMAGE!
THE TRANSDUCER IS A SEALED UNIT.
DO NOT ATTEMPT TO OPEN IT,
SINCE IT IS NOT SERVICEABLE.



WARNING

AVOID INJURY OR DEATH!
THE DEPTH SOUNDER IS NOT TO BE USED
FOR NAVIGATION OR AS A DEVICE
TO AVOID GROUNDING.
USE CAUTION
WHEN OPERATING IN SHALLOW AREAS
AND MAINTAIN A VERY SLOW SPEED.
BE AWARE THAT WATER DEPTHS MAY
CHANGE TOO QUICKLY FOR YOU
TO REACT AND AVOID GROUNDING!



BEFORE STARTING ENGINE

It is important that you read the engine operator's manual carefully and become completely familiar with the operation as well as required maintenance procedures on the engine and related propulsion systems.

Before starting the engine check the guidelines below:

1. Open the engine hatch and sniff for fuel smells and visually check for fuel leaks. If gasoline vapors are sensed or leaks seen be sure to determine the cause and repair the source before starting the engines. If you can not locate a fuel leak contact a marine professional immediately or your closest Regal dealer.
2. Remove any loose canvas and store in a dry location.
3. Shut and secure all hatches and doors.
4. Make sure the swim ladder is secured in its folded position and that the cover is in place.
5. Check fuel supply levels. Use the fuel "1/3" rule.
6. Turn all battery switches to the "on" position at the sump located battery management panel. Access through the aft port seat which is removable.
7. Make sure all passengers are accounted for, seated and their life jackets are properly fitted.
8. Check for a balanced load.
9. Before disembarking make sure a person is aboard who knows how to operate the vessel and is trained in emergency procedures in case the captain would not be able to carry out his duties.
10. Inspect the engine and drive oil levels. Add specified oil as required.
11. Check engine coolant levels. Add specified coolant as required.



TYPICAL STERN DRIVE REMOTE CONTROL



SHOWN IN NEUTRAL POSITION

ELECTRONIC VESSEL CONTROL FUNCTIONS

THROTTLE ONLY BUTTON

SAFETY LANYARD

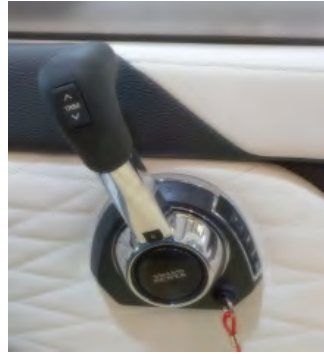

The remote control is in the forward gear position. Once in the forward gear further movement forward of the control handle will result in forward throttle increases only.



The remote control in the forward gear full throttle position. Comparing the two photos gives the operator a bit of insight into the arc of the forward throttle

positions.

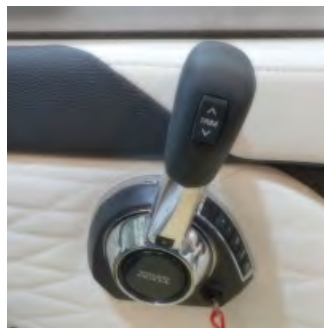

The remote control here is in the reverse gear position. Once in the reverse gear further movement aft of the control handle will result in reverse throttle increases only.



The remote control is in the reverse gear full throttle position. Comparing the two photos gives the operator a bit of insight into the arc of the reverse throttle

positions.

Notes: Never shift from forward to reverse while the vessel is planing since this could force water through the exhaust up into the engine. Always shift between gears at idle speeds only.

The typical remote control on your vessel is side mounted at the helm. This control features a handle which can be shifted between forward, neutral (straight up) or reverse positions. Once forward and/or reverse positions are obtained the handle assumes a throttle function to control vessel speeds. The neutral position uses a push button (see photo) for throttle only neutral enhancements. This feature allows the engine to warm up at a higher rpm but in the neutral only position. Note that the engine key switch will not engage the starter (engine will not crank) until the remote control handle is in the neutral detent position.

Note the safety lanyard in the above photo. It is attached to the remote control on one end and to the vessel's operator at the clip end; for example around a belt. Should the operator be dislodged from his helm position the safety lanyard would automatically shut down the engine.

Note that if the safety lanyard is disconnected from the remote control body the engine will crank but will not start.



Refer to the engine operator's manual for more detailed information on EVC and/or DTS remote controls that are used select Volvo and MerCruiser propulsion packages.

We encourage the vessel operator to practice the basic elements of the remote control shift and throttle segments in an open water environment. Once the operator feels comfortable with the remote control functions he should move on to docking and maneuvering in and out of tighter situations such as those found in marinas and launching ramps.

AFTER STARTING ENGINE

1. Allow the engine to idle for a short period as they warm up. Never race a cold engine!
2. Check gauges for proper operation. Pay particular attention to volts, oil pressure and temperature display panel functions as they are key indicators of a proper performing engine. Also, check that no alarms are displayed and no warning lights are flashing.
3. Open the engine compartment and listen to engine for unusual sounds.
4. Inspect the fuel, exhaust, and engine circulation system for leaks.
5. Visually check the entire sump (bilge) for any unusual conditions such as excessive bilge water.
6. Again, check to see that passengers are in life vests, seated and the load is balanced.



WARNING

AVOID SERIOUS INJURY OR DEATH!
GAS VAPORS CAN EXPLODE!
BEFORE STARTING ENGINE
OPERATE BLOWER 4 MINUTES
AND CHECK ENGINE COMPARTMENT FOR
GASOLINE LEAKS OR VAPORS.
RUN BLOWER BELOW
CRUISING SPEED.

NOTICE

TO PREVENT ELECTRICAL SYSTEM
DAMAGE, NEVER TURN "OFF"
THE BATTERY SWITCH
BEFORE IGNITION KEY IS REMOVED.

NOTICE

TO PREVENT A POSSIBLE DEAD
BATTERY, NEVER LEAVE THE
IGNITION SWITCH KEY IN THE "ON"
POSITION WITHOUT THE ENGINE RUNNING.



TYPICAL STERN DRIVE ENGINE ROOM OVERVIEW

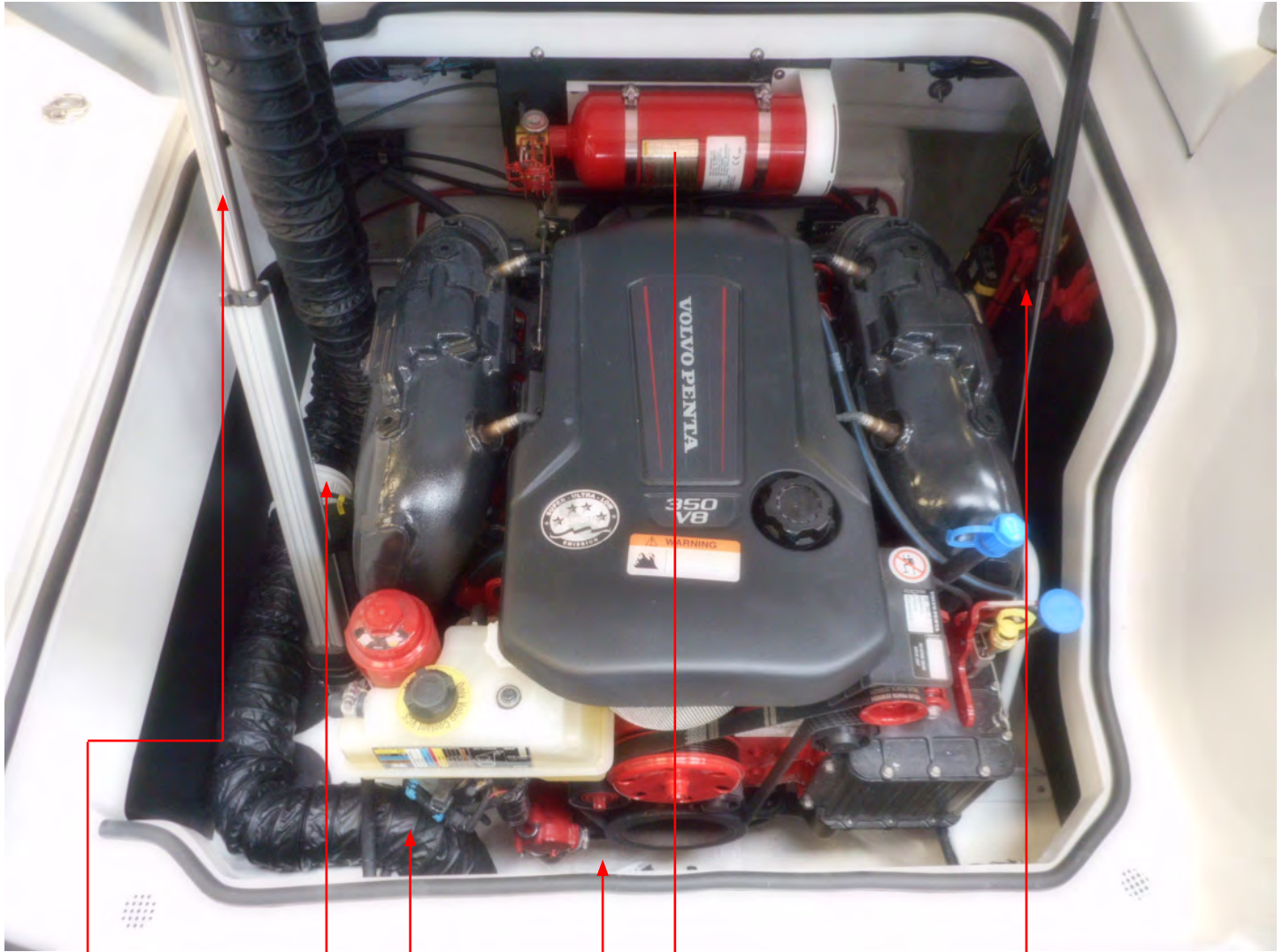

HATCH
ACTUATOR

VENTILATION
BLOWER

EXHAUST
HOSE

BILGE
PUMP

AUTOMATIC
FIRE
EXTINGUISHER

BATTERY
SWITCHES

Note: Equipment shown may be optional. Components, systems and locations are subject to change at any time.



CONTROLS/STEERING

Standard engines use remote controls and mechanical helm steering cables along with engine power steering units.

Select engines use “fly by wire” controls which are designed controls without actual cables for shift and throttle control along with steering functions without steering cables running from the steering wheel to the outdrive.

These units use hydraulics and special engine software. Read your Volvo or MercCruiser operator’s manual for more detailed information on the system on your vessel.

Volvo “fly by wire” is known as Electronic Vessel Control or EVC. MerCruiser “fly by wire” is known as Digital Throttle & Shift or DTS.



REGAL 26 OBX





OUTBOARD ENGINE & CONTROLS

INTRODUCTION TO OBX OUTBOARD

Note that many of the Regal systems and components are similar between the stern drive and OBX models. For that reason it is recommended that the operator read the entire manual to become familiar with the various systems.

In this section we will explore various outboard systems and controls that are unique to the OBX model.

This section follows a sequence in operations before starting the engine, starting the engine, and after starting the engine section.



FUEL OCTANE NOTICE

Outboard engines depending on the model may require a mid-range octane level (89) versus a lower regular octane level (87). Refer to your outboard manufacturer's operation manual for correct information regarding the proper octane level for your outboard model.

Using the wrong octane level may cause permanent internal engine damage.

As an option contact your outboard manufacturer's hot line or contact your closest Regal dealer.



REMOTE CONTROL

TYPICAL DIGITAL CONTROL SHOWN IN NEUTRAL POSITION



A typical digital outboard remote control is shown above. This control is in the straight up (neutral starting) position. Note that mechanical controls are used on select outboard models.

- The interlock switch prevents starting the engine in gear. It is normally found under the far side of the remote control handle and is colored red. When the engine starts to run the interlock switch must be pulled up and held until the remote control handle is shifted into forward or reverse gears.
- The up and down buttons control the trim of the outboard in reference to the bow altitude of the boat. Before starting the engine make sure the unit is trimmed to the down position.
- When the neutral throttle only button is pushed in and the control lever is shifted forward the engine speed increases for a faster neutral idle. When the control handle reassumes the straight up neutral position after warm up the remote control can be then shifted into forward or reverse gear.



Engine & Controls

- The shut-down cord is a safety device that when pulled will shut down the engine by interrupting the ignition. It shall be worn by the boat operator anytime the engine is running. Feed the clip around a belt for example or your arm and latch the clip to the cord. Do not use belt loops or clothing as they may not be adequate to hold in an emergency situation.

Make sure the shut-down cord is attached to the switch on the control box as the switch upon latching will be in the “on” position. Note that the engine will not start but will only crank with the cord-shut down switch in the “off” position.

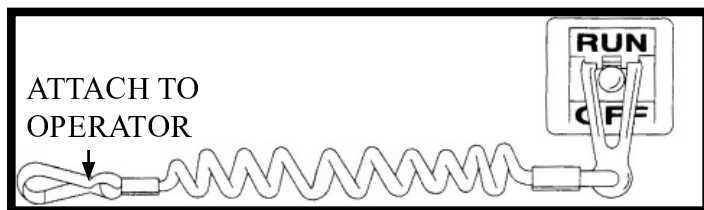

TYPICAL SHUT-DOWN SYSTEM



WARNING

AVOID SERIOUS INJURY OR DEATH
DUE TO A RUNAWAY BOAT
IF THE OPERATOR IS EJECTED OVERBOARD!
ALWAYS HAVE THE SHUT-DOWN CORD
ATTACHED WHEN THE ENGINE IS RUNNING.
MAKE SURE THERE IS SLACK IN THE SHUT-
DOWN CORD FOR BODY MOVEMENT.



WARNING

AVOID SERIOUS INJURY OR DEATH!
ENSURE OPERATOR HAS SUFFICIENT SLACK
IN THE SHUT-DOWN CORD WHEN UNDERWAY
IF THE CORD ACCIDENTALLY COMES OFF THE
CONTROL BOX OR ON SOME MODELS THE
HELM SWITCH, WHEN ENGINE LOSES POWER
STEERING CONTROL IS SEVERELY REDUCED.
ALSO, THE VESSEL SLOWS DOWN RAPIDLY
WHICH COULD CAUSE PEOPLE AND OBJECTS
TO BE PROPELLED FORWARD..



FOLLOW THESE TIPS WHEN SHIFTING:

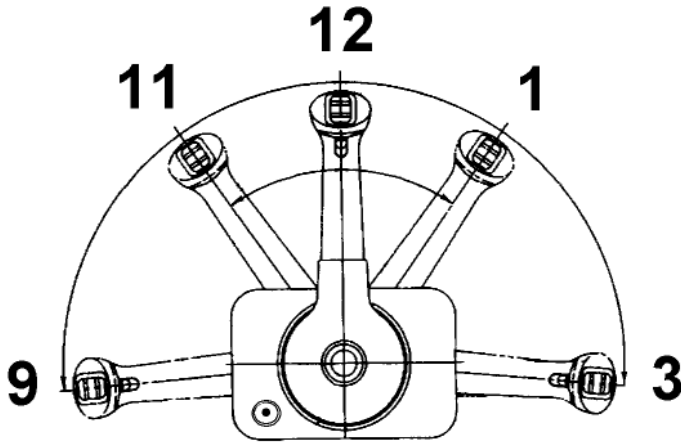

CONTROL WITH SHIFT/THROTTLE POSITIONS

- DO NOT shift quickly from forward to reverse gear positions. Outboard drive system damage may occur.
- DO NOT “pump” the throttle in neutral or flooding will result. The same thing will happen if you keep pumping the automobile accelerator pedal. Today’s engines use direct fuel injection systems that require very little starting throttle.
- DO NOT try to shift into forward or reverse gear at high rpm’s. Personal injury, drive system, or property damage may result.
- Only use idle throttle positions when docking or maneuvering in tight quarters.

Pushing the throttle control lever forward from the neutral 12 o’clock position to the 11 o’clock position will engage forward gear with minimal throttle. From the 11 o’clock position to the 9 o’clock position, the vessel is in forward gear with differing increased levels of throttle selections.

Pulling the throttle control lever back from the neutral 12 o’clock position to the 1 o’clock position will engage the reverse gear with minimal throttle. From the 1 o’clock position to the 3 o’clock position, the vessel is in reverse gear with differing increased levels of throttle selections.

As you shift from neutral to forward or reverse, pull the neutral release button up; this allows the control lever to come out of the indented neutral position.

The control lever features a neutral safety switch which ensures the outboard and control are in the straight up neutral position for starting the engine. You will hear a distinct sound and will feel the remote control’s rotation lock, once in the proper position. If you turn the key to the start position and the engine starter doesn’t crank the engine, ensure the control lever is in the neutral position.

Your control lever also features a trim control switch. This switch allows the captain to set the outboard trim position either up or down to achieve a plane position. Refer to the vessel operations chapter for further information on trim angle.



BEFORE OPERATING ENGINE

Following are basic instructions and tips before and after starting your outboard engine. For more in depth information refer to your outboard engine owner's manual. Be sure to read and understand all safety labels along with all other related information before attempting to operate your craft.

CHECKING CRANKCASE OIL LEVEL

Remove the shroud (cover) and check the crankcase for proper oil levels. Remember that a 4 cycle outboard uses crankcase oil to lubricate all internal engine components such as crankshaft, rods and pistons along with all related bearings and seals. For changing crankcase oil contact your closest Regal dealer for additional information since they have the special tools and knowledge for these maintenance procedures. Check your outboard owner's manual for correct oil type and viscosity. See figure 1 for dipstick location.



FIGURE 1

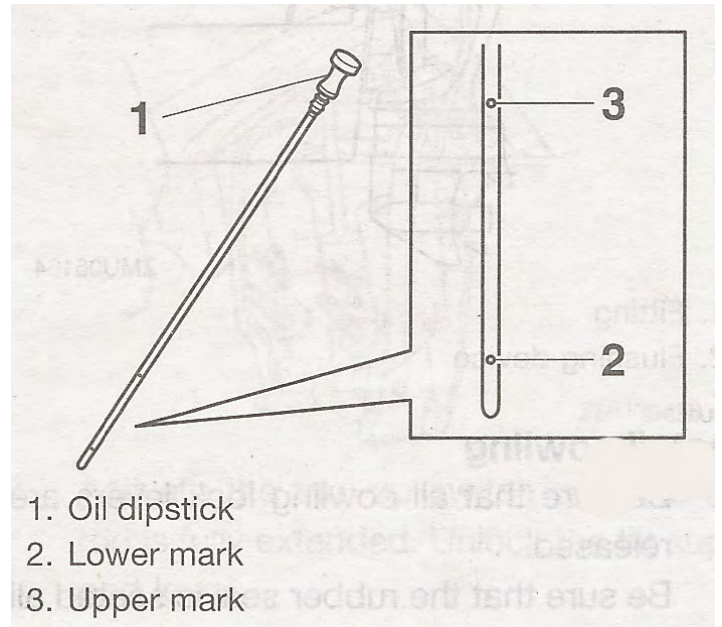

1. Oil dipstick
2. Lower mark
3. Upper mark

To check the crankcase oil do the following:

1. Ensure the outboard is setting in a flat vertical position or the dipstick may not display an accurate oil level.
2. Remove the crankcase oil dipstick and wipe it clean.
3. Reinstall the crankcase oil dipstick completely into the hole. Remove it again.
4. The oil level should be between the upper and lower dipstick holes. As needed add the manufacturer's recommended oil or contact your closest dealer especially if the oil is contaminated with water which will show a milky color verses a clear or light amber look.



CHECKING FUEL SYSTEM

TYPICAL EPA FUEL SYSTEM

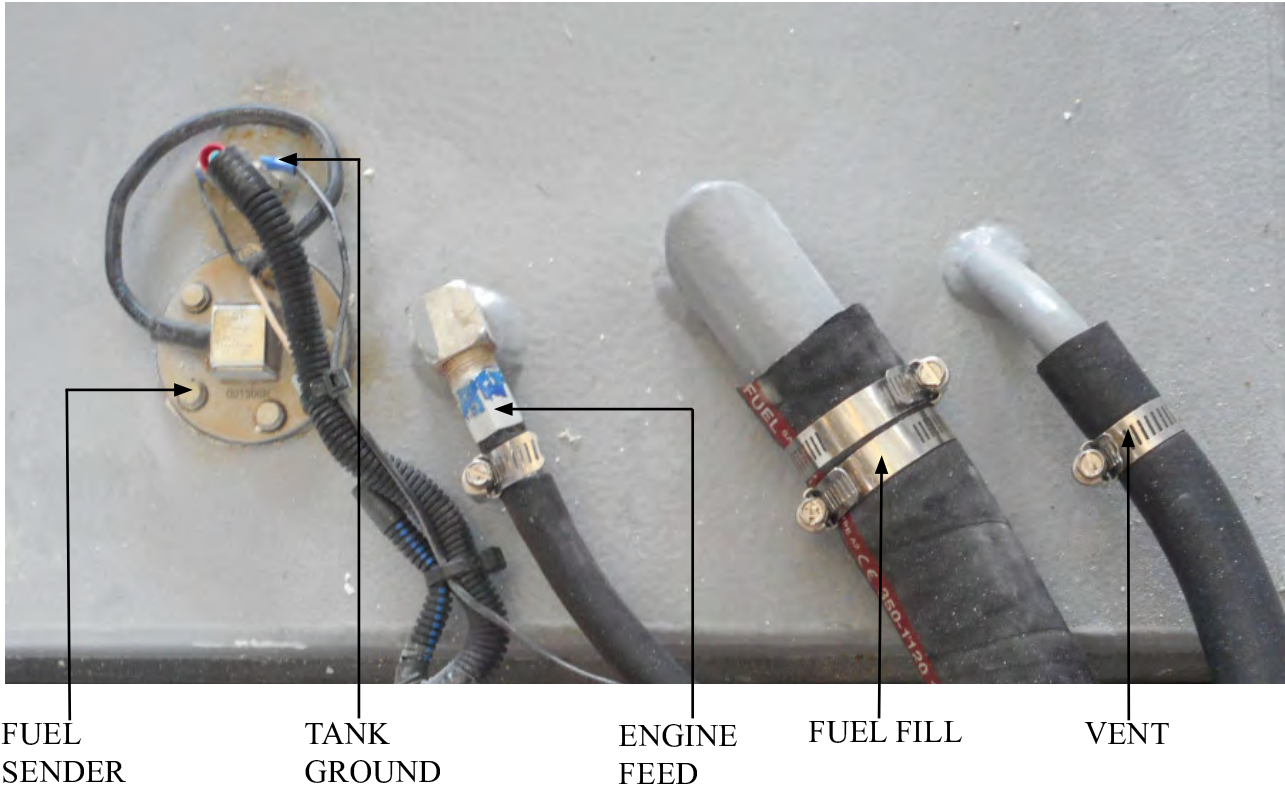

FUEL SENDER

TANK GROUND

ENGINE FEED

FUEL FILL

VENT

Before each outing check the fuel tank components including hoses and related clamps. Be sure to sniff for gasoline vapors in the process. If any vapors exist find the source of the leak and repair as needed. At that point ventilate the compartment until all vapor smell is gone. Read and understand the following fuel system warning labels.

 <b style="font-size: 24px; margin: 0;">WARNING
<p>AVOID SERIOUS INJURY OR DEATH FROM EXPLOSION OR FIRE RESULTING FROM LEAKING FUEL. INSPECT ENTIRE FUEL SYSTEM AT LEAST ONCE A YEAR.</p>

 <b style="font-size: 24px; margin: 0;">WARNING
<p>AVOID SERIOUS INJURY OR DEATH FROM EXPLOSION OR FIRE! NEVER STORE FUEL OR FLAMMABLE LIQUIDS ON BOARD.</p>



Engine & Controls



CHECKING ENGINE MOUNTED FUEL FILTER

As part of select outboards under the motor shroud (engine cover) on the lower port side of the outboard engine is a fuel filter. Periodically check to ensure the fuel filter is clean and free of water. When reinstalling the filter tighten to manufacturer's specifications. Check for leaks after starting the engine. For more information refer to the outboard manufacturer's owners manual or contact a Regal dealer or marine professional.

CHECKING IN-LINE WATER SEPARATOR FILTER



Inside the Lazerete center cockpit storage area a 10 micron in-line water separator filter is installed. Use an oil spanner type wrench and turn the filter counterclockwise to remove the element. Using a clean pan empty the filter contents and examine the fuel. Water in fuel tends to hug the bottom since

it is heavier than fuel and will show a different look. At least yearly or on an as needed basis replace the filter element. Fill the element up with fresh unleaded fuel of the correct octane rating and turn it clockwise until tight. Finish tightening with the spanner wrench. As always check for leaks before starting the engine.

It is a great idea to keep extra filter elements on board in protective wrap for emergency use.



CHECKING STEERING SYSTEM OPERATION

Your outboard features a mechanical-hydraulic rack style steering system. The unit utilizes valves which permit hydraulic fluid to pass through the system allowing the steering arm at the outboard to turn the vessel to port or starboard. This check valve cluster is located behind the steering wheel. The hardware at both the helm and engine ends must be checked regularly for tightness, lubrication, and leaks. Check the steering system for full steering to port and starboard before disembarking. Typical hydraulic pump shown below. It is located in the aft Lazerete storage area. Refer to your outboard motor operator's manual for adding fluid to the pump and type required.

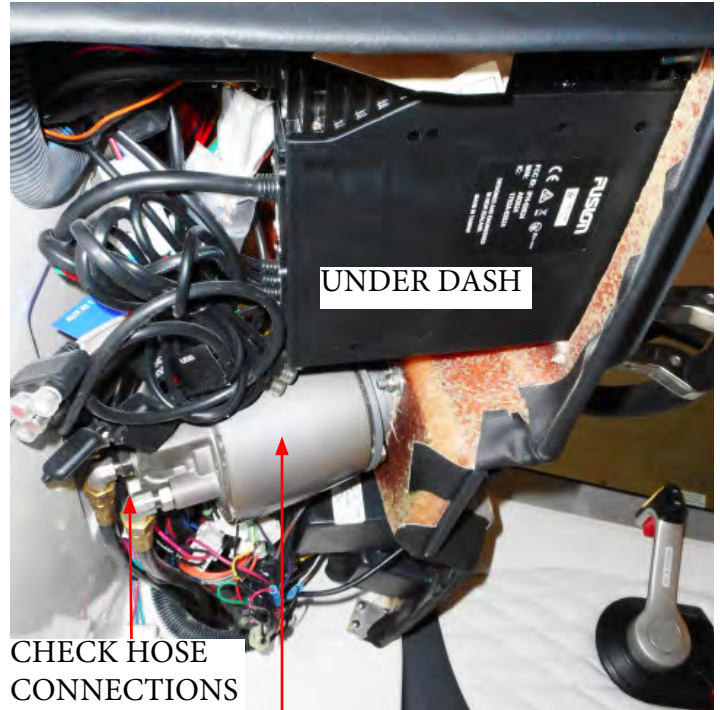

CHECK HOSE CONNECTIONS

HYDRAULIC RACK STEERING CLUSTER



CHECK HOSE CONNECTIONS

TYPICAL HYDRAULIC STEERING PUMP



HYDRAULIC SYSTEM BLEED FITTINGS

STEERING HARDWARE & HOSES AT ENGINE



FILLING HELM STEERING RESERVOIR



FILLING HELM HYDRAULIC STEERING FLUID

There is a fill plug located at the starboard helm used to add hydraulic fluid to the steering system. There is a hose kit used to fill the system. Note that Sea Star Solutions recommends Seastar Hydraulic Steering Fluid for use with the filler kit.

Any non-approved fluid may cause serious damage to the steering system resulting in possible loss of steering, causing property damage, personal injury or death. Contact your closest Regal dealer or marine professional for system filling instructions since the steering system may need to be purged of air by opening bleed fittings as the wheel is turned port and/or starboard.

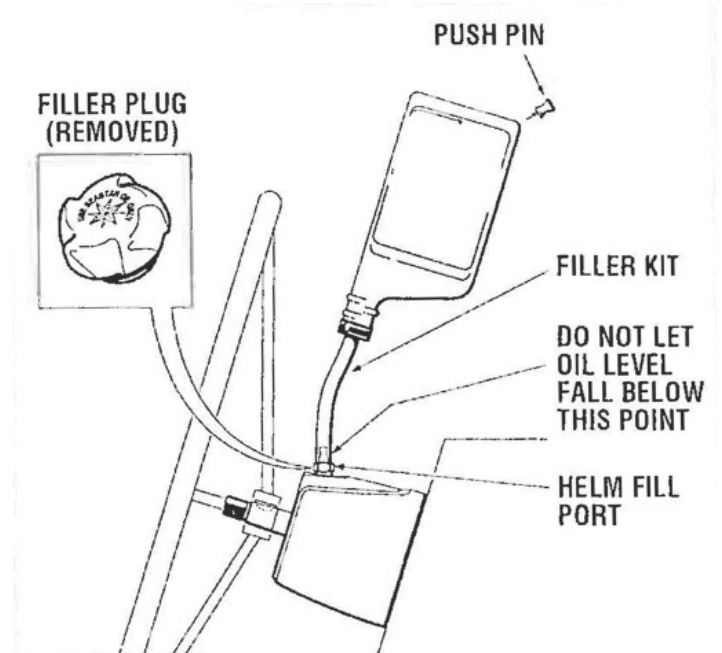

TYPICAL HYDRAULIC STEERING FILL KIT

WARNING

AVOID SERIOUS INJURY OR DEATH!
THE OPERATOR OF THE CRAFT
MUST HAVE COMPLETE CONTROL
OF THE HELM STEERING STATION
WHILE THE VESSEL IS MOVING.
NEVER LEAVE
THE HELM STATION UNATTENDED
WHILE THE VESSEL IS MOVING.



SEA STAR STEERING SYSTEM SCHEMATIC OVERVIEW

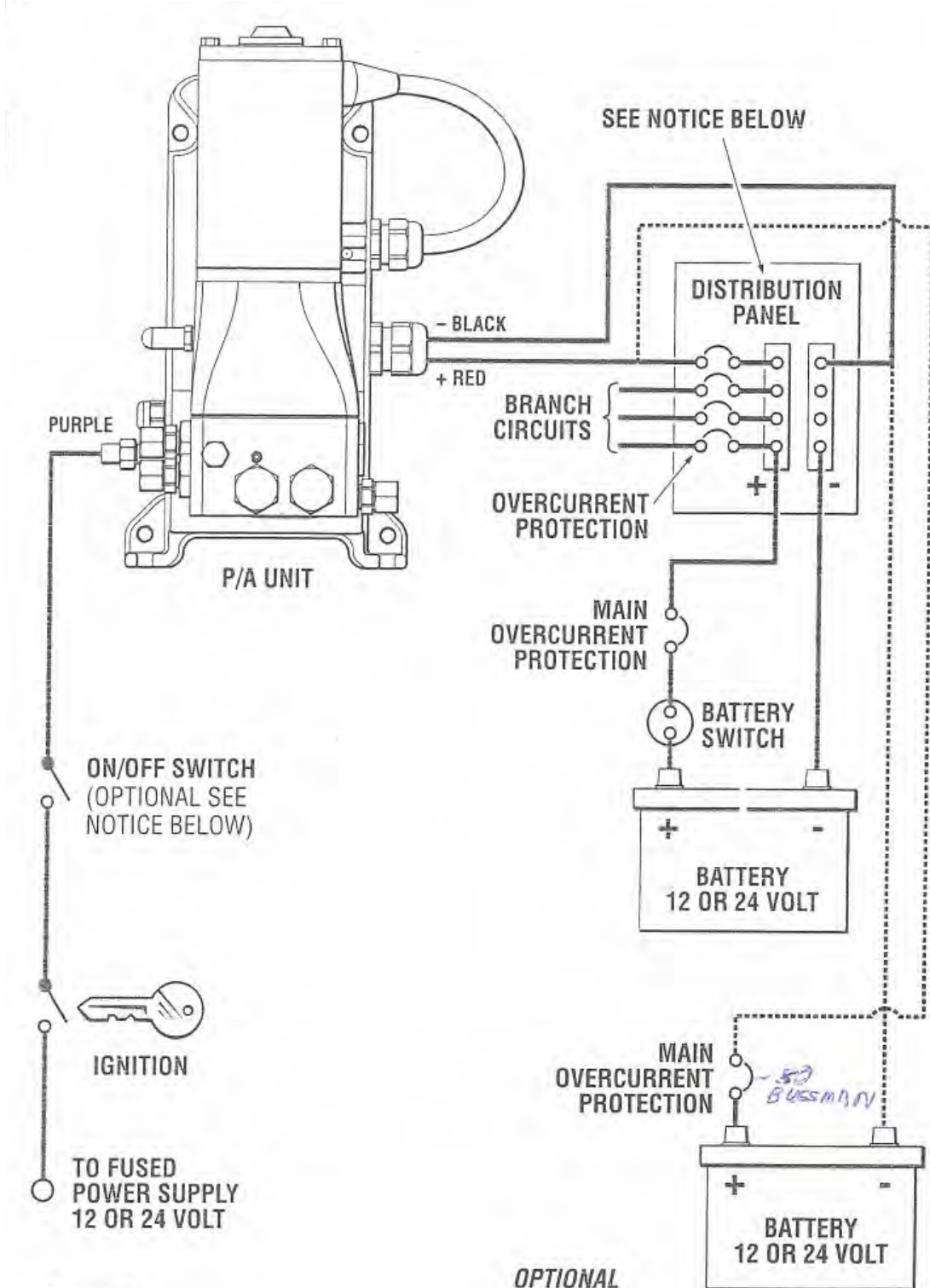

Figure 9.



OTHER SYSTEM CHECKS BEFORE STARTING ENGINE

Check these components/systems before starting engine:

1. Tilt the outboard drive and check the propeller for nicks and bent blades which will cause vibration.
2. While the outboard drive is tilted up check for any debris around the water intakes on the vertical drive shaft housing. These could cause the engine to overheat.
3. Check steering system fasteners at the engine and all related hydraulic hoses and connections for signs of leaks including the ones under the helm.
4. While the shroud is off check for any engine oil leakage or fuel puddling.
5. Check engine transom mounting fasteners for tightness.
6. Repair any signs of leakage and loose fasteners and hoses before attempting to start the engine.
7. Ensure that you use the 1/3 rule for determining if you have adequate supplies for the trip. Fill up as needed,
8. Check all throttle and shift cable linkages at powerhead for tightness.
- 9.

When finished, reinstall the engine shroud ensuring all lock levers are secure.



BEFORE FUELING

1. Make sure a working fire extinguisher is available.
2. Stop engines and any device that can cause a spark.
3. Disembark all passengers and crew not needed for fueling.
4. Fuel if possible during the daylight hours.
5. Check to ensure nobody is smoking in the boat or near the fueling dock.
6. Close all portholes, hatches and doors to keep vapors from blowing aboard and settling in the bilge.
7. Tie up your boat securely at the fuel dock.
8. Identify the fuel fill. Unfortunately, people have mistakenly filled the water or waste with fuel.
9. Visually inspect all fuel system components before each filling.
10. Avoid using fuels with alcohol additives. They can attack fuel system hoses and cause deterioration.

DURING FUELING

NOTICE

SINCE GASOLINE IS AVAILABLE IN SEVERAL GRADES INCLUDING ETHANOL & VARIOUS OCTANE LEVELS, REFER TO THE ENGINE MANUFACTURER'S OWNER'S MANUAL FOR THE CORRECT ONE FOR YOUR ENGINE. USING IMPROPER OCTANE FUEL CAN CAUSE ENGINE DAMAGE AND VOID THE WARRANTY.

1. Keep the fuel nozzle in contact with the fuel fill to guard against static sparks. The fuel fill pipe is grounded through the fuel system wiring to protect against static electricity.
2. Avoid overfilling the fuel tank. Leave room for expansion. Also, if fuel exits the fuel vent indicating the tank is full, this situation is dangerous and unfriendly to the environment.
3. Avoid spilling any fuel. Clean up any fuel accidentally spilled with a clean rag and dispose of it properly.



DANGER

AVOID PERSONAL INJURY OR DEATH!
GASOLINE IS A HIGHLY FLAMMABLE
AND EXPLOSIVE MATERIAL.
PRACTICE "NO SMOKING" AND EXTINGUISH
ALL FLAMMABLE MATERIALS
WITHIN 75 FEET OF THE FUEL DOCK.



Engine & Controls

AFTER FUELING

1. Close all fuel fill openings tightly until the two red points line up on the fuel fill cap/casting. This is the proper locked/sealed position.
2. Open all hatches as needed.
3. Sniff in the lower bilge and floor storage locker (shown below) for gas fumes. If fumes are detected continue to ventilate until the odor is gone. Look for any traces of fuel droplets or spillage. Do not start the engine, smoke or run any electrical components until the fumes can no longer be detected.



FUEL FILL CLOSED AND POINTS LINED UP

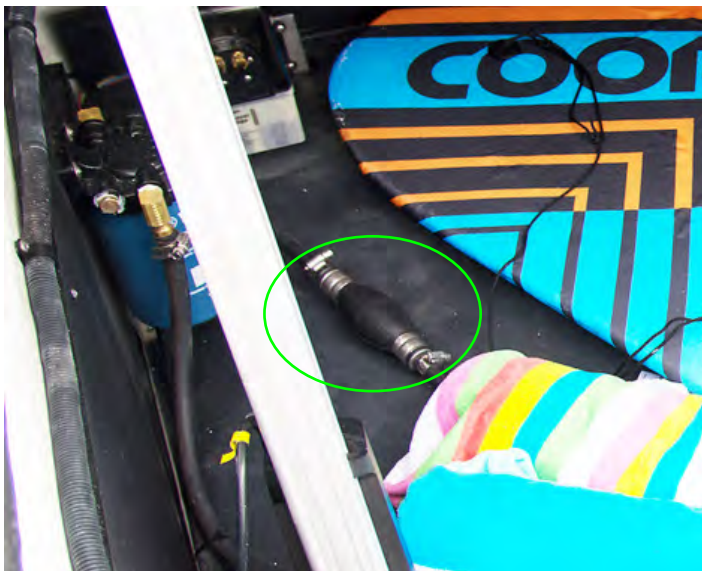

4. Locate the fuel line primer bulb. Hold it at an upward angle and pump it until firm. Periodically check the bulb for loose connections especially at the fuel tank and at the engine end. Also, check for signs of cracking on the bulb rubber surface which can develop with humidity and age.



STARTING THE OUTBOARD ENGINE

The following general information covers the starting and stopping of your outboard engine. Read and understand all previous information on remote controls, fueling and operational procedures. Pay particular attention to all danger, warning and caution labels. Refer to the engine owner's manual for in depth propulsion system information.

Review all pre-departure information. Before starting your engine make sure all canvas is in their boots and stored.

Start engine only in a well ventilated location to avoid CO buildup.

Turn the battery switch to the "on" position.

Set the remote control handle in the neutral straight up position. Advance the neutral throttle position as earlier instructed or refer to the engine owner's manual. Connect the safety lanyard to a belt or secure to the arm. Keep passengers seated and away from controls.

STARTING GUIDELINES

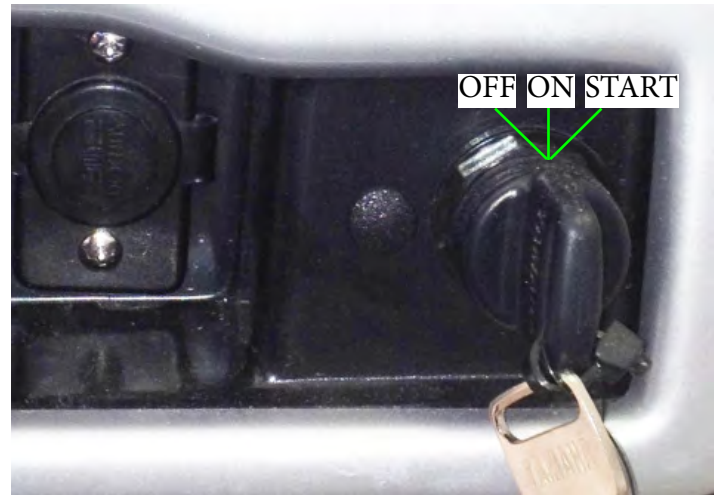

Refer to the key switch position photo above.

Turn the ignition key right to the "on" position. This is known as the "run" or ignition position. Turn the key further right to the momentarily "start" position. Since this key position is "spring loaded" you will need to hold it there. You will hear the starter cranking over the engine. When the engine starts release the key switch. It will automatically align itself in the run position (ignition). If the engine does not start refrain from cranking the engine over 10-12 seconds. Allow the starter and battery a chance to recover.

Once the engine starts, advance the remote control in the neutral throttle position as recommended in the engine manual. Let the engine warm up for a few minutes. Do not race the remote control in the neutral position.



Engine & Controls

AFTER STARTING OUTBOARD ENGINE



POST-STARTING OUTBOARD ENGINE CHECKS

1. Check for a steady stream from the cooling water pilot located on the starboard side of the outboard on a casting below the shroud. Water must be flowing at all speeds out of the pilot hole (see photo). A less than steady flow may indicate possibly one of the following:
 - a. Obstruction in the power head water passages
 - b. worn water pump or plate
 - c. Weeds covering water intakes on vertical drive hsg.
 - d. Pilot hole is plugged with debris. Take a small solid core wire and move it in and out of the pilot hole several times while engine is running. If flow increases the take time to further clean the pilot hole.
2. Let the engine warm up for several minutes listening for any alarms or low oil pressure alerts along with watching the analog helm gauges on selected models. In another scenario the operator can activate the Garmin chartplotter or the RegalVue if installed and program the unit to the engine gauge screen and observe the gauge functions. See the screens on the following pages.

WARNING

AVOID SERIOUS ENGINE DAMAGE!
CHECK THE LOW OIL PRESSURE-ALERT
INDICATOR FOR BLINKING AFTER STARTING.
IF BLINKING SHUT DOWN ENGINE.
INVESTIGATE THE PROBLEM.
CALL YOUR CLOSEST REGAL DEALER OR
MARINE PROFESSIONAL I
F THE CAUSE FOR THE PROBLEM
CANNOT BE FOUND.





HELM INSTRUMENTATION

The helm station may be equipped with a fuel or trim gauge and depth gauge along with the ability to monitor engine functions through the Garmin chartplotter or the RegalVue unit if installed. Selected dashes will show analog gauges alone. Close observation of the gauges may save the engine from damage. Gauges do however have some inaccuracy, so do not rely upon them fully.

Note that with the battery switch in the “off” position, there is no power to the dashboard, and the ignition switch will not function properly.

All electrical features are protected by a main fuse mounted close to the battery switch. A fuse for the stereo memory and the automatic bilge pump system are also located next to the battery switch in the bilge. Fuses for the engine are located either in-line, between components, or in a fuse box. All the switches on the dashboard also have a fuse, located in the forward starboard storage area directly in front of the helm. Should a fuse “blow” it is first necessary to figure out the reason and address the cause before resetting it.

AUTOMATIC CHARGING RELAY/ M-ACR

Note on outboards with dual battery systems there is an automatic charging relay installed on the battery management panel.

The purpose of this device is to protect vessel electronics by temporarily isolating house loads from the engine circuit during the engine cranking cycle.

Also, it automatically combines batteries during charging, isolates batteries when discharging and helps prevent house battery voltage spikes and sags. This device supports outboard alternators up to 65 amps. **Remember when charging up a low or dead battery with the ACR and the dual battery switch, you must select the COMBINE BATTERIES section of the dual battery switch for the low battery to recharge.**

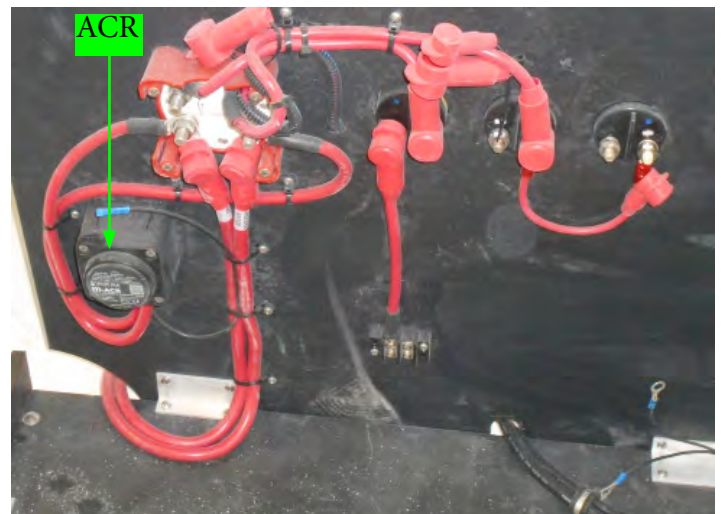



GARMIN ENGINE MONITORING DISPLAY



If a Garmin chartplotter is installed on your vessel it features many GPS features along with the ability to monitor engine system functions including revolutions per minute (rpm's), GPS speed, voltage, fuel flow rate, trim, and temperature along with tracking engine hours.

Note that the Garmin and Fusion circuitry use individual sources to power up the system. The key switch does not power up these 2 systems. Also, the depth and fuel gauge displays are independent of the Garmin engine displays.

1. To power up the Garmin GPS press the on button located on the upper display.

2. The function AV/Gauges,Controls will appear as one of the choice boxes. Press the box. Another screen with engine will appear.

3. Press the engine box and the engine gauge displays will appear (oil pressure is engine code driven only); fuel level uses dash gauge to display fuel levels).



REGALVUE ENGINE MONITORING DISPLAY

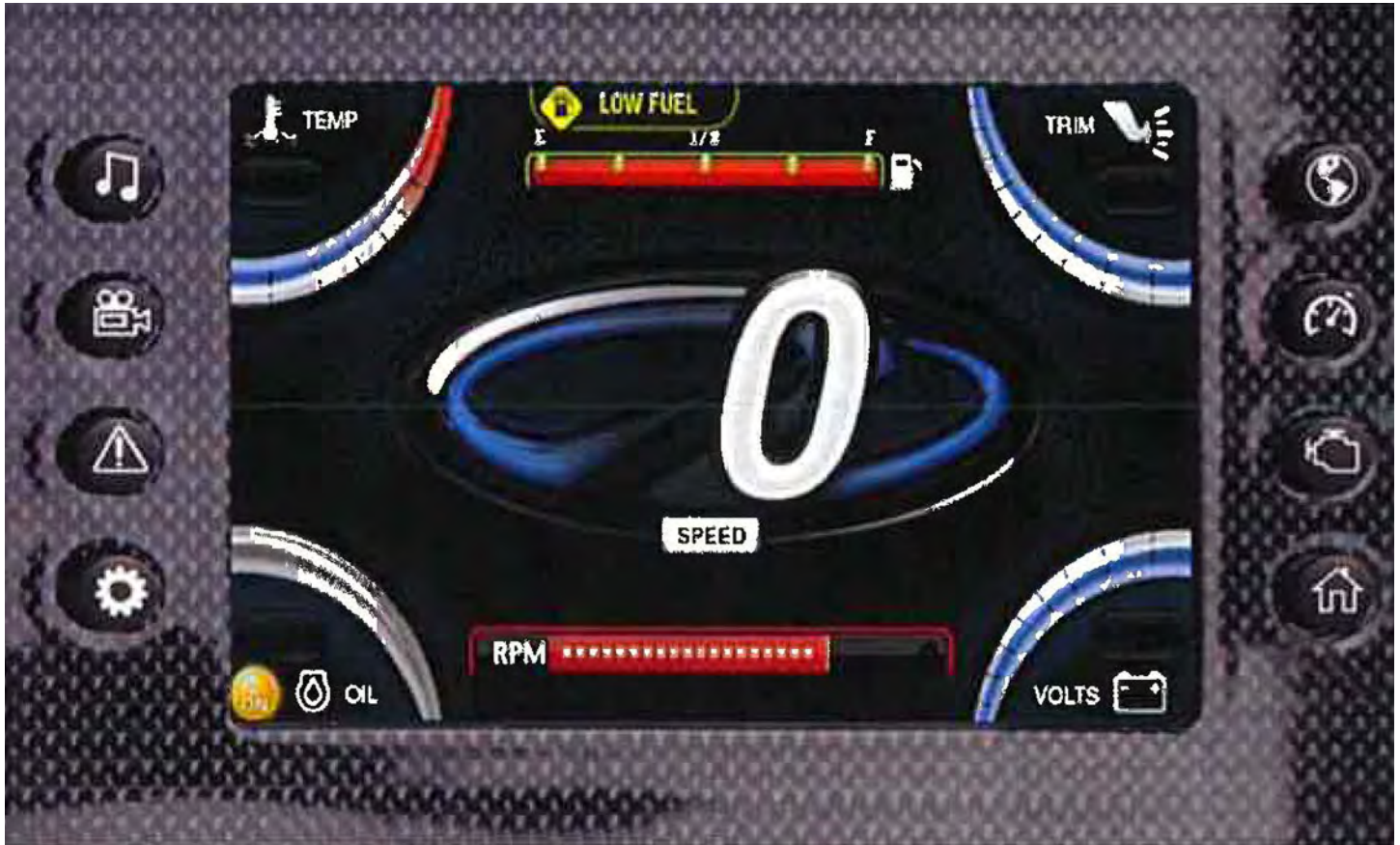

If a RegalVue display is installed on your vessel it features many GPS features along with the ability to monitor engine system functions including revolutions per minute (rpm's), GPS speed, voltage, fuel flow rate, trim, and temperature along with tracking engine hours. The ignition key must be energized for the RegalVue to be programmed or viewed.

The engine statistics can be accessed by pressing the Quick Access Key with the engine icon. This feature displays a summary of engine functions transposed to statistics read by the software as it receives signals from the engine itself.



Engine & Controls

The display may include:

- Engine Temperature
- Oil Level
- Fuel Level
- Speed
- Engine RPM's (Revolutions Per Minute)
- Trim Tabs
- DC Volts

Note as part of Touch Screen Navigation you will find touch points made up of words or graphics that are highlighted with a soft glow.

SHOW DATA BAR when touched is a popup that will display and maintain the engine data at the bottom of the screen when you are using other screens making it a valuable tool when cruising.

The data bar can be customized in the Data Bar Setting display. Select the number of desired slots to be displayed 3,4, or 5 on the first screen.

After the number of slots have been selected, choose the stats to be displayed and the order in which you want them displayed at the second screen.

Touch (DONE) when finished and the data bar will appear with the changes chosen.

As a safety measure the fuel level indicator is always displayed first and cannot be removed from the display.





SHIFTING GUIDELINES



Before shifting into reverse or forward gear positions make sure the coast is clear. When shifting to either gear from neutral make sure the throttle is in the idle position.

Warm up the engine at least 3 minutes in neutral before

shifting into gear. Before the engine is at operating temperature, the idle speed may be higher than normal. High idle speed can keep you from shifting back to the neutral position.

If this occurs, shut down the engine and shift the gearshift into neutral. Restart engine and allow normal warm-up period.

When ready to shift the remote control lever **out of neutral into gear** move it firmly crisply forward (for forward gear) or aft (for reverse gear) or around 35 degrees you will feel a detent at this point in the forward or reverse gear positions. After this point in the forward or reverse gear position the remote control lever picks up throttle only.

When ready to shift the remote control **from either forward or reverse gear into neutral** pull the throttle slowly from either gear firmly to the straight up neutral position. Be prepared for the vessel to take a few seconds for the vessel to slow headway and to assume an engine idle position.

Practice shifting! You will become more familiar with the procedure and self-confidence will build especially in tight docking situations. Stay alert at all times!



STOPPING THE BOAT

Allow your vessel to lose all headway before shifting from reverse or forward gear into neutral. Do not use the reverse gear function to stop the boat at speeds above idle as it could cause the operator to lose control, be ejected or impact steering wheel functions.

Note that bodily injury could occur or damage to the shifting mechanism including the gear case gear unit.

Do not shift into reverse at planing speeds as the operator could lose control, be ejected or the vessel could be swamped by taking water over the transom area.

Remember that the operator is responsible for his passengers! The vessel cannot “stop on a dime” but requires a safe distance to stop headway. Of course this distance is effected by watter current, wind velocity and direction, along with the weight of the boat and how it is balanced.

Passengers shall occupy designated seating positions only while the vessel is making headway. Make sure everyone including the operator are wearing their life vests while cruising.

STOPPING THE OUTBOARD ENGINE

If available it is always a plus to fill the vessel at the marina gas dock if vessel is moored there as you will be then ready for the next cruise.

After cruising and returning to your mooring let the engine cool down at an idle position for several minutes.

Turn the ignition to the “off” position or pull on the safety lanyard cord to stop it. This last endeavor assures that the cut-off system is functioning properly.

Remove the key from the ignition switch. Do not leave the key on the vessel to avoid possible theft. Store at home on a key rack for future use. It is recommended that you put your boat key on a float to prevent submerision and subsequent loss.

When the engine has stopped turn off the single or dual battery switch at the aft located battery management panel.

Cover the vessel with appropriate bow and cockpit covers and/or mooring cover if installed.



FLUSHING ENGINE OUT OF WATER

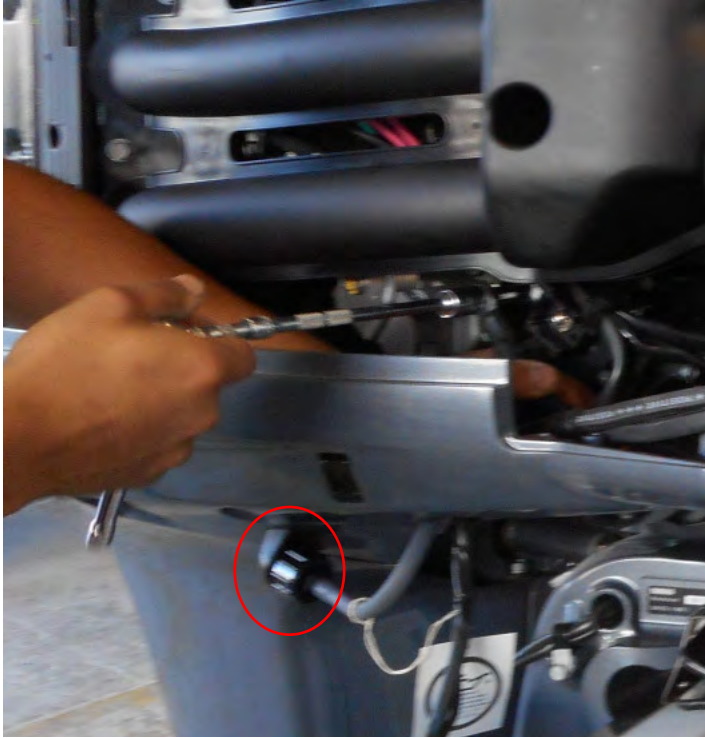

Note that flushing devices that attach to the water intake area of the vertical drive housing can be used with a garden hose to flush the power head. When the water is turned on at the faucet the engine can be started and ran at idle.

These devices also called flushettes can be purchased at marinas, marine speciality stores or can be ordered through the outboard manufacturer. They can be useful for off season fogging of the power head or starting up the engine out of water.

Contact your closest Regal dealer or marine professional for further information and instructions.

Your outboard may feature a flushing device which when connected to a garden hose circulates fresh water through the engine to purge unwanted debris such as found in salty, brackish, and silty water.

To use open the flushing device by turning it counterclockwise. Notice there is a garden hose bib thread. Attach the male end of a garden hose to the fitting and tighten it. Make sure the fitting does not leak as the power head could overheat and cause internal damage. It is best to perform this flushing procedure with the engine still warm from a cruise as the thermostat will be open and will permit more efficient water circulation. Turn on the fresh water supply. When flushing completed remove the garden hose from the fitting and reattach the hose connections and of course check for tightness.



OUTBOARD STORAGE/WINTERIZATION

Your outboard has various detailed systems that are affected by extended storage periods. These systems require professional maintenance to protect the components from extended out of use periods especially in freezing climates.

See storage/winterization information in your manufacturer's outboard owner's manual for a listing of maintenance items.

We recommend leaving storage/winterization endeavors to your closest Regal dealer or marine professional. They have the special equipment, parts, lubricants and technical knowledge to perform these procedures correctly the first time.

Regal boat system storage/winterization tips are noted in the storage and winterization chapter. We recommend leaving these procedures to your closest Regal dealer or marine professional.



Vessel Operation



This chapter explores select parts of running your vessel from casting off to docking and handling emergencies.

We recommend further reading to enhance your information on the chapter

topics. Also, become familiar with your engine owner's manual since many of the items noted here are found there in further detail.

GETTING UNDERWAY

Pre-Departure Questionnaire

- Have all fluid levels been topped off?
- Is the fuel tank full?
- Are the propellers in good condition?
- Is the drain plug in place (dry stored vessels)?
- Have all passengers been briefed on all emergency procedures and seated for departure? Is the boat load balanced?
- Is all safety equipment accounted for and easily accessible?
- Are navigation lights and sound signals in good working condition?
- Is the bilge free of water and do the bilge pumps operate?
- Is the operator sober, alert and ready to skipper the vessel?
- Have all passengers been fitted for the proper size life jackets?
- Has a float plan been filed and left with a competent person?
- Has the bilge been sniffed and the fuel system leak checked?
- Are the appropriate sea cocks open?
- Is all communication equipment in good operating condition?
- Has a second person been briefed on operational, emergency, and VHF procedures should the skipper become disabled?



- Are all gauges and electrical switches functioning properly?
- Has weather information been gathered and analyzed?

UNDERWAY QUESTIONNAIRE

- After casting off have all dock lines and fenders been stowed?
- Are all passengers seated?
- As skipper are you monitoring the dash gauges and chart plotter for changes?
- As skipper are you on the lookout for changing weather?
- As skipper are you checking for abnormal vibration or steering?

DISEMBARKING QUESTIONNAIRE

- Have you removed the keys from the ignition and secured them?
- Have all systems been checked for leaks?
- Have the battery switches been turned to the “off” position?
- Are all storage compartments and seacocks closed?
- Has the fuel tank been filled enough to assist in preventing condensation?
- Is the vessel properly tied and covered with equipment stored?



WARNING

PRACTICE “NO SMOKING” AND EXTINGUISH ALL FLAMMABLE MATERIALS WITHIN 75 FEET OF ANY FUEL DOCK.



WARNING

PREVENT INJURY OR DEATH FROM FIRE CAUSED BY LEAKING FUEL. INSPECT ENTIRE FUEL SYSTEM AT LEAST ONCE A YEAR.



WARNING

TO PREVENT INJURY OR DEATH USE ONLY GENUINE MARINE ENGINE/DRIVE REPLACEMENT PARTS



BEFORE FUELING

- Make sure a working fire extinguisher is at close hand.
- Stop engine while fueling.
- Disembark all passengers and crew not needed for fueling.
- Fuel if possible during the daylight hours.
- Check to ensure nobody is smoking in the boat or near the fueling dock.
- Close all enclosures to keep vapors from blowing aboard and settling in the bilge.
- Tie up your boat securely at the fuel dock.
- Identify the fuel fill.
- Visually inspect all fuel system components before each filling.

DURING FUELING

- Keep the fuel nozzle in contact with the fuel fill to guard against static sparks. The fuel fill pipe is grounded through the fuel system wiring to protect against static electricity.
- Avoid overfilling the fuel tank. Leave room for expansion.
- Avoid spilling any fuel. Clean up any fuel accidentally spilled with a clean rag and dispose of it on shore.

AFTER FUELING

- Close all fuel fill openings tightly.
- Sniff in the lower bilge and engine compartment for gasoline fumes. If fumes are detected find the cause of the gasoline odor until the odor is gone. Look for any traces of fuel droplets or spillage. Do not start the engines, smoke or run any electrical components until the fumes can no longer be detected.



STARTING & STOPPING

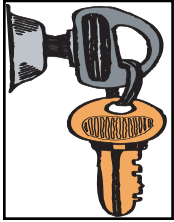

The following general information covers starting and stopping your engine. Read and understand all previous information on remote controls, fueling and operational procedures. Pay particular attention to all labels. Refer to the engine operation manual for in-depth propulsion system information

as most are model specific.

Review all pre-departure information. Before starting your engine make sure all canvas is removed and stored. Start engine only in a well ventilated location to avoid diesel exhaust buildup. Make sure all battery switches are activated. Close and lock the center windshield section.



WARNING

AVOID SERIOUS INJURY OR DEATH!
THE OPERATOR OF THE CRAFT
MUST HAVE COMPLETE CONTROL
OF THE HELM STEERING STATION
WHILE THE VESSEL IS MOVING.
NEVER LEAVE THE HELM
STEERING STATION UNATTENDED
WHILE THE VESSEL IS MOVING.

STARTING GUIDELINES-STERN DRIVE

Position the remote control handles in the neutral position. Keep passengers seated and away from controls. Note: With the Volvo EVC-D control station will be activated once the ignition key is in the "ON" position (key position I) At this point the neutral "N" icon will display a green light .

Next, turn the key to the start position (key position III). You will hear the starter cranking over the engine. When the engine starts release the key switch. If additional cranking attempts are needed, the key must be returned to the 0 position first.

If the engine does not start, refrain from cranking the engine over 10-12 seconds. Allow the starter and battery a chance to recover. Advance the remote control in the neutral throttle position only as recommended in the engine manual. Do not race the remote control in the neutral position.

On later EVC-D systems, turn the key to the "ON" position and then to the start position. Release the key. The starter will continue to crank until the engine starts. With this system once the keys are engaged in the automatic start position they are disengaged if you try to turn them again to the start position.

On select Volvo engines a key fob system is used to start the engines. The system uses two main parts; the key panel and the key fob. Two key fobs come with dual engine installation along with a 2.5" key panel. The key panel uses lighted icons to show active ignition and start/stop positions. Theft protection is vastly improved with the E-key system.

If the starter stays engaged for more than 30 seconds the circuit is automatically cut to protect the starter from overheating. If this happens, let the starter cool for several minutes before attempting to restart the engine.

Note: With all the above systems, refer to the Volvo operator's manual for further information.

The MerCruiser DTS system operates in a similar manner. Both systems use helm mounted panels for system control. Refer to the engine manual for more information.



SHIFTING GUIDELINES

Before shifting mechanical controls into reverse or forward make sure the coast is clear. When shifting to either gear from neutral make sure the throttle is in the idle position. Do not pause but engage the shifter quickly into the desired gear. Allow your vessel to lose all headway before shifting into reverse or forward gear. Practice shifting! You will become more familiar with the procedure and self-confidence will build especially in tight docking situations. Most importantly, stay alert! If installed, when maneuvering into a tight slip or pier be sure to use the joystick “docking” button. If the current or wind is strong use the joystick “high” button which will supply increased idling speeds.

STOPPING GUIDELINES

Before stopping the engine make sure it is in neutral and at idle speed. After an outing let the engine cool down by idling for a few minutes before turning the ignition off. Glance at the gauges one last time to monitor their readings. Never turn the engine off while in forward or reverse gear or back up in excessive speeds since water could enter the engine through the exhaust system and cause extensive damage. Above all, use common sense!

 **CAUTION**

AVOID ENGINE DAMAGE!
CHECK THE OIL GAUGE IMMEDIATELY
AFTER STARTING ENGINE.
IF LOW OR NO READING
SHUT DOWN ENGINE IMMEDIATELY
AND INVESTIGATE THE PROBLEM.

 **CAUTION**

TO PREVENT INJURY DUE TO FALLING
DO NOT OCCUPY AFT SUN PADS WHILE
VESSEL IS MOVING!



FENDERS



FENDER USAGE

Fenders are normally made of a rubberized plastic and are usually filled with air. Most have a fitting like a basketball so they can be inflated or deflated. Fenders are available in a wide range of sizes and shapes to fit both small and large vessels. Fenders are normally designated in inches. They are used for protection between piers, docks, sea walls and the vessel. They protect the topsides of the boat from

rubbing against rough objects. Most fenders have attachment eyes which allow a line to be inserted vertically or horizontally. This will permit the fender to be tied off to fit individual dock and tidal situations. Be sure the fender is correct for the vessel size. The standard fenders specified for your Regal yacht are 10" in diameter and 26" long. It is a good idea to carry extra fenders but half a dozen is normally an acceptable number. Remember to store fenders on board so they can be easily accessed. The forward stairway locker stores 2 fenders. Sometimes people call fenders "bumpers" but this is not correct nautical terminology.

FENDER TYPES



Additional yacht fenders can be ordered through your Regal dealer. Explain how you moor and use your vessel so your dealer can recommend the best fender type for you. We suggest the type with a fill plug so you can inflate them with a hand pump like the ones used for bicycles or a 12 volt compressor (plugged into the 12 volt dash accessory plug).



DOCK LINE BASICS

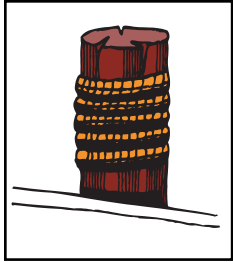

Most skippers use dock line terminology fairly loose but there is more to the basics than just bow or stern lines. There are several lines that can be secured to the bow and stern and depending on their direction and use, can be called other names. Remember that “forward” and “aft” refer to the direction that a spring line runs from the vessel, and not where it is secured on board.

BOW AND STERN LINES

There is only one true bow line. It is secured to the forward cleat and run forward along the dock to prevent the vessel from moving to the stern. The stern line leads from a rear cleat to a piling or cleat on the dock astern of the vessel. This line keeps the boat from moving ahead. For small vessels these are the only lines needed for normal wind and current conditions. If located in a tidal environment, keep slack in the lines.

BREAST LINES

These lines are attached to the bow and stern that lead to nearly right angles from the center of the vessel to the dock. They help keep larger vessels from moving away from the dock, or are pulled in to help people board the vessel. Bigger vessels may use bow or quarter breast lines.

SPRING LINES

Most boats use two spring lines although it is possible to have four. They are called the after bow spring and forward quarter spring.

Bow springs are secured at the vessel's bow area. Forward spring lines lead forward from the boat to the dock and control movement stern ward. After springs stem aft from the vessel, and stop movement ahead. Spring lines are used to prevent movement in a berth, ahead or astern. They are really useful in controlling the effects of a real active tidal surge. Spring lines are useful where fenders need to be kept in place against piles.

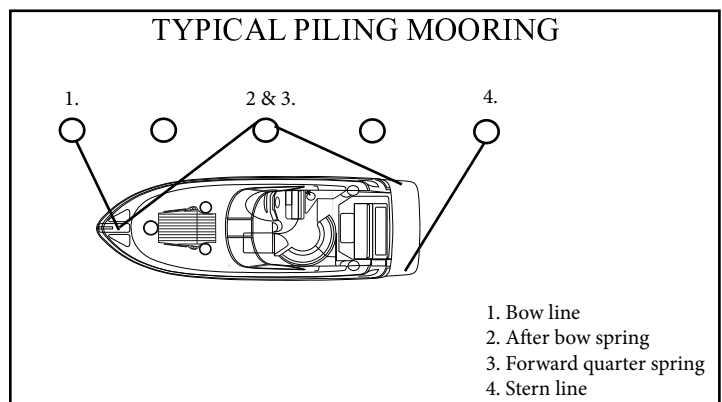
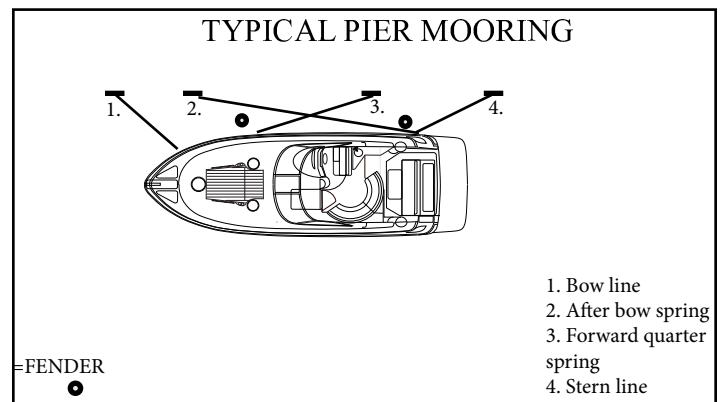

BOAT MOORING

Most boats can be secured to a dock using four lines. The after bow spring is crossed with the forward quarter spring and secured to individual dock cleats or pilings. This ensures longer springs and can be snugged up tighter for more efficient tidal control. Remember, if you only have one piling available, position the vessel so this point is opposite amidships. Run both spring lines to it. These lines will be shorter but still useful.



The bow and stern lines should be relatively at a 45 degree angle with the dock. The stern line can be attached to the near-shore quarter cleat, but will work more efficiently to the offshore quarter cleat. The longer line will allow the boat flow with the tide with less time checking the vessel.

DOCK LINE SIZING

Most dock lines today are made of nylon, either of twisted rope or braided core and cover. The most often used material is nylon because of its stretching abilities absorbing shock loads. It is chafe resistant for extended life and is easier on bare hands.

The line's size varies with the vessel. Normally, a vessel in the 50' range will use 5/8" diameter nylon lines.

Dock lines need to have the strength to hold the vessel and have enough density to resist chafing. They shouldn't be too heavy that they lose their shock-absorbing capabilities. Use the right size line for the vessel since a line too large for the boat will pull hard against the vessel since it won't be forced to stretch. If the line is too small for the vessel, there is no margin for wear and chafe when under strain.

SECURING LINES

When mooring your boat, make sure the dock lines are secured at both ends. Depending on your situation you may need to loop the eye splice of the dock line around a piling. Sometimes the mooring line will lead down sharply from the piling to the deck cleat. Loop the eye splice around the piling twice to keep it from being pulled up off the pile. Pull the line through the looped eye if the mooring line is too small to go around the piling twice or too small to fit over once.

If you must drop a line over a piling that already holds another boat's line, run the eye of the line up through the first eye from below, then loop it over the pile. This will allow either line to be removed without disturbing the other. If another line is dropped over yours, simply reverse the process.

Secure a little slack in the other dock line, then slip your eye up through its loop and over the top of the pile. Your line can be dropped through the other eye.

Note: Never use the swim platform cleats for permanent mooring cleats.

DISEMBARKING-LEAVING THE DOCK

When debarking from a dock, it is easier to release the line from a cleat or piling, from on board the boat, as soon as you leave the dock. Loop a long line around the cleat or pier and leading both ends on board you can release the line easily. Slip one end around the cleat or pile, the pull it back on board. Release the line without the eye splice, so it will run freely from around the pile without hanging up on the splice.



KNOTS

Knots are useful in docking, towing and other emergency situations. Learning to tie knots requires practice. As they say “ Practice makes perfect”. Some of the knots used in boating are the square, bowline, anchor bend, clove hitch, figure eight and half hitch. There are several periodicals available that explain various knots and how to tie them effectively. An experienced skipper will know the basic nautical knots and will use them when on the water. Take the time to know the basic knots.

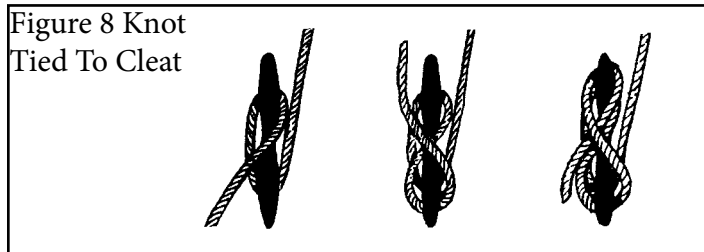

A useful knot to learn for general docking is the figure eight with one end reversed. By turning the free end of the line back under, the knot can be released without disturbing the boat. After some practice one person can secure a vessel easily to a dock or pier in a variety of weather conditions. This knot normally is used to tie the bow and stern. Then the vessel can further be fastened by tying the spring lines in the figure eight knot. Wrap it around the cleat 2 or 3 times.



STEPS TO BASIC STERN DRIVE DOCKING

Inboard/Outboard powered boats are fairly easy to back up and maneuver with a little knowledge and docking practice. One of the most important aspects of the process is to keep your calm in the wake of a busy marina. Basically, the reversing propeller is turned in the direction you want to go by using the wheel.

Some boats tend to be influenced by the wind. When backing down in a crosswind, allow room to maneuver and watch the bow. Try not to overreact or get excited, but use your knowledge and experience. If the wind begins to swing the bow, you need to stop backing, turn the wheel to port and go forward to straighten the boat. Use a quick burst of power but not too much to knock your crew off balance.

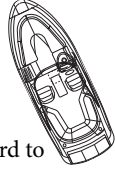
 <p>B. Continue backing up the boat with the wheel hard to port. Keep an eye on the bow, and begin to straighten the wheel as the boat enters the slip.</p>	
<p>* Control in reverse idle position, Outdrive to port.</p>	

 <p>C. Center the wheel to align the boat parallel with the dock. If the stern is too far from the dock, shift to neutral, then put the wheel hard over to port and then go forward a second or two.</p>	
<p>* Control in neutral idle position. Outdrive centered.</p>	

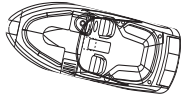
 <p>A. Stop the boat by shifting in reverse. Put the wheel over to the port and begin backing in. Slow down your speed by momentarily shifting into reverse.</p>	
<p>* Control in reverse idle position, Outdrive to port.</p>	

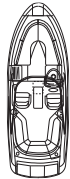
<p>D. When the boat is completely into the dock, stop stern movement by shifting into forward. Put the wheel to port to kick the stern over close to the dock if necessary. Shift into neutral and tie up the boat.</p>	
<p>* Control in forward idle position. Outdrive to port.</p>	



DOCKING WITH FLY-BY-WIRE JOYSTICK

If installed the joystick with a little practice makes you look like a pro while docking your vessel in wind, current, and tight mooring situations.

Read your engine manual to become familiar with the joystick and remote control components. It is a good idea to practice your beginning docking techniques in an open area. Remember practice makes perfect!

Helpful hints using the joystick;

1. For better control hold the joystick knob lightly almost like you would a delicate object. Push the joystick to the port or starboard, forward or aft and the rig instantaneously follows the fine finger movements on the joystick knob. Twist the knob and the boat spins on its own axis.
2. There are 2 buttons on the joystick. Use the gentler left one for most docking (Max. RPM's 1200). The right boost button is most useful in high wind/current situations (Max. RPM's 2000). This mode shows a marked increase in joystick power.
3. Remember that engine must be in neutral before activating the joystick buttons or it will not work.
4. To disengage the joystick press the left joystick button again or engage one of the engine controls into gear.
5. The joystick brain responds to the turns not the position of the wheel. So whatever position you have the wheel facing when you disengage the stern drive joystick that is your new straight ahead position. Most seasoned skippers would position the wheel straight before disengaging the system.
6. You do not have to worry about disengaging the joystick and shifting the control into the drive mode at too high an rpm as the EVC system prevents any shifting above 750 rpm's.

NOTICE

USE THE JOYSTICK ONLY IN DOCKING SITUATIONS. USE THE STEERING WHEEL AND CONTROLS IN ALL OTHER APPLICATIONS.



TYPICAL JOYSTICK FUNCTIONS

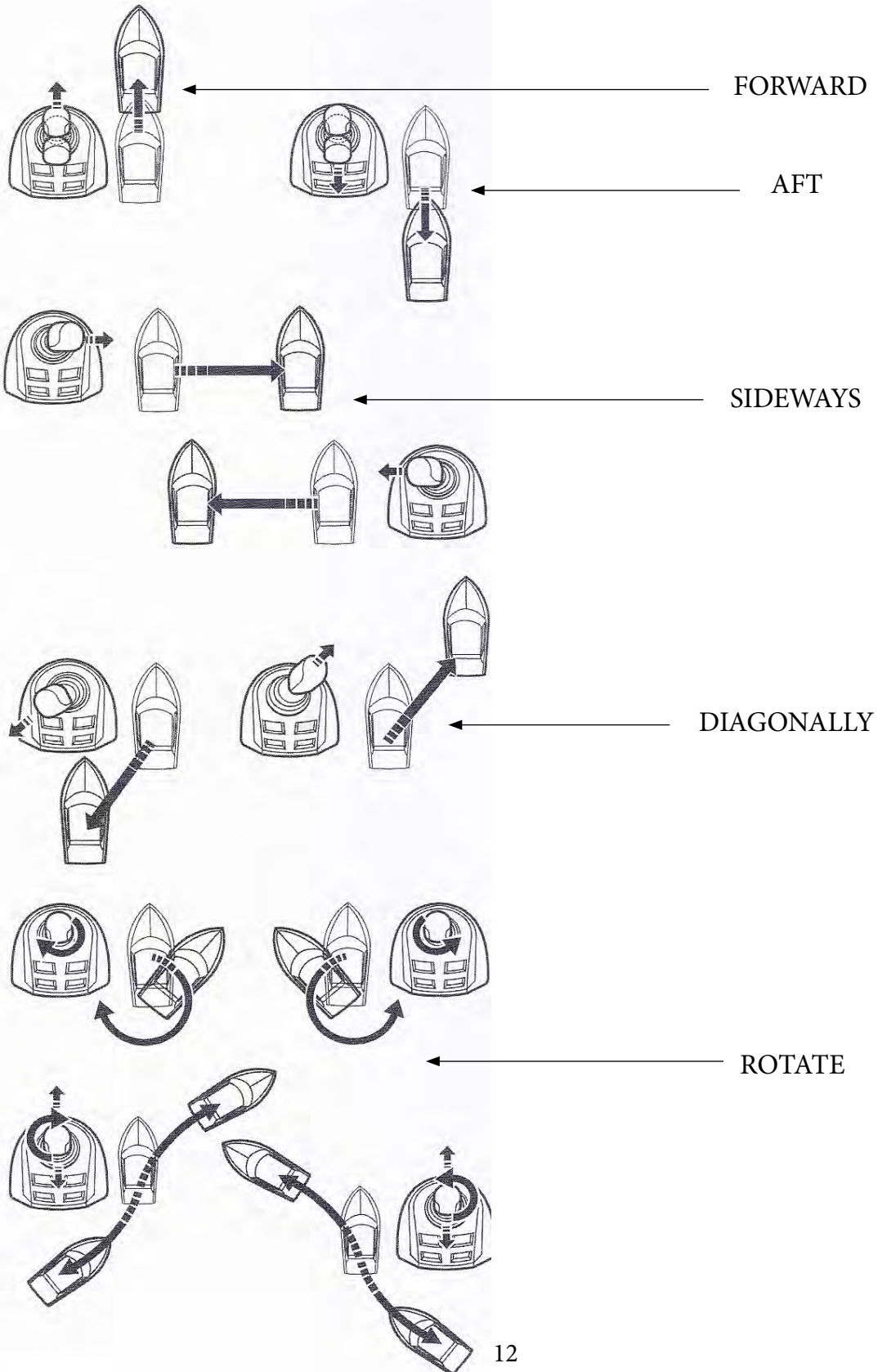



STERN DRIVE MANEUVERING

Inboard/outboard, I/O or sometimes called stern drive boats do not have rudders. The boat uses a steering system that directs the propeller thrust, by turning the stern drive unit where the propeller is mounted. Normally maneuvering the I/O boat is easier than a similar single screw vessel.

Directing propeller energy (thrust) makes slower speed maneuvering easier. The propeller discharge current is turned from one side to the other which results in turning forces. Rudder boats need water to flow by the rudder to be efficient. Stern drive units are designed to have reduced shaft angle, so the propeller does not produce as much unequal blade thrust and resistance as does a propeller on a single screw boat. Large horsepower stern drive boats do produce more thrust and steering torque but your vessel has the advantage of power steering. Below is some basic information on how single stern drive boats handle in normal conditions.

GATHERING HEADWAY

When a stern drive is not moving forward or reverse in the water and the propeller is not turning, (shift in neutral) the boat will not react to the helm steering wheel. As soon as the vessel is shifted into forward gear the propellers action creates a discharge motion and generates energy in the form of thrust. If the stern drive is centered, the discharge motion is directed straight back causing the vessel to advance forward.

You may notice that if you advance the throttle quickly in initial take-off (make sure you have a firm grip on the wheel), the boat has a tendency to pull the stern of the vessel to starboard.

There is a trim tab (also serves as a sacrificial anode) located on the vertical drive housing just to the top of the propeller blade. This trim tab helps compensate for the low speed steering torque. Once the boat increases headway and the propeller is operating in a faster water flow this torque effect decreases.

Sometimes the trim tab may need adjustment on stern drive models. Contact your Regal dealer for further information or consult your engine manufacturer's manual.

TURNING

Once the boat has gathered headway, with the boat planing at the correct bow angle and the stern drive unit and helm straight the boat tends to stay on a uniform course heading. To assure the boat trim angle is correct use the trim gauge as a guide while activating the trim button on the remote control panel.

When the helm wheel is turned to the right or starboard, the stern drive unit is turned in the same direction. The propeller's discharge force is directed to starboard forcing the boats stern to port. Water flowing past the hull strikes the stern drive gear housing in its starboard side, creating additional turning torque. The stern starts a move to port, forcing the bow to starboard.

If the helm is turned to the left or port the stern drive turns to port, the stern of the boat goes starboard as the bow turns to port.

As the vessel operator gains experience, he will better gauge each maneuver and speed situation. In this way he will understand the handling characteristics of his boat. He needs to keep the safety of his passengers in the highest priority.



BACKING DOWN

Inboard/Outboard (I/O) boats do not have rudders. The boat uses a steering system that directs the propeller thrust, by turning the stern drive unit where the propeller is mounted. Normally maneuvering the I/O boat is easier than a similar single screw vessel.

If your boat has the steering wheel and stern drive straight with the control in reverse, the stern will be pushed a bit to port by the reversing propeller thrust. This tendency to back to port can be eliminated by turning the stern drive to starboard.

When the vessel begins to gather speed to stern, the water passing by the lower gearcase housing will continue to increase steering torque. If the helm wheel is turned to starboard, and will direct the propeller thrust to port, tracking the stern to starboard.

Wind and current will affect how a vessel backs. Stern drive boats tend to be light displacements and when backing down in a strong crosswind, the bow will tend to fall toward the windward. This may cause steering problems.

Once increased headway is gathered in reverse gear, the force of the lower hull moving through the water is enough to track straight. When backing, the stern will lead as it heads to port or starboard, before the vessel

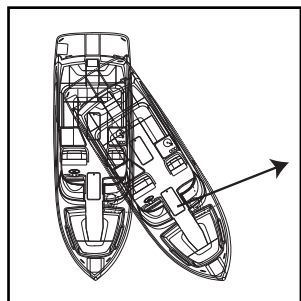

actually starts to turn.

When the control is put in forward gear position, the stern is pushed to starboard; the amount of push depends on the hull design and the amount of throttle advance. See illustration.

STOPPING

Remember that your boat does not have any brakes. It uses reverse thrust from the propeller to stop. If the vessel has headway, with the helm and propeller in reverse the propeller thrust is directed backwards, past the lower gear case of the stern drive.

Depending on how far the throttle is advanced, the discharged thrust may not be strong enough to reverse the water flowing by the gearcase. As the power is increased, the propeller thrust becomes strong enough to stop the flow of water past the lower unit, and, as the throttle is advanced it reverses its flow more completely.

When water is flowing past the gearcase, steering torque is increased, but when the thrust stops the water flow, the boat will not respond to the helm. This is a short lived event and is overcome quickly when the water again flows past the gearcase. Furthermore, added to the



STEERING-NON FLY-BY-WIRE

Vessels without “fly by wire” steering feature a rotary or rack style steering system. These systems transfer helm mechanical motion to the engine. There is a hydraulic steering cylinder which with the assistance of a steering pump sends fluid force to the stern drive steering arm changing the course of the boat, depending on the direction the steering wheel is turned.

Since the steering system is the primary link for engine control, it must be periodically inspected and maintained. The hardware at both the helm and engine must be checked regularly for tightness.

Check the steering system for full steering port and starboard before disembarking. Refer to the steering manufacturer’s literature in the engine owner’s manual. See the typical steering cylinder on the next page.

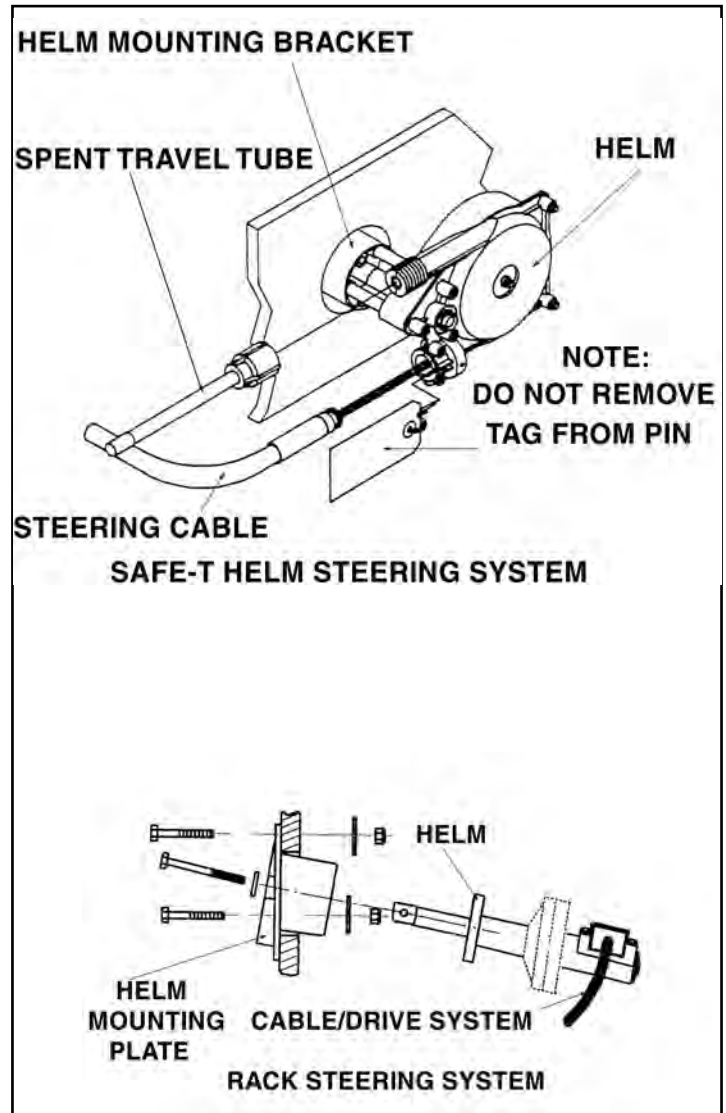

WARNING

AVOID INJURY AND PROPERTY DAMAGE!
LOOSENING OR LOSS
OF ONE OR MORE FASTENERS
MAY CAUSE STEERING SYSTEM FAILURE OR
DAMAGE TO THE STEERING CABLE
RESULTING IN LOSS OF STEERING CONTROL.
INSPECT THE STEERING SYSTEM ANNUALLY.



TYPICAL NON FLY BY WIRE STEERING CYLINDER

CHECK HOSE CONNECTIONS FOR LEAKS & TIGHTNESS

CHECK NUT FOR TIGHTNESS.





ANCHORING



An anchor locker is standard equipment which features a tie off ring. A stainless steel plow type anchor would be a great choice for your vessel. Look for a 20 pounder which is adequate for a 26' boat under most conditions.

The anchor will set quickly in a variety of bottoms because of its unique shank profile and ballasted tip. It is a high holding type anchor. Anchoring is easier with another person on board. First be certain that the line for the anchor is properly attached, to avoid losing the anchor and anchor line overboard.

For more efficiency, a length of galvanized chain can be added to the rode length. The chain will stand up to the abrasion of sand, rock, or mud on the bottom much better than a nylon line. Being galvanized the chain will resist corrosion. Approximately 175' of 3 strand nylon line is recommended to ensure an adequate scope in different depths and weather situations. The nylon will stretch under a heavy strain cushioning the impact of waves or wind on both the boat and the anchor.

To anchor, select an area preferably with a flat bottom. Mud, sandy clay and firm sand afford the best bottoms for anchoring. Grassy bottoms often resist the anchor taking hold and end up pulling out grass and roots. Contrary to modern belief, you do not anchor while the boat is making headway, or moving forward. In fact, the bow of the boat should be brought slowly backward, while releasing the anchor until it hits the bottom. To "snub the line" means to stop its outward "pay" or movement. Usually the length of anchor line used should be 5 to 10 times the depth of the water depending on weather conditions. This ratio is called the "scope"; the minimum scope under average conditions is 7 or 8:1. If the scope is too short the anchor's efficiency is diminished. A longer scope cushions the shock load on the entire system.

Once a scope is determined sometimes it is difficult to know how much line to let out to reach the desired scope especially at night. One way to mark an anchor line that will identify the amount of line is to paint wide and narrow bands from about 50' to 150' in 10' intervals. The wide bands equal 50' and each narrow band would equal 10'. Distinguish each 50' band with a different color paint. This can be done with "see in the dark" paint. Simply tape each length for the appropriate band before painting it. After you have anchored, check your position with landmarks if possible. You need to continue to monitor these landmarks to make sure you are not drifting. Since anchoring can also be an emergency procedure, the anchor and line should be readily accessible. Check anchor locker to ensure an untangled anchor line. Once anchored the anchor line must be secured to a strong tie such as a cleat.

Do not rely on the windlass brake to carry the anchor rode load.

Use a series of full turns and half-hitches around the cleat horn to prevent any line slippage or jamming. This is important as the scope may need to be adjusted over a period of time and you need swift access to the line.

For increased holding power in windy conditions, two anchors are sometimes set. If your primary anchor drags, you can run out your secondary anchor without picking up the primary one. The important thing is to lay them out at an angle. When setting two anchors, make sure they are fastened to separate strong ties such as cleats. This is done in case you need to adjust one later so the line must be accessible.

Note: In times of high waves a buoy on the rode works as a shock absorber and allows the vessel's bow to ride the wave crests without large strains being transmitted to the set anchor. These plastic foam buoys can be purchased at boating retail outlets.



TOWING

In case you find yourself aground or in need of a tow, or should you want to tow another vessel, keep in mind that you never use deck hardware or cleats to secure lines for towing!

Deck hardware is intended for mooring and anchoring, and is not designed to withstand the strain and pull of towing. Rather than tie the line to your cleats on deck, it is suggested that you tie a bridle by passing a line completely around the hull of your boat to avoid structural damage. When towing, always stand clear of a taut line, as any type of line breaking under stress can be extremely dangerous. The preferred line for towing is double-braided nylon, as it has sufficient elasticity to cushion shock loads. Move slowly and cautiously.

ADMIRALTY LAW

The Admiralty law sometimes referred to as the salvage law was founded primarily on English law fundamentals and basically says that a vessel distressed, in danger of flounder, if rendered assistance from a towing company or private agency, can be forced to relinquish a portion of the vessels' worth for the assistance received.

 **DANGER**

AVOID DEATH OR SERIOUS BODILY INJURY!
DO NOT USE DECK HARDWARE
INCLUDING CLEATS FOR TOWING
OR LIFTING PURPOSES.

NOTICE

IN THE EVENT YOUR VESSEL
IS IN DISTRESS
PRIOR TO ALLOWING
ANY TOWING COMPANY
OR PRIVATE AGENCY THE RIGHT
TO PASS A LINE TO YOUR VESSEL,
BE SURE TO ESTABLISH THAT YOU
DO NOT AGREE TO ANY SALVAGE RIGHTS.
ESTABLISH WITH THE CAPTAIN
OR OPERATOR
THAT YOU WISH TO BE ASSISTED
IN A CONTRACT BASIS
AND ESTABLISH A PRICE.
OF COURSE IN CERTAIN SITUATIONS,
YOU MAY NOT HAVE THIS OPTION.
USE YOUR BEST JUDGEMENT!



EMERGENCIES

Always be ready to help others on the water if possible, but do not take any unnecessary risks. Use equipment to save a life, but do not risk a life to save equipment. Consult earlier information in this manual concerning accidents, etc. Also, read other literature concerning on the water emergencies. Be alert and prepared!

FIRE

Fire aboard a vessel can spread quickly and can cause tremendous alarm among everyone. Most fires can be prevented by keeping the bilge free from oil and debris. Keep all equipment stowed and maintained in working order. Carry backup fire extinguishers on board. If something becomes a possible fire hazard, remove that possibility at once.

Never use water on gasoline, oil or electrical fires. When you dump water on an electrical fire you can be shocked since water conducts electricity.

Follow these instructions if a fire breaks out:

1. Fit everyone aboard with a life jacket. Turn off the ignition switch.
 2. Try to keep the fire downwind. If the fire is to the stern, head the bow toward the wind. If forward, put the stern to the wind.
 3. If the engine should catch fire, shut off the fuel supply. Usually there is a fuel tank access that you can crimp the fuel feed line.
 4. Use a hand fire extinguisher. Make sure to insert it into the fire port location. Release entire contents of portable extinguisher. Remember: (A 4 pound extinguisher discharges in approximately 20 seconds)
- These actions help prevent the fire from spreading to other parts of the boat. You can extinguish fires quickly if you act swiftly. Have a plan of action in motion in case a fire breaks out.

FIRST AID

Knowing first aid can save lives. A first aid kit and the ability to use it are important ingredients for the safety of a skippers' passengers, crew and vessel. Having confidence and competence in handling medical emergencies on board is a must for the skipper. Invest your time in a first aid course available at the American Red Cross.

CPR (BASIC LIFE SUPPORT)

If someone is seriously injured have someone call for help while the injured person is being attended.

Check for possible danger signs; loss of breathing, unconsciousness, severe bleeding and heartbeat. If you determine the individual is not breathing or unconscious place the victim on their back on a hard surface and do the following:

1. If unconscious, open the airway. Neck lift, head lift or chin head lift.
2. If not breathing, begin artificial breathing. Pinch the nose. Give 4 quick breaths. If airway is blocked, try back blows, abdominal or chest thrusts and finger probe until airway is open.
3. Check for pulse. Begin artificial circulation. Depress sternum. Fifteen compressions rate 80 per minute. 2 quick breaths. Continue uninterrupted until advanced medical support is available.



HYPOTHERMIA

Hypothermia is a condition where the body temperature decreases because the body can't generate enough heat to maintain its normal temperature. It can be serious and usually occurs where victims have been immersed in water (under 68 degrees) for periods of time. If you encounter a possible hypothermia victim call for help on the radio and get the person out of the water.

Symptoms are:

1. Shivering that if condition is advanced may stop.
2. Confusion, clumsiness or slurred speech.
3. Rigid muscles.
4. Semiconscious to unconscious.

Treat hypothermia by the following:

- Remove wet clothing.
- Monitor the victim's pulse and breathing.
- Rapidly apply heat to the body core by using blankets, naked bodies or warm water.
- Do not give the person any food or drink.
- Do not warm the arms and legs. Warming of these extremities can be fatal.

Follow up immediately with medical authorities!



TYPICAL CALIFORNIA AIR RESOURCE BOARD (CARB) LABEL

Your Regal boat may have a star shaped label affixed to the bow port hullside. It is located at the front of the state registration numbers. This label is part of the California Air Resource Board (Carb) SD/I rule. If your boat is operated in the state of California and/or bordering waters, this label **MUST** remain intact. The label shows that the engine installed as original equipment meets a currently approved California state regulatory emission level. See the example below which shows the current California ultra low 3 star label.



CALIFORNIA PROP 65

Proposition 65 relates to the state of California and is an additional requirement added to their Safe Drinking & Toxic Enforcement Act of 1986. Prop 65 basically summarized states that: “No person in the course of doing business shall knowingly discharge or release a chemical known to the state to cause cancer or reproductive toxicity into water or onto land where such chemical passes or probably will pass into any source of drinking water” and it goes on to say “ no person in the course of doing business shall knowingly and intentionally expose any individual to a chemical known to the state to cause cancer or reproductive toxicity without first giving clear and reasonable warning to such individual”

For more information, contact the California Office of Environmental Health Hazard Assessment at 916-445-6900 or <http://www.oehha.ca.gov/prop65.html>.

WARNING

A wide variety of components used on this vessel contain or emit chemicals known to the State of California to cause cancer and birth defects and other reproductive harm.

EXAMPLES INCLUDE:

- * Engine and generator exhaust
- * Engine and generator fuel, and other liquids such as coolants and oil, especially used motor oil
- * Cooking fuels
- * Cleaners, paints, substances used for vessel repair
- * Waste materials that result from wear of vessel components
- * Lead from battery terminals and from other sources such as ballast or fishing sinkers

TO AVOID HARM:

- * Keep away from engine, generator, and cooking fuel exhaust fumes
- * Wash areas thoroughly with soap & water after handling the substances above



FUEL SPILLAGE

The federal water pollution control act prohibits the discharge of oil or oil waste (such as from the sump bilge pump) into or upon the navigable waters of the United States or the waters of the contiguous zone. Violators are subject to substantial civil fines and criminal sanctions. A placard is normally found inside the engine hatch area or in the sump warning of overboard discharge of oil or oily waste.

ENVIRONMENTAL AWARENESS

There are numerous vessels operating on our waterways on a daily basis. Each boat has an impact on our environment. Boat operation habits, marine sanitation, and maintenance all play a role in a delicate battle to keep the ecosystem clean. Each of us has a role in doing our part as an environmentally conscious skipper to conserve our waterways.

The National Marine Manufacturer's Association lists their top ten of Eco-Boating Practices as follows:

1. Observe all regulatory agency policies regarding marine toilets.
2. If equipped with a holding tank, use marina pump-out facilities.
3. If used, make sure bottom paints are legal and ecosystem friendly.
4. Use only biodegradable cleaning agents.
5. Dispose of all garbage and litter on shore properly, not on the water.
6. Don't top off fuel tanks. Leave expansion room. Clean up spills.
7. Watch your wake and propeller wash.
8. Make sure your engines are well tuned and maintained.
9. Control your bilge water.
10. When fishing, practice the "catch and release" principle.



TRAILERING

This section covers trailering/towing basics including equipment, maintenance, and techniques of using a trailer. Check with state and local agencies for detailed information on required equipment, safety issues, and licensing.

BEFORE TOWING

Before towing your boat, be sure to check the air pressure of your tires for the recommended inflation rating. Also, be certain that your tow vehicle is in good working order. Install bimini top in its boot before towing. Also, remove and store cockpit and bow cover. Store cockpit carpet along with cockpit/mooring/bow covers in ski locker.

This can make it especially difficult to drive safely, as the hitch may be in danger of striking the road. Also, this situation can be caused by worn vehicle rear shock absorbers. One option is to install a set of air shocks which will assist in supporting the load. As a rule of thumb 5 to 7 percent of the total trailer load should be on the trailer tongue.

Check all lights to ensure they all work properly. You may find it helpful to ask someone to check your turn signals, brake lights, and towing lights while you remain in the vehicle. Be certain that the trailer winch cable is securely attached to the boat's bow eye and the cable lock is engaged. Make sure the bow of the boat is snug against the bow stop at the winch stand.

It is a good idea to tie another line or secure an extra cable to the winch stand and boat bow eye as a backup system. Be certain that your trailer is of rated capacity for the size and weight of your boat, including the weight for all fuel, water and gear.

Your authorized Regal dealer can advise you on the proper trailer capacity and tongue weight (the weight exerted on the rear of your vehicle).

service and maintenance instructions. Never use a bumper mounted trailer hitch. Always use a bolted or welded frame-mounted hitch, class 2 or 3. Consult your Regal dealer for more information.

Should your trailer be equipped with surge brakes, that is brakes on the trailer that cut in with a very slight delay when your brakes are applied, be sure to follow recommended instructions. Be sure that the trailer master cylinder is filled with the recommended fluid before towing your boat. Inspect the trailer brake lines for any leakage. Also, if you notice brake fluid on the inside of the tires, you may have a wheel cylinder leaking. Consult a professional. Never place your hands between the trailer hitch coupling and the hitch ball on your towing vehicle while hooking up. Be sure the tongue jack is in the full up position before departure. Be certain safety chains are crisscrossed and secured; do not allow them to drag on the road. Be sure to buy a suitable set of tie downs which can be attached to the boats' stern eyes and the eyelets provided on most trailers. Tighten them securely and neatly fold up the extra strap material and secure it with tape so it doesn't loosen and dangle on the road.

Be sure to buy a suitable set of tie downs which can be attached to the boats' stern eyes and the eyelets provided on most trailers. Tighten them securely and neatly fold up the extra strap material and secure it with tape so it doesn't loosen and dangle on the road.



Check the trailer harness often for signs of fraying. Check the harness connector for corrosion. Make sure the trailer harness when connected to the trailer has enough slack for turning

Check the wheel bearings for wear periodically by a professional. On most trailers, there is a zerk fitting on the wheel hub to add the proper lubricant to the wheel bearing with a grease gun. These wheel bearing waterproof covers for the bearings can be purchased at retail outlets. Check the trailer lug nuts for the proper torque. Use a foot pound wrench and torque in a star sequence to the correct poundage as recommended by the trailer manufacturer. Torque the lug nuts at half the poundage on all nuts. Then set the torque wrench to the full poundage and fasten to the last foot poundage figure. Check the trailer tires often for voids, excessive wear or out of round tire conditions. If the trailer seems to vibrate you may have a bad tire or one that is unbalanced. These wheels can be rebalanced at most automotive or tire shops. Never pull a boat on a patched tire. Buy a spare tire and wheel including a hub and wheel bearing assembly. Mount it on the trailer for speedy installation should a blow out occur.

Be sure everything is secured in the boat and canvas is down in the towing position with the bimini stored in the boot. Tilt the stern drive up to clear the road and any bumps that might occur while in transit.

DRIVING

Practice maneuvering the vehicle and trailer in a large, empty parking lot or open space. If you practice slowly and cautiously, you will soon develop a feel for maneuvering the trailer .

Test your vehicle and trailer brakes before departure along with the lights. Pack a tool kit with extra bulbs, fuses and fluids.

Drive as smoothly as possible, anticipating your stops and giving yourself plenty of room for turning and stopping. Avoid any quick turns or sudden jerks of the steering wheel.

Remember to maintain safe speed limits. It takes longer to stop your loaded boat. Allow enough room to the front in bad weather.

Keep an eye on your rig through the rear view and side mirrors. If your rear view mirror is obstructed, purchase a set of side mirrors that extend out over the side of the vehicle for increased visibility. In addition, it is a good idea to install a set of round mirrors to the side mirrors as they help identify blind spots.

Plan to stop periodically on your way to check the trailer hitch for tightness, harness connector, tires and wheel bearings. Also, check to make sure the load is balanced.



LAUNCHING

Serious accidents can occur at the launching ramp. Therefore, it is imperative you be alert and attentive during launching and docking activities. Study the ramp area and surrounding water for any potential hazards, such as a short ramp or one with a drop off at the end. If you are uncertain of the conditions, ask someone else who has just used the ramp if there are any peculiarities to the area.

Install the drain plug. Attach 2 lines, one each at the bow and stern, to control your boat once it is off the trailer. If you need additional fenders to keep the sides of the boat from banging against the ramp walls, use those as well. Unhook the stern tie-downs and the winch line to the bow. Unplug the trailer harness connector so the hot trailer light bulbs won't blow out when they come in contact with water.

When backing in, have someone assist, giving the palms up stop signal when the boat is in deep enough water to float off, or when the rear wheels of your vehicle approach the water's edge.

After your boat is floating freely, position it clear of the trailer before pulling out of the water. If there is no one to help you, secure one of the lines you've attached from the boat to the dock and use the other line to pull the boat off trailer. The process is easier with 2 people.

Ramps are very slippery. Do not attempt to walk or stand on an angled boat ramp.



CAUTION

AVOID LOSING VEHICLE TRACTION!
DO NOT ALLOW REAR WHEELS TO
ENCOUNTER SAND OR SLIPPERY
CONCRETE CONDITIONS.



WARNING

AVOID BODILY INJURY!
DO NOT ATTEMPT TO WALK OR STAND
ON AN ANGLED BOAT RAMP.



TRAILER TERMINOLOGY

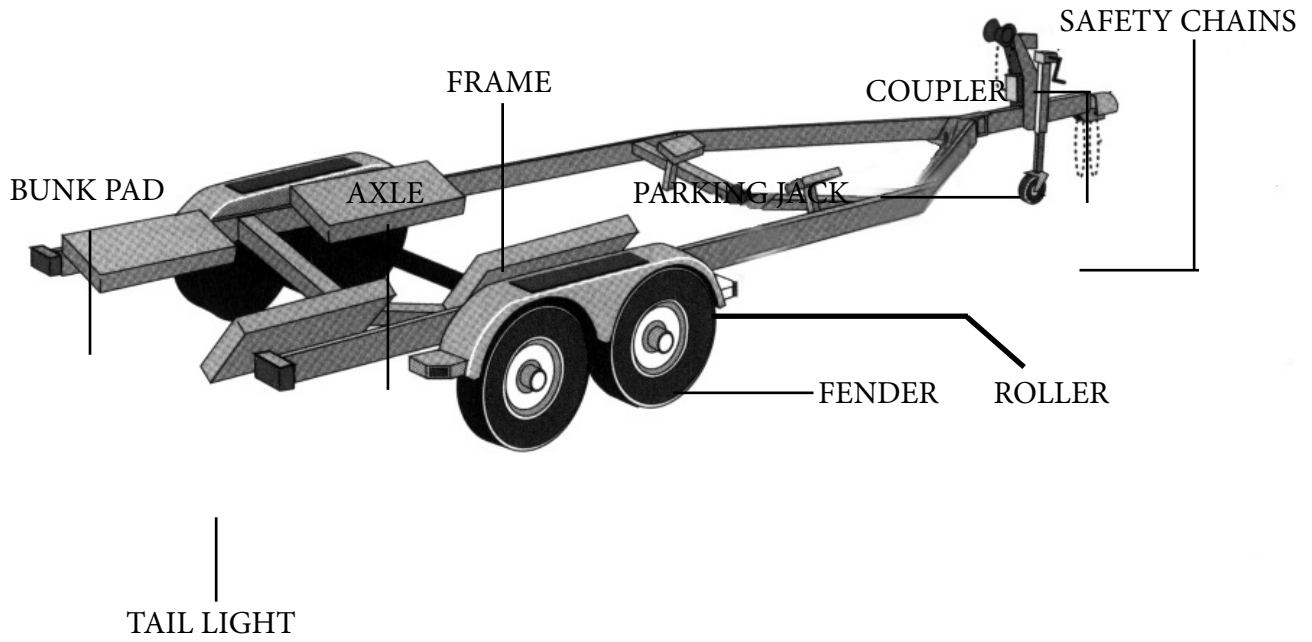

TYPICAL TRAILER SHOWN

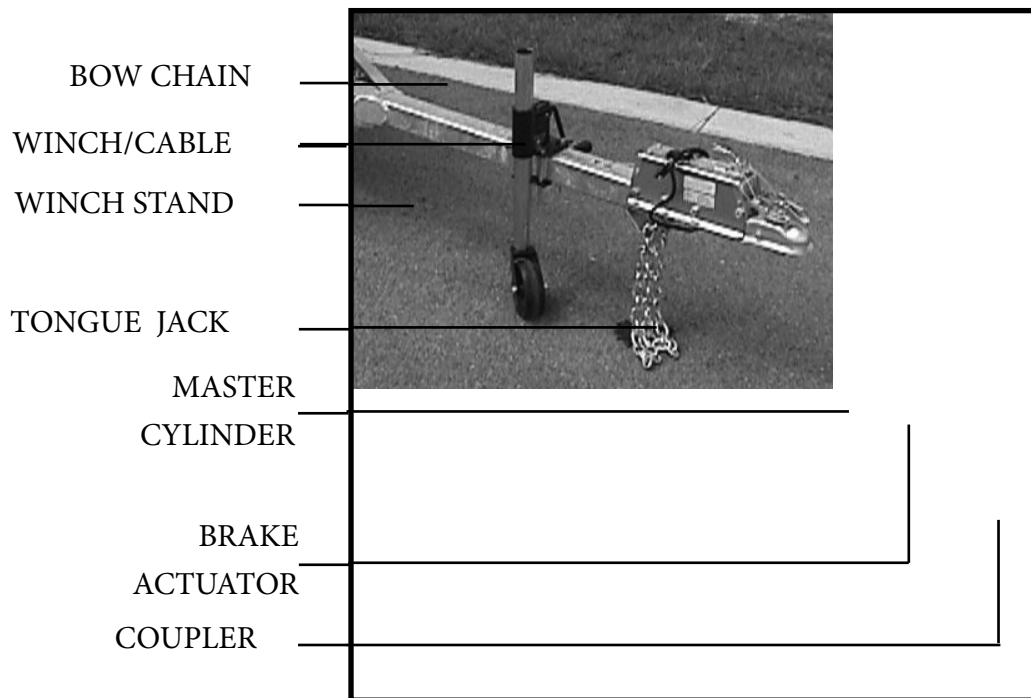
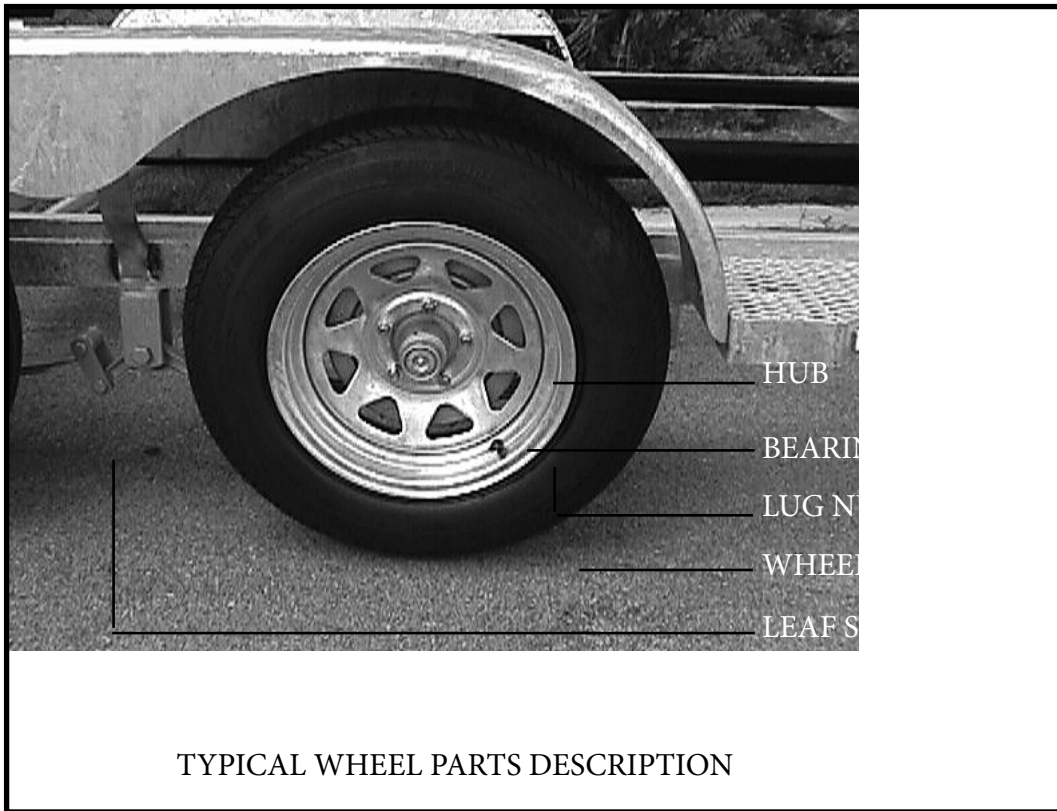



SPARE PARTS CHECKLIST

Longer towing trips increase the need for special preparations. Sometimes these extended trips cover areas where it is difficult in locating repair parts due to a breakdown. Following is a checklist of recommended items to add a safety net to your trip.

Trailer-

1. Trailer tire jack
2. Spare hub assembly including wheel bearings
3. Spare tire
4. Lug wrench
5. Jack stand
6. 12 volt air compressor- found at automotive box stores
7. Spare bearing protector
8. Extra tie-down straps
9. Trailer light bulbs
10. Brake pads and brake fluid

11. Grease gun

Tow Vehicle-

1. Tool kit including necessary ratchet and sockets
2. Jumper cables
3. Extra fuses
4. Engine oil
5. Transmission fluid
6. Wheel chocks
7. Highway flares
8. 12 volt spotlight- type that plugs into 12 volt accessory outlet
9. Flashlight & spare batteries
10. Waterless hand cleaner and rags
11. Electrical connectors and crimpers
12. Low voltage electrical tester



BACKING A TRAILER

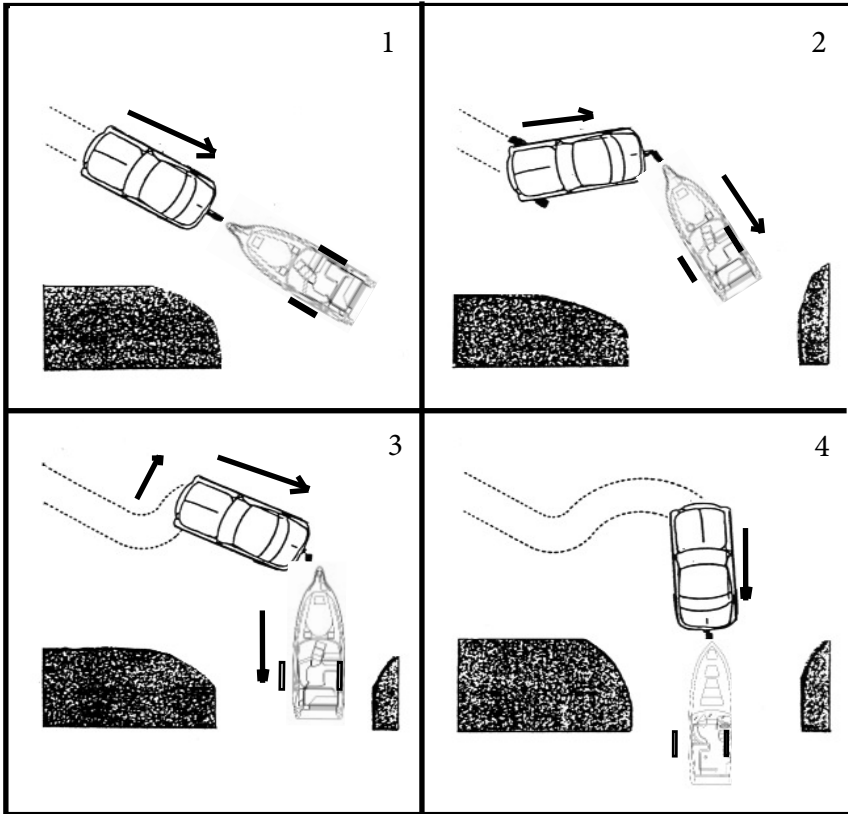

A trailer backs in a direction opposite to an automobile. In 1, driver swings the rig near the launching ramp. In 2, the driver cuts the vehicle toward the driveway. In 3, the driver cuts the vehicle wheels to the left and then backs into the ramp as the trailer moves to the right. In 4, the driver straightens the vehicle wheels to follow the trailer as it backs down the ramp.



LOADING



The most important thing to remember when pulling your boat out of the water is that often the ramp will be crowded. As you approach the ramp, make a visual

inspection of the traffic and people, both at the ramp and all around you. This is an important time to use caution, courtesy, and common sense. While you may feel it's your next turn, another boater may not be as courteous. Don't insist on your rightful place in line; it could lead to disastrous consequences in the confines of a crowded boat ramp. If there is any perceived danger, stand off until you can safely approach the ramp.

Back your trailer down to the water's edge. At this point it is a good idea to let a sufficient amount of line out of the winch to reach the bow eye. Make sure you disconnect the trailer harness to keep the bulbs from blowing out due them being subjected to the cold water.

On roller or bunk style trailers back up until the aft roller is just at the water level. This allows you to hook up the winch cable and to start cranking the boat on to the trailer properly. This method gives you a good starting point and helps keep the boat centered on the trailer as it is reloaded. It may be necessary to further back the trailer into the water. This permits cranking the boat easier on to the trailer.

Once the boat is positioned correctly on the trailer have someone hook up the winch cable hook to the bow eye. Also, this will help keep the boat bow against the trailer roller. Shut down the engine and run the stern drive up to the top of the trailer position.

With the bow snug against the roller, start to crank the boat up on to the trailer. Make sure the hull bottom or keel stays in the center of each roller as it is being cranked on the trailer. Double check to ensure the hitch is locked tight on the vehicle ball.

Make sure the boat is covered properly and all loose gear is stowed. On bunk style trailers, watch the bunks to make sure the boat is centered as they usually do not touch any rollers other than the aft one because the boat weight is being supported more by the bunks as it is cranked onto the trailer. Stop cranking the winch when the boat bow contacts the bow roller. Be sure the winch is in the locked position. Stand back and visually check to see that the boat is centered on the trailer.

After pulling your boat away from the ramp, be sure to go through all the checks involved before departure. Reinstall the harness connector and check the lights, brakes, safety chain, winch, hitch, and tie downs. Remove the drain plug to exit any excess water in the bilge. Reinstall the hull drain plug and tighten it. For longer storage periods remove the drain plug and keep in a plastic bag tied to the steering wheel.



WARNING

AVOID BODILY INJURY!
DO NOT LET ANYONE STAND NEAR THE
CABLE. IT COULD BREAK!



CAUTION

HULL BOTTOM DAMAGE COULD
RESULT FROM THE BOAT NOT BEING
POSITIONED ON THE ROLLERS BUT
RESTING ON THE TRAILER FRAME.
AVOID BACKING TRAILER
TO FAR BACK IN THE WATER.



Auxiliary Equipment Operation

AUXILIARY COMPONENTS



OVERVIEW

In addition to the main components and systems reviewed earlier there are other auxiliary equipment components outlined here. To locate more detailed information for the auxiliary components refer to the appropriate manufacturers owner's manual found in the owner's information packet. Also, further updated information may be available on the internet by using the proper name of the component and the Goggle® search vehicle.

Note: Equipment or vendors may change during a boat's life cycle as we are constantly upgrading our product line. Regal Marine Industries, Inc. retains the right to change vendors, equipment, specifications, component location, and other technical data at any time.



BILGE PUMP/FLOAT SWITCH

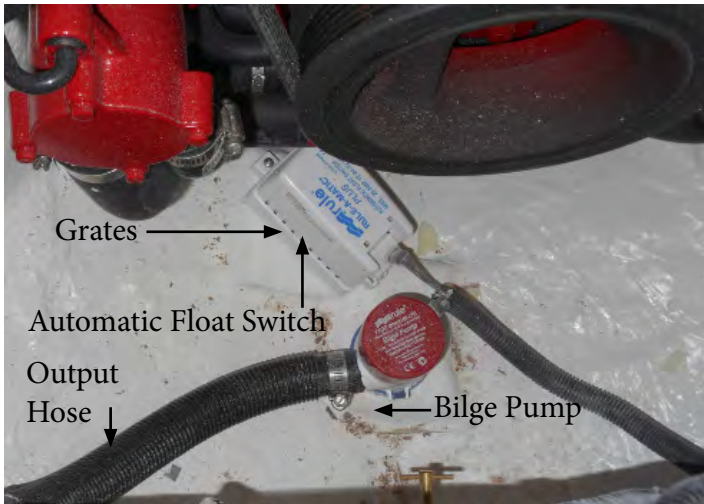

Your Regal boat features a bilge pump and float switch located in the sump (bilge). They are operated through a helm switch.

In the “off” position the switch is connected into the automatic float switch. In this “auto” position if the boat takes on water, the bilge pump will activate and pump excess water overboard. The switch will light up when activated.

Periodically check the grates for debris and spray the units down with water. Make sure a steady stream of water exits the through hull fitting indicating the entire output hose system from the bilge pump itself is debris free.

Monitor your helm bilge pump switch light periodically during your cruise. If a light is on that means that the bilge pump circuit is energied. Stop the vessel and find the cause of the problem.



Auxiliary Equipment Operation

BOARDING LADDER-TYPICAL

When using the bow or stern ladder open the hatch and slide the ladder out to the end of the travel. Then flip the ladder over and let it down gently. Make sure you keep your hands and fingers clear of any moving ladder parts especially the hinged top.

When not using ladders be sure to keep the ladder cover over the ladder to prevent tripping and falling accidents.

Insist that only one person use the ladder at a time. When finished with the ladder flip up the lower section of the ladder and slide the ladder assembly in as far as possible. Lower the fiberglass ladder cover to secure it. Periodically check the ladder hardware for tightness and corrosion. Replace fasteners and lubricate hinges as needed.

Read and understand all warning and information labels found in the vicinity of the ladder or the ladder cover.

Bow Ladder



Keep Body Parts Away From Rotating Rails



Propeller Warning Label

When entering the vessel from the swim platform be sure to utilize the hand hold provided for safer boarding. Make sure the vessel operator provides passengers directions on using both the bow and stern ladders.

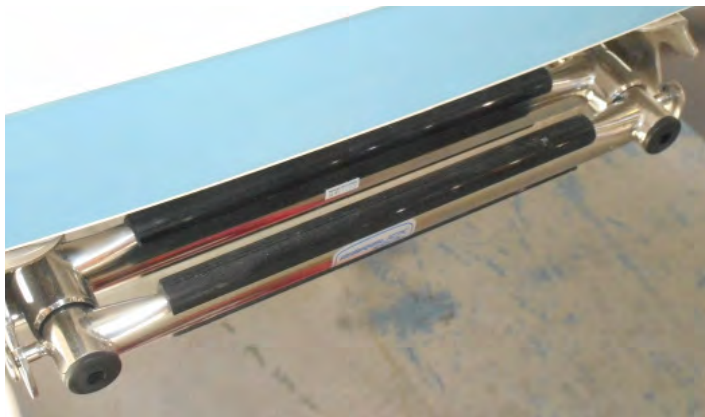

Under Swim Platform Ladder

 WARNING
<p>TO AVOID BODILY INJURY TURN THE ENGINE OFF AND REMOVE THE IGNITION KEYS WHILE PEOPLE ARE SWIMMING NEAR THE VESSEL AND/OR USING THE BOW OR STERN LADDERS.</p>



BOW FILLER CUSHIONS



To use the bow filler cushion locate the support bars found under the bow cushions. One is longer than the other. Make sure both bars are seated in the liner detents (Typical bow seating shown).

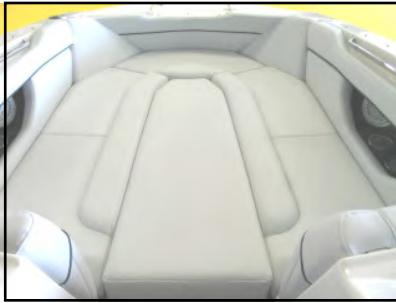

Place cushion on bars. Make sure the cushion is completely seated on the bars before attempting to sit or lay on it.

Typical Bow Filler Cushion



Auxiliary Equipment Operation

BOW WALK THRU DOORS



Optional bow walk-through bow doors are great in foul weather. With the tonneau (bow) cover in place, simply open the doors and pull across the bow opening. Secure shut by pulling down the latch. Snap the tonneau cover closed and you have a protected bow in rough weather.

To secure the doors open simply pull the doors against the walk through and secure with the latch. Periodically wipe the plexiglas doors with fresh soapy water and rinse dry. Do not use any harsh chemicals such as cleanser or ammonia based products on the doors as surface damage may occur.



CANVAS- TYPICAL

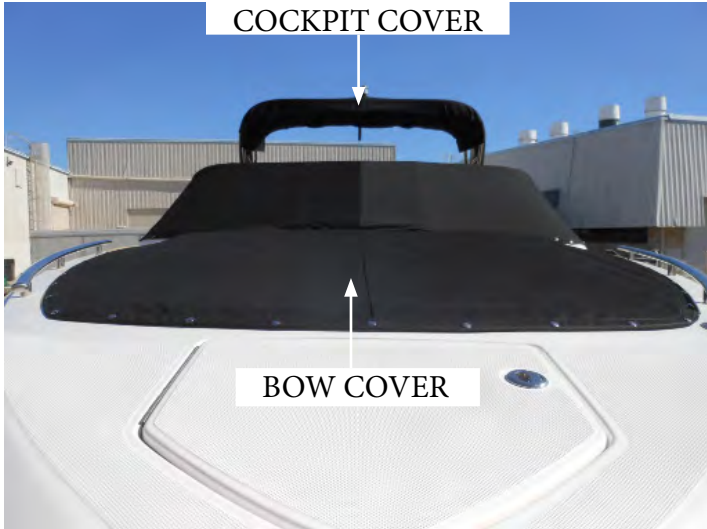

TYPICAL TONNEAU (BOW) COVER

If installed a bow cover protects the front cockpit of the boat from weather and snaps to the deck. Likewise, the bow cover should not be used for towing. On select vessels when both the bow and cockpit cover options are purchased, the two halves snap and velcro together at the center windshield location.

Notice in the middle underside of your bow cover, you may find an area of reinforced canvas with an eyelet snap. This snap connects to a bow cover pole. This pole is adjustable and by opening the lock the pole can telescope out to the desired length. This pole should push the canvas up when positioned correctly on its rubber enclosed foot. The purpose here is to prevent the pooling of water.

INSTALLING BOW COVER/COCKPIT COVER

If installed, the cockpit cover installs over the windshield and snaps to the deck. *The cockpit cover is meant to protect the cockpit of the boat from weather elements, and is not used for towing purposes.*

First note that on the bow end of the cockpit cover, there may be a velcro strip used to attach to an optional bow cover. This strip can be used to align the covers with your boat. Simply align the Velcro edge with the windshield.

Ensure the center windshield is in the closed position. Start snapping the cover to the deck by use of the eyelet snaps, starting at the bow and working aft. Continue snapping the cockpit cover to the deck snaps. When you reach the rear corner, leave enough room for an exit point. Notice in the middle underside of your cover, you may find an area of reinforced canvas with an eyelet snap. This snap connects to a cockpit cover pole. This pole is adjustable, and by opening the lock, the pole can telescope out to the desired length. This pole should push the canvas up when standing straight up on its rubber enclosed foot. Again, the purpose is to shed water off of the top.

The cockpit cover and bow cover should be rolled up for storage inside the ski locker when trailering or storing your boat. This canvas should not be used while the engines are running, or when towing.

	CAUTION
AVOID PROPERTY DAMAGE AND PHYSICAL INJURY!	
DO NOT TOW BOAT WITH BIMINI CANVAS, COCKPIT OR BOW COVERS IN PLACE.	
ONLY TOW YOUR BOAT USING A TRAVEL COVER!.	



Auxiliary Equipment Operation

CANVAS - TYPICAL (CONTINUED)



INSTALLING BIMINI TOP W/O POWERTOWER

Your Regal boat features a bimini top fitted into a boot. This top provides sun protection for the bulk of your cockpit and helm. Stainless steel bimini bows provide support as your bimini top extends forward. *When using your bimini top, read, understand, and follow all warning labels attached to the aft bimini top.*

To install the bimini top it must be removed from the protective boot.

Unzip the center zippers to the outside and the boot can be removed from the bimini and stored in a locker for reinstallation later.

Next, pull the front bow forward and the bimini top will fold out. At this point pull down on each strap and fasten it to the camel-back hardware as shown in the photo. This process may require you to push down on the forward bow on each side to connect the strap to the appropriate camel-back. At this point you can adjust each strap as needed to tighten the entire top.

At the bimini top rear attach the arms on each side and secure by inserting the pin through the latch. On select bimini tops it may be advantageous to secure the aft bow arms before the forward camel backs are secured. *For further information refer to the canvas care instructions located in the bimini top center pocket.*



CANVAS - TYPICAL (CONTINUED)

INSTALLING BIMINI TOP W/ POWERTOWER



TYPICAL BIMINI TOP WITH POWERTOWER

If your vessel is fitted with the PowerTower it features a bimini top which covers the arch for increased resistance to water and leakage.

This top provides sun protection for the center cockpit and helm. Stainless steel bimini bows provide support as your bimini top extends forward. *When using your bimini top, read, understand, and follow all warning labels attached to the aft bimini top especially those regarding towing.*

	WARNING
<p>AVOID PROPERTY DAMAGE AND PHYSICAL INJURY! DO NOT USE THE BIMINI CANVAS CRUISING ABOVE A SPEED OF 35 MILES PER HOUR. IF TOWING BOAT BEFORE TRAILERING MAKE SURE BIMINI TOP IS ATTACHED TO HARDWARE SECURELY AND INSIDE BOOT.</p>	



The first step in using the top is to remove top from the boot. Push both sides of the latch inward simultaneously (green area) and pull on the ends of the latch to open it. Find the boot zippers in the forward center section of the top. Unzip the boot and remove it from the bimini top. Store it in a dry locker for later reinstallation. See the photo above.



Once the boot is removed note there is an alignment snap in both the forward and aft center top bow. Always make sure these snaps are buttoned down or it may become difficult to install the top arms due to misalignment (bimini top not in the center of the forward and/or aft bow).



Auxiliary Equipment Operation

CANVAS - TYPICAL (CONTINUED)

TYPICAL BIMINI TOP WITH POWERTOWER PARTS DESCRIPTION

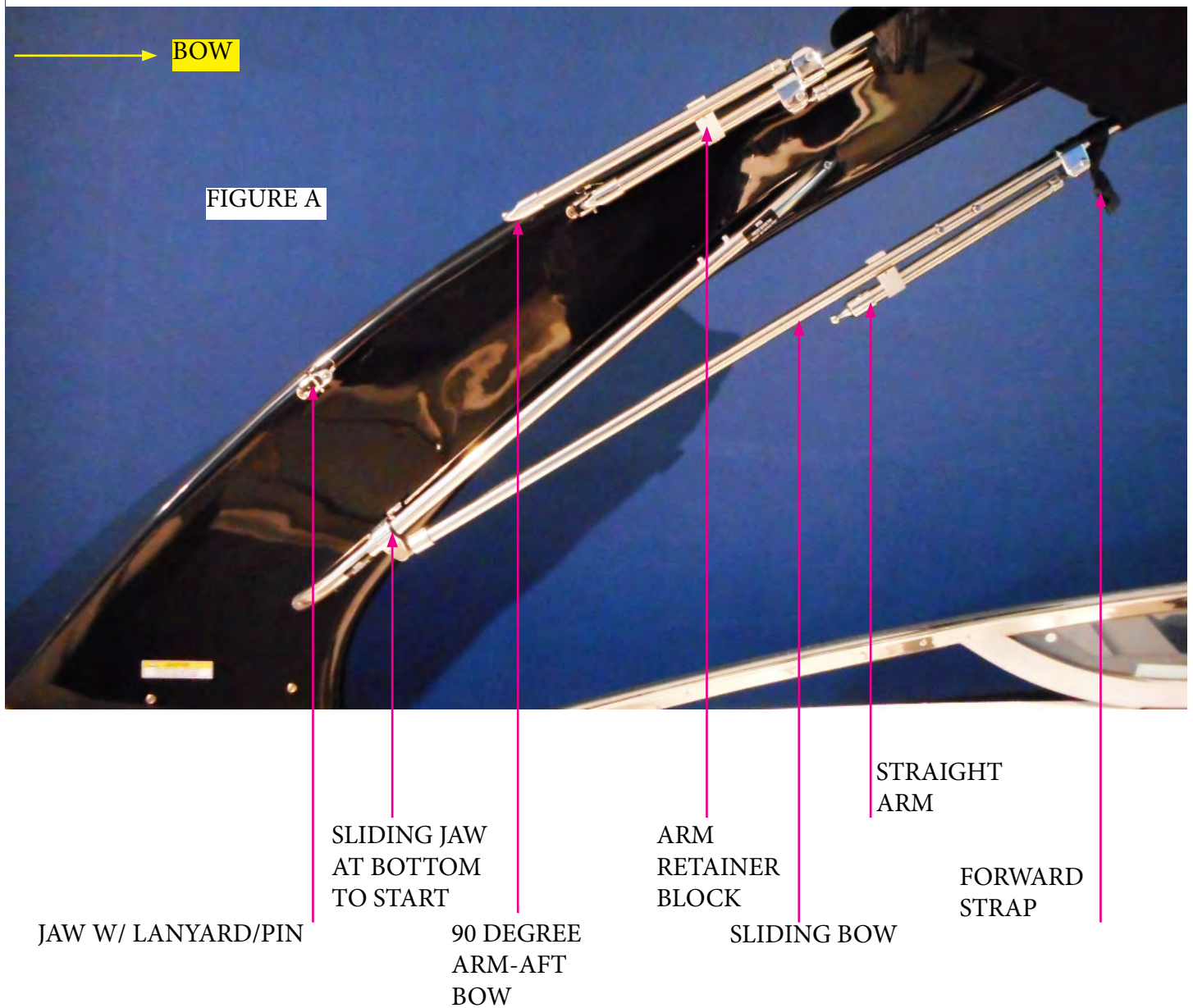

Note that the bimini top hardware shown is in the lay down position (unattached to the hardware). Note the photo on the next page with the top in place and the hardware connected.



SHOWN WITH
HARDWARE
ATTACHED TO JAWS

FIGURE B

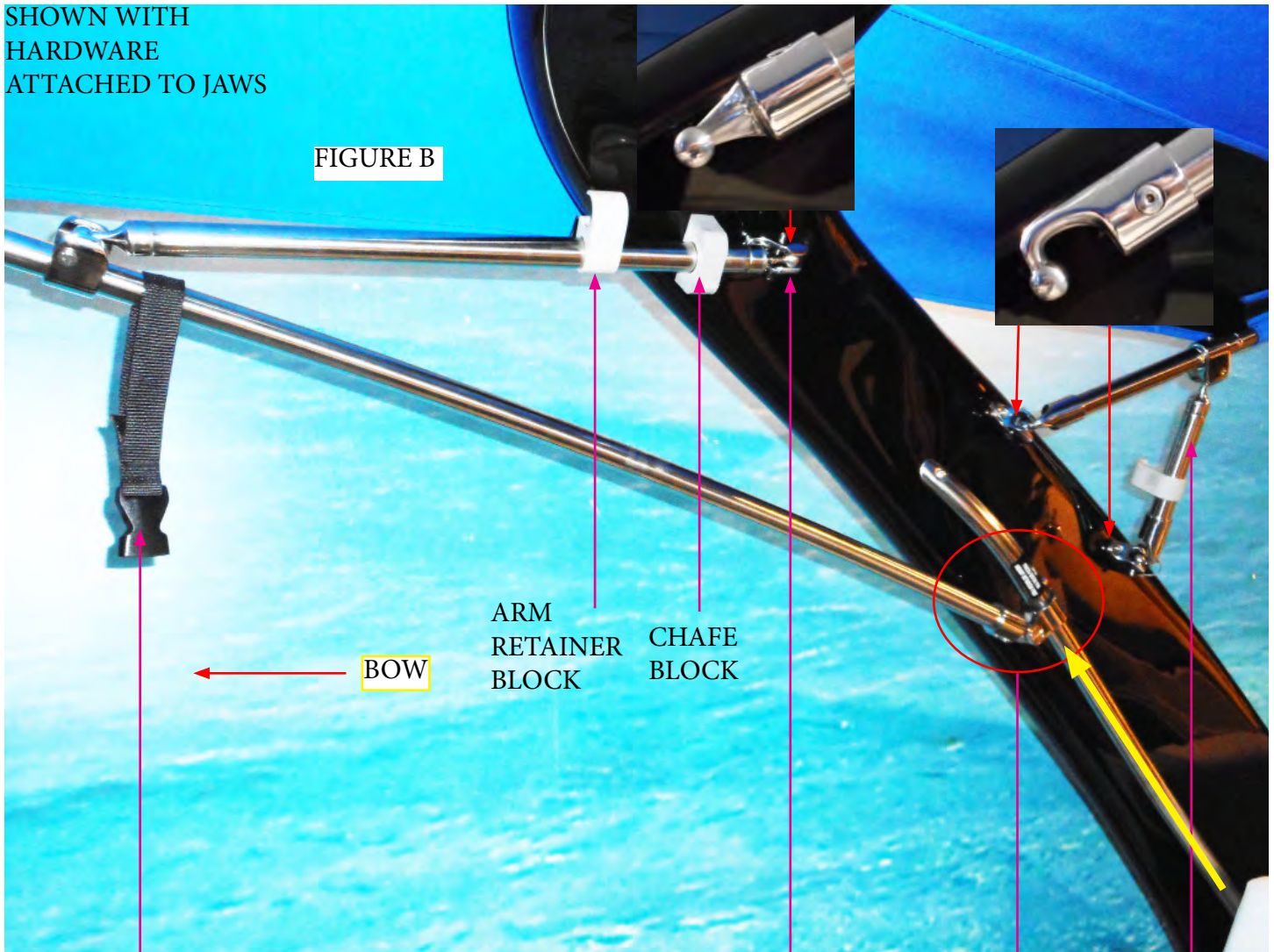

← BOW

ARM
RETAINER
BLOCK

CHAFE
BLOCK

90 DEGREE
PIN IN JAW-
AFT BOW

ATTACH STRAP END
AND LATCH
TO FWD. CAMEL-
BACK ON DECK

STRAIGHT PIN
IN JAW-FORWARD
BOW

FWD, BOW
SLIDING JAW
IN BETWEEN
PINS

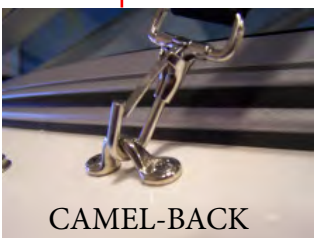

CAMEL-BACK

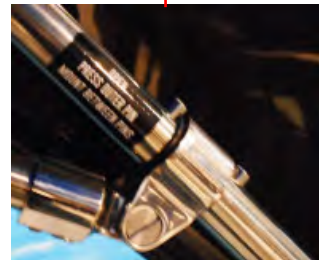



Auxiliary Equipment Operation

USE THE DIAGRAMS AND FOLLOW THESE STEPS TO INSTALL THE BIMINI TOP:

1. Find jaw between pins on bottom of port forward bow. Move sliding jaw over the top pin to release the forward bow and pull up to upper set of pins allowing the jaws to slide over the bottom pin and locking in between the pins (yellow arrow). See figure B. Do the same with the starboard forward bow.

2. Find one of the straight eyed arms as shown in Figure B. Turn the white chafing block in a direction so its flat surface is between the straight arm and the PowerTower to protect it. While pushing down on the starboard forward bow align the straight arm with the forward end of the jaw and install the ball end of the straight arm into the front of the jaw. Install a lanyard pin which will lock it in place. Do the same with the other straight arm.

3. Locate the 90 degree aft arms. There are 2 each for the aft bows. See Figure B. Start with either side. Pull down on the aft top and insert the top arm into the top jaw. Lock the arm in place by inserting a lanyard pin. Repeat the same process with the lower 90 degree arm. Follow the same procedure with the 90 degree arms on the other side.

4. Note that the forward bow utilizes a strap and latch similar to the latch on the boot. This strap assists in holding the bimini top down as the vessel is making forward headway. Attach the upper and lower strap together and attach at the camel-back. **Remember not to exceed 35 mph with the bimini top up on the waterways Also, the bimini top must be disassembled and zipped into the boot before towing on the highway.**

5. Perform the steps in reverse order to disassemble the bimini top. The sliding jaw on the forward bow will need to be pushed down to the lower set of pins on the forward bow on both sides for the top to set in the proper place. Use the arm retainer blocks to latch the arms in place. Reinstall bimini top in boot and zip up the boot.

6. Be sure to read the canvas manufacturer's information regarding caring for your canvas which can be found in the owner's information bag or visit their web-site.



CANVAS - TYPICAL (CONTINUED)

INSTALLING TRAVEL/STORAGE COVER

▲ WARNING: To prevent damage to your boat and/or cover please read and understand instructions before attempting to use cover.

It features:

1. **ON SOME MODELS:** A special anti-pooling system is included to prevent large puddles from ruining your cover.
2. The SurLast® all-weather fabric was chosen to allow stability, water repellency and breathe-ability.
3. The Vacu-Hold™ system allows trailering at highway speeds (65 mph) without billowing or buffeting.
4. The new ratchet and drawstrap type attachment will allow easy, tight and secure installation.

CARE, WARRANTY AND INSTALLATION INSTRUCTIONS

Hint-To properly install ratchet strap system.

1. Pull the webbing through the channeled ratchet cylinder and tension while ratcheting to "start" the webbing.
2. Tension the ratchet with about 5 lbs. of pressure (pinky finger). Pull the sides of the cover to even the webbing throughout. Re-tension about 5 lbs. (the ratchet should be tight on the side of the boat lever, perpendicular to the hull).
3. Crank the ratchet approximately 5 full additional times to add tension (based on an 18' boat).
4. Check boat webbing for tension during stops while trailering. (webbing may stretch during first installation and use CHECK OFTEN).

▲ WARNING: Readjust and retighten the cover after trailering and before storage. To prevent pooling do not allow snow and ice to accumulate on the cover. Never trailer at speeds above the speed limit.

CARE INSTRUCTIONS- Wash with warm soapy water (while installed if possible) and allow to air dry. For stubborn stains, mild detergent is recommended.

Storing the boat in constant direct sunlight will shorten the life of the cover and the components used to construct it. We recommend storing the boat in a location that exposes it to some sun and also shades it throughout the day. Preferably morning sun and afternoon shade.

WARRANTY- This cover includes a two-year warranty from date of purchase against any defects in material or workmanship. If you incur any problems or have any comments please contact your dealer or call Commercial Sewing Customer Service directly at (860) 482-5509.

PROPER INSTALLATION-

A. Pooling System Installation:

Note:

Install anti-pooling system as per illustration putting the front webbing to the cleats, standing pole upright. Pull the other two webbing straps to the two rear cleats. Tighten adjustable buckle strap, until the pole stands upright.

B. Proper Cover Installation:

- Place cover on boat starting at front, use cleats as buttons to keep cover in place, work toward back over pooling system until back cleats are "buttoned" in place.
- Maneuver in place until cover fits over gunwale. Check the symmetry. Connect the confidence straps through the openings on the swim platform to the "U" bolts. Disconnect velcro wrap around ratchet. Begin ratcheting by unzipping ratchet pocket(s) and pulling ratchet(s) handle in right-to-left motion until zippered ratchet pocket no longer sags but rests against the hull.
- Pull on webbing to even the tension around the cover and again tighten the ratchet until it does not sag but rests against the boat. Tighten ratchet four to five more times. The ratchet should be very hard to pull with your pinky finger. Zip ratchet pocket closed and connect velcro wrap around ratchet pocket. **On some models:** Connect the rear strap tiedowns in the back of the boat.

Note: Proper installation and operation of this cover requires that it be very tight at the gunwale. Retighten as necessary before, after and during stops while trailering. **BE SURE** cover is installed below gunwale before final ratchet adjustment. ZIP ratchet pocket closed for final installation.

▲ Warning: Zippered ratchet mechanism should be hand tightened only. Do not pry or attempt to operate ratchet mechanism with any type of tool.

REMOVAL-

- Disconnect velcro wrap & zip open ratchet pocket.
- Follow instructions on ratchet label to release pressure.
- Once pressure is released pull out webbing to allow simple future installation, then close handle and ZIP POCKET closed (this is important to prevent damage in future installation).
- Disconnect holddown straps. Remove and fold cover working from rear to front.

ANTI-POOLING POLE STORAGE-

- Disconnect anti-pooling pole from either the front (colored webbing) or back.
- After disconnecting collapse poles by pushing buttons and telescoping them down. Wrap webbing around poles.

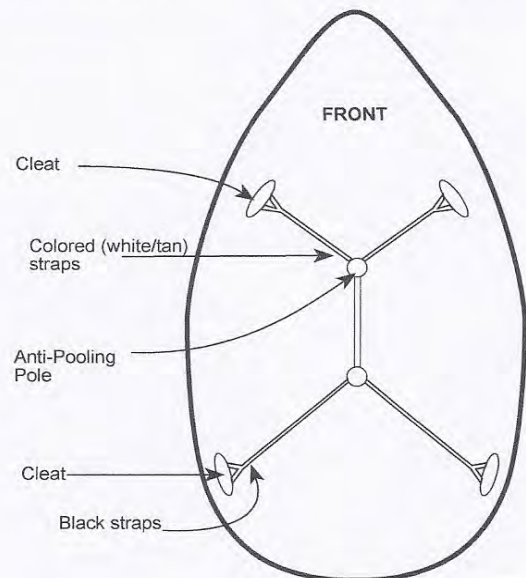



Auxiliary Equipment Operation

CANVAS - TYPICAL (CONTINUED)



TYPICAL TRAVEL/STORAGE COVER



RATCHET STRAP

Ensure the ratchet strap is tight and the velcro flap is closed on the travel cover before pulling boat at highway speeds. Tie cover securely to bow and stern eyes. Do not exceed manufacturer's 65 miles per hour speed limit. Once on the road periodically pull over and check cover, ratchet strap and pertinent hardware for tightness. Note that select covers use dual aft straps.



CARPET-COCKPIT



Cockpit carpet features a forty ounce weight with a heavy duty non-skid marine backing. As required, snaps are installed.

Note: Before towing on the highway roll-up the cockpit carpet and store it in a locker to prevent it from blowing out of the vessel. Do not yank on the carpet to remove it as you may pull out a snap.

When storing cockpit carpet always roll it verses folding it. Also, before rolling it for periods of extended storage make sure the carpet is dry to help eliminate odors and possible mildew.



Auxiliary Equipment Operation

DOCKING LIGHTS



If installed docking lights are integrated into the hull near the bow on both port and starboard sides. They are very useful for night mooring approaches and maneuvering. To operate turn on the helm switch marked “docking lights”. It is recommended not to use the docking lights while navigating in open water at night since the illumination could cause a glare on the bow navigation light possibly causing visibility problems for other vessels. There is a dedicated “docking light” switch located on the helm switch panel.



DRAIN PLUG

Your boat is equipped with a drain plug centrally located on the transom below deck level. Make sure it is installed tightly before launching. Tighten with a small amount of machine torque but do not overtighten it as the thread material is nylon and can be stripped. Do not use your fingers alone to tighten it. After your outing, while the boat is angled on the ramp, remove the drain plug to eliminate any bilge water accumulation. If the water stream is diminished, check for foreign objects stuck in the drain hole. Pull the drain plug if dry storing the boat for extended periods, especially in colder climates.

Refer to the vessel operation chapter for pre-departure use. Refer to the storage and winterization chapter for storage information. Review the trailering section for pre-launch and post-trip instructions.



Auxiliary Equipment Operation

FENDER CLIPS

The fender clip option features receivers integrated into the vessel hull side and quick release pins. The quick release pins attach to fenders with lines so they are ready to deploy as needed. When the vessel approaches a mooring the quick release pin with fender is attached to the receiver and pushed into place. This will help protect the boat from dock “rash” which could damage the rub rail or gel coat. When leaving the dock the pins feature a quick release mechanism which detach easily.



FENDER CLIP RECEIVER



FENDER CLIP RELEASE PIN



FIRE EXTINGUISHER- AUTOMATIC



OVERVIEW

The optional Fireboy automatic fire extinguishing system is usually located in the bilge at the forward engine bulkhead. See the illustration. The system uses an environmentally friendly agent FE-241 which has been approved by the EPA to replace the old Halon agent. This system is formulated only for use in the engine space or bilge of your vessel. FE-241 is to be used with gasoline fuel systems only since the agent will not “stall” diesel engines. This could cause a fire to re-flash.

OPERATION-AUTOMATIC

Fireboy systems are not nor are they intended to be explosion suppression devices. Boat owner's still need to take normal precautions for checking fumes and using the blower.

Read the information in chapter 4 regarding the dash installed portion of the fire extinguisher system. When the system actuation starts you may hear a loud sound similar to that of small arms fire, followed by a rushing air sound.

The system will show actuation whenever the ignition key is ON and the indicator light is OFF. The actual actuation time when a fire occurs is dependent on the severity of the fire.

When the automatic fire extinguisher activates **IMMEDIATELY SHUT DOWN ALL ENGINES, POWERED VENTILATION (BLOWER), ELECTRICAL SYSTEMS AND EXTINGUISH ALL SMOKING MATERIALS. DO NOT OPEN THE ENGINE COMPARTMENT IMMEDIATELY!**

Allow the agent to “soak” the compartment for a period of time and wait for hot metals and any fuels to cool before inspecting for the fire cause. Premature opening of the engine compartment allows an in-rushing of oxygen and could result in a flash-back. When the engine compartment is opened have approved portable fire extinguishers ready to use.

OPERATION-MANUAL

If a fire has started in the engine compartment where the Fireboy is located, **DO NOT WAIT FOR AUTOMATIC ACTIVATION.** Release the system manually. Close any opened hatches leading to the engine compartment, shut down all forced ventilation devices, engines, generators and electrical components. Remove the safety pin from the “Fire” T-handle, and pull T-handle firmly and release. A loud “rushing” or air” sound will be heard. Complete discharge will take several seconds. **DO NOT OPEN THE COMPARTMENT IMMEDIATELY!** Keep the compartment closed for a period of time sufficient to allow the agent to soak all areas of the protected space. This allows hot metals to cool.



Auxiliary Equipment Operation

Premature opening of the compartment could cause a re-flash. When opening the engine compartment for inspection have hand held portable extinguishers ready. Inspect the pressure gauge and system before and after each outing. Refer to the maintenance chapter for caring for your fire extinguisher system.

The illustration opposite shows the actuator not discharged at the top and one which has been discharged at the bottom. Manual pull is located starboard of the helm seat.

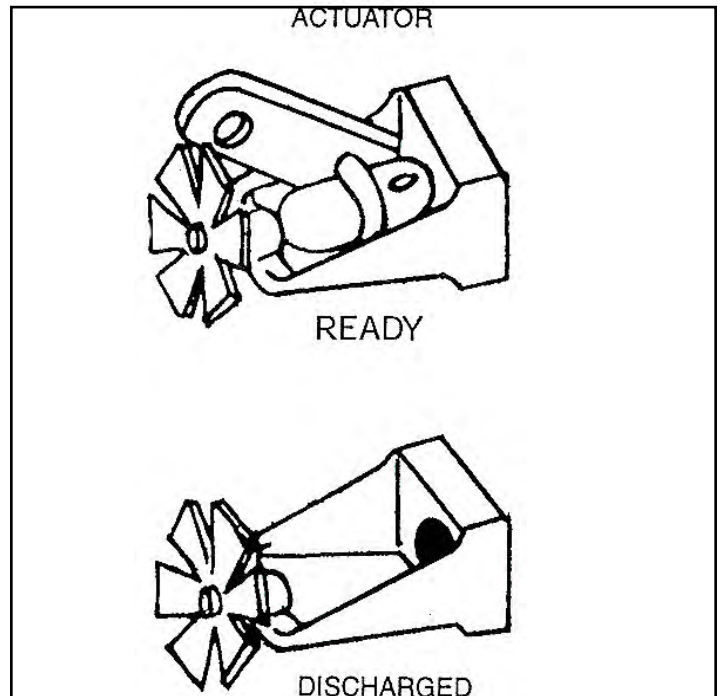

WARNING

AVOID SERIOUS INJURY OR DEATH!
DO NOT BREATHE FUMES OR VAPORS
CAUSED BY A FIRE AS THEY ARE
HAZARDOUS AND TOXIC.

WARNING

AVOID SERIOUS INJURY OR DEATH!
ACCIDENTAL DISCHARGE COULD OCCUR
DURING HANDLING, INSPECTION,
OR WORKING IN THE ENGINE
COMPARTMENT.
WEAR EYE PROTECTION
AT ALL TIMES!



MARKERS-FOR SLINGS-TYPICAL

Sling markers may be located on the forward and aft deck near the rub rail. These markers provide a safe location to locate straps to lift the boat. Failure to use marked sling marker locations could cause damage to the boat structure.

When lifting the vessel close all doors, hatches and portlights. Make sure the spreader bars are adjustable enough to be wider than the sling beam area. This will allow the slings to hold the weight of the boat properly without forcing the boat structure inward. Make sure there is no pressure on the rub rail or swim platform. Always use a flat wide belt-style straps as they distribute and hold the boat weight in a more supported fashion. Do not use the cable-style straps since they may cause hull or rub rail damage. See the technical chapter for more lift information.

NOTICE

AS A SAFETY PRECAUTION,
WHEN THE BOAT IS LIFTED,
TIE A LINE BETWEEN BOTH STRAPS
TO PREVENT THE STRAPS FROM MOVING
FORWARD OR AFT.

NOTICE

TO AVOID POSSIBLE FIBERGLASS DAMAGE, SET
VESSEL FOR EXTENDED STORAGE
ON A FACTORY APPROVED
AND ADJUSTED STEEL CRADLE.
NEVER USE BLOCKING TO SUPPORT THE
VESSEL'S HULL BOTTOM.



Auxiliary Equipment Operation

MAT-COCKPIT SEAGRASS



If installed, cockpit seagrass mats feature urethane backing for marine environments. The mats provide style, comfort and durability as well as additional protection in environments where microbes are a concern.

Chilewich® products contain Microban®. This antimicrobial protection inhibits the growth of stain and odor-causing bacteria, mold and mildew for the product's life.

When storing your Seagrass mats, **always roll with the face of product out and the backing facing in.** Do not fold or crease as the backing may split. Vacuum or hose off for regular cleaning. Dry face up or hang.

Do not machine wash. Matting may be cleaned with a mild detergent and a sponge. Rinse with fresh water.



PORT LIGHT- "D" SHAPED



If installed the D shaped portlight can be used to create cross ventilation and freshen head air. Note the locking devices located on the head side of the portlight. Latch them in place when leaving the vessel. Also, when at sea with inclement weather make sure the portlight is completely shut to prevent water infusion.



Auxiliary Equipment Operation

POWERTOWER-TYPICAL

As part of the innovative design the PowerTower hinges forward for tight overhead clearances such as bridges and restricted storage situations.

The PowerTower features an aluminum framework with a multi-layered powder coated finishing process along with the ability to anchor major electronic equipment.



TYPICAL POWER TOWER

The PowerTower can be hinged forward for clearance purposes. Use the switch marked “tower” found on helm switch panel to energize the power tower. It connects to a lift actuator motor and a set of hydraulic rams that raise or lower the power tower through the switch.

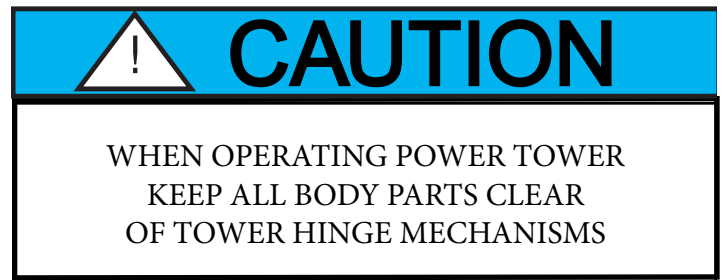

Make sure the operator and all aboard read and understand the above warning.

Before energizing the tower switch explain to all passengers that they shall maintain a safe distance from the tower hinge mechanisms located at the base of the power tower on the deck.

As the operator energizes the switch to hinge the tower forward visually monitor the port and starboard deck to ensure all passengers are clear of the hinge mechanism. This same procedure applies for lowering the mechanism to the cruise position.



Chapter 7



Located at the starboard firewall bulkhead (bow end of bilge) is the power tower actuator control box. The purpose of this device is to provide overload protection for the port and starboard actuators that move the PowerTower forward and aft (see the illustration).

In addition, the control breaker protects the up and down wiring circuit to the dash for the PowerTower circuit.

If a breaker “pops” be sure to determine the cause of the malfunction before resetting the device.



TYPICAL POWERTOWER SHOWN IN FULL FWD. TILT POSITION

For highway towing the PowerTower shall be in the complete forward position and all canvas shall be in their dedicated boots. All attached canvas bow hardware shall be checked for tightness before and after towing. Cockpit carpet shall be rolled up and stored in a dedicated cockpit locker.





Auxiliary Equipment Operation

PRESSURE PUMP-FRESH WATER

Your vessel features a variable speed fresh water pressure pump. The variable speed allows for additional water flow at peak times such as using the forward and aft showers at one time. It is important not to operate the pump unless there is water in the fresh water tank. The pump is controlled by a switch labeled fresh water at the helm switch panel. Energizing the switch allows the pump to build the water pressure in the distribution lines to 35 psi's. When the pump reaches a level of 35 psi the pump should automatically shut off. If the system drops below a certain pressure then the variable speed pump will restart. If the pump cycles on and off with no water being used, a leak in the water system is likely.

Periodically remove the water inlet filter and clean it. Additional filters can be ordered through your Regal yacht dealer or marine outlets.

Be sure to turn the fresh water pump at the main salon DC panel off before performing any type of maintenance.

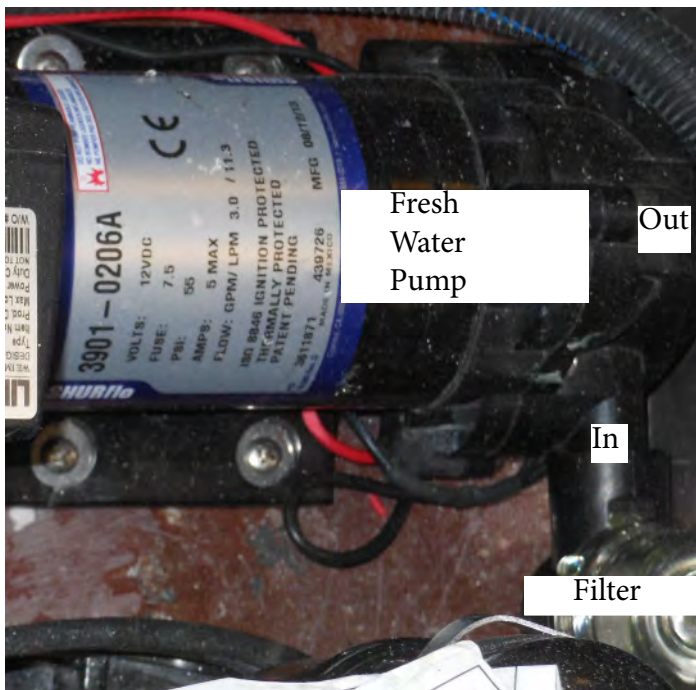

TYPICAL FRESH WATER PUMP



ROD HOLDERS



As an option 2 sets of rod holders are installed on the port and starboard deck gun whales. They feature an angled design for holding most fishing poles. They serve as pole storage to and from your fishing designation or they can be utilized for trolling or still fishing while drifting or when the vessel is anchored.



Auxiliary Equipment Operation

SEADECK COVERING-SWIM PLATFORM



TYPICAL BOAT SHOWN

If installed, SeaDeck® is normally located on swim platform and walk through areas. The non-skid, closed cell material is derived from UV protected non-absorbent foam. You will find the product easy to clean with a high stain resistance.

Other features include noise reduction, great traction even when wet, body comfort when standing, walking or leaning on the swim platform .

To clean small dirt particles first try soap, hot water and a stiff brush.

For surface dirt and footprints use glass cleaner and a clean rag.

If a more thorough cleaning is needed you may use bleach, 409, Simple Green or Soft Scrub.

Stay away from using any acid base cleaners.



SEAT-HELM (TYPICAL)



The helm seat features a leaning post to gain extra height or additional standing room at the helm when maneuvering in close quarters.

To add seat height using the leaning bolster lift the front of the helm seat upward. This permits the leaning bolster to rotate upward until fully extended. See the illustration.



Auxiliary Equipment Operation

SEAT-ULTRALOUNGE (TYPICAL)



The UltraLounge offers passengers the most of aft cockpit versatility with multiple seating/laying positions. Note the adjustment latch in the photos above. Mechanics of changing positions are simple and smooth.

The UltraLounge shown above is the *aft facing seat position* with the backrest angled for stern seating. To obtain this position from the *forward facing position* simply pull the adjustment latch out and push the backrest aft with your other hand until it locks in place.

To change any backrest position (seat to lounge or vice versa) just pull the adjustment latch out with one hand and move the backrest with the other hand in the same motion. The backrest can be moved to the seat or to the lounge position.

The photo above displays the seat in the forward facing seat position.



STEREO PERFORMANCE PACKAGE

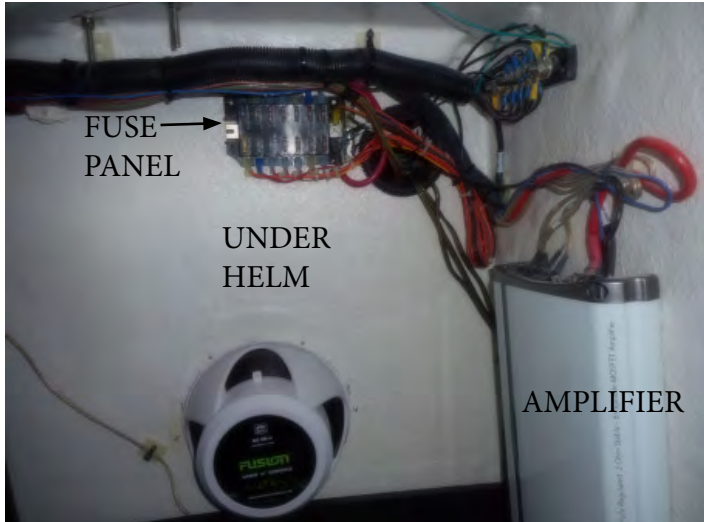

TYPICAL REMOTE CONTROL.

As part of the stereo performance package the Fusion remote control is normally mounted at the transom area which makes it easier to use during water activities. It is a plug and play device and uses the same function buttons and rotary encoder as the helm head unit. It features the ability to select various speaker zones on the vessel. Refer to the Fusion owner's manual for more detailed information.

The stereo performance package features Fusion signature speakers including a sub-woofer, 2 channel amplifier and transom remote to provide leading edge performance in sound, power and usability. The simplicity of design contributes to low distortion and high efficiency. Normally the amp is located under the starboard helm or may be in the cockpit refreshment center. The circuit is protected by twin 40 amp automobile type fuses. It is a good idea to carry extra fuses which are available at local marine or automotive stores. The amplifier does not require any type of maintenance other than periodic checking of the wiring connectors for tightness. Contact your Fusion owner's manual or closest Regal dealer for additional information.

Vessels with the optional sport arch speakers use an additional 4 channel amplifier normally located under the helm or a cockpit storage area.



Auxiliary Equipment Operation

SWIM PLATFORM

The swim platform is used with the boarding ladder to enter and exit the water. Never dive from the swim platform or swim under it. The swim platform is not intended to be used for storing heavy objects. Keep the platform surface free of objects to prevent bodily injury due to falling. Periodically inspect all swim platform fasteners and stanchions under the platform for tightness and corrosion. Replace parts as needed.

Do not exceed the swim platform recommended poundage capacity.

Use the swim platform cleats for temporary tying only such as stopping at an on-the-water restaurant or fuel dock. Use the other deck cleats for permanent moorings. When securing lines leave enough slack for local tidal changes.

Never attempt to lift the boat using the swim platform or cleats on the vessel! See the section on sling markers. Never swim around or under the swim platform while the engines are running due to the effects of carbon monoxide poisoning. Read and understand all CO labels in the safety on board chapter. See the ladder information found earlier in this chapter.

	WARNING
<p>AVOID SERIOUS INJURY OR DEATH! NEVER OPERATE THE VESSEL WITH PEOPLE ON TOP OR HOLDING ON TO THE SWIM PLATFORM STRUCTURE OR HARDWARE.</p>	





TABLE- COCKPIT

As an option, a teak cockpit table may be found in the cockpit storage locker. When using the table ensure the table pedestal leg is installed in the receiver securely. Pull the latch pin and hold until the table pedestal leg slides in the receiver sleeve. Then release the latch pin. When installed, there are normally table receivers located in select areas as shown below. Periodically lubricate the latch pins with a silicone lube spray.



BOW LOCATION



COCKPIT LOCATION



STERN LOCATION



RECEIVER



Auxiliary Equipment Operation

UNDERWATER LIGHTING

OVERVIEW

The underwater light option provides high output, long life and low heat emission. The lights are made from a high impact resistant polycarbonate housing. The lights are installed under the transom for maximum efficiency. Their beam is blue for increased underwater penetration. These lights are based on LED technology which stands for light emitting diode. This electronic device can produce various colors depending on the free electron line-up inside the semiconductor body of the device. There is no filament in the LED light and the light body is sealed.

OPERATION

The underwater lights are energized through the accessory switch located at the starboard helm switch panel. The lights are protected by a breaker located at the helm under the steering wheel on the lower breaker panel.





WATER SPORTS TOW



A water sports tow is located center line at the stern deck. Push down on the top of the sports tow and it will pop up into a towing position. Double loop the line first through the hole and then around the pylon and cinch it tightly. This procedure helps to keep the line intact when there is no strain on it.

Always appoint a person to keep their “eye out” for the tow line when the vessel is running to prevent the line from being caught in the propeller.



Auxiliary Equipment Operation

WATER/WASTE MONITOR



To read either the fresh water or waste water monitor panel the breaker on the main DC panel must be activated.

The optional monitor is normally located inside the ship's AC/DC cabinet or may be located behind the starboard picture window on a trim panel.

The fresh water monitor displays the amount of potable water in the system. There are sensors located in the water tank that send a signal to the display panel when activated. Press the top portion of the toggle switch and read the gauge display.

The waste portion of the display shows the amount of waste water in the holding tank. There are sensors located in the waste tank that send a signal to the display panel when activated. Press the bottom portion of the toggle switch and read the gauge display.

This portion of the system needs to be monitored periodically to prevent the system from being over full which could cause equipment damage and/or a possible leak in the vessel.

If the waste system is determined to be full it can be emptied by connecting a marina pump-out hose to the waste fitting located on the deck. The pump out device will actually remove the waste much like a vacuum cleaner. This is the easiest way to eliminate the vessel's waste and be environmentally friendly while performing the task. An alternative method which can be used in International waters only is to pump the waste overboard using the waste seacock.



WASTE PUMP- OVERBOARD DISCHARGE (MACERATOR) TYPICAL

Notice the key switch portion of the monitor. The key switch controls an optional overboard discharge pump (macerator) which grinds up the waste and sends it through the hull bottom. Make sure the waste seacock is open and you are legal to pump overboard. Turn the macerator breaker on and then energize the monitor panel key switch by turning it to the "on" position and holding it while you press the red button to activate the pump. Be sure to turn the seacock off and secure it with a tie wrap after the pump-out cycle is completed as you can be fined if authorities find the seacock in an unlocked position.



TYPICAL OVERBOARD DISCHARGE PUMP

WASTE FILTER- IN-LINE

As part of the electric toilet option located in the bilge near the through hull fitting is a long cartridge style filter installed in-line at the waste tank vent hose. This filter removes waste odor from the system while still permitting methane fumes to escape via the hull side. The waste filter is not serviceable. The manufacturer recommends that it be replaced each year. See the systems chapter for additional information. Note that there are union connectors on each end of the filter to aid in removal. See typical filter below.

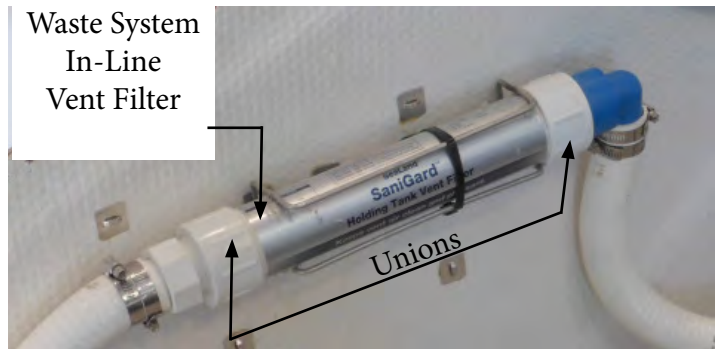



Cosmetic Care & Maintenance

COSMETIC CARE



This chapter covers the general care of your Regal boat. Be sure to read and understand all vendor supplied information on cosmetic care. Many cosmetic care topics are described and expanded in the following pages.

For selected items there may not be specific vendor information available in the owner's information packet. Therefore, we have provided customer cleaning information as needed on each of these topics.

Where cleaning methods are suggested try them on a small area before applying to the entire surface. Never use toxic or caustic chemicals on your yacht. Read and understand each cleaning agent before using it. The labels will alert you to limitations and safety information for each cleaner.

Never mix cleaning agents since this may produce an unsafe chemical reaction which could be toxic, produce fire or explosion and/or effects that may be harmful to the human body.

Provide fresh air while using cleaning agents to reduce any effects of chemical inhalation. It is recommended to vacate the area after cleaning until any chemical odors are diminished.

Most of all, use common sense!

Note that a majority of the *cosmetic care* items cover both the stern drive and outboard model respectively. See the outboard section for more specific outboard *maintenance* information and of course consult your outboard owners manual provided by the outboard vendor.



BILGE/ENGINE COMPARTMENT



Check the transom area for loose hardware. Do not use any flammable products in the bilge. Use environmentally approved procedures to dispose of oily or soiled cloths.

Always keep the bilge pumped out and free of accumulated debris. If oil accumulates on the engine compartment floor becomes it is usually related to engine oil lines, a loose component such as an oil filter, oil pan drain bolt or a leaky gasket/O-ring. Always find the cause of smaller problems before they become larger more expensive ones. The engine compartment, bilge or sometimes called the sump features a light colored gel finish that will be beneficial in finding leak sources.

A periodic bilge cleaning with a brush and bilge cleaner (purchase at a marina or supplier) will be helpful in maintaining an orderly and safe bilge since accumulated dirt and fluids could cause someone to fall. Do not pump bilge contaminated oil overboard but deploy it to a waste receptacle for recycling. **Check the fuel system annually including all hoses, tanks and connectors for possible leaks and deterioration.** A stained area normally could suggest a hose or connection leak.

Inspect all wiring including connectors and hangers for tightness. Clean fuel filters as suggested by the engine manufacturer.

Check all engine and water/waste hoses for tightness and deterioration. Tighten all hose clamps as needed.

Check all battery hardware and terminal connections. Fill the battery cells with distilled water (wet-cell type only) to the battery manufacturer's suggested level.



Cosmetic Care & Maintenance

CABINETS- HEAD



The handcrafted interior cabinets feature a sprayed clear coat finish. This clear coat produces a hard finish which is baked on and is very resilient. Use a warm solution of water and mild detergent to keep the cabinet surfaces looking new. Wipe the surface with the solution using a soft damp cloth, and dry with a soft clean towel. This procedure should eliminate most stains and oily finger marks.

Stay away from heavy scrubbers and compounds which may harm the surface. Avoid polishes containing silicones.

Use the table below as a guide for any cabinet repairs or interior refurbishing needs.

APPLICATION	ADHESIVE
WOOD TO WOOD	WOOD GLUE
WOOD TO FORMICA	CLEAR SILICONE
FORMICA TO FORMICA	CLEAR SILICONE
SINK INSTALL	CLEAR SILICONE
CORIAN TRIM	SIKA FLEX 291
MIRROR TO FORMICA	MIRROR MASTIC



CANVAS CLEANING INSTRUCTIONS



Sunbrella type canvas should be cleaned regularly before substances such as dirt, roof particles, etc., are allowed to accumulate on and become embedded in the fabric. The fabric can be

cleaned without being removed from the boat. Simply brush off any loose dirt, hose down, and clean with a mild solution of natural soap in lukewarm water. Rinse thoroughly to remove soap. **DO NOT USE DETERGENTS!** Allow to air dry.

For heavily soiled fabric, remove the top from the frame. Soak the fabric in a solution that has been mixed to the following proportions: 1/2 cup of Clorox bleach and 1/4 cup of Ivory or Lux soap (liquid or soap) per each gallon of lukewarm water. Allow the fabric to soak until the bleach has killed the mildew and the stains can be brushed out with a common kitchen scrub brush. Rinse the fabric thoroughly in cold water to remove all the soap. This may require several rinsings. Incomplete rinsing can cause deterioration of sewing threads and prohibit the fabric from being properly retreated. Allow the fabric to dry completely. Do not steam press or dry in a gas or electric dryer.

Excessive heat can damage and shrink the fabric since it is heat sensitive.

This method of cleaning may remove part of the water and stain repellents that was applied to the fabric during its manufacture. It is recommended to retreat with such water repellency products as Apeal and Uniseal. We do not recommend any wax based treatments such as Thompson's Water Seal or any of the silicone products such as SC-15 or Aqua-Tite. Wax based products prevent the fabric from breathing, and encourage mildew growth while the silicone products interact with the original fluorocarbon finish and seem to cause a rapid loss of water repellency. Scotchguard has not been found to be very effective for restoring water repellents to Sunbrella. It seems to work well in the short run, but not long term.

CLEAR VINYL, ZIPPER & SNAP CARE

Never store canvas wet or in an unventilated, moist area. Always roll the canvas instead of folding. This is of particular importance on side curtains or any other part with the clear vinyl "glass". Roll the top carefully around the bows and cover with the storage boot provided.

The clear vinyl "glass" used in side curtains, aft curtains, visors, and camper enclosures is very susceptible to heat and cold. Keep vinyl curtains from touching metal tubing to minimize burning the vinyl.

If the boat is stored with top, side curtains and aft curtain in place, heat build up inside the boat may discolor the vinyl.

If installed, clean the clear "vinyl" glass with a solution of Ivory or Lux soap, liquid or flakes, and lukewarm water. Allow to air dry. Never use any type of abrasive cleaner as it will scratch the "vinyl" glass. There are many cleaners and scratch removers on the market specifically for clear vinyl. Handle the clear curtains carefully. They are soft and prone to scratching.

Canvas parts are designed with zippers. When zippers are new they can be a little difficult to use. Zip carefully without forcing the zipper or the material. They will loosen with use. A zipper lubricant may be used to help new zippers as well as maintaining used ones. The most vulnerable part of the zipper is the starts. Use care when starting the zipper.

Canvas snap fasteners should be unsnapped as close to the button as possible. Never remove canvas by pulling roughly on the edge of the material. This can damage the canvas as well as the fasteners. Use petroleum jelly on snaps to keep them from developing corrosion especially in harsh environments.



Cosmetic Care & Maintenance

CARPET-COCKPIT TYPICAL

Regal cockpit carpets feature an aqua tread backing which permits the carpet to weep moisture and still retain steadfast non-slip characteristics. Also, this backing permits the cockpit carpet to lay flat on the fiberglass deck surface without buckling.

Also, your cockpit carpet is produced with 100% ultra-violet resistant fibers. The carpet boasts a special blend of resilient fibers to withstand traffic and retain its beauty.

Cockpit carpet is designed to take a lot of abuse from the sun and sea but it periodically needs to be cleaned which is a different procedure from household types.

To clean cockpit carpet follow these steps:

1. Scrub the soiled areas with a stiff nylon or soft bristle brush to loosen the dirt and grime.
2. Vacuum the carpet thoroughly using a wet-dry type of cleaner.
3. Pour one cup white vinegar into a 1-quart spray bottle; fill with water.
4. Spray the soiled areas with the vinegar solution until saturated; let stand 15 minutes.
5. Brush the soiled areas once more; the dirt and grime will be released from the carpet fibers.
6. Rinse the carpet, with a garden hose at low pressure.
7. Remove any remaining water with a wet-dry vacuum. Allow the carpet to dry completely.
8. Fluff up the clean, dry carpet with the brush or a carpet rake. If applicable, apply vaseline to the snaps.

Stain Removal

Olefin fiber used in the cockpit carpet is very resistant to stain. However, when a stain does occur, follow the stain removal chart below. Remember to remove a stain as soon as possible as this enhances the ability to eliminate it.

Most stains should easily be removed from Olefin fibers. If the stain persists, the cleaning procedure should be repeated to ensure stain removal. Again, the sooner the stain removal process is started, the easier the stain will be to remove.

Under no circumstances should any solvents normally associated with the dry cleaning of apparel (perchloroethylene, carbon tetrachloride, etc.) be utilized, as permanent damage to the fiber will result.

Cockpit Carpet Stain Removal Chart

Miscellaneous Stains	Removal Process
Coffee, Tea, Coke, Fruit Juice, Ice Cream, Motor Oil, Egg, Grease, Catsup, Chocolate, Milk, Rust, Latex Paint, Water Colors, Berry Stains, Blood, Salad Dressing, Furniture Polish, Clay, Wine, Dye, Mayonnaise, Fish Formula or Urine	Apply warm water and household detergent in minimal amounts to the stained area. Sponge or scrape the stain until it is removed. Then wash thoroughly with clean water.
Persistent Stains	Removal Process
Chewing Gum, Crayon, Ink, Wax, Lipstick, Tar, Polish, Oil Paint	Apply warm water and household detergent. Work mixture well into the stained area, and then flush with warm water.



To store cockpit carpet, roll it tightly. This will keep the carpet from developing wrinkles which result from folding the carpet.



COUNTER TOP- HEAD

Solid surface counter tops feature elegance and durability. Periodic maintenance will ensure its beauty.

Another feature of solid surface counter tops is that they are non-porous. Therefore, dirt and germs do not penetrate it. Also, it will not support the growth of germs and mildew. To disinfect or clean see the table. You can use a green Scotch-brite pad along with the table solutions to remove stubborn stains.

Darker colors tend to require more frequent cleaning to maintain a uniform finish. Also, darker colors tend to show fine scratches more easily and require more attention than lighter colors.

The material is a matte or satin finish. To remove scratches and nicks, sand the surface with 180-220 grit sandpaper until the nick is gone. To restore the finish use an abrasive cleanser and a green Scotch-Brite pad. Wrap the sandpaper around a block of wood. The block will sand the areas flat instead of creating hills and valleys.

VINYL- HEAD

Normal interior vinyl such as the headliner and types used on walls need a mild soap and water solution. Rinse immediately with clean water and wipe dry. Always test a small area with a cleaner before applying it to a larger area.

PROBLEM	SOLUTION
Dirt and Residue	Use soapy water, ammonia based cleaner (not window cleaner), rinse and <u>wipe completely dry.</u> Commercially available solid surface cleaners such as Clean Encounters® will work well too.
Preventing Hard Water Marks	Rinse & <u>wipe completely dry</u> after cleaning; clean up spills before they dry.
Removing Hard Water Marks	Use a cleaner formulated for removing hard water marks such as CLR or Lime-A-Way
Difficult Residue	Spray residue with Deep Cleaner for DuPont Corian from Stone Care International. Follow instructions on the bottle. Wash area with soapy water, rinse and <u>wipe completely dry.</u>
Disinfecting	Occasionally, wipe surface with diluted household bleach (1 part water/1 part bleach). Rinse top thoroughly with water and <u>wipe completely dry.</u>



Cosmetic Care & Maintenance

FIBERGLASS & GELCOAT



Routine maintenance is the only practical way to keep the surface of your boat looking shiny and new. Most objects left outdoors will gradually deteriorate from exposure to the sun, water, dust and pollution. Such outdoor exposure can cause your boat's gelcoated surface to change or fade. Darker colors tend to fade more rapidly than lighter colors because they absorb more of the sun's rays (ultraviolet and infrared).

Basic maintenance includes monthly washing of the boat's surface to remove normal accumulation of soil and stain. Use a mild detergent such as dishwasher powder or liquid. Do not use automatic dishwasher detergent. Avoid any kind of alkaline cleaners such as tri-sodium phosphate (TSP), abrasives, bleaches and ammonia. For best results use cleaners that are recommended for fiberglass. It is recommended that you wax the gelcoat surface twice yearly to prevent loss of gloss and to protect the finish. Use only waxes for fiberglass and follow the label instructions. Apply a 3' x 3' section at a time using clean applicator cloths or a buffing bonnet. When a haze develops, use a power buffer at low speeds (1200-2000 rpm) to remove the haze. Keep the buffer moving to avoid heat build-up. Never wax gelcoat in direct sun.

When the washing and waxing as recommended does not restore the shine it may be necessary to use a fine rubbing compound. Do not apply rubbing compound in direct sunlight. A power buffer at lower speeds does an excellent job to remove impurities from the gel coat that cause dulling. Use light pressure and keep the buffer moving. Re-wax after compounding to buff the surface. "Hairline cracks" or "spider webbing" could develop in the gelcoat surface of a hull or deck. This can be caused by impact or other factors. Small air pockets or gouges may also occur through normal wear. These do not affect the strength of the hull or deck and can be repaired by yourself, a marine professional or a Regal dealer.

The affected area should be chipped or sanded away and a thin layer of color matched gelcoat applied. This layer is then sanded smooth and buffed to its original luster.

Most minor scratches, nicks, and dents can be removed by compounding the surface. Marine type compounds can be found at most auto body supply stores.

Specify a number 25 which is a coarser compound up to a number 55 being less coarse. Various glazes and polishes are available as needed. Ask your marine professional or Regal dealer for more information. Fiberglass hulls are strong but they can be damaged. A fiberglass hull has virtually no internal stresses. Thus when a part is broken or punctured, the rest of the hull retains its original shape. A severe blow will either be absorbed or result in a definite localized break. A break of this nature should be checked and repaired by a marine professional or a Regal dealer.

MINOR REPAIRS

You will need the following materials for minor repairs:

- Gelcoat
- Clear Liquid Catalyst
- Putty Knife
- Razor Blade
- Fine Sandpaper (400,600,1000)
- Wax Paper (to cover repair area)



WARNING

AVOID BODILY INJURY!
GELCOAT & FIBERGLASS RESIN
ARE FLAMMABLE.
WORK IN A WELL VENTILATED AREA
FREE FROM OPEN FLAMES.
DO NOT SMOKE!

For minor repairs refer to the following procedure:

1. Clean the area to be repaired and get rid of any wax or grease residues.
2. Clean out scratches, chips, and nicks.
3. Sand area to be repaired so gelcoat will bond.



CAUTION

AVOID BODILY INJURY!
WAXED GELCOAT SURFACES CAN BE VERY
SLIPPERY. DO NOT WAX NORMALLY USED
AREAS OF THE DECK, LINER, OR GUN-
WHALES. DO NOT WAX ANY TEXTURED OR
NON-SKID SURFACES SUCH AS FLOORS,
WALKWAYS, STEPS, LADDERS
OR SWIM PLATFORMS.
ALWAYS WEAR NON-SLIP FOOTWEAR
WHILE ON BOARD THE VESSEL.

4. In a separate container, measure only the amount of gelcoat you will need. Mix a ratio of 2% ratio of catalyst to the amount of gelcoat being used (a spoonful of gelcoat will require only a drop or two of catalyst). Do not pour any unused portions of the gelcoat/catalyst mixture back into either original container.

5. Apply gelcoat to area leaving a slight lift above the surface.

6. Cover the area with wax paper. It will help the mixture to set up faster.

7. Remove wax paper and shave off any extra gelcoat with a razor blade.

8. After the area is shaved smooth, start with the 400, 600, and finally 1000 grit sand papers.

9. Buff the area with compound, polish and a finish wax. You may notice a difference between the repaired area and the original finish due to the natural weathering process.



Cosmetic Care & Maintenance

GAUGES/SWITCH PANELS



Sometimes gauges develop condensation inside their faces. in high humidity environments. To eliminate the condensation droplets, energize the instrument lighting and the heat over a short period of time This process will evaporate the gauge condensation.

For normal dirt and dust accumulation clean with soft cloth and warm water. Dry with a soft cloth or chamois. Near salt water environments deposits can build up on the instrument bezels and faces. Use a soft damp cloth to remove the deposits. Do not use abrasives or rough, dirty cloths to wipe instruments.

Follow the same procedure for all switch panels. Do not use any of the following on panels:

1. Lacquer Thinner
2. Dry Cleaning Fluid
3. Acetone
4. Carbon Tetrachloride
5. Benzine
6. Silicone Spray
7. Gasoline



HULL/DECK

HULL BOTTOM

Never use wire brushes or highly abrasive scouring pads on your hull bottom. It could damage the gelcoat surface or the bottom paint. The bottom of your boat needs to be clean since the build up of natural coatings from water or marine life can potentially create drag and affect boat performance. Use a turkish towel or for heavier build-up a piece of rug to clean the bottom.

HULL/DECK

For normal dirt and insect residue find a soft bristle brush on a long telescopic handle at an automotive store. A good brush is designed with a curved soft base to protect objects it comes in contact with while scrubbing. Rinse down the hull with a hose to loosen up the dirt. Use a mild soap solution in a bucket. Use up and down strokes to clean the hull sides. Rinse off until all residue is removed.

	CAUTION
<p>AVOID BODILY INJURY! GELCOAT SURFACES CAN BE VERY SLIPPERY. ALWAYS WEAR NON-SLIP FOOTWEAR WHILE ON BOARD THE VESSEL. ALWAYS RINSE SURFACES ADEQUATELY TO AVOID SLIPPING ON SOAPY SURFACES!</p>	



Cosmetic Care & Maintenance

PLASTICS

There are different types of plastic aboard your vessel. Use plastic cleaners and polishes recommended for marine use only. Use proper applicators. Read all instructions carefully. Test the product in a small area first. Use a soft rag and always rinse the surface with water. Ammonia based cleaners will damage plastic parts.

One of the basic rules to cleaning plastic is never use abrasive cleaning products. Even hard plastic surfaces are easily scratched. Stay away from steel wool pads, powdered cleaners with abrasive qualities, or harsh detergents.

Instead use sponges, soft cloths, and mild detergents when cleaning plastic.

While cleaners in aerosol cans are convenient they may not be the best for certain types of plastic. Glass cleaner in a can or a spray bottle is not safe to use on your marine toilet fixture or toilet seat. Many times pits will develop over time and the toilet/seat will appear mottled and will not appear clean no matter how hard you scrub.

Refer to a marine store which possesses the expertise and experience to assist the boat owner in selecting the right cleaner for his marine plastic onboard needs.

NOTICE

NEVER CLEAN PLASTIC SURFACES WITH
A DRY CLOTH OR GLASS CLEANING
SOLUTIONS CONTAINING AMMONIA.

NEVER USE SOLVENTS
OR WIPE WITH ABRASIVES.



STAINLESS STEEL



Stainless steel is an alloy made from nickel, chromium and iron. It has been very successful in marine environments due to its ability to resist rusting. If the stainless steel product such as a bow rail is exposed to elements such as ocean spray it will begin to rust over time.

If your stainless steel shows signs of rusting:

1. Wash with fresh water.
2. Clean with a good quality chrome polish periodically but no less than twice annually. “Brasso” is another product that works well. Note that in salt water environments the stainless steel may require cleaning more often.
3. Also, using a good quality car wax will provide extra stainless steel protection.
4. For polished finishes that show grit lines an abrasive such as “Scotch Brite” or sand paper can be used. Always test a spot first and “go with the grain”.

Do not use harsh solvents or cleaners on stainless steel. Do not use steel wool or wire brushes. They will damage the finish.

Do not use any type of acids.



Cosmetic Care & Maintenance

STAINS

Below is a listing of normal stains and clean-up methods. The sooner the stain is removed there is less chance of permanent residue on the surface. Do not use wire brushes, solvents or harsh chemicals on any stain. Damage to the surface will occur.

FREQUENT STAINS	CLEAN-UP STEPS		
	1	2	3
Coffee, Tea, Chocolate.....	B		
Permanent Marker*.....	E	B	C
Household Dirt.....	A	B	
Grease.....	D	B	
Ketchup, Tomato Products.....	A	B	
Latex Paint.....	A	B	
Oil Base Paint.....	D	B	
Mustard.....	A	B	C
Suntan Oil.....	A	B	
Asphalt/Road Tar.....	D	B	
Crayon.....	D	B	
Engine Oil.....	B		
Spray Paint.....	B		
Chewing Gum.....	D	A	
Shoe Polish*.....	D	B	
Ballpoint Pen*.....	E	B	A
Lipstick.....	A	B	
Eye Shadow.....	E	B	
Mildew*.....	C	B	A
Wet Leaves *.....	C	B	A

A= Soft brush; warm soapy water/rinse/ dry

B= Fantastik cleaner

C= One tablespoon ammonia, 1/4 cup of hydrogen peroxide, 3/4 cup of warm water/ rinse/dry

D= Scrape off residue (use ice to lift gum)

E= Denatured alcohol/rinse/dry

* These products contain dyes which leave permanent stains.



UPHOLSTERY



Cockpit vinyl requires periodic cleaning to maintain a neat appearance and to prevent the build up of dirt and contaminants that may stain and reduce the vinyl life if they are not removed. The frequency of cleaning depends on the amount of use and conditions to which the vinyl is subjected.

Most common stains can be cleaned using warm, soapy water and clear rinses. Scrubbing with a soft bristle brush will help loosen soiled material from embossed surfaces and under welting. If the stains are not removed with the above method use a mild cleaner such as Fantastic. This cleaner should be used only as needed and not the normal means.

With more stubborn stains, rubbing alcohol or mineral spirits may be tried cautiously. Widespread solvent use can severely damage or discolor vinyl.

Try to remove stains immediately before they have a chance to penetrate the surface of the vinyl.

Powdered abrasives, steel wool, or industrial strength cleaners are not recommended for cleaning our vinyl. Lacquer solvents will cause immediate damage. Dilute chlorine bleach before using. Do not wax the vinyl as it may cause cracking. Always wear protective gloves and make sure there is sufficient ventilation when cleaning vinyl. Wear eye protection.

Remember that suntan oil will damage vinyl. Use suntan lotion instead of suntan oil. Exposure to the sun is a natural enemy of vinyl upholstery. For maximum life, use a cockpit cover when the vessel is moored, docked or stored.



Cosmetic Care & Maintenance

Ballpoint Pen Removal Instructions

1. Wipe the stain off with ethanol (rubbing alcohol).
2. Prepare a solution of 50% non-chlorinated bleach, 50% water.
3. Place a thin line of tissue over the ink stain.
4. Apply the non-chlorinated bleach solution to the tissue. Be sure not to saturate the tissue.
5. Cover tissue with polyethylene film (plastic wrap) to prevent the non-chlorinated bleach solution from drying.
6. Check on stain repeatedly.
7. Do not leave the non-chlorinated beach solution on for more than 1 hour.
When the stain looks almost gone, remove the tissue and wash the stain with water.
9. To neutralize the bleached area, place tissues on the bleached area and apply 15% hydrogen peroxide solution.
10. Leave on for 30 minutes, & then remove the tissues.
11. Remove the peroxide residue with water.



MAINTENANCE



This section covers maintenance procedures on selected standard and optional Regal installed and/or related equipment. Heed special attention to all caution, warning and danger labels found in the engine/propulsion manuals.

Also, the major electronic and entertainment components are outfitted with detailed system descriptions, wiring schematics, and contact information. The internet can be helpful for select maintenance issues. Numerous web-sites are currently available from vendors on their particular product maintenance procedures and schedules.

NOTICE

ENGINE AND PROPULSION EQUIPMENT, ELECTRONIC AND SPECIFIC ENTERTAINMENT COMPONENTS ARE FOUND BY REFERRING TO INDIVIDUAL VENDOR OWNER'S MANUALS LOCATED IN THE OWNER'S INFORMATION PACKET.

THE ENGINE AND PROPULSION MANUALS ARE QUITE DETAILED. THEY SHOULD BE READ AND UNDERSTOOD BEFORE ATTEMPTING TO UNDERTAKE ANY MAINTENANCE.



Cosmetic Care & Maintenance

BATTERIES

Periodically check your battery terminals for corrosion build-up. If you find a greenish, powdery substance, remove the cable connections and clean both the terminals and the connectors with a wire brush. When the cleaning is finished reconnect the battery cables and coat the terminals with an approved grease or petroleum jelly to help prevent further corrosion. Check the electrolyte level at least every 30 days on non-maintenance free batteries, more often in hot weather. Also, on non-maintenance free batteries the level should be maintained between the top of the battery plates and the bottom of the fill cap opening. Add distilled water as needed after charging the batteries. Do not overfill because sulfuric acid could run over and cause burns or an explosion. Check specific gravity levels with a hydrometer which can be purchased at auto retail stores.



TYPICAL MAINTENANCE FREE BATTERIES

	WARNING
TO PREVENT BODILY INJURY! WEAR GOGGLES, RUBBER GLOVES AND A PROTECTIVE APRON WHEN WORKING WITH A BATTERY. BATTERY ELECTROLYTE CAUSES SEVERE EYE DAMAGE AND SKIN BURNS. IN CASE OF SPILLAGE, WASH AREA WITH A SOLUTION OF BAKING SODA AND WATER.	

Tighten all battery connectors securely. Check their tightness by pulling on the connectors. They should not move from their tightened position. Be sure to reinstall the positive boot over the battery terminal after tightening the battery post connection. While using the boat, keep an eye on the volt meters to monitor the charge level of each battery bank. Monitor the charge with the engines turned off (static condition).

The engine alternators recharge the batteries. A fully charged battery will indicate between 12 and 14 volts on the voltmeter. Readings below this could indicate a dead battery cell or a charging system malfunction which should be checked by a marine professional.

Batteries should be charged outside the boat. Do not smoke or bring flames near a battery that is being or has recently been charged. The hydrogen gas generated by battery charging is highly explosive.

Set the batteries on a block of wood not concrete since the batteries will lose their charge if left on a cement surface. Do not allow a metal object or loose wires to spark across battery posts while working close to the battery. Contact across terminals will cause a short circuit and possible electrical burns, fire, explosion or personal injury.



BATTERY MAINTENANCE

Maintenance Free Type

The Group 31 “maintenance free” engine cranking batteries shown on the previous page are not all together maintenance free. Unlike regular batteries there are no fluid levels to maintain on this style battery but several other items need to be monitored periodically.

1. Check both positive and negative terminal hardware for tightness. Loose connections are known to discharge a battery very quickly.

2. Make sure all terminals are clean. If not a battery cleaner tool (available at car parts stores) or old toothbrush should be used to clean both the positive and negative terminals. Use a small amount of baking soda and water. Remove any residue from the terminal area with a disposable damp cloth.

Install corrosion protection to the posts before reinstalling the terminals. Refer to the illustration.

3. After all preventative maintenance is completed slide the red boot back over the positive terminal. This will prevent any object from arcing across the positive terminal to ground possibly causing a fire.

 **CAUTION**

TO PREVENT BATTERY ARCING
FIRST REMOVE THE NEGATIVE BATTERY CABLE
FROM THE BATTERY.

 **CAUTION**

AVOID EYE DAMAGE/SKIN BURNS!
WEAR GOGGLES & RUBBER GLOVES
WHEN WORKING WITH BATTERIES.
AVOID CONTACT WITH SKIN,
CLOTHING OR EYES.
IN CASE OF CONTACT,
FLUSH WITH WATER
FOR AT LEAST 15 MINUTES.
IF SWALLOWED,
DRINK LARGE QUANTITIES
OF WATER OR MILK.
FOLLOW WITH MILK OF MAGNESIA,
BEATEN EGG OR VEGETABLE OIL.
GET MEDICAL ATTENTION IMMEDIATELY.

 **WARNING**

TO PREVENT BODILY INJURY!
BATTERIES CONTAIN SULFURIC ACID
(POISON)
WHICH ALSO CAN CAUSE BURNS.
AVOID CONTACT WITH THE SKIN,
EYES & CLOTHING.
IF CONTACTED, FLUSH WITH WATER AT
LEAST 15 MINUTES. IF SWALLOWED, DRINK
LARGE AMOUNTS OF WATER OR MILK.
FOLLOW UP WITH MILK OF MAGNESIA,
BEATEN EGG OR VEGETABLE OIL. GET
MEDICAL ATTENTION IMMEDIATELY!



Cosmetic Care & Maintenance

CHECKING BATTERY CONDITION

1. Test for an open-cell voltage. Use a dedicated battery tester or a voltmeter.

With the battery fully charged with no circuits energized the voltage across the terminals should be 12.5 to 12.6 volts. If the battery is not completely charged, but still adequate to crank the engine over, you may see a reading closer to 12 volts.

2. If the battery shows less voltage or will not charge up completely it may be time to replace the battery.

3. The maximum voltage you should see across the battery terminals with the engine running as read by a voltmeter well above idle is 14.6 volts. If the reading is over this amount the charging circuit may be supplying too much voltage to the battery reducing the acid levels inside the battery.

3. Check both positive and negative terminal hardware for tightness. Loose connections are known to discharge a battery very quickly.

4. Make sure all terminals are clean. As discussed earlier, a battery cleaner tool along with a toothbrush should be used to clean both the positive and negative terminals. Use a small amount of baking soda and water. Remove any acid residue from the terminal area and battery top with a damp cloth. Be sure to wear plastic gloves and eye protection. See the illustration.

Install an anti-corrosion lubricant to the posts before reinstalling the terminals. This lubricant is available as a paste or spray type and can be found at most marina or auto supply stores.



Be sure to reinstall any red (+) battery (anti-short) boots.



BATTERY SWITCH MANAGEMENT PANEL

SINGLE BATTERY SWITCH SYSTEM

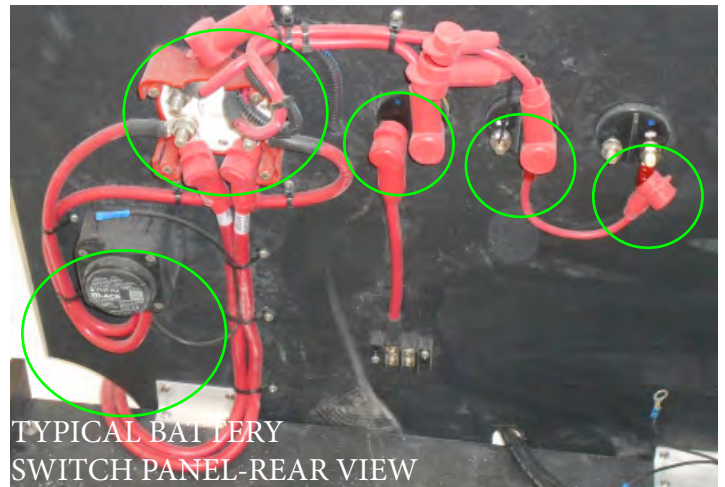
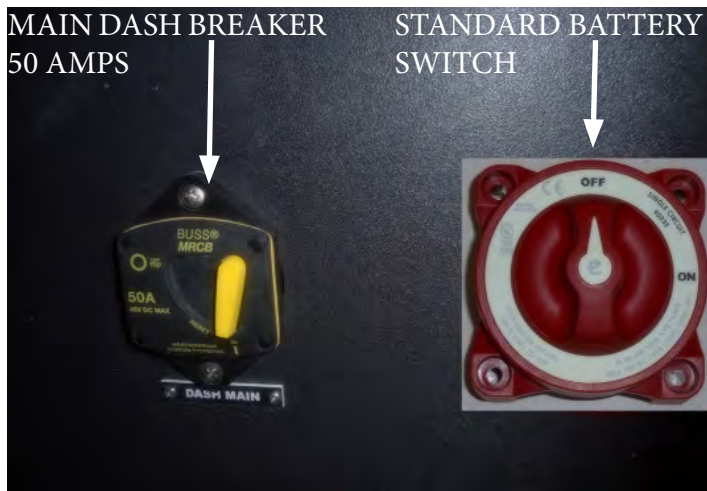

With the standard configuration there is an “on” and “off type battery switch along with a 50 amp breaker to protect the wiring running to the helm. Should an electrical malfunction occur the breaker will “trip” to safely interrupt current through the wiring circuit. Always check for the cause of a breaker tripping before resetting the device. The breaker above is in the normal “on” position. Should it trip the yellow arm would end up halfway to a full up position.

Periodically check all connections to the batteries, battery switch terminals and to the breaker rear. Tighten as needed.

Note that other breakers may accompany the dash breaker depending on the vessel equipment onboard.

Electric head main breaker= 30 amps

Steering system breaker (outboard only)= 50 amps

Note the photo above is a typical aft view of the battery switch management panel. With the battery(ies) disconnected periodically check all nuts for tightness under the red boots. Be sure to reinstall the boots to prevent any arcing possibilities.



Cosmetic Care & Maintenance

DUAL BATTERY SWITCH SYSTEM

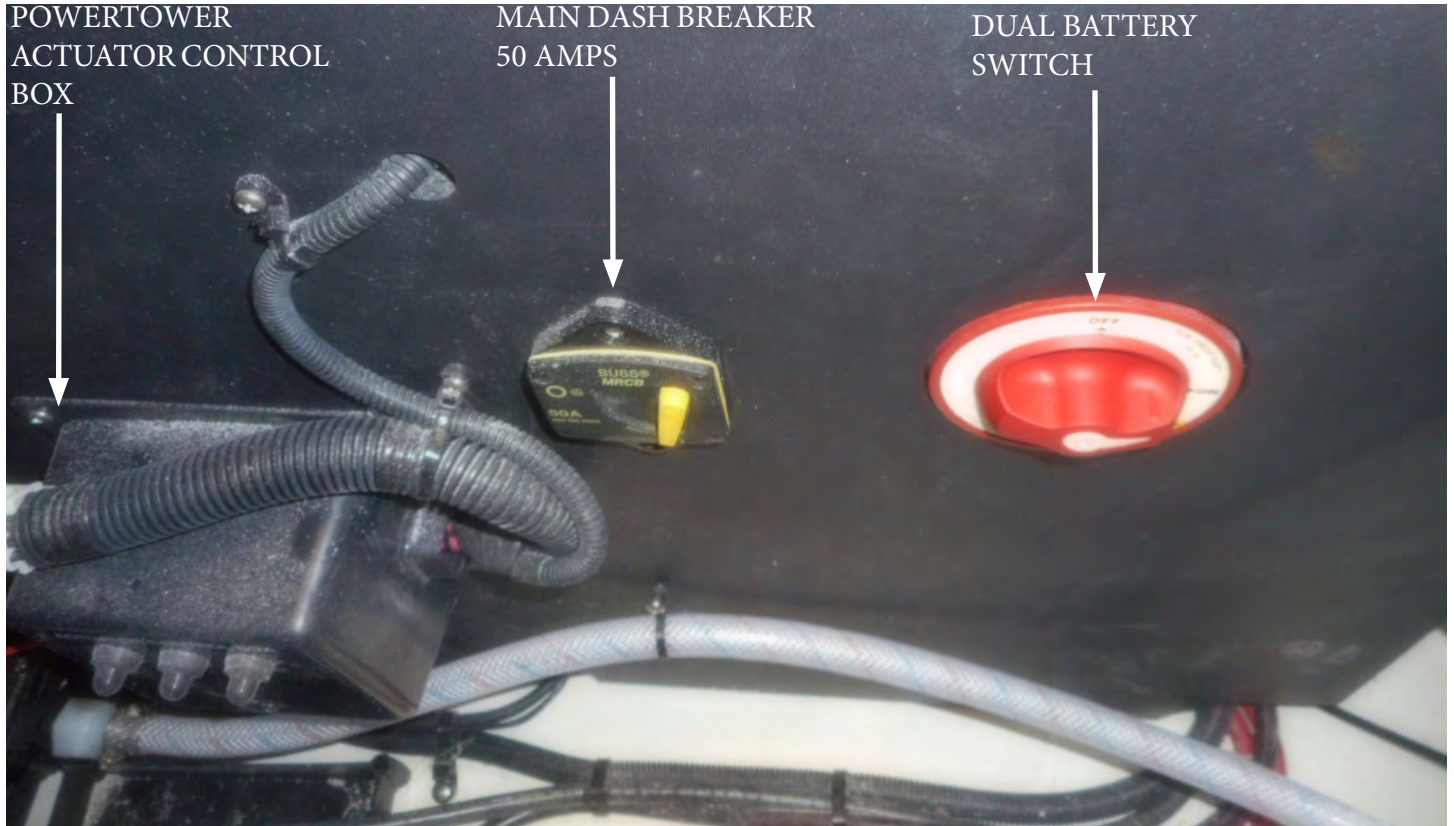

The dual battery switch management panel operates much the same as the standard one except there is normally more main breakers in the system along with an extra system battery. Also, the dual battery switch features a “combine batteries” position for emergency starting due to one of the batteries being weak or dead.

Note: Do not use the “combine batteries” position for cruising. If both batteries for example become discharged from using the stereo for extended periods with the engine off there may not be enough power in the batteries to crank over the engine.



BILGE PUMP/FLOAT SWITCH/TYPICAL

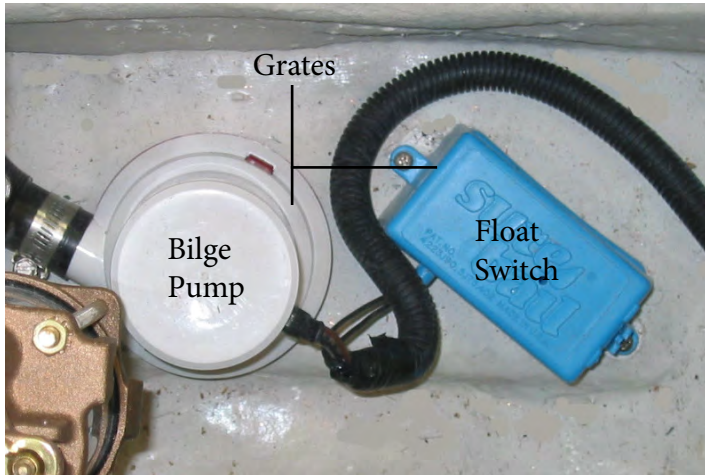

Your vessel offers as standard equipment bilge pump service. Periodically check the grates for debris and test spray the units down with water. Make sure that a steady stream of water exits the through hull fitting indicating the hose from the bilge pump itself is clear. Periodically check all hoses, clamps and electrical connections for tightness.



Cosmetic Care & Maintenance

ELECTRONICS- GARMIN



In some installations, it may not be possible to prevent the equipment from being affected by external influences. In general this will not damage the equipment but it can lead to spurious resetting action, or momentarily may result in faulty operation.

Certain atmospheric conditions may cause condensation to form on the instrument window. This will not harm the instrument and can be cleared up by increasing the illumination setting.

Periodically clean any electronic display screens with a soft damp cloth. Do not use any harsh chemicals, solvents or abrasive materials to clean the instrument.

Note: For detailed information on each component refer to your electronics owner's manuals in the owner's information packet. Also, the vendor can be found online or phone your closest Regal yacht dealer.

General Maintenance

Since there are no user-serviceable parts on electronic products they should be repaired only by specific marine electronic certified factory technicians.

Some products generate high voltages, and so never handle the cables/connectors when power is being applied to the equipment.

When powered up, all electrical equipment produces electromagnetic fields. These can cause adjacent pieces of equipment to interact with one another, with a consequent adverse effect on operation. In order to minimize these effects and enable you to get the best possible performance from your electronic equipment, guidelines are given in the installation instructions, to enable you to ensure minimum interaction between different items of equipment, i.e. ensure optimum Electromagnetic Compatibility (EMC).



FIRE EXTINGUISHING SYSTEM - AUTOMATIC



Inspect the pressure gauge before each outing. The illustration shows the ready and discharge condition of the actuator. Remove and weigh the unit (minus brackets) every 6 months on an accurate

scale (Do not use any hand held scales). If weight is below that shown on the unit nameplate, it must be removed from service immediately. If leakage is suspected, brush liquid soap on all points of possible leaks, or submerge entire unit in clean fresh water and watch carefully for 5 or 10 minutes.

Leaks will appear as tiny bubbles. If leakage is found return to the factory immediately for repair or replacement. Remember the two most important requirements to assure full charge and reliability of your Fireboy system are:

1. Visual inspection of the gauge and the actuator to determine if it has actuated.
2. Weighing to determine the true contents of the agent in the system.

All models from 75 cubic feet are rechargeable. Recharging is possible only if the unit has leaked out verses losing agent due to a fire.

Should the indicator light fail to come ON when the ignition key is ON, first check the pressure gauge and actuator to see if the unit has discharged. If not check the breaker. Next, using a continuity tester, check the electrical pressure switch on the system bottle itself. Pull the molded rubber connector off by pulling straight away from the manifold, and place the probes of the continuity tester directly on the spade connectors. This pressure switch should show a closed circuit.

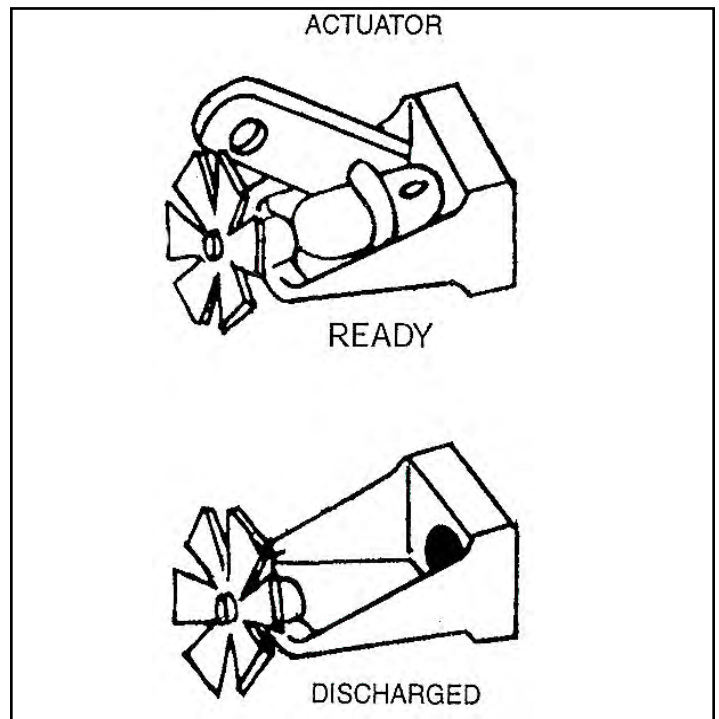

Next, check the continuity of the entire wiring circuit. The indicator lamp is an LED (light emitting diode) and cannot be tested with a continuity tester.

A simple method to test LED'S is to remove the lamp and touch the red wire to the + terminal and the black wire to the - terminal of an ordinary 9 volt battery. Should the indicator lamp be faulty, replacement lamps are available from Fireboy.

Should the continuity of the pressure switch indicate an open circuit, the system will have to be returned to the factory for either replacement or repair.



Cosmetic Care & Maintenance

FUEL SYSTEM



Periodically (at least twice annually) inspect the fuel tank components for loose clamps at the vent, fill, return and feed locations. Examine each hose for signs of deterioration and leakage. Check the fuel sender for loose fasteners. Also, inspect the fuel tank and hardware especially hoses for signs of abrasion. Tighten all components as needed.

Note: Do a visual inspection before each cruise.



Cosmetic Care & Maintenance

PLUMBING CONNECTORS

Plumbing connections to the blue fresh water lines require special instructions when they are to be removed or replaced. Be sure to turn off the fresh water helm breaker.

To remove a tee, 90 degree, or straight connector fitting first remove the cap on the end of the fitting by using a slotted screwdriver. Insert the screwdriver in the cap slot and turn 90 degrees. Cap will release from the fitting.

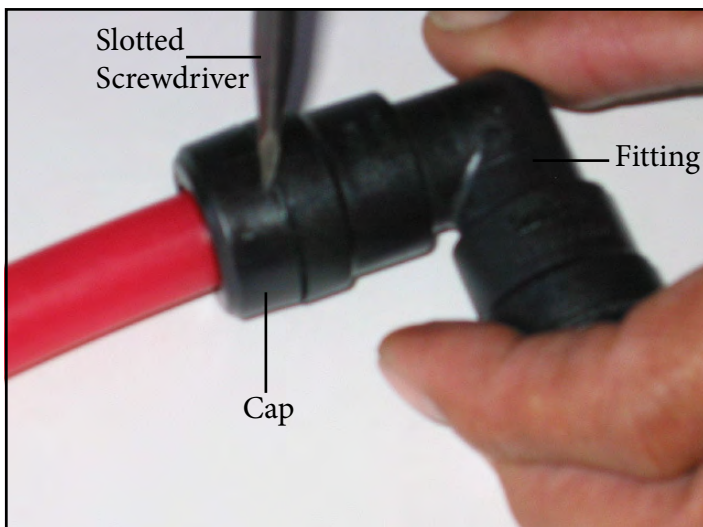

2. Push the connector and collar together. Hold the collar next to the connector with your finger. Pull and the connector/collar will release itself from the water line.

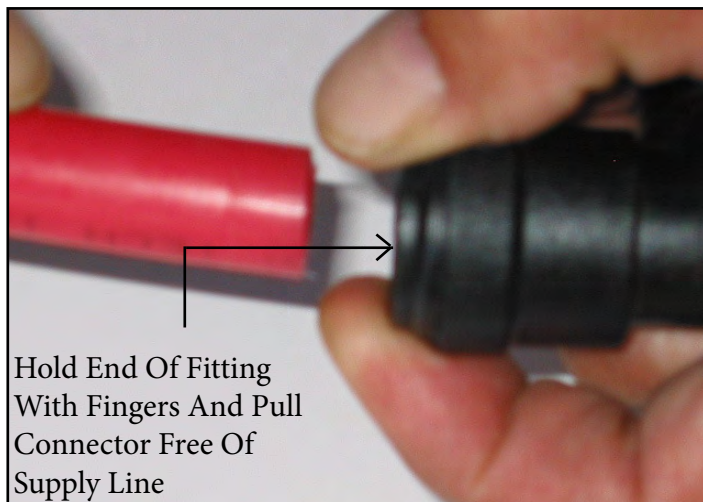

To reinstall a plumbing connection to a water line make sure the line is cut off square and the end is smooth. This will aid in ensuring a leakproof connection.

1. Install the cap on the supply line. You may need to use a slotted screwdriver to remove the cap from a new fitting.
2. Simply push the fitting on to the supply line until pressure is felt. This ensures it is completely in the fitting.
3. Push the cap on the collar until it snaps in place. Turn on the water pressure and check for leaks.

Note: With the connector in place, a movement between the line and connector is normal.



PRESSURE PUMP-FRESH WATER

The fresh water system in general requires very little maintenance.

1. See the equipment operation chapter defining the recommended seasonal disinfection procedure.
2. The fresh water filter needs to be cleaned periodically. Simply remove the hose clamp and unscrew the fresh water filter to access the screen. Rinse the screen off to remove any foreign debris. Be sure to use teflon tape on the pump fitting threads before installing the filter. Reinstall the components and check for leaks.
3. Periodically check all fittings for leaks.
4. In colder climates, use Winterban or its equivalent in all the fresh water system components after draining the system.

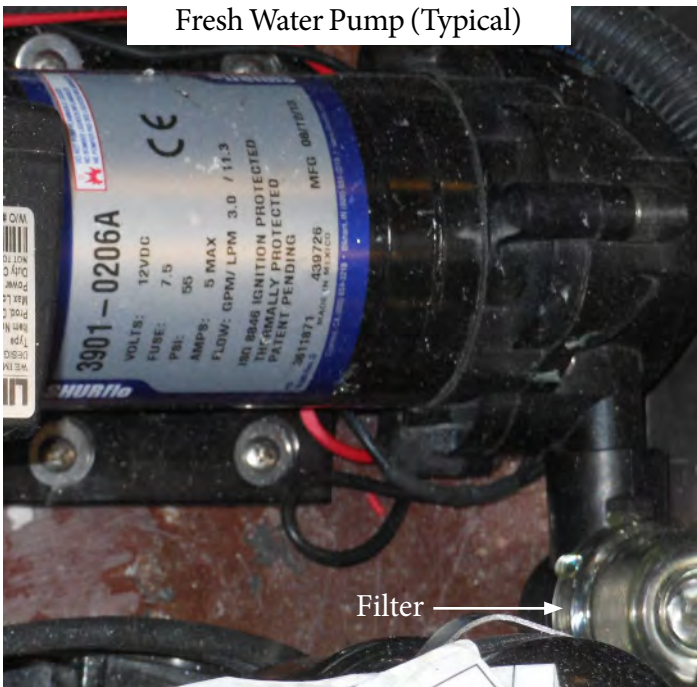



PUMP-OVERBOARD DISCHARGE



If your boat is equipped with an overboard discharge pump pay close attention to what materials are flushed through the waste system as it could become clogged. Do not pump garbage, rags, or sanitary napkins through the overboard discharge pump (macerator). Flush the waste tank and pump with fresh water with each pump out. Do not run the pump dry or for extended periods of time since the impeller can be damaged.

Pump the waste system out at decommissioning time and rinse fresh water through the entire system periodically to keep the hoses clean of debris especially the pump out hose.



STEREO/CD PLAYER

1. To clean the CD slots in stereos use a dry or slightly water moistened swab to remove any buildup of debris. This monthly procedure will assist in preventing the CD discs from being scratched.
2. To clean the faceplates of the various units use a dry soft cloth. If the faceplate is stained badly, use a moist cloth with a neutral cleaner. Do not use harsh, caustic or alcohol based chemicals to keep the letters from coming off the faceplate. Do not use silicone spray or WD-40 since they could damage mechanical parts.
3. If these units will not play CD's properly it they may have developed condensation. Wait 1 hour and retry.
4. Keep all remote controls out of extreme heat and high moisture environments. Change batteries often for best operation.
5. Periodically check CD discs for scratched and dirty ones. Clean the dirty ones with a cleaning kit which can be purchased at most electronic stores.
6. To clean a flat screen display such as the RegalView or the Garmin chartplotter dampen a soft cloth with water or a mild detergent. The best cleaner is a screen cleaning tissue specifically designed for antistatic coating. Never use flammable cleaning materials or glass cleaners with ammonia since they can damage the screen surface.



Cosmetic Care & Maintenance

TRANSOM SHOWER

The transom shower requires little maintenance. If one of the spray holes becomes clogged you can remove/clean the nozzle end with a small brush and baking soda.

In freezing climates ensure that all water is drained from the unit at decommissioning time.





TRIM TABS

If installed, trim tabs are located on the outer edges of your transom below the swim platform. All mechanical and electrical connections should be periodically checked for tightness, corrosion, and chafing. If a malfunctioning tab is suspected, run each tab in and out while someone looks at each tab to make sure it is moving up and down the proper distance. Replace any zinc anodes mounted on trim tabs when at one half their life as determined by size. Check anodes twice a month.

Check the hydraulic power unit fluid (HPU) level. The pump is located in the bilge (sump) close to the transom. To refill, remove the lexan cover and filler plug. Fill with any type automatic transmission fluid (ATF). The fluid level should be 2" from the reservoir bottom.

The trim tabs may be painted for corrosion protection. Do not paint the anodes as they protect the tabs from galvanic corrosion.



TYPICAL TRIM TAB PUMP



TOILET ELECTRIC-VACUUM DESIGN

Vacuum style toilet systems need to be cleaned periodically for maximum sanitation and operational efficiency. Clean the bowl with a cleaner such as Bon Ami which will not abrade the toilet bowl lining. Do not use chlorine solvents or caustic chemicals such as drain openers because the various system seals may be damaged.

Use the following procedure monthly or when leaving the vessel for extended periods.

1. Fill bowl with water.
2. Add 1 cup of biodegradable powdered laundry detergent.
3. Flush toilet by pressing the pedal for about 2 minutes. Release foot pedal to close flush ball.
4. Most marinas offer a service that uses a vacuum hose connected to the deck waste fitting that pulls the waste from the tank. We suggest using a hose after the process and shoot a few bursts of fresh water down the waste fitting at the deck. This helps the residue left from the pump-out process from building up in the waste hose.

If an odor is apparent from the system try the following:

1. Clean the system out using the above procedure.
2. Check to see that the vent from the holding tank to thru-hull fitting is not clogged.
3. Periodically add the correct holding tank deodorant either Secure or Sealand liquid.
4. Annually replace the in-line vent waste filter normally located in the bilge. This filter can be ordered from a Regal dealer or your local marine supply store.
5. Refer to the toilet manual for further information.



Troubleshooting

DIAGNOSTIC CHARTS

The following diagnostic charts will assist you in identifying minor electrical, electronic, fuel, and mechanical problems associated with selected standard and/or optional components. A portion of the items listed require technical training and tools. Additional up-to-date information is available in the various operation manuals as select items and their troubleshooting techniques may change since the printing of this manual and/or are too numerous to cover in this manual such as electronic components.

Contact your closest Regal dealer, marine professional or the internet for further information.

Note: Many times the root cause of a problem can be found using a step by step process of elimination.

	WARNING
AVOID BODILY INJURY AND DEATH! BEFORE PERFORMING ANY MAINTENANCE WORK TURN OFF THE BATTERY SWITCH AND REMOVE THE KEY FROM THE IGNITION SWITCH.	

	CAUTION
TO AVOID BODILY INJURY! USE ONLY APPROVED MARINE REPLACEMENT PARTS.	



ELECTRICAL DIAGNOSTICS (DC)

PROBLEM	POSSIBLE CAUSE	POSSIBLE FIX
No DC (12 volt) power	Battery switch in "off" position	Turn selector switch to "on" position,
	Weak or dead battery	Charge or replace battery
Battery not charging (engine running)	Loose belt	Tighten belt
	Faulty alternator	Repair/replace alternator
	Faulty volt meter	Replace volt meter
Battery will not hold charge	Faulty or old battery	Replace battery; use exact replacement
12 volt equipment not working	Equipment switch in "off" position	Switch to "on" position
	Circuit breaker/fuse blown	Reset breaker. Replace fuse.
	Weak or dead battery	Replace battery
	Corroded connection	Eliminate corrosion
	Loose conductor/ground wire	Tighten connection
	Internal equipment short	Replace equipment component



ELECTRONICS-GENERAL

The Garmin electronic packages installed on your boat are very system specific when troubleshooting. Each package is very unique and we could not cover all the systems here. Therefore, refer to the vendor supplied operator's manual for specific troubleshooting information related to an individual electronic component.

In addition, helpful information is readily available on the internet at each vendor site. Information can be downloaded as needed with additional on-line contact and tech services available.

Also, contact your closest Regal dealer where you will find factory trained professionals to assist you in solving more technical electronic component issues.



FRESH WATER DIAGNOSTIC CHART

PROBLEM	POSSIBLE CAUSE	POSSIBLE FIX
Air in water system	Water tank empty	Fill water tank. With pump "on" bleed air from lines until water flows without air.
Fresh water pump cycles on and off	Water system leak	Locate & repair water leak.
No water at sink faucet	Breaker blown	Reset breaker
	Water tank empty	Refill water tank
	Switch turned off	Turn switch to "on" position
	Blocked water filter; pinched line	Clear obstruction or straighten line; clean water filter
	Manifold valve turned off	Turn on manifold valve
	Loose or disconnected wire	Check wire connections
Low water pressure	Defective fresh water pump	Replace water pump
Weak pressure at transom shower	Line pinched	Find/Repair pinched line
Water to pump. No output.	Faulty fresh water pump/pressure switch	Replace fresh water pump or pressure switch
Fresh water pump continues to cycle	Defective pump pressure switch	Replace pressure switch



INSTRUMENT DIAGNOSTIC CHART		
PROBLEM	POSSIBLE CAUSE	POSSIBLE FIX
No reading on gauge or gauge reads wrong	Faulty gauge	Replace gauge
	Wiring to gauge faulty	Inspect/repair wiring
	Faulty sender	Replace sender
Gauge reads erratic	Loose ground or hot wire	Repair/replace wire and/or connection



PERFORMANCE DIAGNOSTICS

PROBLEM	POSSIBLE CAUSE	POSSIBLE FIX
Excessive vibration	Material obstructing propeller	Reverse engine to remove material
	Bent drive propeller shaft	Call authorized Regal dealer
	Bent propeller blade	Repair/replace propeller
	Noisy drive bearing	Call authorized Regal dealer
	Damaged drive casting	Call authorized Regal dealer
Poor performance	Trim incorrect	Adjust trim
	Unbalanced load	Adjust load
	Engine problem	Call authorized Regal dealer
Engine speed/rpm is low	Growth on hull	Hoist vessel; clean bottom
	Poor quality fuel	Call authorized Regal dealer
	Accumulation of bilge water	Check for leaks
	Trim tab in "up" position	Check trim tab functions/pump fluid levels



STEREO DIAGNOSTIC CHART

TROUBLESHOOTING

Problem	Solution
General	
The unit does not respond to key presses.	<ul style="list-style-type: none"> Reset the unit by pressing the Reset button inside the control panel door. 
What is the best way to prevent corrosion on my 700 Series chrome finish?	As with all products exposed to the harsh marine environment, a little care will help to preserve the finish. FUSION recommends that you clean any salt water and/or salt residue from the front panel with a damp cloth soaked in fresh water.

Problem	Solution
SiriusXM	
When I press the tuner source button the SiriusXM screen is not displayed.	Ensure you have the MS700i Tuner region set to 'USA'. Press Menu > Settings > Tuner region > and select 'USA'. <ul style="list-style-type: none"> Ensure the SiriusXM module is plugged into the MS700i. Unplug the SiriusXM module and check the pins in the SiriusXM plug are not damaged.
SiriusXM message: 'Check Tuner'	<ul style="list-style-type: none"> Ensure the SiriusXM module is plugged into the MS700i. Ensure the SiriusXM cable has not been damaged.
SiriusXM message: 'Check Antenna'	<ul style="list-style-type: none"> Ensure the antenna is plugged into the SiriusXM Tuner module. Ensure the antenna is not damaged. Ensure the antenna cable has not been damaged
SiriusXM message: 'No Signal'.	<ul style="list-style-type: none"> Ensure the antenna is not damaged. Ensure the antenna has a clear view of the sky and is not obscured. Ensure the antenna cable has not been damaged
SiriusXM message: 'Channel xx Not Available'	A SiriusXM message informing you that the current channel is unavailable. Possible causes are SiriusXM has removed the channel or your SiriusXM subscription has changed. <ul style="list-style-type: none"> Contact SiriusXM to update your subscription. Online: Go to www.siriusxm.com/subscriptions Phone: Call 1-866-635-2349



STEREO DIAGNOSTIC CHART

SiriusXM message: 'Channel xx Unsubscribed'	<ul style="list-style-type: none"> • Contact SiriusXM to update your subscription. • Online: Go to www.siriusxm.com/subscriptions • Phone: Call 1-866-635-2349
SiriusXM message: 'Subscription Updated'	<p>A SiriusXM message informing you that you have either been granted access to or unsubscribed from various channels.</p> <p>For more information about your subscription:</p> <ul style="list-style-type: none"> • Online: Go to www.siriusxm.com/subscriptions • Phone: Call 1-866-635-2349

Problem	Solution
iPod	
Why does my FUSION Head unit keep locking up when connected to my iPod/iPhone?	<p>If you are experiencing software lock-ups or your unit freezes:</p> <ul style="list-style-type: none"> • Reset the Head unit by pressing the reset button inside the face plate. • Reset your iPod/iPhone (see Apple website from model-specific information). This should resume normal operation. • Make sure you have the latest version of iTunes and the latest operating software in your iPod/iPhone. It is important to update software when Apple releases new versions. If you are connected via a dock, ensure you are using the correct sleeve and the connection to the Head unit is secure.
Will my iPod/iPhone connect to my FUSION product if the battery is flat?	<p>No. It will take a number of minutes for the Apple product to get a minimum level of charge before it can connect and become operational. Please connect and wait for the unit to initialise.</p>
My Apple Device has gone into thermal protection	<p>Caution: The internal dock temperature of the MS-IP700i will be slightly higher than the ambient temperature outside the head unit. Should your Apple iPhone or iPod shut down due to exceeding the operating temperature please carefully remove it from the MS-IP700i and allow it to cool down before using again. Using your Apple device in a low charged state will increase the heat generated whilst it is charging. For more information relating to this please follow the Apple support web site link below.</p> <p>http://support.apple.com/kb/ht2101</p>



STEREO DIAGNOSTIC CHART

<p>My iPod/iPhone will not connect to the Head unit while in the dock.</p>	<p>If your Head unit displays "Not Connected" while using iPod as input source:</p> <ul style="list-style-type: none"> • Check that you are using the correct sleeve combination. If you have the incorrect sleeve combination this could prevent the iPod connector from mating correctly. It could also damage the connector in the dock or your iPod/iPhone itself. If you are uncertain which iPod model you have, go to http://www.apple.com/support/ to get the correct model information for your iPod and sleeve. If you are still unable to connect once you know for certain you have the correct iPod/iPhone–sleeve combination: • Ensure that you have the latest version of operating software installed in your iPod/iPhone and the latest iTunes version. To do this, connect your iPod/iPhone to iTunes and it will check and, if necessary, prompt you to download the latest version. If you are still unable to connect once you have confirmed that you have the latest software or you have updated your iPod/iPhone: • Reset the iPod/iPhone (see the user manual for your Apple product) and also reset the Head unit (see FUSION user manual). If you are still unable to connect: • Contact your FUSION dealer or contact FUSION via the tech email on the FUSION website.
---	---

Problem	Solution
Wireless Remote App for iPad and iPhone	
<p>My FUSION-Link Wireless application displays "No stereo available"</p>	<p>The first thing to check is that you are connected to the correct wireless network for the 700 Series. Once you have confirmed this close the App on the device and restart it (consult the manufacturers website for instructions on restarting) . If this fails check that you have a valid IP address on the 700 Series and follow the instructions in the below tech support item</p>
<p>My FUSION-Link Wireless remote application will not connect to my 700 Series stereo</p>	<p>The first thing to check is that the 700 Series is displaying a valid IP address on the about screen. Select the settings menu then about to confirm. If the display is " IPNone " the router is either not a compatible DHCP product or not configured correctly. If the IP address starts with the prefix 169. it is not valid, this is a default address when the router is not sending a DHCP generated IP address or is configured incorrectly. Please review the Router's instruction manual or contact the manufacturers website for technical help.</p>



TOILET (ELECTRIC) DIAGNOSTIC CHART

PROBLEM	CAUSE	ACTION/SOLUTION
Toilet does not flush or flush performance is poor	Waste tank is full (tank indicator light on wall switch is RED) Clog at pump inlet Solid object in macerator Low voltage	Empty waste tank before continuing to use toilet. Override full tank lock-out may cause waste tank to overflow Clear clog Call Tecma at (800-521-3032) Check for no more than 10% decrease in voltage when macerator is running. If voltage decreases more than this there may be wiring problem
Water does not enter bowl during flush or water add cycle	Water supply line kinked or not connected No power to water pump Water supply has been turned off Electronic control problem	Check that supply line is properly connected to fresh water supply. Check for kinks in water supply line Check that circuit breaker has not tripped, check all pump electrical connectors Check water supply valve at manifold Call Tecma at (800-521-3032)
Water level in bowl has changed after flush	Flush refill mode has been changed	Reprogram flush refill mode; see Tecma owner's manual
Water continues dripping briefly into bowl after flush cycle is complete	Toilet is installed below water line with vacuum breaker in water supply line	Normal operation; if only a small amount drips from the nozzle
Bowl drains dry after flush	Water is siphoning out of the bowl	Discharge hose from macerator pump bent. Straighten hose
Wall switch does not appear to light up or does not stay lit	No power to toilet Wall switch not properly connected to toilet Wall switch has entered sleep mode	Check that breaker is not tripped. Check electrical connectors are mated Ensure wall switch electrical connector is fully engaged at controller Wall switch enters sleep mode after 8 hours of continuous inactivity but remains functional. No action needed
	Wall switch electronics problem	Call Tecma at (800-521-3032)
Toilet is inoperative and there is no lighting in the wall switch	No power to toilet	Check that breaker is not tripped. Ensure all electrical connectors are mated. Call Tecma.



Storage & Winterization

NOTICE

YOUR WARRANTY DOES NOT COVER DAMAGE TO YOUR BOAT IF IT IS NOT PROPERLY STORED AND WINTERIZED. CHECK WITH A REGAL DEALER OR MARINE PROFESSIONAL ABOUT WINTERIZATION PROCEDURES.

NOTICE

REMOVE ALL BATTERIES WHEN VESSEL IS STORED FOR EXTENDED PERIODS.



WARNING

EXPLOSION, FIRE & POLLUTION HAZARD!
DO NOT FILL FUEL TANK TO RATED CAPACITY.
LEAVE ROOM FOR EXPANSION.

INTRODUCTION



Storage procedures are outlined in this chapter. These are general guidelines to follow in colder climates. Be sure to familiarize yourself with all relevant information in the owner's packet.

Special winterization procedures are necessary for the boat equipment and systems. Use the enclosed checklists to help you identify areas of concern and maintenance. These lists cover land stored boats either inside or outside.

All in all, it is best to contact your closest Regal dealer or marine professional for winterization information and procedures for stern drive and outboard models. They possess the advanced service know how needed to tackle the more complex boat systems.



DECOMMISSIONING CHECKLIST

BOAT

1. Check hull bottom for any fiberglass damage. Repair as needed.
2. Apply a coat of wax to hull and deck surfaces.
3. Pour a pint of 50/50 antifreeze into bilge pump.
4. Remove batteries. Trickle charge over extended periods. Do not set batteries on cement. Use wood blocks.
5. Remove all loose gear from boat such as life jackets, etc. Inspect and store in cool, dry environment.
6. Remove drain plug. Clean drain plug hole of debris as needed. Enclose drain plug in plastic bag and tie to steering wheel.
7. Drain the waste system per instructions in this chapter. Make sure bow is higher than stern to permit proper drainage.
8. Clean all upholstery and store to permit venting.
9. Conduct a visual inspection to ensure boat is balanced properly. Bow should sit slightly up especially if outside.
10. Cover boat with tarp. Tie down for wind protection if outside. Prop tarp up as needed to provide proper ventilation. Be sure not to cover up the fuel vents.
11. Drain the fresh water system per instructions in this chapter. (Ensure that the system has been disinfected)
12. Send in appropriate equipment for calibration such as the automatic fire extinguisher canister or CO detectors.
13. Never use blocking to support the hull bottom as structural hull damage may occur to the vessel which is not covered under the warranty.

ENGINE- STERN DRIVE/OUTBOARD

The propulsion systems on your boat are complex in scope. In colder climates, it is recommended that your Regal dealer winterize your boat's engine. Regal dealers have undergone extensive factory training covering the Regal product line. Also, the dealer is equipped with the parts and tools to perform a care free winterization procedures listed below:

- A. Run engine in water or with flushette attachment at idle. Pour a fuel stabilizer/conditioner in the fuel tank. Allow time for it to circulate through the fuel system. Top off fuel tanks to help prevent condensation.
- B. Change all engine fluids as referenced in the engine manufacturer's owners manual.
- C. Drain cooling and exhaust system per engine manufacturer's instructions or have a marine professional "pickle" the engine with antifreeze and rust preventative.
- D. Spray all exterior parts with a rust preventative.



Storage & Winterization

GENERAL NOTES ON ANTIFREEZE

Engine cooling fluids must be replaced with a marine antifreeze solution; mix antifreeze according to directions for the lowest expected temperature. The above method is much more reliable than just draining the engines and manifolds because sometimes pockets of water can form which can freeze in cold temperatures and cause engine damage. Draining the system fosters rust in engine parts. Historically, antifreeze was originally made with methanol. It was because of its chemical nature to escape into the atmosphere and a high corrosion factor on engine metals that it was replaced.

Today, ethylene glycol is used in auto and marine engine applications because of its positive thermal properties. On the downside ethylene glycol contains silicate rust inhibitors that can clog up marine heat exchanger surfaces. This is why it is so important to follow the engine manufacturer maintenance schedules which include changing the antifreeze periodically. In addition, the unpleasant odor of antifreeze is caused by tolytriazole which also contributes to it being environmentally hazardous. Notwithstanding, ethylene glycol is poisonous to the human body along with animals. **Therefore, it cannot be used in potable marine water systems.**

Propylene glycol is considerably less toxic and retail products are labeled as “non-toxic antifreeze”. It is the product of choice for marine water and waste tanks in freezing climates. It is available at marinas, RV dealerships, and retail marine outlets.

NOTICE

USE A SPECIAL NON-TOXIC ANTIFREEZE
IN THE FRESH WATER & WASTE SYSTEM
WHICH IS AVAILABLE AT RV AND
MARINE DEALERS.

**DO NOT USE AN AUTOMOTIVE
TYPE ANTIFREEZE.
IT CAN BE HIGHLY
POISONOUS AND CORROSIVE!**



BATTERIES:

Remove the batteries and check the electrolyte level. Store in a cool, dry place. If not maintenance-free type add distilled water as necessary to top off the battery.

Monthly recharging or continuous trickle charging should be done to insure the battery life during storage.

Do not store a battery on cement as it may discharge.

FUEL TANK

Fill the fuel tank to minimize condensation but do not overfill. Leave enough space for fuel to expand and add a fuel stabilizer to fuel tank prior to storage following the manufacturer's recommended procedures.



Storage & Winterization

WASTE/TOILET SYSTEM:

1. Pump out waste holding tank, flush the tank with fresh water and pump out again.
2. With non-toxic propylene glycol antifreeze in the fresh water tank, operate head until antifreeze flows into bowl of each head. Allow time between flushes for the vacuum to build up.
3. Operate macerator until antifreeze has a steady flow coming from the discharge fitting. Pour non-toxic propylene glycol antifreeze solution in head and flush head as needed to produce enough flow to winterize the macerator.
4. Leave at least 2 gallons of non-toxic propylene glycol antifreeze solution in the holding tank during storage.

NOTICE

USE A SPECIAL NON-TOXIC ANTIFREEZE
IN THE FRESH WATER & WASTE SYSTEM
WHICH IS AVAILABLE AT RV AND
MARINE DEALERS.
DO NOT USE AN AUTOMOTIVE
TYPE ANTIFREEZE.
IT CAN BE HIGHLY
POISONOUS AND CORROSIVE.



WATER SYSTEM-FRESH

1. Turn on the fresh water pump switch.
2. Open all faucets including transom shower and allow tank to empty. Close faucets.
3. Shut off water pump switch.
4. Mix nontoxic antifreeze with water in accordance with the manufacturer's recommendations.
5. Pour solution into the fresh water tank.
6. Turn on fresh water pump switch.
7. Open each cold water faucet one by one beginning with the one furthest away from the tank and purge the system until a steady stream flows from the faucet. Then close the faucet.
8. Shut off water pump switch.
11. Leave at least 2 gallons of non-toxic antifreeze solution in the holding tank during storage.

NOTICE

USE A SPECIAL NON-TOXIC ANTIFREEZE IN THE FRESH WATER & WASTE SYSTEM WHICH IS AVAILABLE AT RV AND MARINE DEALERS. DO NOT USE AN AUTOMOTIVE TYPE ANTIFREEZE. IT CAN BE HIGHLY POISONOUS AND CORROSIVE.



Storage & Winterization

DISINFECTION OF POTABLE WATER SYSTEM

The following information is taken from the Handbook on Sanitation of Vessel Water Points and is available from the public health service publication #274.

It is a good idea to disinfect the potable water system when entering long periods of storage or at the beginning of your boating season.

Following is a suggested method in proper order to accomplish system disinfection:

1. Flush entire system completely by permitting potable water to flow through it.
2. Drain system completely.
3. Fill entire system with a chlorine solution having a strength of 100 parts per million, and allow to sit for one hour. Shorter time frames will require more concentrations of chlorine solution. See the chart.

4. Drain chlorine solution from entire system.
5. Flush whole system thoroughly with fresh potable water.
6. Fill system with fresh potable water.

The chart below indicates how much disinfecting agent is needed to make up various quantities of 100 parts per million chlorine solution.

CHLORINE COMPOUND AMOUNTS REQUIRED FOR 100 PPM SOLUTION			
SOLUTION (GALLONS)	CHLORINATED LIME 25% (OUNCES)	HIGH TEST CALCIUM HYPOCHLORITE 70%	LIQUID SODIUM HYPOCHLORITE 1% (QUARTS)
5	0.3	0.1	0.2
10	0.6	0.2	0.4
15	0.9	0.3	0.6
20	1.2	0.4	0.8
30	1.8	0.6	1.2
50	3.0	1.0	2.0
100	6.0	2.0	4.0

NOTE: Information from this chart taken from Handbook on Sanitation of Vessel Water Points- US Public Health Service Publication No.274 reprinted June 1963



Glossary & Index

Following is a brief list of nautical terms useful in everyday boating experiences and communications. For more detailed glossaries of nautical terminology we recommend you check your local library, the internet or a marine store for boating books.

GLOSSARY

Abeam: at right angles to the fore and aft line and off the boat

Aboard: on or in the boat

Above: the part of the boat on a bavin vessel which is above the interior of the boat

Aft, After: aft is the boat section toward the stern or back of the boat

Admidships: toward the center of the boat from either side to side or rear to front

Beam: the width of a boat at its widest part

Bilge: the lower interior of the hull of the boat

Bitter end: the end of a line also the end of an anchor line

Bow: the front, or forward part of the boat

Bulkhead: the vertical partition or wall of a boat

Cast off: to let go or release

Chine: the line fore and aft formed by the intersection of the side and bottom of the boat

Chock: deck fitting used to secure or guide anchor or tie lines

Cleat: deck fitting with protruding arms around which lines are secured

Cockpit: the seating space used to accomodate passengers

Cuddy: a small cabin in the fore part of the boat

Deck: the open flooring surface on which crew and passengers walk



Chapter 11

Draft: the depth from the waterline of the boat to the lowest part of the boat, which indicates how much water is required to float the boat

Fathom: a measurement of depth; one fathom equals six feet

Fender: a cushion hung from the side of a boat to prevent it from rubbing against a dock or against other boats

Fend off: to push off to avoid sharp contact with dock or other vessel

Fore: the part of the boat toward the bow or front

Freeboard: the height of the top side from the waterline to the deck at its shortest point. (The distance from the sheer or gunwale to the water)

Galley: cooking area

Gunwale: rail or upper edge of the side of the boat

Hatch: an opening in the deck to provide access below

Head: toilet

Hull: the part of the hull from the deck down

Keel: the lowest point of a boat

Knots: a measurement of speed indicating nautical miles per hour

Lee: the side opposite that from which the wind is blowing; the side sheltered from the wind

Leeward: the direction toward which the wind is blowing

PFD: personal flotation device; required for each person aboard

Port: the left side of the boat when facing forward (an easy way to remember the difference between “port” and “starboard” is that both “port” and “left” have four letters)

Shank: the main body of an anchor

Sheer: the curve of the boat’s deck from fore to aft when seen from the side

Starboard: the right side of the boat when facing forward

Stern: the aft end of the boat

Stern drive: an inboard/outboard (IO) unit

Stringer: strengthening integral unit fastened from fore to aft inside the hull and fiberglass encapsulated for added strength: much like the skeleton system of our body

Top off: to fill up a tank

Transom: the vertical part of the stern.

Trim: the boat’s balance when properly loaded

Wake: the path of a boat left astern in the water



Glossary & Index

A		C	
Accidents	42	Canvas	187
Alcohol Myths & Facts	41	Carbon Canister	61
Anti-Freeze	263	Carbon Monoxide	38
Anchoring	167	Cardiopulmonary Resuscitation	169
Automatic Charging Relay (Battery Charging)		Carpet-Cockpit	195
Stern Drive	116		222
Outboard	143	Chartplotter	106
Automatic Fire Extinguishing System	118	Counter Top (Head Vanity)	220
	199		
	241	D	
B		Dealer Responsibilities	18
Batteries	65	Decommissioning	262
	234	Depth Gauge	119
	264	Diagnostic Charts (Troubleshooting)	251
Battery Management Panel	69	Direct Current (DC)	65
	237	Distress Signals	31
Battery Switches	66	Diver's Flag	44
Battery System Breaker	68	Docking	158
Bilge-Engine Compartment	183	Dock Lines	160
Bilge Pump	219	Dockside Pump-Out	86
Blowers	61	Drain Plug	197
Breaker Panel- Helm	73	Drawings	282
Breast Lines	157		
Bridge Clearance	53		



Chapter 11

E	
Electrical	252 283
Electronics:	105 240 253
Engine- Stern Drive Outboard	108 127
Entertainment System	92
Environmental Awareness	172
Exhaust	38
F	
Fenders	156
Fiberglass Maintenance	224
Filter-(Waste)	86 217
Fire Extinguishers	29
Fire Port	56
First Aid	169
Float Plan	15
Fresh Water System	78 245 254
Fuel System	57 153 242
Fuse Block	71
G	
Gauges/Switch Panels	111
Gelcoat Maintenance	224
General Boating Safety	25
Getting Underway	151
Glossary	268
H	
Helm- Overview	112
HIN	13
Horn	33
Hull/Deck Maintenance	227
Hypothermia	170
I	
Ignition Switch	115 141
Index	270
Instruments (Gauges)	111 226 255
International Distress Signals	32
K	
Knots	159



Glossary & Index

L		R	
Lights	33	Range/Stove	7-8
	196		8-14
M			7-10
Maintaining PFD'S	29	Refrigerator	9-8
Markers-For Slings	201	Registration Information	1-10
	307	Remote Control	5-11
Mayday	33	Right-Of-Way	3-1
Minimum Required Equipment	37	Rules Of The Road	3-1
Monitor Panel	87		
Multi-Gauge	117		
N			
Navigation Aids	50		
Navigation Light Rules	34		
Navigation Rules	46		
Night Running	53		
O			
Oil Spills	35		
Overboard Discharge Pump (Macerator)	87		
	217		
Overloading	26		
Owner's Information Packet	12		
Owner Responsibilities	19		
P			
Performance Diagnosis	256		
Personal Flotation Devices			
Plastics	228		
Plumbing Connectors	244		
Pollution Regulations	35		
PowerTower	204		
Pre-departure Questionnaire	151		
Pressure Pump-Fresh Water	206		
	245		



Chapter 11

S	
Safety Labels	24
Sanitizing Fresh Water System	267
Seacocks	87
Seat- Helm	209
Seat Occupancy Plan (Persons)	
Stern Drive	280
Outboard	281
Shower-Transom	248
Sound Producing Devices	33
Specifications	
Stern Drive	276
Outboard	277
Speedometer	117
Spring Line	157
Stainless Steel	229
Stains	230
Stern Line	157
Steering	
Stern Drive	126
	165
Outboard	135
Stereo	92
	247
	258
Storage	261
Sunbrella Canvas Cleaning	221
Swim Ladder-(Boarding)	184
Swim Platform	41
	212
Switch Panel- Helm	73
T	
Table- Cockpit	213
Tachometer	117
Technical Information	272
Toilet	82
	250
	260
Trailering	173
Trim Gauge	117
Trim Tabs	90
	249
Troubleshooting	251
U	
Underwater Lighting	214
Upholstery	231
V	
VHF	33
Ventilation System	110
Vessel Information Sheet	15
Visual Distress Signals	31
Vessel Security	43
W	
Warranty	20
Waste System	82
	260
Winterization	261
Z	
Zipper Care	221



Technical

TECHNICAL INFORMATION



A portion of the technical drawings found in this chapter are actual product drawings from the Regal factory. These drawings may be of special interest in mechanical and electrical troubleshooting. The equipment in the drawings may be found in the various sections of this manual.

Note as the vessel develops through its production life cycle components, wiring, and specifications may change without notice.

Note that all product specifications, models, standard, optional equipment, systems, along with the technical information is subject to change without notice.

For more information contact your nearest authorized Regal dealer. For the location of your nearest authorized dealer call 407-851-4360 or you can contact Regal through the internet at : www.regalboats.com. Your Regal dealer has received special factory training on the entire product line and his services should be employed to solve more technical problems.



TYPICAL LABEL LOCATIONS

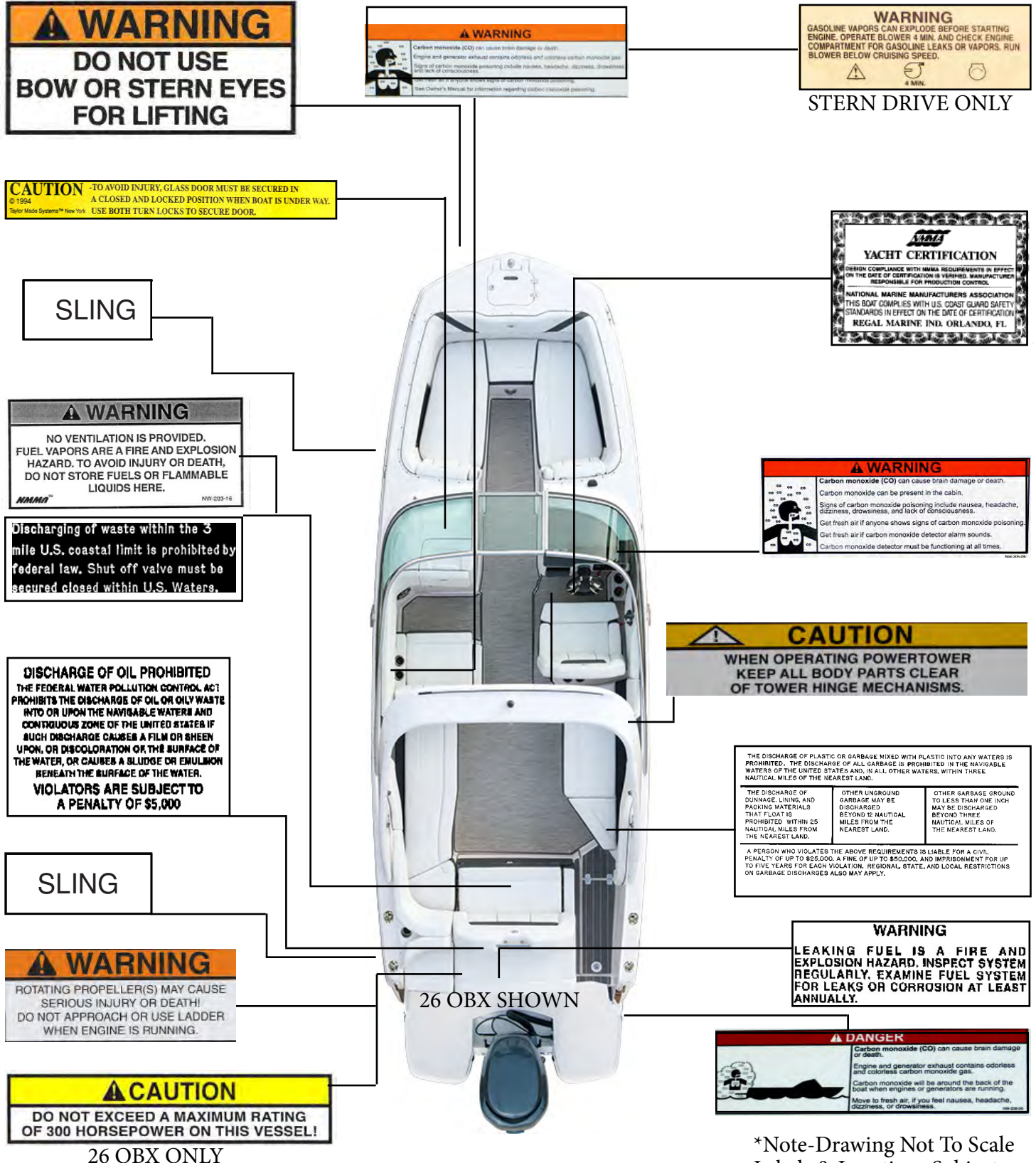

26 OBX ONLY

*Note-Drawing Not To Scale
Labels & Locations Subject
To Change



26 FASDECK SPECIFICATIONS



Length Overall	26' 6"
	8.0 M
Beam	8' 6"
	2.6 M
Approximate Dry Weight	5,050 Lbs
	2,290 Kg
Boat Height - Windshield to Keel	6' 11"
	2.1 M
Boat Height - PowerTower Up To Keel	9' 7"
	2.9 M
Boat Height - PowerTower Down To Keel	7' 2"
	2.2 M
Bridge Clearance - PowerTower Up	8'
	2.4 M
Bridge Clearance - PowerTower Down	5' 7"
	1.7 M
Maximum Capacity Persons	Yacht Certified
	CE 11
Fuel Capacity	74 gal
	280 L
Fresh Water Capacity	12 Gal
	45 L
Deadrise	21°
	21°

*ALL MEASUREMENTS ARE APPROXIMATE



26 OBX SPECIFICATIONS



Length Overall	26' 6"
	8.1 M
Beam	8' 6"
	2.6 M
Approximate Dry Weight	4,750 Lbs.
	2,154 Kg
Boat Height - Windshield to Keel	6' 11"
	2.1 M
Boat Height - PowerTower Up To Keel	9' 7"
	2.9 M
Boat Height - PowerTower Down To Keel	7' 2"
	2.2 M
Bridge Clearance - PowerTower Up	8'
	2.4
Bridge Clearance - PowerTower Down	5' 7"
	1.7 M
Maximum Capacity Persons	Yacht Certified
	CE 11
Fuel Capacity	103 Gal
	390 L
Fresh Water Capacity	12 Gal
	45 L
Deadrise	21°
	21°
Draft - Engine Up	19"
	0.48 M
Draft - Engine Down	36"
	0.9 M

*ALL MEASUREMENTS ARE APPROXIMATE



26 FASDECK PROFILE VIEW



SHOWN WITH OPTIONAL POWERTOWER



26 OBX PROFILE VIEW

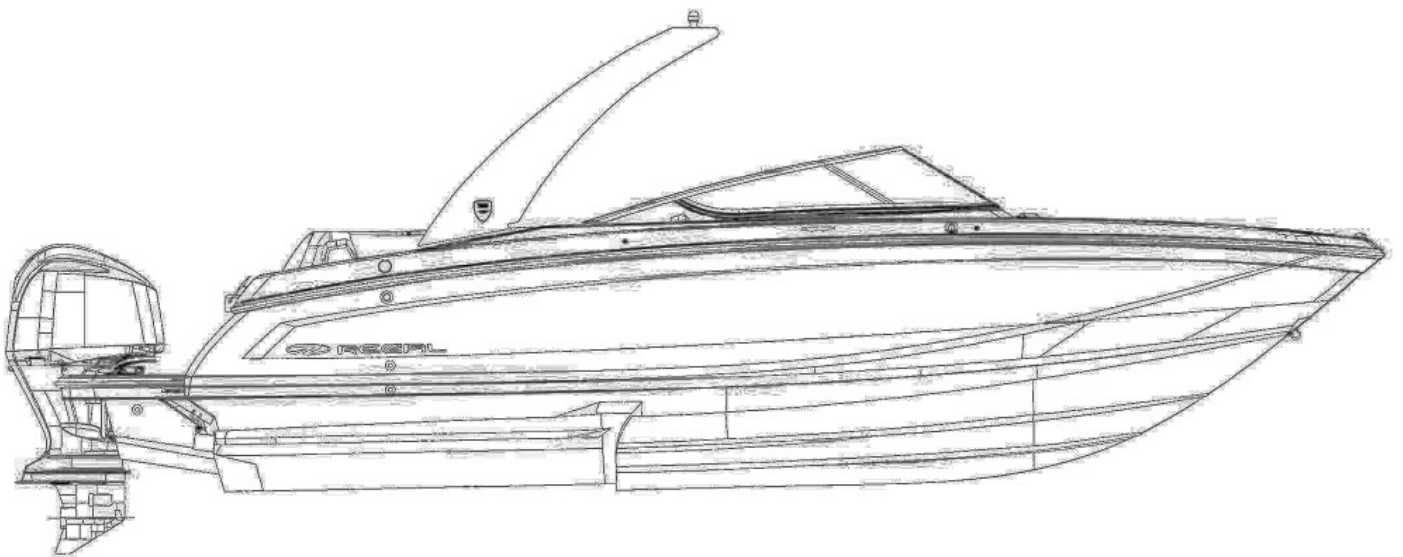

SHOWN WITH OPTIONAL POWERTOWER



26 FASDECK SEAT OCCUPANCY DIAGRAM

IT IS THE RESPONSIBILITY OF THE VESSEL OPERATOR TO ENSURE THE BOAT LOAD IS BALANCED AND ALL PASSENGERS ARE SEATED AND ARE WEARING PFD'S WHILE THE VESSEL IS MAKING HEADWAY. USE THE DRAWING TO ASSIST IN OBTAINING STABLE AND BALANCED LOADS.

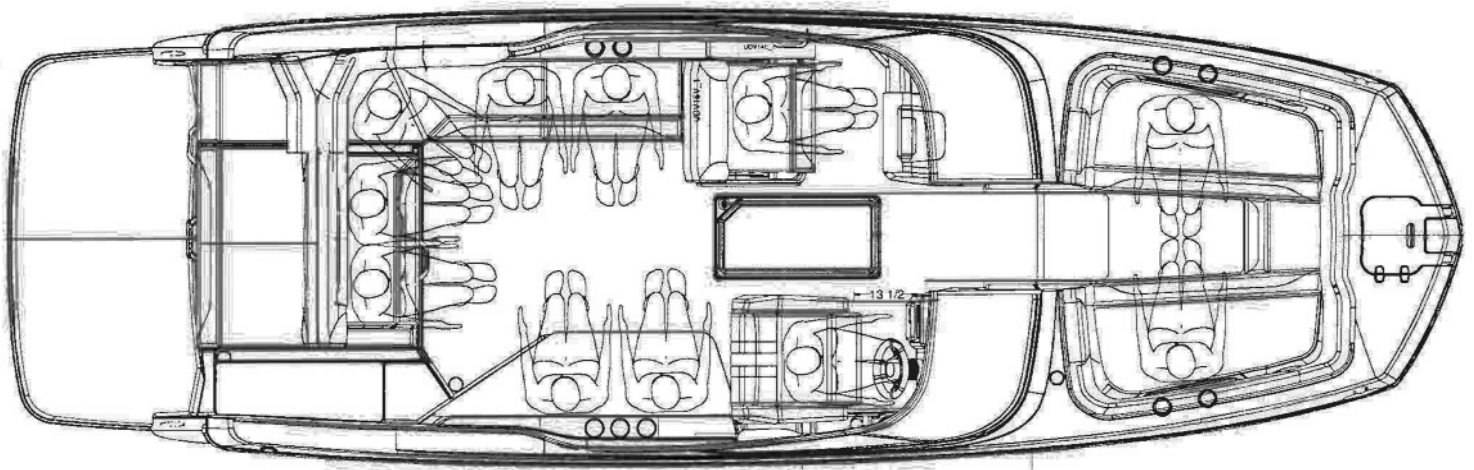

NOTE: ALLOWANCE PER SEAT IS 15.5" WIDTH x 29.5" LENGTH



26 OBX SEAT OCCUPANCY DIAGRAM

IT IS THE RESPONSIBILITY OF THE VESSEL OPERATOR TO ENSURE THE BOAT LOAD IS BALANCED AND ALL PASSENGERS ARE SEATED AND ARE WEARING PFD'S WHILE THE VESSEL IS MAKING HEADWAY. USE THE DRAWING TO ASSIST IN OBTAINING STABLE AND BALANCED LOADS.

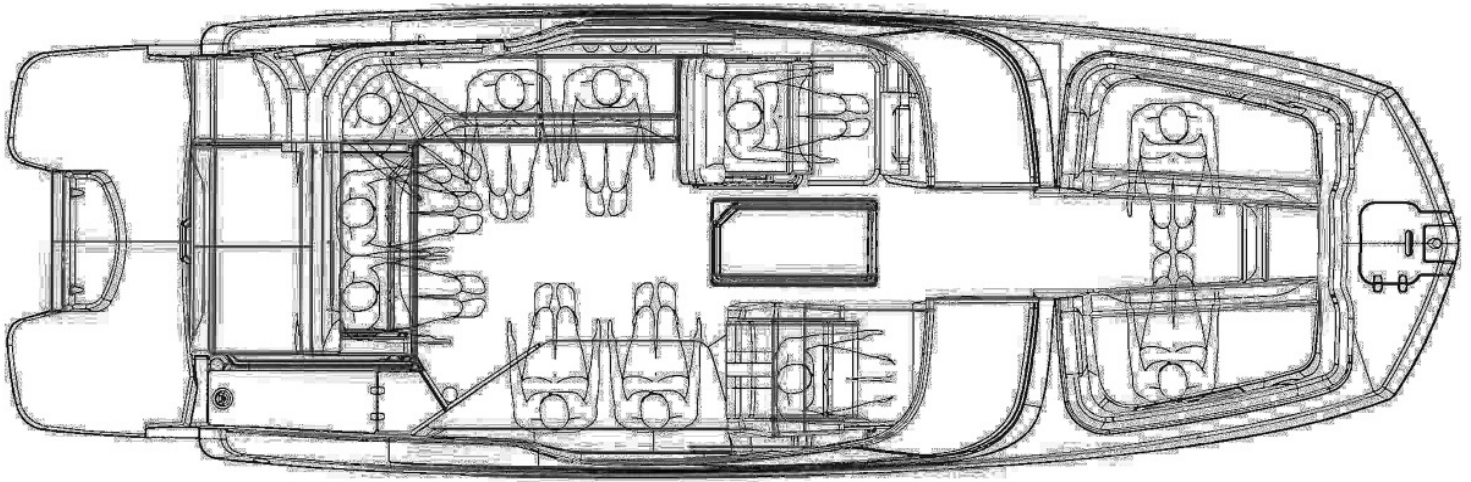

NOTE: ALLOWANCE PER SEAT IS 15.5" WIDTH x 29.5" LENGTH

26 FASDECK-OBX TECHNICAL DRAWINGS

This section includes various Regal system and other technical drawings for both the 26 FASDECK (stern drive) and OBX (outboard model). These drawings were developed from a variety of sources including in-house engineering, vendors, and outside resources. We have grouped the drawings into electrical and mechanical groups where possible. These drawings can be useful in understanding Regal systems including fuel, fresh water, waste and on-board battery management panels and can assist in troubleshooting system electrical or mechanical problems..

The Fasdeck and the OBX systems are very similar so in a majority of the cases only one drawing is shown, but model specific drawings will be titled as needed. Some differences do exist ie; the outboard does not use a powered ventilation system for gas fume exhaust. In addition, the outboard utilizes a unique steering system. Also, there are slight differences in the Halon system if installed. These varying technical points normally show up as a wire or two being changed in schematic.

Note that both the vessels mentioned above may change system, components, and/or wiring needs at any time. The drawings found in the following pages are basic system footprints but Regal is not responsible for any changes in the product that may effect the electrical or mechanical drawings. Use them as a guide.

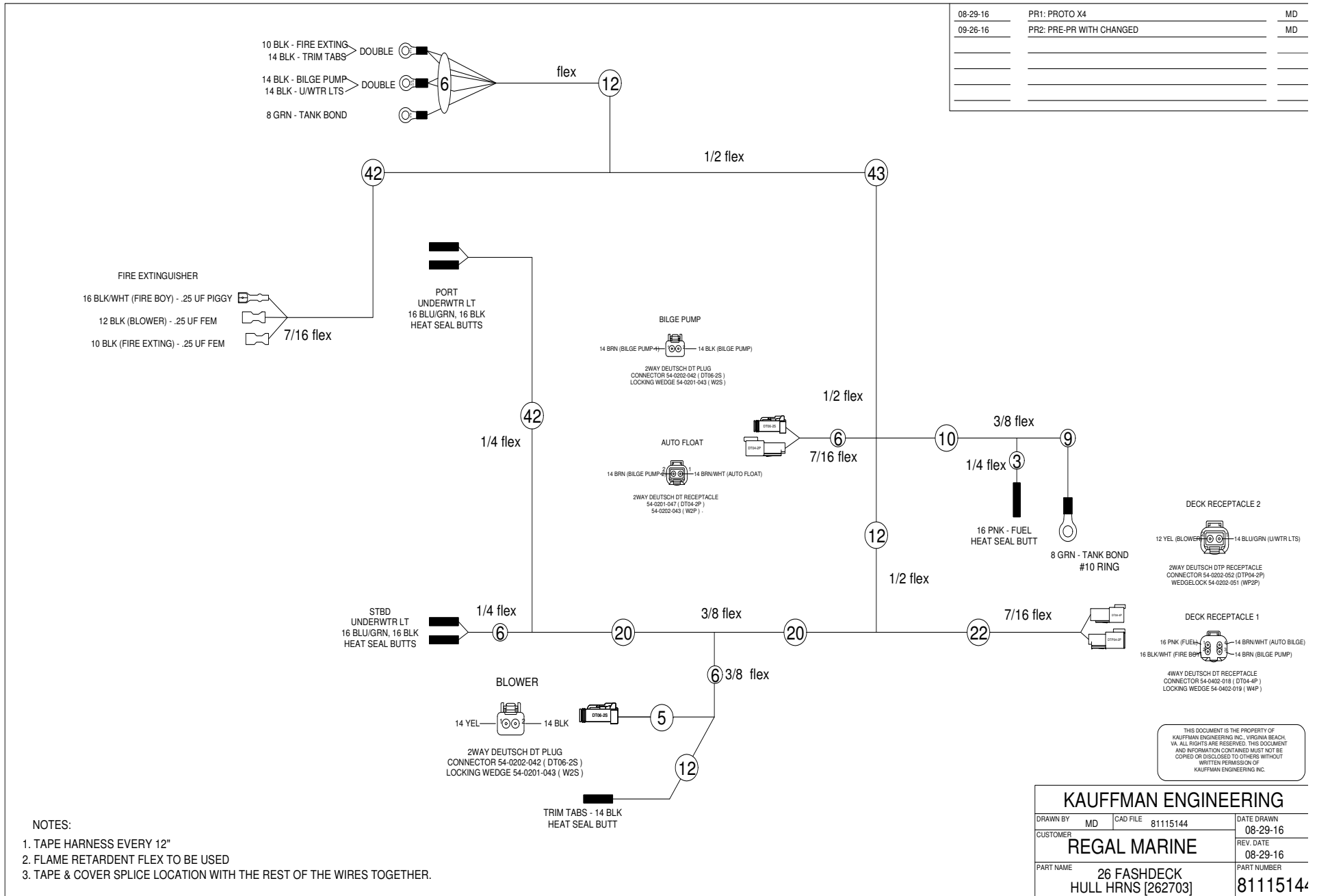

08-29-16	PR1: PROTO X4	MD
09-26-16	PR2: PRE-PR WITH CHANGED	MD

- NOTES:
1. TAPE HARNESS EVERY 12"
 2. FLAME RETARDANT FLEX TO BE USED
 3. TAPE & COVER SPLICE LOCATION WITH THE REST OF THE WIRES TOGETHER.

KAUFFMAN ENGINEERING			
DRAWN BY	MD	CAD FILE	81115144
CUSTOMER	REGAL MARINE		DATE DRAWN
PART NAME	26 FASDECK HULL HRNS [262703]		REV. DATE
		PART NUMBER	8111514

THIS DOCUMENT IS THE PROPERTY OF KAUFFMAN ENGINEERING INC., VIRGINIA BEACH, VA. ALL RIGHTS ARE RESERVED. THIS DOCUMENT AND INFORMATION CONTAINED MUST NOT BE COPIED OR DISCLOSED TO OTHERS WITHOUT WRITTEN PERMISSION OF KAUFFMAN ENGINEERING INC.

08-24-16	PR1: PROTO X4 [SJ#29091]	MD
9-07-16	PR2: UPDATE PRINT & C/S AFTER PROTO	MD

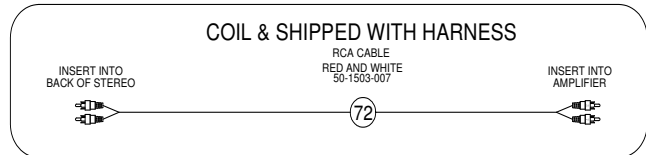

PORT XSOME SPEAKER
16 CLR/RED .187 UF FEM
16 CLR .110 UF FEM

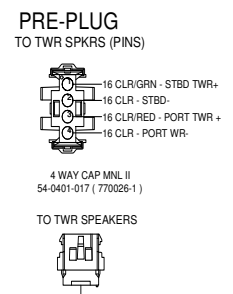

CONNECT TO DECK 81114970 (PINS)

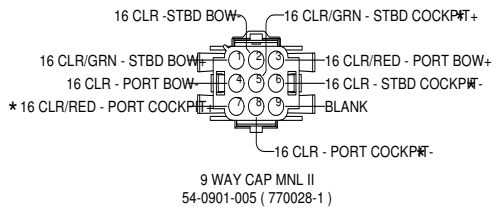

PRE-PLUG TO FUSION STEREO CONN (w/ SOC)

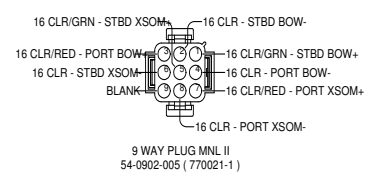

SUBWOOFER
16 CLR/RED- #8 RING
16 CLR - #8 RING



MNLII SOCKET
16 BLU (AMP ON)
REGAL WILL INSERT SOCKET INTO 6-WAY MNLII GOING TO STEREO

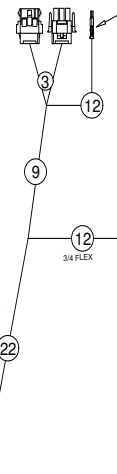

[AMPLIFIER]
w/ Ferrule Pins

- 16 CLR RED (PORT COCKPIT +)
- 16 CLR (PORT COCKPIT -)
- 16 CLR/GRN (STBD COCKPIT +)
- 16 CLR (STBD COCKPIT -)
- 16 CLR RED (PORT TOWER +)
- 16 CLR (PORT TOWER -)
- 16 CLR/GRN (STBD TOWER +)
- 16 CLR (STBD TOWER -)
- 16 CLR RED (SUB WOOFER +)
- 16 CLR (SUB WOOFER -)
- 6 BLU (AMP ON) - FERRULE PIN
- 6 RED (AMP PWR) - FERRULE PIN
- 6 BLK (AMP GRND) - FERRULE PIN
- 6 BLK (AMP GRND) - 1/4 RING ATTACH TO GRND BUSS

NOTES:
1.

THIS DOCUMENT IS THE PROPERTY OF KAUFFMAN ENGINEERING INC. VIRGINIA BEACH, VA. ALL RIGHTS ARE RESERVED. THIS DOCUMENT AND INFORMATION CONTAINED MUST NOT BE COPIED OR DISCLOSED TO OTHERS WITHOUT WRITTEN PERMISSION OF KAUFFMAN ENGINEERING INC.

KAUFFMAN ENGINEERING			
DRAWN BY	MD	CAD FILE	81115145
CUSTOMER	REGAL MARINE		DATE DRAWN
PART NAME	26FD FUSION SPP HRNS [262704]		REV. DATE
			08-24-16
			08-24-16
			PART NUMBER
			81115145

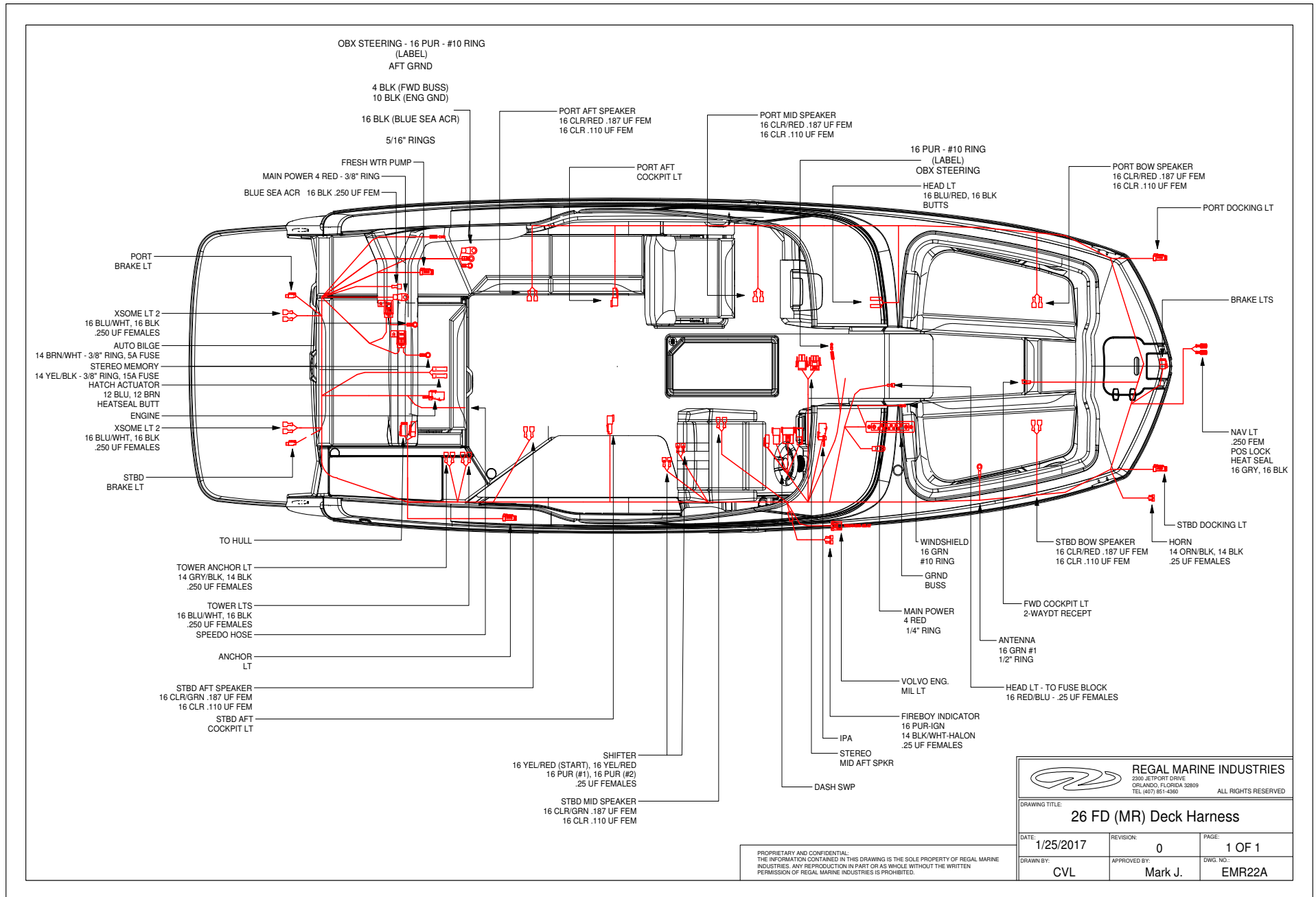

REGAL MARINE INDUSTRIES
 2300 JETPORT DRIVE
 ORLANDO, FLORIDA 32809
 TEL (407) 851-4300 ALL RIGHTS RESERVED

DRAWING TITLE:
26 FD (MR) Deck Harness

DATE: 1/25/2017	REVISION: 0	PAGE: 1 OF 1
DRAWN BY: CVL	APPROVED BY: Mark J.	DWG. NO.: EMR22A

PROPRIETARY AND CONFIDENTIAL:
 THE INFORMATION CONTAINED IN THIS DRAWING IS THE SOLE PROPERTY OF REGAL MARINE INDUSTRIES. ANY REPRODUCTION IN PART OR AS WHOLE WITHOUT THE WRITTEN PERMISSION OF REGAL MARINE INDUSTRIES IS PROHIBITED.

26 FASDECK-OBX DECK HARNESS (CONFIGURED FROM ORIGINAL)



26 FASDECK BATTERY MANAGEMENT PANEL

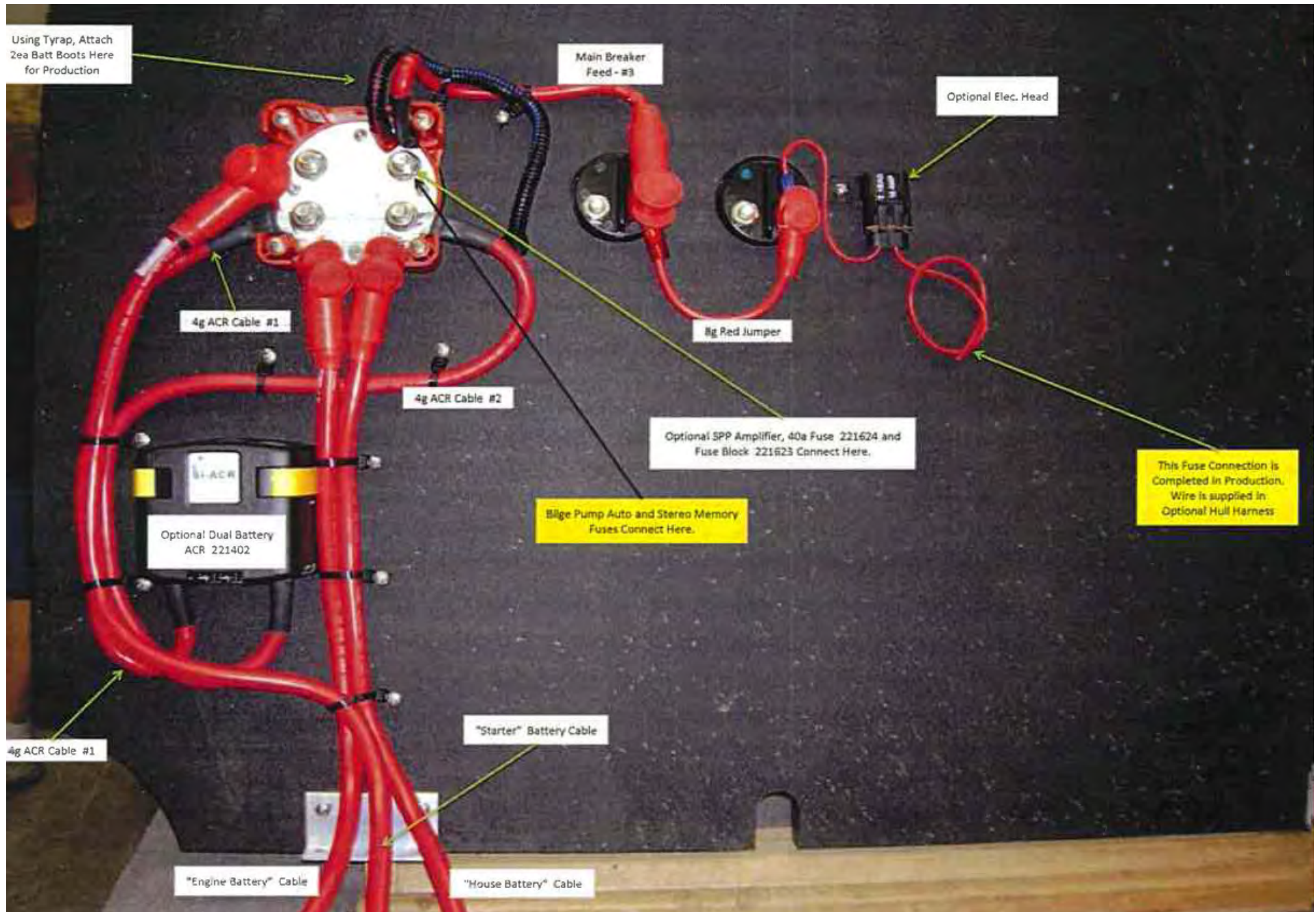

26 FASDECK BATTERY MANAGEMENT PANEL REAR VIEW

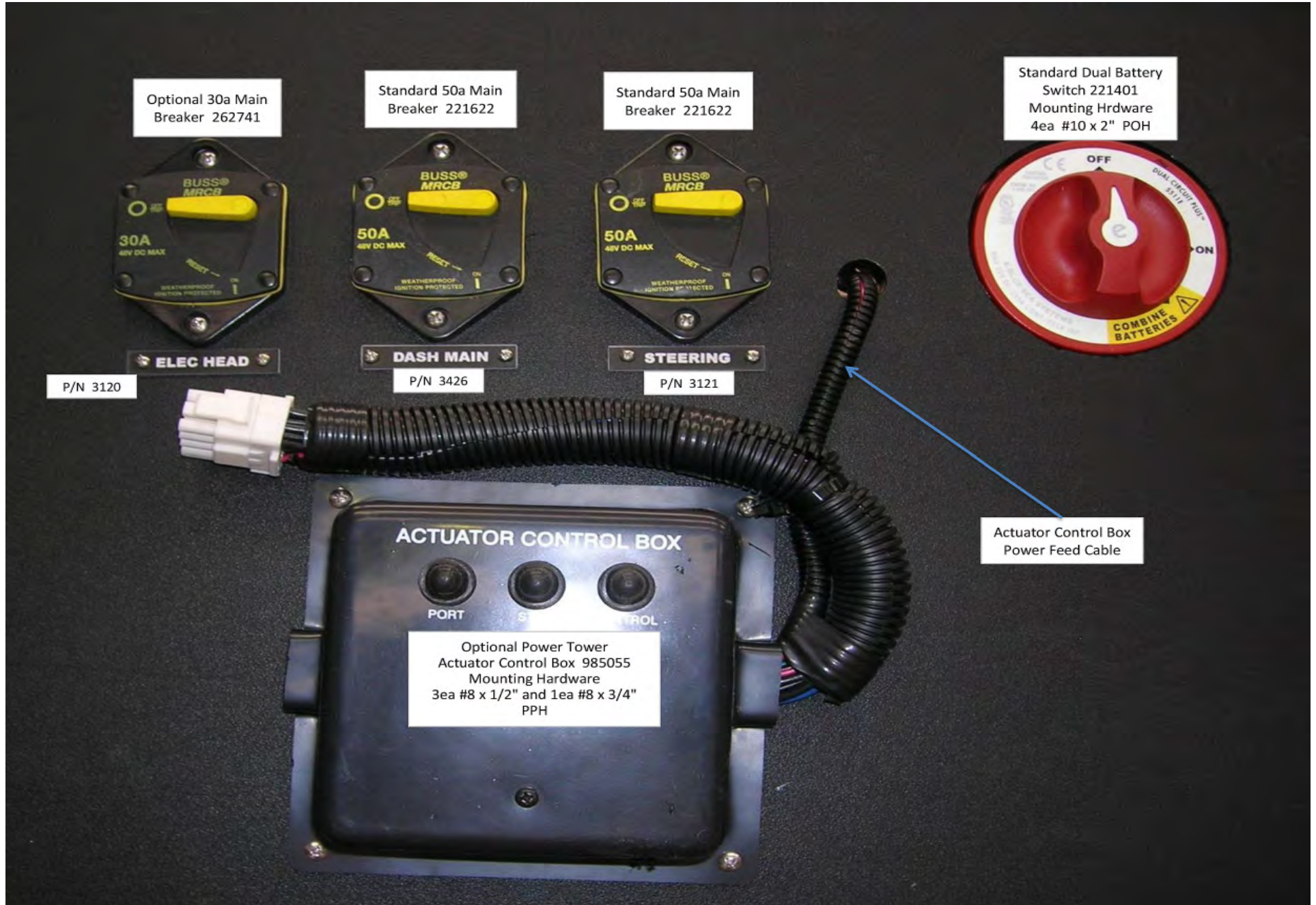

26 OBX BATTERY MANAGEMENT PANEL

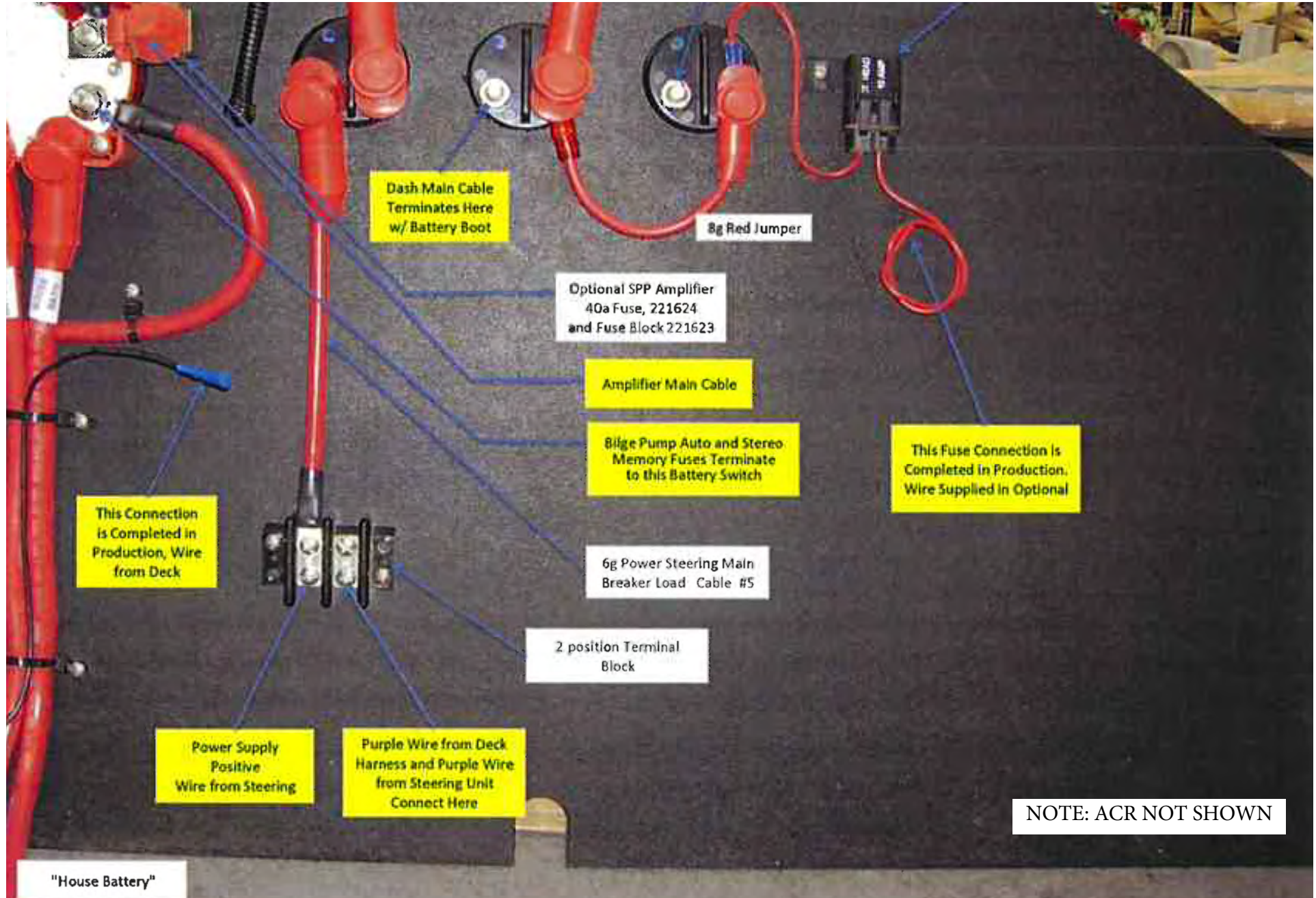

26 OBX BATTERY MANAGEMENT PANEL REAR VIEW

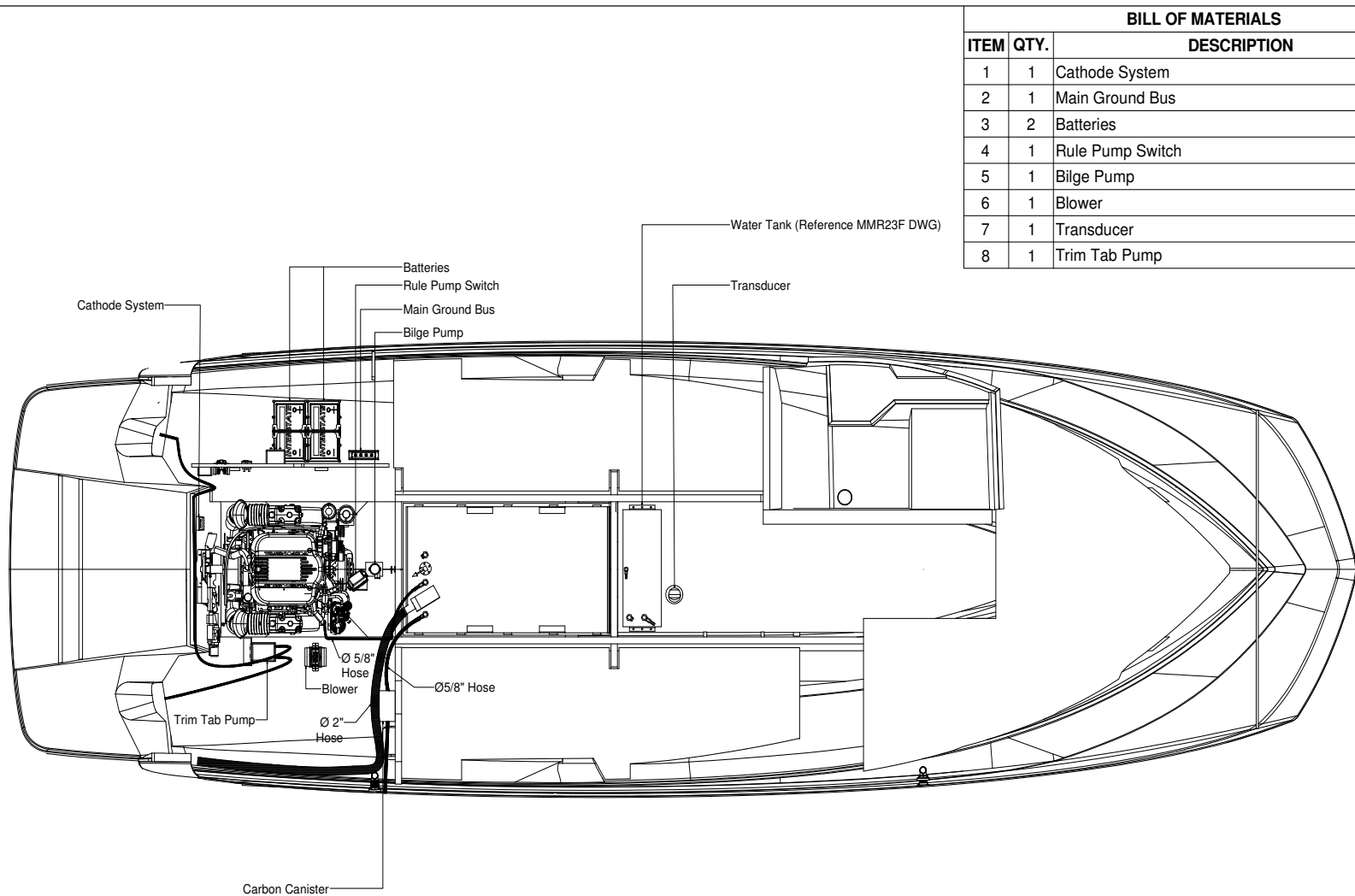

BILL OF MATERIALS		
ITEM	QTY.	DESCRIPTION
1	1	Cathode System
2	1	Main Ground Bus
3	2	Batteries
4	1	Rule Pump Switch
5	1	Bilge Pump
6	1	Blower
7	1	Transducer
8	1	Trim Tab Pump

 REGAL MARINE INDUSTRIES 2300 JETPORT DRIVE ORLANDO, FLORIDA 32809 TEL (407) 851-4380 ALL RIGHTS RESERVED		
DRAWING TITLE:		
26 FD (MR) Sump Layout		
DATE:	REVISION:	PAGE:
1/12/2017	0	1 OF 6
DRAWN BY:	APPROVED BY:	DWG. NO.:
CVL	Maurice T.	MMR23B

PROPRIETARY AND CONFIDENTIAL:
 THE INFORMATION CONTAINED IN THIS DRAWING IS THE SOLE PROPERTY OF REGAL MARINE INDUSTRIES. ANY REPRODUCTION IN PART OR AS WHOLE WITHOUT THE WRITTEN PERMISSION OF REGAL MARINE INDUSTRIES IS PROHIBITED.

26 FASDECK SUMP LAYOUT

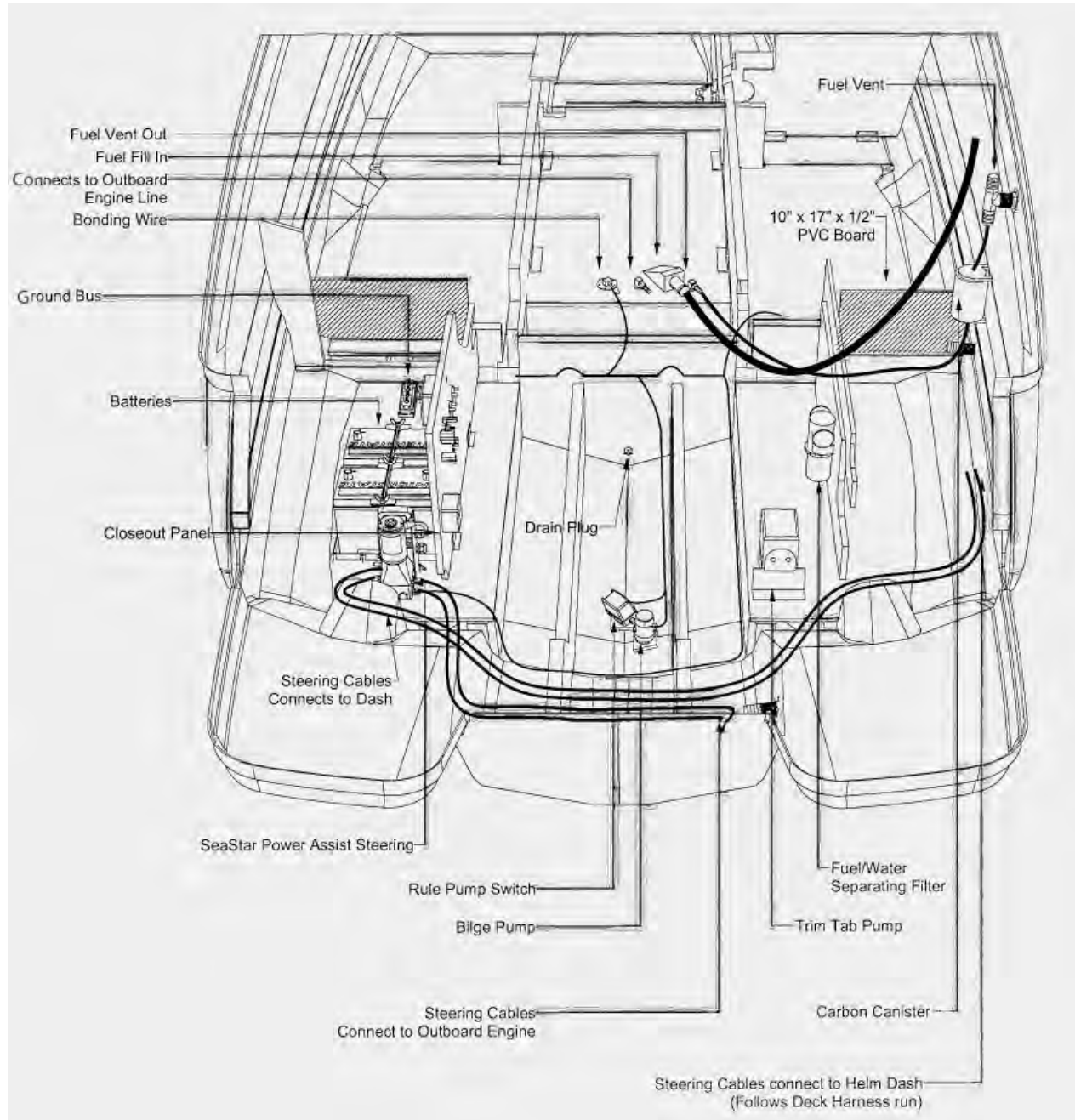

26 OBX SUMP LAYOUT

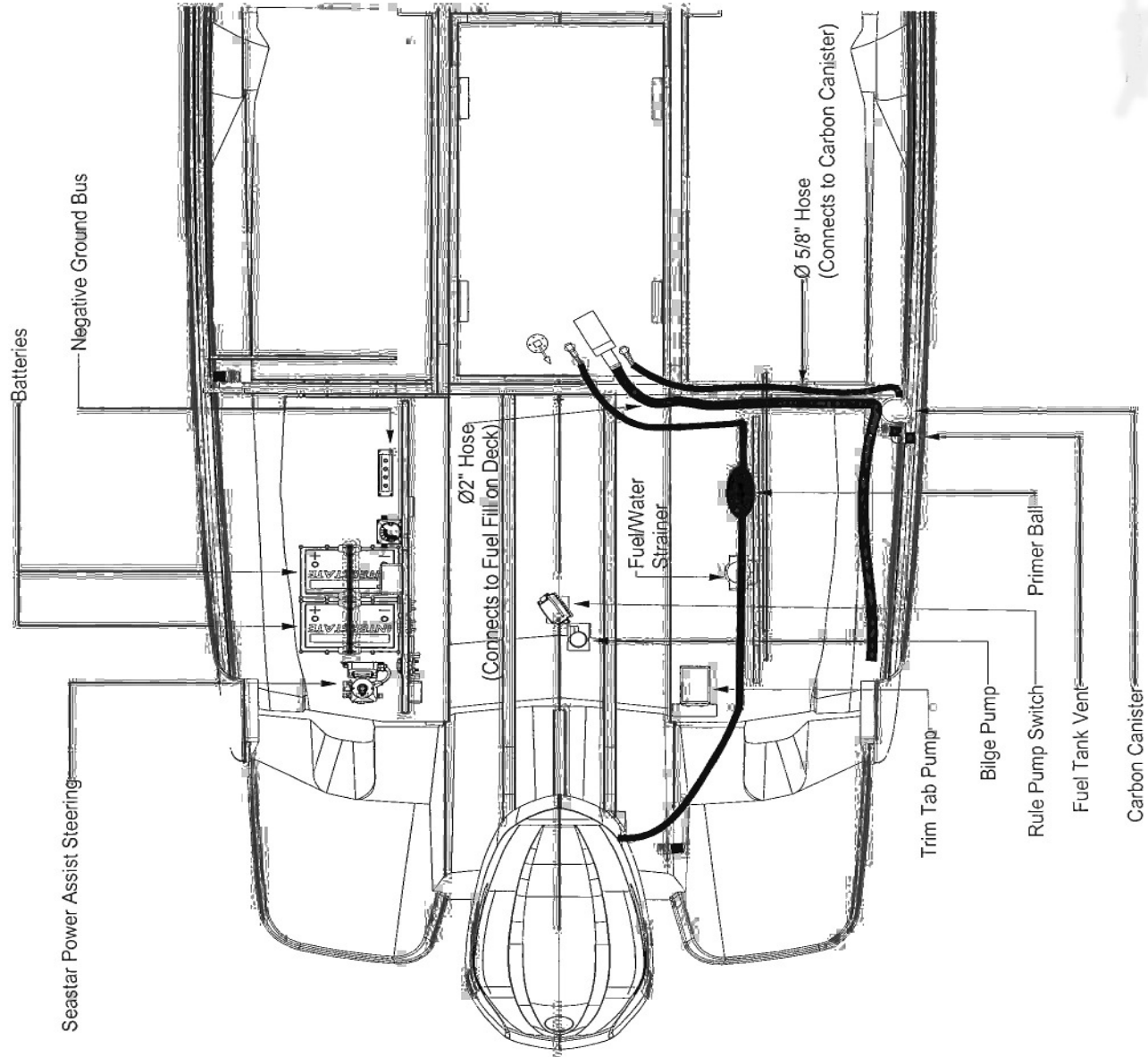

26 OBX SUMP LAYOUT 2

Top View

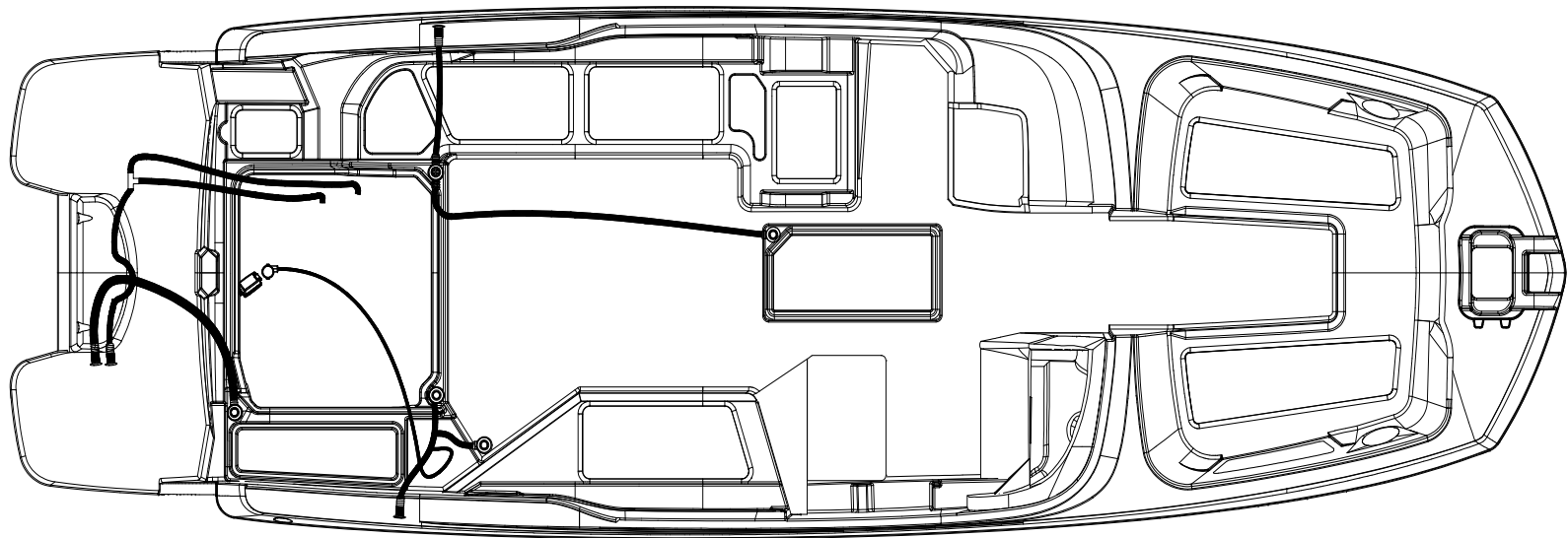

PROPRIETARY AND CONFIDENTIAL.
THE INFORMATION CONTAINED IN THIS DRAWING IS THE SOLE PROPERTY OF REGAL MARINE INDUSTRIES. ANY REPRODUCTION IN PART OR AS WHOLE WITHOUT THE WRITTEN PERMISSION OF REGAL MARINE INDUSTRIES IS PROHIBITED.

			REGAL MARINE INDUSTRIES 2300 JETPORT DRIVE ORLANDO, FLORIDA 32809 TEL (407) 851-4360		
ALL RIGHTS RESERVED					
DRAWING TITLE: 26 OBX (MV) Cockpit Drain Hose Routing					
DATE:	1/12/2017	REVISION:	0	PAGE:	1 OF 6
DRAWN BY:	CVL	APPROVED BY:	Maurice T.	DWG. NO.:	MMV25N

26 OBX COCKPIT DRAIN HOSE ROUTING TOP VIEW

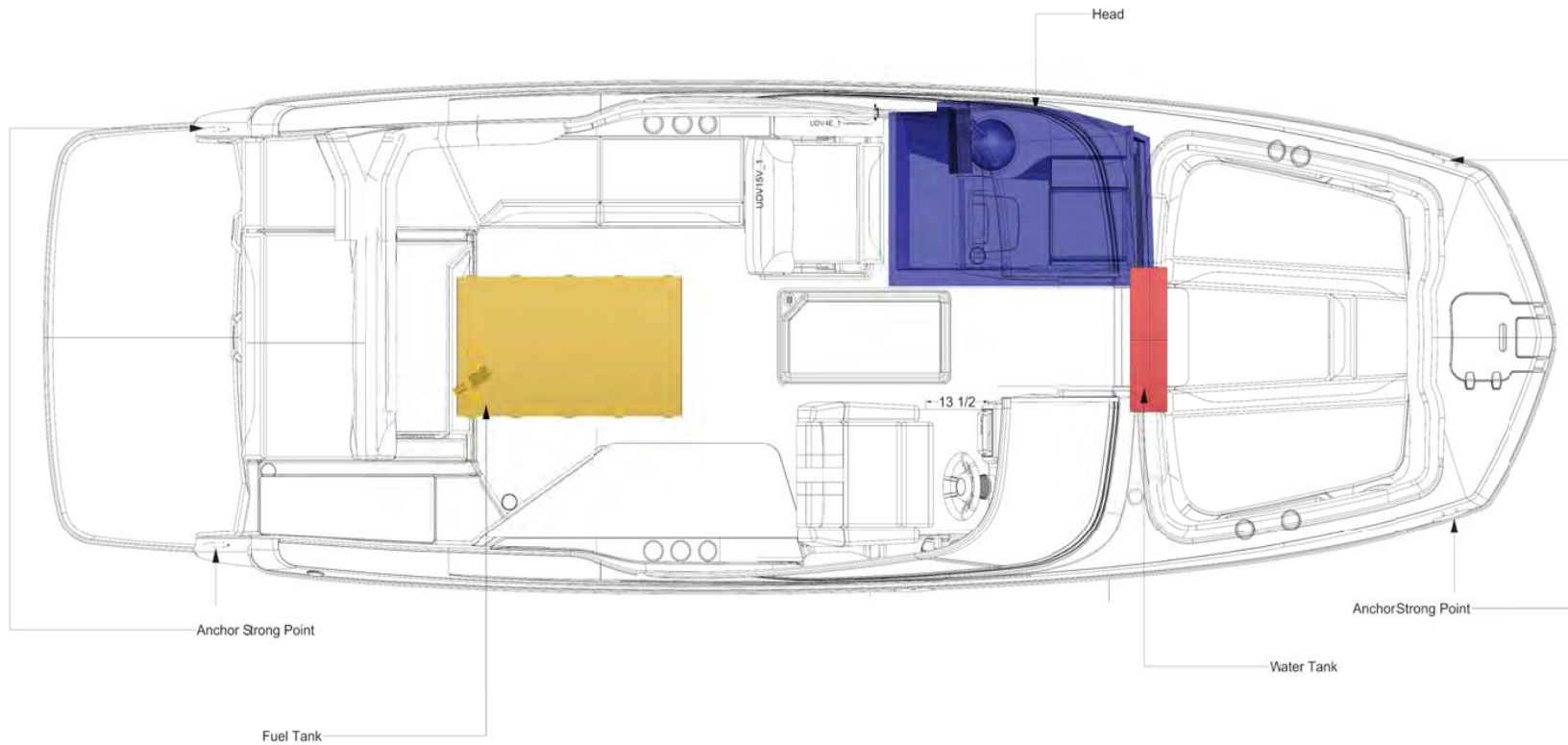

 REGAL MARINE INDUSTRIES 2300 JETPORT DRIVE ORLANDO, FLORIDA 32809 TEL (407) 851-4360 ALL RIGHTS RESERVED		
DRAWING TITLE:		
26 FD (MR) Component Locations		
DATE:	REVISION:	PAGE:
7/8/2016	-	1 OF 1
DRAWN BY:	APPROVED BY:	DWG. NO.:
CVL	Dennis R.	7

PROPRIETARY AND CONFIDENTIAL:
 THE INFORMATION CONTAINED IN THIS DRAWING IS THE SOLE PROPERTY OF REGAL MARINE INDUSTRIES. ANY REPRODUCTION IN PART OR AS WHOLE WITHOUT THE WRITTEN PERMISSION OF REGAL MARINE INDUSTRIES IS PROHIBITED.

26 FASDECK COMPONENT LOCATIONS

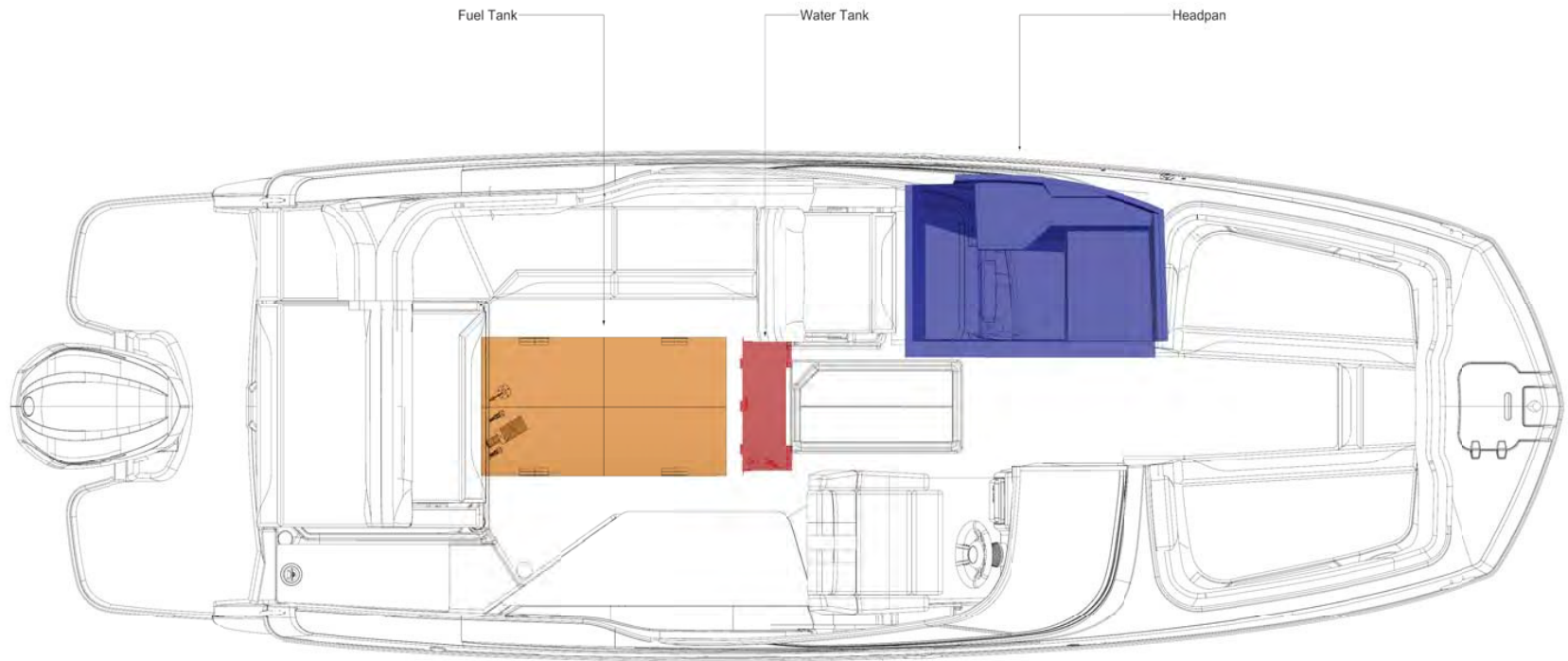

PROPRIETARY AND CONFIDENTIAL.
THE INFORMATION CONTAINED IN THIS DRAWING IS THE SOLE PROPERTY OF REGAL MARINE INDUSTRIES. ANY REPRODUCTION IN PART OR AS WHOLE WITHOUT THE WRITTEN PERMISSION OF REGAL MARINE INDUSTRIES IS PROHIBITED.

 REGAL MARINE INDUSTRIES 2000 JETPORT DRIVE ORLANDO, FLORIDA 32809 TEL (407) 851-4300 ALL RIGHTS RESERVED		
DRAWING TITLE:		
26 OBX (MV) Component Locations		
DATE:	REVISION:	PAGE:
1/10/2017	0	1 OF 1
DRAWN BY:	APPROVED BY:	DWG. NO.:
CVL	Dennis R.	7

26 OBX COMPONENT LOCATIONS

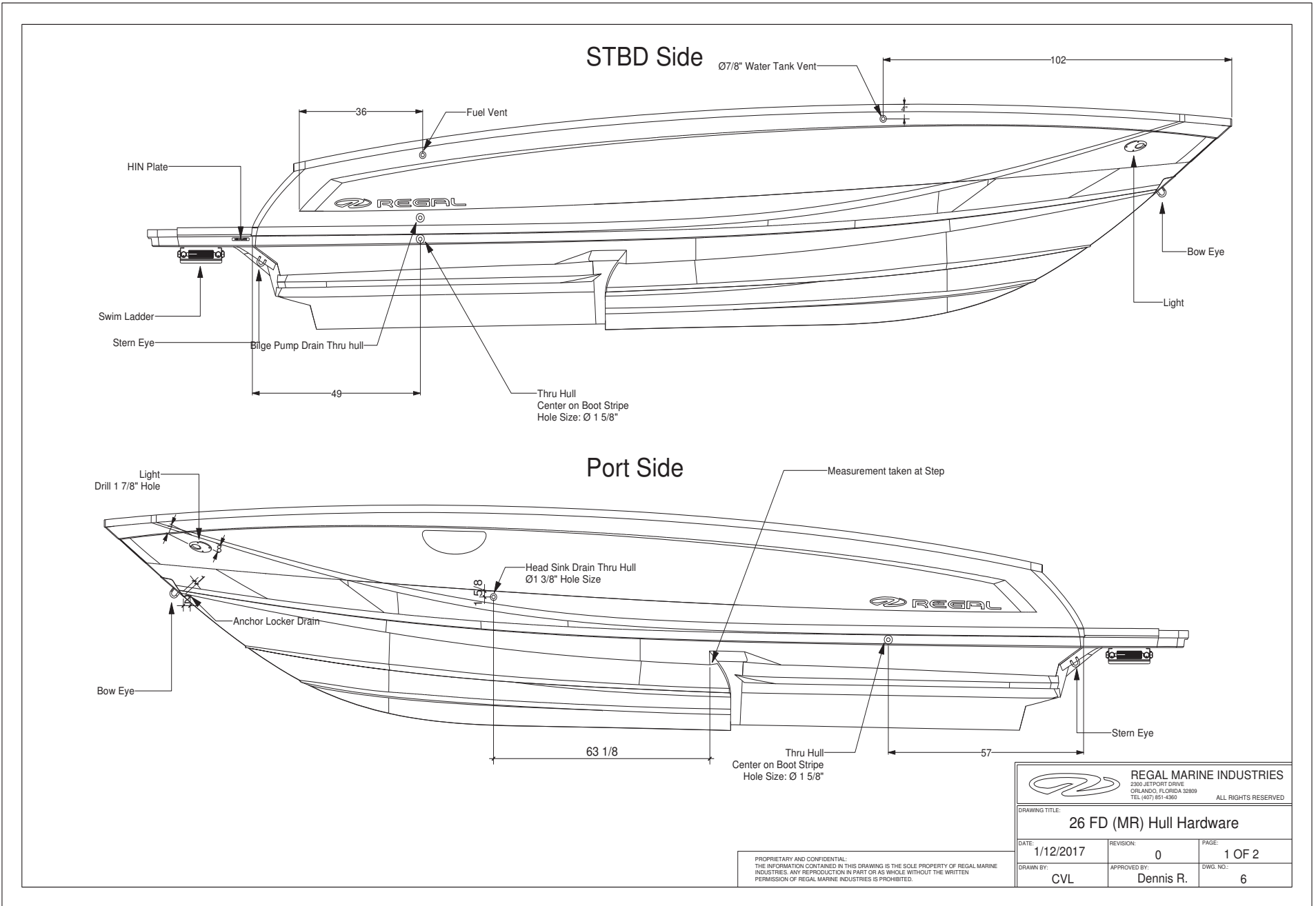

26 FASDECK THRU-HULL FITTINGS

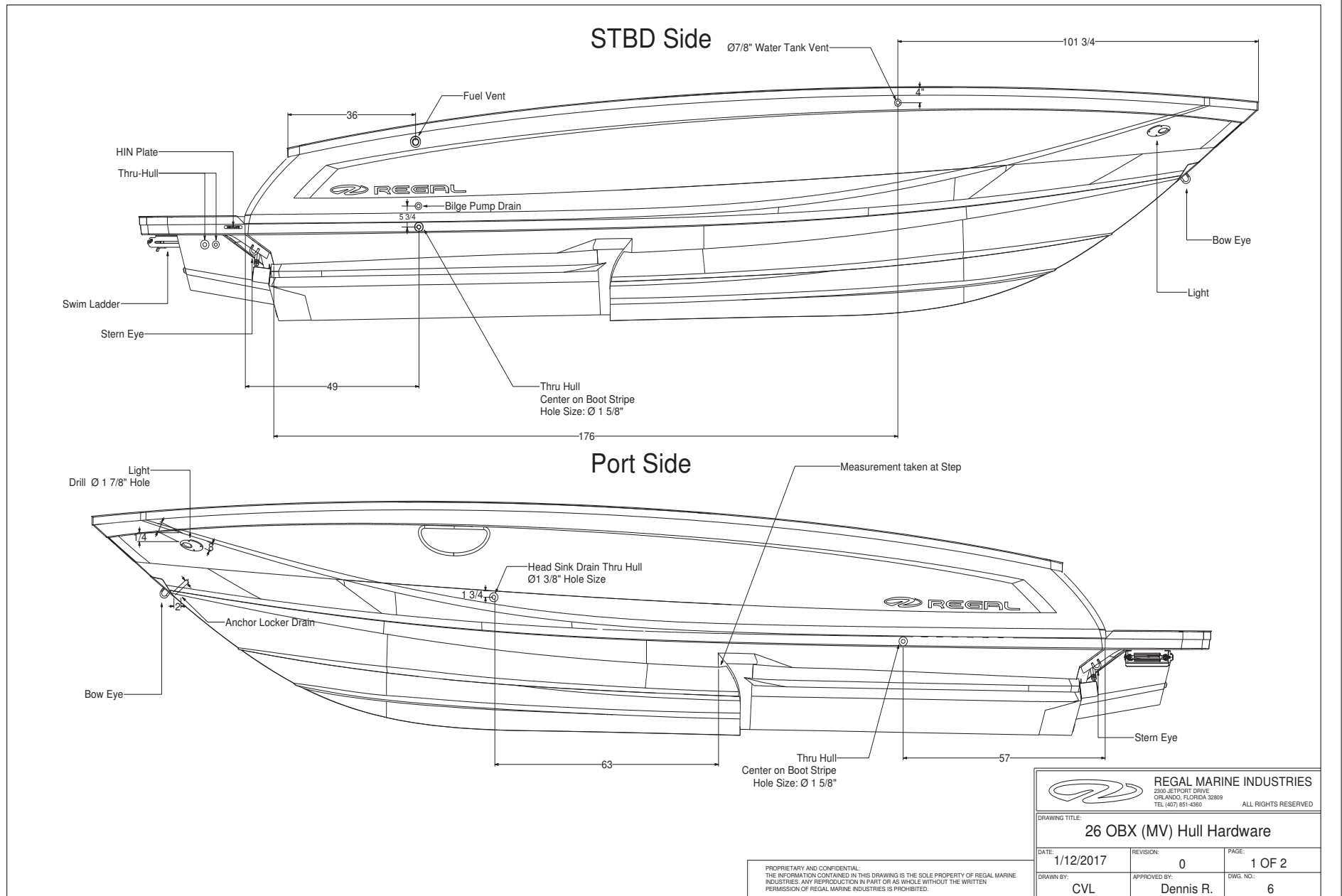



 REGAL MARINE INDUSTRIES 2300 JETPORT DRIVE ORLANDO, FLORIDA 32809 TEL: (407) 951-4390 ALL RIGHTS RESERVED		
DRAWING TITLE:		
26 OBX (MV) Hull Hardware		
DATE:	REVISION:	PAGE:
1/12/2017	0	1 OF 2
DRAWN BY:	APPROVED BY:	DWG. NO.:
CVL	Dennis R.	6

PROPRIETARY AND CONFIDENTIAL:
 THE INFORMATION CONTAINED IN THIS DRAWING IS THE SOLE PROPERTY OF REGAL MARINE INDUSTRIES. ANY REPRODUCTION IN PART OR AS WHOLE WITHOUT THE WRITTEN PERMISSION OF REGAL MARINE INDUSTRIES IS PROHIBITED.

26 OBX THRU-HULL FITTINGS

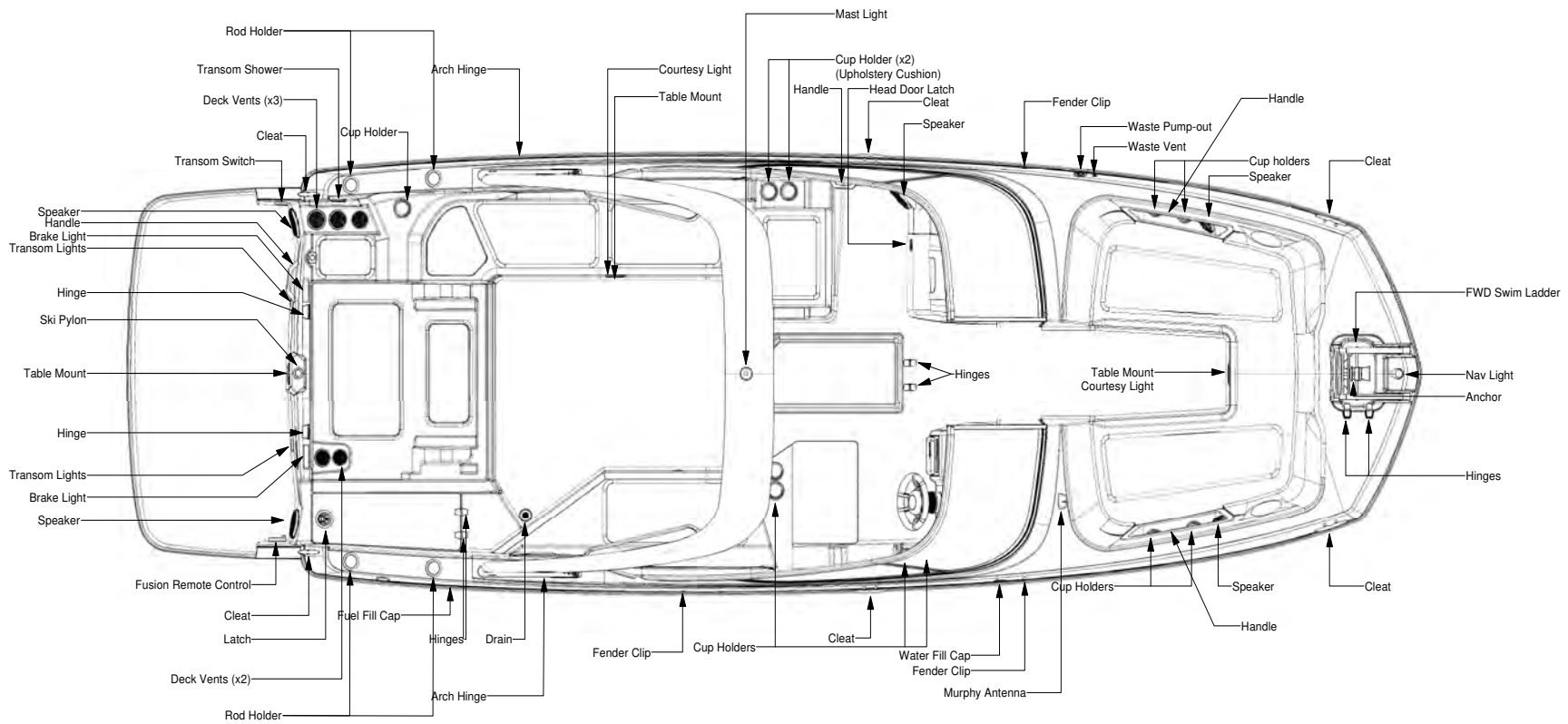
Top View





 REGAL MARINE INDUSTRIES 2300 AIRPORT DRIVE ORLANDO, FLORIDA 32809 TEL (407) 851-4369 ALL RIGHTS RESERVED		
DRAWING TITLE:		
26 FD(MR) Deck Hardware		
DATE:	REVISION:	PAGE:
1/12/2017	0	1 OF 4
DRAWN BY:	APPROVED BY:	DWG. NO.:
CVL	Dennis R.	14

PROPRIETARY AND CONFIDENTIAL:
 THE INFORMATION CONTAINED IN THIS DRAWING IS THE SOLE PROPERTY OF REGAL MARINE INDUSTRIES. ANY REPRODUCTION IN PART OR AS WHOLE WITHOUT THE WRITTEN PERMISSION OF REGAL MARINE INDUSTRIES IS PROHIBITED.

26 FASDECK DECK HARDWARE-TOP VIEW

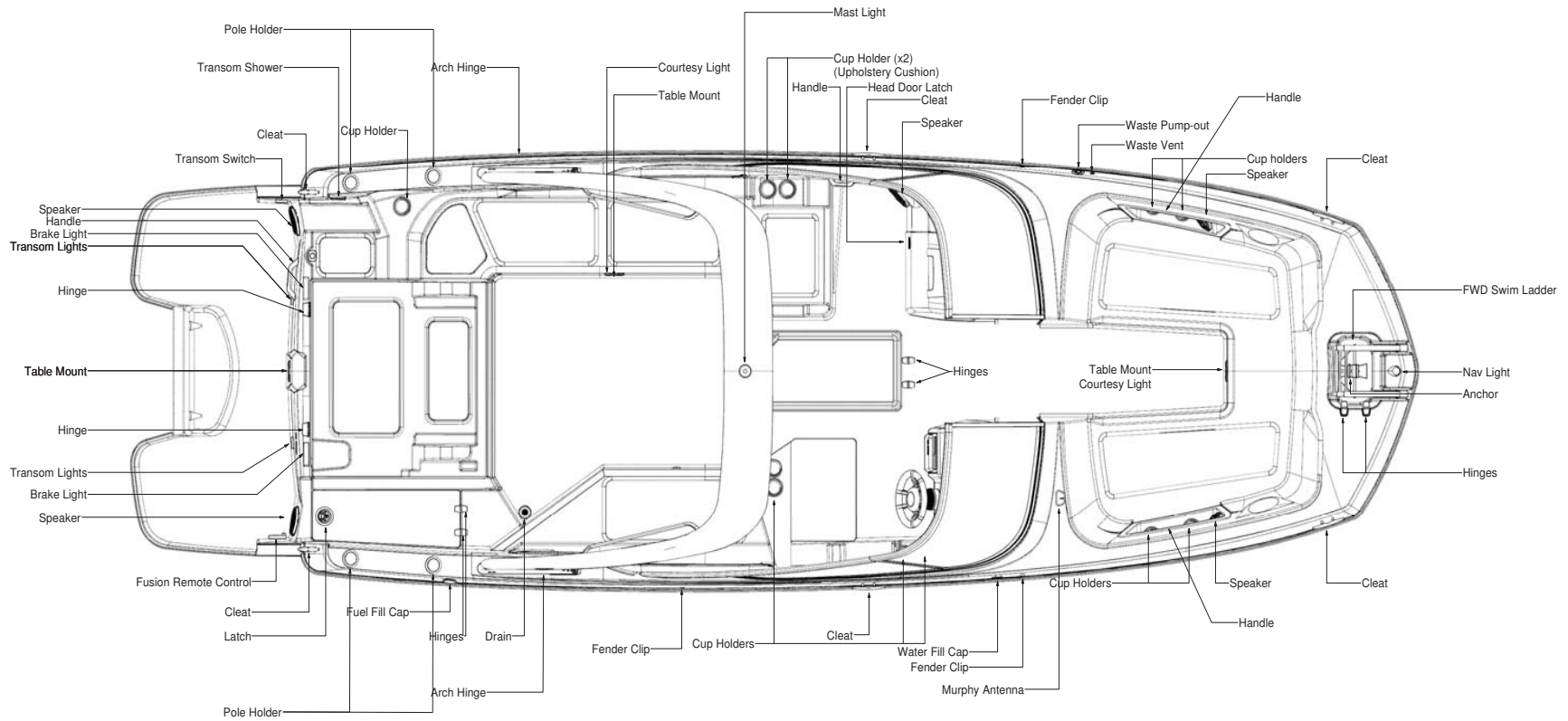
Top View



 REGAL MARINE INDUSTRIES 2500 ELFTPORT DRIVE ORLANDO, FLORIDA 32809 TEL: (407) 951-4000 ALL RIGHTS RESERVED		
DRAWING TITLE:		
26 OBX (MV) Deck Hardware		
DATE:	REVISION:	PAGE:
1/12/2017	0	1 OF 4
DRAWN BY:	APPROVED BY:	DWG. NO.:
CVL	Dennis R.	14

PROPRIETARY AND CONFIDENTIAL:
 THE INFORMATION CONTAINED IN THIS DRAWING IS THE SOLE PROPERTY OF REGAL MARINE
 INDUSTRIES. ANY REPRODUCTION IN PART OR AS WHOLE WITHOUT THE WRITTEN
 PERMISSION OF REGAL MARINE INDUSTRIES IS PROHIBITED.

26 OBX DECK HARDWARE-TOP VIEW

Port View

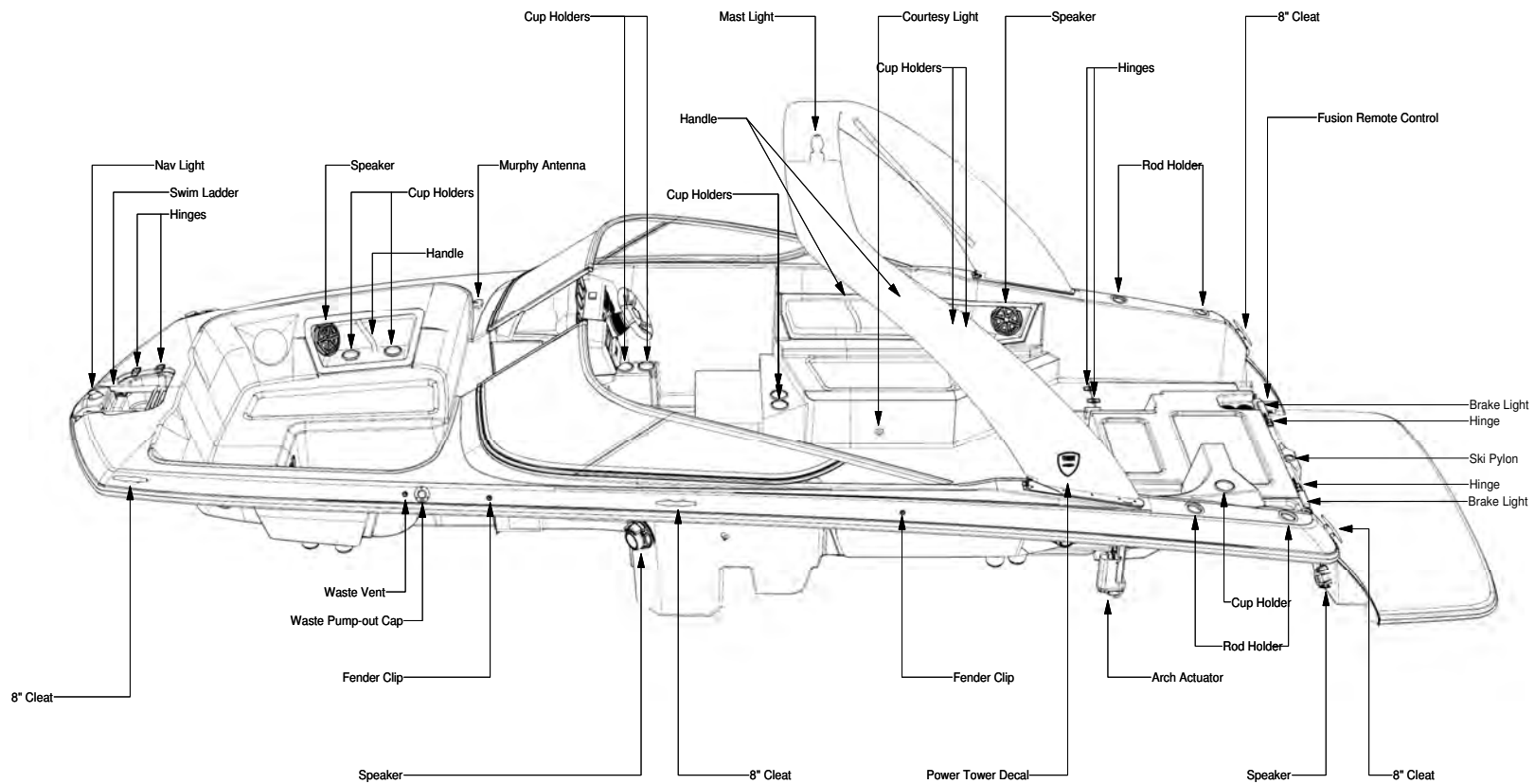



PROPRIETARY AND CONFIDENTIAL:
THE INFORMATION CONTAINED IN THIS DRAWING IS THE SOLE PROPERTY OF REGAL MARINE INDUSTRIES. ANY REPRODUCTION IN PART OR AS WHOLE WITHOUT THE WRITTEN PERMISSION OF REGAL MARINE INDUSTRIES IS PROHIBITED.

 REGAL MARINE INDUSTRIES 2300 JETPORT DRIVE ORLANDO, FL 32809 TEL: (407) 881-4360 ALL RIGHTS RESERVED		
DRAWING TITLE:		
26 FD (MR) Deck Hardware		
DATE:	REVISION:	PAGE:
1/12/2017	0	3 OF 4
DRAWN BY:	APPROVED BY:	DWG. NO.:
CVL	Dennis R.	14

26 FASDECK DECK HARDWARE PORT VIEW

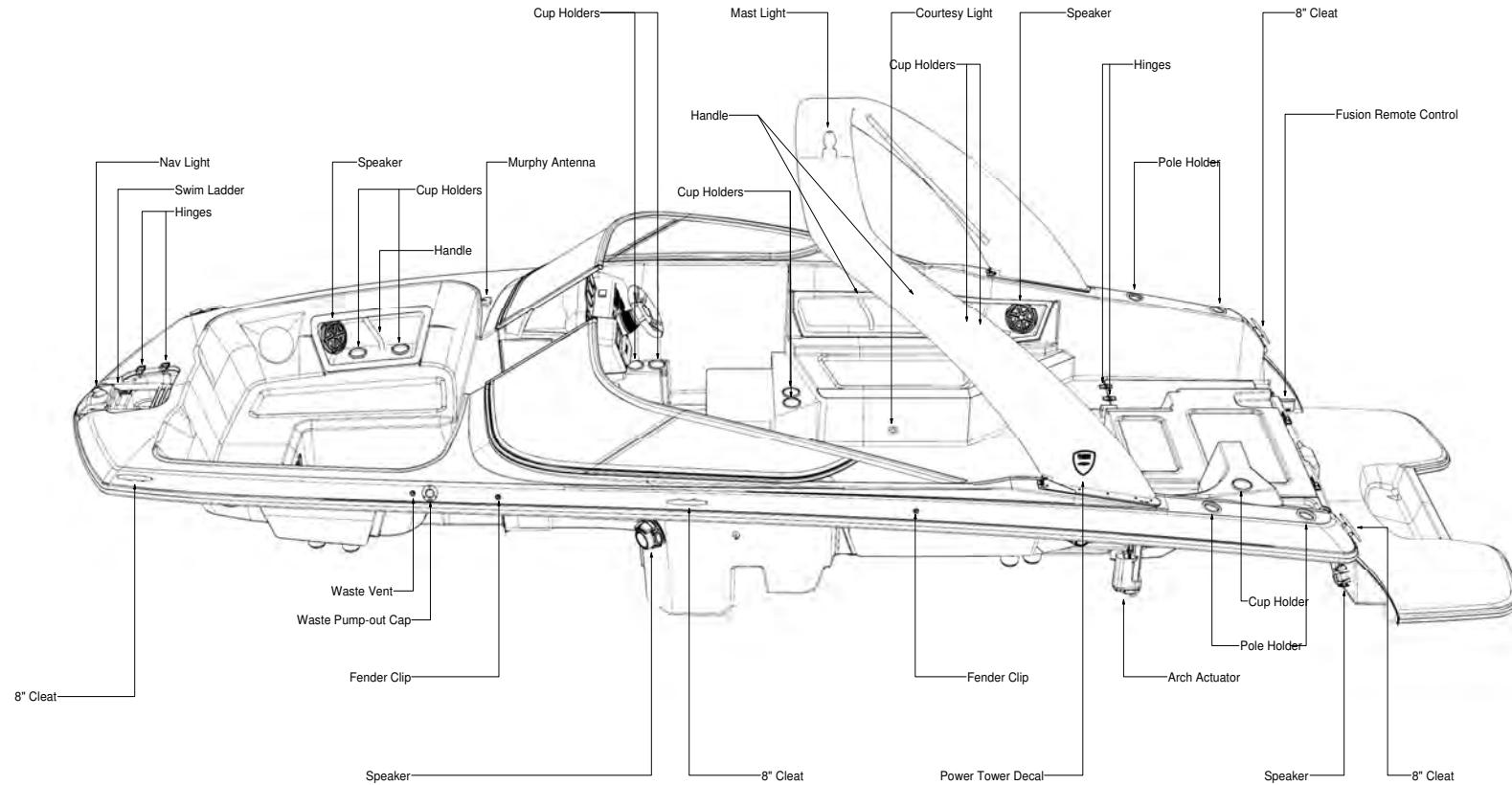
Port View





 REGAL MARINE INDUSTRIES <small>2300 JEFFERSON DRIVE ORLANDO, FLORIDA 32809 TEL. (407) 851-4360</small>		
<small>DRAWING TITLE:</small> 26 OBX (MV) Deck Hardware		
<small>DATE:</small> 1/12/2017	<small>REVISION:</small> 0	<small>PAGE:</small> 3 OF 4
<small>DRAWN BY:</small> CVL	<small>APPROVED BY:</small> Dennis R.	<small>DWG. NO.:</small> 14

PROPRIETARY AND CONFIDENTIAL.
 THE INFORMATION CONTAINED IN THIS DRAWING IS THE SOLE PROPERTY OF REGAL MARINE INDUSTRIES. ANY REPRODUCTION IN PART OR AS WHOLE WITHOUT THE WRITTEN PERMISSION OF REGAL MARINE INDUSTRIES IS PROHIBITED.

26 OBX DECK HARDWARE PORT VIEW

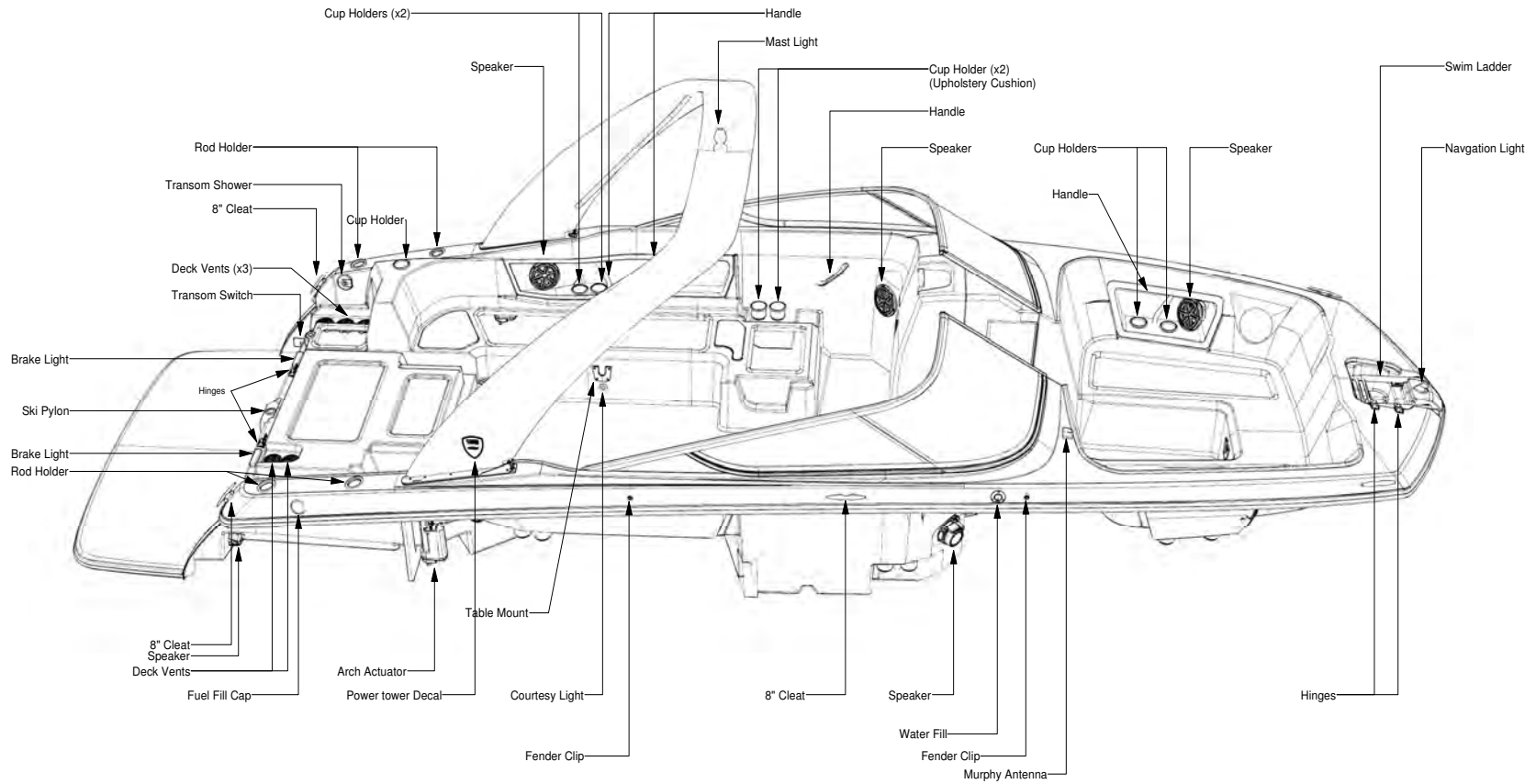
STBD View





 REGAL MARINE INDUSTRIES 2300 JETPORT DRIVE ORLANDO, FLORIDA 32809 TEL (407) 851-4369 ALL RIGHTS RESERVED		
DRAWING TITLE		
26 FD (MR) Deck Hardware		
DATE:	REVISION:	PAGE:
1/12/2017	0	2 OF 4
DRAWN BY:	APPROVED BY:	DWG. NO.:
CVL	Maurice T.	14

PROPRIETARY AND CONFIDENTIAL:
 THE INFORMATION CONTAINED IN THIS DRAWING IS THE SOLE PROPERTY OF REGAL MARINE
 INDUSTRIES. ANY REPRODUCTION IN PART OR AS WHOLE WITHOUT THE WRITTEN
 PERMISSION OF REGAL MARINE INDUSTRIES IS PROHIBITED.

26 FASDECK DECK HARDWARE STARBOARD VIEW

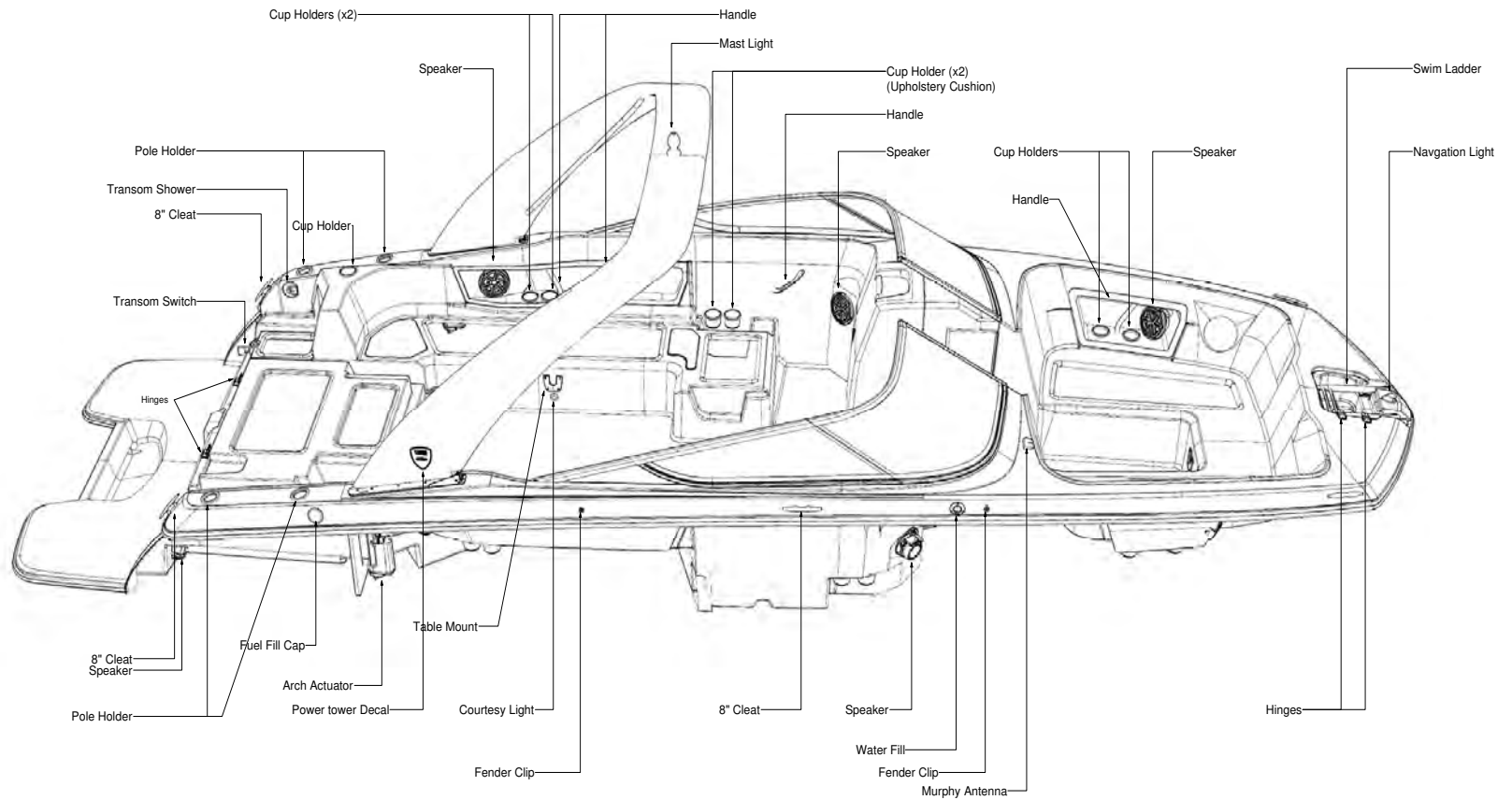
STBD View



 REGAL MARINE INDUSTRIES 2300 JETPORT DRIVE ORLANDO, FLORIDA 32809 TEL (407) 851-4380 ALL RIGHTS RESERVED		
DRAWING TITLE:		
26 OBX (MV) Deck Hardware		
DATE:	REVISION:	PAGE:
1/12/2017	0	2 OF 4
DRAWN BY:	APPROVED BY:	DWG. NO.:
CVL	Dennis R.	14

PROPRIETARY AND CONFIDENTIAL:
 THE INFORMATION CONTAINED IN THIS DRAWING IS THE SOLE PROPERTY OF REGAL MARINE INDUSTRIES. ANY REPRODUCTION IN PART OR AS WHOLE WITHOUT THE WRITTEN PERMISSION OF REGAL MARINE INDUSTRIES IS PROHIBITED.

26 OBX DECK HARDWARE STARBOARD VIEW

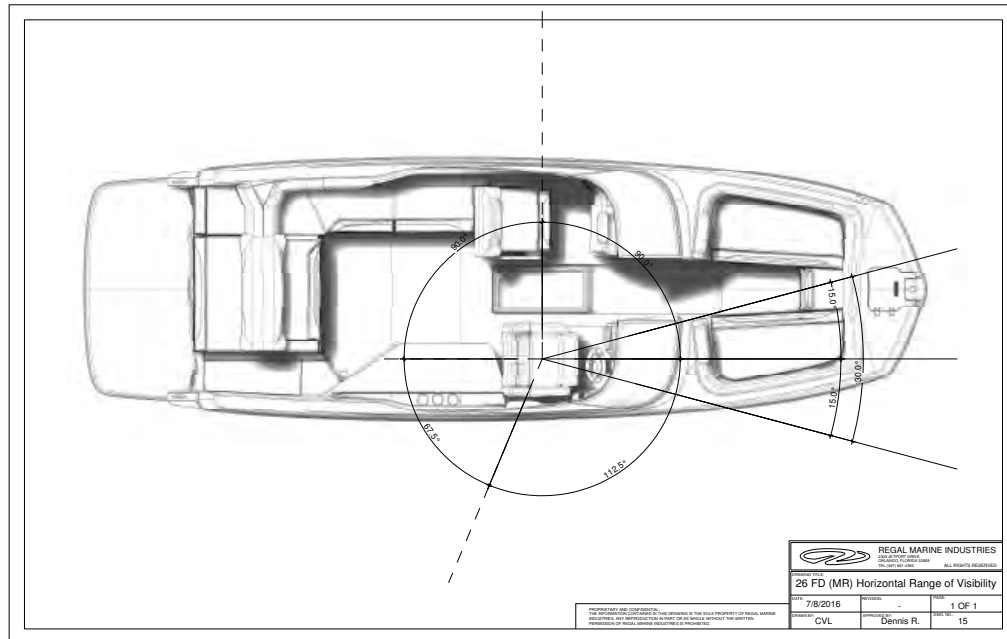
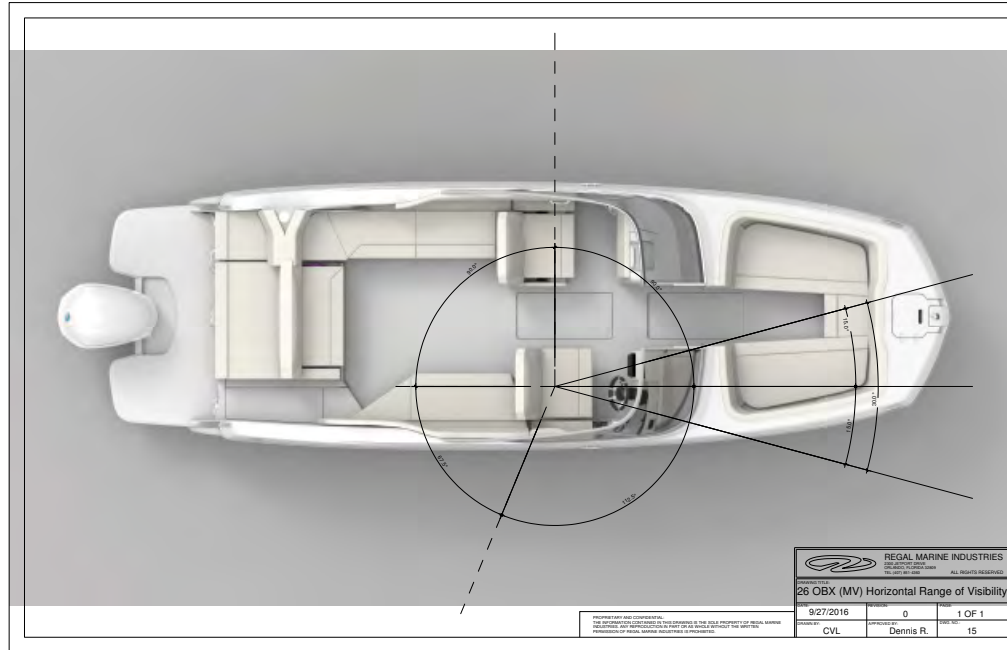

26 FASDECK/OBX HORIZONTAL RANGE OF VISIBILITY

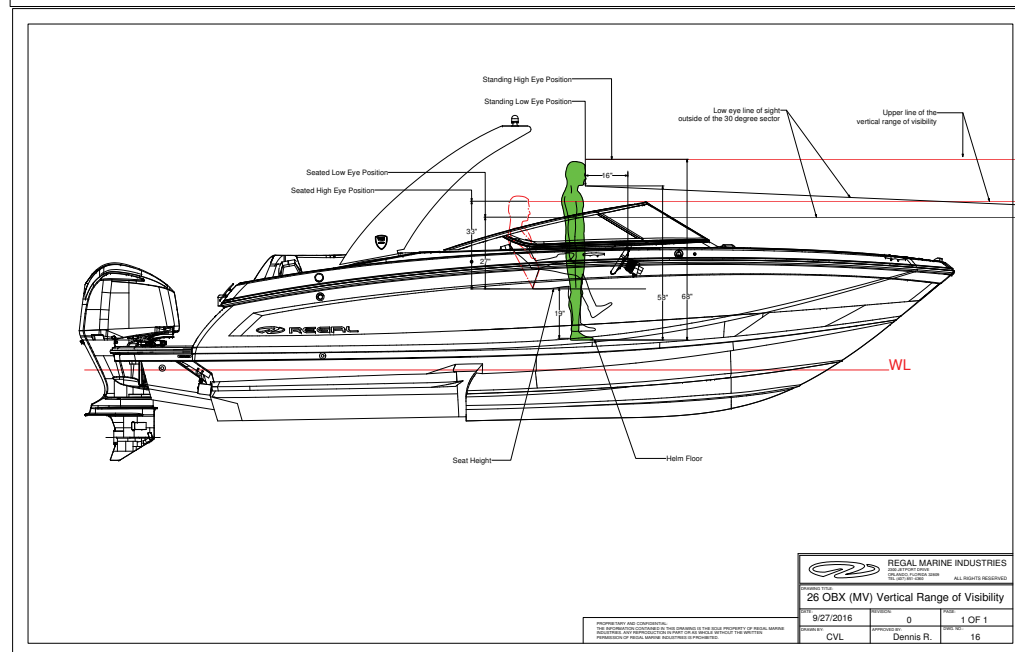
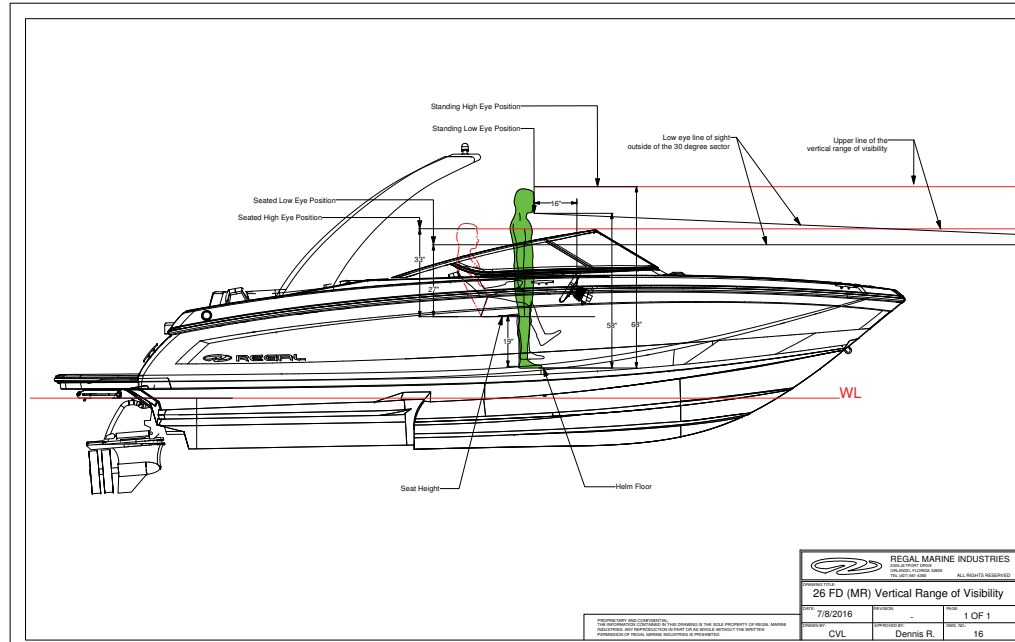

26 FASDECK/OBX VERTICAL RANGE OF VISIBILITY

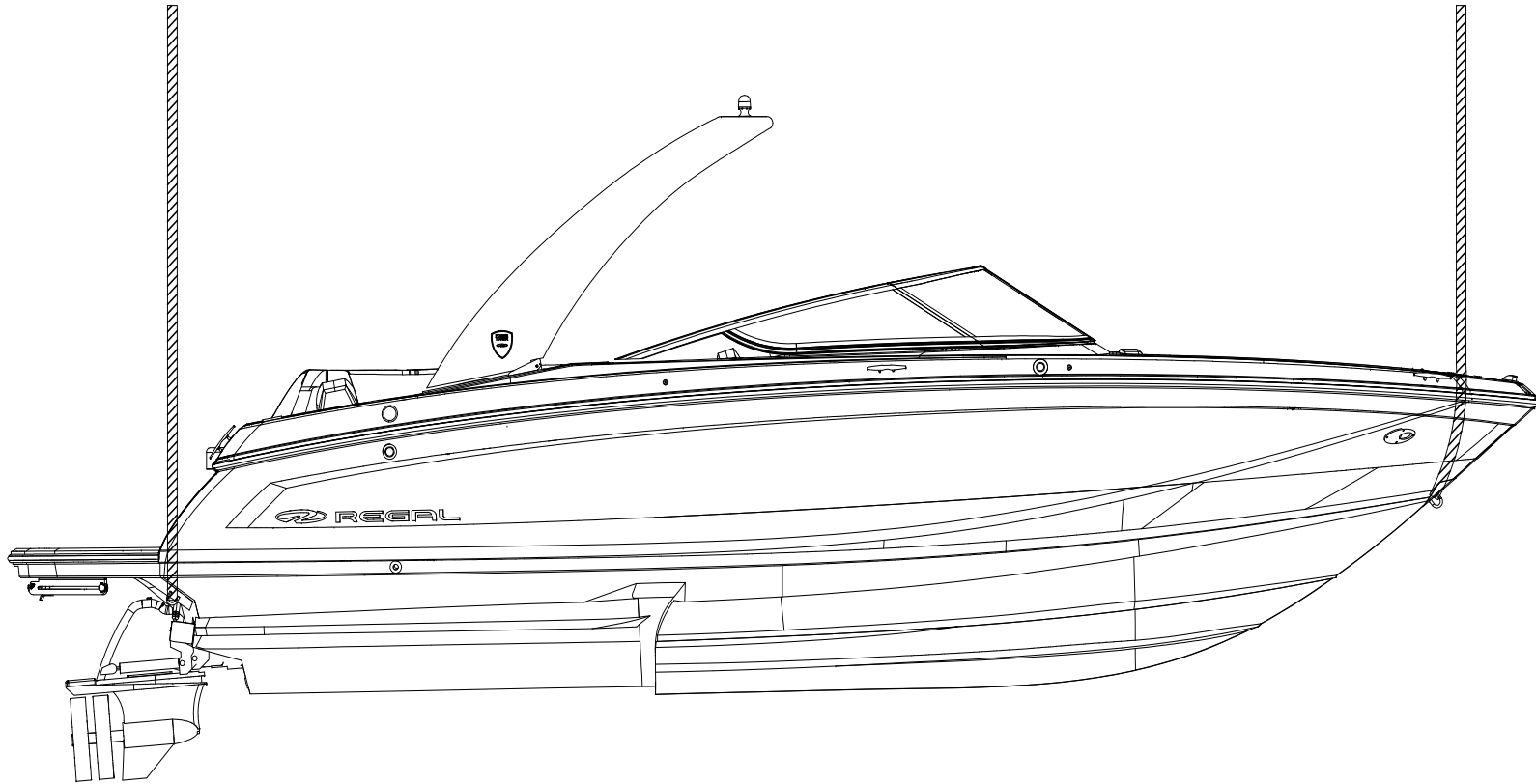

Note: Lifting locations are located at bow eye and aft stern eyes

PROPRIETARY AND CONFIDENTIAL:
THE INFORMATION CONTAINED IN THIS DRAWING IS THE SOLE PROPERTY OF REGAL MARINE INDUSTRIES. ANY REPRODUCTION IN PART OR AS WHOLE WITHOUT THE WRITTEN PERMISSION OF REGAL MARINE INDUSTRIES IS PROHIBITED.

 REGAL MARINE INDUSTRIES 2300 JETPORT DRIVE ORLANDO, FLORIDA 32809 TEL: (407) 851-4360 ALL RIGHTS RESERVED		
DRAWING TITLE:		
26 FD (MR) Sling Locations		
DATE:	REVISION:	PAGE:
10/4/2016	0	1 OF 1
DRAWN BY:	APPROVED BY:	DWG. NO.:
CVL	Dennis R.	17

26 FASDECK SLING LOCATIONS

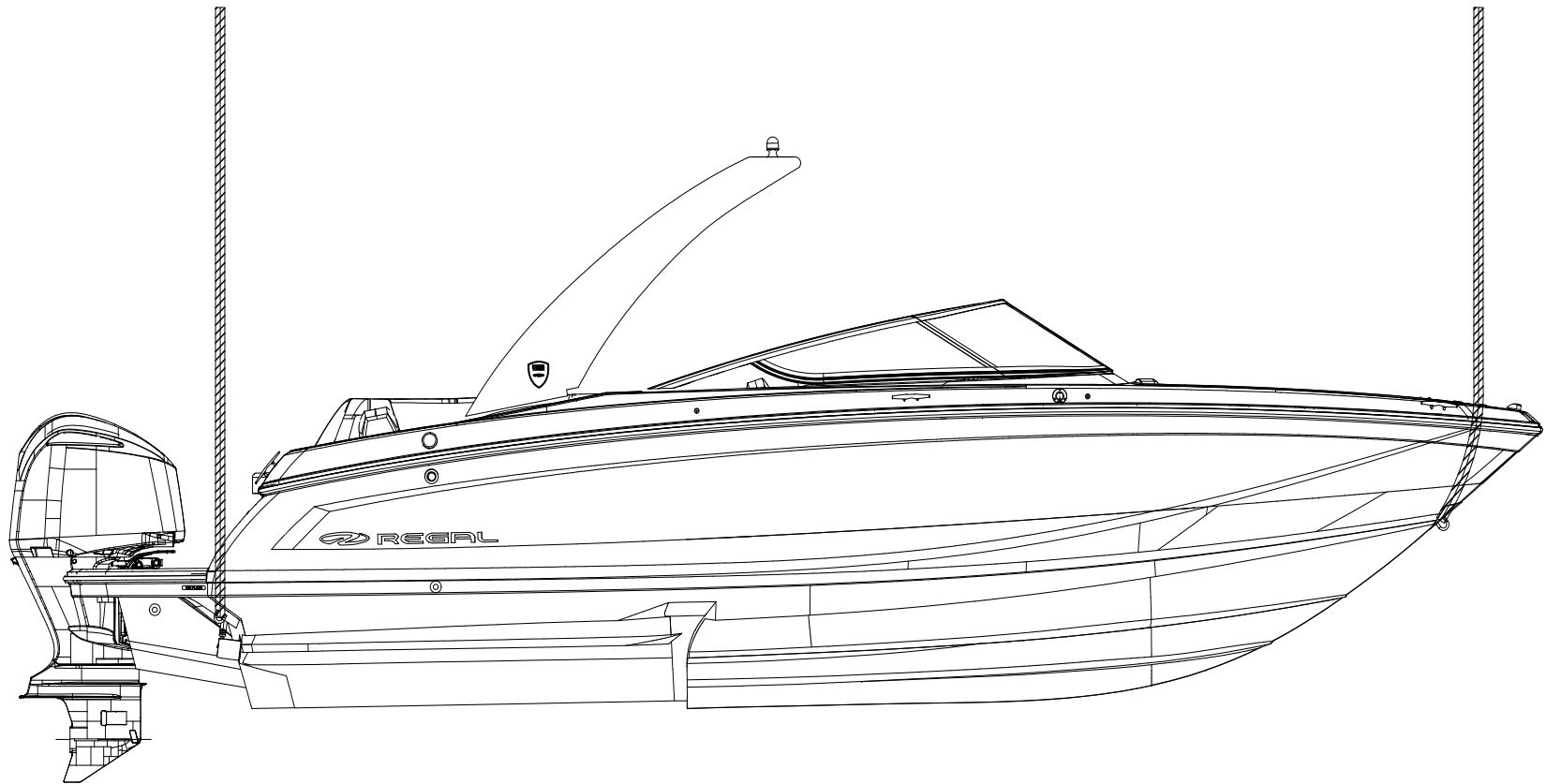

Note: Lifting locations are located at bow eye and aft stern eyes

PROPRIETARY AND CONFIDENTIAL:
THE INFORMATION CONTAINED IN THIS DRAWING IS THE SOLE PROPERTY OF REGAL MARINE INDUSTRIES. ANY REPRODUCTION IN PART OR AS WHOLE WITHOUT THE WRITTEN PERMISSION OF REGAL MARINE INDUSTRIES IS PROHIBITED.

 REGAL MARINE INDUSTRIES 2300 JETPORT DRIVE ORLANDO, FLORIDA 32809 TEL (407) 851-4300 ALL RIGHTS RESERVED		
DRAWING TITLE:		
26 OBX (MV) Sling Locations		
DATE:	REVISION:	PAGE:
9/27/2016	0	1 OF 1
DRAWN BY:	APPROVED BY:	DWG. NO.:
CVL	Dennis R.	17

26 OBX SLING LOCATIONS

BILL OF MATERIALS			BILL OF MATERIALS			BILL OF MATERIALS			BILL OF MATERIALS						
ITEM	QTY.	DESCRIPTION	PART NUMBER	ITEM	QTY.	DESCRIPTION	PART NUMBER	ITEM	QTY.	DESCRIPTION	PART NUMBER	ITEM	QTY.	DESCRIPTION	PART NUMBER
1	-	Bow FWD Center Backrest	UMRMV06A	12	-	Helm Seat	UMRMV13A	24	-	Engine Hatch FWD panel	UMRMV15H	36	-	Cockpit Port tub	UMRMV15V
-	-	-	-	-	-	-	-	25	-	Engine Hatch FWD cushion	UMRMV15J	37	-	Cockpit Port Outboard panel	UMRMV15W
3	-	Bow port tub	UMRMV06C	-	-	-	-	26	-	Engine Hatch backrest	UMRMV15K	-	-	-	-
4	-	Bow port Aft B/R	UMRMV06D	15	-	Helm FWD Coaming	UMRMV13D	27	-	Transom Center cushion	UMRMV15L	39	-	Cockpit Port FWD cushion	UMRMV15Y
5	-	Bow port Cushion	UMRMV06E	16	-	Helm Storage Panel	UMRMV13E	28	-	Transom Port cushion	UMRMV15M	40	-	Cockpit FWD lower panel	UMRMV15Z
6	-	Bow port center cushion	UMRMV06F	17	-	Cockpit STBD AFT B/R	UMRMV15A	29	-	Transom port B/R	UMRMV15N	41	-	Companion Drink Holder	UMRMV14A
-	-	-	-	18	-	Cockpit STBD tub	UMRMV15B	30	-	Cockpit Port AFT B/R	UMRMV15P	42	-	Companion cushion	UMRMV14B
-	-	-	-	19	-	Cockpit STBD aft panel	UMRMV15C	-	-	-	-	43	-	Companion Side panel	UMRMV14C
9A	-	Bow STBD cushion	UMRMV06J	20	-	Cockpit STBD outboard panel	UMRMV15D	32	-	Cockpit Port Corner cushion	UMRMV15R	44	-	Companion B/R	UMRMV14D
9B	-	Bow STBD Aft B/R	UMRMV06K	21	-	Cockpit STBD cushion	UMRMV15E	-	-	-	-	45	-	Head Door B/R	UMRMV14E
10	-	Bow STBD tub	UMRMV06L	22	-	Cockpit STBD corner cushion	UMRMV15F	34	-	Cockpit Port AFT Cushion	UMRMV15T	46	-	Port Armrest	UMRMV06N
11	-	-	-	23	-	Engine Hatch STBD panel	UMRMV15G	35	-	Cockpit Port FWD B/R	UMRMV15U	47	-	STBD Armrest	UMRMV06P

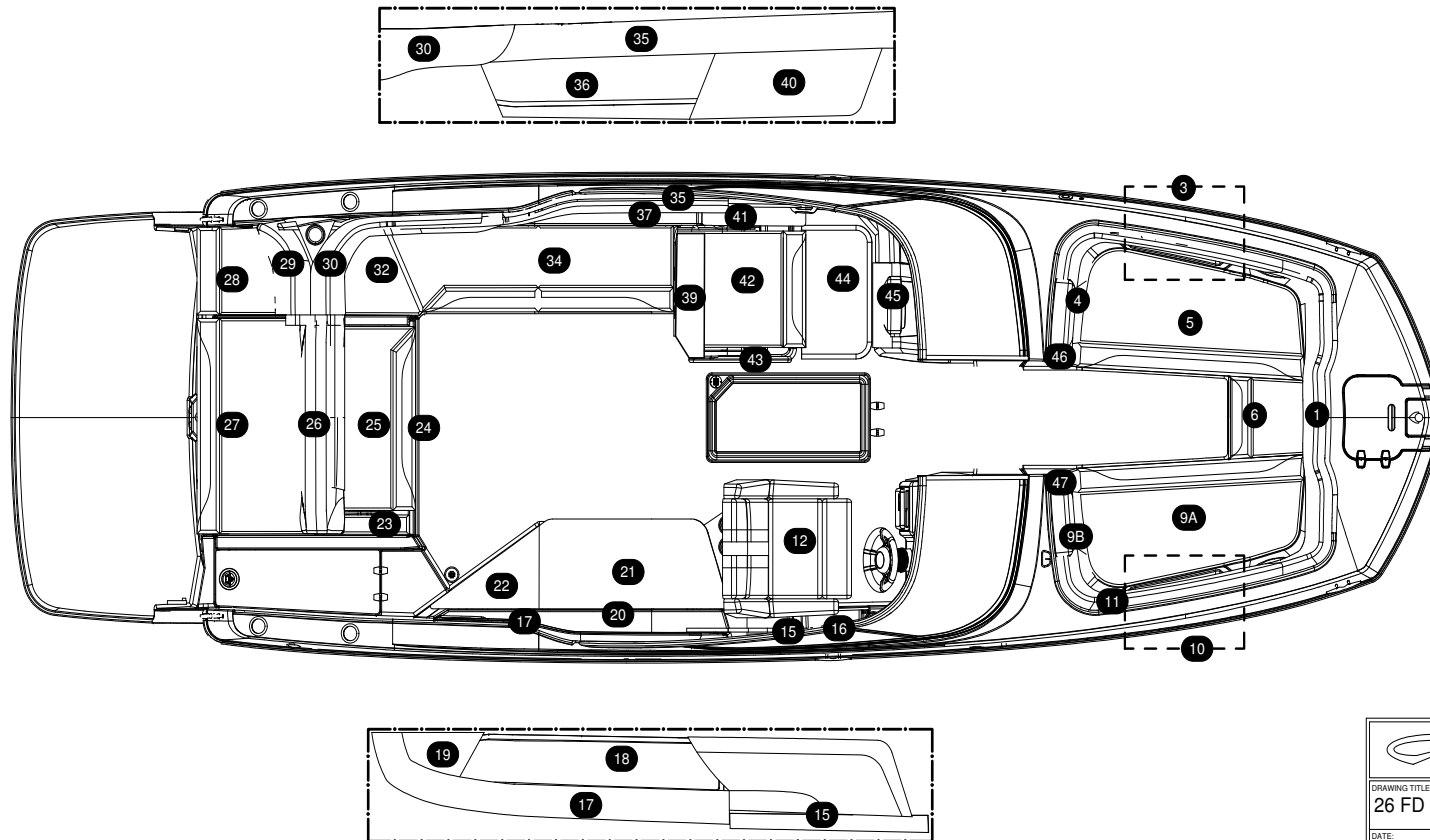

PROPRIETARY AND CONFIDENTIAL:
 THE INFORMATION CONTAINED IN THIS DRAWING IS THE SOLE PROPERTY OF REGAL MARINE INDUSTRIES. ANY REPRODUCTION IN PART OR AS WHOLE WITHOUT THE WRITTEN PERMISSION OF REGAL MARINE INDUSTRIES IS PROHIBITED.

 REGAL MARINE INDUSTRIES 2300 JETPORT DRIVE ORLANDO, FLORIDA 32809 TEL (407) 851-4360 ALL RIGHTS RESERVED		
DRAWING TITLE: 26 FD (MR), 26 OBX (MV) Upholstery Identifier		
DATE: 10/3/2016	REVISION: 0	PAGE: 1 OF 1
DRAWN BY: CVL	APPROVED BY: Ozzie S.	DWG. NO.: UMRMV25X

26 FASDECK-OBX UPHOLSTERY IDENTIFIER