

REGAL



OWNER'S MANUAL 3300 / 33 OBX

07/02/18

FUEL SYSTEMS

Boats manufactured for use in California for model year 2018 and after meet the California EVAP Emissions regulation for spark-ignition marine watercraft. Boats meeting this requirement will have a label affixed near the helm.

WARNING

Operating, servicing and maintaining a recreational marine vessel can expose you to chemicals including engine exhaust, carbon monoxide, phthalates, and lead, which are known to the State of California to cause cancer and birth defects or other reproductive harm. To minimize exposure, avoid breathing exhaust, service your vessel in a well-ventilated area and wear gloves or wash your hands frequently when servicing this vessel. For more information go to: www.P65warnings.ca.gov/marine.

The fuel system in this boat complies with U.S. EPA mandated evaporative emission standards at time of manufacture using certified components.

YOUR WARRANTY RIGHTS AND OBLIGATIONS

The California Air Resources Board and Regal Marine Industries Inc. are pleased to explain the evaporative emission control system warranty on your Model Year 2018 spark-ignition marine watercraft. In California, new spark ignition marine watercraft must be designed, built, and equipped to meet the State's stringent anti-smog standards. Regal Marine Industries must warrant the evaporative emission control system on your spark-ignition marine watercraft for the person listed below provided there has been no abuse, neglect or improper maintenance of your spark-ignition marine watercraft.

Your evaporative emission control system may include parts such as carburetors, fuel tanks, fuel lines, fuel caps, valves, canisters, filters, vapor hoses, clamps, connectors and other associated components.

MANUFACTURER'S WARRANTY COVERAGE

This evaporative emission control system is warranted for two years. If any evaporative emission-related part on your spark-ignition marine watercraft is defective, the part will be repaired by Regal Marine Industries, Inc.

OWNER'S MANUAL RESPONSIBILITIES

- As the spark-ignition marine watercraft owner, you are responsible for the performance of the required maintenance listed in your owner's manual. Regal Marine Industries, Inc. recommends that you retain all receipts covering maintenance on your spark-ignition marine watercraft, but Regal Marine Industries, Inc. cannot deny warranty solely on the lack of receipts.
- As the owner, you should be aware that Regal Marine Industries, Inc. may deny you warranty coverage of your spark-ignition marine watercraft or a part has failed due to abuse, neglect, or improper maintenance or unapproved modifications.
- You are responsible for presenting your spark-ignition marine watercraft to a Regal Marine Industries, Inc. distribution center or a service center as soon as the problem exists. The warranty repairs should be completed in a reasonable amount of time, not to exceed 30 days. If you have any questions regarding your warranty coverage, you should contact Regal Marine Industries, Inc. at 407-851-4360.



OUTBOARD INFORMATION

Icon	INT-9
Launch & Cruise Checklist	INT-17
Outboard Engine Basics	3-1
Starting	5-7

INTRODUCTION

General Information	INT-10
Vessel Information Sheet	INT-12
Float Plan	INT-13
Suggested Tools, Parts & Gear	INT-16
Launch & Cruise Checklist	INT-17
Regal Marine Industries, Inc. Limited Warranty	INT-22

SAFETY ON BOARD

Safety Labels	1-1
General Boating Safety	1-3
Required Safety Equipment	1-7
Fire Extinguishers	1-10
Visual Distress Signals	1-12
International Distress Signals	1-15
Sound Producing Devices	1-16
Radio Communications	1-16
Navigation Lights	1-16
Navigation Light Rules	1-17
Marine Sanitation Devices	1-18
Pollution Regulations	1-18

INT-4

Exhaust & Carbon Monoxide	1-22
Boating Under the Influence	1-27
Boating Accidents	1-29
Water Sports	1-31
Water Ski & Wakeboard Signals	1-34
Weather & Water Conditions	1-36

RULES OF THE ROAD

Navigation Rules Defined	2-1
Navigation Rules	2-2
Lateral Aids	2-8
Mid-Channel Markers	2-9
Regulatory Markers	2-9
Night Running	2-10
Bridge Clearance	2-11

ENGINE & CONTROLS

Outboard Engine Basics	3-1
Stern Drive Engine Basics	3-16
Switches	3-21
Remote Control	3-26
Instrumentation	3-29
Display Panel	3-35

SYSTEMS

Bilge/Drainage System	4-1
Fuel System	4-3
Electrical System	4-8
Fresh Water System	4-14
Steering System	4-17



Table Of Contents

VESSEL OPERATION

Getting Underway	5-1
Starting & Stopping	5-6
Steering	5-8
Fenders.....	5-9
Dock Line Basics.....	5-10
Docking	5-13
Trim Angle	5-17
Anchoring.....	5-22
Emergencies.....	5-26
First Aid.....	5-27
Hypothermia	5-28
Environmental Awareness ...	5-29

FEATURES

Introduction.....	6-1
-------------------	-----

COSMETIC CARE & MAINTENANCE

Cosmetic Care.....	7-1
Maintenance.....	7-12

TROUBLESHOOTING

Diagnostic Charts.....	8-1
------------------------	-----

STORAGE & WINTERIZATION

Decommissioning Checklist ...	9-2
Recommissioning Checklist...	9-5

GLOSSARY & INDEX

Glossary	10-1
Index	10-5



Dear Regal Owner,

I know I speak for everyone at Regal when I welcome you to the ever-growing family of Regal boat owners. You've chosen a craft that is recognized worldwide for its standard of excellence. Each step in construction has been carefully scrutinized to assure comfort, performance, reliability and safety for both your passengers and yourself.

Your boat is certified by the National Marine Manufacturers Association. It also complies with the applicable standards set by the United States Coast Guard and the American Boat and Yacht Council. Your Regal boat was built with the same attention to detail and quality of construction that we would expect in a boat we would purchase ourselves.

Whether you're a veteran boater or a newcomer, we strongly urge you to read this boat owner's manual thoroughly. Familiarize yourself with the various components of your boat, and heed the safety precautions noted herein.

If you have questions that are not covered in this manual, please consult your authorized Regal dealer for assistance or phone the Regal factory at 407-851-4360.

Thank you, and welcome to the "World of Regal!"

Duane Kuck

President



Mission Statement

With God's help

and a steadfast commitment to integrity,

we will develop a team

of exceptional people and relationships

to provide

exceptional customer satisfaction.



Introduction

Boating is becoming more popular every year. There are numerous types of recreational vessels on our waterways today involved in an every growing number of activities. Therefore, as a new boat owner it is of the highest priority to learn about general boating practices before operating your craft.

Your Regal dealer will answer many questions and provide valuable “hands on” information during the completion of the new boat delivery process. In addition, your dealer has received special factory training on the product line and his services should be employed to solve technical problems and periodic maintenance beyond the scope of this manual. Also, your Regal dealer carries a line of factory approved parts and accessories.

Your Regal dealer can provide information regarding national training organizations such as the U.S. Power Squadron and United States Coast Guard Auxiliary. Along with other organizations and literature, they can help build your “boating savvy” by developing the necessary skills and awareness to be a safe and component skipper. Your local library can also help in providing recommended boating literature such as Chapman Piloting (Seamanship & Boat Handling by Elbert S. Maloney).

Remember, the waterways can change from normal to abnormal conditions in a heartbeat. Knowing how to react quickly comes from experience and knowledge which can be gained through boating education.

Welcome aboard!



YOUR REGAL OWNER'S MANUAL

Your Regal owner's manual has been developed to assist you in operating your vessel with safety and pleasure. Be sure to read and become familiar with the contents before operating your craft. Your owner's manual has been divided into general chapters to assist you in becoming more knowledgeable with your Regal boat. This manual is not intended to be a complete source of boating maintenance, boat handling techniques, boating safety or seamanship. These skills require education and experience levels beyond this manual.

In keeping with its commitment to continued improvement, Regal notes that all drawings, specifications, models, standard and optional equipment referred to in this manual are subject to change without notice. *A portion of the equipment described may not be installed on your boat or the pictorials may not exactly match your components. Selected illustrations in this owner's manual may represent typical examples.*

Throughout this manual, the following icons are used to identify specific information.



Indicates information specific to a stern drive boat.



Indicates information specific to an outboard boat.



OWNER'S INFORMATION PACKET

Regal has provided an information pouch aboard the vessel. Read and become familiar with the materials. This packet contains valuable literature on your propulsion package, standard and optional equipment, systems and various care and cleaning instructions. Be sure to store the information pouch in a clean dry area for quick reference.



GENERAL INFORMATION

Hull Identification Number (HIN) ---

The United States Coast Guard has established a universal system of numerically identifying vessels by using a hull identification number or "HIN." This number identifies your Regal boat's model, hull number, month and year of manufacture. The HIN is found on your boat's starboard side, just below the rub rail in the transom area vertical surface. The HIN consists of 12 alpha or numeric characters.

It is recommended that you locate and write down the HIN for future reference. It can be especially useful when ordering parts from your Regal dealer. A second HIN number is found in a hidden location. This second HIN is useful to authorities if for example the boat is stolen and the original transom HIN is modified or eliminated.

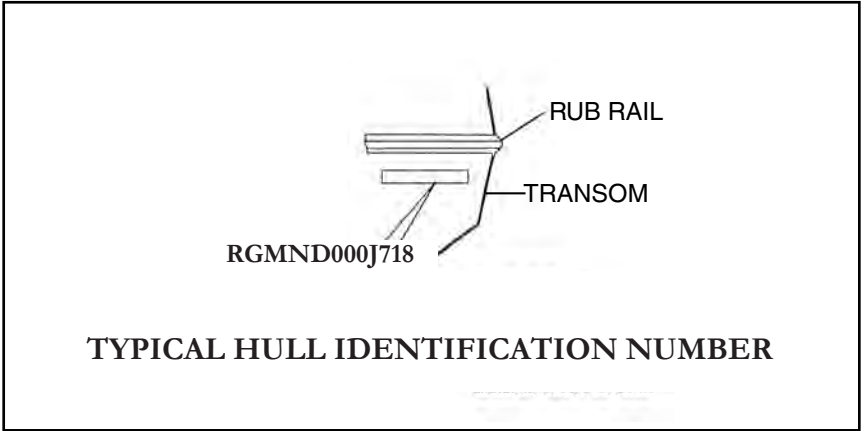

Vessel Information Sheet

It is recommended that you fill out the information on the following page. It will supply vital statistics on your vessel. Make a copy of the data for safe keeping at home.

Vessel Float Plan

Fill out a float plan before departing. Be sure to always leave it with a responsible person who will notify the United States Coast Guard or local law enforcement authorities if you do not return as planned. If you change your plans be sure to notify this person. Make copies of the float plan and use one each time you go boating. This will help people know where to find you should you not return on schedule. Do not file the float plan with the United States Coast Guard.



VESSEL INFORMATION SHEET

Owner: _____

Address: _____

City & State: _____

Home Phone: _____ Business Phone: _____

In Case Of Emergency Notify: _____

Address: _____

City: _____ State: _____

Phone: _____

Insurance Agent's Name: _____

Policy#: _____

USCG Phone: _____ Local Police: _____

Marina Phone: _____ Slip (Dock#): _____

Hull Serial #: RGM _____

Stern Drive

Port Engine Serial # _____ Key # _____

Starboard Engine Serial # _____ Key # _____

Port Stern Drive Serial # _____

Starboard Stern Drive Serial # _____

Outboard Drive

Port Outboard Serial # _____ Key # _____

Starboard Outboard Serial # _____ Key # _____

Key #: _____ Cabin Door: (If Applicable) _____

Selling Dealer: _____

Address: _____

City & State: _____

Phone: _____

Servicing Dealer: _____

Address: _____

City & State: _____

Phone: _____



FLOAT PLAN

Owner: _____

Address: _____

City & State: _____

Telephone #: _____

Cell Phone #: _____

Person Filing Report: _____

Name: _____

Home Telephone #: _____

Cell Phone #: _____

Make Of Boat: _____

Destination: _____

Registration #: _____

Leave From: _____

Length: _____

Time Left: _____

Boat Name: _____

Going To: _____

Gel Color: _____

Fuel Level: 1/4, 1/2, 3/4, F

Trim Color: _____

Stern Drive

Manufacturer _____ Color _____

Outboard

Manufacturer _____ Color _____

Hull I.D.#: _____

Return: _____

Fuel Capacity: _____



FLOAT PLAN (CONTINUED)

Est. Time of Arrival: _____

If not back by _____ o'clock call Coast Guard

Other Information: _____

Names Of People Aboard	Age	Address	Phone#
_____	_____	_____	_____
_____	_____	_____	_____
_____	_____	_____	_____

In addition to having the required equipment, carrying and knowing how to use the following equipment is recommended as an extra safety precaution, especially when operating in open water:

- Cell phone with waterproof case
- Mobile device power pack (battery)
- Solar USB charger
- Forward looking infrared (FLIR) night vision
- Handheld waterproof GPS
- Handheld waterproof VHF radio
- Handheld waterproof compass
- Handheld waterproof two-way radios
- Ditch kit
- Dry bag
- Survival suit
- Foul weather gear and thermal clothing
- Throw raft with oars
- Spare keys/fobs
- First aid kit and manual
- Emergency food and water
- Ring buoy
- Spare anchor and 150 ft (46 m) of 5/8" anchor line



FLOAT PLAN (CONTINUED)

- Sea anchor
- Heaving, mooring and towing lines
- Fenders and boat hook
- Waterproof flashlight, radio and spare batteries
- Mirror, whistle and strobe light
- Emergency Position Indicating Radio Beacon (EPIRB)
- Radar reflectors
- Sunscreen, insect repellent and sunglasses
- Navigational charts
- Binoculars
- Tool kit including propeller replacement tools
- Spare propellers and hardware, one for each right-hand and left-hand rotation
- Spare parts: pumps, belts, filters
- Bung plug
- Duct tape and electrical tape
- Engine oil
- Selection of fuses



SUGGESTED TOOLS, PARTS & GEAR

SUGGESTED TOOLS

Allen Wrenches
Jack Knife
Phillips Screwdriver Set
Slotted Screwdriver Set
Regular Pliers
Combination Wrench Set
Ratchet & Socket Set
Hammer
Wire Crimpers
Vise Grip Pliers
Floating Flashlight
Nut Driver Set
Oil Filter Wrench
Fuel Filter Wrench
Tape Rule

SPARE PARTS

Fuel Filter
Spark Plugs
Water Pump Belt
Propellers (Set)
Alternator Belt
Anti-Siphon Set
Propeller Nut & Hardware
Penetrating Oil
Extra Light Bulbs
Extra Batteries
Duct Tape
Electrical Tape, Connectors
Power Steering Fluid
Water Pump Impeller
Spare Keys On Floater

BASIC GEAR

Tie Lines
Mooring Lines
Dock Fenders
First Aid Kit
Boat Hook
Foul Weather Gear
VHF Radio, EPIRB, GPS, Cell Phone
Charts & Plotting Instruments
Emergency Water & Food
Bailer Or Hand Pump
Fire Extinguisher
Personal Flotation Devices
Anchor & Line
Life Raft



LAUNCH & CRUISE CHECKLIST

- √ Obtain a current weather report.
- √ Inspect the hull and propeller for damage.
- √ Check all electrical system switches for proper operation.
- √ Check operation of bilge blowers.
- √ If your boat has been in the water, run the bilge pump until the flow of water stops.
- √ If your boat has been out of the water, check to see that all bilge water has drained out. Install the drain plug.
- √ Check that all required safety equipment is on board and in good working condition.
- √ Check that all other equipment is on board such as mooring lines, first aid kit, tool kit and extra parts.
- √ **SD** Stern Drive
Open engine compartment. Inspect for fuel odors and visible leaks in the fuel, oil exhaust and power steering systems. Inspect all filters for leaks. Visually inspect engine for cracked hoses, defective belts, and loose fasteners such as bolts, nuts and hose clamps.
- √ **OB** Outboard
Inspect fuel components, hoses and hardware including all filters for fuel leaks.
- √ Check fuel level. Fuel tanks should be filled to near full capacity.



-
- √ Make sure all navigation charts, equipment and vessel registration paperwork are onboard.
 - √ Check operation of steering system, navigation lights and horn.
 - √ Make sure passengers and crew know how to operate safety equipment and react to an emergency.
 - √ File a float plan with a responsible party ashore.



Yacht Plate

At the helm area on Regal boats 26' and longer is located an NMMA yacht plate as shown below. This plate represents manufacturers who participate in the National Marine Manufacturer's Association yacht certification program. This program goes beyond the minimum USCG standards to ensure adherence to the American Boat & Yacht Council (ABYC) standards. NMMA approved inspectors are utilized to verify compliance to standards.

Note the yacht plate information below:

- The operator of the craft must read and understand the plate information before operating the vessel.



Safe Loading

NOTE: Overloading, improper loading and weight distribution are well documented causes of accidents. Provide for an extra margin of safety in rough sea conditions.

The vessel operator is responsible for his passengers. Explain to all passengers before the outing the importance of keeping the overall load balanced. Also, emphasize that passengers must remain seated while the vessel is in motion for the safety of the other passengers. Make sure that all passengers are positioned in their seats to afford clear visibility for the operator in all directions. Appoint passengers as “lookouts” for the operator and to signal before a dangerous situation develops.



Owner's Registration & Systems Checklist

Please note that your Regal boat requires the proper registration by your authorized Regal dealer. To initiate your warranty the dealer must complete the owner's registration form and systems checklist at the time of delivery. The owner must sign the paperwork to acknowledge that the dealer has reviewed the boat systems and warranty provisions with the owner. The owner should keep the original paperwork that features a temporary warranty registration. A Regal express limited warranty certificate containing all relevant boat and engine serial numbers will be sent after the factory receives the paperwork.

Dealer's Responsibility

Your boat has undergone rigid quality assurance inspections before leaving the factory. However, your dealer has been trained to perform final pre-delivery checks and to service your Regal boat prior to your pick-up. Your dealer's responsibilities include:

- ◆ A complete orientation in the operation of your Regal boat, including matters relating to the safe operation of your craft.
- ◆ Completion and mailing of your boat registration warranty form to Regal.
- ◆ Warranties, registration materials, owner's manual, operation, installation and maintenance instructions for all auxiliary equipment supplied with or installed on your Regal boat.



Owner's Responsibility

You are entitled to all the benefits and services outlined in your Regal boat warranty. However, you have certain responsibilities to ensure warranty satisfaction. These are:

- ◆ To read the warranty materials and understand them fully.
- ◆ To examine the boat in detail at the time of delivery.
- ◆ Apply the following: boating rules and regulations, safety equipment, environmental regulations, accident reports and warranty regulations terms and conditions.
- ◆ To read thoroughly all literature supplied with your boat, including this owner's manual and to follow the recommendations in the literature.
- ◆ To return the boat after the recommended hours of engine operation for the proper dealer service inspections.
- ◆ To provide proper maintenance and periodic servicing of your boat and equipment as set forth in the various manuals supplied.



REGAL MARINE INDUSTRIES, INC. LIMITED WARRANTY

Welcome to the Worldwide Family of Regal Owners! We are very pleased that you have chosen a Regal Powerboat!

This document is your Limited Warranty Registration Certificate and Statement of Limited Warranty. Please check the registration information section for accuracy. If this information is not correct or if you change your address at some future date, please notify us at the following address: Regal Marine Industries, Inc. Attention: Warranty Registrations, 2300 Jetport Drive, Orlando, Florida 32809; or e-mail customerservice@regalboats.com.

Please read the warranty carefully. It contains important information on Regal's claims procedures and your rights and obligations under this warranty.

WHAT IS COVERED: This Limited Warranty applies only to Regal boats beginning with model year 2017.

LIFETIME LIMITED STRUCTURAL DECK & HULL WARRANTY: Regal Marine Industries, Inc. warrants to the original retail purchaser of this boat if purchased from an authorized Regal dealer that the selling dealer or Regal will repair or replace the factory installed fiberglass if it is found to be structurally defective in material or workmanship for as long as the original retail purchaser owns the boat. For purposes of this Limited Warranty, the hull is defined as the single fiberglass casting which rests on the water. This Limited Warranty is subject to all limitations and conditions explained below.

FIVE-YEAR TRANSFERABLE LIMITED STRUCTURAL HULL WARRANTY: In addition to the Lifetime Limited Structural Hull Warranty, Regal offers a Transferable Five-Year Limited Structural Hull Warranty. Under the Five-Year Transferable Limited Structural Hull Warranty, Regal will repair or replace the fiberglass hull or deck if it is found to be structurally defective in material or workmanship within the first (5) years after the date of delivery to the original retail purchaser. Any remaining term of this Five-Year Limited Hull Warranty may be transferred to a second owner if within 60 days of purchase, the new owner registers the transfer with Regal and pays the established Limited Warranty transfer fee. Contact Regal Customer Service at the above address for details.

FIVE-YEAR LIMITED HULL BLISTER WARRANTY: Regal warrants that the Regal selling dealer or Regal will repair any underwater gelcoated surfaces of the hull against laminate blisters which occur as a result of defects in material or workmanship within (5) years of the date of delivery, provided that the original factory gelcoat surface has not been altered. Alternation would include but is not limited to damage repair; excessive sanding, scraping, sandblasting; or from improper surface preparation for application of a marine barrier coating or bottom paint, any of which shall void this Five-Year Limited Hull Blister Warranty. Proper preparation must be applied to the hull bottom if the boat is to be moored for periods in excess of (60) days. Regal Marine shall repair or cause to be repaired any covered laminate blisters based on the following prorated schedule. Less than three (3) years from delivery date - 100%, Three (3) to (4) years from delivery date - 50%, Four (4) to (5) years from delivery date - 25%.

Reimbursement shall be limited to one repair, not to exceed (\$100.00) dollars per foot of boat length prior to prorating. Regal's prior authorization for the method and cost of repair, must be obtained before repairs are commenced. All costs to transport the boat for repairs are the responsibility of the owner.



LIMITED GENERAL WARRANTY: In addition to above hull warranties, Regal warrants to the original purchaser of this boat if purchased from an authorized Regal dealer, that the authorized Regal dealer or Regal will repair or replace any parts found to be defective in materials or workmanship for a period of one (1) year from the date of delivery, subject to all exceptions, limitations and conditions contained herein.

LIMITED EXTERIOR FINISH WARRANTY: Regal warrants that the authorized Regal selling dealer or Regal will repair cosmetic defects in the exterior gelcoated finish including cracks, air voids or crazing for one year from the date of delivery, subject to all limitations and conditions contained herein. All warranty work is to be performed at a Regal dealership or other location authorized by a Regal Customer Service Manager after it is established to Regal's satisfaction that there is a defect in material or workmanship.

CUSTOMER OBLIGATIONS: The following are conditions precedent to the availability of any benefits under these limited warranties:

- (a) The purchaser, who is not Regal's sales agent and is otherwise not in any general or sales agency relationship with Regal, must sign and the authorized Regal selling dealer, must submit to Regal the "NEW BOAT DELIVERY and ACCEPTANCE CHECKLIST" within fifteen (15) days of the date of delivery and such information must be on file at Regal.
- (b) The purchaser must first notify the authorized Regal selling dealer from whom the boat was purchased of any claim under this Limited Warranty within the applicable Limited Warranty period and within a reasonable period of time (not to exceed thirty (30) days) after the defect is or should have been discovered.
- (c) Regal will not be responsible to repair any condition or replace any part, (1) if the use of the boat is continued after the defect is or should have been discovered; and (2) if such continued use causes other or additional damage to the boat or component parts of the boat.
- (d) Based on the authorized Regal selling dealer's knowledge of Regal's Limited Warranty policy and/or consultations with Regal, the dealer will accept the claim and arrange for appropriate repairs to be performed, or deny the claim if it is not within the Limited Warranty policy.
- (e) The authorized Regal selling dealer will contact the Regal boat owner regarding instructions for delivery of boat or part for covered warranty repair if it is covered by the Limited Warranty.

ALL COSTS TO OR FROM THE BOAT AND/OR TRANSPORT OF THE BOAT FOR REPAIRS ARE THE RESPONSIBILITY OF THE OWNER.

- (f) If the Regal boat owner believes a claim has been denied in error or the authorized Regal selling dealer has performed the warranty work in an unsatisfactory manner, the owner must notify Regal's Customer Service Department in writing at the address listed for further consideration. Regal will then review the claim and take appropriate follow-up action.
- (g) Before bringing any action, claim, lawsuit, or otherwise seeking relief against Regal based on any alleged breach of any of the Limited Warranties, terms or conditions herein, the Regal Boat owner must contact Regal's Customer Service Department Directly allow Regal, beyond those efforts made by its authorized Regal dealer, notice an opportunity to cure any alleged breach of any of the terms of any of the Limited Warranties.



WARRANTY EXCEPTIONS: THIS LIMITED WARRANTY does not cover, the following are not warranted are excluded from the terms of the Regal Limited Warranty and the following terms apply to any Regal Limited Warranty.

- (a) Engines, drives, controls, propellers, batteries, metal plating or finishes, windshield breakage, leakage, fading and deterioration of paints, canvas, vinyl, upholstery and fabrics;
- (b) Gelcoat surfaces including, but not limited to discoloration or blistering except as noted above;
- (c) Accessories and items which were not part of the boat when shipped from the Regal factory, or which carry their own individual warranty and/or any damage caused by such accessories or items;
- (d) Damage caused by one or more of the following: misuse, accident, corrosion, galvanic corrosion, negligence, lack of proper maintenance, or improper trailering;
- (e) Any boat used for racing, or used for rental or commercial purposes;
- (f) Any boat operated contrary to any instructions furnished by Regal, including instructions and guidance provided in the Regal Owner's Manual, or operated in violation of any federal, state, Coast Guard or other governmental agency laws, rules, or regulations;
- (g) The limited warranty is void if alterations have been made to the boat;
- (h) Transportation of boat or parts to and/or from the REGAL factory or service location;
- (i) Travel time or haul outs, loss of time or inconvenience;
- (j) Any published or announced catalog performance characteristics of speed, fuel and oil consumption, and static or dynamic transportation in the water;
- (k) Any boat that has been re-powered beyond Regal's power recommendations;
- (l) Boats damaged by accident and boats damaged while being loaded onto, transported upon or unloaded from trailers, cradles, or other devices used to place boats in water, remove boats from water or store or transport boats on or over land;
- (m) Any item repaired, replaced or modified under the terms of this warranty does not in any way prolong, extend or change any terms set forth in this limited warranty;
- (n) Water damage to, dry rot to, condensation to, or absorption by interior surfaces, wood structures or polyurethane foam; interior wood including, but not limited to mold, bleeding and/or discoloration as a result of condensation or moisture or water continually contacting the plywood causing staining to upholstery, carpet or other interior surfaces;
- (o) Costs or charges derived from inconvenience or loss of use, commercial or monetary loss due to time loss, and any other special, incidental or consequential damage of any kind or nature whatsoever;
- (p) Regal reserves the right to improve the design or manufacture process of Regal boats without obligation to modify previously produced product;

NO WAIVER OF THESE TERMS: The terms, conditions, limitations and disclaimers contained herein cannot be waived except by the Customer Service Manager of Regal. Any such waiver must be in writing. Neither the dealer, nor the customer, nor any service, sales and/or warranty representative of Regal is authorized to waive and/or modify these conditions, limitations and/or disclaimers.

EXCEPT AS SET FORTH HEREIN OR ON ANY OTHER WRITTEN EXPRESS LIMITED WARRANTIES BY REGAL, THERE ARE NO OTHER WARRANTIES EITHER EXPRESSED OR IMPLIED PROVIDED BY REGAL ON THIS BOAT. ALL OTHER WARRANTIES, EXPRESS OR IMPLIED, INCLUDING IMPLIED WARRANTIES OF FITNESS AND MERCHANTABILITY, ARE EXPRESSLY EXCLUDED. REGAL FURTHER DISCLAIMS ANY LIABILITY FOR ECONOMIC LOSS ARISING FROM CLAIMS OF PRODUCT FAILURE, NEGLIGENCE, DEFECTIVE DESIGN, MANUFACTURING DEFECT, FAILURE TO WARN AND/OR INSTRUCT, LACK OF SEAWORTHINESS, AND ANY OTHER THEORY OF LIABILITY NOT EXPRESSLY COVERED UNDER THE TERMS OF THIS LIMITED WARRANTY.



AS SET FORTH ABOVE, REGAL MAKES NO IMPLIED WARRANTY OF MERCHANTABILITY AND EXPRESSLY EXCLUDES ANY SUCH WARRANTY. TO THE EXTENT SUCH EXCLUSION IS NOT ALLOWED BY LAW OR AN IMPLIED WARRANTY OF MERCHANTABILITY IS ALLOWED BY LAW: (1) ANY IMPLIED WARRANTY OF MERCHANTABILITY THAT IS, AS A MATTER OF LAW, NOT PERMITTED TO BE EXCLUDED AS SET FORTH ABOVE, IS LIMITED TO ONE YEAR FROM THE DATE OF DELIVERY TO THE FIRST RETAIL OWNER; (2) NEITHER REGAL NOR ANY SELLING DEALER SHALL HAVE ANY RESPONSIBILITY FOR LOSS OR USE OF THE BOAT, LOSS OF TIME, INCONVENIENCE, COMMERCIAL LOSS, INCIDENTAL OR CONSEQUENTIAL DAMAGES. SOME STATES MAY NOT ALLOW EXCLUSIONS OF IMPLIED WARRANTIES OR LIMITATIONS ON HOW LONG ANY IMPLIED WARRANTY LASTS, SO THE ABOVE LIMITATION MAY NOT BE APPLICABLE. SOME STATES MAY NOT ALLOW THE EXCLUSION OR LIMITATION OF INCIDENTAL OR CONSEQUENTIAL DAMAGES, SO THE ABOVE LIMITATIONS OR EXCLUSIONS MAY NOT BE APPLICABLE IN THOSE STATES. THIS WARRANTY GIVES THE OWNER SPECIFIC LEGAL RIGHTS, AND THE OWNER MAY ALSO HAVE OTHER RIGHTS WHICH VARY FROM STATE TO STATE.

THE TERMS AND CONDITIONS CONTAINED HEREIN, AS WELL AS THOSE OF ANY DOCUMENTS PREPARED IN CONJUNCTION WITH THE SALE OF THIS VESSEL MAY NOT BE MODIFIED, ALTERED OR WAIVED BY ANY ACTION, INACTION OR REPRESENTATIONS, WHETHER ORAL OR IN WRITING, EXCEPT UPON THE EXPRESSED, WRITTEN AUTHORITY OF A MANAGEMENT LEVEL EMPLOYEE OF REGAL. Some states do not allow limitations on how long an implied warranty lasts, so the above limitation may not apply to you. Regal's obligation with respect to this warranty is limited to making repairs to or replacing the defective parts and no claim for breach of warranty shall be cause for cancellation or rescission of the contract or sale for any boat manufacturer by REGAL MARINE INDUSTRIES, INC.

Regal will discharge its obligations under this warranty as rapidly as possible, but cannot guarantee any specific completion date due to the different nature of claims which may be made and services which may be required. Regal reserves the right to change or improve the design of its boats without obligation to modify any boat previously manufactured. This limited warranty gives you specific legal rights, and you may also have other rights which may vary from state to state. Regal shall in no way be responsible for any repairs not PRE-AUTHORIZED by a Regal Customer Service Manager or repairs performed by a repair shop not PRE-AUTHORIZED by a Regal Customer Service Manager.

ARBITRATION OF DISPUTES AND WAIVER OF JURY TRIAL

EXCEPT AS SPECIFICALLY EXCLUDED IN THIS LIMITED WARRANTY, PURCHASER, REGAL AND AUTHORIZED REGAL DEALER AGREE TO SUBMIT ANY AND ALL CONTROVERSIES, CLAIMS OR DISPUTED ARISING OUT OF OR RELATING TO THE BOAT AND THIS LIMITED WARRANTY AND ALL OTHER AGREEMENTS EXECUTED BY PURCHASER RELATED TO THE BOAT TO BINDING ARBITRATION. IT IS THE EXPRESS INTENT OF PURCHASER, REGAL AND DEALER THAT THIS ARBITRATION PROVISION APPLIES TO ALL DISPUTES, INCLUDING CONTRACT DISPUTES, TORT CLAIMS, FRAUD CLAIMS AND FRAUD-IN-THE-INDUCEMENT CLAIMS, STATUTORY CLAIMS AND REGULATORY CLAIMS RELATING IN ANY MANNER TO THE BOAT AND THIS LIMITED WARRANTY.



IF ANY CONTROVERSY OR CLAIM DESCRIBED IN THIS ARBITRATION PROVISION IS DETERMINED FOR ANY REASON TO BE INELIGIBLE FOR ARBITRATION, AND FOR ANY CONTROVERSIES, CLAIMS, OR DISPUTES SPECIFICALLY EXEMPTED FROM ARBITRATION, THEN THOSE CONTROVERSIES, CLAIMS, OR DISPUTES SHALL INSTEAD BE DECIDED BY A JUDGE OF A COURT OF COMPETENT JURISDICTION, IN ORANGE COUNTY, FLORIDA, WITHOUT A JURY. PURCHASER, REGAL AND DEALER KNOWINGLY AND VOLUNTARILY WAIVE THE RIGHT TO A TRIAL BY JURY FOR ALL SUCH CONTROVERSIES, CLAIMS AND DISPUTES. PURCHASER, REGAL, AND DEALER UNDERSTAND THAT THERE SHALL BE NO JURY TRIAL, WHETHER THE CONTROVERSY OR CLAIM IS DECIDED BY ARBITRATION OR BY TRIAL BEFORE A JUDGE. NOTWITHSTANDING THE PROVISIONS OF THIS ARBITRATION AGREEMENT, WITH REGARD TO CONTROVERSIES AND/OR ENTITLEMENT TO POSSESSION OF EITHER THE BOAT OR ANY TRADE-IN, ANY PARTY HERETO MAY RESORT TO A JUDICIAL DETERMINATION (BY A JUDGE AND NOT A JURY). OF SUCH CONTROVERSIES, DISPUTES OR CLAIMS WITHOUT WAIVING ANY RIGHT TO DEMAND ARBITRATION WITH RESPECT TO ALL OTHER CONTROVERSIES, DISPUTES OR CLAIMS BETWEEN THE PARTIES A MORE SPECIFICALLY SET FORTH IN THIS ARBITRATION PROVISION.

ALL ARBITRATIONS SHALL PROCEED THROUGH THE AMERICAN ARBITRATION ASSOCIATION AND BE SUBJECT TO ITS COMMERCIAL ARBITRATION RULES, EXCEPT AS SET FORTH HEREIN. THE ARBITRATORS SHALL HAVE THE AUTHORITY TO AWARD ANY FORM OF RELIEF THAT COULD BE PROPERLY AWARDED IN A CIVIL ACTION IN THE STATE OF FLORIDA FOR THE TYPE OF CLAIMS PRESENTED, SUBJECT HOWEVER, TO ALL LIMITATIONS, PREDICATES, AND CONDITIONS COVERING SUCH REMEDIES OR RELIEF UNDER FLORIDA LAW.

THE PURCHASER, REGAL OR DEALER MAY DEMAND ARBITRATION OF A CLAIM BY FILING A WRITTEN DEMAND FOR ARBITRATION, ALONG WITH A STATEMENT OF THE MATTER IN CONTROVERSY WITH THE AMERICAN ARBITRATION ASSOCIATION, AND SIMULTANEOUSLY SERVING A COPY UPON THE OTHER PARTY. PURCHASER, REGAL AND DEALER AGREE THAT THE ARBITRATION PROCEEDING SHALL BE CONDUCTED IN ORANGE COUNTY, FLORIDA UNLESS OTHERWISE AGREED BY THE PARTIES. EACH PARTY AGREES TO BEAR THEIR OWN ATTORNEY FEES AND COSTS. THE FILING FEES AND ALL OTHER THIRD-PARTY COSTS FOR THE ARBITRATION, INCLUDING THE ARBITRATOR'S FEE SHALL BE PAID BY THE FILING PARTY INITIATING THE ARBITRATION. THE PREVAILING PARTY SHALL BE ENTITLED TO REIMBURSEMENT OF THEIR REASONABLE ATTORNEY FEES AND REASONABLE EXPENSES FROM THE NON-PREVAILING PARTY.

REGISTRATION INFORMATION:



Safety On Board

Safety awareness can't be over emphasized. Safety on board needs to be the skipper's number one priority. In this manual you will find many safety precautions and symbols to identify safety related items. Heed all safety precaution information. Remember, the skipper is responsible for the safety of his passengers and crew.

SAFETY LABELS

Safety Precaution Definition ---

Safety precautions are stated as caution, warning and danger signal words. They are highlighted in this manual by font design and symbol usage. Also, a notice heading is included which provides operation and maintenance information but is not hazard-related.

Become familiar and understand all safety precaution labels!



Note: This safety alert symbol appears with most safety statements. It means attention, become alert, your safety is involved! Please read and abide by the message that follows the safety alert symbol.



DANGER

Indicates a hazardous situation that, if not avoided, *will* result in death or serious injury.



CHAPTER 1

WARNING

Indicates a hazardous situation that, if not avoided, *could* result in death or serious injury.

CAUTION

Indicates a hazardous situation that, if not avoided, *could* result in minor or moderate injury.

NOTICE

Indicates a situation that can cause damage to equipment, personal property and/or the environment, or cause the equipment to operate improperly.

NOTE: Indicates a procedure, practice or condition that should be followed in order for the equipment to function in the manner intended.

Precautionary Labels ---

Read and understand all safety labels affixed to your Regal boat. Most of the safety labels are found close to the helm, aft cockpit and or swim platform. The location of the labels may vary by model and the label list does not cover everything! Use common sense to analyze the result of an action on board your vessel. **Always think safety first!**



NOTICE

All safety labels must be legible to alert personnel of safety hazards. Replace any illegible or missing labels immediately. Safety labels must be replaced in their original position. Keep harsh chemicals away from the safety labels, as harsh chemicals can cause damage to the safety label. Contact your Regal dealer for ordering replacement safety labels. Do not operate the boat if there are missing or badly worn safety labels.

GENERAL BOATING SAFETY

We understand that you are eager to get your Regal boat on the water. However, we strongly suggest that you thoroughly familiarize yourself and friends or members of your family with safe boating practices before setting out.

Remember, that along with the freedom and exhilaration of boating comes the responsibility that you have for the safety of your passengers and other boaters who share the water with you.

Boating regulations vary from state to state. Check with your local state and local authorities for the regulations pertaining to your area.

- Check with local weather stations, the U. S. Coast Guard, or weather station broadcasts for the latest conditions. Remember getting caught in severe weather is hazardous. Check weather conditions periodically while you are boating and before your outing. If you are forced to operate your boat in a storm condition, take common sense precautions; wear PFD's, store gear, reduce speed and head for safe refuge.
- It is best to avoid operating your boat in foggy weather. When fog sets in, take bearings, log courses and speeds. You are required to emit a five second blast from your horn or whistle once a minute. Also, have your passengers wear PFD's and look out for oncoming vessels.
- Operating in shallow water presents a number of hazards including



CHAPTER 1

sand bars and water levels influenced by tides. If the vessel strikes an underwater hazard, check for boat and engine damage. If the engine vibrates excessively after striking an underwater obstruction, it may indicate a damaged propeller. If you run aground, seek help by radio or flares.

- Make sure your boat and equipment are in top condition. Do this by frequently inspecting the hull, engine and gear.
- You must provide a Coast Guard approved personal flotation device (PFD) for every person on board. These PFD's should be in good condition and easily accessible.
- Insist that non-swimmers and children on board wear a PFD at all times. Any time you encounter rough weather conditions, make sure everyone on board is wearing a PFD, including yourself. Instruct your passengers in how to put on their PFDs and be sure they know their storage location on the boat. Remember, in an emergency, a PFD that cannot be quickly located and worn is useless.
- Never allow anyone to sit anywhere on the boat not specifically designed a seat. While underway, **ALWAYS** insist passengers remain seated.
- **Use maximum caution when fueling. Never** allow any smoke or flame nearby while you are fueling. **ALWAYS** check for fuel leaks and fumes when fueling is completed.



WARNING

Always operate the bilge blower (if installed) prior to starting the engines or generator. Gasoline vapors can explode, resulting in death or serious injury. Before starting the engines or generator, perform the following:

- Sniff the engine room for fuel vapors.
- Operate the bilge blower(s) for a minimum of 4 minutes.
- Verify the bilge blower(s) are operating properly.

Always run the bilge blower when the vessel is operating below cruising speed.



- **Never drink and drive!** As captain, you are responsible for the safety of your passengers and yourself. Alcohol and boating can be a dangerous combination. **DO NOT** mix them. Alcohol impairs the boat operator's ability to make conscious decisions and react to emergency situations quickly.

- **Never overload your boat!** An overloaded boat, or one with uneven weight distribution, can be difficult to steer.

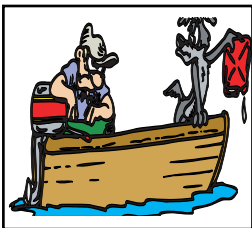

- **Be certain there is enough fuel aboard for your cruising needs.** Include any reserve that might be needed should you change your plans due to weather or emergency. **Practice the "one-third rule:** (Use one-third of your fuel going out, one-third to return and keep one-third as a reserve).
- Have up-to-date charts aboard. You will need current charts of the area you'll be cruising to stay on proper course. Charts can be obtained at your closest marine outlet or store or through the U.S. Government online bookstore.



CHAPTER 1

- **File a float plan.** Leave details of your trip with someone responsible who will be remaining on shore. Include expected return, plus name and phone number of a contact person in case of emergency.
- Use care, courtesy and common sense when launching, docking or operating your boat.
- Learn and obey the “Rules of the Road”. A copy of the “Rules of the Road” can be obtained from the U. S. Coast Guard Auxiliary or local Power Squadron organizations.
- In case of emergency: Know the international distress signals if you have a VHF radio aboard. The spoken word “**MAYDAY**” is the international signal of distress and is for emergency use only. Under no circumstances should this word be used, unless there is danger at hand.
- Posted speed limits, swimming areas, “no wake” zones and other restrictions should be red-flagged. They are so noted for a reason.

Sensible boat use plus courtesy fosters enjoyable and safe boating.

- It is your responsibility to stay abreast of all federal, state and local rules, as some laws or regulations may change or be different from state to state. Contact your local boating agencies for updated information.
- We can not stress safety enough! Remember, there are no brakes on your boat, and the water current and wind velocity all affect your ability to respond. The driver must use caution at all times to maintain control of his vessel and especially to maintain a safe distance from other boats and obstacles.
- Always keep all safety gear in optimum condition. Pay special attention to attached tags and plates indicating expiration dates on equipment such as fire extinguishers, life jackets, EPIRBs, etc. Establish a periodic maintenance check on all safety equipment. Contact your Regal dealer or marine professional for more information.



REQUIRED SAFETY EQUIPMENT

Personal Flotation Devices



All personal flotation devices (PFD's) must be Coast Guard approved, in good working condition, and must be the correct size for the wearer. All PFD's must be readily accessible. This means being able to wear them in a reasonable amount of time in

case of an emergency (fire, boat sinking, etc.). They should not be stored or locked in closed areas. Also, make sure that all coverings are removed, such as plastic from any PFD's. Throwable devices such as a ring buoys need to be available for immediate deployment. A PFD should be worn at all times when your boat is operating on the water. A PFD may save your life, but it must be worn to do so.

As minimum U. S. Coast Guard requirements all recreational boats must carry one type I, II, III, or V PFD (wearable) for each person aboard. See the explanation following for each type. For type V to be counted they must be used according to the label instructions. In addition, all boats over 16' must carry one Type IV (throwable) PFD.

Some states require that PFD's be worn by children of specific ages at all times. Check with state boating agencies for particular requirements in your state before taking children on the water.

Remember PFD's will not necessarily keep you from drowning, even though they are designed to keep a person from sinking. When purchasing PFD's make sure it safely fits the person wearing it. It is a good idea to test PFD's in a shallow pool then take to the water.



CHAPTER 1

Refer to the *USCG minimum equipment requirements on Page 1-20*. It is meant to be a guide only. Contact state and local agencies for additional equipment requirements. Remember as the captain of your vessel you are responsible for its safe operation.

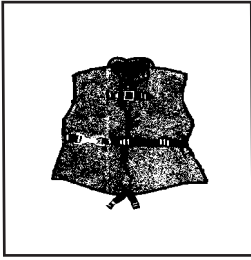

- **TYPE I-** Also known as an offshore jacket, it provides the most buoyancy. It is a PFD for all waters and is especially useful in rough waters where rescue may encompass additional time. It is designed to turn most unconscious users in the water to a face-up position. Type I PFD is available in adult and child sizes.

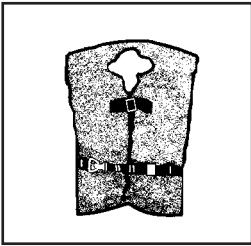

- **TYPE II-** Also known as near-shore buoyant vest, it is recommended for calm, inland water where rescue time will be minimal. It will turn some unconscious people face-up in the water but not as numerous as Type I. They are available in adult, medium child, along with infant and small child sizes.

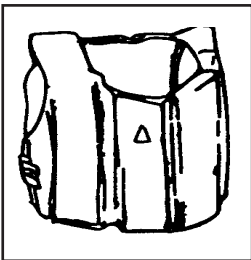

- **TYPE III-** Known as a flotation aid it is good for calm, inland water or where there is a chance for quick rescue. It is designed so wearers can place themselves in a face-up position in the water. The wearer may have to tilt their head back to avoid turning facedown in the water.

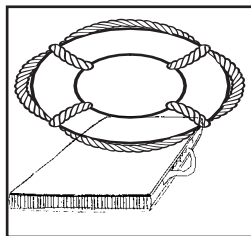

- **TYPE IV-** Intended for calm, inland water with heavy vessel traffic, where help is constantly present. It is designed to be thrown into the water for someone to grab on to and held until rescued. It should not be worn. Type IV includes ring buoys, buoyant cushions, and horseshoe buoys.

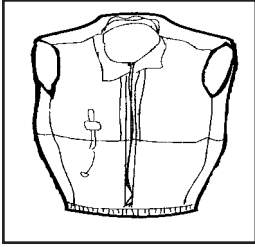

- **TYPE V-** This is the least bulky of all PFD's. It contains a small amount of inherent buoyancy, and an inflatable chamber. It is rated even to a Type I, II, or III PFD (as noted on the jacket label) when inflated. Hybrid PFD's must be worn to be acceptable equipment.

Maintaining your PFD's

A PFD is only useful if it's well maintained. Always be aware of PFD age since it has a life expectancy like any other piece of equipment.

- √ Do a periodic operation check of all PFD's in shallow water.
- √ Be sure to air dry all PFD's after each use. Store in a dry, easily accessible location.
- √ Check periodically for broken zippers, frayed webbing, water soaked kapok bags, missing straps, and sewing that is undone.
- √ Clean each PFD with mild soap and water only. Let dry sufficiently before storing.
- √ Keep PFD's out of grease and oil since they can deteriorate the jacket inner and outer materials.
- √ Check any kapok-bagged jackets by squeezing. If jacket loses air the bag is defective and the PFD should be thrown away.
- √ Grab the cover with the fingers. If the cover material rips, the PFD is rotted and should be thrown away.
- √ If the kapok bag is hard the PFD should be discarded.



CHAPTER 1

FIRE EXTINGUISHERS

General Information

Fire extinguishers are classified by a letter and numeric symbol. The letter references the type of fire the unit is designed to extinguish.

For example, type B extinguishers commonly used on boats are designed to put out flammable liquids such as grease, oil and gasoline.

The number indicates the general size of the extinguisher and minimum extinguishing agent weight.

Boat fires are dangerous, particularly on the water. Regal recommends carrying more than the minimum for the safety of you and your family.

FIRE EXTINGUISHER CONTENTS				
CLASS	FOAM IN GALS.	CO2 IN LBS.	DRY CHEM. IN LBS.	HALON IN LBS.
B-I	1.25	4	2	2.5
B-II	2.5	15	10	10

MINIMUM PORTABLE FIRE EXTINGUISHERS REQUIRED		
VESSEL LENGTH	NO FIXED SYSTEM	WITH FIXED SYSTEM
LESS THAN 26' 26' TO LESS THAN 40' 40' TO 65'	1 B-1 2 B-1 OR 1 B-II 3 B-1 OR 1 B-II	0 1 B-1 2 B-1 AND 1 B-1 OR 1 B-II



U. S. Coast Guard approved fire extinguishers are required on all boats. Besides the minimum Coast Guard requirements always check state and local agencies for additional requirements and equipment.

Coast Guard approved extinguishers are hand-portable, either B-I or B-II classification.

U. S. Coast Guard approved hand-portable and semi-portable extinguishers contain a metal plate that shows the manufacturer's name and extinguisher type, capacity and operating instructions. They have a special marine type mounting bracket which keeps the extinguisher solidly mounted until needed. The extinguisher needs to be mounted in a readily accessible location but one out of being bumped by people while underway. All approved extinguishers need to have an indication gauge.

USCG-Approved Fire Extinguisher Types & Features



The dry chemical agent is widely used because of its convenience and low cost. The extinguisher canister is filled with a white dry chemical powder along with a pressurized gas. It is a good idea to shake this type periodically because they tend to “pack” on the canister bottom.



The foam type uses a chemical foaming agent plus water and is best when used for fires involving flammable liquids- solvents, gasoline, oil, grease and various paints. It will work on fires involving rubber, plastics, cloth, wood, and paper. It leaves a messy residue. Not for electric fires.



CHAPTER 1



The carbon dioxide unit uses CO₂ gas under high pressure, with a funnel discharge hose usually swivel mounted. This extinguisher leaves no residue and does not cause interior engine harm. To ensure workability, weigh the unit annually. A 10% max. wt. variance is allowed.

Another type of liquefied gas is used today in automatic fire extinguishing systems which is used on select models. The canister gas is colorless and odorless, heavier than air and sinks to the lower bilge to extinguish fires. Since the year 2000 ingredients for fire extinguishers have changed to a more environmental friendly formula. The canister needs to be weighed once a year. Automatic fire extinguishing systems feature a dash mount status indicator.

VISUAL DISTRESS SIGNALS

All vessels used on coastal waters, any of the Great Lakes, territorial seas, and those waters connected directly to them, up to point where a body of water is less than two miles wide, must have U.S. Coast Guard approved visual distress signals.

Pyrotechnic Devices

Pyrotechnic visual distress signals must be ready for service and must be readily accessible. They all display a marking which is the service life, which must not have expired. A minimum of 3 devices are required for day and 3 devices for night.



Some devices meet both day and night requirements. Pyrotechnic devices should be stored in a cool, dry location. Most of these devices can be purchased in an highly visible (orange) watertight container. Types of Coast Guard approved pyrotechnic distress signals and associated devices are:

- Pyrotechnic red flares, hand-held or aerial type.
- Pyrotechnic orange smoke, hand-held or floating type.
- Launchers for parachute flares or aerial red meteors.

All in all, each distress signal has certain pros and cons. There is no distress signal that is best under all situations. Pyrotechnics are recognized worldwide as superior distress signals. A downfall is they emit a very hot flame that can cause burns and or ignite flammable materials. Pistol launched and hand-held parachute flares operate consistent with firearms and therefore must be carefully handled. Check with local and state regulations since some of these device are considered firearms and are prohibited.

Non-Pyrotechnic Devices

Non-pyrotechnic devices must all be in serviceable condition, readily accessible, and must be certified by the manufacturer to comply with Coast Guard standards. They include:

- Orange distress flag
- Electric distress flag
- U.S. Coast Guard approved handheld strobe

The distress flag is for day use only. It must be 3 x 3 or larger with a black square and ball on an orange background. It can be spotted when attached to a boat hook, long fishing rod, or paddle with the person waving the flag back and forth overhead.



CHAPTER 1

The electric distress flag is for night use only flashing the international SOS distress signal (... _ _ _ ...).

Under Inland Navigation Rules, a high intensity white light that flashes at regular intervals from 50-70 times per minute is considered a distress signal.

Remember that regulations prohibit the display of visual distress signals on the water under any circumstances except when assistance is required to prevent immediate or potential danger to passengers on a vessel.



INTERNATIONAL DISTRESS SIGNALS



BLACK SQUARE
AND BALL ON
ORANGE
BACKGROUND



CODE FLAGS
NOVEMBER AND
CHARLIE



SQUARE
FLAG AND
BALL



PERSON
WAVING
ARMS



MORSE
CODE
S.O.S.



"MAYDAY"
BY
RADIO



ENSIGN
UPSIDE
DOWN



PARACHUTE
RED
FLAG



RED METEOR
FLARES



SMOKE



FOG HORN
SOUNDED
CONTINUOUSLY



GUN FIRED
AT 1-MINUTE
INTERVALS

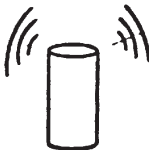

POSITION
INDICATING
RADIO BEACON



DYE MARKER
(ANY COLOR)



HAND-HELD
FLARE



CHAPTER 1

SOUND PRODUCING DEVICES

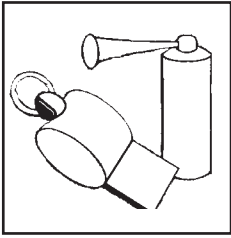

According to both Inland and International Rules, all boats **must** carry some way of producing an efficient sound signal. If your vessel is 12 meters (39' 4") or longer, a power whistle, power horn or bell must be carried. The bell must be 7 7/8" in diameter.

Boats less than 12 meters a horn or whistle is **recommended** to signal intentions or signal position. The sound signal made in all cases must be capable of a four or six second blast audible for one half mile. See the *section discussing bridge and whistle signals on Page 2-4* for more information.

RADIO COMMUNICATIONS

VHF radios are used for distress and ship to shore and ship to ship communications today. Learn the specialized messages such as

Mayday, Mayday, Mayday is only used when life or vessel is in imminent danger.

NAVIGATION LIGHTS

The U. S. Coast Guard requires recreational boats operating at night to display navigation lights between sunset and sunrise. Navigation lights help avoid collisions by improving the night visibility of vessels. Red and green directional lights, white stern lights, white masthead lights and white all-around lights must be displayed in specified positions, depending on boat size, and mode of operation. The configuration of visible lights tells and operator the size, direction of travel and means of propulsion (sail, power, rowing or at anchor) of another vessel. Larger boats are required to carry larger, brighter lights that are visible over longer distances.



NAVIGATION LIGHT RULES

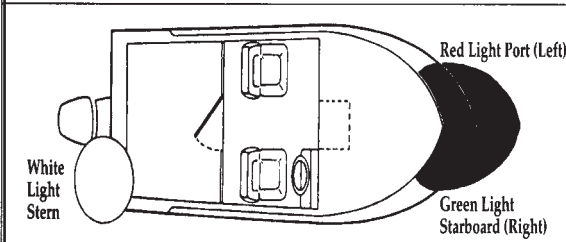

Location of lights on vessel	Visible Range		Degrees of arc lights
	Less than 12 m.	12 m. but less than 20 m.	
Masthead	2	3	225°
All-round	2	2	360°
Side lights	1	2	112.5° each color
Stern light	2	2	135°

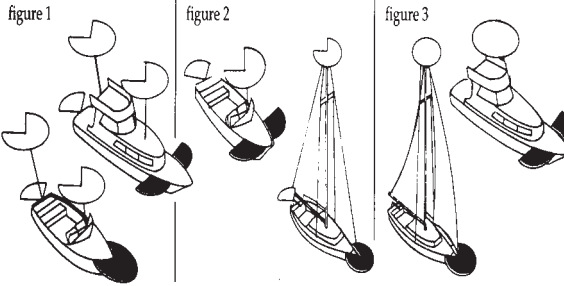

Boats less than 12 meters in length
Motorboats or sailboats using power: The lighting arrangements to figure 1, 2 or 3 may be used.

Sailboat using sails alone: The lighting arrangements in figure 4, 5 or 6 may be used.

Boats 12 meters but less than 20 meters in length

Motorboats or sailboats using power: The lighting arrangements to figure 1 or 2 may be used.

Sailboat using sails alone: The lighting arrangements in figure 4, 5 or 6 may be used.

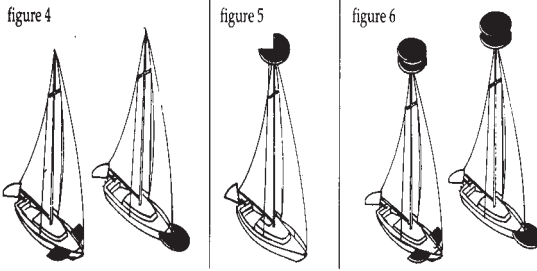

Location of lights

Lights should be located as shown in the drawings.

The masthead light (forward white light in figures 1, 2 and 7d) must be at least one meter higher than the colored lights on a boat less than 12 meters in length and at least 2.5 meters above the gunwale on a boat 12 meters but less than 20 meters in length.

Exceptions

Motorboat or sailboat using power, built before December 24, 1980: The lighting arrangement in figure 1, 2 or 3 may be used. However, the arrangement in figure 3 is not acceptable on a boat that is 12 meters or longer on international waters.

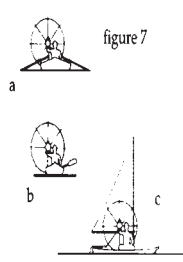

Row Boats or Paddle Boats
 One all-round white light ready to display in time to prevent a collision (figure 7a or b).

Great Lakes

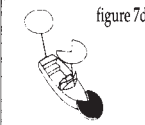

Motorboat or sailboat using power on Great Lakes: The lighting arrangements in figure 7d may be used instead of the arrangements in figures 1 and 2.



CHAPTER 1

MARINE SANITATION DEVICES

Recreational vessels under 65' with installed toilet facilities must have an operable marine sanitation device (MSD) on board. Vessels 65' and under may use Type I, II, or III MSD. All installed MSD's must be U.S. Coast Guard certified. The sanitation devices as used are labeled to show conformity to the regulations.

POLLUTION REGULATIONS

The Federal Water Pollution Control Act prohibits the discharge of oil or hazardous substances which may be harmful into U. S. navigable waters. *Vessels 26' and over* must display a placard at least 5" x 8", made of durable material, fixed in a conspicuous machinery space location.

You must immediately notify the U. S. Coast Guard if your vessel discharges oil or hazardous substances in the water. Report the following information: location, source, size, color, substances and time observed.

NOTICE

DISCHARGE OF OIL PROHIBITED

THE FEDERAL WATER POLLUTION CONTROL ACT PROHIBITS THE DISCHARGE OF OIL OR OILY WASTE INTO OR UPON THE NAVIGABLE WATERS OF THE UNITED STATES, OR THE WATERS OF THE CONTIGUOUS ZONE, OR WHICH MAY AFFECT NATURAL RESOURCES BELONGING TO, APPERTAINING TO, OR UNDER THE EXCLUSIVE MANAGEMENT AUTHORITY OF THE UNITED STATES, IF SUCH DISCHARGE CAUSES A FILM OR DISCOLORATION OF THE SURFACE OF THE WATER OR CAUSES A SLUDGE OR EMULSION BENEATH THE SURFACE OF THE WATER. VIOLATORS ARE SUBJECT TO SUBSTANTIAL CIVIL PENALTIES AND/OR CRIMINAL SANCTIONS INCLUDING FINES AND IMPRISONMENT.



Garbage

The Act to Prevent Pollution from Ships places limitations on the discharge of garbage from vessels. It is illegal to dump plastic trash anywhere in the ocean or navigable waters of the United States. Also, it is illegal to discharge garbage in the navigable waters of the United States, including the Great Lakes. The discharge of other types of garbage is allowed outside certain specified distances from shore as determined by the nature of that garbage.

THE DISCHARGE OF PLASTIC OR GARBAGE WITH PLASTIC INTO ANY WATERS IS PROHIBITED. THE DISCHARGE OF ALL GARBAGE IS PROHIBITED IN THE NAVIGABLE WATERS OF THE UNITED STATES AND IN ALL OTHER WATERS, WITHIN THREE NAUTICAL MILES OF THE NEAREST LAND.		
THE DISCHARGE OF DUNNAGE, LINING, AND PACKING MATERIALS THAT FLOAT IS PROHIBITED WITHIN 25 NAUTICAL MILES FROM THE NEAREST LAND.	OTHER UNGROUND GARBAGE MAY BE DISCHARGED BEYOND 12 NAUTICAL MILES FROM THE NEAREST LAND.	OTHER GARBAGE GROUND TO LESS THAN ONE INCH MAY BE DISCHARGED BEYOND THREE NAUTICAL MILES FROM THE NEAREST LAND.
A PERSON WHO VIOLATES THE ABOVE REQUIREMENTS IS LIABLE FOR A CIVIL PENALTY OF UP TO \$25,000, A FINE OF UP TO \$50,000, AND IMPRISONMENT FOR UP TO FIVE YEARS FOR EACH VIOLATION. REGIONAL, STATE, AND LOCAL RESTRICTIONS ON GARBAGE DISCHARGES MAY ALSO APPLY.		



CHAPTER 1

USCG Minimum Equipment Requirements for Recreational Vessels

Boat Size in Feet	16'	26'	40'	65'	165'
Personal Flotation Devices¹	One Type I, II, III, or V per person		One Type I, II, III, or V per person plus one Type IV throwable		
Fire Extinguishers²	One B-I, any type	One B-II or Two B-I	One B-II and one B-I, or three B-I	One B-II and one B-I, or three B-I	One or more B-II (vessels 0-50 tons gross) Two or more B-II (vessels 50-100 tons gross)
No Fixed System			One B-I	Two B-I or one Class B-II	
With Fixed System	No Portables Required				
Visual Distress Signals	Night signals required when operating at night		Minimum of three day-use and three night-use (or three day/night combination) pyrotechnic devices ⁵		
Sound Producing Devices	Horn or whistle recommended to signal intentions or signal position		One bell, and one whistle or horn required to signal intentions or position		
Backfire Flame Arrestor	One CG-approved device on each carburetor of all gasoline-powered engines built after April 1940, except outboard motors				
Ventilation					
Navigation Lights	CG standard system required on gasoline powered vessels with enclosed engine compartments built after August 1980				
Under Power ^{3,4}			Sidelights, Stern Light and Masthead ^{6,7}		
Under Sail			Sidelights and Stern Light ^{6,8}		
Rowing			Same as "Under Sail"		
At Anchor			All-round light, 2nm (at night) or black anchoring ball (during the day) when outside a designated anchorage		
Visibility Range	1nm Sidelights, 2nm all others		3nm Masthead, 2nm all others	5nm Masthead, 2nm all others	
Pollution Regulations	"Honor system" (no plaques required)		5" x 8" Oil Discharge placard and 4" x 9" Waste Discharge placard		
Marine Sanitation			Vessels over 40' with a galley must have a Waste Management Plan		
Devices	Vessels with installed toilet facilities must have an operable,		Type II or III MSD only		
Navigation Rules	CG-certified Type I, II or III Marine Sanitation Device (MSD). Subject to local laws!				
	Familiarity with the Inland Navigation Rules required				The Inland Navigation Rules ("Rules of the Road") must be kept on board

1. PFD's must be CG approved, wearable by the intended user and readily accessible.
2. Fire extinguishers required on boats with enclosed engine compartments (not outboards).
3. Sailboats operating under engine power are considered power driven and must follow the "Under Power" rules. During the day, motorsailing vessels are required to fly a motoring cone.
4. Power-driven vessels under 23' and under 7 knots can substitute a white lantern or torch in place of the required lights.
5. Non-pyrotechnic substitutes: 1 orange distress flag (day-use) and 1 electric SOS signal light (night-use).
6. All boats under 65' can substitute a single bi-color light for sidelights.
7. Boats under power under 40' can substitute a single all-round light for separate stern and masthead lights.
8. Boats under sail under 40' can substitute a tri-color light for separate sidelights and stern light.

Additions to these requirements are prescribed by some individual state laws. Check your state's Boating Safety Handbook for a complete list.



Communications

EPIRB

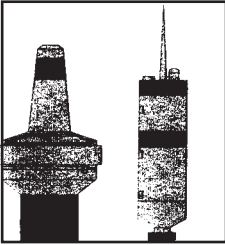

It is a good idea to carry communication gear such as a VHF-FM and/or HF transceivers set up for your operating area. Also, cell phones are useful in many coastal areas. Be sure to carry extra batteries. Also, mainly for offshore vessels, EPIRB's are designed to quickly and accurately alert rescue forces, indicate an accurate distress position, and guide units to the distress scene.

These devices operate from satellite signals sent to a ground station where the signal is downloaded. The downside is that they are relatively expensive but they are reliable even when other communications have been exhausted.

Life Rafts

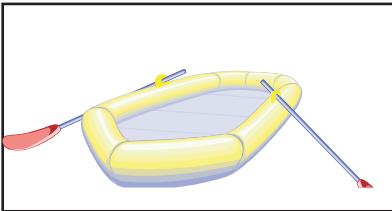

Inflatable life rafts are recommended for oceangoing and operating a vessel in a large body of water like the Great Lakes. They provide a shelter for extended periods. If used, make sure it is large enough for all aboard and contains the

proper emergency equipment pack. Periodically find a professional to service the life raft. Store it on board in an area safe from sharp objects. Make sure the life raft is Coast Guard approved.

Remember the U. S. Coast Guard requirements are minimal standards. They are an excellent starting point. Check with local and state boating agencies for further required safety equipment. You are best prepared for emergencies by a well equipped vessel. Don't skimp when purchasing equipment for your boat!



CHAPTER 1

EXHAUST & CARBON MONOXIDE

Carbon monoxide (CO) in exhaust can be hazardous. It is important for you and your passengers to be aware of the potential safety hazard created by exhaust gases. Familiarize yourself with the symptoms of carbon monoxide poisoning.

For safety sake avoid the following:

1. Do not allow the boat to remain stationary with the engine idling for an extended period of time.
2. Do not disable the carbon monoxide alarms that come with your Regal boat. Test the unit in accordance with the alarm manufacturers instructions.
3. Do not operate the engine for extended periods of time while in a confined area or where exhaust outlets face a wall or bulkhead.
4. Do not operate the engine for an extended period of time with the canvas in the upright and installed position.
5. Have the engine exhaust system inspected when the boat is in for service.
6. Persons sleeping can easily be overcome by carbon monoxide without realizing it. Do not sleep on board while the engine is running or a neighboring boats engine is running.



WARNING

Always shut the engines off when people are in the water around the boat. Carbon monoxide may be present. Operating the engines while people are in the water around the boat may cause CO poisoning or propeller strike, resulting in death or serious injury.

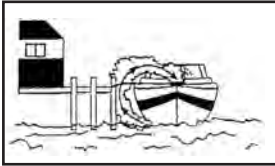

Blockage of exhaust outlets can cause carbon monoxide to accumulate in the cabin and cockpit area even when the hatches, windows, portholes and doors are open.

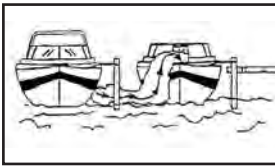

Exhaust from another vessel alongside your boat, while docked or anchored, can emit poisonous CO gas inside the cabin and cockpit areas of your boat.

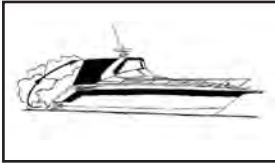

The “station wagon effect” or backdrafting can cause CO gas to accumulate inside the cabin, cockpit or bridge areas when the boat is under-way, using protective weather coverings, high bow angle, improper or heavy loading, slow speeds, or when boat is at rest.



CHAPTER 1

Typical Carbon Monoxide Label At Helm

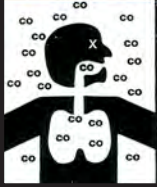
⚠ WARNING	
	<p>Carbon monoxide (CO) can cause brain damage or death.</p> <p>Engine and generator exhaust contains odorless and colorless carbon monoxide gas.</p> <p>Signs of carbon monoxide poisoning include nausea, headache, dizziness, drowsiness, and lack of consciousness.</p> <p>Get fresh air if anyone shows signs of carbon monoxide poisoning.</p> <p>See Owner's Manual for information regarding carbon monoxide poisoning.</p>

Typical Carbon Monoxide Label At Transom

⚠ DANGER	
	<p>Carbon monoxide (CO) can cause brain damage or death.</p> <p>Engine and generator exhaust contains odorless and colorless carbon monoxide gas.</p> <p>Carbon monoxide will be around the back of the boat when engines or generators are running.</p> <p>Move to fresh air, if you feel nausea, headache, dizziness, or drowsiness.</p> <p><small>NW-206-05</small></p>

Typical Carbon Monoxide Label In Cabin/Head

⚠ WARNING	
	<p>Carbon monoxide (CO) can cause brain damage or death.</p> <p>Carbon monoxide can be present in the cabin.</p> <p>Signs of carbon monoxide poisoning include nausea, headache, dizziness, drowsiness, and lack of consciousness.</p> <p>Get fresh air if anyone shows signs of carbon monoxide poisoning.</p> <p>Get fresh air if carbon monoxide detector alarm sounds.</p> <p>Carbon monoxide detector must be functioning at all times.</p>

In high concentrations, CO can be fatal in minutes. However, lower concentrations over an extended period of time can be just as lethal.



Safety On Board

Symptoms of excessive exposure to carbon monoxide are:

- Dizziness
- Drowsiness
- Nausea
- Headache
- Ringing in the ears
- Throbbing temples
- Watery, itchy eyes
- Flushed appearance
- Inattentiveness
- Incoherence
- Fatigue or vomiting
- Convulsions

Carbon monoxide accumulation requires immediate attention! Thoroughly ventilate cabin and cockpit areas. Determine the probable source of the carbon monoxide and correct the condition immediately. Regal has installed CO detectors on your boat. Have these detectors professionally calibrated at regular intervals.



**DESIRED AIR FLOW
THROUGH BOAT**

To help prevent carbon monoxide accumulation, ventilate your cabin and cockpit while underway. Open a forward hatch, porthole or window to allow air to travel through the boat's interior. See the illustration below for desired air flow.



CHAPTER 1

SD

Each Trip

- ☑ Make sure all exhaust clamps are in place and secure.
- ☑ Look for exhaust leaking from the exhaust system components, indicated by rust and or black streaking, water leaks, or corroded or cracked fittings.
- ☑ Inspect all rubber exhaust hoses for burned or cracked areas. All rubber hoses should feel soft and be free of kinks.
- ☑ Visually verify that water exits at the engine exhaust outlet.
- ☑ Keep an ear tuned for any change in exhaust sound that could indicate an exhaust component malfunction.

DO NOT OPERATE THE VESSEL IF ANY OF THE ABOVE ITEMS EXIST; CONTACT A MARINE PROFESSIONAL!

At Least Annually (To be performed by a marine professional)

- ☑ Replace exhaust hoses or mufflers if any evidence of cracking, charring or deterioration is found.
- ☑ Replace the engine water pump impeller along with the plate and housing if necessary. This will help prevent cooling system and in turn exhaust system overheating.
- ☑ Inspect each of the metallic exhaust components for cracking, rusting, leaking or looseness. Pay detailed attention to the exhaust manifold, cylinder head and water injection elbows. Make sure all exhaust clamps are in place and secure.



BOATING UNDER THE INFLUENCE

WARNING

Never operate the boat under the influence of alcohol or other drugs. Federal and state law prohibit operating a yacht under the influence of alcohol or other drugs. Authorities actively enforce these regulations.

Operating a vessel while intoxicated became a specific federal offense effective in 1988. The ruling set federal standards for determining when an individual is intoxicated. If the blood alcohol content (BAC) is .10% (.08 in some states) or higher for operators of recreational vessels being used only for pleasure are subject to a civil penalty up to \$1,000 or criminal penalty up to \$5,000, one year imprisonment or both. In some states the fines and imprisonment may increase significantly.

The effects of alcohol and drugs account for the highest single cause of marine accidents and deaths. Most deaths in boating accidents occur when someone falls into the water. Balance is one of the first things you lose when drinking alcohol or under the influence of drugs. The problem arises out of not knowing your balance is restricted.

Overall vision is reduced by alcohol especially at night, along with double or blurred vision. Peripheral vision is lessened which restricts seeing vessels or objects on the side. Also, color awareness decreases especially with red and green which happen to be the colors of boat navigation lights, buoys, and channel markers.

Alcohol will greatly increase your heat loss so it increases the effects of hypothermia. Finally, your ability to make correct judgements in emergency situations is greatly reduced. Alcohol takes away the brains ability to process information quickly and delays a persons reaction time. **Don't drink and drive!**



CHAPTER 1

Alcohol Myths And Facts

Myth: Beer is less intoxicating than other alcoholic beverages.

Fact: One 12 oz. can of beer has about the same amount of alcohol as a 5oz. glass of wine or a shot of liquor.

Myth: Black coffee, fresh air, and a shower will sober the effects of alcohol.

Fact: After consuming alcohol time is the only thing that will sober you up. Our bodies average burning 1 oz. of alcohol every hour. If a person is drunk, it will take about seven or more hours to sober up.

Myth: Telling if a person is too drunk to operate a vessel is easy.

Fact: Many experienced drinkers have learned to compensate for the visual effects of alcohol and can disguise their drunk condition.

Myth: You're the best person to judge if you are fit to operate a boat.

Fact: Judgement is one of the first elements you lose when drinking.

BLOOD ALCOHOL CONTENT CHART									
Body Weight In Pounds	Number of Drinks In A 2 Hour Period (12 oz. beer=5 oz. wine=1 oz. 80 proof liquor)								
100	1	2	3	4	5	6	7	8	9
120	1	2	3	4	5	6	7	8	9
140	1	2	3	4	5	6	7	8	9
160	1	2	3	4	5	6	7	8	9
180	1	2	3	4	5	6	7	8	9
200	1	2	3	4	5	6	7	8	9
220	1	2	3	4	5	6	7	8	9
240	1	2	3	4	5	6	7	8	9
BAC to .05%	— — Be Careful- Loss of Judgement & Coordination								
BAC .05% to .10%	==== Abilities Impaired- Accident Chance Increased								
BAC Over 10%	===== Do Not Operate A Boat- High Accident Risk								



BOATING ACCIDENTS

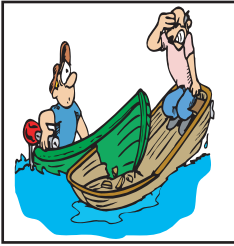

The following is a list of common causes of boating accidents. Be aware of them and take the necessary steps to ensure that your crew and yourself are educated and prepared to act in an emergency.

- Drowning by not wearing life jackets.
- Mixing boating and alcohol. Remember the skipper is responsible for his boat and crew.
- Distracted driving due to using cell phones, conversing, etc.
- Trying to reach the bow by the deck walk-around while the boat is moving too fast.
- Someone sitting on the bow, deck, or swim platform while underway.
- Choosing a boating outing day with inclement weather, especially with high winds and thunderstorms in the forecast or staying out when bad weather is approaching.
- Disembarking without checking all fluids or systems and especially fuel system components.
- Not monitoring the boating traffic or possible obstructions around you.
- Emergency communications equipment, signaling devices, and navigation lights not working.
- Improper boat handling especially high speed turns in rough water. Improper trim.
- Being too far from shore with inadequate fuel supply or navigational aids.



CHAPTER 1

- Passengers, especially children with improperly-fitting life jackets.
- Skipper or passengers not seated in the boat.
- Running a craft that is mechanically marginal.

Reporting Boating Accidents

The operator must report any accident involving collision or other casualty within 48 hours to the nearest state boating authority when the incident involves:

1. Death
2. Injury requiring treatment other than first aid
3. The disappearance of someone from a boat under death or injury circumstances.

A formal report must be made within 10 days for accidents involving more than \$500 damage or complete loss of vessel.

For information regarding accident reporting, go to:

<http://uscgboating.org/recreational-boaters/accident-reporting.php>

Rendering Assistance

The operator of a vessel is obligated by law to provide assistance that can be provided safely to any individuals in dangerous situation on the waterways. The operator is subject to fine and or imprisonment for failure to do so. Move cautiously and think before acting.



WATER SPORTS

Besides learning the safety precautions for safe boating, as well as understanding and knowing required rules and regulations, you are obligated to be particularly careful around other water sportsman, such as scuba divers, water skiers, wake boarders, and fisherman.

Skin & Scuba Divers

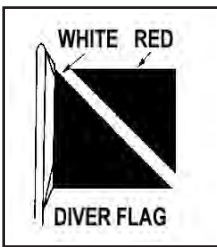

Whenever you see a “Diver Down” flag, maintain a distance of at least 100 feet on inland waters. In bays and open waters stay 300 feet away. The flag indicates a diver in the water. If a diver is operating from your boat, be certain to use this flag and post a lookout on board for a divers air bubbles. Sometimes divers stray from the flag area.

Water Skiers & Wakeboarders



For information on water skiing and how to get started, we recommend you contact the American Water Ski Association, P. O. Box 191, Winter Haven, Florida 33880. They offer pamphlets and instructional materials.

For wake boarding information there are numerous training schools throughout the country along with instructional videos and the internet.



CHAPTER 1

General safety procedures for towing skiers and wake boarders include the following:

- Know your hand signals and make sure all your passengers know them. See the *illustration on Page 1-34*.
- Do not allow non-swimmers to ski or wake board. You're asking for trouble!
- Always have an observer on board whose sole job is to watch the skier/wakeboarder and communicate with the driver.
- If you plan to do a lot of skiing/wake boarding, it is advisable to have a ski pylon and driver's rear view mirror installed.
- Acquaint yourself with the ski site before skiing/wake boarding.
- Follow the speed limits and all posted signs- i.e. no wake, etc.
- Keep the boat away from swimmers or other people in the water.
- Avoid running near the shoreline or in heavily congested areas with skier/wake boarder in tow.
- Do not allow skier/wake boarder to spray fisherman or other parties.
- Keep the engine speed steady while towing a skier/wake boarder.
- Make wide turns with skier/wake boarder in tow.
- Instruct skier/wake boarder in case of a fall to raise his ski in the air to ensure his visibility.
- Always turn your engine off when the skier/wake boarder is near the platform or transom.
- If the skier falls, return promptly to retrieve him, circling wide from the starboard side, to bring his rope within easy grasp.



WARNING

Never use the ski tow fitting for parasailing or lifting the boat. The ski tow fitting could pull out of the deck, causing death or serious injury.

Swim Platform; Typical Label

WARNING!
MAXIMUM CAPACITY
OF SWIM PLATFORM
500 POUNDS
226 KG

On integrated or extended swim platforms you should make periodic inspections of the swim ladder and swim platform hardware to ensure that all connectors and fittings are tight and free from corrosion. Never run the boat with someone holding on to or standing/sitting on the platform. Use heed when operating the boat in reverse to insure that water does not accumulate excessively on the platform especially in rough seas or strong currents. Do not exceed the platform recommended maximum capacity label!



CHAPTER 1

WATER SKI & WAKEBOARD SIGNALS

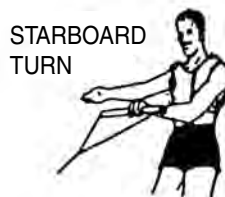
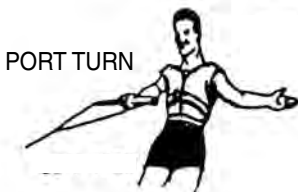
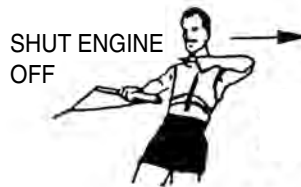
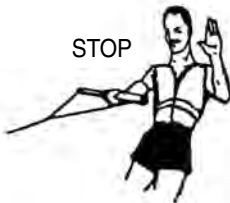



WARNING

Always shut the engines off with people in the water or on top of or holding on to the swim platform structure or hardware. Failure to do so could result in death or serious injury.

Fishing

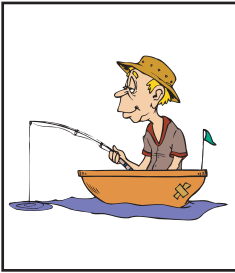

Most boaters fish from time to time. With the propulsion systems of today it is possible to fish in out-of-the-way places. When cruising, stay clear of fisherman. They may have lines or nets out which might be cut or get caught in your propeller if you come too close. Slow down when approaching fishing boats.

Do not return to cruising speed until the boats have been passed. If a fishing boat should be anchored, a large wake could flip or swamp the boat, upset fishing gear, pull the anchor loose from the bottom or worse yet cause someone to fall overboard.

When fishing from your boat, never anchor in shipping channel or tie up to any navigational aids. These must be kept clear of at all times.

Be sure to carry a chart of the area and be on the lookout for shallow water and hidden obstructions. Pick up a local tidal chart if appropriate so you do not end up grounded.

Remember, the skipper is responsible for any damage caused by his wake. Use common sense and be a responsible captain!



CHAPTER 1

WEATHER & WATER CONDITIONS

Before a boating outing check the weather conditions. As we all know the weather can change rapidly in many parts of the country. It does so sometimes without being predicted. NOAA weather radio reports are continuously available on designated frequencies installed on VHF radios and various handheld devices. Also, many local radio stations carry weather reports.

Cloud Formations

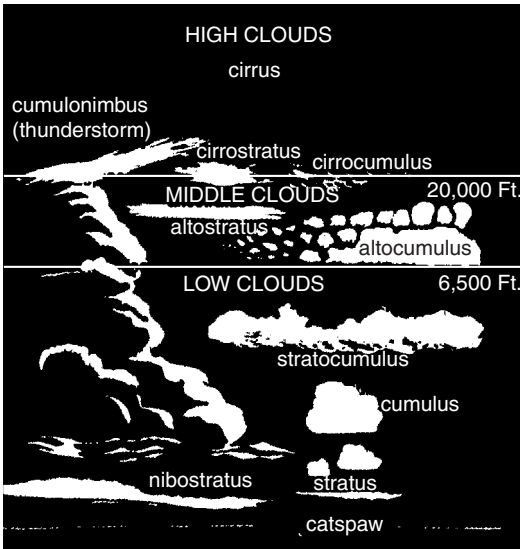

Clouds indicate the type of current weather and upcoming changes in the weather. Knowing the type of cloud formations can assist you in choosing the appropriate boating day or if already on the water will help you understand any upcoming weather changes.

Flat clouds (stratus) normally indicate stable air. Cumulus clouds indicate unstable air. Many times a “cotton ball” or cumulus cloud builds vertical height in the afternoon and the result is a thunderstorm with increased winds and waves; sometimes these storms are quite violent. You can find additional information on weather (meteorology) at your local library.



Waves & Fog



As the wind blows across water waves are created. The stronger the wind and increased distance across the water enlarges the wave action.

Other factors that can cause problem situations for vessels are fog, currents, and tidal changes.

Fog can develop inland on clear, calm mornings. Coastal areas see large “blankets” of fog roll in and stay for extended time periods causing sometimes hazardous navigation conditions. If you are caught in the fog, do not panic. Think of the best plan of action and proceed carefully. If you are limited in navigation equipment at the first sign of fog proceed to the nearest shoreline and wait until the fog lifts.

Boats equipped with navigation equipment, local waterway experience and charts should proceed to a safe harbor. Use extreme caution, signal as needed, and reduce to a speed where you can stop within half of your forward vision range.

If foul weather catches you at sea do the following:









1. Slow down and post a lookout in fog. Proceed with caution and put on your life jackets.
2. Try to reach the nearest safe shoreline.
3. Navigate your vessel slowly into the waves at a 45 degree angle.
4. Passengers should sit low in the center of the vessel.
5. Monitor your bilge pump. Make sure bilge stays free of water.

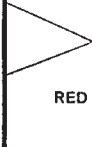

CHAPTER 1

6. Secure loose gear. Make ready emergency equipment.
7. If the engine stops, throw the anchor over the bow. If needed use a sea anchor. Never anchor off the stern.

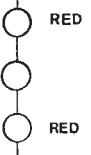
Marine Weather Symbols

	SMALL CRAFT	GALE	STORM	HURRICANE
DAY FLAGS	 RED	 RED	 RED & BLACK	 RED & BLACK
NIGHT LIGHTS	 RED WHITE RED	 WHITE WHITE RED	 RED WHITE RED	 RED WHITE RED

Although the National Weather Service has discontinued the use of the day flags and night lights, many marinas and ports of call still display them.



Rules Of The Road

NAVIGATION RULES DEFINED

The Navigation Rules set forth actions to be followed by boats to avoid collision. They are referred to as the “Rules of the Road”. There are two main parts referred to as the inland and international rules. The inland rules apply to vessels operating inside the boundaries of the United States. The international rules referred to as 72 COLREGS apply to vessels operating on the high seas and all connected waters outside the established demarcation boundaries. Most navigational charts show the demarcation lines by red dotted lines and are published in the navigation rules. Remember to consult state and local agencies since areas such as “no wake zones”, swimming beaches, “diver down flag” and inland landlocked lakes fall under their jurisdiction. This section is only an introduction to the “rules of the road”. We strongly recommend additional training before getting behind the “wheel” of your boat.



WARNING

Always follow the “Rules of the Road” when navigating your boat to avoid a collision. Failure to follow the “Rules of the Road” could cause a collision resulting in death or serious injury.

You can order a printed version of the Navigation Rules from the U.S. Government Bookstore at:

bookstore.gpo.gov

To view Navigational Rules online or download go to www.navcen.uscg.gov.



CHAPTER 2

NAVIGATION RULES

Operation

- Cross waves at right angles.
- When caught in heavy water or squalls, head either directly into the waves or at a slight angle. Reduce speed, but maintain enough power to maneuver your boat safely.
- Keep your speed under control. Respect the rights of other boaters engaged in all water sports. Give them a “wide berth”.
- Remember the unwritten “rule of tonnage”. Basically a smaller tonnage vessel should take every effort to avoid close quarters with a larger tonnage vessel. One way to accomplish this is to have a designated human lookout to “eyeball” the horizon for any developing collision course.
- Use defensive driving skills on the waterway just as you do on the roadway. The other vessel may not know the “rules of the road” Be alert and ready to take immediate action.

Right of Way

1. Whenever meeting a boat head on, keep to the right where possible.
2. When two boats cross, the boat to the right (starboard) has the right of way.
3. When overtaking or passing, the boat being passed has the right of way.



Rules Of The Road

4. In general, boats with less maneuverability have right-of-way over more agile craft. The skipper must keep his craft clear of the following vessels:
 - A vessel not under command or aground; due to their circumstances, these vessels have no maneuverability.
 - A vessel restricted in its maneuverability; these vessels usually are performing work which limits their maneuverability such as surveying, dredging, laying pipe or cable, or servicing navigational markers among others.
 - A vessel engaged in fishing; these include boats fishing with lines, trawls or nets, but not trolling lines.
 - Sailboats; they have the right-of-way over power boats. However, if a sailboat is using a prop to move forward, it is considered a powerboat even if the sails are up.
5. If a collision course is unavoidable neither boat has the right of way. Both boats must react to avoid an accident according to the rules of the road.









CHAPTER 2

Signals

WHISTLE SIGNALS

- ONE LONG BLAST:** Warning signal
(Coming out of slip)
- ONE SHORT BLAST:** Pass on my port side
- TWO SHORT BLASTS:** Pass on my starboard side
- THREE SHORT BLASTS:** Engine(s) in reverse
- FOUR OR MORE BLASTS:** Danger signal

BRIDGE SIGNALS

		DAY (Flag)	NIGHT (Lights)
SOUND	VISUAL		
VESSEL: Open	VESSEL: Open		
BRIDGE: OK	BRIDGE: OK		
No	No	Same	Same
VESSEL: Replies:	No		
RADIO: VHF CH. 13			



Rules Of The Road

NAVIGATION RULES

The Navigation Rules set forth 3 types of crossing situations- crossing, meeting, and overtaking. In each case, both boats are governed by special procedures.

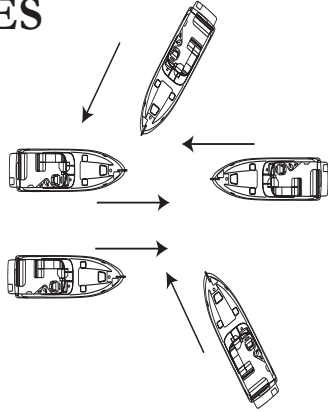

In a head-on meeting, both vessels must sound a single blast to give way toward starboard and pass to port.

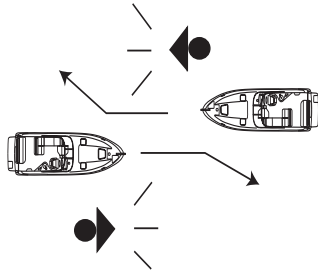

These rules appear when there is a risk of collision. In a crossing situation be aware of the other craft's position. For safety, there should be a noticeable change in the angle, bow or stern; a gradual change in position indicates possible danger.

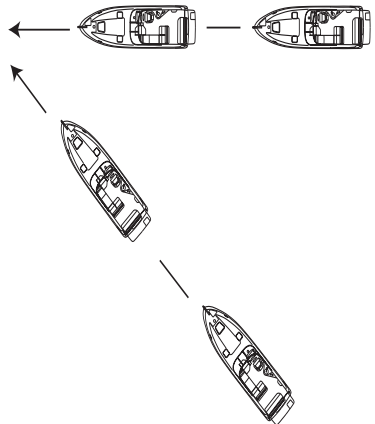



CHAPTER 2

NAVIGATION RULES

An overtaking boat is burdened, and is not the privileged craft, even though it approaches the danger zone of the overtaken boat.

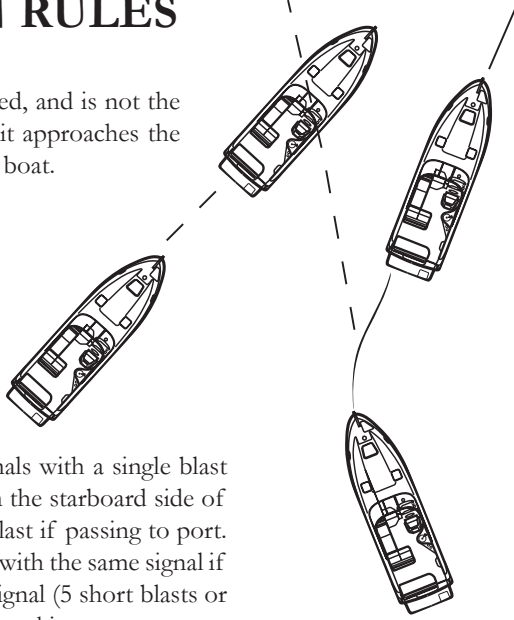

The overtaking boat first signals with a single blast if that boat desires to pass on the starboard side of the boat ahead, or a double blast if passing to port. The overtaken craft responds with the same signal if it is safe, or with the danger signal (5 short blasts or more) if unsafe. The boat overtaking must not pass unless the appropriate signals are sounded.

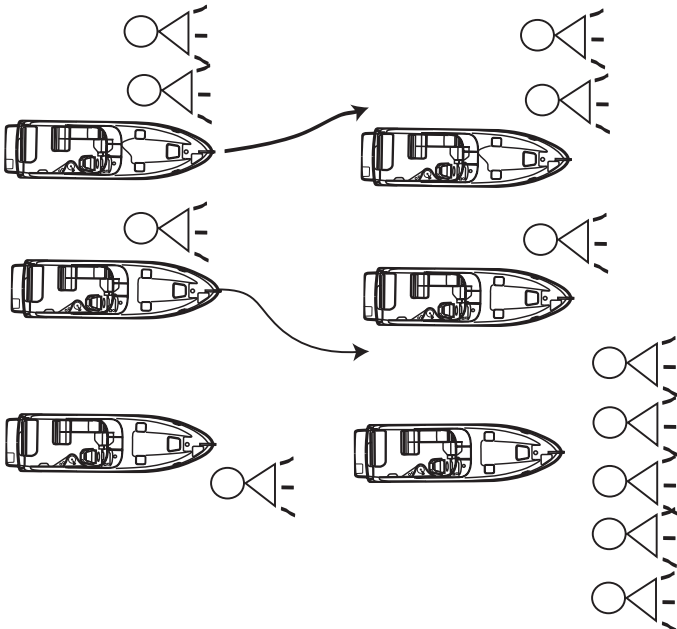



NAVIGATION AIDS

Navigation aids are placed along coasts and navigable waters as a guide for mariners in determining their position in reference to land and hidden danger. Each aid provides specific information. They form a continuous system of charted markers for accurate piloting on paper (and helm display if equipped) and on the water.

Nautical charts are provided by the National Ocean Service (NOS) and are distributed nationwide through marinas and outlet stores. These charts show the geography of the coast, water depth, landmarks, navigation aids (buoys and markers), marine hazards, and port facilities. Use only up-to-date charts for navigation. We recommend when purchasing a chart to look for the weather resistant ones.

Buoys provide a road map to keep the skipper on course and to avoid hazards. Buoys are identified by light, shape, color and in severe weather conditions by sound.

Buoys or beacons called lateral markers indicate the port and starboard sides of the waterway to be followed. U. S markers follow the buoy system known as Red Right Returning. When returning from sea or traveling upstream, the green markers are to port (on your left) and the red markers are to the starboard side (on your right). When traveling downstream or out to sea the marker color would be reversed. The Intercoastal waterway uses a different system of lateral markers for port and starboard. Before operating your vessel, learn to identify the various navigational aids such as lateral aids, mid-channel markers, information and regulatory markers.

NOTICE

Do not rely on buoys alone for boat position. Severe weather conditions and wave action can alter a buoy's position.



CHAPTER 2

LATERAL AIDS

NOTICE

Never tie up to a buoy. It is illegal and extremely dangerous.

Port Side
Odd Numbers

Starboard Side
Even Numbers

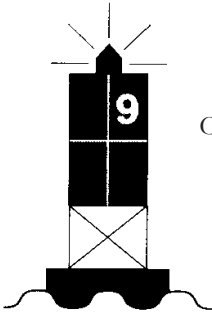

Chart Symbol



G "9"
Fl G 4 sec

Lighted Buoy
(Green Light Only)

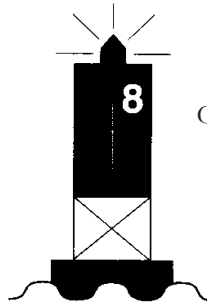

Chart Symbol



R "8"
Fl R 4 sec

Lighted Buoy
(Red Light Only)

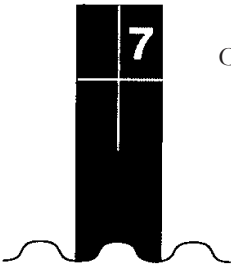

Chart Symbol



C "7"

Can Buoy
(Unlighted)

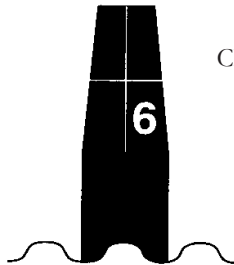

Chart Symbol



N "6"

Nun Buoy
(Unlighted)



Chart Symbol



G "1"

Daymark



Chart Symbol



R "2"

Daymark



MID-CHANNEL MARKERS

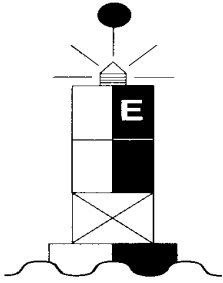

Chart Symbol

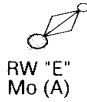

Chart Symbol



MR

Chart Symbol



REGULATORY MARKERS

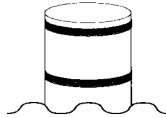

Diamond Shape
Danger Warning



Diamond Shape With Cross-
Boats Keep Out



Circle Marks Area Controlled
As Indicated



For showing information such as
locations, distances and directions



CHAPTER 2

NIGHT RUNNING

Boats operating between sunset and sunrise (hours vary by state), or in conditions of reduced visibility, must use navigation lights. Nighttime operation, especially during bad weather and fog, can be dangerous. All Rules of the Road apply at night, but it is best to slow down and stay clear of all boats regardless of who has the right-of-way.

To see more easily at night, avoid looking at bright lights when possible. Also, it is helpful to have a passenger keep watch for other boats, water hazards and navigational aids.

To determine the size, speed and direction of other vessels at night, you should use the running lights. A green light indicates starboard side, and a red light indicates port side. Generally, if you see a green light, you have the right-of-way. If you see a red light, give way to the other vessel.

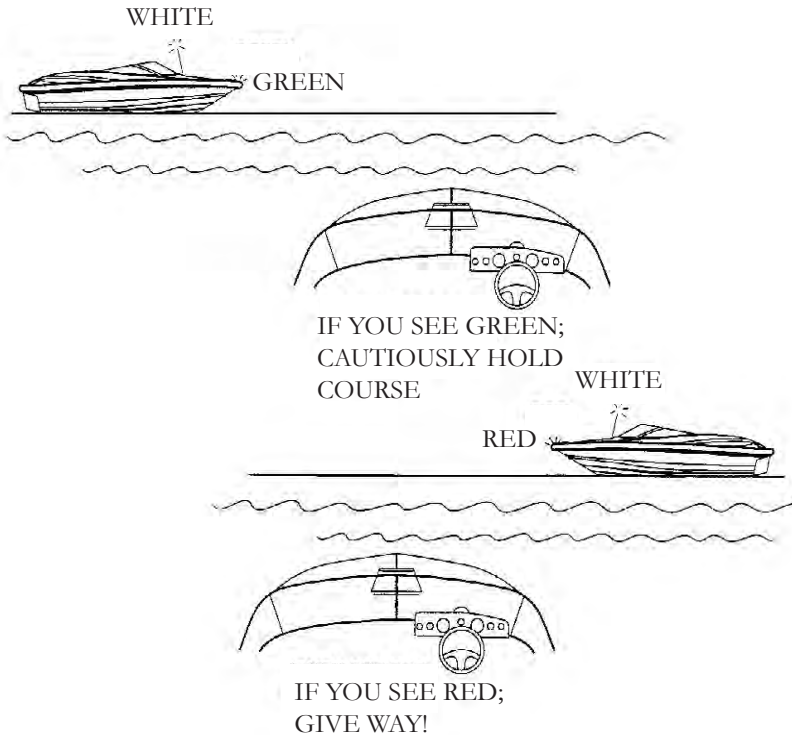



BRIDGE CLEARANCE

Be aware that your vessel requires a specified bridge clearance height. This height is a measured estimate from the waterline to the top of the highest object usually the power tower, radar or the masthead light depending on what tower equipment is installed. All canvas should be in the stored position. The estimated height can change because of variances in the loaded condition of the vessel. An easy way to measure bridge clearance is to have someone place a long straightedge such as a piece of wood at a 90 degree angle across the highest point of the boat with the boat in the water. Then with a tape rule measure the distance straight down (90 degrees) to the waterline. Take this measurement with the fuel and water tanks 1/2 full and only 1 person besides yourself on board. This will give you a safe measurement. As your boat is loaded down with people the bridge clearance will be slightly lower.

Some bridges are tendered. Know and use the proper bridge signals when approaching these bridges (*see Bridge Signals on Page 2-4*). You can also monitor and communicate on channel 13 of a VHF radio for bridge information in most domestic locals. Other bridges are marked with a clearance measurement and you are on your own. After determining your vessel will clear the bridge proceed with caution at a safe idle speed. Keep your eye on vessel traffic at all times in order to react quickly. Resume a safe speed once clear of the bridge structure and acknowledgment of clear visibility.

Use common sense regarding bridge clearance because bodily injury and property damage could result if a mishap occurs with a bridge structure.



CHAPTER 2

Notes



Engine & Controls



OUTBOARD ENGINE BASICS



It is important that you read your outboard engine manual carefully and become completely familiar with the operation as well as necessary maintenance on the engine and propulsion systems. Pay careful attention to the sections on winterization if you live in freezing climates.

Extensive damage can result if proper winter storage is not followed in freezing climates. Contact your Regal dealer for information regarding technical issues and parts. Also, refer to the *Maintenance section on Page 7-12* of this manual.



WARNING

Be sure to read and understand the outboard engine manual before operating your vessel. Failure to do so could result in equipment damage and/or death and serious injury.

This chapter is intended to give general information about the location and function of typical outboard engine and controls. Control systems and engines may vary from model to model. Refer to the specific engine owner's manual for your equipment that would include the following information and much more in greater detail and accuracy.



CHAPTER 3

Fuel

Gasoline Requirements – Always follow the outboard manufacturer’s fuel octane requirements and ethanol guidelines in the owner’s manual.

Gasoline is blended with 10% ethanol and is known as E-10 at the pumps. Marine engines used in your Regal boat may be operated with gasoline blended with no more than 10% ethanol and that meets the minimum octane specification.

Ethanol in fuel is a strong cleaning solvent that can clean fuel system gum and varnish. As a trade off these released deposits can clog fuel system parts such as filters and engine fuel injectors.

Do not use ethanol blends greater than 10% such as E-15 to E-85. Your marine engine may be damaged by more than 10% ethanol. This type of fuel can cause a loss of performance, starting problems, serious fuel system and engine damage.



WARNING

Always use approved marine replacement parts that are ignition protected. Using non-marine replacement parts may cause fire and explosion that could result in death or serious injury.

Engine

Engines function is based from four principles; fuel, compression, ignition, and exhaust. The proper ratio of fuel and air must be drawn into the engine’s cylinders in order to be compressed by the pistons and ignited by a spark the force of which pushes the piston back down, providing the energy used to turn your propeller, before the engine kicks into the exhaust stage where it expels the by-products. If any of these four functions fail, so does the engine itself.



Beyond these basic concepts of engine functionality include engine cooling, lubrication, and electrical systems. The specific details of these systems can be found in the outboard manufacturer's owner's manual for the specific engine option you chose on your Regal boat.

Engine Removal

In the event the outboard engine needs to be removed from the transom consult your Regal dealer. He has the factory trained knowledge and equipment to remove the engine safely and efficiently.

Engine Checklist Before Each Outing

Every engine option may require different checks before each use, but a general engine checklist is included here as a guide.

- Check engine and gearcase oil levels.
- Check steering fluid.
- Check power trim fluid.
- Check power trim operation.
- Check control levers for smooth operation and neutral detent.
- Check the clip and safety lanyard for functionality.
- Check gauges for proper operation.
- Check fuel level and ensure the level is sufficient for the trip with a reserve.



Engine Cooling System

Outboards use raw water for cooling the engine with intakes at the gearcase. It is important that this system continues to run unobstructed at all times to avoid hazardous situations and to ensure a safe voyage.

Raw water is drawn up into the outboard vertical driveshaft housing through pick-up feeds in the gearcase vicinity. Water passes through a powerhead thermostat which controls how much water circulates through the powerhead. The cool water absorbs heat produced by the engine, before being emitted via the coolant exhaust system.

There is an access hole on the port side of the powerhead which shows a visual stream of water at all times. If no water is visible with the engine running shut down the engine and investigate the problem. At times this relief hole can be plugged by debris.

Impeller/ Water Pump

Periodically, the cooling system water pump and impeller should be inspected for debris, damage or excessive wear due to use, water chemistry such as mineral and/or silt conditions. Damaged parts will affect the system's ability to function, and may cause engine overheating or damage. Contact your Regal dealer for more information and maintenance schedules of key outboard engine systems.

Thermostat

If the temperature gauge starts yielding abnormal readings, it may become necessary to look at or replace the powerhead thermostat after determining whether it is functioning properly. The thermostat reads the temperature of coolant and determines whether to open or close a valve to allow warm sea water to pass into the exhaust manifold. The thermostat may recirculate hot coolant for the purposes of reaching standard operating temperatures. If standard operating temperatures have been reached, the thermostat will open a valve and allow hot raw



water to exit through the exhaust manifold. For more information read your outboard engine manual or contact your Regal dealer. Dealers have the necessary knowledge and tools to troubleshoot any engine related problems.



WARNING

Allow the engine to cool to ambient temperature before inspecting, servicing or repairing the engine. Some engine components and fluids are extremely hot even after the engine has been shut down. Allow sufficient time for all engine components and fluids to cool to ambient temperature before attempting any service procedure. Failure to do so could result in death or serious injury.

NOTICE

Never operate the engine without a functioning thermostat. The engine may overheat and cause damage.

Freshwater Flushing Attachment

Your outboard features a fresh water flushing system. After linking up to a fresh water hose at the flush port, water can be pumped through the engine's raw water cooling system to flush out all salt and debris that may be left behind. Normally there is a hose thread fitting on the side of the engine. After the connection is opened a garden hose is connected to the fitting and the engine can be flushed. It is best to connect the flushing system up when the engine is warm since the thermostat is open at this time to allow water to circulate through the entire head rather than bypassing the cylinder head areas. *Do not run the engine while using the flushing system device as engine damage may occur.*



Engine Exhaust System ---

Your engine expels the by-products of the engine operation through an exhaust system, just like cars do. In boats however, this exhaust system mixes the debris left over after the power stroke of the engine with the hot water that is expelled after cooling the engine.

Basically the exhaust flows through the powerhead before expelling the exhaust through the vertical drive housing either just above the propeller, or through the prop shaft.

Engine Electrical System ---

Spark Plugs

The spark plugs are the piece of equipment that help make ignition occur. As electrical potential builds on one side of the gap based upon the energy distributed by the distributor, the potential eventually grows large enough to cause the electric current to jump the gap on the spark plug. This spark is what ignites the compressed fuel, generating a controlled explosion that will power the piston down and deliver power to the drive shaft.

Stator/Alternator

Under normal circumstances, the starter battery would wear down after being used so often to generate a spark for the engine. This isn't an ideal setup because a strong battery is needed for continual operation. A weak battery does no good out on the water. The stator/alternator takes care of recharging the battery(ies)

However, in an effort to conserve battery life, the starter battery switch should still be turned off after every trip and turned on at the start of every trip. This limits the drain on the battery while the boat is not in use. The stator will only recharge the battery while the engine is running.



Alarms

When a malfunction with your outboard engine occurs, the Garmin plotter alerts the skipper of a problem. Common engine problems include overheating, low oil pressure, or a miscommunication with equipment. Learn the alarm systems that apply to your engine by consulting your engine owner's manual.



WARNING

Avoid operation of the engine after an alarm has sounded. Use of the engine without addressing the problem may result in engine damage or failure.

Engine Lubrication

Whenever two components rub together, friction causes wear on both components. To minimize the wear on your engine, a lubrication system has been put in place to help components slide next to each other easier. This is particularly important within the inner workings of an engine. It is important to ensure your lubrication system is working properly at all times.

Your Regal utilizes lubrication and fluids that need regular check ups. Refer to your outboard engine owner's manual for specific details regarding the proper maintenance procedure of your lubrication system.

NOTE: Your outboard uses other lubricants in addition to engine oil such as power trim fluid and propshaft gearcase lubricants to reduce wear on moving components. These fluids should be checked according to the recommended maintenance procedures determined by the outboard manufacturer.



Engine Oil

The purpose of engine oil is to lubricate the internal components of the engine and ensure that parts that regularly move against each other have reduced friction to reduce wear and noise between components. An oil filter keeps metal particles and water out of the engine's interior.

Gearcase Oil

Gearcase oil keeps all the mechanical components of the propshaft gear assembly functioning optimally. It reduces friction in the gearcase as the gears revolve. Sometimes gearcase oil is called gear lubricant, as the oil essentially lubricates the gears inside the gear box. Gearcase oil should be inspected periodically according to factory maintenance schedules. Use outboard manufacturer's recommended oil.

Power Trim Fluid

Power trim fluid allows your outboard to trim up or down. This is particularly useful when trying to get your boat to plane where the hull is as much out of the water as physically possible, reducing friction, and improving ride performance. This power trim fluid is used in hydraulic rams that maneuver the outboard unit, and shouldn't need to be replaced very often, if at all.

Power trim fluid should be checked regularly, despite not requiring replacement unless something serious happens. Discoloration or water presence indicates a water leak in the system. In that case, contact your Regal dealer. Use outboard manufacturer's recommended fluid.



Propellers



We have carefully tested and chosen the propellers to give your boat the best possible performance and have allowed for the additional weight in equipment that might be added to the boat. It is a good idea to carry a spare set of propellers and hand tools in order to handle an emergency propeller change.

Refer to the engine manual for proper procedures since each application is unique. Call your Regal dealer for further information.

Outboard Steering System

Your outboard boat features as standard equipment an electronic helm “power steering” system. Overall this system lends itself to single and dual outboard installations well with an effortless “power steering” feel. In addition, this system features light friction at low speed and higher friction at higher speed to provide a higher degree of maneuverability. Furthermore, it can be programmed for toe-in and toe-out settings which provide optimum vessel performance.

Also, this system eliminates the need for a tie bar which normally is used in twin outboard installations.

The hardware at both the helm and engine must be checked regularly for tightness, lubrication, and leaks. Check the steering system for full steering to port and starboard before disembarking.

The main system components are the electronic helm, electrical connection board, hydraulic steering pump and “smart cylinder”. Note the adjacent drawing which shows normal system components. For service contact your Regal dealer or certified marine technician.

See the outboard manufacturer’s owner’s manual for more information.



CHAPTER 3

Electronic Helm

The electronic helm features a sport steering wheel and several tilt positions for maximum control taking into account individual driver needs and body types. The steering wheel motion can be adjusted to various lock to lock turning positions, along with the ability to adjust wheel friction tension through the cruising rpm range to afford the greatest driver control and feel at the helm.

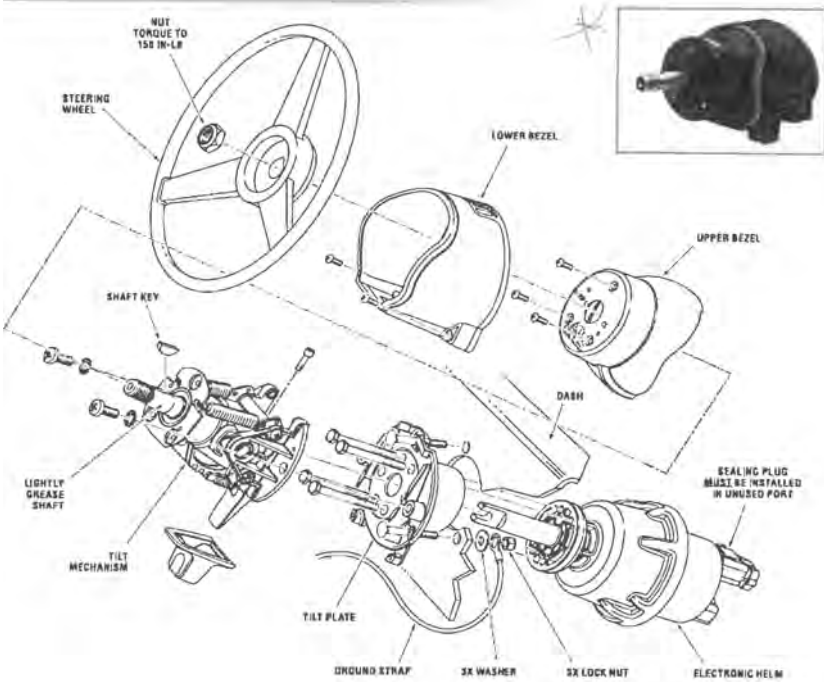



Power Steering Wiring

The electronic power steering is an on demand system using minimal power. The system uses two 60 amp breakers (one per starting battery) located near the battery source. The breakers are between each battery (twins) and the PCM mounting board. The illustration below shows a typical twin engine steering setup.

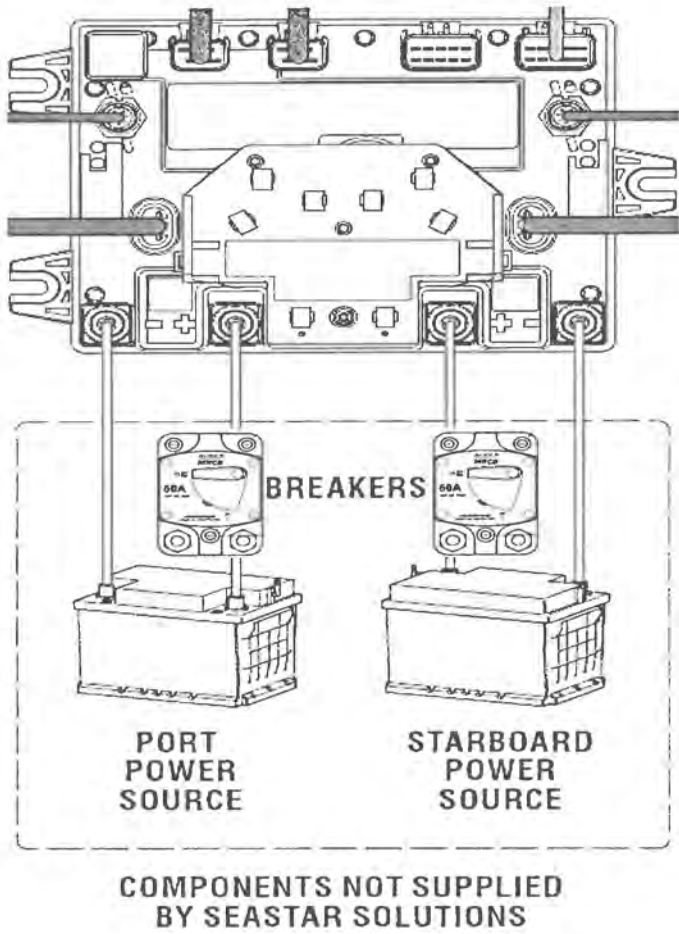



Hydraulic Steering Pump



Located under the aft center cockpit storage compartment is the steering system hydraulic pump system. Each pump controls the port or starboard steering cylinder. Always use the steering fluid recommended by the manufacturer; do not use any substitutions. It is a good idea to have extra fluid, funnel and cloth on board for emergency filling of the system. Also, note that there is a service valve located on each pump. It allows for manual realignment of the engines during service or a system fault. Use the decal information as needed for manual realignment situations. Engine(s) must not be running while performing these realignment procedures.





Smart Cylinder

Located on the front of each engine is the steering smart cylinder. It is footprinted with redundant sensors to determine the steering response to the wheel movement. If one sensor should fail there are back-up ones on each cylinder. The stainless steel cylinder includes ORB fittings with bleeders to purge air as needed.





CHAPTER 3

Smart Cylinder Description

For information purposes components used in the smart cylinder are shown in the drawing. This illustration may be useful too for ordering needed parts as well as a troubleshooting breakout. Contact your closest Regal dealer to order parts.

CAUTION
Use plastic spacer to ensure there is no metal to metal contact

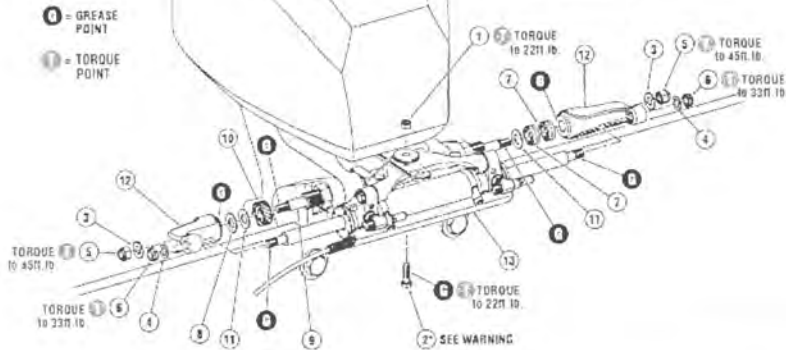
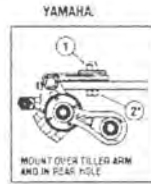

ITEM	PART #	QTY	DESCRIPTION
*1	113529	1	Nut, 3/8" NF Nylok® SS
*2	113225	1	HHCS 3/8" UNJFX 1.35 HSS
*3	731625	2	Washer, Flat, 7/16" SS
*4	731720	2	Nut, 7/16" NF Nylok® SS
*5	202027	2	Washer, Flat, 1/2" SS
*6	192126	2	Nut, 1/2" NF Nylok® NI Plate Br
*7	995876	2	Spacer, Thick
*8	996689	1	Spacer, Thin

ITEM	PART #	QTY	DESCRIPTION
9	730229	1	Support Rod
10	828085	1	Adjusting Nut & Screw, SS, Teflon Coated
11	202300	2	Washer, Flat, 5/8" SS
12	839120	2	Support Brackets
13	907099	1	SmartCylinder (EC5310) or SmartCylinder (EC5340)
14	728994	1	Spacer, Medium (some 1995 to 1998)
15	113350	1	HHCS 3/8" NF x 1-1/2" SS



Engine & Controls

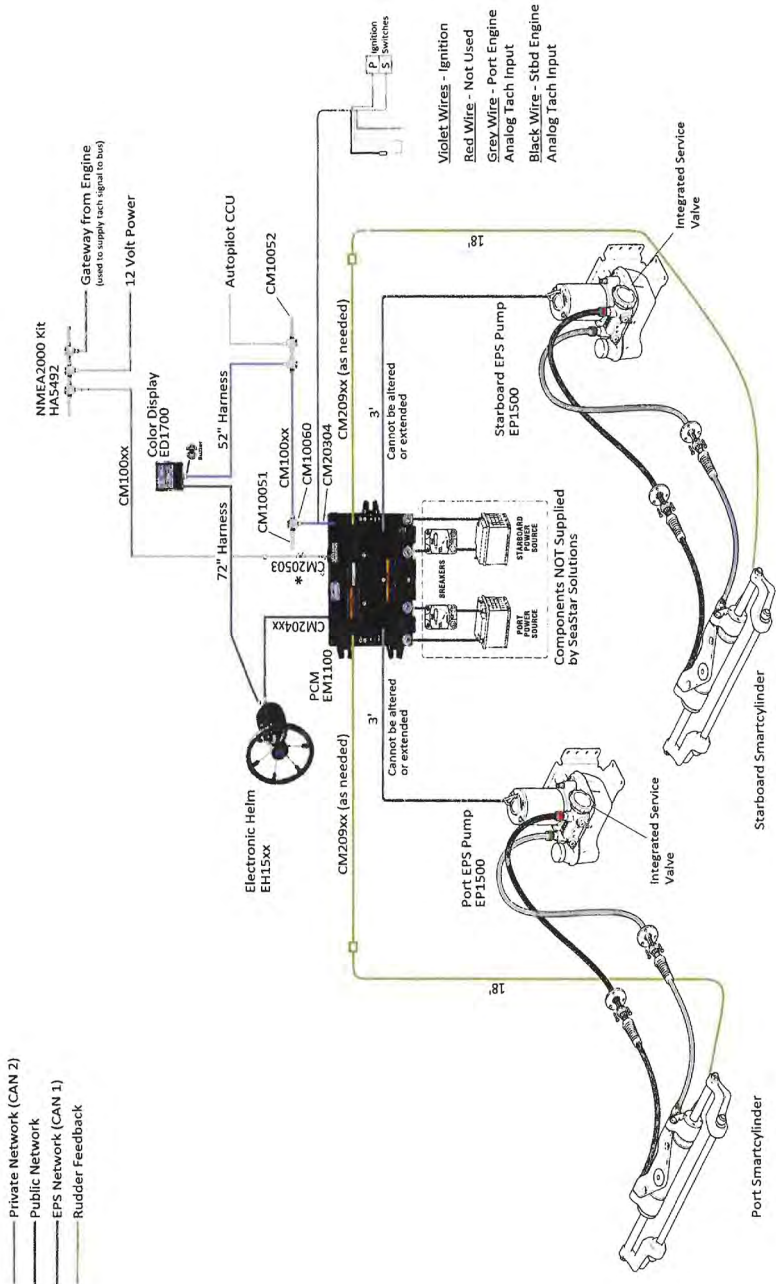



SD

STERN DRIVE ENGINE BASICS

It is important that you read the engine manual carefully and become familiar with the operation as well as necessary maintenance on the engine and propulsion systems. Pay careful attention to the sections on winterization if you live in freezing climates. Extensive damage can result if proper winter storage is not followed. Your Regal dealer has been factory trained on Regal boat systems. Consult your Regal dealer for further information regarding technical issues and parts.



WARNING

Be sure to read and understand the engine and propulsion unit manual before operating your vessel. Failure to do so could result in equipment damage and/or death and serious injury.

Engine Mounts

The engine is set in the boat on a group of metal platforms called mounts. These engine-hull attached rubber isolation mounts keep the engine from moving laterally and at right angles to the center-line. The mounts help reduce the vibration caused by the engine and drive. Periodically, the mount hardware should be checked for tightness.

Fuel

Gasoline Requirements – Always follow the outboard manufacturer's fuel octane requirements and ethanol guidelines in the owner's manual.

Gasoline is blended with 10% ethanol and is known as E-10 at the pumps. Marine engines used in your Regal boat may be operated with gasoline blended with no more than 10% ethanol and that meets the minimum octane specification.



Ethanol in fuel is a strong cleaning solvent that can clean fuel system gum and varnish. As a trade off these released deposits can clog fuel system parts such as filters and engine fuel injectors.

Do not use ethanol blends greater than 10% such as E-15 to E-85. Your marine engine may be damaged by more than 10% ethanol. This type of fuel can cause a loss of performance, starting problems, serious fuel system and engine damage.

WARNING

Always use approved marine replacement parts that are ignition protected. Using non-marine replacement parts may cause fire and explosion that could result in death or serious injury.

Engine Alignment ---

The engine uses a rubber spline hub to which the stern drive shaft is attached. This alignment specification between the engine and stern drive needs to be checked periodically. It should be checked after each 50 hours of operation or if the vessel has run aground or hit a submerged object. Alignment should be checked by a Regal dealer or marine professional since special tools and procedures are required.

Engine Removal ---

In the event the engine or out-drive (sometimes referred to as stern drive) requires major service where it needs to be removed, consult your Regal dealer.



Engine Ventilation

Ventilation systems are required for engine compartments. Your boat features a set of deck vent shrouds with mesh covers which supply fresh air constantly to the engine compartment. A powered blower motor connected to ducts in the lower one third of the bilge evacuates air to the atmosphere. **Read and understand the following warning.**



WARNING

Be sure to read and understand the engine and propulsion unit manual before operating your vessel. Failure to do so could result in equipment damage and/or death and serious injury.

All owners are responsible for keeping their boat's ventilation systems in operating condition. This means making sure the ventilation covers are obstruction free, ducts are not blocked or torn, blower operates properly and any worn parts are replaced with approved marine parts.

Catalyst Engines

Most 4-stroke marinized engines are equipped with a catalytic converter to meet U.S. EPA emissions requirements.

A catalytic converter utilizes extreme heat to reduce the engine's output of hydrocarbons and carbon monoxide thus reducing pollutants. The system theory involved follows the automotive market but the actual parts and closed loop designs are unique to the marine industry due to temperature, space restrictions, weight and corrosion factors found in the marine environment.

Both major engine manufacturers incorporate catalytic converters within a water-jacketed manifold. Oxygen sensors are placed in the system along with on board monitoring equipment. The systems permit the engines to operate at normal horsepower ratings.



Read the engine manufacturer's operation manual for more detailed information regarding catalytic converters and the system maintenance information.

WARNING

Always use approved marine replacement parts that are ignition protected. Using non-marine replacement parts may cause fire and explosion that could result in death or serious injury.

Stern Drive

It is important that you read the engine/stern drive operator's manual carefully and become familiar with the operation as well as necessary maintenance on the drive unit components. Pay careful attention to the sections on winterization if you live in freezing climates. Extensive damage can result if proper winter storage is not followed.

Propellers



We have carefully tested and chosen the propellers to give your boat the best possible performance and have allowed for the additional weight in equipment that might be added to the boat. It is a good idea to carry a spare set of propellers and hand tools in order to handle an emergency propeller change.

Refer to the engine manual for proper procedures since each application is unique. Call your Regal dealer for further information.



WARNING

Always use approved marine replacement parts that are ignition protected. Using non-marine replacement parts may cause fire and explosion that could result in death or serious injury.



DANGER

Always shut off the engines near swimmers to avoid contact with rotating propeller blades. Failure to do so could result in death and serious injury.

Propeller Checklist

Before each outing check the propeller for:

- Loose, missing or corroded hardware.
- Nicks, dings or missing propeller material.
- Bent propeller blades.
- Objects wrapped around the propeller such as fish line.
- Decomposing blades (electrolysis symptom).
- Paint coming off (OB) aluminum propeller near the blade tip (ventilation symptom).

Contact a propeller shop or your Regal dealer if any of the above symptoms exist. They have special equipment to refurbish both stainless and aluminum propellers. After making any blade alternations, the propellers are “re-pitched” in special propeller jigs.



SWITCHES

Main Switch Panel

The main helm switch panel controls various vessel electrical components. The main battery switch must be activated for most of the switch functions to work except for the automatic side of the bilge pumps. Below is a brief description of each switch. These switches are illuminated for night operation. Note that select switches may represent optional equipment that is not installed on your vessel.



All electrical features are protected by a main battery management panel.





Blower

WARNING

Always operate the bilge blower (if installed) prior to starting the engines or generator. Gasoline vapors can explode, resulting in death or serious injury. Before starting the engines or generator, perform the following:

- **Sniff the engine room for fuel vapors.**
- **Operate the bilge blower for a minimum of 4 minutes.**
- **Verify the bilge blowers are operating properly.**

Always run the bilge blower when the vessel is operating below cruising speed.

This switch controls the bilge ventilation blowers. The blower's function is to evacuate any fumes and engine exhaust gases that have accumulated in the lower bilge. The blower must be activated at least 4 minutes prior to starting the engine. Check the ventilation ducts and black bilge hose to ensure they are not obstructed. Be careful not to step on the blower hoses when doing bilge maintenance. Always run the blower when the vessel is operating below cruising speed.

Horn

This momentary switch controls the audible electric bow horn located at the starboard bow area. It is protected by a stainless grill cover. Make sure the horn is tested before each outing, as it can be valuable in navigation situations and can be used for bridge communications. Normally there is an adjustment screw on the horn top to alter the horn tone. Periodically inspect the horn hardware for tightness and polish the horn grill located on the outer hull side.



Nav/Anc ---

This switch controls the running, masthead and stern lights. It is a two-position switch. Activate the forward section and the running lights (navigation and stern lights) are activated along with the instrumentation and switch lights for night running. Activate the aft portion and the 360° masthead light is activated. Remember the navigation lights, sometimes called running lights, must be used between sunset and sunrise. Should you anchor or stop the vessel at night you are required to illuminate the 360° mast light. On vessels with hard tops and Power Towers the masthead light takes the place of the stern light.

Wiper ---

This switch controls the optional starboard windshield wiper. Do not run the wiper blade over dry glass, as it can leave permanent scoring on the windshield. Periodically check the blade for wear.

Docking Lights ---

This switch activates the bow hullside-mounted docking lights. They are useful maneuvering in nighttime docking opportunities and can be beneficial in night channel navigation and anchor retrieving.

Cockpit Lights ---

This switch controls the courtesy lights in the cockpit area. Using these lights is especially useful when boarding or exiting the vessel at night.



Fwd Bilge Pump

This switch controls the bilge pump manual operation. The bilge pump is used to remove any accumulated bilge water. It sends the water through a hose and a hull fitting to the outside hull. Even with the switch in the off position the bilge pump will automatically activate through a float switch located near the pump itself. This feature is especially useful when the vessel is moored and vacant. When excess water causes the float switch to rise the pump activates in the automatic position and a red icon lights up on the switch bottom. The operator should monitor this icon periodically while operating the vessel. If the light activates, stop the vessel and investigate the problem. Check the bilge pump before each outing and remove any foreign objects caught in the float switch or bilge pump grating. Never run the bilge pump in a dry mode since it may shorten the pump life. The bilge pump is energized even with the battery switch turned to the “off” position.

Aft Bilge Pump

This switch controls the bilge pump normally located in the aft cockpit under the front of the engine. The switch operates the same as the forward bilge pump.

Hatch

This cockpit switch controls the electric hatch operation. Should the batteries go dead, plug in a 3-prong grounded 14-gauge extension cord into the battery charger plug. After a few minutes, you should be able to raise the hatch with the extension cord still plugged into the plug. Make sure all body parts are clear of the hatch when it is traveling up or down.



Power Tower

This switch controls the Power Tower up and down movement which can be useful when navigating under a bridge or other overhead structure. Keep all body parts away from Power Tower as it is being lowered or extended up. Always travel on the highway with the Power Tower in the full UP position along with all carpet and canvas stored in latched lockers.

Underwater Lts

This switch controls the hull-mounted underwater lights. If installed, these blue LED lights illuminate the water around the aft sides and transom areas.

Fresh WTR

This switch energizes the onboard freshwater system. It permits the water pump to transport fresh water from the water tank to any faucets or showers mounted aboard.

Windlass

If installed, this switch activates the up and down movement of the anchor windlass. This switch is located at the bow anchor locker wall.

Seat Switches

If installed, there is a switch for controlling the up and down helm seat movement. Also, there may be a switch on the helm seat base for moving the helm seat forward and aft.

If installed, there is a switch for controlling the fore and aft movement of the aft seat.



Acc (Accessory)

This switch normally is unused at the factory and it may be utilized for any aftermarket equipment installed on the boat. Make sure any added components are matched to the overcurrent protection (fuse).

Elect.

This switch controls the optional plotter and VHF marine radio

SD Exhaust

If installed, this switch controls the Corsa exhaust system available on select engines. When activated, exhaust is evacuated through the hull side instead of the stern drive. Check with local and state authorities before using the system, as various restrictions may be mandated.

REMOTE CONTROL

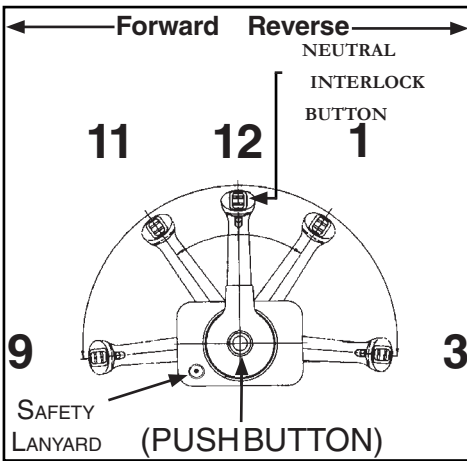

Your vessel uses dual single lever binnacle mounted controls. To help visualize the operating principals we have used a clock mode. The levers in the straight-up or 12 o'clock (neutral) position are detented and feature a push button (see illustration) which allows advancing the throttles for neutral or starting the engine without engaging the gearshifts. This

feature is useful when trying to start cold engines.



Pushing the throttle levers forward from the neutral 12 o'clock position to the 11 o'clock position will engage forward gear with minimum throttle. From the 11 o'clock position to the 9 o'clock position the vessel is in forward gear with forward throttle selections.

Pulling the throttle levers back from the neutral 12 o'clock position to the 1 o'clock position will engage reverse gear with minimum throttle. From the 1 o'clock position to the 3 o'clock position the vessel is in reverse gear with reverse throttle selections.

As you shift from neutral to forward or reverse positions, *push up on the neutral interlock button* located under the gearshift knob. This will allow the control to shift into the desired gear.

Neutral Safety Switch

The remote control features a neutral safety switch which ensures the propulsion unit and control handle are in the detented neutral position for starting the engines.

Typical Binnacle Control



You will hear a distinct sound and will “feel” the remote control in the neutral position. If you turn the key to the “start” position and the engine starter doesn't crank over the engine make sure the remote control is in the neutral position.

Remember these points when shifting :

1. Do not shift from forward to reverse gear position with the engine not running as component damage may result.
2. Do not “pump” the throttle in neutral or flooding will result. Today's engines require very little starting throttle.



CHAPTER 3

3. Do not try to shift into forward or reverse gear at high rpm's as personal injury, drive system or property damage may result.
4. Remember to squeeze the shift interlock button to engage the remote control into forward or reverse.
5. Only use idle throttle positions when docking or maneuvering in tight quarters.
6. Never shift the controls with the engine not running. Control, linkage and or stern drive damage may occur.

For more information on controls read your engine operator's manual.

Electronic Propulsion Controls ---

Your boat may be equipped with optional electronic controls for the propulsion units. These controls are manufacturer-specific, communicate digitally over an NMEA 2K network and replace mechanical ignition, throttle and shift controls. Refer to the propulsion manufacturer owner's manual for more information.



INSTRUMENTATION

The engine wiring is protected by a main breaker or fuses mounted on or close to the engine. Refer to your specific engine manual for information on type and location. If an ignition breaker “pops” figure out the reason why before resetting it.

Each dash switch is also protected by a breaker located on the breaker panel.

The helm station is equipped with a fuel gauge and depth gauge along with the ability to monitor engine functions through a display panel. Close observation of the gauges may save the engine from damage. Gauges do, however, have some inaccuracy, so do not rely upon them fully.

Note with the battery switches in the OFF position, there is no power to the dashboard, and the ignition switch will not function properly.



CHAPTER 3

Depth Gauge



The depth gauge indicates the water depth under the keel of the boat. It features a shallow water alarm to warn the skipper of hazardous situations. By monitoring the water depth, damage to props and underwater hardware can be avoided. This gauge is connected to a transducer on the bottom of the hull, accessible through a removable plate in the ski locker.

Fuel Gauge



The fuel gauge indicates the level of fuel inside the fuel tank as sent by the fuel sender. It is a good idea to keep the fuel tank “topped off” when possible to reduce fuel vapors inside the tank. Do not run your fuel too low, as this style gauge is not always accurate. Always allow for a “safety” factor.



Gas Vapor Detector



If equipped, the gas vapor detector determines if there is a level of gasoline vapors that is unsafe in the engine room of the boat. If installed, turn on the unit and wait about one minute for it to do its safety test. If all is well it will display a green light. You must run the test before you start the engines. In the event you don't get a green light, you must investigate the

bilge of the boat for gas fumes or signs of a fuel leak before starting the engines. If uncertain, consult a marine service professional.



Automatic Fire Extinguisher



If equipped, the automatic fire extinguishing system utilizes an instrument display unit (gauge) that provides the operator with a system status of charged or uncharged condition by an audible alarm. With the ignition turned on the indicator light shows system is charged and operating properly. With the ignition on and no light indicates the system has discharged.

If the system should discharge the ignition system will be instantaneously interrupted. Should this occur shut down the engine, ventilation blower and any electrical system components. Investigate the source of the shutdown immediately and take appropriate action. Also, in the cockpit is located a manual release for the fire extinguishing system. Find the release and read the related sections in this manual along with the vendor's information concerning the operation of the manual release. In case of emergency inform other crew members on the operation of the fire extinguishing system.

High Water Alarm

Located at the helm is another indicator device called a high water alarm. This component warns the skipper of a possible bilge emergency. There is an automatic float device installed at a predetermined bilge level. If water rises over this level the bilge switch sends a signal to the helm mounted alarm. This float device is mounted above the normal positioning of the bilge pumps. If the alarm sounds bring the vessel back to an idle position. Shift both engines into neutral and turn off both ignition switches. Open the engine hatch and find the cause of the problem. Test before each outing. Refer to operation manual.



SD

Catalyst Engine Monitoring Panel



Shown is a typical dash mounted engine emission status panel used with catalyst engines. It provides a visual and audible (beeping alarm) means of monitoring engine and emission control systems. The panel will show the outline of an engine on the left

side and a warning sign on the right.

When an emissions related fault is detected an amber colored light will appear on the left side.

When an engine related malfunction is detected the warning sign will light red on the right side. If the situation is serious enough there may be a significant power reduction of the engine.

If either of the above lights is lighted an audible short beep alarm will be activated.

When the engine is initially started there is a series of self-checks involving the various emission system sensors.

Read the engine manufacturer's operation manual for more detailed information on emission monitoring systems related to the particular engine brand installed on your vessel.



Audible Alarms

The engines use audible alarms. They are designed to use sensors which pick up deviations from the normal operating parameters.

NOTICE

Always shut off the engine when an audible alarm sounds to prevent possible engine damage. Investigate and repair the problem before starting the engine.

On start up it is not unusual to hear an audible alarm sound when cranking the engine over. This occurs normally because it takes a second or two to build up the engine oil pressure. Then the alarm will stop.

A seasoned skipper monitors his instrument panel often while cruising.

Refer to the engine manufacturer's operation manual for additional information.

Ignition Switch

Each ignition switch features 3 positions. In a clockwise direction they are off, run, and start. The start position is spring loaded and the key should be held in this position to engage the starter. Once the engine has started release the key from the start position. The electrical system will then be energized in the run position.

Be a smart skipper and remove the ignition keys from the ignition switches with children aboard and/or when there are people in the water.

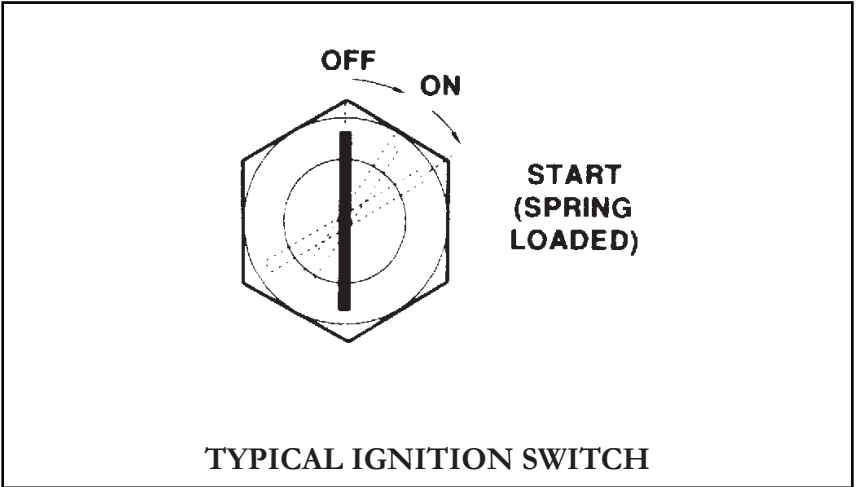

NOTICE

Do not leave ignition switch in the ON position when the engine is not running. Otherwise, draining of the battery may occur.

DISPLAY PANEL

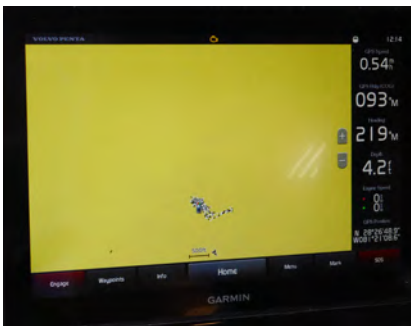

Your boat may be equipped with a manufacturer-specific display panel, sometimes referred to as a chartplotter or “glass cockpit.” The panel can be dedicated to a single function such as switching, or multi-functional for engines, navigation, systems, etc. Some multi-function displays allow side-

by-side or four-quadrant display of information at the same time. The panel can also be dedicated to the propulsion system.

Operation of the display can vary by type, brand, and installed options; be sure to read the display operation information and control specific user manuals for proper use.



CHAPTER 3

The display panel and some electronic controls can also integrate one or more optional capabilities such as:

- Auto Pilot
- Station Keeping
- Cruise Control
- Tow Control
- Trim Control
- Second Station
- Joystick Operation
- Radar/AIS/Video/Camera Image Display

Some options can be retro-fitted if the NMEA 2K network is in place, but it is dependent on the propulsion/display manufacturer. Your Regal dealer is your best source of information.



WARNING

Multi-function display panel features and options are only tools to assist skippers with operation. Use of these tools does not relieve the skipper of the responsibility to safely operate the boat.

- **Never leave the helm unattended and be prepared to quickly regain helm control should a situation arise.**
- **Never operate the boat while watching video. Distracted driving while the boat is moving is extremely dangerous.**
- **Units with GPS are a navigational aid only and cannot be used for precise measurement of direction, distance, location or topography.**



Systems

BILGE/DRAINAGE SYSTEM

Regal boats are designed with a drainage system so water can be moved to the bilge from the deck where it can exit hull side via a thru-hull fitting. It is important to keep all drains clear of debris so when a wave floods the deck of the boat, all water will leave in an effective manner.

The bilge pump is used to remove any accumulated bilge water. It sends the water through a hose and a hull fitting to the outside sea water. Even with the switch in the OFF position, the bilge pump will automatically activate through a float switch located near the pump itself. This feature is especially useful when the vessel is moored and vacant. When excess water causes the float switch to rise, the pump activates in the automatic position and a red icon lights up on the switch bottom. The operator should monitor this icon periodically while operating the vessel. If the light activates, stop the vessel and investigate the problem. Check the bilge pump before each outing and remove any foreign objects caught in the float switch or bilge pump grating. Never run the bilge pump in a dry mode since it may shorten the pump life. The bilge pump is energized, even with the battery switch turned to the OFF position.

Monitor your bilge pump condition to keep your vessel from sinking due to taking on large amounts of water. Debris should be cleared from the impeller regularly. Inspect the condition of the impeller and replace the impeller as necessary. To gain access to the impeller, the pump must be disassembled from the bilge pump grate. Simply push the tabs of the grate inward towards the bilge pump, while simultaneously pulling up on the bilge pump. This locking mechanism functions much like a



CHAPTER 4

quick disconnect clip. If the breaker for your bilge pump “trips”, be sure to investigate why the bilge pump was drawing too much power. Likely causes of bilge pump malfunction are debris in the impeller, bad impeller, debris in the float switch, bad motor, or short circuit.



Typical Bilge Pump And Automatic Float Switch



FUEL SYSTEM

The fuel system consists of a fuel tank, fuel fill fittings, fuel hoses, fuel vents, anti-siphon valve, internal tank valves, fuel filter, fuel gauge and sender. Each one of these components plays an important role in providing an uninterrupted flow of fuel while operating your boat.

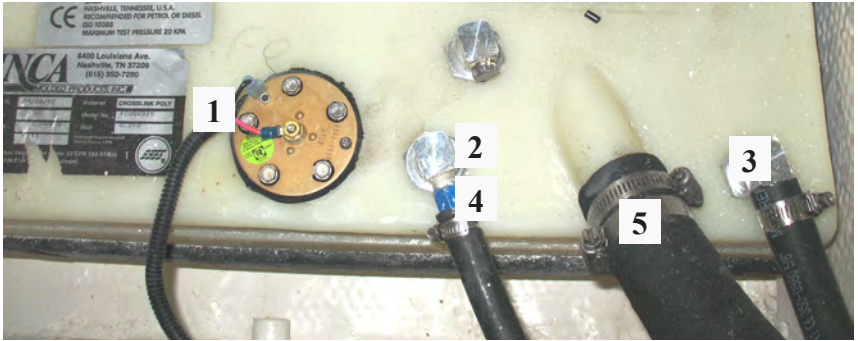

European Style Fuel Tank Shown

- | | |
|----------------------|-------------------|
| 1) Fuel Sender | 4) Fuel Feed Line |
| 2) Anti Siphon Valve | 5) Fuel Fill Line |
| 3) Fuel Vent Line | |



CHAPTER 4

Fuel Tank

Select overseas vessels use a polyester tank. *Boats manufactured for domestic use are now required to be EPA compliant and will be outfitted with an aluminum tank.* This system uses parts such as a valve located inside the fuel tank and cannot be serviced. Also, there is a carbon canister that functions much like the one in an automobile located between the fuel tank and hullside vent. This canister under normal usage requires no service. These tanks are tested along with the complete fuel system for safety requirements and quality in house. Also, they are inspected independently by National Marine Manufacturers Association for conformance with American Boat and Yacht Council standards.

TYPICAL EPA COMPLIANT FUEL TANK

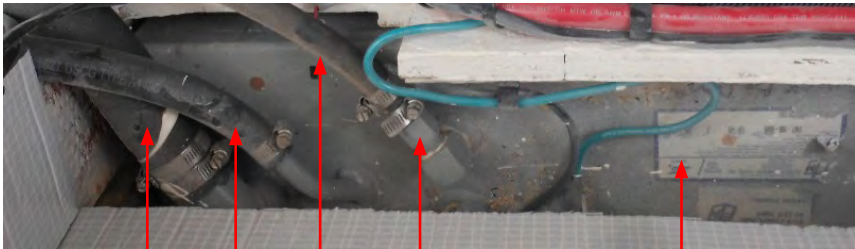

FILL HOSE VENT HOSE FEED HOSE ANTI-SIPHON VALVE FUEL TANK LABEL



Fuel Fill/Vent

The fuel fill fitting is labeled “gas” and in addition displays the international symbol. When fueling the boat keep the fill nozzle in contact with the fuel fill pipe since it decreases static electricity. Always use the recommended fuel octane rating as specified in your engine owner’s manual.

Extinguish all flame-producing agents before fueling!



Currently, domestic EPA-compliant fuel tanks vent fumes back into the fuel tank system. While the tank is filled, air displaced by the incoming fuel is vented through the fuel system charcoal canister.

Your vessel uses a combo type (internal vented) fuel fill. Both the fuel fill and vent occupy the same cavity under a protective cover. If fuel overflows through the vent, the design forces it back into the fuel fill hose and tank.

A seasoned skipper will hear a distinct sound as the tank nears the “top out” or full mode and may see fuel overflowing back into the fuel hose through the vent. **DO NOT OVERFILL THE TANK.** This helps avoid any overboard spills that harm the environment. There is a key that fits the fuel fill. Use it to secure the fitting from leaking fuel. Store the key in a safe place so it can be easily found for fueling. Check the vent fill screen periodically for debris.



CHAPTER 4

Fuel Hoses

Fuel hoses transport gasoline from one component to another. These hoses are required to be of certain diameters in order to comply with engineering and environmental standards. Hoses showing signs of cracking or abrasion must be replaced immediately. Hose clamps are often used to seal the hose to a fitting, and these connections should be checked regularly.

Anti-Siphon Valve

The fuel tank feed line uses an anti-siphon valve. The valve is threaded into the fuel tank fitting at the feed line. The valve is pulled off its seat by fuel pump pressure as the engine is cranking or running. It allows a one-way fuel roadway to the engine fuel pump. It prevents fuel from siphoning out of the tank in the event of a fuel line rupture or disconnected fuel feed hose. Never remove an anti-siphon valve as it is a fuel system safety component. Clean or replace a clogged or stuck anti-siphon valve. Contact your closest Regal dealer or certified marine technician for more information.

Fuel Gauge and Sender

The dash fuel gauge is only an indication of the onboard fuel supply. They are not exact reading instruments. Therefore, use the one-third rule presented earlier for monitoring your fuel supply. *There are not many filling stations on the open waterways!* The gas sender located in the fuel tank uses a float system, which sends a signal regarding the fuel tank level to the dash fuel gauge.



Fuel Filters



Outboards use a 10 micron-style water separator filter which is a spin-on type similar to an automobile oil filter. Its main purpose is to trap dirt particles and condensation in fuel. If the fuel becomes contaminated with water, the water separator filters must be replaced. It is a good idea to keep an extra fuel filter on board along with a filter wrench, catch container and clean rags for emergencies. Never use automotive-style fuel filters on your vessel. Dispose of all fuel residue materials in an

environmentally safe fashion. In-line water separator filter is previously shown. Refer to engine manufacturer's manual for additional information.



ELECTRICAL SYSTEM

The standard electrical system on board uses a low voltage system called direct current (DC for short). It is referred to as DC because current flows one-way in the circuit.



WARNING

Always use caution when operating and maintaining the 12V DC electrical system. Improper use of the electrical system may cause a fire or explosion, which could result in death or serious injury.

Direct Current (12 volt DC)

Batteries are the heart of the onboard DC electrical system. The system consists of two group-24 wet-cell type batteries for the engine-cranking circuits and one group 31 for the house circuit.

The engines require large reserve amounts of battery power for starting purposes. Check the maintenance chapter for battery specification information.

Batteries supply the power to crank over the engines and to operate the electrical equipment through the engine charging system. The dash voltmeter displays the battery voltage. If the voltmeter shows below 12 volts there could be a charging system malfunction. This condition needs to be investigated before the batteries become completely drained.

NOTICE

Never switch off the batteries from an engine while it is running. Doing so will damage the charging circuitry of the engine.



The battery hardware features a red boot to protect the positive terminal and a battery tray with hold-downs. Make sure the red (positive) boot is completely covering the positive terminal of the battery. Check the terminal nuts periodically for tightness and corrosion.



In colder climates consider battery removal for the winter months. Trickle-charge as needed, placing battery on wood in a well-ventilated area free from any gas or propane appliances.

NOTICE

Never charge a battery in the boat or directly on cement. Remove the battery from the boat first. Check the water level periodically on non-maintenance-free batteries. Add distilled water only.

Contact your closest Regal dealer for further battery information and service schedules.



Battery Management Panel



Your boat features a battery management panel located at the starboard cockpit area. This battery management panel includes twin battery switches. *The port on/off style battery switch controls the house battery functions.* The circuit is protected by a 150 amp circuit breaker located close to the sump battery bank.

NOTICE

Never turn off the engine's battery switch while the engine is running. The engine's alternator and electronics could be damaged.

The starboard battery switch controls both engine cranking batteries. Notice that the starboard engine battery switch can be switched to “combine batteries” which will permit cranking either engine with both engine batteries simultaneously. This can be useful if one of the batteries is discharged. Be sure to reset the switch to ON after the engines have started.

Notice the four breakers at the panel center. These breakers protect the distribution panels located at the helm and in the cabin. Also, note there are additional equipment breakers at the top port and starboard panel.

NOTICE

Should a breaker “trip” or fuse “blow” determine the cause of the problem before resetting the breaker or replacing the fuse. When replacing breakers and fuses use the correct type and amperage.



WARNING

Never replace a failed fuse without first correcting the problem. Failure to make necessary corrections may create a dangerous electrical situation that could result in death or serious injury.

When leaving the vessel for extended periods of time it is recommended to deactivate each of the battery switches. Even with both switches in the “off” position, the automatic bilge pump and stereo memory remain energized.

Voltage Sensitive Relay Module (VSR)

Located next to the battery switches on either side of the battery management panel are 2 voltage sensitive relay modules. The purpose of the VSR is to protect the battery circuit from being discharged. Also, when the engine batteries are fully charged it can send current to the house battery.

When the engine cranking batteries rise above 13.7 volts DC the VSR switches to charge (cranking and house) both batteries simultaneously. When the battery voltage drops to 12.8 volts DC the VSR disengages.

This VSR capability is known as “dual sense” technology. It permits the VSR to sense the voltage of all batteries that the unit is connected between. If one of the batteries is receiving a charge the VSR will close by paralleling both battery banks to charge the house battery along with the engine cranking batteries.

If the VSR senses the engine batteries are being discharged at a fast rate it will open and will not allow those batteries to be overly discharged to the point that the engines will not crank.

An example of the above situation would be if the vessel was stationary at sea for an extended period with various electronic and entertainment equipment energized along with the engines off the battery (ies) would normally discharge.



CHAPTER 4

NOTE: The VSR uses a LED type light that indicates that the VSR is closed and is sending a charging current to the batteries.

If the LED light stays on after the engine is turned off do not panic. This is a normal condition. The residual battery voltage because of battery charging has not yet dropped below 12.8 volts for the VSR to cut out.

Breaker Panels

Your vessel features 2 main breaker panels. One of these panels is located at the helm area. Become familiar with the components that this panel protects. Should a breaker “trip” find the cause of the problem before resetting the breaker. Push in on the breaker to reset it.

Select breakers may not be used on your boat for optional accessories.



UNDER HELM BREAKER PANEL



Wire Color Codes

Wire color, gauge and function shown is used throughout the marine industry. Your boat may not feature all these functions, as some are optional features or are unavailable on your model.

COLOR	GAUGE	FUNCTION
Black	16 to 4	All Grounds
Black / White	16	Halon Automatic Fire Extinguishing System
Blue	14	Interior Lights
Blue	10	Cabin Light Main Feed
Blue / White	16	Transom Courtesy Lights
Blue / White	14	Cockpit Lights
Brown	12	Water Pressure Pump
Brown	16	Aft Bilge Pump / Manual
Brown	16	Fwd. Bilge Pump / Manual
Brown / Black	10	Overboard Discharge
Brown / Pink	16	Carbon Monoxide Detector
Brown / Red	16	Fwd. Auto Bilge Pump
Brown / White	16	Aft Auto Bilge Pump
Grey	16	Bow Navigation Lights
Grey / Black	16	Mast Light (Anchor Light)
Grey / White	16	Mast Light (Fwd. Running)
Green	16	Tank Level Monitor
Green	8	Bonding
Orange	16	Windshield Wiper / Run
Orange	12	Refrigerator, Hatch Run
Orange	10	Spotlight
Orange / Black	16	Horn
Orange / White	16	Windshield Wiper Park
Purple	16	Hour Meter
Red	16	Gas Vapor Detector, Stereo Remote, Breaker To Dash Feed Lines
Red	14	Positive Feed, Electronics
Red	8	Positive Feed, Alternator Charge



CHAPTER 4

COLOR	GAUGE	FUNCTION
Red	4	Positive Feed
Red	2	Positive Feed, Starter Battery
Red	2/0	Main DC Panel Feed
Red	2/0	Battery Cable To Engine
Red / Black	16	Windlass Up
Red / White	16	Windlass Down
Yellow / Black	10,16	Stereo Memory
Yellow / Black	16	Waste Tank Monitor
Pink	16	Fuel Tank Sender
Red / Black	16	Stereo, Regal Vue
Yellow / Red	14	Engine Cranking Circuit

FRESH WATER SYSTEM



WATER FILL



Your vessel is equipped with a fresh water pressurized supply system. It consists of a water tank, fill/vent fitting, sink, drain hose, faucet and a washdown or transom shower, if equipped. Water is supplied by a fresh water pressure pump.

A water fill fitting is normally located on the deck area. It features an internal vent. When the water tank reaches full capacity water will be seen cycling from the vent into the fill hose. To energize the system there is a dash switch marked fresh water pump. When activated the switch sends power to the pressure pump which supplies fresh water.

When the water supply line is full a pressure valve switch releases and the fresh water pump stops.

We recommend turning the water pressure switch “off” when the vessel is left for extended periods.

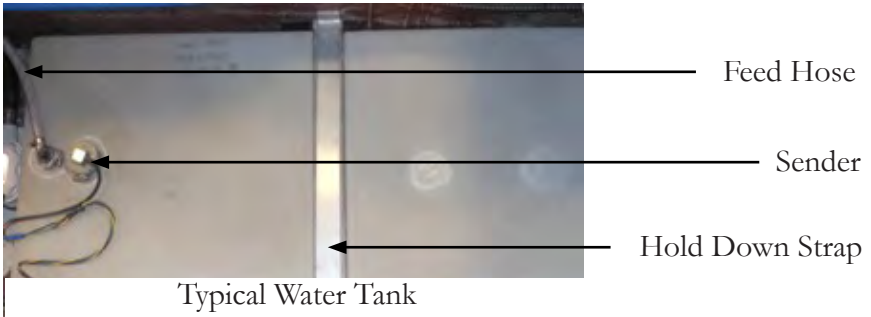

The fresh water tank level is located under the cockpit floor. The capacity is approximately 29 gallons. A feed hose connects the system to the fresh water pump/strainer for distribution purposes. In cold climates, use appropriate winterization procedures for entire water system.

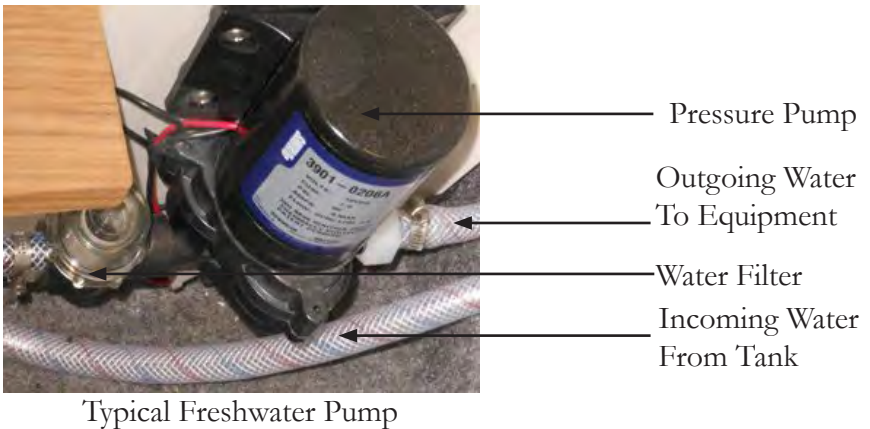

NOTE: The fresh water tank level should be topped off before leaving the dock. Ensure the water quality is potable before filling the tank at the deck fill point.

To Fill Fresh Water System:

1. Unscrew the “water” fill deck fitting. Fill the fresh water tank with approximately 29 gallons of fresh water with a suitable container or hose. Make sure the water is safe for drinking.



CHAPTER 4

2. Find the fresh water pump breaker located on the 12 volt head panel and pull the switch out to engage it. You will hear the pressurized water pump fill the entire system with fresh water. When full the pump pressure switch will stop the pressure pump.
3. Open the faucet to allow any air to escape. Close the faucet when there is a steady stream of water without air. You will hear the fresh water pressure switch shut off indicating the system is full.
4. After these initial procedures, “top” the system off with fresh water.
5. Check for system leaks as evidenced by the pressure water pump recycling even though no water is being used from the components.
6. It is a good idea to turn “off” the fresh water pump switch after each use and especially during extended times of non-use.
7. Clean the pressure water filter periodically by disassembling the filter element and rinsing in fresh water. Ensure the pump switch is off. Replace and check for leaks. For parts, contact an authorized Regal dealer.

NOTICE

Do not activate the freshwater system with the water tank empty. Activating the system with the water tank empty could cause damage to the pressure pump.



STEERING SYSTEM

Electronic Steering System

Your boat may be equipped with an electronic steering system. The system uses a helm-mounted unit with a steering wheel that controls a cylinder mounted to the drives, outboards or rudder.

Electronic or steer-by-wire systems consist of an electronic helm unit, helm-mounted display screen, aft-mounted pump control module, aft-mounted hydraulic pump/reservoir and drive/rudder-mounted hydraulic cylinder. The electronic components communicate over a data network to control the hydraulic pump to operate the cylinder and steer the boat. The steering pumps have an integral service valve that can be opened to bypass the pumps for service or in case of emergency. Refer to the steering manufacturer owner's manual for more information.

The electronic steering systems allow for easy integration with NMEA 2K compatible joystick controls and autopilots, and can be dealer-programmed to adjust engine-toe and turning ratio. The systems also have built-in redundancy and safety features.

NOTICE

The drives must be aligned to provide maximum stability on straight-ahead runs and proper tracking through cornering. Damage to the drives or steering system may require the drives to be realigned by your dealer. Refer to the drive manufacturer's owner's manual for specific information.



Notes



Vessel Operation



This chapter explores the many phases of running your vessel from casting off to docking and handling emergencies. We cover the basics but suggest you read other information on the chapter topics. Also, become familiar with your engine owner's manual since many of the items discussed here are found there in more detail.

GETTING UNDERWAY

Pre-Departure Questionnaire ---

- Is the drain plug in place ?
- Have all fluid levels been topped off?
- Is there enough fuel? (1/3 to get out, 1/3 to return, 1/3 reserve)?
- Is all required safety equipment accounted for and easily accessible?
- Are navigation lights and horn operating properly?
- Is the bilge free of water and does the bilge pump operate?
- Are the engines, drives, and propellers in good working condition?
- Have all passengers been briefed on emergency procedures and seated for departure? Is the boat load balanced?



CHAPTER 5

- Is the operator sober, alert and ready to skipper the vessel?
- Has weather information been gathered and analyzed?
- Have all passengers been fitted for life jackets and briefed on safety equipment locations?
- Has a float plan been filed and left with a component person?
- Has the bilge been sniffed and the fuel system leak checked?
- Are the seacocks open (if applicable)?
- Is all communication equipment in good operating condition?
- Has a second person been briefed on operational procedures should the skipper become disabled?
- Are all gauges and electrical switches functioning properly?

Underway Questionnaire

- Is the remote control safety lanyard (if equipped) tightly secured to your belt or clothing?
- After casting off have all dock lines and fenders been stowed?
- Are all passengers seated properly and all transom doors closed?
- As skipper are you monitoring the dash instruments for changes?
- As skipper are you on the lookout for changing weather?
- As skipper are you checking for abnormal vibration?



Disembarking Questionnaire

- Have you removed the keys from the ignition and secured them?
- Have all systems been checked for leaks?
- Has the battery switch been turned to the “off” position?
- Are all seacocks closed?
- Has the fuel tank been filled enough to prevent condensation?
- Is the vessel properly tied and covered with equipment stored?

NOTICE

To prevent unwarranted engine damage, see your Engine Operator's Manual for manufacturer-recommended fuel and oil specifications.



WARNING

Always follow safe practices when fueling. Gasoline is extremely flammable and highly explosive under certain conditions. Failure to follow safe practices when fueling could result in death and serious injury.

When refueling, observe the following:

- Have a proper and charged fire extinguisher ready.
- Secure the boat to the dock.
- Stop all engines, motors and fans before refueling.
- Never smoke or allow open flames or sparks within 50 feet (15 meters) of the fueling area.



CHAPTER 5

- Close all doors, windows, hatches and ports that could allow fuel vapors to enter the boat's enclosed spaces.
- Avoid spills and know how much fuel is already in the tank before adding fuel. Wipe up any spills immediately.
- Always fill fuel tanks slowly. Be aware that if the boat's attitude changes while floating, the fuel level and position change in the tank, which could cause spillage.
- Never overfill the fuel tanks.
- Always allow space (at least 6%) for expansion of fuel in the fuel tank.
- Check to be sure you are filling the proper tank; some deck filler plates appear similar to the fuel tank.
- Never pump fuel into an unapproved container.
- Use only fuel approved by the engine manufacturer.
- Check for fuel leaks.
- Refuel only at safe and approved filling stations such as marina fuel docks or automotive fuel stations. Approved venues have safeguards in place to lessen the likelihood of static discharge.
- Read and follow all warnings on the pump or in the vicinity of the pump.
- Maintain contact between the fuel nozzle and the fill pipe at all times, before and during refueling, to prevent an electrostatic spark.
- Keep away from the fuel tank vent to avoid splash-back and fumes.
- Never reenter your vehicle while refueling on land and towing your boat. Getting into and out of your vehicle might build up a static charge that could ignite the fumes at the fill pipe.



- If a fire occurs, do not panic, and do not remove the nozzle from the gas tank.
- Evacuate all passengers from the vehicle and refueling area, and immediately alert station attendants so they can use the emergency shutoff and fire extinguisher.
- If you are unable to pump fuel at a reasonable speed, check the fuel tank vent for restrictions.

After refueling, observe the following:

The first time you fill your boat's fuel tank(s) and after each refueling, check the entire fuel system for leaks and/or damaged parts. Leaks and/or damaged parts must be repaired and the area ventilated to remove explosive fumes.

- Close the fill cap(s) securely.
- Wipe up any spilled fuel completely. Dispose of the rags properly.
- Open all doors, windows, hatches and ports to ventilate all spaces.
- Check for fuel vapors before starting any engines or appliances.
- Operate the bilge blower (if installed) before the engine is started for a minimum of 4 minutes.



WARNING

Always operate the bilge blower (if installed) prior to starting the engines or generator. Gasoline vapors can explode, resulting in death or serious injury. Before starting the engines or generator, perform the following:

- **Sniff the engine room for fuel vapors.**
- **Operate the bilge blower(s) for a minimum of 4 minutes.**
- **Verify the bilge blower(s) are operating properly.**

Always run the bilge blower when the vessel is operating below cruising speed.



WARNING

Be sure to inspect the entire fuel system for deterioration and leakage at least once a year. Failure to inspect the entire fuel system at least once a year may result in fire and explosion caused by a deteriorated and/or leaking fuel system component that could result in death and serious injury.

STARTING & STOPPING

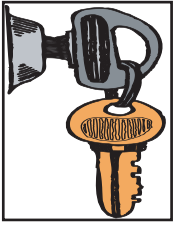

The following general information covers starting and stopping your engine. Read and understand all previous information on remote controls, fueling and operational procedures. Pay particular attention to all labels. Refer to the engine owner's manual for in depth propulsion system information.

WARNING

Always operate the bilge blower (if installed) prior to starting the engines or generator. Gasoline vapors can explode, resulting in death or serious injury. Before starting the engines or generator, perform the following:

- **Sniff the engine room for fuel vapors.**
- **Operate the bilge blower(s) for a minimum of 4 minutes.**
- **Verify the bilge blower(s) are operating properly.**

Always run the bilge blower when the vessel is operating below cruising speed.

Starting Guidelines

Review all pre-departure information. Before starting your engine make sure all canvas is removed and stored. Start engine only in a well ventilated location to avoid CO buildup. Turn the battery switch to the number 1 or 2 position.



Set the remote control handle in the neutral position. Advance the neutral throttle position as instructed in the engine owner's manual. Connect the safety lanyard (if equipped) to a belt or secure to clothing such as a pants belt loop. Keep passengers seated and away from controls.

For stern drives turn the key to "momentary" start position. You will hear the starter cranking over the engine. When the engine starts release the key switch. It will automatically align itself in the run position (ignition).

If the engine does not start, refrain from cranking the engine over 10-12 seconds. Allow the starter and battery a chance to recover. Advance the remote control in the neutral throttle position as recommended in the engine manual. Do not race the remote control in the neutral position.



For starting outboards:

Position the key switch to the right ignition position or the engine will not start. Press the start/stop button.

You will hear the starter cranking over the engine. When started, release the button. To stop the engine press and hold the start/stop button or turn the ignition key to the "off" position.

Note that both outboards can be stopped by turning the key switch off or by pressing each of the stop buttons.

Insert the control in the neutral idle position before attempting to shut down the engine.

NOTICE

If equipped, check the oil gauge immediately after the engine starts. If low or no oil reading, shut off the engine and investigate the problem. Damage to the engine may occur.



CHAPTER 5

Shifting Guidelines



Before shifting into reverse or forward gear positions make sure the coast is clear. When shifting to either gear from neutral make sure the throttle is in the idle position. Allow your vessel to lose all headway before shifting into reverse or forward gear. Practice shifting! You will become more familiar with the procedure and self-confidence will build especially in tight docking situations. Stay alert at all times!

Stopping

NOTE: Unless in an emergency, do not use the safety lanyard (if equipped) to stop the engines.

Before stopping the engines, make sure they are in neutral and at idle speed. After an outing let the engines cool down at idle speed for a few minutes before turning the ignition off. Glance at the gauges to monitor their reading.

SD

Never turn off the engine while in forward or reverse gear since water could enter the engine through the exhaust system and cause extensive damage. The same holds true for running the boat in reverse.

STEERING

The boat is equipped with an electronic helm, which affords an effortless power steering feel. The helm features lighter system friction at lower speeds and increased friction at higher speeds. The electronic helm eliminates the need for hydraulic fluid at the dash.

Check the steering system for full port and starboard before disembarking. Refer to the equipment manufacturer's manual for additional information.



WARNING

Never leave the helm unattended while the vessel is moving. The skipper must have complete control of the helm steering while the vessel is moving. Leaving the helm unattended could cause death or serious injury.

FENDERS

Fender Usage

Fenders are available in a wide range of sizes and shapes to fit both small and large vessels. They are used between piers, docks, sea walls and the boat. They protect the top sides of the boat from rubbing against rough objects. Most fenders have eyes of attachment which allow a line to be inserted vertically or horizontally. This will permit the fender to be tied off to fit a variety of marina, dock and tidal situations. Be sure the fender is correct for the vessel size. Fenders are normally made of a rubberized plastic and are usually filled with air. Most have a fitting like a basketball so they can be inflated or deflated. It is a good idea to carry extra fenders but half a dozen is normally an acceptable number. Remember to store fenders on board so they can be easily accessed.

NOTE: Your Regal dealer has a large variety of fender sizes and accessories.

Fender Types



There is a variety of fender styles and types, each selected for specified uses. When choosing fenders, contact a marine dealer or supply house. Explain how you moor and use your vessel so they can recommend the best fender type for you. We suggest the type with a fill plug so you can inflate them with a hand pump like the ones used for bicycles.



DOCK LINE BASICS

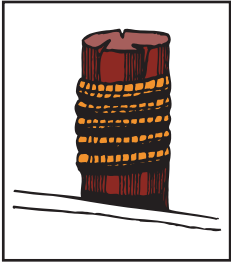

Most skippers use dock line terminology fairly loose but there is more to the basics than just bow or stern lines. There are several lines that can be secured to the bow and stern and depending on their direction and use, can be called other names. Remember that “forward” and “aft” refer to the direction that a spring line runs from the vessel, and not where it is secured on board.

Bow & Stern Lines

There is only one true bow line. It is secured to the forward cleat and run forward along the dock to prevent the vessel from moving to the stern. The stern line leads from a rear cleat to a piling or cleat on the dock astern of the vessel. This line keeps the boat from moving ahead. For small vessels these are the only lines needed for normal wind and current conditions. If located in a tidal environment, keep slack in the lines.

Breast Lines

These lines are attached to the bow and stern that lead to nearly right angles from the center of the vessel to the dock. They help keep larger vessels from moving away from the dock, or are pulled in to help people board the vessel. Larger vessels may use bow or quarter breast lines.

Spring Lines

Most small boats use two spring lines although it is possible to have four. They are called the after bow spring and forward quarter spring.



Bow springs are secured at the vessels bow area. Forward spring lines lead forward from the boat to the dock and control movement toward the stern. After springs stem aft from the vessel, and stop movement ahead. Spring lines are used to prevent movement in a berth, ahead or astern. They are really useful in controlling the effects of a real active tidal surge. Spring lines are useful where fenders need to be kept in place against piles.

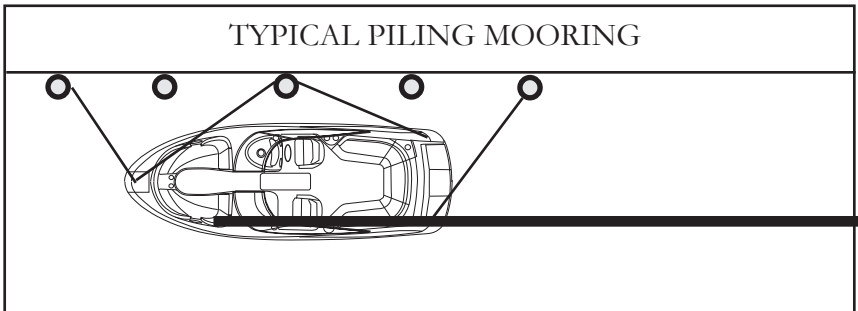
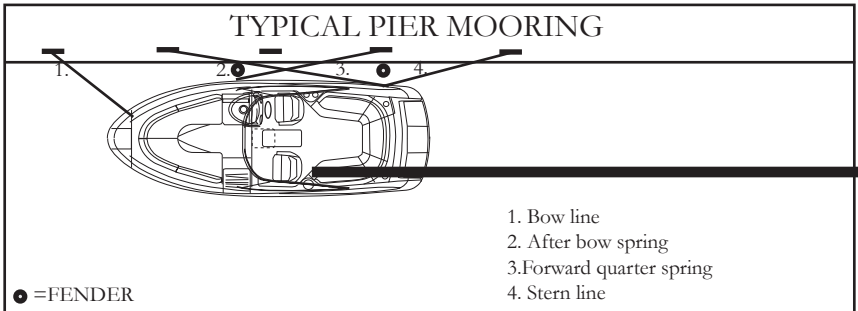

Boat Mooring

Most boats can be secured to a dock using four lines. The after bow spring is crossed with the forward quarter spring and secured to individual dock cleats or pilings. This ensures longer springs and can be snugged up tighter for more efficient tidal control. Remember, if you only have one piling available, position the vessel so this point is opposite admidships. Run both spring lines to it. These lines will be shorter but still useful.



CHAPTER 5

The bow and stern lines should be relatively at a 45 degree angle with the dock. The stern line can be attached to the near-shore quarter cleat, but will work more efficiently to the offshore quarter cleat. The longer line will allow the boat flow with the tide with less time checking the vessel.

Dock Line Sizing

Most dock lines today are made of nylon, either of twisted rope or braided core and cover. The most often used material is nylon because of its stretching abilities absorbing shock loads. It is chafe resistant for extended life and is easier on bare hands.

The line's size varies with the vessel. Normally, a vessel in the 20' to 40' boats will use 1/2" diameter nylon lines. Larger yachts use 5/8" and 3/4" diameter nylon lines. Smaller boats can use 3/8" nylon lines.

Dock lines need to have the strength to hold the vessel and have enough density to resist chafing. They shouldn't be too heavy that they lose their shock-absorbing capabilities. Use the right size line for the vessel since a line too large for the boat will pull hard against the vessel since it won't be forced to stretch. If the line is too small for the vessel, there is no margin for wear and chafe when under strain.

NOTE: Consult your Regal dealer for appropriate lines and chafing protection.

Securing Lines

When mooring your boat, make sure the dock lines are secured at both ends. Depending on your situation you may need to loop the eye splice of the dock line around a piling. Sometimes the mooring line will lead down sharply from the piling to the deck cleat. Loop the eye splice around the piling twice to keep it from being pulled up off the pile. Pull the line through the looped eye if the mooring line is too small to go around the piling twice or too small to fit over once.



If you must drop a line over a piling that already holds another boat's line, run the eye of the line up through the first eye from below, then loop it over the pile. This will allow either line to be removed without disturbing the other. If another line is dropped over yours, simply reverse the process. Secure a little slack in the other dock line, then slip your eye up through its loop and over the top of the pile. Your line can be dropped through the other eye.

When debarking from a dock, it is easier to release the line from a cleat or piling, from on board the boat, as soon as you leave the dock. Loop a long line around the cleat or pier and leading both ends on board you can release the line easily. Slip one end around the cleat or pile, then pull it back on board. Release the line without the eye splice, so it will run freely from around the pile without hanging up on the splice.

DOCKING

Twin Powered Boats

As a general rule, stern drive twin powered boats are fairly easy to back up and maneuver with a little knowledge and docking practice.

One of the most important aspects of the docking and/or maneuvering process is to keep your calm in the wake of a busy marina. Some boats tend to be influenced by the wind. When backing down in a crosswind, allow room to maneuver and watch the bow. Try not to overreact or get excited, but use your knowledge and experience. Appoint passengers as "lookouts" to alert the operator of any unusual situations.

Twin-powered vessels can be easily maneuvered in tight quarters which is always a plus in winds, currents, or busy marina environments. Depending on the conditions, stop the boat in front of the dock slightly to windward or up current. The steering wheel can be used as needed. Use the examples below as a guide since each situation can be unique.



CHAPTER 5

It may be necessary to switch “starboard” for “port” and vice versa. In the following instance, engage both gear shifts in reverse with both throttles in idle as backing begins.

As the boat begins to back, it will track in a port direction. By moving in a forward direction with the port engine the boat will be forced to turn and align with the dock. When you reach a comfortable alignment, the port engine is put in reverse which will allow continued backing to the dock.

Some adjustment in tracking can be realized by putting either control momentarily in neutral or forward. Going forward on the port engine pushes the stern to port; the starboard engine going forward pushes the stern to starboard. Again, keep your calm and do not overreact to the situation.

Twin Powered Boats Maneuvering ---

Twin powered vessel propellers are counter-rotating which will balance steering torque. On most twin powered vessels the port propeller is left-handed and the starboard propeller is right-handed. Mark the propellers in case they ever to be changed or repaired at some point as they could be mismatched on reinstallation since they both fit the shaft.

Moving forward with the starboard engine for a port turn, the propeller offset from the centerline enhances significantly to pushing the stern to starboard.

In reverse, the starboard propeller throws its thrust energy toward the starboard side of the hull to assist in turning the stern to port. The port propeller reversing, throws its thrust against the port hull side to assist the pivot of the stern to starboard.

The important ingredients in turning and steering are combined by the outward turning propellers. The steering result is used in the same direction as the turning movement caused by the off centerline propeller location.



Gathering Headway

As opposed to a boat with a single propeller, when a twin powered vessel's engines are put in gear together, the vessel will make headway without the tendency to pull to the port or starboard. Of course the throttles must be in the same rpm range as read on the tachometers. This factor is very basic to this type of vessel having superior handling and control in tight spaces along with being able to handle wind and current much more adequately than single screw stern drive boats.

Turning

When maneuvering twin powered boats at slow speeds the steering wheel is not normally used; the skipper uses the shift and throttle handles to control the vessels actions.

A vessel's stern may be pushed to one side or the other by moving ahead or reversing with just one propeller. A bit of headway or sternway does accompany the turning motion. You can gain the most turning effect by energizing one drive in forward and the other drive in reverse.

One advantage of twin powered boats becomes evident when you can turn the vessel in a circle just larger than the vessel itself. As an example, to turn to starboard, the wheel can be centered, while the port engine moves forward and the starboard engine reverses.

Begin this type of turn with the engines at idle or in gear at the same rpm (revolutions per minute). For a starboard turn, insert the port shifter in forward and the starboard shifter in reverse. When the vessel starts to turn, it may begin to make headway. This relates to the boat and propeller design. As a result, you may have to advance the port throttle somewhat to increase the rpm of the reversing starboard propeller.

When the port engine speed is increased somewhat, the circle is bigger and the vessel makes headway. If the port engine speed is decreased, the circle becomes larger, but the vessel goes sternway as the reversing starboard propeller pulls it around, stern to port.



Backing Down

The twin powered vessel can use the throttles to slow down one or both engines as a help to steering when maintaining sternway. As an option, the skipper is able to stop one set of propellers for a higher control factor in reverse.

Stopping

The best way to stop a twin powered vessel is by reversing the propellers. This action will not push the stern to one side like other type powered vessels.

The skipper of a twin powered boat can use the following approach idea in both port and starboard situations; with the boat stopped, the skipper can reverse the drives so the stern will be pushed toward the dock. With the starboard approach, reverse the outboard drive to check headway when approaching parallel to a dock which will cause the stern to move in. With the port approach, the reversing starboard drive will move the stern toward the port. When approaching to put the vessel's starboard side to the pier, the reversing port drive propeller will move the stern toward starboard.



TRIM ANGLE

Your boat has the ability to angle in or out its drive unit in relationship to the transom.

The purpose of the power trim/tilt is to enable the operator to change the angle of the drive while at the helm or tilting the drive unit out of the water when moored. Changing the angle of the drive or “trimming” while underway provides the following benefits:

1. Improves acceleration onto a plane.
2. Maintains boat on plane at reduced throttle settings.
3. Increases fuel economy.
4. Provides smoother ride in choppy water.
5. Increases top speed.

In short, it is a way of fine-tuning the ride of your boat and will enable you to get the most efficient and comfortable ride possible, whatever the conditions.

If your boat is also equipped with trim tabs, they can be used in combination with the drive unit power trim to balance unequal side-to-side load distribution.



Use Of Power Trim

The power trim is normally used prior to accelerating onto a plane, after reaching the desired RPM or boat speed and when there is a change in water or boating conditions. Position passengers and equipment in the boat so that the weight is balanced correctly fore and aft as well as side to side. Trimming will not compensate for an unbalanced load.

To operate the trim, push the switch until the desired bow position is reached. The trim may be operated at any boat speed or at rest. Avoid operating the trim system when running in reverse. Observe the trim/tilt gauge which indicates the boat's bow position achieved by the trim angle of the drive unit. "Bow-Up" corresponds to the upper portion of the trim range on the gauge while "Bow Down" corresponds to the lower portion of the trim range on the gauge.

To determine the proper trim angle, experiment a little until you are familiar with the changes in your boat. The vessel will be properly trimmed when the trim angle provides the best boat performance for the particular operating conditions. A trim position that provides a balanced steering load is desirable.

To familiarize yourself with the power trim, make test runs at slower speeds and at various trim positions to see the effect of trimming. Note the time it takes for the boat to plane. Watch the tachometer and speedometer readings as well as the ride action of the boat.



Operation In “Bow Up” Position

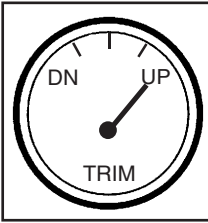

The “Bow Up” or out position is normally used for cruising, running with a choppy wave condition, or running at full speed. Excessive “bow up” trim will cause propeller ventilation resulting in propeller slippage. Use caution when operating in rough water or crossing another boat’s wake. Excessive “bow up” trim may result in the boat’s bow rising rapidly, creating a hazardous condition.

Operation In “Bow Down” Position

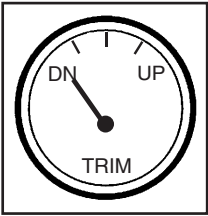

The “Bow Down” or in position is normally used for acceleration onto a plane, operating at slow planning speeds, and running against a choppy wave condition. It is also used when pulling water skiers, tubers, kneeboarders, etc. In this position the boats’ bow will want to go deeper into the water. If the boat is operated at high speed and/or against high waves, the bow of the boat will plow into the water.

Operation In “Level” Position

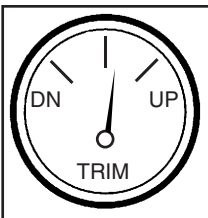

In normal running conditions, distribute passengers and gear so boat is level. At or below cruising speeds, trim the vessel for optimum performance. The trim gauge will show somewhere in the center of the gauge. This position will also enhance running visibility and overall stability. Again, each outing provides different wave, load and running conditions. Be prepared to make trim changes as needed.



CAUTION

Always adjust the boat trim to provide balanced steering as soon as possible each time you get underway. Some boat/engine/propeller combinations may create boat instability and/or high steering torque when operated at/or near the limits of the “Bow UP” or “Bow DOWN” positions. Boat stability and steering torque can also vary due to changing water conditions. Operating the boat with unbalanced steering could produce a dangerous steering condition that could result in minor or moderate injury. If you experience boat instability and/or high steering torque, see your Regal dealer immediately.

Shallow Water Operation

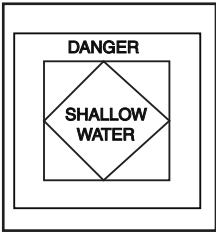

Operating your vessel in shallow water presents various hazards. You are more apt to hit a submerged object such as a rock, sand bar, stump coral, or other unmarked objects.

Pay close attention to your charts for descriptions of any shallow areas along with marked submerged objects. Always post a lookout when operating in shallow water. Trim the drives up as needed to provide adequate draft. Set the alarm on the depth sounder and travel at a speed that will keep the boat level in these shallow areas.

If your boat strikes a submerged object stop immediately and check for hull, outdrive and propeller damage.



Vessel Operation

TRIMMED "TOO FAR IN" POSITION

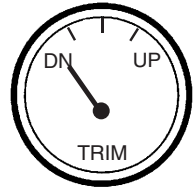

TRIMMED "TOO FAR OUT" POSITION

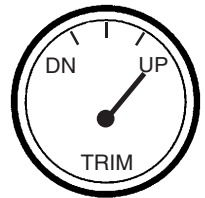
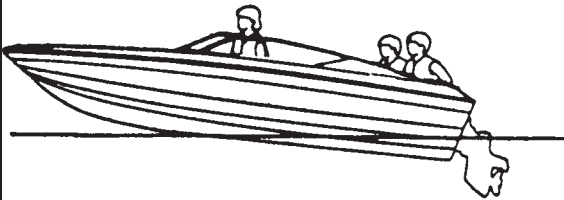

WELL TRIMMED "LEVEL" POSITION

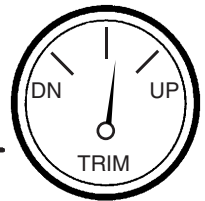
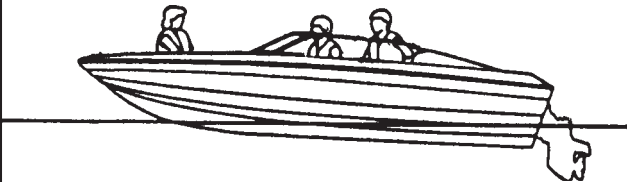

WARNING

On stern drive boats, do not run engines above 1000 rpm with the stern drive trimmed for shallow water maneuvering since the stern drive is out beyond the gimbal ring side support brackets. Operating in this manner could produce a dangerous steering condition and could result in death or serious injury and damage the stern drive components.



ANCHORING

Selecting the correct anchor is an important decision. The anchor style in part depends on the usage and boat type. Regal boats designate an anchor type and or model. Some models incorporate chain, line with the windlass. Consult your Regal dealer and local boaters for more information on anchor types.



Anchoring is easier with another person on board. First be certain that the line for the anchor is properly attached, to avoid losing the anchor and anchor line overboard.

For most anchors to perform more efficiently, you should attach 3 to 6 feet of chain. The chain will stand up to the abrasion of sand, rock, or mud on the bottom much better than a nylon line. It should be galvanized to reduce corrosion. Next, attach a length of nylon line to the other end of the chain. The nylon will stretch under a heavy strain cushioning the impact of waves or wind on both the boat and the anchor.

To anchor, select a well protected area, preferably with a flat bottom. Contrary to modern belief, you do not throw the anchor over while the boat is making headway, or moving forward. In fact, the bow of the boat should be brought slowly backward, while easing the anchor slowly over the side of the boat until it hits the bottom. To “snub the line” means to stop its outward “pay” or movement. Usually the length of anchor line used should be 5 to 10 times the depth of the water.

After you have anchored, check your position with landmarks if possible. You need to continue to monitor these landmarks to make sure you are not drifting. Since anchoring can also be an emergency procedure, the anchor and line should be readily accessible.



Vessel Operation

For increased holding power in windy conditions, two anchors are sometimes set. If your primary anchor drags, you can run out your secondary anchor without picking up the primary one. The important thing is to lay them out at an angle. When setting two anchors, make sure they are fastened to separate rodes or cleats. This is done in case you need to adjust one later so the line is accessible.

If two anchors are used ahead of a boat, make sure to set the rodes at an angle rather than in a straight line to reduce the chances of tangling as the boat moves in wind and current.

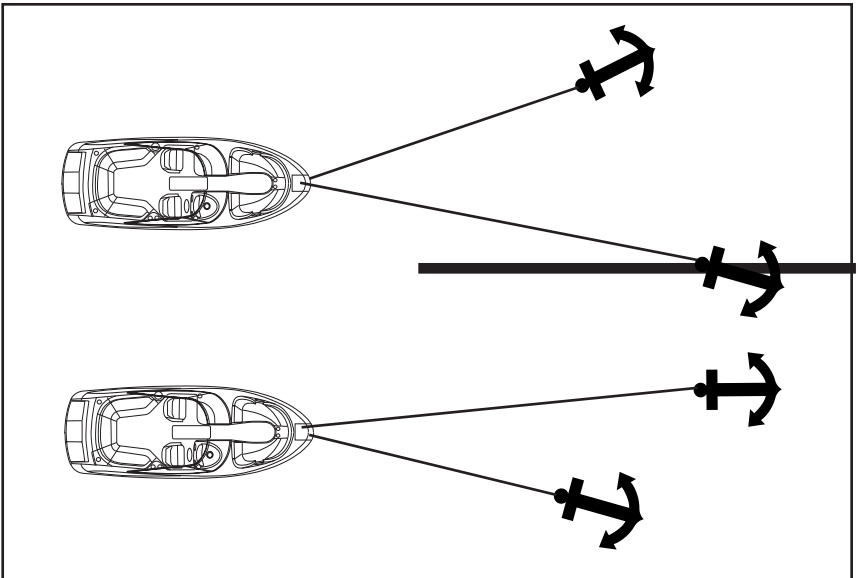



TOWING



Never use deck hardware including cleats for towing. Deck hardware is intended for mooring and anchoring. Deck hardware may become unattached from the boat and could result in death or serious injury and damage to the boat.

In case you find yourself aground or in need of a tow, or should you want to tow another vessel, keep in mind that you **never use deck hardware or cleats to secure lines for towing!**

Deck hardware is intended for mooring and anchoring, and is not designed to withstand the strain and pull of towing. Rather than tie the line to your cleats on deck, it is suggested that you tie a bridle by passing a line completely around the hull of your boat to avoid damage.

When towing, always stand clear of a taut line, as any type of line breaking under stress can be extremely dangerous. The preferred line for towing is double-braided nylon, as it has sufficient elasticity to cushion shock loads. Move slowly and cautiously.

Law Of Salvage

The Admiralty law sometimes referred to as the salvage law was founded primarily on English law fundamentals and basically says that a vessel distressed, in danger of flounder, if rendered assistance from a towing company or private agency, can be forced to relinquish a portion of the vessels' worth for the assistance received.



NOTICE

In the event your vessel is in distress, prior to allowing any towing company or private agency the right to pass a line to your vessel, be sure to establish that you do not agree to any salvage rights. Establish with the captain or operator that you wish to be assisted in a contract basis and establish a price.

Of course in certain situations, you may not have this option.

Use your best judgement!

Knots

Knots are useful in docking, towing and other emergency situations. Learning to tie knots requires practice. As they say “Practice makes perfect”. Some of the knots used in boating are the square, bowline, anchor bend, clove hitch, figure eight and half hitch. There are several periodicals available that explain various knots and how to tie them effectively. An experienced skipper will know the basic nautical knots and will use them when on the water. Take the time to know the basic knots.



A useful knot to learn for general docking is the figure eight with one end reversed. By turning the free end of the line back under, the knot can be released without disturbing the boat. After some practice one person can secure a vessel easily to a dock or pier in a variety of weather conditions. This knot normally is used to tie the bow and stern. Then the vessel can further be fastened by tying the spring line in the figure eight knot. Wrap it around the cleat 2 or 3 times.



EMERGENCIES

Always be ready to help others on the water if possible, but do not take any unnecessary risks. Use equipment to save a life, but do not risk a life to save equipment. Consult earlier information in this manual concerning accidents, etc. Also, read other literature concerning on the water emergencies. Be alert and prepared!

Fire

Fire aboard a vessel can spread quickly and can cause tremendous alarm among everyone. Most fires can be prevented by keeping the bilge free from oil and debris. Keep all equipment stowed and maintained in working order. Carry a backup fire extinguisher on board. If something becomes a possible fire hazard, remove that possibility at once.

Never use water on gasoline, oil or electrical fires. When you dump water on an electrical fire a you can be shocked since water conducts electricity.

Follow these instructions if a fire breaks out:

- A. Fit everyone aboard with a life jacket. Turn off the ignition.
- B. Try to keep the fire downwind. If the fire is to the stern, head the bow toward the wind. If forward, put the stern to the wind.
- C. If the engine should catch fire, shut off the fuel supply. Usually there is a fuel tank access that you can crimp the fuel feed line.
- D. Use a hand fire extinguisher. Make sure to point it at the base of the flames. Use short bursts and sweep the extinguisher side to side.

Remember : (4 lb. extinguisher discharges in 20 seconds)

These actions help prevent the fire from spreading to other parts of the boat. You can extinguish fires quickly if you act swiftly. Have a plan of action in motion in case a fire breaks out.



FIRST AID

Knowing first aid can save lives. A first aid kit and the ability to use it are important ingredients for the safety of a skipper's passengers, crew and vessel. Having confidence and competence in handling medical emergencies on board is a must for the skipper. Invest your time in a first aid course available at the American Red Cross.

CPR (Basic Life Support)

If someone is seriously injured have someone call for help with a "PAN" call on VHF Channel 16 while the injured person is being attended.

Check for possible danger signs; loss of breathing, unconsciousness, severe bleeding and heartbeat. If you determine the individual is not breathing or unconscious place the victim on their back on a hard surface and do the following:

1. If unconscious, open the airway. Neck lift, head lift or chin head lift.
2. If not breathing, begin artificial breathing. Pinch the nose. Give 4 quick breaths. If airway is blocked, try back blows, abdominal or chest thrusts and finger probe until airway is open.
3. Check for pulse. Begin artificial circulation. Depress sternum 2".
15 compressions rate 80 per minute. 2 quick breaths. Continue uninterrupted until advanced medical support is available.

Follow up immediately with medical authorities!



HYPOTHERMIA

Hypothermia is a condition where the body temperature decreases because the body can't generate enough heat to maintain its normal temperature. It can be serious and usually occurs where victims have been immersed in water (under 68 degrees) for extended periods of time. If you encounter a possible hypothermia victim call for help on the radio and get the person out of the water.

Symptoms are:

1. Shivering that if condition is advanced may stop.
2. Confusion, clumsiness or slurred speech.
3. Rigid muscles.
4. Semiconscious to unconscious.

Treat hypothermia by the following:

- Remove wet clothing.
- Monitor the victim's pulse and breathing.
- Rapidly apply heat to the body core by using blankets, naked bodies or warm water.
- Do not give the person any food or drink.
- Do not warm the arms and legs. Warming of these extremities can be fatal.

Follow up immediately with medical authorities!



ENVIRONMENTAL AWARENESS

There are numerous vessels operating on our waterways on a daily basis. Each boat has an impact on our environment. Boat operation habits, marine sanitation, and maintenance all play a role in a delicate battle to keep the ecosystem clean. Each of us has a role in doing our part as an environmentally conscious skipper to conserve our waterways.

The National Marine Manufacturer's Association lists their top ten of Eco-Boating Practices as follows:

1. Observe all regulatory agency policies regarding marine toilets.
2. If equipped with a holding tank, use marina pump-out facilities.
3. If used, make sure bottom paints are legal and ecosystem friendly.
4. Use only biodegradable cleaning agents.
5. Dispose of all garbage and litter on shore properly, not on the water.
6. Don't top off fuel tanks. Leave expansion room. Clean up spills.
7. Watch your wake and propeller wash.
8. Make sure your engines are well tuned and maintained.
9. Prevent the spread of aquatic invasive species by decontaminating trailered boats.
10. When fishing, practice the "catch and release" principle.

Follow these basic practices when on the waterways. Treat the environment in a way that you would like to be treated.



CHAPTER 5

Notes



Features

INTRODUCTION

This chapter assists the operator in understanding typical standard and optional equipment which may be featured on your vessel. *A portion of the equipment described may not be installed on your boat or the pictorials may not exactly match your components. A portion of the Regal boat illustrations in this owner's manual may represent typical examples.*

Regal is constantly improving its product line and therefore may make changes in vendors, parts and specifications at any time without notice.

For further equipment information, refer to the individual vendor literature provided in the owner's packet.

Read and understand all equipment information before attempting to use the components.



CHAPTER 6

Drain Plug



To prevent vessel from sinking, install drain plug!

Your boat is equipped with a drain plug. Make sure it is tightly installed before launching. Tighten with a wrench. Do not use your fingers alone. Before dry storing remove the drain plug to help eliminate any bilge water accumulation or run the bilge pump. When the water stream is diminished, remove foreign objects stuck in the drain hole. Remove the drain plug if storing the boat for extended periods especially in colder climates.



Bilge Pump/Automatic Float Switch

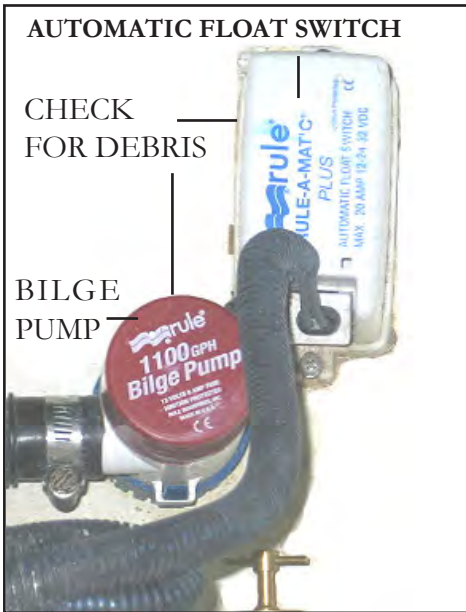

Before each outing check the operation of the bilge pump and automatic switch. With the dash switch in the automatic position manually pick up the automatic switch or you can activate the switch by throwing a bucket of water in the bilge. The automatic switch should energize the bilge pump. Periodically, check for debris around the grates of bilge pump base. The bilge pump and automatic switch are located in the bilge in front of the engine.

By holding up the end of the float switch, you can periodically test the unit. With the automatic float switch held up the bilge pump should activate itself.



Automatic Fire Extinguisher ---

If equipped, the automatic fire extinguisher uses sensors to automatically discharge when a fire occurs, although it can be manually discharged. Upon actuation, you may hear a sound similar to that of a small firearm, followed by a rushing air sound. A charged system shows a light at the dash indicator, while a discharged system shows no light at the indicator - refill accordingly.

Automatic activation will occur at different times depending on the severity of the fire picked up by sensors. **WHEN THE FIRE EXTINGUISHER IS ACTIVATED, IMMEDIATELY SHUT DOWN ALL ENGINES, POWERED VENTILATION (BLOWER), ELECTRICAL SYSTEMS, AND EXTINGUISH ALL SMOKING MATERIALS. DO NOT OPEN THE ENGINE COMPARTMENT UNTIL A SUITABLE AMOUNT OF TIME HAS PASSED SINCE THE EXTINGUISHER STOPPED DISCHARGING.** Opening the aft compartment prematurely may cause a reflash as air is allowed to fill the compartment. When opening the aft compartment hatch have a hand-held extinguisher ready in case of reflash. Be cautious of hot metal when investigating the cause of the fire.

If a fire has started in the aft compartment, **DO NOT** wait for the automatic fire extinguisher system to engage. Locate the fire extinguisher manual discharge lever after closing the aft compartment, and turning off any electronic equipment. Remove the safety pin from the “T” handle, and pull firmly to release.



For safety information, refer to your fire extinguisher label. General safety requirements are described in the safety on board chapter of this manual. Refer to the equipment manufacturer's manual for additional information.

DANGER

Avoid inhalation of potentially toxic combustion products. If extinguishing system discharge occurs, ventilate space before entering. Fumes and vapors caused by an extinguishing agent are hazardous and toxic and could result in death and serious injury.





Anchor Windlass



If installed the windlass features a stainless steel anchor complete with swivel in the anchor locker. A 50 amp breaker for windlass overcurrent protection is located at the

battery management panel. A rocker switch located at the anchor locker controls power to the windlass.



Located below the windlass switch in the anchor rope locker is a cut-off switch similar looking to a battery switch. It is used to disconnect the windlass circuit. If the deck cut-off switch is not energized the windlass switch will not activate the windlass.

NOTICE

Never use the windlass to break the anchor free from the bottom. This may cause excessive strain on the windlass motor and or hardware.



Refer to the equipment manufacturer's manual for additional information.



WARNING

Do not “pay out” the anchor until it is determined that there are no swimmers or divers near the area. Be sure that all body parts and clothing are kept clear of the anchor rope and windlass during operation. Failure to do so could result in death or serious injury.



CHAPTER 6

Battery Charger

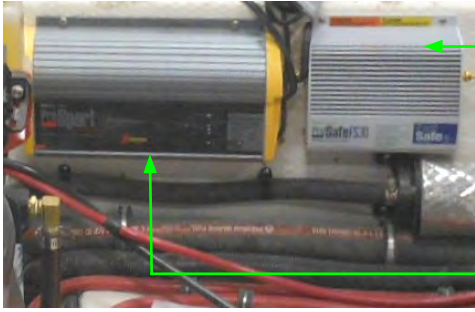

GALVANIC
ISOLATOR (TYPICAL)

BATTERY
CHARGER (TYPICAL)

Overview

A battery charger may be installed on your vessel. It features digital microprocessor charging technology, 15 amp grounded receptacle and a galvanic isolator. Other features include digital bank trouble indicators, monthly storage reconditioning mode and digital LED display (LED's for operation status and trouble-shooting). Use the battery charging system at dockside by plugging in an approved extension cord. The available current will be able to support on board components such as cockpit refrigerator, stereo system, cockpit heater along with any electronics including gaming devices.

Role Of Galvanic Isolator

The galvanic isolator is part of the battery charger option. Technically speaking the galvanic isolator blocks DC current flow on the grounding circuit. The system minimizes the possibility of electrocution.



RECEPTACLE FOR SHORE EXTENSION CORD



As soon as this extension cord circuit is activated it is also connected to the dock and all the other boats around you. Your boat is now part of a larger electrical system (Galvanic cell).

Bottom line is that the zinc anodes on your vessel and drive may erode at a much faster rate due to stray current in the water. Zinc is more sacrificial than many other metals used on

boats such as stainless steel.

At the end of the day, you want your underwater metals protected, and you want your zincs to erode at a predictable rate for ease of maintenance.

With the galvanic isolator installed as part of your battery charger option, it effectively isolates your boat from others around you (blocking any damaging DC flow) while still maintaining the integrity of the shore power safety ground (extension cord plugged into dockside). The galvanic isolator is the best way to prevent damage to vital metal parts on your vessel.

Refer to the equipment manufacturer's manual for additional information.



WARNING

Be sure to read and understand the following information before using the battery charger system to avoid death or serious injury from fire, explosion or electrical shock:

- Always connect the battery charger with an approved 14-gauge grounded extension cord to a GFCI-protected AC outlet.
- Always connect the extension cord to the boat's 15-amp receptacle plug before connecting to the GFCI-protected AC outlet.
- Always make connection in an open atmosphere free of explosive fumes.
- Always make cord connections securely with strain relief and avoid any cord-water contact.

Depth Finder/Sounder



In theory the depth finder picks up a bottom signal sent through a transducer to the helm gauge unit which is converted to readings in feet, meters, or fathoms and displayed on the gauge. The unit features shallow or deep water alarms, both of the audio and visual type, and keel offset.



The depth finder will display depths of 2-199 feet, 1-92 meters, or 1-54 fathoms. To accommodate greater depths to be displayed in the “ft” feet mode the depth sounder will automatically change to “F” fathoms mode and continue to display depths to around 54 fathoms.

When the depth decreases below 200 feet the display will return to the “ft” mode. Limits on depth will vary depending on transducers and bottom conditions.

If the reading is less than 19.9 feet, meters, or fathoms, 1/10th increments will be displayed. If the reading is more than 19.9 feet, all readings will be in whole numbers.

The depth finder features an audible and LCD displayed depth alarm with adjustable shallow and deep limits and a depth below keel offset feature. These settings once made are stored in memory and will remain even if the battery is not connected. Store vessel with bow slightly tilted for proper drainage.

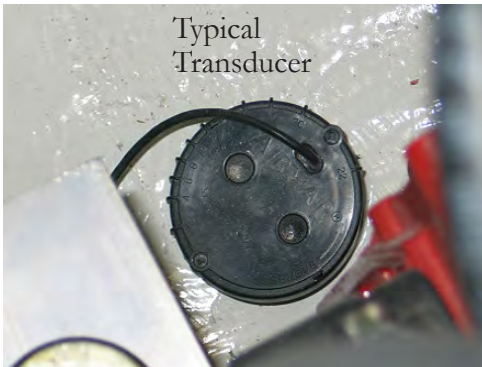

NOTE: Near the keel (center of boat bottom) the depth sounder transducer is located. It bounces a constant signal off the bottom and sends it to the dash head unit. Never use bottom paint on the hull side of the transducer since it will effect the unit's operation.

Refer to the equipment manufacturer's manual for additional information.



CHAPTER 6

Docking Lights

If equipped, docking lights are integrated into the hull. They are very useful for night docking and maneuvering. To operate turn on the helm switch marked “docking lights”.

It is recommended not to use the docking lights while navigating in open water at night since the illumination could cause a glare on the bow navigation light possibly causing visibility problems. There is a dedicated “docking light” switch near the helm.

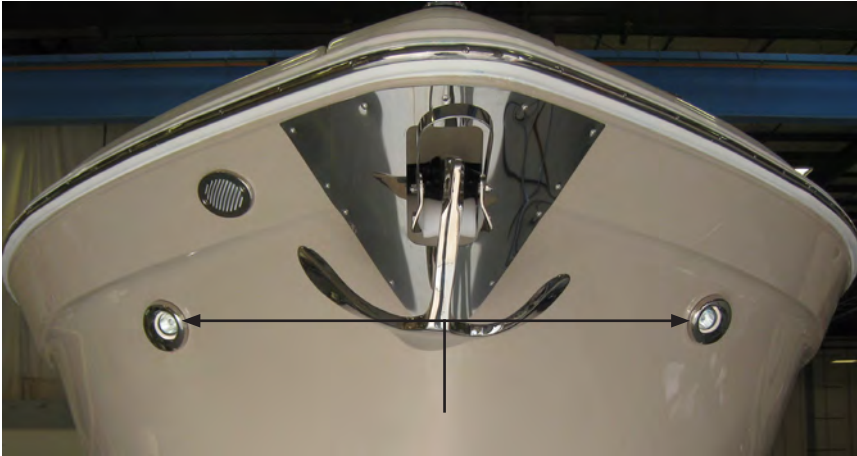

Typical Docking Lights

Gas Vapor Detector

If equipped, a gas vapor detector is a state of the art fume monitoring and alarm system. It is a highly effective detector of engine compartment gasoline fumes from unburned hydrocarbons emitted from faulty exhaust systems and hydrogen battery vapors.

The unit operates with a head unit at the helm, a sensor located in the bilge installed just above the normal accumulation of oily bilge water. A .5 amp buss fuse (for overcurrent protection) is located behind the helm head unit.



The display panel at the helm features 3 windows. The left window is a green power on indicator. The right window is an opening for the Var-a-Brite light intensity detector. The center window is the red warning indicator.

To check for fumes, turn the ignition key to the “on” position. The green power on LED will show on and the red warning LED may light momentarily to indicate a warm-up period for the sensor. The alarm horn will not sound during this period.

If a vapor build-up reaches 10-20% of lower explosion limit the red warning LED will light indicating a detection of fumes. Should this condition last for longer than 10 seconds, the alarm horn will sound.

The alarm will continue as long as vapors are present. The alarm horn may be silenced by pressing the “mute” switch, the red warning light will remain on until the vapor problem has been resolved.

NOTE: The problem should never be considered corrected until red warning light is out.

If the red LED begins to glow softly and or intermittently, it is an indication that the gasoline vapor build-up is beginning to occur and you can anticipate a full alarm momentarily.

Immediately have all passengers and crew exit the passenger compartment. If an explosion or fire should occur, the probability of injury will be greatly reduced if no one is in a confined area of the vessel.

In the event of an alarm:

NOTE: It is important to understand that an alarm would not occur unless a problem existed. Carefully check all fuel lines, gas lines, and any other potential sources of gas leaks.



Testing System



The head unit can be tested for electrical continuity by pressing the “Test” switch. The Red LED will come on. The light will glow as long as the switch is held down. If the test switch is held down longer than 10 seconds the horn will sound and the “MUTE” switch must be pushed to silence the horn.

Unplug the sensor wire from the helm display head while the unit is powered up. The Red LED will illuminate and within 10-15 seconds the alarm horn will sound. If warning Red LED fails to come on & horn fails to sound, remove display head & return to factory for repair.

Refer to the equipment manufacturer’s manual for additional information.

WARNING

Always operate the bilge blower if equipped prior to starting the engines or generator. Gasoline vapors can explode, resulting in death or serious injury. Before starting the engines or generator, perform the following:

- Check the engine room for fuel vapors.
- Operate the bilge blower(s) for a minimum of 4 minutes.
- Verify the bilge blowers are operating properly.

Always run the bilge blower(s) when the vessel is operating below cruising speed.



Trim Tabs



PORT ROCKER

STBD. ROCKER

TRIM TAB SWITCH

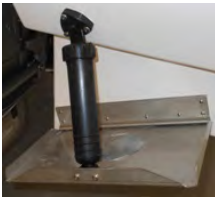

Trim tabs are located on the lower hull of the transom. Water is deflected and redirected as the trim tabs are raised and lowered from the starboard helm located trim tab switch. This change in water flow creates upper pressure under the tabs, and raises the stern. When the stern rises, the bow is lowered. Lowering the port tab will cause the port stern to rise, making the starboard bow lower. Lowering the starboard tab will cause the starboard stern to rise, making the port bow lower. The pressure originates from a pump and valve system at the aft bilge.

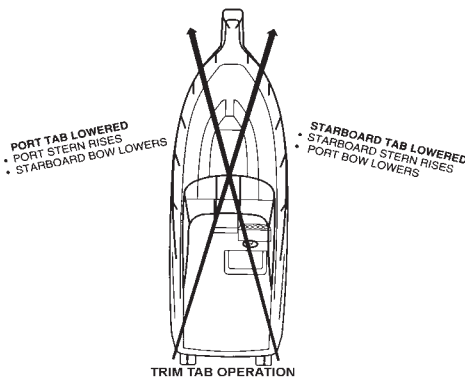

Using trim tabs in conjunction with the power trim will compensate for uneven weight distribution, listing, water conditions, and other factors that cause inefficient operation. Remember, that trim tabs are trimming the hull while power trim is trimming the propulsion units.

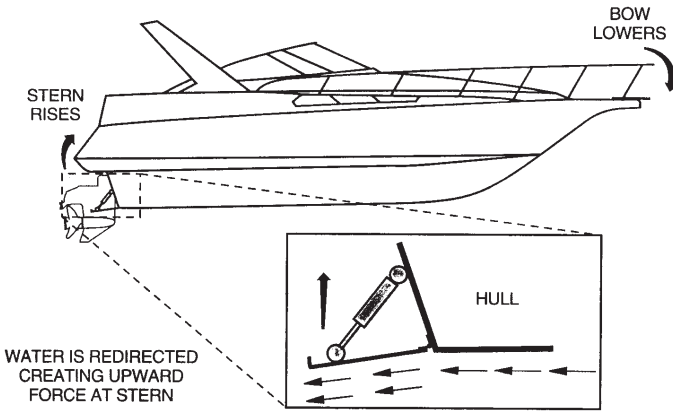

Obtaining A Trimmed Position

Your vessel will reach a planing position at a specific speed. This speed is determined by bottom design, weight distribution, water conditions, and on board equipment. As the throttle is advanced the stern squats and the bow rises initially. The trim tabs allow your boat to plane at a slower speed than natural conditions allow.

In short bursts both trim tab rocker switches are pushed simultaneously in the “bow down” position which causes the trim tabs to move down. As the boat breaks over the bow high attitude the boat speed accelerates and visibility increases.

If the boat is over-trimmed, it will plow the bow and the boat will lose maneuverability. If this occurs, simply short burst the “bow up” trim tab rocker switches simultaneously.

In the “learning curve” process, press the tab switches in half second bursts. You will notice a slight delay from the time the switches are pushed until the boat reacts depending on vessel speed. You will know after awhile the optimum planing angle and speed.



When running in heavy seas press the “bow down” position which will assist the vessel to cut through the waves. This will produce a drier and more comfortable ride. In a following sea run the tabs in a fully retracted angle for maximum outboard drive response.

Sometimes you can watch the bow spray or stern wake and the rooster tail (mound of water produced by propulsion units). In a bow up position the spray is far aft to the hull, the wake is high and the rooster tail is high.

When trimmed or in the bow down position, the bow spray is farther forward, the wake and rooster tail are smaller, and positioned further behind the vessel. Also, when trimmed you will notice that tachometers show an increase in rpm's.

Rectifying A List

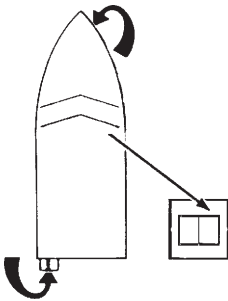

Your vessel can use the trim tabs to rectify a list. The trim tabs adjust the boat's attitude in the direction the helm rocker switch is pushed.

If the port bow is high, push the left-hand “bow down” direction on the dash rocker and the port bow will lower. If the starboard bow is high, push the right-hand “bow down” direction and the starboard bow is lowered.



Using Propulsion Unit Power Trim With Trim Tabs

TRIM TABS WITH POWER TRIM

- Trim Tabs Trim Hull
- Power Trim Trims Prop

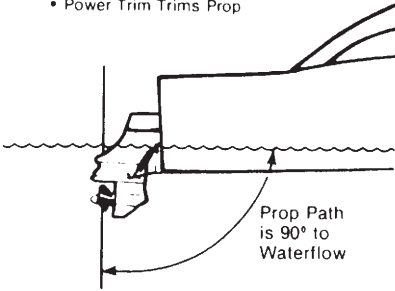

Adjust the trim tabs to achieve a planing attitude. Use the power trim to position the prop path parallel to the water flow. At this point the trim tabs may need a fine adjustment.

One advantage of the trim tab system is that they allow trimming of the hull while the power trim results in trimming the props.

NOTE: Illustrations show stern drives vs. outboard drive units.

Porpoising

Porpoising is a running condition where the bow “bounces” up and down similar to a porpoise’s swimming motion. This condition is normally caused by the trim being too far “up” as indicated on the trim gauge. Press “bow down” in one-half second bursts and the porpoising should recede and the vessel speed should increase. Only a small amount of “bow down tab” is normally necessary to make the vessel bow actually go down.



Trim Tab Indicators



Optional trim tab indicators feature port and starboard icons. As the tabs move up or down through the activation of the switches, indicators illuminate the appropriate directional lighting icons. It eliminates the task of constantly trying to figure out the tab position. Makes it easy to reset the tabs for a balanced initial “down” or “in” take-off position. By monitoring the icon position the operator can help eliminate an

over tabbed position that can cause porpoising and other unsafe bow positions.

Refer to the equipment manufacturer’s manual for additional information.



CHAPTER 6

Underwater Lights



If installed, the light bars w/ sealed LED bulbs make up the underwater lighting system. The lights are located on the transom. There is a dash switch for energizing the lights.





Windshield



The typical windshield features tempered marine safety glass. The unit is tinted and gasketed to deflect water. The windshield is supported by a port and starboard brace. Periodically check the brace hardware for tightness.

The center windshield opens for bow access. When vessel is in motion ensure that both windshield latches (located at the center windshield track opposite the hinged side) are in the locked mode. **Never leave the center windshield open when the vessel is in motion as personal injury and/or property damage may occur.**

When cleaning the glass do not use products with ammonia as it causes corrosion and can damage the metal extrusion finish. Keep the windshield clean for optimum operator visibility.



Windshield Wiper

A wiper may be installed on the driver's side. Do not operate the wiper on dry glass. Periodically check the wiper blade for excessive wear and replace blade as needed. If operating in rain-prone environments, store an extra wiper blade onboard.

Bow Thruster



If installed, the bow thruster system provides thrust to PORT or STARBOARD of the bow. It is controlled by a single joystick at the helm. FORE and AFT movement of the vessel, as well as PORT and STARBOARD movement of the vessel's stern, are accomplished by use of the engine controls.



WARNING

- **Be sure to read and understand the safety information and all thruster operation information before attempting to use the thruster system.**
- **Do not operate the bow thruster system close to swimmers as a high powered suction is produced at the propellers.**

NOTICE

Make sure the propeller lock nut is torqued to the required foot pound specification.



Using The Thruster:

To use the thruster first make sure the battery switch is activated.

As part of the thruster system there is a joystick on the helm. The thruster will assist in slow speed maneuvering especially around a dock or close mooring situations. It operates similar to a gaming or marine engine joystick.

To activate the joystick, push and hold the black button. The red icon will illuminate.

- Never run the thruster dry; it will weld the relay contacts as it becomes a generator in spool down.
- Do not make quick changes from one direction to the other direction, or it will damage the unit.

The minimum running voltage for the thruster is 10.5 volts; therefore the outboard engine(s) should be running to maintain this voltage requirement.

There is an in-line ANL fast activation fuse for overcurrent protection behind the thruster switch panel.

Refer to the equipment manufacturer's manual for additional information.



Carbon Monoxide Detector

If equipped, a carbon monoxide (CO) detector alerts you of dangerous fumes.

DANGER

Always avoid exposing your passengers or yourself to carbon monoxide. Carbon monoxide gas is colorless, odorless and extremely dangerous. All engines and fuel-burning appliances produce CO as exhaust. Direct and prolonged exposure to CO will cause death or brain damage.

Never tamper with the operation of the carbon monoxide detector.

Never sleep while the engines or generator are running. People sleeping onboard can easily be overcome by carbon monoxide.

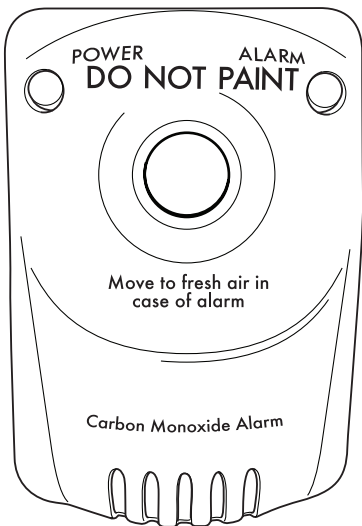

Test the carbon monoxide detector operation before each trip, at least once a week and after the yacht has been in storage. Also have the CO detector professionally tested at regular intervals. The detector is required to be replaced every 5 years.

Refer to the equipment manufacturer's manual for additional information.



Cockpit Table-Typical



If installed, a teak cockpit table is stored in a cockpit storage locker. When using the table ensure the table pedestal leg is installed in the receiver securely. Pull the latch pin and hold until the table pedestal leg slides in

the receiver sleeve. Then release the latch pin. When installed, there are normally table receivers located in select cockpit areas. Periodically lubricate the latch pins with a silicone lube spray.





Cockpit Refreshment Center



The cockpit refreshment center features a Corian countertop with stainless steel sink, strainer, and under counter refrigerator.

Other components of the system include a fresh water tank, pressurized 12 volt pump cold water sink and cockpit washdown. As part of the fresh water pressure pump is a filter which can be easily removed for periodic cleaning.

See the section on the *fresh water system on page 4-14* for further maintenance information.



TRANSOM SHOWER

See the *winterization chapter on page 9-1* for vessels in colder climates. Follow the procedure for “laying up” the fresh water system to prevent system and/or component damage.



Bow Filler Cushions



If installed, place the bow filler cushion inserts between the port bow seat and forward cushion. Be sure to store in a locker when not in use.



CHAPTER 6

Cockpit Carpet



Cockpit carpet features a forty ounce weight with an “aqua tread” slip resistant backing. As required, snaps are installed.

When storing the carpet, roll it up versus folding it. If the carpet gets wet, dry out before

attempting to store. This will help prevent mold in warmer climates. Unsnap individual fasteners carefully when storing carpet to help protect the snaps from pulling out. Do not yank on the carpet to remove it.



Cockpit Refrigerator



The DC cockpit refrigerator is located at the cockpit refreshment center. The unit operates from 12 volts and features an ice tray and brushed stainless steel door.

To regulate the temperature there is a control knob positioned near the refrigerator rear wall. Just rotate the knob to the right to obtain the desired temperature setting.

On units without the battery charger option deactivate the unit and clean out any foods after each outing. If the unit is turned on it will slowly drain the battery bank.



THERMOSTAT CONTROL

With the battery charger option the refrigerator can be left energized.

It is a good idea to leave an open box of baking soda in the unit to help eliminate any food odors.

Periodically clean the unit inside with a solution of bleach and water. Prop empty refrigerator door open when leaving vessel for extended periods of time to inhibit mold growth and food odor. An optional second 120-volt refrigerator may be installed.

Refer to the equipment manufacturer's manual for additional information.



CHAPTER 6

Canvas



Typical PowerTower In “Up Position w/Sunshades



Canvas-Sunshades w/PowerTower

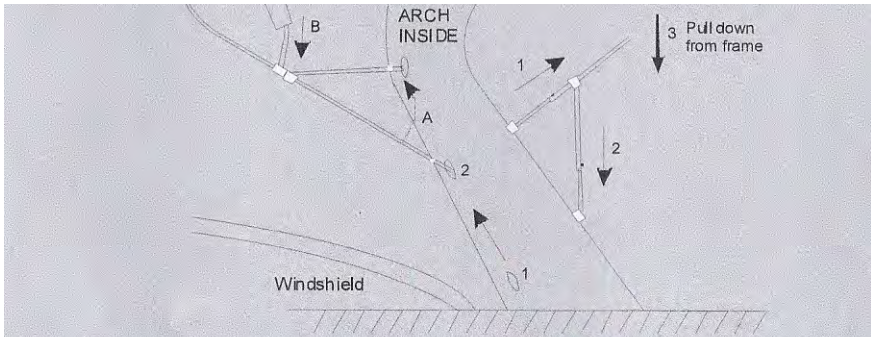

FORWARD TOP INSTALLATION:

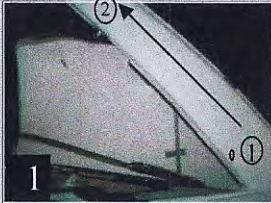

1 Move your main bow from position 1 to position 2.



2 Locate your middle bow in place (Step B).

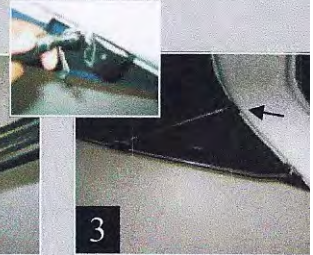

3 Install your support stanchion (Step A).

AFT TOP INSTALLATION:



4 Extend your bow. Release push button and adjust in place (Step 1).



5 Extend your rear stanchion. Then secure in arch-mount (Step 2).



Adjust stanchion in place (Step 3).

TYPICAL INSTALLATION

NOTE: That on typical canvas installation the canvas boot zipper does not unzip completely to the center. This allows you to hold the forward sunshade and make it easier to install.



CHAPTER 6

NOTE: On typical canvas installations, canvas straps are at times noisy when underway. To help deminish the noise simply twist any straps as needed and relatch.

NOTICE

While cruising all sunshades and bimini tops should be zipped in the boot to avoid damage due to wind or sea conditions as well as from possible higher cruising and/or highway speeds.

NOTICE

Always roll not fold any loose canvas pieces to help curtail any damage especially with see through (clear) parts.

NOTICE

Because of the beam size on the 3300 and 33 OBX, most states require special permits to tow the vessel. Check with state and local authorities for more specifics before attempting to tow vessel on highway. Private towing services for hire are available in many locales.

CAUTION

Do not tow the boat with any canvas parts installed. Store the canvas parts in their boot. For water use, store bimini top in boot. Towing the boat with canvas parts installed may result in a hazard that could cause minor or moderate injury and property damage.



Cockpit Cover



TYPICAL COCKPIT COVER

The optional cockpit cover installs over the windshield and snaps to the deck. To install the cockpit cover, start at the bow area.

Complete

snapping the canvas to the outside and then down each gunnel to admidships.

This type of canvas cover may be equipped with cockpit cover poles. If installed, their purpose is to keep the canvas tight and water out of the interior. There may be on the underside of the cover areas of reinforced canvas material or grommets. These are for the cockpit cover poles. Each pole is adjustable by opening it to the desired length and tightening the thumb screw. You may find it helpful to mark the poles so you can install them in the same location each time.



Canvas-Bow



TYPICAL TONNEAU COVER

The optional bow cover (sometimes called a tonneau cover) is used mainly for mooring purposes and foul weather conditions.

To set it up, fasten the cover starting at the front center snap working your way around the port and starboard sides. When you reach the aft section fasten the snaps to the center windshield. Install the pole at the center of the cover at the designated point which is designed to fit the pole. If equipped, select poles are adjustable.

You may want to purchase an optional storage (mooring) cover. They can be ordered from your authorized Regal dealer.



Power Tower

As part of the innovative design the tower hinges forward for tight overhead clearances such as bridges and restricted storage situations.

The tower features an aluminum framework and a multi-layered finishing process.



Typical Power Tower- Sunshades In Cruise Position

The power tower hinges forward for tight overhead clearances such as bridges and restricted storage situations. **For highway towing the power tower must be in the complete forward position and all canvas shall be in their dedicated boots. All attached canvas bow hardware must be checked for tightness before and after towing.**

Cockpit carpet must be rolled up and stored in a dedicated cockpit locker.



CHAPTER 6



Typical Power Tower Shown In Booted Cruise Position



Typical Power Tower Shown In Full Forward Tilted Position

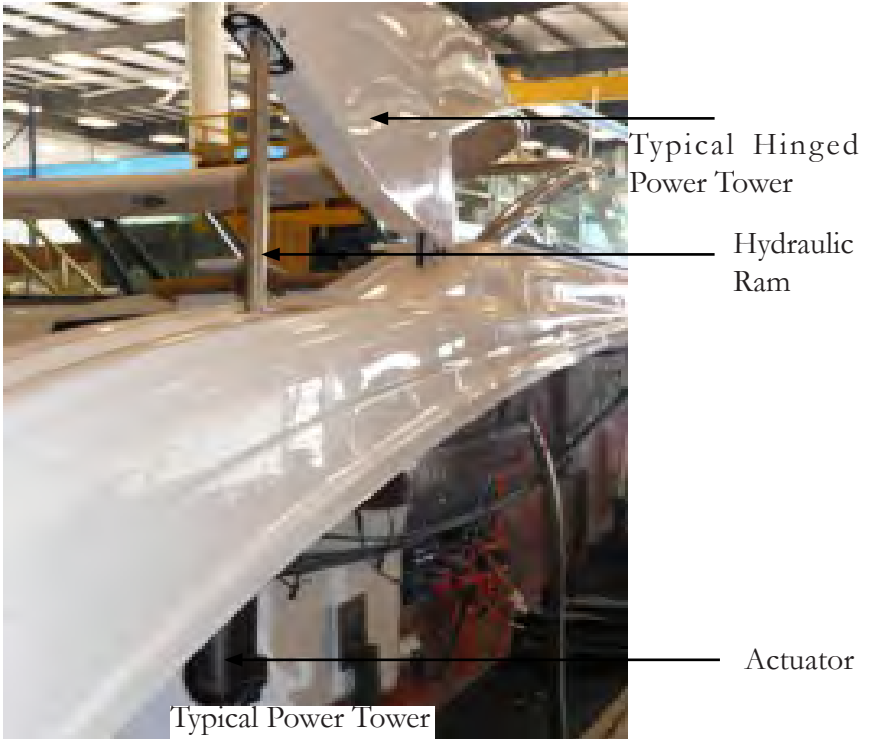

The power tower can be hinged forward for clearance purposes. Normally one of the switches at the helm area is designated as arch or tower. It connects to a lift motor and a set of hydraulic rams that raise or lower the wakesport tower through the switch.

WARNING

Always keep body parts away from the hinge mechanisms while raising and lowering the Power Tower. Body parts may become entangled within the hinge mechanisms, which could result in death or serious injury.

Make sure the operator and all aboard read and understand the above warning.



CHAPTER 6

Before energizing the arch switch explain to all passengers that they maintain a safe distance from the tower hinge mechanisms located at the base of the power tower on the deck. As the operator energizes the switch to hinge the tower forward visually monitor the port and starboard deck to ensure all passengers are clear of the hinge mechanism. This same procedure applies for lowering the mechanism to the original position.

Bow Walk-Through Doors

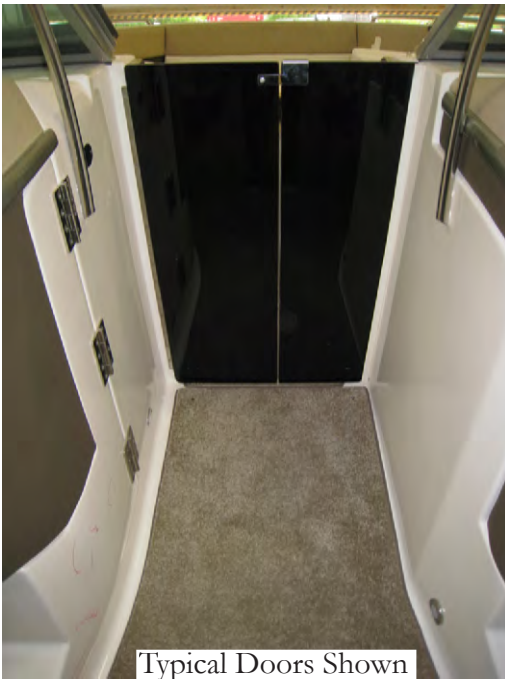

Walk-through bow doors are great in foul weather. With the tonneau cover in place, simply open the doors and pull across the bow opening. Secure shut. If installed, close the tonneau cover.

To store, fold against the walk-thru and secure in place.



Bow Scuff Plate

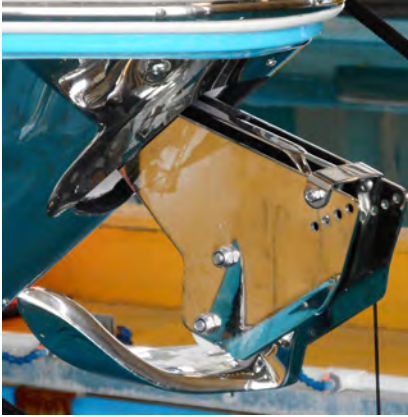

Your vessel features a stainless steel bow scuff plate. This stainless steel plate protects the fiberglass bow area from scuffing. The innovative design helps protect the boat bow when using the anchor especially in foul weather conditions.

Horn



A switch at the helm controls the audible horn signal installed on your vessel. Be sure to test the horn before each outing and learn the horn and bridge signals by reviewing the rules of the road chapter. Hold the button in as needed for on-going signals.



CHAPTER 6

Seating – UltraLounge (4 Positions)

Your boat features 6 position aft seat/sun lounger. Using the handle on the port forward lower section of the seat you can push or pull on the lever which will change seat positions from a seat to a lounger with one additional back rest in between position each way. Typical seating shown.



FORWARD FACING SEAT
POSITION



AFT FACING SEAT POSITION



AFT FACING SUN LOUNGE WITH
FLAT HEAD REST

The backrest can be positioned as to form a sun lounge head support or the headrest can be angled up for aft viewing as shown in the lower photo. There is also one backrest in between position.



AFT FACING SUN LOUNGE WITH
TILTED HEAD REST



WARNING

Do not occupy the aft-facing position sundeck lounge while the boat is moving. Occupying the aft-facing sundeck lounge while the boat is moving may result in falling overboard, which could cause death or serious injury.



Through-Hull Exhaust

Select optional engine packages permit the exhaust to exit above the waterline at the hull side versus the normal stern drive underwater passageways. There is a helm switch which activates the device. When the switch is off the exhaust exits through the stern drive. Refer to the appropriate engine operator's manual for further information.

NOTE: It is the duty of the operator to check appropriate local, state and national regulations in reference to using the through-hull exhaust system in that designated area. Some areas induce strict fines for sound decibels over a set number.

Seating-Double Helm w/Flip-Up Bolster



The double wide helm seat can be moved forward or aft with a lever located under the seat. Pull lever to left while pushing the seat aft or forward. Also, located at the forward end of the seat is a flip-up bolster which can afford you additional visibility

for docking and maneuvering in tight quarters. With the bolster cushion in its up position, the operator gains additional leg room.



Seating/Typical Bow-Arm Rests



Your vessel features bow seating arm rests.

To use the arm rest simply push down on the top of the arm rest until it falls in place.



To fold away pull up on the arm rest until it rests against the bulkhead.

Toilet-Electric w/Overboard Discharge Pump

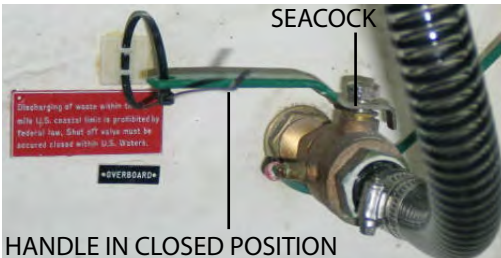

If installed, federal regulations prohibit pumping waste overboard within the territorial limits of the United States. Check with authorities regarding specific laws and

regulations before attempting to pump waste overboard.



CHAPTER 6

1. Locate the seacock. Remove the locking mechanism from the seacock and turn the valve to the “open” position by aligning the seacock handle with the valve.



2. The overboard pump uses an enhanced monitor panel with a built-in key switch located in the head compartment. To activate the macerator pump turn the switch on and completely to the right. At this point the macerator pump will sound starting the pump out process. It will be required to hold the switch to the right until the tank is emptied. Once empty return the key switch to the “off” position. Have someone monitor the waste tank level visually during the pump out process. Avoid running the discharge pump “dry”.

Holding Tank

The holding tank level needs to be monitored periodically for content fullness. Do not operate the waste system when the holding tank is full. Before venturing out on a cruise it is a good idea to have the holding tank pumped out. Normally when the waste tank is overfull it may clog the charcoal vent line filter.

Since a small amount of water usually remains in the holding tank it is a good idea to rinse the tank especially after cleaning. Add water to the toilet bowl along with 8 ounces of manufacturer’s tank deodorant and cleaner until the discharge is clear. Do not use chlorine based or caustic cleaners along with drain openers as damage to the seals and hoses may occur.

Rinsing the pump-out hose at the deck fitting with a bit of fresh water should be done after the marina pump-out equipment hose is removed. This prevents a build-up of particles and tissue on the waste hose.



TO CHANGE FILTER, UNSCREW UNIONS

On electric toilet installations a waste filter is connected between the overboard hull vent and the waste tank. It eliminates the majority of the ingredients that cause waste system odor. It is recommended that this filter be changed once per year.

Refer to the equipment manufacturer's manual for additional information.

Toilet-Electric w/Pump Out Fittings



Electric toilets feature a deck fitting that permits a marina or waste station to pump out the vessel waste or holding tank. A hose attachment screws into the deck fitting and removes the waste in the vessel toilet holding tank by activating a land pump.

Read the manufacturer's recommendations regarding toilet paper type since household varieties are not usually "friendly" to the onboard system or the marine environment.

As part of your pre-cruise inspection monitor the waste tank level and obtain a pump out before undertaking any extended day cruising.



Air Conditioning System

If installed, the air conditioning system needs an AC power source to operate, supplied either by shore power or an onboard generator.

NOTICE

Never switch the air conditioning system water pump breaker ON until after the seacock supplying the air conditioning system with seawater has been opened. Operating the air conditioning with the seacock closed can damage the system.

The air conditioning system produces heat when operated in reverse cycle mode. Reverse cycle operation is affected by the temperature of the seawater. The air conditioning system's ability to produce warm air decreases as seawater temperature decreases. It is recommended to avoid operating the air conditioning system in reverse cycle mode when the seawater temperature is below 40°F (4°C).

Refer to the equipment manufacturer's manual for additional information.



Shore Power

If equipped, your boat has a dual 30-amp shore power connection.

WARNING

When connected to shore power, never swim anywhere near the yacht. Stray voltage may leak from the shore power cord and/or yacht shore power connector, which could result in death or serious injury.

Never supply power to the water heater when it is empty. Fire may result if the heating element is damaged, which could result in death or serious injury.

Never alter shore power cable connectors. Use only compatible cable connectors and shore power receptacles.

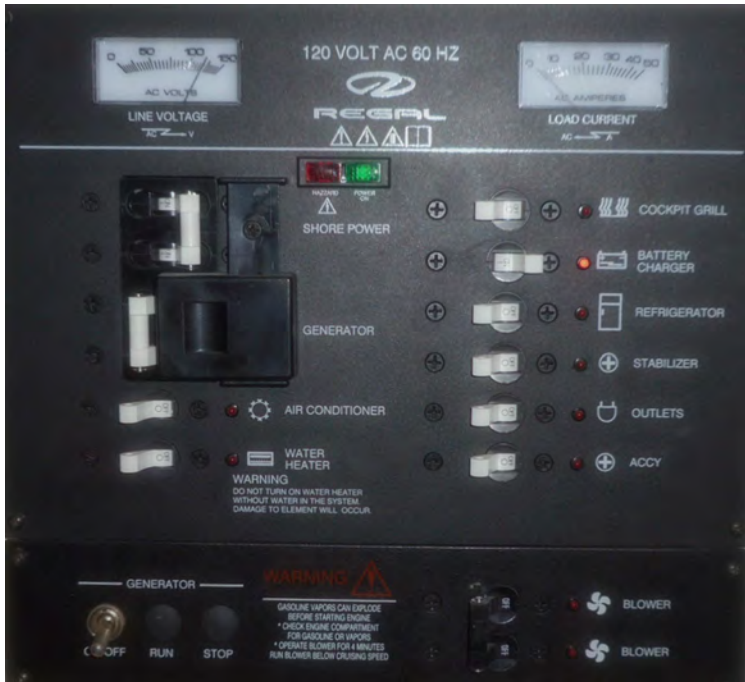



WARNING

To minimize shock and fire hazard that could result in death or serious injury:

- Before using the shore power cord, examine the cable for damage. Never use the shore power cord if it appears cut or damaged.
- Turn off the yacht's shore connection switch before connecting or disconnecting the cord.
- Connect the shore power cord to the yacht's inlet before connecting to the shore power source.
- If the yacht is equipped with a polarity indicator that activates, disconnect the shore power cord and correct the polarity.
- Disconnect the shore power cord at the shore outlet first.
- Never leave the shore power cord connected to the shore outlet when the cord is not in use.
- Close the shore power inlet cover tightly.
- If the reverse polarity indicator light is activated, do not use the electrical system. Correct the polarity fault before activating the electrical system on the yacht.
- Never alter the plug and connector on the shore power cord..

NOTICE

Always turn off the SHORE 1 and SHORE 2 circuit breaker groups before connecting to the shore power. This prevents arcing and burning of the shore power cord receptacles. Disconnecting will protect the electrical equipment on board from rapid ON/OFF current connections, which may occur during the connection process.



WARNING

Only use a shore power cord that is in excellent condition with no cuts, nicks or abrasions in the exterior plastic cover. The cord must be specifically designed to connect the yacht to a shore power source. Electrical shock that could result in death or serious injury can occur by using a damaged shore power cord or a cord that is not designed for the intended purpose.

Never allow the end of the shore power cord to hang in the water. An electrical field may exist that could cause death or serious injury to nearby swimmers.

Electronic Leakage Circuit Interrupter (ELCI)



On boats with shore power, the AC electrical system is also equipped with an Electronic Leakage Circuit Interrupter (ELCI) which will open (trip) under dangerous conditions. This situation can occur when there is a combination of a ground fault, and, a faulty ground, and is a hazard to both people in the boat and in the water.

The ELCI is installed near the boat's shore power connector inlet and provides whole boat protection for everything downstream of it. AC outlets are further protected with marine-grade Ground Fault Circuit Interrupters (GFCI) for protection in potentially wet environments.

It is important that the ELCI is working properly to provide protection against electric shock. It should be tested at least once each month to ensure proper operation by pressing the TEST/ RESET buttons in the faceplate. Refer the ELCI manufacturer's instructions for testing details and fault codes.



DANGER

The following safety messages pertain to Electrocutation Hazards:

- To reduce the possibility of an electrical shock, it is important that the AC ground system is functioning properly and that a proper connection exists between the shore power cord, the shore power inlet, the boat bonding system and the outlet ground circuits. If there is any doubt about the integrity of the ground circuit, a qualified marine electrician should be contacted immediately and the AC power should be disconnected until the necessary repairs are completed.
- Reversed polarity and ground fault conditions will damage the system and expose passengers to electrocution hazards that will cause severe injury or death. This condition could also cause a fire in the electrical system. Never operate the AC electrical system with reversed polarity or a ground fault condition.
- Electric shock can cause severe injury or even death. Do not attempt to correct the wiring yourself. Always have a qualified electrician check wiring. Keep children away from any electrical cables or equipment and always use grounded appliances on board your boat. Undetected faults in the AC electrical system could cause the water around the boat to become energized. This could cause a severe shock or even death to someone in the water near the boat. Never swim or allow swimming around the boat when the AC system is activated by the shore power connection or the generator.

Failure to follow these messages will result in death or serious injury.



Generator

If installed, the generator can be used to power the AC electrical system when a shore power source is not available.

The generator starter is powered by a designated 12-volt battery. Power to the generator from the battery is controlled by a battery switch.

NOTICE

Do not turn off the generator battery switch while the generator is operating. The generator and/or alternator wiring can be damaged.

NOTICE

Do not operate the generator while the generator's cooling system seacock is closed. Operating the generator with the seacocks closed can damage the system.



WARNING

Always operate the bilge blower(if installed) prior to starting the engines or generator. Gasoline vapors can explode, resulting in death or serious injury. Before starting the engines or generator, perform the following:

- Sniff the engine room for fuel vapors.
- Operate the bilge blower for a minimum of 4 minutes.
- Verify the bilge blowers are operating properly.

Always run the bilge blower when the vessel is operating below cruising speed.



DANGER

Never inhale generator exhaust. Generator exhaust contains carbon monoxide, a poisonous gas that could result in death or brain damage.



CHAPTER 6

Refer to the equipment manufacturer's manual for additional information.

Swim Platform



Periodically inspect the swim ladder and platform support hardware to insure that all connections and fittings are tight and in a non-corrosive state. Never dive off the swim platform. *Do not store or add objects to the swim platform since additional weight*

will affect steering and maneuvering characteristics of the vessel.

Remind passengers entering from the water to use caution in safe boarding.



WARNING

Always turn off the engines and remove the ignition keys with people around, on top or holding on to the swim platform structure or hardware. Failure to turn off the engines and remove the ignition keys could result in a dangerous situation that could result in death or serious injury.



WARNING

Never use the propulsion unit to access the swim platform. Injury from propeller blades and/or propulsion unit parts could result in death and serious injury.



Flexiteek

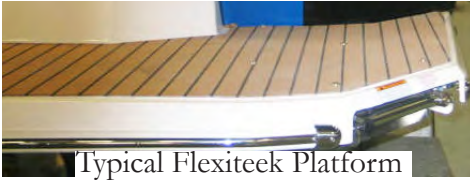

Typical Flexiteek Platform

If equipped Flexiteek decking features significant advantages over similar wood products. It is made from synthetics. Color is as natural as timber and uniform through the entire thickness adding to its appeal. It sands like wood resulting in a natural wood look and feel. It provides superior grip making it great for boating in general and water sports. It is stain resistant with most washing away with soap and water. The product is UV resistant. Gentle sanding removes most marks on the decking with a minimum of product loss.

Flexiteek may be installed on cockpit sole as shown above and/or on the swim platform.

Aft Boarding Ladder



Typical Aft Boarding Ladder

Your boat is equipped with a stainless steel aft boarding ladder. Be sure all body parts are clear of the ladder when folding the ladder up or down and repositioning it under the swim platform. Be sure to read and understand any written warnings posted at the helm area or swim platform regarding ladder load limits and CO

(carbon monoxide poisoning).

Periodically rinse the ladder frame and rungs to keep the device clean and in a non-slip condition. Salt water usage will require even closer attention to cleaning cycles over fresh or brackish water.

NOTE: Before cruising, ensure the ladder is stowed properly.



CHAPTER 6

WARNING

Always turn off the engines and remove the ignition keys while people are in the water near the boat or using the swim platform and/or transom ladder. Failure to turn off the engines and remove the ignition keys could result in a dangerous situation that could result in death or serious injury.

WARNING

Always use the ladder and never use the propulsion unit for entering and existing the boat. Using the propulsion unit to enter or exist the boat could cause a dangerous situation that could result in death or serious injury.

Seadeck[®]

As an option SeaDeck[®] is featured on select vessel swim platform and walk through areas. The non-skid, closed cell material is derived from UV protected non-absorbent foam. You will find the product easy to clean with a high stain resistance.

Other features include noise reduction, great traction even when wet, body comfort when standing, walking or leaning on the swim platform .

To clean small dirt particles first try soap, hot water and a stiff brush.

For surface dirt and footprints use glass cleaner and a clean rag.

If a more thorough cleaning is needed you may use bleach, 409, Simple Green or Soft Scrub. Stay away from using any acid base cleaners.



Sports Tow

A water sports tow is located on Power Tower models. Always appoint a person to keep their “eye out” for the tow line when the vessel is running to prevent the line from being tangled in an object such as the propellers.

Optional hard top models at the time of manual printing do not offer a water tow option.

NOTICE

Never use the sports tow for lifting the boat. Damage to the sports tow and boat will occur.

SureShade

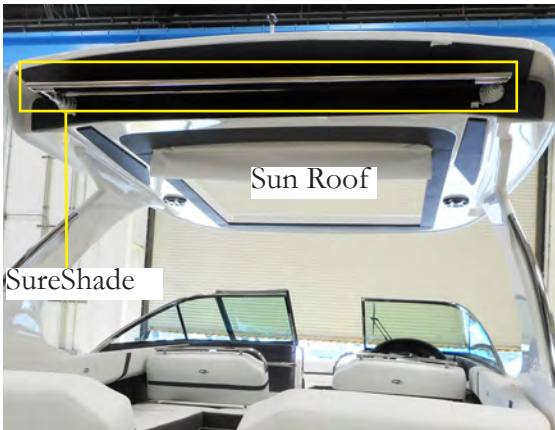

If installed, the hard top features a center soft sun roof. A built-in SureShade is optional. The hard top may also include 2 speakers and a LED accent lighting system. A switch controls the shade operation.

NOTE: The SureShade is to be used only when the boat is moored or not making headway. Do not use the component when the boat is in motion.



CHAPTER 6

Cockpit Seagrass Mat



If installed, cockpit seagrass mats feature urethane backing for marine environments. The mats provide style, comfort and durability as well as additional protection in environments where microbes are a concern.

Chilewich® products contain Microban®. This antimicrobial protection inhibits the growth of stain and odor-causing bacteria, mold and mildew for the product's life.

When storing your seagrass mats, always roll with the face of product out with the backing facing in. Do not fold or crease as the backing may split. Vacuum or hose off for regular cleaning. Dry face up or hang.

Do not machine wash. Matting may be cleaned with a mild detergent and a sponge. Rinse with fresh water.



NOTE: Before towing roll up the cockpit seagrass mat and store it in a locker to prevent it from blowing out of the vessel.

Do not yank on the product to remove it.



Storage



Select models feature under the center aft hatch a huge storage area for equipment and other cargo. Use common sense when prepping for your cruise. Always try to balance the passenger load and supplies carried and stored on board.



Note that in the event of battery failure the aft hatch compartment can be opened by an emergency harness. Simply plug in the harness male end into the dash 12 volt receptacle. Hook up a battery to the harness eyelets observing red for positive and black for negative. At this point activate the hatch switch to open the compartment (OBX only).

WARNING

Never store any combustable materials in any on board compartments. Combustible material can explode or start a fire that could result in death or serious injury.



SD

Engine Hatch

The engine hatch is controlled by a cockpit switch which when energized uses actuators to lift the hatch.





Ski Tow/Pylon



If equipped, a water sports ski pylon is located center line at the stern platform. Double loop the line first through the hole and then around the ski pylon and cinch it tightly. This procedure helps to keep the line intact when there is no strain on it.

Always appoint a person to keep their “eye out” for the tow line when the vessel is running to prevent the line from being caught in the propeller.

Lighting-Stern/All Around

Power Towers use a folding all-around light which is mounted at the center of the tower top. It is controlled by the navigation-anchor helm switch. It must be used between dusk and dawn and must be lighted when the vessel is stopped or anchored at night and shall be visible 360 degrees.



Electric Grill



If installed, the electric grill is located on the aft swim platform area and this is the only approved location for grilling. Refer to the electric grill manufacturer's manual for more information.



WARNING

Be sure to obey the following safety messages when operating the electric grill. Failure to do so could result in death or serious injury:

- **Only use the grill with the intent to cook food like meat, fish or vegetables. Do not use it for any other purpose since it could be dangerous.**
- **Do not operate the grill in rough seas or under power.**
- **Do not use burning type charcoal bricketts or volcanic stone.**
- **Keep combustible material away from the grill.**
- **Keep children away from grill hot parts.**
- **Let the grill cool down before attempting to store it.**
- **Do not tamper or modify any parts adjusted or sealed by the manufacturer.**
- **Periodically check all components for leaks, corrosion or wear.**
- **Always have a portable fire extinguisher available when using the grill.**
- **Never leave the grill unattended by an adult while using.**

Bluetooth Marine Stereo with Remote Control

A Fusion NRX200i Bluetooth marine stereo with remote is installed on the boat. The stereo features a 2.6 in. daylight viewable LCD and is integrated to the existing NMEA 2000 network.

Refer to the manufacturer's instruction manual for operating instruction.



Transom Hand Shower



The transom hand shower supplies warm, fresh water after swimming. The hand shower is especially useful when the boat is run in saltwater. The hand shower is an integral part of the boats freshwater system.

Simply turn on the faucet and adjust for the desired water temperature.



CHAPTER 6

Notes



Cosmetic Care & Maintenance

COSMETIC CARE



This section covers the care and maintenance of your boat. Many cosmetic care topics including exterior hardware, upholstery, fiberglass and canvas are covered along with major equipment and systems. As always, refer to the owner's information packet and the appropriate engine manufacturer's owner's manuals for further detailed instructions.

Upholstery

Cockpit and interior vinyl require periodic cleaning to maintain a neat appearance and to prevent the build up of dirt, mildew and contaminants that may stain and reduce the vinyl life if they are not removed. The frequency of cleaning depends on the amount of use and conditions to which the vinyl is subjected.

Most common stains can be cleaned using warm, soapy water and clear rinses. Scrubbing with a soft bristle brush will help loosen soiled material from embossed surfaces and under welting. If the stains are not removed with the above method use a mild cleaner such as Fantastic. This cleaner should be used only as needed and not the normal means.

With more stubborn stains, rubbing alcohol or mineral spirits may be tried cautiously. Widespread solvent use can severely damage or discolor vinyl. Try to remove stains immediately before they have a chance to penetrate the surface of the vinyl.



CHAPTER 7

Powdered abrasives, steel wool, or industrial strength cleaners are not recommended for cleaning our vinyl. Lacquer solvents will cause immediate damage. Dilute chlorine bleach before using. Do not wax the vinyl as it may cause cracking. Always wear protective gloves and make sure there is sufficient ventilation when cleaning vinyl. Wear eye protection.

Remember that suntan oil will damage vinyl. Use suntan lotion instead of suntan oil. Exposure to the sun is a natural enemy of vinyl upholstery. Keep the vessel covered with a cockpit cover when not in use.

Cockpit Carpet

Use approved cleaners on carpet. Always try on a test area first. Many spots and spills can be removed using a cleaner combined with a clean, white terry towel. Try not to soak an area excessively and do not use solvents because most interior carpet is rubber backed and glued in place. Solvents and abrasives will break down the backing and fibers.

NOTE: Always roll up cockpit carpet before storing your boat. Store carpet in a locker.

Plastics

Use plastic cleaners and polishes recommended for marine use only. Use proper applicators. Read all instructions carefully. Test the product in a small area first. Use a soft rag and always rinse the surface with water. Ammonia based cleaners and abrasives will damage plastic parts.

NOTICE

Never clean plastic surfaces with a dry cloth or glass cleaning solutions containing ammonia. Never use solvents or wipe with abrasives. Damage to the plastic surface could result.



Interior Fabrics

Clean flat good interior fabrics with dry cleaning fluid style cleaners approved for use with soft fabrics. Allow adequate ventilation and follow the label instructions carefully. Normal interior vinyl such as used on the headliner on cruisers and head clean up with a mild soap and water solution. Rinse immediately with clean water and wipe dry. Always test an area with a cleaner before applying it to a larger area.

Fiberglass & Gelcoat

CAUTION

Do not wax normally used areas of the deck, liner or gunwales. Do not wax any textured or non-skid surfaces such as floors, walkways, steps ladders or swim platform. Applying wax to these surfaces could cause minor or moderate injury from slipping. Wear non-slip footwear when walking on vessel surfaces.

Routine maintenance is the only practical way to keep the surface of your boat looking shiny and new. Most objects left outdoors will gradually deteriorate from exposure to the sun, water, dust and pollution. Such outdoor exposure can cause your boat's gelcoated surface to change or fade. Darker colors tend to fade more rapidly than lighter colors because they absorb more of the sun's rays (ultraviolet and infrared). Basic maintenance includes monthly washing of the boat's surface to remove normal accumulation of soil and stain.

Use a mild detergent such as dishwasher powder or liquid. Do not use automatic dishwasher detergent. Avoid any kind of alkaline cleaners such as trisodium phosphate (TSP), abrasives, bleaches and ammonia. For best results use cleaners that are recommended for fiberglass.



CHAPTER 7

NOTICE

Wire brushes, scouring pads, or other abrasive type materials and solutions should never be used on the hull or deck of your boat. They create small scratch marks that will collect marine growth and other foreign materials.

It is recommended that you wax the gelcoat surface twice yearly to prevent loss of gloss and to protect the finish. Use only waxes for fiberglass and follow the label instructions. Apply a 3' x 3' section at a time using clean applicator cloths or a buffing bonnet. When a haze develops, use a power buffer at low speeds (1200-2000 rpm) to remove the haze. Keep the buffer moving to avoid heat buildup. The power buffer is very efficient at removing contaminants from gelcoat. Never wax gelcoat in the direct sun.

When the washing and waxing as recommended does not restore the shine it may be necessary to use a fine rubbing compound. Do not apply rubbing compound in direct sunlight. A power buffer at low speed does an excellent job to remove impurities from the gel coat that cause dulling. Use light pressure and keep the buffer moving. Re-wax after compounding to buff the surface.

“Hairline cracks” or “spider webbing” could develop in the gelcoat surface of a hull or deck. This can be caused by impact or other factors. Small air pockets or gouges may also occur through **normal** wear.

These do not affect the strength of the hull or deck and can be repaired by yourself, a marine professional or a Regal dealer.

The affected area should be chipped or sanded away and a thin layer of color matched gelcoat applied. This layer is then sanded smooth and buffed to its original luster.



Cosmetic Care & Maintenance

Most minor scratches, nicks, and dents can be removed by compounding the surface. Marine type compounds can be found at most auto body supply stores. Specify a number 25 which is a coarser compound up to a number 55 being less coarse. Various glazes and polishes are available as needed. Ask your marine professional or Regal dealer for more information. Fiberglass hulls are strong but they can be damaged. A fiberglass hull has virtually no internal stresses. Thus when a part is broken or punctured, the rest of the hull retains its original shape. A severe blow will either be absorbed or result in a definite localized break. A break of this nature should be checked and repaired by a marine professional or a Regal dealer.

Minor Repairs

You will need the following materials for minor repairs:

- Gelcoat
- Clear Liquid Catalyst
- Putty Knife
- Razor Blade
- Fine Sandpaper (400,600,1000)
- Wax Paper (to cover repair area)



WARNING

Always work in a well-ventilated area free from open flames when using gelcoat and fiberglass resin. Gelcoat and fiberglass are flammable and could ignite if open flames are present, causing death or serious injury.

For minor repairs refer to the following procedure:

1. Clean the area to be repaired and get rid of any wax or grease residues.
2. Clean out scratches, chips, and nicks.
3. Sand area to be repaired so gelcoat will bond.
4. In a separate container, measure only the amount of gelcoat you will need. Mix a ratio of 2% ratio of catalyst to the amount of gelcoat being used (a spoonful of gelcoat will require only a drop or two of catalyst). Do not pour any unused portions of the gelcoat/catalyst mixture back into either original container.
5. Apply gelcoat to area leaving a slight lift above the surface.
6. Cover the area with wax paper. It will help the mixture to set up faster.
7. Remove wax paper and shave off any extra gelcoat with a razor blade.
8. After the area is shaved smooth, start with the 400, 600, and finally 1000 grit sand papers.
9. Buff the area with compound, polish and a finish wax. You may notice a difference between the repaired area and the original finish due to the natural weathering process.



Canvas

Boat canvas is in most cases subjected to more severe punishment than practically any other type of material. Moisture, dirt and chemicals from industrial fallout, heat, ultraviolet rays and salt water are all factors which accelerate the deterioration of your boat canvas.

These elements can cause serious damage if left unchecked.

The boat top and other canvas supplied on your Regal boat are manufactured from top quality materials to provide you with years of trouble free service. The following information on the care, cleaning and proper storage of the fabrics and fasteners that make up your marine canvas is being provided to help you maintain the appearance and ease of operation.

Sunbrella is used on most Regal tops, aft curtains, camper enclosures, bow tonneaus and cockpit covers. Sunbrella is a woven fabric made from 100% solution dyed acrylic fiber. It is color fast and will withstand long term exposure to the sun (ultraviolet rays) without excessive fading.

Sunbrella is a woven fabric. Even though it is treated with water repellency some “misting” through the fabric is typical. With new canvas, the greatest potential for leakage is through the sewn seams. Because Sunbrella and the long term thread used is synthetic, the holes created by sewing will not swell up and seal when exposed to water as cotton does. Usually the movement of the fabric in use will move the fibers enough to seal the holes. You may apply Apséal or Uniseal to the seams to speed up this process.

When the canvas is new, the fit will normally be tight. It is designed this way because Sunbrella stretches as it ages, The initial tight fit allows for a suitable fit for the life of the canvas. The Sunbrella fit will vary slightly in the heat, cold, and rain.



Sunbrella Cleaning Instructions

Sunbrella should be cleaned regularly before substances such as dirt, roof particles, etc., are allowed to accumulate on and become embedded in the fabric. The fabric can be cleaned without being removed from the boat. Simply brush off any loose dirt, hose down, and clean with a mild solution of natural soap in lukewarm water. Rinse thoroughly to remove soap. **DO NOT USE DETERGENTS!** Allow to air dry.

For heavily soiled fabric, remove the top from the frame.

Soak the fabric in a solution that has been mixed to the following proportions: 1/2 cup of bleach and 1/4 cup of Ivory or Lux soap (liquid or soap) per each gallon of lukewarm water. Allow the fabric to soak until the bleach has killed the mildew and the stains can be brushed out with a common kitchen scrub brush. Rinse the fabric thoroughly in cold water to remove all the soap. This may require several rinsings. Incomplete rinsing can cause deterioration of sewing threads and prohibit the fabric from being properly retreated. Allow the fabric to dry completely.

NOTICE

Do not steam press or dry in an electric or gas dryer! Excessive heat can damage and shrink the fabric since it is heat sensitive.

This method of cleaning may remove part of the water and stain repellent that was applied to the fabric during its manufacture. It is recommended to retreat with such water repellency products as Apsel and Uniseal. We do not recommend any wax based treatments such as Thompson's Water Seal or any of the silicone products such as SC-15 or Aqua-Tite. Wax based products prevent the fabric from breathing, and encourage mildew growth while the silicone products interact with the original fluorocarbon finish and seem to cause a rapid loss of water repellency.



Clear Vinyl, Zipper & Snap Care

Never store canvas wet or in an unventilated, moist area. Always roll the canvas instead of folding. This is of particular importance on side curtains or any other part with the clear vinyl “glass”. Roll the top carefully around the bows and cover with the storage boot provided.

The clear vinyl “glass” used in side curtains, aft curtains, visors, and camper enclosures is very susceptible to heat and cold. Keep vinyl curtains from touching metal tubing to minimize burning the vinyl.

If the boat is stored with top, side curtains and aft curtain in place, heat build up inside the boat may discolor the vinyl.

To clean the clear “vinyl” glass, use a solution of Ivory or Lux soap, liquid or flakes, and lukewarm water. Allow to air dry. Never use any type of abrasive cleaner as it will scratch the “vinyl” glass. There are many cleaners and scratch removers on the market specifically for clear vinyl. Handle the clear curtains carefully. They are soft and prone to scratching.

Canvas parts are designed with zippers. When zippers are new they can be a little difficult to use. Zip carefully without forcing the zipper or the material. They will loosen with use. A zipper lubricant may be used to help new zippers as well as maintaining used ones. The most vulnerable part of the zipper is the starts. Use care when beginning to close the zipper.

Canvas snap fasteners should be unsnapped as close to the button as possible.



CHAPTER 7

NOTICE

Never remove canvas by pulling roughly on the edge of the material. This can damage the canvas as well as the fasteners. Use petroleum jelly on snaps to keep them from developing corrosion especially in harsh environments.

Metal

Keep all stainless steel and other metal parts rinsed and wiped dry. To maintain their finish annually polish the stainless steel and other bright works at least annually. Use commercially available metal products and read the labels carefully before use. Refer to the flyer in the owners information pouch. Most marinas and boating retail outlets carry metal care products.

Hull Bottom

Never use wire brushes or highly abrasive scouring pads on your hull bottom. It could damage the gel coat surface or the bottom paint. The bottom of your boat needs to be clean since the build up of natural coatings from water or marine life can potentially create drag and affect your boat's performance. Contact a marine professional or Regal dealer for more information.



Cosmetic Care & Maintenance

FREQUENT STAINS/CLEAN-UP STEPS	1	2	3
Coffee, Tea, Chocolate.....	B		
Permanent Marker*.....	E	B	C
Household Dirt.....	A	B	
Grease.....	D	B	
Ketchup, Tomato Products.....	A	B	
Latex Paint.....	A	B	
Oil Base Paint.....	D	B	
Mustard.....	A	B	C
Suntan Oil.....	A	B	
Asphalt/Road Tar.....	D	B	
Crayon.....	D	B	
Engine Oil.....	B		
Spray Paint.....	B		
Chewing Gum.....	D	A	
Shoe Polish*.....	D	B	
Ballpoint Pen*.....	E	B	A
Lipstick.....	A	B	
Eyeshadow.....	E	B	
Mildew*.....	C	B	A
Wet Leaves *.....	C	B	A

A= Soft brush; warm soapy water/rinse/ dry

B= Fantastik cleaner

C= One tablespoon ammonia, 1/4 cup of hydrogen peroxide, 3/4 cup of warm water/ rinse/dry

D= Scrape off residue (use ice to lift gum)

E= Denatured alcohol/rinse/dry

* These products contain dyes which leave permanent stains.



MAINTENANCE

WARNING

Always turn off all battery switches and remove the keys from the ignition switches before performing any maintenance work. Failure to do so may cause accidental starting of the engines and result in death or serious injury.

WARNING

Always use approved marine replacement parts that are ignition protected. Using non-marine replacement parts may cause fire and explosion that could result in death or serious injury.

Refer to the propulsion unit manual for break-in and maintenance procedures.

Automatic Fire Extinguisher



If installed the automatic fire extinguisher system should be checked for tightness at the engine compartment monthly. At that time the unit itself should be weighed to ensure it is full.

If the green dash indicator light is not on when the key is in the ignition position there is a system malfunction that must be investigated immediately. Cylinders must be removed and weighed periodically in accordance with manufacturer's schedule. Refer to the operator's manual in the owner's packet.



Battery System

WARNING

To avoid fire and explosion when working with a battery:

- **Do not overfill a battery with sulfuric acid.**
- **Do not smoke or bring flames near a battery that is being or recently been charged. Hydrogen gas generated by the battery charging is highly explosive.**
- **Never short out the battery terminals, including when checking the remaining battery charge.**

Failure to follow the above safety messages could result in death or serious injury.

Frequently check your battery terminals for corrosion build-up. If you find a greenish, powdery substance, remove the cable connections and clean both the both the terminals and the connectors with a wire brush. When the cleaning is finished reconnect the battery cables and coat the terminal with an approved grease or petroleum jelly to help prevent further corrosion. Check the electrolyte level at least every 30 days, more often in hot



weather. The level should be maintained between the top of the battery plates and the bottom of the fill cap opening. Add distilled water as needed after charging the batteries or periodically as needed. Do not overfill as sulfuric acid could run over and cause burns or an explosion.

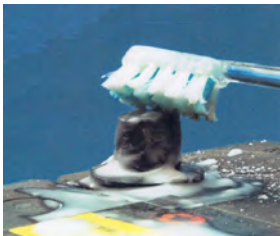

Batteries should be charged outside the boat. Do not smoke or bring flames near a battery that is being or has recently been charged. The hydrogen gas generated by battery charging is highly explosive.

Set batteries on a block of wood rather than concrete since this procedure will help the batteries from losing their charge.



CHAPTER 7

Do not allow metal objects such as tools or loose wires to spark across battery posts while working close to the battery. Contact across terminals may cause a spark.

Tighten all battery connectors securely. Check their tightness by pulling on the connectors. They should not move from their tightened position. Be sure to reinstall the positive boot over the battery terminal after tightening the battery post connection. While using the boat, use the volt meter to monitor the charge level of the battery. Monitor the charge with the engines turned off (static condition).

The engine alternators recharge the batteries. A fully charged battery will indicate between 12.3 and 12.6 volts on the voltmeter. Readings below this could indicate a dead battery cell or a charging system malfunction which should be checked by a marine professional.



WARNING

Avoid battery acid contact with the skin, eyes and clothing. Batteries contain sulfuric acid (poison) which also can cause burns. If contacted, flush with water at least 15 minutes. If swallowed, drink large amounts of water or milk. Follow up with milk of magnesia, beaten eggs or vegetable oil. Get medical attention immediately. Failure to do so could result in death or serious injury.



WARNING

Always wear goggles, rubber gloves and a protective apron when working with a battery. Battery acid causes severe eye damage and skin burns that could result in death or serious injury. In case of battery acid spillage, wash area with a solution of baking soda and water.



Bilge Pump

AUTOMATIC FLOAT SWITCH

CHECK
FOR DEBRIS

BILGE
PUMP



TYPICAL BILGE PUMP

Check each bilge pump for foreign materials stuck in the strainer area or discharge hose.

Check all clamps and electrical connections for tightness. A quick check of the bilge pump automatic float switch when installed is afforded by lifting up on the float and listening for the pump operating. Look around the float area for foreign debris and remove as necessary.

It may sometimes become necessary to replace the bilge pump impeller. Unfasten the bilge pump housing from the unit by pressing on the quick release tabs on the grate and pulling up, similar to a quick disconnect clip on a backpack. Remove the o-ring and access the impeller. Remove any debris lodged in the impeller and replace if fractured in any form. Then reinstall the unit as before. The bilge pump impeller should be changed as often as every couple years.



Blower

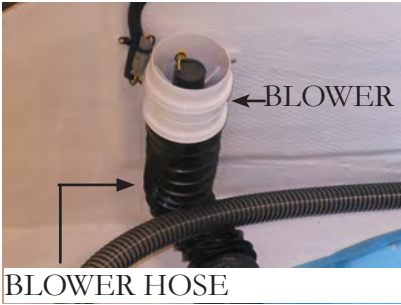

If equipped, check the blower hoses to ensure they are fastened in the bilge properly and there are no holes in them. The ventilation hose connected to the blower needs to be positioned about 3/4 of the way down in the bilge to evacuate fumes properly. All vents need to be checked for debris.

Make sure the blower motor is securely fastened and all hose clamps and or tie wraps are tight. Also, check all electrical eyelet connectors for tightness.



Fuel Tank & Fittings

WARNING

Be sure to inspect the entire fuel system for deterioration and leakage at least once a year. Failure to inspect the entire fuel system at least once a year may result in fire and explosion caused by a deteriorated and/or leaking fuel system component that could result in death and serious injury.

Periodically inspect the fuel tank components for loose clamps at the vent including charcoal canister, fill and feed locations. Examine each hose for signs of deterioration and leakage. Check the fuel sender for loose bolts, nuts, and leaks at all areas of contact. Also, inspect the fuel tank for signs of leakage or abrasion. Tighten all components as needed. Inspect entire fuel system at least once per year.

TYPICAL EPA COMPLIANT FUEL TANK



CARBON CANISTER

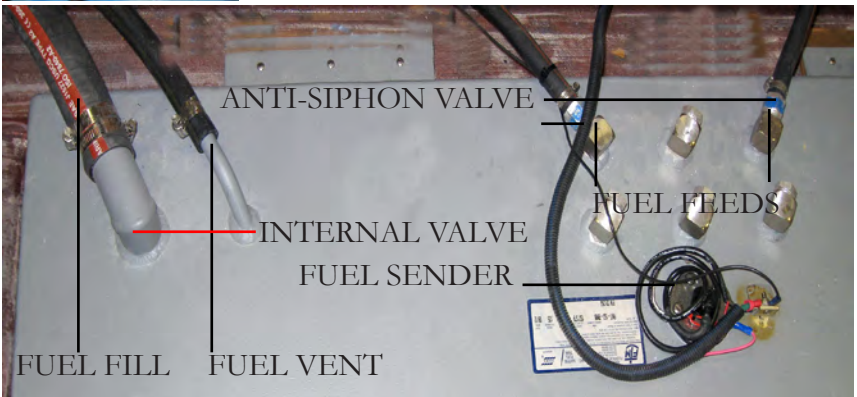



CHAPTER 7

Galvanic/Stray Current Corrosion

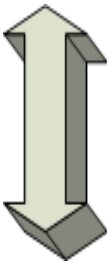
CORROSION TABLE	
Gold	<p>Least Active</p>  <p>Most Active</p>
Stainless Steel	
Bronze	
Copper	
Brass	
Steel	
Aluminum	
Zinc	
Magnesium	

Metal parts underwater can be subjected to two basic styles of electrolysis: galvanic corrosion and stray current corrosion. Both can damage the drive, propeller, underwater parts, boat and motor if not correctly monitored (testing at 2 week intervals) and avoided.

Galvanic corrosion is an electrochemical reaction between two or more metals. Drive systems consist of several different metals. Some are more active than others.

Galvanic corrosion of the more chemically active metals can occur whenever two or more dissimilar metals that are “grounded” (connected by actually touching each other, or through a wire or metal part) are immersed in a conductive solution (any material that can conduct electricity). Anything but pure water is conductive. Saltwater, fresh water with a high mineral content and polluted freshwater are highly conductive. Conductivity increases with temperature. That is why Florida boats experience more corrosion than boats in Maine.

Specifically look at a typical marine drive unit with a stainless steel propeller. The aluminum is the more chemically active metal (called the anode) and the stainless steel propeller is the less chemically active metal (called the cathode).



Cosmetic Care & Maintenance

Typically electrons flow from the anode (the aluminum drive unit), via the external conducting path to the cathode (stainless steel propeller). If there is a very large anode connected to a small cathode, the anode will corrode very slowly. If a very large cathode is connected to a small anode, the anode will corrode very quickly. Obviously, if you do not control galvanic corrosion, over time the aluminum will corrode away.

The first sign of galvanic corrosion is paint blistering (starting on sharp edges) below the water line- a white powdery substance forms on the exposed metal areas. As the corrosion advances, the exposed metal will become deeply pitted as the metal is actually eaten away.

Another condition which will increase galvanic corrosion is the removal or reduction in surface area of the sacrificial anodes. Never add aftermarket products that are connected to the engine ground such as stainless steel steering aids and trim planes.

Zinc connected to aluminum will form a corrosion cell but the aluminum (drive) becomes the cathode and the zinc (anode) corrodes.

Even though your boat may not have shore power aboard current from nearby vessels with shore power can produce stray current galvanic corrosion. Stray current corrosion occurs when metal with an electrical current flowing into it is immersed in water that is grounded (lake, ocean, pond). The current can leave the metal and flow through the water to ground. This will cause rapid corrosion of the metal at the point where the current leaves.

When a vessel nearby is plugged into shore power, they can potentially tie your aluminum drive unit to their boat via the green grounding shore power lead. Your aluminum drive unit could be the receiving end of a large galvanic cell (a battery) interconnected with nearby vessels or even through the marina's metal structures via their electrical system.



CHAPTER 7

The vessel should be tested every couple of weeks to determine the integrity of the anode protection system. If not installed, Volvo and Mercury offer an optional corrosion protection system that utilizes the anode/cathode theory to assist in offsetting galvanic corrosion.

Another way to test the system is to measure the hull potential. This is accomplished by immersing a reference electrode, usually a silver/silver chloride into the water about six inches behind the drive. With leads attached to a digital multi-meter the hull potential is read on the DC scale and compared to recommended specifications for the water body type.

Tips To Aid In Maintaining Galvanic Integrity

1. *Test the galvanic integrity of your vessel every 2 weeks.* Raise the outdrive and inspect anodes/parts for signs of galvanic corrosion, stray current corrosion or loose fasteners. *Contact your closest Regal dealer/certified marine technician where signs of galvanic corrosion exist.*
2. Never paint over anodes as they will become inoperative. Always leave at least one inch between bottom paint and any underwater fitting such as seacocks, swim platform stanchions and all drive and propulsion related underwater parts.
3. Periodically remove vessel from water and clean/pressure wash all outdrive, anode and hull bottom areas to remove growth.
4. Ensure vessel is using the correct anode metal for the body of water that it is moored. See the engine/drive manufacturer information packets for more information or contact an authorized dealer.
5. Ensure that the drive is completely “in” down to provide more complete anode protection when vessel is moored.
6. Do not attempt to use magnesium anodes in saltwater. They will provide overprotection.



7. If marina moored, contact appropriate personnel if signs of galvanic corrosion appear on your drive system. Ask them to check for stray electrical current which may be originating from a nearby vessel's faulty DC wiring or from a marina pier, piling or dock carrying leaking marina ground wiring such as a dockside cord partially submerged.

Refer to the propulsion unit manual for additional information.

GALVANIC/STRAY CURRENT CORROSION	
<i>Cause/Observed Condition</i>	<i>Corrective Action</i>
Sacrificial anodes consumed	Replace anodes when 30% consumed
Sacrificial anodes not grounded to drive	Remove anodes, clean contact surface, reinstall, check for continuity
Loss of continuity between underwater parts & ground	Provide good ground connections
Nearby vessel with stray current	Contact appropriate personnel Remove your vessel from water
Paint on drive heavily worn, exposing more metal	Prime and repaint or install additional anodes
Sacrificial anodes painted	Remove paint or replace anodes
Drive tilted/anodes out of water	Leave drive down, install additional anodes below water
Power trim cylinders only corroded	Provide a good ground to drive, all parts must be grounded
Corrosion in area of exhaust outlets	Remove deposits
Corrosion occurring after vessel is removed from saltwater	Wash exterior and flush interior with freshwater
Stainless steel parts corroding	Clean parts, remove foreign material, ensure continuity
Underwater drive parts corroded, sacrificial anodes OK	Oxide film on anode (fresh water only) Replace anode Poor grd. Remove/scrape anode



CHAPTER 7

Remote Control ---

NOTE: Volvo EVC and Merc DTS propulsion units do not use an actual control cable in the system. Shifting is accomplished through electronic software. See appropriate engine operation manual for further information.

Seating ---

Inspect all fasteners and metal for fatigue. Lubricate the slider track of the helm seat with a good quality silicone lube. Check all fasteners periodically for tightness and the effects of corrosion especially in moist environments.

It is a good practice to use a small amount of silicone lube on all hinges to keep them freed up for proper operation.



Steering

NOTE: Volvo EVC and Merc DTS propulsion units do not use an actual control cable in the system. Steering is accomplished through electronic software. See appropriate engine operation manual for further information.



CHAPTER 7

Trim Tabs



TYPICAL TRIM TAB PUMP

they will not work properly. Remember they are softer than the aluminum tab they protect and need to be free of barnacles, algae and debris to work the best. In the aft bilge area is located a trim tab pump.



Periodically, check for the correct amount of oil in the reservoir. The oil is used to lower and raise the hydraulic cylinders attached to the trim tab plates. Refer to the trim tab operator's manual for oil type and viscosity.

Also, check the rams and hoses for leaks. One sign of a seal leak may be a milky look to the oil or the tabs responding slowly. An air leak in the system will normally cause a jerky tab motion.

Refer to the operator's manual for troubleshooting information.

Stereo

The Fusion® stereo head unit requires little maintenance. When washing the cockpit, do not spray water directly at the stereo unit. Possible damage may result. Never allow water to enter the mechanism behind the head cover.

Refer to the equipment manufacturer's manual for additional information.



Troubleshooting

DIAGNOSTIC CHARTS

NOTE: Refer to the equipment manufacturer's manual for troubleshooting procedures.

The following diagnostic charts will assist you in identifying minor electrical, fuel, and mechanical problems. Some of the items listed require technical training and tools. You can contact your closest Regal dealer or certified marine technician for more information. Most problems can be solved by following a logical sequence of elimination.



WARNING

Always turn off all battery switches and remove the keys from the ignition switches before performing troubleshooting procedures. Failure to do so may cause accidental starting of the engines and result in death or serious injury.



WARNING

Always use approved marine replacement parts to service the equipment. Using non-approved marine replacement parts could result in death or serious injury.



CHAPTER 8

NOTICE

Boats equipped with optional EVC/DTS systems have electronic gauges, throttle/shift and/or steering. If you experience a problem, shut down the engines and turn battery switches off. Wait 30 seconds and restart engines. If the problem persists, contact your Regal dealer or certified marine technician.

INSTRUMENT DIAGNOSTIC CHART

PROBLEM	POSSIBLE CAUSE	POSSIBLE FIX
No reading on gauge or gauge reads wrong	Faulty gauge	Replace gauge
	Wiring to gauge faulty	Inspect/repair wiring
	Faulty sender	Replace sender
Gauge reads erratic	Loose ground or hot wire	Repair or replace wire and/or connection



PERFORMANCE DIAGNOSTIC CHART		
PROBLEM	POSSIBLE CAUSE	POSSIBLE FIX
Excessive vibration	Material obstructing propeller	Remove material by reversing engine
	Bent propeller shaft	Call Regal dealer
	Bent propeller blade	Repair/replace propeller
	Propeller hub slipping	Replace propeller
Poor performance	Engine trim incorrect	Adjust trim
	Uneven load distribution	Adjust boat load
	Engine problem	Call Regal dealer

FUEL SYSTEM DIAGNOSTIC CHART		
PROBLEM	POSSIBLE CAUSE	POSSIBLE FIX
Engine won't start or not running right	Fuel tank vent obstructed	Clean vent hose or/and fitting. Check for kinks
	Fuel line blocked	Check for kinked hose
	Lack of fuel	Clean filter. Check for clogged anti-siphon valve
	Water in fuel	Replace filter element
	Clogged fuel filter	Replace filter element
	No fuel reaching engine	Check fuel pump output. Clean filters. Check fuel tank gauge level.



CHAPTER 8

DC ELECTRICAL DIAGNOSTIC CHART		
PROBLEM	POSSIBLE CAUSE	POSSIBLE FIX
No 12 volt power	Battery switch in “off” position	Turn selector switch to “on” position
	Master breaker tripped	Reset master breaker
	Weak or dead battery	Charge or replace battery
Battery not charging (Engine running)	Loose belt	Tighten belt
	Faulty alternator	Repair/Replace alternator
	Faulty volt meter	Replace volt meter
Battery will not hold charge	Faulty/Old battery	Replace battery
12 volt equipment not working	Equipment switch “off”	Switch to “on” position
	Equipment circuit breaker blown	Push reset on circuit breaker
	Weak or dead battery	Replace battery
	Corroded connection	Eliminate corrosion
	Loose wire	Tighten connection
	Internal equipment short	Replace equipment



Storage & Winterization

Storage procedures are outlined in this chapter. These are **general guidelines** to follow before longer periods of storage such as over the winter in colder climates. Be sure to familiarize yourself with all relevant information in the owner's pouch. Special winterization procedures are necessary for the boat equipment and systems. Use the enclosed checklists to help you identify areas of concern and maintenance. These lists cover land stored boats either inside or outside. Call a Regal dealer or marine professional for further information.



WARNING

Do not fill the fuel tank to its rated capacity during storage. Leave room for expansion. Failure to do so may cause a fire and explosion, which could result in death or serious injury.

NOTICE

Remove all batteries from the boat when it is being stored for extended periods. Perform proper maintenance on the batteries during the extended storage period.

NOTICE

Use only antifreeze recommended by the engine manufacturer for engine storage. Do not use alcohol-based products. Using alcohol-based antifreeze may cause engine damage.



DECOMMISSIONING CHECKLIST

STERN DRIVE ENGINE/OUTBOARD

- Run engine. Pour a fuel stabilizer/conditioner in the fuel tank. Allow time for it to circulate through the fuel system.
- Change all engine fluids as referenced in the engine manufacturer's owners manual. Contact your Regal dealer.
- Drain cooling and exhaust system or have a certified marine technician drain the engine. Contact your Regal dealer.
- Spray all exterior metal parts with a rust preventative.

STERN DRIVE

- Perform maintenance as referenced in the manufacturer's owners manual. Contact your Regal dealer.
- Remove propeller. Refurbish as needed.
- After cleaning touch up paint on stern drive as needed.
- Apply coat of wax to stern drive.



Storage & Winterization

BOAT

NOTICE

Contact your Regal dealer for all winterization procedures for your boat. Failure to properly winterize your boat may cause damage to the boat and engines that is not covered by Regal warranty or the engine manufacturer's warranty.

- Check hull bottom for any fiberglass damage.
- Inspect anodes on engine, transom, drives, tabs and other underwater gear. Remove any corrosion with sandpaper or replace if deteriorated.
- After cleaning apply a coat of wax to hull and deck surfaces.
- Pour a pint of 50/50 antifreeze into bilge pump.
- Drain the fresh water system if equipped.
- Pump out the waste holding tank if equipped.
- Never block up boat bottom. It may cause structural damage.*
- Remove batteries. Use a trickle charger as needed.
- Remove all loose gear and electronics from boat. Inspect all equipment for wear and damage. Store in a clean, dry environment.
- Remove drain plug. Clean drain plug hole of debris as needed. Enclose drain plug in plastic bag and tie to steering wheel.
- Make sure bow is higher than stern to permit proper drainage.
- Clean all upholstery and store so it breathes.



CHAPTER 9

- Conduct a visual inspection to ensure boat is balanced properly on the trailer, cradle or rack.

- Cover boat with appropriate cover. Tie down for protection from rain, snow and/or wind. Prop up cover to provide proper ventilation. Do not cover up the fuel vents. A properly vented boat wrap is recommended. See your Regal dealer.

FRESH WATER SYSTEM

1. Activate the fresh water pump switch.

2. Open all faucets including transom shower (if equipped) and allow tank to empty.

3. Drain the water tank. Shut off fresh water pump switch.

4. Mix nontoxic antifreeze with water in accordance with the manufacturer's recommendations. (Available at marina & RV stores)

5. Pour solution into the fresh water tank.

6. Turn on fresh water pump switch.

7. Open water faucet and purge until a steady stream of nontoxic antifreeze flows from the faucet. If equipped, do the same to the transom shower. Turn the fresh water switch to the "off" position.

WASTE SYSTEM

1. With **chemical** heads, make sure to dump both upper and lower tanks. Rinse well with fresh water.

2. With **vacuum type** head, pump out holding tank. Add nontoxic antifreeze to toilet and holding tank. Pump from toilet to holding tank to eliminate any water remaining in supply lines.



RECOMMISSIONING CHECKLIST

BOAT

- Install hull drain plug.
- Install batteries and tighten all terminals.
- Check all equipment, switches, alarms, gauges and breakers for proper operation.
- Add necessary chemicals and water to **chemical** head.
- Add water to fresh water tank. Turn on faucet to purge tank. Refill water tank with fresh, potable water.
- Make sure all safety gear is on board and in excellent working condition.
- After launching, check controls and gauges for proper operation.

STERN DRIVE ENGINE/OUTBOARD

- Check all components per engine manufacturer's owners manual especially fluid levels.
- Run engine on "ear muffs" (flushette) before launching. Check for fuel, exhaust, oil, and water leaks.



CHAPTER 9

Notes



Glossary & Index

Below is a brief list of nautical terminology. For more detailed glossaries we recommend you check your local library, book retailer, marine store or internet.

GLOSSARY

Abeam: at right angles to the fore and aft line and off the boat

Aboard: on or in the boat

Above: the part of the boat on a vessel which is above the interior of the boat

Aft, After:: aft is the boat section toward the stern or back of the boat

Admidships: toward the center of the boat from either side to side or rear to front

Beam: the width of a boat at its widest part

Bilge: the lower interior of the hull of the boat

Bitter end: the end of a line also the end of an anchor line

Bow: the front, or forward part of the boat

Bulkhead: the vertical partition or wall of a boat



CHAPTER 10

Cast off: to let go or release

Chine: the line fore and aft formed by the intersection of the side and bottom of the boat

Chock: deck fitting used to secure or guide anchor or tie lines

Cleat: deck fitting with protruding arms around which lines are secured

Cockpit: the seating space used to accommodate passengers

Cuddy: a small cabin in the fore part of the boat

Deck: the open flooring surface on which crew and passengers walk

Draft: the depth from the waterline of the boat to the lowest part of the boat, which indicates how much water is required to float the boat

Fathom: a measurement of depth; one fathom equals six feet

Fender: a cushion hung from the side of a boat to prevent it from rubbing against a dock or against other boats

Fend off: to push off to avoid sharp contact with dock or other vessel

Fore: the part of the boat toward the bow or front

Freeboard: the height of the top side from the waterline to the deck at its shortest point. (The distance from the sheer or gunwale to the water)

Galley: cooking area

Gunwale: rail or upper edge of the side of the boat

Glossary & Index

Head: toilet

Hull: the part of the hull from the deck down

Keel: the lowest point of a boat; the backbone of the vessel

Knots: a measurement of speed indicating nautical miles per hour

Lee: the side opposite that from which the wind is blowing; the side sheltered from the wind

Leeward: the direction toward which the wind is blowing

PFD: personal flotation device; required for each person aboard

Port: the left side of the boat when facing forward (an easy way to remember the difference between “port” and “starboard” is that both “port” and “left” have four letters)

Shank: the main body of an anchor

Sheer: the curve of the boat’s deck from fore to aft when seen from the side

Starboard: the right side of the boat when facing forward

Stern: the aft end of the boat

Stern drive: an inboard/outboard (I/O) unit

Stringer: strengthening integral unit fastened from fore to aft inside the hull and fiberglass encapsulated for added strength: much like the skeleton system of our body

Top off: to fill up a tank

Transom: the vertical part of the stern



CHAPTER 10

Trim: the boat's balance when properly loaded

Wake: the path of a boat left astern in the water

Windward: the direction from which the wind blows; opposite of leeward

Glossary & Index

INDEX

A

Accidents 1-29
Accident Reporting 1-30
Aft Boarding Ladder 6-53
Air Conditioning System 6-46
Anchor Light 1-17
Anchoring 5-22
Anchor Windlass 6-6
Audible Alarms 3-34
Automatic Fire Extinguisher 3-32

Automatic Float Switch 6-3

B

Battery 4-8
Battery Charger 7-13
Battery Management Panel 6-8
Battery Switch 4-10
Bilge Pump 4-10
Blower 3-24
Boating Accidents 4-1
Boating Under The Influence 6-3
Bow Filler Cushion 7-15
Bow Scuff Plate 3-22
Bow Thruster 7-16
Bow Walk-Through-Doors 1-29
Breakers & Fuses 1-27
Breaker Panels 6-27
Breast Lines 6-39
Bridge Clearance 6-22

C

Canvas 6-30
Carbon Monoxide 7-7
Cardiopulmonary Resuscitation 1-22
Clear Vinyl, Zipper & Snap Care 6-24
Cockpit Carpet 5-27
Cockpit Seagrass Mat 7-9
Cockpit Table 6-28
Cockpit Refreshment Center 7-2
Cockpit Refrigerator 6-56
Communications 6-25
Cosmetic Care 6-26
6-29
1-21
7-1

D

Decommissioning Checklist 9-2
Depth Finder/Sounder 3-30
Diagnostic Charts 6-10
Direct Current (DC) 8-1
Display Panels 4-8
Distress Signals 3-35
Diver's Flag 1-12
Docking 1-31
Docking Lights 5-13
Dock Lines 6-12
Drain Plug 5-10
Drainage System 6-2
4-1



CHAPTER 10

E		G	
EPIRB	1-21	Galvanic/Stray Current Corrosion	7-18
Electrical	4-8	Garbage Placard	1-19
		Gas Vapor Detector	3-31
Electronic Leakage Circuit			6-12
Interrupter	6-49	Gathering Headway	5-15
Emergencies	5-26	Gauges (Instrumentation)	3-29
Engine	3-1	Gelcoat Maintenance	7-3
Engine Hatch	6-58	General Boating Safety	1-3
Engine Status Monitoring Panel	3-33	Generator	6-51
Environmental Awareness	5-29	Getting Underway	5-1
Exhaust	1-22	Glossary	10-1
		Grill	6-60
F		H	
Features	6-1	HIN	Int-10
Fenders	5-9	Holding Tank	6-44
Fiberglass Maintenance	7-3	Horn	3-22
Fire Extinguishers	1-10		6-39
	3-32	Hull Bottom	7-10
	6-4	Hypothermia	5-29
	7-12		
First Aid	5-27	I	
Fishing	1-35	Ignition Switch	3-34
Flexiteek	6-53	Index	10-5
Float Plan	Int-13	Instrumentation	3-29
Fresh Water System	4-14	Interior Fabrics	7-3
	9-4	International Distress Signals	1-15
Fuel	3-2		
	3-16	K	
	4-3	Knots	5-25
	7-17		
	8-3		

Glossary & Index

L

Labels	1-1
Ladder	6-53
Lateral Aids	2-8
Law of Salvage	5-24
Lighting-All Around/Stern	1-17 6-59
Loading	Int-19
Launch & Cruise Checklist	Int-17

M

Maintenance	7-12
Maintaining PFD'S	1-9
Maneuvering	5-14
Marine Weather Symbols	1-38
Marine Sanitation Devices	1-18
Masthead Light	1-17
Mayday	1-16
Metal (Cleaning)	7-10
Mid-Channel Markers	2-9
Minimum Required Equipment	1-20
Minor Repairs	7-5
Mooring	5-11

N

Navigation Aids	2-7
Navigation Lights	1-16
Navigation Rules	2-1
Neutral Safety Switch	3-27
Night Running	2-10

O

Oil Spills	1-18
Outboard	3-1
Overloading	Int-19
Owner's Information Packet	Int-10
Owner's Registration	Int-20
Owner Responsibilities	Int-21

P

Personal Flotation Devices	1-7
Plastics	7-2
Pollution Regulations	1-18
Power Tower	3-25 6-35
Power Trim	3-8 5-17
Precautionary Safety Labels	6-18
Pre-departure Questionnaire	1-2
Propellers	5-1 3-9 3-19

R

Radio Communications	1-16
Recommissioning Checklist	9-5
Registration Information	Int-20
Regulatory Markers	2-9
Remote Control	3-26
	5-7 6-60
Right-Of-Way	2-2
Rules Of The Road	2-1

S

Safety	1-1 Int-19
Seadeck®	6-54
Seating	6-40 7-22
Shallow Water Operation	5-20
Shore Power	6-47
Ski Tow/Pylon	6-59
Sound Producing Devices	1-16
Sports Tow	6-55
Spring Line	5-10
Starting & Stopping	5-6
Stern Line	5-10



CHAPTER 10

Steering	4-17	V	
	5-8	Ventilation	3-18
	7-23	Visual Distress Signals	1-12
Stereo	6-60	Voltage Sensitive Relay Module	4-11
	7-24		
Stern Drive	3-16	W	
	9-2	Wake	1-34
Storage	6-57	Warning Labels	1-1
	9-1	Warranty	Int-22
Sunbrella Cleaning	7-8	Water Skiing	1-34
SureShade	6-55	Water Sports	1-31
Swim Platform	1-33	Weather & Water Conditions	1-36
	6-52	Windshield	6-21
Switches	3-21	Windshield Wiper	6-22
		Winterizing	9-1
		Wiring Color Codes	4-13
T		Y	
Table/Cockpit	6-25	Yacht Certification Plate	Int-19
Thermostat	3-4		
Toilet	6-43		
Towing	5-24		
Trim Angle	5-17		
Trim Tabs	6-15		
Through-Hull Exhaust	6-42		
Transom Hand Shower	6-61		
Troubleshooting	8-1		
Turning	5-15		
U			
Underwater Lights	6-20		
Upholstery	7-1		



Technical Information

SD

NOTICE



The following technical information and drawings can be an aid to troubleshooting electrical and mechanical problems along with the charts located in the troubleshooting chapter.

Note that all product specifications, models, standard and optional equipment, systems, along with the technical information, are subject to change without notice.

For more information, contact your nearest authorized Regal dealer. For the location of your nearest authorized dealer, call 407-851-4360 or visit the website at www.RegalBoats.com.

Your Regal dealer has received special factory training on the entire product line and his services should be employed to solve technical problems.



Technical Information

3300 BOW RIDER SPECIFICATIONS		
LENGTH OVERALL W/ PLATFORM	USA 34' 2"	CE 10.4 M
BEAM	10' 4"	3.16 M
DEADRISE	21 DEGREES	
APPROXIMATE DRY WEIGHT W/ TW VOLVO 350 CATALYST W/ DP STERN DRIVE	9300 LBS	4218.4 KG
APPROXIMATE BRIDGE CLEARANCE POWER TOWER UP TO TOP OF LIGHT	10' 1"	3.1 M
APPROXIMATE BRIDGE CLEARANCE W/ TOWER IN LOW- ERED FORWARD POSITION	6' 6"	1.98 M
COCKPIT DEPTH	35"	.88 M
APPROXIMATE DRAFT - DRIVE DOWN	35"	.9 M
FUEL CAPACITY *	150 GALS	567.8 L
WATER CAPACITY *	24 GALS	90.8 L
WASTE CAPACITY *	2.5 Est. Gallons w/ Chemical Toilet	9.4 Est. Liters w/ Chemical Toilet
PERSONS CAPACITY	YACHT CERTIFIED	14
MAXIMUM CAPACITY; PERSONS & GEAR	YACHT CERTIFIED	N/A
MAXIMUM LOAD RECOMMENDED; PERSONS & GEAR	YACHT CERTIFIED	1557 KG

* = APPROXIMATE
N/A = NOT APPLICABLE

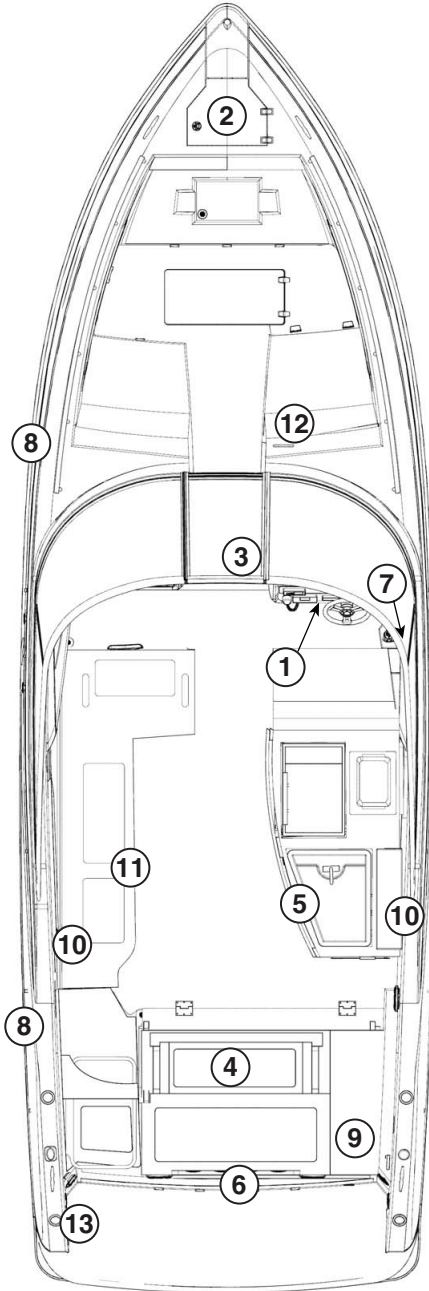

3300 Typical Label & Placard Locations



Location ① Labels

**MEETS U.S. EPA EVAP
STANDARDS USING
CERTIFIED COMPONENTS**
REGAL MARINE INDUSTRIES INC., ORLANDO, FL

WARNING
USE PROPER BLOCKING TECHNIQUES
WHEN LIFTING BOAT

WARNING
ROTATING PROPELLER MAY CAUSE
SERIOUS INJURY OR DEATH.
SHUT OFF ENGINE WHEN
NEAR PERSONS IN THE WATER.
NW-207-08

WARNING
Carbon monoxide (CO) can cause brain damage or death.
Carbon monoxide can be present in the cabin.
Signs of carbon monoxide poisoning include nausea, headache,
dizziness, drowsiness, and lack of consciousness.
Get fresh air if anyone shows signs of carbon monoxide poisoning.
Get fresh air if carbon monoxide detector alarm sounds.
Carbon monoxide detector must be functioning at all times.
NW-207-08

**NMMA
CERTIFIED**
with ABYC standard
YACHT CERTIFICATION
DESIGN COMPLIANCE WITH NMMA REQUIREMENTS IN EFFECT
ON DATE OF CERTIFICATION IS VERIFIED.
MANUFACTURER RESPONSIBLE FOR QUALITY CONTROL.
NATIONAL MARINE MANUFACTURER'S ASSOCIATION
THE BOAT COMPLIES WITH U.S. COAST GUARD SAFETY
STANDARDS IN EFFECT ON THE DATE OF CERTIFICATION
MEETS U.S. EPA EVAP STANDARDS
USING CERTIFIED COMPONENTS
REGAL MARINE INDUSTRIES, INC. ORLANDO, FL

WARNING
INTERRUPTER SWITCH MUST BE ATTACHED TO THE OPERATOR
WHILE THE ENGINE IS RUNNING. A QUALIFIED OPERATOR MUST
BE IN CONTROL AT ALL TIMES. READ THE OWNER'S MANUAL
BEFORE USE.

Scan with your smart phone
to download your owner's manual.



REGALBOATS.COM/OWNER

Location ② Labels

NOTICE
Retrieval of Windlass Chain
Winch operator may be required
to periodically spread chain out
within anchor locker

Location ③ Labels

WARNING
CLOSE DOOR BEFORE USING
WINDSHIELD WALKTHROUGH!

CAUTION: TO AVOID INJURY, WINDOW MUST BE SECURED
IN THE CLOSED POSITION WHEN VESSEL IS
IN MOTION. USE BOTH WINDOW LOCKS.
TAYLOR MADE SYSTEMS, INC.



Location ④ Labels

DISCHARGE OF OIL PROHIBITED

The Federal Water Pollution Control Act prohibits the discharge of oil or oily waste into or upon the navigable waters of the United States, or the waters of the contiguous zone, or which may affect natural resources belonging to, or under the exclusive management authority of the United States. If such discharge causes a film or discoloration of the surface of the water, or causes a sludge or emulsion beneath the surface of the water. Violators are subject to substantial civil penalties and/or criminal sanctions including fines and imprisonment.

WARNING



Avoid serious injury or death from fire or explosion, resulting from leaking fuel. Inspect system for leaks at least once a year.

GM1850681

WARNING

COMPONENTS IN ENGINE COMPARTMENT

ARE NOT IGNITION PROTECTED.

DO NOT STOW GASOLINE CONTAINERS, FLAMMABLE PRODUCTS OR MOTORS INSIDE!

Location ⑤ Labels

THE DISCHARGE OF ALL FORMS OF PLASTIC INTO ALL WATERS IS PROHIBITED

THE DISCHARGE OF ALL GARBAGE IS PROHIBITED

into the navigable waters of the United States, and into all other waters except as specifically allowed.

ALLOWED: 3 to 12 nautical miles from land – Food waste ground to pass through a one-inch mesh screen.

ALLOWED: 12 or more nautical miles from land – Food waste ground as above, and waste water, and cleaning agents, en route as far from shore as practicable, that are not harmful to the marine environment.

MARPOL ANNEX V – SPECIAL AREAS

GULF OF MEXICO & CARIBBEAN SEA – Food waste en route ground to pass through a one-inch mesh screen.

WESTERN CARIBBEAN REGION – Discharge of all garbage prohibited within 12 nautical miles of land.

Any person who violates the above requirements is liable for civil and/or criminal penalties and regional, state and local restrictions on garbage discharges may also apply.

REPORT ILLEGAL DISPOSAL TO THE U.S. COAST GUARD ON VHF RADIO CHANNEL 16

Location ⑥ Labels

DANGER



Carbon monoxide (CO) can cause brain damage or death.

Engine and generator exhaust contains poisonous and colorless carbon monoxide gas. Carbon monoxide will be around the back of the boat when engines or generators are running. Move to fresh air. If you feel nauseous, headache, dizziness, or drowsiness.

WARNING

ROTATING PROPELLER(S) MAY CAUSE SERIOUS INJURY OR DEATH! DO NOT APPROACH OR USE LADDER WHEN ENGINE IS RUNNING.

Location ⑦ Labels





Location ⑧ Labels



Location ⑨ Labels



Location ⑩ Labels



Location ⑪ Labels



Location ⑫ Labels

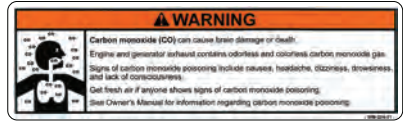

Location ⑬ Labels

⚠ WARNING

Electrical shock and fire hazard. Failure to follow these instructions may result in injury or death.

- (1) Turn off the boat's shore power connection switch before connecting or disconnecting the shore power cable.
- (2) Connect the shore power cable to the boat first.
- (3) If polarity-warning indicator is activated, immediately disconnect cable.
- (4) Disconnect shore power cable at shore outlet first.
- (5) Close shore power inlet cover tightly.

DO NOT ALTER SHORE POWER CABLE CONNECTORS

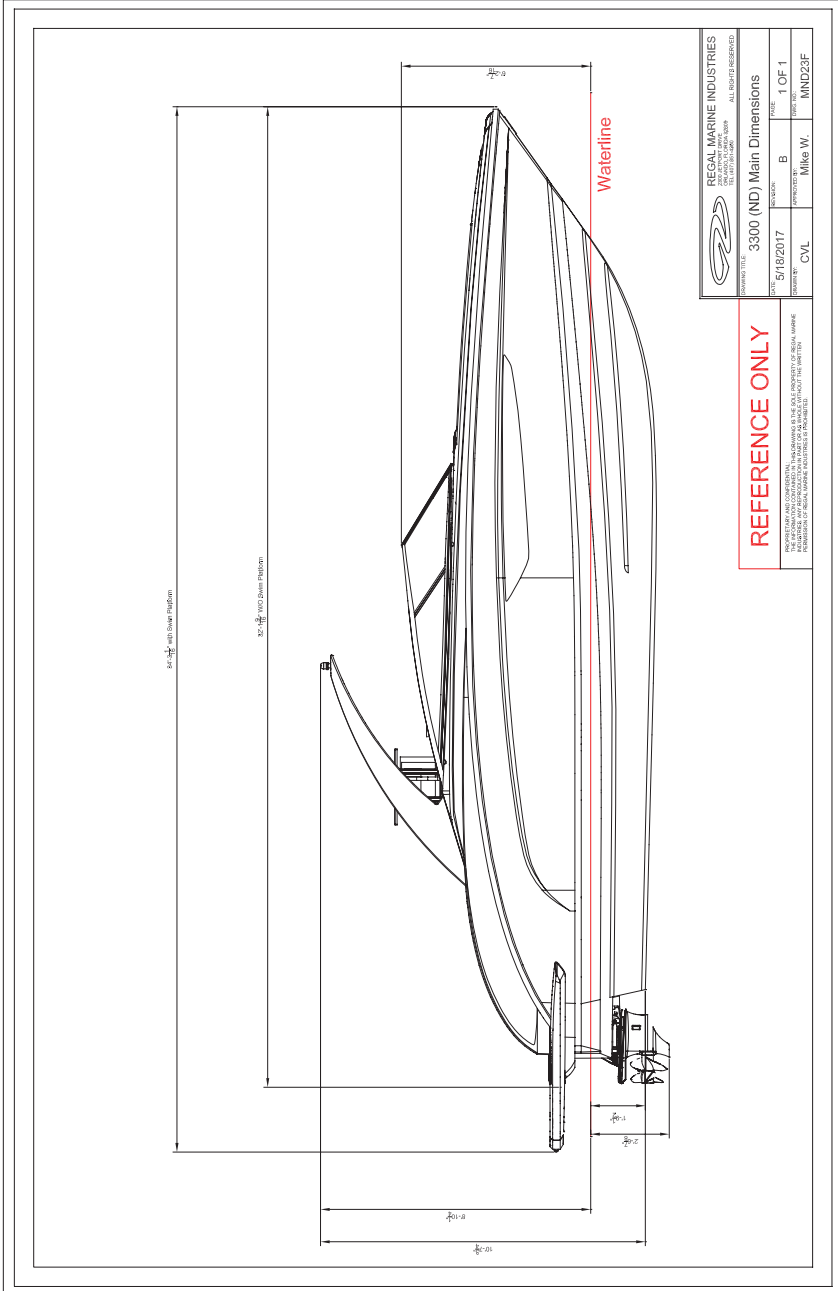

REGAL MARINE INDUSTRIES 10000 W. 10th Ave. #100 Denver, CO 80231		ALL RIGHTS RESERVED	
DRAWING TITLE 3300 (ND) Main Dimensions	DATE 5/18/2017	SCALE B	SHEET 1 OF 1
DRAWN BY CVL	CHECKED BY Mile W.	PROJECT NO. MND23F	DATE PLOT MND23F

REFERENCE ONLY

THIS DRAWING IS FOR REFERENCE ONLY. IT IS NOT TO BE USED FOR CONSTRUCTION. THE DIMENSIONS IN THIS DRAWING ARE THE DIMENSIONS OF THE ORIGINAL DRAWING. ANY CHANGES TO THE ORIGINAL DRAWING WILL BE REFLECTED IN THE DIMENSIONS OF THE ORIGINAL DRAWING. THE DIMENSIONS OF THIS DRAWING ARE NOT TO BE USED FOR CONSTRUCTION OF ANY PARTS OR COMPONENTS OF THIS DRAWING.

3300 Bow Rider Dimensions 1 of 2



Technical Information

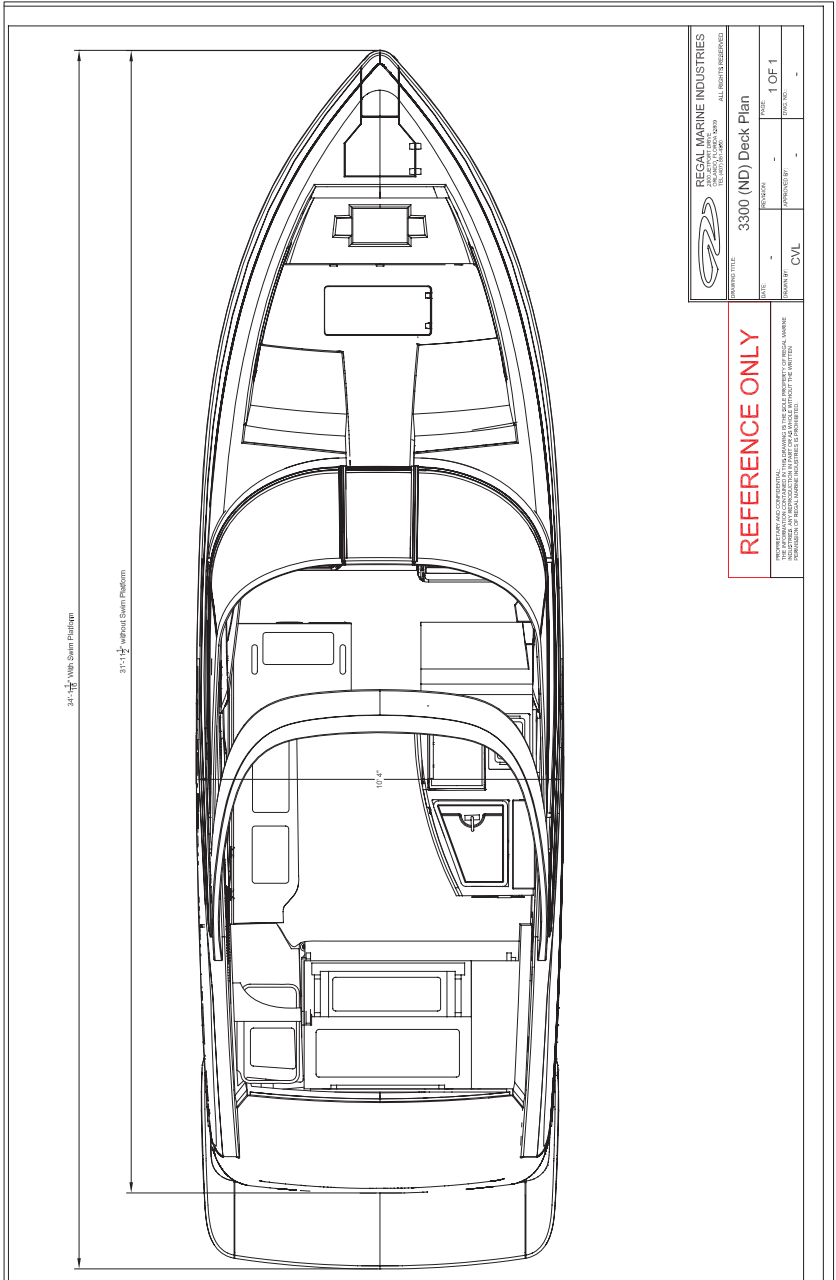

3300 Bow Rider Dimensions 2 of 2



Persons Occupancy: 12 Persons

15.5" W X 29.5" L
Allowance Per Person

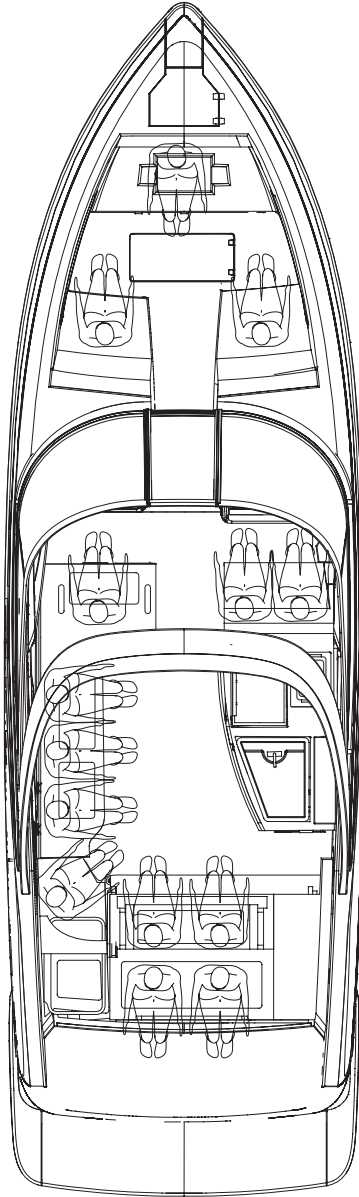

<p>REGAL MARINE INDUSTRIES 10000 W. 10th Street Eden Prairie, MN 55324 ALL RIGHTS RESERVED</p>	
MODEL NO.	3300 (ND) Person Occupancy
DATE	
DESIGNED BY	CVL
APPROVED BY	
REVISED	1 OF 1
SCALE	

REFERENCE ONLY

THIS DRAWING IS THE PROPERTY OF REGAL MARINE INDUSTRIES. IT IS TO BE USED ONLY FOR THE PURPOSES SPECIFIED IN THE DRAWING. IT IS NOT TO BE REPRODUCED OR TRANSMITTED IN ANY FORM OR BY ANY MEANS, ELECTRONIC OR MECHANICAL, INCLUDING PHOTOCOPYING, RECORDING, OR BY ANY INFORMATION STORAGE AND RETRIEVAL SYSTEM.

3300 Persons Occupancy

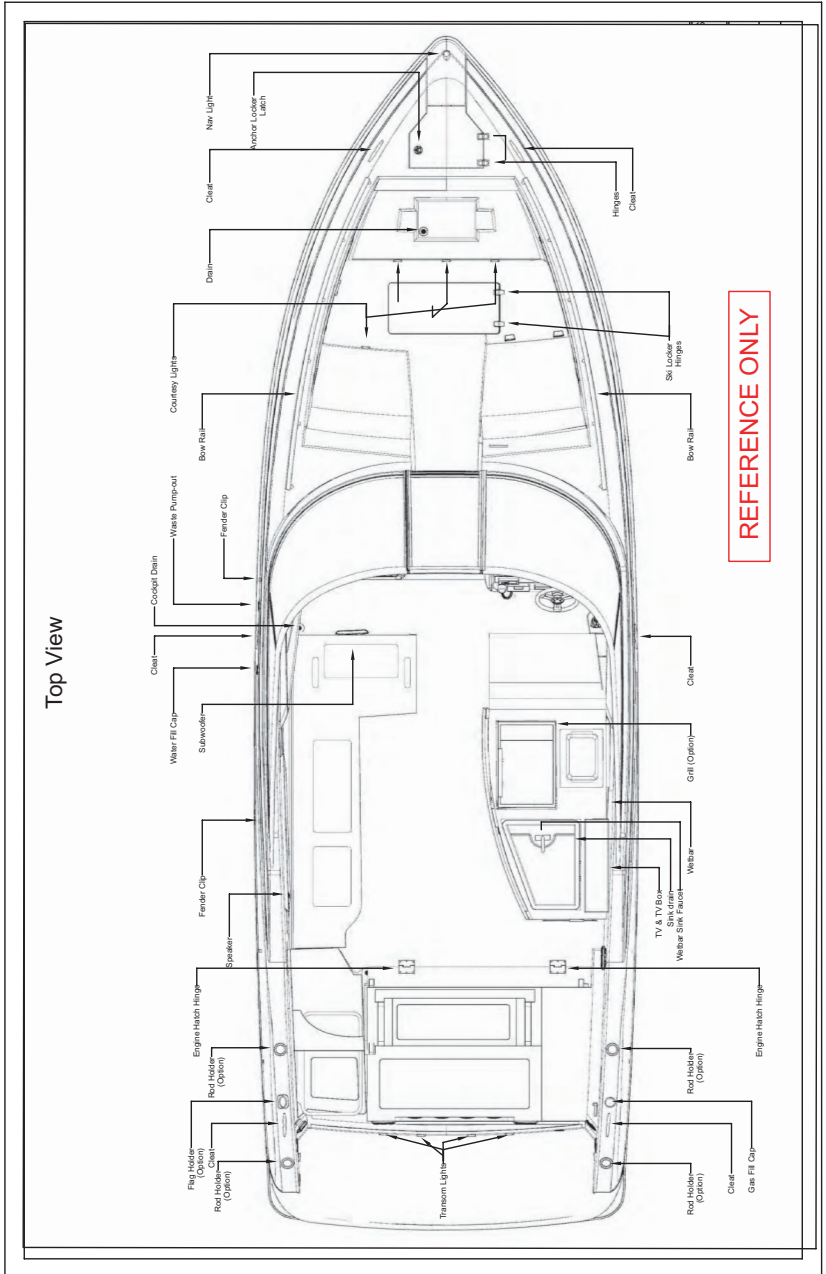

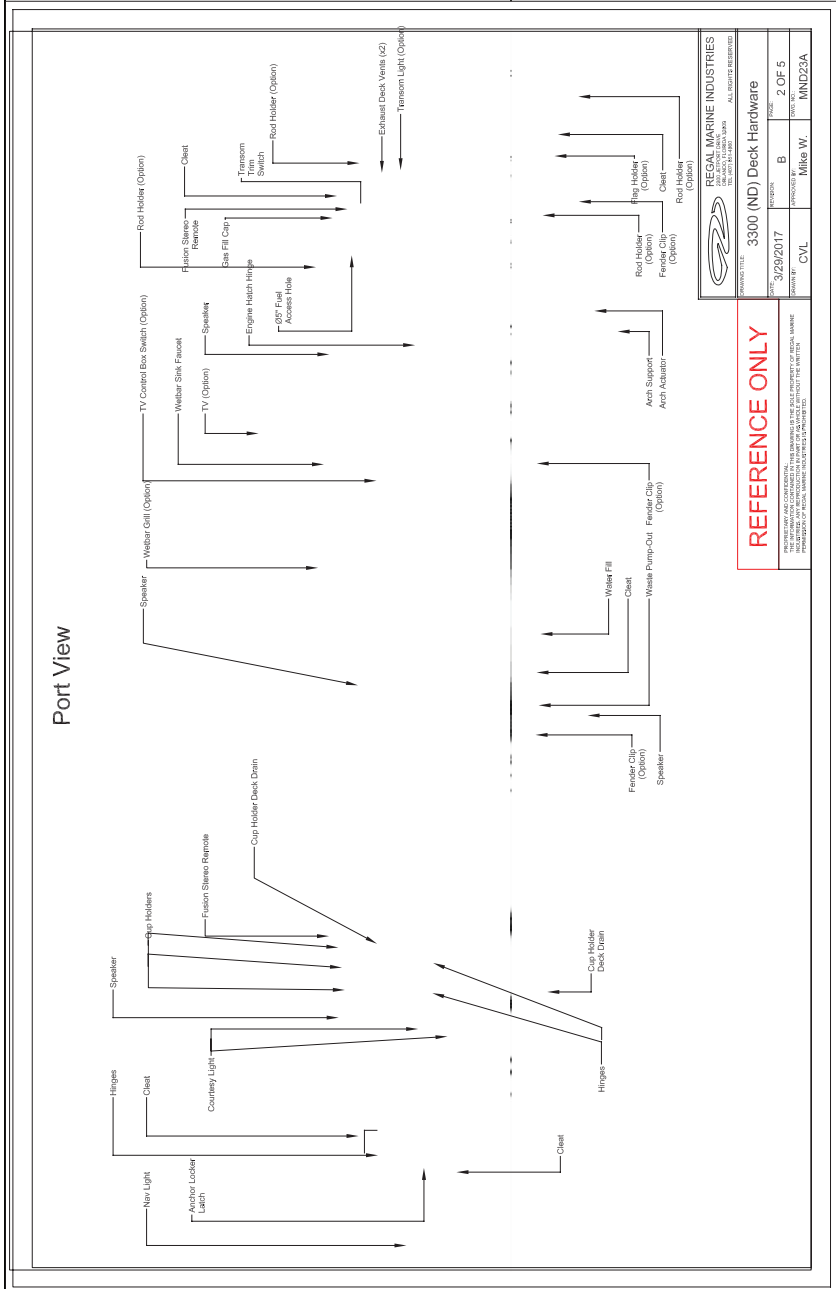

RECAL MARINE INDUSTRIES
 10000 W. 10th Street
 Suite 1000, Denver, CO 80202
 ALL RIGHTS RESERVED

PROJECT: **3300 (ND) Deck Hardware**
 DATE: **3/29/2017**
 DRAWN BY: **CVL**
 CHECKED BY: **B**
 APPROVED BY: **Mike W.**
 TITLE: **2 OF 5**
 PART NO.: **MND23A**

REFERENCE ONLY

THIS DRAWING IS THE PROPERTY OF RECAL MARINE INDUSTRIES. IT IS TO BE USED ONLY FOR THE PROJECT AND VESSEL IDENTIFIED HEREON. IT IS NOT TO BE REPRODUCED OR TRANSMITTED IN ANY FORM OR BY ANY MEANS, ELECTRONIC OR MECHANICAL, INCLUDING PHOTOCOPYING, RECORDING, OR BY ANY INFORMATION STORAGE AND RETRIEVAL SYSTEM.

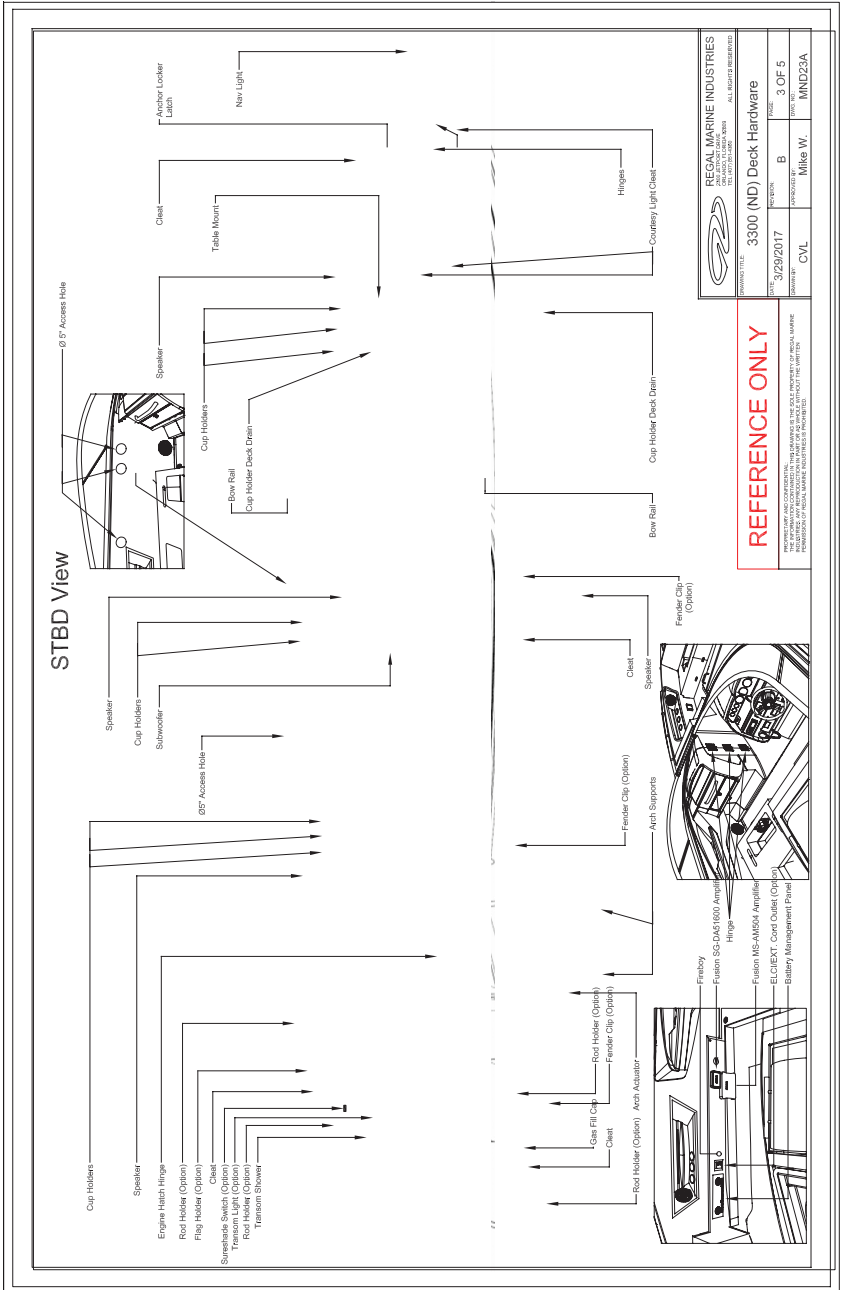



Port View

****Note: Dimensions are for reference.**
Locate using splash.**

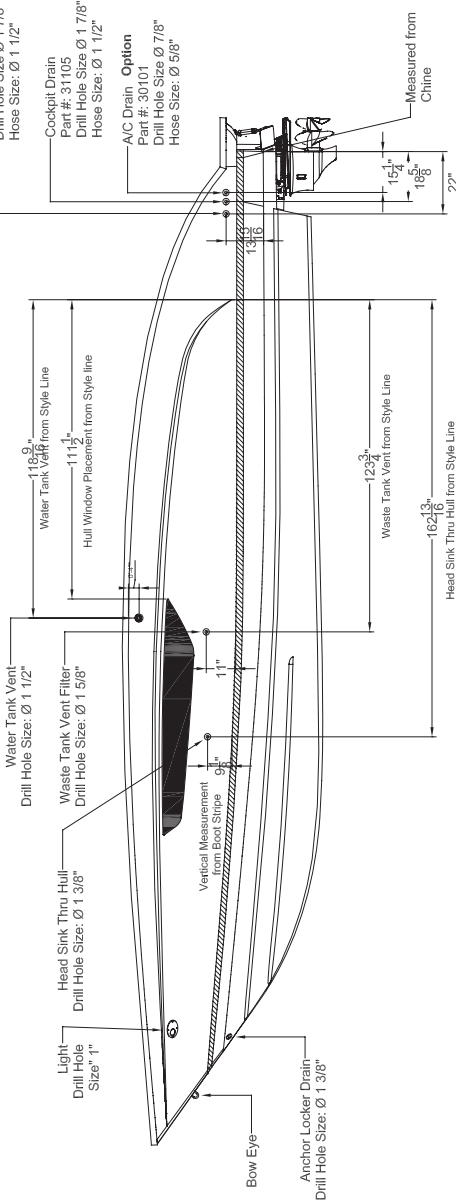

REGAL MARINE INDUSTRIES <small>REGAL MARINE GROUP</small> ALL RIGHTS RESERVED	
3300 (ND) Hull Hardware	1 OF 3
DATE: 5/23/2017	VERSION: C
DRAWN BY: CVL	CHECKED BY: MIND24A

REFERENCE ONLY

THIS DRAWING IS FOR REFERENCE ONLY. THE INFORMATION CONTAINED HEREIN IS NOT TO BE USED FOR THE DESIGN OR CONSTRUCTION OF ANY VESSEL. THE INFORMATION CONTAINED HEREIN IS NOT TO BE USED FOR THE DESIGN OR CONSTRUCTION OF ANY VESSEL. THE INFORMATION CONTAINED HEREIN IS NOT TO BE USED FOR THE DESIGN OR CONSTRUCTION OF ANY VESSEL.



STBD View

Note: Dimensions are for reference.
Locate using splash.

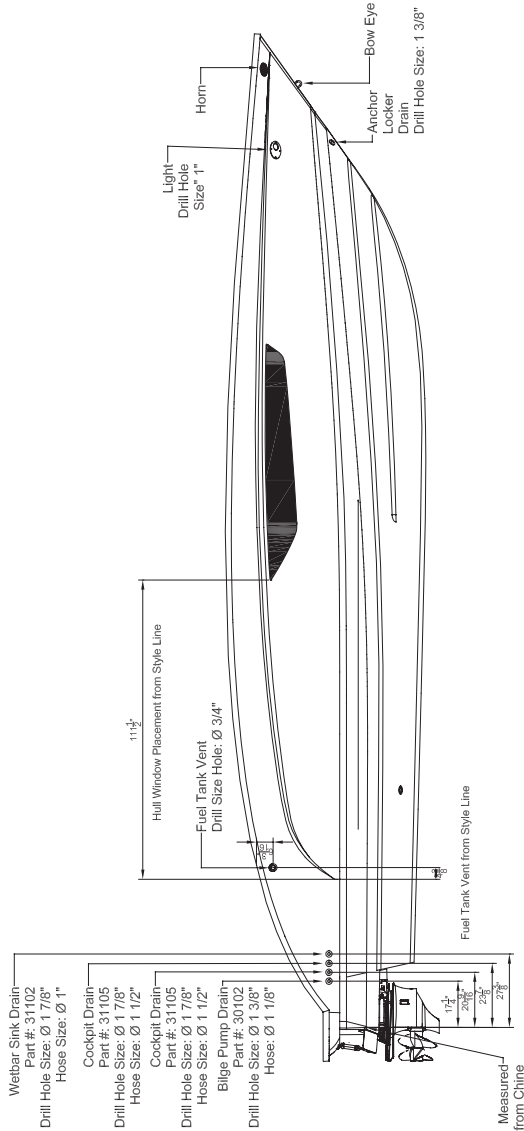

 REGAL MARINE INDUSTRIES 10000 W. 11TH AVENUE DENVER, CO 80231-1000 ALL RIGHTS RESERVED	
DRAWING TITLE 3300 (ND) Hull Hardware	SIZE 2 OF 3
DATE 5/23/2017	DESIGNER C
DRAWN BY CVL	CHECKED BY Mike W.
	PART NO. MND24A

REFERENCE ONLY

THIS DRAWING IS PROVIDED FOR YOUR INFORMATION ONLY. IT IS NOT TO BE USED FOR CONSTRUCTION. THE DRAWING IS THE SOLE PROPERTY OF REGAL MARINE INDUSTRIES. NO PART OF THIS DRAWING IS TO BE REPRODUCED OR TRANSMITTED IN ANY FORM OR BY ANY MEANS, ELECTRONIC OR MECHANICAL, INCLUDING PHOTOCOPYING, RECORDING, OR BY ANY INFORMATION STORAGE AND RETRIEVAL SYSTEM.



Back View

**Note: Dimensions are for reference.
Locate using splash.

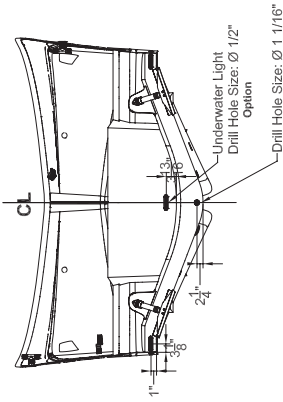
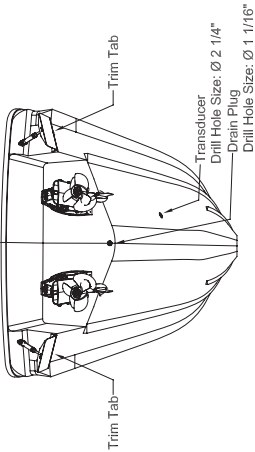

Front View

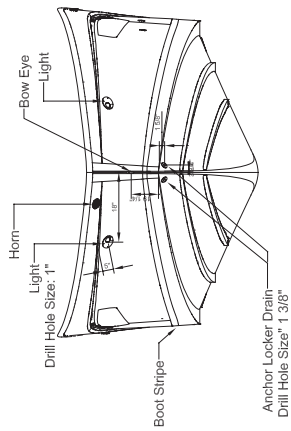

REGAL MARINE INDUSTRIES 10000 WILSON BOULEVARD FORT MYERS, FL 33907-1000 ALL RIGHTS RESERVED			
PART NUMBER 3300 (ND) Hull Hardware	REV. NO. C	QUANTITY 3 OF 3	ORDER NO. MING24A
DATE 5/23/2017	DRAWN BY CVL	CHECKED BY Mike W.	

REFERENCE ONLY

THIS DRAWING IS FOR REFERENCE ONLY. THE INFORMATION CONTAINED HEREIN IS THE PROPERTY OF REGAL MARINE INDUSTRIES. IT IS TO BE USED FOR INFORMATIONAL PURPOSES ONLY AND IS NOT TO BE USED FOR THE DESIGN OR CONSTRUCTION OF ANY PRODUCT. REGAL MARINE INDUSTRIES IS NOT RESPONSIBLE FOR ANY DAMAGE TO PERSONS OR PROPERTY CAUSED BY THE USE OF THIS DRAWING.



Technical Information

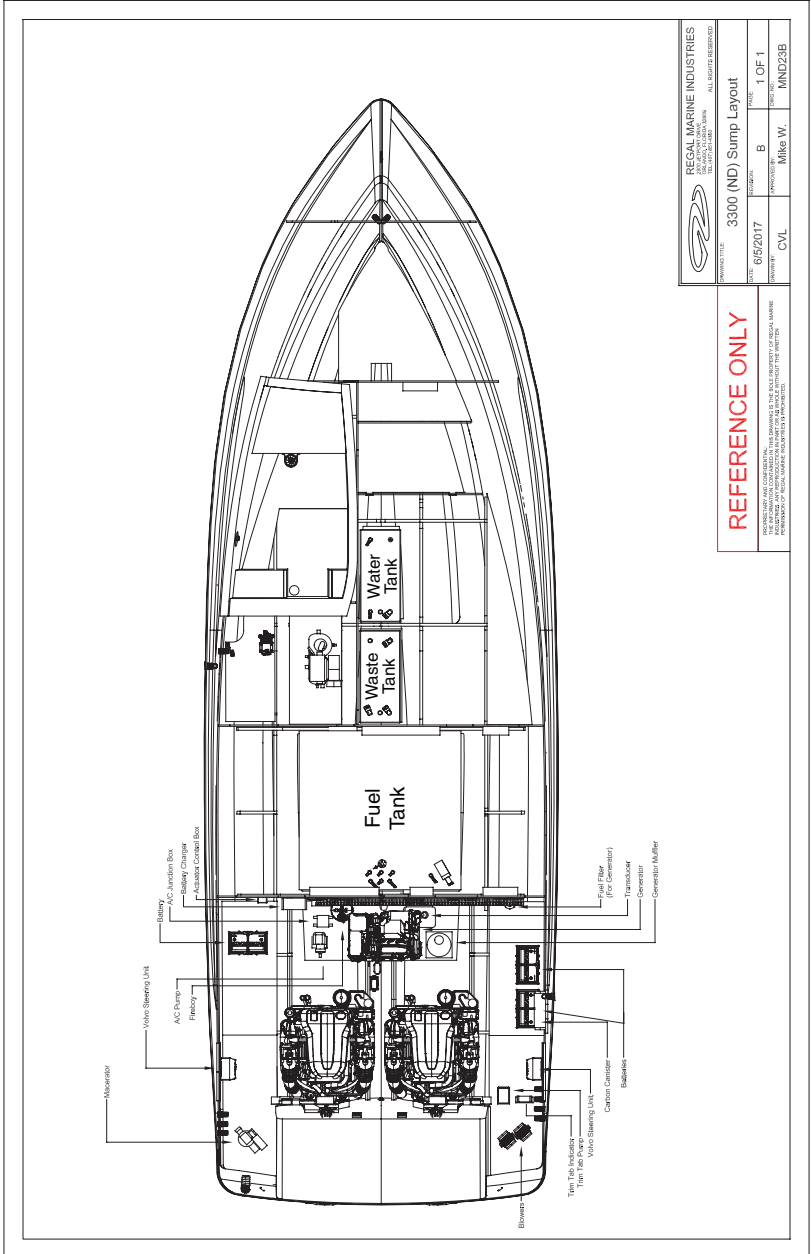

RECAL MARINE INDUSTRIES 2000 W. 10th St., Suite 100 Lincoln, NE 68502	
3300 (ND) Sump Layout	ALL RIGHTS RESERVED
DRAWN BY: 6/5/2017	CHECKED BY: B
DESIGNED BY: CVL	PROJECT NO.: MND238
SCALE: 1 OF 1	SHEET NO.:

REFERENCE ONLY

THIS DOCUMENT IS UNCLASSIFIED, UNCONTROLLED, AND AVAILABLE TO THE PUBLIC WITHOUT RESTRICTIONS. ANY REPRODUCTION OF THIS DOCUMENT IS STRICTLY PROHIBITED. THIS DOCUMENT IS NOT TO BE USED FOR ANY OTHER PURPOSES.

3300 Bow Rider Machinery Layout

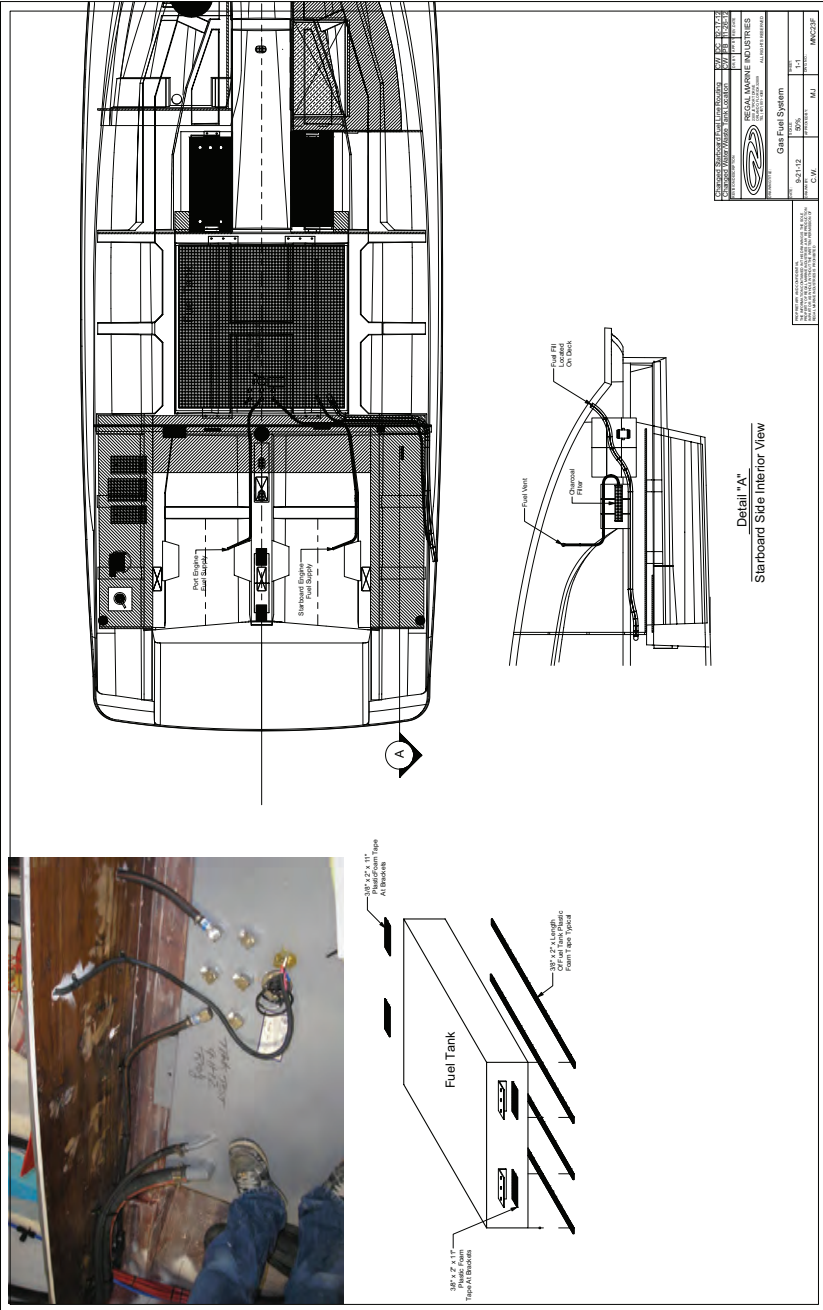

		Zodiac MARINE INDUSTRIES 10211 112th Ave. S.E. Bellevue, WA 98004-3200 (206) 461-1111	
PRODUCT CODE 10211112	PART NUMBER 10211112	QUANTITY 1	UNIT EACH
C/W 10211112	M/U 10211112	MFG CODE 10211112	

Detail "A"
Starboard Side Interior View

3300 Bow Rider Typical EPA-Compliant Fuel Tank Installation



Technical Information

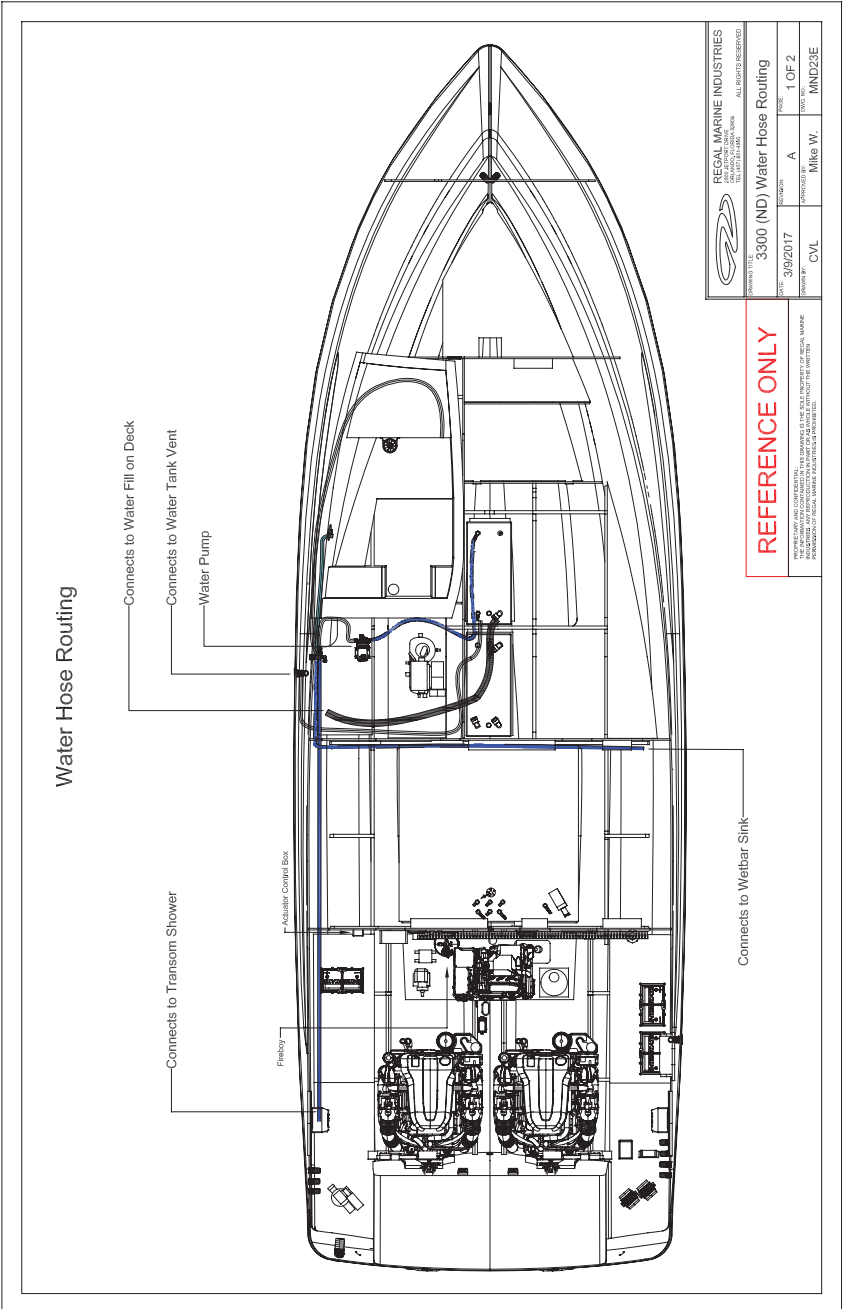

BSEA MARINE INDUSTRIES 14250 CHESAPEAKE BLVD. SUITE 100 DUBLIN, CA 94568 ALL RIGHTS RESERVED	
DESIGNED BY	3300 (ND) Water Hose Routing
DATE	3/9/2017
REVISED BY	CVL
APPROVED BY	Mike W.
CONTROL NO.	MND23E
PAGE	1 OF 2
NETWORK	A

REFERENCE ONLY

THIS INFORMATION IS UNCLASSIFIED
DATE 05/01/2013 BY 60322 UCBAW/STP/STP
REASON FOR DESIGNATION: INFORMATION IS NEITHER
SENSITIVE NOR CRITICAL TO THE NATIONAL DEFENSE
AND IS SUBJECT TO PUBLIC RELEASE IN ACCORDANCE
WITH E.O. 13526, UNLESS INDICATED OTHERWISE.



Water Hose Routing

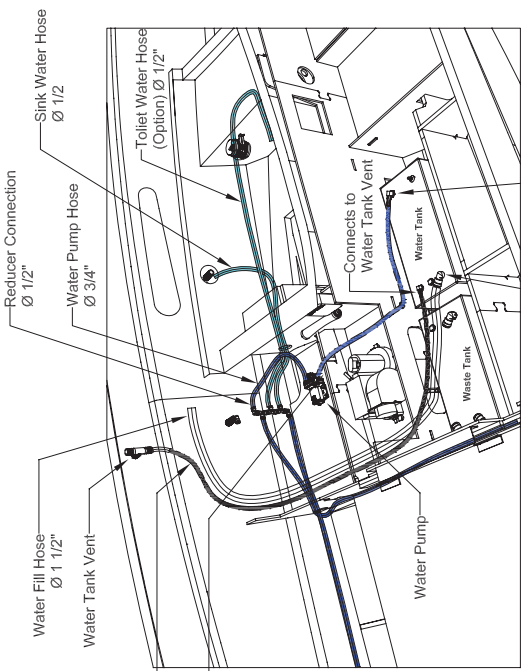

Water Tank Vent Hose
Ø 5/8"

Water Pump Hose
Ø 3/4"

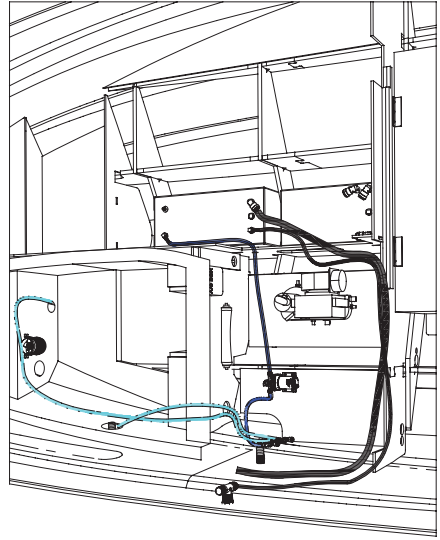

Connects to Water Fill on Deck

 REGAL MARINE INDUSTRIES <small>2000 W. GOLF COURSE DRIVE BOCA RATON, FL 33433</small> <small>REGAL MARINE INDUSTRIES</small>	
REVISED DATE	REVISED BY
DATE	BY
ISSUE	DESCRIPTION
3/6/2017	A
CVL	Mike W.
	MIND23E

REFERENCE ONLY

REGAL MARINE INDUSTRIES, INC. ASSUMES NO LIABILITY FOR ANY DAMAGE, LOSS, OR INJURY THAT MAY OCCUR AS A RESULT OF USING THIS INFORMATION. THE INFORMATION IS PROVIDED AS A SERVICE TO OUR CUSTOMERS AND IS NOT INTENDED TO BE USED AS A SUBSTITUTE FOR PROFESSIONAL ADVICE.



Technical Information

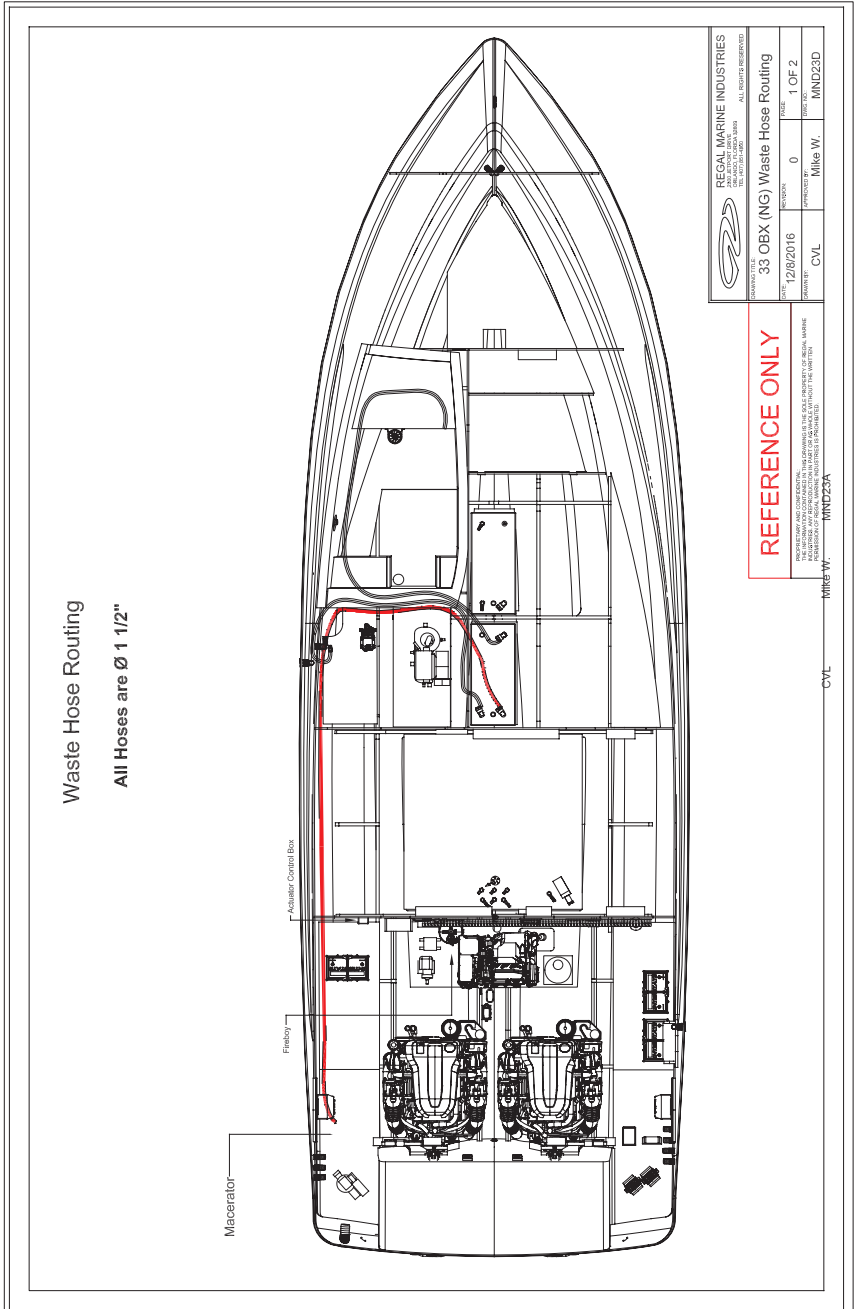

 RECAL MARINE INDUSTRIES <small>12000 W. 120th St. - Overland Park, KS 66204 Tel: 913.241.2200</small> <small>ALL RIGHTS RESERVED</small>	
DATE: 12/8/2016	NO. OF PAGES: 0
REVISED BY: CVL	ISSUED BY: Mile W.
PROJECT: 33 OBX (NG) Waste Hose Routing	PROJECT NO.: MND23D
DATE: 12/8/2016	PAGE: 1 OF 2

REFERENCE ONLY

RECAL DRAWING AND CODE CONTROL. THIS DRAWING IS THE PROPERTY OF RECAL MARINE INDUSTRIES. NO PARTS OF THIS DRAWING ARE TO BE REPRODUCED OR TRANSMITTED IN ANY FORM OR BY ANY MEANS, ELECTRONIC OR MECHANICAL, INCLUDING PHOTOCOPYING, RECORDING, OR BY ANY INFORMATION STORAGE AND RETRIEVAL SYSTEM.

MILE W. MND23A

CVL



Waste Hose Routing

All Hoses are \varnothing 1 1/2"

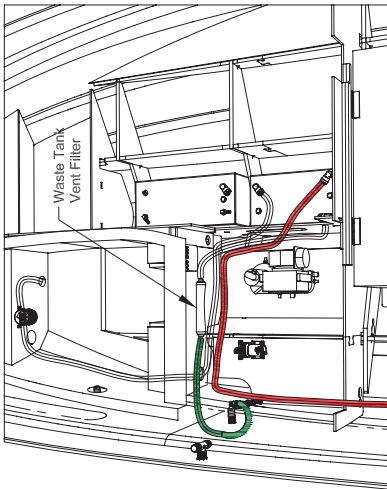

Connects to Waste Cap on Deck

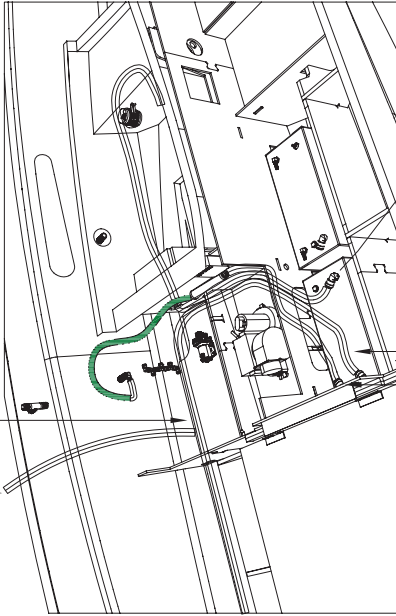

Connects to Waste Tank Vent Filter

Connects to Macerator (Option)

Connects to Toilet

REFERENCE ONLY

THIS INFORMATION IS PROVIDED BY REGAL MARINE INDUSTRIES AS A SERVICE TO OUR CUSTOMERS. IT IS THE PROPERTY OF REGAL MARINE INDUSTRIES AND IS NOT TO BE REPRODUCED, COPIED, OR TRANSMITTED IN ANY FORM OR BY ANY MEANS, ELECTRONIC OR MECHANICAL, INCLUDING PHOTOCOPYING, RECORDING, OR BY ANY INFORMATION STORAGE AND RETRIEVAL SYSTEM.

 REGAL MARINE INDUSTRIES <small>10000 10th Street, Fort Lauderdale, FL 33304</small> <small>ALL RIGHTS RESERVED</small>	
33 OBX (NG) Waste Hose Routing	REVISED: 0
DATE: 12/8/2016	PAGE: 2 OF 2
DRAWN BY: CVL	APPROVED BY: Mike W. MND23D



10-SWITCH COAMING PANEL
REGAL # 321317

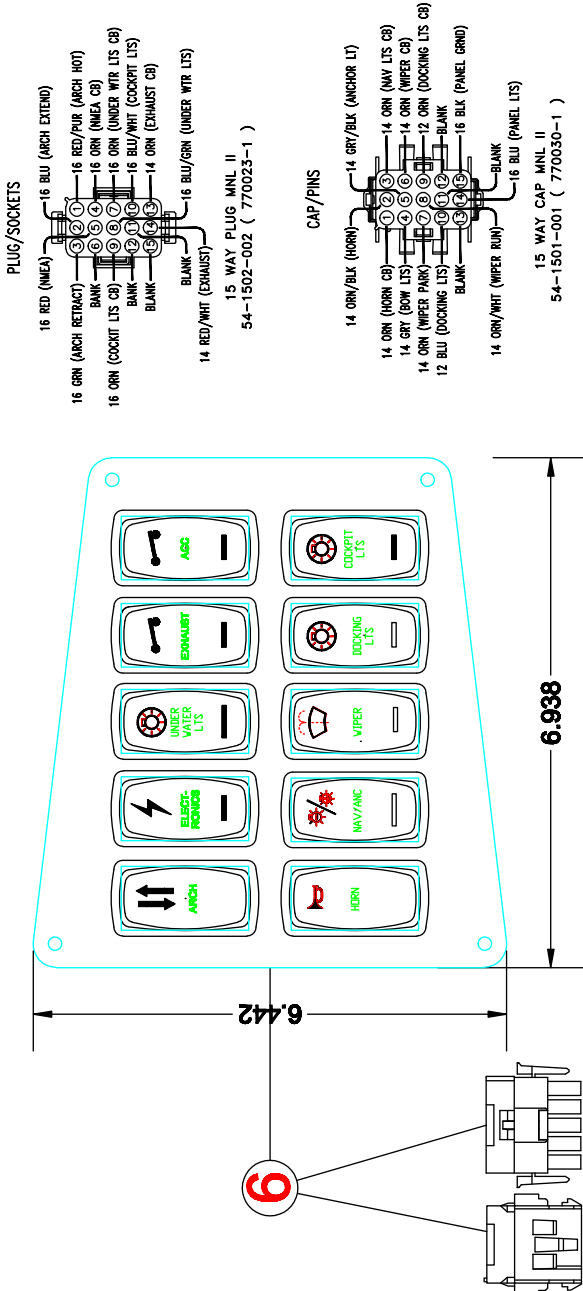

3300 Bow Rider Helm Switch Panel



HELM BREAKER PANEL REGAL # 321357

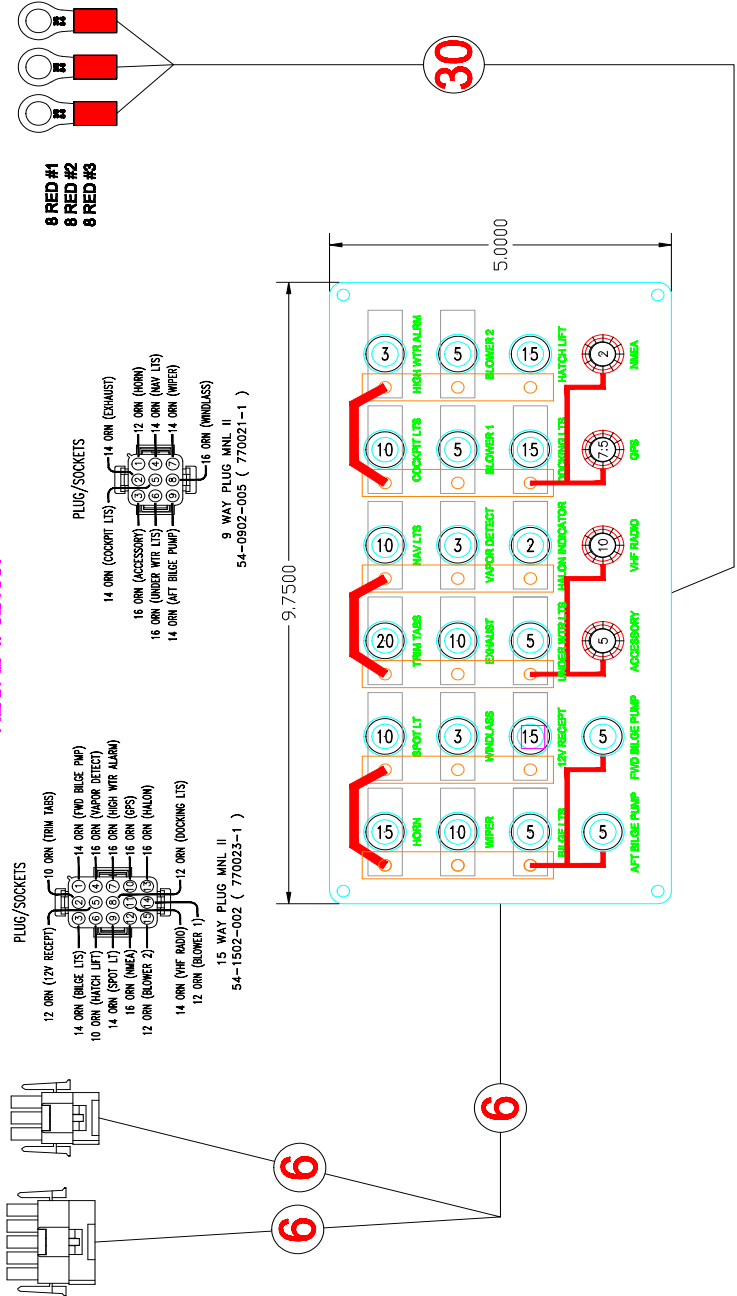

3300 Bow Rider Helm Breaker Panel

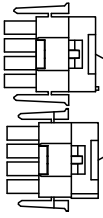

4

ANALOG/VC GAS IGNITION PANEL
REGAL # 221322

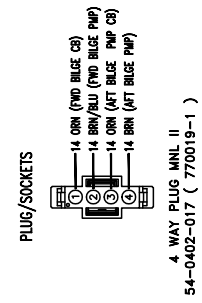
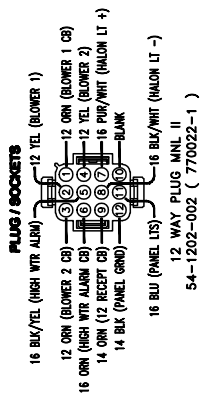
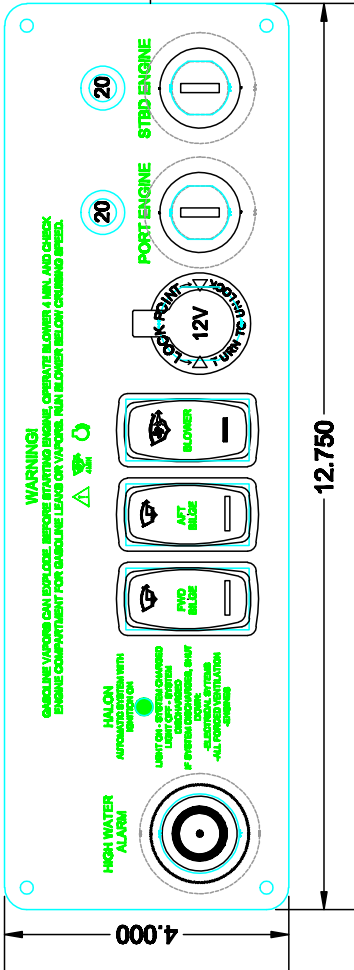

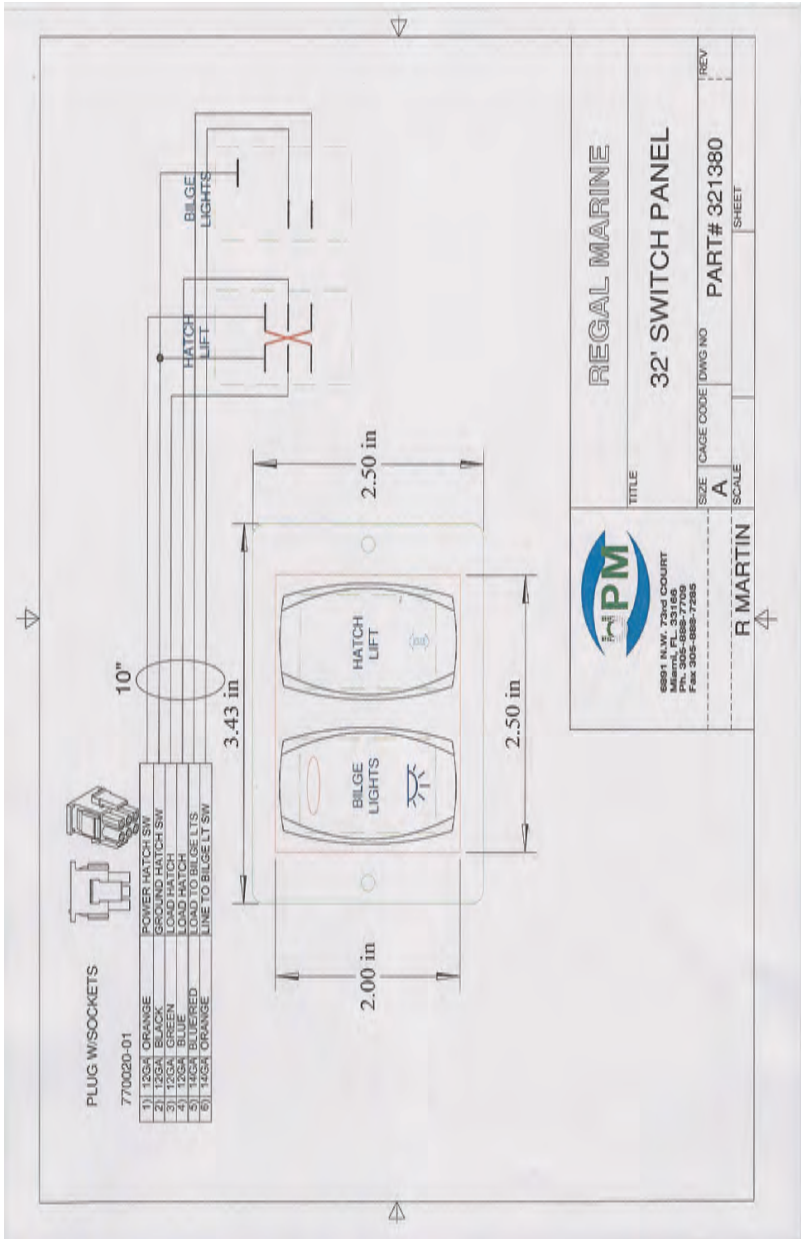

3300 Bow Rider Aft Switch Panel



Technical Information

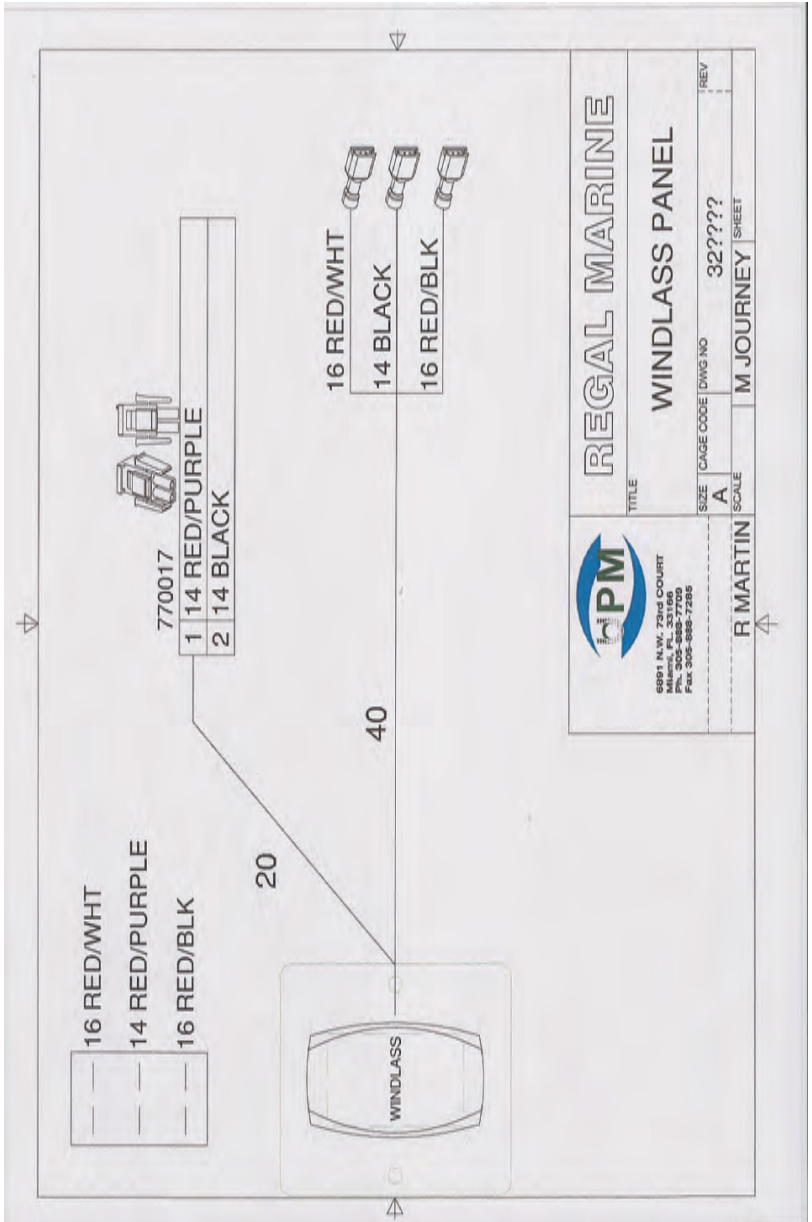

3300 Bow Rider Windlass Panel

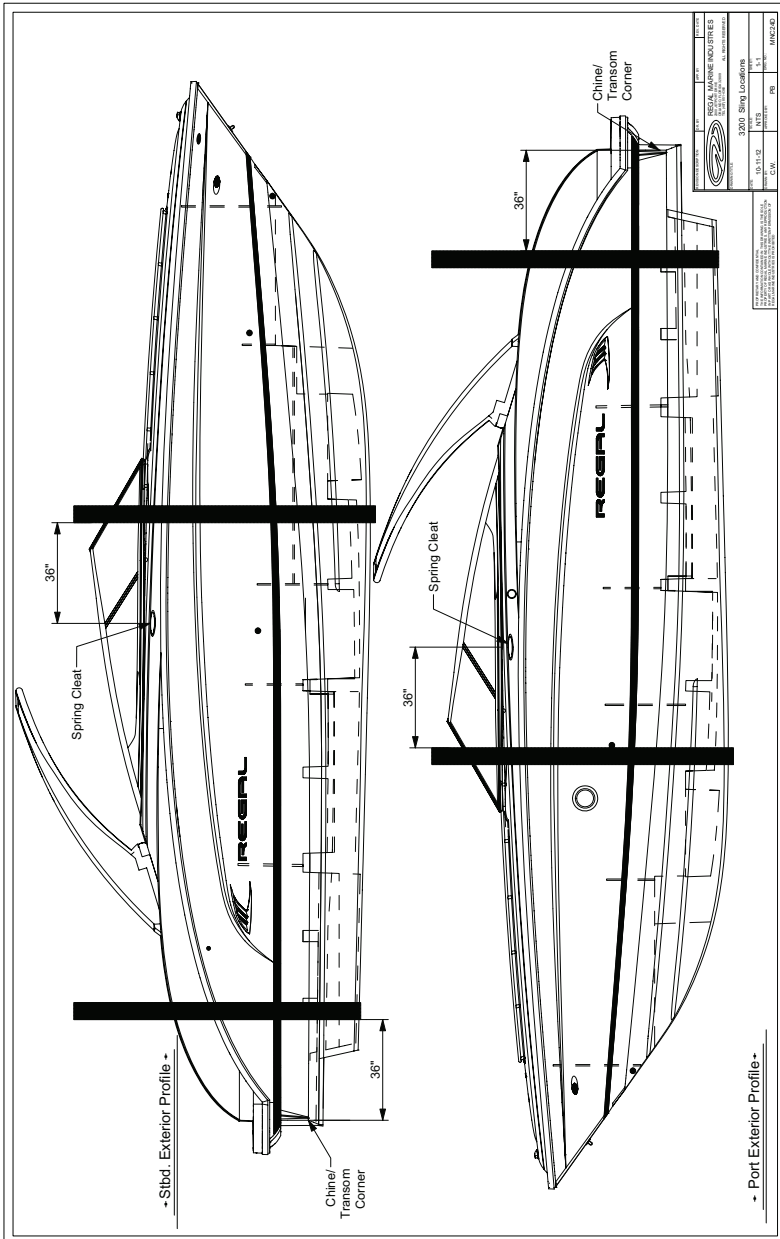

3300 Bow Rider Sling Locations



Technical Information



NOTICE

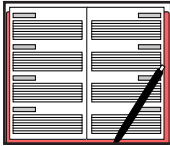

The following technical information and drawings can be an aid in troubleshooting electrical and mechanical problems along with the charts located in the troubleshooting chapter.

Note that all product specifications, models, standard and optional equipment, systems, along with the technical information, are subject to change without notice.

For more information, contact your nearest authorized Regal dealer. For the location of your nearest authorized dealer, call 407-851-4360 or visit the website at www.RegalBoats.com.

Your Regal dealer has received special factory training on the entire product line and his services should be employed to solve technical problems.



TYPICAL DOMESTIC COMPLIANT FUEL SYSTEM

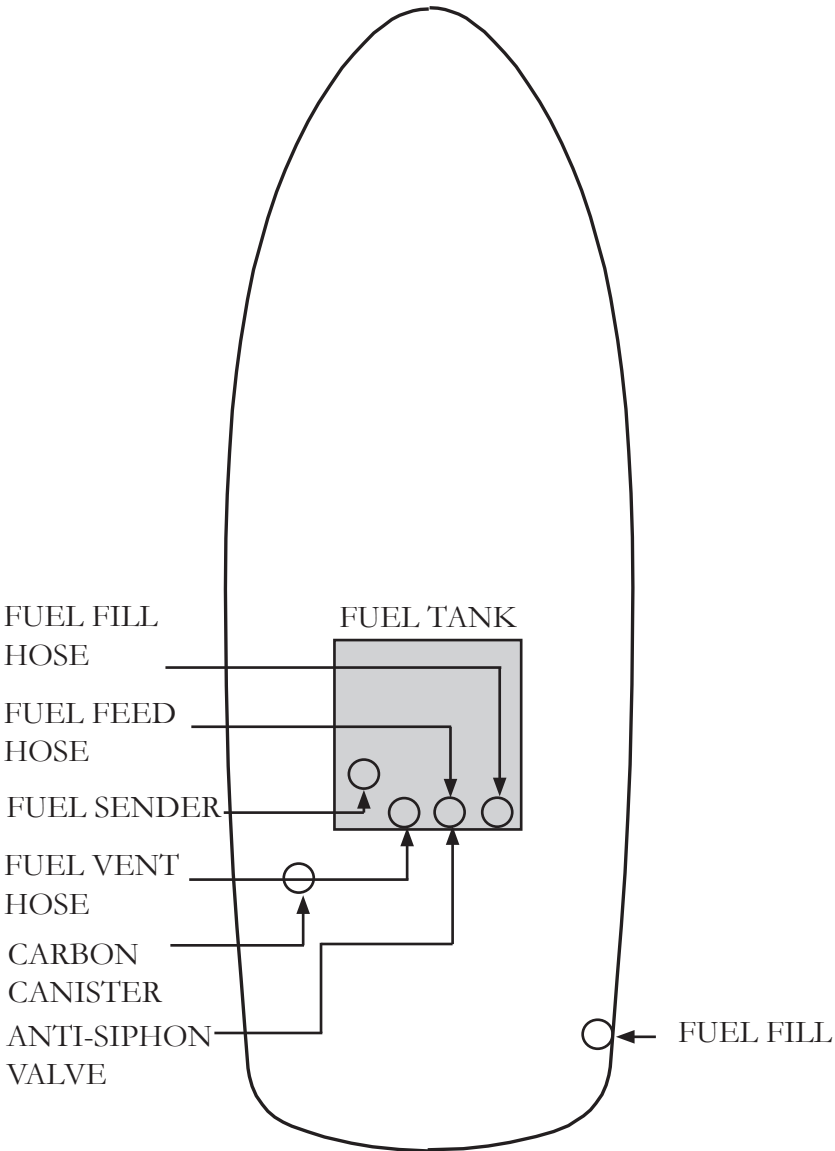

SINGLE OR TWIN OUTBOARD(S)



Technical Information



33 OBX Typical Label & Placard Locations



Location ① Labels

**MEETS U.S. EPA EVAP
STANDARDS USING
CERTIFIED COMPONENTS**
REGAL MARINE INDUSTRIES INC., ORLANDO, FL

WARNING
USE PROPER BLOCKING TECHNIQUES
WHEN LIFTING BOAT

⚠ WARNING
ROTATING PROPELLER MAY CAUSE
SERIOUS INJURY OR DEATH.
SHUT OFF ENGINE WHEN
NEAR PERSONS IN THE WATER.
NW-207-08

⚠ WARNING
Carbon monoxide (CO) can cause brain damage or death.
Carbon monoxide can be present in the cabin.
Signs of carbon monoxide poisoning include nausea, headache,
dizziness, drowsiness, and lack of consciousness.
Get fresh air if anyone shows signs of carbon monoxide poisoning.
Get fresh air if carbon monoxide detector alarm sounds.
Carbon monoxide detector must be functioning at all times.
NW-033-07

**NMMA
CERTIFIED**
YACHT CERTIFICATION
DESIGN COMPLIANCE WITH NMMA REQUIREMENTS IN EFFECT
ON DATE OF CERTIFICATION IS VERIFIED.
MANUFACTURER RESPONSIBLE FOR QUALITY CONTROL.
NATIONAL MARINE MANUFACTURER'S ASSOCIATION
THE BOAT COMPLIES WITH U.S. COAST GUARD SAFETY
STANDARDS IN EFFECT ON THE DATE OF CERTIFICATION
MEETS U.S. EPA EVAP STANDARDS
USING CERTIFIED COMPONENTS
REGAL MARINE INDUSTRIES, INC. ORLANDO, FL

⚠ WARNING
INTERRUPTER SWITCH MUST BE ATTACHED TO THE OPERATOR
WHILE THE ENGINE IS RUNNING. A QUALIFIED OPERATOR MUST
BE IN CONTROL AT ALL TIMES. READ THE OWNER'S MANUAL
BEFORE USE.

Scan with your smart phone
to download your owner's manual.



REGALBOATS.COM/OWNER

WARNING
GASOLINE VAPORS CAN EXPLODE BEFORE STARTING
ENGINE. OPERATE BLOWER 4 MIN. AND CHECK ENGINE
COMPARTMENT FOR GASOLINE LEAKS OR VAPORS. RUN
BLOWER BELOW CRUISING SPEED.
⚠ ⏱ 4 MIN. 🔧

Location ② Labels

NOTICE
Retrieval of Windlass Chain
Winch operator may be required
to periodically spread chain out
within anchor locker

Location ③ Labels

⚠ WARNING
CLOSE DOOR BEFORE USING
WINDSHIELD WALKTHROUGH!

CAUTION: TO AVOID INJURY, WINDOW MUST BE SECURED
IN THE CLOSED POSITION WHEN VESSEL IS
IN MOTION. USE BOTH WINDOW LOCKS.
TAYLOR MADE SYSTEMS, INC.



Technical Information

Location ⑤ Labels

THE DISCHARGE OF ALL FORMS OF PLASTIC INTO ALL WATERS IS PROHIBITED

THE DISCHARGE OF ALL GARBAGE IS PROHIBITED
into the navigable waters of the United States, and into all other waters except as specifically allowed.

ALLOWED: 3 to 12 nautical miles from land – Food waste ground to pass through a one-inch mesh screen.

ALLOWED: 12 or more nautical miles from land – Food waste ground as above, and waste water, and cleaning agents, en route as far from shore as practicable, that are not harmful to the marine environment.

MARPOL ANNEX V – SPECIAL AREAS

GULF OF MEXICO & CARIBBEAN SEA – Food waste en route ground to pass through a one-inch mesh screen.

WESTERN CARIBBEAN REGION – Discharge of all garbage prohibited within 12 nautical miles of land.

Any person who violates the above requirements is liable for civil and/or criminal penalties and regional, state and local restrictions on garbage discharges may also apply.

REPORT ILLEGAL DISPOSAL TO THE U.S. COAST GUARD ON VHF RADIO CHANNEL 16



Location ⑥ Labels

⚠ DANGER

Carbon monoxide (CO) can cause brain damage or death.

Engine and generator exhaust contains carbon monoxide and carbon dioxide gas.

Carbon monoxide will be around the back of the boat when engines or generators are running.

Move to fresh air. If you feel nausea, headache, dizziness, or drowsiness.

⚠ WARNING

ROTATING PROPELLER(S) MAY CAUSE SERIOUS INJURY OR DEATH!

DO NOT APPROACH OR USE LADDER WHEN ENGINE IS RUNNING.

Location ⑦ Labels



Location ⑧ Labels



Location ⑨ Labels

⚠ WARNING

TRANSOM DOOR MUST BE CLOSED AND SECURED WHEN ENGINE IS RUNNING

Location ⑩ Labels

⚠ CAUTION

WHEN OPERATING POWERTOWER KEEP ALL BODY PARTS CLEAR OF TOWER HINGE MECHANISMS.



Location ⑪ Labels



Location ⑫ Labels

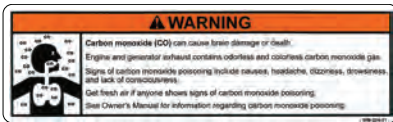

Location ⑬ Labels

WARNING

Electrical shock and fire hazard. Failure to follow these instructions may result in injury or death.

- (1) Turn off the boat's shore power connection switch before connecting or disconnecting the shore power cable.
- (2) Connect the shore power cable to the boat first.
- (3) If polarity-warning indicator is activated, immediately disconnect cable.
- (4) Disconnect shore power cable at shore outlet first.
- (5) Close shore power inlet cover tightly.

**DO NOT ALTER SHORE
POWER CABLE CONNECTORS**



Technical Information

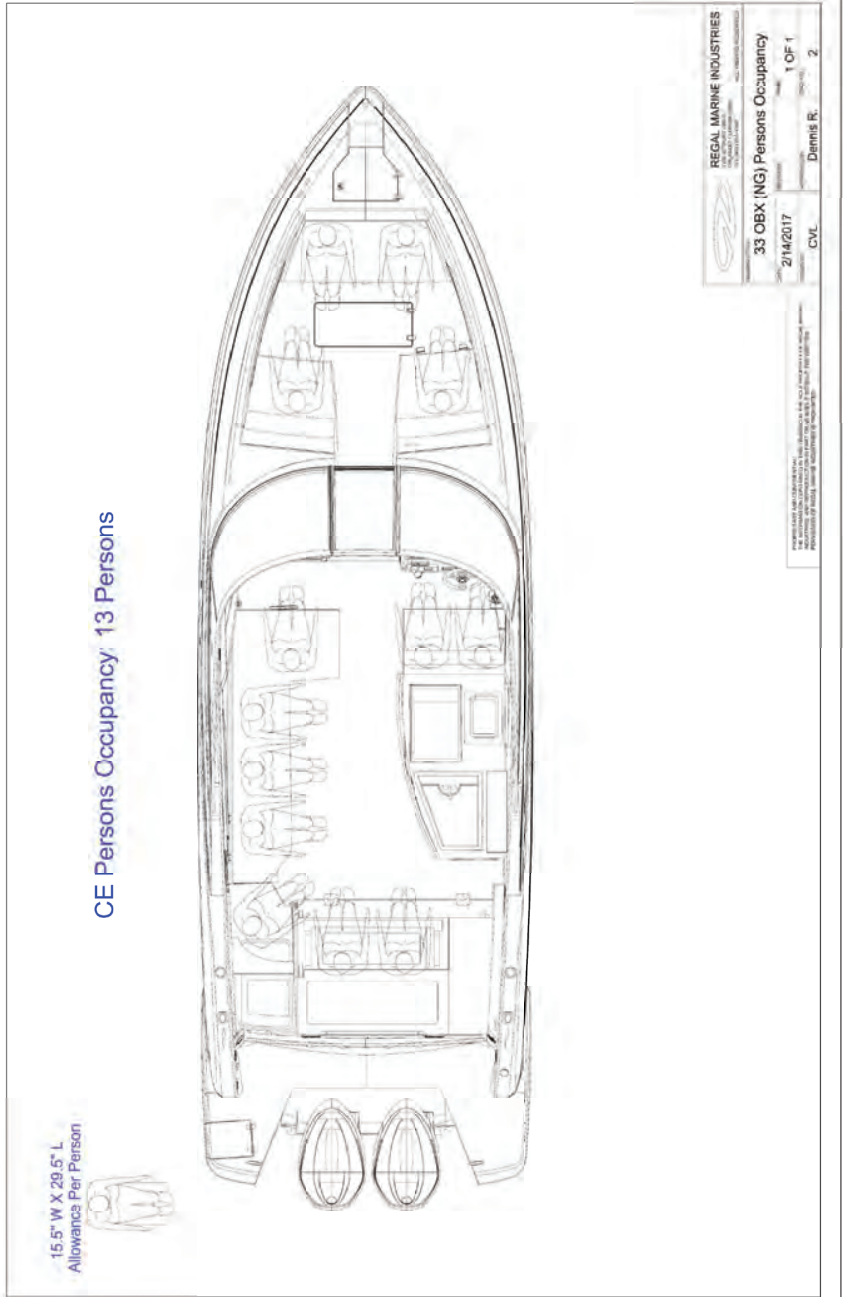

33 OBX Persons Occupancy

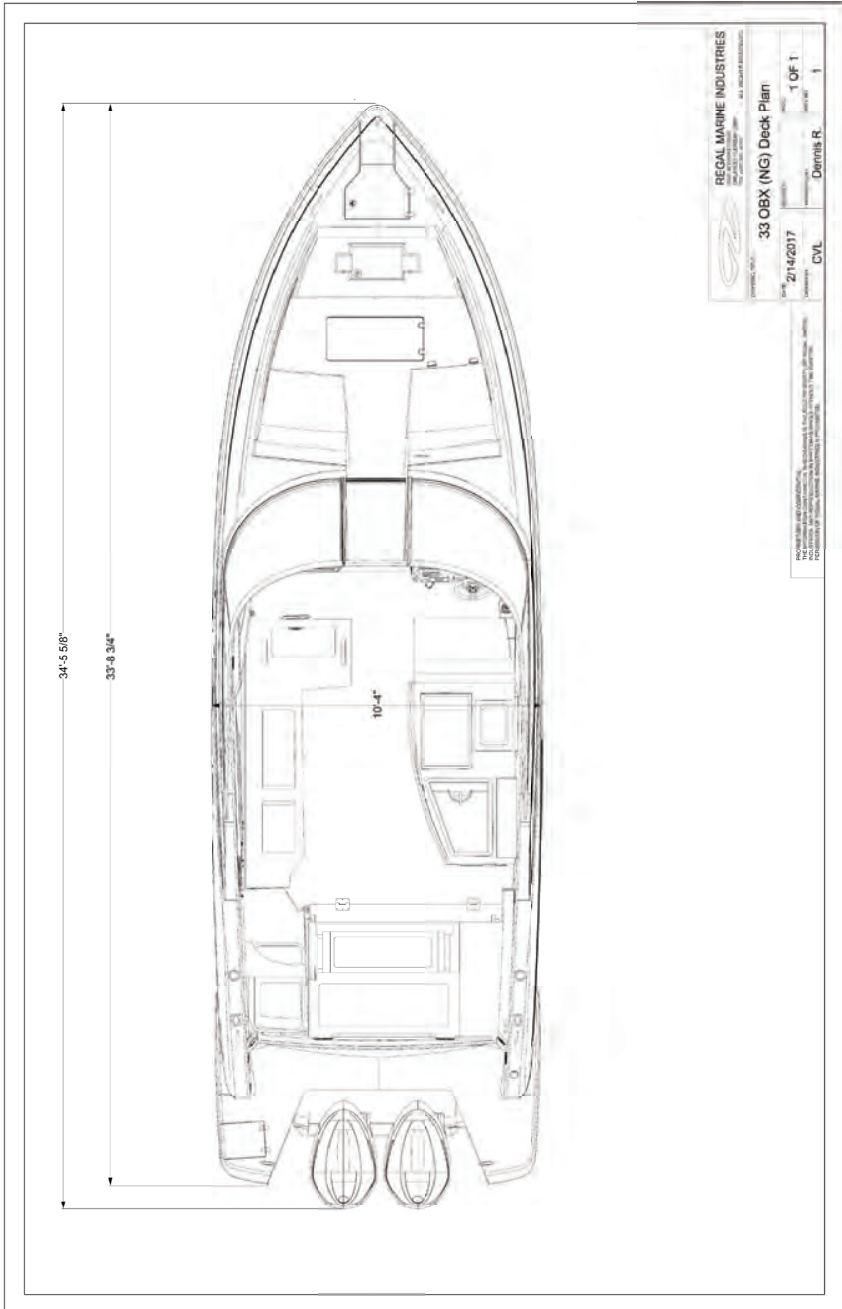

REGAL MARINE INDUSTRIES
1000 W. 10th Street
Fort Lauderdale, FL 33304
Tel: 954.343.8300
Fax: 954.343.8301
www.regalmarine.com

33 OBX (NG) Deck Plan

DATE: 2/14/2017
DRAWN BY: CVL
CHECKED BY: Dennis R.
SCALE: 1 OF 1
SHEET NO: 1

REGAL MARINE INDUSTRIES, INC. AND ITS AFFILIATED COMPANIES ARE NOT RESPONSIBLE FOR ANY DAMAGE TO YOUR VESSEL OR PERSONAL PROPERTY CAUSED BY THE USE OF THIS PLAN. ALWAYS CONSULT WITH YOUR DEALER FOR THE LATEST AND MOST ACCURATE INFORMATION.

33 OBX Deck Plan



Technical Information

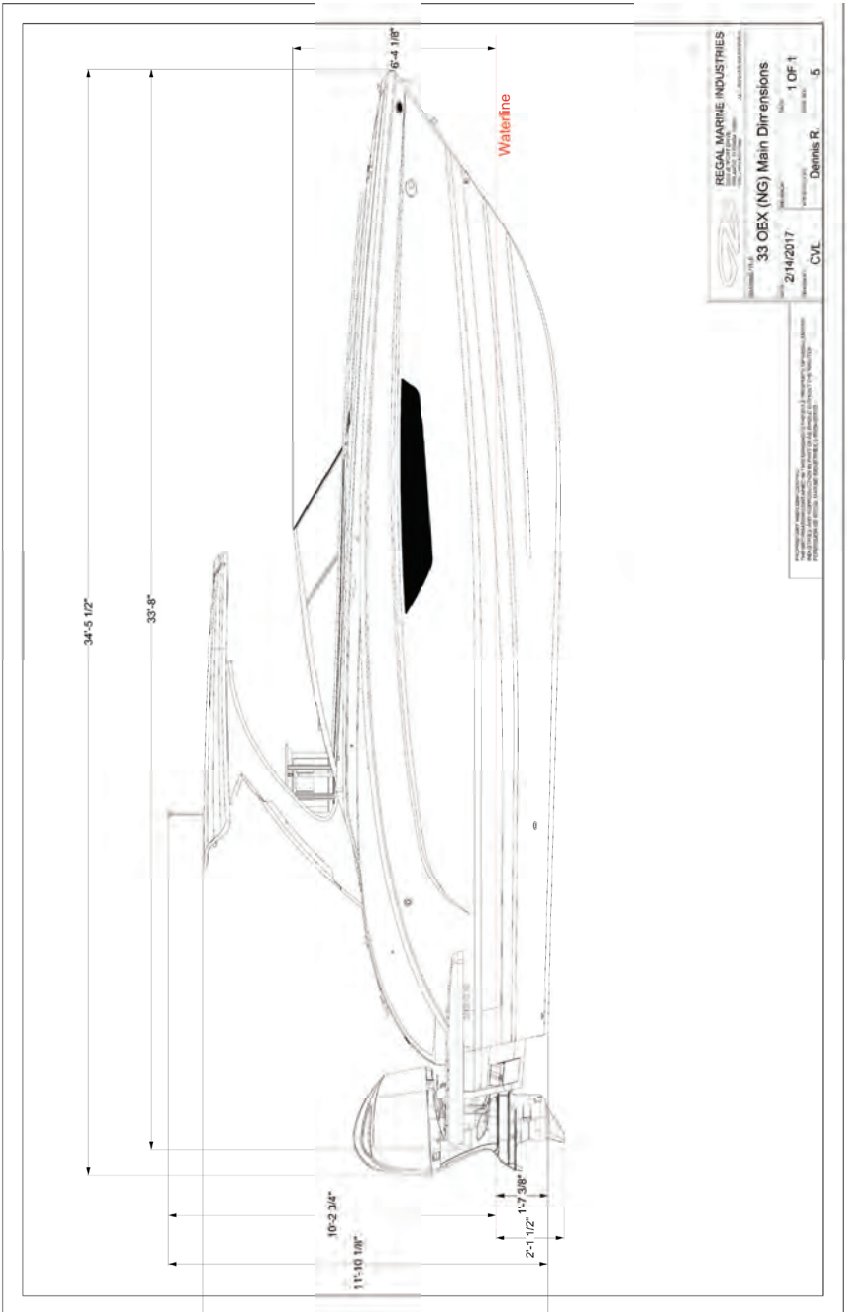

33 OBX Main Dimensions



Port View

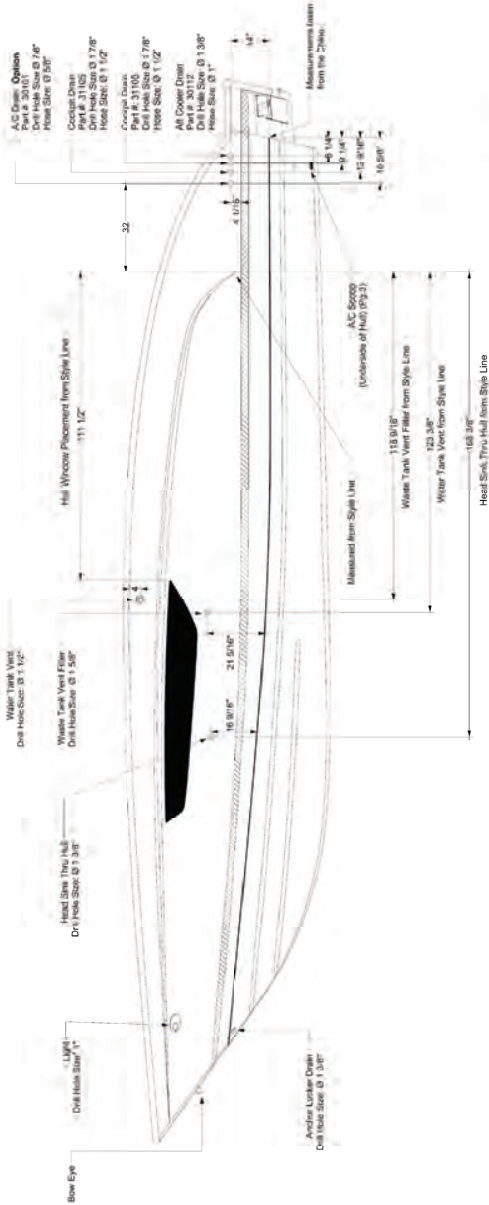

REGAL MARINE INDUSTRIES
33 OBX (NG) Hull Hardware
3/27/2017
CVL
1 OF 3
Dennis R.

REGAL MARINE INDUSTRIES
10000 W. Highway 104, Ft. Lauderdale, FL 33309
REGAL MARINE INDUSTRIES
REGAL MARINE INDUSTRIES
REGAL MARINE INDUSTRIES

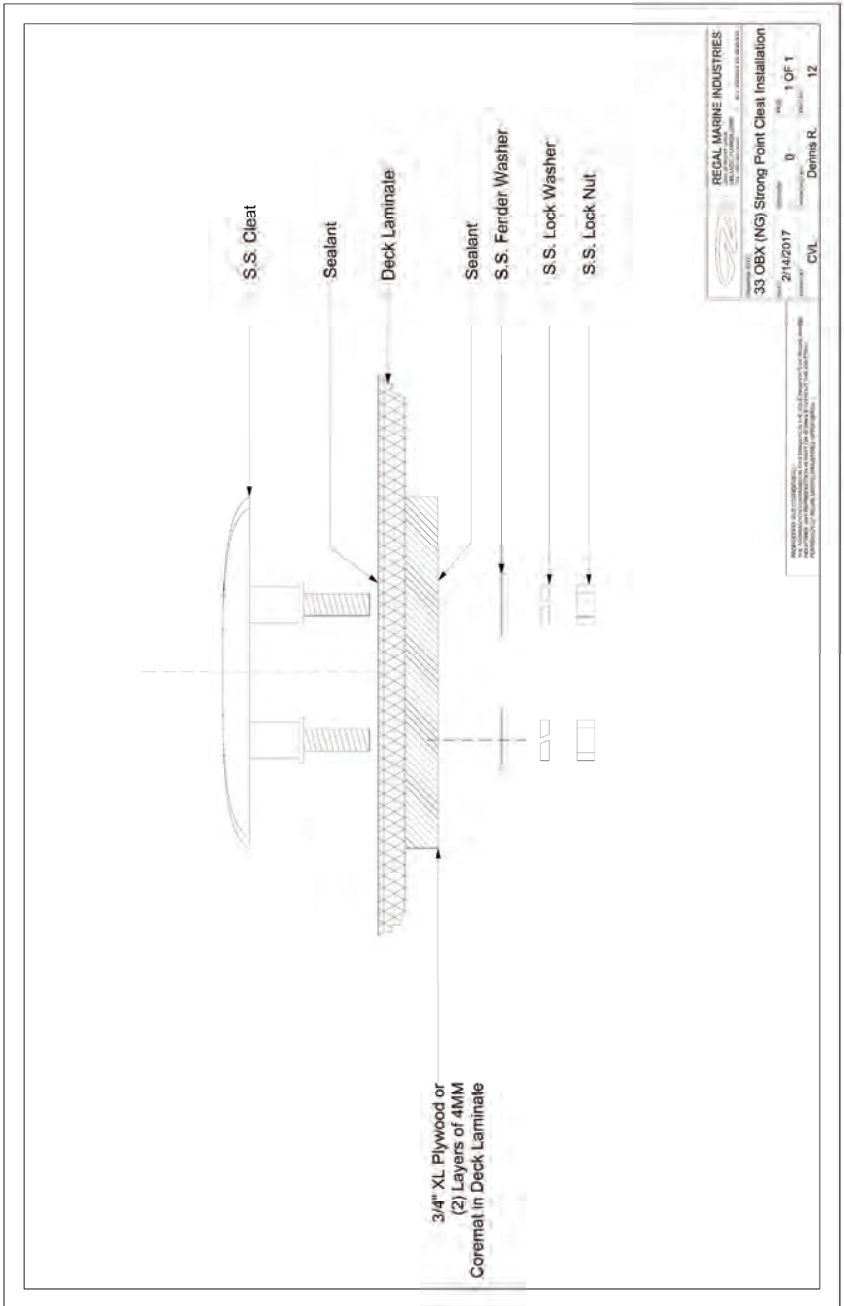

33 OBX Strong Point Cleat Installation



Technical Information

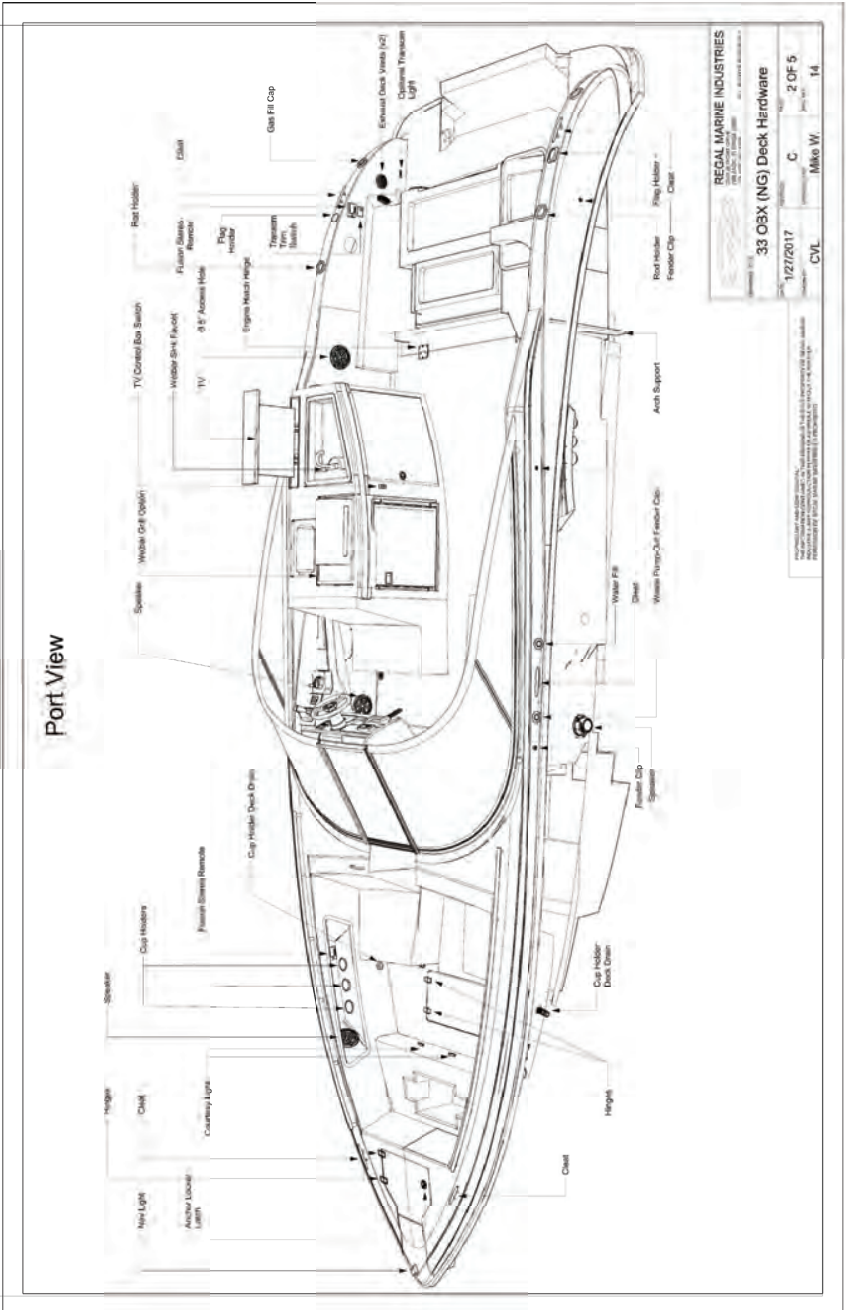

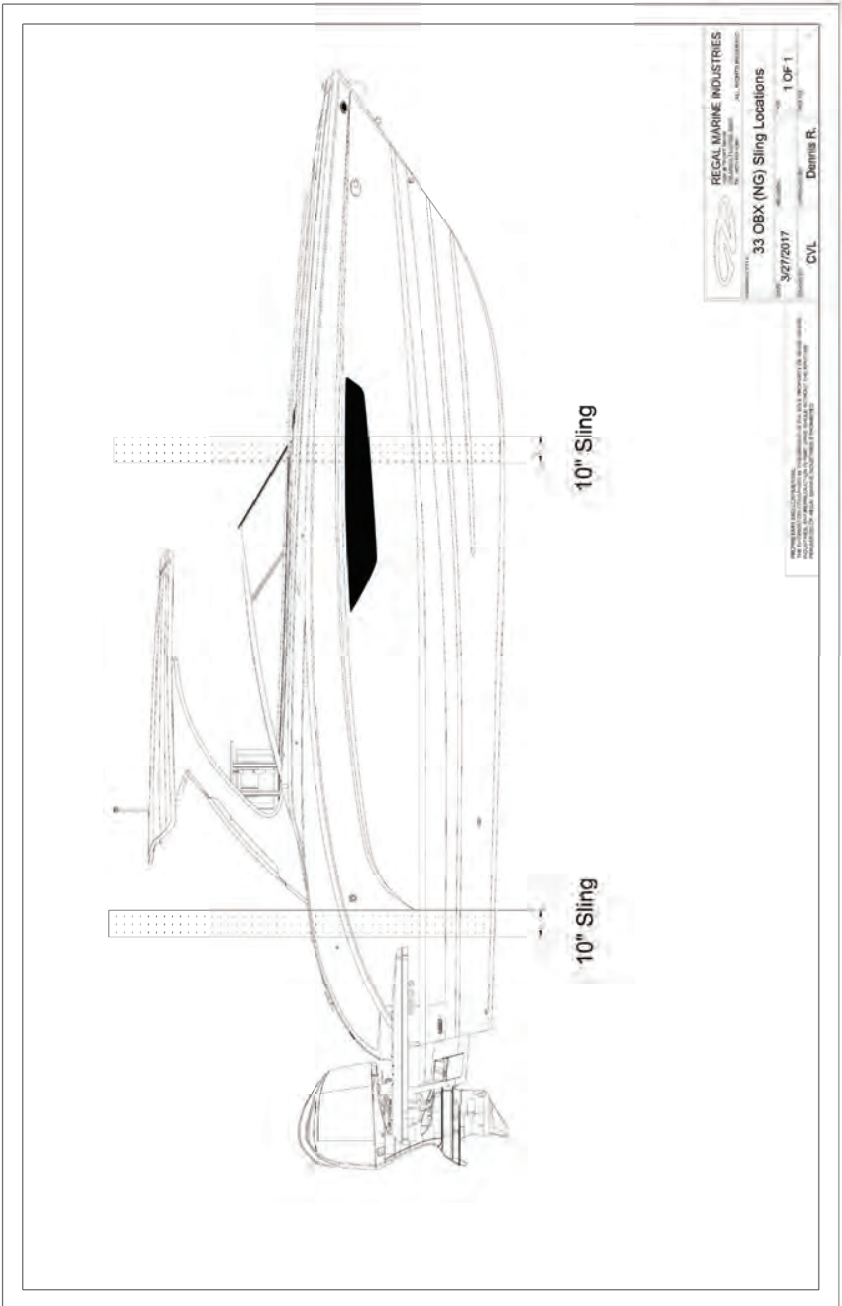

33 OBX Sling Locations

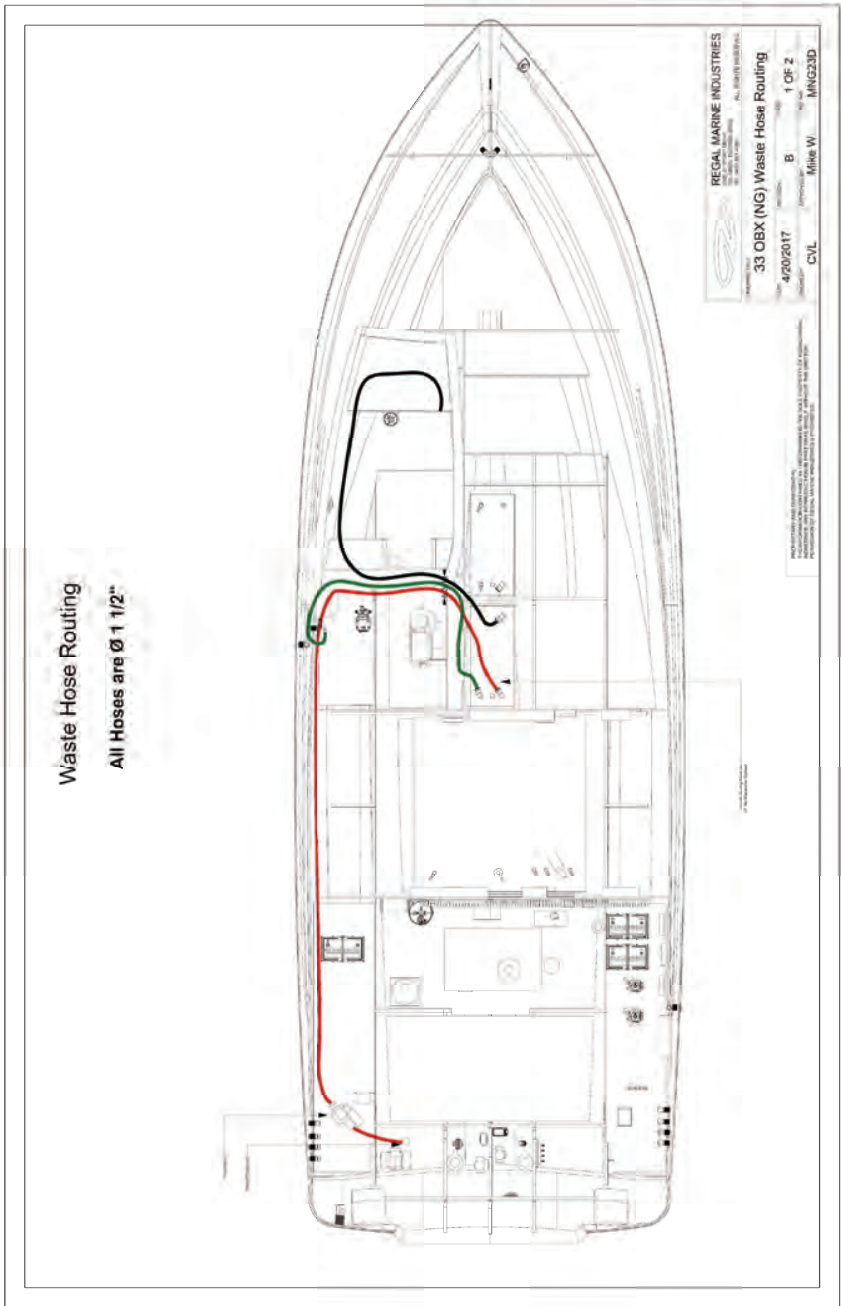

33 OBX Waste Hose Routing 1 of 2

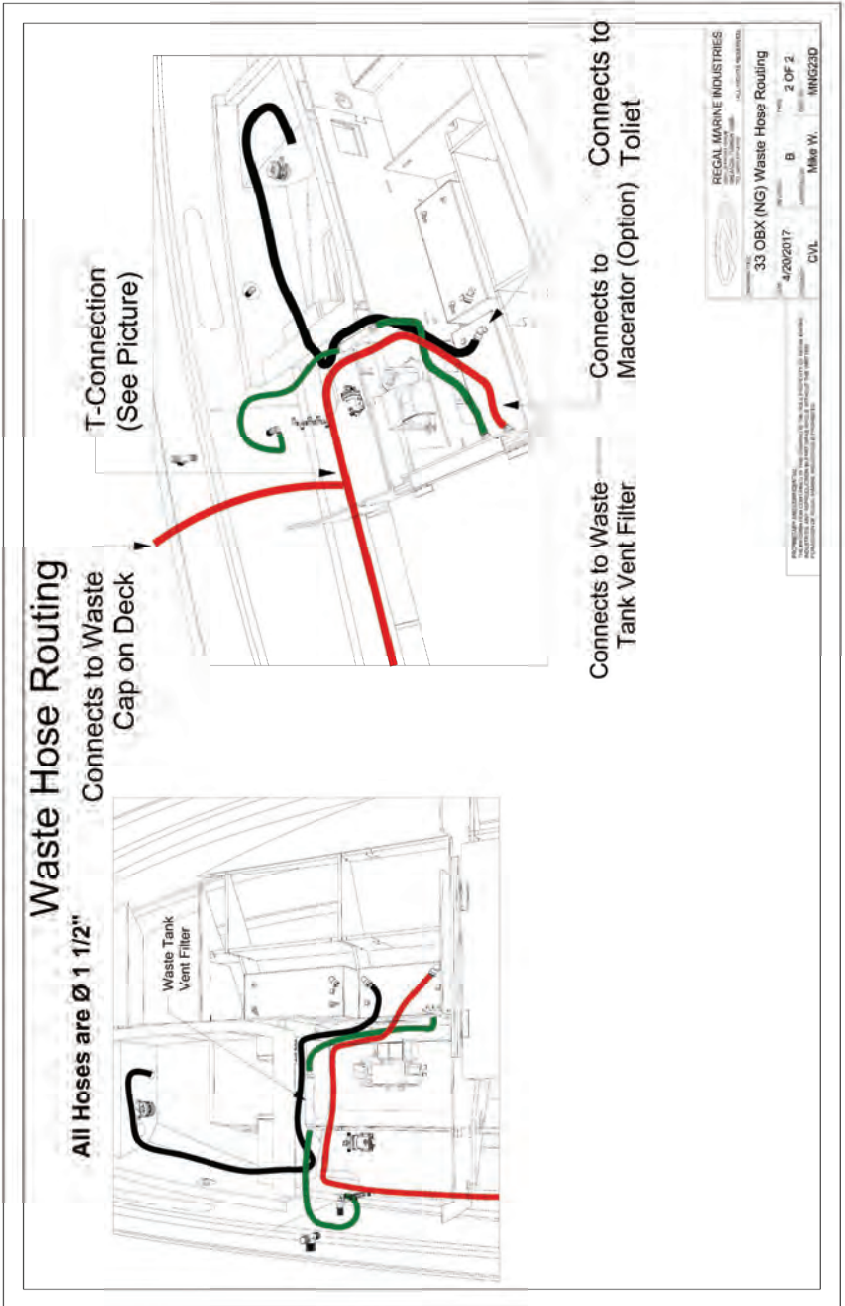

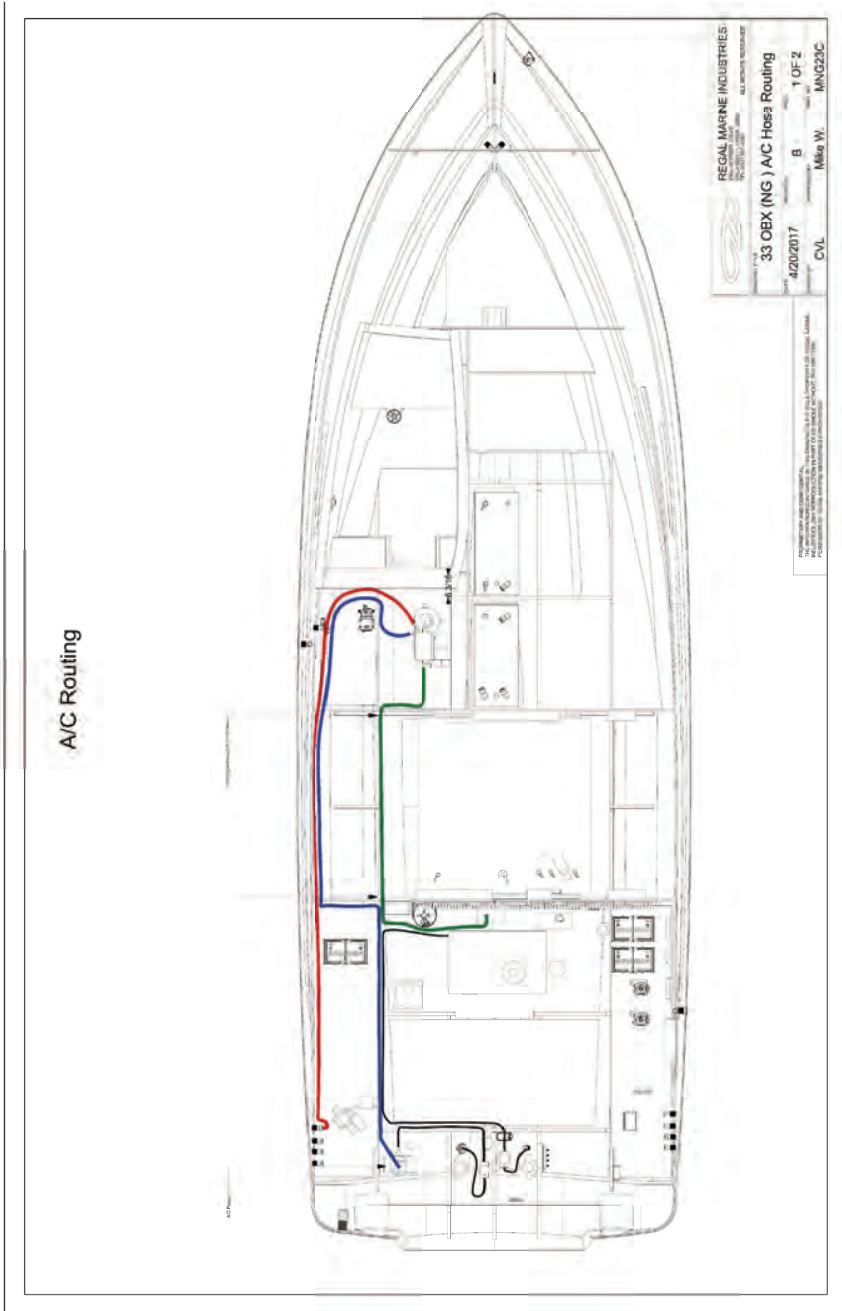

33 OBX A/C Hose Routing 1 of 2

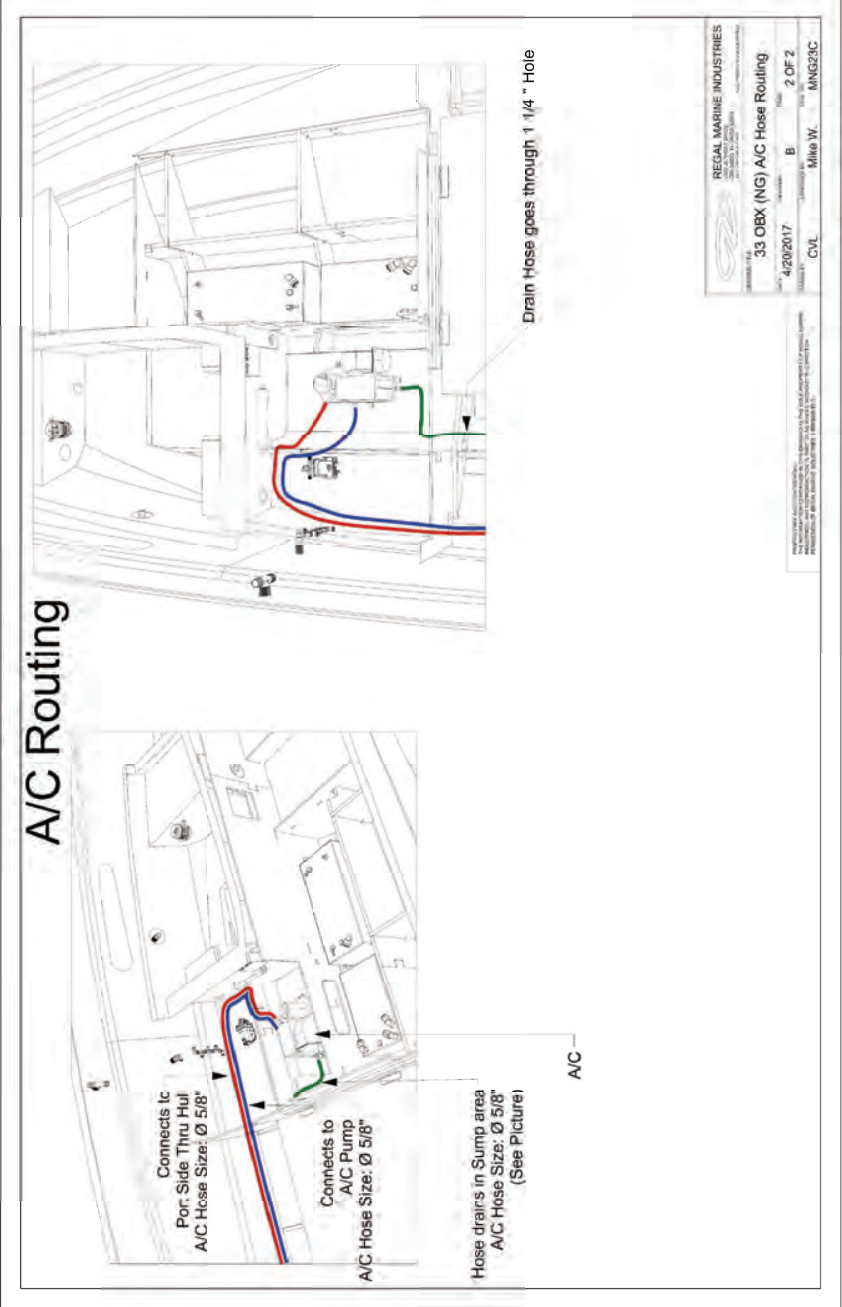

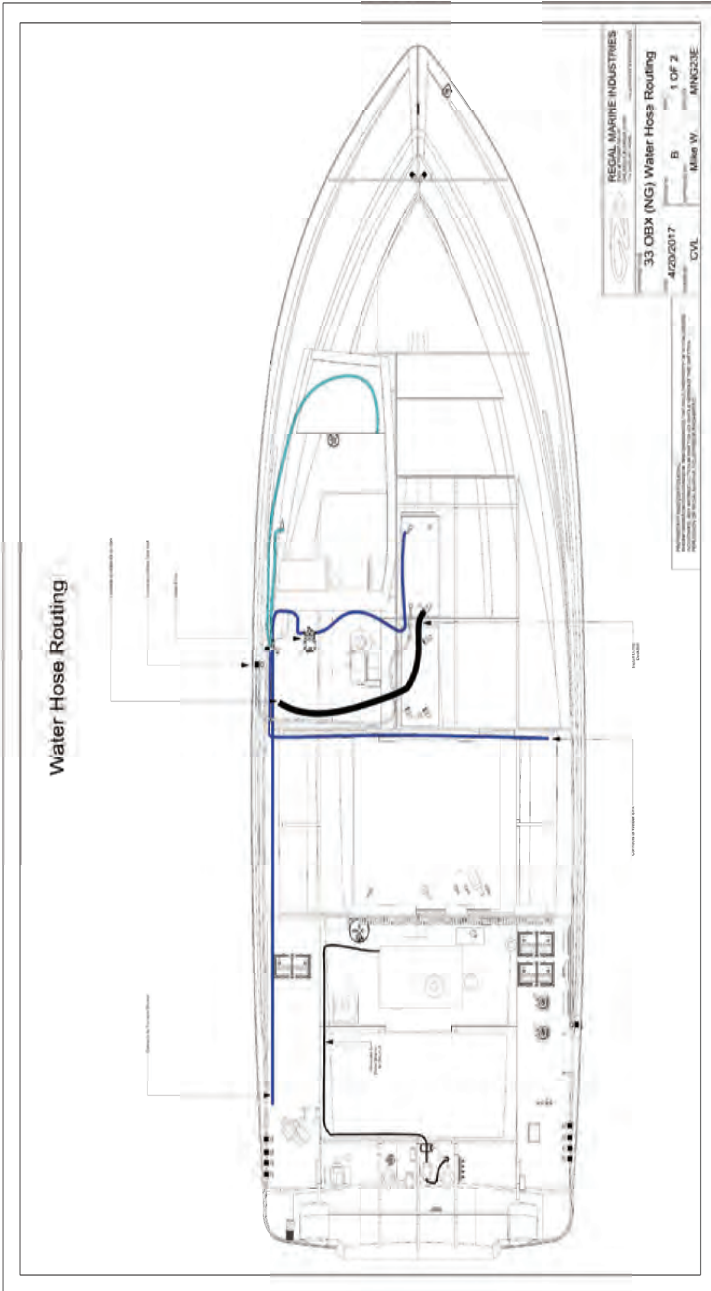

33 OBX Water Hose Routing



Technical Information

