



SAMSUNG

SPLIT-TYPE AIR CONDITIONER

INDOOR UNIT

OUTDOOR UNIT

Basic : AQV18NSAN

AQV24NSAN

Model : AQV18NSD

AQV24NSD

Model Code: AQV18NSD

AQV24NSD

AQV18NSDX

AQV24NSDX

SERVICE *Manual*

AIR CONDITIONER



AQV18NSD / AQV24NSD



AQV18NSDX / AQV24NSDX

THE FEATURE OF PRODUCT

■ **High Energy Efficiency BLDC Air Conditioner**

■ **Simple Flat Grille Design**

■ **good'sleep Mode**

: good'sleep Mode can help you sleep quickly and soundly and wake up refreshed.

■ **Multi Functional Cleaning System**

: Silver Nano Health System and Deodorizing/ Catechin Filter are adopted.

■ **Silence Mode**

: When you use the "Silence Mode", you can experience extremely quiet operation of your air conditioner.

Refer to the service manual in the GSPN(see the rear cover) for the more information.

Contents

1. Precautions	1-1
1-1 Installing the air conditioner	1-1
1-2 Power supply and circuit breaker	1-1
1-3 During operation	1-1
1-4 Disposing of the unit	1-2
1-5 Others	1-2
2. Product Specifications	2-1
2-1 The Feature of Product	2-1
2-2 Product Specifications	2-2
2-3 The Comparative Specifications of Product	2-3
2-4 Accessory and Option Specifications	2-5
3. Alignment and Adjustments	3-1
3-1 Test Mode	3-1
3-2 Indoor Display Error and Check Method	3-2
3-3 Outdoor LED Error Display and Check Method	3-3
3-4 Setting Option Setup Method	3-4
4. Disassembly and Reassembly	4-1
4-1 Indoor Unit	4-2
4-2 Outdoor Unit	4-5
5. Exploded Views and Parts List	5-1
5-1 Indoor Unit	5-1
5-2 Outdoor Unit	5-3
5-3 Ass'y Control In	5-5
5-4 Ass'y Control Out	5-7
6. Electrical Parts List	6-1
7. Wiring Diagram	7-1
7-1 Indoor Unit	7-1
7-2 Outdoor Unit	7-2
8. Schematic Diagram	8-1
8-1 Indoor Unit	8-1
8-2 Outdoor Unit	8-2

Contents

9. Circuit Descriptions	9-1
9-1 PCB Circuit Descriptions	9-1
9-2 Refrigerating Cycle Diagram	9-3
10. PCB Diagram	10-1
10-1 Indoor PCB	10-1
10-2 Outdoor PCB	10-2
11. Operating Instructions	11-1
11-1 Name of Each Part	11-1
11-2 Wireless Remote Control-Buttons and Display	11-3
11-3 Main Function	11-4
12. Troubleshooting	12-1
12-1 Items to be checked first	12-1
12-2 Fault Diagnosis by Symptom	12-2
12-3 PCB Inspection Method	12-20
12-4 Main Part Inspection Method	12-22
13. Block Diagram	13-1
13-1 Indoor Unit	13-1
13-2 Outdoor Unit	13-3
14. Reference Sheet	14-1
14-1 Index for Model Name	14-1
14-2 Low Refrigerant Pressure Distribution	14-2
14-3 Pressure & Capacity mark	14-3
14-4 Q & A for Non-trouble	14-4
14-5 Cleaning/Filter Change	14-7
14-6 Installation	14-9
14-7 Installation Diagram of Indoor Unit and Outdoor Unit	14-10

1. Precautions

1-1 Installing the air conditioner

- Users should not install the air conditioner by themselves.
Ask the dealer or authorized company to install the air conditioner except the window-type air conditioner in U.S.A and Canada.
- If you don't install the air conditioner properly, it may cause a fire, a water leakage or an electric shock.
- You must install the air conditioner according to the national wiring regulations and safety regulations.
- Install the indoor unit higher than 8.2ft(2.5m) om the floor to avoid the injury caused by the operation of the fan.
(except the window-type air conditioner)
- The manufacturer is not responsible for any accidents or injury caused by an incorrect installation.
- When installing the built-in type air conditioner, keep all electric cables such as the power cable and the connection cord in pipes, ducts, or cable channels to protect them from the danger of impact or any other incidents.

1-2 Power supply and circuit breaker

- If the power cord of the air conditioner is damaged, it must be replaced by the manufacturer or a qualified person in order to avoid a hazard.
- The air conditioner must be plugged into an independent circuit if applicable or connect the power cable to the auxiliary circuit breaker.
An all pole disconnection from the power supply must be incorporated in the fixed wiring with a contact opening of >0.12inch(3mm).
- Do not extend an electric cord to the air conditioner.
- The air conditioner must be plugged in after you complete the installation.

1-3 During operation

- Do not repair the air conditioner at your discretion.
It is recommended to contact a service center directly.
- Never spill any kind of liquid on the air conditioner.
If this happens, turn off the air conditioner and contact an authorized service center.
- Do not insert anything between the airflow blades to prevent damage of the inner fan and consequent injury.
Keep children away from the air conditioner.
- Do not place any obstacles in front of the air conditioner.
- Do not spray any kind of liquid into the indoor unit. If this happens, turn off the air conditioner and contact a service center.
- Make sure that the air conditioner is well ventilated at all times:
Do not place a cloth or other materials over it.
- Remove the batteries if you don't use the remote control for a long time. (If applicable)
- Use the remote control within 23ft(7m) from the indoor unit. (If applicable)

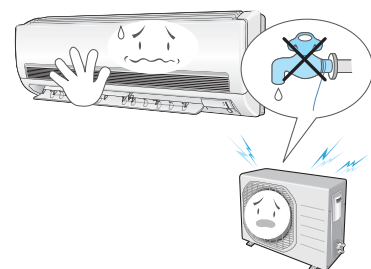

1-4 Disposing of the unit

- Before throwing out the air conditioner, remove the batteries from the remote control.
- When you dispose of the air conditioner, consult your dealer. If pipes are removed incorrectly, refrigerant may blow out and cause air pollution. When it contacts with your skin, it can cause skin injury.
- The package of the air conditioner should be recycled or disposed of properly for environmental reasons.

1-5 Others

- Never store or load the air conditioner upside down or sideways to prevent the damage to the compressor.
- Young children or infirm persons should be always supervised when they use the air conditioner.
- Max current is measured according to IEC standard for safety.
- Current is measured according to ISO standard for energy efficiency.

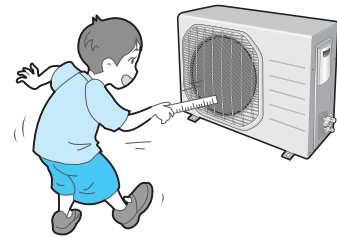

2. Product Specifications

2-1 The Feature of Product

■ **High Energy Efficiency BLDC Air Conditioner**

BLDC Technique arises the efficiency of air conditioner and makes a room cool and warm with high energy saving.

■ **Simple Flat Grille Design**

With a Smart and fashionable style, the high impressive interior design allow this product to set place in anywhere.

■ **good'sleep Mode**

good'sleep Mode can help you sleep quickly and soundly and wake up refreshed.

■ **Multi functional cleaning system**

With Silver Nano Health System and Deodorizing/Catechin Filters makes your room more refreshed.





■ **Silence Mode**

When you use the "Silence Mode", you can experience extremely quiet operation of your air conditioner.

2-2 Product Specifications







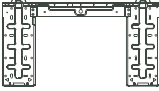

Item				Model		AQV18NSD		AQV24NSD				
				Indoor Unit		Outdoor Unit		Indoor Unit		Outdoor Unit		
Performance	Type			Wall-mounted				Wall-mounted				
	Capacity	Cooling	Btu/hr (Low / Std / Max)	6,600 / 18,000 / 21,000		6,600 / 24,000 / 27,000		6,300 / 20,500 / 28,000		6,300 / 27,000 / 33,000		
				Running Frequency	Cooling	Hz (Low / Std / Max)	15/40/46		15 / 60 / 68		15/44/62	
	Dehumidifying	Cooling	ℓ/h				2.5		3.0		2.5	
				Air Volume	Heating	m ³ /min (H/M/L)	9.2/11.2/13.25		47		9.2/11.2/13.25	
	Noise	Cooling	dB (H/L)				48/33		58		48/33	
				SEER	Cooling	(Std)	16.0		15.0		16.0	
	HSPF	Heating	(Std)				8.0		7.8		8.0	
				Power			ph-V-Hz		1-208/230-60		1-208/230-60	
	Power	Power Consumption	Cooling	W (Low / Std / Max)	630/1700/1950		630/2750/3150		590/1850/2650		590/2900/4000	
Operating Current					Cooling	A (Low / Std / Max)	3.0/7.5/9.0		3.0/12.0/13.8		2.8/8.2/12.0	
		Power Factor	Cooling	%			75 / 90 / 95		70 / 90 / 95		75 / 90 / 95	
Breaker Size					MCA	A	20		25		20	
		MOP	MOP	A			17.17		17.17		30	
Outer Dimension					Width x Height x Depth	inch	41.9X11.7X8.6		34.6 X 25.1 X 12.2		41.9X11.7X8.6	
		Weight (Net)	lb	28.7			114.6		28.7		114.6	
Drain Hose	D(inch) x L(ft)			Φ0.7 x 1.8		Φ0.7 x 1.8		D(mm) x L(mm)		Φ18 x 550		
		Compressor	Type	Type	Rotary, G8T260FUA EW		Rotary, G8T260FUA EW		Rotary, G8T260FUA EW		Rotary, G8T260FUA EW	
Motor	Rated Output				W	Hermetic		Hermetic		2454W		2454W
			Oil Type	Oil Type		FREOLa68ES-T		FREOLa68ES-T		FREOLa68ES-T		FREOLa68ES-T
RLA	RLA				A	13.0		13.0		13.0		13.0
		Blower	Type	Type		Cross-flow		Propeller		Cross-flow		Propeller
Motor	Rated Output				W	Resin / Steel, AC		Resin / Steel, DC		Resin / Steel, AC		Resin / Steel, DC
			FLA	FLA		40		90		40		93
Piping	Maximum Spec.	Length			ft (m)	98.4 (30)		98.4 (30)		98.4 (30)		98.4 (30)
			Height	ft (m)		49.2 (15)		49.2 (15)		49.2 (15)		49.2 (15)
	Refrigerant Pipe	Liquid			OD(inch) x L(ft)	Φ1/4 x 24.6		Φ1/4 x 24.6		OD(mm) x L(m)		Φ6.35 x 7.5
			Gas	OD(inch) x L(ft)		Φ1/2 x 24.6		Φ5/8 x 24.6		OD(mm) x L(m)		Φ12.7 x 7.5
		Heat Exchanger			Heat Exchanger	Type	2 Row 16 Step		2 Row 28 Step		2 Row 16 Step	
			Refrigerant Control Unit	Refrigerant Control Unit			Type	EEV		EEV		EEV
Freezer Oil Capacity	Freezer Oil Capacity	gal			0.16			0.18		cc		700
			Refrigerant to be Charged (R410A)	Refrigerant to be Charged (R410A)	oz	51.1		51.1		g		1,450
Refrigerant to be Added (R410A)	Refrigerant to be Added (R410A)	oz/ft				0.16		0.16		g/m		15
			Protection Device (OLP)			None		None		None		None
Cooling Test Condition			Indoor Unit : DB80°F WB67°F Indoor Unit : DB26.7°C WB19.4°C		Outdoor Unit : DB95°F WB75°F Outdoor Unit : DB35°C WB23.9°C		Indoor Unit : DB70°F WB60°F Indoor Unit : DB21.1°C WB15.6°C		Outdoor Unit : DB47°F WB43°F Outdoor Unit : DB8.3°C WB6.1°C			
Heating Test Condition			Indoor Unit : DB70°F WB60°F Indoor Unit : DB21.1°C WB15.6°C		Outdoor Unit : DB95°F WB75°F Outdoor Unit : DB35°C WB23.9°C		Indoor Unit : DB70°F WB60°F Indoor Unit : DB21.1°C WB15.6°C		Outdoor Unit : DB47°F WB43°F Outdoor Unit : DB8.3°C WB6.1°C			
Operation conditon range	cooling	indoor	61°F to 90°F approx. 16°C to 32°C approx.		61°F to 90°F approx. 16°C to 32°C approx.		14°F to 115°F approx. -10°C to 46°C approx.		14°F to 115°F approx. -10°C to 46°C approx.			
			heating	indoor	80°F or less 27°C or less		80°F or less 27°C or less		5°F to 75°F approx. -15°C to 24°C approx.		5°F to 75°F approx. -15°C to 24°C approx.	
	heating	Outdoor			14°F to 115°F approx. -10°C to 46°C approx.		14°F to 115°F approx. -10°C to 46°C approx.		5°F to 75°F approx. -15°C to 24°C approx.		5°F to 75°F approx. -15°C to 24°C approx.	

2-3 The Comparative Specifications of Product

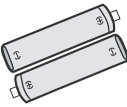



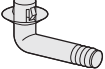

Item		Development Model	
		AQV18NSD	AQV24NSD
Design	Indoor Unit		
	Outdoor Unit		
Net Weight	Indoor Unit	28.7lb(13kg)	13kg
	Outdoor Unit	114.6lb(52kg)	52kg
Outer Dimension (WidthxHeightxDepth)	Indoor Unit	41.9x11.7x8.6 (inch) 1065x298x218 (mm)	41.9x11.7x8.6 (inch) 1065x298x218 (mm)
	Outdoor Unit	34.6 x 25.1 x 12.2 (inch) 880 x 638 x 310 (mm)	34.6 x 25.1 x 12.2 (inch) 880 x 638 x 310 (mm)
Noise	Indoor Unit	48dB ↓	48dB ↓
	Outdoor Unit	58dB ↓	60dB ↓
Air Purifying System	Filter	Silver Nano Evaporator Catechin Filter Deodorizing Fiter	Silver Nano Evaporator Catechin Filter Deodorizing Fiter
Indoor Display		Three Color LED Display	Three Color LED Display

2-4 Accessory and Option Specifications

2-4-1 Accessories

Item	Descriptions	Code-No.	Q'TY	Remark
	Ass'y Plate Hanger	DB90-02738A	1	Indoor Unit
	Remote Control	DB93-05083P	1	
	Batteries for Remote Control	DB47-90024A	2	
	User's Manual	DB98-29981A	1	
	Installation Manual	DB98-29790A	1	
	Service Manual	DB98-30186A	1	
	Drain Plug	DB67-20011A	1	Outdoor Unit
	Rubber leg	DB73-20134A	4	

Accessories(cont.)

Item	Descriptions	Code-No.	Q'TY	Remark
	Putty 100g	DB98-10568A	1	
	Pipe Clamps A	DB39-20224A	3	
	Pipe Clamps B	DB39-20224B	3	
	Cement Nail	-	6	Option
	M4x25 Tapping Screws	6002-000540	6	
	Drain Hose, length 6.56ft(2m)	DB62-00487A	1	

3. Alignment and Adjustments

3-1 Test Mode

1. How to Operate Test Mode

Press the Power button of indoor unit for 5 seconds
(Cooling test operation).

Or press the K1 switch of the display board once
(Cooling test operation) or twice (Heating test operation)
after removing the Cover Control of outdoor unit.

The Unit operates Test Mode for sixty minutes.

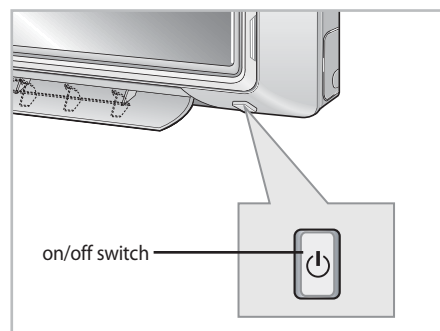

2. How to Check the Unit on Test Mode

Please check the three LED and Error Mode Display.

Please check the low pressure as connecting a manifold gauge
with the service valve.

3. How to Quit Test Mode



Press the power button of indoor unit once again

Or press the K1 switch of display board three times again.

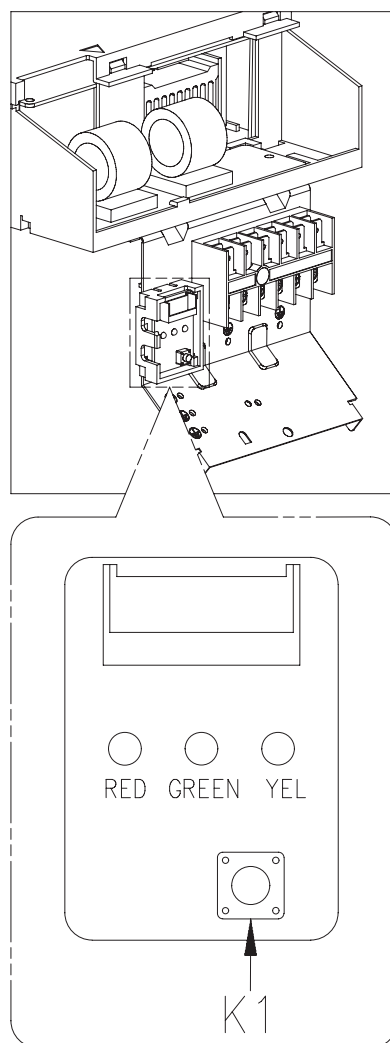
- * After the test operation is finished, you cannot retry the test operation without power reset.
- * The blade places to set position and then the indoor fan operates.
- * The Compressor is operated by rated frequency before sixty minutes or enforced stop.



3-2 Indoor Display Error and Check Method

Description	LAMP			Main Checking Point
	OPERATION	TIMER	TURBO	
				
Indoor unit room temperature sensor error (open or short)	○	●	○	3-2P
Indoor unit heat exchanger temperature sensor error (open or short)	●	●	○	3-3P
Indoor fan motor malfunction	○	○	●	3-4P
EEPROM error	●	●	●	Option Setting
Option error (option wasn't set up or option data error)	●	●	●	Option Setting
Outdoor unit error	●	○	●	Remote Control on/off Outdoor Unit Power Reset

● : Lamp on, ○ : Lamp off, ● : Lamp blink

3-3 Outdoor LED Error Display and Check Method



No.	LED Display			Explanation
	Yellow	Green	Red	
1	○	○	○	Power off/VDD NG
2	○	○	◎	IPM Over Current(O.C)
3	○	○	●	Abnormal Serial communication
	○	●	●	
4	○	◎	○	Compressor Starting error
5	○	◎	●	Normal Operation
6	○	●	○	Compressor Lock error
7	○	●	◎	DC-Link voltage under/over error
8	◎	○	◎	Outdoor temperature sensor error
9	◎	○	●	Discharge over temperature
10	◎	◎	○	Discharge temperature sensor error
11	◎	◎	●	Current sensor error
12	◎	●	○	Compressor limit error
13	◎	●	◎	Coil temperature sensor error
14	◎	●	●	1min. Time out Communication
15	●	○	○	Fan error
16	●	○	◎	OTP error
17	●	○	●	Compressor rotation error
18	●	◎	○	Operation condition secession(Dual only)
19	●	◎	◎	DC-Link voltage sensor error
20	●	◎	●	I_Trip error / PFC Over current
21	●	●	○	GAS Leak error
22	●	●	◎	AC Line Zero Cross Signal out
23	●	●	●	Power ON reset(1sec)
24	◎	○	○	Capacity miss match
25	○	◎	◎	Test Operation at Cooling Mode
26	◎	◎	◎	Test Operation at Heating Mode

● : LED ON, ○ : LED OFF, ◎ : LED BLINK

3-4 Setting Option Setup Method

ex) Option No. : 084777-17524E

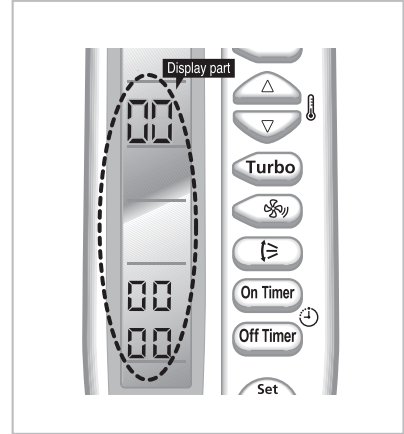

Step 1 : Enter the Option Setup mode.

- 1st Take out the batteries of remote control.
- 2nd Press the temperature  button simultaneously and insert the battery again.
- 3rd Make sure the remote display shown as .





Step 2 : Enter the Option Setup mode and select your option according to the following procedure.



* Setting is not required if you must  a value which has a  default.

- 1**

The default value is .

Otherwise, push the  button to .

Every time you push the button, the display panel reads *1* or *0* repeatedly.
- 2**

Push the  button to set the display panel to *0*.

Every time you push the button, the display panel reads *0* → *1* → *2* → *3* → ... → *9* → *A* → *b* → *c* → *d* → *E* → *F* repeatedly.
- 3**

Push the  button to set the display panel to *4*.

Every time you push the button, the display panel reads *0* → *1* → *2* → *3* → ... → *9* → *A* → *b* → *c* → *d* → *E* → *F* repeatedly.
- 4**

Push the  button to set the display panel to *7*.

Every time you push the button, the display panel reads *0* → *1* → *2* → *3* → ... → *9* → *A* → *b* → *c* → *d* → *E* → *F* repeatedly.
- 5**

Push the  button to set the display panel to *7*.

Every time you push the button, the display panel reads *0* → *1* → *2* → *3* → ... → *9* → *A* → *b* → *c* → *d* → *E* → *F* repeatedly.
- 6**

Push the  button to set the display panel to *7*.

Every time you push the button, the display panel reads *0* → *1* → *2* → *3* → ... → *9* → *A* → *b* → *c* → *d* → *E* → *F* repeatedly.



7 Press **Mode** button, then the default value is $\begin{matrix} 10 \\ 00 \\ 00 \end{matrix}$.

8 Push the **▲** button to set the display panel to 7. Every time you push the button, the display panel reads 0 → 1 → 2 → 3 → ... 9 → A → b → c → d → E → F repeatedly.

9 Push the **▼** button to set the display panel to 5. Every time you push the button, the display panel reads 0 → 1 → 2 → 3 → ... 9 → A → b → c → d → E → F repeatedly.

10 Push the **Turbo** button to set the display panel to 2. Every time you push the button, the display panel reads 0 → 1 → 2 → 3 → ... 9 → A → b → c → d → E → F repeatedly.

11 Push the **On Time** button to set the display panel to 4. Every time you push the button, the display panel reads 0 → 1 → 2 → 3 → ... 9 → A → b → c → d → E → F repeatedly.

12 Push the **Off Time** button to set the display panel to E. Every time you push the button, the display panel reads 0 → 1 → 2 → 3 → ... 9 → A → b → c → d → E → F repeatedly.

* Setting is not required if you must $\begin{matrix} 10 \\ 00 \\ 00 \end{matrix}$ a value which has a $\begin{matrix} 10 \\ 00 \\ 00 \end{matrix}$ default.

Step 3 : Upon completion of the selection, check you made right selections.

Press the Mode Selection key, **Mode** to set the display part to $\begin{matrix} 10 \\ 00 \\ 00 \end{matrix}$ and check the display part.

➔ The display part shows $\begin{matrix} 10 \\ 47 \\ 77 \end{matrix}$.

Press the Mode Selection key, **Mode** to set the display part to 7 and check the display part.

➔ The display part shows $\begin{matrix} 17 \\ 52 \\ 4E \end{matrix}$.

Step 4 : Pressing the ON/OFF button (**Set/Cancel)**

When pressing the operation ON/OFF key with the direction of remote control for unit, the sound "Ding" or "Diriring" is heard and the OPERATION ICON(\approx) lamp of the display is flickering at the same time, then the input of option is completed. (If the diriring sound isn't heard, try again pressing the ON/OFF button.)

Step 5 : Unit operation test-run

First, Remove the battery from the remote control.

Second, Re-insert the battery into the remote control.

Third, Press ON/OFF key with the direction of remote control for set.

• Error Mode

1st If all lamps of indoor unit are flickering, Plug out, plug in power plug again and press ON/OFF key to retry.



2nd If the unit is not working properly or all lamps are continuously flickering after setting the option code, see if the correct option code is set up for its model.

■ **OPTION ITEMS**

REMOCON MODEL	SEG1	SEG2	SEG3	SEG4	SEG5	SEG6	SEG7	SEG8	SEG9	SEG10	SEG11	SEG12
AQV18NSDNKCV	0	A	C	7	7	7	1	7	7	2	8	E
AQV24NSDNKCV	0	B	C	7	7	7	1	7	7	2	8	E

4. Disassembly and Reassembly

■ Necessary Tools

Item	Remark
+SCREW DRIVER	
MONKEY SPANNER	



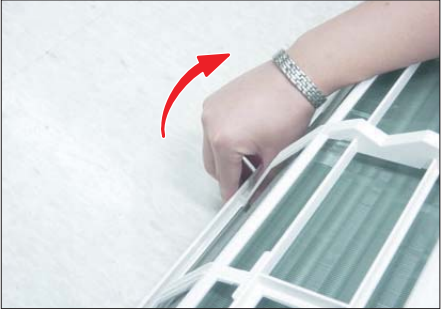
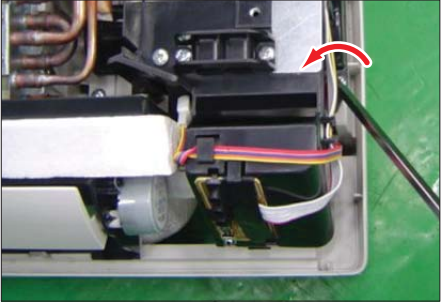
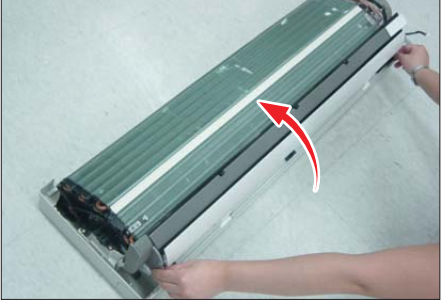

4-1 Indoor Unit

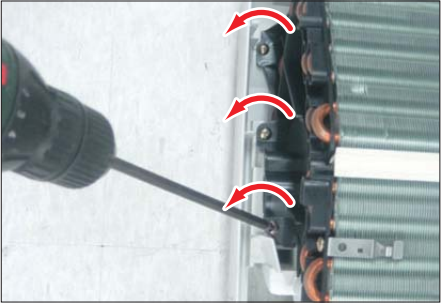
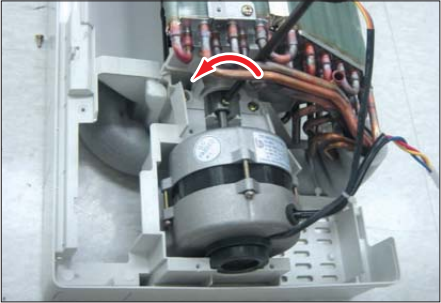
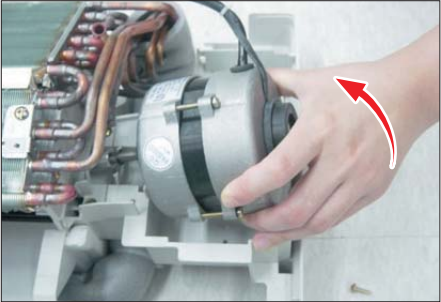
No	Parts	Procedure	Remark
1	Front Grille	<ol style="list-style-type: none"> 1) Stop the air conditioner operation and shut off the main power. 2) Open the Front Grille by pulling right and left sides of the hook. 3) Loosen 1 of the right screw(CCW) and detach the Terminal Cover. (Use +Screw Driver.) 4) Detach the thermistor from the Front Grille. 5) Loosen 2 fixing screws(CCW) of Front Grille. 6) Unlock 3 hooks to fix Panel Front and Tray Drain. (Use +Screw Driver.) 	    





No	Parts	Procedure	Remark
		7) Unlock 3 hooks to fix Panel Front and Back-Body.	
2	Control-In (Main PCB)	1) Take all the connector of PCB upper side out. (Inclusion Power Cord) 2) Detach the outdoor unit connection wire from the Terminal Block. 3) Loosen 4 fixing screws(CCW) of Ass'y Control-In. (Use +Screw Driver.) ⚠ You can disassembly Ass'y Control In without evaporator disassembled.	
3	Tray Drain	1) Pull Tray Drain out from the Back Body.	



No	Parts	Procedure	Remark
4	Heat Exchanger	<ol style="list-style-type: none"> 1) Loosen 2 fixing earth screws(CCW) of right side. (Use +Screw Driver.) 2) Detach the Connection Pipe. 3) Detach the Holder Pipe at the rear side. 4) Loosen the 4 fixing screws(CCW) of right and left side. (Use +Screw Driver.) 5) Lifting the Heat Exchanger up a little to push the up side for separation from the indoor unit. <p style="color: red; margin-top: 10px;">⚠ First, check Comp. Down and then disconnect the connection pipes before you disassemble the Evaporator from indoor unit.</p>	 
5	Fan Motor & Cross Fan	<ol style="list-style-type: none"> 1) Loosen the fixing screw(CCW). (Use +Screw Driver.) 2) Detach the Fan Motor from the Fan. 3) Detach the Fan From the left Holder Bearing. 	 

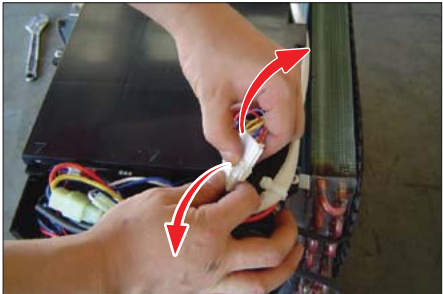

4-2 Outdoor Unit

No	Parts	Procedure	Remark
1	Common Work	<p>1) Loosen 1 fixing screw(CCW) of the Cover-Control and detach the Cover Control.</p> <p>2) Loosen fixing screws(CCW) and detach the Cabinet-Upper.</p> <p>3) Loosen 1 screw(CCW) fixed to assemble Control Box with Cabinet-Side RH.</p> <p>4) Loosen 6 fixing screws(CCW) and detach the Cabinet-Side RH.</p>	   

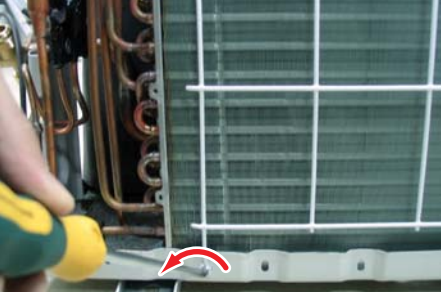
No	Parts	Procedure	Remark
		<p>6) Loosen fixing screws(CCW) of the Cabinet Front.</p>	
		<p>5) Loosen 2 screws(CCW) fixed on the Guide Condenser.</p>	

No	Parts	Procedure	Remark
2	Fan & Motor	<p>1) Detach the Nut Flange like the picture on the right side. (Turn clockwise because the screw is left-handed.)</p> <p>2) Detach the Fan Propeller.</p> <p>3) Loosen 4 fixing screws(CCW) to detach the Motor.</p> <p>4) Disconnect the wire between Ass'y Control Out and Motor.</p> <p>5) Loosen 2 fixing screws(CCW) and detach the Bracket Motor.</p>	   

No	Parts	Procedure	Remark
3	Ass'y Control Out	1) Detach several connectors from the Ass'y Control Out. 2) Detach several connectors from the PCB of Ass'y Control Out. 3) Pull up the Ass'y Control Out.	
4	Heat Exchanger	1) Release the refrigerant at first 2) Loosen fixing screw(CCW) and detach the steel bar. 3) Disassemble the pipes in both inlet and outlet with welding torch. ⚠ Before you disassemble the pipes and Condenser, be sure that there should be no refrigerant remained in the unit.	
		1) Loosen fixing screw(CCW) and detach the Heat Exchanger	

No	Parts	Procedure	Remark
5	Compressor	1) Disassemble the Felt Comp Sound. 2) Loosen the fixing nut(CCW) and detach the Compressor Lead Wire.	 
		3) Loosen the 3 bolts(CCW) at the bottom of Compressor like the picture on the right side.	

5. Exploded Views and Parts List

5-1 Indoor Unit

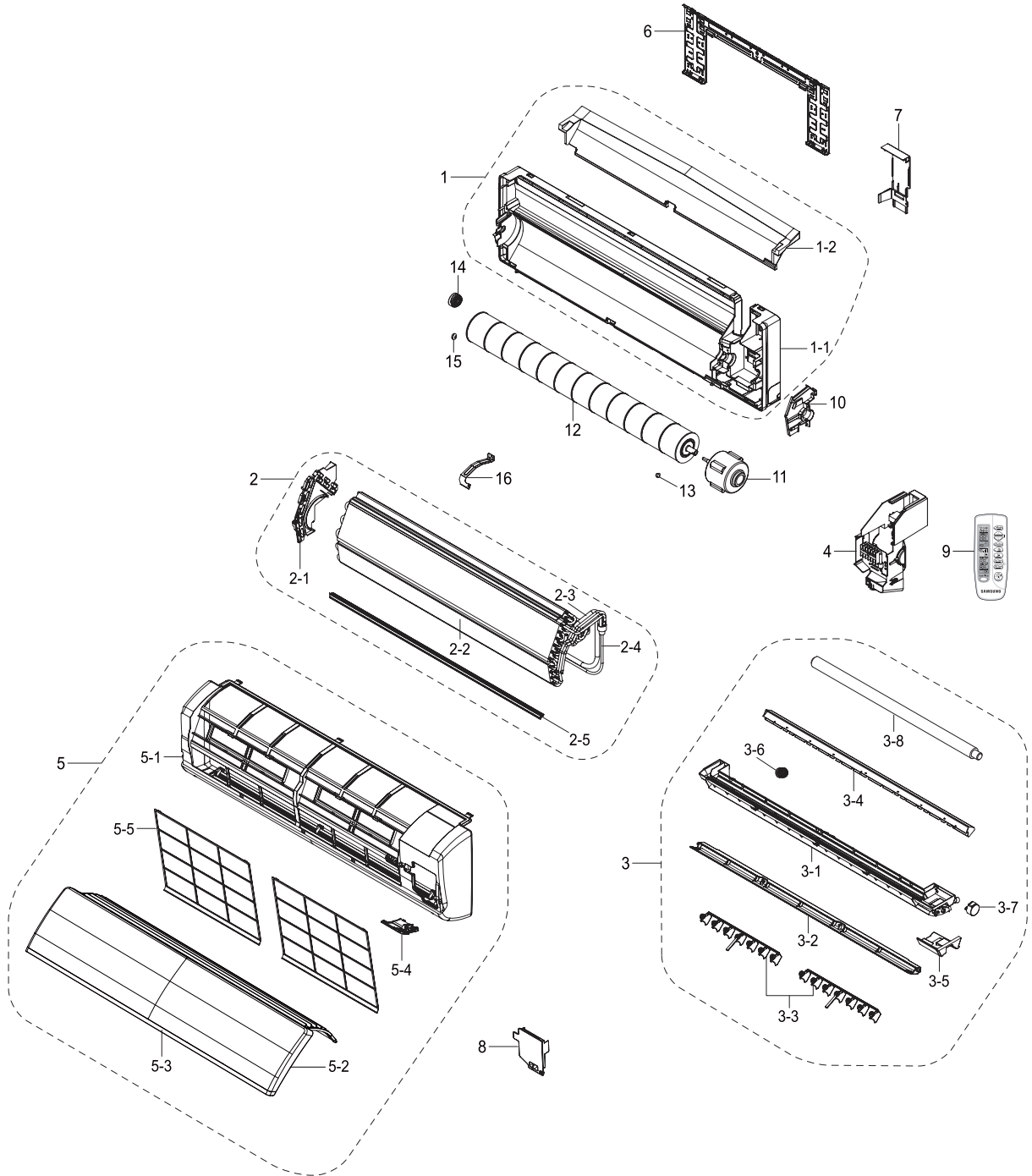

■ Parts List

No.	Code No.	Description	Specification	Q'TY		SA/SNA
				AQV18NSDKCV	AQV24NSDKCV	
1	DB94-00615D	ASS'Y BACK BODY	ASS'Y	1	1	SA
1-1	DB61-01974B	BACK BODY	HIPS	1	1	SNA
1-2	DB69-01039A	CUSHION BACK BODY	EPS	1	1	SNA
2	DB96-06587E	ASS'Y EVAP TOTAL	ASS'Y	1	-	SA
	DB96-06587F	ASS'Y EVAP TOTAL	ASS'Y	-	1	SA
2-1	DB63-01065A	COVER BEARING	ABS	1	1	SA
2-2	DB96-04040Q	ASS'Y EVAP MAIN	ASS'Y	1	1	SNA
	DB96-06525F	ASS'Y EVAP SUB	ASS'Y	1	1	SNA
2-3	DB96-11682B	ASS'Y TUBE EVAP OUT	ASS'Y	1	-	SA
	DB96-11682A	ASS'Y TUBE EVAP IN	ASS'Y	-	1	SA
2-4	DB96-06500B	ASS'Y TUBE EVAP IN	ASS'Y	1	1	SA
2-5	DB60-00192A	SPACER EVAP LOW	-	1	1	SA
3	DB94-00616E	ASS'Y TRAY DRAIN	ASS'Y	1	1	SA
3-1	DB63-01071A	TRAY DRAIN	ABS	1	1	SNA
3-2	DB61-01975C	BLADE-H	ABS	1	1	SA
3-3	DB61-01976A	BLADE-V	PP	2	2	SA
3-4	DB63-01066A	TRAY STABILIZER	ABS	1	1	SA
3-5	DB69-01024A	CUSHION EPS TRAY RH	EPS	1	1	SNA
3-6	DB73-00180A	RUBBER CAP DRAIN	GUM-EPM	1	1	SA
3-7	DB31-00285A	ASS'Y MOTOR STEPPING	220-240V~, 50/60Hz, Class E	1	1	SA
3-8	DB94-00458A	ASS'Y DRAIN HOSE	ASS'Y	1	1	SA
4	DB93-05868D	ASS'Y CONTROL IN	ASS'Y	1	1	SA
5	DB92-01235B	ASS'Y PANEL FRONT	ASS'Y	1	1	SA
5-1	DB64-01184C	PANEL FRONT	ABS	1	1	SA
5-2	DB92-01196B	ASSY GRILLE AIRINLET	ASSY	1	1	SA
5-3	DB64-02046A	DECORATION GRILLE	ABS	1	1	SNA
5-4	DB93-02867C	ASS'Y COVER DISPLAY	ASS'Y	1	1	SA
5-5	DB63-01592B	GUARD AIR FILTER	PP	2	2	SA
6	DB90-02738A	ASS'Y PLATE HANGER	ASS'Y	1	1	SA
7	DB61-01981B	HOLDER PIPE	HIPS	1	1	SA
8	DB90-04486A	ASSY COVER TERMINA	ASSY	1	1	SA
9	DB93-05083P	ASS'Y REMOCON	ARH-470	1	1	SA
10	DB96-03817A	ASS'Y SUPPORT EVAP RH	HIPS	1	1	SA
11	DB31-00442A	MOTOR IN	220-240V~, 50/60Hz, Class E	1	1	SA
12	DB94-00456B	ASS'Y CROSS FAN	OD92	1	1	SA
13	DB97-02075A	ASS'Y BOLT SPECIAL	BOLT	1	1	SNA
14	DB94-00455B	ASS'Y RUBBER BEARING	ASS'Y	1	1	SA
15	DB94-40007B	ASS'Y BEARING MOTOR	BEARING	1	1	SNA
16	DB61-01977A	BRACKET EVAP	SGCC-M	1	1	SA

5-2 Outdoor Unit

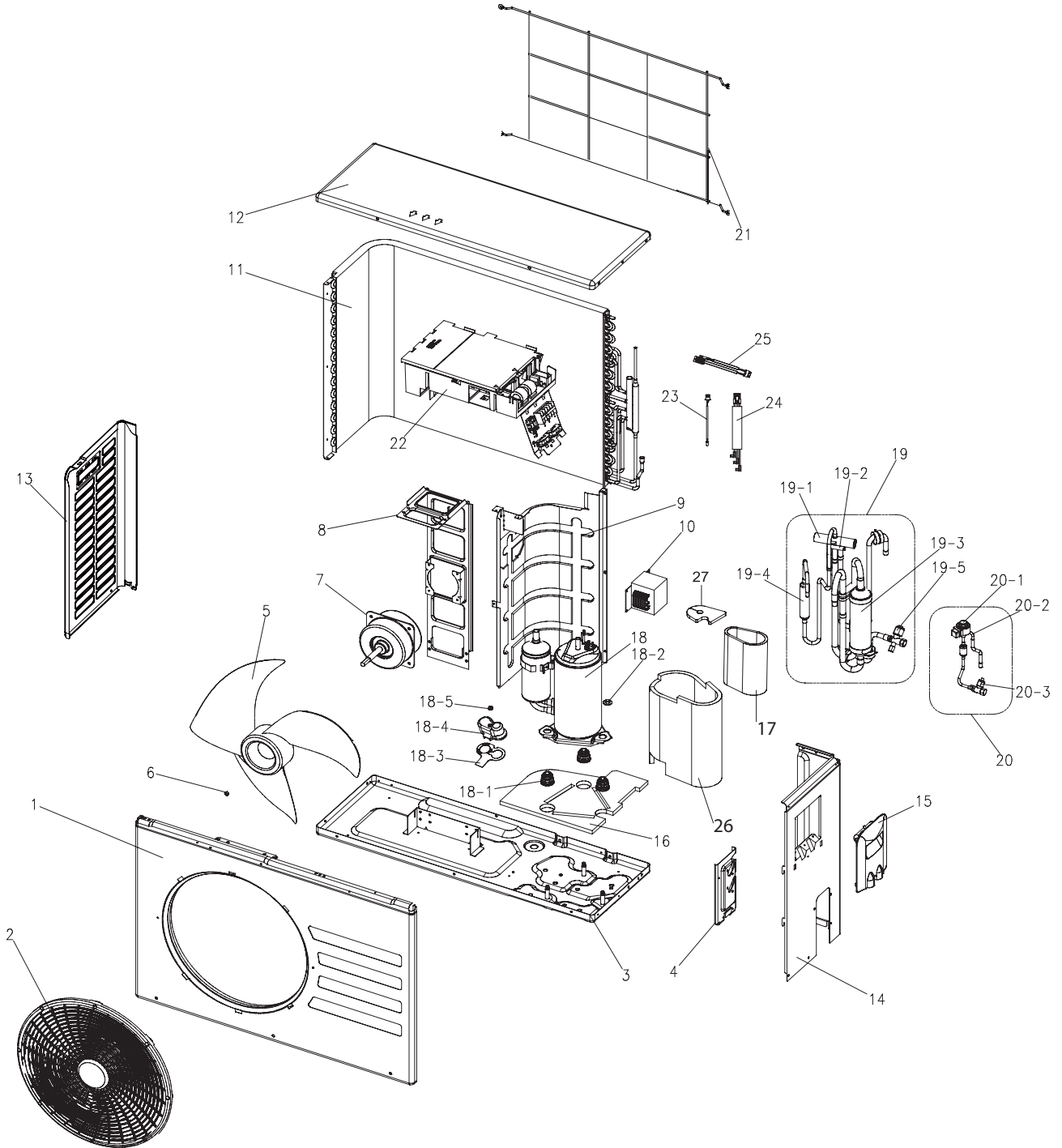

■ Parts List

No.	Code No.	Description	Specification	Q'TY		SA/SNA
				AQV18NSDXKCV	AQV24NSDXKCV	
1	DB90-03914B	ASS'Y CABI FRONT	ASS'Y, SC-94445T	1	1	SA
2	DB63-00838B	GUARD FAN	PP	1	1	SA
3	DB90-00970V	ASS'Y BASE OUT	ASS'Y, SC-94445T	1	1	SA
4	DB61-01593A	BRACKET VALVE	SECC-P, SC-94445T	1	1	SA
5	DB67-00142A	FAN-PROPELLER	AS+G/F20%, Φ420	1	1	SA
6	DB60-30020A	SCREW-MACHINE	M6	1	1	SA
7	DB31-00445B	MOTOR FAN OUT	AC Motor	1	1	SA
8	DB61-00686A	BRACKET MOTOR	SGCC-M	1	1	SA
9	DB94-01210B	ASS'Y PARTITION	ASS'Y, SGCC-M	1	1	SA
10	DB27-00043A	REACTOR	PPS, 20A	1	1	SA
11	DB96-04087B	ASS'Y COND UNIT	ASS'Y	1	1	SA
12	DB90-10616G	ASS'Y CABI UP	ASS'Y, SC-94445T	1	1	SA
13	DB90-01351A	ASSY CABI SIDE LF	ASSY	1	1	SA
14	DB90-03308B	ASS'Y CABINET SIDE RH	ASS'Y, SC-94445T	1	1	SA
15	DB90-03305A	ASSY COVER CONTROL	ASSY	1	1	SA
16	DB63-01719A	FELT COMP BASE	FELT+PVC Sheet	1	1	SA
17	DB63-01668A	FELT COMP SIDE	FELT+PVC Sheet	1	1	SA
18	G8T260FUAEW	COMPRESSOR	ROTARY, BLDC	1	1	SA
18-1	DB63-00815A	GROMMET ISOLATOR	NR	3	3	SA
18-2	DB60-30028A	SCREW HEX	M8	3	3	SA
18-3	DB63-00817A	GASKET	EPDM	1	1	SA
18-4	DB63-00816A	COVER TERMINAL	PBT (G/F 15%)	1	1	SA
18-5	6021-001142	NUT-HEXAGONE FLANGE	M5	1	1	SA
19	DB96-08939B	ASS'Y VALVE 4WAY	ASS'Y	1	-	SA
	DB96-08939A			-	1	
19-1	DB62-02338A	4WAY VALVE	R410A, SANHUA	1	1	SNA
19-2	DB33-00002C	SOLENOID COIL	ASS'Y	1	1	SNA
19-3	DB67-00765A	ACCUMULATOR	STEEL ACCUM.	1	1	SNA
19-4	DB97-02054A	TUBE MUFFLER	C1220T-0	1	-	SNA
19-5	DB62-02285A	VALVE SERVICE	R410A, SANHUA, 1/2"	1	-	SNA
	DB62-02342A		R410A, SANHUA, 5/8"	-	1	
20	DB96-09092A	ASS'Y VALVE EEV	ASSY	1	1	SA
20-1	DB62-03964A	VALVE EXPANSION COIL	FUJIKOKI	1	1	SA
20-2	DB62-02863A	VALVE EXPANSION BODY	FUJIKOKI	1	1	SNA
20-3	DB62-02283A	VALVE SERVICE	R410A, SANHUA, 1/4"	1	1	SNA
21	DB64-02120A	SCREEN-COND BAR	P.E.H 100%	1	1	SA
22	DB93-07025K	ASS'Y CONTROL OUT	ASS'Y	1	-	SA
	DB93-07025L	ASS'Y CONTROL OUT	ASS'Y	-	1	SA
23	DB32-00176A	THERMISTOR OUT/DIS	ASS'Y	1	1	SA
24	DB32-00175A	THERMISTOR COND	ASS'Y	1	1	SA
25	DB93-07443B	CONNECT WIRE COMP	ASS'Y	1	1	SA
26	DB63-02024A	FELT COMP SIDE OUT	FELT-PVC SHEET	1	1	SA
27	DB63-02025A	FELT COMP TOP	FELT-PVC SHEET	1	1	SA

5-3 Ass'y Control In : DB93-05868D

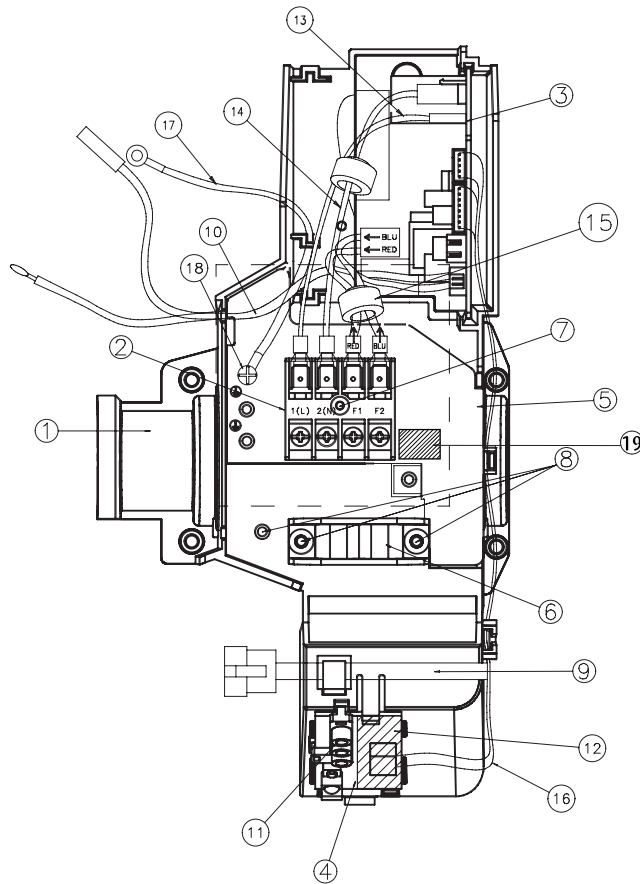

Parts List

No.	Code No.	Description	Specification	Q'ty	SN/SNA
1	DB61-01979B	CASE-CONTROL IN	ABS	1	SA
2	DB65-00004U	TERMINAL BLOCK	DAF-4P	1	SNA
3	DB93-05877G	ASSY-PCB IN MAIN	FORTE, 18K/24K	1	SA
4	DB93-03117A	ASSY-PCB DISPLAY	WW1 Dynamic	1	SNA
5	DB70-00507A	PLATE CONTROL IN	SGCC-M, T1.2	1	SNA
6	DB61-01097A	HOLDER WIRE CLAMP	ABS,BLK	1	SA
7	6001-000929	SCREW	PH+,M3,L23	1	SNA
8	6001-001054	SCREW	TH+,M4,L16	3	SNA
9	DB93-04832A	CONNECT WIRE	STEP MOTOR	1	SNA
10	DB95-01113A	SENSOR	4P(103AT)	1	SA
11	DB63-00851A	COVER DRAIN	ABS	1	SNA
12	DB73-00242B	RUBBER BAND	RUBBER	1	SNA
13	DB39-00765T	CONNECT WIRE	BRN	1	SNA
14	DB39-01193A	CONNECT WIRE	SKYBLU,3P	1	SNA
15	DB39-01210B	CONNECT WIRE	RED/BLU	1	SNA
16	DB93-04685A	CONNECT WIRE	DISPLAY	1	SNA
17	DB39-00148A	CONNECT WIRE	EARTH	1	SNA
18	6009-001001	SCREW	TH+,M4,L8	1	SNA
19	DB98-27584A	LABEL-CAUTION	ASSY	1	SNA

MEMO

5-4 Ass'y Control Out

■ Aqv18N**: DB93-07025K

Aqv24N**: DB93-07025L

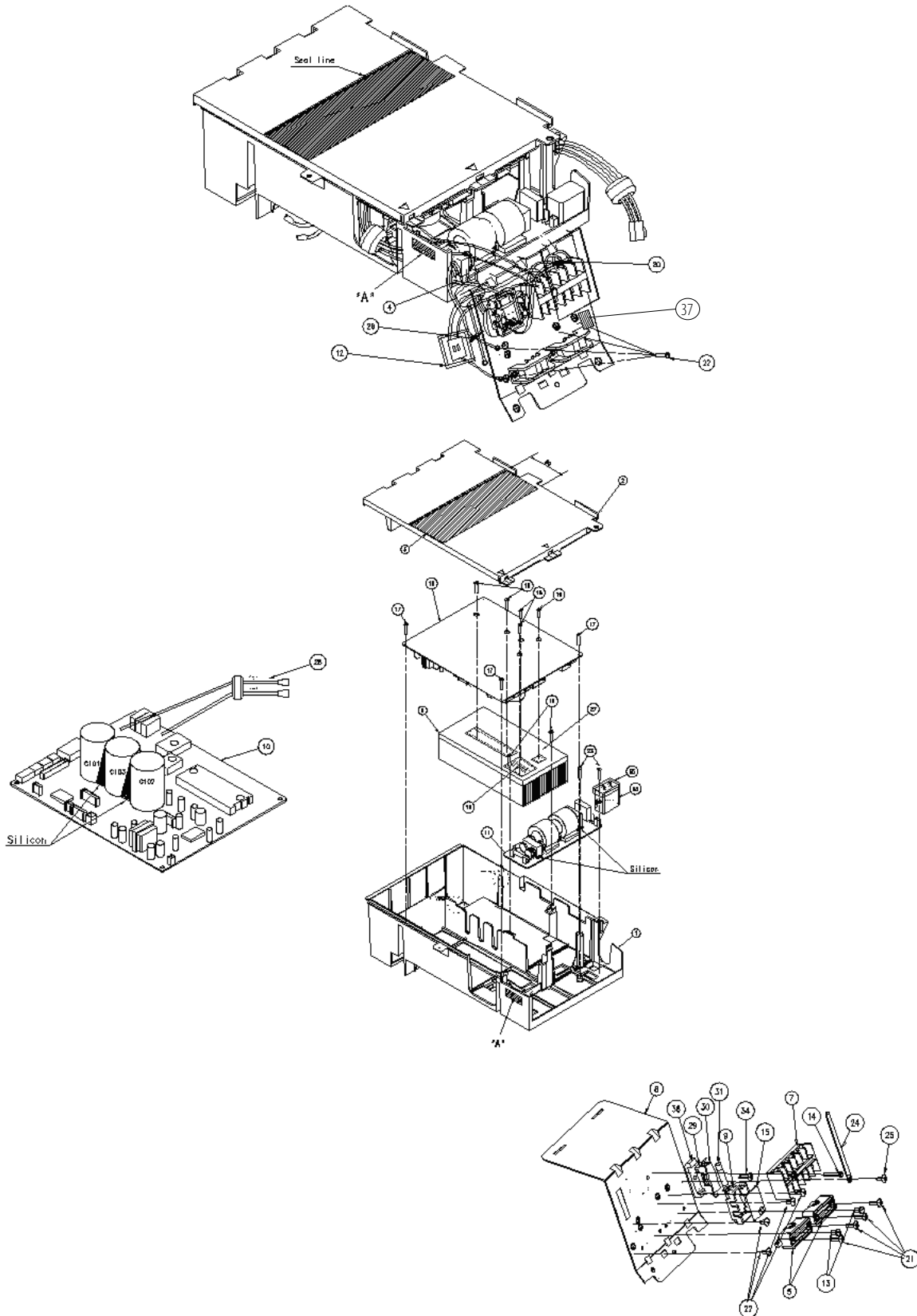

 Part List

NO.	CODE	DESC.	Spec.	18K	24K
1	DB61-02973B	CASE-CONTROL BASE	ABS 5V,SSEC_INV	1	1
2	DB61-02974B	CASE-CONTROL COVER	ABS 5V,SSEC_INV	1	1
3	DB62-04566B	SEAL-COVER CONTROL	FORTE1-INV,FOAM-LEX,WHT,T2,50,210,SSEC	1	1
4	DB93-04337A	ASSY CONNECTOR WIRE	AQV12JAKCV,12K	1	1
5	DB61-00250A	HOLDER-WIRE CLAMP	-,ABS,-,-,-,BLK,ISI,SAMLINE	0	0
6	DB62-05315A	HEAT SINK	HP-HC230V,ALUMINUM,8,100,185,WHT,-,-,50	1	1
7	DB95-01078F	ASSY-TERMINAL BLOCK	MB1-PJT,300V,25A,6P,DAF-6P	1	1
8	DB61-02977B	PLATE-CONTROL OUT	UH070EAS,SGCC-M,T0.6,144,258,NO SPRAY,SSEC	1	1
9	DB61-02975A	CASE-DISPLAY PCB	AQV24FAX,ABS V0,T2.0,30,40,BLK,07R_SSEC_INVERT ER_Q	1	1
10	DB93-07112G	ASSY PCB MAIN-OUT	Forte/Vivace 18K,XSA, AC	1	0
	DB93-07112H	ASSY PCB MAIN-OUT	Forte/Vivace 24K,XSA, AC	0	1
11	DB93-07054A	ASSY PCB SUB-EMI	MONT BLANC,SSEC,18K	1	1
12	DB95-01712A	ASSY-NOISE ABSORBER	MONT BLANC,SSEC	1	1
13	6001-001054	SCREW-TAPTITE	BH,+,-,S,M4,L10,SN PLT,SWRCH18A,-	0	0
14	6002-000555	SCREW-TAPPING	PH,+,-,2S,M4,L25,ZPC(WHT),SWRCH18A,-	1	1
15	DB93-04329A	ASSY PCB SUB-DISPLAY	AQV12JAKCV,ASSY PCB DISPLAY	1	1
16	DB62-05320A	INSULATION-MICA	HP-HC230V,MICA,0.1T,43.75,44.4,-,-,-,-	1	1
17	6002-000630	SCREW-TAPPING	PH,+,-,2S,M3,L8,ZPC(WHT),SWRCH18A,-	3	3
18	DB91-00306A	ASSY-SCREW MACHINE	BLDC INV. CONTROLLER,M3*16,WSP,PH,+ZPC	2	2
19	DB91-00307A	ASSY-SCREW MACHINE	WW-INV,M4*16,WSP,PH,+ZPC	5	5
20	DB93-04908D	ASSY CONNECTOR WIRE-POWER	MONT BLANC,SSEC	1	1
21	6002-000214	SCREW-TAPPING	TH,+,-,2S,M4,L16,ZPC(WHT),SWRCH18A,-	0	0
22	6009-001001	SCREW-SPECIAL	TH,+,-,M4,L8,ZPC(WHT),SWRCH18A,-,-	4	4
23	6002-000536	SCREW-TAPPING	PH,+,-,2S,M4,-,ZPC(WHT),STS304,-	2	2
24	DB61-00206B	HOLDER-WIRE	-,GALVA-SBHG,-,-,-,BLK,SHRINK TUBE S-PJT SSEC	1	1
25	6002-000231	SCREW-TAPPING	TH,+,-,2S,M4,L12,ZPC(WHT),SWRCH18A,-	1	1
26	DB65-10088D	CABLE-TIE	-,NY-66,-,-,-,L100MM	1	1
27	DB98-24813A	ASSY	Thermal Grease,Unit:gram	2	2
28	DB93-04334B	ASSY CONNECTOR WIRE	Montblanc-PJT(INV),UL1015 14AWG, CORE	1	1
29	DB61-40239A	HOLDER-FUSE	FR-66,-,-,-,A3064-0019	1	1
30	DB61-02474A	HOLDER-FUSE CASE	3025N1,11.4mm,15.6mm,35.4mm	1	1
31	3601-001159	FUSE-CARTRIDGE	250V,20A,SLOW-BLOW,CERAMIC,31.8x6.35mm	1	0
	3601-001381	FUSE-CARTRIDGE	250Vac,30Aac,FAST-ACTING,CERAMIC,31.8*6.35	0	1
32	DB93-07036A	ASSY CONNECT WIRE	Forte/Vivace,XSA,FUSE TO TERMINAL	0	0
33	2301-001369	C-FILM,LEAD-OTHER	3000nF,+10-5%,450V,BK,47x19x28mm,-	1	0
	2301-001379	C-FILM,LEAD-OTHER	4000nF,+10-5%,450V,BK,48x22x35mm,43	0	1
34	DB97-11259A	SCREW-TAPPING	M4x16	1	1
35	DB73-00449A	RUBBER-CAPACITOR	FORTE,NR,51*30*10,-,-,-,BLACK,-,-,-,SSEC	1	1
36	DB73-00471A	RUBBER-FUSE HLDER	DVM OUTDOOR,CR,-,-,-,BLK	1	1
37	DB98-27584A	LABEL CAUTION	ASSY	1	1

6. Electrical Parts List

■ MAIN PCB : DB93-05877G

Location No.	Code No.	Description	Specification	Q'ty	SNA/SA
D701	0402-000012	DIODE-RECTIFIER	UF4007,1KV,1A,DO-41,TP	1	SNA
BD71	0402-001298	DIODE-BRIDGE	DF06S,600V,1A,SMD-4,TP	1	SNA
D101	0402-001427	DIODE-RECTIFIER	ES1D,200V,1A,DO-214AC,TP	1	SNA
ZD11	0403-000252	DIODE-ZENER	BZX84C3V6,3.4-3.8V,350MW,SOT-23,TP	1	SNA
ZD13	0403-000466	DIODE-ZENER	BZX84C4V3,4.3,225mW,SOT-23,TP	1	SNA
ZD12	0403-001285	DIODE-ZENER	BZX84-C11,10.4-11.6V,350mW,SOT-23,TP	1	SNA
CD11	0406-001086	DIODE-TVS	ST02D-200,185/200/215V,200W,DO-214	1	SNA
Q201	0501-000534	TR-SMALL SIGNAL	2SC2412K,NPN,200mW,SOT-23,TP,180-390	1	SNA
Q401	0501-000534	TR-SMALL SIGNAL	2SC2412K,NPN,200mW,SOT-23,TP,180-390	1	SNA
Q601	0501-000534	TR-SMALL SIGNAL	2SC2412K,NPN,200mW,SOT-23,TP,180-390	1	SNA
Q603	0501-000534	TR-SMALL SIGNAL	2SC2412K,NPN,200mW,SOT-23,TP,180-390	1	SNA
Q602	0501-002296	TR-SMALL SIGNAL	MMST2907A,PNP,200MW,SMT3,TP,100-300	1	SNA
Q101	0504-001064	TR-DIGITAL	DTC114EKA,NPN,200mW,10K/10K,SOT-23,TP	1	SNA
IC05	0506-000175	TR-ARRAY	2003,NPN,7,1W,SOP-16,ST,1000	1	SNA
IC06	0506-000175	TR-ARRAY	2003,NPN,7,1W,SOP-16,ST,1000	1	SNA
IC08	0506-000175	TR-ARRAY	2003,NPN,7,1W,SOP-16,ST,1000	1	SNA
PC02	0604-001003	PHOTO-COUPLER	TR,50-150%,200mW,DIP-4,ST	1	SNA
PC01	0604-001038	PHOTO-COUPLER	TR,130-260%,200mW,DIP-4,ST	1	SNA
IC07	1003-001462	IC-SOURCE DRIVER	TD62783AFW,SOL,	1	SNA
IC09	1103-001175	IC-EEPROM	93LC56	1	SNA
IC02	1203-000429	IC-POS.FIXED REG.	78L05A,TO-92,3P,-,PLASTIC,4.6/	1	SNA
IC01	1203-002545	IC-PWM CONTROLLER	266,DIP,8P,300MIL,PLASTIC,-0.3/700V	1	SNA
IC59	1203-003334	IC-RESET	S-801,SOT-23,5P,2.9x1.6mm,PLASTIC	1	SNA
NTC	1404-001274	THERMISTOR-NTC	22ohm,1.4A,3100K,9.5mW/C,-,7.0,-	1	SNA
VA71	1405-000154	VARISTOR	460Vdc,2500A,17.5x7.5mm,TP	1	SNA
R103	2002-001104	R-COMPOSITION	12Mohm,5%,1/2W,AA,TP,3.4x9mm	1	SNA
R104	2002-001104	R-COMPOSITION	12Mohm,5%,1/2W,AA,TP,3.4x9mm	1	SNA
R405	2007-000076	R-CHIP	330ohm,5%,1/10W,TP,1608	1	SNA
R406	2007-000076	R-CHIP	330ohm,5%,1/10W,TP,1608	1	SNA
R412	2007-000076	R-CHIP	330ohm,5%,1/10W,TP,1608	1	SNA
R607	2007-000077	R-CHIP	470ohm,5%,1/10W,TP,1608	1	SNA
R608	2007-000077	R-CHIP	470ohm,5%,1/10W,TP,1608	1	SNA
R210	2007-000078	R-CHIP	1Kohm,5%,1/10W,TP,1608	1	SNA
R211	2007-000078	R-CHIP	1Kohm,5%,1/10W,TP,1608	1	SNA
R401	2007-000078	R-CHIP	1Kohm,5%,1/10W,TP,1608	1	SNA
R402	2007-000078	R-CHIP	1Kohm,5%,1/10W,TP,1608	1	SNA
R404	2007-000078	R-CHIP	1Kohm,5%,1/10W,TP,1608	1	SNA
R409	2007-000078	R-CHIP	1Kohm,5%,1/10W,TP,1608	1	SNA
R503	2007-000078	R-CHIP	1Kohm,5%,1/10W,TP,1608	1	SNA
R602	2007-000078	R-CHIP	1Kohm,5%,1/10W,TP,1608	1	SNA
R604	2007-000078	R-CHIP	1Kohm,5%,1/10W,TP,1608	1	SNA
R610	2007-000078	R-CHIP	1Kohm,5%,1/10W,TP,1608	1	SNA
R611	2007-000078	R-CHIP	1Kohm,5%,1/10W,TP,1608	1	SNA
R606	2007-000084	R-CHIP	4.7Kohm,5%,1/10W,TP,1608	1	SNA
R909	2007-000084	R-CHIP	4.7Kohm,5%,1/10W,TP,1608	1	SNA

■ MAIN PCB : DB93-05877G (cont.)

Location No.	Code No.	Description	Specification	Q'ty	SNA/SA
R403	2007-000087	R-CHIP	6.8Kohm,5%,1/10W,TP,1608	1	SNA
R802	2007-000087	R-CHIP	6.8Kohm,5%,1/10W,TP,1608	1	SNA
R209	2007-000090	R-CHIP	10Kohm,5%,1/10W,TP,1608	1	SNA
R301	2007-000090	R-CHIP	10Kohm,5%,1/10W,TP,1608	1	SNA
R605	2007-000090	R-CHIP	10Kohm,5%,1/10W,TP,1608	1	SNA
R801	2007-000090	R-CHIP	10Kohm,5%,1/10W,TP,1608	1	SNA
R908	2007-000090	R-CHIP	10Kohm,5%,1/10W,TP,1608	1	SNA
R502	2007-000093	R-CHIP	20Kohm,5%,1/10W,TP,1608	1	SNA
R410	2007-000109	R-CHIP	1Mohm,5%,1/10W,TP,1608	1	SNA
R501	2007-000109	R-CHIP	1Mohm,5%,1/10W,TP,1608	1	SNA
R609	2007-000119	R-CHIP	560ohm,5%,1/10W,TP,1608	1	SNA
R101	2007-000290	R-CHIP	100ohm,5%,1/8W,TP,2012	1	SNA
R102	2007-000493	R-CHIP	2.2Kohm,5%,1/8W,TP,2012	1	SNA
R106	2007-000872	R-CHIP	4.7Kohm,5%,1/8W,TP,2012	1	SNA
R105	2007-000931	R-CHIP	470ohm,5%,1/8W,TP,2012	1	SNA
R201	2007-000944	R-CHIP	47Kohm,5%,1/4W,TP,3216	1	SNA
R202	2007-000944	R-CHIP	47Kohm,5%,1/4W,TP,3216	1	SNA
R203	2007-000944	R-CHIP	47Kohm,5%,1/4W,TP,3216	1	SNA
R204	2007-000944	R-CHIP	47Kohm,5%,1/4W,TP,3216	1	SNA
R205	2007-000944	R-CHIP	47Kohm,5%,1/4W,TP,3216	1	SNA
R206	2007-000944	R-CHIP	47Kohm,5%,1/4W,TP,3216	1	SNA
R207	2007-000944	R-CHIP	47Kohm,5%,1/4W,TP,3216	1	SNA
R208	2007-000944	R-CHIP	47Kohm,5%,1/4W,TP,3216	1	SNA
R504	2007-000962	R-CHIP	5.1Kohm,1%,1/10W,TP,1608	1	SNA
R407	2007-001068	R-CHIP	6.8Kohm,1%,1/10W,TP,1608	1	SNA
R408	2007-001068	R-CHIP	6.8Kohm,1%,1/10W,TP,1608	1	SNA
R411	2007-001068	R-CHIP	6.8Kohm,1%,1/10W,TP,1608	1	SNA
C107	2201-000987	C-CERAMIC,DISC	2.2NF,20%,400V,Y5U,BK,12.5X6MM,10	1	SNA
C108	2201-000987	C-CERAMIC,DISC	2.2NF,20%,400V,Y5U,BK,12.5X6MM,10	1	SNA
C109	2201-002193	C-CERAMIC,DISC	0.082nF,±10%,3000V,SL,-,8.5 X 3,5	1	SNA
C502	2203-000189	C-CER,CHIP	100nF,+80-20%,25V,Y5V,1608	1	SNA
C503	2203-000189	C-CER,CHIP	100nF,+80-20%,25V,Y5V,1608	1	SNA
C504	2203-000189	C-CER,CHIP	100nF,+80-20%,25V,Y5V,1608	1	SNA
C505	2203-000189	C-CER,CHIP	100nF,+80-20%,25V,Y5V,1608	1	SNA
C506	2203-000189	C-CER,CHIP	100nF,+80-20%,25V,Y5V,1608	1	SNA
C507	2203-000189	C-CER,CHIP	100nF,+80-20%,25V,Y5V,1608	1	SNA
C508	2203-000189	C-CER,CHIP	100nF,+80-20%,25V,Y5V,1608	1	SNA
C509	2203-000189	C-CER,CHIP	100nF,+80-20%,25V,Y5V,1608	1	SNA
C510	2203-000189	C-CER,CHIP	100nF,+80-20%,25V,Y5V,1608	1	SNA
C102	2203-000192	C-CER,CHIP	100nF,+80-20%,50V,Y5V,2012	1	SNA
C201	2203-000192	C-CER,CHIP	100nF,+80-20%,50V,Y5V,2012	1	SNA
C202	2203-000257	C-CER,CHIP	10nF,10%,50V,X7R,1608	1	SNA
C203	2203-000257	C-CER,CHIP	10nF,10%,50V,X7R,1608	1	SNA
C404	2203-000257	C-CER,CHIP	10nF,10%,50V,X7R,1608	1	SNA
C401	2203-000440	C-CER,CHIP	1nF,10%,50V,X7R,1608	1	SNA

■ MAIN PCB : DB93-05877G(cont.)

Location No.	Code No.	Description	Specification	Q'ty	SNA/SA
C405	2203-000440	C-CER,CHIP	1nF,10%,50V,X7R,1608	1	SNA
C406	2203-000440	C-CER,CHIP	1nF,10%,50V,X7R,1608	1	SNA
C104	2203-005249	C-CER,CHIP	100nF,10%,50V,X7R,1608	1	SNA
C106	2203-005249	C-CER,CHIP	100nF,10%,50V,X7R,1608	1	SNA
C402	2203-005249	C-CER,CHIP	100nF,10%,50V,X7R,1608	1	SNA
C403	2203-005249	C-CER,CHIP	100nF,10%,50V,X7R,1608	1	SNA
C407	2203-005249	C-CER,CHIP	100nF,10%,50V,X7R,1608	1	SNA
C501	2203-005249	C-CER,CHIP	100nF,10%,50V,X7R,1608	1	SNA
C801	2203-005249	C-CER,CHIP	100nF,10%,50V,X7R,1608	1	SNA
C901	2203-005249	C-CER,CHIP	100nF,10%,50V,X7R,1608	1	SNA
XC71	2301-001220	C-FILM,LEAD-PPF	100nF,10%,275V,BK,18x6x12,15	1	SNA
XC72	2301-001220	C-FILM,LEAD-PPF	100nF,10%,275V,BK,18x6x12,15	1	SNA
CR71	2301-001363	C-FILM,LEAD-PPF	2000nF,+10-5%,450V,BK,38x18x30mm,33	1	SNA
C105	2401-000037	C-AL	470uF,20%,16V,GP,TP,8x11.5,5	1	SNA
C103	2401-000151	C-AL	1000uF,20%,25V,GP,TP,10x20,5	1	SNA
C601	2401-002300	C-AL	47?F,20%,50V,GP,TP,6.3x11,5mm	1	SNA
C101	2401-003895	C-AL	15uF,20%,450V,GP,TP,12.5x20mm,5	1	SNA
XTAL51	2802-001179	RESONATOR-CERAMIC	4MHZ,0.5%,BK,8X3X5.5MM	1	SNA
BZ61	3002-001129	BUZZER-PIEZO	85DB,-,-,2KHZ,-	1	SNA
SS71	3502-000115	SSR	12Vdc,-,2A,1mS,1mS	1	SNA
F701_1	3601-000263	FUSE-CARTRIDGE	250V,3.15A,TIME-LAG,GLASS,5x20mm	1	SNA
F702	3601-001209	FUSE-RADIAL LEAD	250V,1A,TIME-LAG,-,8.5x8mm	1	SNA
CN72	3711-000262	HEADER-BOARD TO CABLE	1WALL,3P,1R,7.92MM,STRAIGHT,SN,WHT	1	SNA
CN44	3711-000879	HEADER-BOARD TO CABLE	BOX,3P,1R,2.5mm,STRAIGHT,SN,BLU	1	SNA
CN71	3711-003404	HEADER-BOARD TO CABLE	1WALL,2P,1R,7.92mm,STRAIGHT,SN,BLU	1	SNA
CN93	3711-003942	HEADER-BOARD TO CABLE	BOX,2P,1R,2mm,STRAIGHT,SN,WHT	1	SNA
CN92	3711-004236	HEADER-BOARD TO CABLE	BOX,6P,1R,2MM,STRAIGHT,SN	1	SNA
CN43	3711-004379	HEADER-BOARD TO CABLE	BOX,4P,1R,2mm,STRAIGHT,SN,NTR	1	SNA
CN61	3711-004484	HEADER-BOARD TO CABLE	BOX,5P,1R,2mm,STRAIGHT,SN,NTR	1	SNA
AC_L	3712-001139	CONNECTOR-TERMINAL	TAB,MALE,-,6.35X0.8MM	1	SNA
ST11	DB26-00015A	TRANS SWITCHING	JT1916-09,	1	SNA
FT71	DB27-00017A	COIL CHOKE	USAV-07153,UU1116,15.0mH	1	SNA
CN22	DB39-01194A	CONNECT WIRE-15P	26 AWG,-,15,140,WHT	1	SNA
PCB	DB41-00526A	PCB MAIN	CEM-3,2,1.0,T 1.6mm,160*140mm	1	SNA
F701	DB61-00924A	HOLDER-FUSE	-,FH-51B,-,-,-,SSEC	1	SNA
IC04	DB91-00835A	ASSY-MICOM	MB90F823 ,Forte USA	1	SNA
CN21	DB93-04257C	ASSY PCB SUB	COMM 485	1	SA
VA71	DB67-00942A	VARISTOR CAP	---	1	SNA

■ INDOOR SUB PCB : DB93-04257C

LOCATION	CODE	DESC_SPEC	PARA1	PARA2	Q'ty	SA/SNA
CD312	0406-001204	DIODE-TVS	SMBJ5.0CA	*	1	SNA
IC20	0801-000393	IC-CMOS LOGIC	MM74HC86M	SOIC-14	1	SNA
IC18	1006-001371	IC-BUS TRANSCEIVER	ISL3175EIBZ	*	1	SNA
CN31	3711-000015	CONNECTOR-HEADER	SMW250-02	WHT	1	SNA
CN12	3711-003847	HEADER-BOARD TO CABLE	SMAW200-12	WHT	1	SNA
RY01	3501-001248	RELAY-MINIATURE	G6S-2	12V/2A	1	SNA
CN11	3711-006040	HEADER-BOARD TO BOARD	25430WR-10A00	BLK	1	SNA
R315	2007-000090	R-CHIP	10K-J	1/10W,1608	1	SNA
C304,C305,C306,C307	2203-000192	C-CER,CHIP	100nF	50V,2012	4	SNA
R201,R202,R203	2007-000084	R-CHIP	4.7K-J	1/10W,1608	3	SNA
R302,R303,R304,R305	2007-000300	R-CHIP	10K-J	1/8W,2012	4	SNA
R204,R205,R206	2007-000078	R-CHIP	1K-J	1/10W,1608	3	SNA
R350	2007-000029	R-CHIP	0ohm,5%,	1/8W,TP,2012	1	SNA
C302,C303	2203-000189	C-CER,CHIP	100nF	25V,1608	2	SNA
C316	2203-005249	C-CER,CHIP	100nF	50V,1608	1	SNA
PCB	DB41-00528A	PCB SUB-INDDOR 485	CEM3	*	1	SNA

■ DISPLAY PCB : DB93-03117A

Location No.	Code No.	Description	Specification	Q'TY	SA/SNA	Remark
C91	2202-000780	C-CERAMIC,MLC-AXIAL	100nF,+80-20%,50V,Y5V,-,3.5x19mm,-	1	SNA	
C92	2202-000173	C-CERAMIC,MLC-AXIAL	1nF,10%,50V,Y5P,-,1.9x3.5mm,-	1	SNA	
CN92	3711-003846	HEADER-BOARD TO CABLE	BOX,8P,1R,2mm,ANGLE,SN	1	SNA	
COOL	0601-001375	LED	ROUND,GRN,3mm,570nm	1	SNA	
D91	0401-000005	DIODE-SWITCHING	1N4148,75V,150mA,DO-35,TP	1	SNA	
R91	2001-000109	R-CARBON(S)	470ohm,5%,1/2W,AA,TP,2.4x6.4mm	1	SNA	
R92	2001-000109	R-CARBON(S)	470ohm,5%,1/2W,AA,TP,2.4x6.4mm	1	SNA	
RM91	0609-001204	MODULE REMOCON	HORIZONTAL,6.5mm,TR	1	SNA	
SW91	3404-001220	SWITCH-TACT	12V,50mA,160gf,6.1x6.1x5.0mm,SPST	1	SNA	
TIMER	0601-001375	LED	ROUND,GRN,3mm,570nm	1	SNA	
TURBO	0601-001373	LED	ROUND,RED,3mm,630nm	1	SNA	
-	DB41-00352A	PCB SUB	WW1-P/J,TSE,FR-1,1,00,T1.6,-,-,-,-,DISP/MODULE/SWITCH	1	SNA	

OUTDOOR MAIN PCB DB93-07112G(AQV18**),DB93-07112H(AQV24**)

LOCA.	CODE	DESC_SPEC	PARA 1	PARA 2	18K	24K	SA/SNA
					DB93-07112G	DB93-07112H	
D451,D452, D453,D454	0401-000133	DIODE-SWITCHING;RLS4148,75V,150mA,LL-34,TP	RLS4148	100V/200mA	4	4	SNA
D103,D104, D105,D106	0402-001427	DIODE-RECTIFIER;ES1D,200V,1A,DO-214AC,TP	ES1D	200V/1A	4	4	SNA
D102,D401, D402,D403	0402-001429	DIODE-RECTIFIER;US1J,600V,1A,DO-214AC,TP	US1J	600V/1A	4	4	SNA
BD01	0402-001553	DIODE BRIDGE;GBPC3506W,600V,35A,SQUARE-4	GBPC3506W	*	1	1	SNA
ZD451,ZD452, ZD501,ZD502	0403-000258	DIODE ZENER;MMBZ5232B,5%,225mW,SOT-23,	MMBZ5232B	5.6V/225mW	4	4	SNA
CD31, CD32	0406-001109	DIODE-TVS;SAC5.0,7.6V/-V,500W,DO-15	SAC5.0	7.6V/500W	2	2	SNA
D201	0407-000123	DIODE-ARRAY;DAN202K,80V,100mA,CA2-3,SOT-23,TP	KDS184	*	1	1	SNA
Q904,Q905, Q906,Q907	0504-000001	TR-DIGITAL;DTA114EKA,PNP,200mW,10K/10K,SOT-23,TP	DTA114EKA	200MW	4	4	SNA
Q801	0504-000127	TR-DIGITAL;FJV3102RMTE,NPN,200MW,10K/10K,SOT-23,T	FJV3102RMTE	200MW	1	1	SNA
IC51,IC52,IC53,IC54, IC55,IC72	0506-000175	TR-ARRAY;2003,NPN,7,1W,SOP-16,ST,1000	ULN2003D013TR	1W	6	6	SNA
Q803	0508-001154	TR-IGBT; -,600V,80A,-,195W,TO-3P	SGH80N60UF	*	1	1	SNA
IC12,IC61, IC62	0604-001172	PHOTO-COUPLER;TR,100-300,200mW,SOP,TP	TLP181-GRH-TPL	100-300%	3	3	SNA
IC30	0801-000393	IC-CMOS LOGIC;74HC86,OR GATE,SOP,14P,150MIL,QUAD,S	MM74HC86M	SOIC-14	1	1	SNA
IC20	1006-001371	IC-BUS TRANSCEIVER	ISL3175EIBZ	*	1	1	SNA
IC21	1202-000104	IC-VOLTAGE COMP.;393,SOP,8P,150MIL,DUAL,36V,CMO	KIA393F	*	1	1	SNA
IC16,IC19	1203-000274	IC-POS.FIXED REG.;7805,TO-220,3P,-,PLASTIC,4.8/5	KA7805A	TO-220	2	2	SNA
IC13	1203-002948	IC-POS.ADJUST REG.;TL431ACD,SOP,8P,4.9X3.9MM,PLA	TL431ACD	*	1	1	SNA
IC59	1203-003334	IC-RESET;S-801,SOT-23,5P,2.9x1.6mm,PLASTIC,3.716/	S-80142ANMC-JC3-T2	*	1	1	SNA
IC11	1203-003527	IC-PWM CONTROLLER;TOP243,DIP,7P,9.83x6.6mm,PLASTIC	TOP243PN	*	1	1	SNA
R107	2003-000708	R-METAL OXIDE(S);47ohm,5%,1W,AA,TP,3.3x9mm	47-J	1W	1	1	SNA
R101	2003-000855	R-METAL OXIDE(S);47Kohm,5%,3W,AA,TP,6x16mm	47K-J	3W	1	1	SNA
R001	2006-001168	R-CEMENT(S);200ohm,5%,10W,CB,BK,15.7x11.5x34.2mm	200-J	10W	1	1	SNA
R421	2006-001145	ASSY-R CEMENT	10m-J	15W	1	1	SNA
R401,R402,R403,R404, R405,R406	2007-000074	R-CHIP;100ohm,5%,1/10W,TP,1608	100-J	1/10W,1608	6	6	SNA
R504,R505,R506, R507,R553,R606, R607	2007-000076	R-CHIP;330ohm,5%,1/10W,TP,1608	30	1/10W,1608	7	7	SNA
R323,R342,R808	2007-000077	R-CHIP;470ohm,5%,1/10W,TP,1608	470-J	1/10W,1608	3	3	SNA
R103,R512,R557, R559,R601,R604	2007-000078	R-CHIP;1Kohm,5%,1/10W,TP,1608	1K-J	1/10W,1608	6	6	SNA
R205,R208	2007-000080	R-CHIP;2Kohm,5%,1/10W,TP,1608	2K-J	1/10W,1608	2	2	SNA
R104	2007-000082	R-CHIP;3.3Kohm,5%,1/10W,TP,1608	3.3K-J	1/10W,1608	1	1	SNA
R324,R325,R327, R328,R407	2007-000084	R-CHIP;4.7Kohm,5%,1/10W,TP,1608	4.7K-J	1/10W,1608	5	5	SNA
R315	2007-000097	R-CHIP;47Kohm,5%,1/10W,TP,1608	47K-J	1/10W,1608	1	1	SNA
R302,R303,R304,R305, R306,R316,R509,R552, R554,R555,R556,R558, R560,R561,R562,R563, R566,R573,R574,R805, R916,R917	2007-000090	R-CHIP;10Kohm,5%,1/10W,TP,1608	10K-J	1/10W,1608	22	22	SNA

OUTDOOR MAIN PCB DB93-07112G(AQV18),DB93-07112H(AQV24**)(cont.)**

LOCA.	CODE	DESC_SPEC	PARA 1	PARA 2	18K	24K	SA/SNA
					DB93-07112G	DB93-07112H	
R510	2007-000109	R-CHIP;1Mohm,5%,1/10W,TP,1608	1M-J	1/10W,1608	1	1	SNA
R102	2007-000111	R-CHIP;6.8ohm,5%,1/10W,TP,1608	6.8-J	1/10W,1608	1	1	SNA
R408,R409,R410	2007-000113	R-CHIP;33ohm,5%,1/10W,TP,1608	33-J	1/10W,1608	3	3	SNA
R301	2007-000116	R-CHIP;120ohm,5%,1/10W,TP,1608	120-J	1/10W,1608	1	1	SNA
R115	2007-000385	R-CHIP;14.3Kohm,1%,1/4W,TP,3216	14.3K-F	1/4W,3216	1	1	SNA
R502,R515	2007-000455	R-CHIP;18Kohm,1%,1/10W,TP,1608	18K-F	1/10W,1608	2	2	SNA
R706,R707,R708	2007-000512	R-CHIP;2.4Kohm,5%,1/10W,TP,1608	2.4K-J	1/10W,1608	3	3	SNA
R807	2007-000553	R-CHIP;20ohm,5%,1/4W,TP,3216	20-J	1/4W,3216	1	1	SNA
R503,R514	2007-000614	R-CHIP;24Kohm,1%,1/10W,TP,1608	24K-F	1/10W,1608	2	2	SNA
R112,R113,R114	2007-000924	R-CHIP;470Kohm,1%,1/4W,TP,3216	470K-F	1/4W,3216	3	3	SNA
R412	2007-000929	R-CHIP;470ohm,1%,1/10W,TP,1608	470-F	1/10W,1608	1	1	SNA
R806	2007-000950	R-CHIP;47ohm,5%,1/4W,TP,3216	47-J	1/4W,3216	1	1	SNA
R511,R910,R911,R912	2007-000965	R-CHIP;5.1Kohm,5%,1/10W,TP,1608	5.1K-J	1/10W,1608	4	4	SNA
R907,R908,R909	2007-001179	R-CHIP;8.2Kohm,5%,1/10W,TP,1608	8.2K-J	1/10W,1608	3	3	SNA
R900,R901,R902,R903, R904,R905,R906	2007-001318	R-CHIP;1Kohm,5%,1/4W,TP,3216	1K-J	1/4W,3216	7	7	SNA
R201,R202,R206,R207	2007-002667	R-CHIP;90.9Kohm,1%,1/4W,TP,3216	90.9K-F	1/4W,3216	4	4	SNA
R106,R203,R204	2007-007342	R-CHIP;1.82Kohm,1%,1/10W,TP,1608	1.82K-F	1/10W,1608	3	3	SNA
R105	2007-007445	R-CHIP;9.09Kohm,1%,1/10W,TP,1608	9.09K-F	1/10W,1608	1	1	SNA
R116,R117,R118	2007-008261	R-CHIP;150Kohm,1%,1/2W,TP,5025	150K-F	1/2W,5025	3	3	SNA
C307,C308,C309, C310	2201-000154	C - C E R A M I C , D I S C ; 1 0 N F , + 8 0 - 20%,2KV,Y5P,TP,20X5MM,7.5	10nF	2KV	4	4	SNA
C105,C106	2201-000322	C-CERAMIC,DISC;2.2NF,10%,2KV,Y5P,TP, 13X5MM,10	2.2nF	2KV	2	2	SNA
C411,C412,C413,C414, C415,C416	2203-000125	C-CER,CHIP;1.2nF,10%,50V,X7R,TP,1608,-	1.2nF	50V,1608	6	6	SNA
C201,C203,C204,C205, C301,C451,C452,C453, C454,C567,C603,C607, C801,C900,C901,C902, C907,C908	2203-000257	C-CER,CHIP;10nF,10%,50V,X7R,TP,1608,-	10nF	50V,1608	18	18	SNA
C108	2203-001414	C-CER,CHIP;330NF,10%,50V,X7R,TP,2012	330nF	50V,2012	1	1	SNA
C318,C319,C320,C321	2203-002002	C-CER,CHIP;33pF,5%,50V,NPO,BK,1608,-	33pF	50V,1608	4	4	SNA
C109,C112,C116,C117, C121,C202,C302,C303, C304,C305,C306,C404, C405,C406,C407,C408, C409,C410,C417,C418, C501,C502,C503,C504, C505,C506,C507,C508, C509,C510,C511,C512, C513,C553,C554,C555, C556,C560,C561,C563, C565,C568,C570,C575, C576,C706,C3011	2203-005249	C-CER,CHIP;100nF,10%,50V,X7R,TP,1608,-	100nF	50V,1608	47	47	SNA
C419,C420	2203-002398	C-CER,CHIP;22nF,10%,50V,X7R,1608	22nF	50V,1608	2	2	SNA
C113,C122,C802	2203-005261	C-CER,CHIP;1000nF,10%,25V,X7R,-,3216	1000nF	25V,3216	3	3	SNA
C008	2301-000141	C - F I L M , L E A D - PEF;10nF,10%,630V,TP,16x11x7.5mm,5	10nF	630V	1	1	SNA
C422,C803	2306-000123	C - F I L M , L E A D - PPF;100nF,5%,630V,BK,26x16.5x8.5,2/ 100nF,5%,630V,17x12x6,15mm	100nF	630V	2	2	SNA
C123	2401-000303	C-AL;100uF,20%,25V,GP,TP,6.3x11,5	100uF	25V	1	1	SNA
C552,C559,C562,C564, C569,C574,C577	2401-000493	C-AL;10uF,20%,50V,LZ,TP,5x11mm,5mm, 105°C	10uF	50V	7	7	SNA
C114,C421	2401-002274	C-AL;220uF,20%,35V,WT,TP,8x11.5mm,5, 105°C	220uF	35V	2	2	SNA
C107,C118,C401,C402, C403	2401-002438	C-AL;47uF,20%,50V,WT,TP,6.3x11,5mm,1 05°C	47uF	50V	5	5	SNA
C104	2401-003541	C-AL;10uF,20% ,450V,WT,TP,12.5x20mm, 5	10uF	450V	1	1	SNA
C110,C119,C805	2401-003585	C-AL;220uF,20%,35V,WT,TP,8x11.5mm,5, 105°C	220uF	35V	3	3	SNA

OUTDOOR MAIN PCB DB93-07112G(AQV18),DB93-07112H(AQV24**)(cont.)**

LOCA.	CODE	DESC_SPEC	PARA 1	PARA 2	18K	24K	SA/SNA
					DB93-07112G	DB93-07112H	
C101,C102,C103	2401-003740	C-AL;560uF,20%,400V,WT,BK,35x50mm,10,105°C	560uF	400V	3	3	SNA
XTAL51	2802-001179	R E S O N A T O R - CERAMIC;4MHZ,0.5%,BK,8X3X5.5MM	4MHZ	*	1	1	SNA
XTAL	2802-001198	R E S O N A T O R - CERAMIC;10MHZ,0.5%,BK,8X3X5.5MM	10MHZ	*	1	1	SNA
RY03,RY04	3501-001154	RELAY MINIATURE;12Vdc,200mW,3000mA,1FormA,10mS,10m	PCJ-112D3MH,501X	12Vdc,3A	2	2	SNA
RY05	3501-001154	RELAY MINIATURE;12Vdc,200mW,3000mA,1FormA,10mS,10m	PCJ-112D3MH,501X	12Vdc,3A	1	1	SNA
RY31	3501-001248	RELAY MINIATURE;12V,11.7MA,DPDT,4MS	G6S-2	12V/2A	1	1	SNA
RY01	3501-001268	RELAYPOWER;12V,0.9W,25000mA,SPST,20mS,10mS	PCF-112D2M	*	1	1	SNA
CN00	3711-003843	HEADER-BOARD TO CABLE	BOX,8P,1R,2mm,STRAIGHT,SN,WHT		1	1	SNA
CN34	3711-004182	C O N N E C T O R - HEADER;BOX,10P,1R,2MM,STRAIGHT,SN,NTR	SMW200-10	NTR	1	1	SNA
CN61	3711-004484	C O N N E C T O R - HEADER;BOX,5P,1R,2mm,STRAIGHT,SN	SMW200-05	NTR	1	1	SNA
REACTOR01, REACTOR02	3712-001139	CONNECTOR-TERMINAL;TAB,MALE,-.6.35X0.8MM	TAB	YTR250	2	2	SNA
PT02	DB26-00075A	TRANS PULSE;PT_50,MH080FXEA4,10,65.5,8~14,EI2218,	PT_50AM / EI22-399N1	*	1	1	SNA
IC451,IC452	DB32-00173A	SENSOR MAG-CT SENSOR;ASC712,5HP INVERTER,-,-40~150	ACS712	30A	2	2	SNA
PCB MAIN	DB41-00773A	PCB	CEM-3	---	1	1	SNA
IC01	DB91-00532C	X S A O U T D O O R I n v Micom,MN103SFA7K,80P, ROM Size: 256K bytes	MN103SFA7K	*	1	1	SNA
IC50	DB91-00733A	ASSY MICOM 09R FORTE,VIVACE, MONTBLANC 18K24K	MB90F823		1	1	SNA
IC701	DB91-00848A	EEPROM DATA	F/V18K 260AC USA	512B	1	0	SNA
	DB91-00849A	EEPROM DATA	F/V24K 260AC USA	512B	0	1	SNA
L/W COMM 485	DB93-04333B	CONNECT WIRE	#1015 22 AWG	5TURN	1	1	SNA
C/W COMP	DB93-04335B	CONNECT WIRE	#1015 14 AWG	5 T U R N , AQV24JAKCV	1	1	SNA
YEL,BLU ,RED	DB93-04338A	CONNECT WIRE	FAN -MOTOR	UL1015 18#	1	1	SNA
L/W EARTH	DB93-04344A	CONNECT WIRE	EARTH	#1015 16 AWG	1	1	SNA
C/W 4 WAY	DB93-04349A	CONNECT WIRE	4WAY	AS18BPBX	1	1	SNA
L/W POWER L_1	DB93-04351A	CONNECT WIRE	L/W POWER L	#1015 AWG 14, BRN	1	1	SNA
L/W POWER N	DB93-04351B	CONNECT WIRE	L/W POWER N	#1015 AWG 14, SKYBLU	1	1	SNA
IC81	DB95-00595A	ASSY-PHOTO COUPLER;MH080FXEA4,-	TLP250	*	1	1	SNA
IPM	DB95-00954A	ASSY-IPM;MH080EAV2A,MITSUBISHI IPM	MH080EAV2A	21267	1	1	SNA
D101	DB98-16591A	ASSY-DIODE RECTIFIER;FEP30JP	FEP30JP	*	1	1	SNA
LED2	DB98-16600A	ASSY-LED GREEN;-	TLPG5600	GRN	1	1	SNA
LED1	DB98-16601A	ASSY-LED RED;-	TLPR5600	RED	1	1	SNA
LED3	DB98-16602A	ASSY-LED YEL;	TLPY5600	YEL	1	1	SNA
CN51	DB98-22298A	A S S Y - H O O K WHT;INVERTER,SMAW250A-04,RED	SMAW250A-04	RED	1	1	SNA
CN50	DB98-22299A	A S S Y - H O O K WHT;INVERTER,SMAW250A-04,WHT	SMAW250A-04	WHT	1	1	SNA
CN30	DB98-24921A	A S S Y - C O N N E C T O R ; A S - WB670X,SMAW250A-06,WHT	SMAW250A-06	WHT	1	1	SNA

■ OUTDOOR EMI PCB :DB93-07054A

Location No.	Code No.	Description	Specification	Q'ty	SNA/SA	Remark
VA01	1405-000154	VARISTOR	460Vdc,2500A	1	SNA	
VA02	1405-000154	VARISTOR	460Vdc,2500A	1	SNA	
VA03	1405-000154	VARISTOR	460Vdc,2500A	1	SNA	
VA05	1405-000154	VARISTOR	460Vdc,2500A	1	SNA	
R002	2001-001150	R-CARBON(S)	470KOHM,5%,1/2W	1	SNA	
R003	2001-001150	R-CARBON(S)	470KOHM,5%,1/2W	1	SNA	
C004	2201-000154	C-CERAMIC,DISC	10NF,+80-20%,2KV	1	SNA	
C005	2201-000154	C-CERAMIC,DISC	10NF,+80-20%,2KV	1	SNA	
C009	2201-000540	C-CERAMIC,DISC	4.7NF,20%,2KV	1	SNA	
C010	2201-000540	C-CERAMIC,DISC	4.7NF,20%,2KV	1	SNA	
C003	2301-001577	C-FILM,LEAD-PPF	680NF,10%,275V	1	SNA	
C007	2301-001285	C-FILM,LEAD-PPF	680NF,10%,275V	1	SNA	
FUSE	3601-001159	FUSE-CARTRIDGE	250V,20A	1	SNA	
FUSE CLIP	3602-001038	FUSE-CLIP	250V,30A,10mohm	2	SNA	
L	3712-001139	CONNECTOR-TERMINAL	TAB,MALE,-,6.35X0.8MM	1	SNA	
N	3712-001139	CONNECTOR-TERMINAL	TAB,MALE,-,6.35X0.8MM	1	SNA	
DSA	4715-001093	SURGE ABSORBER	3600V,20%,2000A,-,AXIAL	1	SNA	
FT00	DB27-00040A	COIL CHOKE	SSC3120030B,3.0mH,	1	SNA	
FT01	DB27-00040A	COIL CHOKE	SSC3120030B,3.0mH,	1	SNA	
PCB	DB41-00724A	PCB SUB	FORTE,CEM-3,2,1.0,1.6T,160*140	1	SNA	
L/W EARTH	DB93-04344B	ASSY CONNECTOR WIRE-EARTH	WIRE	1	SNA	
C/W POWER	DB93-06817A	ASSY CONNECTOR WIRE	WIRE	1	SNA	

■ OUTDOOR DISPLAY PCB : DB93-04329A

Location No.	Code No.	Description	Specification	Q'ty	SNA/SA
D901	0401-000005	DIODE-SWITCHING	1N4148,75V,150mA,DO-35,TP	1	SNA
LED93	0601-001373	LED	ROUND,RED,3MM,630NM	1	SNA
LED92	0601-001375	LED	ROUND,GRN,3mm,570nm,3.8x5.3mm	1	SNA
LED91	0601-001377	LED	ROUND,YEL,3mm,585nm,3.8x5.3mm	1	SNA
K1	3404-001220	SWITCH-TACT	12V,50mA,160gf,6.1x6.1x5.0mm,SPST	1	SNA
CN953	3711-004068	HEADER-BOARD TO CABLE	BOX,5P,1R,2MM,ANGLE,SN,WHT	1	SNA
PCB	DB41-00545A	PCB MAIN-DISPLAY	AQV12JAKCV,FR-1,1,1.0,1.6T,-,Q,30,-,-	1	SNA

7. Wiring Diagram

7-1 Indoor Unit

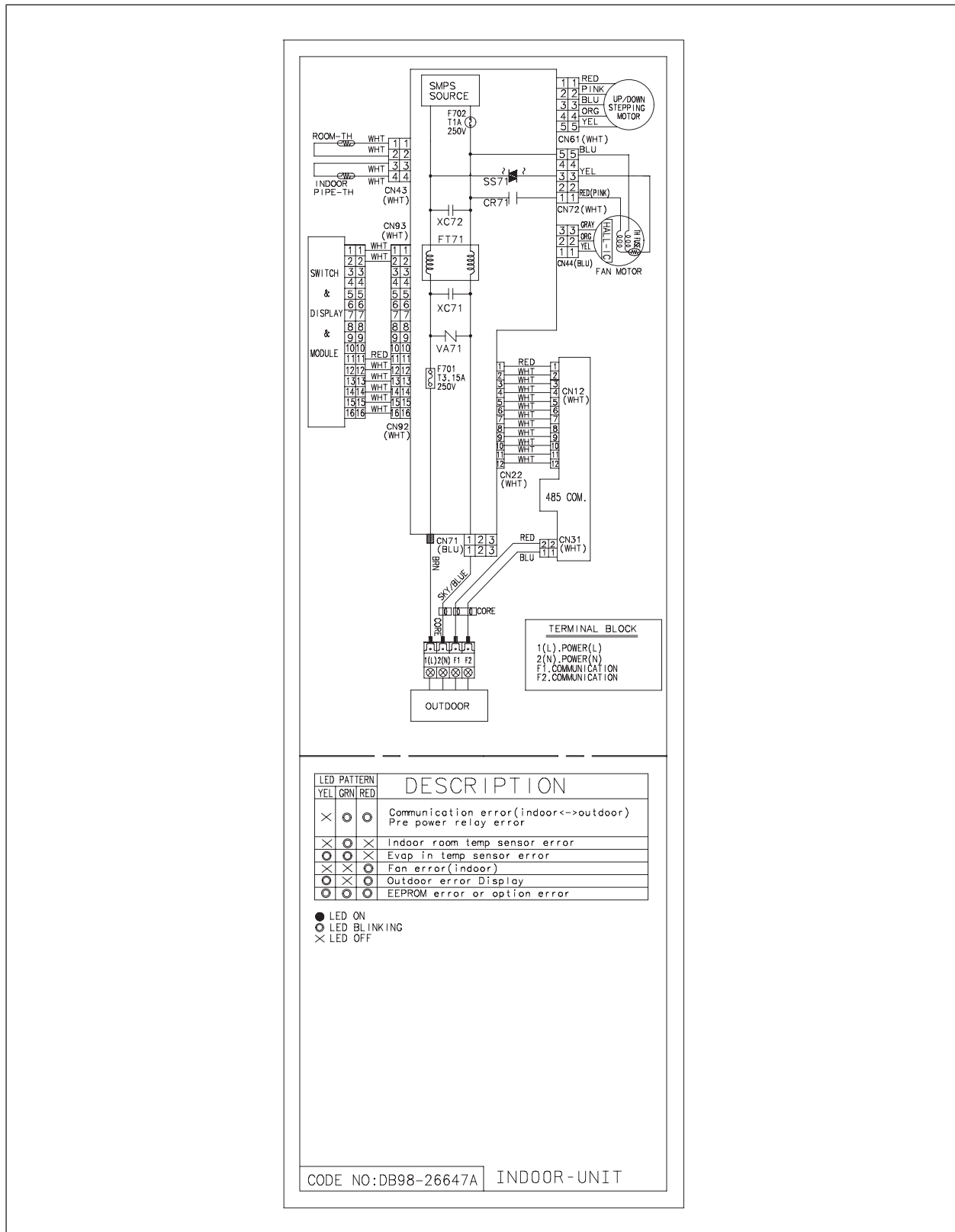

This Document can not be used without Samsung's authorization.

7-2 Outdoor Unit

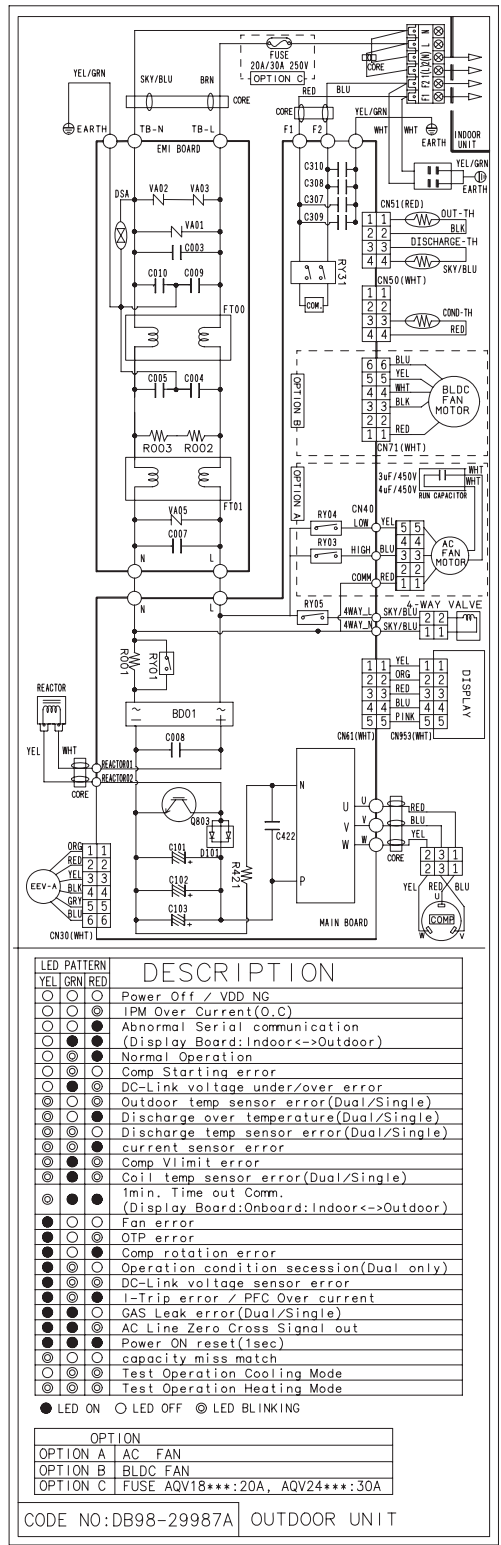

LED PATTERN	DESCRIPTION
YEL GRN RED	
○ ○ ○	Power Off / VDD NC
○ ○ ●	IPM Over Current(O.C)
○ ○ ●	Abnormal Serial communication (Display Board:Indoor<->Outdoor)
○ ○ ○	Normal Operation
○ ● ○	Comp Starting error
○ ● ●	DC-Link voltage under/over error
○ ○ ●	Outdoor temp sensor error(Dual/Single)
○ ○ ●	Discharge over temperature(Dual/Single)
○ ○ ●	Discharge temp sensor error(Dual/Single)
○ ○ ●	current sensor error
○ ● ●	Comp Vlimit error
○ ● ●	Coil temp sensor error(Dual/Single)
○ ● ●	1min. Time out Comm. (Display Board:Onboard:Indoor<->Outdoor)
● ○ ○	Fan error
● ○ ○	OTP error
● ○ ●	Comp rotation error
● ○ ●	Operation condition secession(Dual only)
● ○ ●	DC-Link voltage sensor error
● ○ ●	I-Trip error / PFC Over current
● ○ ●	GAS Leak error(Dual/Single)
● ● ○	AC Line Zero Cross Signal out
● ● ○	Power ON reset(1sec)
○ ○ ○	capacity miss match
○ ○ ●	Test Operation Cooling Mode
○ ○ ●	Test Operation Heating Mode
● LED ON ○ LED OFF ● LED BLINKING	

OPTION
 OPTION A AC FAN
 OPTION B BLDC FAN
 OPTION C FUSE AQV18***:20A, AQV24***:30A

CODE NO:DB98-29987A OUTDOOR UNIT

This Document can not be used without Samsung's authorization.

MEMO

8. Schematic Diagram

8-1 Indoor Unit

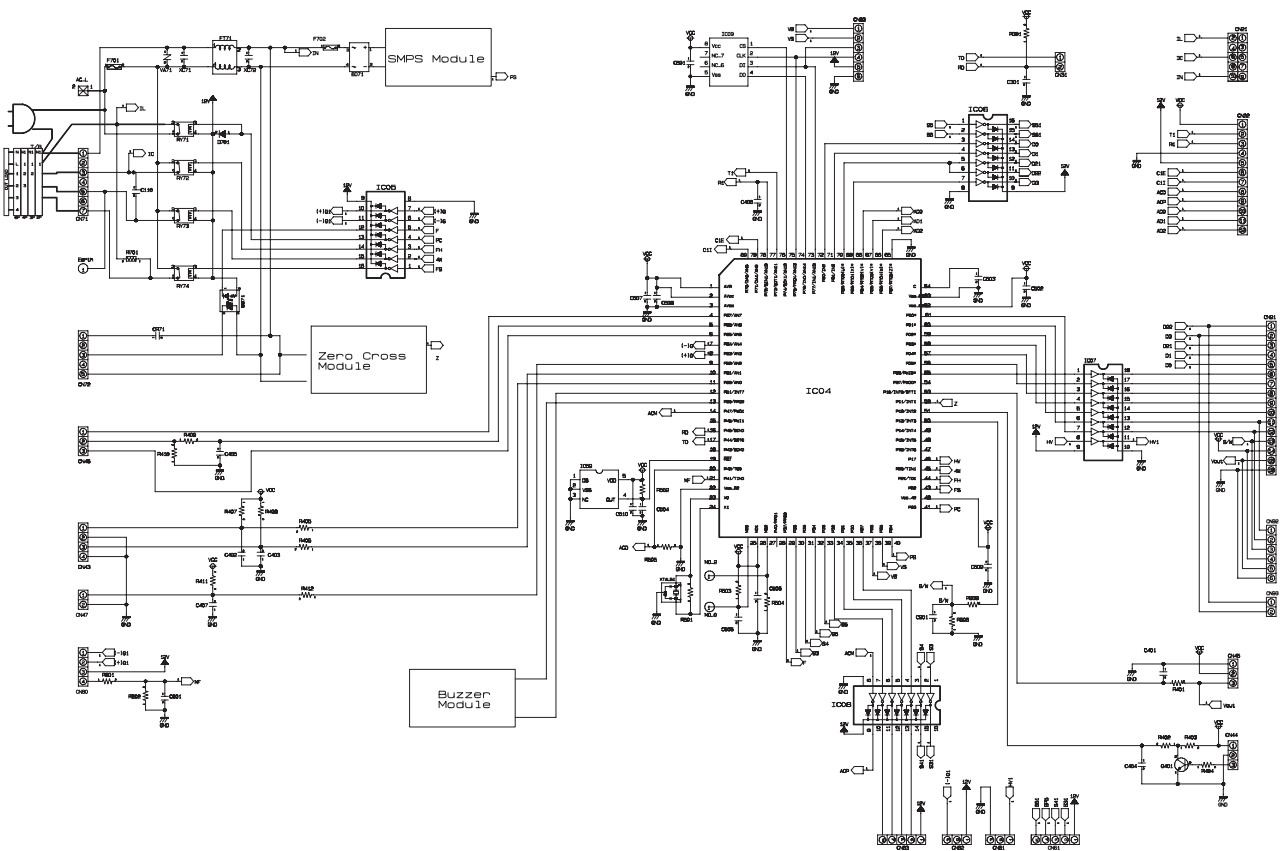

This Document can not be used without Samsung's authorization.

8-2 Outdoor Unit

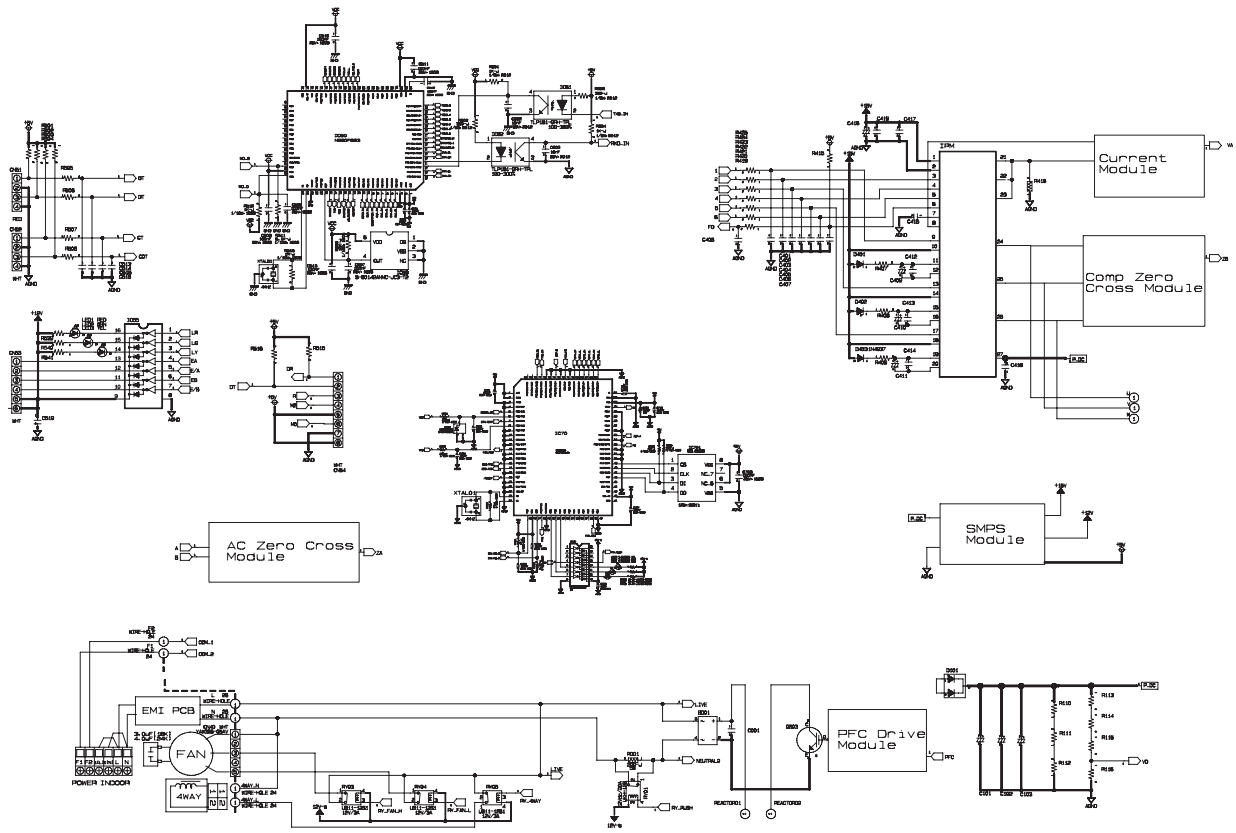

This Document can not be used without Samsung's authorization.

9. Circuit Descriptions

9-1 PCB Circuit Descriptions

9-1-1 Indoor Unit

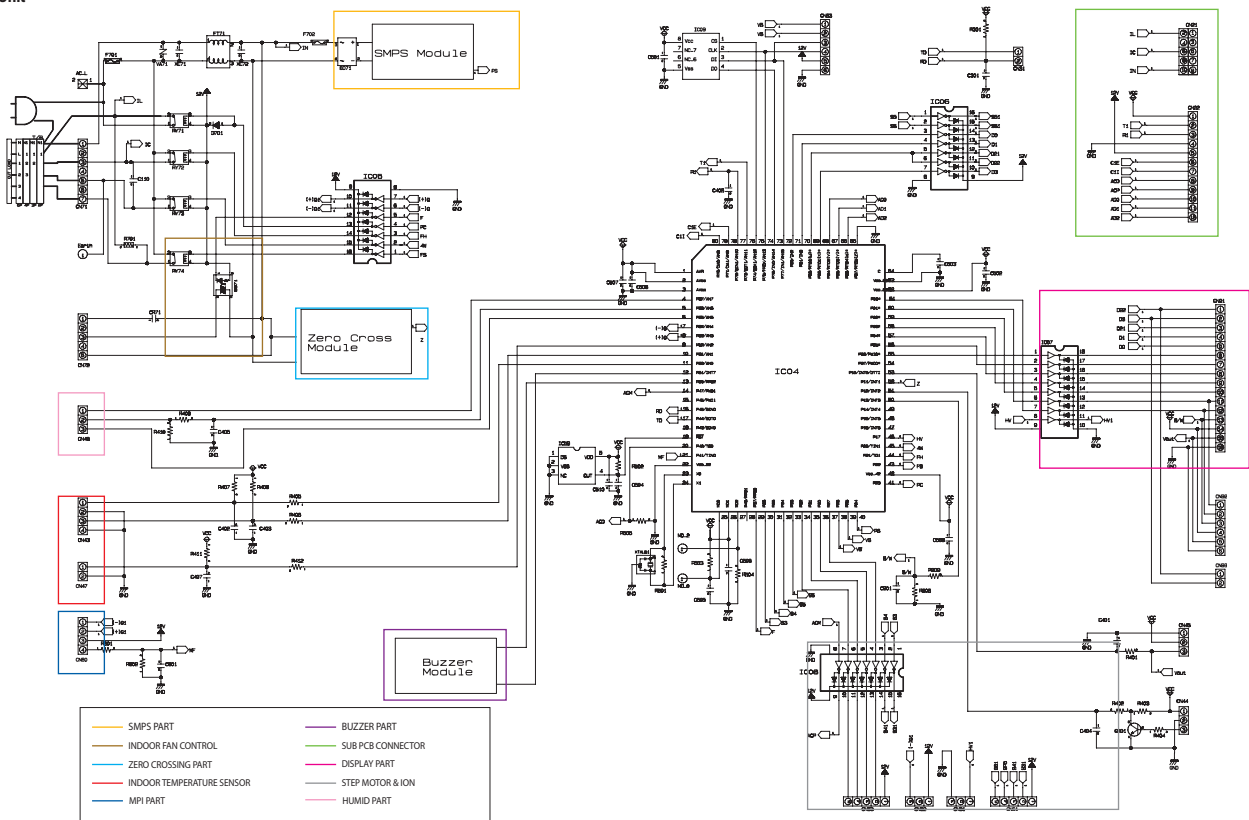

This Document can not be used without Samsung's authorization.

9-1-2 Outdoor Unit

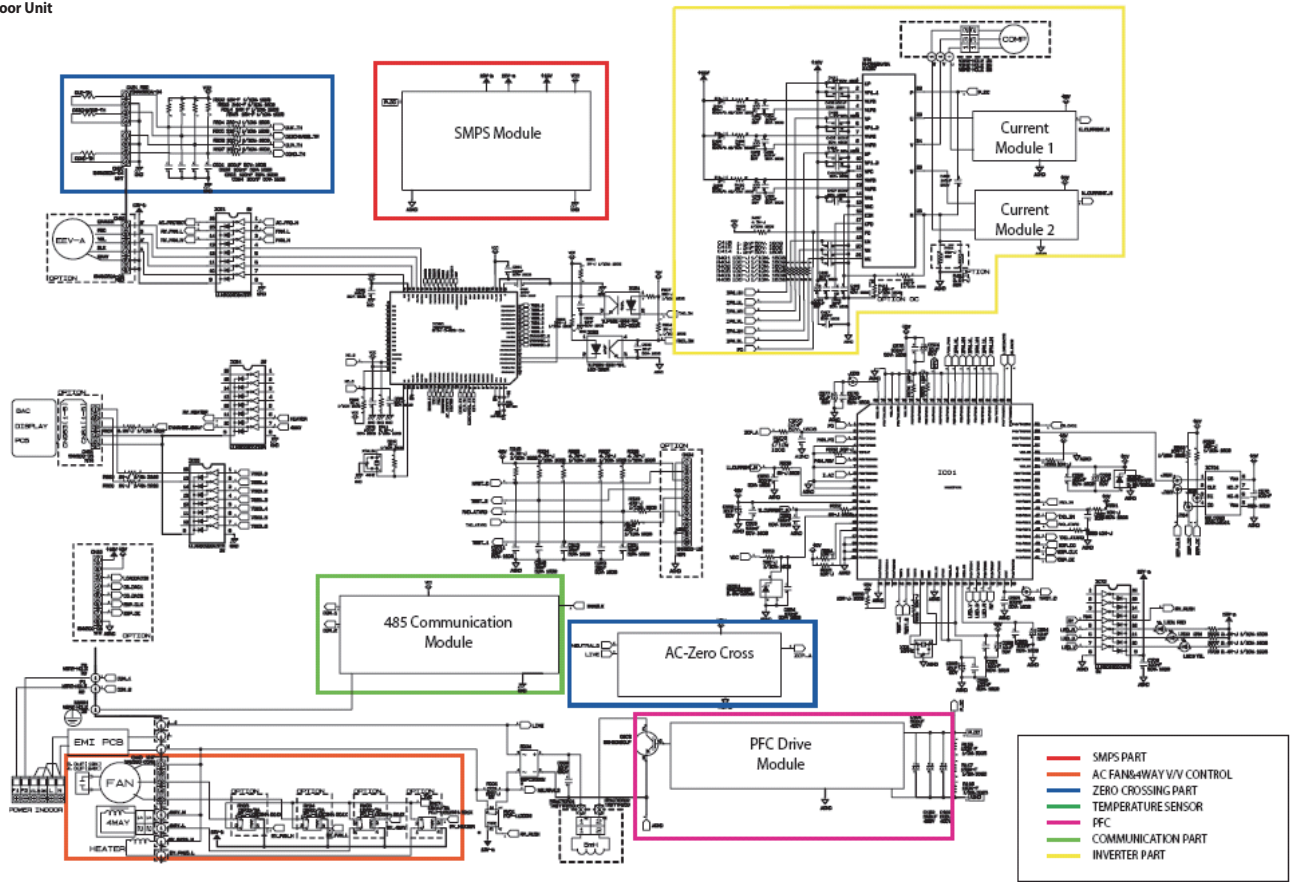

This Document can not be used without Samsung's authorization.

9-2 Refrigerating Cycle Diagram

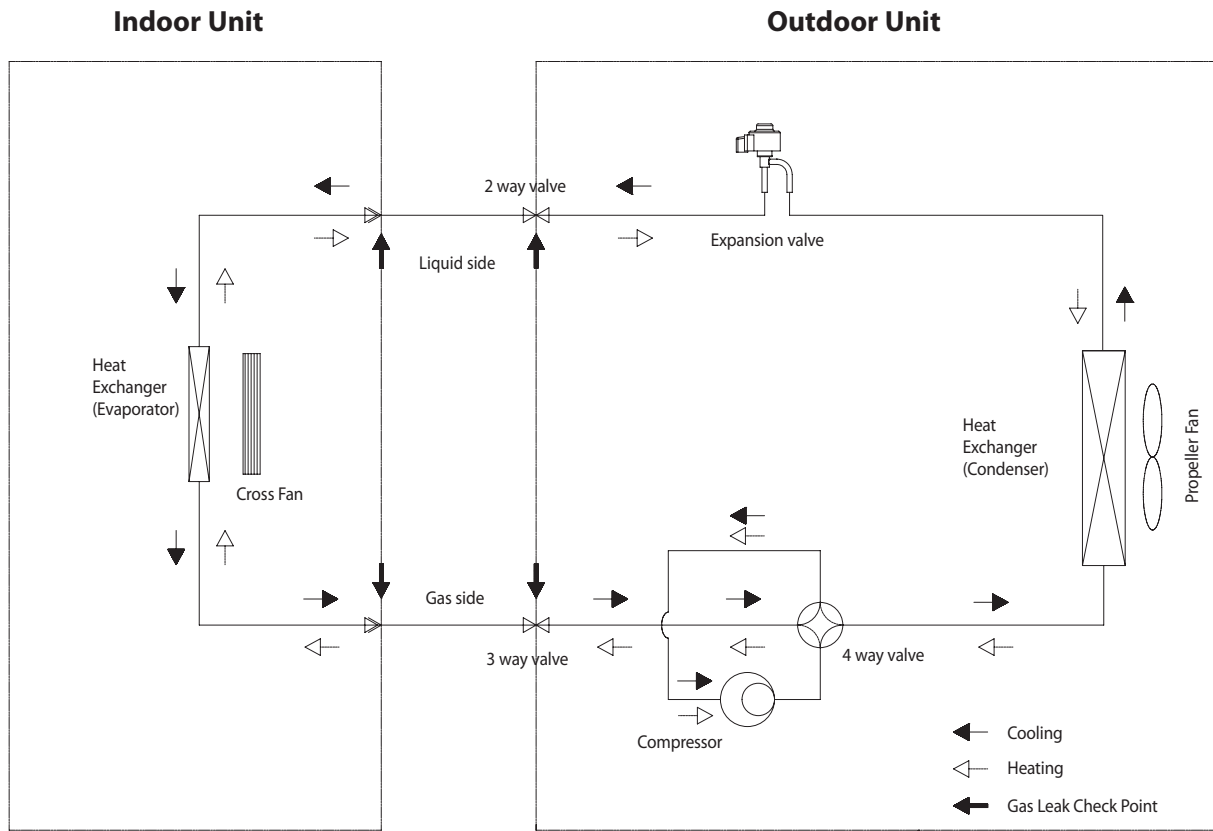

10. PCB Diagram

10-1 Indoor PCB

⚠ The red number connector is not used.

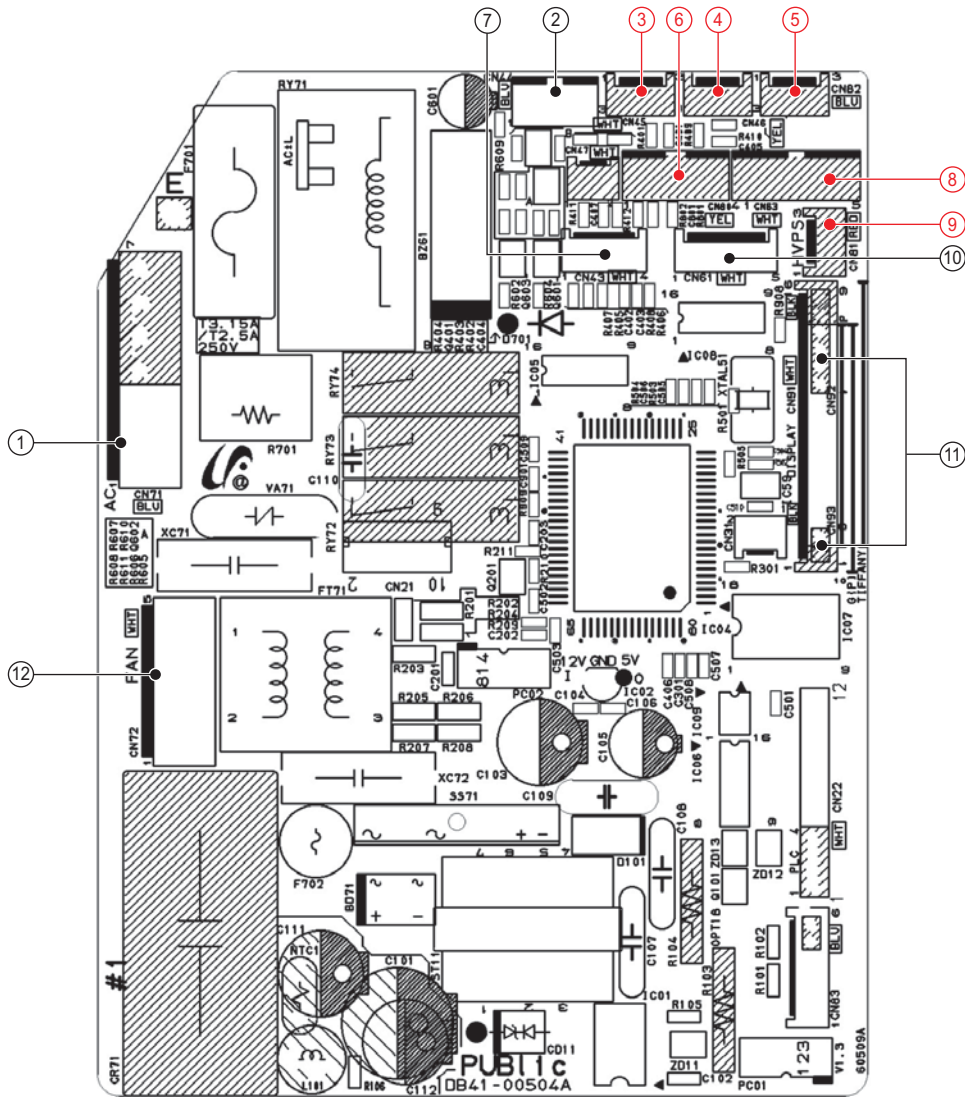

①	Power	⑦	Temperature Sensor
②	Motor RPM Feedback	⑧	Auto Grill
③	Remocon Module	⑨	HVPS(High voltage Generator)
④	Humidity Sensor	⑩	BLADE-H Step Motor
⑤	Anions	⑪	Display
⑥	MPI	⑫	Indoor Fan Motor

10-2 Outdoor PCB

 The red number connector is not used.

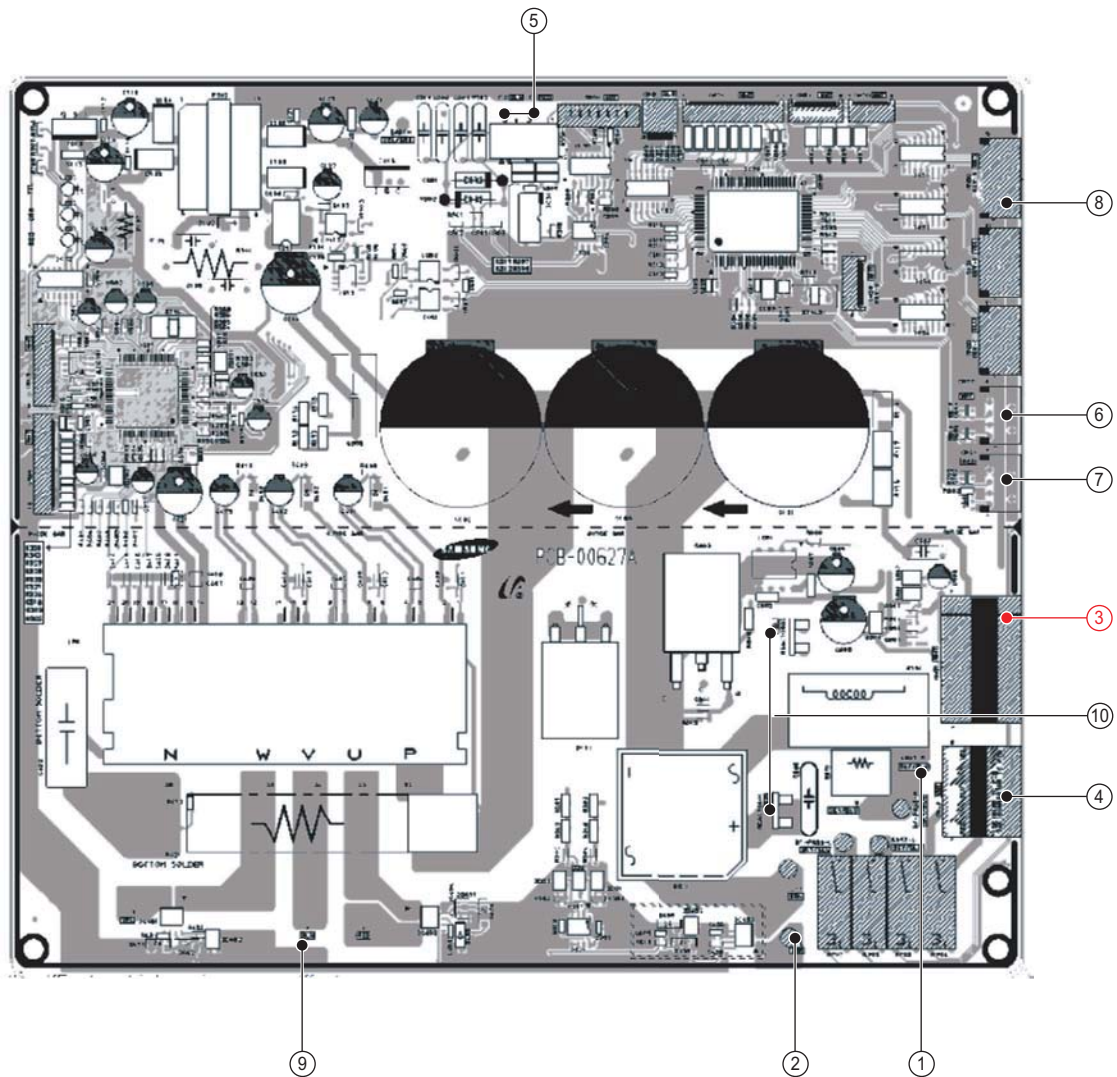

①	Power N	⑥	COND/OLP Temperature Sensor
②	Power L	⑦	DIS/OUT Temperature Sensor
③	BLDC FAN	⑧	EEV Connector
④	AC FAN	⑨	Comp. Connector Wire
⑤	Communication 485	⑩	Reactor Connector Wire

11. Operating Instructions

11-1 Name of Each Part

11-1-1 Indoor Unit

The design and shape are subject to change according to the model.

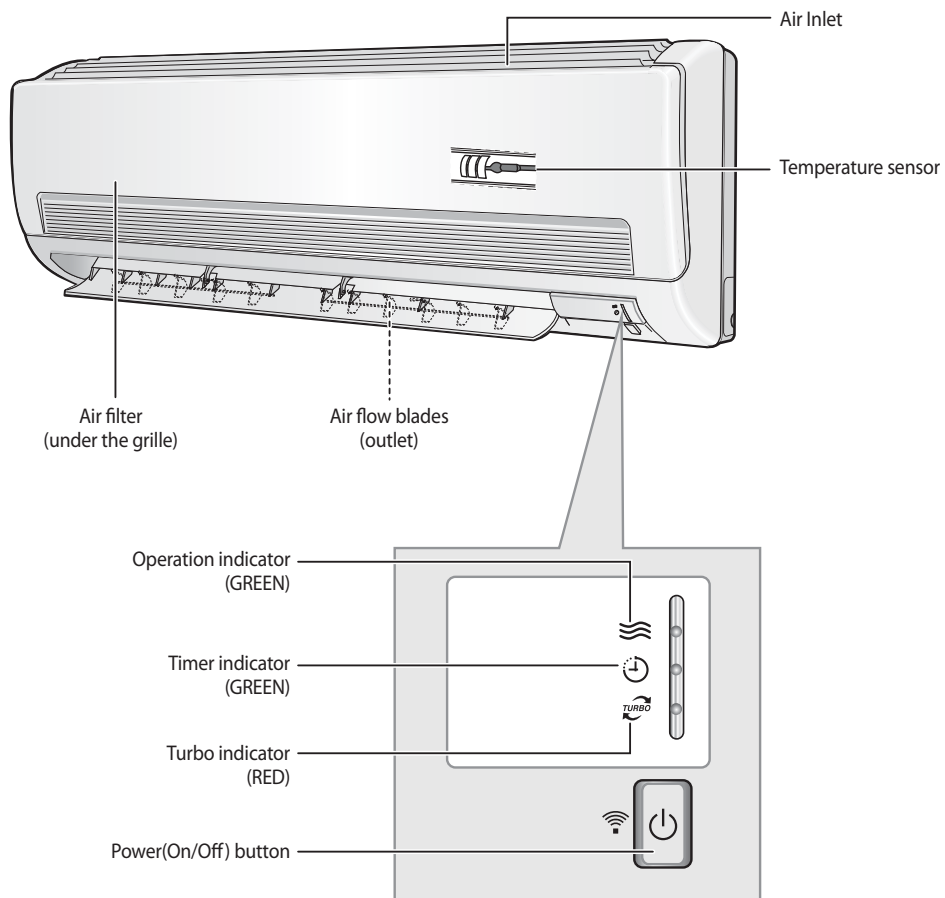

11-1-2 Outdoor Unit

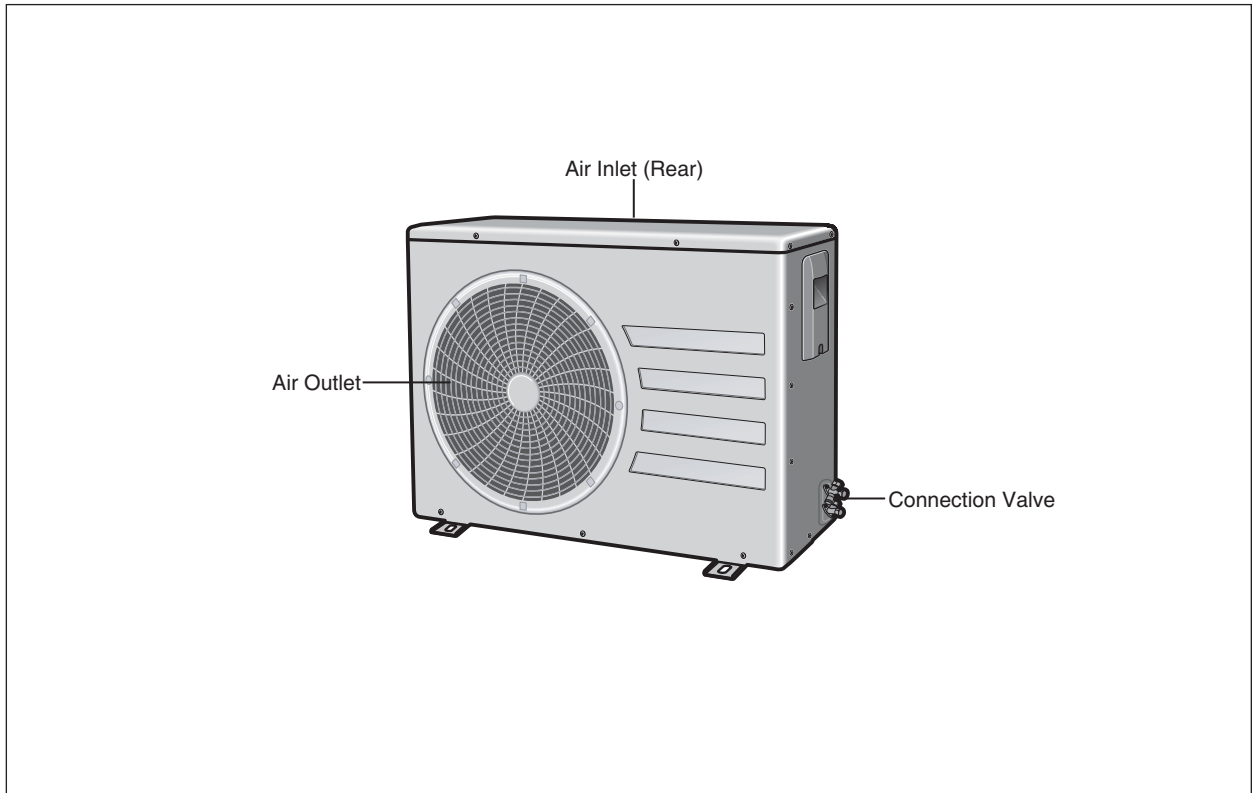



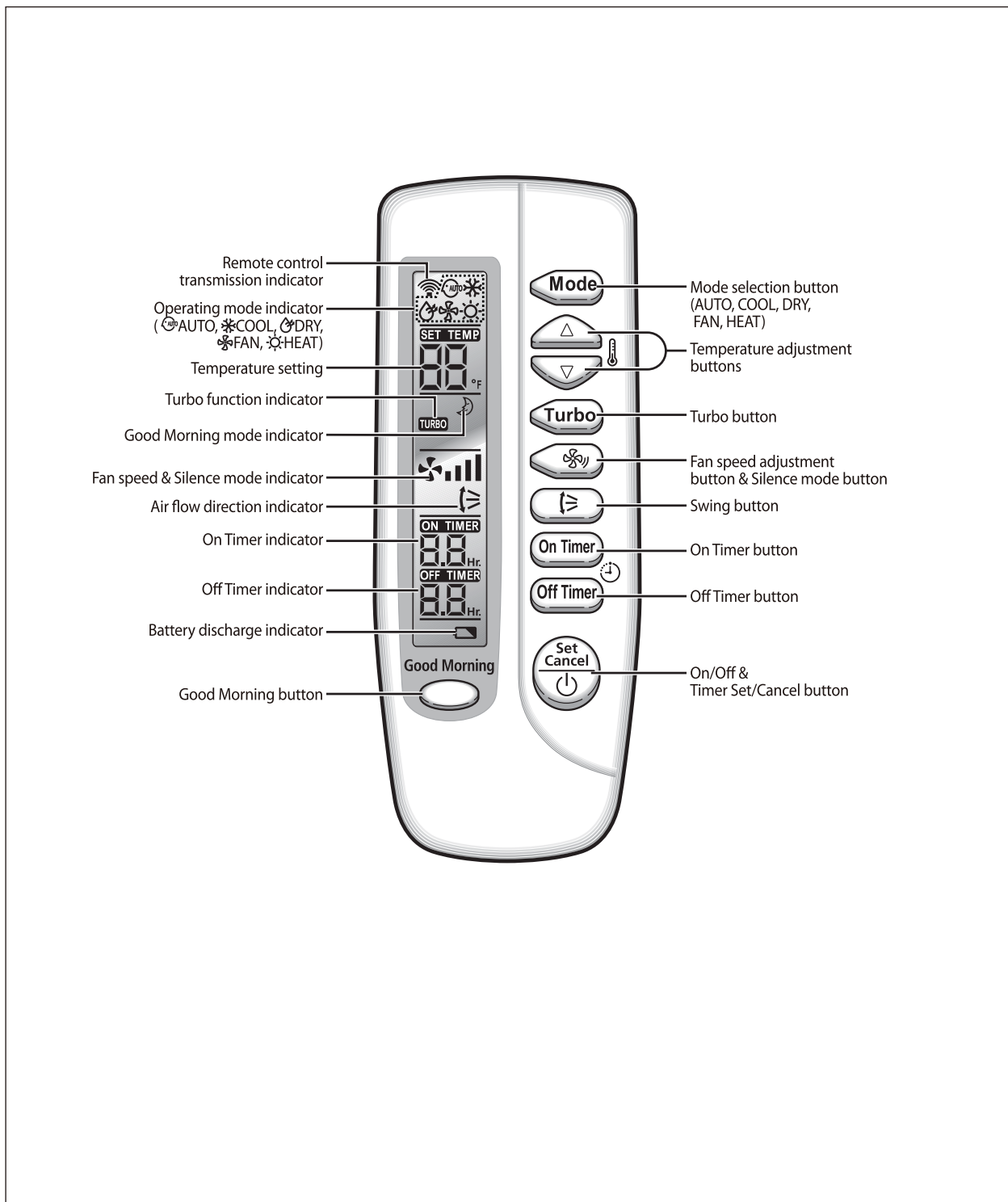







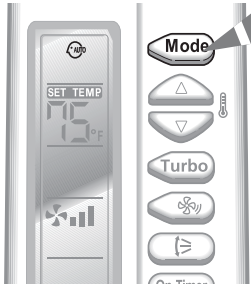













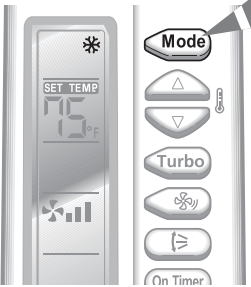
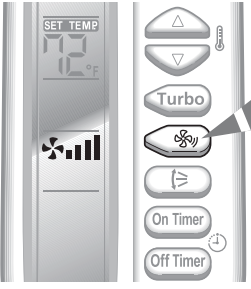





11-2 Wireless Remote Control-Buttons and Display





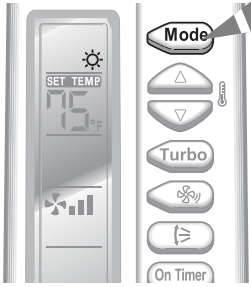
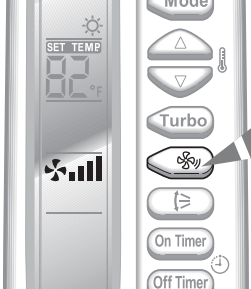

11-3 Main Function

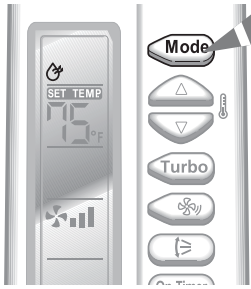

11-3-1 Basic Function

Mode	Explanation	Remark
<p>Auto Mode</p>	<p>Press the  button on the remote control until  is displayed.</p>	
<p>Cool Mode</p>	<p>Press the  button on the remote control until  is displayed.</p> <p>Press the  button to select the fan speed until the required setting is displayed.</p> <ul style="list-style-type: none">  Automatic (rotated :  →  →  →   Low  Medium  High  Maximum  Silence mode 	 
<p>Heat Mode</p>	<p>Press the  button on the remote control until  is displayed.</p> <p>Press the  button to select the fan speed until the required setting is displayed.</p> <ul style="list-style-type: none">  Automatic (rotated :  →  →  →   Low  Medium  High  Maximum  Silence mode 	 

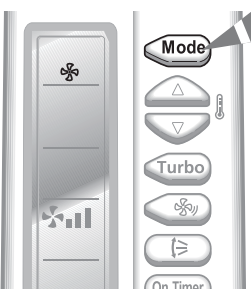
Basic Function(cont.)

Mode	Explanation	Remark
Dry Mode	Press the  button on the remote control until  is displayed.	
Fan Mode	Press the  button on the remote control until  is displayed.	

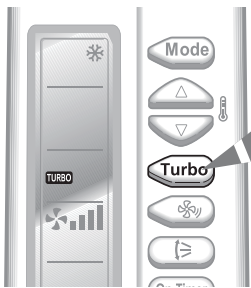

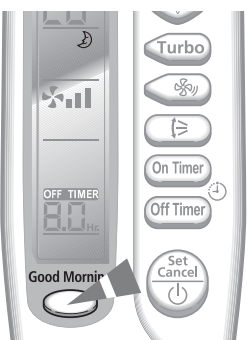
11-3-2 Applied Function

Mode	Explanation	Remark
Turbo Function	Press the  button. <ul style="list-style-type: none"> After 30 minutes, the air conditioner is reset automatically to the previous mode, temperature and fan settings. You can select the Turbo function in the Auto, Cool and Heat mode. If you select this function in the Dry or Fan mode, it will return to the Auto mode. 	
Good Morning Mode	Press the  button one or more times until  is displayed on your remote control.	

12. Troubleshooting

12-1 Items to be checked first

- The input voltage should be rating voltage $\pm 10\%$ range.
The air conditioner may not operate properly if the voltage is out of this range.
- Is the link cable linking the indoor unit and the outdoor unit linked properly?
The indoor unit and the outdoor unit shall be linked by 5 cables.
Check the terminals if the indoor unit and outdoor unit are properly linked by the same number of cables.
Otherwise the air conditioner may not operate properly.
- When a problem occurs due to the contents illustrated in the table below it is a symptom not related to the malfunction of the air conditioner.

No	Operation of air conditioner	Explanation
1	The OPERATION indication LED(BLUE) blinks when a power plug of the indoor unit is plugged in for the first time.	It indicates power is on. The LED stops blinking if the operation ON/OFF button on the remote control unit is pushed.
2	In a COOL operation mode, the compressor does not operate at a room temperature higher than the setting temperature that the INDOOR FAN should operate. [In case of heat pump model] In a HEAT operation mode, the compressor does not operate at a room temperature lower than the setting temperature that indoor fan should operate.	In happens after a delay of 3 minutes when the compressor is reoperated. The same phenomenon occurs when a power is on. As a phenomenon that the compressor is reoperated after a delay of 3 minutes, the indoor fan is adjusted automatically with reference to a temperature of the air blew.
3	Fan speed setting is not allowed in DRY() mode.	The speed of the indoor fan is set to LL in DRY mode. Fan speed is selected automatically in AUTO mode.
4	Compressor stops operation intermittently in DRY() mode.	Compressor operation is controlled automatically in DRY mode depending on the room temperature and humidity.
5	Timer LED(ORANGE) of the indoor unit lights up and the air conditioner does not operate.	Timer is being activated and the unit is in ready mode. The unit operates normally if the timer operation is cancelled.
6	The compressor stops intermittently in a COOL mode or DRY mode, and fan speed of the indoor unit decreases.	The compressor stops intermittently or the fan speed of the indoor unit decreases to prevent inside/outside air frozen depending on the inside/outside air temperature.
7	[In case of heat pump model] Compressor of the outdoor unit is operating although it is turned off in a HEAT mode.	When the unit is turned off while de-ice is activated, the compressor continues operation for up to 9 minutes(maximum) until the deice is completed.
8	[In case of heat pump model] The compressor and indoor fan stop intermittently in HEAT mode.	The compressor and indoor fan stop intermittently if room temperature exceeds a setting temperature in order to protect the compressor from overheated air in a HEAT mode.
9	[In case of heat pump model] Indoor fan and outdoor fan stop operation intermittently in a HEAT mode.	The compressor operates in a reverse cycle to remove exterior ice in a HEAT mode, and indoor fan and outdoor fan do not operate intermittently for within 20% of the total heater operation

12-2 Fault Diagnosis by Symptom

12-2-1 No Power (completely dead)-Initial diagnosis

1. Checklist :

- 1) Is input voltage normal?
- 2) Is AC power linked correctly?
- 3) Is input voltage of DC regulator IC KA7805 (IC02) normal? (11VDC-12.5VDC)
- 4) Is output voltage of DC regulator IC KA7805 (IC02) normal? (4.5VDC-5.5VDC)

2. Troubleshooting procedure

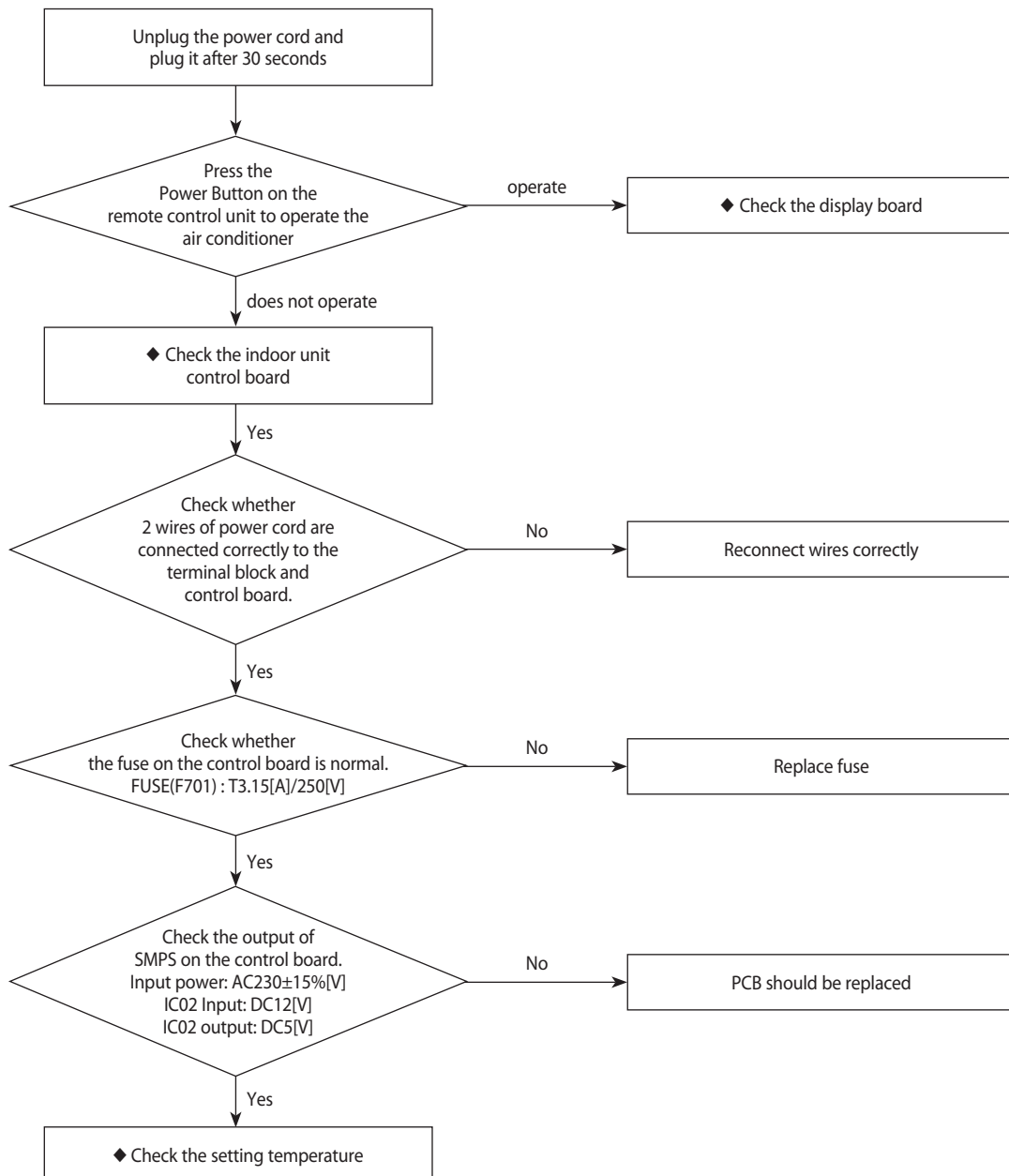

12-2-2 The Outdoor unit power supply error

1. Checklist :

- 1) Are the input power voltage and the power connection correct?
- 2) Is there no Fuse short in the indoor unit and outdoor unit?
- 3) Is the cable connected correctly between the indoor unit and outdoor unit in order.
- 4) Is the wire connected correctly to the terminal block of the indoor unit and outdoor unit?

2. Troubleshooting procedure

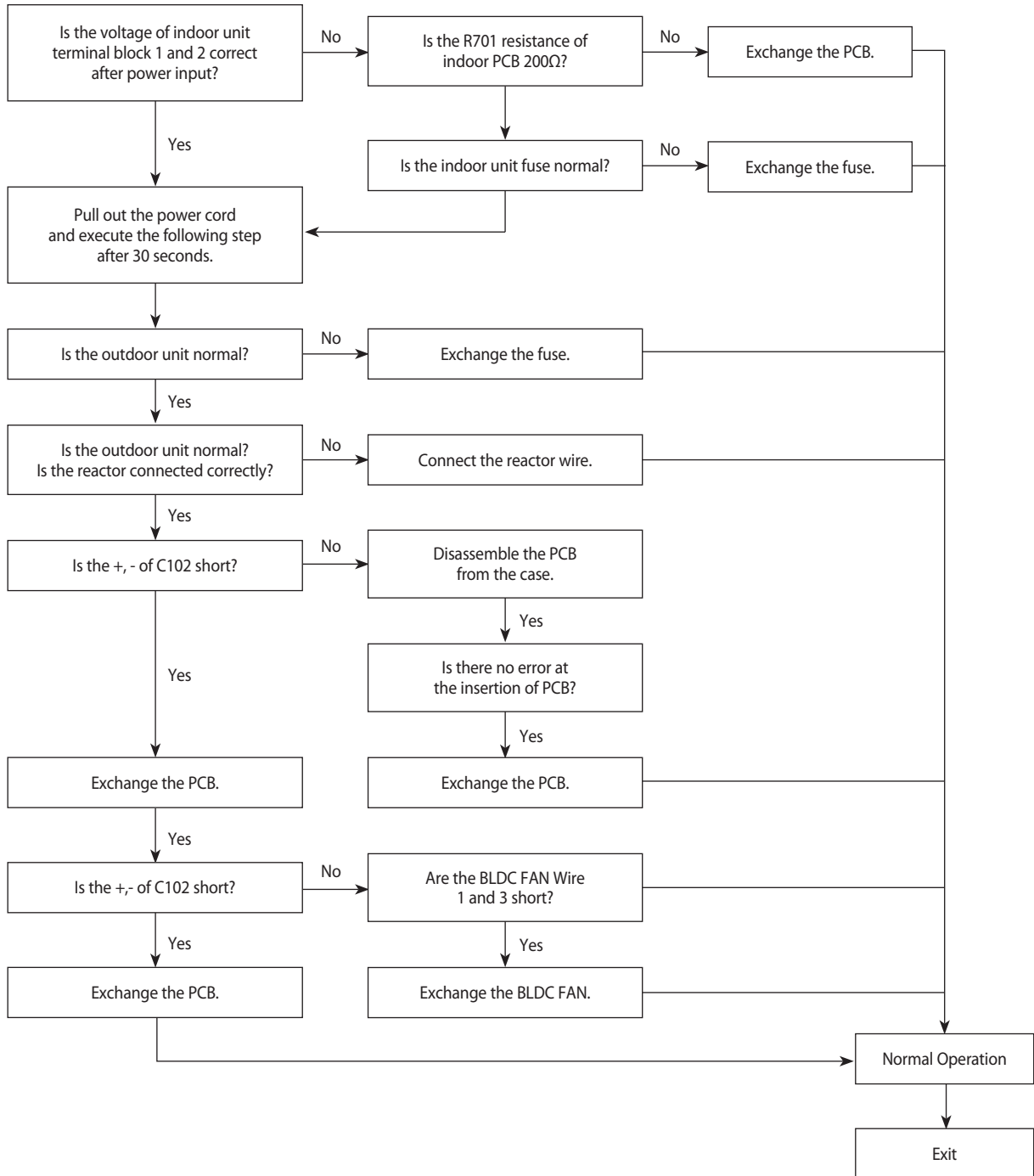

12-2-3 When the Up/Down Louver Motor Does Not Operate. (Initial Diagnosis)

1. Checklist :
 - 1) Is input voltage normal?
 - 2) Is the Up/Down louver motor properly connected with the connector (CN61)?
2. Troubleshooting procedure

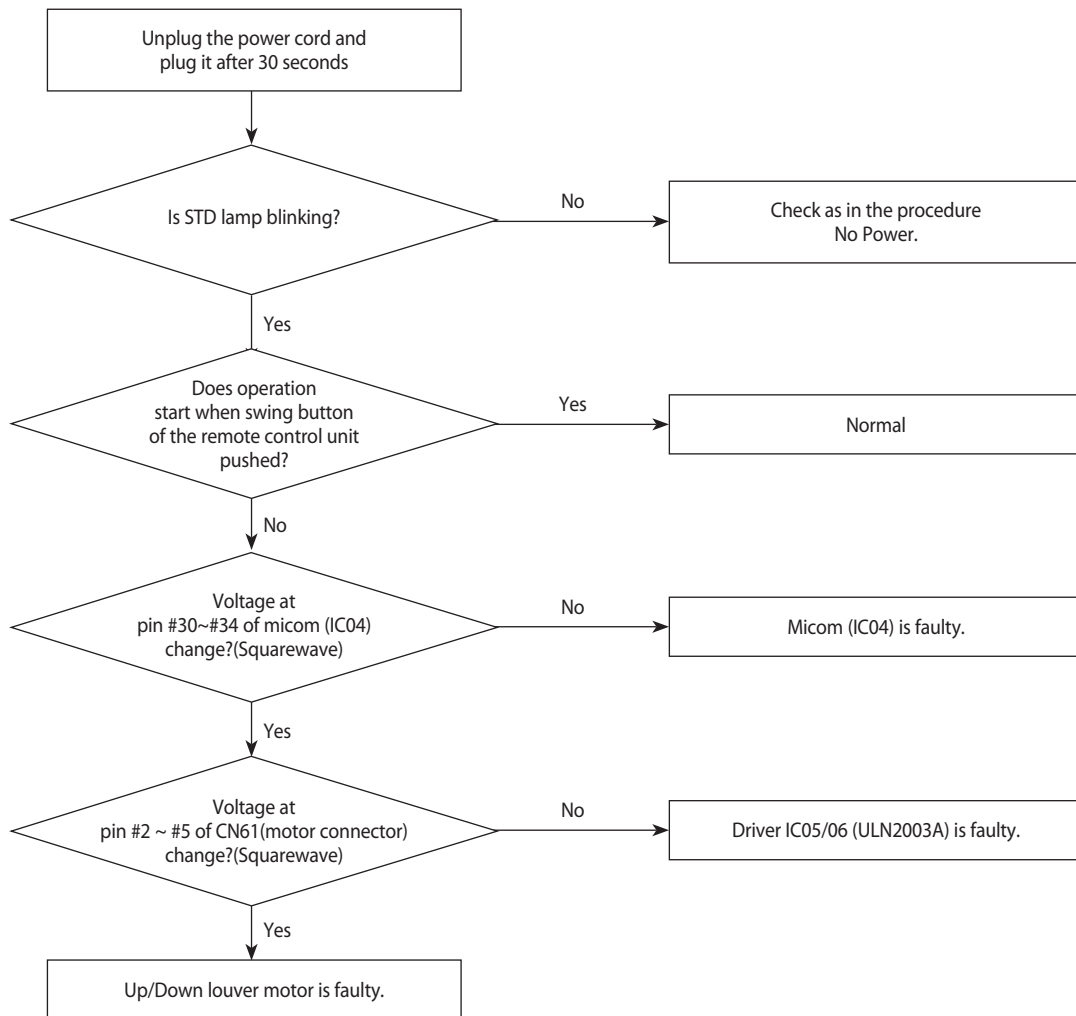

12-2-4 The Outdoor unit Fan error

1. Checklist :
 - 1) Are the input power voltage and the power connection correct?
 - 2) Is the motor wire connected to the outdoor PCB correctly?
 - 3) Is there no assembly error or none-assembly in the terminal of motor wire connector?
 - 4) Is there no obstacle at the surrounding of motor and propeller?

2. Troubleshooting procedure

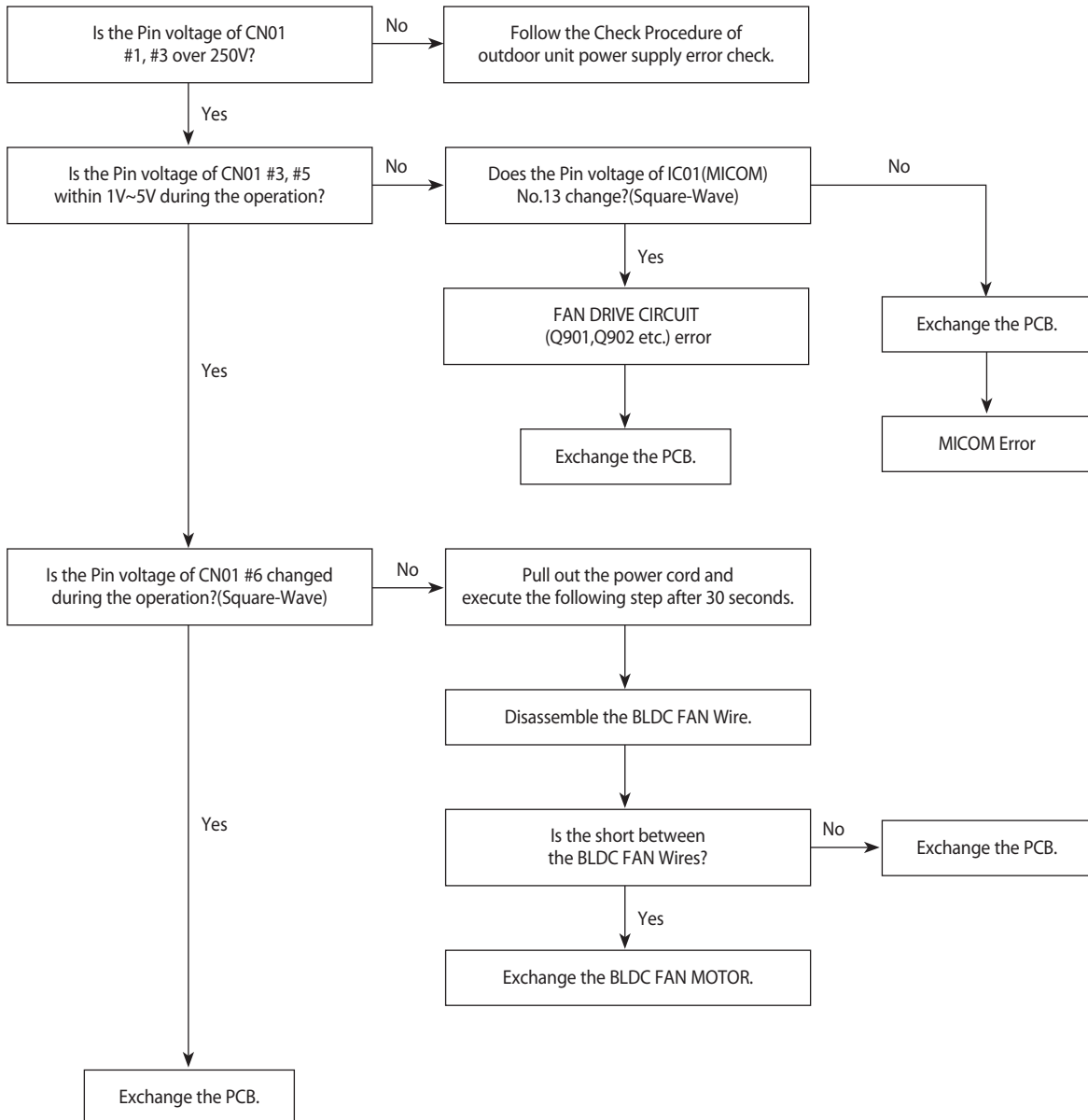

12-2-5 Total current Trip error

1. Checklist :

- 1) Is the input power voltage proper?
- 2) Is the refrigerant charged properly?
- 3) Does the compressor rotate normally? (Reverse rotation, Locking etc.)
- 4) Dose the outdoor fan operate normally? (Fan propeller loss, Motor error etc.)
- 5) Is the installation condition of outdoor unit good? (Piping, Space etc.)
- 6) Is there no ventilation obstruction at the surrounding of outdoor? (Outdoor unit cover, Fan front obstruction etc.)

2. Troubleshooting procedure

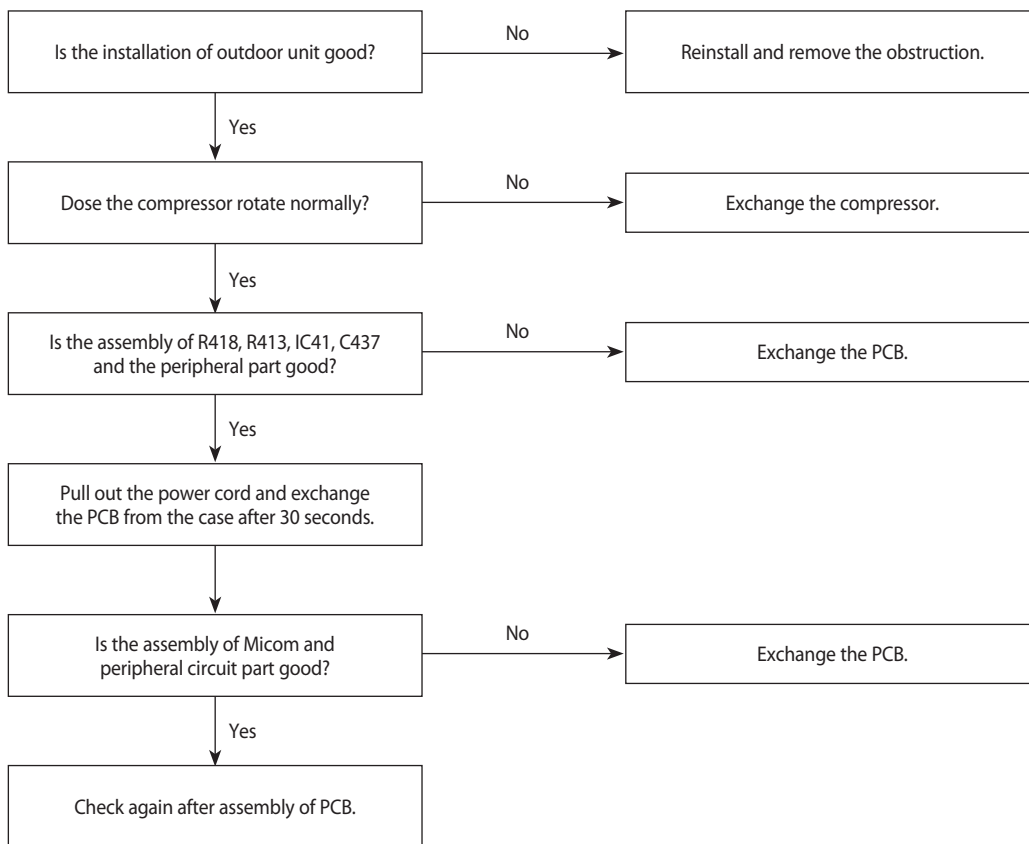

12-2-6 In case of heating at the cooling mode or cooling at the heating mode

1. Troubleshooting procedure

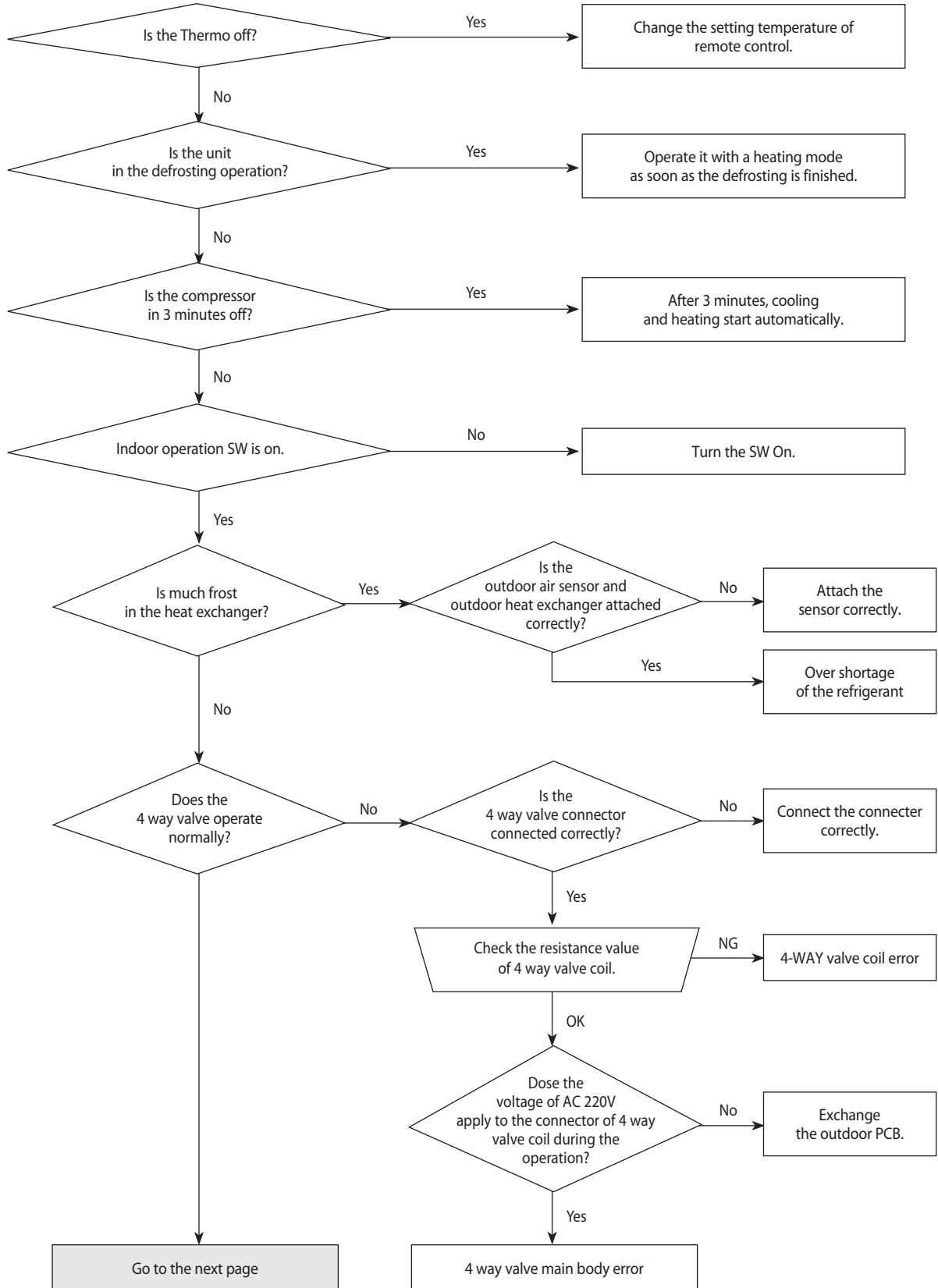

In case of heating at the cooling mode or cooling at the heating mode(cont.)

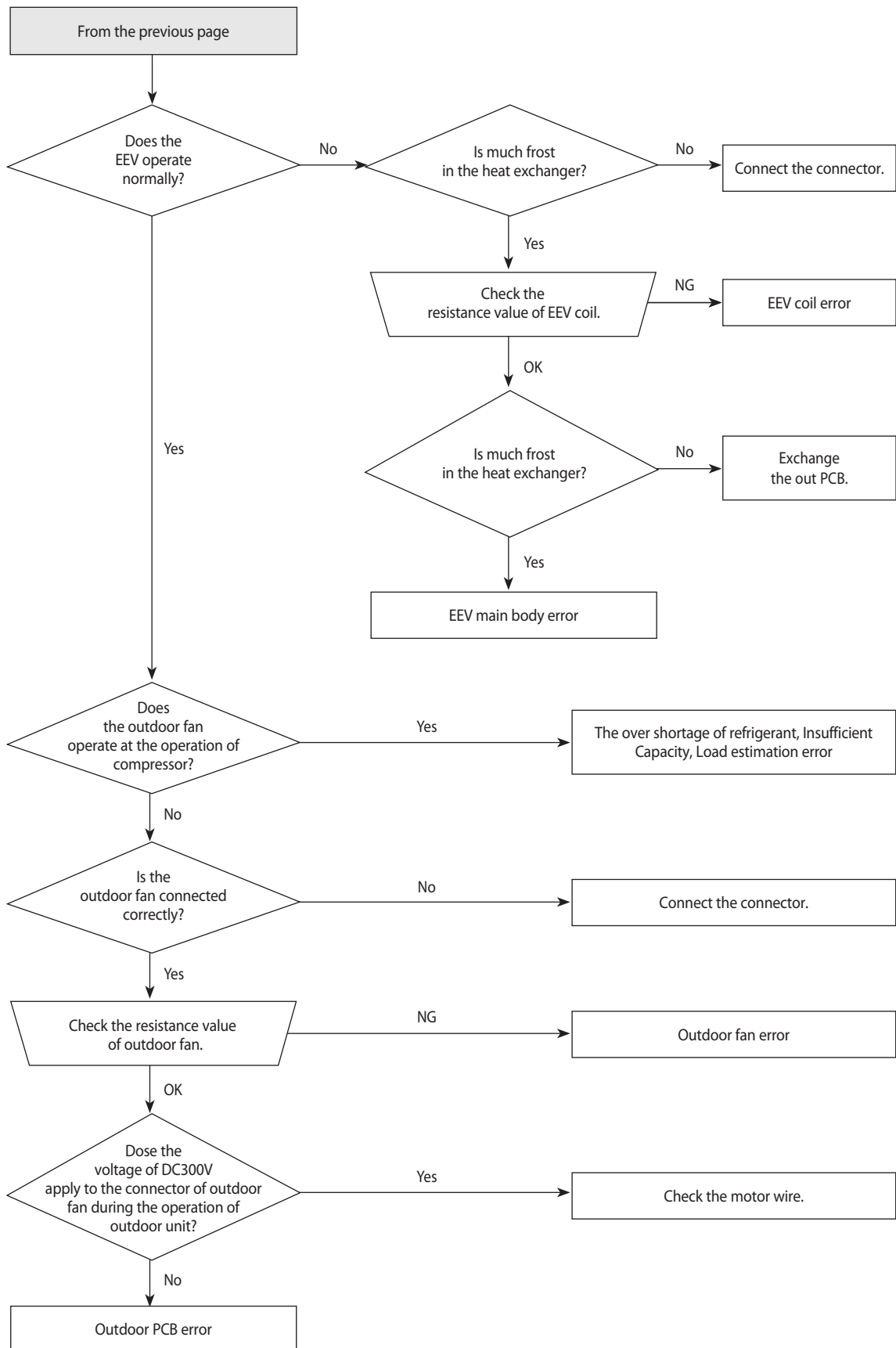

12-2-7 Outdoor temperature sensor error

1. Checklist :
 - 1) Is the sensor connector connected correctly?
 - 2) Is the sensor placed correctly?
 - 3) Does the both terminal of sensor satisfy the resistance value in accordance with temperature?
 - 4) Is the resistance value of sensor connection pull_up correct?

2. Troubleshooting procedure

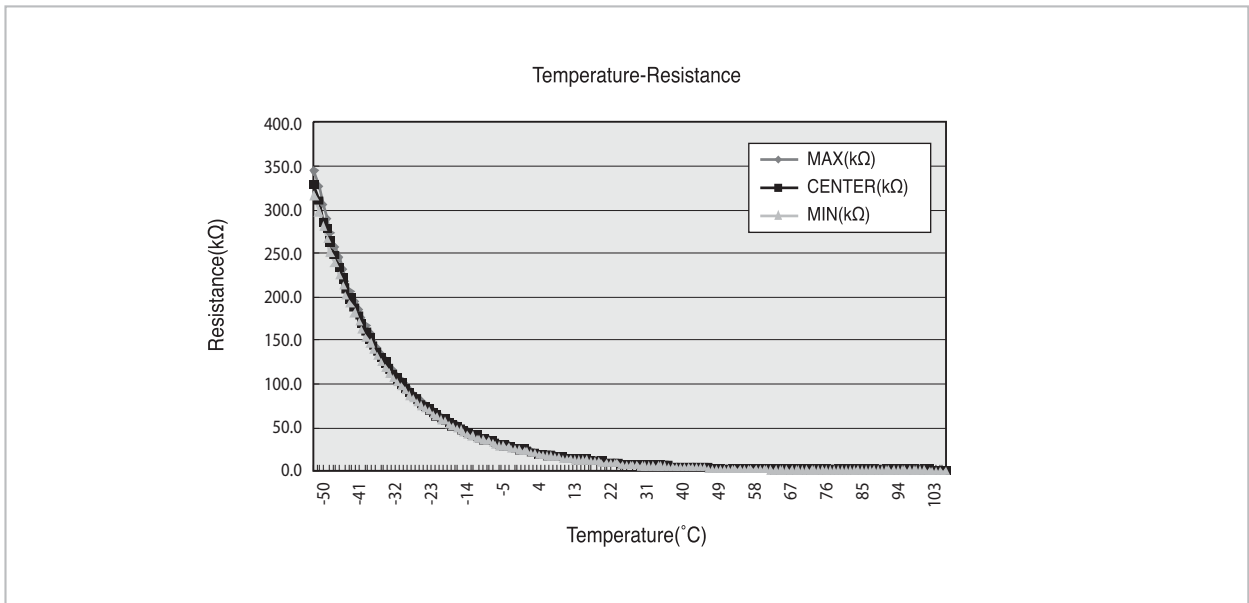
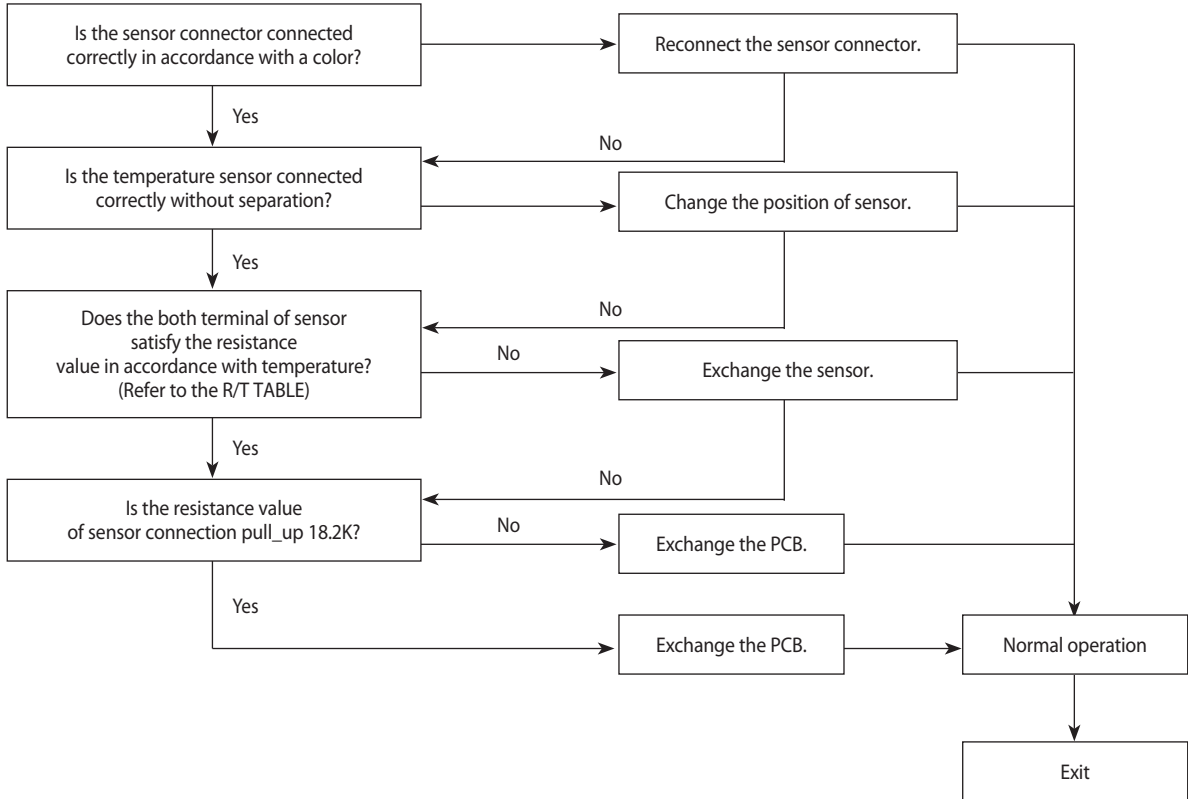

12-2-8 Discharge temperature sensor error

1. Checklist :

- 1) Is the sensor connector connected correctly?
- 2) Is the sensor placed correctly?
- 3) Does the both terminal of sensor satisfy the resistance value in accordance with temperature?
- 4) Is the resistance value of sensor connection pull_up correct?

2. Troubleshooting procedure

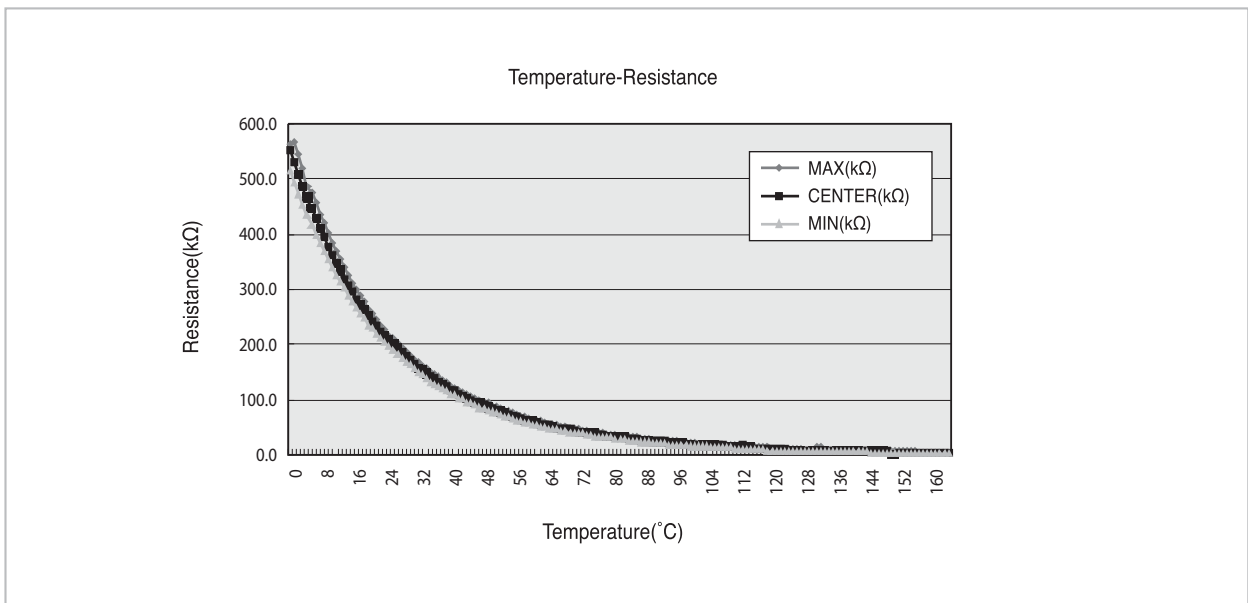
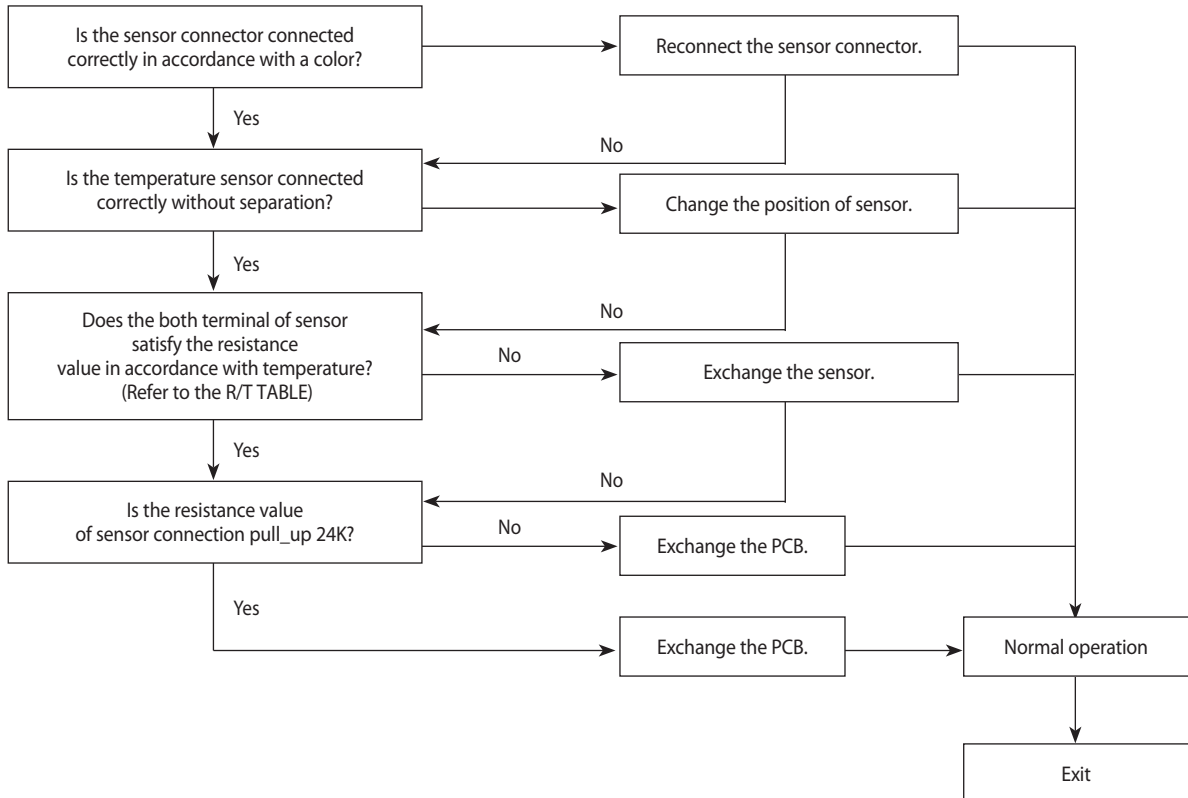

12-2-9 Coil temperature sensor error

1. Checklist :
 - 1) Is the sensor connector connected correctly?
 - 2) Is the sensor placed correctly?
 - 3) Does the both terminal of sensor satisfy the resistance value in accordance with temperature?
 - 4) Is the resistance value of sensor connection pull_up correct?

2. Troubleshooting procedure

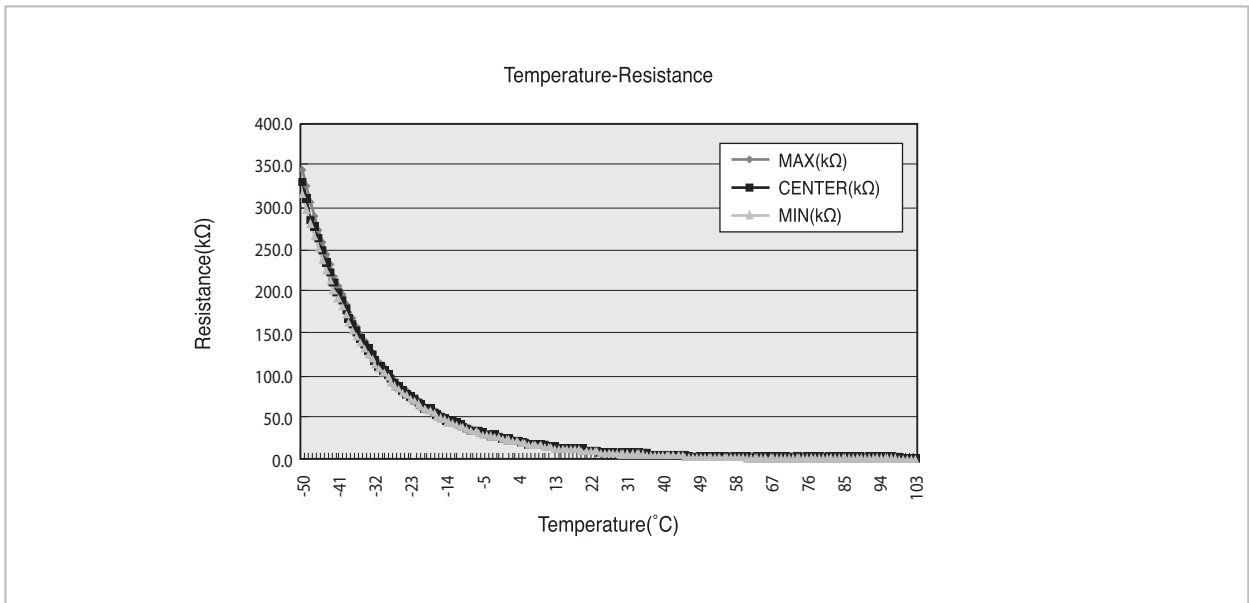
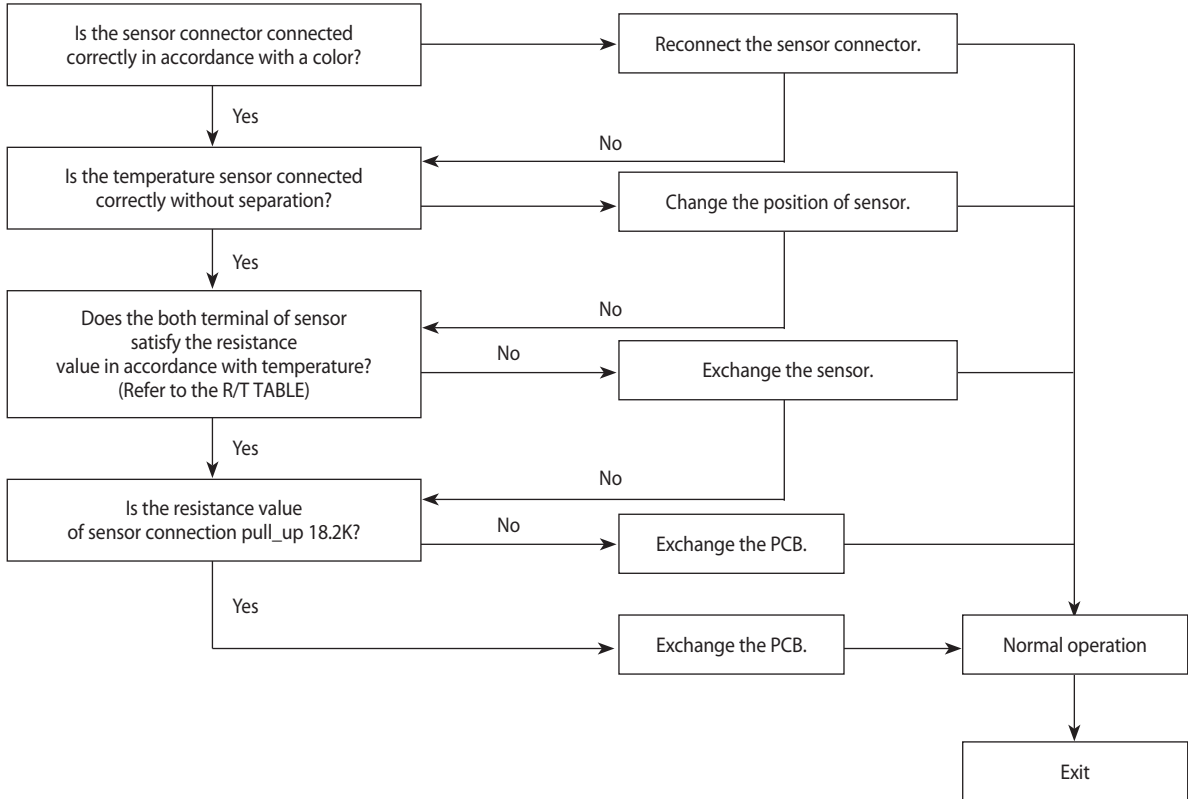

12-2-10 Fan error

1. Checklist :
 - 1) Isn't the fan locked?
 - 2) Is the sensor placed correctly?
 - 3) Does the both terminal of sensor satisfy the resistance value in accordance with temperature?
 - 4) Is the resistance value of sensor connection pull_up correct?

2. Troubleshooting procedure

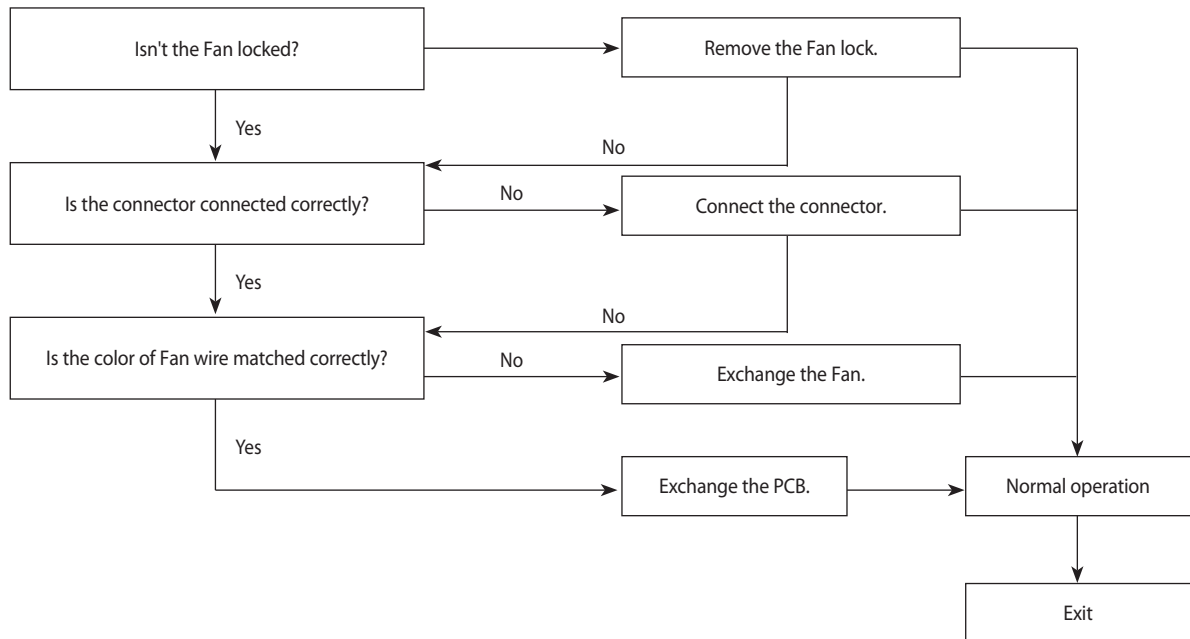

12-2-11 DC-Link voltage sensor error

1. Checklist :

- 1) Is the voltage of indoor unit terminal block 1, 2 correct after power supply?
- 2) Is the capacitor(C101, C102, C103) for DC-Link assembled in accordance the specification?
- 3) Are R112, R113, R114 470 Kohm?
- 4) Is R115 14.3Kohm?

2. Troubleshooting procedure

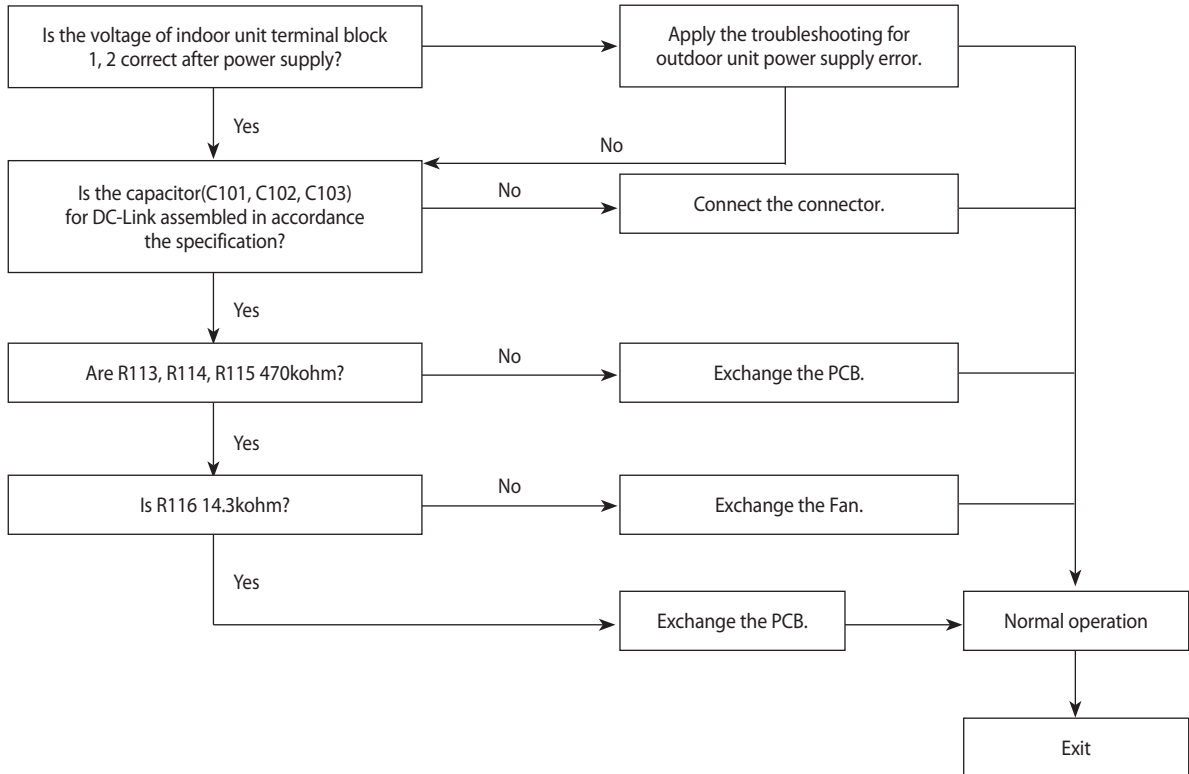

12-2-12 O.C.(Over Current) error

1. Checklist :
 - 1) Is the Shunt resistance value correct?
 - 2) Is the condition of surrounding temperature abnormal overload?
 - 3) Is there any problem as like the temperature sensor separation or measurement value error?
 - 4) Is the interphase resistance of compressor normal?

2. Troubleshooting procedure

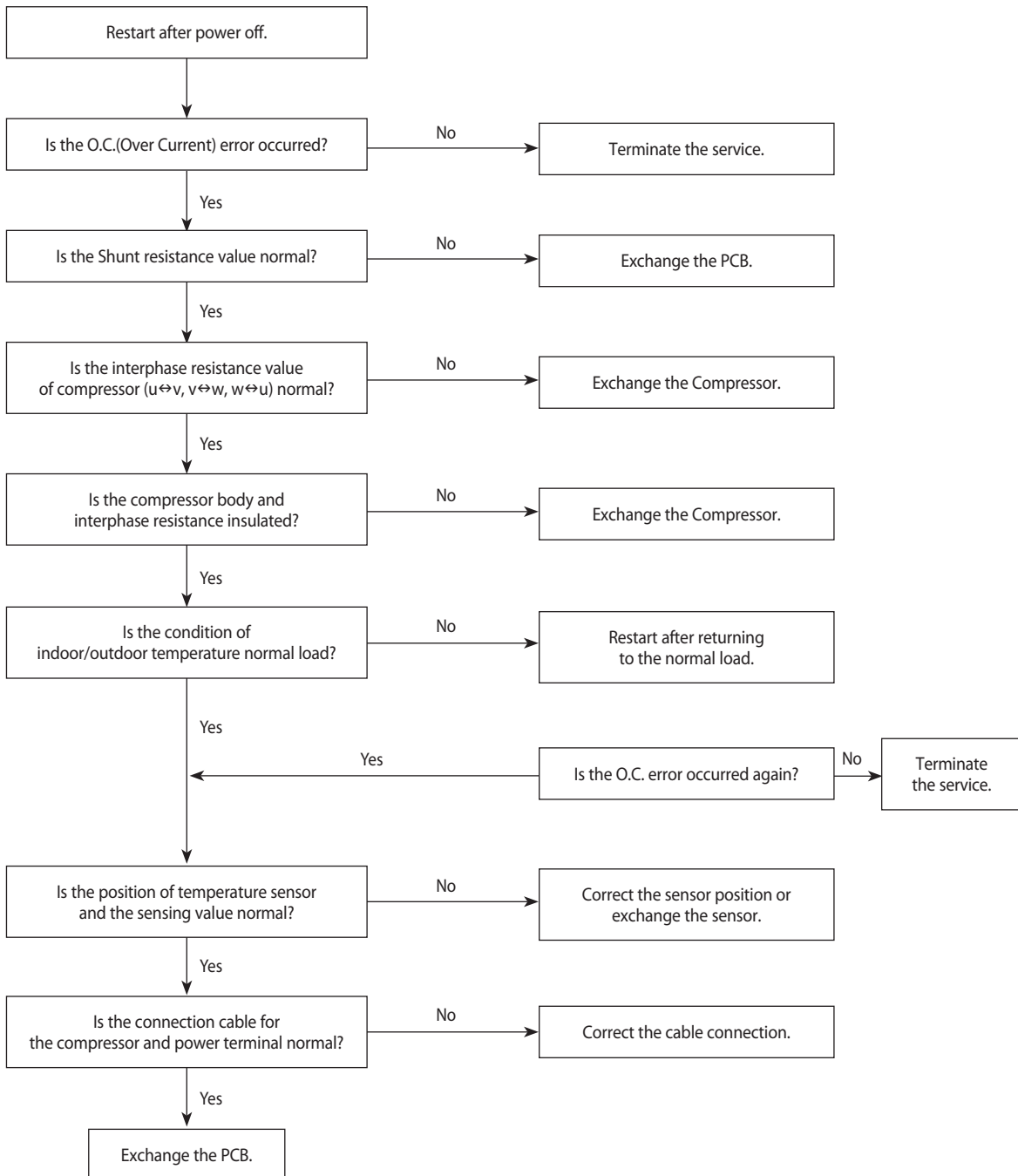

12-2-13 Communication error

1. Checklist :
 - 1) Is the communication cable between the indoor unit and outdoor unit connected correctly?
 - 2) Isn't the power cable and communication cable error?
2. Troubleshooting procedure

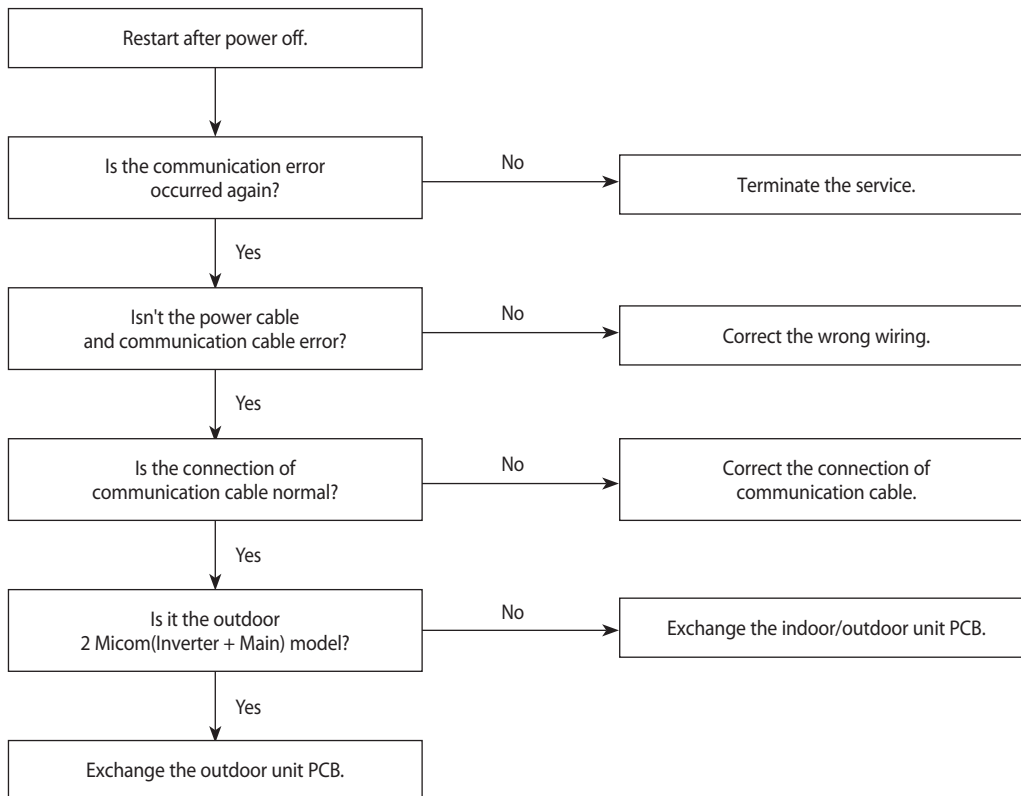

12-2-14 Compressor start error

1. Checklist :
 - 1) Is the connection of cable for the compressor and power?
 - 2) Is the interphase resistance of compressor normal?

2. Troubleshooting procedure

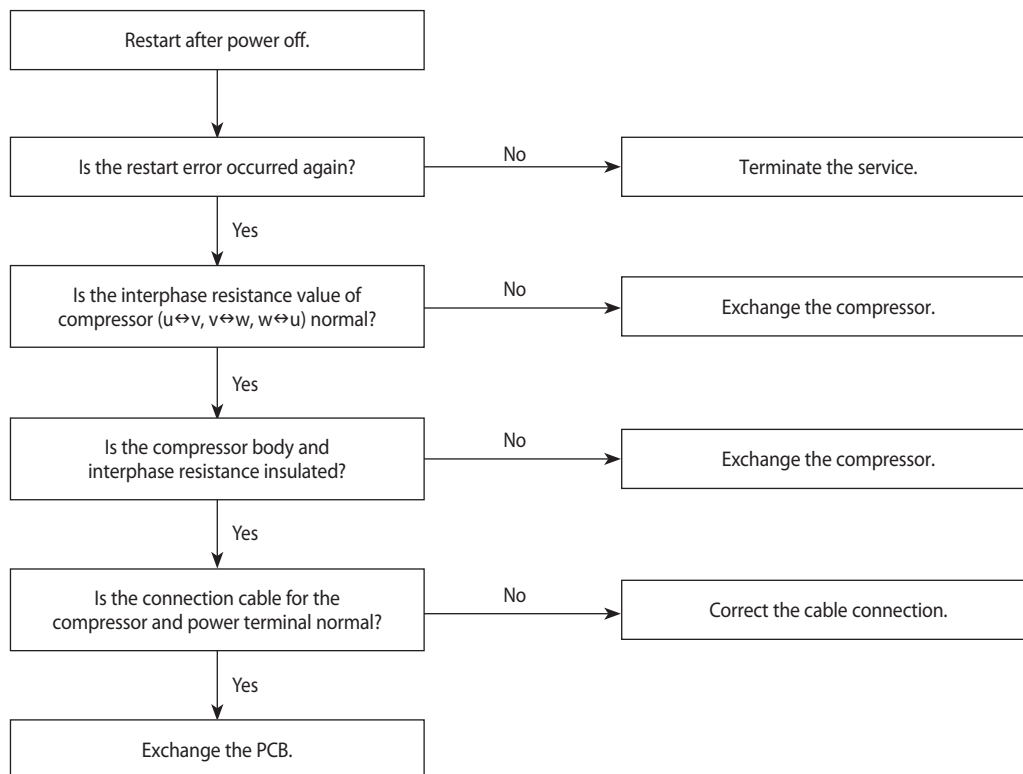

12-2-15 Compressor lock error

1. Checklist :
 - 1) Is the connection of cable for the compressor and power?
 - 2) Is the interphase resistance of compressor normal?

2. Troubleshooting procedure

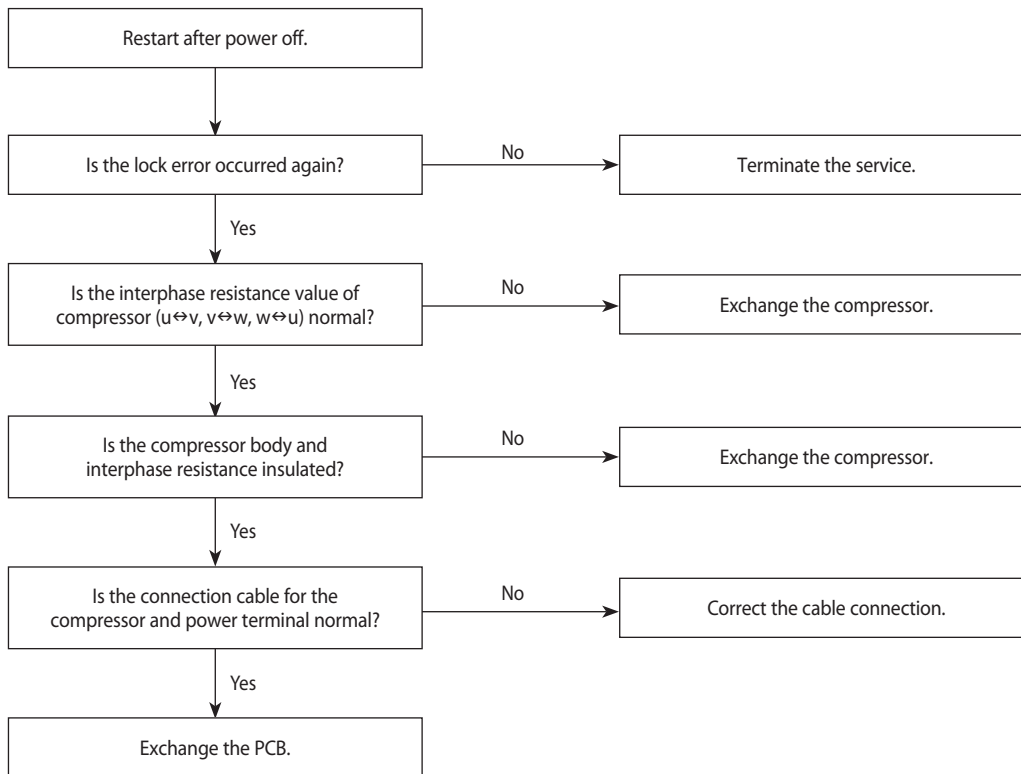

12-2-16 DC Link Over voltage/ Low voltage error

1. Checklist :

- 1) Is the power voltage normal?
- 2) Is the voltage of front and back terminal of indoor(outdoor) power relay normal?
- 3) Is the resistance value for DC Link voltage detection NORMAL?
- 4) Is the resistance value of DC Link discharge normal?
- 5) Is the appearance of DC Link Capacitor normal?

2. Troubleshooting procedure

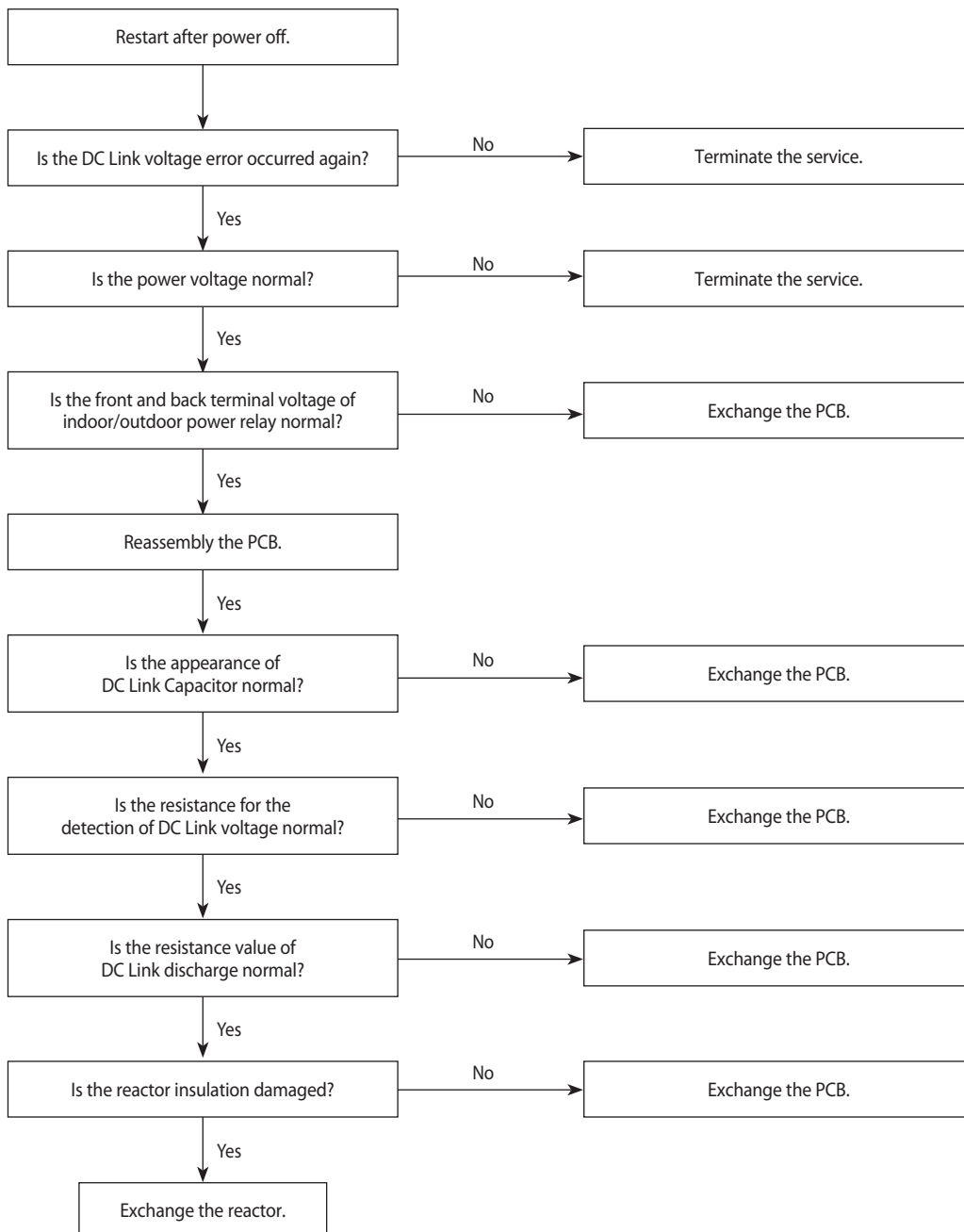

12-2-17 When the remote control is not receiving

1. Check if the connector was normally assembled.
2. Put the set in operation and check the voltage of No. 15(+) and No. 16(-) of the main PCB CN91 while operating the remote control. When the voltage descends below 3V, the assembly module PCB is normal and the main PCB is poor. Then replace the main PCB.
3. Replace the assembly display PCB because the module PCB is poor if the voltage between No. 15~16 of CN91 maintains 5V after the remote control starts operation.

12-2-18 The others

1. AC Line Zero Cross Signal OUT
 - Check the assembly condition of peripheral part of IC21, ZD21, ZD20 and D200 on the PCB.
2. Capacity miss match
 - Check again the indoor unit option code.

12-3 PCB Inspection Method

12-3-1 Pre-inspection Notices

1. Check if you pulled out the AC power plug when you eliminate the PCB or front panel.
2. Don't hold the PCB side not impose excessive force on it to eliminate the PCB.
3. Don't pull the lead wire but hold the whole housing to connect or disconnect a connector to the PCB.
4. In case of outdoor PCB disassembly, check first the complete discharge of condenser (C103) after 30 seconds power off.

12-3-2 Inspection Procedure

1. Check connector connection and peeling of PCB or bronze coating pattern when you think the PCB is broken.
2. The PCB is composed of the 3 parts.
 - Indoor Main PCB Part : MICOM and surrounding circuit, relay, room fan motor driving circuit and control circuit, sensor driving circuit, power circuit of DC12V and DC5V, and buzzer driving circuit.
 - Display part : LED lamp, Switch, Remocon module
 - Outdoor Main PCB part : MICOM and surrounding circuit. IPM and PFC circuit and control circuit.
 - EMI PCB Part : Line filter and Noise Capacitor, Varistor

12-3-3 Indoor Detailed Inspection Procedure

No	Procedure	Inspection Method	Cause
1	Plug out and pull the PCB out of the electronic box. Check the PCB fuse.	1) Is the fuse disconnected?	<ul style="list-style-type: none"> • Over current • Indoor Fan Motor Short • AC Part Pattern Short of the MAIN PCB
2	Supply power. If the operating lamp twinkles at this time, the above 1)~3) have no relation.	Checking the power voltage.	
		1) Is the DB71 input voltage AC200V~AC240V?	<ul style="list-style-type: none"> • Power Cord is fault, Fuse open. Wrong Power Cable Wiring, AC Part is faulty.
		2) Is the voltage between both terminals of the C104 on the 2 nd side of the transformer DC12V $\pm 0.5V$?	<ul style="list-style-type: none"> • Switching Trans or Power Circuit is faulty
3	Press the ON/OFF button.	3) Is the voltage between both terminals of OUT and GND of IC19(KA78L05) DC5V $\pm 0.5V$?	<ul style="list-style-type: none"> • Power Circuit is faulty, Load Short
		Checking the power voltage.	
		1) Is the voltage over AC180V being imposed on terminal #3 and #5 of the fan motor connector(CN72)?	<ul style="list-style-type: none"> • Relay(RY71) Coil Disconnection, IC05 is faulty
4	Press the ON/OFF button. 1. FAN Speed [High] 2. Continuous Operation	2) Check the voltage of both terminals of terminal block 1 and N(1) after 3 minute operation.: AC220V	<ul style="list-style-type: none"> • Relay(RY71) Contact is faulty
		1) Is the voltage over AC180V being imposed on terminal #3 and #5 of the fan motor connector(CN72)?	<ul style="list-style-type: none"> • Fan Motor of the indoor is faulty
		2) The fan motor of the indoor unit doesn't run.	<ul style="list-style-type: none"> • Fan Motor Connector(CN72) is faulty
4	Press the ON/OFF button. 1. FAN Speed [High] 2. Continuous Operation	3) The power voltage between terminal #3 and #5 of the connector(CN72) is 0V.	<ul style="list-style-type: none"> • ASS'Y Main PCB is faulty • Connection is faulty

12-3-4 Outdoor Detailed Inspection Procedure

No	Procedure	Inspection Method	Cause
1	Wait 30 seconds over after disconnecting the power cable Check the outdoor PCB.	1) Is C101 discharged? 2) Is the resistance of both terminals of C101 opened? 3) Is the fuse of EMI PCB normal? 4) Is the reactor wire connected?	<ul style="list-style-type: none"> • Over Current • Inner short of PCB • BLDC FAN Motor Error
2	Check the Outdoor unit PCB.	1) Is R701 200ohm? 2) Does ry74 operate normally? (IC05 & 16:0V, 1:5V) 3) Is the fuse(F701) normal? 4) Is the Sub PCB assembled normally?	<ul style="list-style-type: none"> • Outdoor PCB Error • SUB Relay(RY74) Error • IC05 Error • Indoor PCB Error
3	Check the LED lighting after power supply.	1) Normal: Red: Light On, Green: Flickering, Yellow: Light Off? 2) Is the voltage of C101 250V over? 3) Is the input of IC19 8V, and the output 5V? 4) Recheck after disassembling BLDC FAN Wire.	<ul style="list-style-type: none"> • Inner short of outdoor PCB • Wrong assembly of outdoor PCB • BLDC FAN Error
4	Check the condition of indoor & outdoor connection cable.	1) Is the green LED light on once per second? 2) Is the indoor & outdoor connection cable connected in order? 3) Is the grounding wire connected to the both of indoor & outdoor unit? 4) Is the voltage of terminal block N(1), 225V?	<ul style="list-style-type: none"> • Wrong connection of Indoor/Outdoor wiring • Wrong assembly of outdoor communication circuit
5	Check the Comp Wire.	1) Is it connected red, blue, and yellow in order in counterclockwise. 2) Are the valve and its installation condition good? 3) Is the installation condition of outdoor unit?	<ul style="list-style-type: none"> • Wrong assembly • Installation condition is bad.
6	Check the BLDC Fan.	1) Is CN01 1, 3 over 250V? 2) Is CN01 3, 5 within 1V~5V? 3) Is the voltage of CN01 6 changed? 4) Is the resistance of BLDC Motor 1, 3 opened after power off?	<ul style="list-style-type: none"> • Outdoor PCB Error • BLDC Motor Error

12-4 Main Part Inspection Method

Part	Breakdown Inspection Method									
Room Temperature Sensor	Measure resistance with a tester									
	Normal	At the normal temperature 37kΩ~ 8.3kΩ(19.4°F~86°F) *Refer to Table 12-3-4.								
	Abnormal	∞, 0Ω . . . Open or Short								
Room Fan Motor	Measure the resistance between terminals of the connector (CN72) with a tester.									
	Normal	At the normal temperature (50°F~86°F)								
		<table border="1" data-bbox="668 573 1273 696"> <thead> <tr> <th data-bbox="668 573 903 618">Compare terminal</th> <th data-bbox="903 573 1137 618">Resistance</th> <th data-bbox="1137 573 1273 618">Remark</th> </tr> </thead> <tbody> <tr> <td data-bbox="668 618 903 651">Yellow, Blue</td> <td data-bbox="903 618 1137 651">404.4Ω ± 10%</td> <td data-bbox="1137 618 1273 651">Main</td> </tr> <tr> <td data-bbox="668 651 903 696">Yellow, Red</td> <td data-bbox="903 651 1137 696">340Ω ± 10%</td> <td data-bbox="1137 651 1273 696">Sub</td> </tr> </tbody> </table>	Compare terminal	Resistance	Remark	Yellow, Blue	404.4Ω ± 10%	Main	Yellow, Red	340Ω ± 10%
Compare terminal		Resistance	Remark							
Yellow, Blue	404.4Ω ± 10%	Main								
Yellow, Red	340Ω ± 10%	Sub								
Abnormal	∞, 0Ω . . . Open or Short									
Stepping Motor	Measure the resistance between the red wire and each terminal wire with a tester.									
	Normal	About 300Ω at the normal temperature (68°F~86°F)								
	Abnormal	∞, 0Ω . . . Open or Short								

13. Block Diagram

13-1 Indoor Unit

* : OPTION

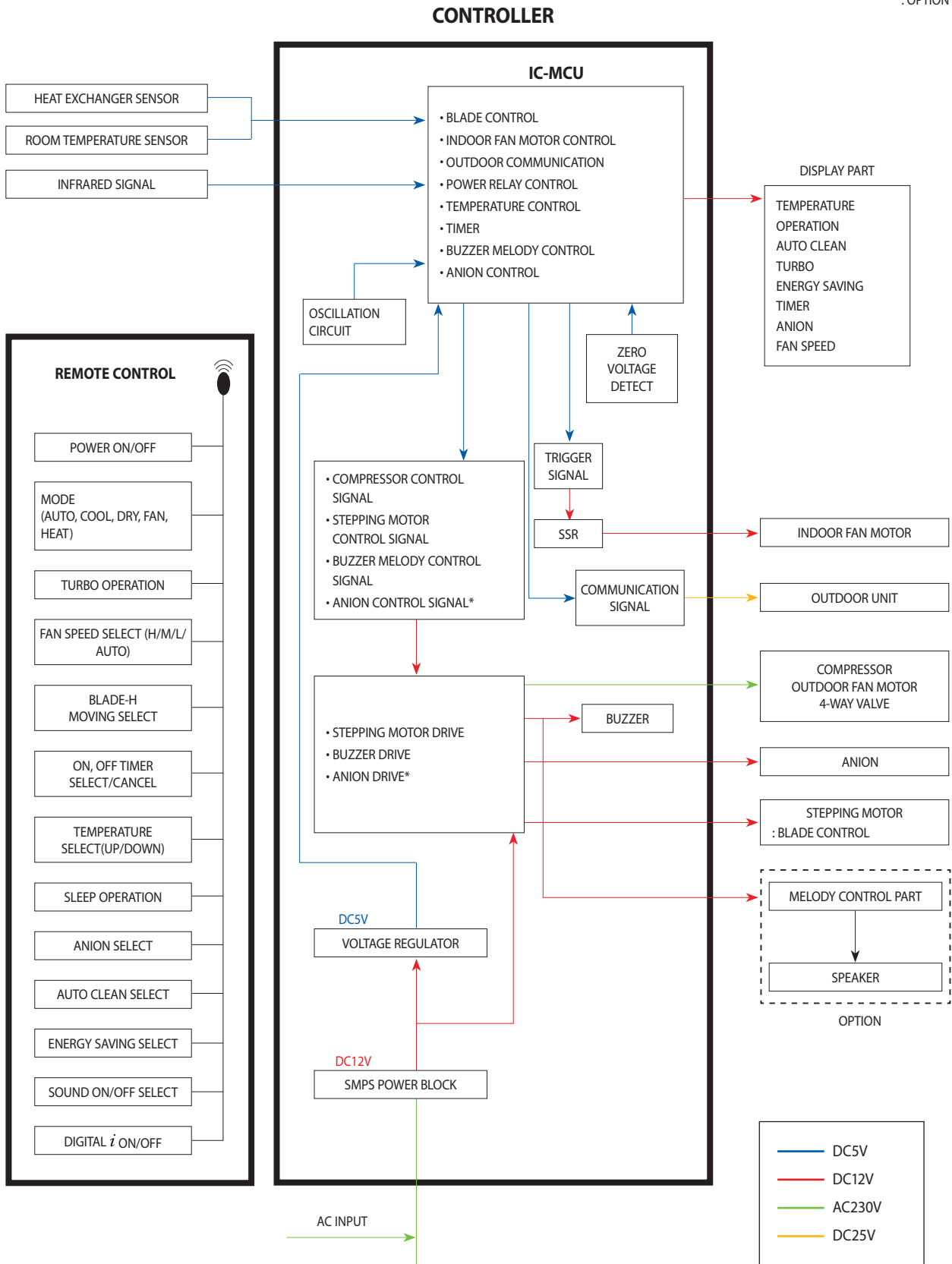

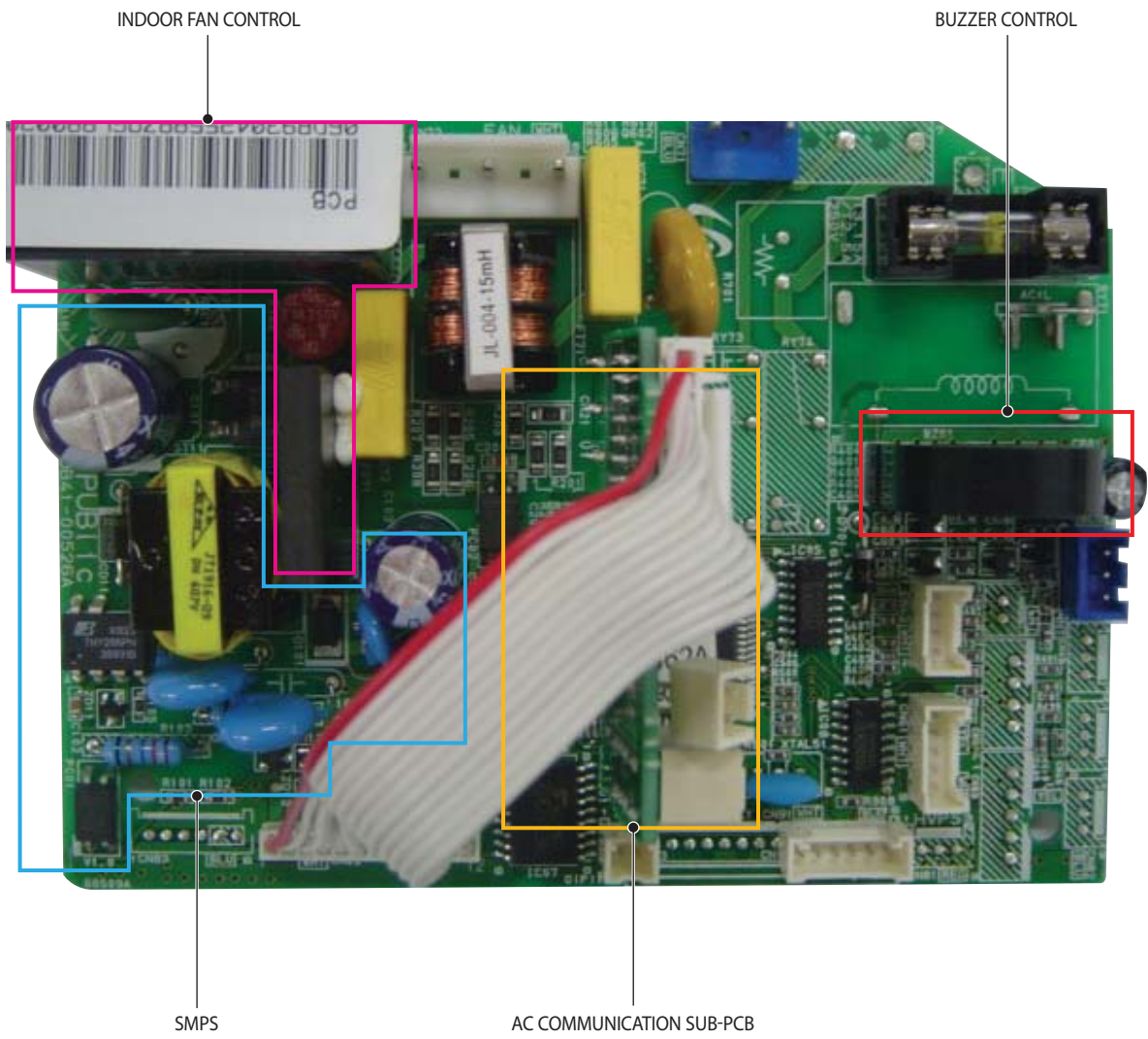

13-2 Outdoor Unit

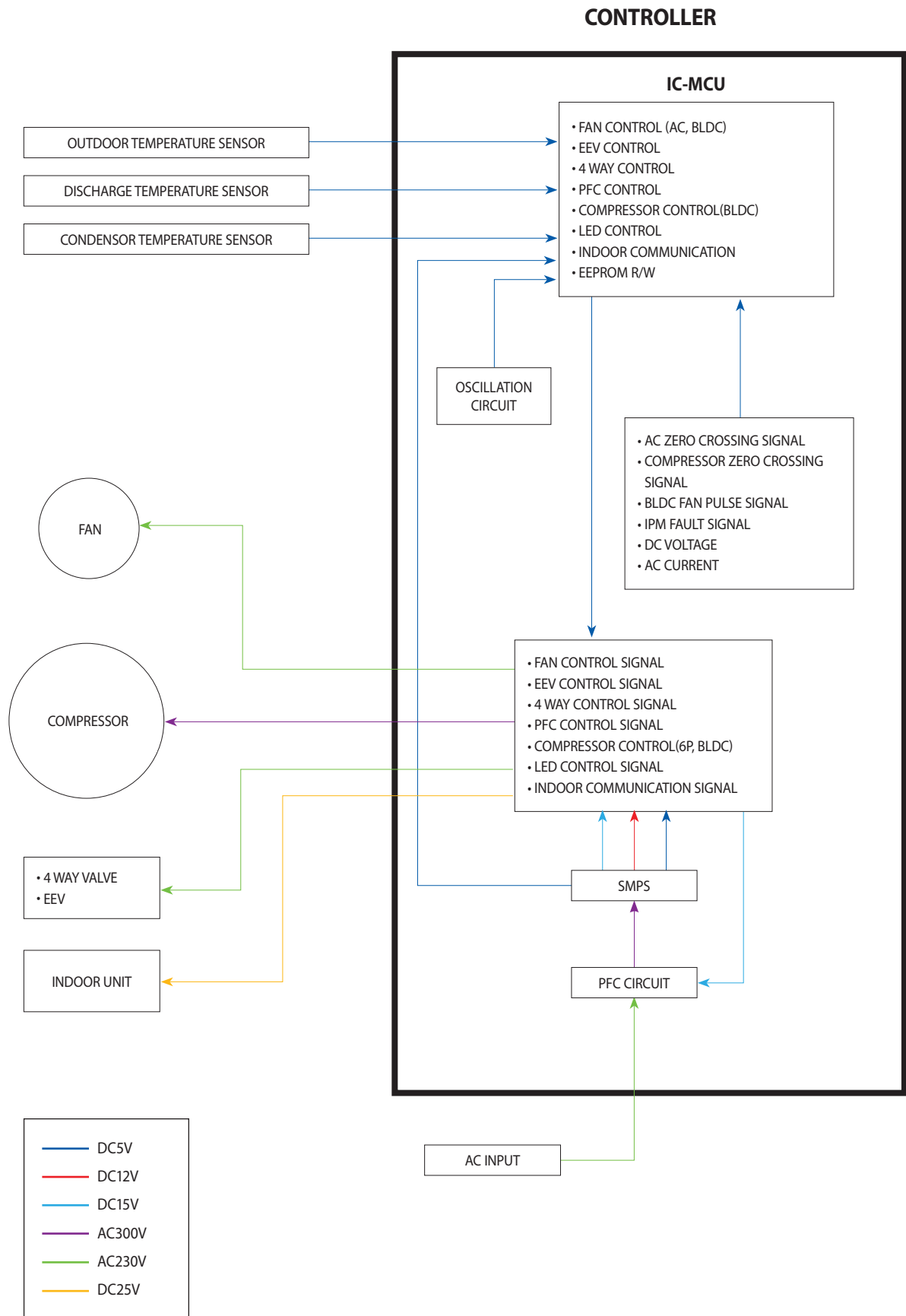

14. Reference Sheet

14-1 Index for Model Name

* Project model code for overseas from 2007(For RAC Export Models)

Model Code

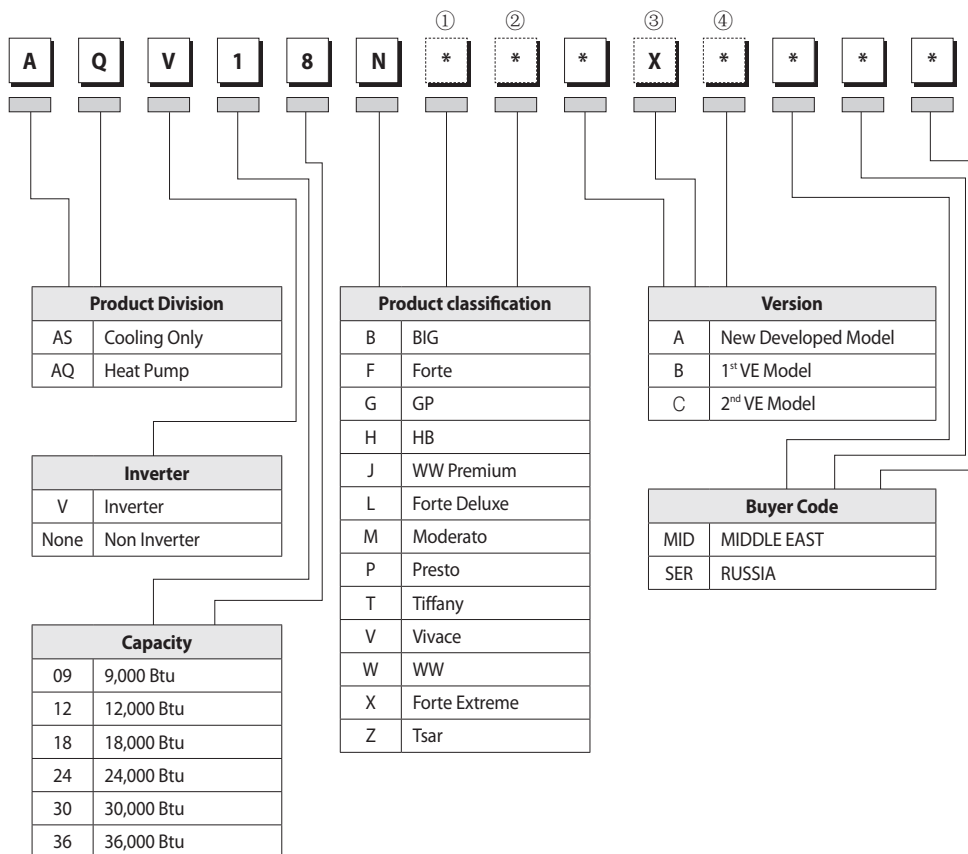

- ①: Use the " ① " digit for Grille Color deviation.
: Don't use the digit for Basic White model.
ex) Silver : S, Black : B, White : W, etc.
- ②: Use the " ② " digit for Electric Source deviation.
: Only for "XAP", "XAX", "GEM" Buyer.
- ③: Use the " ③ " digit for classification between indoor and outdoor.
Indoor ⇒ "N" & Outdoor ⇒ "X".
- ④: Use the " ④ " digit for KD models.
"CKD" ⇒ "1" & "SKD" ⇒ "2".

● Except the RAC Export Models for China.

14-2 Low Refrigerant Pressure Distribution

Note : • Please measure the refrigerant pressure after the air conditioner operates on testing cooling mode during more than 10 minutes.

- Indoor Temp. Variation : 68°F(20°C)~90°F(32°C)
- Outdoor Temp. Variation : 23°F(-5°C)~113°F(45°C)

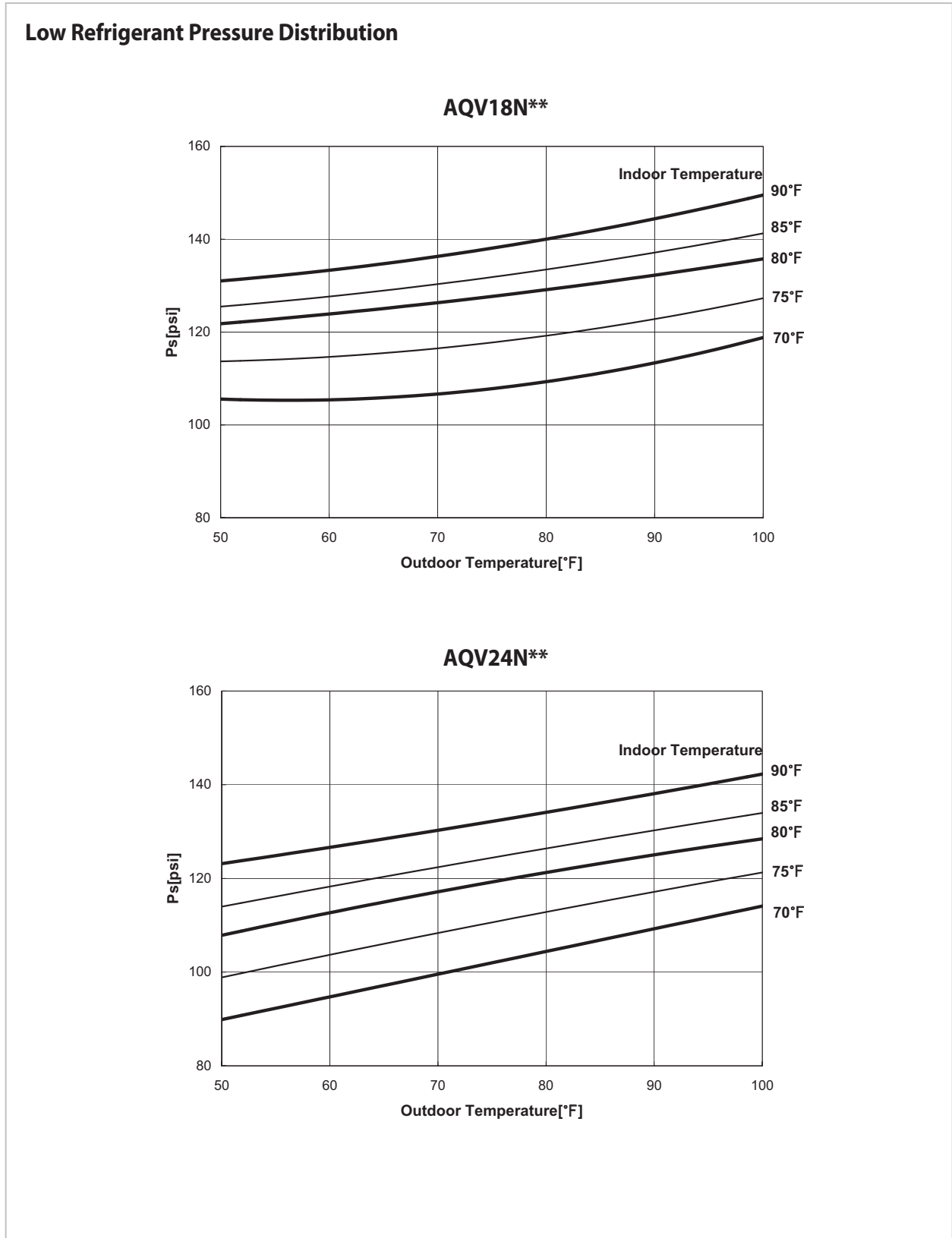

14-3 Pressure & Capacity mark

■ Power/Heat

W	cal/s	kcal/h	Btu/h	HP	kg·m/s	lb·m/s
1	0.23885	0.85985	3.4121	0.001341	0.10197	0.73756
4.1868	1	3.6	14.286	0.0056146	0.42693	3.088
1.163	0.27778	1	3.9683	0.0015596	0.11859	0.85778
0.29307	0.06999	0.252	1	3.9302×10^{-4}	0.029885	0.21616
745.7	178.11	641.19	2,544.4	1	76.04	550
9.8067	2.3423	8.4322	33.462	0.013151	1	7.233
1.3558	0.32383	1.1658	4.6262	0.0018182	0.13826	1

14-4 Q & A for Non-trouble

Classification	Class	Description
Cooling	Q	The cooling is weak.
	A	When it is hot outside, its cooling capacity decreases due to the increase of the ambient temperature. When the dust filter gets blocked or warm outside air gets in, the cooling capacity will decrease. So, make sure to clean the dust filter frequently, prevent heat loss by closing the doors and insulate the cooling area by using curtains, blinds, shades or window tinting.
	Q	The cooling is good generally. But, it gets weak when it is considerably hot.
	A	It occurs when the outdoor unit is exposed to direct sun light and heat-up air is not ventilated well. So, set up a sunblind over the outdoor unit and keep stuff away from the unit to increase the ventilation. When the cooling capacity decreases during a heat wave, clean the heat exchanger of the outdoor unit or spray some cold water to the heat exchanger to increase the cooling capability.
	Q	The cooling is weak. Does it need refrigerant charging?
	A	It is not correct charging refrigerant regularly. Except that you have moved in several times or the connection pipes are broken, the refrigerant does not run low. So, when refrigerant is additionally charged, it could be costly and cause a product's failure. When the refrigerant leaks, all of it will escape in a short time resulting in cooling failure and no water coming out of the drain hose. So, if water comes out from the drain hose, it indicates the normal operation of the product and it does not need refrigerant charging.
	Q	It fails to do cooling.
	A	When the air conditioner is set to Ventilation or the desired temperature is set higher than the current temperature, it fails to do cooling. In this case, select Cooling or set the desired temperature lower.
Leakage	Q	It floods the floor.
	A	Place the drain hose properly. When it is not placed properly, the drain water would flow back flooding the floor. So, straighten out the drain hose for the water to be drained well.
	Q	Water drips at the drain connection (service valve) of the outdoor unit.
	A	When a glass bottle is taken out of the refrigerator, moisture gets condensed on its surface due to the temperature differences. The same principle applies to the air conditioner. When cold refrigerant goes through the copper tube, moisture gets condensed on the surface of the tube and the connection areas. To prevent the water condensation, the pipes are insulated. But, the connection areas of the outdoor unit are not insulated for the purpose of maintenance or repair, and water gets condensed due to the temperature differences and drips down. Generally, it evaporates right away. But, when it drips much during muggy days, put a water pan on the floor.
	Q	It leaks even though a drain pump is used.
A	It occurs when the drain pump is plugged out or it is out of order. Check the power of the drain pump and the position of the drain hose, and when the pump is faulty, contact the drain pump manufacturer. Samsung Electronics do not manufacture drain pumps. So, we are not able to correct the drain pump problems.	
Smells	Q	Whenever the air conditioner is turned on, it irritates my eyes and gives me a headache.
	A	There are no components in the air conditioner irritating the eyes and sending out chemical smells. But, when the air conditioner is turned on, other smell sources are sucked into the air conditioner and get out of it. So, find and root out the smell sources. Generally, it occurs at a interior renovated place, a pharmacy, a gasoline handling place, a tire shop, a second-hand book shop or an electronic component handling place; when its chemical or musty smells are sucked in and sent out, it can be misled that the air conditioner generates them. So, find and root out the problem or refresh the room frequently.

Classification	Class	Description
Smells	Q	Whenever the air conditioner is turned on, it stinks.
	A	There are no components in the air conditioner sending out chemical smells. But, when the air conditioner is turned on, other smell sources are sucked into the air conditioner and get out of it. So, find and root out the smell sources. Generally, when the drain hose is taken out to the washing room or there are sources of smells such as a diaper bin, a shoe shelf or a socks bin, bad smells generate. Also, it occurs where glass cleaners or air fresheners are used; when they are sucked in interacting with dusts and moistures inside, bad smells generate. These kinds of organic materials noxious to human bodies. So, we recommend against the use of them.
	Q	Whenever the air conditioner is turned on, it smells sour.
	A	When the room is papered recently, its paste smells would be sucked inside. Also, when the air conditioner is installed in the study room of young boys loving sweat-generating activities such as the basketball, excessive sweats evaporate and get sucked into the air conditioner resulting in bad smells. So, find and root out the problem or refresh the room frequently.
	Q	Whenever the air conditioner is turned on, it smells musty.
	A	It is due to the improper keeping of the product after its use. When keeping the product, dry up the inside with the operation of Ventilation to prevent must. When the product is kept without drying up the inside with Ventilation, mold would grow inside resulting in must. So, open the windows and switch on the Ventilation function to get rid of the saturated smell inside.
	Q	Whenever the air conditioner is turned on, it sends out bad smells such as stale smells.
	A	It occurs generally when there are pet animals in the house. Their smells stay at the same place. But, when the air conditioner is turned on, the air gets circulated resulting in the circulation of the smells. So, find and root out the problem or refresh the room frequently.
	Q	It sends out bad smells.
A	When the air filter is filthy, it could send out bad smells. So, clean the filter and ventilate the room with the windows open while operating the Ventilation function.	
Operation	Q	It won't start.
	A	There is a power failure or it is plugged out. Also, check if the power distribution panel is switched off.
	Q	It goes off during operation.
	A	When the hot air does not escape properly, it goes off during operation. It occurs when it does not ventilate properly because the outdoor unit is covered, the back of the outdoor unit is blocked by a cardboard or a plywood panel, and the front of the outdoor unit is blocked by the closed window or other obstacles. Clear the above obstacles from the outdoor unit.
	Q	It generally works properly. But, when it's considerably hot, it goes off during operation.
	A	It occurs when the outdoor unit is exposed to direct sunlight and the hot air does not escape properly. Set up a sun blind over the outdoor unit and clear the neighboring obstacles from the outdoor unit to provide good ventilation. When it goes off frequently during a heat wave, it would prevent the turn-off and increase the cooling capacity cleaning the outdoor unit or spraying some water to the heat exchanger.
Q	The remote controller won't operate.	
A	When the batteries run out or the transmitter or receiver of the remote controller is blocked by obstacles, change the batteries or keep the obstacles away from the controlling area. Also, the remote controller may not work under intensive light from a 3-wave length lamp or a neon sign due to the EMI. In this case, take the remote controller closer to the receiver.	

Classification	Class	Description
Installation	Q	Who installs the air conditioner? (Relocation/Re-installation)
	A	When relocating or re-installing the air conditioner, make sure to contact Samsung Electronics Service Center or Authorized Service Agent and have them to do the job. (If not, it could cause personal injury or product damage.) The cost for the relocation/re-installation of the air conditioner is subject to the customer's expense. There is a cost table. But, our service engineer needs to visit to total up the cost correctly. When you move in, make sure to contact Samsung Electronics Service Center or Authorized Service Agent in advance to streamline the process.
	Q	Is it possible to install the outdoor unit outside?
	A	It is possible to install it at a designated place in the apartment or on the rooftop nearby. But, it's illegal hanging an angle iron case with the outdoor unit in it outside the apartment. Also, it is illegal obstructing passers-by with the outdoor unit installed outside.
	Q	What can be done to install the outdoor unit facing the road because it is a commercial building?
	A	The following is an excerpt from Building Code going into effect from JUNE 1st 2005. "The exhaust pipe of a cooling or ventilation facility installed in a building adjacent to the streets of commercial or residential areas shall be installed higher than 2 m to prevent the exhaust air from blowing directly to passers-by and the current facilities shall be corrected by MAY 31st 2005." So, please install it higher than 2 m or not to blow the hot exhausting air directly to passers-by.
	Q	What about installing a windscreen during installation not to blow hot air directly to passers-by?
A	When the hot air from the front of the outdoor unit is blocked, the product's performance will be affected and it will fail to operate properly. So, keep it at least 300mm away from its surrounding walls and give it good ventilation.	

14-5 Cleaning/Filter Change

14-5-1 Cleaning your Air Conditioner

To get the best possible use out of your air conditioner, you must clean it regularly to remove the dust that accumulates on the air filter.



• Before cleaning your air conditioner, ensure that you have switched off the breaker used for the unit.

1. Open the upper front grille by pulling the lower right and left tabs of the grille.

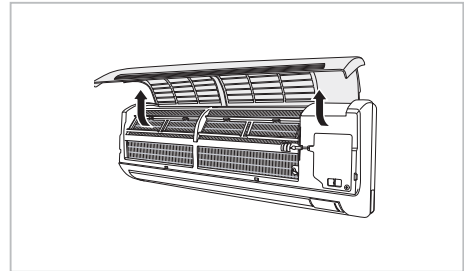

2. Pull air filters out of each tab of the grille.
3. Remove all dust on the air filters with a vacuum cleaner or brush.
4. When you finished, insert air filters by fixing it to each tab of the grille.
5. To close the front grille, fix it to hooks and push down the lower right and left tabs of the grille.

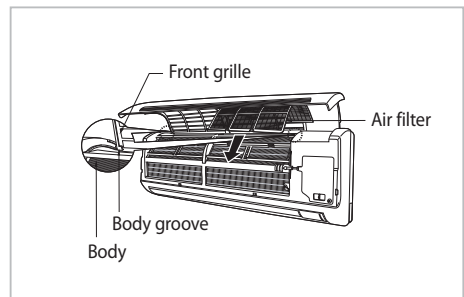

6. Clean the front grille with a damp cloth and mild detergent (do NOT use benzene, solvents or other chemicals).

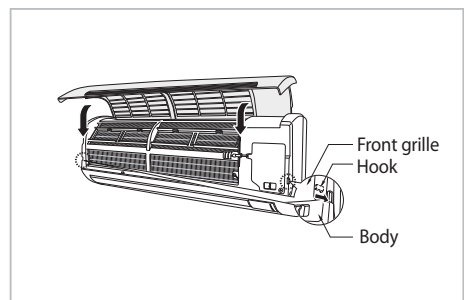

Note : • If you have not used the air conditioner for a long period of time, set the fan going for three to four hours to dry the inside of the air conditioner thoroughly.

14-5-2 Cleaning Deodorizing and Bio filter (Option)

To remove minute dust particles and odors, deodorizing and Bio filter are installed in the air conditioner. You should clean the filters every 3 months.

1. Open the upper front grille by pulling the lower right and left tabs of the grille.
2. Pull out the deodorizing and Bio filter.
3. Wash the filters with clean water, then dry them in the shade.
4. Insert the filters into the original position.
Note : • You can change the position of filters with each other.
5. Close the front grille.

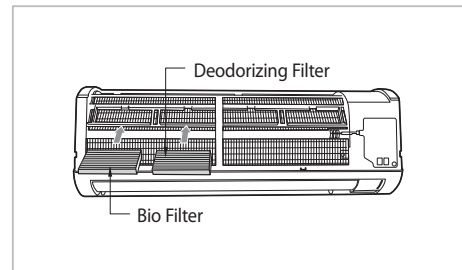

14-6 Installation

14-6-1 Before Installation

Keep the air conditioner outlet and inlet free from its surroundings.
In case of installation, keep the symmetry and fix it to prevent vibration.
The pipe length shall meet the standard as far as possible.

14-6-2 Installation Procedure

■ Location

Install the product in an area to guarantee the best cooling effect, convenience of piping and electric work, and inexistence of vibration or wind.

■ Wall Drilling

Drill the wall downward in a diameter of 60 to 65mm.

■ Fixing Indoor Unit & Outdoor Unit

Fix the air conditioner indoor unit securely to the wall. Secure the outdoor unit in a suitable position.

■ Pipe Spooling & Connecting

You shall cut the pipe with a pipe cutter and grind all the burrs of the cut surface.
Pipe expansion may continue until the pipe surface becomes uneven or torn apart.
Be sure to use a torque wrench to tighten pipes or flare nuts.

<Torque & Depth>

Outer Diameter(D)	Torque(kgf·cm)	Depth(A)
6.35mm(1/4")	10.0~12.3ft.lb(140~170kgf.cm)	0.05inch(1.3mm)
9.52mm(3/8")	18.1~20.3ft.lb(250~280kgf.cm)	0.07inch(1.8mm)
12.70mm(1/2")	27.5~30.4ft.lb(380~420kgf.cm)	0.08inch(2.0mm)
15.88mm(5/8")	31.8~34.7ft.lb(440~480kgf.cm)	0.09inch(2.2mm)

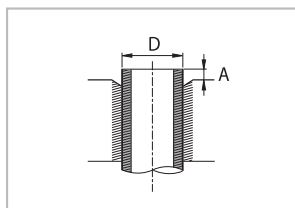

■ Leak Test

Put an inert gas like nitrogen in the outdoor unit pipe and put soap bubbles or other test liquids on the pipe surface for the leak test.

■ Drain Hose Connecting

Install the drain hose downward to drain water naturally. Be sure to pour water into the hose to check if it drains well.

■ Electric & Earth Work

Electric and earth work shall meet the "Electric Facility Technology Standard" and the "Internal Wire Regulation" of the Electric Business Laws.

■ Inspection & Trial Run

Upon completion of the tests, you shall make a trial run while you explain the main functions of the air conditioner to finish the installation.

14-7 Installation Diagram of Indoor Unit and Outdoor Unit

14-7-1 Air-Purge Procedure

1) Connect each assembly pipe to the appropriate valve on the outdoor unit and tighten the flare nut.



2) Connect the charging hose of low pressure side of manifold gauge to the packed valve having a service port as shown at the figure.



3) Open the valve of the low pressure side of manifold gauge counter-clockwise.



4) Purge the air from the system using vacuum pump for about 30 minutes.

- Make sure that pressure gauge show $-0.1\text{MPa}(-76\text{cmHg})$ after about 30 minutes.
- This procedure is very important in order to avoid gas leak.
- Turn off the vacuum pump.
- Close the valve of the low pressure side of manifold gauge clockwise.
- Remove the hose of the low pressure side of manifold gauge.



5) Set valve cork of both liquid side and gas side of packed valve to the open position.



6) Mount the valve stem nuts and the service port cap to the valve, and tighten them at the torque of $183\text{kgf}\cdot\text{cm}$ with a torque wrench.



7) Check for gas leakage.

- At this time, especially check for gas leakage from the 3 way valve's stem nuts, and from the service port cap.

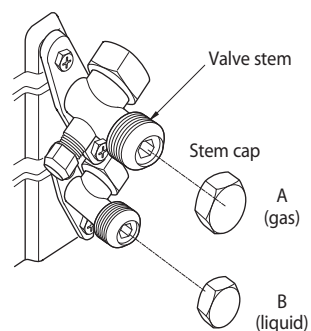
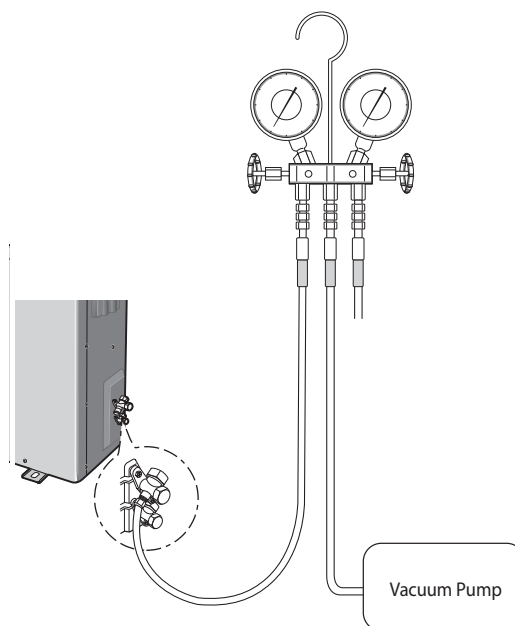
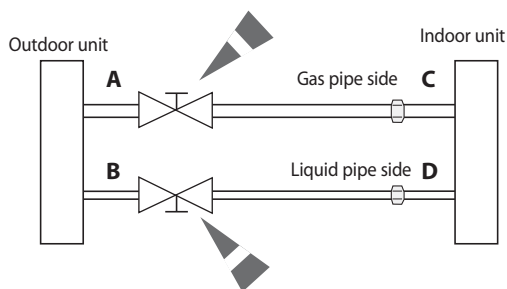

14-7-2 "Pump down" Procedure

Pump down will be carried out when an evaporator is replaced or when the unit is relocated in another area.

1) Remove the caps from the 3 way valve and the 3-Way valve.



2) Turn the 3-Way valve clockwise to close and connect a pressure gauge (low pressure side) to the service valve, and open the 3 way valve again.



3) Set the unit to cool operation mode.
(Check if the compressor is operating.)



4) Turn the 3-Way valve clockwise to close.



5) When the pressure gauge indicates "0" turn the 3-Way valve clockwise to close.



6) Stop operation of the air conditioner.



7) Close the cap of each valve.

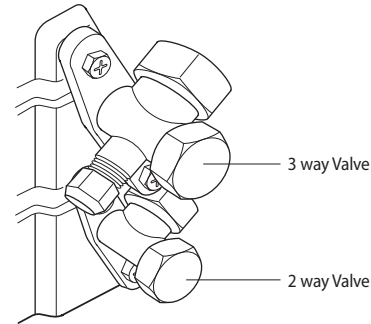

Relocation of the air conditioner

- Refer to this procedure when the unit is relocated.
- Carry out the pump down procedure (refer to the details of 'pump down').
- Remove the power cord.
- Disconnect the assembly cable from the indoor and outdoor units.
- Remove the flare nut connecting the indoor unit and the pipe.
- At this time, cover the pipe of the indoor unit and the other pipe using a cap or vinyl plug to avoid foreign material entering.
- Disconnect the pipe connected to the outdoor unit.
At this time, cover the valve of the outdoor unit and the other pipe using a cap or vinyl plug to avoid foreign material entering.
- Make sure you do not bend the connection pipes in the middle and store together with the cables.
- Move the indoor and outdoor units to a new location.
- Remove the mounting plate for the indoor unit and move it to a new location.



GSPN(Global Service Partner Network)

Area	Web Site
North America	http://service.samsungportal.com
Latin America	http://latin.samsungportal.com
CIS	http://cis.samsungportal.com
Europe	http://europe.samsungportal.com
China	http://china.samsungportal.com
Asia	http://asia.samsungportal.com
Mideast & Africa	http://mea.samsungportal.com

This Service Manual is a property of Samsung Electronics Co., Ltd.
Any unauthorized use of Manual can be punished under applicable
International and/or domestic law.

© Samsung Electronics Co., Ltd. Dec.2008.
Printed in China.
Code No. DB98-30186A(1)