

Flying Companion

A Pilot-Friendly® Manual



*From passenger to helpful crew member—
50 tasks a non-pilot can complete*

Table of Contents

Introduction

| | |
|------------------------------|---|
| How To Use This Manual | 1 |
| Aviation Acronyms..... | 2 |

Before the Flight

| | |
|-----------------------------------|----|
| Create a Mindset for Flight | 3 |
| Pack Food and Water | 4 |
| Pack Stuff You Can't Eat..... | 5 |
| Research Your Destination..... | 6 |
| Share the Load(ing)..... | 8 |
| Run the Numbers | 10 |
| Check the Pilot..... | 12 |



Ramp Operations

| | |
|---|----|
| Check the Fuel | 13 |
| Drain the Fuel Sumps | 14 |
| Pay for Fuel (Gas) | 15 |
| Fuel the Airplane | 16 |
| Check and Add Oil..... | 18 |
| Check Tire Pressures..... | 19 |
| Clean the Windshield | 20 |
| Load the Baggage..... | 21 |
| Assist With Preflight | 22 |
| Climb Aboard | 24 |
| Give (or Ask for) a Passenger Briefing..... | 25 |
| Restrain Yourself..... | 26 |
| Adjust Your Headset | 27 |
| Find the Runway..... | 28 |

Tasks for Every Phase of Flight

| | |
|--|----|
| Adjust the Air and Temp | 30 |
| Get the Weather (ASOS, AWOS, or ATIS)..... | 31 |
| Keep a Sterile Cockpit..... | 32 |
| Read a Checklist | 33 |
| Watch for Traffic | 34 |
| Call Out the Altitude..... | 36 |
| Find the Frequencies..... | 37 |



| | |
|--------------------------|----|
| Tune the Radio..... | 38 |
| Talk on the Radio | 40 |
| Voice Your Concerns..... | 41 |

Departure and Cruise

| | |
|---|----|
| Monitor Performance | 42 |
| Take the Controls (for a Moment) | 43 |
| Track Your Progress | 44 |
| Prevent Air Sickness..... | 45 |
| Use Supplemental Oxygen | 46 |
| Give an Airborne Weather Report (PIREP) | 47 |
| Take Photos | 48 |
| Relieve Yourself..... | 50 |

Approach and Landing

| | |
|-----------------------------|----|
| Find the Airport | 51 |
| Calculate a Crosswind | 52 |
| Find the FBO..... | 53 |
| Score the Landing..... | 54 |
| Secure the Airplane | 55 |

Abnormalities and Emergencies

| | |
|--|----|
| Engage the Autopilot..... | 56 |
| Request Help in an Emergency..... | 58 |
| Find an Abnormal or Emergency Procedure..... | 59 |
| Use the Fire Extinguisher | 60 |
| Bust Out a Window..... | 61 |
| Land the Airplane..... | 62 |
| Go Direct-To | 64 |

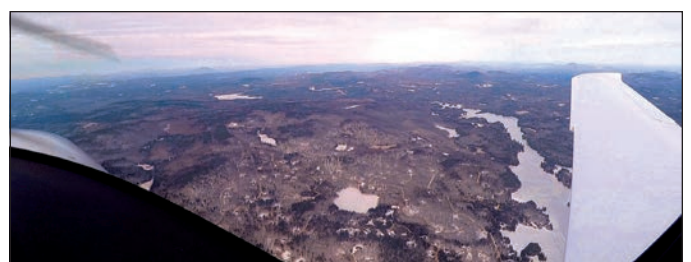

Drain the Fuel Sumps

The fuel used in the airplane must be clean and free from water, so some fuel is drained from each tank and checked prior to flying. You'll use a fuel testing tool. Pilots normally carry one on board at all times (it's that important) or keep it handy in the hangar.

Take fuel samples before your first flight of the day (especially if the airplane sat outside in the rain, or you're in a humid environment) and after fueling. You'll always check to see if there's water in the fuel and that the fuel is the correct type.

Locate the sumps on the airplane, using the pre-flight section of the POH as a guide, and check with the pilot to ensure you've found them all. Some high-wing Cessnas have 13 sumps. There's often a fuel drain at the lowest point in the system, on the belly. Sometimes a drain is actuated by pulling a knob in the engine compartment, or even inside the cabin.

Drain enough fuel so that you have a good visual—a few ounces or so, like a full shot glass. Look at the sample in the cup. If your aircraft uses 100LL avgas, it should look light blue.



Clear liquid mixed in with the blue is a bad sign: water in the fuel. Water may also show up as a large bubble at the bottom of the cup (water is heavier than fuel) or in smaller bubbles suspended in the fuel. You'll need to empty the water-contaminated fuel, dry out the cup to remove any droplets, and sump again—repeating until you no longer see water in the samples.

If your airplane was parked outside during a rain storm, quite a bit of water may find its way into the tanks. You might sump a lot of fuel to clear it all out.

Dirt and other foreign objects can clog the fuel screens in the system. So look for debris in the cup as well. Again, drain fuel until the sample runs clear of particles—there should be none.

The common 100LL avgas is a leaded fuel. While it's still legal to burn, dumping it on the ramp is dumping a toxic substance, as well as wasting a valuable resource. The airport may have a receptacle for hazardous liquids, but many don't.

Some sump tools, such as the one shown here, let you pour the fuel back into the tanks. They even strain out any water from the sampled fuel as you pour. Check with your pilot about pouring sumped fuel back into the tanks.

Fuel drains are spring-loaded. Pushing up releases the fuel into a collection jar. Drains with a hole in the center require pushing up with a metal pin (top left). Drains with a T-shape are pushed with a notched cylinder (bottom left). Water will settle in the bottom of the collection jar (below).



TIP

Wait 15 minutes after fuel is added (page 16) before sumping the fuel tanks. It can take that long for water to settle.

You don't need to check tire pressure before every flight. However, if you suspect the pressure is low, checking tire pressure for airplane tires is roughly the same as with cars. Look up the tire pressure required in the POH or service manual. There may be a different pressure required on the nose or tailwheel tire compared to the tires on the main landing gear. The number is given in *pounds per square inch*, or psi, and you'll look for the same number on the tire pressure gauge.

Go to the tire, and unscrew the cap on the tire valve stem. If the airplane has wheel covers (commonly called "wheel pants"), you may need to roll the airplane forward or backward to uncover the valve stem. If the cap is missing, let the pilot know.

Slide the tire pressure gauge over the stem and press down to release air from the tire into the gauge. An instant readout appears on a dial, display, or along the side of a scale that extends.

The reading you get at first is the highest pressure that you'll see from that tire. Remove the gauge in a quick motion so as little air escapes as practical.

If you need to add air to the tires, the FBO can bring out their portable tank or compressor on a fuel or maintenance truck. Alternately, you may have a portable tank or compressor in your hangar that you can use. Have the pilot show you how to fill a tire, bringing it slowly up to the right pressure.

If you overfill the tire, you can release the extra air pressure by pushing in the pin in the tire valve stem. It hisses as air is released.

Changes in the weather can affect your tires. If there has been a significant change in barometric air pressure, that can cause some change in tire pressure. So you should consider checking the tire pressure before flight in this case.



TIP

Periodically look for worn spots. To do this with wheel pants, have someone roll the airplane forward and back to see each tire's full circumference.

EYEBALL TIRES BY THE SIDEWALLS

Even when inflated to their full pressure, aircraft tires can look low compared to car tires, especially on a cold day.



This tire is at its full pressure of 30 psi. One clue that it's fine is gleaned from the side of the tire coming up from the ground to the metal wheel, called the sidewall. If the angle between the lowest part of the sidewall and the ground is at least 45 degrees, the tire is probably fine.



As the air leaks out, the belly of the tire gets bigger and the sidewall droops lower. This tire is down to about 25 psi. It wouldn't be unsafe, but it's not good for the tire. Tell your pilot.



When the sidewall of the tire is close to—or touching—the ground, the tire almost certainly needs air. Tell your pilot right away.

Referring back to the weight and balance chart (page 8), you should know the exact weights and locations (stations) where you'll load baggage into the airplane. It's important the bags go where you planned because there are maximum weights for each cargo or seating area. Placards or signs in the airplane's interior state these limits. If it turns out something you planned for a specific station in the airplane doesn't fit and must be stowed elsewhere, you must recheck how shifting that baggage effects the weight and balance.

Make sure heavier items are near the bottom of the baggage area, otherwise they may topple onto passengers, or fall out of the baggage door when you open it after the flight. It's also good practice to put the biggest, heaviest items in first and toward the forward part of the baggage area. Pack the smaller stuff around them.

Smaller, soft-sided bags, such as duffels or backpacks, are easier to load and arrange than larger hard-sided luggage. A soft-sided duffel made of a comfortable fabric and filled with clothing can also double as a pillow in the back seat. However, anything fragile should be in a lightweight, hard-sided case. If you pack a bunch of smaller bags, you can arrange them so that you can access the items you need along the way, or for earlier parts of the trip. You'll also be able to adjust loading to fit cargo in tighter spots in the baggage area.



Aircraft baggage doors are smaller than your average car trunk. This is another reason to pack in multiple, soft-sided bags

Bags can really jump in turbulence or maneuvering flight such as takeoff and landing. Not to criticize your pilot's skills in this regard—unless you're keeping score (page 54). Bungee cords or webbed cargo straps that hook onto tie-down points in the baggage areas are a good idea.

This is particularly important for anything up high, such as on a shelf, that could fly forward with sudden deceleration. If you don't have a cargo net on these areas, get something from a sporting goods or outdoor store.

KNOW YOUR LIMITATIONS: WEIGHT & BALANCE

The weight and balance section in the POH (normally Section 6) carries much of the info you need to safely load the airplane, but you also need to pay attention to the placards and any markings in the cargo areas and other sections of the airplane.

**120 POUNDS MAXIMUM BAGGAGE
INCLUDING 12 LBS. MAXIMUM
IN BAGGAGE WALL HATSHelf**

**FOR ADDITIONAL LOADING INSTRUCTIONS SEE
WEIGHT AND BALANCE DATA.**

MAXIMUM BAGGAGE THIS COMPARTMENT 100 LBS.

**SEE THE LIMITATIONS SECTION OF
THE AIRPLANE FLIGHT MANUAL**

**ALL WEIGHT IN EXCESS OF 3112
POUNDS MUST BE FUEL WEIGHT ONLY
FILL TIP TANKS FIRST
USE MAIN TANKS FIRST
RESTRICT PASSENGER WEIGHTS OR CARGO
WEIGHT AS REQUIRED FOR COMPLIANCE**

Assist With Preflight

As you become familiar with the airplane, your pilot may ask you to perform portions of the aircraft's preflight duties and checks, so that you can attend to the airplane. You can learn to check the fuel (page 16), oil (page 18), tire pressure (page 19), and other consumables.

You can also help with part (or all) of the walk-around inspection while your pilot checks weather, files a flight plan, or takes care of other items. You'll want to learn the flow that the pilot uses to check the airplane's airworthiness—or fitness—for flight. Your pilot may use a special checklist, an app, or the guide directly from the POH.

A graphic in the POH shows the walk-around pattern, which is typically a path a pilot follows to check items in each area. It includes making sure the flight controls operate correctly, doors and windows are secure, the engine's condition looks good, and all the ropes, covers, and wheel chocks are removed.

You don't need to be an expert to assist with these items. You simply need to gain some experience with your pilot as to how all these parts normally look and move—and then get the pilot to check them out if something seems off or out of place.

It's also a good idea to check the general appearance of the airplane. It's overall cleanliness is important—dirt can hide all kinds of problems, like loose parts, dents, and corrosion. You can also look the airplane over for those issues. Another set of eyes can see things that a pilot accustomed to a particular airplane may miss.

You can print or take a picture of the page in the POH to carry with you as you learn the walk-around inspection.



inspection.

When you remove a tiedown rope, grasp the loose end lightly as you pull it through the tiedown ring so it doesn't swing up and smack the aircraft fuselage.

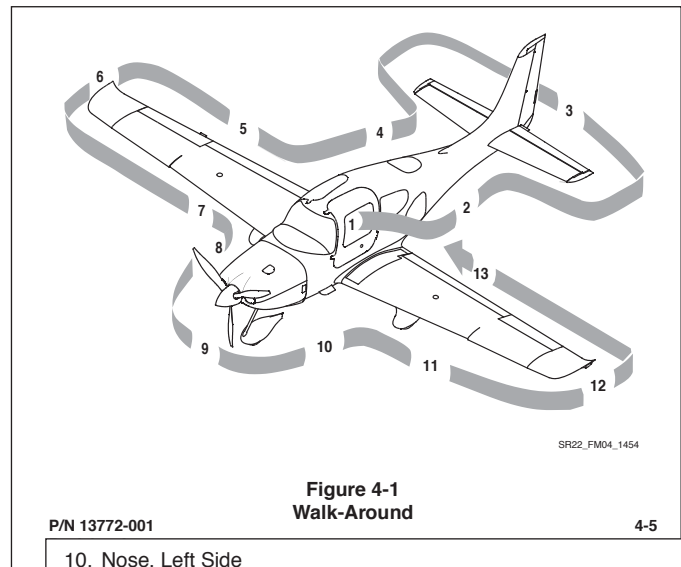

10. Nose, Left Side

- a. Landing Light.....Condition
- b. Engine Oil.....Check 6-8 quarts, Leaks, Cap & Door Secure
- c. Cowling.....Attachments Secure
- d. External PowerDoor Secure
- e. Vortex GeneratorCondition
- f. Exhaust Pipe(s)Condition, Security, and Clearance

11. Left Main Gear and Forward Wing

- a. Wheel fairings..... Security, Accumulation of Debris
- b. TireCondition, Inflation, and Wear

There are also apps, like MiraCheck, which let you check off items as you go, as well as customize the list for items specific to your airplane that your pilot may have pointed out for you.

It's often best to remove all the covers, plugs, control locks, and tiedowns first, and stow them. That way they're not in your hands as you try to do the preflight inspection. However, it's usually a good idea to leave at least one wheel chocked until you're ready to go.

The same is true with checking the fuel (page 13), sumping the fuel (page 14) and checking the oil (page 18). These tasks require rags and tools which are annoying to hold as you walk around the airplane. You also might need to clean your hands after some of those tasks.

TIP

If you think you may need fuel from the FBO, check that item first and call them right away. There may be a wait to get the fuel truck out to you, so you might as well start that clock ticking ASAP.

PREFLIGHTING THE OTHER FLUIDS AND GASSES

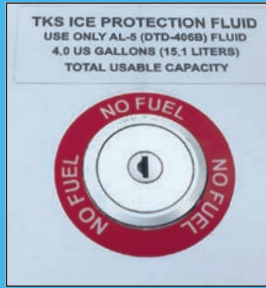

Preflight may reveal the need for fuel, oil, or air in the tires. But it might also reveal a need for other consumables.

Some aircraft require a special fluid for their de-ice systems. Your pilot may keep this fluid in a bottle in the

hangar or purchase it from an FBO. Because it's not always available when you travel, it's worth asking if there's enough onboard for a winter trip and whether extra should be packed in back.

De-icing can also happen on the ground. If snow

or frost on the wings is found on preflight, you can be the one to request de-icing from the FBO line staff.

When you fly at 10,000 feet or higher in an unpressurized airplane, you may need supplemental oxygen. This can be from a portable tank or be built into the airplane. It's another item you can check and report to the pilot to ensure it isn't overlooked.



If you find something you're not certain about and the pilot isn't right there, make a note of it and continue. Present the list to your pilot when you're done. You can also use your phone to take pictures of questionable items you find to show your pilot (or help you remember what you found).

If you're assisting with preflight, the most important thing, however, is that you and your pilot have agreed who is responsible for each item on the preflight inspection. You don't want each of you thinking the other one checked—when actually nobody did.

Even if you didn't do the preflight, take one last look at the airplane before you get in. Is a tire chocked, a towbar on the nose gear, or the tail still tied down? Your final look may save embarrassment ... or worse.



STRANGE THINGS MAY TURN UP

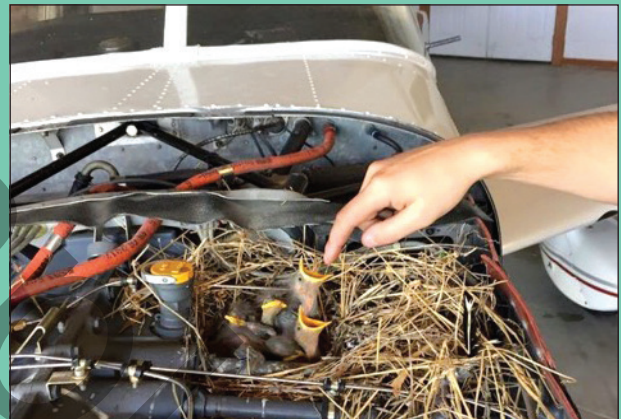

It's easy to get complacent with preflight inspections because it's rare that anything turns up out of the ordinary. However, you must treat every preflight inspection as if lives depend upon it (even if those lives might not exactly be yours).

OTHER DUTIES AS ASSIGNED

Other items you can handle prior to departure:

1. Settle the bill for fuel/parking with the FBO.
2. Make sure any kids stopped in the restroom.
3. Gather last-minute snacks or drinks, and ensure ice is in the cooler and it's easy to reach.
4. Confirm destination car or hotel reservations.
5. Tell any emergency or destination contacts of changes in your departure time or overall plan.

Restrain Yourself

Seat belts in GA airplanes resemble automotive seat belts—although some of them resemble automotive seat belts from 1955. It's critical you tighten them down correctly however, because you're not just securing yourself against a crash. Turbulence or a momentary unusual attitude during flight could send you out of your seat, causing injury.

It's usually best to adjust your seat position before you adjust your seat belt because many belts are attached to the floor and side of the aircraft. Also, once you're strapped in, it can be hard to reach some adjustments. Strapping in should be the last thing you do.

The lap parts are pretty straightforward. Most tighten manually and release with a large buckle, almost identically to what you find on airline seats.

When closing a four-point belt, ensure you tighten down the lower straps so the buckle is below your belly button and the straps are over your hips.



TIP

Connect your seatbelt loosely before you close the airplane door. Many airplane seats practically touch the door after it closes making it impossible to reach the belt dangling down by the floor.

Some airplanes only have lap belts, particularly for the rear seats.

Older aircraft with shoulder harnesses may have a fastener that clicks into the main latch. It's usually best to click this shoulder harness to the latch before you connect it across your lap. After you attach them, adjust the straps so that the lap belt rides along your waist. Then tighten down this shoulder belt enough to keep you from moving too far forward in a sudden stop or turbulence, but not so tight you can't reach items in the cabin.

Some restraint systems have a fifth strap that comes up between your legs. In these systems, there is usually a tab on one lap belt that passes through rings on the shoulder belts and center belt before connecting to the other lap belt. As you might imagine, it's usually best to get these separate parts arranged before you even climb into the seat.

Just like on the airlines, you may remove your belt in the air with the permission of the pilot. But it's best to wear it whenever you can.

To see if a manual shoulder belt is tight enough, lean all the way forward. Your body and head shouldn't reach the aircraft's glareshield.



Find the Runway

Runway ends are identified by the heading in which they point, rounded to the nearest multiple of 10 with the last zero dropped. For example, “Runway 18” refers to a runway pointed to a compass heading of 180 degrees when an airplane sits in position ready to take off. The opposite end of the same strip of pavement is the reciprocal direction, 360 degrees, and is called “Runway 36.”

When spoken aloud, you read the individual digits, so you would say “Runway Three Six,” not “Runway Thirty-six.” Sometimes the entire strip of pavement is referred to by both ends: “Runway 18-36.” The point is that a “runway” is really two runways from a pilot’s point of view with a different name depending on which way the airplane is facing.

Taxiways are designated “A,” “B,” and so on, in alphabetical order, with the primary taxiway along the main runway normally designated “Taxiway A” (pronounced “Taxiway Alpha”).

Pilots want to take off into the wind as much as possible, so if the wind is blowing from 180 at 12 knots, the pilot will use Runway 18 unless there’s a compelling reason not to. The runway pilots are using is called the “active runway.”

That’s where you can help. There are two critical

TIP

Short taxiways connecting to a runway are often numbered in sequence. So, when you see a taxiway called “N2,” look on the chart to see where “N1” and “N3” are, and so forth.

tasks that must happen to reach the active runway: One is finding the route to the runway, and the other is ensuring the airplane doesn’t enter any forbidden areas, or conflict with other aircraft, on the way.

At a towered airport, the pilot is assigned a path to the active runway. It might sound like, “Runway Two Nine, taxi via Charlie, Alpha. Cross Runway One Eight.” That means to follow Taxiway C, until it reaches Taxiway A, then turn whichever way on Taxiway A takes you towards Runway 29. In the process, you may cross over Runway 18-36.

Find that route on an airport diagram that has the taxiways and runways marked, and trace that route so you understand which way to go. You’ll need to know where your starting point is, so ask your pilot where you’re starting from if you’re not sure. As your pilot taxis along, watch the direction of each turn to ensure the airplane is going the right way. Compare



You’re on Taxiway C and about to cross Taxiway A

Runway signs use a color code. Yellow-on-black is the taxiway you are on. Black-on-yellow is a taxiway you will join if you turn in the direction of the arrow. White-on-red is a runway you will cross if you continue past the sign.



You’re on Taxiway C and about to cross Runway 29-11



Get the Weather (ASOS, AWOS, or ATIS)

The winds, temperatures, cloud cover, and altimeter settings are critical pieces of information for a pilot departing from, or arriving at, an airport. Even if you don't understand how these elements are used by a pilot, you can retrieve and relay them to the pilot.

Each airport has its own local weather, so this need recurs throughout the flight. If the pilot must change plans and find an alternate airport for landing quickly, your help getting this data could be critical.

If there's no control tower, the weather will either be from an automated system or not available at all. There are two systems (ASOS and AWOS) but you use them the same way. Find the frequency or phone number to use (page 37). Then tune that frequency (or call that phone number) and listen (page 38).

It plays on an endless loop, so listen for the report to cycle through to the beginning. It will sound something like this:

Chatham Municipal Airport, Chatham, Massachusetts, automated weather two three two seven Zulu. Wind two five zero at seven. Visibility one zero. Sky condition clear. Temperature two one Celsius. Dewpoint one four Celsius. Altimeter two niner eight eight. Remarks, density altitude eight hundred.

After you have listened to it once or twice, write down the information on a notepad to show the pilot and keep as a reference. Try to be as clear as possible—your shorthand may not be instantly legible during taxiing or in flight. Again, it's more important that you can relay it accurately than understand all the details, but the more you participate, the more each element will make sense.

TIP

Store local ASOS/AWOS or ATIS phone numbers for quick updates while waiting in the FBO, standing by the airplane, or in the car on the way to the airport.

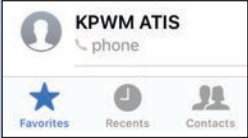

If it's a towered airport, this information will be on a recording called ATIS. It also plays on a loop and sounds something like this:

Centennial Airport, Information Zulu, two zero five three Zulu observation. Wind two three zero at one three. Visibility one zero. Few clouds eight thousand, few clouds at one one thousand. Temperature one three, dewpoint one zero. Altimeter three zero four zero. Visual approach in use. Landing and departing Runway One Seven Left and One Seven Right. Notice to Airmen: Eighty-four foot lighted crane two miles southeast. Advise on initial contact you have Information Zulu.

You'll notice there's weather plus additional information about the airport, including critical items such as closed runways. All of this should get relayed to the pilot. Each hourly ATIS is assigned a phonetic letter (which is Z, or "Zulu" in this example). The pilot will use that letter in the first call to the air traffic controller—and it's easy to forget what it was—so you can be a help just by writing it down.

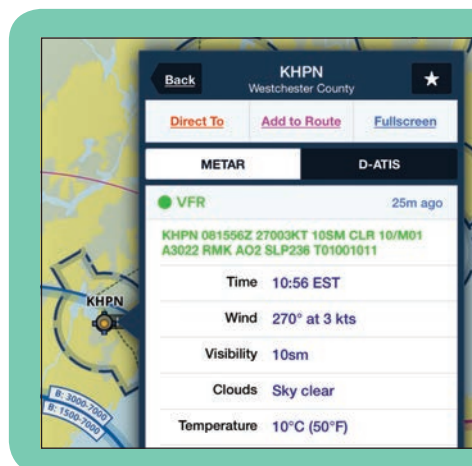
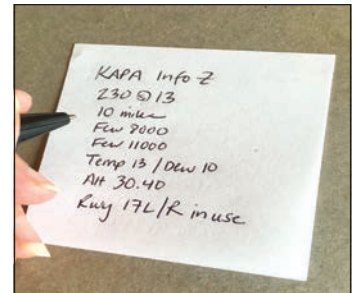

TAP THE APP FOR AIRPORT WEATHER—AND MAYBE ATIS

Many tablet apps let you tap an airport and see a pop-up with the current weather information. This is via the internet on the ground and may be available in the air as well. Panel-mounted screens in the aircraft may also have this function. You'll probably see it listed as a "METAR." Ask your pilot if you have access to this information while airborne. If so, you can quickly report recent weather at different airports nearby, which could help if the pilot needs to pick one for landing. Be sure to tell your pilot how old the information is (25 minutes old on the left). ATIS usually isn't available by tapping. This airport is an exception.

Pilots use checklists to make sure that all of the airplane’s switches, buttons, knobs, and other controls are configured properly for each phase of flight. Many pilots use checklists as “do” lists—they read an item, then do it, read the next item, and so on. An alternative (used by virtually all airline crews) is configuring the airplane using a memorized pattern, or “flow,” and then referencing the checklist to ensure nothing was missed.

You can help with either system. When your pilot calls for a specific checklist—“Before Takeoff checklist”—read the name of the checklist, then read each item in sequence, waiting for the pilot’s response:

- Pilot: “Before Takeoff Checklist, please”
- You: “Before Takeoff Checklist. Parking Brake?”
- Pilot: “Set.”
- You: “Seat Backs?”
- Pilot: “Secure.”
- ... and so on.

When you reach the end of a checklist you say, “Before Takeoff Checklist complete.”

If this was a do-list, the pilot would perform each action as you read it off. If it was a true checklist, the pilot would simply verify each item was done (or do it with a slightly abashed look on his or her face). Running checklists is a great way to get more familiar with the airplane. In time, you can even verify that the pilot’s response to each item is accurate.

During a busy time like the approach to land-

Your aircraft and pilot may use a digital checklist that’s integrated into an app or the aircraft systems. Most let you check off each item as it is completed, which is great if you leave and come back to a checklist. Sometimes it’s easier for a pilot to run digital checklists solo rather than with help.

CHECKLISTS: STEP-BY-STEP

- When the pilot calls for a checklist, read the checklist name, and then the first item.
- Verify the accuracy of the pilot’s response and then continue to the next item.
- When you reach the end of a checklist, say “[Checklist Name] Complete.”

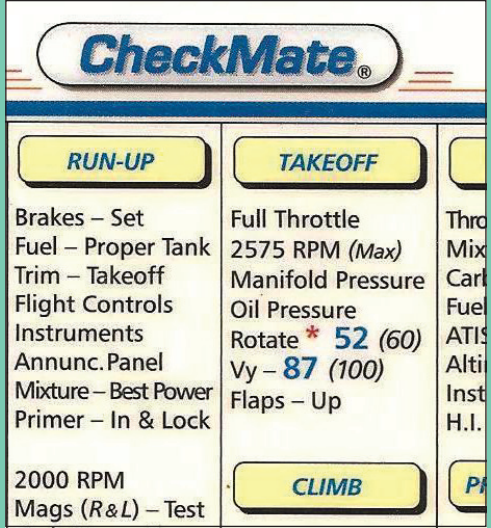

ing, a pilot will sometimes respond to checklist items based on recollection, or out of habit, instead of actually checking. If you notice a discrepancy, point it out. If you say, “Landing Gear?” and the pilot responds “Down and Locked,” but you see they are still up, state the fact: “The gear handle is still up.”

Keep track of your place in a checklist by using your finger. If the checklist gets interrupted (say, by a call from air traffic control), continue where you left off. If you lose your place, play it safe and start over.

After a few flights, you’ll know when each checklist should be called for. If it seems like your pilot forgot, offer a reminder.

Checklists are organized by phase of flight (typically something like: Preflight Inspection, Before Takeoff, Climb, ... Before Landing, After Landing, and Securing Aircraft.) There are also “Non-normal” and “Emergency” checklists for critical actions when things go wrong (page 59).

GROUP Normal Procedures

CHECKLIST Before Starting Engine

- 1. Preflight Inspection. COMPLETED
- WARNING: Ensure that the airplane is properly loaded and within the AFM’s weight and balance limitations prior to takeoff.
- 2. Weight and Balance. Verify within limits
- 3. Emergency Equipment. ON BOARD
- 4. Passengers. BRIEFED
- 5. Seats, Seat Belts, and Harnesses. ADJUST and SECURE

Watch for Traffic

Every pilot flying outside the clouds has a responsibility to see and avoid other airplanes. The challenge is that other aircraft are really hard to see in the air until they are so close that it's almost too late. It's also easier to see an aircraft that's crossing your path ahead of you, and consequently not a threat, than an aircraft that's heading straight for you.

Typically, a pilot increases the chances of spotting another aircraft by pausing his or her eyes to look carefully at each segment of the sky. Just sweeping your eyes across the sky doesn't allow the focus needed to spot a small airplane while it's still far away. The farther away an airplane is when spotted, the less aggressive the pilot must be to avoid a collision.

Certain places attract more airplanes, such as established routes, popular cruising altitudes, and, of course, airports. To keep all that traffic converging on an airport organized, aircraft follow established traffic patterns. (See "The Traffic Pattern" on page 35.)

You can concentrate your scan for traffic during take-off and landing on the segments of this rectangular pattern.

Because the traffic pattern has a specific altitude, most of the aircraft will be at the same altitude you are. Since most mid-air collisions happen in the traffic pattern on good-weather days, it pays for everyone on board to pay attention to the skies when coming into the airport to land. As you develop an understanding of radio calls, you'll hear aircraft use these terms when they announce their positions, and you'll have a better idea where to look for them.

Of course, not all aircraft follow the standard traffic pattern (whether out of disregard, operational reasons, or for an emergency), so a pilot cannot limit the scan to just the normal traffic pattern.

While the traffic scan shouldn't totally disappear during cruise flight, it's most critical when you're arriving and departing from airports.

THE TRAFFIC SCAN

Divide the world outside the windshield or side windows into segments of 10 degrees along the horizon. Pause and focus your eyes within each segment to spot traffic. Any traffic that's a concern for you would be within a few degrees above or below the horizon.

Teach other passengers to scan (so long as it doesn't make them overly concerned about a mid-air collision). Kids enjoy this task, but ensure they have maturity to do so. Passengers may be able to see traffic in the pilot's blind spots as well.



THE TRAFFIC PATTERN

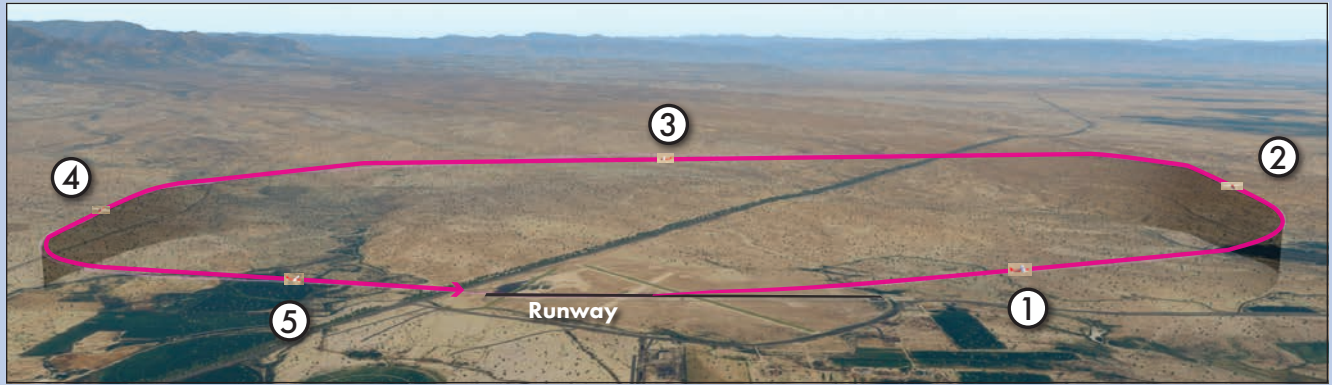

① On the **upwind** leg or departure leg, the airplane leaves the departure runway and climbs skyward, into the prevailing wind.

② The **crosswind** leg establishes a good distance from the runway and gives the airplane more room to climb to pattern altitude.

③ The **downwind** leg gives the pilot time to configure the airplane, to check the strength of the wind, and to begin bringing the airplane to approach speed. Airplanes often merge into this leg as they arrive at an airport.

④ The **base** leg allows the pilot to descend and slow down more, and get into position to turn into alignment with the runway. The pilot often corrects towards the runway to account for the wind—since you normally land an airplane into the wind.



⑤ On the **final** leg, sometimes called “final approach,” pilots align the airplane with the runway, to land straight ahead. You may find it easier to make an emergency landing from a long final (page 62) instead of a pattern.

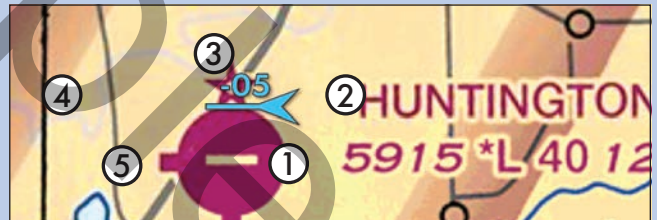

DIGITAL TRAFFIC DISPLAYS



Traffic can appear on cockpit displays or tablets as well. The display may simply show the presence of another aircraft on a map view. Other times it could show the direction of that aircraft’s flight with a line, the relative altitude to you (with a + or - and a number representing hundreds of feet above or below you), and an up or down arrow showing if the other aircraft is climbing or descending. A potential collision hazard usually appears in yellow. The yellow target (upper left) is 1200 feet above you, descending, and a potential threat.



Pilots use a wide range of radio frequencies to communicate with ATC and other pilots, as well as retrieve the latest weather. Throughout the flight, you can look up these frequencies to help out, especially when you travel to a new destination, or during a time when the pilot needs to focus full attention on flying the airplane.

There are two main sources of frequency information: printed information (whether on real paper or digital representation of paper) and database information stored in the systems built into the aircraft.

Sectional Charts show towered airports in blue, with the frequencies for the control tower (CT) and ATIS. Non-towered airports are shown in magenta, with the ASOS/AWOS and CTAF frequencies. The CTAF frequency is immediately in front of the inverse “C.”

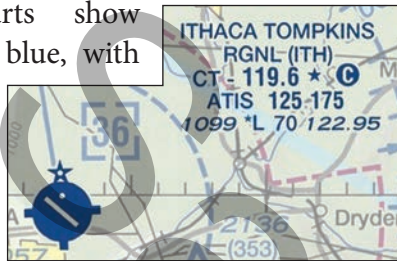

If you see an inverse C on a towered airport, then the tower frequency becomes the CTAF when the tower is closed.

If you’re using a tablet, tapping an airport on whatever map you’re viewing usually brings up an information window where you’ll find all the airport frequencies in a scrolling list. You can

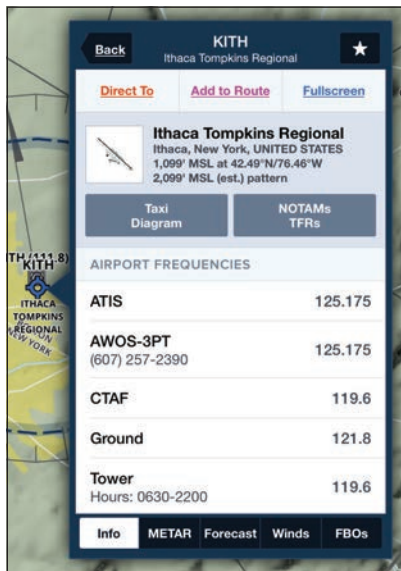

| KITH: Ithaca Tompkins Regional | | | |
|---|----------------------|------------|---------|
| Ithaca, New York, US 42.49°N/76.46°W Sunrise, set: 06:49, 16:50 EST | | | |
| Flight category | VFR | ATIS | 125.175 |
| Elevation | 1,099' MSL | Clearance | ----- |
| Pattern altitude | 2,099' MSL (est.) | Ground | 121.8 |
| Fuel | Jet A+, Jet A, 100LL | Tower | 119.6 |
| Procedures | ILS, GPS, LOC, RNAV | Appr & Dep | 124.3 |

WHO'S WHO ON AVIATION RADIO

ASOS, AWOS, and ATIS provide weather and airport information from a recording.

CTAF, or Common Traffic Advisory Frequency, lets pilots talk to each other at non-towered airports.

Unicom is used at both towered and non-towered airports for talking to FBOs or other services.

Clearance, Ground, and Tower are air traffic controllers at towered airports controlling up to five miles from the airport (usually).

Approach and Center control aircraft around busy airports and the whole country, respectively.

Flight Service provides weather and flight planning services by radio or telephone.

usually view the complete airport information full screen with key frequencies always at the top and all the rest under a “frequencies” tab.

ITHACA TOMPKINS RGNL (ITH)(KITH) 3 NE UTC-5(-4DT)

AIRPORT MANAGER: 607-257-0456
 WEATHER DATA SOURCES: AWOS-3PT 125.175 (607) 257-2390.
 COMMUNICATIONS: CTAF 119.6 ATIS 125.175 UNICOM 122.95
 RCO 122.1R 111.8T (BUFFALO RADIO)
 (R) ELMIRA APP/DEP CON 124.3 (1100-0500Z+)
 (R) NEW YORK CENTER APP/DEP CON 133.35 (0500-1100Z+)
 TOWER 119.6 (1130-0300Z+) GND CON 121.8

The Chart Supplement (sometimes called the A/FD) is a book with information for most U.S. airports, including frequencies. It’s printed on paper and included in most aviation apps. This is also where you’ll find phone numbers (including for the airport manager if you ever need it).

Finally, navigators installed in your aircraft store information in the waypoint (WPT) pages or groups. Ask your pilot to show you how your specific system works—and always ask before changing something on installed equipment, even if you’re just looking something up.



Tune the Radio

First off: **Do not adjust anything having to do with the radios without the express permission of the pilot each and every time.**

This permission requirement isn't because you're not a pilot; it's true in professional airline cockpits, too. Only one crew member "owns" a particular piece of equipment, and the other crew member may not use it without permission. As you gain experience, you might take responsibility for radios and communication—and your pilot would ask *you* for permission.

Presuming you have the OK to tune a frequency, the next step is finding the controls. Communication, or "com," radios are usually combined with some kind of navigation radio. That's often a GPS with a screen

BIG NUMBERS AND LITTLE NUMBERS

Aviation radio frequencies have two parts, divided by a decimal. This is for convenience because telling someone to tune "123,025,000 Hertz" is awkward. Instead, the first part of the frequency is three numbers in millions of Hertz (MHz), which is "123" here. The second number is a fraction of one MHz, or ".025." This frequency is written "123.025" and is pronounced, "One two three point zero two five."

capable of showing a map, but sometimes it only displays a few glowing numbers. Ask your pilot where the frequencies appear in your aircraft, and where the knobs are to control them. Unless you have a system with a touchscreen or keypad, you will probably enter the frequency with concentric knobs (below).

Virtually all modern aviation radios tune frequencies in a standby frequency position. This means

TUNING THE STANDBY FREQUENCY WITH CONCENTRIC KNOBS AND BUTTONS

Most aviation radios, such as with this Garmin GNS 430W, use some form of concentric knobs to enter radio frequencies. Usually the bigger, outer knob controls MHz and the smaller, inner one controls kHz.



- 1 Locate the radio frequencies. The standby frequency will be below or to the right of the active frequency. It will usually be highlighted, but if not, push once on the knob marked "Push C/V."
- 2 Twist the outer (big) knob to change MHz (large frequency numbers left of the decimal).
- 3 Twist the inner (small) knob to change kHz (small frequency numbers to the right of the decimal).
- 4 Once you're sure it's correct, push the "flip-flop" button to swap standby and active frequencies.



TIP

A frequency to memorize is 121.5, the all-purpose emergency frequency. All ATC facilities monitor this frequency (yes, globally) as well as most airline flights and many general aviation pilots. Many radios have a quick access function to dial this automatically. On a Garmin 430 or 530, hold down the flip-flop button.

the frequency you're tuning isn't the one currently in use and doesn't affect anyone listening to, or talking on, a radio. Once the frequency is tuned, you or the pilot can push a frequency exchange (flip-flop) button that moves the standby frequency into the active frequency position, and moves the formerly active frequency into the standby position. It's only after the frequencies have been exchanged that the radio is affected. Once the frequency has been made active, you can't edit it without flip-flopping it back to standby.

You must also know which radio is in use. Most light aircraft have two radios, both for redundancy (in case one fails), and so a pilot or crew can listen to two radios at once (really). This is commonly controlled by an audio panel. Your pilot can explain how your audio panel works.

It's important to know which radio is which because the pilot may be listening to ATC on Com 1

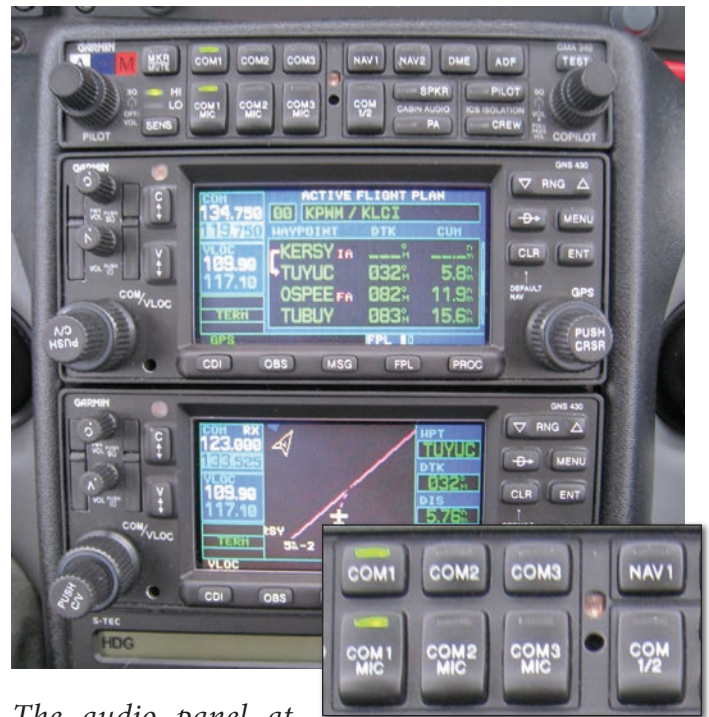
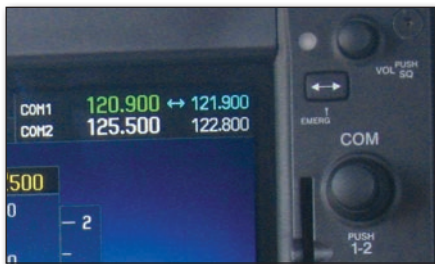

The audio panel at the top of this stack controls which radios are in use. The top row of buttons (labeled COM) control what you and the pilot are listening to, and more than one could be selected. The bottom row (labeled COM/MIC) are the radio used for transmitting, and only one can be selected—unless the COM 1/2 button is used. That means the pilot can listen and transmit on COM 1 while you could listen—and transmit if you wanted (page 40)—on COM 2.

and charge you with, “Put Tower in the active and Ground in the standby of Com 2.” You'd dial the tower frequency into the standby of Com 2, make it active, and then dial the ground frequency into the standby. Then you'd confirm to the pilot, “Tower in active of Com 2. Ground in standby of Com 2.”

Of course, you might be flying in an aircraft with only a handheld radio, which the pilot will probably control, or an aircraft with no radio at all. For many operations, they aren't required.



The locations of radio controls and the display of selected frequencies varies widely. Also, keypads and touchscreens let you enter frequencies as a sequence of digits—once you get to the right screen or control. Ask your pilot to show you.

When you park an airplane, you don't just walk away from it, even when you land at a full service FBO and step out onto a red carpet. There will always be certain items your pilot must accomplish to make sure the airplane is ready for the next flight.

No matter what, check the cockpit and see if any lights have been left on. You'll find them on the rheostats (knobs) and buttons (overhead panel) on most airplanes. There may also be a yoke-mounted light if you were flying at night. Not all of these go off with the master switch. For that matter, did your pilot remember to turn off the master switch?

Clean up any trash and fasten the seatbelts and shoulder harnesses over the seats so they're easy to find. If you're staying for a few days and want to pamper your plane (and yourself) some FBOs offer interior detailing. Replace covers on the pitot tube (and other appendages) and control locks. Every aircraft is different, but once your pilot shows you how these go on, it's easy to do.

If you're parking outside, you'll need to secure the airplane with some kind of tiedown. Ropes or chains are the most common. Ask your pilot if you can assist with any of these items.

You may also have an aircraft cover, especially if you have an airplane with a canopy. A lot of them leak more readily, as do any classic airplanes. This is also a good time to remove any bugs from the leading edges.

Finally, give the airplane a once-over to ensure that nothing looks out of place. Have you left a tow bar in place on the nose gear? Is a baggage door open or unlatched? Are the doors locked? Is the key still in the door? Did you leave any bags under the airplane or on the wings? Any lights still on? It's always best to check again and find something rather than have it nag at you—or, worse yet, cause a real problem.

TIP

Clean the windshield (page 20) before you put on an aircraft cover. Any debris on the Plexiglass can be rubbed against the windshield by the cover if it's windy.

THE "FIGURE 4" AVIATION KNOT

Here is one of the most effective ways to secure the airplane using the ropes.

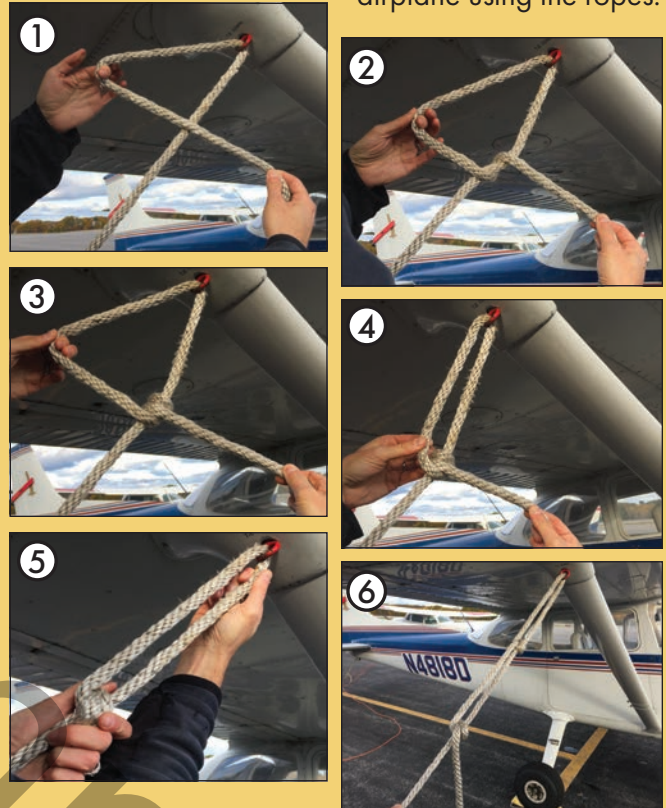

- ① Lift the rope from the ground, run it through the aircraft attach point, and then make a "4" shape with the rope. (This big "4" is for demonstration. In practice, the shape is like the image in step 4 the whole time.)
- ② Pass the rope around and through the triangle of the "4." Leave space between the two turns of rope.
- ③ Pass the rope around and through a second time so the turn of rope goes between the two rope turns in step 2.
- ④ Twist or tighten the loops you just made so there isn't so much slack.
- ⑤ Pull the knot down the rope toward the ground, while simultaneously pulling up on the rope heading up to the attach point on the aircraft. This removes slack in the rope coming up from the ground and tightens the knot you just made.
- ⑥ With light winds or short ropes, this is enough. You can add a second knot of any style to secure the loose end if you wish.

Engage the Autopilot

While this is (obviously) useful during a pilot incapacitation, engaging the autopilot can be helpful in any emergency, if the pilot approves. The autopilot will keep the airplane straight and level and give you (and your pilot) more time to attend to other tasks. It's a skill worth knowing if your airplane has one installed.

TIP

This is great to practice in flight with your pilot before you need it. If you don't know whether the airplane has an autopilot or not, ask your pilot.

The first step is checking if the autopilot is already active. The last thing you want is to turn it off if it's already on. If your airplane has a PFD, look for text at the top of the display that says "AP" plus some combination of the functions "HDG," "GPS," or "NAV." These mean the aircraft's direction is under autopilot control. If you don't have a PFD, look for lit words on a display at the top of the instrument panel or on the autopilot controls. If there's a glowing "HDG" or "NAV" or even "A/P" or "A/P ENG," the autopilot is on. You can take a breath before deciding what to do next. If "NAV" or "GPS" is lit, the autopilot is probably set for your destination.

Conversely, if you see "AP READY" or a light by "RDY" on a control, the airplane has an autopilot, but it's not controlling the aircraft. In this case, keep the airplane straight-and-level with the flight controls (page 43) until you find the autopilot controls.

Autopilots on a light airplane are often stand-alone units. These usually have controls on the pan-



KEEPING THINGS ON THE LEVEL

Some autopilots have a function where one button push will both engage the autopilot and return the airplane to straight-and-level flight. It may be labeled "Level" or similar and is sometimes outlined in blue.

Have your pilot show you this mode—because it's a great first step for you to take in ensuring the airplane stays on a safe path while you sort things out.



el in an instrument cluster, or in the avionics (radio) stack. If you have an integrated system of controls plus flight displays, the autopilot controls could be on the PFD, at the top center of the panel (dashboard), or part of the radio and flight management controls.

Most autopilots will come on if you engage one of their modes. Right now, all you want is to keep the airplane flying straight-and-level. If there's a button for that, push it. If not, the safest two modes to engage—and virtually all autopilots have them—are HDG to hold a heading and ALT to hold the current altitude. Push both of them. The airplane may turn to a new heading, but then it will fly wings level.

If that didn't work—and only if that didn't work—look for a button labeled "AP," or "On/Off" near the HDG or AP buttons. Push it and look for the annunciations that the autopilot is now active.

Remember to control the airplane by hand until you're certain the autopilot is on.

Most autopilot installations require an annunciation panel to indicate they're on. These could be beside the control buttons or top center on the PFD. "Ready" is not on.

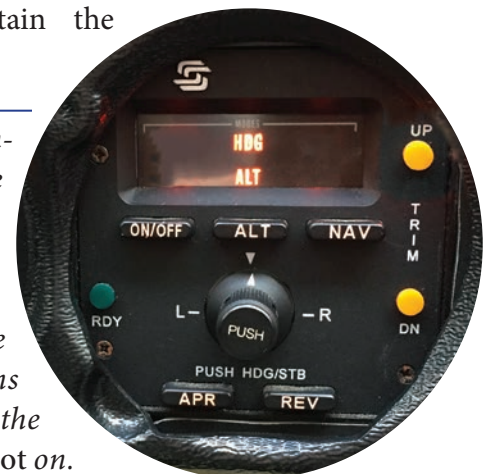

BASIC AUTOPILOT CONTROL MODES

Autopilots vary with the manufacturer but certain functions are common to all. No matter where the control buttons are located (beside the PFD, the center radio stack, the top of the panel) the labels are usually consistent.

HDG points the nose of the airplane using the heading bug on the PFD or heading indicator. This is perhaps the easiest mode to use so long as you know how to turn the heading bug to point the airplane in the direction you want, or where you're told to go when you call for help (page 58).

NAV, GPS, or GPSS follows a course. In light aircraft, that's commonly a GPS course. If you enter a direct-to waypoint (page 64) to get you somewhere safe, pushing NAV should take you there.

ALT holds your current altitude. If the airplane is climbing or descending, ALT should make it level off. Most autopilots will release altitude hold if you push ALT a second time. You can change altitude manually and then reengage ALT at the new altitude. Some autopilots illuminate lights if they need you to trim nose up or down (page 62) as you fly.



VS is vertical speed. You can use this to change altitude in a controlled manner. Pushing VS will turn off ALT. Now you can enter a vertical speed, typically with



either a knob or "UP" and "DN" buttons. If there's a digital display, you should see the rate on that display.

To turn off the autopilot, press the On/Off or AP button, or look for a (usually red) autopilot disconnect switch on the yoke (to the right of the thumb in photo on the right).

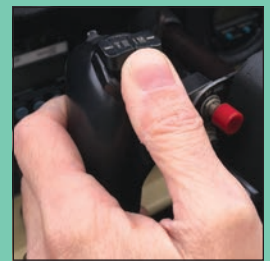

Whenever you use the autopilot, watch the annunciations to ensure you know what mode the autopilot is in.



ADJUSTING THE BUGS



To change the direction the airplane is flying in heading (HDG) mode, you must move the heading bug. This is done with a knob either on the heading indicator, on a center console, or on the PFD. It's usually labeled HDG.

The airplane will turn in the same direction you move the bug and stop turning when the bug is at the top of the instrument again. PFDs have altitude bugs, but changing the bug usually won't change the airplane's altitude.



Request Help in an Emergency

Help in an emergency is only a radio call away. Not only can you contact ATC, but you can also get help from other aircraft, Flight Service, search and rescue ops such as the Civil Air Patrol, or other folks on the ground monitoring the radio, like FBOs. If your pilot is incapacitated and you're flying the airplane by hand (page 43) or by autopilot (page 56), you can even reach a flight instructor to help you land the airplane (see below).

Of course, you may just be relaying messages for a pilot busy dealing with the emergency. In that case, you can ask what frequency to call, tune it (page 38) and repeat what your pilot wants you to say.

If the pilot is incapacitated, the first frequency to try is whatever frequency is already active in the radio. Key the mic and ask for help: "Any facility listening, I'm not a pilot and I need help." The odds are several people will respond and that will get the ball rolling. If no one answers, you should tune 121.5, which is the "guard" or emergency frequency. Every air traffic control location and many airplanes monitor this frequency 24 hours a day.

State who you are and where you are—this is actually the most important information. Not only does it help ATC direct you to the right solution, but it also gives the folks who can help a starting point in the unlikely event that you end up needing search and rescue later on. If you have little time, such as if the pilot has elected to land the airplane off-airport immediately, this may be the critical information that gets rescue personnel heading in your direction.

Then, tell that person the nature of the emergency. Don't worry about special terminology—just relate the problem as succinctly and calmly as possible.

REQUESTING HELP VIA TRANSPONDER

Setting 7700 in the airplane's transponder triggers alarms in ATC facilities even if you never get to say "emergency" on the radio. Ask your pilot how to put 7700 into your aircraft transponder.



A controller may ask you to "ident." This makes your radar signal flash on the controller's radar display so you're easier to find. Push the button labeled "Ident" or "ID" and release it.



Write down any instructions—have pen and paper handy. Even if you're relaying information for your pilot, write it down. It's easy to forget details under stress. Ask for what you need (see below). Verify anything that you don't understand.

The person will likely ask how many people are on board and how much fuel is left. (Include all members of the family, like pets, too.) This is vital info, in both giving you assistance in flight, and setting the stage for search and rescue later.

Many ATC personnel are also pilots—and these professionals have experience helping other pilots in all kinds of situations. Asking for assistance when it's needed is the mark of a good pilot.

SOME THINGS YOU CAN REQUEST FROM ATC IN AN EMERGENCY

You can ask air traffic controllers for things directly, or have them contact the people you need.

"We are landing off-airport. Send search and rescue to our position."

"We need a vector to the nearest airport." (This will be a heading to fly and a distance.)

"We are having a problem and would like personnel standing by when we land." (State the prob-

lem if you know it: "The landing gear won't lower.")

"A passenger on our airplane is in distress. We would like an ambulance waiting when we land."

"I'm not a pilot and need an instructor on the radio to help me land this airplane."

"We're having trouble finding the airport amongst the city lights. Can you turn the runway lighting up and down?" (Really. You can ask that.)

Sample

PilotWorkshops is dedicated to proficiency training for general aviation pilots. Details and samples of our many products are available at www.PilotWorkshop.com.

When you visit, be sure to sign up for the free [Pilot's Tip of the Week](#) (if you don't already subscribe). These are short, focused, and practical tips you can take directly to the cockpit. Developed by our team of nationally recognized instructors, the tips are enjoyed by over 185,000 fellow pilots.

