

CipherLab Reference Manual

Windows Embedded Handheld 6.5

CP60 / CP60G

Version 0.5



PREFACE

COPYRIGHT

Copyright © 2012 CIPHERLAB CO., LTD.

All rights reserved

The information contained in this document, including all pictures, illustrations and software, is the proprietary information of CIPHERLAB CO., LTD. and its respective legal owners; it is protected by copyright laws and international copyright treaties, as well as other intellectual property laws and treaties, with all rights reserved.

In no event and by no part shall this document be reproduced, stored in a retrieval system, or transmitted in any form or by any means including but not limited to electronic, mechanical, photocopying, and recording without the prior written consent of CIPHERLAB CO., LTD. Any reverse engineering of software is also prohibited.

DISCLAIMER

The information herein is subject to change without notice. The information and the intellectual property herein are confidential between you and CIPHERLAB CO., LTD. and remain the exclusive property of CIPHERLAB CO., LTD. and its respective legal owners. Should you find any problems in this document, please report them to CIPHERLAB in writing. CIPHERLAB does not warrant this document is error-free.

TRADEMARK RECOGNITION

CipherLab logo is a registered trademark of CIPHERLAB CO., LTD. Windows Embedded Handheld is a registered trademark or trademark of Microsoft Corporation in the United States and/or other countries. All other brands, products and services, and trademark names are the property of their registered owners. The editorial use of these names is for identification as well as to the benefit of the owners, with no intention of infringement.

CONTACT

For product consultancy and technical support, please contact CIPHERLAB's sales representative in your local area. You may also visit CIPHERLAB web site for more information.

CIPHERLAB CO., LTD.
Website: <http://www.cipherlab.com>

SAFETY NOTICES

FOR HAND-HELD PRODUCT WITH RF FUNCTIONS

CP60 serial handheld equipment uses wireless radios that have been designed and manufactured to meet safety requirements for limiting exposure to radio waves. When used in accordance with the instructions set forth in this manual, the equipment has been independently verified to not exceed the emission limits for safe exposure to radio frequency (RF) energy as specified by EN50360 of EEC.

These limits are part of comprehensive guidelines and establish permitted levels of RF energy for the general population. The guidelines are based on standards that were developed by independent scientific organization through periodic and thorough evaluation of scientific studies. The standards include a substantial safety margin designed to assure the safety of all persons, regardless of age and health.

The exposure standard for all wireless devices employs a unit of measurement known as the Specific Absorption Rate, or SAR; the SAR limit set by CE is 2.0W/Kg.

For trunk, the SAR value of CP60 serial body is: 1.028W/Kg

EEC: MAX 1.35 W/Kg (CP60G)

FOR PRODUCT WITH LASER



CAUTION

This laser component emits FDA / IEC Class 2 laser light at the exit port. Do not stare into beam.

SAFETY PRECAUTIONS

RISK OF EXPLOSION: IF BATTERY IS REPLACED BY AN INCORRECT TYPE. DISPOSE OF USED BATTERIES ACCORDING TO THE INSTRUCTIONS.

- ▶ The use of any batteries or charging devices, which are not originally sold or manufactured by CipherLab, will void your warranty and may cause damage to human body or the product itself.
- ▶ DO NOT disassemble, incinerate or short circuit the battery.
- ▶ DO NOT expose the scanner or the battery to any flammable sources.
- ▶ For green-environment issue, it's important that batteries should be recycled in a proper way.
- ▶ Under no circumstances, internal components are self-serviceable.
- ▶ The charging and communication cradle uses an AC power adapter. A socket outlet shall be installed near the equipment and shall be easily accessible. Make sure there is stable power supply for the mobile computer or its peripherals to operate properly.

CARE & MAINTENANCE

- ▶ This mobile computer is intended for industrial use. The mobile computer is rated IP65, however, the mobile computer can get damaged when being exposed to extreme temperatures or soaked wet.
- ▶ When the enclosure of the mobile computer gets dirty, use a clean and wet cloth to wipe off the dust. DO NOT use/mix any bleach or cleaner. Always keep the LCD dry.
- ▶ For a liquid crystal display (LCD) or touchscreen, use a clean, non-abrasive, lint-free cloth to wipe dust off the screen. DO NOT contact the surface with any pointed or sharp object.
- ▶ If you want to put away the mobile computer for a period of time, download the collected data to a host computer, and then take out the battery pack. Store the mobile computer and battery pack separately.
- ▶ When the mobile computer resumes its work, it takes some time for the main and backup batteries to become fully charged.
- ▶ If you shall find the mobile computer malfunctioning, write down the specific scenario and consult the sales representative in your local area.

DECLARATION OF CONFORMITY



Declaration of Conformity

Manufacturer

CIPHERLAB Co., Ltd.

12F., 333, Dunhua S. Rd., Sec. 2

Taipei, Taiwan 106, R.O.C.

Tel: +886 2 8647 1166

<http://www.cipherlab.com>

European information

CipherLab GmbH

Willicher Damm 145

41066 Mönchengladbach, Germany

Tel: +49 2161 56230

<http://www.cipherlab.de>

Type of Equipment

Mobile Computer

Model(s) Declared

CP60, CP60G

Initial Year of Manufacture

2012

Reference to the specification under which conformity is declared in accordance with Directive-2004/108/EC, 95/5/EC

EN 300 328 V1.7.1:2006	EN 300 440-1 V1.6.1:2010
EN 300 440-2 V1.4.1:2010	EN 301 489-1 V1.8.1:2008
EN 301 489-17 V2.1.1:2009	EN 301 489-24 V1.5.1:2010
EN 301 489-3 V1.4.1:2002	EN 301 489-7 V1.3.1:2005
EN 301 511 V9.0.2:2003	EN 301 908-1 V5.2.1:2011
EN 301 908-2 V3.2.1:2007	EN 50360:2001
EN 62209-1:2006	EN 62209-2:2010
EN 62311:2008	EN 62479:2010

The manufacturer also declares the conformity of above mentioned product with the actual required safety standards in accordance with Directive 2006/95/EC

EN 60950-1 : 2006+A11:2009

Safety for information technology equipment including electrical business equipment

I the undersigned, hereby declare that the equipment specified above conforms to the above Directive(s) and Standard(s).

Representative:

Signature

Full Name

Title

Herbie Jiang
Assistant Manager

Herbie.Jiang@cipherlab.com.tw

<http://www.cipherlab.com>

RELEASE NOTES

Version	Date	Notes
0.5	20 th Sep 2012	Draft version

CONTENTS

PREFACE	- 2 -
Copyright.....	- 2 -
Disclaimer.....	- 2 -
Trademark Recognition	- 2 -
Contact.....	- 2 -
Safety Notices.....	- 3 -
For Hand-held Product with RF Functions	- 3 -
For Product with Laser	- 3 -
Safety Precautions.....	- 4 -
Care & Maintenance.....	- 4 -
Declaration of Conformity	- 5 -
RELEASE NOTES	- 6 -
INTRODUCTION	1
About This Document	1
Features.....	2
Inside the Package	2
Accessories	2
USE MOBILE COMPUTER	3
1.1. Take A Tour	4
1.1.1. Overview	4
1.1.2. Inside Battery Chamber	5
1.1.3. Before Initial Use	5
1.2. Power On Mobile Computer	6
1.3. Notifications	7
1.4. Battery.....	9
1.4.1. Main Battery Setup	9
1.4.2. Charge Batteries	12
1.4.3. Monitor Battery Level	14
1.4.4. Power Management.....	17
1.4.5. Optimize Battery Life	18
1.5. Text Input.....	19
1.5.1. Physical Keypad	19
1.5.2. Onscreen Keyboard	28
1.5.3. Edit Text	32
1.6. Touch Control	34
1.6.1. Use Touchscreen	34
1.6.2. Adjust Backlight	34
1.6.3. Calibration	35
1.7. Memory	37
1.7.1. Data Loss Caution	37
1.7.2. Check Storage	37
1.7.3. Insert SD Card	40

1.8.	Direct Data Connection	41
1.8.1.	Use Cable.....	41
1.8.2.	Use Cradle.....	41
1.8.3.	Syncing Tools	42
1.8.4.	Sync Partnership	42
1.8.5.	1 st USB Sync	42
1.8.6.	Disconnect USB ActiveSync	45
1.8.7.	ActiveSync Actions to Take.....	46
1.9.	Audio Playback	52
1.9.1.	Volume Control.....	52
CAMERA	54
2.1.	Launch Camera.....	55
2.1.1.	Camera Screen	55
2.2.	Take Pictures	56
2.2.1.	Camera Settings	56
2.3.	Launch Video Camera	59
2.3.1.	Video Camera Screen.....	59
2.4.	Shoot Videos	60
2.4.1.	Video Camera Settings	60
2.5.	Pictures & Videos	63
OPERATING SYSTEM.....	66
3.1.	1 st Startup	67
3.2.	Today Screen	68
3.2.1.	Customize Today Screen.....	69
3.2.2.	Return to Today Screen	69
3.3.	Start Screen.....	70
3.3.1.	Return to Start screen	71
3.3.2.	Title Bar	71
3.3.3.	Manage Notifications	73
3.3.4.	Customize Start Screen	75
3.3.5.	Start Screen Icons.....	78
3.4.	Suspend & Reset Mobile Computer.....	80
3.4.1.	Suspend Mobile Computer	80
3.4.2.	Wake up Mobile Computer.....	81
3.4.3.	Reset Mobile Computer	81
3.5.	Set Screen Lock	83
3.5.1.	Unlock Screen	83
3.6.	Work with Menus	84
3.6.1.	Option Menus	84
3.6.2.	Context Menus.....	85
3.7.	Manage Applications.....	86
3.7.1.	Task Manager	86
RADIOS.....	93
4.1.	Access Cellular WAN.....	93
4.1.1.	Status Icons	93
4.1.2.	Check What Network You're Using.....	93

4.1.3.	Enable/Disalbe Mobile Data	94
4.1.4.	Use Only 2G Networks.....	94
4.1.5.	Cellular Data Setup	95
4.1.6.	Edit & Add Access Points	96
4.1.7.	USB Internet Sharing	97
4.2.	Use Wi-Fi	99
4.2.1.	Status Icons	99
4.2.2.	Enable/Disable Wi-Fi	99
4.2.3.	Wi-Fi Connection Setup	100
4.2.4.	Connect Another Wi-Fi network	104
4.2.5.	Edit Wi-Fi Networks	104
4.2.6.	Forget Wi-Fi Netowrks	104
4.2.7.	Receive notifications of Available networks.....	104
4.2.8.	Add Wi-Fi Networks.....	105
4.2.9.	Connect by Static IP	106
4.2.10.	Advanced Wi-Fi Settings	107
4.3.	Use Bluetooth.....	108
4.3.1.	Status Icons	108
4.3.2.	Change Bluetooth name	108
4.3.3.	Expose Mobile computer	109
4.3.4.	Turn on/off Bluetooth.....	111
4.3.5.	Pair & Connect Bluetooth devices.....	111
4.3.6.	Disconnect Bluetooth Devices.....	113
4.3.7.	Unpair Bluetooth Devices.....	114
4.3.8.	Reconnect Bluetooth devices	114
4.3.9.	Edit Bluetooth Features to Use	114
4.3.10.	Bluetooth File Exchange	115
4.3.11.	Bluetooth ActiveSync	117
4.3.12.	Bluetooth Internet Sharing	118
4.3.13.	Bluetooth Pass-through Networking.....	119
4.4.	Connect to Virtual Private Networks	120
4.4.1.	VPN Connection Setup	120
4.4.2.	Connect VPN	122
4.4.3.	Disconnect VPN.....	123
4.4.4.	Edit a VPN.....	123
4.4.5.	Delete a VPN.....	123
4.5.	Install Secure Certificates	125
4.5.1.	Supported Certificate Formats	125
4.5.2.	View Secure Certificates.....	125
4.5.3.	Install secure Certificates	125
4.6.	Location Discovery	127
4.6.1.	Launch GPS.....	127
4.6.2.	Use GPS.....	128
PHONE	129
5.1.	About Phone	130
5.2.	SIM Card	130
5.2.1.	Assemble SIM Card	130
5.3.	Status Icons	130

SPECIFICATIONS..... 133

- Platform, Processor & Memory 133
- Communications & Data Capture 133
- Electrical Characteristics..... 134
- Physical Characteristics 135
- Environmental Characteristics..... 136
- Programming Support 136
- Accessories 137

INTRODUCTION

Thank you for choosing CipherLab products. CipherLab welcomes another Windows Embedded by introducing CP60 Series Mobile Computer. Powered by Windows Embedded Handheld 6.5, the mobile computer delivers better user experience and promises enterprise mobile computing.

The mobile computer has transfective LCD to hold up the readability in a wide range of light conditions, courtesy of the supplementary backlight enabled by a built-in ambient light sensor. Also on board is a G-sensor to save power according to the mobile computer's motion and posture. G-sensor also enables screen orientation when the device is posed sideways or upright. Furthermore, the mobile computer has integrated a built-in e-compass and gyroscope, both of which provide useful functions in navigation.

The series sports satisfactory data connections by integrating a communication port for direct data exchange. For wireless data connections it hosts each Bluetooth and 802.11a/b/g/n module while a HSPA+ module (CP60G only) is provided on option.

Dedicated to data capture, the mobile computer has essential 1D (laser) reader or 2D imager. A high-specced 5 mega-pixel camera also comes inside to take pictures and shoot videos to deliver better documentation for users.

Rated with IP65/67, the rugged CP60 Series are light-weighted and easy to cradle in your hand, and will be your good help on field works.

ABOUT THIS DOCUMENT

This guide distills the information about CP60 Series Mobile Computer. Subjects discussed include the mobile computer's physical features, platform basics, software and applications, and part of the accessories to boost the mobile computer's performance.

We recommend that you keep one copy of this manual at hand for the quick reference for necessary maintenance.

CP60 Series include CP60 and CP60G,

CP60 : Radio include WLAN (a/b/g/n), Bluetooth (2.1+EDR), GPS

CP60G : Radio include WWAN (HSPA+), WLAN (a/b/g/n), Bluetooth (2.1+EDR), GPS

FEATURES

- ▶ Rugged yet smoothened outlined, with hand strap for secure hold
- ▶ IP65/67-rated tough form to survive drop, shock, heat, cold, and impervious to moisture/dust.
- ▶ Windows Embedded Handheld 6.5 OS, TI DM3730 1GHz CPU
- ▶ 512MB SDRAM to run application programs
- ▶ 4GB NAND flash to store OS, applications, settings and so on.
- ▶ Storage expansion: Up to 32GB MicroSDHC.
- ▶ OS upgradable through USB connection
- ▶ Sunlight-readable screen to enhance the viewability of outdoor use.
- ▶ Ambient light sensor to enable supplementary backlight for LCD and keypad.
- ▶ G-sensor for power management and screen orientation.
- ▶ Gyroscope sensor and E-compass for direction sensing
- ▶ Proximity sensor for disabling touch screen action during calls
- ▶ 2 symmetric side-triggers for ambidextrous scanning
- ▶ Total data solution — supporting Bluetooth, 802.11a/b/g/n and HSPA+ (CP60G only)
- ▶ Built-in GPS receiver to deliver location discovery
- ▶ 5 mega-pixel camera for taking pictures and shooting videos.
- ▶ C++ and .Net programming support

INSIDE THE PACKAGE

The mobile computer ships with the following items. Save the box and packaging material in case of future need to store or deliver the mobile computer.

- ▶ Mobile Computer
- ▶ Rechargeable Li-ion battery pack (standard/high capacity)
- ▶ Stylus
- ▶ Screen protector
- ▶ Hand strap
- ▶ Product CD
- ▶ Quick Start Guide

ACCESSORIES

Optional accessories to enhance the mobile computer's performance:

- ▶ Pistol Grip
- ▶ Snap-on Charging and Communication Cable
- ▶ Charging & Communication Cradle
- ▶ Belt Holster

Chapter 1

USE MOBILE COMPUTER

Before the mobile computer takes part in your work, get to know it first. This chapter combs the basic features of the mobile computer including the power supply, memory, and the units that bridge users with the mobile computer. This chapter helps you set the mobile computer to work at the earliest.

1. IN THIS CHAPTER

1.1 Take A Tour	4
1.2 Power On.....	6
1.3 Notifications.....	7
1.4 Battery.....	9
1.5 Text Input	19
1.6 Touch Control.....	34
1.7 Memory.....	37
1.8 Direct Data Connection	41
1.9 Audio Playback	52

2.1. TAKE A TOUR

This section shows the major components on the mobile computer and inside battery chamber. You will also learn how to power on/off the mobile computer and how the mobile computer gives information about its status.

2.1.1. OVERVIEW

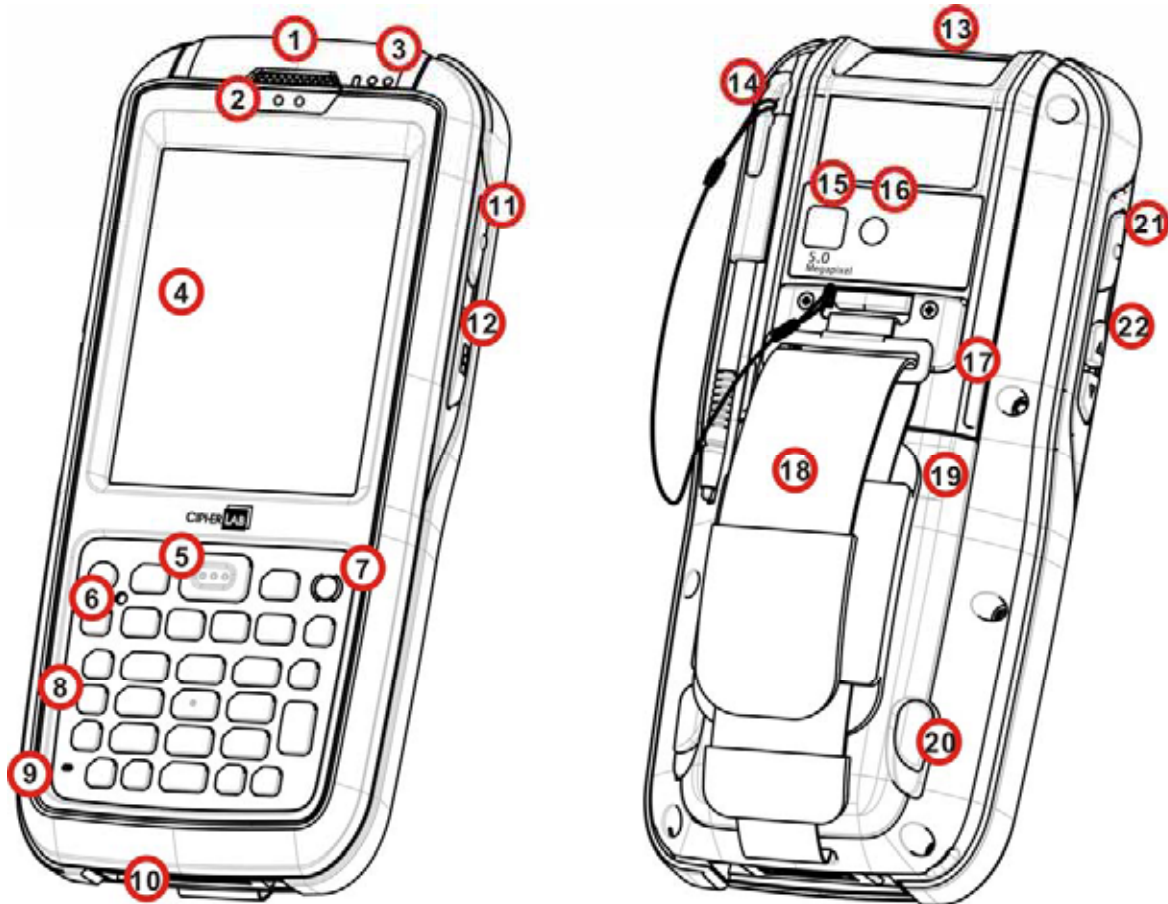

Figure 1: Overview

No.	Description	No.	Description
1	Receiver	2	Sensors (proximity sensor & light sensor)
3	Status LEDs	4	Touchscreen (QVGA)
5	Scan key	6	Reset button (recessed in keypad)
7	Power button	8	Keypad
9	Microphone	10	Charging and communication port
11	Side trigger (user-definable)	12	Camera shutter key
13	Scan window	14	Stylus (with attaching cord)
15	Camera	16	Camera flash
17	Speaker	18	Handstrap
19	Battery door	20	Battery door latch
21	Side trigger (user-definable)	22	Volume rocker

2.1.2. INSIDE BATTERY CHAMBER

Inside the battery chamber of the mobile computer are the sockets for SIM card and storage card. Each is equipped with a hinged cover.

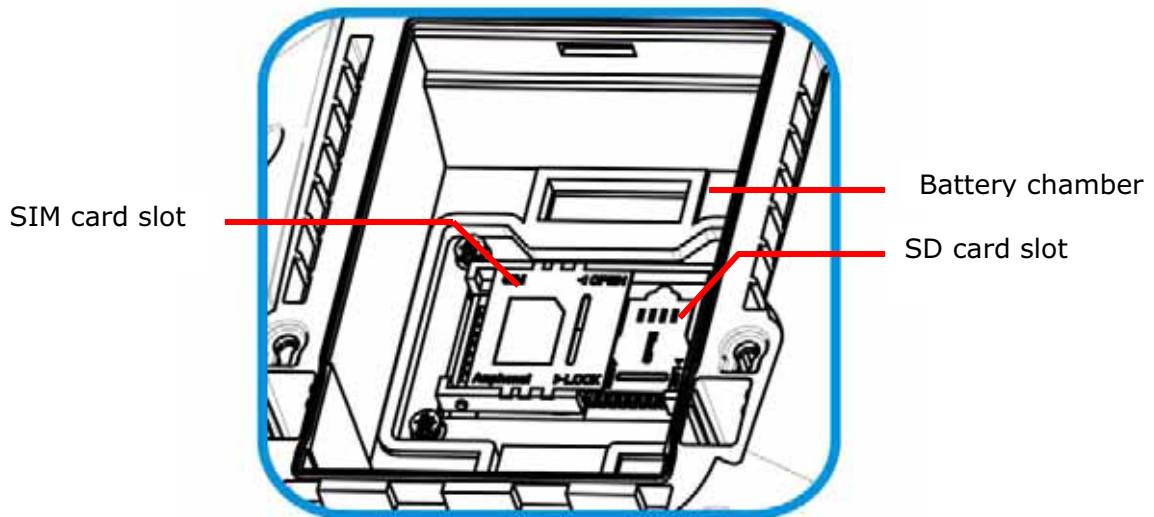

Figure 2: Inside Battery Chamber

2.1.3. BEFORE INITIAL USE

Prior to using the mobile computer for the first time, it is recommended to apply the protective film over the LCD. This will prevent scratching the touchscreen during daily usage, and also help enhance the durability of the touchscreen.

To apply the LCD protective film:

- 1) Upon delivery, the touchscreen of the mobile computer is covered with a thin transparent film. Peel off and discard this film.
- 2) Wipe the touchscreen with a clean, non-abrasive, lint-free cloth.
- 3) Carefully apply the LCD protective film to the touchscreen by aligning its edges with the edges of the touchscreen. Make sure the film adheres tightly to the surface.

The mobile computer is then ready for usage.

2.2. POWER ON MOBILE COMPUTER

To power on the mobile computer, press the Power button  sitting at the upper right of the keypad.

This Power button is also a suspend button. Press without holding this button to suspend the mobile computer when you are not actively using it. Press it again to wake the mobile computer from suspension. See [Suspend Mobile Computer](#) for details.

2.3. NOTIFICATIONS

The mobile computer features visible, audible, and tactile feedback to draw users' prompt awareness of the mobile computer's contiguous events such as barcode reading, wireless/mobile data connections, and battery charging.

STATUS LED

Three LED lights are located on the upper-right corner of the mobile computer. Their functions are:

Matter	LED Color	Action	Description
Battery Charging (Right)	Green, Orange, Red	Green, solid	Battery is nearly fully charged (battery level > 95%).
		Orange, solid	Battery is charging, and battery level is sufficient for the mobile computer to power on.
		Red, solid	Battery is charging, but battery level is too low for the mobile computer to power on.
		Red, slow blinking for 3 times	Battery charging error (battery failure). Replace battery with another one.
		Red, fast blinking continuously	Charging error that may be caused by temperature dropping below 0°C or exceeding 35°C. See also Charge Batteries .
Scanning Good Read (Middle)	Green	On for less than 1 second, then off	Indicates good reading results of the scanned barcode. Enable/disable this notification with the CipherLab utility Reader Config.
Radios (Left)	Blue	Blinking	Wi-Fi, Bluetooth or mobile data in use.

LED light is also programmable. See the API library that is readied for your reference.

SPEAKER

The mobile computer has a speaker on the back for audio signaling, audio playback, and phone ringtones.

The speaker sounds for system events, application warnings, onscreen items selections and stroke on physical keypad. In noisy environment, the speaker remains efficacious with the help of a headset. To control sound volume, see [Volume Control](#).

The speaker also sounds for good barcode reading, which can be enabled/disabled by CipherLab's Reader Config.

VIBRATOR

The mobile computer owes the tactile feedback to the vibrator built inside. Vibration delivered to the mobile computer alerts users of its currents status.

Working based on user's sense, the vibrator is particularly helpful when the mobile computer is serving in noisy environment.

Same as the speaker and LED light, the vibrator works for good barcode reading. CipherLab's utility Reader Config enables users to turn the vibration on/off and decides the duration.

The vibrator is also programmable. See the API library that is provided for your reference.

2.4. BATTERY

The mobile computer is fed by two batteries, main battery pack and backup battery. The main battery is removable and replaceable from battery chamber while the backup battery is mounted on the main board inside the mobile computer.

When the mobile computer is shipped, the main battery is stored in a package separated from the mobile computer, which keeps it in good condition for future use.

MAIN BATTERY

The main battery is a Li-ion battery pack that comes in two sizes, a standard 3.7V/3600mAh pack and an extended 3.7V/4400mAh pack. Both types will take around 4 hours to charge to full. The working time of the mobile computer varies by its working states. Under normal operation, it works for at least 12 hours. An icon on [Title Bar](#) helps monitor main battery level. See [Main Battery Level](#).

See also [Main Battery Setup](#) for the assembly.

BACKUP BATTERY

The backup battery settles on the main board inside the mobile computer. It is a 15 mAh rechargeable Li-ion battery. When main battery is absent or depleted, backup battery takes over to feed the mobile computer. Without main battery, a fully charged backup battery retains the data in the DRAM and holds the system in suspension for 30 minutes(as long as wireless modules are inactive).

The backup battery is rechargeable by the external power (through power adapter) or main battery pack. It takes about 58 hours to charge it to full. An  icon on the [Title Bar](#) makes it observant that backup battery gets low. See also [Backup Battery Level](#).

2.4.1. MAIN BATTERY SETUP

To secure main battery in place, the battery door is equipped with two latches, one on each side.

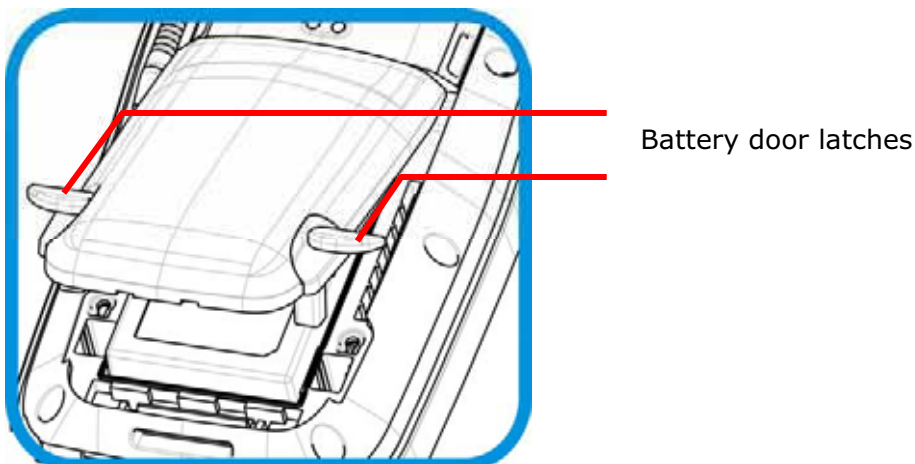

Figure 3: Battery Door Latches

To install main battery pack, follow through the steps below by referencing to the illustrations:

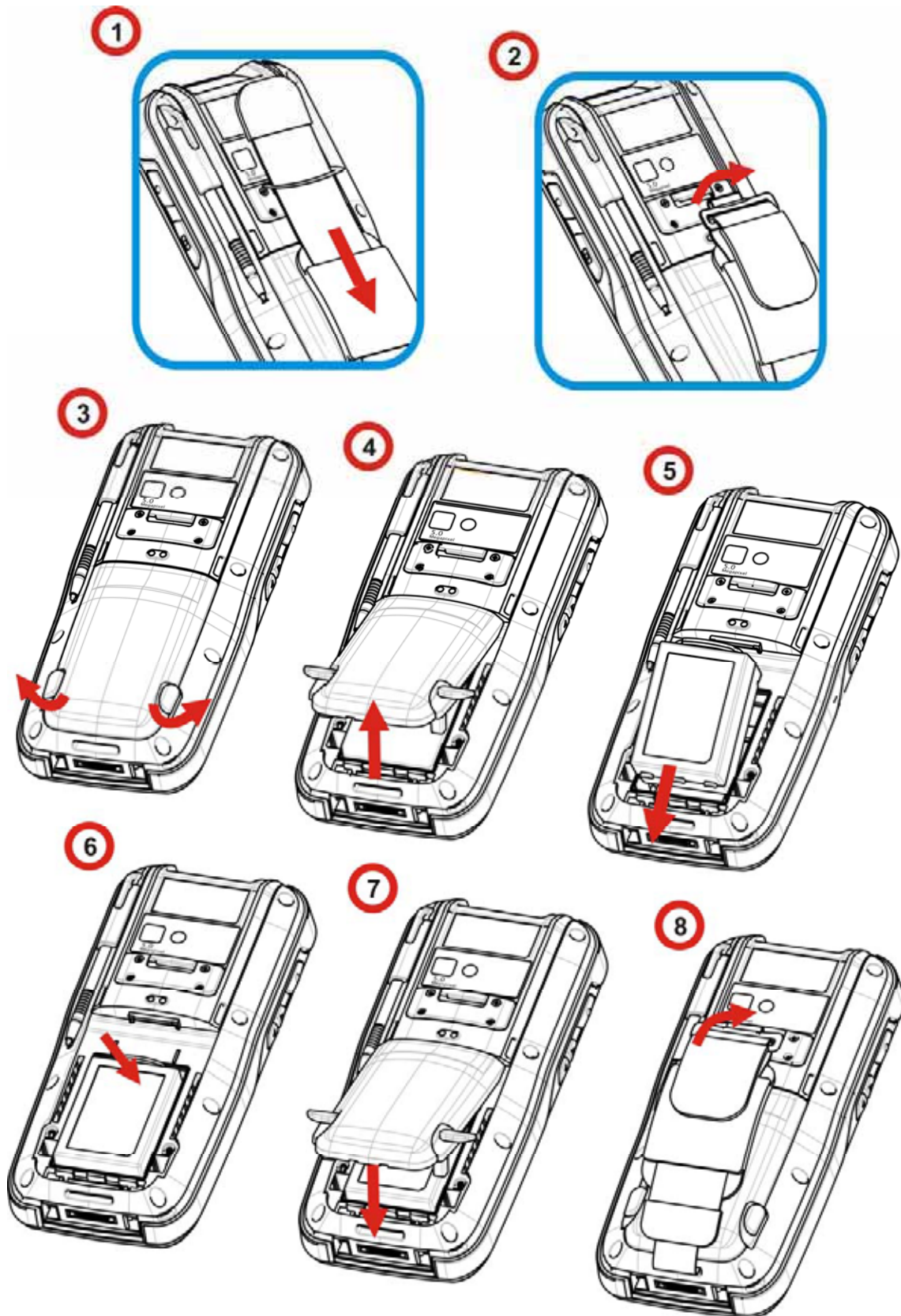

Figure 4: Main Battery Setup

- 1) Loosen the handstrap and pull it downwards so the metal hook is positioned at the lower edge of the Velcro band
- 2) Unhook the hand strap by pressing the square metal ring lightly in the middle and lifting it upwards in a single motion.
Note: The lower end of the handstrap can be left as is without detaching. After the main battery is installed, the handstrap can be hooked back into place.
- 3) On the outer sides of the battery door are two door latches. Pull them outwards to unlock battery door.
- 4) Lift up the lower end of the battery door to remove it.
- 5) Position the main battery pack into the battery chamber with the contact pins facing down. Fix the bottom edge first.
- 6) Press the upper end of the main battery inwards until the clip at the top "clicks" into place.
- 7) Replace the battery door. Fix the upper edge first and then press the lower edge in. Push the door latches back to their original position.
- 8) Secure the handstrap hook back into its groove.

Note: (1) When main battery level drops to low level, charge it ASAP or replace it with a charged one.
(2) Always turn off the mobile computer to replace the main battery pack.
(3) The battery door must be secured in place for the mobile computer to operate.
(4) Any improper handling may reduce battery life.

2.4.2. CHARGE BATTERIES

Due to shipment, it is likely that the main battery and backup battery won't be fully charged when you receive the package. Before setting the mobile computer to work, charge the main battery to full by direct charging via a power adapter (with the help of a Snap-on Charging & Communication Cable or Charging & Communication Cradle).

Since the main battery is the only source backup battery taps power from, be sure to install main battery for the 1st charge so both main battery and backup battery get charged.

Some key facts about charging batteries:

Charging Time

- ▶ **Main battery:** It takes circa 4 hours to charge main battery to full (via direct charging with power adapter). The battery charging LED above the touchscreen (the one to the right) lights red or orange during charging (depending on the battery level at the moment), and lights green when mobile computer is near 100% charged.
- ▶ **Backup battery:** The backup battery is rechargeable by both main battery and power adapter. It takes about 8 hours to charge it to full, however it does not need to be fully charged for the mobile computer to work.

Charging Temperature

- ▶ It is recommended that batteries be charged at room temperature (18°C~25°C) for optimal performance.
- ▶ Charging stops when temperature drops below 0°C or exceeds 35°C. In this case the battery charging LED will be continuously blinking in red.

Power Consumption

- ▶ When all radios (802.11 a/b/g/n, Bluetooth, mobile data (HSPA+), GPS) are active on battery power, main battery level drops substantially.
- ▶ In order to prevent the system from shutting down due to depleted main battery, we suggest that you keep a fully charged battery for replacement or have the mobile computer access the radios on external power.

The following guides how to charge batteries.

DIRECT CHARGING USING SNAP-ON CABLE

Direct charging the mobile computer relies on the Snap-on Charging & Communication Cable (hereinafter "snap-on cable"). There is a power jack on the connector of this cable to connect external power.

Prior to charging, install main battery as described in [Main Battery Setup](#). Then follow the steps below:

- 1) Attach the snap-on cable to the mobile computer.
- 2) Plug the head of the power adapter cord into the power jack located on snap-on cable's connector.
- 3) Connect the power adapter to a power outlet.

To output data to your PC or laptop, connect the snap-on cable (either USB or RS-232 format) to it. See [Direct Data Connection](#) for follow-ups.

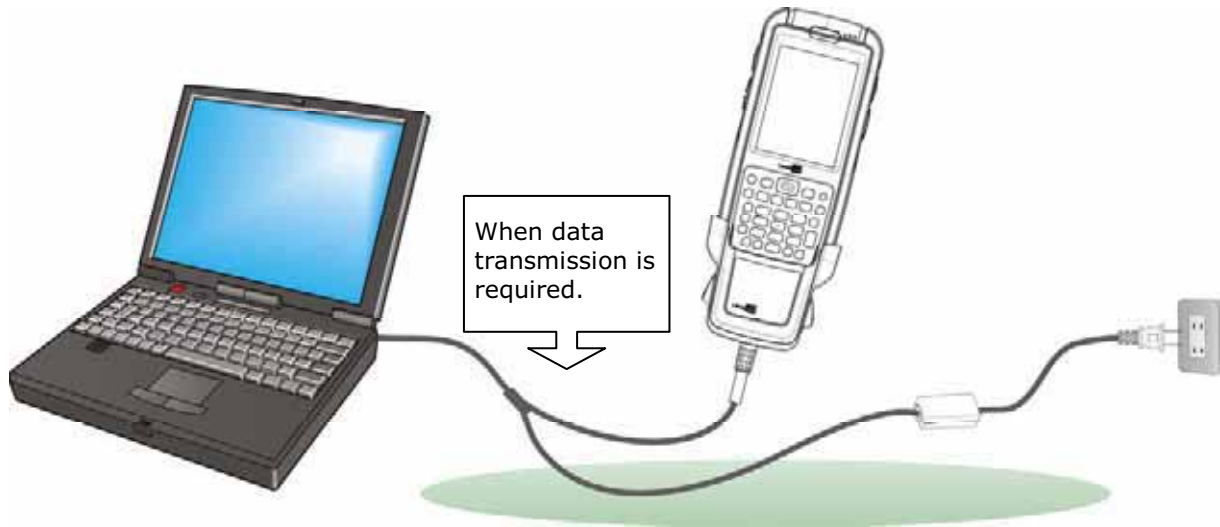

Figure 5: Direct Charging Using Snap-on Cable

2.4.3. MONITOR BATTERY LEVEL





Main battery is the only source that feeds the mobile computer to work. It also supplies the backup battery on main board to retain the data stored in DRAM. Hence when main battery level gets low, recharge it or change it as soon as possible. But foremost, back up the important data from time to time to protect your work.

MAIN BATTERY LEVEL

The O.S. features a few icons for user's immediate awareness of main battery level. These icons avail themselves of [Title Bar](#) to show. [Title Bar](#) settles at the top of almost every screen.



STATUS ICONS

Main battery icons communicate the following statuses:

Icon	Battery Status
	Main battery is being charged from external power.
	Main battery level is 70% to full.
	Main battery level is partially drained between 40%-69%.
	Main battery level is between 20%-39%.
	Main battery has dropped between 10%-19% Battery needs charging immediately.

MORE CHARGE INFO

To know more about main battery level:

- 1) Tap Windows icon  on [Softkey bar](#) or hit physical Windows key . Start screen opens.
- 2) Tap **Settings | System | Power** .

Power application opens showing **Battery** tabbed page. The page shows a horizontal bar to enable quick grasp of battery level at a glance.

When main battery isn't being charged, the page displays the remaining power in a horizontal bar. When main battery is being charged, the page indicates that the battery is in "charging" state. The current battery level is encapsulated in the horizontal bar whether the battery is under charging or not.

Main battery isn't being charged.

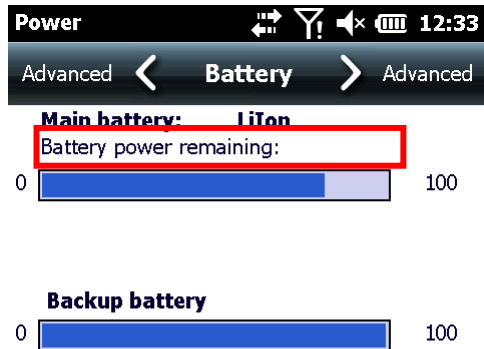

Main battery is being charged.

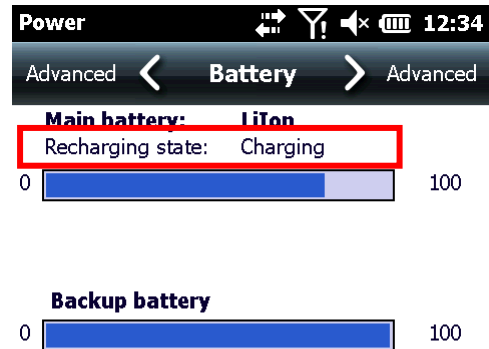

Power amount delivered in percentage enables more accuracy.



The horizontal graphic bar shows coarse power amount.

LOW BATTERY ALERTS

When main battery level drops below 40% , the mobile computer prompts "Main Battery Low" for a recharge. When further reduced to under 20%, the mobile computer prompts "Main Battery Very low" to solicit your immediate transaction.

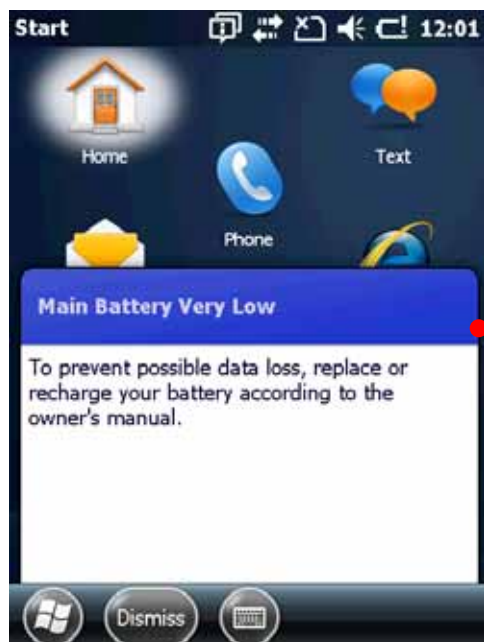

Main Battery Very Low prompt

Low battery may incur shutdown to the mobile computer and cause DRAM data damage. Always save data before running short of power or keep a fully charged battery at hand for replacement.

Note: Constant usage of the mobile computer at low battery level can affect battery life. For maximum performance, recharge the battery periodically to avoid battery drain out and maintain good battery health.

When main battery drains out entirely, the mobile computer shuts down automatically. Backup battery takes over to hold DRAM data for 30 minutes if it is fully charged. When this occurs, replace main battery pack immediately.

BACKUP BATTERY LEVEL

For user's immediate awareness of backup battery level, O.S. shows an  icon on [Title Bar](#) when battery level drops low.



STATUS ICONS

Backup battery icon delivers the following statuses:

Icon	Battery Status
	Battery level has dropped low and needs charging.

MORE CHARGE INFO

To learn more about backup battery level:

- 1) Tap Windows icon  on [Softkey bar](#) or hit physical Windows key .
Start screen opens.
- 2) Tap **Settings | System | Power**.

Power application opens showing Battery tabbed page. Backup battery level displays in a horizontal bar beneath Main battery level:

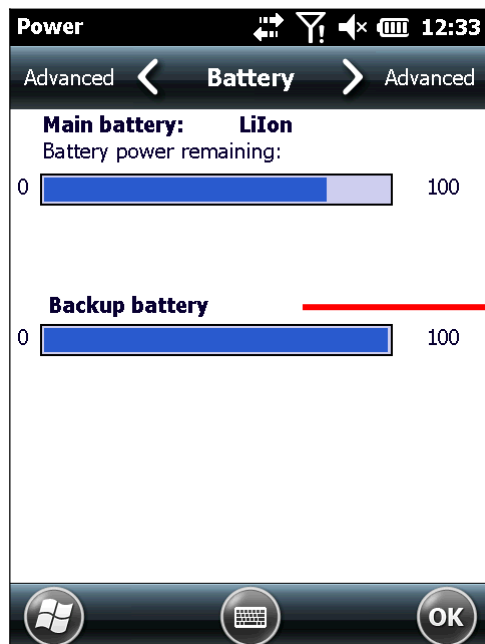

Backup battery level is displayed in a horizontal bar

LOW BATTERY ALERT

When backup battery drops low, the mobile computer prompts for recharge with a dialog. And [Title Bar](#) shows an  icon.

Backup battery is rechargeable by external power (through power adapter) or main battery pack.

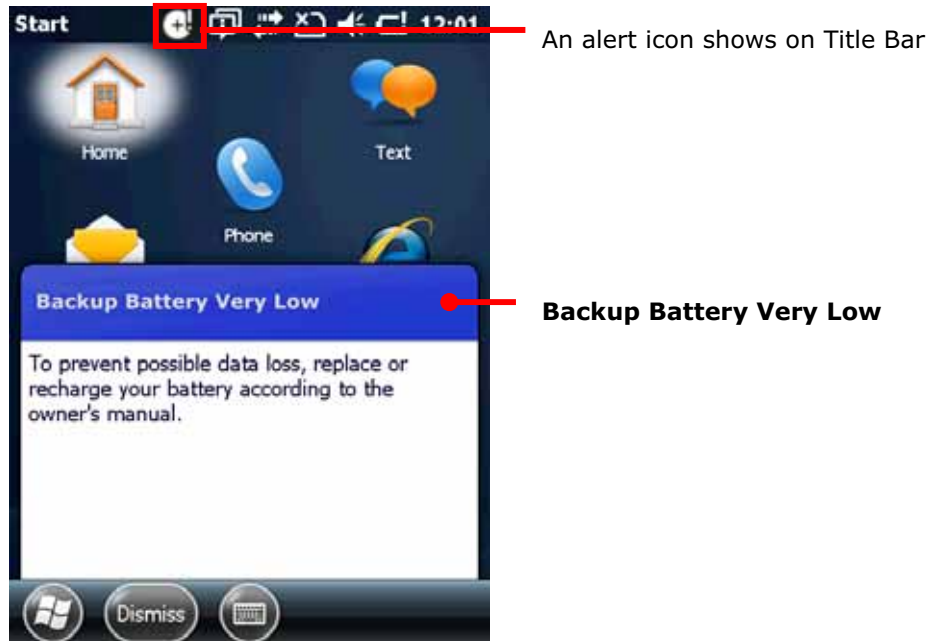

Low backup battery puts DRAM data in great danger. Always save data from time to time or keep a fully charged battery at hand for replacement.

Once backup battery drains out completely, the data in DRAM is gone. Any data yet to be saved is lost!

2.4.4. POWER MANAGEMENT

The mobile computer features "suspension", a "soft-off" state allowing the mobile computer to consume less power and quickly to wake up.

The mobile computer auto-enters "suspension" when one of the following happens:

- ▶ When placed face-down, which suggests the mobile computer isn't actively used.
- ▶ When battery door isn't in place.

And it wakes up from the following events:

- ▶ Power button or scan key pressed
- ▶ USB cable plugging

Note the mobile computer is also manually suspensible through Power button. See [Suspend Mobile Computer](#).

2.4.5. OPTIMIZE BATTERY LIFE

Power issues are critical for portable devices. Always turn off the features you don't need on the mobile computer to save power. To extend battery life as long as possible, always take the following actions:

- ▶ Suspend the mobile computer when it isn't actively used. (See [Suspend Mobile Computer](#).)
- ▶ Turn down LCD backlight brightness as described in [Adjust Backlight](#), and set a shorter LCD timeout as described in [Suspend & Reset Mobile Computer](#)
- ▶ Auto Sync the mobile computer with your PC less frequently. See [Direct Data Connection](#).
- ▶ If you are using any "push e-mail" or any automatic syncing service on the mobile computer, change the syncing schedule to manually check updates.
- ▶ When Wi-Fi, Bluetooth, mobile data (HSPA+), or GPS isn't used, turn it off. See [Radios](#).

2.5. TEXT INPUT

The mobile computer has a physical keypad and a touchscreen to receive user's input. Among the two, the touchscreen provides more intuitiveness than the physical keypad to interact with the device.

This section shows how to input text using physical keypad and onscreen keyboard. To know how to touch-control the mobile computer, see [Touch Control](#).

2.5.1. PHYSICAL KEYPAD

The physical keypad sitting front the mobile computer is quite an advanced one with much resemblance to laptop or PC keyboards. It supports multi-key operation, which normally requires two keys hit simultaneously, one of which a modifier key,

The physical keypad is either a numeric type or a QWERTY one. Each wedges a set of "enhanced keys" along the top and a set of character keys at the lower half.

As for entering text, the numeric and QWERTY keypad are equally capable of entering numbers, letters, symbols and a few punctuations. Both also receive supplementary backlight as the screen does.



Figure 6: Numeric Keypad



Figure 7: QWERTY Keypad

"ENHANCED KEYS"

"Enhanced keys" are arranged along the top of physical keypad and separated from character keys. Use these "enhanced keys" to launch actions from the mobile computer and O.S., cause the active application to work, or switch physical keypad between input modes. Navigation keys are included also to move the caret in a text input field.

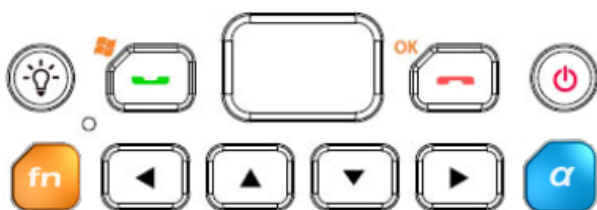













































































Figure 8: Enhanced Keys



Enhanced keys can be categorized to five groups and explicated as follows:

Key Group	Description																
ACTION KEYS	<p>“Action keys” are Scan key and Backlight key. They cause the mobile computer to deliver functions as below:</p> <table border="1"> <thead> <tr> <th>Key</th> <th>Press</th> </tr> </thead> <tbody> <tr> <td> Scan Key</td> <td>Reads barcodes</td> </tr> <tr> <td> Backlight Key</td> <td>Turns on/off screen backlight.</td> </tr> </tbody> </table>	Key	Press	 Scan Key	Reads barcodes	 Backlight Key	Turns on/off screen backlight.										
Key	Press																
 Scan Key	Reads barcodes																
 Backlight Key	Turns on/off screen backlight.																
O.S. KEYS	<p>The following tabulates O.S. keys and their functions. Some of them are engraved in orange colorm, which means Fn key needs to be pressed beforehand in order to function.</p> <table border="1"> <thead> <tr> <th>Key</th> <th>Press</th> </tr> </thead> <tbody> <tr> <td>Windows </td> <td>Opens Start Screen. (Requires Fn key pressed beforehand.)</td> </tr> <tr> <td>OK</td> <td> <ul style="list-style-type: none"> Confirms input in an input field. (Requires Fn key pressed beforehand.) Delivers the same function as the “OK” command on Softkey bar does. (Requires Fn key pressed beforehand.) See Today Screen and Start Screen for more details about Softkey bar. </td> </tr> <tr> <td></td> <td> <p> key applies its function when used in conjunction with other keys. Together they make the O.S. take actions or produce functions F1 through F12.</p> <p> key comes with an LED indicator beside it. When pressed once, the LED indicator lights up in orange and the function indicated in orange is delivered to the next pressed key. When another key is pressed, keypad returns to default mode.</p> <p>When  key is pressed twice, the LED indicator stays lit and the function is delivered to all pressed keys. To quit this mode, press  key again</p> </td> </tr> <tr> <td>Call </td> <td>Launches phone or places a call.</td> </tr> <tr> <td>End </td> <td>Closes phone or ends a call.</td> </tr> <tr> <td>Esc</td> <td> <ul style="list-style-type: none"> Opens the previous screen worked on. Closes a menu of an application, or an opened dialog. </td> </tr> <tr> <td>Tab </td> <td> <ul style="list-style-type: none"> Navigates among the highlight items in some applications. Enters Tab character, which means it moves the caret to the next tab stop. </td> </tr> </tbody> </table>	Key	Press	Windows 	Opens Start Screen . (Requires Fn key pressed beforehand.)	OK	<ul style="list-style-type: none"> Confirms input in an input field. (Requires Fn key pressed beforehand.) Delivers the same function as the “OK” command on Softkey bar does. (Requires Fn key pressed beforehand.) See Today Screen and Start Screen for more details about Softkey bar. 		<p> key applies its function when used in conjunction with other keys. Together they make the O.S. take actions or produce functions F1 through F12.</p> <p> key comes with an LED indicator beside it. When pressed once, the LED indicator lights up in orange and the function indicated in orange is delivered to the next pressed key. When another key is pressed, keypad returns to default mode.</p> <p>When  key is pressed twice, the LED indicator stays lit and the function is delivered to all pressed keys. To quit this mode, press  key again</p>	Call 	Launches phone or places a call.	End 	Closes phone or ends a call.	Esc	<ul style="list-style-type: none"> Opens the previous screen worked on. Closes a menu of an application, or an opened dialog. 	Tab 	<ul style="list-style-type: none"> Navigates among the highlight items in some applications. Enters Tab character, which means it moves the caret to the next tab stop.
Key	Press																
Windows 	Opens Start Screen . (Requires Fn key pressed beforehand.)																
OK	<ul style="list-style-type: none"> Confirms input in an input field. (Requires Fn key pressed beforehand.) Delivers the same function as the “OK” command on Softkey bar does. (Requires Fn key pressed beforehand.) See Today Screen and Start Screen for more details about Softkey bar. 																
	<p> key applies its function when used in conjunction with other keys. Together they make the O.S. take actions or produce functions F1 through F12.</p> <p> key comes with an LED indicator beside it. When pressed once, the LED indicator lights up in orange and the function indicated in orange is delivered to the next pressed key. When another key is pressed, keypad returns to default mode.</p> <p>When  key is pressed twice, the LED indicator stays lit and the function is delivered to all pressed keys. To quit this mode, press  key again</p>																
Call 	Launches phone or places a call.																
End 	Closes phone or ends a call.																
Esc	<ul style="list-style-type: none"> Opens the previous screen worked on. Closes a menu of an application, or an opened dialog. 																
Tab 	<ul style="list-style-type: none"> Navigates among the highlight items in some applications. Enters Tab character, which means it moves the caret to the next tab stop. 																
NAVIGATION KEYS	<p>The buttons right below Scan key are the up/down/right/left navigation keys . They move the caret in an input field. In certain applications, they navigate vertically or horizontally among highlighted items.</p>																
FUNCTION KEYS	<p>F1 through F12 are known as the functions keys on physical keypad. They are all</p>																

	<p>application-dependent and they all team up with  key to cause actions from the active application. They produce nothing when pressed alone.</p>												
[ALPHA] KEY	<p> key changes keypad input mode. When  key is pressed once, [alpha] mode is activated temporarily, and the LED indicator next to the physical key lights up in blue accordingly. This mode will end after a single key has been pressed. Upon pressing any key, keypad input mode will resume back to default, and the LED indicator will turn off.</p> <p>When  key is pressed twice, [alpha] mode is activated permanently, and the LED indicator next to the physical key stays lit. Press the key again to quit this mode and return to default.</p> <p>With combined use of the Shift key ,  key enables maximum six input modes for physical keypad. Mode availability however depends on keypad type, numeric or QWERTY. On a numeric keypad, 6 text input modes are triggered by the [alpha] key, while on a QWERTY keypad, 2 modes are available.</p> <p>The icons       on the Title Bar signify current input state.</p> <p>► Numeric keypad input modes triggered by  key:</p> <table border="1"> <thead> <tr> <th>Mode</th> <th>Description</th> </tr> </thead> <tbody> <tr> <td>  </td> <td>Physical keypad enters an alphabetic character for the first key pressed.</td> </tr> <tr> <td>  </td> <td>Physical keypad enters alphabetic characters for all keys pressed.</td> </tr> </tbody> </table> <p>► QWERTY keypad input modes triggered by  key:</p> <table border="1"> <thead> <tr> <th>Mode</th> <th>Description</th> </tr> </thead> <tbody> <tr> <td></td> <td>Physical keypad enters a number or symbol for the first key pressed.</td> </tr> <tr> <td></td> <td>Physical keypad enters numbers and symbols for all keys pressed.</td> </tr> </tbody> </table>	Mode	Description	  	Physical keypad enters an alphabetic character for the first key pressed.	  	Physical keypad enters alphabetic characters for all keys pressed.	Mode	Description		Physical keypad enters a number or symbol for the first key pressed.		Physical keypad enters numbers and symbols for all keys pressed.
Mode	Description												
  	Physical keypad enters an alphabetic character for the first key pressed.												
  	Physical keypad enters alphabetic characters for all keys pressed.												
Mode	Description												
	Physical keypad enters a number or symbol for the first key pressed.												
	Physical keypad enters numbers and symbols for all keys pressed.												







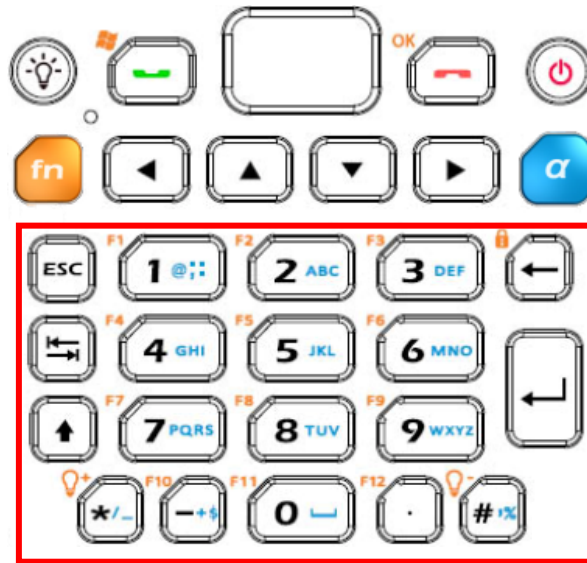















NUMERIC KEYPAD CHARACTER KEYS

Numeric keypad wedges a set of character keys at the lower half. They are laid out analogously to a telephone keypad, and additionally featured are an Esc key, Tab key , Enter key , Backspace key , and Shift key  that enable more sophisticated text input.

Numeric keypad enters numbers 0 through 9 by default. Symbols * through) and alphabetic characters can be entered by combined use of the  key and Shift key . See [\[Alpha\] Key](#) for more details.



Key	Description									
Esc	<ul style="list-style-type: none"> Opens the previous screen worked on. Closes a menu of an application, or an opened dialog. 									
Tab ⇄	<ul style="list-style-type: none"> Navigates among the highlight items in some applications. Enters Tab character, which means it moves the caret to the next tab stop. 									
Enter ↵	Executes a command or confirms input. For text input, it inserts a break between paragraphs.									
Backspace ←	Erases the characters to the left of caret.									
Space ␣	Inserts a blank space where caret is.									
Shift ↑	<p>Shift key ↑ changes keypad input mode. When ↑ is pressed once, [Shift] mode is activated temporarily, and the LED indicator next to the physical key lights up in green accordingly. This mode will end after a single key has been pressed. Upon pressing any key, keypad input mode will resume back to default, and the LED indicator will turn off.</p> <p>When ↑ key is pressed twice, [Shift] mode is activated permanently, and the LED indicator next to the physical key stays lit. Press the key again to quit this mode and return to default.</p> <p>With combined use of the α key, Shift key ↑ enables eight input modes for the physical keypad. The icons ▲ ■ □ ▲ ■ ▲ ■ on Title Bar signify current input state.</p> <ul style="list-style-type: none"> Numeric keypad input modes: <table border="1"> <thead> <tr> <th>Mode</th> <th>Description</th> <th>Trigger and Withdrawal</th> </tr> </thead> <tbody> <tr> <td>No icon</td> <td>Keypad enters numbers only.</td> <td>Default mode. This mode remains until α key or Shift key ↑ is pressed.</td> </tr> <tr> <td>▲</td> <td>Keypad enters the first</td> <td>Press ↑ once to enter this mode.</td> </tr> </tbody> </table>	Mode	Description	Trigger and Withdrawal	No icon	Keypad enters numbers only.	Default mode. This mode remains until α key or Shift key ↑ is pressed.	▲	Keypad enters the first	Press ↑ once to enter this mode.
Mode	Description	Trigger and Withdrawal								
No icon	Keypad enters numbers only.	Default mode. This mode remains until α key or Shift key ↑ is pressed.								
▲	Keypad enters the first	Press ↑ once to enter this mode.								



		typed key as a symbol.	Input mode returns to default once a key is pressed.
		Keypad enters all typed keys as symbols.	Press  twice to enter this mode. Input mode returns to default by pressing  again.
		Keypad enters the first typed key as an alphabetic letter.	Press  once to enter this mode. Input mode returns to default once a key is pressed.
		Keypad enters the first typed key as a capitalized alphabetic letter.	Press  and  once to enter this mode. Input mode returns to default once a key is pressed.
		Keypad enters the first typed key as a capitalized alphabetic letter.	Press  once and  twice to enter this mode. Input mode returns to default once a key is pressed.
		Keypad enters all typed keys as alphabetic letters.	Press  twice to enter this mode. Input mode returns to default by pressing  again.
		Keypad enters all typed keys as alphabetic letters and capitalizes the first one.	Press  twice and  once to enter this mode. Input mode returns to default by pressing  again.
		Keypad enters all typed keys as capitalized alphabetic letters.	Press both  and  twice to enter this mode. Input mode returns to default by pressing  again.

For details about  key, see [\[Alpha\] Key](#).





TEXT INPUT





To enter text by numeric keypad:

- ▶ Numeric Input

The numeric keypad enters numbers 0-9 by default when neither  key nor Shift key  is pressed.





- ▶ Literal Input

- 1) To enter a single letter, press  key once so  appears on the [Title Bar](#). To enter the letter in uppercase, press Shift key  additionally to trigger  mode.

To enter multiple letters, press  key twice so  appears on the [Title Bar](#). Additionally press Shift key  once to activate  mode and enter the first letter in uppercase, or press it twice to activate  mode in which all letters are entered in uppercase.







- 2) Continuously press a key engraved with blue-color character until the character you desire is entered.

▶ Symbols Input

- 1) To enter a single symbol, press Shift key  once so  is seen on the [Title Bar](#). To enter multiple symbols, press Shift key  twice to activate  mode.

- 2) Press one or more key(s) engraved with white-color characters until the desired symbol(s) is entered.

▶ Symbols Input





Press  key and/or shift key  continuously until seeing an  or  on [Title Bar](#).  means numeric keypad ready to enter one symbol while  means numeric keypad ready to continuously enter more symbols.

Note there are cases when a typed letter is capitalized automatically:

- ▶ The letter follows a period mark and a blank space (because it is seen as the start of a new sentence).
- ▶ The letter is typed after a paragraph break (because it is seen as the start of a new paragraph).

QWERTY KEYPAD CHARACTER KEYS





















QWERTY keypad also arranges its character keys in the lower half and features them in a compact "QWERTY" layout as its name suggests.





QWERTY keypad is a pared down version of an average laptop's keyboard that bears also an Esc key, Tab key , Enter key , Backspace key , Shift key , and space key .

QWERTY keypad enters alphabetic characters by default. To enter numbers and some symbols, press  key. See [\[Alpha\] Key](#) for more details.



Ctrl key, Alt key and shift key  are the modifier keys. Ctrl/Alt key is pressed with another key to launch particular actions from O.S. or the active application while shift key capitalizes the letter(s) typed.



Key	Description															
Ctrl key	Performs a special operation from O.S. or the active application when pressed in conjunction with another key.															
Alt key	Changes the function of the key pressed together with. The launched function depends on the application.															
Backspace ←	Erases the characters to the left of caret.															
Enter ↵	Executes a command or confirms input. For text input, it inserts a break between paragraphs.															
Space ␣	Inserts a blank space where the caret is.															
Esc	<ul style="list-style-type: none"> ▶ Opens the previous screen worked on. ▶ Closes a menu of an application, or an opened dialog. 															
Tab ⇆	<ul style="list-style-type: none"> ▶ Navigates among the highlight items in some applications. ▶ Enters Tab character, which means it moves the caret to the next tab stop. 															
Shift ↑	<p>Shift key ↑ changes keypad input mode. When ↑ is pressed once, [Shift] mode is activated temporarily, and the LED indicator next to the physical key lights up accordingly. This mode will end after a single key has been pressed. Upon pressing any key, keypad input mode will resume back to default, and the LED indicator will turn off.</p> <p>When ↑ key is pressed twice, [Shift] mode is activated permanently, and the LED indicator next to the physical key stays lit. Press the key again to quit this mode and return to default.</p> <p>With combined use of the  key, Shift key ↑ enables four input modes for the physical keypad. The icons     on Title Bar signify current input state.</p> <ul style="list-style-type: none"> ▶ QWERTY keypad input modes: <table border="1"> <thead> <tr> <th>Mode</th> <th>Description</th> <th>Trigger and Withdrawal</th> </tr> </thead> <tbody> <tr> <td>No icon</td> <td>Keypad enters lowercase letters.</td> <td>Default mode. This mode remains until  key or Shift key ↑ is pressed.</td> </tr> <tr> <td></td> <td>Keypad enters the first typed key as an uppercase letter.</td> <td>Press ↑ once to enter this mode. Input mode returns to default once a key is pressed.</td> </tr> <tr> <td></td> <td>Keypad enters all typed keys as uppercase letters.</td> <td>Press ↑ twice to enter this mode. Input mode returns to default by pressing ↑ again.</td> </tr> <tr> <td></td> <td>Keypad enters the first typed key as a</td> <td>Press  once to enter this mode.</td> </tr> </tbody> </table>	Mode	Description	Trigger and Withdrawal	No icon	Keypad enters lowercase letters.	Default mode. This mode remains until  key or Shift key ↑ is pressed.		Keypad enters the first typed key as an uppercase letter.	Press ↑ once to enter this mode. Input mode returns to default once a key is pressed.		Keypad enters all typed keys as uppercase letters.	Press ↑ twice to enter this mode. Input mode returns to default by pressing ↑ again.		Keypad enters the first typed key as a	Press  once to enter this mode.
Mode	Description	Trigger and Withdrawal														
No icon	Keypad enters lowercase letters.	Default mode. This mode remains until  key or Shift key ↑ is pressed.														
	Keypad enters the first typed key as an uppercase letter.	Press ↑ once to enter this mode. Input mode returns to default once a key is pressed.														
	Keypad enters all typed keys as uppercase letters.	Press ↑ twice to enter this mode. Input mode returns to default by pressing ↑ again.														
	Keypad enters the first typed key as a	Press  once to enter this mode.														





		number/symbol.	Input mode returns to default once a key is pressed.
		Keypad enters all typed keys as numbers/symbols.	Press  twice to enter this mode. Input mode returns to default by pressing  again.
For details about  key, see [Alpha] Key .			

TEXT INPUT





To enter text using QWERTY keypad:

▶ Literal Input

The QWERTY keypad enters lowercase letters a-z by default when neither  key nor Shift key  is pressed.

To enter a letter in uppercase, press Shift key  so  appears on the [Title Bar](#).
To continuously type in uppercase, press Shift key  twice to trigger  mode.

▶ Numeric or symbols Input

- 1) To enter a single number/symbol, press  key once so  appears on the [Title Bar](#). To enter multiple numbers/symbols, press Shift key  twice to trigger  mode.
- 2) Press a key engraved with blue-color character to enter number(s) and symbol(s) as desired.

Note there are cases when a typed letter is capitalized automatically:

- ▶ The letter follows a period mark and a blank space (because it is seen as the start of a new sentence).
- ▶ The letter is typed after a paragraph break (because it is seen as the start of a new paragraph).

CHANGE INPUT TEXT SIZE

Set the size to show typed text:

- 1) On Start screen, tap **Settings | System | Screen | Text Size**.
- 2) Tap **Text Size** tab.
- 3) Adjust the text size by moving the slider.
- 4) Tap the "OK" command on [Softkey bar](#) to apply the change and quit setting.

2.5.2. ONSCREEN KEYBOARD

The O.S. provides users with an onscreen keyboard. Compared to physical keypads, the onscreen keyboard bears more likeness to a conventional laptop's keyboard by all the modifiers keys arranged on the left edge and the "QWERTY" layout. The onscreen keyboard isn't overshadowed by physical keypads at all but outdoing them by being able to enter a series of diacritics for European languages.

Onscreen keyboard auto-opens in some applications while in others it doesn't unless you tap on a field that accepts input.

In case the onscreen keyboard doesn't open, tap the keyboard icon  on [Softkey bar](#) to open it.

Onscreen keyboard opens and readies to enter lowercase letters, numbers, and a few frequently used symbols.

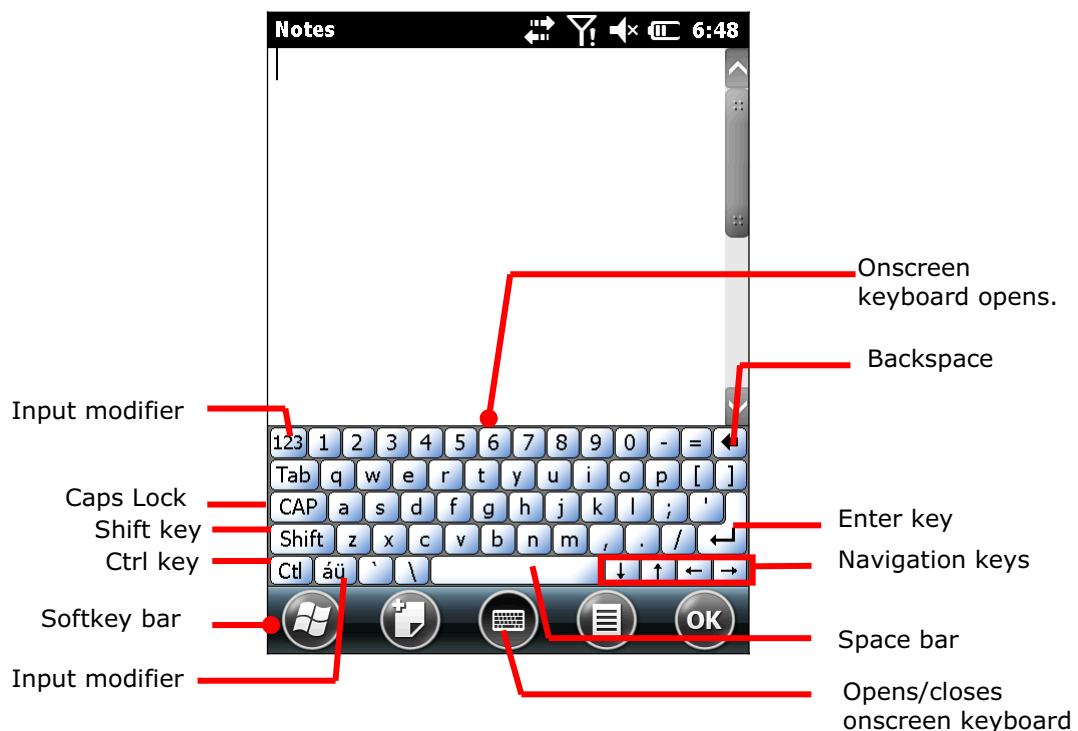

MODIFIER KEYS



Although the touchscreen is a resistive single-touch type, use of modifier key, which normally involves hitting two keys, are still available on onscreen keyboard.

On onscreen keyboard there are five modifier keys. They all sit at the left edge. This is how they basically work:

- 1) Hit a modifier key on onscreen keyboard.
The onscreen keyboard enters modifier state.
- 2) Hit the second key.

The desired performance will be produced to the active application or screen at the moment.

Modifier keys are explicated as following

Key	Description
<p>Ctrl key Ctrl</p>	<p>Once tapped, it becomes color-inverted Ctrl and causes a special action from O.S. or the active application when a character key is tapped. It quits once the said action is triggered or when it is tapped again.</p> <p>For example: Tap Ctrl key and then tap key "A" to produce Ctrl+A function, which in Windows environment usually selects all content on the active screen. Once "A" is tapped, the onscreen keyboard quits Ctrl state.</p>
<p>Shift key Shift</p>	<p>Once tapped, it becomes color-inverted Shift and capitalizes the (one) letter typed. It quits once a character key is tapped or it is tapped again.</p> <p>To enter all caps, use Caps Lock CAP.</p>
<p>Caps Lock CAP</p>	<p>Once tapped, it becomes color-inverted CAP and capitalizes all the alphabetic characters typed. It doesn't quit until it is tapped again.</p> <p>This key does not affect numbers, punctuation marks, or symbols.</p>
<p>Input modifier 123</p>	<p>Once tapped, it becomes color-inverted 123 and presents more symbols and a set of digits and enters them. It won't quit until it is tapped again.</p> <div style="display: flex; justify-content: space-around; align-items: flex-start;"> <div style="text-align: center;">  <p>Tap input modifier 123.</p> </div> <div style="text-align: center;">  <p>When tapped it becomes color-inverted.</p> <p>And have more symbols with a set of digits.</p> </div> </div>

Input modifier
áü

Once tapped, it becomes color-inverted **áü** and presents a series of accented vowels such as ä, æ, ë, ì, ö, ú or letter variants such as ß and ç which are needed for European languages. It quits once a character key is tapped.



Tap **áü** key on onscreen keyboard.



áü key becomes color-inverted **áü**. Then tap a character key.

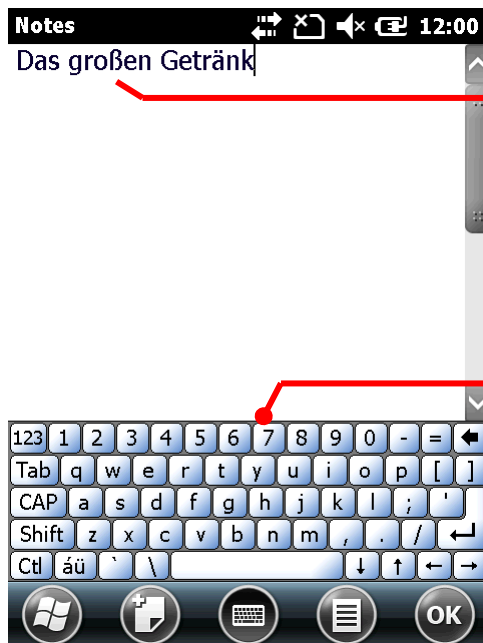

Letter variant "ß" is entered.





Once an accented vowel or letter variant is entered, the onscreen keyboard restores to English keyboard.

After the letter variant "ß" is entered, the onscreen keyboard restores to normal English alphanumeric layout.

Diacritical letters and letter variants are presented both lowercase and uppercase.



OTHER KEYS

Key	Description
Tab key 	Navigates among the highlight items in some applications. For text input, it inserts Tab character, which means it moves caret to the next tab stop.
Backspace 	Erases the characters to the left of caret.
Enter key 	Executes a command or confirms input. When text input, it inserts a break between paragraphs.
Nav 	Move caret in an input field. In certain applications, they navigate vertically or horizontally among highlight items.
Spacebar 	Inserts a blank space where caret is.

DICTIONARY

Onscreen keyboard comes with an English dictionary. When onscreen keyboard is opened, the dictionary is enabled and will display a list of suggested words as you type to allow quick selection.

When you tap a letter key on the onscreen keyboard, a list of suggested words displays shortly over the keyboard. Tap a suggested word from the list to enter it. When you have entered a word that is not in the dictionary, it is added to the dictionary and becomes a suggestible word next time.

The screenshot below shows an example when "L" is entered on onscreen keyboard:

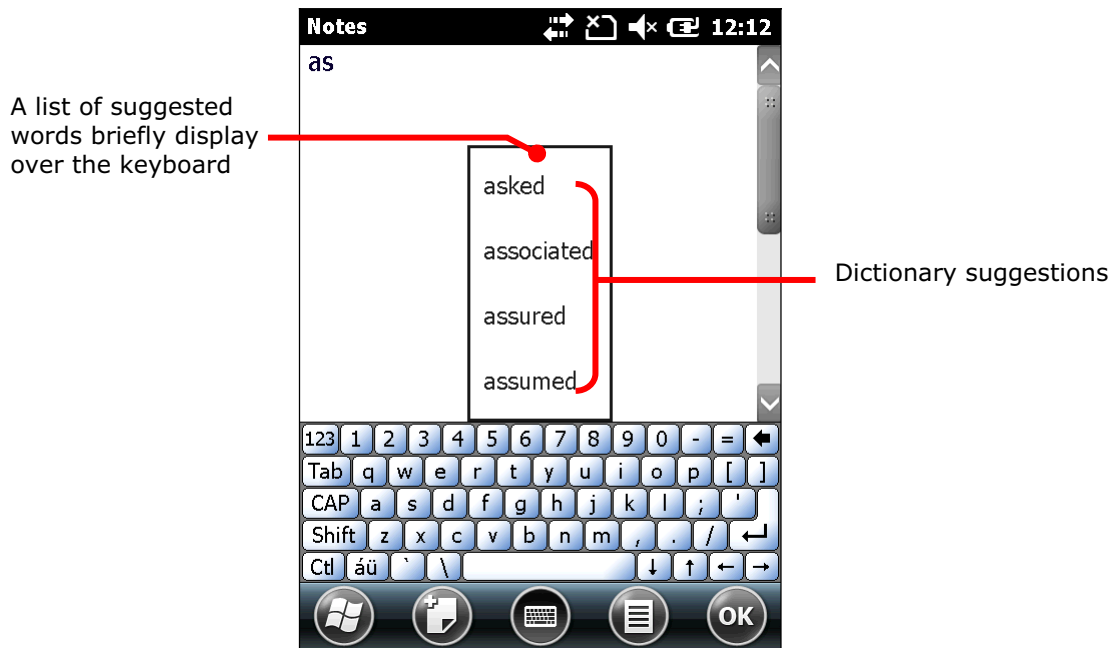

CHANGE KEYBOARD ORIENTATION

The mobile computer is built-in with a G-sensor and supports screen orientation, which is enabled by default. So when the mobile computer turns sideways or upright, the screen changes its orientation, and onscreen keyboard readjusts itself to the new orientation.

CHANGE TEXT INPUT SIZE

See [Note there are cases](#) when a typed letter is capitalized automatically:

- ▶ The letter follows a period mark and a blank space (because it is seen as the start of a new sentence).
- ▶ The letter is typed after a paragraph break (because it is seen as the start of a new paragraph).

Change Input Text Size.

2.5.3. EDIT TEXT

On the mobile computer, cut, copy, and paste text within an application or across applications by the menu commands. Some applications don't support editing some or all of the text they display while others may offer their own way to edit text.

EDIT TEXT IN INPUT FIELDS

To edit text in a text input field:

- 1) Tap where you want to edit text.

Caret moves there and manifests itself as a vertical bar that blinks to indicate where the typed or pasted text will be inserted.

- 2) Type, paste or delete text.

To paste text, see [Paste Text](#).

SELECT TEXT

When you see some text on a page you want to copy, select it first. Selecting texts varies from application to application. But primarily it requires you to tap & hold somewhere on the text to open a context menu or open the applications' option menu which provide commands to select a text.

To select a text:

- 1) Tap & hold somewhere on the text.
A context menu comes up.
- 2) Tap the command that makes selection.
- 3) Select the desired text.

It relies on defining the start and end to make selection of a text. Some applications support tapping and dragging along the text to select it while others require you to mark the start and end of the desired text with the onscreen facility featured by the application.

CUT OR COPY TEXT

After a text is selected, system then presents Copy/Cut commands on "[Softkey bar](#)" or a context menu shows up featuring Copy/Cut commands. Tap them to copy/cut the selected text.

PASTE TEXT

Within the O.S., texts can be copied to and from different applications.

To paste a text:

- 1) Tap & hold the text field where you want to paste the text.
Context menu opens.
- 2) Tap the "Paste" command from the context menu.
The copied/cut text is pasted.

2.6. TOUCH CONTROL

The mobile computer's LCD is overlaid by a resistive touch panel and thus forms a resistive touchscreen. Since a resistive touchscreen locates the user's touch by the force applied on it, by operating with the stylus one can apply minimum force to trigger actions from the touchscreen.

Touch control is one of the main ways to interact with the mobile computer. Users are able to manipulate icons, buttons, menu commands, the onscreen keyboard, or any onscreen items with touch control.



2.6.1. USE TOUCHSCREEN

The mobile computer comes with a stylus. Touch-operate the mobile computer with the stylus. Apply the gestures below to work on the touchscreen:

- ▶ **Tap** – Touch any item on the screen such as an application icon or a setting icon to work on them, or touch any key on the onscreen keyboard to type it.
- ▶ **Tap & hold** – Touch an item on the screen and do not release until an action occurs.
- ▶ **Drag** – Touch and hold an item for a moment and then, without release, move the item onscreen until you reach the target.
- ▶ **Flick** – Quickly move your finger or stylus across the surface of the screen. Note when the stylus contacts the screen, do not pause so you don't drag an item instead. Flick is helpful, for example, for scrolling up or down a list.
- ▶ **Double-tap** – Touch quickly twice on a webpage or other screen to zoom. For example, double-tap a section of a webpage in a web browser to zoom that section to fit the width of the screen. Some applications such as map-info applications support picture zooming with double-tap.
- ▶ **Rotate screen** – On most screens, the screen rotates as the mobile computer changes its orientations between upright and sideways.

2.6.2. ADJUST BACKLIGHT

To adjust backlight

- 1) Tap Windows icon  on [Softkey bar](#) or hit physical Windows key .
Start screen opens.
- 2) Tap **Settings | System | Backlight** .
Backlight settings open.
- 3) Select between **Battery Power** and **External Power** tabbed pages.
- 4) Select **Manual brightness control** and manually adjust the brightness level, or deselect **Manual brightness control** and leave the brightness on automatic.

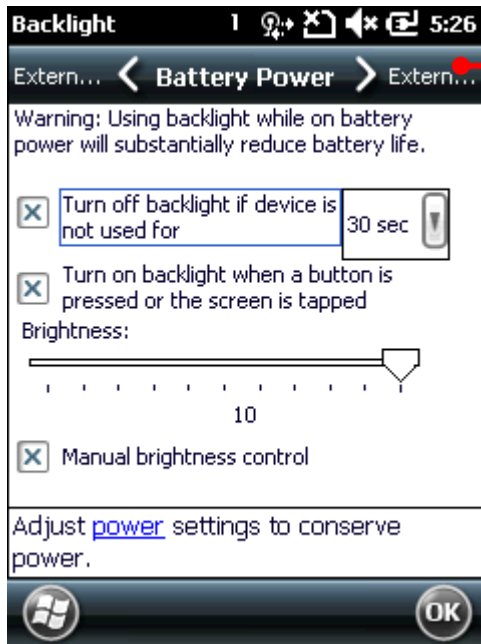



Backlight's Battery Power tabbed page

1.6.3. CALIBRATION

A resistive touchscreen needs calibration to work accurately after serving for a period of time. Calibration aligns the coordinates of touch panel and the LCD underneath to improve touch accuracy.

To calibrate touchscreen:

- 1) Tap Windows icon  on [Softkey bar](#) or hit physical Windows key . Start screen opens.
- 2) Tap **Settings | System | Screen** . Screen settings open showing Alignment tabbed page.

- 3) Tap **Align Screen** button.

Screen alignment application opens.

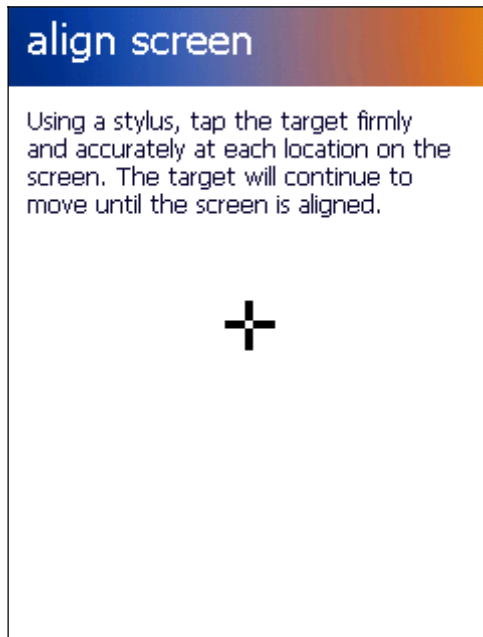

- 4) Accurately tap on the centers of each cross mark to show consecutively onscreen, 5 in total.
- 5) Follow through the calibration.

2.7. MEMORY

The mobile computer packs the following memory units to retain data and instructions from users:

- ▶ Random-access Memory (RAM)
512 MB SDRAM for temporary storage and fast access of active applications. SDRAM is fed by backup battery to hold data.
- ▶ Internal Storage
4GB flash memory to store O.S. (Windows Embedded Handheld 6.5), application files, settings, and other data used by applications.
- ▶ External Storage
Insert a storage card to increase the mobile computer's storage capacity. Supported are MicroSDHC cards up to 32GB.

2.7.1. DATA LOSS CAUTION

When main battery is absent or used up, backup battery on the main board takes over to supply power to the mobile computer. A fully charged backup battery retains SDRAM data and suspends the mobile computer for 30 minutes.

Note if you are leaving the mobile computer to sit for a couple of days, data loss is to occur when both main and backup batteries drain out. Consider backing up data before putting away the mobile computer.

2.7.2. CHECK STORAGE

RAM SIZE

To check RAM size:

From start screen, tap **Settings** | **System** | **System Information** to open Device Information application. It opens retrieving the information about the mobile computer, including device manufacturer, device ID, memory size, and firmware/software version. RAM size will be listed among this info.

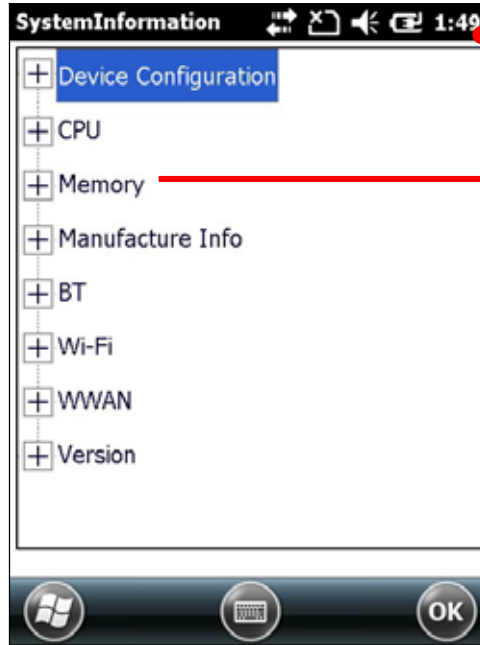

System Information page

Tap to view information on memory size

INTERNAL STORAGE

On Start screen, tap **Settings | System | Memory**. Memory screen opens showing Main tabbed page. This page gives the information about the mobile computer’s use of RAM and internal storage.

Main tabbed page delivers two labels – **Storage** and **Program**:

- ▶ **Storage** - Internal memory for files storage, such as O.S., applications and the files needed for applications.
- ▶ **Program** - RAM usage for running applications.

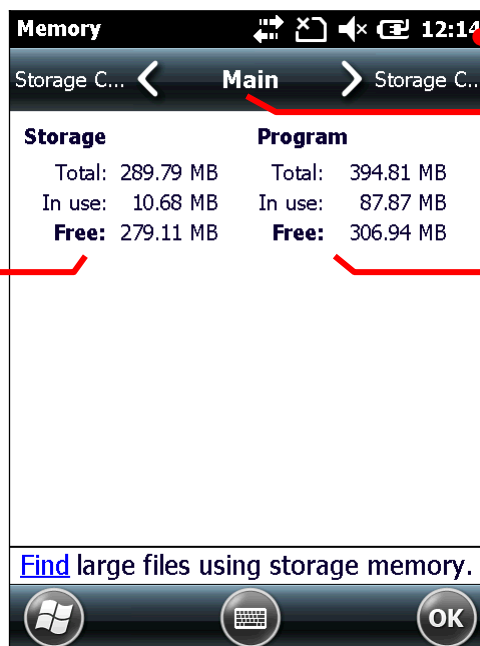

Memory settings

Main tabbed page

Internal storage

RAM usage for running applications

EXTERNAL STORAGE

When Memory screen opens, tap **Storage Card** tab. **Storage Card** tabbed page then opens and shows the info about external storage (when a storage card is inserted).



2.7.3. INSERT SD CARD

Day-to-day use of the mobile computer might cause the available internal storage to run short. Equip the mobile computer with an external memory unit to expand storage capacity.

Follow the steps below to install a SD card:

- 1) Power off the mobile computer.
- 2) Place the mobile computer face-down on a flat and soft surface.
- 3) Remove the battery door and main battery pack as described in [Main Battery Setup](#).
Battery chamber is opened.
- 4) Locate the SD card socket inside battery chamber. (See [Inside Battery Chamber](#).) The SD card socket is equipped with a hinged cover.

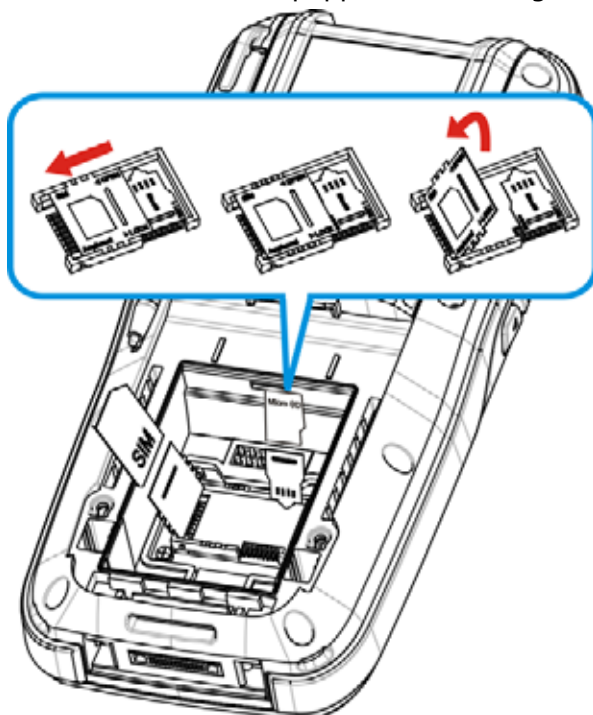

- 5) Push the hinged cover to the open position.
- 6) The hinged cover unlocks.
- 7) Swivel up the cover.
- 8) Insert SD card into the cover slot in the direction indicated . The metal contact pins should face down.
- 9) Put down the hinged cover and lock it into place.
- 10) Restore main battery pack and the battery door.

Figure 9: Inserting SD Card

2.8. DIRECT DATA CONNECTION

“Direct” data connection means “hardwired” data connection between the mobile computer and a Windows-based PC as opposed to wireless connection. Direct data connection relies on a RS-232 cable or a USB cable (sometimes plus an auxiliary cradle) between the two mentioned devices. Once the mobile computer and PC are “directly” connected with each other by a RS-232 or USB-cable, they can sync data with each other.

2.8.1. USE CABLE

Direct data connection using a cable:

- 1) Connect the mobile computer to your PC with a USB or RS-232 type Snap-on Charging and Communication Cable. Fix the cable to both sides.

ActiveSync will automatically detect connection between the two and prompt for data synchronization.

See [Syncing Tools](#) and subsequent sections to know how to use ActiveSync.



Figure 10: Direct Data Connection Using Cable

1.8.2. SYNCING TOOLS

Microsoft's syncing tools enables users to update or back up the data on their handheld computers to desktop computers.

Two syncing tools are featured by Microsoft - ActiveSync and Windows Mobile Device Center (hereinafter "WMDC"). Which tool to use depends on which OS is running on your PC. See the rule below:

O.S.	Syncing Program
Windows Vista or Windows 7	WMDC 
Windows XP SP3 and earlier	ActiveSync 

ActiveSync and WMDC can be downloaded from Microsoft's website. Download and install the right one on your PC.

Hereafter in this manual, we will focus on ActiveSync only. For WMDC usage, see its documentation or help file.

1.8.3. SYNC PARTNERSHIP

Once a direct connection is established between the mobile computer and your PC as described in [Use Cable](#), they are able to form the following ties:

Sync Partnership	Services
Synchronization Relationship	<ul style="list-style-type: none"> ▶ Allows the mobile computer and PC to sync Microsoft Office Outlook data with each other. ▶ Allows PC to add and remove programs to/from the mobile computer. ▶ Allows PC to browse files on the mobile computer. ▶ Allows PC to copy files to/from the mobile computer. ▶ Allows PC to back up the files on the mobile computer.
Temporary Relationship (Mobile computer works as a "guest" to PC)	<ul style="list-style-type: none"> ▶ Allows PC to add and remove programs to/from the mobile computer. ▶ Allows PC to browse files on the mobile computer. ▶ Allows PC to copy files to/from the mobile computer. ▶ Allows PC to back up the files on the mobile computer.

Note that data stored on external storage (the SD card) cannot be synchronized.

See [ActiveSync Actions to Take](#) that details each mentioned service.

1.8.4. 1ST USB SYNC

This section will guide you through USB syncing. For Bluetooth syncing, see [Bluetooth ActiveSync](#).

To connect ActiveSync using USB:

- 1) Download the right syncing tool as described in [Syncing Tools](#) and install it on your PC.
- 2) Connect the mobile computer and your PC as described in [Use Cable](#)

3) On your PC, run the syncing program.

ActiveSync should detect the mobile computer. **Sync Setup Wizard** launches and prompts to set up "[Sync Partnership](#)" between two computers

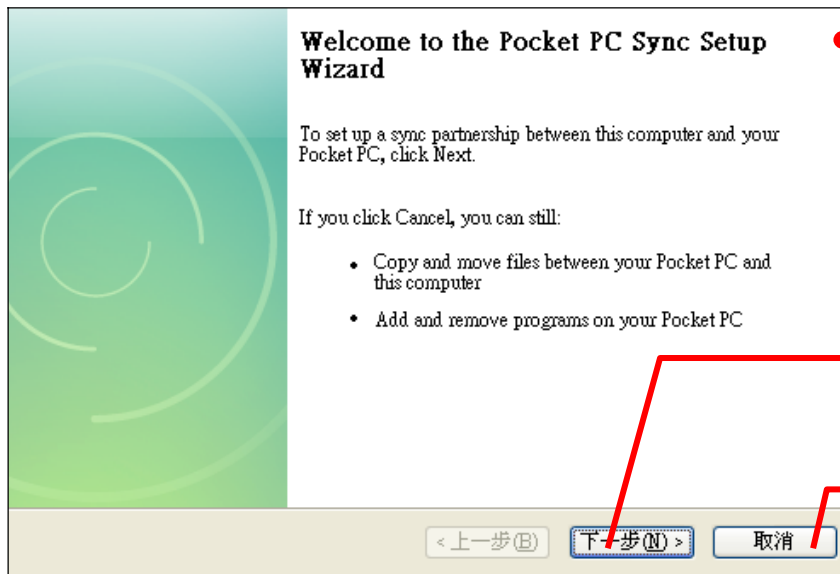

ActiveSync **Sync Setup Wizard** opens.

Press **Next** to set up "Synchronization Relationship".

Press **Cancel** to create "Temporary Relationship" by which the mobile computer works as a "guest" to the PC.

- 4) Press **Next** button for "Synchronization Relationship", or press **Cancel** button for "Temporary Relationship" if you don't plan to connect to the PC on a regular basis.

If you have pressed **Next**, follow the onscreen instructions to go through the setup of "Synchronization Relationship". Once setup finishes, ActiveSync opens showing "Synchronizing". Two computers are synchronized.

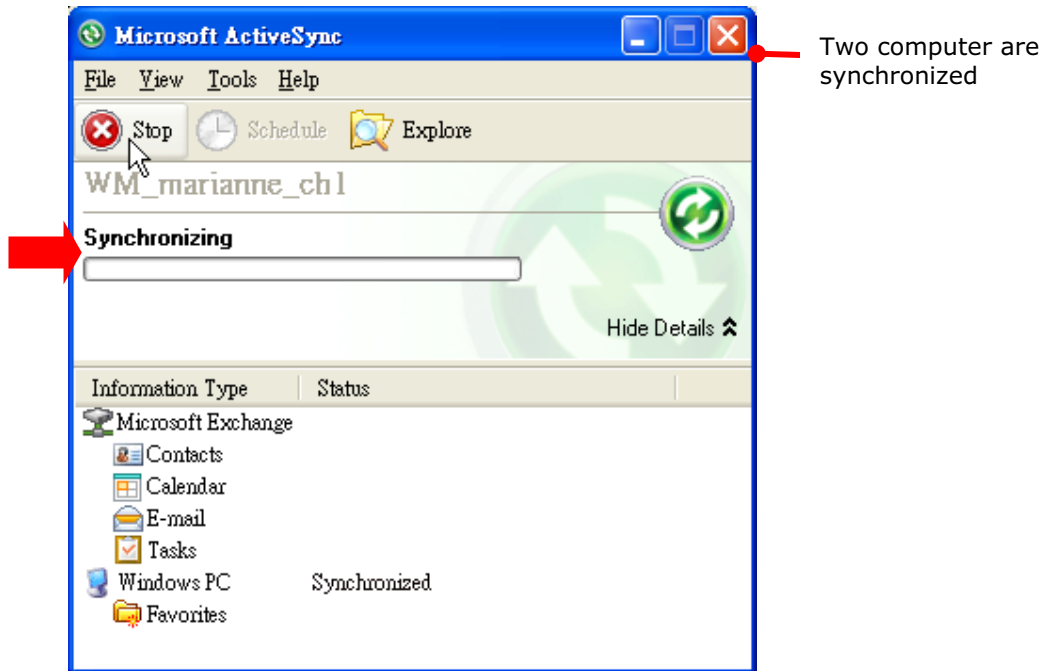

OR

If you have pressed **Cancel**, Microsoft ActiveSync opens showing "Guest" and "Connected". Two computers are connected.

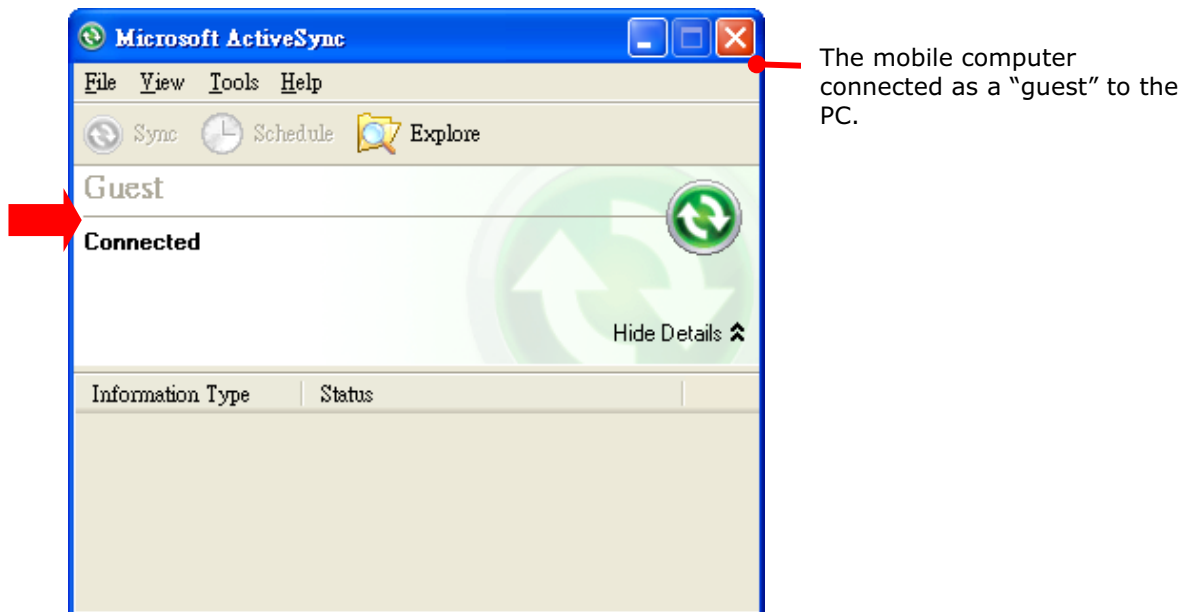

2.8.5. DISCONNECT USB ACTIVESYNC

To disconnect USB ActiveSync:

- 1) On your PC, open ActiveSync by double-clicking its icon  in the notification area. ActiveSync opens.
- 2) From the menu bar, click **File | Connection Settings**.
[**Connection Settings**] window opens.
- 3) Deselect **Allow USB connections**.
- 4) Press the **OK** button to apply the change and quit setting.

This way when you plug your mobile computer the next time, it still gets charged but ActiveSync won't attempt to synchronize with it.

To disconnect Bluetooth syncing, see [Disconnect Bluetooth ActiveSync](#).

2.8.6. ACTIVESYNC ACTIONS TO TAKE

Once "Synchronization Relationship" or "Temporary Relationship" is established between two computers, a variety of actions can be taken to enhance resource sharing between them as previously mentioned in [Sync Partnership](#).

In summary, "Synchronization Relationship" outshines "Temporary Relationship" by being capable of syncing Microsoft Office Outlook data. However "Temporary Relationship" provides satisfactory file sharing if you don't want to synchronize information.

See the following to know what actions to take with ActiveSync:

CHANGE MICROSOFT OFFICE OUTLOOK DATA TO SYNCHRONIZE

Note this is for "Synchronization Relationship" only.

In default state, "Synchronization Relationship" doesn't synchronize all Microsoft Office Outlook data but only a limited amount between two computers in order to save storage on the mobile computer. You can change the amount of information to synchronize:

- 1) On your PC, from the menu bar of ActiveSync, select **Tool | Options**.

ActiveSync's **[Settings]** window opens showing Options tabbed page.

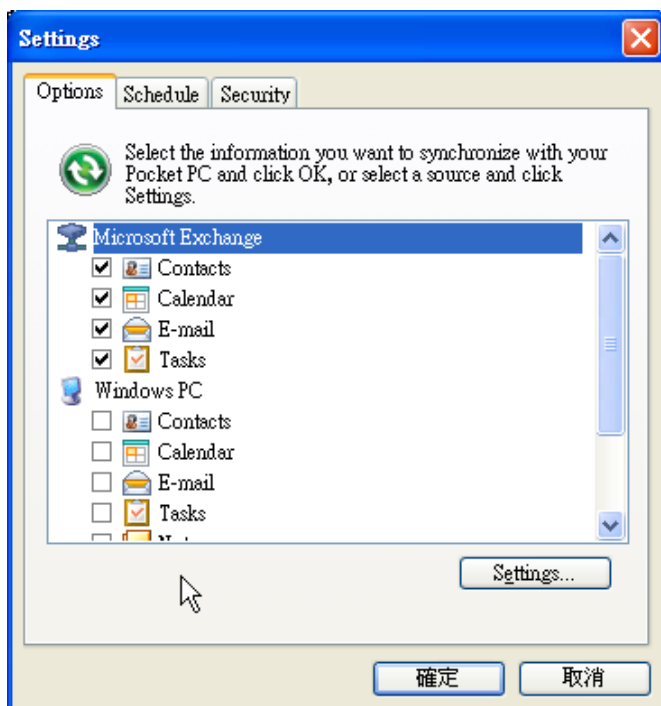

- 2) Select an information type to synchronize, and deselect an information type to stop synchronizing.
- 3) Press OK button to save the change and quit setting.

Note you can also change the information to synchronize on the mobile computer by disconnecting ActiveSync first as mentioned in [Disconnect USB ActiveSync](#) or [Disconnect Bluetooth ActiveSync](#) and then tap ActiveSync's "Menu" command on [Softkey bar](#) and tap **Options**.

ADD/REMOVE PROGRAMS

Note basically the applications to be installed to the mobile computer need to be installed on your PC first. So download the application programs to your PC first and install them on your PC so they can be installed onto the mobile computer later.

Many application programs are installed in different ways. Read their installation guides or documentation to know how they are installed. If you are installing an application that cannot be installed on your PC first, try to install it right from the mobile computer, see [Download & Install Applications](#) for more details.

To install an application on the mobile computer:

- 1) Connect two computers as described in [Use Cable](#)
- 2) Sync two computers as described in [1st USB Sync](#).
- 3) On the PC, from the menu bar of ActiveSync, select **Tools | Add/Remove Programs**.

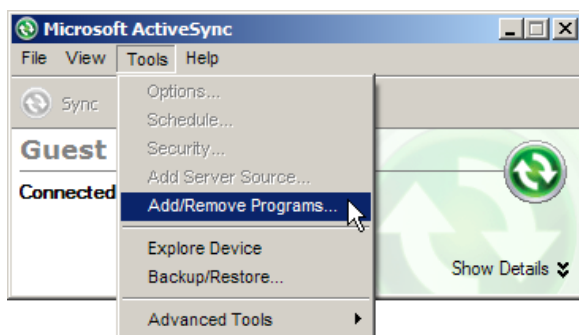

ActiveSync starts to search for the application programs installed on your PC and opens its [**Add/Remove Programs**] dialog which lists those found. Each entry comes with a check box on the left. An unchecked box means the program is yet to install to the mobile computer while a checked one means an installed program.

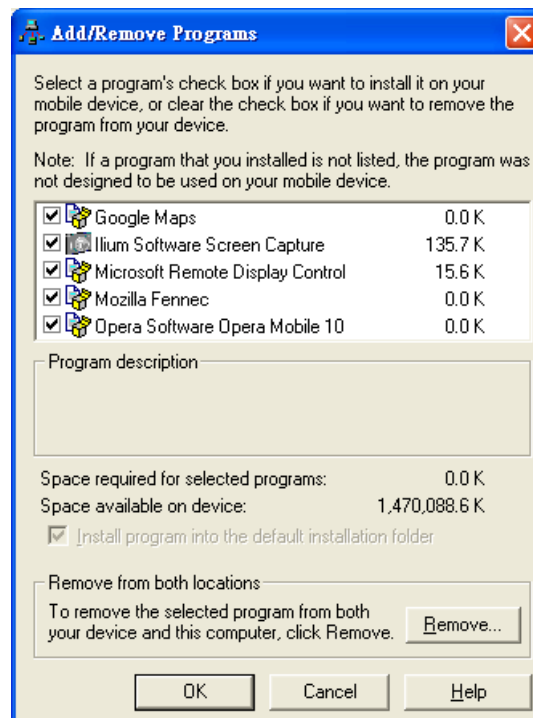

- 4) Select the application program(s) to install to the mobile computer, and deselect the application program(s) to uninstall from the mobile computer.
- 5) Hit the **OK** button.

ActiveSync proceeds to install programs and/or remove programs to/from the mobile computer.

- 6) Follow the onscreen instructions on both your PC and the mobile computer to proceed.

Noteworthy facts:

- ▶ Normally the application program(s) downloaded from external resources are installed to the mobile computer's directory at **Mobile Device\Program Files**. However sometimes there are exceptions and it depends on the application.
- ▶ You can uninstall application(s) right by the mobile computer rather than on the PC. See [Uninstall Applications](#) for more details.
- ▶ If you would like to uninstall a program isn't listed in the **[Add/Remove Programs]** dialog, browse to it on the mobile computer using File Explorer . Tap & hold it, and select **Delete** from the context menu that pops up.

ADD APPLICATION SHORTCUTS TO START SCREEN

ActiveSync features "Explore" to add an application shortcut to Start screen where it is easier to launch the application.

To add an application shortcut to Start screen:

- 1) Connect two computers as described in [Use Cable](#)
- 2) Sync two computers as described in [1st USB Sync](#).
- 3) On the PC, from ActiveSync's menu bar, select **Tools | Explore Pocket PC**, or from its toolbar, press **Explore**  button.

The mobile computer's internal storage's root directory "**Mobile Device**" opens presenting a few folders (and files).

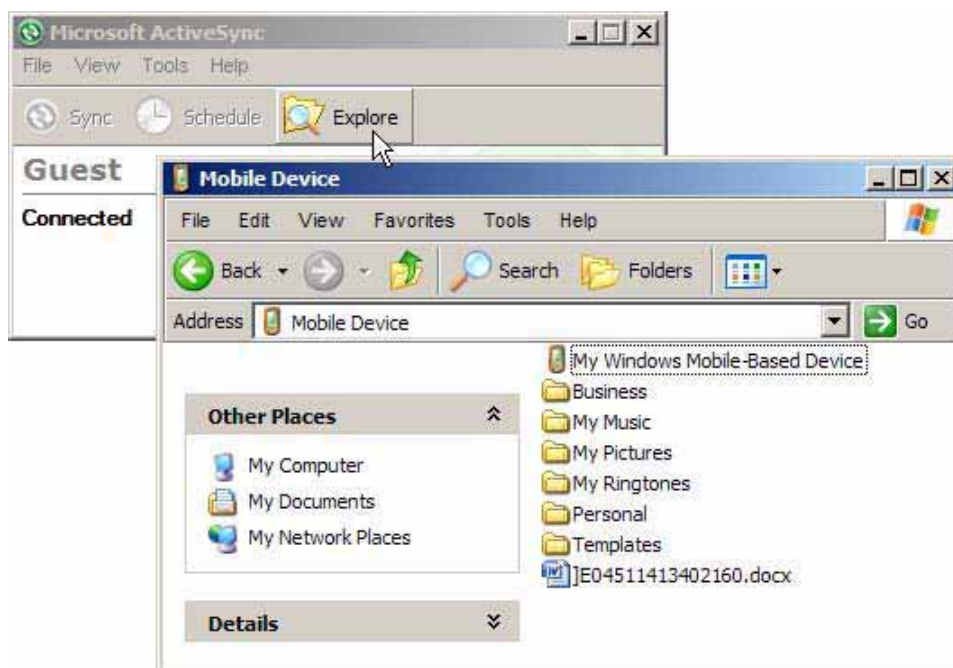

- 4) Double-click **My Windows Mobile-Based Device** .
My Windows Mobile-Based Device opens.
- 5) Double-click **Program Files**.
Program Files folder opens. This is where the downloaded applications are normally installed on the mobile computer's local storage.
In the folder, each sub-folder stores an application.
- 6) Open the folder of the application to create shortcut for.
- 7) Find the executable file of that application. Right-click on it and select **Copy** from the context menu that comes up.
The executable file is copied.
- 8) Browse to **My Windows Mobile-Based Device\Windows\Start Menu\Programs**.
Programs folder opens.
- 9) Right-click any vacant spot in the folder and select **Paste shortcut** from the context menu that comes up.
A shortcut to the application is added to Start screen.

Note: You can also copy & paste by the sequence **Create Shortcut -> Cut -> Paste**.

You can also add an application shortcut to Start screen right by the mobile computer. See [Add Items to Start Screen](#) for more details.

ADD FILE SHORTCUTS TO START SCREEN

ActiveSync features "Explore" to add to Start screen a shortcut to some local file so it is accessible more easily.

To add a file shortcut to Start screen:

- 1) Connect two computers as described in [Use Cable](#)
- 2) Sync two computers as described in [1st USB Sync](#).
- 3) On the PC, from ActiveSync menu bar, select **Tools | Explore Pocket PC**, or from its toolbar, press **Explore**  button.
The mobile computer's internal storage root directory "**Mobile Device**" opens presenting a few folders.
- 4) Browse for the file to create shortcut for.
- 5) Right-click on the file and select **Copy** from the context menu that comes up.
- 6) Browse to **My Windows Mobile-Based Device\Windows\Start Menu\Programs**.
Programs folder opens.
- 7) Right-click any vacant spot in the folder and select **Paste shortcut** from the context menu that comes up.
A shortcut to the file is added to Start screen.

Note: You can also copy & paste by the sequence **Create Shortcut -> Cut -> Paste**.

You can also add a file shortcut to Start screen right by the mobile computer. See [Add Items to Start Screen](#) for more details.

REMOVE SHORTCUTS FROM START SCREEN

Note the inherent shortcuts aren't removable. Only the added shortcuts are removable.

To remove an added shortcut from Start screen, simply use ActiveSync's **Explore**  to delete the shortcut from **My Windows Mobile-Based Device\Windows\Start Menu\Programs** folder.

You can also remove an added shortcut from Start screen right by the mobile computer. See [Remove Items from Start Screen](#) for more details.

CREATE NEW FOLDERS

To create a new folder on the mobile computer:

- 1) Connect two computers as described in [Use Cable](#)
- 2) Sync two computers as described in [1st USB Sync](#).

On the PC, from ActiveSync menu bar, select **Tools | Explore Pocket PC**, or from its toolbar, press **Explore**  button.

The mobile computer's internal storage root directory "**Mobile Device**" opens presenting a few folders (and some files).

- 3) Browse where you want to create a folder.
- 4) Right-click any vacant spot there.

Context menu opens

- 5) Select **New Folder**.

A new folder is created.

BACKUP DATA

To best protect your work, back up regularly the data on your mobile computer. Manually back up using ActiveSync by either "Synchronization Relationship" or "Temporary Relationship" with simple copy & paste to back up files to your PC.

USB PASS-THROUGH NETWORKING

ActiveSync supports "Pass-Through Networking" whereby the mobile computer networks using your PC's data connection.

For security, disable the network bridging on the PC, especially the bridging to a Remote NDIS adapter. For more information on network bridging, see Windows Help on the PC.

After sync partnership is up between the mobile computer and your PC:

- 1) On your PC, from the menu bar of ActiveSync, select **File | Connection Settings**.
[Connection Settings] window opens.
- 2) For **This computer is connected to**, select a network which your PC should connect to when passing through ActiveSync. Options are:

Option	Description
Automatic	Auto-detects proxy <ul style="list-style-type: none">▶ This option detects if a proxy should be used when passing connections through the PC. If yes, configure the proxy on the mobile computer.▶ This option best suits connecting to a PC (laptop) that may be used at home (with no proxy), as well as to a corporate network (with proxy).
Work Network	Always uses proxy <ul style="list-style-type: none">▶ This option assumes a proxy should be used when passing connections through the PC, and uses whatever proxy is already configured on the mobile computer.▶ This option best suits connecting to a PC that is always on corporate network.
The Internet	Never uses proxy <ul style="list-style-type: none">▶ This option assumes no proxy is necessary when passing connections through the PC.▶ This option best suits connecting to a PC connected directly to the Internet through ISP (at home)

- 3) Select **Open ActiveSync when my device connects**.
- 4) Hit **OK** button to apply the change and quit setting.

To pass-through network using Bluetooth, see [Bluetooth Pass-through Networking](#).



Also compare with [USB Internet Sharing](#).



2.9. AUDIO PLAYBACK

Use a headset for audio playback and hands-free telephone communication. Bluetooth headsets are supported to deliver better mobility. See [Use Bluetooth](#).

2.9.1. VOLUME CONTROL

The mobile computer has two volume control facilities – the physical volume rocker perched on the waist of the mobile computer and the onscreen volume gauges featured by the O.S. The physical rocker controls the system volume (media playback and event/notification sounds).

When either the system volume or phone ringer volume is enabled, the O.S. shows an  icon on [Title Bar](#); otherwise it shows an . See the table after the break for a summary.

Volume Control	System volume	Ringer volume	In-call volume
Physical Volume Rocker	Yes	No	Yes
Onscreen Volume Gauge	Yes	Yes	Yes
Title bar Volume Icons  	Yes	Yes	No

PHYSICAL VOLUME ROCKER

Use physical volume rocker to turn up and down system volume.

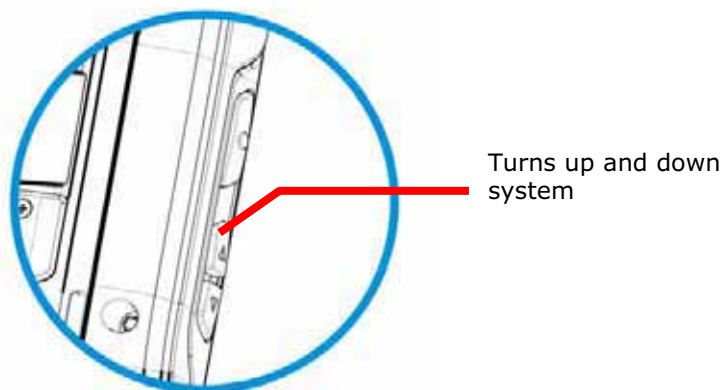



Figure 11: Physical Volume Rocker

ONSCREEN VOLUME GAUGES

The onscreen volume gauges adjust all three of system, phone ringer. To adjust any of them:

- 1) Tap Title bar at the top of the screen.
A horizontal drop-down bar opens.
- 2) Tap the volume icon .

[Volume] dialog opens presenting the gauges for system volume and phone ringer volume. Two radio buttons [On] and [Off] are featured on the right. Select [On] or [Off] to enable or mute both volumes.

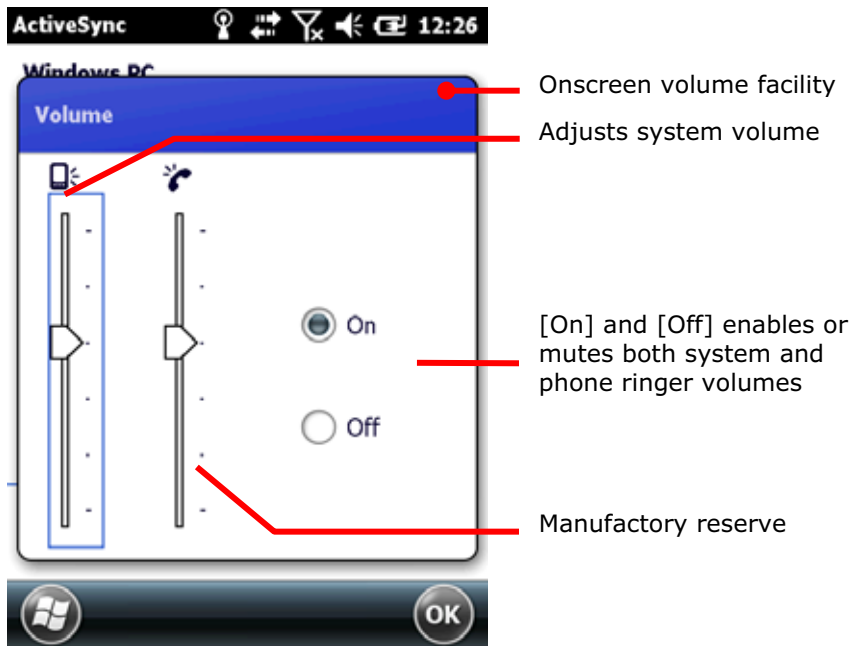

3) Adjust to the setting that meets your needs.

CAMERA

The mobile computer is adorned with a 5.0 mega-pixel camera that can also serve as a camcorder. The O.S. provides a camera/camcorder application, which launches the camera, takes pictures, shoots videos and stores the works on the mobile computer's storage where they can be viewed, edited and output.

The camera/camcorder application provides users with satisfactory customization that is helpful for users' image capture for better documentation.

This chapter will guide you to use the camera.

2. IN THIS CHAPTER

2.1 Launch Camera	55
2.2 Take Pictures	56
2.3 Launch	59
2.4 Shoot Videos.....	59
2.5 Pictures & Videos	63

2.1. LAUNCH CAMERA

To launch the camera:

- 1) On Start screen, tap **Pictures and Videos** .
Pictures and Videos application opens.
- 2) Tap **Camera** icon located at the upper left of the window.
Camera opens in portrait mode and ready to take pictures.

2.1.1. CAMERA SCREEN

Camera opens showing subject area on the screen with related information displayed in the lower right corner. A menu bar sitting on the bottom allows users to switch to thumbnail display under **Pictures & Videos**, adjust camera settings, switch to video shooting mode, exit the camera tool and more.

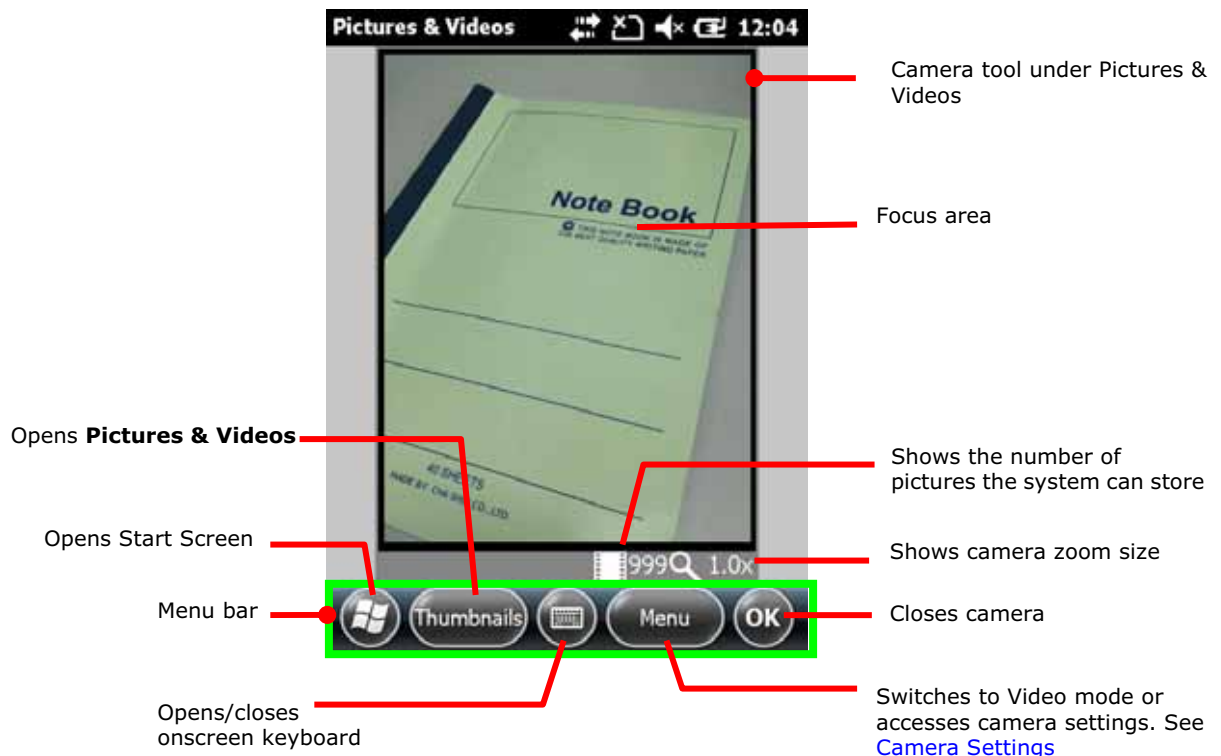

2.2. TAKE PICTURES

By default, pictures are taken in JPEG format and are saved to the mobile computer's internal storage under **My Device\My Documents\My Pictures**. To change the default storage path, see [Camera Settings](#).

To take a picture:

- 9) Open camera as described in [Launch Camera](#).

Camera opens in portrait mode and readies to take pictures.

- 10) Adjust picture quality and any other settings according to your preferences. See [Camera Settings](#).

- 11) Frame your object on the screen.

- 12) Press the physical shutter button to take the picture. (See [Overview](#).)

After the picture is taken, a preview of it will appear briefly on the screen.



2.2.1. CAMERA SETTINGS

The camera supports changing shooting mode, brightness, resolution, and camera zoom. Users can also enable full screen shooting mode which leaves the screen clean of option buttons and picture information.

To access camera settings:

- 13) Open camera as described in [Launch Camera](#).

- 14) Tap **Menu** command on the Softkey bar

A pop-up option menu appears onscreen showing various option settings.

Note: The **Menu** command and pop-up option menu are also available in the picture preview screen.

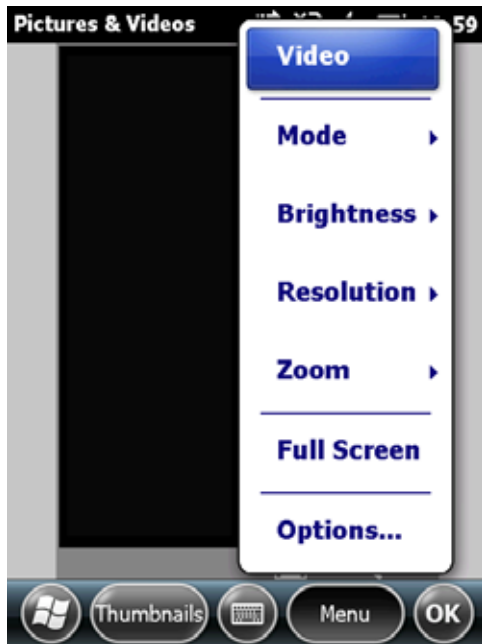

Available menu items are detailed as below:

Item	Description
Video	Switch to video camera.
Mode	Sets camera mode between normal, burst or timer.
Brightness	Sets brightness between -3 EV to +3 EV in 1 EV increments.
Resolution	The mobile computer supports QVGA resolution.
Zoom	Sets zoom from 1x to 4x in 0.5x increments.
Full Screen	Switches to full screen mode (all menu buttons will be hidden).
Options...	Opens Pictures & Videos settings page showing four tabbed pages: Camera , Video , General , and Slide Show . <div style="display: flex; justify-content: space-around; margin-top: 5px;"> Camera tabbed page Video tabbed page </div>

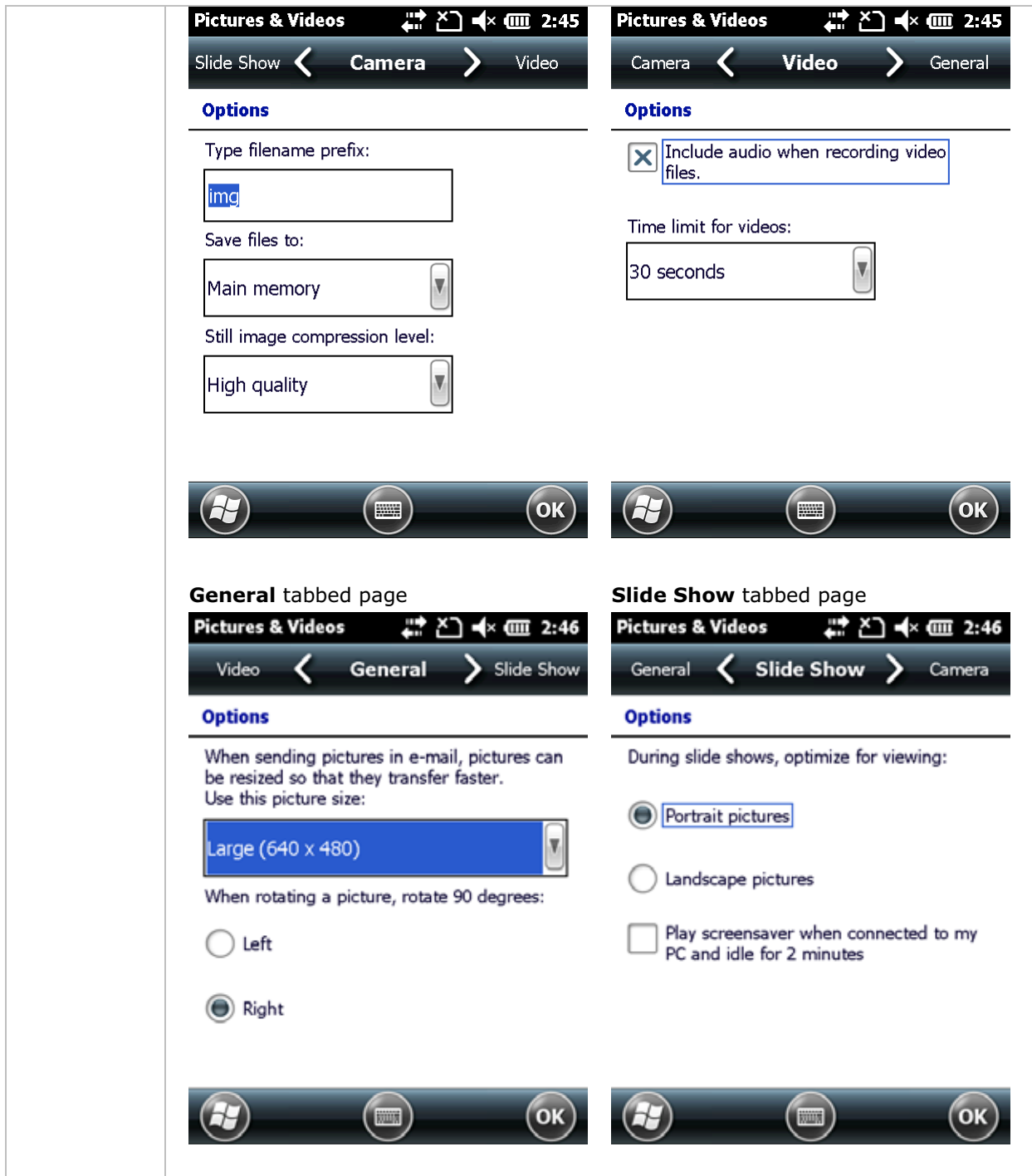

2.3. LAUNCH VIDEO CAMERA

To launch the video camera:

- 1) Launch camera as described in [Launch Camera](#).
- 2) Tap **Menu** command on the Softkey bar

A pop-up option menu appears onscreen showing various option settings.

- 15) Tap **Video** in the option menu.

Video camera is readied to begin shooting.

2.3.1. VIDEO CAMERA SCREEN

Video camera launches showing subject area onscreen with the remaining recording time displayed in the lower right corner. A menu bar sitting on the bottom allows users to switch to thumbnail display under **Pictures & Videos**, adjust camera settings, switch to picture taking mode, exit the camera tool and more.

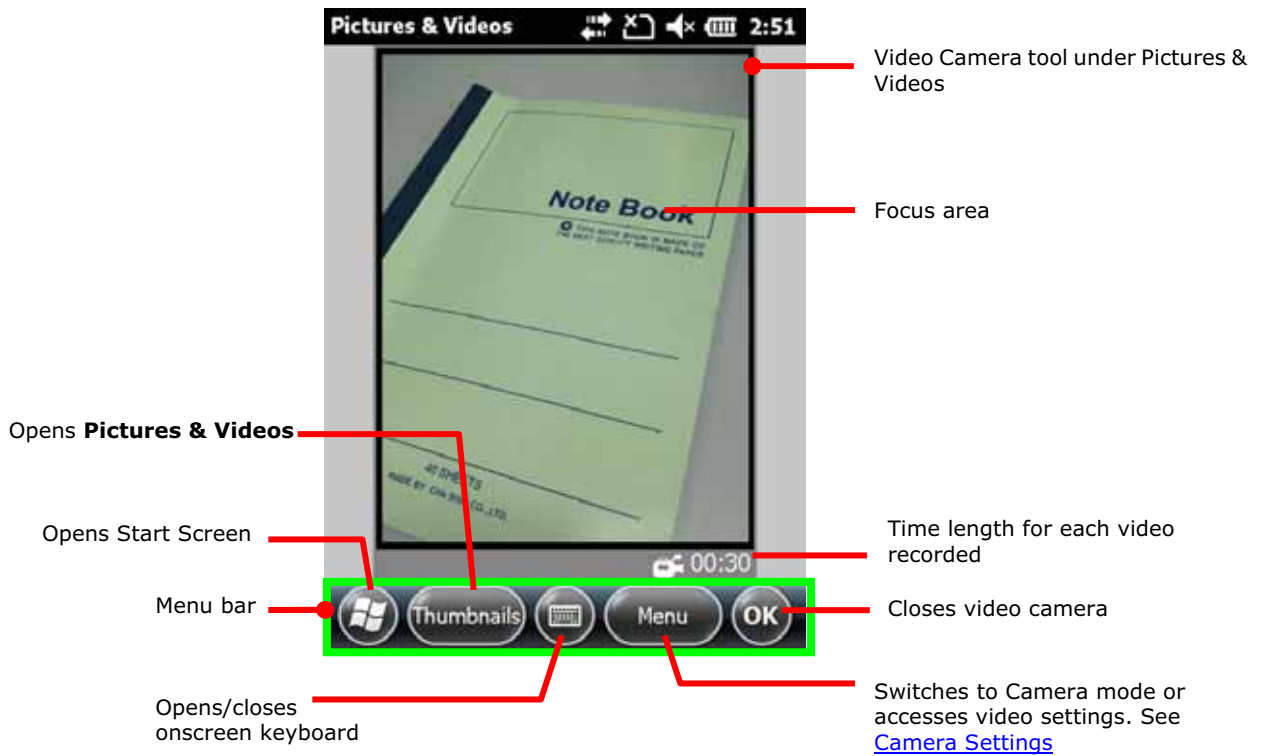

2.4. SHOOT VIDEOS

By default, videos are shot in WMV format and are saved to the mobile computer's internal storage under **My Device\My Documents\My Pictures**. To change the default storage path, see [Camera Settings](#).

To shoot a video:

- 1) Open video camera as described in [Launch Camera](#).
Video camera opens in portrait mode and readies to shoot.
- 16) Adjust brightness and other settings according to your preferences. See [Camera Settings](#).
- 17) Frame your object on the screen.
- 18) Press the physical shutter button. (See [Overview](#).)

The video then starts shooting, and two time meters located respectively on the lower left and right will show the shooting time and the remaining time allowed for shooting the video.

Note: Video shooting length can be adjusted in **Video** tabbed page under **Pictures & Video** settings. See [Camera Settings](#) for more details.

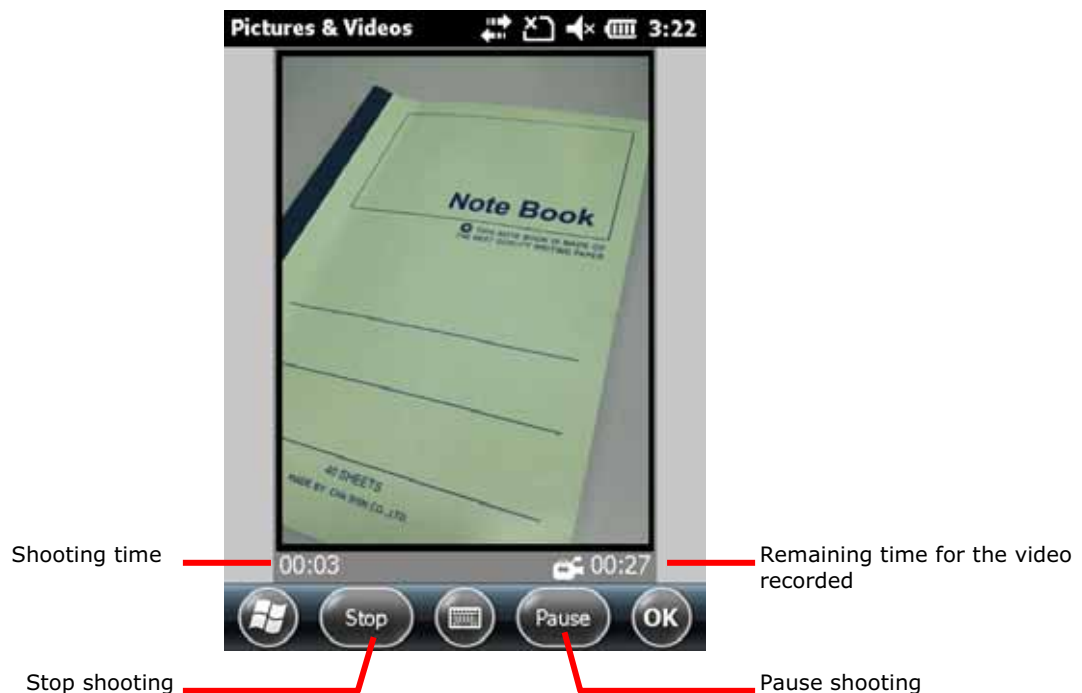

2.4.1. VIDEO CAMERA SETTINGS

The video camera supports changing brightness and quality. Users can also enable full screen shooting mode which leaves the screen clean of option buttons and picture information.

To access camera settings:

- 1) Open video camera as described in [Launch Camera](#).

2) Tap **Menu** command on the Softkey bar

A pop-up option menu appears onscreen showing various option settings.

Note: The **Menu** command and pop-up option menu are also available in the video preview screen.

Available menu items are detailed as below:

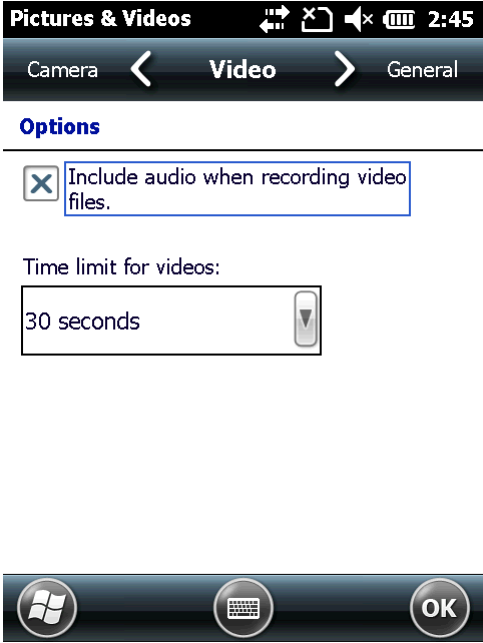
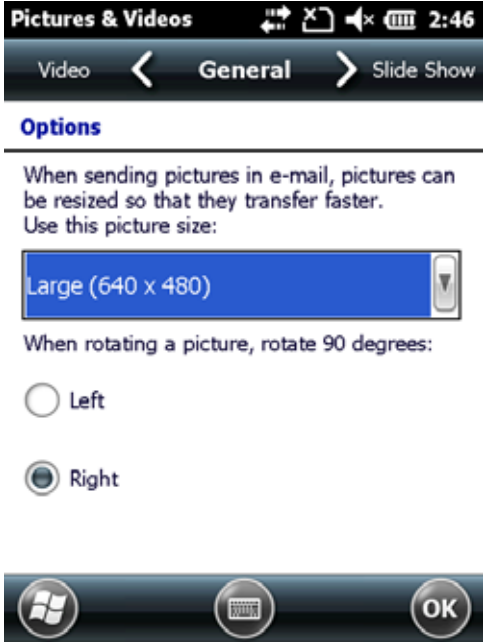
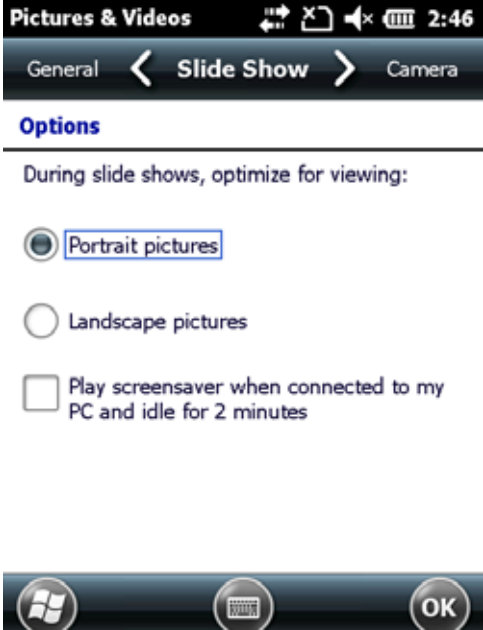
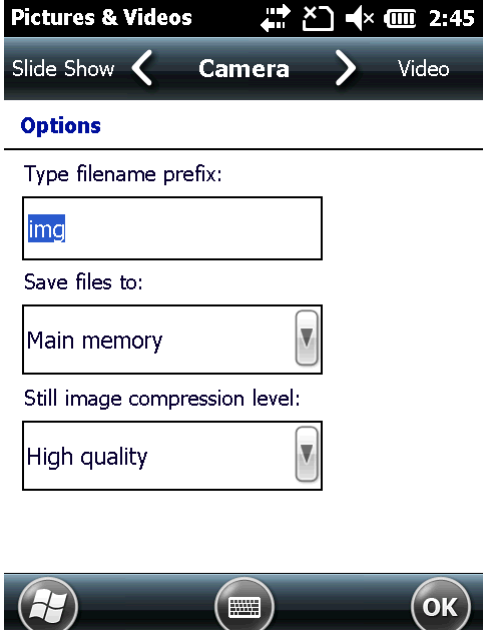
Item	Description
Still	Switch to camera.
Brightness	Sets brightness between -3 EV to +3 EV in 1 EV increments.
Quality	The mobile computer supports QVGA resolution.
Full Screen	Switches to full screen mode (all menu buttons will be hidden).
Options...	<p>Opens Pictures & Videos settings page showing four tabbed pages: Video, General, Slide Show and Camera.</p> <div style="display: flex; justify-content: space-between;"> <div style="width: 48%;"> <p>Video tabbed page</p>  </div> <div style="width: 48%;"> <p>General tabbed page</p>  </div> </div> <div style="display: flex; justify-content: space-between; margin-top: 20px;"> <div style="width: 48%;"> <p>Slide Show tabbed page</p>  </div> <div style="width: 48%;"> <p>Camera tabbed page</p>  </div> </div>

2.5. PICTURES & VIDEOS

Pictures & Videos is an application that views and edits the pictures taken and videos shoot, or those copied or downloaded. It also sets background for [Today Screen](#) and [Start Screen](#), and sets avatars for your contacts. It also emails pictures and videos.

LAUNCH PICTURES & VIDEOS

To launch Pictures & Videos:

- 1) On Start screen, tap **Pictures & Videos** icon .

OR

Tap **Thumbnails** command on camera or camcorder menu bar if it is active at the moment.

Pictures & Videos opens unfolding **My Device\My Documents\My Pictures**, the default folder that stores the pictures and videos copied/downloaded from external resources or took/shot on the mobile computer. Each picture and video therein displays in thumbnail.

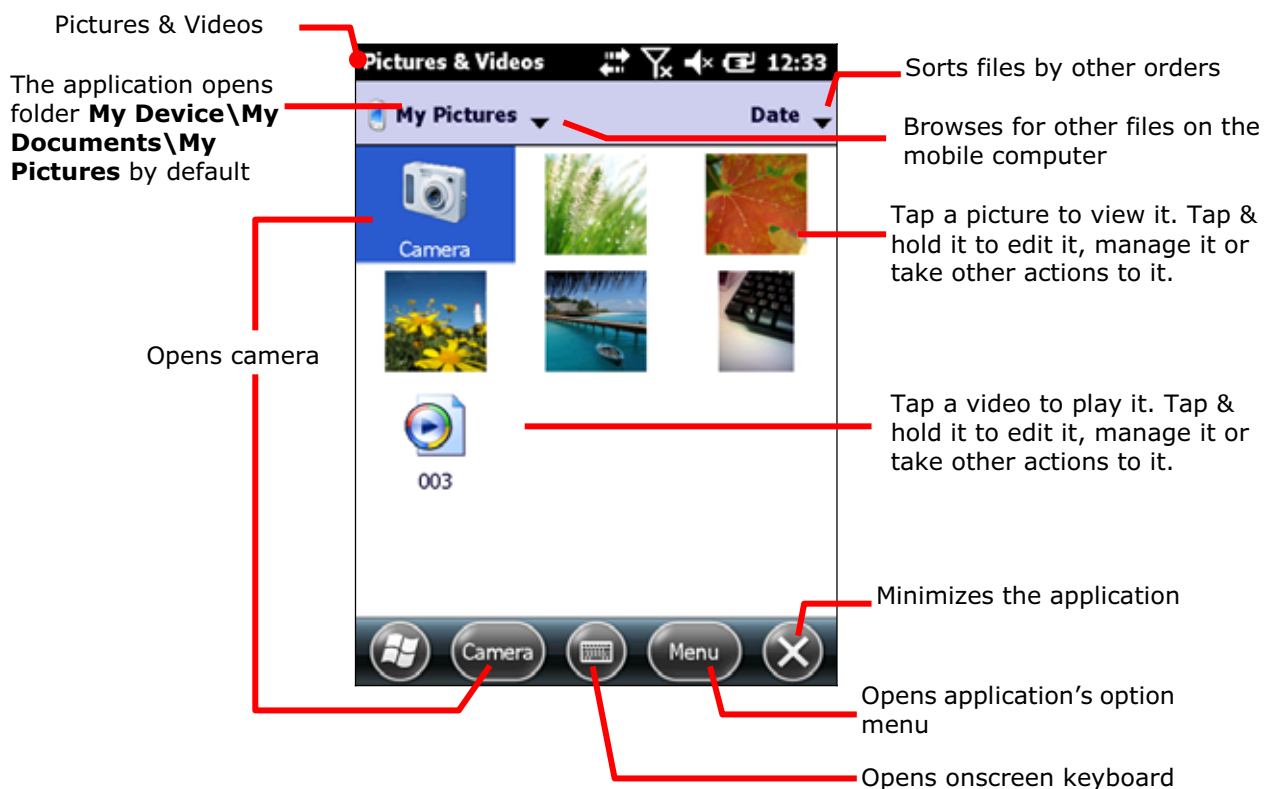

VIEW A PICTURE OR VIDEO

To view a picture or video:

- 1) Open Pictures & Video as described in [Launch Pictures & Videos](#).
Pictures & Videos opens.
- 2) Tap the thumbnail of the picture or video to view.

The picture displays or the video starts to play onscreen.

TAKE OTHER ACTIONS TO A VIDEO OR A PICTURE

To edit, manage or take other actions to a video or picture:

- 1) Open Pictures & Video as described in [Launch Pictures & Videos](#).
Pictures & Videos opens.
- 2) Tap & hold the thumbnail of the picture or video to edit, manage or take other actions to.
A context menu comes up.
- 3) Tap a menu item to perform the desired action.

OR

- 1) Tap the thumbnail of the prospective picture or video.
It becomes selected with highlight.
- Tap the command button that comes up on [Softkey bar](#).

<reserved>

OPERATING SYSTEM

The mobile computer is powered by Windows Embedded Handheld 6.5, a member of Windows Embedded family branded for full compatibility with Windows Mobile 6.5.

Windows Embedded Handheld 6.5 features a prettier UI and a series of fresh new looks unseen in the predecessor Windows CE. The most important enhancement of all is those touch-friendlier UI elements such as the inertial scrolling of lists and redesigned context menus. These elements are offered throughout the platform and are particularly helpful for mobile computing. Users rely only on a few basic gestures such as Tap or Flick to navigate within the O.S.

Windows Embedded Handheld 6.5 also features a [Today Screen](#). The [Start Screen](#) on the other hand lays out application icons in a staggered manner to maximize the space available to touch each icon and increase icons allowed onscreen.

This chapter goes through the basics of the O.S. and guides to [Today Screen](#) and [Start Screen](#) where all features on the mobile computer are accessible from.

3. IN THIS CHAPTER

3.1 1st Startup	67
3.2 Today Screen	68
3.3 Start Screen	70
3.4 Suspend & Reset Mobile Computer	80
3.5 Set Screen Lock.....	83
3.6 Work with Menus	84
3.7 Manage Applications.....	86

3.1. 1ST STARTUP

Finished with the setup as described in [Main Battery Setup](#) and [Insert SD Card](#), proceed to power on the mobile computer as described in [Power On Mobile Computer](#).

If you haven't installed a SIM card, the mobile computer isn't able to connect to mobile networks for phone or data.

Upon first power-on, the O.S. boots into [Today Screen](#), a new feature introduced by Windows Embedded Handheld 6.5:



3.2. TODAY SCREEN

It is Today screen that first shows onscreen when the mobile computer powers on or is unlocked. Today screen shows a scrollable list of applications such as pictures, music, phone, voicemail, clock & time and so on, and the application in the center is always the active one.

When an application is active, today screen displays additional information, and command buttons appear on the [Softkey bar](#) to take actions to the application. Tap an active application to open it.

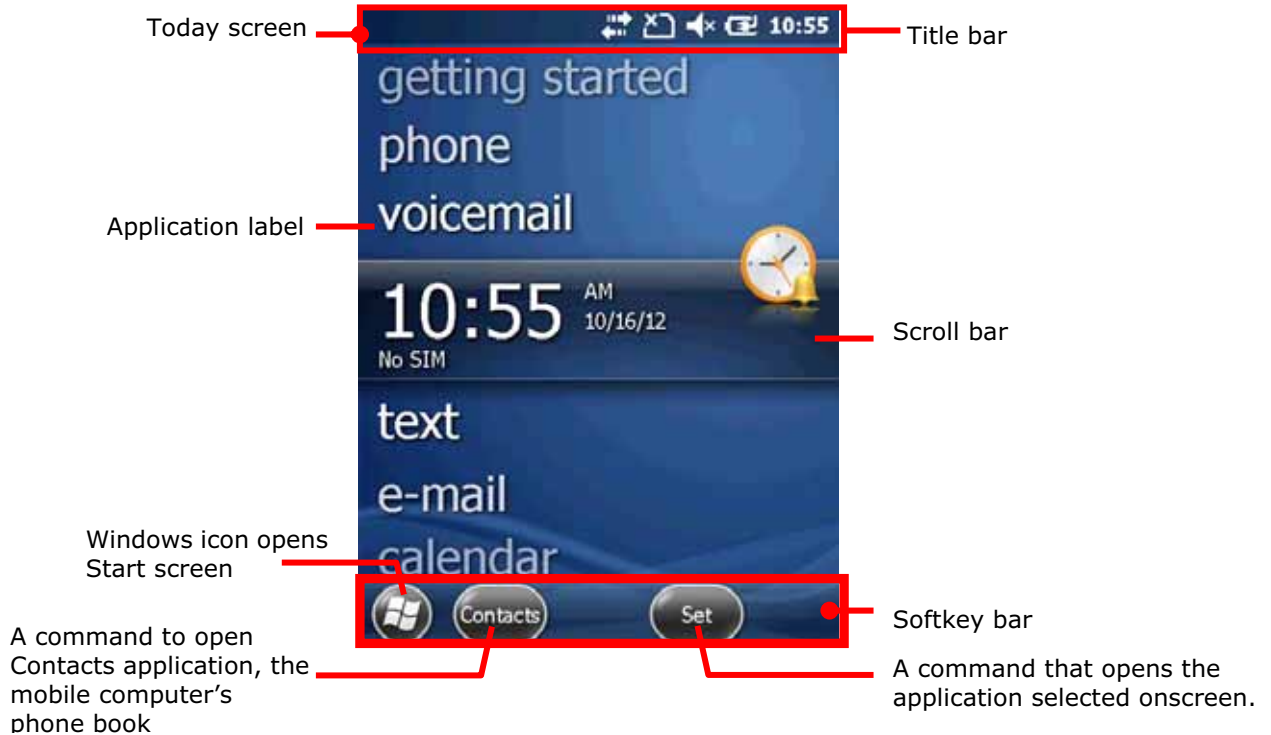



Facility	Description
Notification area	<ul style="list-style-type: none"> Shows the mobile computer's statuses such as time, radio signal strength, battery level and so on. Displays the notifications issued by O.S.
Scroll bar	Scrolls up and down the screen to select among the applications.
Application label	<ul style="list-style-type: none"> Delivers application name. Delivers application status when selected by scroll bar. Opens the application when selected (by scroll bar) and tapped.
Softkey bar	A horizontal rectangle bar presented at the bottom of almost every screen within the O.S. It bares the commands to cause the currently active application/screen to take actions.
Command	Launch actions from the current screen or currently active application. Commands are available in context with the application selected onscreen.
Windows icon 	Opens Start screen.

3.2.1. CUSTOMIZE TODAY SCREEN

Customize Today screen to change its appearance and presented items.

To customize Today screen:

- 1) Tap Windows icon  on [Softkey bar](#) or hit physical Windows key .
- 2) Tap **Settings | Home**.
Home settings open.
- 3) Select between **Appearance** and **Items** tabs.

Appearance tabbed page changes the background for Today screen while Items tabbed page changes the items to present.

Home Settings

- Appearance tabbed page

Changes the background for Today screen



Home Settings

- Items tabbed page

Changes the items to present on Today screen



3.2.2. RETURN TO TODAY SCREEN

Tap the Home icon  on the Start screen to re-open the today screen..

3.3. START SCREEN



Start screen is where all features on the mobile computer are accessed from. This screen lays out the application icons, shortcuts and so on in a staggered manner so each icon are more touchy and icons allowed onscreen are increased.

Basic operations on Start screen:



- ▶ If you see the icon of the application you want to open, tap it.
- ▶ Flick the screen to scroll down and bring more application icons into view. (See also [Use Touchscreen.](#))
- ▶ Customize Start screen by changing background and the items to display. See [Customize Start Screen](#) for more details.

Take a look around Start screen:



Facility	Description
Start screen	Accesses all applications and settings.
Notification area	Shows the time, radio signal strength, battery status, and other information. It also displays notification icons and status icons.
Minimize button 	Minimizes the active application or current screen.
Windows icon 	Opens Start screen.
lock icon 	Locks screen.

3.3.1. RETURN TO START SCREEN

Tap Windows icon  on [Softkey bar](#) or hit physical Windows key  to return to Start screen.

3.3.2. TITLE BAR

At the top of almost every screen is Title bar. It shows a title on the left and a notification area on the right. The title delivers the name of the current screen or currently active application while notification area shows a sequence of graphic icons delivering system statuses or notifications issued to users.

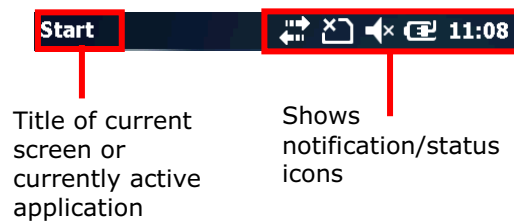

























Status icons assert mobile computer's contiguous statuses such as time, radio signal strength, battery level and so on. Notification icons report the arrival of a new message, alarm, and some ongoing events. When a notification is issued, an icon comes up in notification area, and the mobile computer produces a sound or vibrates.

A general view of the status/notification icons on the mobile computer:

STATUS & NOTIFICATION ICONS

The O.S. presents the following icons for users. Note there may be application-particular icons not included here.

-  External power connected
-  Battery level (See [Monitor Battery Level](#) for details.)
-  Numeric keypad enters symbols; QWERTY keypad enters uppercase letters.
-  Numeric keypad enters alphabetic letters; QWERTY keypad enters numbers/symbols.
-  System sound or phone ringer enabled
-  System sound or phone ringer muted
-  Vibration on
-  No SIM card installed
-  Phone off
-  SIM card locked. PIN code required to turn on phone.
-  Phone on with signal strength
-  Mobile data (HSPA+/EDGE/GPRS) in use
-  Wi-Fi on but not connected

-  WiFi network(s) available
-  WiFi in use
-  Bluetooth in use
-  Bluetooth headset in use
-  Alarm on
-  More notifications to be viewed. Tap Title bar or tap the "Notification" command on [Softkey bar](#) to view them all.
-  Email received
-  Text message received
-  Syncing data with a Windows-based PC
-  Roaming
-  Microsoft's appeal for customer feedback to help improve Windows Embedded Handheld software.

To learn more status icons of mobile/wireless data connections, see [Radios](#).

3.3.3. MANAGE NOTIFICATIONS





Status/notification icons are relatively small, however by tapping the Title bar a drop-down bar will appear to provide larger and touchy icons.



Note there are commands that come up on [Softkey bar](#) to manage a notification.

A general view of bigger notification/status icons on Drop-down bar:

Icon	Description
	Zooms in/out of current screen.
	Leads to Wireless Manager and Connections (Manager) where your current mobile data can be viewed and configured.
	Delivers current system/ringer volume and opens volume settings. See Onscreen Volume Gauges for more details.
	Opens power settings where battery level and charging status can be viewed. See More Charge Info .
	Opens clock settings.
	Reports customer feedback to Microsoft for improving Windows Embedded Handheld software.
	Opens the reminder for an alarm or appointment.

	Bluetooth A2DP profile in use. Tap it to access Bluetooth devices list.
	Checks a new e-mail.
	Opens Text application.
	Roaming on

RESPOND TO NOTIFICATIONS

- 1) Tap Title bar to open Drop-down bar.
Drop-down bar opens.
- 2) Tap the status/notification icon to manage.
Drop-down bar closes and you are taken to the application in question.

CLEAR NOTIFICATIONS

A notification won't be cleared until it is managed. Upon receiving a notification, tap Title bar to open Drop-down bar to manage it, or tap the action command which appears on the [Softkey bar](#).

3.3.4. CUSTOMIZE START SCREEN

Customize Start screen by changing the background, application shortcuts, and so on. Rearrange the application shortcuts to make the applications that you use most often easiest to access.

CHANGE BACKGROUND

Craft your Start screen and Today screen with any of your own pictures or a number of designer's themes bundled with the O.S.

APPLY ONE OF YOUR OWN PICTURES:

- 1) On Start screen, tap **Pictures & Videos** .
Pictures & Videos opens.
- 2) Tap a picture. The picture opens. Tap the "Menu" command on [Softkey bar](#).

OR

- Tap & hold a picture.
Context menu shows up directly.
- 3) Tap **Set as Home background**.
The picture is set as background

APPLY ONE OF THE DESIGNER'S THEMES:

- 1) On Start screen, tap **Settings | Home**.
Appearance tabbed page opens.
- 2) Tap a theme from the list.
- 3) Tap the "OK" command on [Softkey bar](#).
Change is applied to Today & Start screens.

MOVE APPLICATION SHORTCUTS ON START SCREEN

On Start screen, you can re-tile the application shortcuts (icons) as you like. For example, move your favorite applications atop others:

- 1) Tap & hold an application icon until it is hoisted by a white border.
- 2) Drag the application icon and do not release until it reaches the desired position.

ADD ITEMS TO START SCREEN

A variety of shortcuts can be added to Start screen to quick-open some files or bookmarked webpages or applications.

The mobile computer relies on File Explorer , one of the O.S. featured applications, to add application shortcuts to Start screen:

ADD APPLICATION SHORTCUTS

- 1) On Start menu, tap File Explorer .
File Explorer opens.
- 2) Browse to the executable file of the application to add shortcut for.

- 3) Tap & hold the executable file.
A context menu comes up.
- 4) Tap **Copy**.
- 5) Browse to **My Device\Windows\Start Menu\Programs**.
Programs folder opens.
- 6) Tap & hold any vacant spot onscreen.
Context menu comes up
- 7) Tap **Paste Shortcut**.
The application shortcut is added to Start screen.

ADD BOOKMARKED WEBPAGE SHORTCUTS

- 1) On Start screen, tap File Explorer .
File Explorer opens.
- 2) Browse to **My Device\Windows\Favorites**.
- 3) Tap & hold the bookmark to create shortcut for.
Context menu comes up.
- 4) Tap **Copy**.
- 5) Browse to **My Device\Windows\Start Menu\Programs**.
Programs folder opens.
- 6) Tap & hold any vacant spot onscreen.
Context menu comes up
- 7) Tap **Paste Shortcut**.
Shortcut to the bookmarked page is added to Start screen.

ADD FILE SHORTCUTS

- 1) On Start screen, tap File Explorer .
File Explorer opens.
- 2) Browse to the file to create shortcut for.
- 3) Tap & hold it.
Context menu comes up.
- 4) Tap **Copy**
- 5) Browse to **My Device\Windows\Start Menu\Programs**.
Programs folder opens.
- 6) Tap & hold any vacant spot onscreen.
Context menu comes up.
- 7) Tap **Paste Shortcut**.
Shortcut to the file is added to Start screen.

REMOVE ITEMS FROM START SCREEN













The mobile computer relies on File Explorer  to remove an application shortcut from Start screen:















- 1) On Start screen, tap File Explorer .
File Explorer opens.
- 2) Browse to **My Device\Windows\StartMenu\Programs**.
Programs folder opens. This is where all applications/bookmarks/file shortcuts are.
- 3) Tap & hold the shortcut to remove.
Context menu comes up.
- 4) Tap **Delete**.

The shortcut is removed from Start screen.

3.3.5. START SCREEN ICONS

Start screen presents a number of icons in a staggered pattern that makes them easily touchable. Each icon opens an application, folder or a group of settings when it is tapped. This section will give an overview of these icons.

Icon	Name	Description
	Home (Today)	Opens Today screen. See Today Screen .
	Text	Sends SMS text messages.
	E-mail	Pens and sends emails.
	Contacts	Integrates all types of contacts including phone contacts, email contacts, instant messenger contacts and so on. This application is similar to the phone book on a cell phone.
	Internet Explorer	Browses world wide web.
	Calendar	Creates and manages events, meetings, and appointments.
	Settings	Accesses system settings.
	Getting Started	Opens Getting Started application to set up some O.S. basic features.
	Alarms	Opens Clock & Alarms application to: <ul style="list-style-type: none"> ▶ Set date, time, time zone for your locale. ▶ Set and manage alarms.
	Pictures & Videos	Views pictures and plays videos downloaded, copied or taken/shot with the built-in camera. See Pictures & Videos .
	Internet Sharing	Shares the mobile computer's mobile data connection with another computer through a USB or serial cable. See USB Internet Sharing & Bluetooth Internet Sharing for details.
	Search Phone	Searches contacts, files and other data on the mobile computer.
	Office Mobile 2000	Opens Microsoft Office suite applications including Excel Mobile, SharePoint WorkSpace Mobile, OneNote Mobile, Word Mobile, and PowerPoint Mobile.

	Camera	Takes pictures and shoots videos. See Camera for details.
	Windows Media	Plays audio/video files.
	Marketplace	An online software download/purchase service which was shut down on 22 nd May 2012.
	MSN Weather	Checks the weather of your locale and other parts of the world.
	Windows Live	Accesses Windows Live services (such as Hotmail) or searches world wide web.
	MSN Money	Checks stocks.
	Calculator	Performs mathematical calculations.
	Notes	Creates notes by typing on the physical keypad or text entering on the onscreen keypad.
	Tasks	Creates, tracks, and manages tasks.
	File Explorer	Browses and manages the files on local storage.
	ActiveSync	Synchronizes Microsoft Office Outlook data between the mobile computer and another Windows-based computer such as your PC. See Syncing Tool and subsequent sections for more details
	Task Manager	Monitors the active applications and CPU/memory usage on the mobile computer. See Task Manager .
	Help	Accesses O.S. online help.
	Remote Desktop Mobile	Connects to a remote computer.
	SimTkUI	Accesses the WAP/XML services provided by your mobile carrier.

3.4. SUSPEND & RESET MOBILE COMPUTER

To save from repeatedly charging and replacing batteries more often than you would like to, suspend the mobile computer when you are not actively using it. "Suspension" is a state to hold the device from running without turning off power. It is a "soft-off" state which enables less power consumption, and also a state from which a device can quickly awake from since there is no need to restart the software (applications).

3.4.1. SUSPEND MOBILE COMPUTER

The mobile computer is suspendible both manually and automatically. See also [Wake up Mobile Computer](#).

MANUAL SUSPENSION

Press physical Power button without holding it to suspend the mobile computer.

AUTO-SUSPENSION

Set up a power plan to suspend the mobile computer in an apt timing.

To set up a power plan:

- 1) On Start screen, tap **Settings | Systems | Power** .

Power setting opens showing Battery tabbed page.

- 2) Tap **Advanced** tab.

Advanced tabbed page opens.

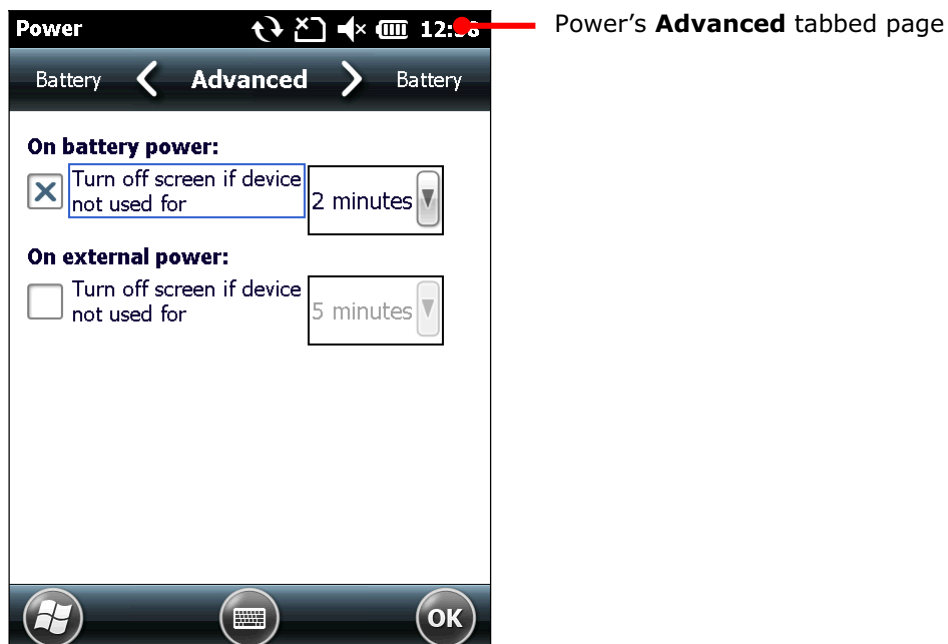

- 3) Set a time to turn off LCD and suspend the mobile computer.

Note the following cases also suspend the mobile computer:

- ▶ Battery door isn't in place.
- ▶ Battery fails.

To get the most from the battery power, see [Optimize Battery Life](#).

3.4.2. WAKE UP MOBILE COMPUTER

"Waking up" is to restore the suspended device to its previous working state. The mobile computer can be awoken both manually and automatically.

MANUAL AWAKENING

Press (without holding) the physical Power button or central scan key to wake up the mobile computer.

AUTO-AWAKING

The mobile computer wakes up by itself when either of the following happens:

- ▶ Plugging of USB or serial cable.
- ▶ Plugging of AC power cord.

- ▶ RTC alarm occurs.

Note: There are certain cases when the mobile computer cannot be awoken:

- (1) When battery door isn't installed in place.
- (2) Imperfect contact between main battery and battery chamber contact pins.

3.4.3. RESET MOBILE COMPUTER

The mobile computer features 2 reset mechanisms, warm boot and cold boot. Performing these two resetting acts helps resolve certain problems within the O.S. and applications. Make use of the physical Power button and the reset toggle located on the mobile computer's keypad to produce the said actions.

- [1] Power button
- [2] Reset toggle

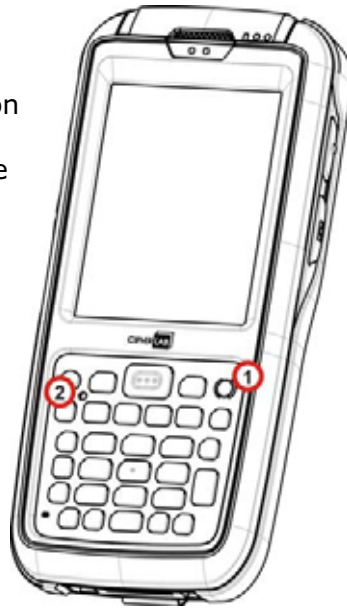

Figure 12: Reset

WARM BOOT (SOFT RESET)

“Warm boot” is also known as “soft reset”. When the mobile computer runs slower than normal or when one or more active applications crash, perform warm boot to close all active applications and restart the mobile computer without turning off power supply to hardware.

After warm boot, all flash memory, system settings and clock/calendar time are kept, and all saved data are preserved. However unsaved data is gone after warm boot if the warm boot is performed when the application in question is still running.

To perform “warm boot”:

- ▶ Poke the reset toggle using the stylus.

COLD BOOT (HARD RESET)

“Cold boot” is also known as “hard reset”. In case one or more applications are misbehaving and the mobile computer doesn’t cooperate, perform cold boot as the final act.

“Cold boot” restarts the mobile computer by turning power off just like pulling the battery and then powering on again. As “Cold boot” initializes DRAM, all data cached in DRAM is gone after cold boot. However all flash memory, system settings and clock/calendar time are preserved.

To perform “cold boot”:

- ▶ Press and hold the physical Power button and poke the reset toggle.

Note Power button should be held down and not released until the mobile computer powers on again.

OR

- ▶ Simply reload main battery and re-power on the mobile computer.

3.5. SET SCREEN LOCK

For the sake of security, you may want to restrict the access to the mobile computer by a self-set password. The O.S. supports setting up a password to recover the access to the mobile computer.

To set up an unlock password:

- 1) On Start screen, tap **Settings | Lock**.
Password setting opens.
- 2) Configure how much time the mobile computer should be left unused before locking out the screen. Set up a unique password to unlock the screen.
- 3) Tap the "OK" command on Softkey bar to apply the change and quit setting.

3.5.1. UNLOCK SCREEN

Once a screen lock is set, the screen locks out all access after the mobile computer is left idled for the defined time. To recover access to the mobile computer:

- 1) On the locked screen, tap and drag the lock icon  to the right or left.
An onscreen keypad appears resembling an average phone keypad.
- 2) Enter either the password that unlocks the screen or an emergency call number.



Enter the password to unlock screen.



If an emergency call number is entered, the buttons to place and end calls display.

- 3) Follow onscreen instructions to proceed.

3.6. WORK WITH MENUS

The O.S. presents two kinds of menus: option menus and context menus. By these menus, users are able to operate onscreen and use applications.

3.6.1. OPTION MENU

Normally a screen or an active application features a “Menu” command  on [Softkey bar](#) to launch an “option menu”, which causes actions to be taken by the screen or the active application. Examples:



Internet Explorer features a menu bar along the bottom that includes a “Menu” command to open a option menu.

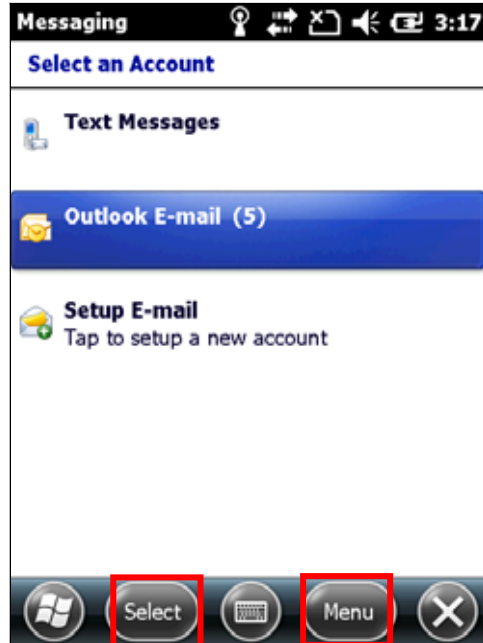

E-mail application features two commands on [Softkey bar](#). Tap a command to produce actions taken by the application.

Note some screens/applications may not have an option menu.



A screen that doesn't feature a "Menu" command on [Softkey bar](#).

An example of Start screen.

3.6.2. CONTEXT MENUS

The context menu on the other hand contains the actions to be performed on a specific item selected onscreen. Tap & hold an onscreen item to open the context menu.

Not all items have context menus. Nothing happens if you tap and hold such an item.

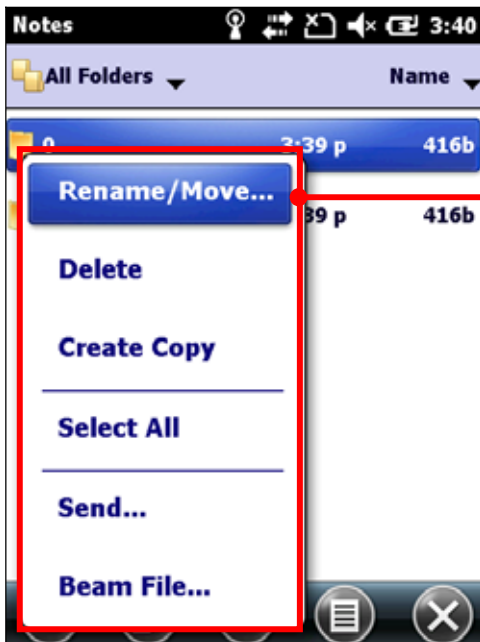

A context menu launches for a selected item.

An example of Notes application.

3.7. MANAGE APPLICATIONS

On Windows Embedded Handheld 6.5, Start screen is where all inherent applications of the O.S. are accessed from.

In the O.S., when you run an application, the other applications that have been running don't shut down but keep on running whether it is music that is being played or a webpage that is being browsed.

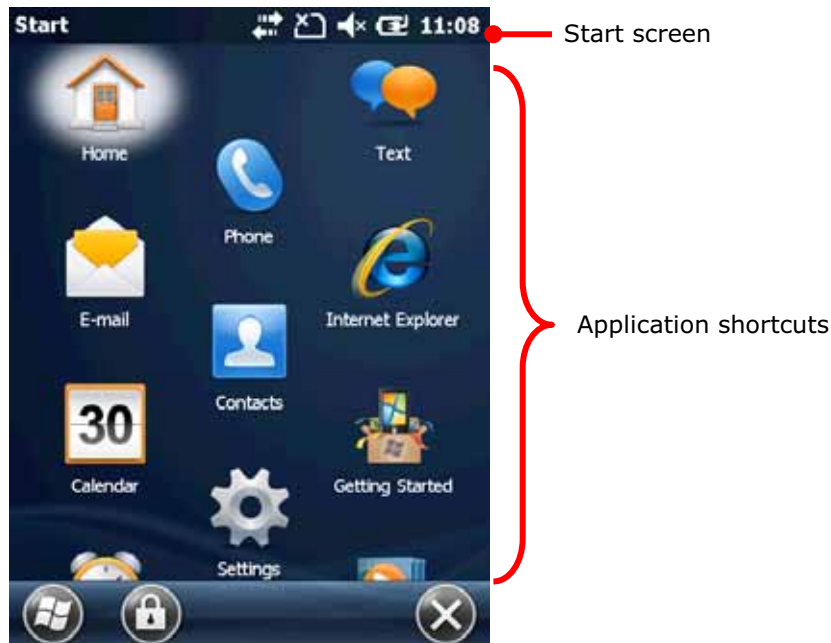

3.7.1. TASK MANAGER

The O.S. featured Task Manager  is a tool to monitor the memory and CPU resources consumed by each running application and cached process. Task Manager also provides an interface for users to close applications and switch between the opened applications.

LAUNCH TASK MANAGER

To launch Task Manager:

- 1) On Start screen, tap Task Manager icon .
Task Manager opens showing monitored applications.

MONITOR OPENED APPLICATIONS

Upon launch, Task Manager shows a list of all opened applications which are under monitor:

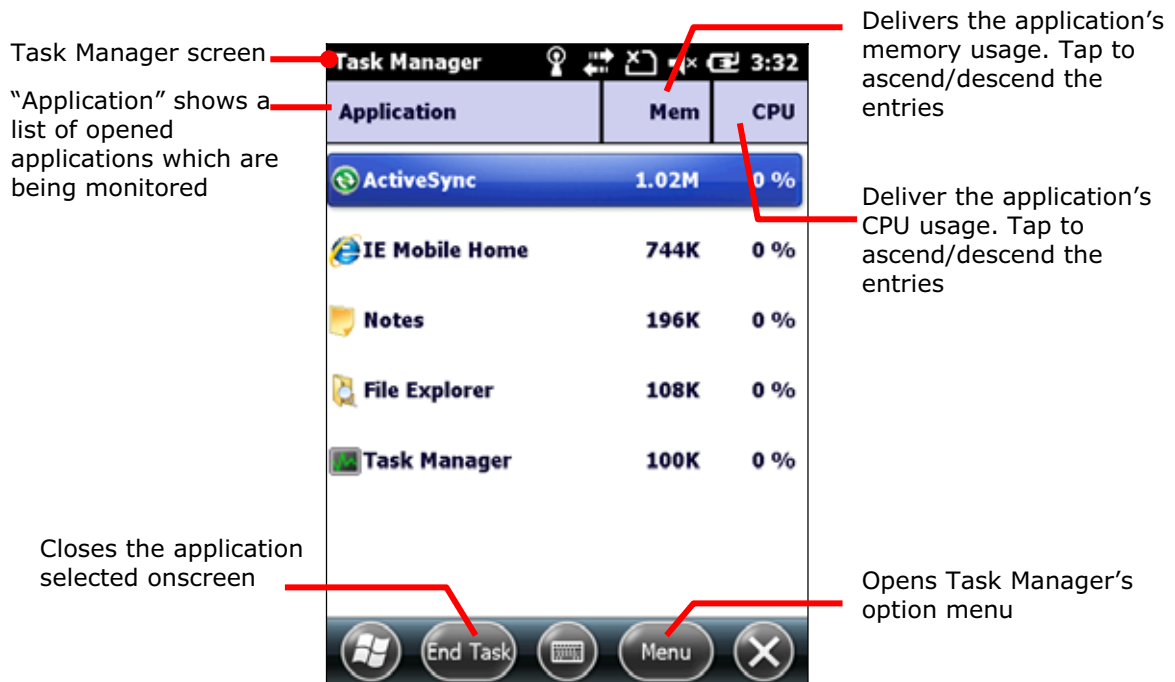

To monitor cached processes, see [Monitor Cached Processes](#).

CLOSE APPLICATIONS

Close an application when it isn't used, or when it is misbehaving. Check for any misbehaving applications by looking up its usage of memory and CPU.

In the O.S., how to close an application varies. Some applications have inherent facilities to close themselves such as a GUI button or a menu command while others don't. When it is the latter case, Task Manager closes them for you.

To close an application by Task Manager:

- 1) Launch Task Manager as described in [Launch Task Manager](#).
Task Manager opens monitoring opened applications.
- 2) Tap & hold the application to close. From the context menu that comes up, tap **End Task**.

OR

Tap the application to close. The application is then highlighted onscreen. Tap the "End Task" command on [Softkey bar](#).

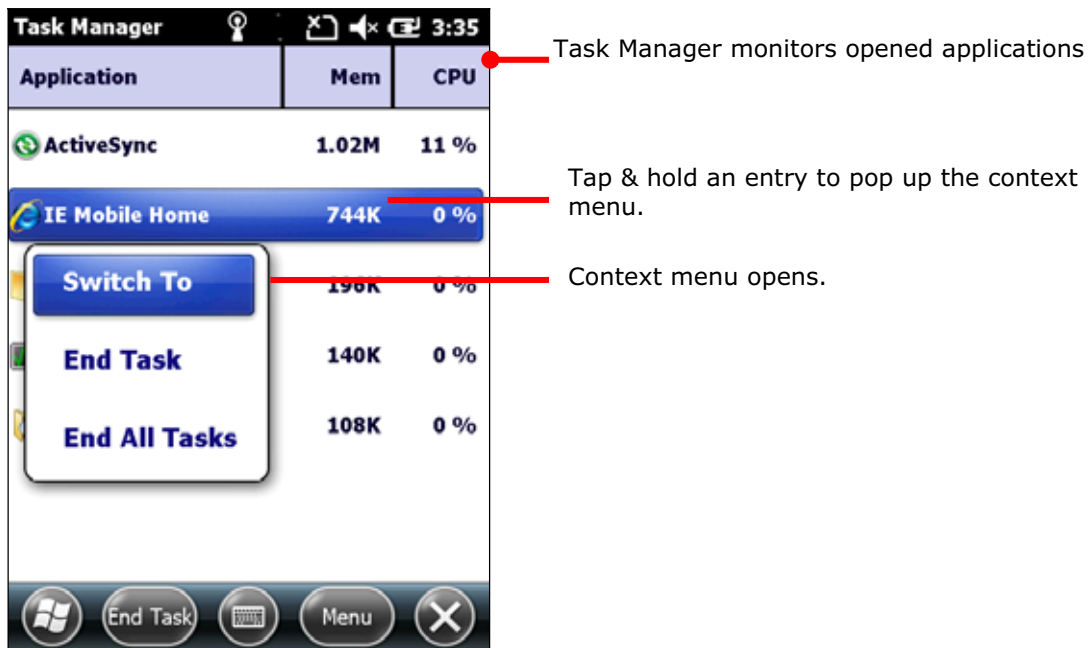

SWITCH TO ANOTHER OPENED APPLICATION

To switch to another opened application:

- 1) Launch Task Manager as described in [Launch Task Manager](#).
Task Manager opens monitoring opened applications.
- 2) Tap & hold the application to switch to.
Context menu shows up.
- 3) Tap **Switch to**.
The desired application opens onscreen.

MONITOR CACHED PROCESSES

Task Manager  also monitors how much RAM and CPU is being consumed by a cached processes.

To monitor cached processes:

- 1) Launch Task Manager as described in [Launch Task Manager](#).
Task Manager opens monitoring opened applications.
- 2) Tap the "Menu" command on [Softkey bar](#).
Option menu opens.
- 3) Tap **View | Processes**.

Task Manager shifts to monitor processes.

Task Manager monitors cached processes.

Process	Mem	CPU
connmgr.exe	324K	0 %
cprog.exe	1.53M	0 %
device.exe	10.7M	1 %
fexplore.exe	108K	0 %
filesys.exe	14.0M	0 %
gwes.exe	5.59M	0 %
iexplore.exe	744K	0 %

Note: Stopping an application or process or service may interrupt one or more dependant functions on the mobile computer. You may need to restart the mobile computer to recover full functionality.

DOWNLOAD & INSTALL APPLICATIONS

A rich resource of applications is downloadable from the Internet to run on the O.S. The executable files for installing on Windows Embedded Handheld 6.5 devices are named with the suffix ".cab", short for "cabinet". Download a ".cab" file that supports Windows Embedded Handheld 6.5.

Warning: To protect your mobile computer and personal data, always download applications from trusted sources.

As mentioned in [Add/Remove Programs](#), you can download and install an application on your PC first and offload it to the mobile computer later using Microsoft's ActiveSync.

Alternatively, the O.S. allows you to download and install an application right from the mobile computer.

To download an application, the mobile computer needs to connect to Internet first. See [Radios](#) or [USB Pass-through Networking](#) or [Bluetooth Pass-through Networking](#) to get data connections for the mobile computer.

After download finishes, use File Explorer  to browse to the application program in the local storage. Tap the program file to run the installation.

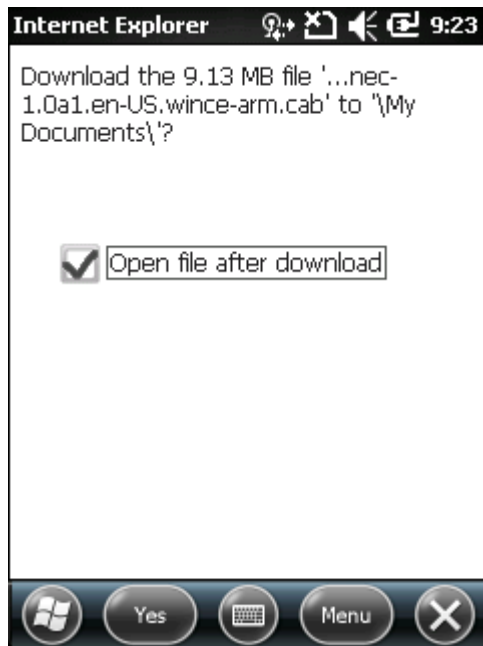

This screenshot shows downloading an application program on the mobile computer. When asked to confirm the download, tap the “Yes” command on [Softkey bar](#).

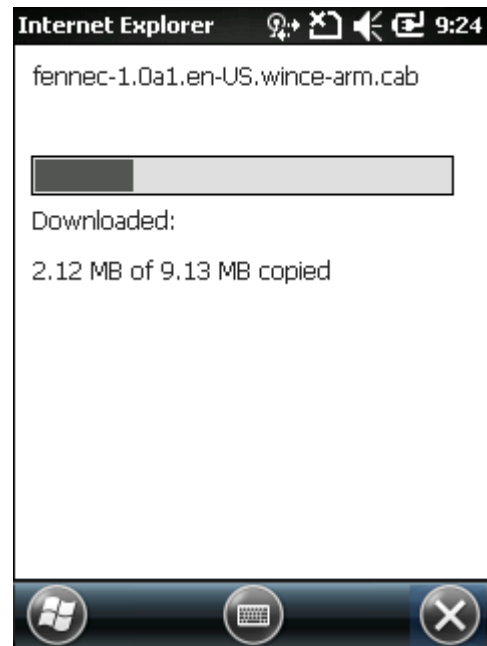

Download starts and proceeds.

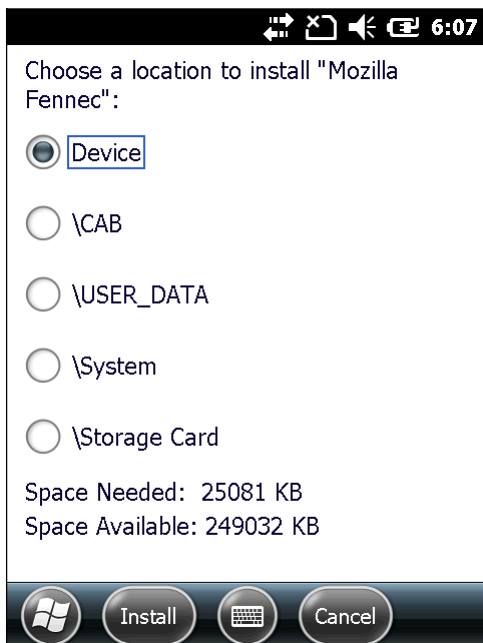

If an SD card is equipped, you’re asked where to install the application; or this screen won’t show and the application is straight installed to internal storage.

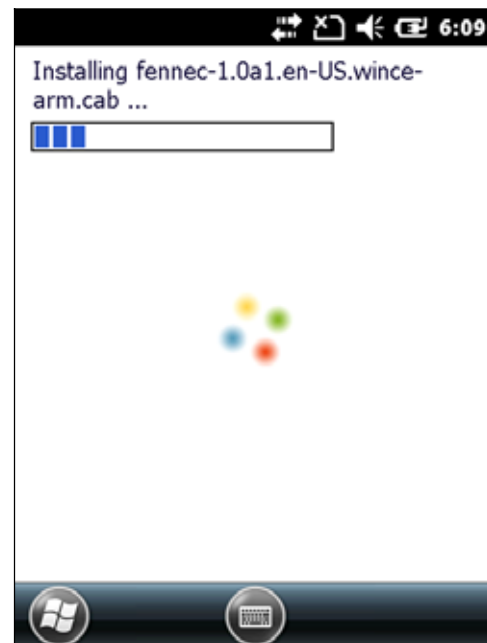

Installation progresses.

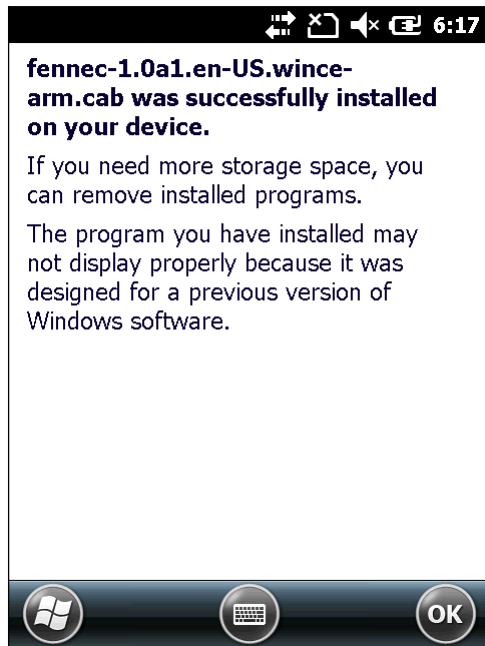

Installation completes. Tap "OK" command to finish and quit installation.

UNINSTALL APPLICATIONS

On the mobile computer, the acquired (non-inherent) applications are subject to your manual uninstallation. To uninstall an application:

- 1) On Start screen, tap **Settings | System | Remove Programs** .

Remove Programs opens showing the applications downloaded and installed from external sources.

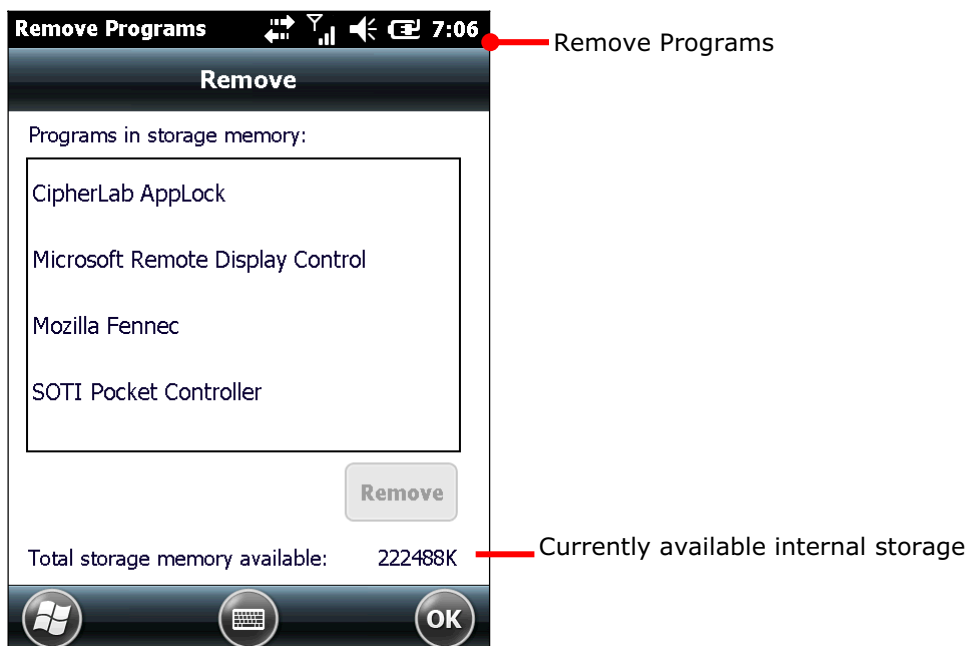

- 2) Tap the application to remove.

The lower-right "Remove" button becomes available.

- 3) Tap the "Remove" button to uninstall the application.
- 4) Follow onscreen instruction to complete through the uninstallation.

RADIOS

The mobile computer is a versatile networker. It integrates Wi-Fi and Bluetooth for wireless data, and optionally a HSPA+ module for mobile data. It also includes a GPS receiver which can detect your locations on earth with street-level accuracy. With the help of these radios, the mobile computer keeps users online all the time.

In this chapter, you will learn how these radios can work for you.

4. IN THIS CHAPTER

4.1 Access Cellular WAN.....	93
4.2 Use Wi-Fi.....	99
4.3 Use Bluetooth.....	108
4.4 Connect to Virtual Private Networks.....	120
4.5 Install Secure Certificates	125
4.6 Location Discovery	127

4.1. ACCESS CELLULAR WAN

When you insert a SIM card and turn on the mobile computer, the mobile computer connects to your mobile carrier's cellular wide area networks for data.

Different locations may have different mobile networks available. The mobile computer auto-connects to the fastest mobile network available for data.

To access Internet, set the mobile computer to use either Wi-Fi or SIM-enabled mobile data. See also [Use Wi-Fi](#).

4.1.1. CHECK WHAT NETWORK YOU'RE USING

To check what network you're using now:

- 1) On Start screen, tap **Settings | Connections | Wireless Manager** .
Wireless Manager opens.
- 2) Tap the "Menu" command on [Softkey bar](#).
Option menu shows.
- 3) Tap **Phone Settings**.
Phone settings open showing Sound tabbed page.
- 4) Tap continuously on the tabs to bring **Network** tab into view.
- 5) Tap **Network** tab.

Network tabbed page opens showing the network currently connected to at the top.



4.1.2. ENABLE/DISALBE MOBILE DATA

To turn on/off the mobile computer's mobile data (HSPA+):

- 1) On Start screen, tap **Settings | Connections | Wireless Manager** . Wireless Manager opens.
- 2) Tap the "Menu" command on [Softkey bar](#). Option menu opens.
- 3) Tap **Disconnect Cellular Data**. Mobile data is disabled.

4.1.3. USE ONLY 2G NETWORKS

Limit mobile data to 2G networks (GPRS or EDGE) to extend battery life or when you are not intensively transmitting data.

To limit mobile data to only 2G:

- 1) On Start screen, tap **Settings | Connections | Wireless Manager** . Wireless Manager opens.
- 2) Tap the "Menu" command on [Softkey bar](#). Option menu opens.
- 3) Tap Phone Settings. Phone settings open.
- 4) Tap continuously on the tabs to bring **GSM/UMTS** tab into view.
- 5) Tap **GSM/UMTS** tab.

GSM/UMTS tabbed page opens.

- 6) Tap **GSM (2G Only)** from the drop-downs.
- 7) Tap **Apply** to apply the change.
- 8) Tap the "OK" command on [Softkey bar](#) to quit setting.

4.1.4. CELLULAR DATA SETUP

To set up mobile data (GPRS/EDGE/UMTS/HSPA):

- 1) On Start screen, tap **Settings | Connections | Connections** (Manager)  .
Connections setting opens showing Tasks tabbed page.
- 2) Tap **Add a new modem connection** under **My ISP**.
Make New Connection page opens.
- 3) Name the connection.
- 4) From **Select a modem** drop-down menu, tap **Cellular Line (GPRS)**.

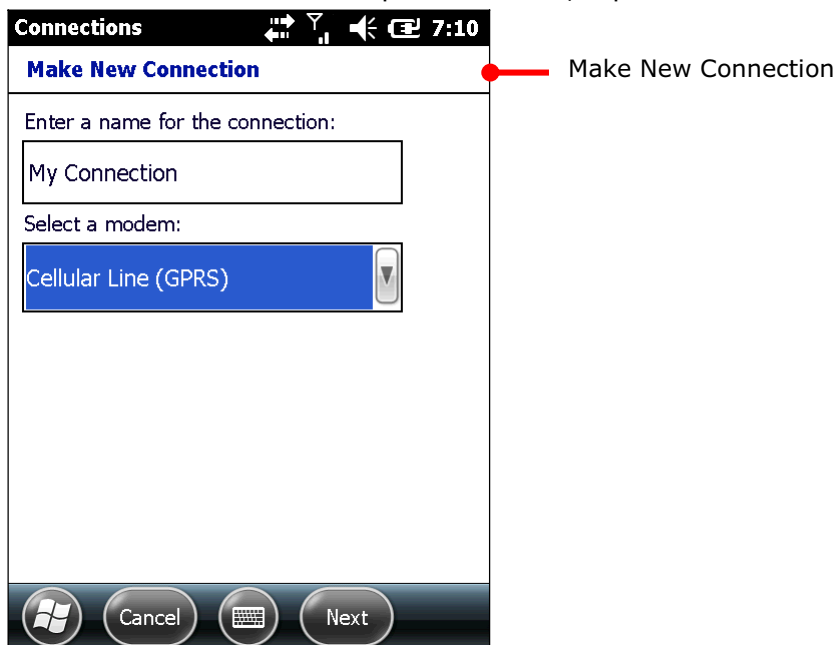

- 5) Tap **Next** to proceed.
- 6) Enter the Access Point Name (APN) of the connection. Consult your mobile carrier for such APN (for instance, "Internet").
- 7) Enter the username, password, and domain if your connection needs them. And tap the **Advanced...** button if your connection needs TCP/IP and specific server address.
- 8) Tap the "Finish" command on [Softkey bar](#) to apply the change and settings.

The mobile computer tries to connect to your mobile service. Once connected, it can be checked up as described in [Check What Network You're Using](#).

If you have two or more different networks set up, tapping and holding an item provides options for you to either delete or connect to the selected network.

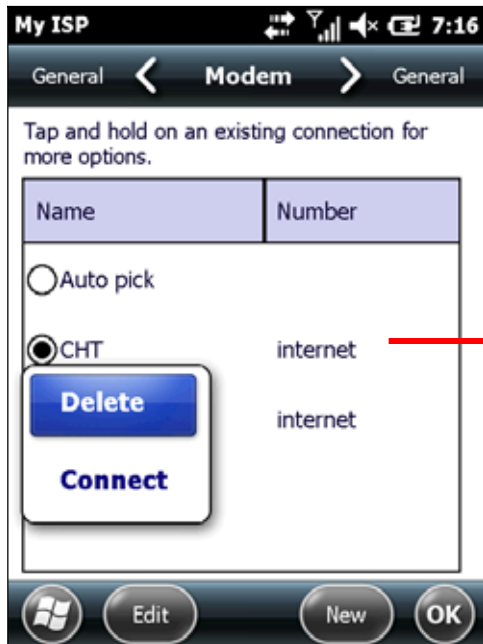

Tap and hold the selected item. Context menu pops up.

Note to turn off Wi-Fi to access mobile data because Wi-Fi supersedes mobile data.

4.1.5. EDIT & ADD ACCESS POINTS

When it is agreed between you and your mobile carrier that the current Access Point Name (APN) should be changed or a new access point needs to be created, consult your mobile carrier for the APN and detailed settings.

To edit an existing APN:

- 1) On Start screen, tap **Settings** | **Connections** | **Connections** (Manager)  .
Connections setting opens showing Task tabbed page.
- 2) Under **My ISP** label, tap **Manage existing connections** link.
- 3) My ISP opens showing Modem tabbed page.

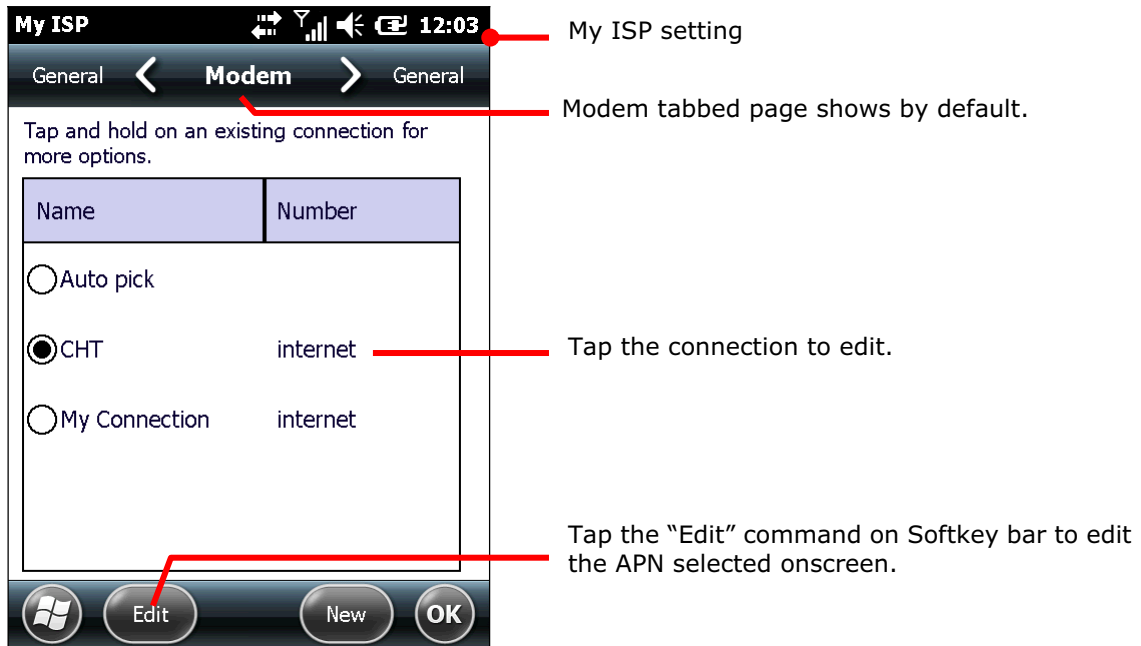

- 4) Tap the APN to edit.

The APN to edit is selected onscreen, and the "Edit" command becomes available on [Softkey bar](#).

- 5) Tap the "Edit" command on [Softkey bar](#).
- 6) Follow onscreen instruction to finish editing.

4.1.6. USB INTERNET SHARING

"Internet Sharing" or "Internet Tethering" enables your Windows-based PC to connect to Internet using the mobile computer's mobile data (or dial-up data).

By "Internet Sharing" , the mobile computer uses USB or Bluetooth to tether your PC to to Internet. For Bluetooth-based internet tethering, see [Bluetooth Internet Sharing](#).

To USB-tether your PC to Internet:

- 1) Connect the mobile computer and your PC with a USB cable that came with your purchase as described in [Direct Data Connection](#).
- 2) On the mobile computer, tap **Internet Sharing**  from Start screen.

Internet Sharing opens.

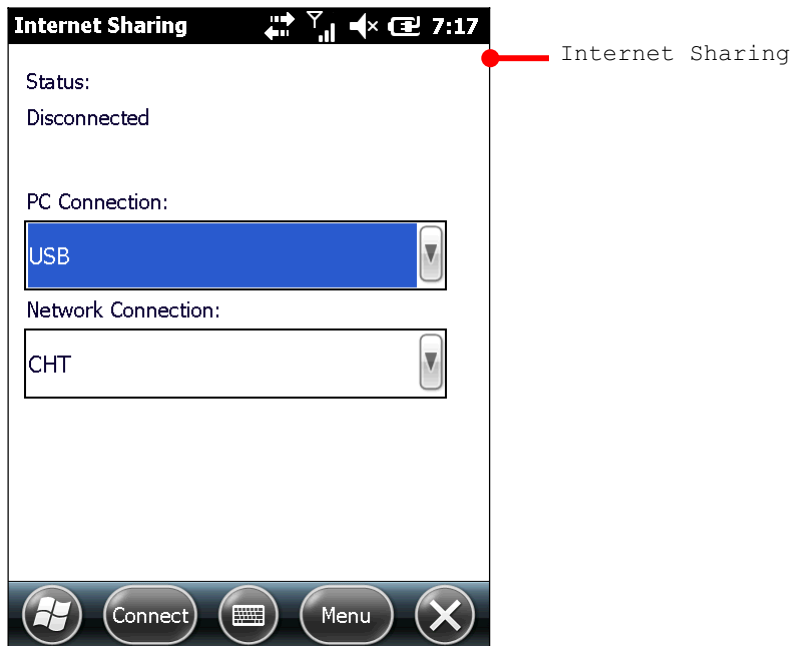

- 3) Select **USB** for **PC Connection**, and select your mobile service for **Network Connection**.
- 4) Tap the "Connect" command on [Softkey bar](#) to start Internet tethering.

The mobile computer prompts "Connected" in a few seconds when the PC connects to Internet.

Tap the "**Discon...**" command on the mobile computer to disconnect.



In case of problems, open Start screen | **Settings** | **Connections** | **USB to PC**, and make sure **Enable advanced network functionality** is selected.

4.2. USE WI-FI

For the authentications based on secure certificates, see [Install Secure Certificates](#).
Turn off Wi-Fi when it isn't used to extend battery life. See [Enable/Disable Wi-Fi](#).

4.2.1. STATUS ICONS

Wi-Fi status icons:



Status Icon	Description
	Wi-Fi on but not connected
	WiFi network(s) available
	WiFi in use

4.2.2. ENABLE/DISABLE WI-FI

To enable/disable Wi-Fi data on the mobile computer:

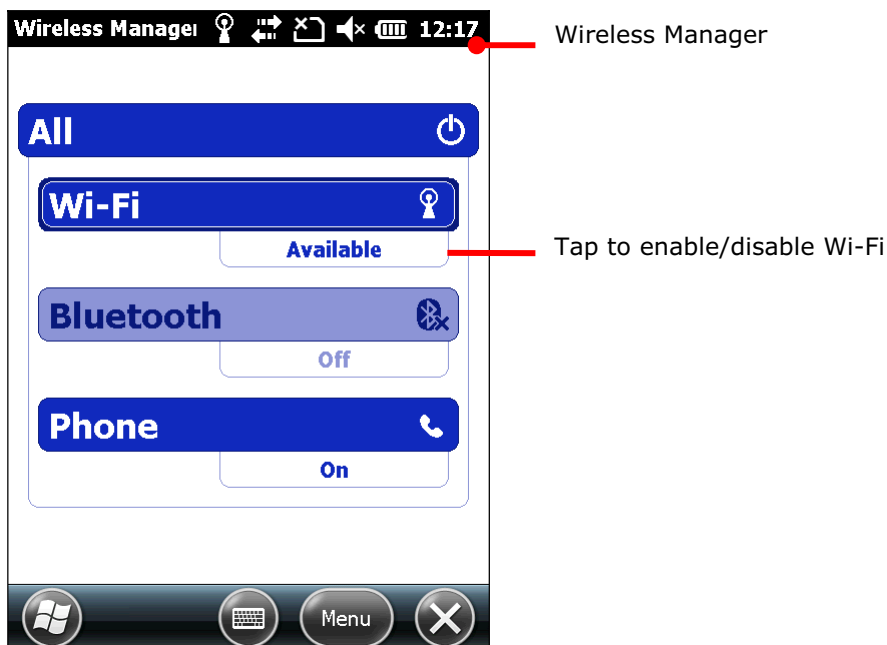
- 1) On Start screen, tap **Settings | Connections | Wireless Manager** .
Wireless Manager opens.





The Wi-Fi entry shows an  if Wi-Fi is off at the moment; otherwise it shows an  icon suggesting Wi-Fi is on.

- 2) Tap the "Wi-Fi" entry.

Wi-Fi is on or off.

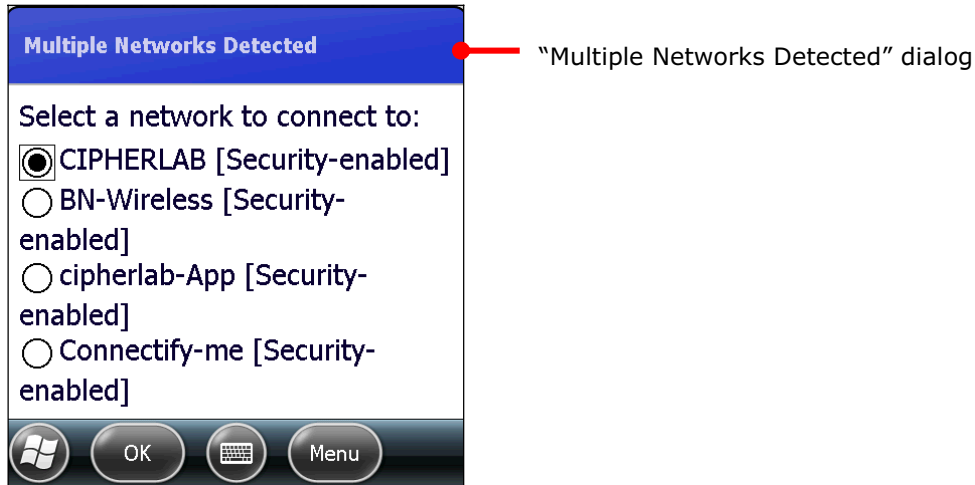
Once Wi-Fi is on, the mobile computer starts scanning for the available Wi-Fi networks within its reach. The O.S. shortly displays a “Multiple Networks Detected” dialog prompting a few names of those found.



If the “Multiple Networks Detected” dialog doesn’t show, tap Title bar to open Drop-down bar and tap  icon to display the dialog.

4.2.3. WI-FI CONNECTION SETUP

Once Wi-Fi is on as described in [Enable/Disable Wi-Fi](#), proceed to set up a Wi-Fi connection. There are two approaches:

- 1) From “Multiple Networks Detected” dialog, tap the Wi-Fi network to connect.
- 2) Tap the “OK” command on [Softkey bar](#).
- 3) Select where the selected network connects to.

Select **The Internet** if you’re using the network to access Internet; or select **Work** if you’re using the network to access an internal network, i.e. the work network (the intranet).







- 4) Tap the “Connect” command on Softkey bar.
- 5) Enter the network key if required.
- 6) Tap the “Connect” command on Softkey bar.

OR

- 1) From “Multiple Networks Detected” dialog, tap **Show all networks** link to bring all detected networks into view.

Wi-Fi settings open showing **Wireless** tabbed page. It displays both open and secured networks with signal strength. Secured networks have a lock graphic on them. 



Icon	Description
 (no-bar)	Signal strength (RSSI) is -91 dBm or weaker.
 (one-bar)	Signal strength (RSSI) is -90 dBm to -82 dBm.
 (two-bar)	Signal strength (RSSI) is -81 dBm to -72 dBm.
 (three-bar)	Signal strength (RSSI) is -71 dBm to -68 dBm.
 (four-bar)	Signal strength (RSSI) is -67 dBm or stronger.
 (secured)	A secured network with signal strength.
 (fail)	No signal for this network.

Note if the mobile computer detects a network connected to previously, it auto-connects to it.

2) Tap the network to connect.

"Configure Wireless Network" page opens.

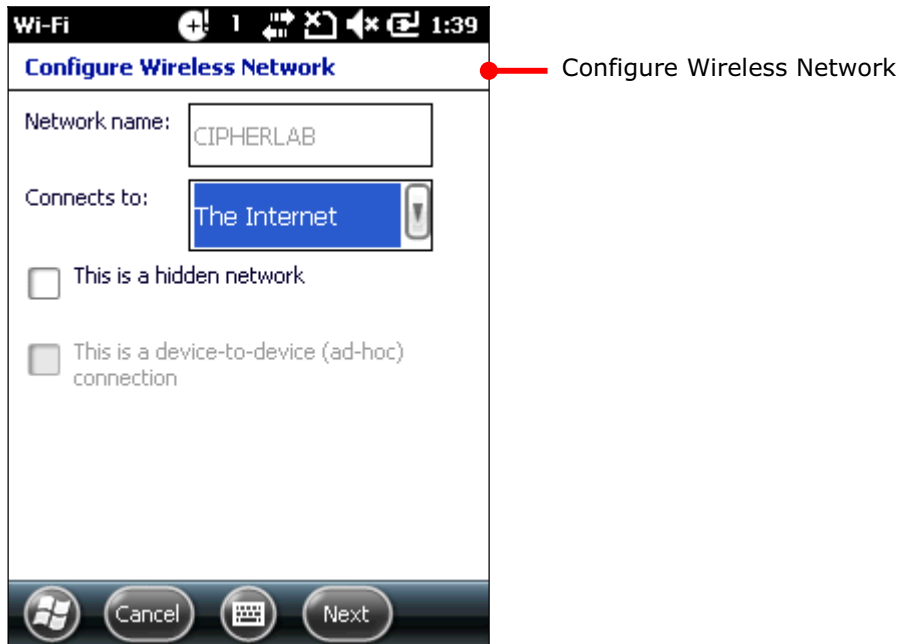

For **Connects to**, select between **The Internet** and **Work**. Select **The Internet** if you're using the network to access the Internet; or select **Work** if you're using the network to access an internal network, i.e. the work network (the intranet).

Select **This is a hidden network** if the network doesn't broadcast its name.

If you're adding a hidden network, see [Add Wi-Fi Network](#).

3) Tap **Next** to proceed.

"Configure Network Authentication" page opens.

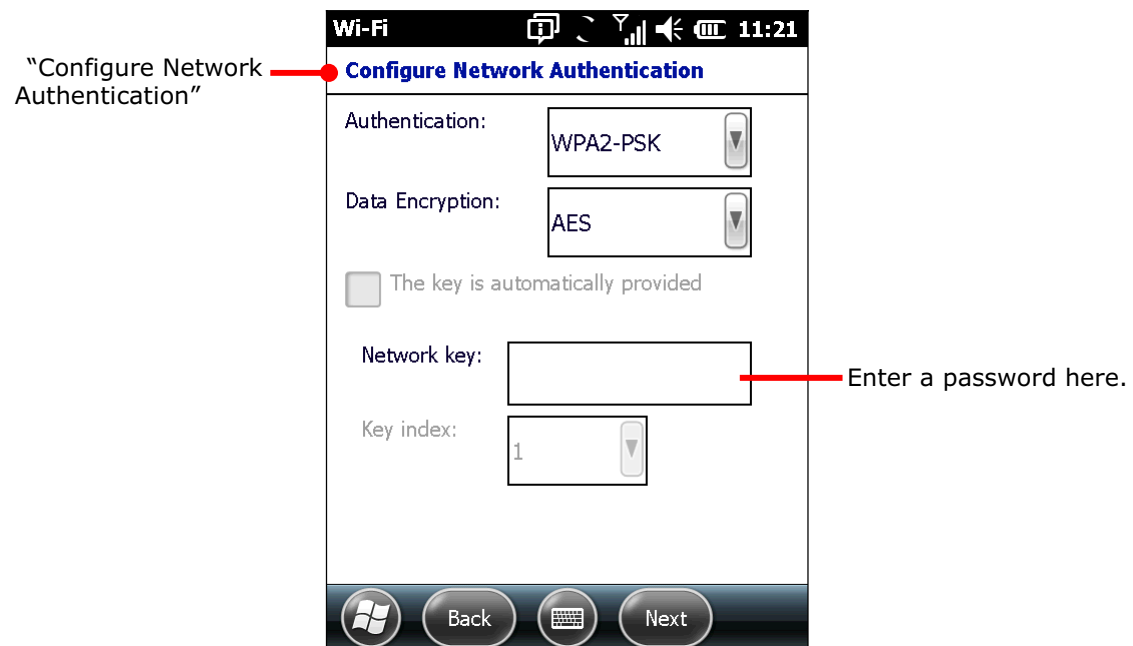

If the network to connect to is secured, you're prompted to enter a password or other credentials. Ask your network administrator for the details.

- 4) Tap **Next** to proceed.
- 5) Follow onscreen instruction to follow through the setup.

When setup finishes, the mobile computer tries to connect to the Wi-Fi network set and reopens Wireless tabbed page. Once connected, the network displays "Connected". To edit it, tap & hold it.



On Wireless Manager screen, Wi-Fi entry will show the name of the connected network.



4.2.4. CONNECT ANOTHER WI-FI NETWORK

To connect to another Wi-Fi network:

- 1) Open Wi-Fi's Wireless tabbed page. (Start screen | **Settings** | **Connections** | **Wireless Manager** | Softkey bar "Menu" command | **Wi-Fi Settings**.)

Wi-Fi's Wireless tabbed page opens.

- 2) Tap & hold the Wi-Fi network to connect that is available but unconnected (marked as "Available").

Context menu opens.

- 3) Tap **Connect**.
- 4) Follow onscreen instructions to proceed.

4.2.5. EDIT WI-FI NETWORKS

To edit a Wi-Fi network:

- 1) Open Wi-Fi's Wireless tabbed page. (Start screen | **Settings** | **Connections** | **Wireless Manager** | Softkey bar "Menu" command | **Wi-Fi Settings**.)

- 2) Tap & hold the Wi-Fi network to edit.

Context menu opens.

- 3) Tap **Edit**.
- 4) Follow onscreen instructions to proceed.

4.2.6. FORGET WI-FI NETWORKS

To forget a Wi-Fi network:

- 1) Open Wi-Fi's Wireless tabbed page. (Start screen | **Settings** | **Connections** | **Wireless Manager** | Softkey bar "Menu" command | **Wi-Fi Settings**.)

- 2) Tap & hold the Wi-Fi network to forget that is previously connected.

Context menu opens.

- 3) Tap **Remove Settings**.
- The Wi-Fi network is forgotten.

4.2.7. RECEIVE NOTIFICATIONS OF AVAILABLE NETWORKS

When Wi-Fi is enabled, the mobile computer issues notifications on Title bar to report available Wi-Fi network detected. This report is enabled by default. In case you need to disable it:

- 1) Turn on Wi-Fi as described in [Enable/Disable Wi-Fi](#).
- 2) On Wi-Fi's Wireless tabbed page, tap the "Menu" command on [Softkey bar](#).

Option menu opens.

- 3) Tap **Advanced**.

Wi-Fi's Advanced settings open:

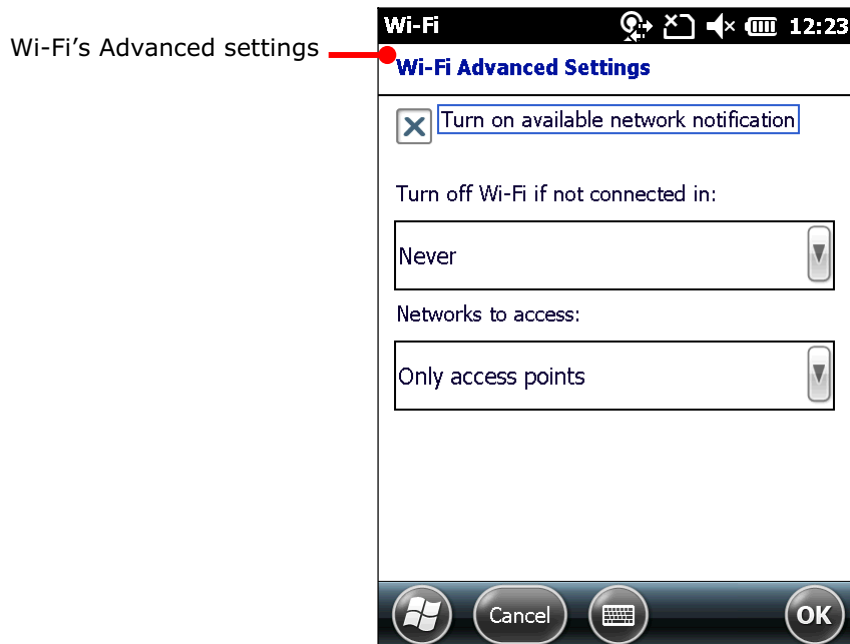

4) Deselect **Turn on available network notifications**.

See also [Advanced Wi-Fi Settings](#).

4.2.8. ADD WI-FI NETWORKS

"Adding" Wi-Fi networks are usually needed for the following cases:

- ▶ when it doesn't broadcast its name (SSID), or
- ▶ when you're out of its wireless coverage

This step is done so the mobile computer can connect to it (in the former case), or remember it and connect to it once its wireless coverage becomes reachable (in the latter case).

To add a secured network, contact the network's administrator to learn the security scheme deployed and get the password or other required security credentials.

To add a Wi-Fi network:

- 1) Turn on Wi-Fi as described in [Enable/Disable Wi-Fi](#).
- 2) Open Wireless Manager, tap the "Menu" command on [Softkey bar](#).

Option menu opens.

- 3) Tap **Wi-Fi Settings**.

Wi-Fi's Wireless tabbed page opens.

- 4) Tap **Add New...** (, which is listed above all found networks)
- 5) Enter the SSID (name) of the network to add and configure the security deployed on it. Enter any required security credentials.
- 6) Follow onscreen instructions to proceed.

The network is saved on the mobile computer. If it's out of reach, it appears unavailable  (fail) among the founded networks. If it is a hidden one, it is connected in a few seconds.

4.2.9. CONNECT BY STATIC IP

When the mobile computer connects to a Wi-Fi network by DHCP protocol, the mobile computer fetches a network address and other info needed from the network. But when you are connecting a Wi-Fi network by a fixed IP address, make the following setting:

- 1) Turn on Wi-Fi as described in [Enable/Disable Wi-Fi](#).
- 2) On Wi-Fi setting screen, tap **Network Adapters** tab.

Network Adapters tabbed page opens.

Wi-Fi's "Network Adapters" tabbed page

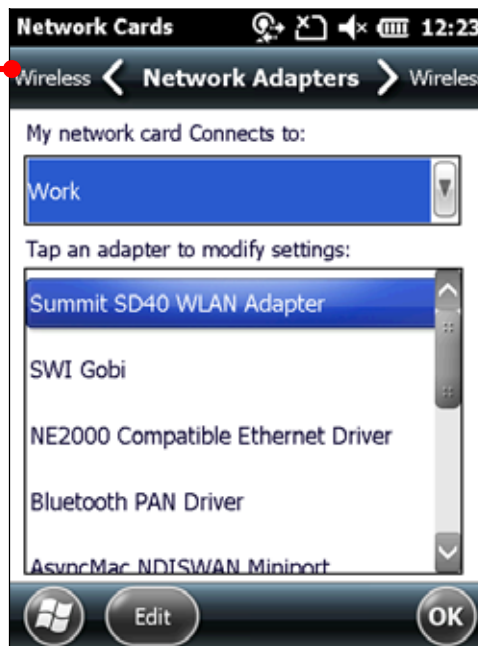

- 3) Tap the WLAN adapter, and tap the "Edit" command on [Softkey bar](#) to access the settings.

4.2.10.ADVANCED WI-FI SETTINGS

Access advanced Wi-Fi settings for the following:

- ▶ To turn on/off available network notifications.
- ▶ To set the time to turn off Wi-Fi after Wi-Fi connection keeps failing

To access advanced Wi-Fi settings:

- 1) Turn on Wi-Fi as described in [Enable/Disable Wi-Fi](#).
- 2) On Wi-Fi's Wireless tabbed page, tap the "Menu" command on [Softkey bar](#).

Option menu opens.

- 3) Tap **Advanced**.

Wi-Fi's advanced settings open.

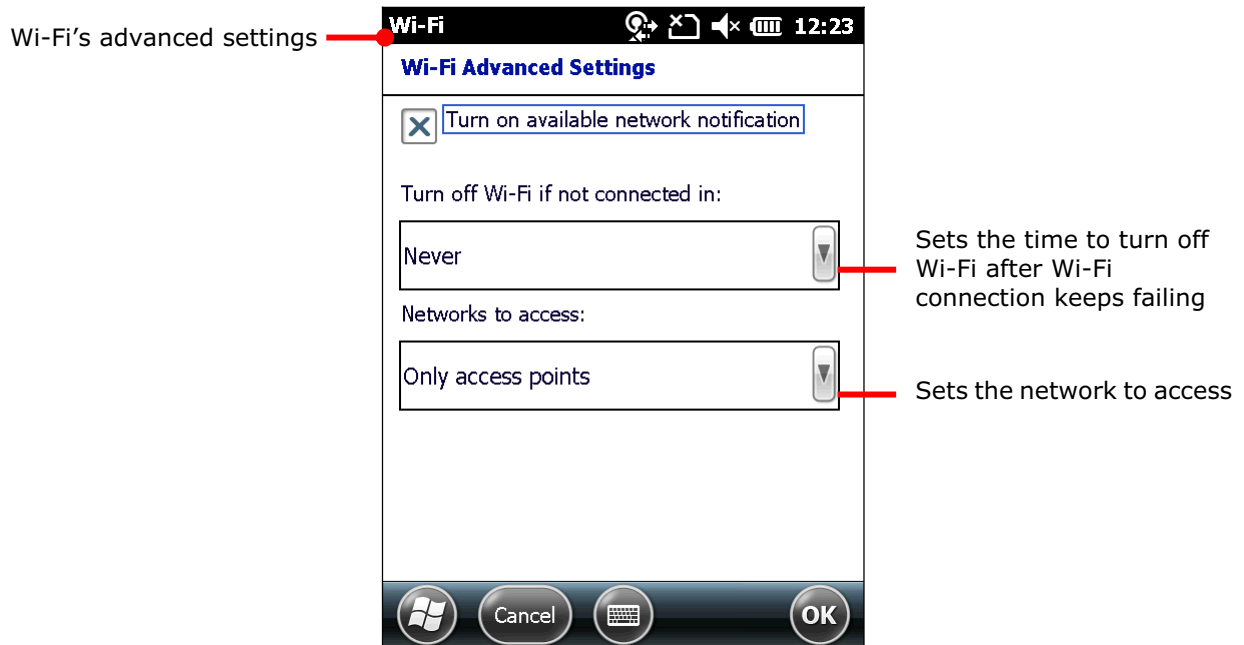

- 4) Make your desired setting.

4.3. USE BLUETOOTH



The mobile computer is Bluetooth-enabled to synchronize data with other devices such as PCs, car hands-free, headsets, printers, PDAs, and cell phones.

Bluetooth enables wireless connections over a short distance about 8 meters. It is specified in IEEE 802.15.1 as a “wireless personal area network” (WPAN).

To connect a Bluetooth device for the 1st time, the mobile computer needs to “pair” with it. Such “pairing” involves the authentication between two devices to justify their accesses to each other. After their initial pairing, they can connect to each other without pairing.

4.3.1. STATUS ICONS

Bluetooth status icons:

Status Icon	Description
	Bluetooth in use (data transmission ongoing)
	Bluetooth headset in use

4.3.2. CHANGE BLUETOOTH NAME

By default the mobile computer has the device name for its Bluetooth name and isn't visible to other devices. Change the name if it isn't recognizable enough.

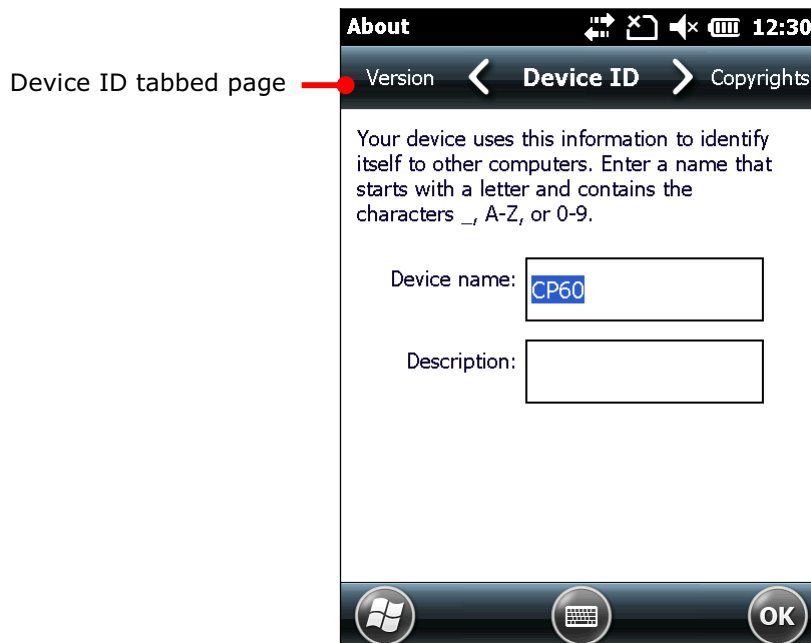

To change the mobile computer's Bluetooth name:

- 1) On Start screen, tap **Settings** | **System** | **About**  .
About screen opens showing Version tabbed page.
- 2) Tap **Device ID** tab.

Device ID tabbed page opens.

- 3) Enter a name following the prompted rule.
- 4) Tap the "OK" command on Softkey bar to apply the change and quit setting.

4.3.3. EXPOSE MOBILE COMPUTER

In default state the mobile computer is hidden from other Bluetooth devices. To allow other devices to be able to find mobile computer, make the following setting:

- 1) On Start screen, tap **Settings** | **Bluetooth**  .
Bluetooth settings open showing Devices tabbed page.
- 2) Tap **Mode** tab.
Mode tabbed page opens.

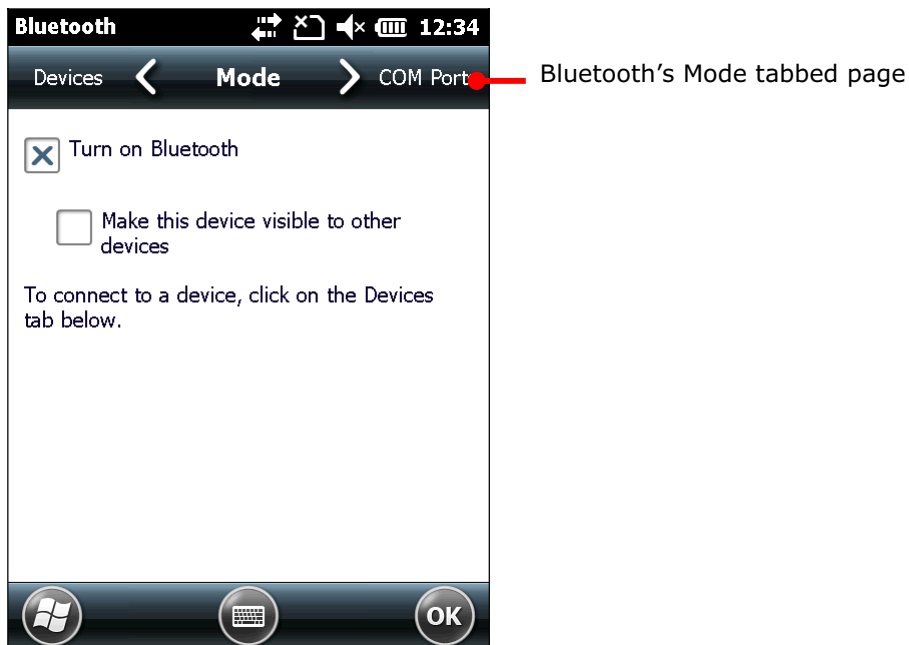

- 3) Select **Make this device visible to other devices**.
- 4) Tap the "OK" command on [Softkey bar](#).



Bluetooth entry shows a "Visible" label on Wireless Manager screen

The mobile computer becomes discoverable by other Bluetooth devices. On Wireless Manager screen, the Bluetooth entry show a "Visible" label.

4.3.4. TURN ON/OFF BLUETOOTH

To turn on/off Bluetooth:

- 1) On Start screen, tap **Settings** | **Connections** | **Wireless Manager**  .
Wireless Manager opens.
- 2) Tap the **Bluetooth** entry.
Bluetooth powers on.

OR

- 1) On Start screen, tap **Settings** | **Bluetooth**  .
Bluetooth's Devices tabbed page opens.
- 2) Tap **Mode** tab.
Mode tabbed page opens.
- 3) Select **Turn on Bluetooth**.
- 4) Tap the "OK" command on [Softkey bar](#).
Bluetooth powers on.

4.3.5. PAIR & CONNECT BLUETOOTH DEVICES

Before the mobile computer can connect another Bluetooth device, it needs to pair with that device first. Once they are paired, they stay paired unless they are unpaired.

To pair with & connect to a Bluetooth device:

- 1) On the mobile computer, turn on Bluetooth as described in [Turn on/off Bluetooth](#).
- 2) On Start screen, tap **Settings** | **Bluetooth**  .

Bluetooth settings open showing Devices tabbed page.



Bluetooth's Devices tabbed page

3) Tap **Add new device...**

The mobile computer scans and displays the names of all Bluetooth devices found within reach.

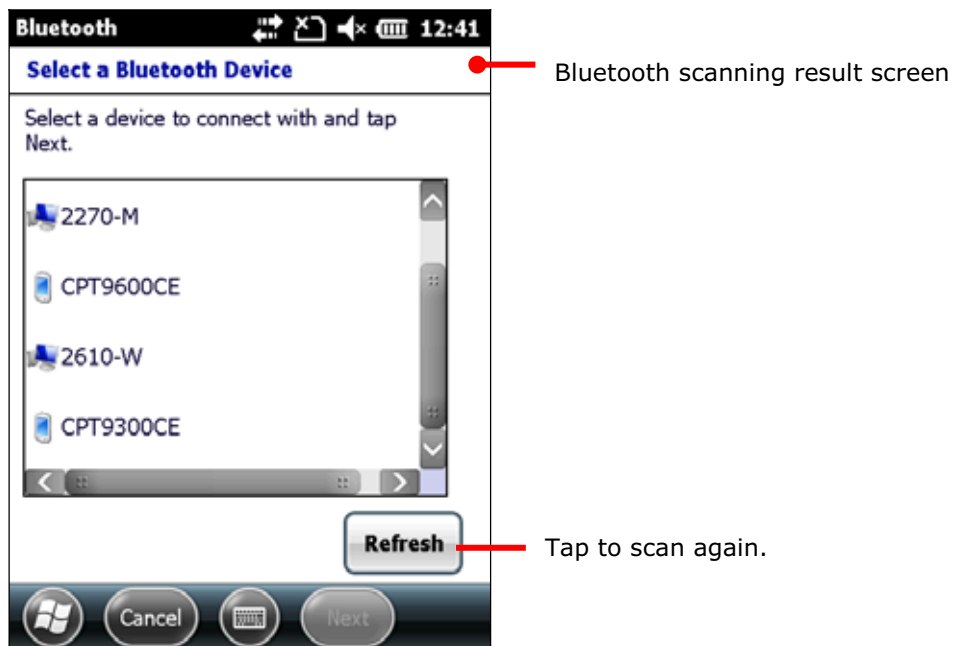

If the device to pair with doesn't display, make it discoverable. If the mobile computer stops scanning before the device to connect becomes discoverable, tap **Refresh**.

4) Tap the name of the found device that you wish to connect. Tap **Next**.

The two devices pair with each other. You may be asked for a passcode for a secure connection. Try entering 0000 or 1234 (the most common passcode). Sometimes you need to consult the other Bluetooth devices' documentation for this code.

Some devices are paired and connected at once depending on the Bluetooth feature(s) in use. Once the device is paired (and connected), you are prompted by a dialog.

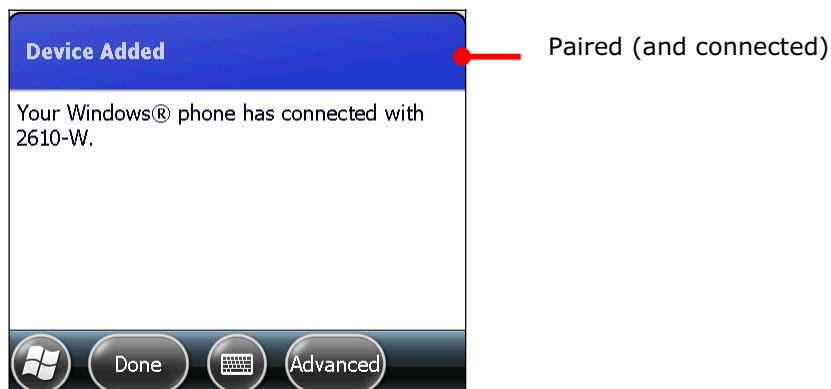
5) Tap the "Done" command on [Softkey bar](#).

OR

Tap the "Advan..." command on [Softkey bar](#), which only briefly shows, to configure the Bluetooth features to use with that device. Then tap **Save**.

Devices tabbed page re-opens listing the just connected Bluetooth device among others.

A device connected is listed under **Connected** label. A paired but unconnected device is listed under **Disconnected** label.

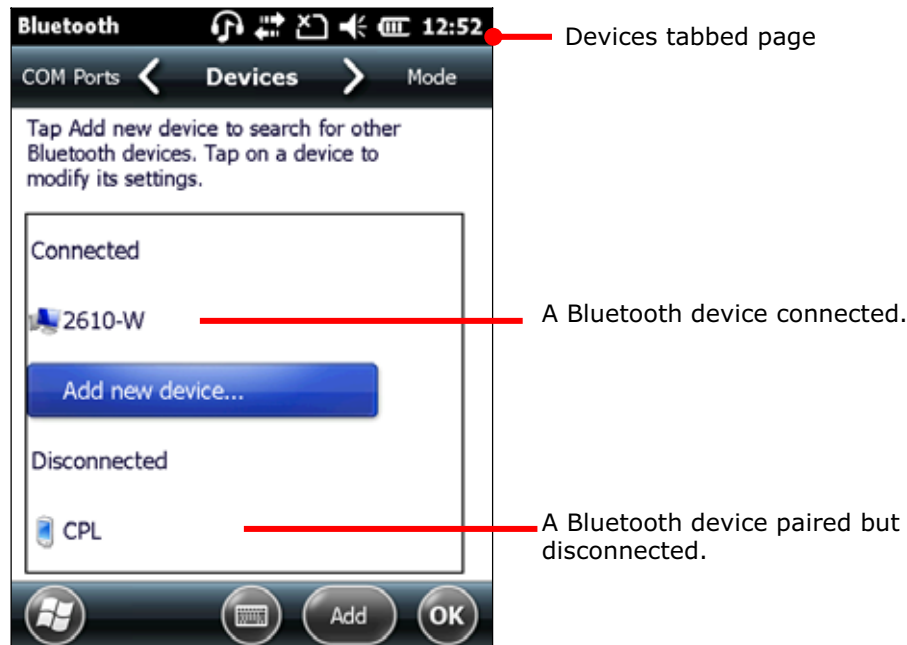

- 6) Tab & hold a connected device to edit its Bluetooth features to use, or disconnect or delete (unpair) it.

OR

Tap & hold a disconnected device to edit the Bluetooth features to use, reconnect it, or delete (unpair) it.

See also [Disconnect Bluetooth Devices](#), [Unpair Bluetooth Device](#), and [Edit Bluetooth Features to Use](#).

4.3.6. DISCONNECT BLUETOOTH DEVICES

To disconnect the mobile computer from a Bluetooth device, there are two approaches:

Simply turn off the Bluetooth as described in [Turn on/off Bluetooth](#). The mobile computer is disconnected from all connected Bluetooth devices.

OR

- 1) Open Bluetooth settings. (Start screen | **Settings** | **Bluetooth** or Start screen | **Settings** | **Connections** | **Wireless Manager** | "Menu" command on Softkey bar | **Bluetooth Settings**.)

Bluetooth settings open showing Devices tabbed page.

- 2) Tap & hold the device to disconnect from.

Context menu opens.

- 3) Tap **Disconnect**.

The mobile computer is disconnected from the Bluetooth device.

4.3.7. UNPAIR BLUETOOTH DEVICES

To unpair a Bluetooth device:

- 1) Open Bluetooth settings. (Start screen | **Settings** | **Bluetooth**.)
Bluetooth settings open showing Devices tabbed page.
- 2) Tap & hold the device to unpair from.
Context menu opens.
- 3) Tap **Delete**.
The Bluetooth device is unpaired. The mobile computer needs to pair with it again to reconnect it.

4.3.8. RECONNECT BLUETOOTH DEVICES

Before the mobile computer reconnects a Bluetooth device, make sure the two devices are paired and within each other's wireless reach.

To reconnect a Bluetooth device:

- 1) Open Bluetooth settings. (Start screen | **Settings** | **Bluetooth**.)
Bluetooth settings open showing Devices tabbed page.
- 2) Tap & hold the device to reconnect (normally under **Disconnected** label).
Context menu opens.
- 3) Tap **Connect**.
The Bluetooth device is reconnected and its name displays under **Connected** label.

4.3.9. EDIT BLUETOOTH FEATURES TO USE

A Bluetooth profile defines the features and communications supported by a Bluetooth device. For two Bluetooth devices to share files with each other, they need to both support the due profiles. Some Bluetooth devices have multiple profiles. Profiles can cover the ability to transmit phone conversations, to play music in stereo, or to transfer files or other data. The mobile computer enables configuring the profiles you want to use on the mobile computer.

- 1) Open Bluetooth settings. (Start screen | **Settings** | **Bluetooth**.)
Bluetooth settings open showing Devices tabbed page.
- 2) Tap & hold the device to configure.
Context menu opens.
- 3) Tap **Edit**.

Partnership Settings opens listing the device's available profiles.

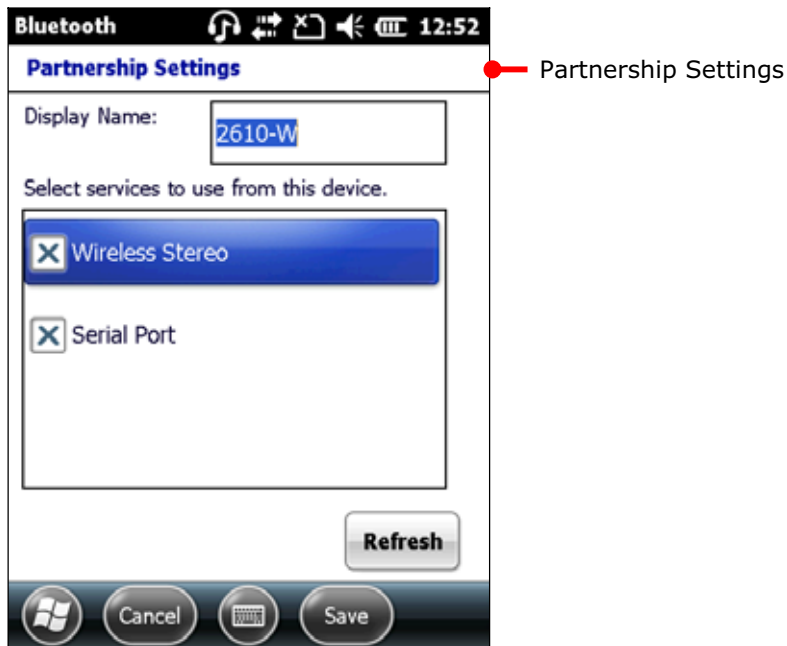

- 4) Select or deselect a profile to use it or not.

4.3.10. BLUETOOTH FILE EXCHANGE

Once connected with other devices using Bluetooth, the mobile computer can offload or download files to/from them. Basically it relies on File Explorer  to get it done.

OFFLOAD FILES

- 1) On the mobile computer, turn on Bluetooth as described in [Turn on/off Bluetooth](#) if you haven't.
- 2) Open File Explorer .
- 3) Browse to the file to offload.
- 4) Tap & hold the file to offload.
Context menu comes up.
- 5) Tap **Beam File...**

The Bluetooth application generates a list of Bluetooth devices found.

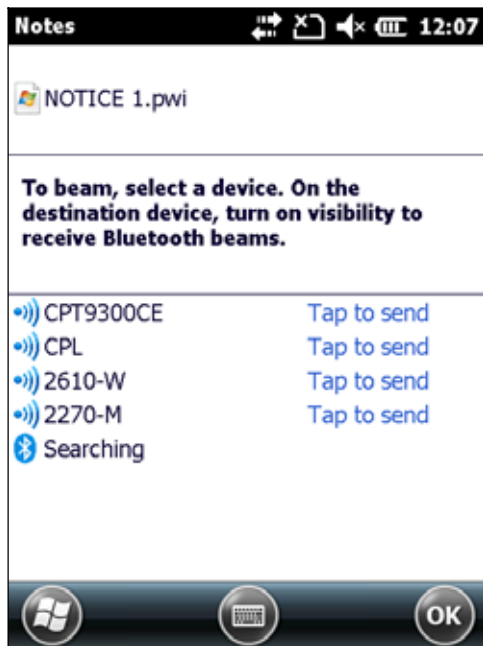

- 6) Select the device to offload the file to.

The device will receive a notification asking for confirmation to accept the file.

- 7) Confirm accept.

The device proceeds to receive it inbound.

DOWNLOAD FILES

For the mobile computer to download files from other devices using Bluetooth, "Beam mode" must be enabled first:

To enable Beam mode:

- 1) On Start screen, tap **Settings** | **Connections** | **Beam** .
- 2) Select **Receive all incoming beams**.

To download files from other devices using Bluetooth:

- 3) Enable the mobile computer's "Beam" as mentioned above.
- 4) Turn on Bluetooth as described in [Turn on/off Bluetooth](#) if you haven't.
- 5) Make the mobile computer discoverable as mentioned in [Expose Mobile computer](#).

The mobile computer readies to receive an inbound file with Bluetooth. The mobile computer asks if you what to accept the file when it is coming in.

- 6) Confirm **Yes** or **No**.

The file is saved to the mobile computer or rejected.

4.3.11. BLUETOOTH ACTIVESYNC

The advantage of Bluetooth ActiveSync is to save the trouble perpetually switching between multiple devices by changing cables or adapters.

Note to disable network bridging on your PC (specifically bridging to a Remote NDIS adapter) before connecting Bluetooth ActiveSync. For more information on network bridging, see Windows Help on the PC.

To use ActiveSync using Bluetooth:

- 1) Note the virtual Bluetooth COM port on your PC. If your PC doesn't have any, add one.
- 2) Run ActiveSync on your PC. From the menu bar, click **File | Connection Settings**.
- 3) Deselect **Allow USB connection** and select **Allow connections to one of the following**.
- 4) Select the COM port you noted in step 1.
- 5) Hit OK button to apply change and quit setting.

- 6) On the mobile computer, tap **ActiveSync**  from Start screen.

ActiveSync opens. If this is your first time opening it, it shows some guidelines to set up sync, ignore whatever the screen says. Proceed as described in the following.

- 7) Tap the "Menu" command on [Softkey bar](#).

Option menu opens.

- 8) Tap **Connect via Bluetooth**.

For 1st setup, you are prompted to set up Bluetooth partnership with your PC.

- 9) Tap **Yes** in the popup dialog inquiring if a partnership should be set up.

You are taken to Bluetooth's Mode tabbed page.

- 10) Turn on Bluetooth if you haven't.

- 11) Tap **Device** tab.

Bluetooth's Device tabbed page open.

- 12) For the 1st setup, tap **Add new device** and complete through pairing and connection as described in [Pair & Connect Bluetooth device](#).

OR

Select the name of your PC if it is connected before.

Once paired and/or connected, you are taken back to Device tabbed page.

- 13) Reopen **ActiveSync**  on the mobile computer.

- 14) Tap the "Menu" command on [Softkey bar](#).

Option menu opens.

- 15) Tap **Connect via Bluetooth**.

Bluetooth connection is established within a few seconds. ActiveSync on your PC opens its **Sync Setup Wizard**.

- 16) Set up the sync partnership you desire. See [1st USB Sync](#) for the setting.

DISCONNECT BLUETOOTH ACTIVESYNC

To disconnect Bluetooth ActiveSync:

- 1) On the mobile computer, tap **ActiveSync**  from Start screen.
ActiveSync opens.
- 2) Tap the "Menu" command on [Softkey bar](#).
Option menu opens.
- 3) Tap **Disconnect**.
Bluetooth ActiveSync is disconnected.

4.3.12. BLUETOOTH INTERNET SHARING

As mentioned in [USB Internet Sharing](#), "Internet Sharing" or "Internet Tethering" enables a Windows-based PC to connect to Internet using the mobile computer's mobile data (or other dial-up). Well "Internet Sharing" is supported by Bluetooth too. To tether to Internet using Bluetooth, make the follow setting:

- 1) Set up Bluetooth connection between the mobile computer and your PC as described in [Pair & Connect Bluetooth device](#).
- 2) On the mobile computer, tap **Internet Sharing**  from Start screen.
Internet Sharing opens.

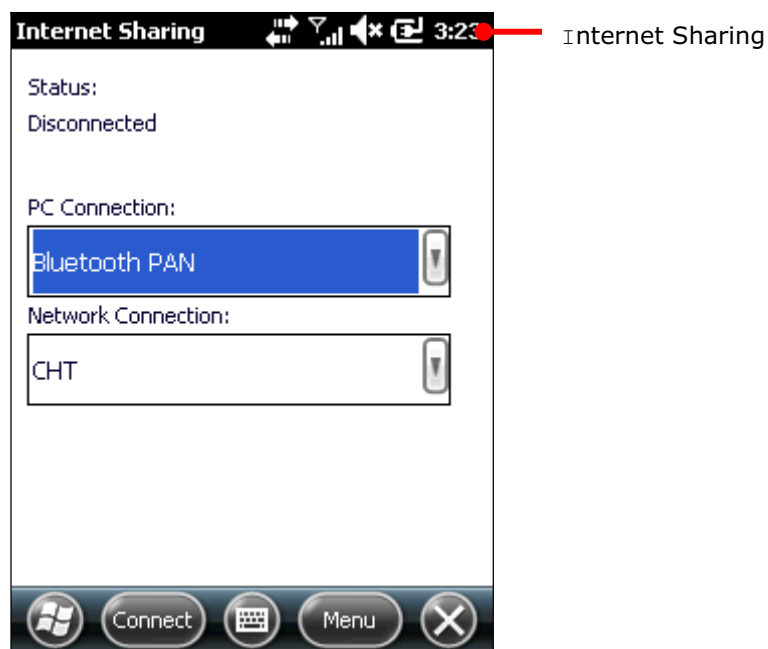

- 3) Select **Bluetooth PAN** for **PC Connection**, and select your wireless service for **Network Connection**.
- 4) Tap the "Connect" command on [Softkey bar](#).
- 5) On your PC, set up a **Bluetooth Personal Area Network** with the mobile computer.
Setting up a Bluetooth PAN varies between different Bluetooth utilities. Consult the documentation of your Bluetooth utility or Windows Help on your PC to know about the setup.

In a few seconds Internet Sharing prompts "Connected" on the mobile computer. Your PC connects to Internet.

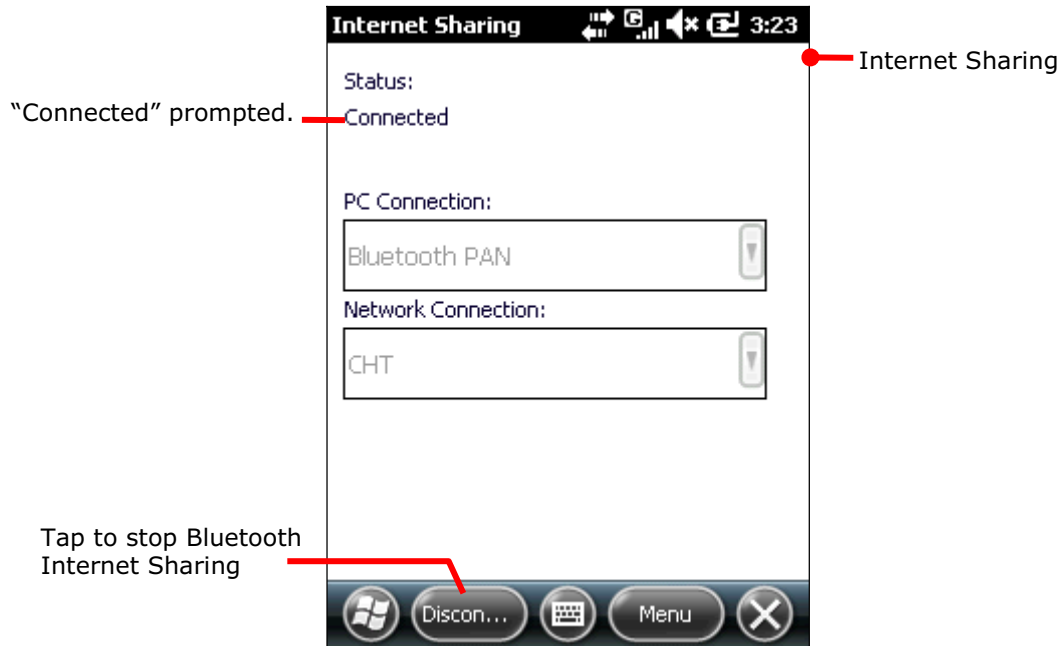

Tap the "Discon..." command on Softkey bar to stop.

For the internet sharing using USB, see [USB Internet Sharing](#).

Compare [Bluetooth Pass-through Networking](#) & [USB Pass-through Networking](#).

4.3.13. BLUETOOTH PASS-THROUGH NETWORKING

"Pass-Through Networking" enables the mobile computer to network using your PC's data connection, courtesy that two computers are synced, whether by a hardwired USB approach or wirelessly by Bluetooth.

- 1) Establish sync partnership between the mobile computer and your PC using Bluetooth as described in [Bluetooth ActiveSync](#).
- 2) On your PC, from the menu bar of ActiveSync, select **File | Connection Settings**.
Connection Settings open.
- 3) For **This computer is connected to**, select a connection to which your PC should connect when passing through ActiveSync.
- 4) Select **Open ActiveSync when my device connects**.
- 5) Press **OK** button to apply the change and quit setting.

You can proceed to network on the mobile computer.

For the pass-through networking with USB, see [USB Pass-through Networking](#).

Compare [Bluetooth Internet Sharing](#) & [USB Internet Sharing](#).

4.4. CONNECT TO VIRTUAL PRIVATE NETWORKS

Virtual Private Networks (VPN) are a group of individual networks on a public network (such as the Internet) that connect to each other by private lines and communicate among themselves by encryption technology so their data are kept safe from unauthorized access. VPN is the infrastructure commonly adopted by corporations so their users can access corporate network resources when they are not in offices or tripping out of town.

The mobile computer supports VPN connection to access the resources inside a secured network from the outside.

There is a variety of security protocols for VPN. Some work based on secure certificates while others requires passwords to permit the access. To access a VPN with secure certificates, see [Install Secure Certificates](#).

To be able to set up a VPN connection on the mobile computer, obtain the needed credentials from your network administrator, and note VPN is always accessed via mobile data connection, i.e. the mobile computer's HSPA+.

4.4.1. VPN CONNECTION SETUP

To add a VPN connection to the mobile computer:

- 1) On Start screen, tap **Settings** | **Connections** | **Connections** (Manager) .

Connections (Manager) opens showing Tasks tabbed page.

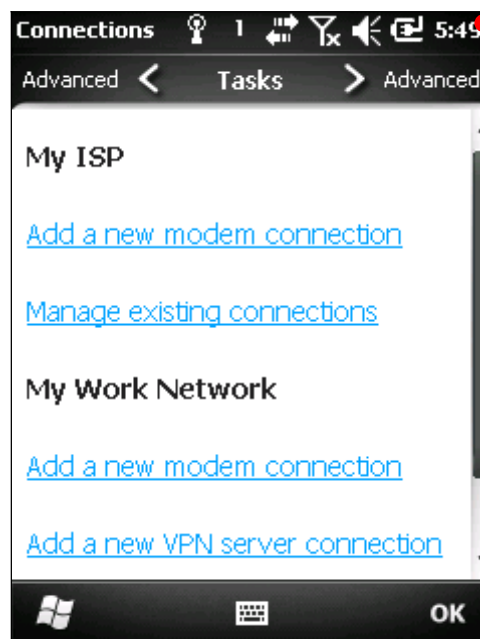

Connections (Manager) opens showing Tasks tabbed page.

- 2) Under **My Work Network** label, tap **Add a new VPN server connection**.

"Make New Connection" page opens.

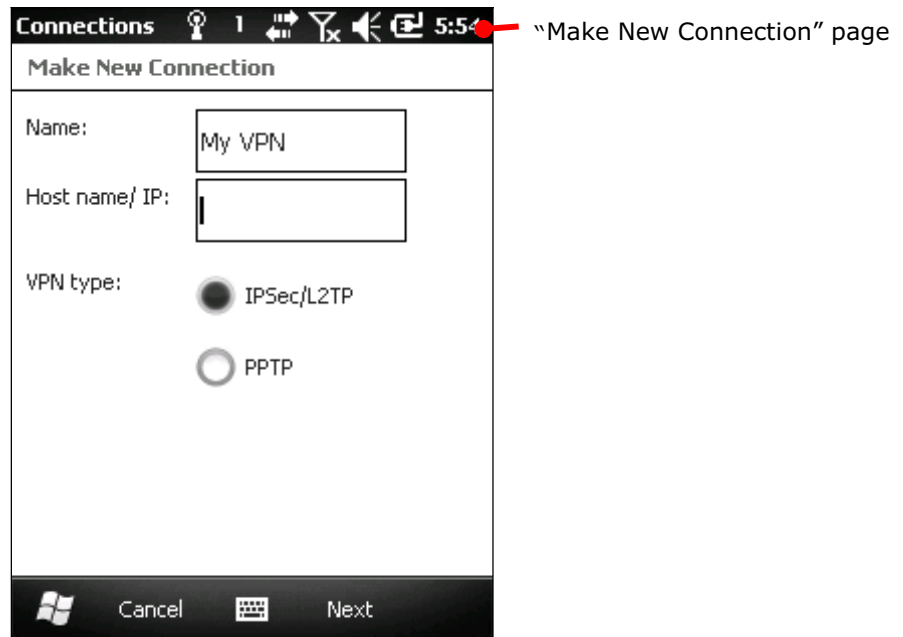

- 3) Complete each VPN settings. Consult your network administrator for the protocol employed on the VPN and other requested credentials.
- 4) Follow onscreen instructions to proceed.

Once a VPN connection is set up, a link **Edit my VPN servers** shows up under **My Work Network** label.

Proceed to connect your VPN as described in [Connect VPN](#).

4.4.2. CONNECT VPN

After a VPN connection is set up as described in [VPN Connection Setup](#), a link **Edit my VPN servers** shows up under **My Work Network**. Move on to connect to the prospective VPN.

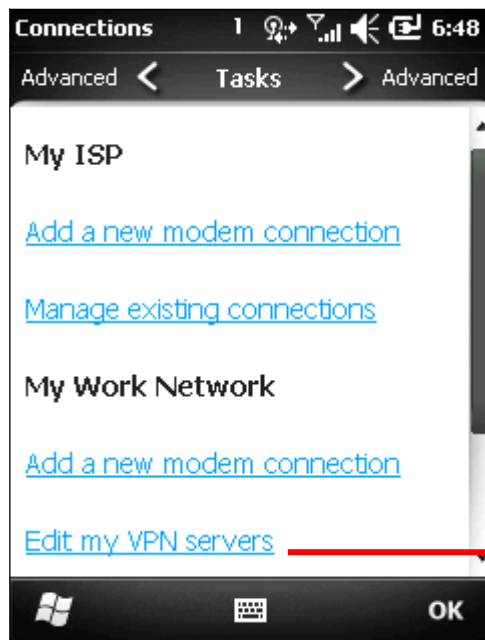

A link **Edit my VPN servers** shows up.

To connect VPN:

- 1) Tap **Edit my VPN servers** link.

My Work Network opens showing VPN tabbed page.

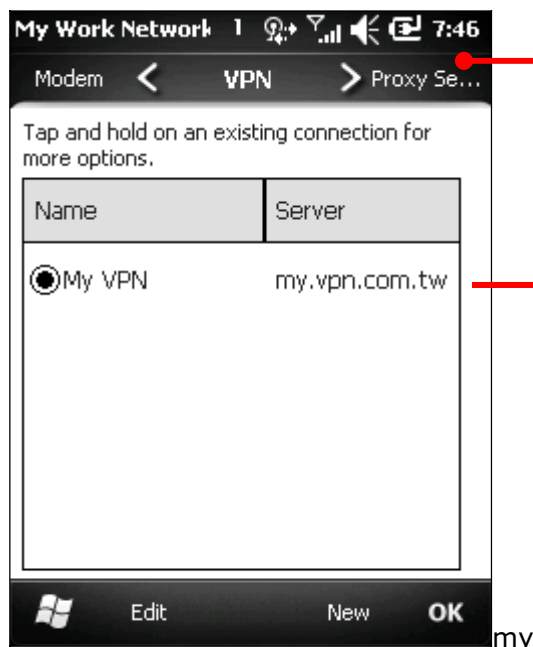

My Work Network's VPN tabbed page

Tap & hold to pop up context menu.

- 2) Tap & hold the VPN to connect.

Context menu shows up.

- 3) Tap **Connect**.

A dialog briefly displays noticing the attempt to connect.

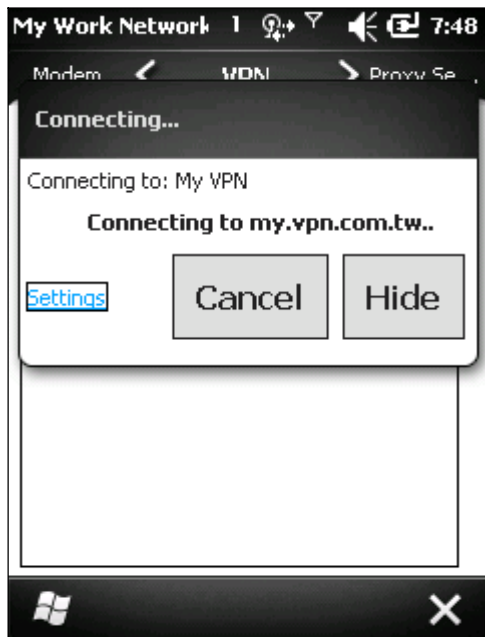

In a few seconds, the VPN is connected. Once connected, the mobile computer makes a sound as per settings in Sounds & Notifications.

4.4.3. DISCONNECT VPN

The O.S. doesn't feature any facility or mechanism to disconnect VPN, consider using a third-party application to disconnect VPN.

4.4.4. EDIT A VPN

To edit a VPN:

- 1) On Start screen, tap **Settings | Connections | Connections** (Manager)  .
Connections (Manager) opens showing Tasks tabbed page.
- 2) Tap **Edit my VPN servers** link.
My Work Network's VPN tabbed page opens.
- 3) Select the VPN to edit.
- 4) Tap the "Edit" command on [Softkey bar](#).
- 5) Follow onscreen instructions to follow through editing.

4.4.5. DELETE A VPN

To delete a VPN:

- 1) On Start screen, tap **Settings | Connections | Connections** (Manager)  .
Connections (Manager)'s Tasks tabbed page opens.
- 2) Tap **Edit my VPN servers** link.

My Work Network's VPN tabbed page opens.

- 3) Tap & hold the VPN to edit.

Context menu shows up.

- 4) Tap **Delete**.

The VPN is deleted.

4.5. INSTALL SECURE CERTIFICATES

To connect to a VPN or Wi-Fi network that deploys secure certificates, the mobile computer must have these certificates. Where the mobile computer stores these secure certificates is called "certificate store".

Windows Embedded Handheld 6.5 has three "certificate stores" – the Personal, Intermediate and Root certificate stores. A certificate store usually has numerous certificates, possibly issued from a number of different certification authorities. To view the certificates stored on the mobile computer, see [View Secure Certificates](#).

4.5.1. SUPPORTED CERTIFICATE FORMATS

Windows Embedded Handheld 6.5 supports installing the following certificate formats:

- ▶ .PFX/.P12 – Public-Key Cryptography Standards #12 (PKCS #12): This file format includes personal certificates with private keys. They install into the intermediate and root certificate stores.
- ▶ CER – Base64-encoded or DER-encoded X.509 certificates that install into the intermediate and root certificate stores.
- ▶ P7B - Public-Key Cryptography Standards #7 (PKCS #7) format files that install multiple certificates to any certificate store on the device.

Certificates with their features:

File Type	Private Key Support	Installs a certificate chain	Installs only one certificate	Installs multiple certificates (can include chains)
.PFX/.P12	Yes	Optional	Optional	Yes
.CER	No	No	Yes	No
.P7B	No	Optional	Optional	Optional

Note: If you are referred to download a certificate from a website, you will be asked to set a password for the credential storage when you download it.

4.5.2. VIEW SECURE CERTIFICATES

Certificates  is the O.S.' featured tool to view to the "certificate stores" on the mobile computer.

To view the secure certificates:

On Start screen, tap **Settings** | **System** | **Certificates** .

Certificates open showing Personal certificate store.

4.5.3. INSTALL SECURE CERTIFICATES

It is recommended that you install a certificate issued by a trusted authority. To install a secure certificate:

- 1) Copy the certificate file to the mobile computer first.
- 2) Browse to the file using File Explorer.
- 3) Tap the certificate file to install.

Certificate installer installs the file.

- 4) Follow the onscreen instructions to proceed.

Once the installation completes, it can be viewed in Certificates .

4.6. LOCATION DISCOVERY

Adorned with a GPS module, the mobile computer is capable of finding your location on earth. GPS relies on the satellites covering the sky around the world to pinpoint your whereabouts.

A location-aware application is necessary, such as CipherLab's GPS Viewer for NMEA-based location discovery. There are other applications downloadable from Internet. Download ".cab"-suffixed programs that confirm the compatibility with Windows Embedded Handheld 6.5. Note always download programs from trusted sources.

As GPS is a big power consumer, close GPS application when you are not using it.

4.6.1. LAUNCH GPS

The O.S. doesn't feature any facility to turn on/off GPS module but a GPS intermediate driver (hereinafter "GPSID"), a software layer between GPS hardware and GPS software to stream GPS data from hardware to software without parsing NMEA syntax and in the meanwhile enable multiple applications to simultaneously access GPS data.

Hence the approach to turn on GPS module is to launch a GPS software or a location-aware application on the mobile computer because the software COM port for GPS is turned on then. In case of any difficulty launching GPS, open **Start screen | Settings | System | External GPS | Access** tabbed page to check if **Manage GPS automatically** is selected.

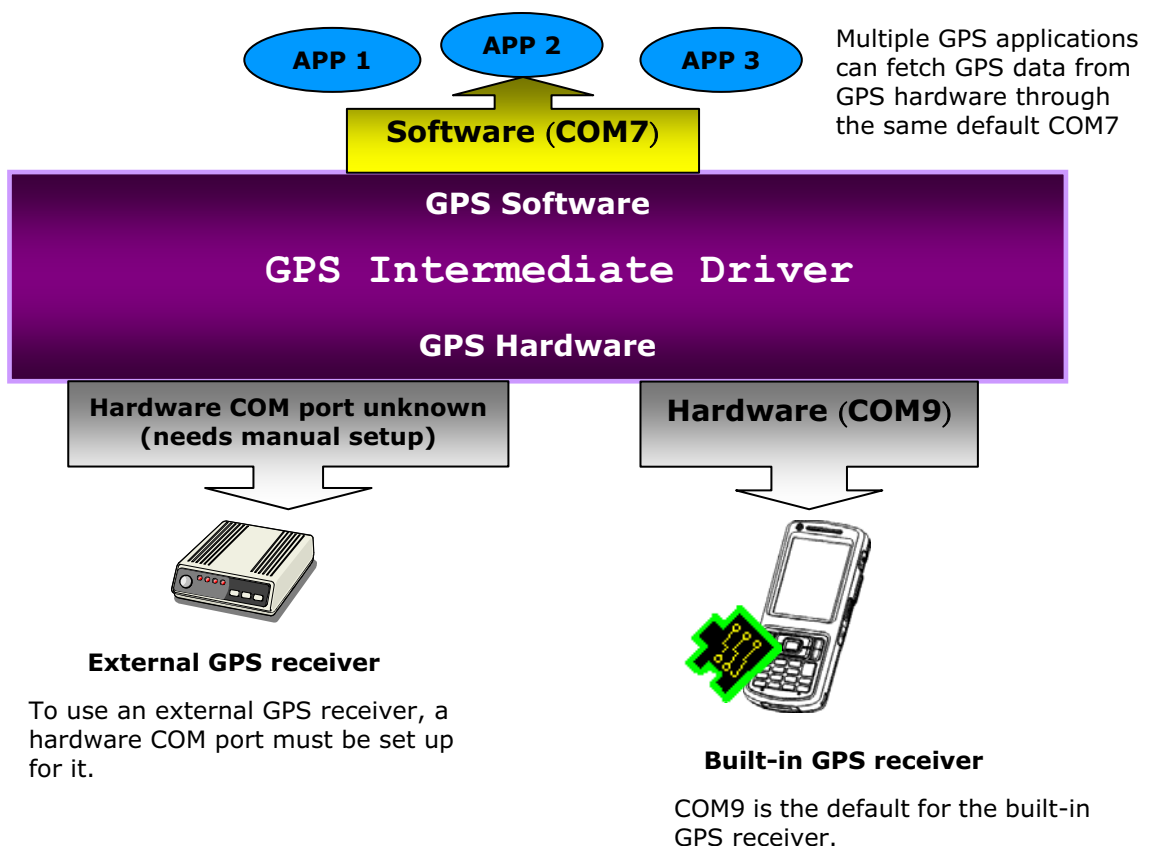

4.6.2. USE GPS

To discover locations by GPS:

- 1) Launch GPS as described in [Launch GPS](#).
- 2) Launch a GPS software or location-aware application.

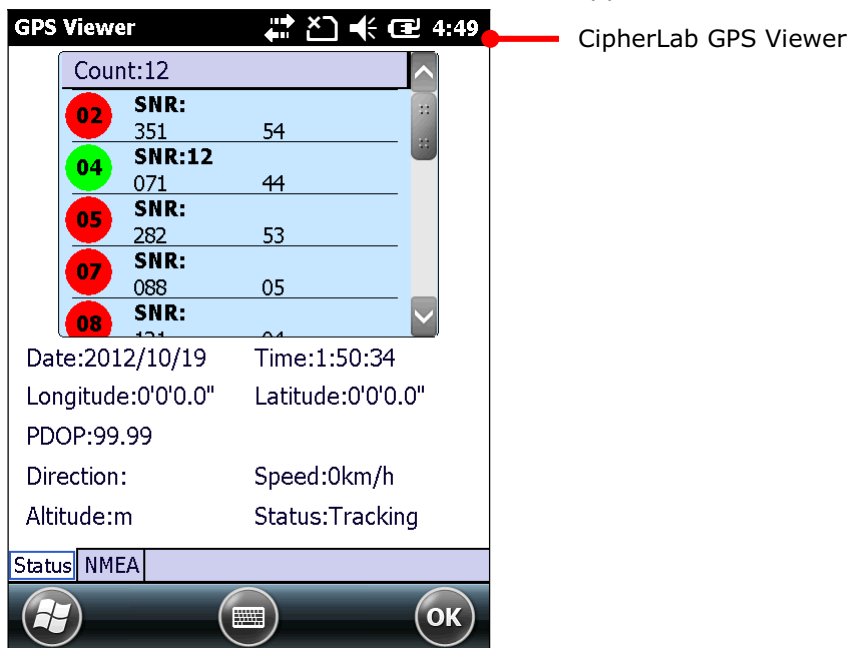

PHONE

This chapter depicts SIM card installation and status icons associated with phone connection. For the phone's data calls, see [Access Cellular WAN](#).

5.1. SIM CARD

To use the mobile computer's phone, first obtain a SIM card from your mobile carrier. Activate the SIM card and assemble it to the mobile computer. The phone is enabled by default and connects to your wireless network when the mobile computer powers on.

The mobile computer may ask you for a PIN to unlock the SIM card when it powers on. Contact your mobile carrier for their default PIN.

5.1.1. ASSEMBLE SIM CARD

To assemble a SIM card, follow the steps below:

- 1) Power off the mobile computer. Remove the hand strap, battery door and main battery.
- 2) Locate the SIM card socket inside the battery chamber. (See also [Inside Battery Chamber](#).) SIM card socket has a hinged cover.
- 3) Push back the hinged cover to unlock it.
- 4) Swivel up the hinged cover.
- 5) Insert SIM card into the cover slot in the direction indicated . The metal contact pins should face down.
- 6) Put down the hinged cover.
- 7) Lock the hinged cover into place.
- 8) Restore the battery, battery door, and hand strap.

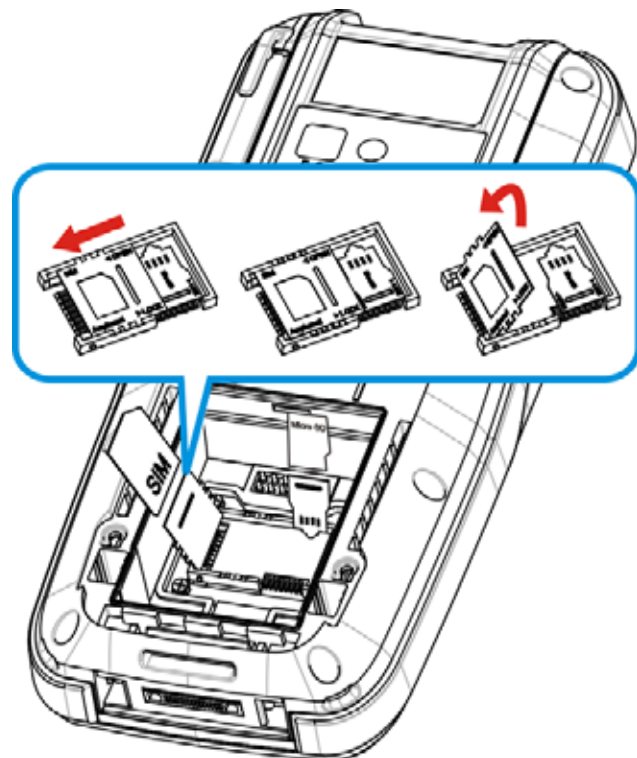







Figure 13: Inserting SIM Card

5.2. STATUS ICONS

Status icons for phone connection:

Status Icon	Description
	No SIM card installed
	Phone off
	SIM card locked. PIN code required to turn on phone.
	Phone on with signal strength. The more bars lit, the stronger the signal.
	Connected to another mobile carrier's network (roaming)

<reserved>

<reserved>

SPECIFICATIONS

PLATFORM, PROCESSOR & MEMORY

Operating System & CPU

O.S. Version	Microsoft Windows Embedded Handheld 6.5
CPU	TI DM3730 1GHz Processor

Memory

RAM	512MB DDR SDRAM
Flash	4GB Flash ROM
Expansion Slot	One MicroSDHC card slot, supports up to 32GB

COMMUNICATIONS & DATA CAPTURE

Communications

USB Host/Client	USB 1.1 / USB 2.0
WPAN	Built-in module for Bluetooth version 2.1 + EDR Class II connectivity
WLAN	Built-in module for 802.11 a/b/g/n networking
GPS	Built in GPS module

Data & Image Capture

Digital Camera	5 mega-pixel with auto focus and photoflash
Barcode Reader	Ordering options include <ul style="list-style-type: none">▶ Laser (Symbol SE955)▶ Long Range Laser (Symbol SE-965HP)▶ 2D (Symbol SE4500)

ELECTRICAL CHARACTERISTICS

Batteries

Main Battery Pack	Standard: 3.7V, 3600 mAh High Capacity: 3.7V, 4400 mAh Rechargeable Li-ion battery Charging time: approximately 4 hours
Backup Battery	3.3V, 15 mAh Rechargeable Li-ion battery Data retention for 30 minutes Charging time: 5 hours

Power Adapter

Power Supply Cord for Snap-on Cable	Input	AC 100~240V, 50/60 Hz
	Output	DC 5 V, 4A
Power Supply Cord for Charging & Comm. Cradle	Input	AC 100~240V, 50/60 Hz
	Output	DC 12V, 3.3A

Operating Time

Standard Battery (1 scan per 20 seconds; 50% backlight)

Laser	Wi-Fi mode	Approximately 16 hours
	3G mode	Approximately 9 hours
2D	Wi-Fi mode	Approximately 15 hours
	3G mode	Approximately 11 hours

PHYSICAL CHARACTERISTICS

Color Tap Screen Display

Display	3.5" Transflective TFT-LCD, 65K colors, sunlight readable
Resolution	QVGA 240 (W) x 320 (H)/VGA 480 (W) x 640 (H)

Keypad

Layout	Numeric or QWERTY keypad
Backlight	White LED backlight for display and keypad

Notifications

Status LED	Three LEDs for showing scanning good read, battery charging and radio connection status
Audio	<ul style="list-style-type: none">▶ Integrated with speaker▶ Bluetooth headset supported

Sensors

Built-in Sensors	G-sensor, E-compass, Gyroscope, Light Sensor, Proximity Sensor
------------------	--

Enclosures

Materials	Plastic & metal
Dimensions	182 mm (L) x 83 mm (W) x 44 mm (H) with standard battery 182 mm (L) x 83 mm (W) x 47 mm (H) with high capacity battery
Weight	516g (with standard battery) / 535g (with high capacity battery)

ENVIRONMENTAL CHARACTERISTICS

Temperature

Operating ^{Note}	-20 °C to 50 °C / -4°F to 122°F
Storage	-30 °C to 70 °C / 32°F to 95°F (without battery)
Charging	0 °C to 35 °C / -22°F to 158°F (without battery)

Humidity

Operating	5% to 95%, non-condensing
Storage	20% to 95%, non-condensing

Resistance

Impact Resistance	Multiple 1.8m drops onto concrete
Tumble Test	1,000 tumbles at 1 m (2,000 drops) per applicable IEC tumble spec.
Splash/Dust Resistance	IP 65/IP 67 per applicable IEC 60529 sealing spec.
Electrostatic Discharge	± 15 kV air discharge, ± 8 kV direct contact discharge

Note: CipherLab will not be held responsible for the mobile computer's malfunction incurred by the operation outside operating temperature range.

PROGRAMMING SUPPORT

Development Environment & Tools

Integrated Development Environment	Visual Studio 2008 Visual Studio 2005
Software Development Kit	Microsoft SDK System API (DLL) for system configuration Reader API (DLL) for reader configuration

Software & Utilities

Cipherlab software package	<ul style="list-style-type: none"> ▶ Reader Configuration ▶ Button Assignment ▶ App-Lock ▶ Signature Capture ▶ SPB SmartShell ▶ Backup Utility ▶ GPS Viewer ▶ MIRROR Browser for web application ▶ Terminal Emulation
Third-party software	<ul style="list-style-type: none"> ▶ SOTI MobiControl for remote device control ▶ Naurtech CETerm – Terminal emulator (3270, 5250, VT) and industrial web browser ▶ SYSDEV Kalipso

ACCESSORIES

Accessory Options

- ▶ Detachable Pistol Grip
- ▶ Belt Holster (with or without shoulder strap)
- ▶ Charging & Communication Cradle
- ▶ Snap-on Charging and Communication Cable (USB & RS-232)

According to FCC 15.407(e), the device is intended to operate in the frequency band of 5.15GHz to 5.25GHz under all conditions of conditions of normal operation. Normal operation of this device is restricted to indoor used only to reduce any potential for harmful interference to co-channels MSS operations.

This equipment has been tested and found to comply with the limits for a class B digital device, pursuant to part 15 of the FCC rules. These limits are designed to provide to provide reasonable protection against harmful interference in a residential installation. This equipment generates, uses and can radiate radio frequency energy and, if not installed and used in accordance with the installation, may cause harmful interference to radio communication. However, there is no guarantee that interference will not occur in a particular installation. If this equipment does cause harmful interference to radio or television reception, which can be determined by turning the equipment off and on, the user is encouraged to try to correct the interference by one or more of the following measures:

- Reorient or relocate the receiving antenna
- Increase the separation between the equipment and receiver
- Connect the equipment into an outlet on a circuit different from that to which the receiver is connected
- Consult the dealer or an experienced radio / TV technician for help

You are cautioned that changes or modifications not expressly approved by the party responsible for compliance could void your authority to operate the equipment.

This device complies with part 15 of the FCC rules. Operation is subject to the following two conditions
(1) This device may not cause harmful interference and
(2) this device must accept any interference received, including interference that may cause undesired operation.

FCC RF radiation exposure statement:

This transmitter must not be co-located or operating in conjunction with any other antenna or transmitter.

Body-worn operation

This device was tested for typical body-worn operations with the back of the phone kept 1.5cm from the body. To maintain compliance with FCC RF exposure requirements, use only belt-clips, holsters or similar accessories that maintain a 1.5cm separation distance between the user's body and the back of the phone, including the antenna. The use of belt-clips, holsters and similar accessories should not contain metallic components in its assembly. The use of accessories that do not satisfy these requirements may not comply with FCC RF exposure requirements, and should be avoided.

SAR Information

1.028 W/Kg (Body)

* The CP-60 is not support Hotspot function.