

CorelDRAW<sup>®</sup>  
Technical Suite 2017  
*includes Corel DESIGNER<sup>®</sup>*

REVIEWER'S GUIDE

# CorelDRAW<sup>®</sup> Technical Suite 2017 *includes Corel DESIGNER<sup>®</sup>*

---

## Contents

1   Introducing CorelDRAW Technical Suite 2017.....	1
2   Customer profiles .....	5
3   What's included? .....	7
4   Key features.....	9
5   Lattice3D Studio CAD Corel Edition (optional add-on) .....	23

---

# 1

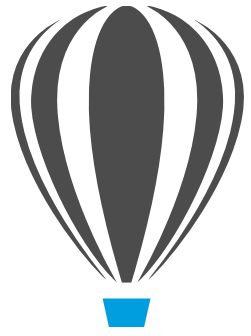

## Introducing CorelDRAW® Technical Suite 2017

CorelDRAW® Technical Suite 2017 is the complete solution for visual communication and technical publication — print, online and to mobile devices. Industry-leading file compatibility, precise illustration tools, and productivity-enhancing features streamline the workflow of today's technical communication professionals and technical graphics users, simplifying single-source publishing of standards-compliant technical publications for a global market.

### Precision

Corel DESIGNER® 2017 is renowned for its specialized tools and features designed for the specific tasks

required by technical illustrators. From intuitive projected drawing and enhanced boundary effects to new node customization and selection, Corel DESIGNER 2017 offers everything you need to create clear and accurate technical illustrations. A large collection of powerful and dedicated illustration tools simplifies the creation of high-quality technical communication projects, including sophisticated documentation, detailed assembly instructions, user and maintenance manuals, and more.

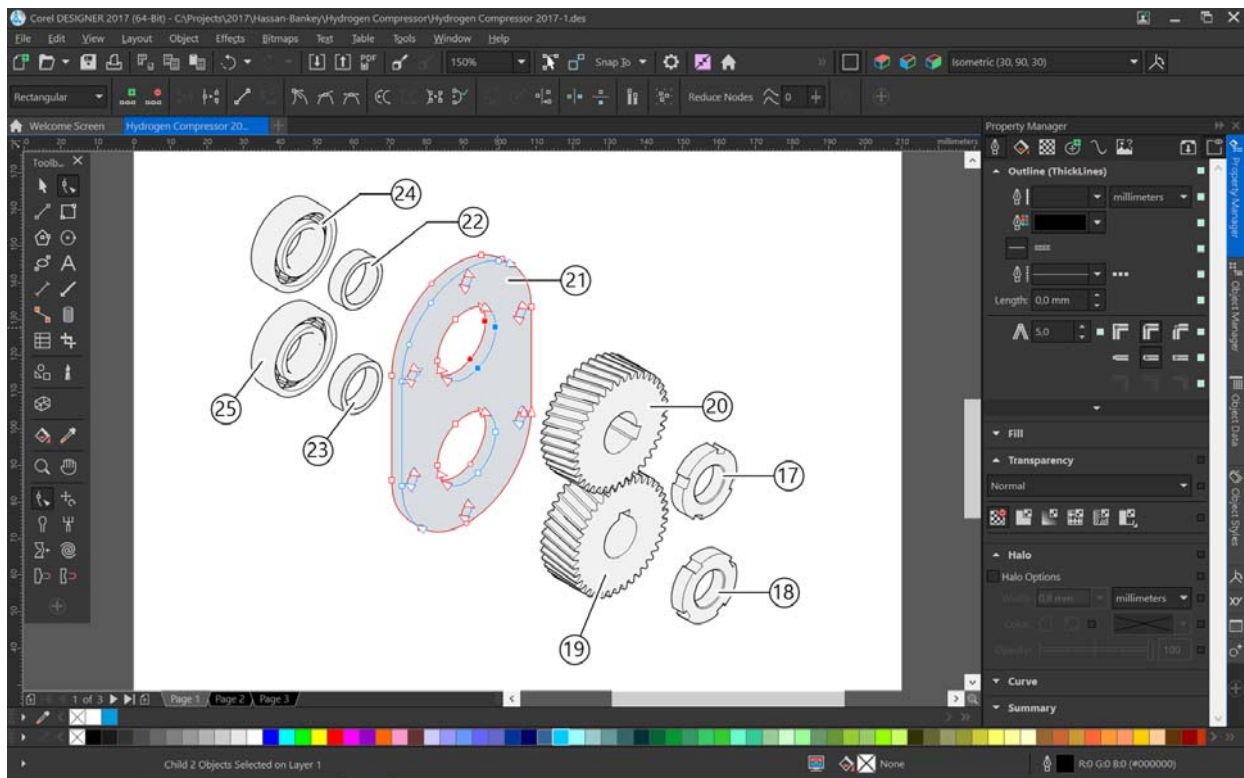

## Compatibility

The industry-leading file format compatibility of CorelDRAW Technical Suite 2017 ensures that technical graphics professionals can access critical data from various sources and deliver technical files in a readable format. You can export to over 100 file formats, so you can exchange files with colleagues and clients worldwide and produce a range of downstream outputs, including 3D PDF.

You can also rely on compliance with various standards-based systems thanks to enhanced support for technical publication standards, including WebCGM, S1000D, ATA iSpec 2200, SVG and PDF. Collaborating with colleagues and clients has never been easier. Whether it's AutoCAD® DWG® and DXF, Adobe® Illustrator® CS/CC, Adobe® Photoshop® CS/CC, Microsoft® Publisher, or Adobe® Acrobat®, you can access and repurpose data from a wide range of formats.

You can take advantage of Lattice3D Studio Corel Edition to open, edit, and modify 3D models and import 3D views into your technical illustrations. This 3D visualization application is fully integrated with Corel DESIGNER, CorelDRAW® and Corel® PHOTO-PAINT™, so you can easily output 3D files to high-quality vector illustrations and bitmap renderings. As an optional add-on, Lattice3D Studio CAD Corel Edition has enhanced native file format support for 3D CAD systems and exchange file formats.

## Productivity

With CorelDRAW Technical Suite 2017, you'll work more efficiently and productively thanks to a wide array of new and enhanced features — from workspace customization options to support for Ultra HD and multi-monitor workflows.

Corel DESIGNER 2017 also offers enhanced Translation Memory System (TMS) support that allows for cost-effective production of multi-lingual technical communication.

What's more, CorelDRAW Technical Suite 2017 provides professional creative design and image editing applications, such as CorelDRAW 2017 and Corel PHOTO-PAINT 2017, which are ideal for producing downstream outputs from a technical illustration or imported 3D design, such as marketing collateral, graphics, and presentation materials.

## Choose your purchase option

In the interest of user choice, there are several CorelDRAW Technical Suite purchase options.

### Perpetual License

At Corel, we strongly believe that you should not be forced into a rental model if you don't want it. For a onetime payment, a CorelDRAW perpetual license gives you the right to use the software forever, with no extra monthly cost. By purchasing a box, download version or volume license version of the product, you get access to the full benefits of a specific version, and there is no need for a permanent Internet connection. With the optional Upgrade Program or Maintenance Program (for volume licenses) customers can additionally benefit from receiving major version upgrades immediately when they become available.

### Subscription

A CorelDRAW® Subscription is an affordable way to stay up-to-date with the latest tools and enhancements of CorelDRAW Technical Suite. It offers a cost-effective alternative to paying the upfront cost of the software. Instead, you'll get a full, downloadable version of CorelDRAW Technical Suite\* that remains entirely functional for as long as your subscription is active. You decide how and when you want to use it. An annual plan offers an overall discount, with the option to auto-renew or end your subscription after the 12-month period. Your subscription entitles you to the latest performance enhancements and updates. It also entitles you to the next major version upgrade for as long as your subscription is active.

### Upgrade Program

The CorelDRAW® Upgrade Program is the hassle-free way for technical illustrators and technical graphics users to keep their toolbox up-to-date at the best price. If you own a version of CorelDRAW Technical Suite with a perpetual license, you pay one affordable fee once a year, and you're assured of working with the latest design tools, new file compatibility, and the most current technology. And as long as your account is active, you'll automatically get the latest version of CorelDRAW Technical Suite. Best of all, sign up once and forget about it. In addition, if your needs change, you will continue to own the last version you received through the upgrade program.

### Volume License options for teams and organizations

CorelDRAW Technical Suite can also be licensed for teams and larger groups in an organization. Both options — perpetual license, and software subscription license — are commonly referred to as the Corel Transactional License program (or CTL for short) and are available to order from one of our many authorized Channel resellers. Organizations who purchase CorelDRAW Technical Suite licenses in volume can secure a much lower overall cost to the organization. If perpetual license owners want to stay current with new releases however, they can opt in for the Maintenance program. The Corel Maintenance Program guarantees that customers automatically receive all new releases during the lifetime of the program, as well as benefiting from advanced support and cumulative cost savings if additional seats are required.

For more information about the Corel Licensing program, please visit [www.coreldraw.com/business](http://www.coreldraw.com/business).

*\* A corel.com account and Internet connection are required to download and use the application and manage your subscription.*



# 2

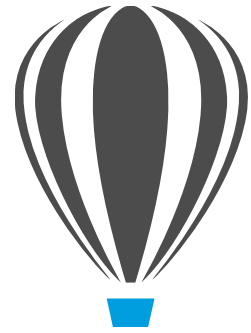

## Customer profiles

### Technical communication professionals

These users often have formal training in a technical or graphics field, such as technical illustration or technical writing. They work in discrete manufacturing, automotive, aerospace, high tech and telecommunications, architecture, engineering and construction (AEC), and apparel industries.

The graphics created by technical illustrators are used in assembly instructions, user guides, illustrated parts catalogs (IPCs), maintenance manuals, schematics, or wiring diagrams. These documents are output to various media, such as print, the web, mobile devices, and interactive electronic technical manuals (IETMs).

Technical communication professionals in today's global markets need to create technical publications in multiple languages for a worldwide customer base. The ability to work seamlessly with Translation Memory Systems (TMS) used in the localization workflow is critical to streamline processes.

In addition, many organizations rely on content authoring and management systems, so they seek solutions that can be easily integrated.

### Technical graphics users

These users are often self-taught in graphic-creation tasks and include knowledge workers in medium to large enterprise environments, such as manufacturing, automotive, telecommunication, pharmaceuticals, chemicals, and energy industries.

Among their many tasks and responsibilities is the need to create a variety of graphics, including diagrams used in presentation materials, floor plans, schematics, and marketing materials.

These users may create graphics from scratch or base them on legacy files. They often work collaboratively, and the graphics they create may later be imported for reuse with office-productivity, diagramming, and desktop-publishing software.

In a typical organization, there may be many technical graphics users spread across several departments. They are not generally required to use the software daily, and as such, they do not often get opportunities for extensive training.

Organizations require cost-effective and easy-to-use solutions that enable their users to repurpose legacy files and 2D CAD data — and eventually 3D CAD data. They also need tools for creating basic technical diagrams and publishing standardized outputs.





# 3

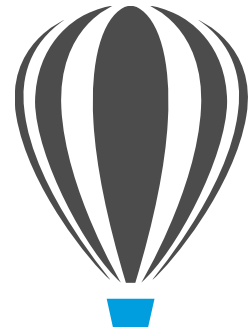

## What's included?

### Applications

- **Corel DESIGNER® 2017:** This specialized application streamlines the technical graphics workflow by offering precision vector drawing, page layout, and diagramming tools that meet the demands of technical illustrators and technical graphics users.
- **CorelDRAW® 2017:** This intuitive vector-illustration and page-layout application is the perfect partner for Corel DESIGNER. It offers graphics users additional creative graphics and design tools that are ideal for more artful endeavors, such as marketing collateral outputs.
- **Corel® PHOTO-PAINT™ 2017:** This professional image-editing application lets you quickly and easily retouch and enhance photos for both technical communication and creative graphics projects.
- **Lattice3D Studio Corel Edition:** This 3D authoring application lets you create vector illustrations and photo-realistic renderings from 3D views, including cross sections and 3D element modifications, such as the creation of exploded views.
- **Corel Font Manager™ 2017:** This standalone font management application lets you find, organize, and preview local fonts, as well as online fonts on the Content Exchange.
- **Corel® PowerTRACE® 2017:** This convenient utility lets you quickly and accurately convert bitmaps, such as scanned blueprints, into editable vector graphics.
- **Corel® CONNECT™ 2017:** This full-screen browser connects you to the suite's digital content library, and lets you search your computer, local network, and online sources to quickly find the perfect

complement for an illustration. Fully integrated, it is also available as a docker in Corel DESIGNER, CorelDRAW, and Corel PHOTO-PAINT.

- **Lattice3D Player:** This 3D viewer is integrated with Corel DESIGNER 2017 for the insertion of 3D data assets in technical illustrations. It provides the ability to modify 3D views and display modes.
- **Corel CAPTURE™ 2017:** This one-click utility lets you capture images from your computer screen, which is especially useful for creating illustrated software documentation, such as user guides.
- **PhotoZoom Pro 4:** This plug-in lets registered users export and enlarge digital images from Corel PHOTO-PAINT.

### Supporting applications

- **Microsoft® Visual Basic® for Applications 7.1:** This integrated development environment includes 64-bit support and helps you streamline your workflow by automating tasks.
- **Microsoft® Visual Studio® Tools for Applications:** This toolset includes the power of the .NET framework, so developers can create time-saving plug-ins and add-ons with Visual Studio to automate tasks and extend functionality.
- **Duplexing wizard:** This wizard helps you optimize your work for two-sided printing.
- **Barcode wizard:** This wizard lets you generate bar codes in a wide range of industry-standard formats.

### Content

- More than 4,000 industry-standard Architectural, Electrical, General, Mechanical, and Tools symbols
- More than 350 templates, including more than 40 technical ANSI, DIN, and ISO standard templates

## Content

- More than 4,000 industry-standard Architectural, Electrical, General, Mechanical, and Tools symbols
- More than 350 templates, including more than 40 technical ANSI, DIN, and ISO standard templates
- 10,000 high-quality clipart and images
- 2,000 high-resolution digital photos
- Over 1,000 TrueType and OpenType® fonts
- Over 500 interactive frames and photo frames
- Over 600 fountain, vector and bitmap fills

## Documentation

- Online Help files
- User Guides (PDF and eBook formats)
- Video tutorials

## CoreIDRAW Technical Suite 2017 system requirements

- Microsoft® Windows® 10, Windows® 8.1 or Windows® 7 SP1, in 32-bit or 64-bit, with the latest updates and service pack installed
- Intel® Core® i3/5/7 or AMD Athlon™ 64
- 2 GB RAM
- 1 GB hard disk space (for typical installation without content)
- Mouse, tablet, or multi-touch screen
- 1280 x 720 screen resolution at 100% (96 dpi)
- DVD drive (required for box installation)
- Microsoft® Internet Explorer® 11 or higher
- Microsoft .NET Framework 4.6
- Internet connection is required to sign in to authenticate CoreIDRAW Technical Suite, receive performance and stability updates, access online content, and use some features, such as QR Codes or the Content Exchange. You can use CoreIDRAW Technical Suite offline. As a subscription user you need to connect to the Internet at least once a month.

## Lattice3D Studio CAD Corel Edition system requirements

For processing 3D CAD assembly data we recommend:

- Microsoft Windows 10, Windows 8.1 or Windows 7 (64-bit editions) with the latest updates and service pack installed
- 8 GB RAM or more
- 1280 x 800 or higher screen resolution
- Internet connection required for product activation and installing updates

Lattice3D Studio Corel Edition is included and installed with CoreIDRAW Technical Suite 2017. The Lattice3D Studio CAD Add-On product unlocks additional functionality for the integrated application.

# 4

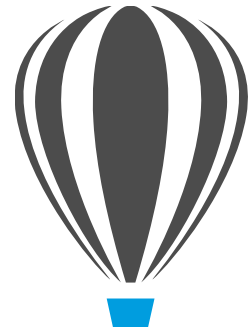

## Key features

CorelDRAW Technical Suite 2017 is a complete and cost-effective solution for authoring visual communications for publishing to print, online, and mobile devices.

### Precision

Technical illustrators require specialized tools, designing to the exact specifications of visually detailed assembly instructions, complex user manuals and multi-faceted documentation. CorelDRAW Technical Suite 2017 provides projected drawing, illustration, callout, dimension, boundary and image-editing tools that help users work with precision and deliver the accuracy required for any type of technical communication project.

**Enhanced! Projected drawing:** In response to user feedback, projected drawing in Corel DESIGNER is more intuitive. Now you can create new objects and edit existing ones using the dimensions and coordinates of the active projected plane. The UI displays the projected-plane values that you'd expect, so you can accurately draw, move, copy, stretch, and scale objects, giving you increased precision and productivity when authoring isometric drawings.

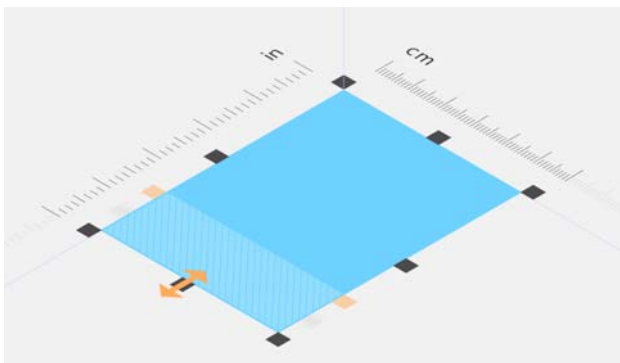



*You can draw and edit using the scale of the projected axes according to the settings of the active projected plane.*

### Give it a try

#### Working with isometric drawing

- 1 Press **F10** to display the document grid.
- 2 On the Drawing Plane toolbar, click the **Top**  button.
- 3 Click **Window** ▶ **Object Coordinates** to open the Object Coordinates docker.
- 4 Click **View** ▶ **Toolbars** ▶ **Transform** to open the Transform toolbar.
- 5 In the Object Coordinates docker, type **20** in both **Object Size** boxes, and click **Create Object**.
- 6 Type **10** in both **Object Size** boxes, and click **Create Object** to create a concentric square.

Note the Transform toolbar and Object Coordinates docker display the projected height and projected width values.

- 7 Click **Window** ▶ **Transformations** ▶ **Size** to open the Size page of the Transformations docker.
- 8 Type **1** in the **Copies** box, type **5** in the **X** and **Y** boxes, and click **Apply** to create a new shape instead of modifying the selected square.
- 9 On the Drawing Plane toolbar, click the **Front**  button.
- 10 Click the **3-Point Rectangle**  tool in the toolbox.
- 11 In the drawing window, point to the left corner of the largest rectangle, drag to bottom corner, and release the mouse button.
- 12 Move the pointer down to draw the height, and click.  
  
Note the Transform toolbar displays the actual height in the active projection.
- 13 You can precisely adjust the height. On the Transform toolbar, click a top point on the origin locator  and enter the precise height in the **Object Size** box, and press **Enter**.

**Enhanced! Boundary options:** When 2D CAD files or previously converted line drawings are used as the source for technical illustrations, sometimes there are gaps in lines that were supposed to form a closed shape. This can lead to time-consuming manual reworking of the illustration. To that end, Corel DESIGNER 2017 offers more flexibility when using a boundary around multiple shapes to create a single closed curve object. You can now include open lines in the object being created with the Boundary effect. A new gap tolerance control lets you specify a distance between the end points of open lines. End points within that tolerance are temporarily repositioned to close the gap between objects and allow a boundary to be created.

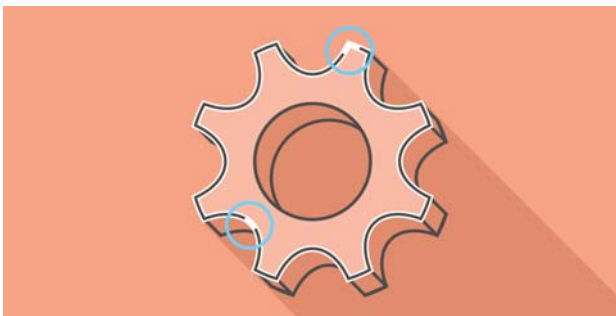

*You can extend curves to create boundaries in shapes that have small gaps between curves.*

**Enhanced! Vector previews, nodes, and handles:** CorelDRAW Technical Suite 2017 simplifies shaping curves and objects with redesigned nodes and handles that are easier to see and manipulate. Enhanced vector previews help you edit more efficiently by ensuring nodes and curves stand out against background colors in your design.

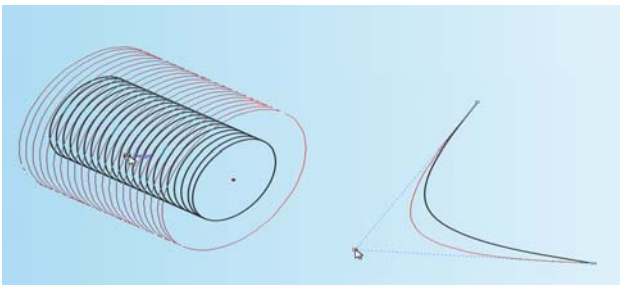

*Enhanced previews, nodes, and handles don't get lost in background colors.*

**New! Prominent interactive sliders:** It's easier than ever to work with object fills, transparencies, blends, extrusions, drop shadows and more thanks to enhanced interactive sliders that are more visible.

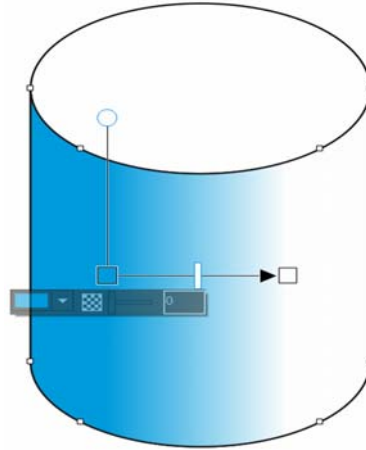

*Prominent interactive sliders simplify working with object fills, transparencies, and more.*

**New! Selecting adjacent nodes:** Corel DESIGNER 2017 and CorelDRAW 2017 offer enhanced node selection that simplifies working with complex shapes. You can now select adjacent nodes on curves by using the Shape tool while holding down Shift. You can also change the direction in which the nodes are selected.

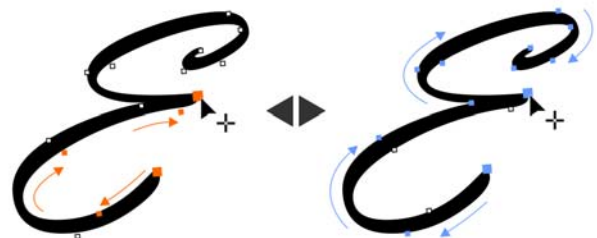

*You can select several adjacent nodes (left), and you can change the direction in which the nodes are selected (right).*

**New! Copying curve segments:** Another new time-saving enhancement in Corel DESIGNER 2017 and CorelDRAW 2017 is the ability to copy or cut a specific part of a curve segment. You can then paste it as an object, making it easy to create new adjacent shapes with similar contours.

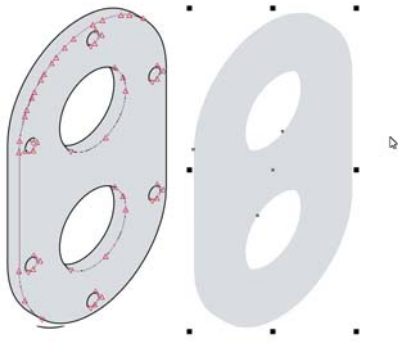

*You can copy, paste, or duplicate pieces of existing curves, allowing you to reuse curve segments in your projects.*

**New! Custom node shapes:** Corel DESIGNER 2017 and CorelDRAW 2017 simplify shaping curves and objects by assigning each node type a unique shape, making it easy to identify smooth, cusp, and symmetrical nodes. Technical graphics users can tailor the look of nodes to best suit their workflow or project with new options for customizing their shape, size, and color. They can also accelerate modifying elements in designs by choosing to show the direction of curves and using a range of drawing tools to edit nodes.

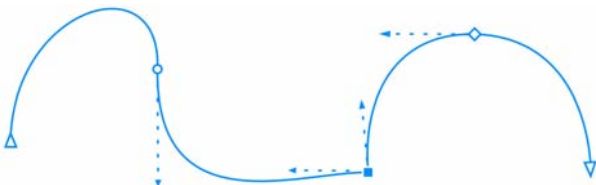

*You can assign each node type a unique shape, making them easy to identify.*

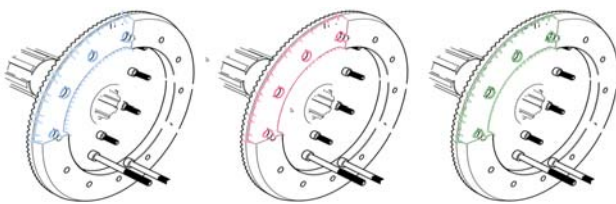

**New! Custom colors for previews and curve editing:** New color personalization options help you edit objects more efficiently by letting you choose the colors for nodes, handles and previews that will stand out against underlying colors, making them easier to see.



*You can choose custom colors for nodes, handles, and previews.*

## Give it a try

### Using enhanced node editing

- 1 Click **Tools** ▶ **Options**.
- 2 In the **Workspace** list of categories, click **Nodes and handles**.
- 3 In the **General settings** area, do any of the following:
  - To change the node size, choose a size from the **Node size** list box.
  - To change the node shape, choose a shape for cusp, smooth and symmetrical nodes from the **Node shape** list boxes.
  - To show or hide the direction of selected curves, enable or disable the **Show curve direction when editing** check box
- 4 In the **Colors** area, choose **Custom** from the **Color scheme** list box., and do any of the following:
  - Open the **Main color** picker, and choose the color used in nodes and handles when an object is selected for editing.
  - Open the **Secondary color** picker, and choose the color used in nodes and handles when additional objects are selected for editing with the **Shape** tool or when you are editing vector effects such as extrusions
  - Enable the **Show node types in different colors** check box to display each node type in a different color.
- 5 With a document open, click the **LiveSketch**  tool in the toolbox, and sketch in the drawing window.
- 6 Click the **Shape**  tool, hold down **Shift**, and select adjacent nodes.
- 7 Press **Ctrl + C** to copy it or **Ctrl + X** to cut it, then **Ctrl + V** to paste it.

**New! Hiding and displaying objects:** Corel DESIGNER lets you hide objects and groups of objects so that only the sections you want or need to see in a project are displayed. When working with complex designs, the ability to hide a particular element in your drawing can be a great time-saver. It ensures that you don't inadvertently select and edit an object that you hadn't intended to work on, and it lets you experiment with your designs more easily.

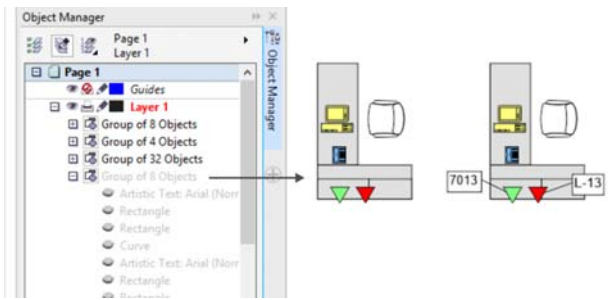

You can hide individual objects or groups of objects on a layer without hiding the entire layer.

**Enhanced! Knife tool:** With the enhanced Knife tool, you can split vector objects, text and bitmaps along straight, freehand or Bézier lines. You can create a gap between the split objects or have them overlap. You can also choose whether to convert outlines into curve objects that can be manipulated or keep them as outlines. And if you're unsure, Corel DESIGNER can eliminate any guesswork by automatically choosing the option that best preserves outline appearance.



Splitting objects with the enhanced Knife tool

**Font list box:** With the Font list box in CorelDRAW Technical Suite 2017 applications, you can view, filter, and find fonts easily. In addition to the font filters available before, you can filter fonts based on weight, width, supported scripts, and more. You can also use keywords to search for fonts. In addition, any folders or font collections added to **Corel Font Manager** are accessible from the Font list box in Corel DESIGNER, CorelDRAW and Corel PHOTO-PAINT, allowing you to use fonts that are not installed in your drawings and documents.

**New! Drop shadows with Gaussian Blur feathering:**

Drop shadows are a great way to enhance elements in your designs. In Corel DESIGNER 2017, you can create more realistic drop shadows that have natural-looking feathered edges in an instant thanks to the Feathering direction button on the property bar.

**New! Correcting perspective distortions:**

With the Straighten Image dialog box in Corel DESIGNER, CorelDRAW and Corel PHOTO-PAINT, you can correct perspective distortions in photos that have straight lines and flat surfaces. Now in a few clicks, you can easily fix photos of buildings, landmarks, or objects that appear in the wrong perspective or that were taken from an angle other than directly in front.

**Symbol Manager docker:** Technical illustrators often use symbols for standard drawing components, which can appear multiple times in an illustration. To that end, the Symbol Manager docker simplifies creating, editing, and managing symbols, including custom defined symbol libraries. Corel DESIGNER 2017 also offers over 4,000 technical symbols, helping you quickly add precise detail to technical illustrations.

**Alignment and Dynamic Guides docker:**

When creating a design, alignment and dynamic guides give technical illustrators speed and precision. Alignment guides help you position objects more quickly and lay out a drawing with precision by appearing on the fly with suggested alignments to existing objects on your page. Dynamic guides help to align, draw, and move objects in precise relation to other objects. You can use the Alignment and Dynamic Guides docker to access and modify the configuration of these guides more quickly.

Fully customizable, dynamic guides are temporary guides that appear from the following snap points in objects — center, node, quadrant, and text baseline. With gravity snapping, technical illustrators snap the cursor to various points in objects, making it easy to create and position objects accurately. And so you can work more efficiently, gravity shortcut keys let you activate a single type of gravity snap.

## Compatibility

Technical graphics professionals need to easily exchange files with colleagues and clients worldwide. To that end, CorelDRAW Technical Suite 2017 provides industry leading file format compatibility, including enhanced support for 3D CAD, CGM (including WebCGM, S1000D, ATA iSpec 2200), SVG, DWG, PSD, AI, PDF and RAW formats. The ability to export to over 100 file formats, including 3D PDF, ensures hassle-free file sharing.

**Enhanced! CGM support:** Corel DESIGNER delivers advanced support for CGM files, an industry-standard format critical to a range of sectors, including aerospace, defense and automotive. If your drawings are used in interactive electronic technical manuals (IETMs), you can make those files even more information-rich by adding hotspots to callout shapes. Then, when you output a drawing to a CGM V4 file, the callout is responsive when clicked or hovered over.

A redesigned CGM Export dialog box gives technical illustrators complete control when outputting a drawing to a CGM file. More CGM V4 profiles are supported, including S1000D (2.3, 3.0, 4.0, and 4.1) and ATA GREXCHANGE (2.8-2.12). Metadata support is improved, including enhanced Application Structure (APS) attribute handling. You can also now include Information Control Number (ICN) when using the S1000D profile and Graphic Number (GNBR) when using ATA GREXCHANGE. Corel DESIGNER also offers better CGM file importing, with improved handling of bitmap elements in CGM files.

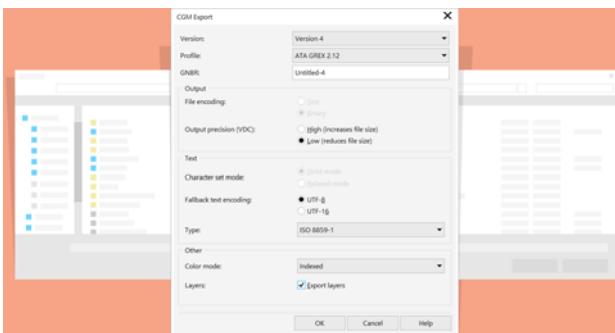

*The redesigned CGM export dialog box offers more settings for advanced support for industry-standard CGM profiles.*

**Enhanced! File format compatibility:** Corel DESIGNER has enhanced support for the latest versions of two formats widely used in technical publications, WebCGM and SVG, ensuring that you can easily exchange files with colleagues and clients worldwide and produce a range of downstream outputs. Corel DESIGNER also offers a range of PDF options, including publishing your document as a 3D PDF or to the ISO compliant PDF/A archiving format. In addition, if a PDF that you're importing contains objects that fall outside the drawing page, you can now leave them intact or crop them to the drawing page. You can import from and export to more than 100 file formats, including EPS, DWG, TIFF, PNG, JPEG. What's more, files saved in the AI or PSD file format can be easily imported to Corel's ecosystem where work can continue without missing a beat.

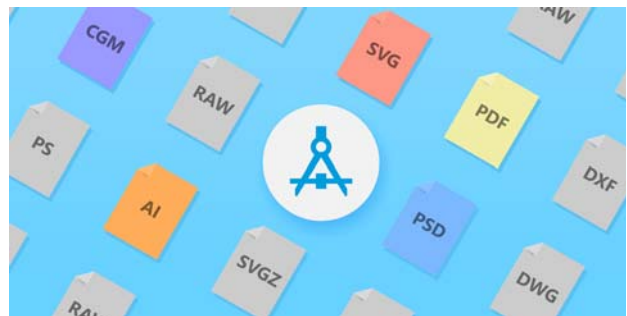

*You can work and share with confidence using enhanced support for technical publication standards.*

**Enhanced! 3D authoring:** Lattice3D Studio Corel Edition has been enhanced for CorelDRAW Technical Suite 2017. This 3D-authoring application lets you open, edit, and modify 3D models and import 3D views into your technical illustrations. You can now create vector illustrations and photo-realistic renderings from 3D views and send them to Corel DESIGNER or CorelDRAW, where you can import 3D models as 2D vector graphics to your drawings. You can also import IGES files, a 3D CAD exchange format that supports solid geometries. Lattice3D Studio Corel Edition also offers enhanced search-and-select functionality, a more streamlined UI, and improved display options for selections.

**New! Stylus tilt, bearing, and rotation:** Increased support for a number of real-time input factors let you get more out of your stylus. In Corel DESIGNER, the new Expression tool lets you use pressure, tilt, and bearing to vary brushstrokes, and the improved Eraser tool is now responsive to your pen or stylus. Plus, stylus support has been enhanced in Corel PHOTO-PAINT for the Eraser tool, the Paint tool, and other brush tools.



*Increased support real-time input factors lets you get more out of your stylus.*

**Enhanced! Windows Real-Time Stylus Support:**

You can use your RTS-compatible pen tablet or device to work on the fly. Support for the Windows Real-Time Stylus delivers truly responsive pressure sensitivity and tilt and gives you full control of your brushstrokes in CorelDRAW Technical Suite 2017. What's more, there's no stylus driver to install, so you can get to work right away.



*You can use your RTS-compatible device to control your brushstrokes.*

**New! Microsoft Surface Dial support:** If a Microsoft Surface Dial is part of your workflow, Corel DESIGNER

offers native support on Windows 10 to give you a greater range of ways to create and interact with technology.



*The Surface Dial can help you zoom in and out as well as undo actions while you're working.*

**Insert 3D Model:** Unique to Corel DESIGNER 2017, when you import 3D models, you can place them and resize them interactively similarly to other imported objects, and combine them with 2D vector illustrations, text, and images in the same document. You can embed a 3D model (XVL file), which gives you the option of editing the 3D model within the Corel DESIGNER (DES) file at any time. What's more, if you share the file with other users, they'll be able to work directly with the embedded 3D model, eliminating the need to distribute both the DES and external XVL files. You can link a 3D model, which automatically updates it in a DES file whenever the XVL file is modified in Lattice3D Studio Corel Edition.

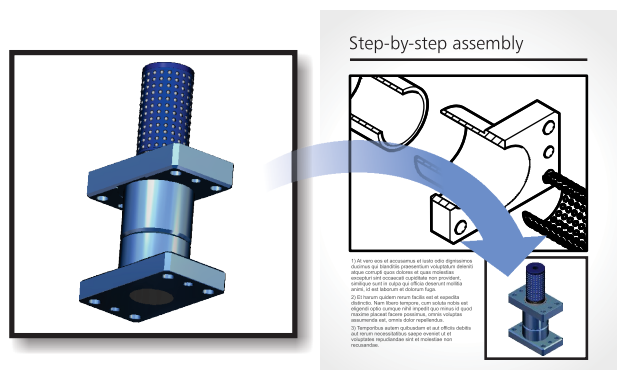

*You can embed or link 3D models in drawings.*

**3D PDF support:** You can publish technical drawings to 3D PDF from Corel DESIGNER 2017, giving you the power to create documents that combine text, vector graphics, images, and embedded 3D models. Using a PDF reader that supports 3D PDF viewing, the end user can interact with the 3D model. They can



intuitively rotate, move and size it, access assembly and part structure information, and take a look inside a 3D model by displaying cross-sections.

3D PDF is an excellent cross-media format. In addition to being ideal for electronic distribution, it can also be used for print, with the 3D content being printed in its default view.

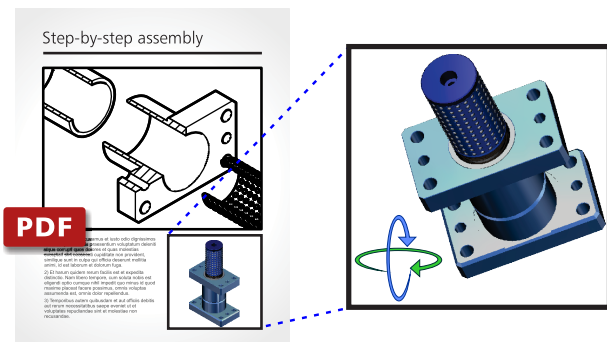

You can create 3D PDFs.

## Give it a try

### Inserting a 3D model and publishing it to 3D PDF

**1** With a drawing open, click **File ▶ Insert 3D Model**.

If this menu command is not available, you must update your installation to include Lattice3D Player.

**2** Locate and open the XVL (\*.xv2) file that you want to insert.

To embed the 3D model, disable the **Import as linked file** check box.

**3** Drag in the drawing window to insert the file at the desired size and position.

You can modify the view of the 3D model, or access stored views and cross-sections that were created in Lattice3D Studio Corel Edition.

**4** Click **File ▶ Publish to PDF**.

**5** In the **Publish to PDF** dialog box, click **Settings**, and choose Acrobat 8.0 or higher from the **Compatibility** list box to ensure that the 3D model is interactive in PDF readers.

**6** In the **Publish to PDF** dialog box, click **Save**.

**7** In a PDF reader that supports 3D PDF viewing, such as Adobe Reader, open the file you created in step 6.

The 3D model can be rotated, panned, and more.

**New! Send to CorelDRAW:** In addition to transforming 3D views to vector graphics for technical-illustration authoring in Corel DESIGNER, you can now also send an active 3D view in Lattice3D Studio Corel Edition to CorelDRAW. The vector graphics output from Lattice3D Studio can then be used as source files for the creation of marketing collateral and other creative deliverables based on engineering data.

## Productivity

Technical communication professionals are always seeking new ways to streamline their workflow and work faster. CorelDRAW Technical Suite 2017 offers a wide array of time-saving new and enhanced features. You can customize your workspace to suit the way you work, take advantage of Ultra HD and multi-monitor support, create illustrations with localized text for a global market, and more.

**Enhanced! TMS support:** The creation of technical documentation for a global market and the reduction of localization costs offered by a Translation Memory System (TMS) has been enhanced. Now when exporting text in a drawing to the XML Localization Interchange file format (XLIFF) — the industry-standard format for sharing translatable text between a TMS and software — recognition of the source language has been improved in Corel DESIGNER 2017. In addition, the translated text you receive back now always respects the original formatting. This lets you create a language-specific file with identical content and formatting, except the translated text strings. Alternatively, a new option for importing translated text into copied text objects on a separate layer allows for the creation of multi-lingual documents with language-specific layers, which can be turned on and off as needed.



Corel DESIGNER simplifies the creation of technical documentation for a global market.

## Give it a try

### Working with translated text

- 1 Open the sample file **TMS-workflow-sample.des**.  
This file can be found in the sample files, available for download: [www.coreldraw.com/cdts2017samples](http://www.coreldraw.com/cdts2017samples).  
The sample file contains text.
- 2 Click **File ▶ Import for Translation**.  
Locate the folder where you want to save the file that will contain the translated text, and click **Save**.
- 3 In the **Open** dialog box, choose the file **TMS-workflow-sample-EN-DE.xlf**, and click **Open**.  
This XLIFF file contains German translations of all text objects in the file **TMS-workflow-sample.des**.
- 4 Click **Open**.  
The English text is replaced with German text.
- 5 In the Object Manager, show the **FR** layer using the **Show or Hide** button and unlock it using the **Lock or Unlock** button.  
The FR layer contains copies of the original English text objects.
- 6 In the Object Manager, make the **EN** layer containing the translated German text visible using the **Show or Hide** button and lock it using the **Lock or Unlock** button.
- 7 Click **File ▶ Import for Translation**.
- 8 Choose the file **TMS-workflow-sample-EN-FR.xlf**, and click **Open**.  
This XLIFF file contains French translations of all text objects in the file **TMS-workflow-sample.des**.
- 9 In the Object Manager, hide the **FR** layer visible and show the **EN** layer using the **Show or Hide** buttons to switch between languages displayed in the multi-lingual document.

**New! Support for UltraHD 5K displays:** An updated interface and support for 5K monitors means that technical communication professionals can comfortably view Corel DESIGNER, CorelDRAW, and Corel PHOTO-PAINT on even the most high-definition monitors, including UltraHD. This allows designs and photos to be edited at their native resolution while maintaining the subtlest details in the image. And with

more pixels to work with, several windows can be opened side-by-side for an efficient workflow.



*You can scale the UI up to 250%.*

**Enhanced! Windows 10 support:** Thanks to our relentless pursuit of delivering the highest quality user experience, CorelDRAW Technical Suite 2017 is fully compatible with and certified for Windows 10. Corel delivers enhanced reliability and performance, so users can maximize their productivity when working on the world's most popular operating system.

**New! Advanced multi-monitor support:** Per-Monitor UI scaling and improvements to multi-monitor support allow technical graphics professionals to take advantage of the sharpness and fidelity of new High-DPI monitors and laptops while still using lower-DPI monitors to maximize design space (requires supported hardware and Windows 8.1 or later). This ensures that UI elements scale properly and appear crisp and legible on screens of all resolutions. For example, you can drag a document out of the application window and place it within a second screen, dedicating one monitor to a drawing or image and the other to frequently used dockers and toolbars.

**New! Product Details tab:** You can learn about the product and your account in the updated Welcome Screen in CorelDRAW Technical Suite 2017. The new Product Details tab provides important information about the product, user account details, and authentication status. Users can also find useful information about product updates. Links to upgrade to the next release or a trial version to a full license, and even renew a subscription can all be found here.

**New! LiveSketch™ tool:** This revolutionary tool uses an Artificial Intelligence technology called a neural network that gives users an entirely new way to bring their vector designs to life. LiveSketch is perfect for kick-starting a project and getting the idea in your imagination onto the screen in front of you. Great when working with a stylus or on a touch-enabled device, it combines the speed of sketching with flexible stroke-adjustment controls so you can begin your design concepts using hand-drawn vector curves right from the get-go.

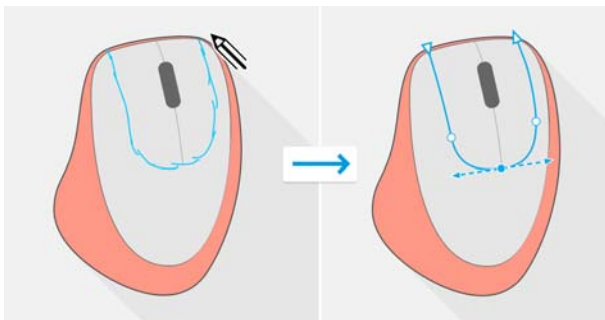

Capture design concepts using hand-drawn vector curves.

The LiveSketch tool lets you capture design concepts using hand-drawn vector curves. If you've ever used a scanned sketch as the basis for a project, you'll quickly see the time-saving possibilities that the LiveSketch tool offers. Not only does it eliminate the need to scan and trace a drawing, but it also gives you total control over how your strokes are adjusted and converted to curves. Intuitive settings let you easily fine-tune how CorelDRAW 2017 meshes with your sketching cadence.

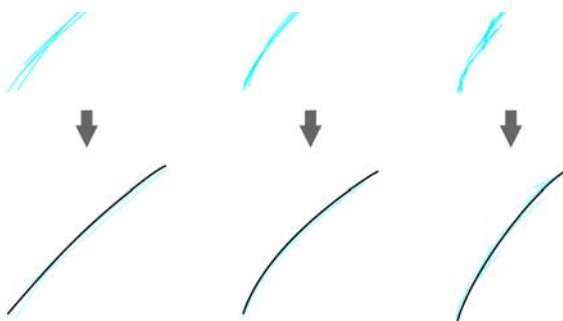

Strokes before (top) and after (bottom) stroke adjustment: discrete overlapping strokes (left), folded strokes (middle), chicken scratch (right)

Strokes created with the LiveSketch tool are adjusted and added to existing curves based on the time and distance between them. You can set the time it takes

to activate stroke adjustment after you've stopped drawing and the distance at which strokes are automatically added to existing curves.

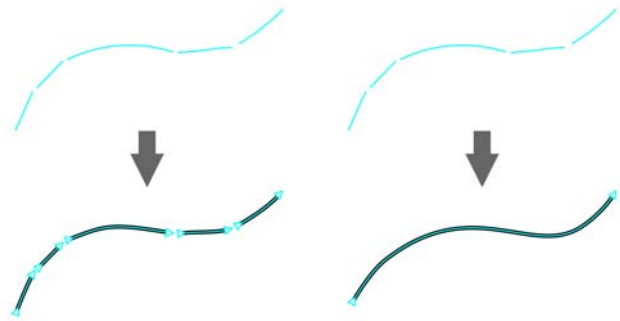

With the timer set to 0 milliseconds (left), successive strokes are converted into discrete curves. With the timer set to 1 second (right), successive strokes are joined into a single curve.

You also have the option of combining all strokes drawn within the specified time frame into a single curve, regardless of the distance between them.

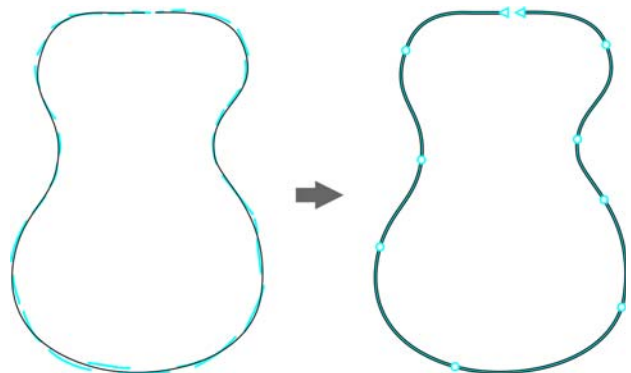

An example of an object created from strokes joined into a single curve.

If you want to extend an existing curve, simply hover over it until it turns red and continue to sketch. The subsequent stroke is seamlessly added to the existing curve, allowing you to sketch, adjust and edit on the fly. When you include an existing curve into a sketch, the resulting curve inherits the properties of the existing curve.

Regardless of your sketching experience, you'll be amazed how quickly you can produce impressive results.

**New! Touch-friendly UI:** Tablet Mode support makes it easy to sketch on the fly and make quick adjustments using touch or a stylus. The new Touch workspace streamlines the UI to maximize the size of the drawing window by displaying only the tools and commands that you're most likely to use in the field on a tablet. All other features are still accessible in a couple of taps. And if you prefer working with one of the desktop workspaces when you're in Tablet mode, you can choose whatever UI configuration works best for you. You can now also save time and work faster by panning and zooming in a single gesture.

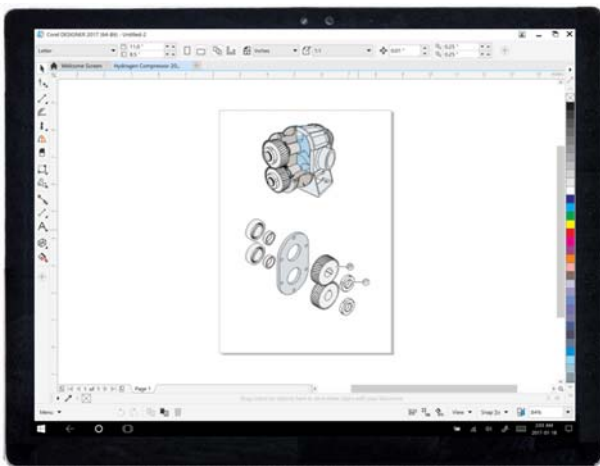

*The Touch workspace offers a touch-friendly environment with access to all the essentials.*

**Corel Font Manager:** When the number of fonts on your system become less of a benefit and more of a hassle, Corel Font Manager is the answer. It lets you easily handle, organize, and explore your typeface and font collections by giving you the tools to control every aspect of your typography workflow. Whether you want to find fonts for your projects, organize fonts for easy access, or manage unneeded fonts, Corel Font Manager has the tools you need. It lets you access online fonts from the Content Exchange, which can be installed or downloaded to use later. You can browse and search online and local fonts, preview font glyph sets, add custom font collections, and more.

When you add folders and create collections, all your fonts, including ones that aren't installed, become accessible from the Font list box in Corel DESIGNER, CorelDRAW, and Corel PHOTO-PAINT. This means that you can use fonts that are not installed in your

drawings and documents. In addition, any collections that you create appear as font filters in the Font list box of the main applications, so fonts can be filtered to show only the ones included in specific collections.

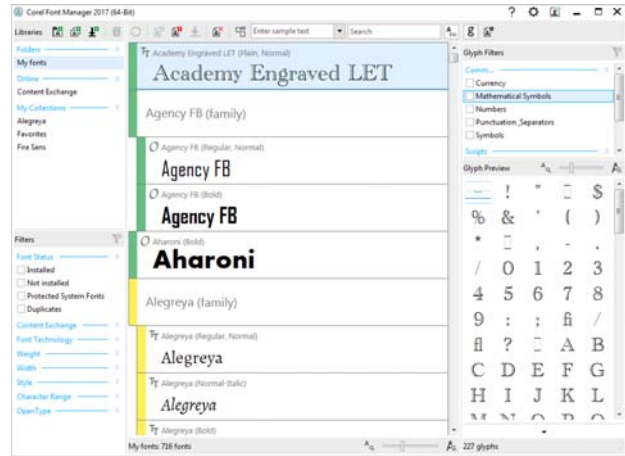

*The Corel Font Manager simplifies exploring, organizing, and managing your typeface and font collections.*

**New! Import legacy workspaces:** CorelDRAW Technical Suite 2017 lets you reuse Corel DESIGNER workspaces that were created in versions X6 and X7. You can also import CorelDRAW and Corel PHOTO-PAINT workspaces that were created in versions X6, X7, and X8. You have the flexibility of importing some workspace elements and excluding others. You also have the option of adding them to your current workspace or creating a totally new UI configuration. And choosing which workspace elements to import or export is faster than ever.

**New! Fully customizable UI:** CorelDRAW Technical Suite 2017 offers more UI customization options than ever before, allowing you to tailor your design space to create a unique work environment. Newly redesigned icons permit scaling up to 250%, and you can lighten or darken the application background by choosing a theme.

CorelDRAW Technical Suite 2017 offers flexible desktop color scheme options. You can change the color of the area surrounding the drawing page in Corel DESIGNER to set up the optimal environment for each project, reduce the overall workspace contrast, or increase the legibility of design elements.

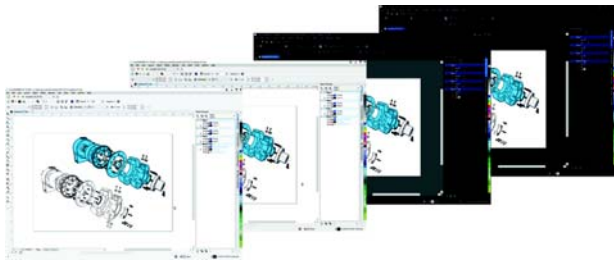

You can set the UI color to optimize your work environment.

You can customize the color of window borders in CoreIDRAW Technical Suite 2017 to match your personal preference. If you use more than one of the suite's applications simultaneously, you can set different border colors for each, which lets you quickly identify them when switching programs.

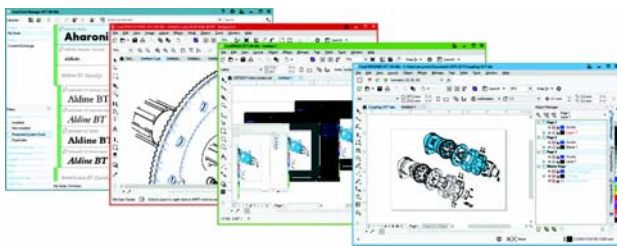

You can set border colors to switch between programs faster.

## Give it a try

### Customizing the UI

- 1 Click **Tools** ► **Options**.
- 2 In the **Workspace** list of categories, click **Appearance**.
- 3 In the **Size** area, move the slider to the right for larger UI items, and to the left for smaller UI items.

The scaling level is relative to the scaling level of the operating system. The default setting is 100%, which means that UI items in the application appear the same size as similar UI items in the operating system. Scaling by 200% makes the application UI items appear twice as large as the UI items of the operating system.

- 4 In the **Color** area, choose from the **Theme** list box.  
To make the workspace lighter or darker, you can choose one of the following themes: **Light**, **Medium**, **Dark**, or **Black**.
- 5 To change the border color of the application window and dialog boxes, open the **Window border** color picker, and choose a color.
- 6 To change the color of the area surrounding the drawing page, open the **Desktop** color picker, and choose a color.

**Instant customization:** The toolbox, dockers, and property bars contain handy Quick customize buttons which will help you tailor the interface to suit your workflow. These buttons offer a fast and convenient way to add dockers to your workspace, add or remove tools from the toolbox, and add or remove items from a property bar.

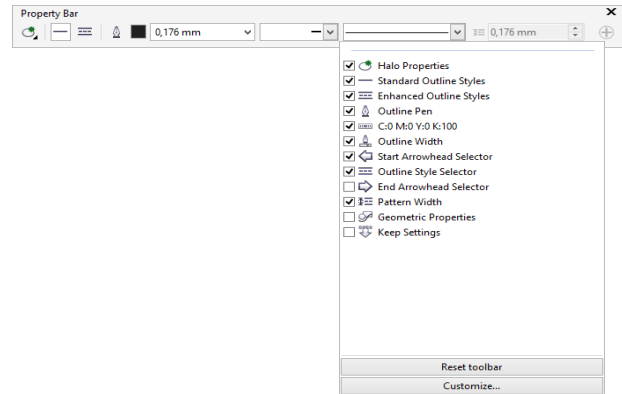

The Quick Customize buttons make workspace customization fast and easy.

**Open documents in floating windows:** So you can set up your workspace in the way that best suits your style, Corel DESIGNER offers options for how your documents open. You can have a number of documents visible simultaneously in floating windows. Or if you want to focus on one at a time, you can open files in a the default tabbed view.

**Get More dockers:** You can expand your collection of tools by downloading for free or purchasing applications, plug-ins, and extensions directly from within CoreIDRAW Technical Suite 2017. You can download your free license of PhotoZoom Pro, purchase AfterShot Pro for the ultimate RAW workflow, experience Corel ParticleShop for amazing bitmap effects, and more. In order to access this collection of tools, you need to be connected to the Internet"

**Accessing eBooks:** The Corel DESIGNER 2017 User Guide, CorelDRAW 2017 User Guide, and Corel PHOTO-PAINT 2017 User Guide are now available as eBooks. Published to the EPUB and MOBI file format, the eBooks brings most comprehensive and up-to-date information about product features to your eBook reader. Following the user guides on an eBook reader saves you switching between program windows on your system, allows you to keep learning on the go, and ensures access to the suite's Help files when you don't have Internet access.

**New! Community website for developers:** With support from the new Developer Community site, you can create your own automation tools. There's a variety of useful resources, including in-depth programming articles and code samples, which can help you automate tasks with macros and create custom features. And when you have questions, you can turn to a community forum, knowledge base, or the FAQ page. For more information, visit [www.community.coreldraw.com/sdk](http://www.community.coreldraw.com/sdk).

**Object Styles:** This productivity-enhancing feature ensures a consistent visual style in technical publications, making it easy to comply with military and civil aerospace standards, such as S1000D and ATA iSpec 2200. Object styles lets you edit a style or a style set once and have the changes applied instantly throughout a project. What's more, a pop-up appears when you hover over a style in the Object Styles docker, offering a quick preview of the style before it's applied.

**Color Styles docker:** The Color Styles docker lets you use styles and color harmonies to manage colors and quickly implement project-wide color changes, which is especially useful for producing iterative designs and varying graphic outputs. The Color Styles docker also offers convenient View Options, including Hint View, which provides a visual indication of all document objects that use a specific color style, and Page Sorter, which displays thumbnails of all pages in a multi-page document and previews changes as you adjust colors. You can also click **View ▶ Page Sorter** to access thumbnails of all pages in a document, with live

previews of changes you make to the document's color styles.

**QR Codes:** With Corel DESIGNER 2017, you can add scalable QR codes to a drawing, allowing you to give technicians in the field the ability to access online technical documentation from printed documentation or machine labels using a smartphone. It's easy to customize a QR code and analyze it to ensure it can be read by QR code readers, mobile devices, and scanners.

**Multiple document interface:** You can work with multiple documents in a tabbed view, which helps you stay organized and quickly switch between several active documents.

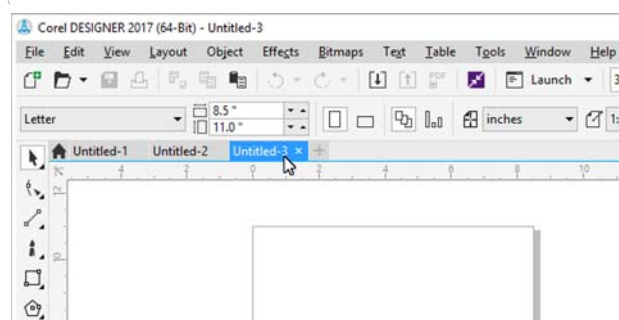

*You can easily work on multiple documents simultaneously.*

**Content Exchange:** The Content Exchange is an online repository that integrates with Corel CONNECT and the suite's applications, making it quick and effortless to access and share vector fills, bitmap fills, and fountain fills with a community of other users. You can instantly set any asset that catches your eye in the Content Exchange as a favorite, which is a quick and convenient way to keep a list of content that you might want to download later.

**Transparency:** You can apply transparency to individual color nodes within a fountain fill, allowing you to adjust an object's transparency so that all objects beneath it are partially visible.

Transparency settings are accessible in the Property Manager docker in Corel DESIGNER 2017 (and the Object Properties docker in CorelDRAW 2017), making it fast and easy to apply and adjust object transparency.

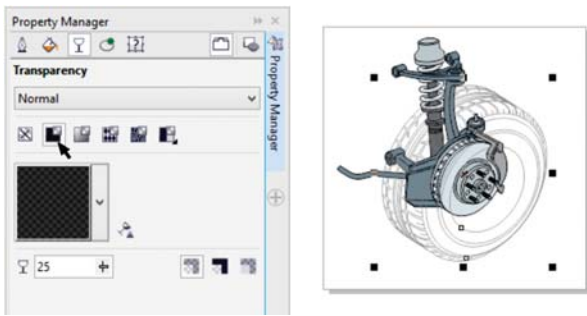

*It is fast and easy to apply and adjust object transparency.*

**Enhanced! Corel PHOTO-PAINT 2017:** This professional image-editing application offers technical illustrators and technical graphics users a broad range of professional and advanced photo-editing tools, which are ideal for producing high-quality photo-based technical documentation. Corel PHOTO-PAINT 2017 includes a variety of new tools and creative options for retouching photos, correcting distortions, blurring images, and enhancing your workflow.

The Healing Clone tool discreetly removes unwanted spots and imperfections from an image by painting with sampled texture and matching it to the color of the area that you're retouching. In a few clicks, you can seamlessly repair and blend a blemish or scar into the rest of the photo.

With the enhanced Straighten Image dialog box, you can correct perspective distortions in photos that have straight lines and flat surfaces. Now in a few clicks, you can easily fix photos of buildings, landmarks, or objects that appear in the wrong perspective or that were taken from an angle other than directly in front.

The Gaussian Blur special effect is now available as a lens, so you can blur images without overwriting the original image. When you create a lens, the changes you make are non-destructive, so any edits are displayed on the screen through the lens rather than applied to the image pixels. The lens is created as a separate object on a layer above the image background so you can edit the lens and the background image separately, maintaining the original's data and quality.

And so you can set up your workspace in the way that best suits your style, Corel PHOTO-PAINT offers options for how your photos open. You can now have

a number of documents visible simultaneously in floating windows. Or if you want to focus on one image at a time, you can open files in a the default tabbed view.





# 5

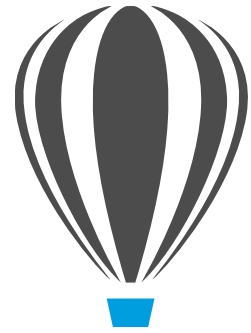

## Advanced 3D CAD repurposing: Lattice3D Studio CAD Corel® Edition (optional add-on)

For organizations that require additional 3D editing capabilities and direct access to 3D CAD assembly files, CorelDRAW Technical Suite 2017 offers an upgrade to Lattice3D Studio CAD Corel Edition. This add-on provides native assembly and part file support for 3D CAD systems used in discrete manufacturing, such as the automotive, aerospace, and machinery industries. Lattice3D Studio CAD Corel Edition lets users do more with CAD files without the steep learning curve of 3D CAD software.

Lattice3D Studio CAD streamlines the workflow of technical communication professionals by reducing the need to consult design engineers when preparing graphics content. It supports a broad range of native 3D CAD file formats, such as assembly and part files from CATIA, SolidWorks, PTC Creo Parametric (formerly Pro/ENGINEER), Autodesk Inventor, NX, SolidEdge, and more. It also supports 3D CAD exchange formats, such as JT, IGES, STEP, and Parasolid.

**Enhanced! 3D CAD file options:** You can send multiple 3D views to Corel DESIGNER as vector illustrations in one go. What's more, you can resend newer versions of views stored as snapshots to update existing illustrations in a DES file. In addition, illustrations sent to Corel DESIGNER no longer include a background rectangle, so objects behind the imported illustration aren't hidden by a rectangular frame. 3D CAD file format support has been updated, including improved STEP file importing. You can take advantage of enhanced annotation features, display

options, and more. You also have the flexibility of adding specific options from the standalone version of Lattice3D Studio, such as the Process PDF Template option, to a Lattice3D Studio CAD Corel Edition license.

**Enhanced! Lattice3D Studio Corel Edition:** A series of enhancements are designed to help you work faster and with more precision. You can now customize the color of markers for increased visibility. Search results are highlighted in the Assembly tree and Manufacture tree panels and sorted by part number, simplifying finding drawing components. A new option lets you specify the range of neighboring parts to be displayed, helping accelerate the design-review process. And when making rectangular selections, you can now choose to include all touched components or only ones that are wholly enclosed.

**Enhanced! Lattice3D Studio CAD Corel Edition:** This optional add-on delivers a variety of productivity enhancements. When sending a snapshot to Corel DESIGNER, you can specify which parts will be outlined, significantly reducing file size. You can also align notes to a specified link. The new Selection Process view displays only parts that you specify, so you can easily compare the selected parts to the entire model view. To simplify managing assemblies, you can highlight ones that aren't registered in the Manufacture and Process trees, reducing the chance of having missing parts. And when you're publishing to Microsoft Excel, you can customize the size of images in the report.

### Update / replace assembly functionality:

Once a design moves to the production phase, construction changes are common. With Lattice3D Studio CAD, you can update early designs at any time due to changes determined by construction.

Disassembly views, animations, and other 3D authoring functions are maintained, so that you can efficiently update technical illustrations with the most current revision of the manufacturing design.

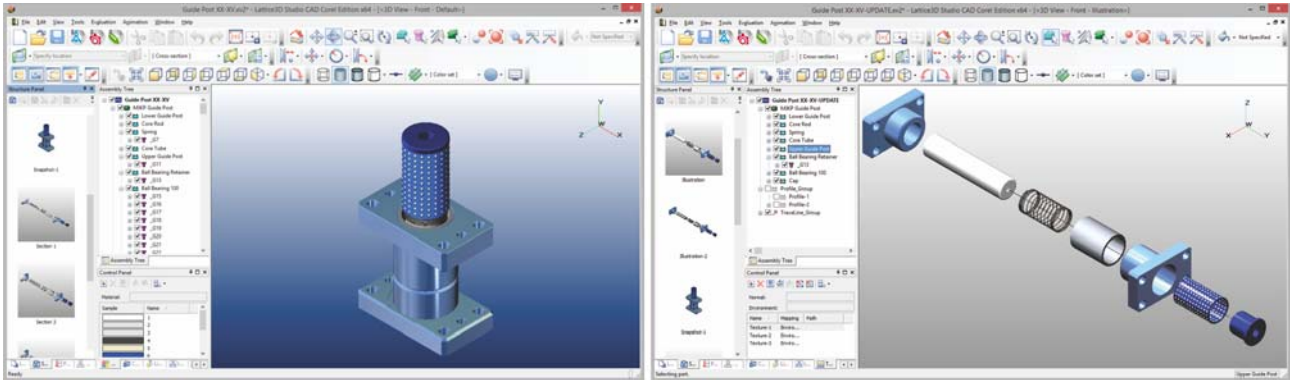

*The update or replace assembly functionality offered by Lattice3D Studio CAD Corel Edition helps you ensure that the most current manufacturing revisions are reflected at any time in the visualization workflow.*

**Update a 3D-sourced illustration:** To speed up technical-publication authoring, CorelDRAW Technical Suite 2017 with Lattice3D Studio CAD Corel Edition offers the **Auto Detection and Update** command. It updates 3D visualizations created in Lattice3D Studio CAD, stored snapshots, cross-sections and animated procedures — including process animations for illustrating complex, multi-step assembly, disassembly, or maintenance procedures — based on the modifications applied to the CAD source data. It also lets you automatically generate updated vector illustrations to replace ones in DES files that were created using the **Send to Corel DESIGNER** command. The illustration specifications, such as view, positions of the objects, line weights and export settings, are fully recognized and maintained. As a result, the illustrations are recreated using the updated 3D model and inserted in the same place as the original, allowing technical illustrators to start a publication with a preliminary 3D design and update it with the final design instantly.

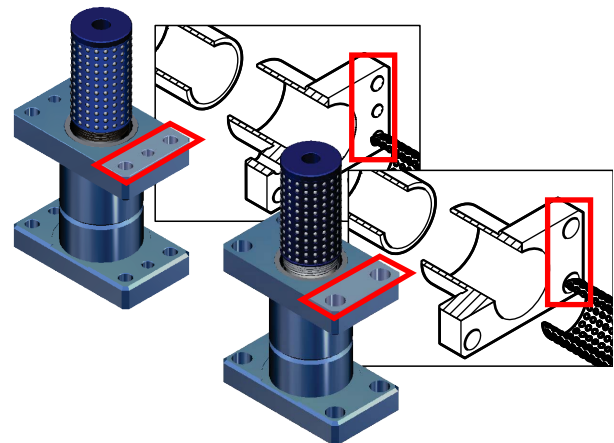

*You can automatically update 3D-sourced illustrations.*

## Give it a try

### Updating a 3D-sourced illustration

To try this feature, *Lattice3D Studio CAD Core Edition is required. The trial version of CorelDRAW Technical Suite 2017 includes Lattice3D Studio CAD Core Edition (30-day trial).*

- 1 In Lattice3D Studio CAD, open the sample file **3D-assembly-v1.xv2**.

This file can be found in the sample files, available for download: [www.coreldraw.com/cdts2017samples](http://www.coreldraw.com/cdts2017samples).

- 2 Click **File** ► **Send to Corel DESIGNER**.

- 3 In the **Send to Corel DESIGNER** dialog box, make sure the **Add snapshot** check box is enabled, and click **Send**.

In Corel DESIGNER 2017, the 3D illustration is inserted in the active page. If the application is not running, it will launch automatically.

- 4 Click **File** ► **Save**.

- 5 In Lattice3D Studio CAD, save **3D-assembly-v1.xv2**.

- 6 Open the sample file **3D-assembly-v2.xv2**.

This file contains a modified version of the 3D model.

- 7 Click **File** ► **Auto Detection and Update**.

- 8 In the **Auto Detection and Update** dialog box, choose the file **3D-assembly-v1.xv2** in the **Edited XVL** box.

- 9 Click **OK** to all warning messages that appear.

- 10 In Lattice3D Studio CAD, click the **Apply and Execute** button.

- 11 In the **Auto Detection and Update** dialog box, enable the **Update Illustration in Corel DESIGNER** check box, and click **OK**.

The 3D illustration is updated in the DES file.

**Evaluation tools:** Before 3D models and data can be used in downstream applications, the integrity of the 3D model requires validation. Lattice3D Studio CAD provides assembly evaluation tools for geometry and measurements, interference check, and collision detection so you can quickly verify the integrity of a 3D assembly.

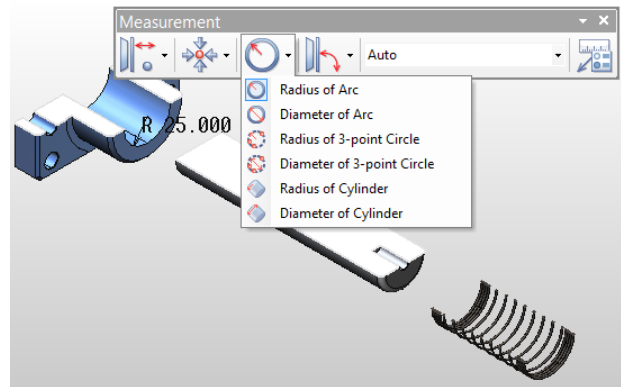

**Additional 3D CAD tools:** With Lattice3D Studio CAD, you can edit 3D models and combine 3D models from different CAD sources. It provides a rich 3D CAD toolset that lets you modify and transform 3D parts, shapes, and assemblies.

**Animation tool set:** Lattice3D Studio CAD provides a full set of animation tools, including a dedicated editing console as well as a method for automated creation of disassembly animations. Process animations can be created to capture complex, multi-step assembly or maintenance procedures with detailed instructions. The hierarchical structure of the Assembly Tree view and the ability to create custom tree structures for disassembly and process animations gives you full control over the creation of assembly, sub-assembly, and part structures for use in illustrated assembly and maintenance instructions.

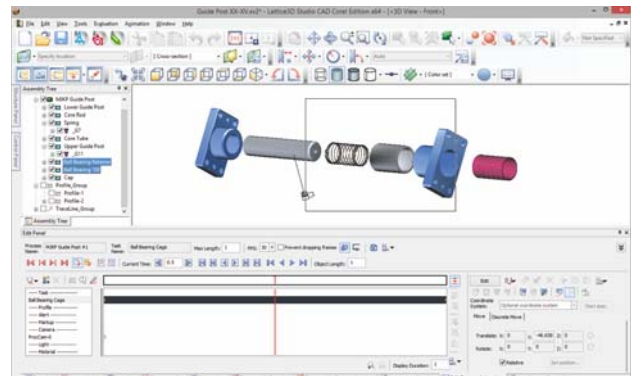

**Online and mobile outputs:** Lattice3D Studio CAD supports output of 3D models to HTML5 and for mobile devices. By using the highly compressed XVL<sup>®</sup> file format, you can share complex models with virtually anyone, using the free Lattice3D Player as browser plug-in for desktop/laptop or iXVL apps for iOS. XVL is the most lightweight 3D format in the industry, enabling data to be compressed to an average 0.5% of its original size with high accuracy. For example, a 500 MB 3D CAD assembly file can be shared on mobile devices as an XVL file with an approximate file size of 2.5 MB.

**3D outputs:** With Lattice3D Studio CAD Corel Edition, you can output to various 3D file formats, including 3DS, DXF, IGES, OBJ, STL, U3D, and VRML. You can also publish directly to 3D PDF from Lattice3D Studio CAD Corel Edition, using a PDF template with animation controls.

# About Corel

Corel is one of the world's top software companies providing some of the industry's best-known graphics, productivity and digital media products. Boasting the most comprehensive portfolio of innovative software, we've built a reputation for delivering solutions that are easy to learn and use, helping people achieve new levels of creativity and productivity. The industry has responded with hundreds of awards for innovation, design, and value.

Used by millions of people around the world, our product lines include CorelDRAW® Graphics Suite, CorelDRAW® Technical Suite, CorelCAD™, Corel® Painter®, Corel® PaintShop® Pro, Corel® VideoStudio®, and Corel® WordPerfect® Office. For more information on Corel, please visit [www.corel.com](http://www.corel.com).

Copyright © 2017 Corel Corporation. All rights reserved.

CorelDRAW® Technical Suite 2017 Reviewer's Guide

Protected by U.S. Patents 5652880; 5347620; 5767860; 6195100; 6385336; 6552725; 6657739; 6731309; 6825859; 6633305; Patents Pending.

Product specifications, pricing, packaging, technical support and information ("specifications") refer to the retail English version only. The specifications for all other versions (including other language versions) may vary.

INFORMATION IS PROVIDED BY COREL ON AN "AS IS" BASIS, WITHOUT ANY OTHER WARRANTIES OR CONDITIONS, EXPRESS OR IMPLIED, INCLUDING, BUT NOT LIMITED TO, WARRANTIES OF MERCHANTABILITY, SATISFACTORY QUALITY, MERCHANTABILITY OR FITNESS FOR A PARTICULAR PURPOSE, OR THOSE ARISING BY LAW, STATUTE, USAGE OF TRADE, COURSE OF DEALING OR OTHERWISE. THE ENTIRE RISK AS TO THE RESULTS OF THE INFORMATION PROVIDED OR ITS USE IS ASSUMED BY YOU. COREL SHALL HAVE NO LIABILITY TO YOU OR ANY OTHER PERSON OR ENTITY FOR ANY INDIRECT, INCIDENTAL, SPECIAL, OR CONSEQUENTIAL DAMAGES WHATSOEVER, INCLUDING, BUT NOT LIMITED TO, LOSS OF REVENUE OR PROFIT, LOST OR DAMAGED DATA OR OTHER COMMERCIAL OR ECONOMIC LOSS, EVEN IF COREL HAS BEEN ADVISED OF THE POSSIBILITY OF SUCH DAMAGES, OR THEY ARE FORESEEABLE. COREL IS ALSO NOT LIABLE FOR ANY CLAIMS MADE BY ANY THIRD PARTY. COREL'S MAXIMUM AGGREGATE LIABILITY TO YOU SHALL NOT EXCEED THE COSTS PAID BY YOU TO PURCHASE THE MATERIALS. SOME STATES/COUNTRIES DO NOT ALLOW EXCLUSIONS OR LIMITATIONS OF LIABILITY FOR CONSEQUENTIAL OR INCIDENTAL DAMAGES, SO THE ABOVE LIMITATIONS MAY NOT APPLY TO YOU.

Corel, the Corel logo, the Corel balloon logo, CorelDRAW, the CorelDRAW balloon logo, Corel DESIGNER, CAPTURE, CONNECT, LiveSketch, PHOTO-PAINT, PowerTRACE, CorelCAD, PaintShop Pro, Painter, VideoStudio, and WordPerfect are trademarks or registered trademarks of Corel Corporation and/or its subsidiaries in Canada, the U.S., and/or other countries.

Other product, font, and company names and logos may be trademarks or registered trademarks of their respective companies.



**Media Contact:**  
**[media@corel.com](mailto:media@corel.com)**