

ECHO

CHAIN SAW

OPERATOR'S MANUAL

CS-500VL



898 561-1233 0

CAUTION

Read Rules for Safe Operation
and Instructions Carefully

(NOTE)

FRONT HANDLE and HAND GUARD INSTALLATION ECHO CHAIN SAW MODEL CS-500VL

Insert the front handle before installing the guide bar and chain as follows.

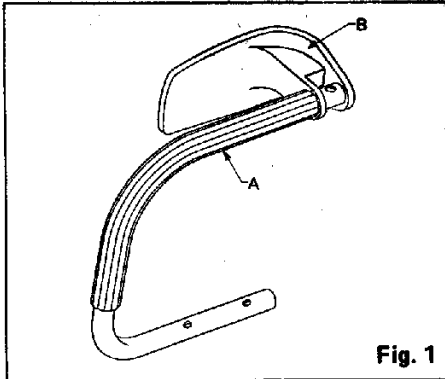

Fig. 1

1. Install HAND GUARD (B) to FRONT HANDLE (A).

See Fig. 1.

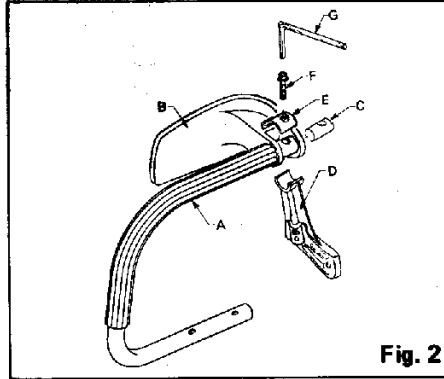

Fig. 2

2. Install INSERT (C) into FRONT HANDLE (A). Install FRONT HANDLE (A) and HAND GUARD STOPPER (E) to FRONT HANDLE SUPPORTER (D) with SCREW (F). Tighten SCREW (F) with fingers and confirm SCREW (F) is sitting internal thread of FRONT HANDLE SUPPORTER (D) first, and tighten SCREW (F) with WRENCH (G).

See Fig. 2.

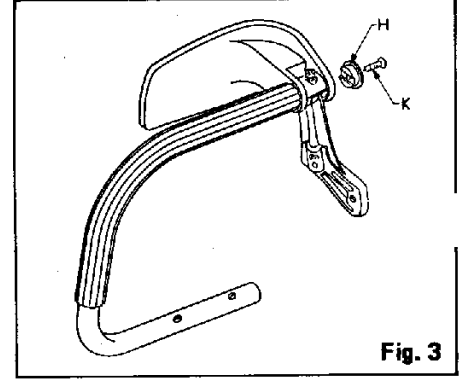

Fig. 3

3. Engage HAND GUARD HOLDER (H) with INSERT (C) and tighten SCREW (K). See Fig. 3.

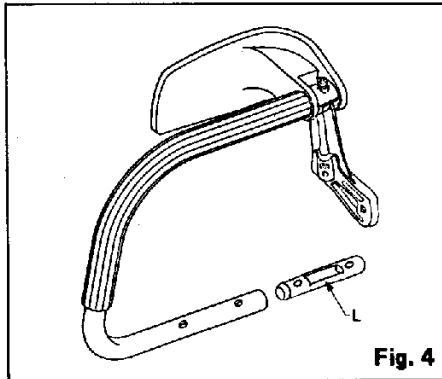

Fig. 4

4. Install the INSERT (L) in HANDLE (A) as illustrated.

See Fig. 4.

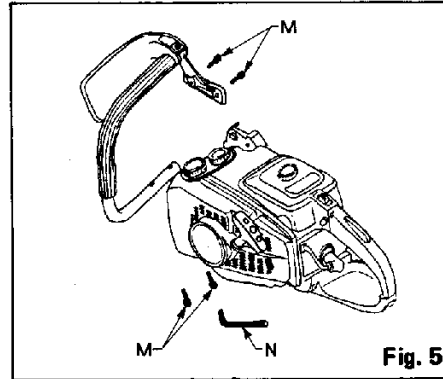

Fig. 5

5. Place pre-assembled front handle to the mounts. Tighten four SCREWS (M) with finger and confirm all four screw are sitting in the internal threads of casting. Tighten four SCREWS (M) evenly with WRENCH (N). See Fig. 5.

IMPORTANT

RULES FOR SAFE OPERATION

A: GENERAL WARNING TO USE CHAIN SAWS

- A-1. Obey Rules and/or Regulations in the area.
- A-2. Do not let a person, young or grown up, operate the saw unless he is well trained to operate the saw.
- A-3. Do not attempt a pruning or limbing operation in a standing tree unless specifically trained to do so.
- A-4. Never operate the chain saw when you are fatigued.
 - Fatigue causes carelessness.
 - Keep sufficient rest periods and breaks when operating.
 - Be more cautious before rest periods and before the end of your shift.
- A-5. Do not smoke while running, fueling engine and operating.
- A-6. When working in dry areas, bring a fire extinguisher.
- A-7. For Echo chain saws, fire preventing mufflers (spark arresting screen) are available as option for preventing the unforeseen risk of fire when working surrounded by the inflammable objects like chips, dry grass etc., and during the summer or dry seasons.

B: NOTE FOLLOWINGS BEFORE OPERATION

- B-1. Read this Operator's Manual well to acquaint yourself with how to handle the saw safely and effectively before use.
 - Before starting operation, study the working procedures well.
 - If there is anything doubtful, contact and inquire with an Echo distributor or dealer.
- B-2. Handle gasoline with care. It is highly inflammable.
 - Always store gasoline in approved container.
 - Handle at a clean and cleared place and away from fire.
 - Do not smoke while handling fuel.
 - Always stop the engine to refuel the tank.
 - Do not refuel a hot engine. Wait until the engine has cooled down.
 - Avoid spilling fuel or oil. Spilled fuel should always be wiped up.
 - Move at least 3 meters (10 feet) away from the fueling point before starting engine.
 - Do not move the fuel tank cap when engine is still warm or running.
- B-3. Do not operate in unventilated area. Exhaust gas is highly poisonous.
- B-4. Always wear safety footwear, snug-fitting clothing, and eye, hearing and head protection devices. Wear gloves when handling the saw chains.
- B-5. Clean the saw before and after use without fail. Clean up the area around the cap and port before refilling fuel or oil.
- B-6. When transporting your chain saw,
 - Always stop the engine.
 - Use the appropriate guide bar scabbard.
 - The guide bar and saw chain to the rear and the muffler away from your body.
- B-7. When starting the engine or cutting, make sure
 - Bar and chain in the clear.
 - Keep other persons, bystanders or animals out of the work area.
 - When 2 or more operators should work together, do keep a proper distance between each other.
- B-8. Never operate a chain saw that is damaged, improperly adjusted, or is not completely and securely assembled, e.g.
 - Damaged muffler system kept un-repaired
 - Oiler system is not functioning properly
 - Carburetor improperly adjusted
- B-9. Be sure that the saw chain stops moving when the throttle trigger is released.
- B-10. Never start cutting until you have a clear work area, secure footing and a planned retreat path from the falling tree.

C: CAUTION DURING OPERATION

- C-1. Be sure of your footing when operating.
 - Open the feet slightly to evenly distribute weight on both feet.
 - When bucking on incline, stand on the uphill side.
- C-2. When checking or adjusting the chain saw always stop the engine, and wait until it is cooled down.
- C-3. When stopping the chain saw, switch off the engine after releasing the throttle trigger.
- C-4. When the engine is running.
 - Keep the handle dry, clean and free of oil or fuel mixture.
 - Keep all parts of your body and clothing away from the chain saw.
 - Hold the unit firmly with both hands with the thumb and fingers encircling the handles on your right hand side and never stand on saw chain running place.
- C-5. Before starting cutting work, put the spike bumper rectangularly to the wood, otherwise, at an instant the saw starts, it may be suddenly pulled toward wood recklessly, causing unexpected accident.
- C-6. Guard against Kickback.

Kickback is the upward motion of the guide bar which occurs when the saw chain, at the nose of the guide bar, contacts an object. Kickback can lead to dangerous loss of control of the saw.

TO AVOID KICKBACK:

 - Hold the chain saw firmly with both hands. Don't over reach.
 - Don't let the nose of the guide bar contact a log, branch, ground or any other obstruction.
 - Cut at high engine speed.
 - Don't cut above shoulder height.
 - Don't try to cut at the nose of the guide bar.
 - Avoid cutting the knob of a hard wood, or cement, metals or the like buried in wood.
 - Follow manufacturer's sharpening and maintenance instructions for the saw chain.
- C-7. Use extreme caution when cutting small size brush and saplings, because slender material may catch the saw chain and be whipped toward you or pull you off balance.
- C-8. When cutting a limb that is under tension, be alert for spring back so that you will not be struck when the tension in wood fibers is released.
- C-9. When the tree starts to fall, stop engine, and retreat quickly to the predetermined retreat path (take refuge to the direction 45° from the extended line opposite to the falling direction).
- C-10. When boring with the chain saw, the initial cut should be introduced with the lower part of the nose (tip) until the hole is sufficiently large so as to introduce the entire nose (tip) of the guide bar.

This manoeuvre should reduce the danger of kickback.
- C-11. Before setting down the chain saw, switch off the engine after releasing throttle trigger.

D: MAINTENANCE

All chain saw service, other than the items listed in the Operator's Manual maintenance instructions, should be performed by competent chain saw service personnel.

CONTENTS

	Page
Rules for Safe Operation	1
Technical Data	3
Nomenclature of Parts	4
Preparation for Use	4
Operation	5
Method of Cutting	8
Maintenance and Care	9
Setting the Chain	11
Correct Use of Chain Brake	13
Trouble Shooting	14
Storage After Use	16
Parts Catalogue	18

TECHNICAL DATA

Dimension:	L x W x H (mm)	400 x 245 x 264 (15.8" x 9.7" x 10.4")		
Weight:	Power Head, dry (kg)	5.8 (w/o chain and guide bar): (12.8 lbs)		
Engine:	Type	Air cooled 2-cycle single cylinder		
	Displacement (cc)	49.9 (3.0 cu.in.)		
	Carburetor	Walbro diaphragm type HDB		
	Magneto	Flywheel magneto, contact breaker point system		
	Spark plug	NGK BPM6A		
	Starter	Recoil starter		
	Power transmission	Automatic centrifugal clutch		
Fuel:	Mixture ratio	Regular grade gasoline 20 parts: 1 part ECHO brand motor oil (or an air cooled 2-cycle engine oil of a reputable brand name.)		
	Tank capacity (l)	0.50 (16.9 FL.OZ.US)		
Oil:	Chain oil	Motor oil		
	Tank capacity (l)	0.25 (8.5 FL.OZ.US)		
Guide bar and chain:	Lubrication	Automatic		
	Chain pitch	3/8"		
	Gauge	.050"		
	Number of drive link	60	64	72
	Guide bar type	40S50	43S50	50S50
	Guide bar gauge	.050"		
Safety device:		Front hand guard Rear hand guard Safety throttle lock Chain catcher Anti-vibration device Spike bumper (Option) Chain brake (Option) Spark arrester muffler (Option)		

Technical data may be changed without advance notice.

NOMENCLATURE OF PARTS

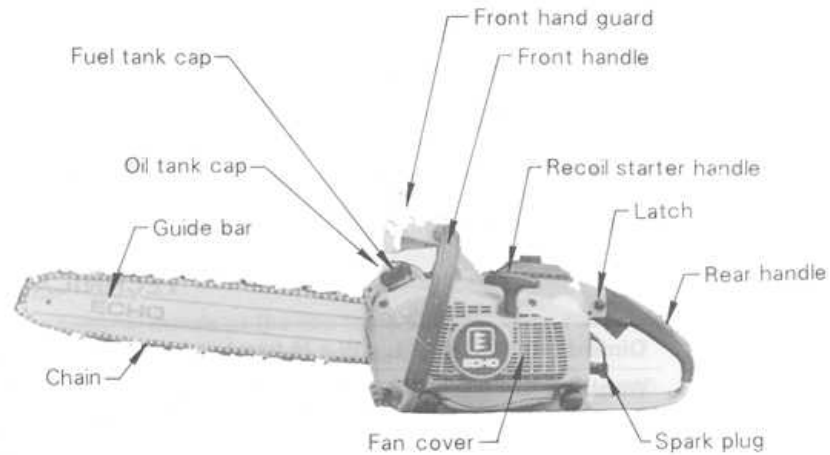
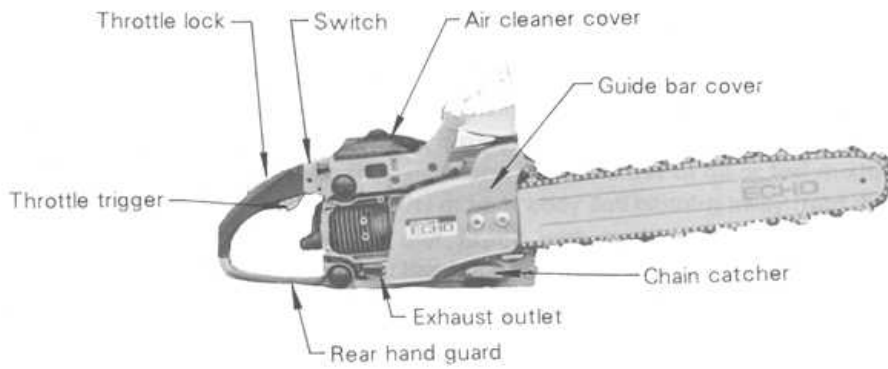

PREPARATION FOR USE

MOUNTING GUIDE BAR AND CHAIN

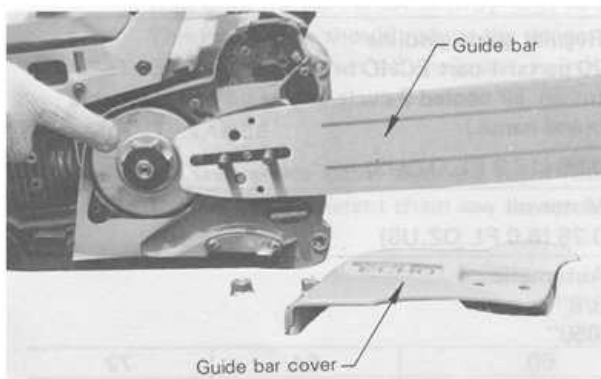

- Unscrew two nuts and remove guide bar cover.
- Mount bar and slide toward sprocket to make saw chain installation easier.

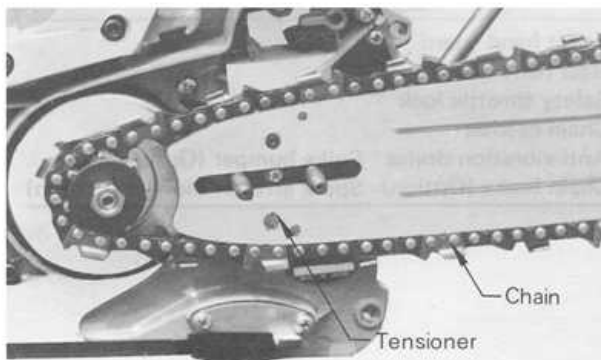

- Install saw chain as shown. (Ensure cutter links direction.)
- Fit tensioner to bar. Move tensioner as required. (Refer to next figure.)

[NOTE]

Spike bumper is optional supply at extra cost. (Part No. 880 210-1233 0) When in use of spike bumper, fix it to the machine before installing guide bar.

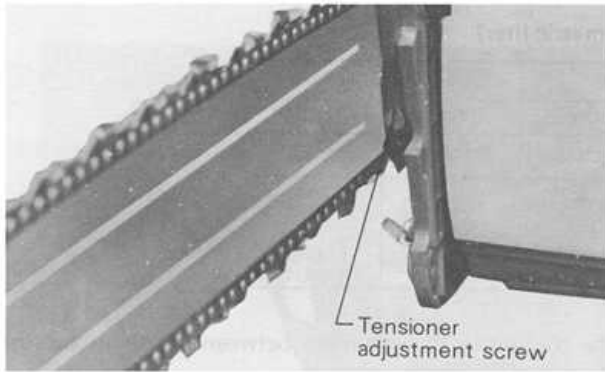

- Install guide bar cover.
- Fasten two nuts lightly. (Do not tighten up totally.)
- Lift guide bar and turn adjustment screw clockwise until chain comes in contact lightly with bottom of bar.

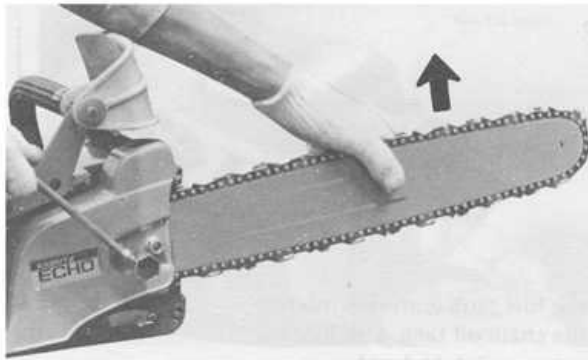

- Fasten two nuts firmly holding bar toward arrow as shown.
- Confirm chain can be pulled by hand.
- Retension chain if necessary.

OPERATION

CHECK UP of Nuts and Screws

Check up on loose nuts and screws on the handle, fan cover and so on before using the chain saw every day.

FUEL AND LUBRICANT

- Fuel is a mixture of regular grade gasoline and the ECHO brand motor oil (or an air cooled 2-cycle engine oil of a reputable brand name).

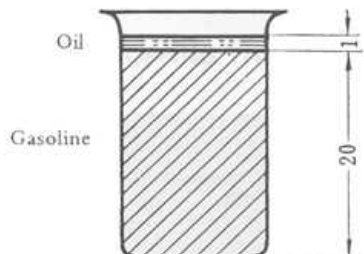

- Mixture ratio is
Gasoline 20 parts: Oil 1 part.

— Fuel mixture at a ratio other than 20:1 may cause malfunction of the engine. Watch out for mixture ratio.

- Pour 1/2 the gasoline into the safe container, add the oil and mix thoroughly. Now add the remainder of gasoline and mix again.
- Disregard instruction on oil container.
- Do not use motor oil at random choice.
- Do not mix directly in engine fuel tank.
- Avoid spilling fuel or oil. Spilled fuel should always be wiped up.

- Fuel Mix Chart

Fuel mix chart (Gallon vs metric-liter)

US		IMPERIAL		METRIC	
GAS	OIL	GAS	OIL	GAS	OIL
GAL.	FL.OZ.	GAL.	FL.OZ.	LITERS	C.C.
1	6.4	1	8	4	200
2	12.8	2	16	8	400
5	32.0	5	40	20	(1 Liter) 1,000

- Chain Lubricant

Proper lubrication of the chain while in operation reduces the friction to the minimum between the chain and the guide bar, and assure a longer service life. Use motor oil of proper quality for this purpose.

- Do not use waste or reclaimed oil to avoid various oiler problems.
- Use motor oil of the following grades:
 - SAE NO. 30 in summer
 - SAE NO. 10 in winter or when cutting resinous trees
- When refilling fuel mixture, fill up chain oil at the same time.

STARTING THE ENGINE

- WHEN THE ENGINE IS COLD

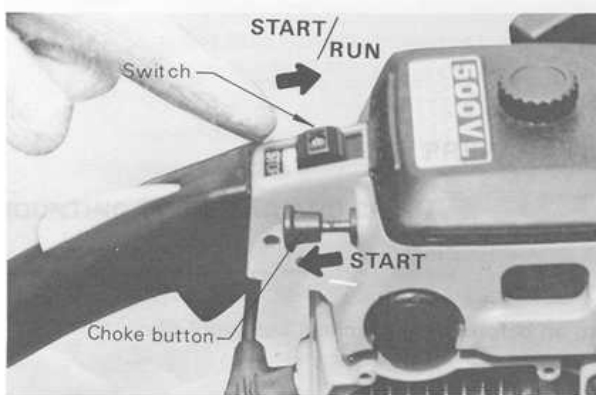

- Fill the fuel tank with fuel mixture.
- Fill the chain oil tank with lubricant.
- Slide stop switch to front.
- Pull choke fully.



- Securely hold the saw as shown and pull starter handle several times until first firing sound.
- Make sure bar and chain in the clear while starting the saw.

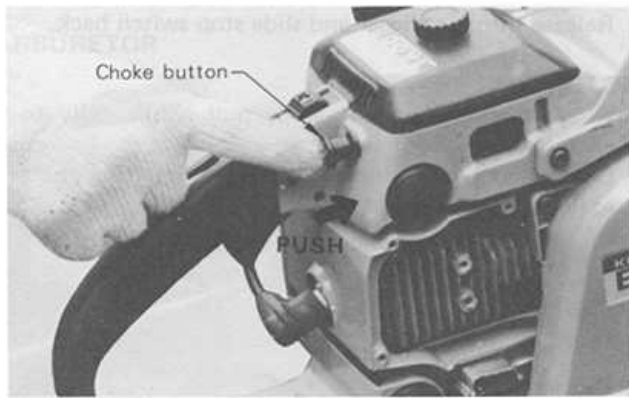

- Push choke in totally.
- Pull starter handle again.

WHEN THE ENGINE IS HARD TO START

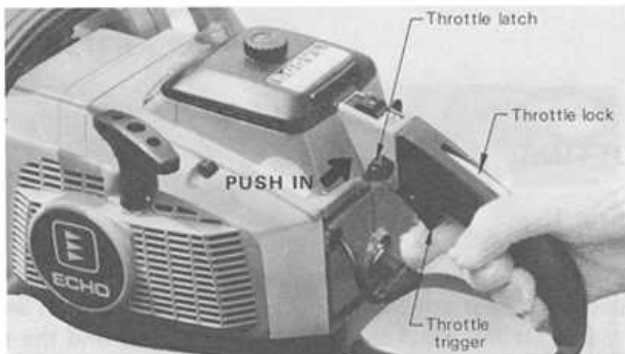

- Press lock down as grasping throttle trigger and push in latch as shown.
- Pull starter handle.
- When engine starts, immediately push throttle trigger up, to release the latch.

[CAUTION]

Be careful that chain runs when engine is started.
 Never use the latch for cutting.
 Use it only when starting the engine.

WHEN THE ENGINE IS WARM

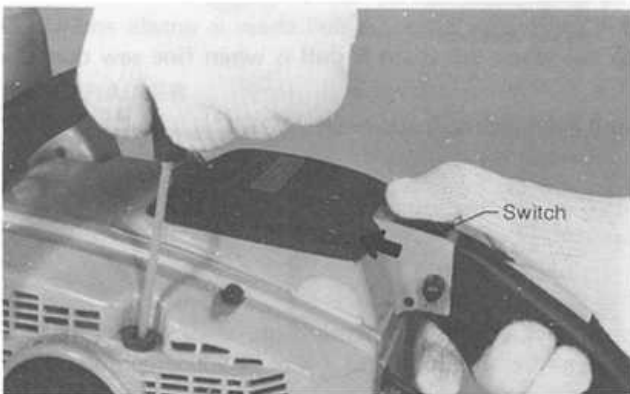

- Confirm fuel and chain oil in the tanks.
- Slide stop switch to front.
- Pull starter handle.
- Choke may be used if necessary but be sure to push it back on first firing sound.

RUNNING AND STOPPING THE ENGINE

RUNNING



- When engine starts, keep idling for a few minutes.
- Pull throttle trigger gradually and increase revolution of the engine.
- The chain starts running when the engine reaches to 3,000 rpm.
- Confirm proper acceleration and lubrication of chain and bar.
- Do not run the engine at high speed unnecessarily.

STOPPING



- Release throttle trigger and slide stop switch back.

[NOTE]

When engine does not stop, pull choke fully to stop engine.

Check and repair stop switch before starting the engine again.

METHOD OF CUTTING

- Read carefully the "RULES FOR SAFE OPERATION" on page 1.
- Familiarize yourself with your chain saw before you start actual cutting.
- For this purpose, it may be wise to practice by cutting some small logs or limbs several times.
- After you have learned the basic techniques of using the saw, your best aid will be your own good common sense.
- Racing the engine with the chain jammed will burn your clutch. If the chain should become jammed and the saw can not be removed from the cut, do not force it out. Stop the saw and force a wedge into the cut to open it up. Never force the saw out of a jam.
- Do not force the saw into the cut. It will cut through a log surprisingly fast by applying light pressure. If you find you have to bear down on the saw to cut, your chain is dull, get it sharpened. A dull chain is unsafe and will cause excessive wear to the cutting attachments. A good way to tell when the chain is dull is when fine saw dust comes out instead of chips.
- Use safety footwear, snug-fitting clothing, and eye, hearing and head protection devices.

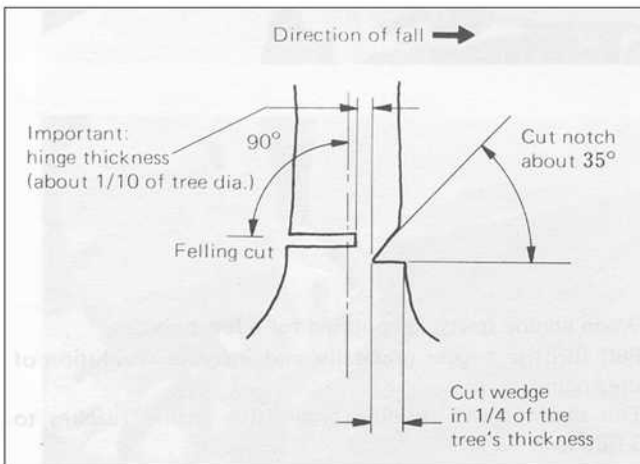

- Decide on the direction in which you wish to fell the tree.
 - Check the wind.
 - Check the lean.
 - Check the weight distribution.
- When the direction has been decided, completely clear the area around the tree and establish a good foothold.
- Also decide on a path of retreat for your own safety.
- Cut a notch in the tree on the side to which the tree is to be brought down.
- Then start making a felling cut from the opposite side of the notch and at the level slightly higher than the notch.

LUMBERING

- Before lumbering, stabilize the felled tree. A tree on a slope may roll down as you limb it.
- Keep the tree off the ground by a support so that the chain or bar will not be pinched.

MAINTENANCE AND CARE

CARBURETOR

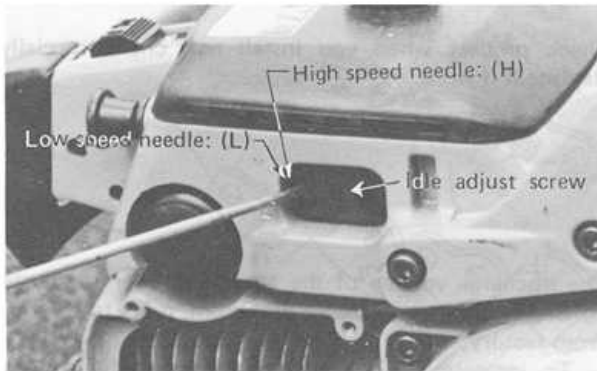

- Do not adjust the carburetor unless necessary.
- To adjust the carburetor, proceed as follows:
 - Low speed needle: (L) 1-1/8 ~ 1-3/8
 - High speed needle: (H) 1/8 ~ 3/8
 - Screw in the needles until lightly seated and return indicated turn above

[CAUTION]

Always open high speed needle MORE THAN 1/8 turn.

AIR FILTER

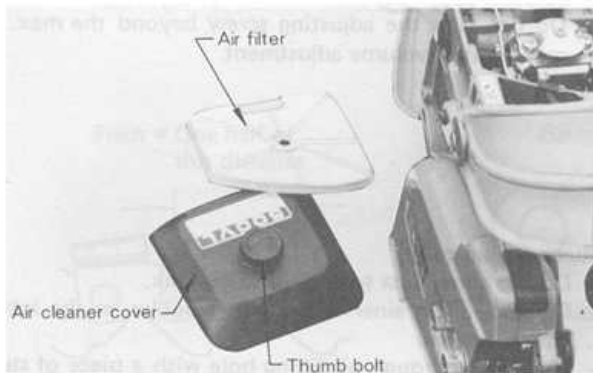

- Check before every use.
- Loosen thumb bolt, and remove air cleaner cover and filter.
- Brush off dusts lightly, or wash it in gasoline if necessary. Dry it completely before installation.

FUEL STRAINER

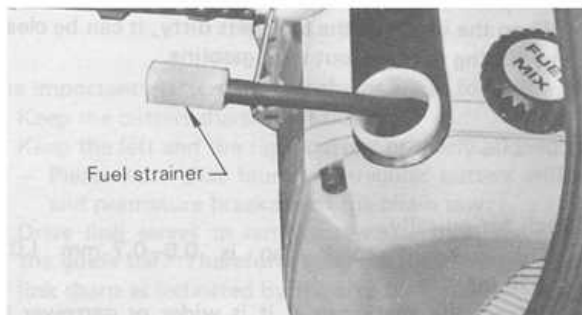

- Check periodically.
 - Do not allow dust to enter into fuel tank.
 - Clogged strainer will cause difficulty in starting engine or abnormalities in engine performances.
 - Pick up the fuel strainer through fuel inlet port with a piece of steel wire or the like.
 - When the strainer is dirty, wash it in gasoline. Dry it completely to remove moisture.
 - When the inside of the fuel tank is dirty, it can be cleaned by rinsing the tank out with gasoline.

GUIDE BAR

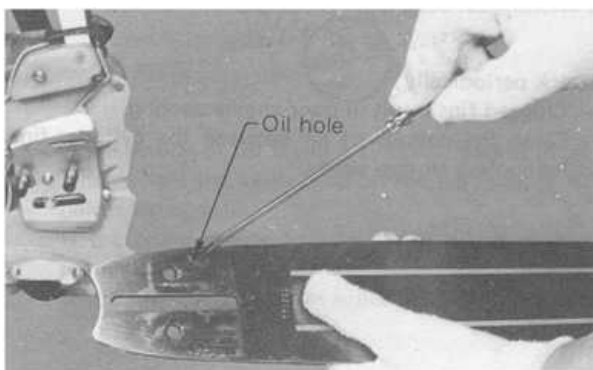

- Clean before cutting work.
 - Clean the groove of the guide bar with, for example, a small screw driver.
 - Clean oil holes with a wire.
- Reverse guide bar periodically.
- Clean sprocket, clutch and bar mount area before installation of bar.

SPROCKET

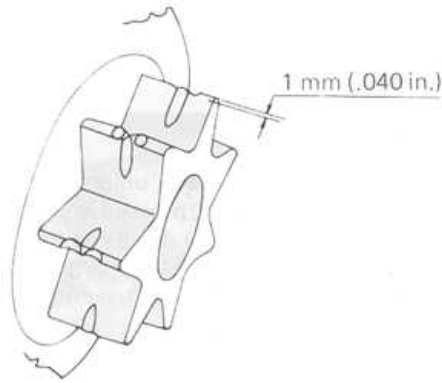

- The damaged sprocket causes premature damage or wear of saw chain.
 - When the sprocket has worn out 1.0 mm (.040 in.) or more, replace it.
- Check sprocket when you install new chain, specially. Replace it if worn.

AUTOMATIC OILER

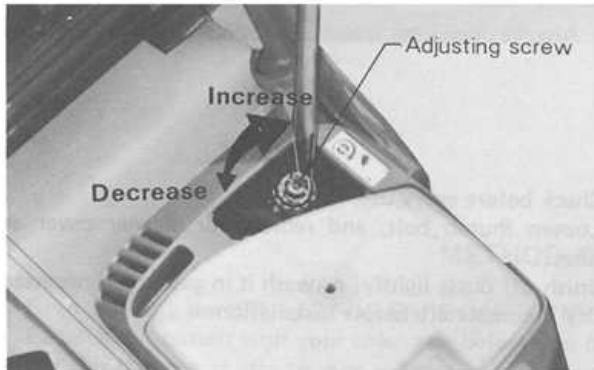

- The discharge volume of the automatic oiler is adjusted to 8–12 cc/min. approx. at 8000 rpm, prior to shipment from factory.
 - To increase the delivery volume, turn the adjusting screw clockwise. When the screw touches stopper and stops, this position indicates maximum discharge volume. (20 ~ 25 cc/min. 8000 rpm)
 - Do not turn the adjusting screw beyond the max. or min. limit of volume adjustment.

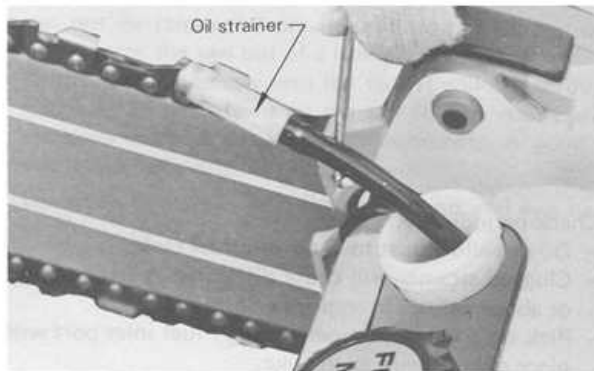

- Check periodically.
 - Do not allow dust to enter into oil tank.
 - Clogged oil strainer will cause troubles in the lubrication system.
 - Pick it up through oil filling hole with a piece of steel wire or the like.
 - If the strainer is dirty, wash it in gasoline. Dry it completely to remove moisture.
 - When the inside of the tank gets dirty, it can be cleaned by rinsing the tank out with gasoline.

SPARK PLUG

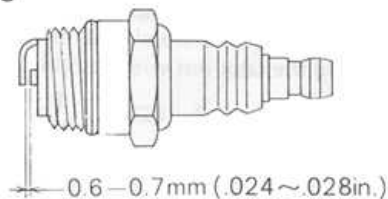

- Check periodically.
 - The standard spark gap is 0.6–0.7 mm (.024–.028 in)
 - Correct the spark gap if it is wider or narrower than the standard gap.
 - When it is fouled, clean it before fitting to the engine.
- Fastening torque = 145–155 kg·cm (125–135 in·lb).

CYLINDER FINS

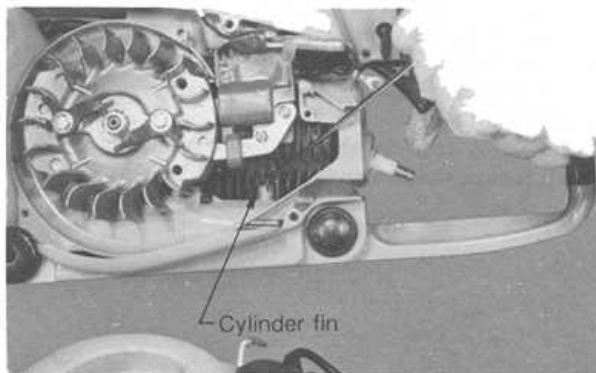

- Check periodically.
 - Clogged fins result in poor engine cooling.
 - Clean the passage of air between the cylinder fins to let cooling air pass easily.

SETTING THE CHAIN

NOMENCLATURE OF PARTS

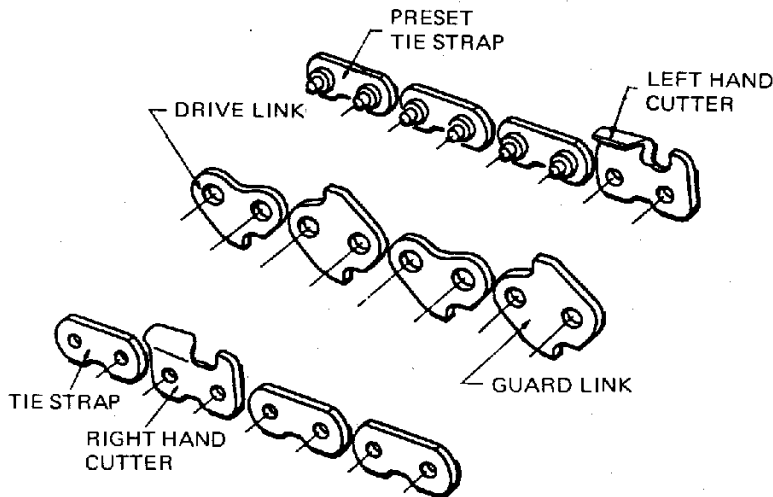

- Guard links reduce the potential of kickback.

CUTTER PART NAMES

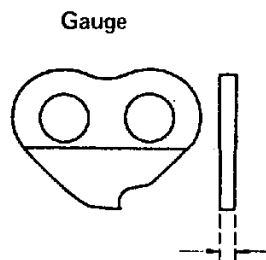
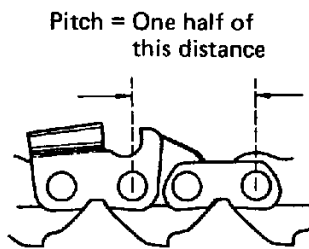
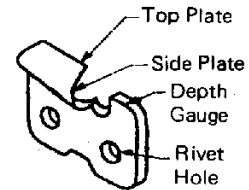

Depth gauge setting

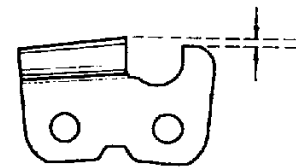

- Gauge is nominal width of guide bar groove and thickness of drive links.

- Depth gauge controls the cutting depth.

The important matters for saw chains are as follows.

- Keep the cutters sharp at all times.
- Keep the left and the right cutters properly aligned.
 - Please note that blunt or irregular cutters will result in poor cutting performance, increased vibration of chains and premature breakage of the chain saw.
- Drive link serves to remove sawdust from the groove of the guide bar. Therefore, keep the lower edge of the drive link sharp as indicated by the arrow.

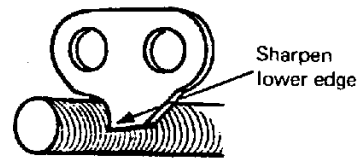
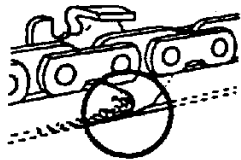

- When setting of the chain is finished, soak it in oil and wash away filings completely before using.
- When chain has been filed on the bar, supply sufficient oil on it, rotate the chain slowly to wash away the filings before using again.
- If the chain saw is operated with filings clogged in the groove, the saw chain and the guide bar will be damaged prematurely.
- If the saw chain becomes soiled with resin, for instance, clean it up with kerosene and soak it in oil.

For setting saw chains, round file (5.0 mmφ : 3/16") and flat file are used.

- To keep correct position and correct angle, use the file holder (Sure Sharp).
 - Round file (P-No. 897510-00330) and flat file (P-No. 897511-00230) are option.
 - Please inquire as to the details of file holder, if necessary.

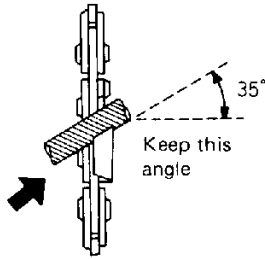

PUSH FILE AS SHOWN

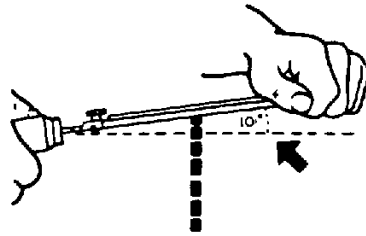

LOW FILE HANDLE 10°

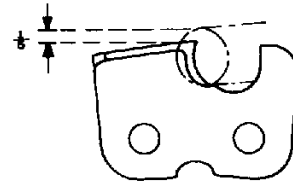

ONE FIFTH OF FILE DIAMETER
REMAINS ABOVE CUTTER EDGE.

- Place the depth gauge tool firmly on guide bar so that depth gauge protrudes. Then file top of depth gauge with flat file until flat with top of the depth gauge tool.
 - Round off the front edge without fail.

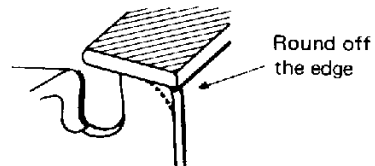
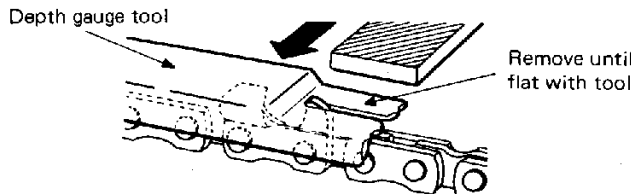

- Cutters, filed properly are as follows.

(Top plate angle)

(Side plate angle)

(Top plate cutting angle)

(Depth gauge)

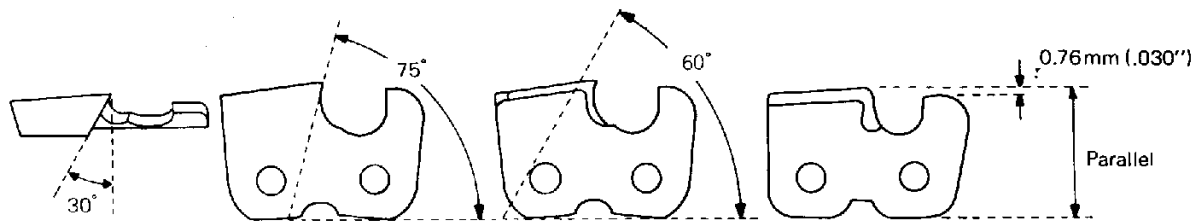

[NOTE]

Top plate angle becomes 30° when filed properly. (File angle 35°, and lowered file holder 10°)

These angles are referred to **Oregon 76LP**.

To sharpen other type chain, follow chain manufacturer's instruction.

CORRECT USE OF CHAIN BRAKE (OPTIONAL SUPPLY AT EXTRA COST)

Chain Brake is one of the Safety Devices, which protects operator against injury due to malfunction of saw chains. Most hazardous is the kick-back motion of the guide bar such that, in an instant the tip of the bar touches a wood or the like, the guide bar is kicked back. Chain Brake is the device to stop the motion of saw chains instantaneously in such event.

Kickback Motion:

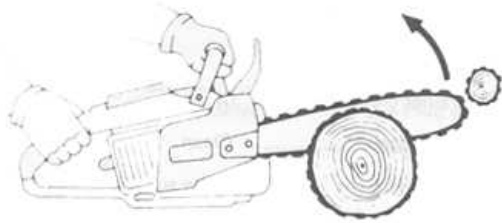

- When the bar nose hits the other tree etc.

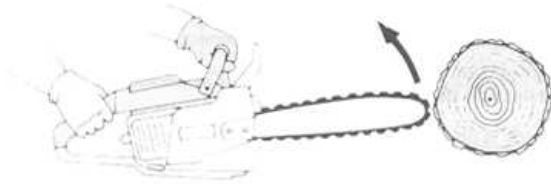

- Improper thrust cutting.

Function:

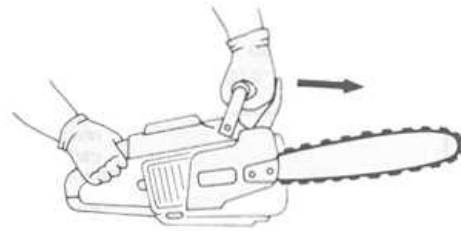

- When the lever is pushed forward, chain brake instantly works to stop the chain.

Release:

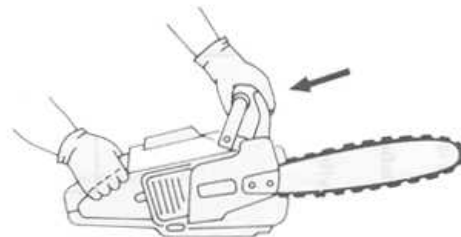

- When the lever is fully pulled toward the arrowed direction, brake is released.

ADJUSTING THE BRAKE BAND

When brake band is worn or elongated, adjust the location of adjuster peak as follows.

- Remove the cover and side plate.
- Loosen screw and turn adjuster to set its peak to a correct tensioning location.
- Ensure that clutch drum is turned freely by hand when brake handle is in cutting position (Released position).

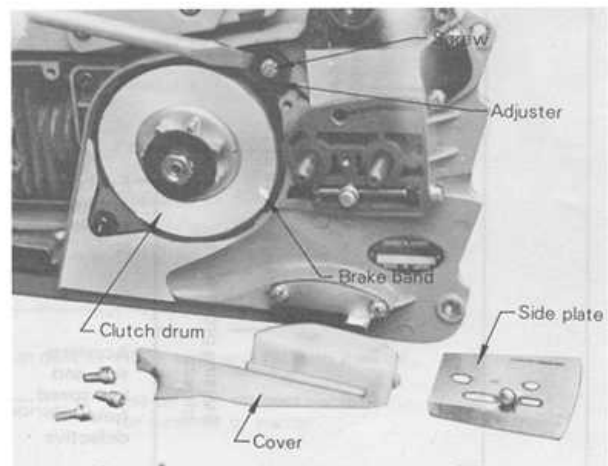
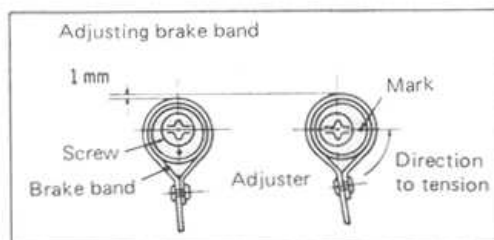

[NOTE]

- For practice, while cutting a small tree, push the lever forward to function the brake.
- At all times, confirm whether the brake works properly before every, cutting work.
- If wood chips are clogged, function of the brake deteriorates a little. Keep the device always clean.
- Do not recklessly elevate revolution of the engine by squeezing the throttle trigger while the chain brake is at work.
- Chain brake is the device used only in emergency. Do not use them at random unless really necessary.
- When in use of throttle lock at starting, keep the chain brake in brake position. And after starting the engine, release the brake immediately.
- Never check the function of brake in the area of fuel-air mixture.

CHAIN BRAKE KIT is available as optional supply at extra cost. (Parts No. 433 100-1233 1) Refer to page 16~17.

TROUBLE SHOOTING

The details of **TROUBLE SHOOTING** refer to Table 1 and 2.

- Refer to the chart to locate the problem and repair as necessary.

FAILURES such as difficulty in starting engine, irregularity in functions and abnormality in cutting performances can normally be prevented completely if a little attention is paid in advance.

Such failures can be readily disposed of even by a beginner.

In the following we wish to give essential points in countering failures of the chain saw and the trouble-shooting table. When the engine does not function properly, check the following 3 points systematically in particular:

- Whether compression of the engine is adequate or not.
- Whether the fuel system is in good condition and fuel is supplied fluently, or not.
- Whether the electrical system is in good condition and the spark plug sparks correctly, or not.

When there is serious trouble with your chain saw, do not try to repair at random yourself, but have your chain saw distributor or dealer do it for you.

Table 1

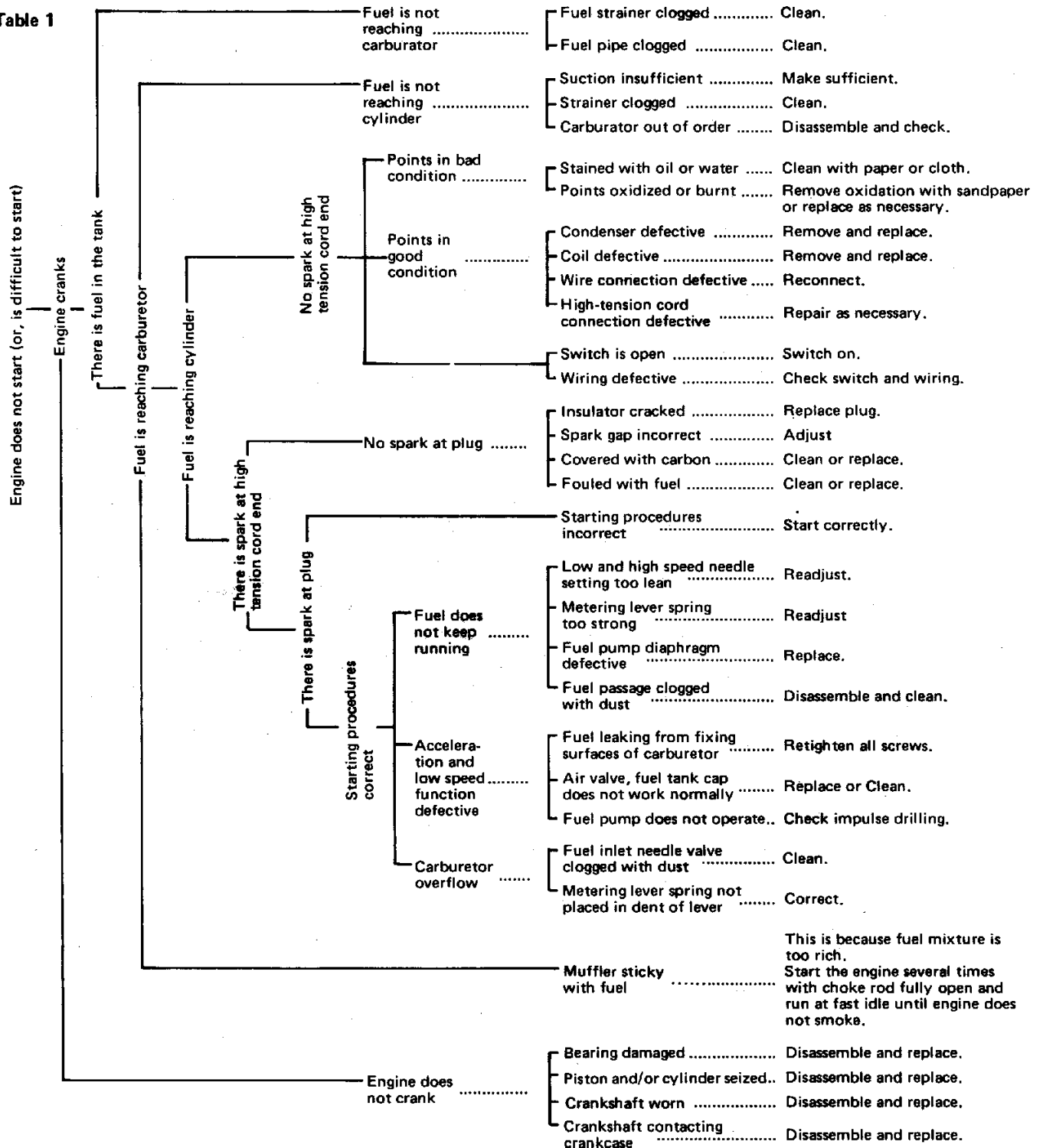
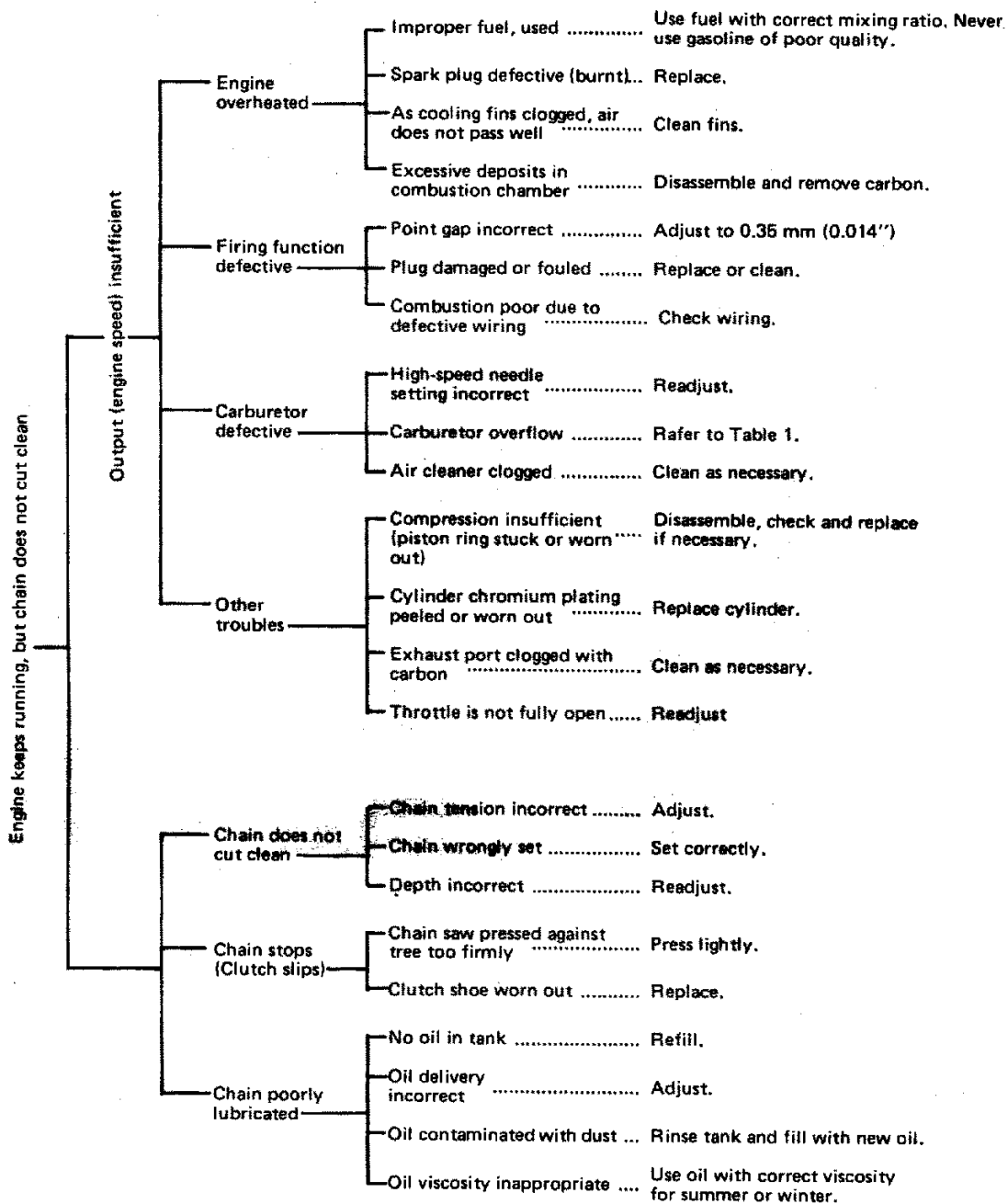

Table 2



STORAGE AFTER USE

- Inspect and adjust every part of the chain saw.
 - Completely clean every part, and repair, if necessary.
 - Apply thin coating of oil on metal parts to prevent rust.
 - Remove chain and guide bar, apply them sufficient oil coating and wrap them up in plastic sheet.
- Drain fuel tank, pull starter slowly a few times to drain fuel from carburetor.
- Pour a little amount of clean motor oil into spark plug hole, pull starter and then manually crank the engine until the TOP DEAD CENTER.
- Store in a dry area, free from dust.