

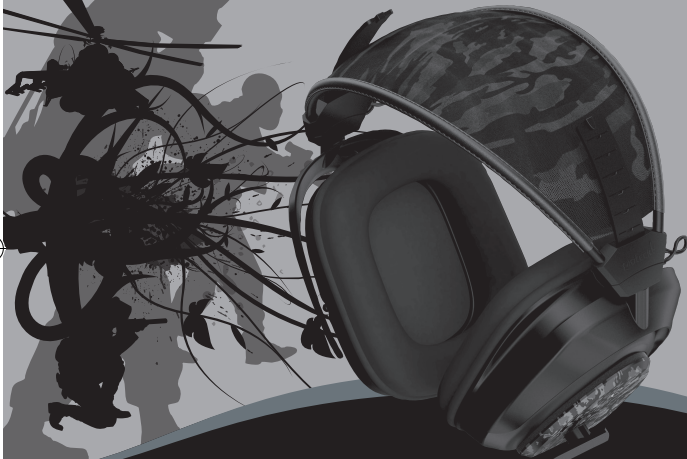

gioteck
COME GET SOME



EX-05 MILITARY STYLE HEADSET

CRISP AND DEEP WIRED STEREO HEADPHONES





thank you

Thank you for purchasing the EX-05 Military Style Headset from Gioteck. We hope that this product will go beyond your expectations for a quality made accessory. Please read this booklet thoroughly before using the product. Thank you & enjoy!

precautions

This product has been designed with the highest concern for safety. However, any electrical device, if used improperly, has the potential to cause harm. To help ensure risk-free operation please pay attention to the following guidelines.

- Use only as intended. This is a precision product, handle with care.
- Contains small parts. Not suitable for children under 3 years of age.
- Store in a dry & dust free area. Do not store in areas of extreme heat or cold, and avoid direct sunlight or heat sources eg. heaters.
- Do not allow the product to get wet or dirty; doing so may cause damage.
- Do not clean with benzene, paint thinner, acetone, alcohol, or other such solvents.
- Do not take the product apart; doing so will void your warranty and may cause electrical shock.

warnings



This symbol indicates important installation, operational or maintenance instructions. Always follow these instructions closely.

environment



Please help to conserve the environment by recycling all of the packaging of this product.



This headset should NOT be disposed of in normal household waste. It should be disposed of separately. Please take it to an electrical waste collection point.

CONTENTS

- 02 | Contents & Precautions
- 03 | Features & Details
- 05 | Set Up - Xbox
- 10 | Set Up - PS3
- 13 | Set Up - PC
- 14 | Troubleshooting
- 15 | Legals





features & details

The EX-05 comes with true-to-life sound acoustics that make sure you hear your enemy, before you see them. Providing high quality, true sound & using the latest cutting edge audio technology, the EX-05 comes with a lightweight headband, ergonomic adjusters and circumaural ear cups to provide outstanding comfort.

headset

- 01 | Lightweight Headband
- 02 | Headset Adjusters
- 03 | Micro-Fibre Mufflers
- 04 | Flexible Rubber Mic Boom
- 05 | Connector Cable
- 06 | Connector Plug

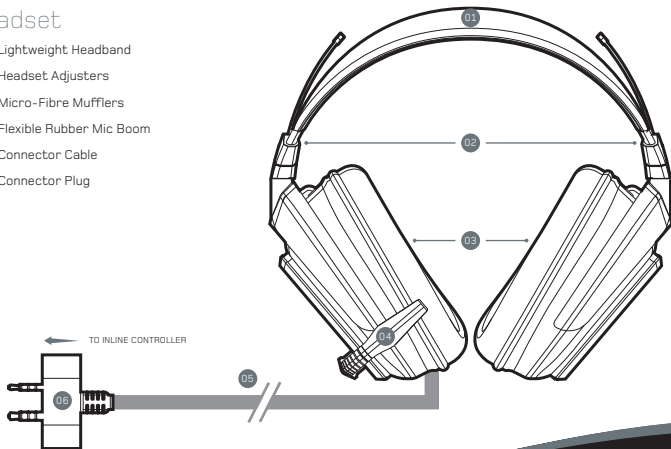



features & details

wired inline connector

- 01 | Headset Connector
- 02 | Inline Control Box
- 03 | Game Volume
- 04 | Chat Volume
- 05 | Mute Switch
- 06 | Xbox/PC - PS3 Switch
- 07 | RCA Pass Through Connectors
- 08 | USB Connector
- 09 | Mini Jack Cable (for Xbox Live Chat)

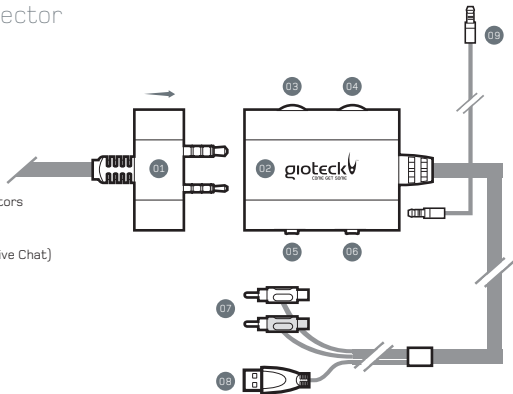



set up - xbox 360 slim using standard a/v cables

Use the AV cable supplied with your Xbox 360 to connect your console to your TV (or sound system) as shown. This will allow you to hear your game time through your TV or EX-05 Headset.

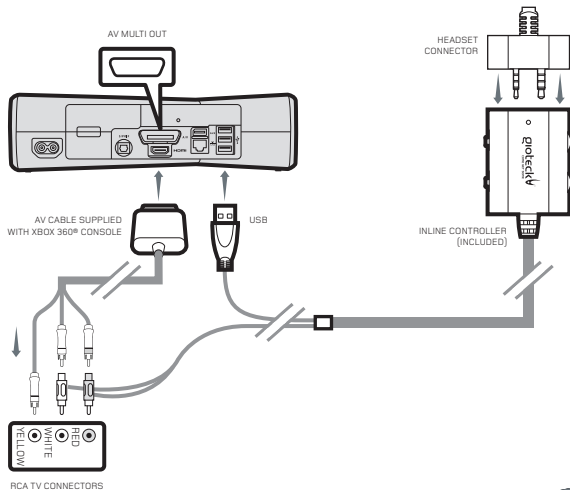



set up - xbox 360 using hdmi

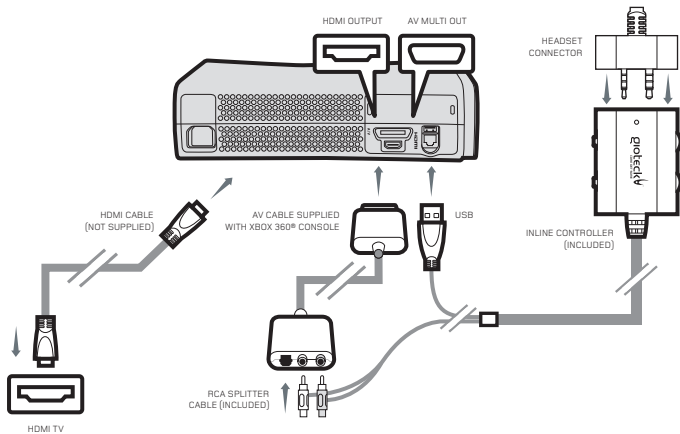



set up - xbox 360 slim using hdmi

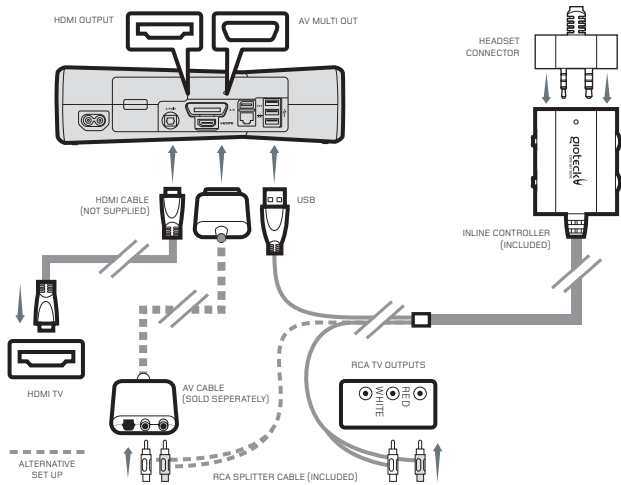



set up - chat on xbox 360

The EX-05 may be used to communicate with other players during XBOX live multi player gaming sessions. Plug the Mini Jack cable supplied into the Mini Jack cable port of the inline connector (1) and connect the other end of the cable to the input of your Xbox controller (2). To customise your chat settings, follow the instructions opposite.

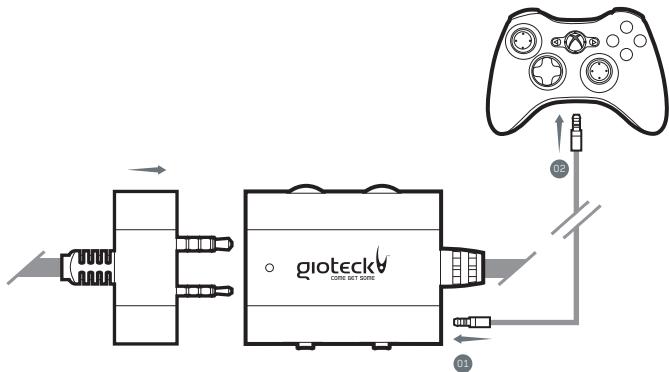



1. At the Xbox dashboard select the 'settings' menu.

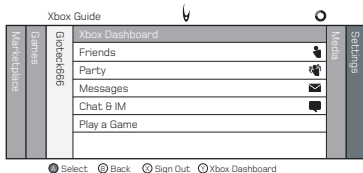

2. Select 'preferences' from the 'settings' menu.

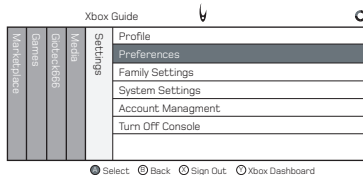

3. Select 'voice' from the 'preferences' menu.

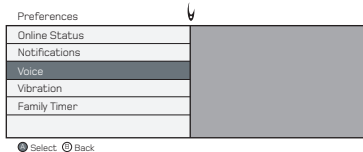

4. Adjust settings.

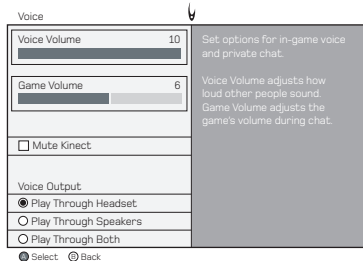



set up - ps3 using standard a/v cables

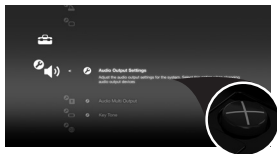

1. After navigating to the Sound Settings' menu, press X on Audio Output Settings.

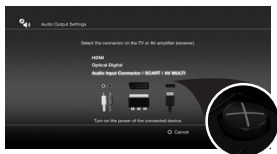

2. Press X on the icon labelled: Audio Input Connector / SCART / AV MULTI to select this option.

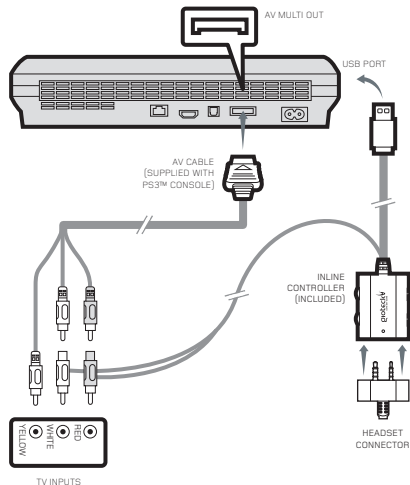

set up - ps3 using hdmi

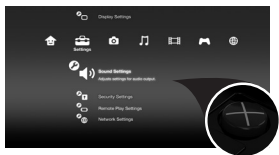

1. Within the Settings' menu, press X on Sound Settings.

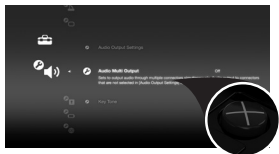

2. Press X on the icon labelled: Audio Multi Output and turn setting to ON.

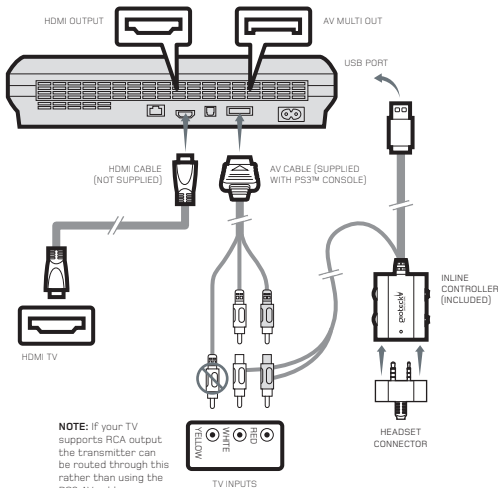



set up - chat on ps3

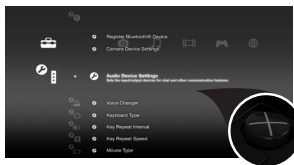

1. Within the Settings' menu, press X on Accessory Settings.



2. Choose **Giateck EX-05 Headset** as your input and output device from the lists. Press X to confirm.



3. Set the microphone level to 3 or 4 press X on OK. Your EX-05 Military Style Headset is now ready to use.. Enjoy :)





set up - connection to a pc

To connect the EX-05 to a PC, plug the usb cable (1) into spare usb port on your PC.

Note: The RCA pass through connectors are not required for the PC set up.

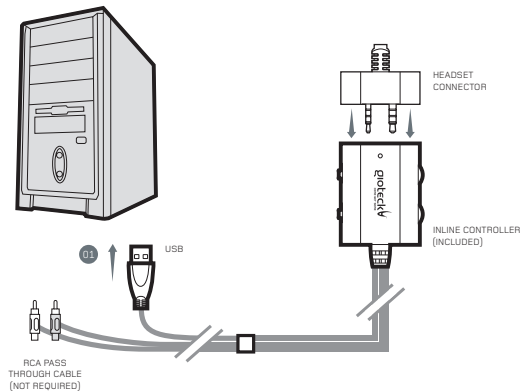



troubleshooting

Having trouble with your EX-05 Military Style Headset? These troubleshooting steps will show you the smoothest path to resolving your issue. Be sure to perform troubleshooting before returning your headset.

When using chat my friends can't hear me

- Check that the headset is connected to the Xbox 360® Controller.
- Make sure the Mute switch on the inline controller is turned OFF.

When using chat I can't hear my friends.

- Have you remembered to turn up the chat volume on the inline controller.
- Check that you have set up the audio configuration correctly

I can't hear the game audio.

- Make sure the game volume is turned up on the inline controller?
- Check that the headset is plugged in to the inline controller correctly.
- Check that you have set up the audio configuration correctly.

For further assistance please contact our customer support team on our website: www.gioteck.com





legals

This product complies with the following legal regulations. For further information go to www.gioteck.com



This device complies with Part 15 of the FCC Rules. Operation is subject to the following two conditions: (1) this device may not cause harmful interference, and (2) this device must accept any interference received, including interference that may cause undesired operation of this product.



Gioteck hereby declares that this headset is in compliance with the essential requirements and other provisions of Directive 2004/108/EC. To view the full version of the Declaration of Conformity please go online to doc.gioteck.com.



N28707

FCC Notice to User

NOTE: THE MANUFACTURER IS NOT RESPONSIBLE FOR ANY RADIO OR TV INTERFERENCE CAUSED BY UNAUTHORIZED MODIFICATIONS TO THIS EQUIPMENT. SUCH MODIFICATIONS COULD VOID THE USER'S AUTHORITY TO OPERATE THE EQUIPMENT.

NOTE: This equipment has been tested and found to comply with the limits for a Class B digital device, pursuant to part 15 of the FCC Rules. These limits are designed to provide reasonable protection against harmful interference in a residential installation. This equipment generates, uses and can radiate radio frequency energy and, if not installed and used in accordance with the instructions, may cause harmful interference to radio communications. However, there is no guarantee that interference will not occur in a particular installation. If this equipment does cause harmful interference to radio or television reception, which can be determined by turning the equipment off and on, the user is encouraged to try to correct the interference by one or more of the following measures:

- Reorient or relocate the receiving antenna.
- Increase the separation between the equipment and receiver.
- Connect the equipment into an outlet on a circuit different from that to which the receiver is connected.
- Consult the dealer or an experienced radio/TV technician for help.