



Content

1	Introduction	8
1.1	System Requirements	9
1.2	General Technical Specifications	10
1.3	H6D-50c	11
	Technical Specifications	11
1.4	H6D-100c	12
	Technical Specifications	12
2	Safety	14
2.1	Warnings	15
2.2	Cautions	15
2.3	Disposal	16
3	Overview	17
3.1	The H6D Interaction Displays	18
3.2	Main Camera Parts	19
3.3	Parts, Components, Buttons and Controls	20
3.4	Grip Buttons and Controls	23
3.5	Camera Body Buttons and Controls	24
3.6	Sensor Unit	25
3.7	Viewfinder	26
3.8	Lenses	27
3.9	Display Information	28
3.10	Sensor Unit Display and Controls	29
3.11	Grip Display	30
3.12	Viewfinder Display	31
	Typical Viewfinder Display	31
3.13	Re-assignable Grip Buttons Function Options	33
3.14	Short cuts	34
3.15	Phocus Overview	35
3.16	Camera Configuration in Phocus	36
3.17	Battery and Battery Grip	37
3.18	Battery Charger	38
	Charge the Battery	38
	Rechargeable Battery Grip Specification	39
	Battery Life and Battery Warning	40
3.19	Temperature Warning	40
3.20	Power Modes	41
3.21	Automatic Settings	42
3.22	Remove and Attach the Viewfinder	43
3.23	Eyepiece Adjustment	44

3.24	Rubber Eye Cup	44
3.25	Accessory Connection	45
3.26	PC Flash Connector	45
3.27	Protective Baseplate	46
	Remove the Protective Baseplate	46
	Attach the Protective Baseplate	46
3.28	Memory Cards	47
	To Insert a Memory Card	48
	To Remove a Memory Card	49
	Formatting Memory Cards	50
	Format Button	50
	Format Memory Cards via Sensor Unit	50
3.29	Carrying Strap	51
3.30	Remove the Carrying Strap	52
3.31	Change Lens	53
	Attach a Lens	53
	Remove a Lens	53

4 To Prepare 54

4.1	Check the Delivery	55
4.2	Reassign Grip Buttons	56
4.3	Connect to a Computer	57
4.4	Camera Interval Settings	58
4.5	Set Date and Time	59
4.6	Set Language	60
4.7	Set Brightness of the Display	61
4.8	Insert a Memory Card (CFast or SD)	62
4.9	Remove a Memory Card (CFast or SD)	63
4.10	Format a CFast Card	64
	Format Button	64
	Format Memory Cards via Sensor Unit	64
4.11	Set Drive Mode	65

5 To Use 66

5.1	Navigating the Menus	67
	Description of the Sensor Unit Menu Items	67
	Overview of Menus and Settings on Sensor Unit	68
	Touch Screen Navigation	69
5.2	Sensor Unit Display Navigation	70
	Control Screen	70
	Control Screen Description	71
	Add And Remove Favourite Functions to Control Screen	75
5.3	Camera Settings Menu	76
5.4	Camera Exposure Settings	77

ISO and White Balance	78
ISO and White Balance on Grip	79
Exposure Settings Modes	80
Select Metering / Exposure Setting Modes	80
Manual Exposure Mode	81
Automatic Exposure Mode	82
Automatic Exposure - P and PV Mode	83
AE-L Button	84
Fixed Exposure Compensation Setting	85
Light Meter Exposure Mode	86
True Exposure	87
White Balance Settings - Presets and Manual	89
White Balance Setting by Using a “Grey Card”	90
Exposure Adjust	91
Exposure Compensation / Quick Adjust	92
Flash Settings	93
Flash and Strobe Settings	94
Access to Flash Controls	95
Integral Flash	96
Separate Flash Unit Connection	97
Flash Measure of Separate Flash Unit	98
Exposure Lock	99
AE-Lock / Quick Adjust	100
Mirror Settings	101
Image Orientation	102
5.5 Camera Focus Settings	103
Focusing Distance Calculation	104
Stop Down / Depth of Field Preview	104
Infrared Focus Setting	105
Focus Assist	106
Manual Focus	107
Manual Override in Autofocus Mode	107
Auto / Manual Focus Setting	107
Autofocus	108
Autofocus Check in Manual Mode	108
Single Shot Focus	109
Continuous Focus	109
5.6 Camera True Focus	110
True Focus and Absolute Position Lock	111
True Focus and Camera Handling	112
Focus Checking	112
5.7 Camera True Focus Methods	113
Activated By Shutter Release - True Focus Retained	113

Temporarily Activated - Autofocus Retained	114
Activated by True Focus - Autofocus Deactivated	115
Activated by an Assigned Button - Manual Focus Retained	116
5.8 Camera Self Timer	117
5.9 Camera Interval Settings	118
5.10 Camera Bracketing Settings	119
Bracketing Function	119
5.11 Camera Live View Settings	120
Live View	121
Zooming in Live View	121
Focus in Live View	121
Live View with HDMI External Screen	122
5.12 Camera Controls Settings	123
5.13 Video Settings Menu	124
Video Settings	124
5.14 Video Quality Settings	125
Video Quality Settings	125
5.15 Video Recording	126
5.16 General Settings Menu	127
General Settings WI-FI	128
5.17 General Settings Display	129
5.18 General Settings Storage	130
Format CFast and SD cards	131
Format Button	131
Format Memory Cards via Sensor Unit	131
Image and Video Destination	132
5.19 General Settings Date and Time	133
5.20 General Settings Power and Timeouts	134
Set Display Off Mode	135
Power Off	135
5.21 General Settings Language	136
5.22 General Settings Service	137
5.23 General Settings Check for Update	138
5.24 General Settings About	139
5.25 Grip Display Navigation	140
Buttons and Controls on Grip Display	140
To Adjust Shutter and Aperture on Grip	141
Grip Display Navigation	142
5.26 Viewfinder Display Navigation	145
Typical Viewfinder Display	145
Viewfinder Display Navigation Overview	146
Viewfinder Display Examples	147
5.27 Remove / Attach Viewfinder	150
Remove the Viewfinder	150

	Attach the Viewfinder	150
	Adjust the Eyepiece	151
	Change Focusing Screen	152
5.28	Preview, Histogram and Browsing	153
	Preview Modes	153
	Standard Preview	154
	9 View Mode	154
	Histogram Types	155
	Histogram Mode	155
	Capture Details Mode	155
	Luminance Histogram Mode	155
	Separate Histogram RBG Mode	155
	Histogram Mode - Exposure	156
	Browsing	157
	Zoom in and out	158
5.29	Phocus	159
	Features in Phocus	159
	Phocus Mobile	159
	Phocus and Hasselblad Capture Files	160
5.30	Lenses and Focus Modes	161
	Remove the Lens	161
	Attach the Lens	162
	Remove the Lens Cap	163
	Attach the Lens Cap	163
	Remove the Lens Shade	164
	Attach the Lens Shade	164
	Filters	165
	To Set Focus Distance	166
5.31	Battery	167
	Charge the Battery	167
	Check the Battery Status	168
5.32	Protective Baseplate	169
	Remove the Protective Baseplate	169
	Attach the Protective Baseplate	169
5.33	Store the Camera	170

6	Accessories	171
6.1	Accessories Connectivity Diagram	172
6.2	HC Lens Range	173
6.3	Optional HC Lens Accessories	174
	HTS 1.5	174
	CF Adapter	174
	H 13, 26 and 52 Extension tubes	174
	Converter H 1.7X	174
	Macro Converter H	174
6.4	Optional Accessories	175
	HVM waist level viewfinder	175
	Pro shade V/H 60 – 95	175
	Pro shade adapters	175
	GIL (Global Image Locator)	175
	Tripod quick coupling H	175
	Flash adapter SCA 3902	176
	UV-sky filters	176
	Pola filters	176
	Support strap with Quick plate H	176
	Camera strap H	176
	Focusing screens	176
	Release cord H	177
	HVM correction lens holder	177
	HVD 90x / HV 90x & 90x-II viewfinders	177
	Angle finder H	177
	DC power grip	177
6.5	HM 16-32 Film Magazine	178
7	Troubleshooting	186
7.1	Error Messages	188
7.2	Change Language on Sensor Unit from Unknown Language	189
7.3	Clean the Lens Glass	190
	Remove Dust	190
	Remove Smear	190
7.4	Clean the Sensor Unit Filter	191

1.1 SYSTEM REQUIREMENTS

Storage and editing of images requires a certain minimum standard regarding computer capabilities. Large images require a reasonably high-performance computer with sufficient memory, advanced graphics capabilities and a recent operating system.

It is recommended that the computer has a USB 3 connector, which will allow you to load images more quickly from the camera.

A USB CFast card and SD card reader can also be used for image transfer from the CFast and SD cards.

1.2 GENERAL TECHNICAL SPECIFICATIONS

Camera Type	Medium Format Digital SLR camera with Auto-focus, Auto-exposure, interchangeable Viewfinders and Lenses.
Construction	One piece stainless steel shell. Die-cast aluminium internal structure. Tripod sockets (1/4 and 3/8") and quick coupling tripod plate for rapid mounting.
Lenses	Hasselblad HC/HCD lenses with built-in electronically controlled shutter and aperture. Automatic or manual focusing with instant manual focus override. All HC/HCD lenses meet the exacting requirements of digital photography. Lens shades can be mounted in reverse for transport. V- system lenses can be used with a CF adapter.
Lens factor	HC – 1.0 / HCD –1.0.
Viewfinder (HV 90x-II for 100c with 2.7 times magnification and HVD 90x for 50c 3.1 times magnification)	A 90° reflex viewfinder, providing 100% field of view even when wearing eyeglasses, and built-in multi-mode light metering system. Image magnification 3.1x. Integrated fill-in flash with guide number 12. Hot-shoe for automatic flash (Metz SCA3002 system / adapter SCA3902). Dot matrix display with presentation of all relevant information. Built-in diopter adjustment from -5 to + 3.5D. Interchangeable.
Focusing	Automatic and manual focusing with electronic focus aid in manual mode. Instant manual focus override. Automatic focusing using passive central cross type phase detection sensor. AF metering range EV 1 to 19 (ISO 100).
Shutter	Electronically controlled lens shutter with speeds up to 1/1000. Flash sync at all speeds.
Flash control	TTL centre-weighted system. Can be used with the built-in flash or a wide variety of flashes compatible with the SCA3002 (Metz) system using adapter SCA3902. ISO range 16 to 6400. Flash output can be adjusted (-3 to +3EV) for fill-in purposes independent of ambient light. Synch at all shutter speeds.
Flash measurement	The H6D has a built-in measurement system that measures flash light from non-TTL flashes, such as studio flashes.
Exposure metering	Multi-mode exposure metering using 90° reflex viewfinder. Metering options are: Spot (diameter 7.5 mm), Centre Weighted, and CentreSpot. Metering range at f/2.8 and ISO100: Spot: EV2 to 21, Centre-weighted: EV1 to 21, CentreSpot: EV1 to 21.
Auto bracketing	Bracketing using predetermined number of captures (2, 3, 5, 7 or 9) in 1/3, 1/2, or 1 EV step difference intervals.
Interval timer	Number of captures from 2 to 'no limit' and interval from 1 second to 1 hour.
ISO range	ISO range: H6D-50c ISO 100 - 6400. H6D-100c 64 - 12800.
Displays	The camera features two dot-matrix displays that provide clear and easy-to-understand information to the user. One is located on the grip and the other in the 90° viewfinder. The sensor unit has a high resolution full touch 3 inch TFT display.
Focusing screen	Bright Spherical Acute-Matte type D with sensor format markings. Grid marked type also available as option.
Compatibility	All H System lenses and accessories except film magazines. V system C type lenses with optional CF lens adapter.
Accessory connection	Provided with two M5 threads and an electrical connector for accessories.
Customization	A large number of the H6D's functions can be customized by the user to suit specific styles or situations through the built-in menu system.
User interface	Full touch user interface, including swipe, scroll and pinch/spread to zoom. Camera grip with buttons and control wheels. Many camera functions and settings can be controlled from a tethered computer or iPhone/iPad over Wi-Fi.
Rechargeable battery grip Li-ion	3200 mAh output.

1.3 H6D-50C

TECHNICAL SPECIFICATIONS

Sensor type	CMOS, 50 megapixels (8272 × 6200 pixels, 5.3 × 5.3 µm)
Sensor dimensions	43.8 × 32.9mm
Image size	Stills: RAW 3FR capture 65MB on average. TIFF 8 bit: 154MB; Video: HD (1920 x 1080p)
File format	Stills: Hasselblad 3FR Video: H.264 Compressed (30 fps)
Shooting mode	Single shot stills, Video
Colour definition	16 bit; Dynamic range approx. 14 stops
ISO speed range	ISO 100, 200, 400, 800, 1600, 3200, 6400
Storage options	CFast card, SD card or tethered to Mac or PC
Colour management	Hasselblad Natural Colour Solution, HNCS
Storage capacity	16GB card holds 240 images on average
Capture rate	TBD
Display	3 inch TFT type, 24 bit colour, 920K pixels; Touch functionality: Yes, full support Live View: On camera, host and iOS device with high frame rate
Histogram feedback	Yes, on Sensor Unit Display
IR filter	Mounted in front of sensor
Software	Phocus for Mac and Windows
Platform support	Macintosh: OSX version 10.9; PC: XP/Vista/Windows 7 (32 and 64 bit)/ 8 / 10
Host connection type	USB 3.0 (5 Gbit/s) Type-C connector, Mini HDMI, Audio In/Out
Additional connections	Mini HDMI, Audio In/Out, Flash sync In/Out, Power In
View camera compatibility	Yes, Mechanical shutters controlled via flash sync. Electronic shutters can be controlled from Phocus
Operating temperature	-10 - 45 °C / 14 - 113 °F
Wi-Fi	802.11 a, b, g, n (depending on region), ac
Dimensions	Complete camera w/ HC80 lens: 153 x 131 x 205mm [W x H x D]
Weight	2105g (Complete camera w/ HC80 lens, Li-Ion battery and card)
Camera type	Large sensor medium format DSLR
Lenses	Hasselblad H system lens line with integral central lens shutter
Shutter speed range	60 minutes to 1/2000 sec (depending on lens type used)
Flash sync speed	Flash can be used at all shutter speeds
Viewfinder options	HVD 90x: 90° eye-level viewfinder w. dioptre adjustment (-5 to +3.5D). Image magnification 3.1x. Integral fill-flash (GN. 12 @ ISO100). Hot shoe for SCA3002-system flashes from Metz™ HV 90x II: 90° eye-level viewfinder w. dioptre adjustment (-4 to +2.5D). Image magnification 2.7x. Integral fill-flash (GN. 12 @ ISO100). Hot shoe for SCA3002-system flashes from Metz™ HVM: Waist-level viewfinder. Image magnification 3.2x
Focusing	Autofocus metering with passive central cross-type sensor. Ultra focus digital feedback. Instant manual focus override. Metering range EV 1 to 19 at ISO 100
Flash control	Automatic TTL centre weighted system. Uses built-in flash or flashes compatible with SCA3002 (Metz™). Output can be adjusted from -3 to +3EV. For manual flashes a built-in metering system is available
Exposure metering	Spot, Center Weighted and Center Spot Metering range Spot: EV2 to 21, Center Weighted: EV1 to 21, Center Spot: EV1 to 21
Power supply	Rechargeable Li-ion battery (7.2 VDC/3200 mAh); Socket for external power
Film compatibility	Yes

1.4 H6D-100C

TECHNICAL SPECIFICATIONS

Sensor type	CMOS, 100 megapixels (11600 × 8700 pixels, 4.6 × 4.6 µm)
Sensor dimensions	53.4 × 40.0mm
Image size	Stills: RAW 3FR capture 120MB on average. TIFF 8 bit: 289MB; Video: HD (1920 x 1080p), UHD (3840 x 2160p)
File format	Stills: Hasselblad 3FR Video: H.264 Compressed (30 fps) (HD only), Hasselblad RAW (HD & UHD)
Shooting mode	Single shot stills, Video
Colour definition	16 bit; Dynamic range 15 stops
ISO speed range	ISO TBD: 64, 100, 200, 400, 800, 1600, 3200, 6400, 12800
Storage options	CFast card, SD card or tethered to Mac or PC
Colour management	Hasselblad Natural Colour Solution, HNCS
Storage capacity	16GB card holds 120 images on average
Capture rate	TBD
Display	3 inch TFT type, 24 bit colour, 920K pixels; Touch functionality: Yes, full support Live View: On camera, host and iOS device with high frame rate (30 fps)
Histogram feedback	Yes (on rear display and on camera grip display)
IR filter	Mounted in front of sensor
Software	Phocus for Mac and Windows
Platform support	Macintosh: OSX version 10.9; PC: XP/Vista/Windows 7 (32 and 64 bit)/ 8 / 10
Host connection type	USB 3.0 (5 Gbit/s) Type-C connector, Mini HDMI, Audio In/Out
Additional connections	Mini HDMI, Audio In/Out, Flash sync In/Out, Power In
View camera compatibility	Yes, Mechanical shutters controlled via flash sync. Electronic shutters can be controlled from Phocus
Operating temperature	-10 - 45 °C / 14 - 113 °F
Wi-Fi	802.11 a, b, g, n (depending on region), ac
Dimensions	Complete camera w/ HC80 lens: 153 x 131 x 205mm [W x H x D]
Weight	2105g (Complete camera w/ HC80 lens, Li-Ion battery and card)
Camera type	Large sensor medium format DSLR
Lenses	Hasselblad H system lens line with integral central lens shutter
Shutter speed range	60 minutes to 1/2000 sec (depending on lens type used)
Flash sync speed	Flash can be used at all shutter speeds
Viewfinder options	HVD 90x: 90° eye-level viewfinder w. dioptre adjustment (-5 to +3.5D). Image magnification 3.1x. Integral fill-flash (GN. 12 @ ISO100). Hot shoe for SCA3002-system flashes from Metz™ HV 90x II: 90° eye-level viewfinder w. dioptre adjustment (-4 to +2.5D). Image magnification 2.7x. Integral fill-flash (GN. 12 @ ISO100). Hot shoe for SCA3002-system flashes from Metz™ HVM: Waist-level viewfinder. Image magnification 3.2x
Focusing	Autofocus metering with passive central cross-type sensor. Ultra focus digital feedback. Instant manual focus override. Metering range EV 1 to 19 at ISO 100
Flash control	Automatic TTL centre weighted system. Uses built-in flash or flashes compatible with SCA3002 (Metz™). Output can be adjusted from -3 to +3EV. For manual flashes a built-in metering system is available
Exposure metering	Spot, Centre Weighted and CentreSpot Metering range Spot: EV2 to 21, Centre Weighted: EV1 to 21, CentreSpot: EV1 to 21
Power supply	Rechargeable Li-ion battery (7.2 VDC/3200 mAh); Socket for external power
Film compatibility	Yes

2.1 WARNINGS

Warning!

Do not place cables between camera and computer so that there is a risk for people to trip and fall. This can cause personal injury and/or damage to the equipment.

Warning!

If you use spare battery packs, make sure to use protective caps on the contacts. The contacts can short-circuit and catch fire if not protected. This can cause personal injury and/or damage to the equipment.

Warning!

Do not expose batteries (battery pack and batteries installed) to excessive heat such as sunshine, fire or similar. If exposed, the batteries can catch fire. This can cause personal injury, damage to the equipment and the surrounding environment.

Warning!

Be careful when working with strobe and flash units. This will prevent personal injury and/or damage to the equipment.

2.2 CAUTIONS

Caution!

Be careful when you use the camera. The camera is a precision instrument. This will help prevent damage to the camera.

Caution!

Danger of explosion if battery is incorrectly replaced. Replace only with the same or equivalent type.

Caution!

Do not use batteries other than specified. This can cause damage to the batteries.

Caution!

Use protective covers as much as possible. The protective covers will help prevent damage to the equipment.

Caution!

Use a protective case or camera bag when you transport the equipment. This will help prevent damage to the equipment.

Caution!

Protect the equipment from oil fumes, steam, humid conditions and dust. This will help prevent damage to the equipment.

Caution!

Seal all equipment in a plastic bag or similar if you enter damp

and humid condition from dry and cold condition. Wait until the equipment has acclimatized to the new temperature before you remove the equipment from bag. This will help prevent damage to the equipment.

Caution!

Avoid frequent and high temperature changes. This can cause damage to the equipment.

Caution!

Keep camera and equipment away from moisture. If your camera becomes wet, disconnect from electric power and let camera dry before further use. This will help prevent damage to the equipment.

Caution!

Store the equipment in a dry environment. This will help prevent damage to the equipment.

Caution!

Be careful when you attach/detach the components to/from the camera. This will help prevent damage to the data bus connections.

Caution!

Use the grip or strap when you lift and handle to camera. This will help prevent damage to the camera.

Caution!

Do not insert fingers into the camera body. This can cause damage to the equipment.

Caution!

Do not touch the glass surface with your fingers. This can cause damage to the equipment.

Caution!

Do not touch the CMOS/Sensor with your fingers. This can cause damage to the equipment.

Caution!

When you remove the sensor unit, keep foreign objects away from the camera opening. The camera opening is very sensitive. This will help prevent damage to the equipment.

Caution!

When you remove the sensor unit, make sure to be careful with the CMOS sensor protective filter. The CMOS sensor protective filter is very sensitive. This will help prevent damage to the equipment.

Safety

Caution!

Keep all equipment out of reach of small children. This will prevent damage to the equipment.

Caution!

When cleaning the camera, remove the batteries. This will prevent damage to the camera.

Caution!

If you leave the camera unused for a long period, remove the batteries. This will prevent damage to the equipment.

Caution!

Do not open the sensor unit. This can cause damage to the sensor unit.

Caution!

Do not cover the ventilation openings on the sensor unit. It can overheat and cause damage to the equipment.

Caution!

Before you connect the sensor unit to camera after storage, always replace the protective CMOS/filter cover. This will prevent damage to the equipment.

Caution!

Do not try to remove the glass IR filter from the front of the CMOS (due to dust or similar). This can cause damage to the equipment. Always contact your local Hasselblad Authorized Service Center.

Caution!

If you use canned compressed air to clean the glass of IR filter, read the instructions very carefully before use. This will help prevent damage to the filter.

2.3 DISPOSAL



This product must be put in municipal waste.
Check local regulations for disposal.

3.1 THE H6D INTERACTION DISPLAYS



Viewfinder Display



Sensor Unit Display

This display is touch sensitive and you can use it in the same way you navigate on a smart phone. Swipe, select, pinch and spread to zoom for example. You can also navigate by using the 5 soft buttons under the display and scroll wheels on the Camera Grip.

Grip Display and Viewfinder Display

Press the WB, AF, ISO, Menu, Play or Profile buttons near the Grip display. The + / - and EXP buttons on the side of the Viewfinder are part of the Grip interaction. Change settings by scrolling the Front Scroll Wheel or the Rear Scroll Wheel. Press the same button again to Exit and Save.

Sensor Unit Display



Grip Display



3.2 MAIN CAMERA PARTS



3.3 PARTS, COMPONENTS, BUTTONS AND CONTROLS

All items mentioned on this page are described in greater detail elsewhere in this manual.

- 1 Focus assist illuminator
- 2 Mirror Up button
- 3 Remote release port
- 4 Stop Down button
- 5 Battery grip



- 1 True Focus button
- 2 Card Format button
- 3 AE-L button
- 4 Camera strap holder
- 5 Grip lever release button
- 6 Battery grip locking lever

- 1 Speaker
- 2 Product number
- 3 Sensor unit

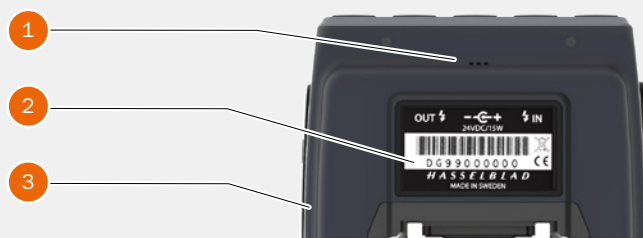

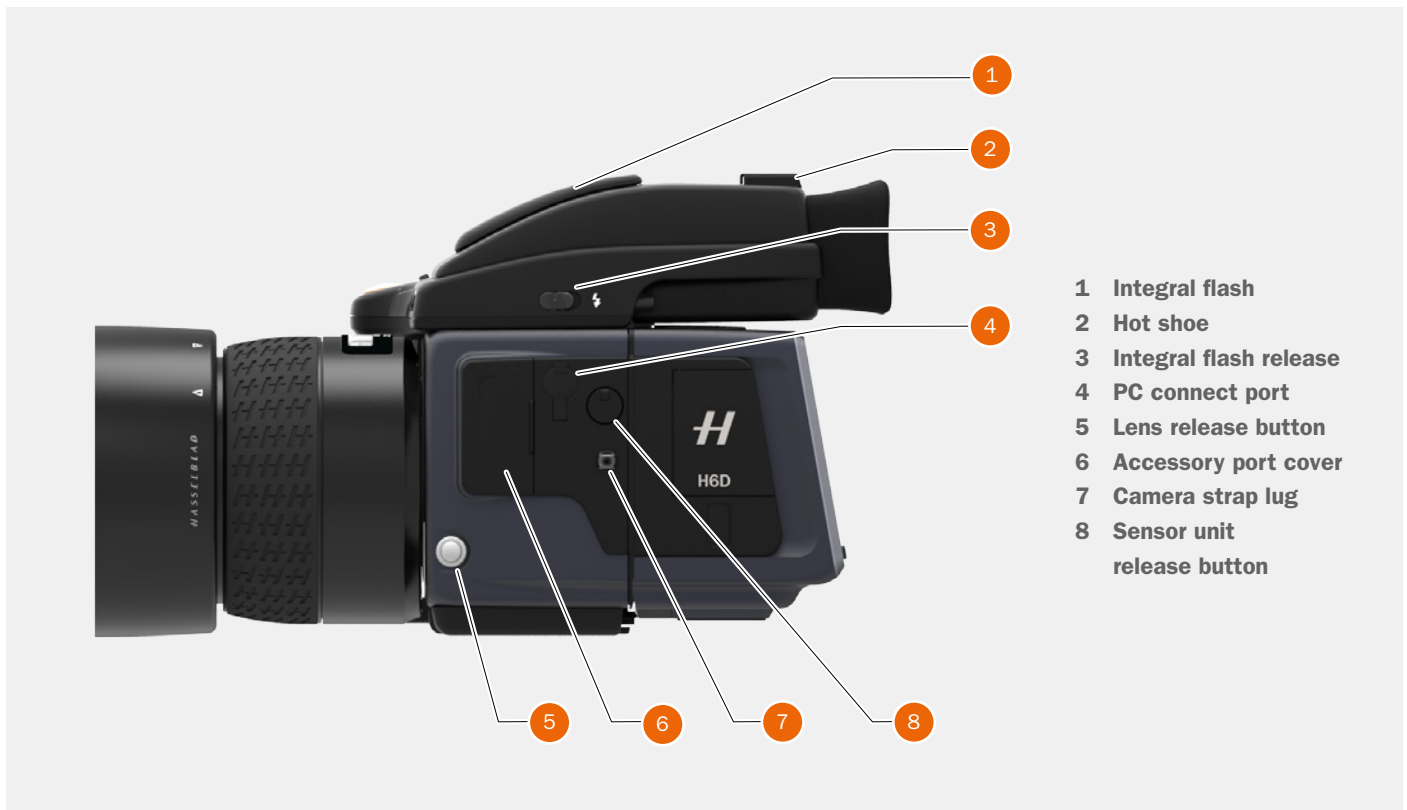

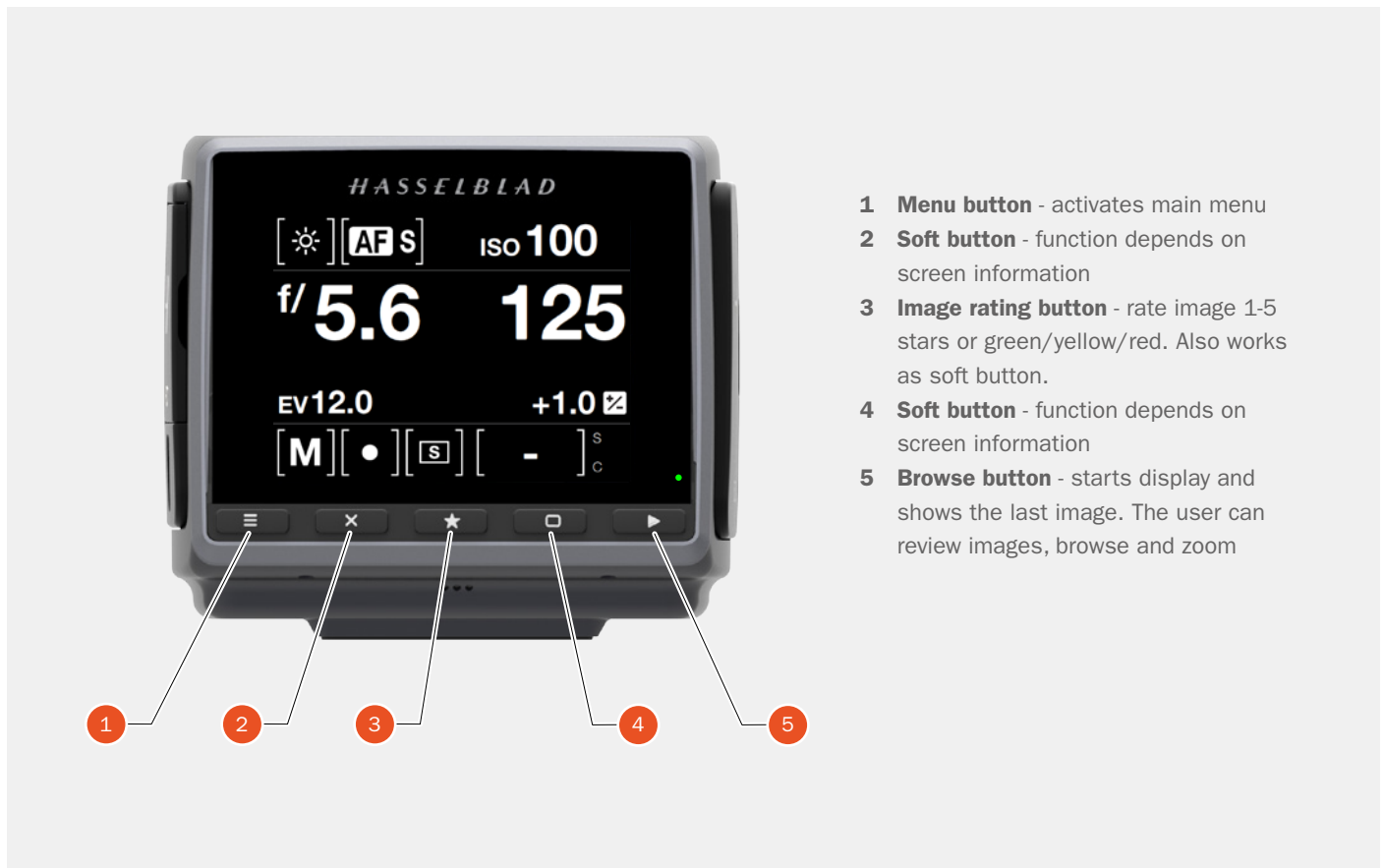
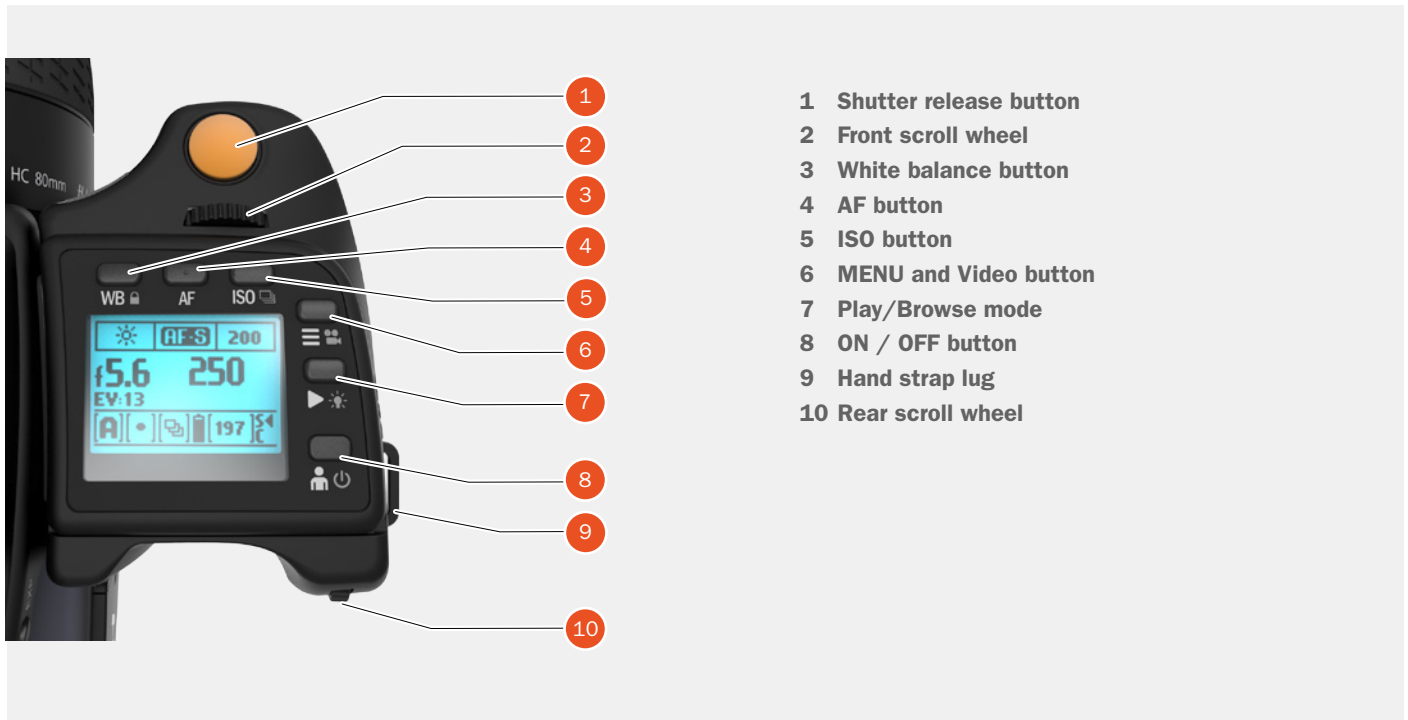

Overview

3.4 GRIP BUTTONS AND CONTROLS

Note that some of the buttons have multiple functions according to the settings made.

1 Shutter release button

This button has two positions. Press half-way (or softly) to activate the camera, auto focus function and exposure meter. Press all the way down (or more firmly) to release the shutter. The chosen exposure procedure and the self timer are also activated with this button.

2 Front scroll wheel

The front and rear scroll wheels are used to make changes in exposure settings, provide access to the grip menu for settings, navigate the sensor unit's menu as well as acting as browse controls.

3 WB button / (Control Lock)

This is a triple function button. Press the button for one second and the beeper will sound (if set) and a key symbol will appear on the grip display signifying that the controls (except the shutter release) have been locked and therefore cannot be altered unintentionally. Press the button for one second again to unlock.

4 AF button

Press this button to directly access the autofocus/manual focus selection screen from the main screen. See under Lenses for full details.

5 ISO

This is a triple function button. It provides direct access to the ISO settings (see Light Metering & Exposure Control for full details). A long press on the ISO button toggles Drive Mode between Single and Continuous.

6 MENU / Video button

Press this button to activate the Main Menu on the Sensor Unit Display. A long press activates Video Recording Mode. A long press again returns to Camera Mode.

7 Browse Mode / Illumination

One click enters Browse mode. Click again to exit Browse mode. The wheels now controls Aperture/Shutter. A long press illuminates the display. Remains active until the camera enters Display Off mode.

8 ON / OFF (Profiles) button

Press the button for 1 second to activate the camera. The H6D start-up logo will appear and then the main screen.



After a few seconds (customizable) the camera will enter Display Off mode. A long press of the button turns the camera off completely (even from Display Off mode) signified by an audible signal (if set). Click on the button to access the Profiles feature (see later section for details).

9 Rear scroll wheel

The scroll wheel is used to make changes in exposure settings, to provide access to the grip menu for settings, to navigate the sensor unit's menu as well as acting as browse control.

Note!

For the soft buttons 3 to 8 there is a difference between a short click and a long press. A long press is at least one second. Soft button 4 does not have any long press function.

3.5 CAMERA BODY BUTTONS AND CONTROLS

1 True Focus button

As default setting, this button activates True Focus (see separate section for description), but it also acts as a Zoom-in button when browsing or as Selector button when making a setting change on the sensor unit, according to mode. This button can be programmed to have other functions.

2 CFast and SD Card format button

This button displays the Format Dialogue on the Sensor Unit Display. It is recessed to prevent unintentional use.

3 AE-L button

As default setting, this button activates AE-L that locks a light reading made in both automatic and manual exposure modes. It also acts as a Zoom out button when browsing or as Exit button when making a setting change on the sensor unit, according to mode. This button can be programmed to have other functions. See Light Metering and Exposure Control/AE-L button for full details.

4 M.UP button

This button has a toggle function: press to raise the mirror and press again to lower it. A quick double press of the button (two within a half second) will access the Self timer function. This button can be programmed to have other functions.

5 Remote release cord port

Port to attach a remote release cord (electrical). The socket is protected by a captive rubber plug.

6 STOP DOWN button

Press to make a visual check of the depth-of-field on the viewfinder screen at the chosen aperture. The aperture will close according to the setting and remain closed as long as the pressure is maintained. You can alter the aperture at the same time to see the changes taking place. This button can be programmed to have other functions.

Note!

Some buttons can be re-assigned to other functions. There are three control buttons on the rear of the grip.



Note!

Customizable buttons True Focus, AE-L, M.UP and Stop Down, are very useful and can save you a great deal of time and effort. See separate sections for full details.

3.6 SENSOR UNIT

1 MENU / (EXIT) button

This button opens and closes the menu system. It is also used for other tasks (for example EXIT button) as you issue commands navigating the menu system.

2 Soft button

This button is “delete image” in browse mode. Can also be soft button depending on screen information.

3 Image rating button

Rate image 1-5 stars or green/yellow/red. Also works as soft button. (Only available in a later Firmware release).

4 Soft button

Function depends on screen information.

5 Browse button

Starts display and shows the last image. The user can review images, browse and zoom. Preview images and zoom in to view close-ups of previews for focus checking. Zoom out to view several at once and finally to view and select folders and media.

6 CMOS and IR filter

The sensor is positioned behind a permanently mounted IR filter. Always be very careful not to touch or scratch the surface of the filter when it is exposed. Replace the protective cover whenever the sensor unit is not mounted on a camera.

7 Data bus connectors

Connectors for digital communication with the camera body.

8 Retaining bar

Main support for the sensor unit.

9 Storage media cover

CFast or SD cards.

10 Connections cover

Cover for External Connections.

11 Audio Out

Connector for external 3.5 mm Stereo Audio Out Plug.

12 Flash sync input

Connector for 2.5 mm Flash Sync input plug.

13 Audio in

Connector for Audio In Microphone 3.5 mm stereo plug.

14 Flash sync output

Connector for 3.5 mm Flash Sync output plug.

15 External power in

Connector for External Power in plug.

16 HDMI

Connector for Mini HDMI plug.

17 USB 3 Tethering plug

Connector behind protective door for USB 3 plug.

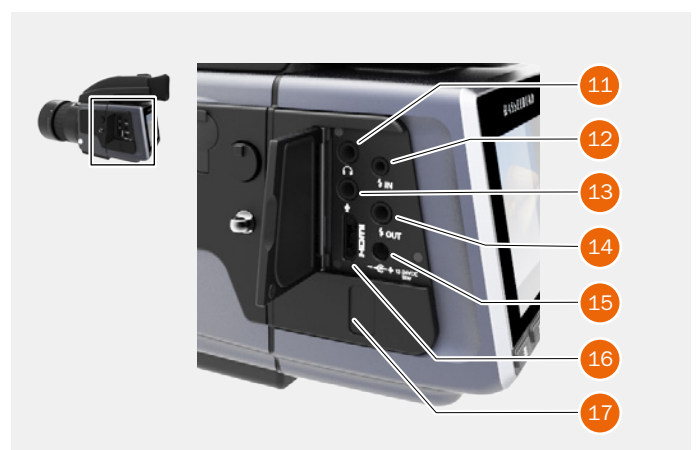
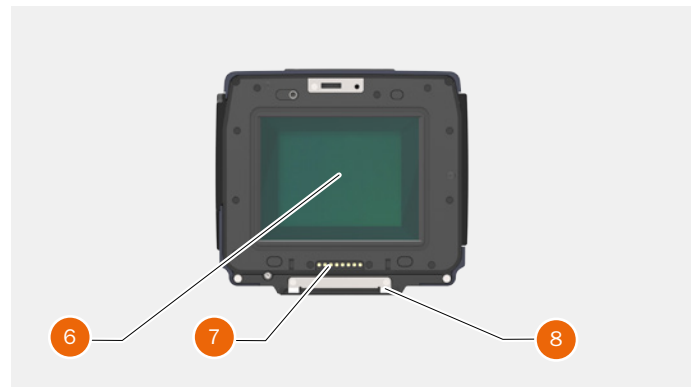
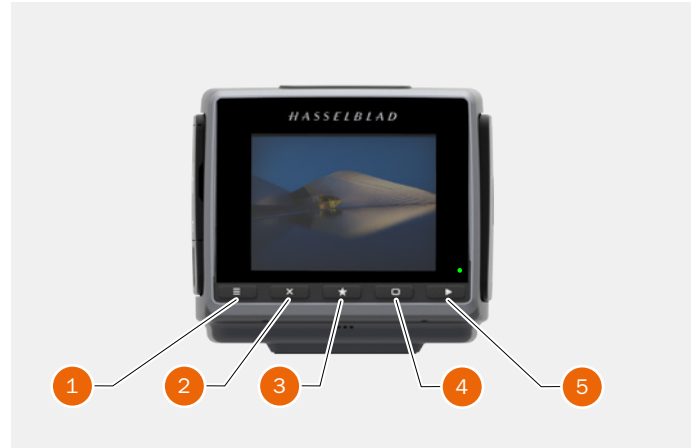

3.7 VIEWFINDER



1 Hot shoe

Connection for automatic flash unit (with SCA 3902 adapter) or for wireless flash trigger.

2 Rubber eye cup

Can be exchanged for another model.

3 Eyesight adjustment wheel

The personal eyesight adjustment facility has a dioptre range of -5 to +3.5, to suit most users.

4 Exposure and flash compensation button

Press this button to access the EV compensation screen. Flash settings are made with the front scroll

wheel. Exposure settings are made with the rear wheel. The EV correction values are shown on the grip. In the viewfinder display, a plus or minus symbol is shown, if the value differs from zero.

5 Exposure mode / Metering mode

The EXP (Exposure) button accesses the exposure and metering mode options screen. Settings are made with the front and rear scroll wheels and the appropriate symbols appear on the grip and viewfinder displays accordingly.

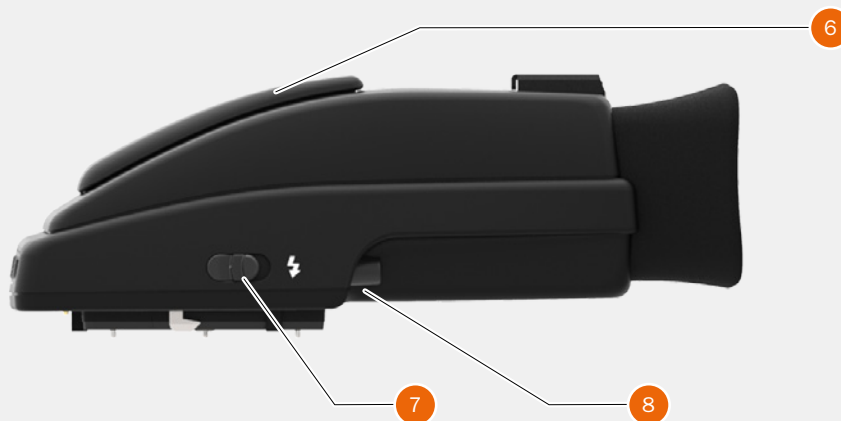

6 Integral flash unit

Manually opened with flash unit release button.

7 Integral flash unit release button

Slide the button towards the rear of the camera to raise the integrated flash. Activation is automatic.

8 Viewfinder release button

Press towards the front of the camera and lift the viewfinder upwards. Mount protection lid.

3.8 LENSES



You can also download technical data sheets from the Hasselblad website, www.hasselblad.com, or you can download a combined version. You can also download a lens booklet that contains a round up of the available lenses and some general information.

3.9 DISPLAY INFORMATION

Viewfinder information

- Metering method
- Aperture setting
- Shutter speed
- Exposure method
- Capture counter
- Exposure compensation
- Focus assist
- Warning triangle
- Flash warning
- Spirit level
- ISO
- WB

Grip LCD information

- Metering method
- Aperture setting
- Shutter speed
- Exposure method
- Capture counter
- ISO
- White Balance
- Flash indication
- Focus
- Drive
- EV
- Battery status
- Histogram (optional)
- Memory Card Status



PHOCUS / PHOCUS MOBILE INFORMATION

- Metering method
- Aperture setting
- Shutter speed
- Exposure method
- ISO
- White Balance
- Flash indication
- Focus
- Drive
- EV

Rear LCD information

- ISO / White Balance
- IAA rating
- Storage medium
- OPTIONAL**
- Exposure comp.
- Histogram
- Date
- Time
- Lens focal length
- Spirit level



Optional accessible full screen display of grip information to show:

Metering method, Aperture setting, Shutter speed, Flash indication, Focus, Drive, EV, Battery status, Exposure method, Capture counter, ISO, White balance.

3.10 SENSOR UNIT DISPLAY AND CONTROLS

When shooting, the Sensor Unit can display the information most often required for a quick settings check. The unit's buttons, grip scroll wheels and camera buttons together with the touch display are used to navigate the main menu and change settings.

The touch display can show all saved captures on a CFast or SD card. You can Browse and Zoom the Captures for detailed inspection.

When shooting, you can control the amount of information visible together with the current preview by choosing various modes.



Buttons and scroll wheels

In Browse mode, the Scroll Wheels, True Focus and AE-L buttons are used for navigation.

Activate Browse mode by pressing on the right button below the Sensor Unit Display or on the Browse button on the Grip.



Control Screen with Grip information

The Control Screen is interactive. Swipe down to display the Control Screen. Select any of the settings to change the value. Aperture setting, shutter speed, focus setting, drive, EV, battery status, exposure method, capture counter, ISO and white balance can simultaneously be displayed and changed on the sensor unit on the Control Screen.



3.11 GRIP DISPLAY

TYPICAL GRIP DISPLAY

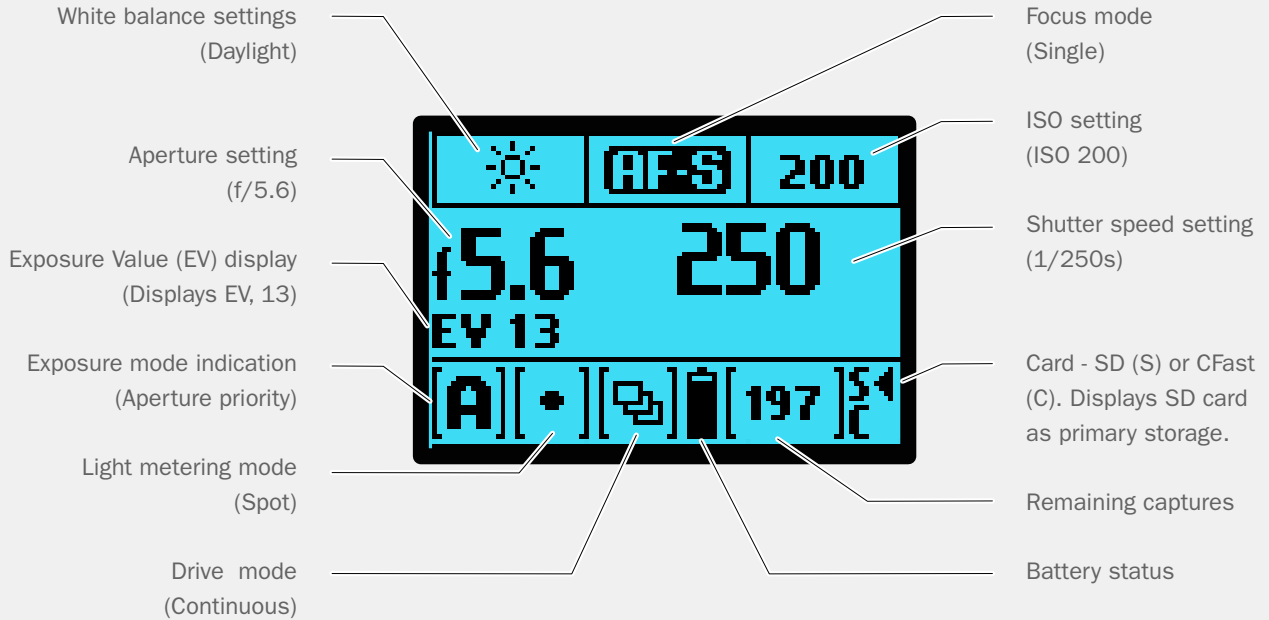

TYPICAL GRIP DISPLAY WHEN CHANGING SETTINGS



- 1 White Balance, Autofocus and ISO settings**
The upper row on the screens display the White Balance (WB) the selected Autofocus (AF) and ISO settings selected.
- 2 Settings symbols**
Symbolize the options available when settings are changed.
- 3 Setting information**
The lower row on the screen displays information about the current state of the setting.

Note!

Scroll wheel description and direction
Arrowheads symbolize which scroll wheel should be used to change setting.

left and right arrow = front scroll wheel
up and down arrow = rear scroll wheel



3.12 VIEWFINDER DISPLAY

TYPICAL VIEWFINDER DISPLAY

Viewfinder Display visual user interface

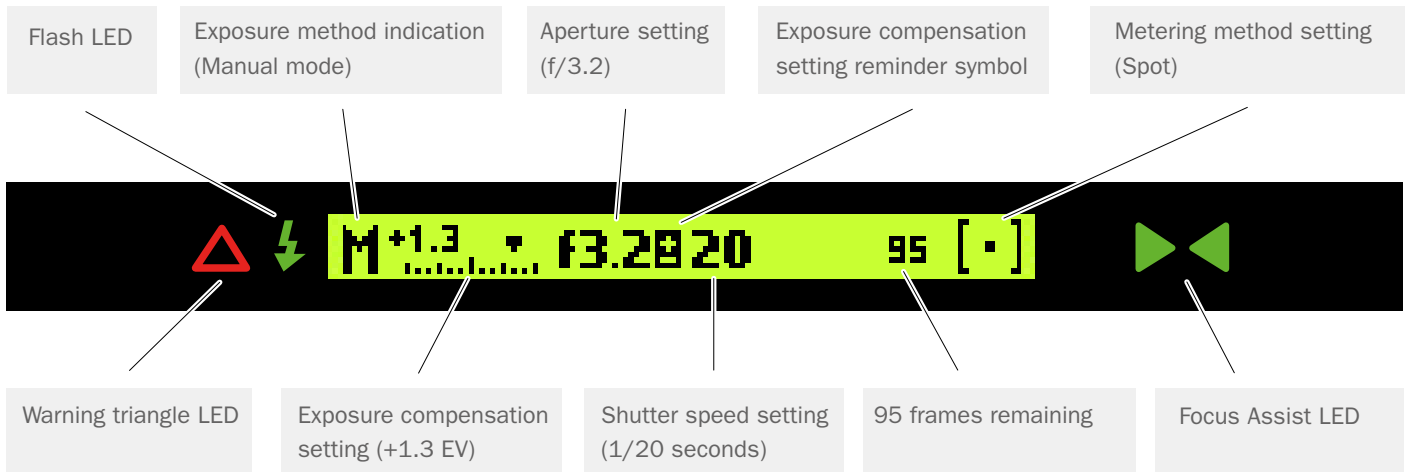

Note!

The LED's will only be visible when activated by the camera or a setting.

VIEWFINDER DISPLAY ACCORDING TO SETTING

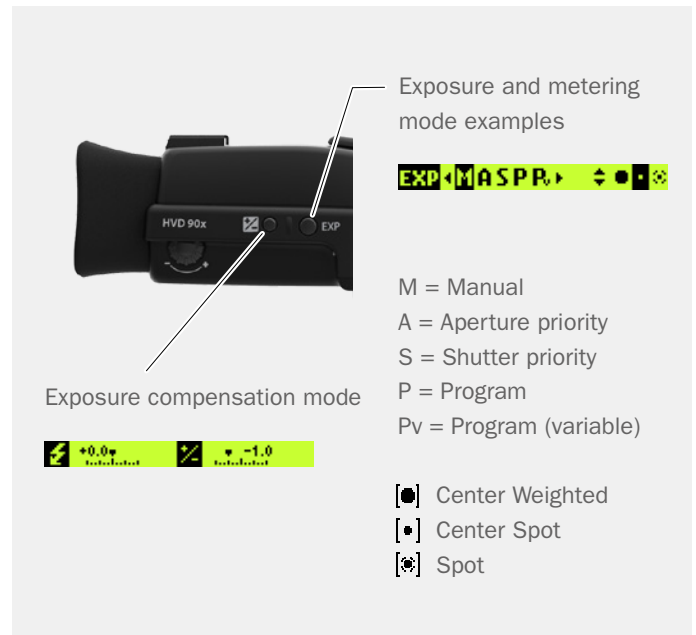
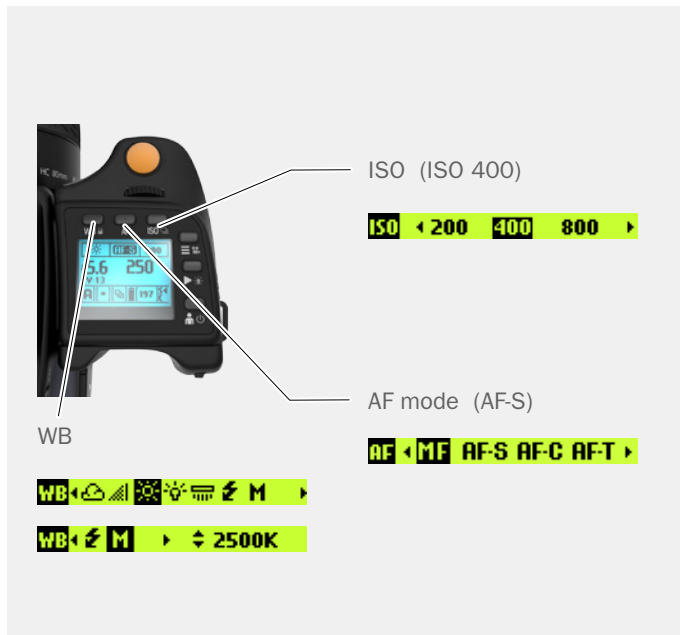

Exposure and metering mode examples

- M = Manual
- A = Aperture priority
- S = Shutter priority
- P = Program
- Pv = Program (variable)

- Center Weighted
- Center Spot
- Spot

3.13 RE-ASSIGNABLE GRIP BUTTONS FUNCTION OPTIONS

These four grip buttons are by default assigned according to name but can be reassigned (in Main Menu > Camera Settings > Controls or in the Camera Configuration tool in Phocus) to various other functions listed here.

True Focus

Temporarily activates True Focus function.

AF-Drive

Temporarily activates AF Drive.

AE-L

Temporarily locks a light reading in auto or manual modes. Also used in Zone metering.

M.UP / Mirror up

Locks mirror up for minimal vibration.

Stop down

Activates stop down function for depth of field checking.

Self timer

Sets self timer mode. Provides a timed remote shutter release function with the option of a change in sequence of the mirror movement (to reduce vibration).

Bracketing

Sets Bracketing mode. This function provides an automatic series of captures; one at the standard exposure setting, Manual or Auto, and the others with predetermined deviations in EV from the standard exposure.

B mode

Sets B mode shutter setting. Shutter stays open as long a pressure is maintained on shutter release button.

T mode

Sets T mode shutter setting. Shutter stays open after first press of shutter release button (toggle function to close again).

Flash Measure

Activates manual flash measure function.

Interval timer

Activates interval function start screen.



Cycle Light Meter mode

Selects next light metering mode.

Expose

Provides alternative to shutter release button.

3.14 SHORT CUTS

- 1 Menu button** – Setting option access. Press MENU button on the Sensor Unit.
- 2 Browse button** – Starts image browse mode.
- 3 Shutter release button** – Camera activation. Re-activates camera from Display Off mode. After making any changes, press EXIT (Menu button) or shutter release button to save the new setting.
- 4 Shutter release button** – A half press always exits all menus and returns to shooting mode.
- 5 Front scroll wheel** – Menu navigator / Browser. Functions as a horizontal navigator on sensor unit menu as well as a capture browser in Browse mode.
- 6 Menu button** – Toggles the Grip Menu Mode On and Off
When in Menu Mode the wheel is used to navigate the menus of the Sensor Unit. When not in Menu Mode the wheel controls the Aperture and Shutter speed. A long press on this button toggles the camera between video and camera mode.
- 7 Profiles button** – Camera activation
Enters Profiles menu. Profiles will be available in a firmware update. Re-activates camera from Display Off mode.
- 8 Rear scroll wheel** – Menu navigator
Functions as a vertical navigator on sensor unit menu while in menu mode. When not in Menu Mode the wheel controls the Aperture or Shutter speed.
- 9 True Focus button** – Camera activation
Re-activates camera from Display Off mode.
- 10 True Focus button** – Zoom-in button
Automatically acts as Zoom-in button when in Browse mode.
- 11 True Focus button** – Selection button
Automatically acts as value selector on sensor unit menu when in Menu mode.
- 12 CFast and SD Card format button** – Formats the current inserted CFast or SD card (requires confirmation).
- 13 AE-L button** – Re-activates camera from Display Off mode.
- 14 AE-L button** – Zoom-out button. Automatically acts as zoom-in button when in Browse mode.



- 15 AE-L button** – Selection button. Automatically acts as value selector on sensor unit menu when in Menu mode.
- 16 Mirror Up button** – Camera activation. Re-activates camera from Display Off mode.
- 17 Stop Down button** – Re-activates camera from Display Off mode.

3.15 PHOCUS OVERVIEW



Phocus

Phocus is the Capture Processing and File Management application aimed primarily at Hasselblad 3F file handling. Phocus is available for both Mac and Windows.

Professional Image Quality

Phocus combines Hasselblad Natural Colour Solution (HNCS) with Digital Auto Correction (DAC) to provide high digital image quality in the images you create. With Phocus, the moiré effect that can occur on even extremely high resolution images is effectively removed automatically and directly on the raw data, leaving the image quality intact and saves time in post production work. Tethered shooting is efficient with Phocus Remote camera controls providing a number of remote functions. For example remote focusing, live view, aperture and exposure time controls.

Phocus Mobile

Phocus Mobile is available for iPhone®, iPad® and iPod Touch®. It enables you to connect wireless to a computer running

Phocus and to remotely browse your high-resolution RAW, JPEG and TIFF images. This provides a solution for working with clients in the studio, enabling each person to view images on an individual iOS device, rather than all gathering around a single computer. Phocus Mobile also allows users to remotely operate and trigger a tethered camera, giving control of many parameters, all neatly presented in a virtual camera display. This feature is very convenient for remote control of the camera when it's located in a difficult to access position.

Phocus Mobile is available for free download in the Apple App Store. www.apple.com.

3.16 CAMERA CONFIGURATION IN PHOCUS

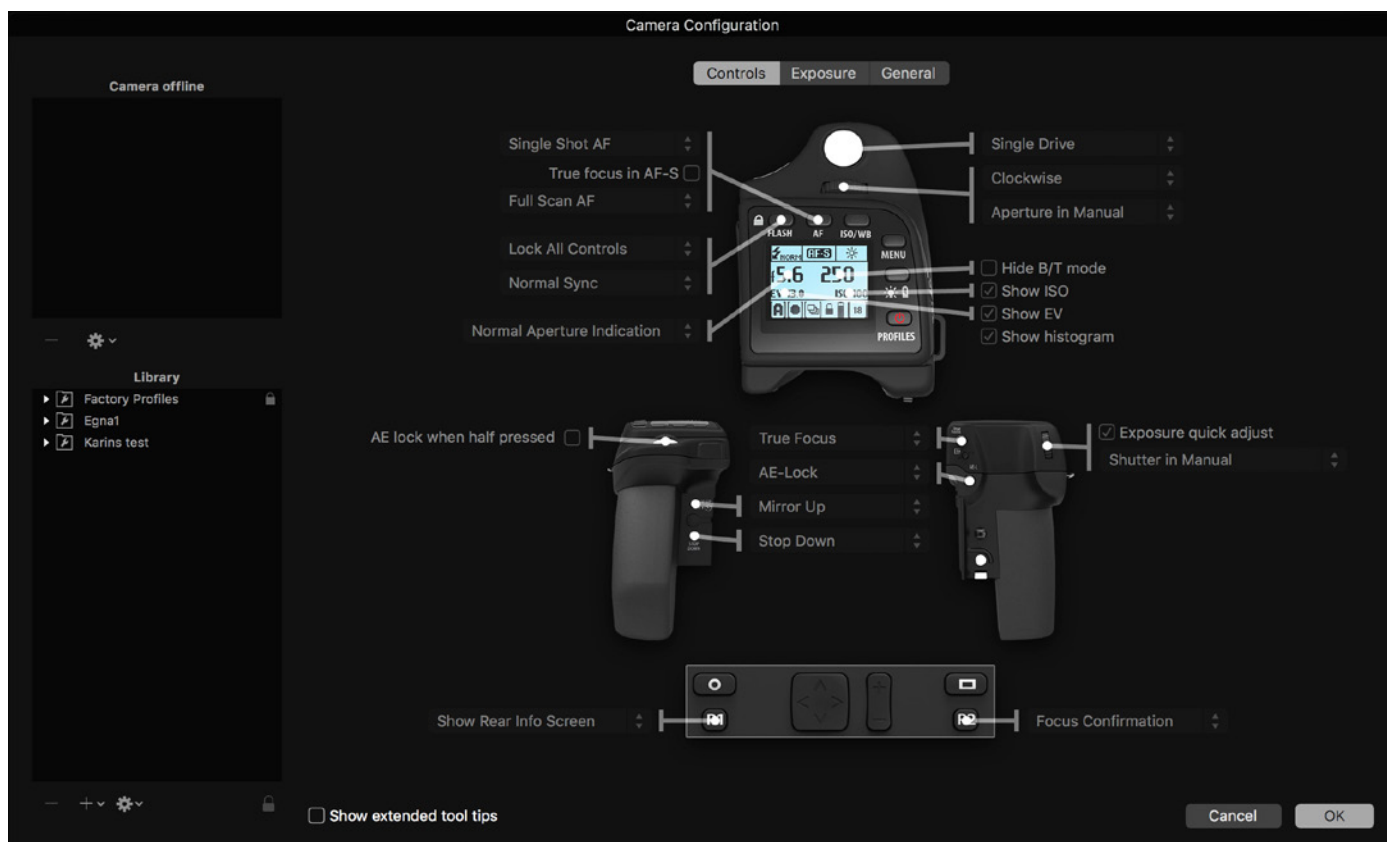

The Camera Configuration tool in Phocus offers a very thorough and secure way of creating comprehensive profiles for the H6D. There are three windows – Controls, Exposure and General – that present virtually all parameters to enable total control at the press of a button. This means that separate and specific custom profiles created in advance can cover a number of shooting scenarios.

In addition these profiles can be easily imported and exported. For instance, you can create a special profile to suit a specific type of shoot and keep it on a memory stick or laptop. So, when renting an H6D for example, you only have to upload the saved profile to ensure that all parameters have been reset without you having to go through each detail – simple and secure.

The interface has three tabs at the top, Controls, Exposure and General, that access the windows. Descriptive information appears as you mouse over the various menus and extra tool tips are additionally available as an option. To take an example, the Controls window is illustrated here. On the left are two lists: Camera and Library. The Camera list includes the various available configuration profiles already stored in the camera – the profile currently in use as well as the default settings and those you have created or imported from other sources. Library contains the factory pre-sets stored on disk.

Creating a profile

- 1 Open Camera Configuration located under the Windows menu.
- 2 Connect the camera and in the Camera list click on a profile you want to change or a spare profile and name it.
- 3 Cycle through the three windows, Controls, Exposure and General, making the appropriate selections that you require. When complete, select the new profile and drag and drop or right click it to store in the Library.
- 4 Right click the Library version of the profile to access the Transfer Profile Set to Camera option then click on OK to complete the action. This causes the new profile to appear on the grip display for selection when you click on the Profiles button.

Right click a profile in Library to access the Rename, Reset to Standard, Delete and Export options if required. Import, Export, Transfer, Add Profile etc. tools are also available.

3.17 BATTERY AND BATTERY GRIP

Rechargeable battery grip

The environmentally approved Battery grip Li-ion (3043357) is the standard power source for the H6D camera. The H6D requires a power supply for all actions as there is no mechanical reserve facility. It is therefore advisable to keep a reserve rechargeable battery grip at hand. As is the case with most batteries, problems might be encountered when used in very low temperatures. In this situation it is advisable to keep the reserve battery in an inside pocket, for example, to maintain it near body temperature.

Remove a battery

Remove the battery from the camera by pressing the battery holder button (1) and simultaneously swinging the battery holder retaining lever (2) down until it stops. Pull the battery downwards (3).

Mount a battery

To fit, hold the battery flat against the camera body and aligning the two upper lugs with the slot, slide it back into position as far as it will go. Swing back the battery holder retaining lever (2) until it clicks back into place.

Store a battery

If you intend to store the battery separate from the camera, ensure the safety cover is mounted over the electric connections on the battery to prevent short-circuiting. It snaps into place and is removed by pulling outwards and upwards on the locking clip.

Connect battery to charger

Mount the charger plug in the plug connector on the inside of the battery (4).

See next page for more in depth information.

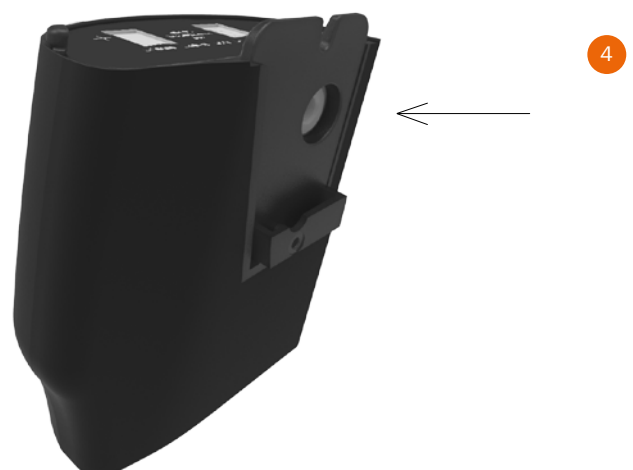

Overview

3.18 BATTERY CHARGER

The battery charger is supplied with a number of plug attachments to suit various types of domestic electrical sockets available worldwide. Other types of socket will require a domestic socket converter.

Attach the chosen plug by sliding it into position as in the diagram. Removal is by the reverse procedure. Please note that the Battery charger BCH-2 (3053572) is designed for use with Battery grip Li-ion 3200 (3043357) but can also be used together with the Battery grip rechargeable 7.2V Li-Ion 2900 (3043356) intended for H5D use.



CHARGE THE BATTERY

With the battery removed from the camera, insert the jack plug from the battery charger into the socket on the battery grip (1). Insert the battery charger into a standard (100–240V~/50–60 Hz) domestic socket.

During the charging procedure, the lamp on the charger signifies the following:

- | | |
|----------------------|--------------------------------|
| Steady Green light: | Standby (no battery connected) |
| Steady Yellow light: | Charging |
| Steady Green light: | Ready! |

NOTE!

It can take about 6 hours to charge the battery completely up to 100% the first time.

See next page for more details and precautions.



RECHARGEABLE BATTERY GRIP SPECIFICATION

LHION/ BATTERY CHARGER 3053572 BCH-2

– PRECAUTIONS and GENERAL

The battery should be charged for approximately 6 hours before first time use.

The battery must be charged at room temperature.

Maximum battery capacity is reached only after the battery has been charged and discharged several times.

Avoid frequent full discharges (a full discharge is signalled by the appearance of the Replace battery warning on the grip display). As the battery is a Li-ion type, it has no 'memory effect' of practical importance and therefore frequent recharges will cause no problems such as loss of capacity or poor performance. It is therefore better policy to recharge the battery at very regular intervals, regardless of use.

Remove the battery if you intend to store the camera for some while as it will eventually become completely drained, even though the camera is turned off.

The battery has an integrated 'fuel gauge' capability that supports the Replace battery and Battery status functions on the grip display. As with most Li-ion batteries, this capability should be occasionally calibrated, depending on how much the battery is used. To do this, leave the camera on (or use it), until the Replace battery warning appears. Then, recharge the battery for 6 hours. This will improve the accuracy of the measurements.

When removing a battery from the charger and immediately replacing it with another, allow a few seconds to elapse so that the charger can automatically reset for the next charging procedure.

It is perfectly normal for the battery to become warm when being charged.

A slight temporary loss of battery performance might be noticed at very high or low temperatures. Take the appropriate measures if this is the case.

If you do not intend to use the battery for a while, it is best to store it at room temperature with an approximate 30 to 40% charge. You can check the percentage level on the status screen.

The battery should have a usable service life of around 400 recharge/discharge cycles.

Connect the battery grip to the camera correctly.

Keep the protective cover in place when not in use. (Short circuiting across keys in a pocket, for example, could cause a fire risk).

Do not immerse the battery grip in liquids.

Do not incinerate the battery grip.

Please recycle or discard in an environmentally approved manner.

Use indoors only (protect against moisture).

Do not short circuit the jack plug.

Do not alter the charger in any way other than changing the plug attachment.

Note!

You can save battery consumption by changing the Display Off / Sleep / Power Off settings as well as the brightness settings of the display.

BATTERY LIFE AND BATTERY WARNING

Battery life is dependent on a number of variable factors and therefore cannot be exactly predicted. If the camera is left in the active state instead of Display Off or Sleep modes for long periods, for example, then the battery will become exhausted much faster. A low camera battery state is indicated by a symbol on the grip display, in the viewfinder as well as on the sensor unit display. In addition, an audible signal sounds. When the battery is almost completely exhausted, a warning message “Replace battery” will appear on the grip display.

3.19 TEMPERATURE WARNING

Many rapidly taken captures make heavy demands on the processor in the sensor unit which in turn produces heat. This, particularly in combination with high ambient temperature, can result in noise in the image files. To prevent this, the sensor unit displays a warning icon when the temperature rises. At ca. 60° C a warning dialogue appears notifying that the sensor unit is temporarily shutting down to allow the unit to cool.



3.20 POWER MODES

MAIN MENU > GENERAL SETTINGS > POWER & TIMEOUT

The H6D Camera can be set to automatically turn off the Sensor Unit Display after a set amount of seconds to save battery for example.

It can also be set to Power Off after 5, 10 or 30 minutes.

- 1 Press the General Settings icon on the Sensor unit display.
- 2 The General Settings Menu will appear.
- 3 Press the Power and Timeouts icon.

Swipe right or press Menu / EXIT button to get back to Main Menu.



Power and Timeouts Menu

Display Off

Select Display Off Settings.

- 3 seconds.
- 5 seconds.
- 10 seconds.
- 20 seconds.
- 30 seconds.
- 60 seconds.
- Never.

Power Off

Select Display Power Off Settings.

- 5 minutes.
- 10 minutes.
- 30 minutes.
- Never.

3.21 AUTOMATIC SETTINGS

DISPLAY OFF

MAIN MENU > GENERAL SETTINGS > POWER AND TIMEOUTS > DISPLAY OFF

In this mode the camera turns off the grip and sensor unit displays but remains ready to be immediately reactivated to the ON mode. The time intervals are: 3, 5, 10, 20, 30, 60 seconds and Never.

POWER OFF

MAIN MENU > GENERAL SETTINGS > POWER AND TIMEOUTS > DISPLAY OFF

In this mode the camera is completely without power and has to be started by pressing the ON button again - simple reactivation is not sufficient. The time intervals are 5, 10, 30 minutes and Never.



3.22 REMOVE AND ATTACH THE VIEWFINDER

To remove, hold the viewfinder in the right hand and while pressing the viewfinder release button (1), lift the rear of the viewfinder up and away from the camera body (2).

To attach, hold the viewfinder at a slight angle and rest it on the top of the camera. Slide the viewfinder forward until the front locating pin is in position in the recess in the front edge of the viewfinder screen aperture on camera body.

Press the rear part of the viewfinder firmly downwards until it clicks into place.

Ensure that both sides of the viewfinder are seated correctly and that it has been firmly attached and locked into position.

Failure to do so could cause an intermittent malfunction if the data bus interface connections between the viewfinder and camera body are not positively secured.

Note!

Do not lift or hold the camera by the viewfinder alone.



3.23 EYEPIECE ADJUSTMENT

No corrective lenses are needed to adjust the eyepiece to suit most requirements. The dioptre range is from -5 to +3.5D. Eyeglass wearers can rapidly and accurately change the settings according to whether they wish to wear eyeglasses for viewing or not. Personal eyepiece adjustments can be carried out by pointing the camera at the sky or similar smoothly toned area. While holding the camera in your left hand, you can with your right thumb turn the adjustment wheel until the markings on the viewfinder screen reach the optimum sharpness for your eyesight. If you normally wear eyeglasses for distance viewing and intend to wear them for camera use then do not remove them for the above procedure. If, on the other hand, you prefer to remove your eyeglasses for camera work, then repeat the above procedure without wearing your eyeglasses.



3.24 RUBBER EYE CUP

Two rubber eye cups are available for the H6D. The one supplied is suitable for users who do not intend to use eyeglasses when photographing. The second shorter eye cup is for those who either prefer to position their eye further from the viewfinder and those who wish to wear eyeglasses. The eye cups can be rapidly changed by a Hasselblad Authorized Service Center.



3.25 ACCESSORY CONNECTION

There are two accessory retaining screw threads (M5) as well as a data bus connector on the left hand side of the camera body, protected beneath a cover (1).

The cover can be removed by first lifting the left hand edge (1) a little and then sliding the cover to the left (2), as in the illustration.

Lift the front edge of the cover first (1).



3.26 PC FLASH CONNECTOR

A PC connector for non TTL flash synchronisation (3) is located on the left side of the body. It is protected by a captive rubber plug.



3.27 PROTECTIVE BASEPLATE

REMOVE THE PROTECTIVE BASEPLATE

- 1 To remove the protective base plate, lift the securing catch while pushing the plate towards the lens (A).



ATTACH THE PROTECTIVE BASEPLATE

- 1 To attach it again, slip it over the camera foot until it stops and the securing catch snaps into place (B).



3.28 MEMORY CARDS

There are two types of memory cards that can be used with the H6D camera.

- 1 CFast card.
- 2 SD card.

When using a CFast card or SD card, the H6D is completely self contained. No additional wires or connectors need to be attached.

The recommended type is UDMA/type 4 /60MBs (400x) or better. Please see the Appendix in this manual for a list of recommended cards.

The H6D is shipped with an 16 GB SDXC SD card, which is capable of holding approximately 75 – 150 captures (according to model).

Note!

All cards should be formatted in the camera before first use!

Memory Card Status Display

CFast card

- C = Inserted, non active.
- C< = Inserted, active.
- C[0] = Full.
- C! = Card Error.
- No Symbol = No Card inserted.

SD card

- S = Inserted, non active.
- S< = Inserted, active.
- S[0] = Full.
- S! = Card Error.
- Lock Symbol = Card Write Protected.
- No Symbol = No Card inserted.

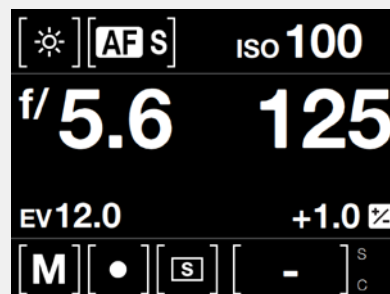
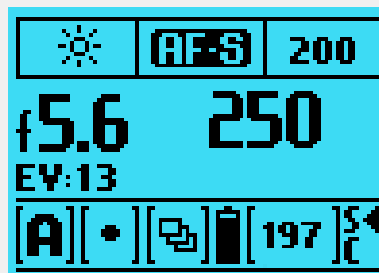

TO INSERT A MEMORY CARD

Insert CFast card

Open the CFast card cover (1) on the sensor unit by inserting a thumb in the recess and then sliding the slot cover backwards.

Behind the cover, you will see a cover for the CFast card (2) and a cover for the smaller SD card (3).

Hold the CFast card so that the connector holes face into the slot and you can read the brand label when you are behind the camera.

Gently press the CFast card into the slot. If you encounter resistance, it might be because you are holding the card backwards or upside down.

If the card can be easily inserted nearly all the way into the back, then you are inserting it correctly. Press the card another couple of millimetres firmly into place.

Close the slot cover and slide it to the right to lock it.

Insert SD card

When the card slot cover door is opened, mount the SD card in the SD card slot (3).

Close the slot cover and slide it forward to lock it.



TO REMOVE A MEMORY CARD

Remove CFast card

Open the memory card slot cover on the sensor unit (1).

Press the CFast card (2) a little way in and then release it.

As you do this, the card will be pushed out a few millimeters.

Grab the card and pull it away from the sensor unit.

Close the slot cover door.



Remove SD card

Open the memory card slot cover on the sensor unit (1).

Press the SD card a little way in and then release it. The SD card will then move out from the SD card slot (3).

Grab the card and pull it away from the sensor unit.

Close the slot cover door.



Note!

Do not remove a CFast or SD card from the sensor unit if the “ready” light is blinking! The “ready” light is displayed in the lower right corner on the Sensor Unit Display. All files on the card may become corrupted (and consequently lost) if you do so and new formatting may also be necessary.

Overview

FORMATTING MEMORY CARDS

MAIN MENU > GENERAL SETTINGS > STORAGE

The camera is only able to read and write to storage media that have been formatted correctly. New cards sometimes have no formatting, or you might want to convert a card that is currently using a format that the camera cannot read. In either case, you must reformat both CFast cards and SD cards in the sensor unit for H6D use.

There are two ways to format cards. The quickest way is to use the Format card button on the grip but if you prefer, you can also use the menu on the sensor unit.



FORMAT BUTTON

Press the Format button (A) on the camera grip. It is purposely recessed to avoid unintentional use, so use a ballpoint pen or similar. It is also possible to click the button with a hard press with the tip of your thumb. A prompt is displayed on the sensor unit for confirmation.



FORMAT MEMORY CARDS VIA SENSOR UNIT

MAIN MENU > GENERAL SETTINGS > STORAGE

- 1 Press MENU.
- 2 Navigate to General Settings.
- 3 Choose Storage.
- 4 Navigate to Format Card.
- 5 Navigate to Format CFast or Format SD.
- 6 Confirm by pressing OK (Display button).

Note!

Only UDMA/type 4/60MBs (or 400x) cards or better are recommended for H6D use. See full list in 'Appendix' in this manual.

Note!

All CFast and SD memory cards should be formatted in the sensor unit before using them the first time.

Note!

You can add a Favourite function on the Main Menu if you often use formatting.

Storage Menu

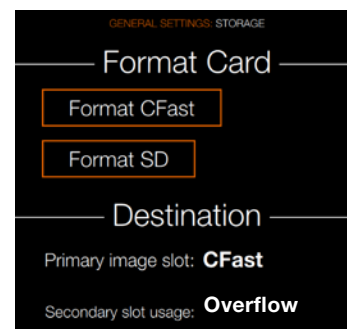

3.29 CARRYING STRAP



Carrying strap

First withdraw the safety collar. The hook is then freed and can be attached to the strap lug. Slide back the safety collar to ensure the hook remains in the locked position between the small protruding lugs. The collar is purposely a tight fit to avoid unintentionally slipping back and therefore might need some effort to slide.



3.30 REMOVE THE CARRYING STRAP

- 1 Withdraw the safety collar.
- 2 Remove the opened hook from the strap lug.



3.31 CHANGE LENS



ATTACH A LENS

- 1 Push the lens removal button (A) and remove protection cover lid (B) from the camera body.
- 2 Rotate the lens so that the red mark on the lens (C) lines up with the red mark (D) on the camera body.
- 3 Mount the lens into the camera body (E) and then turn the lens clockwise to lock its position.
- 4 Make sure the lens is locked to the camera body before using or moving the camera.



REMOVE A LENS

- 1 Hold the lens with one hand and hold the camera body (E) still.
- 2 Push the lens removal button (A).
- 3 Rotate the lens counter clockwise.
- 4 Push the lens away from the camera body.
- 5 Attach the protection cover lid (B) on the camera body directly.
- 6 Attach a lens protection lid on the detached lens to prevent damage.
- 7 Store the lens with both lens protection lids on and the lens hood (F) inverted over the lens instead of in front of the lens.



4.1 CHECK THE DELIVERY



- 1 Unpack all items.
- 2 Make sure that all the items listed on the attached package information are supplied.
- 3 Inspect all the items for damage.
- 4 If any items are missing or damaged, write down the product number of that item. If not, proceed to step 6.
- 5 Contact your Hasselblad dealer or distributor and tell them the product number of the item missing or damaged.
- 6 Keep the purchase details and the warranty in a safe place.

In the package

USB stick with instruction manual and Phocus software.

Viewfinder
Grip with battery
Sensor unit
Sensor unit protection lid

Camera body
Camera body protection lid

Lens (if included in purchase)
Lens hood
Lens protection lid x2

Battery
Battery electric socket protection lid
Battery charger plus connectors and cable



1 SD card included

USB 3 cable

Carrying strap

4.2 REASSIGN GRIP BUTTONS

These four grip buttons by default are assigned according to name but can be reassigned (in Main Menu > General Settings or in the Camera Configuration tool in Phocus) to various other functions listed here.

True Focus

Temporarily activates True Focus function.

AF-Drive

Temporarily activates AF Drive.

AE-L

Temporarily locks a light reading in auto or manual modes. Also used in Zone metering.

Self timer

Sets self timer mode. Provides a timed remote shutter release function with the option of a change in sequence of the mirror movement (to reduce vibration).

Bracketing

Sets Bracketing mode. This function provides an automatic series of captures; one at the standard exposure setting, Manual or Auto, and the others with predetermined deviations in EV from the standard exposure.

M.UP / Mirror up

Locks mirror up for minimal vibration.

Stop down

Activates stop down function for depth of field check.

B mode

Sets B mode shutter setting. Shutter stays open as long a pressure is maintained on shutter release button.

T mode

Sets T mode shutter setting. Shutter stays open after first press of shutter release button. Press the shutter release button again to close the shutter.

Flash Measure

Activates manual flash measure function visible in grip display.

Interval

Activates interval function start screen.

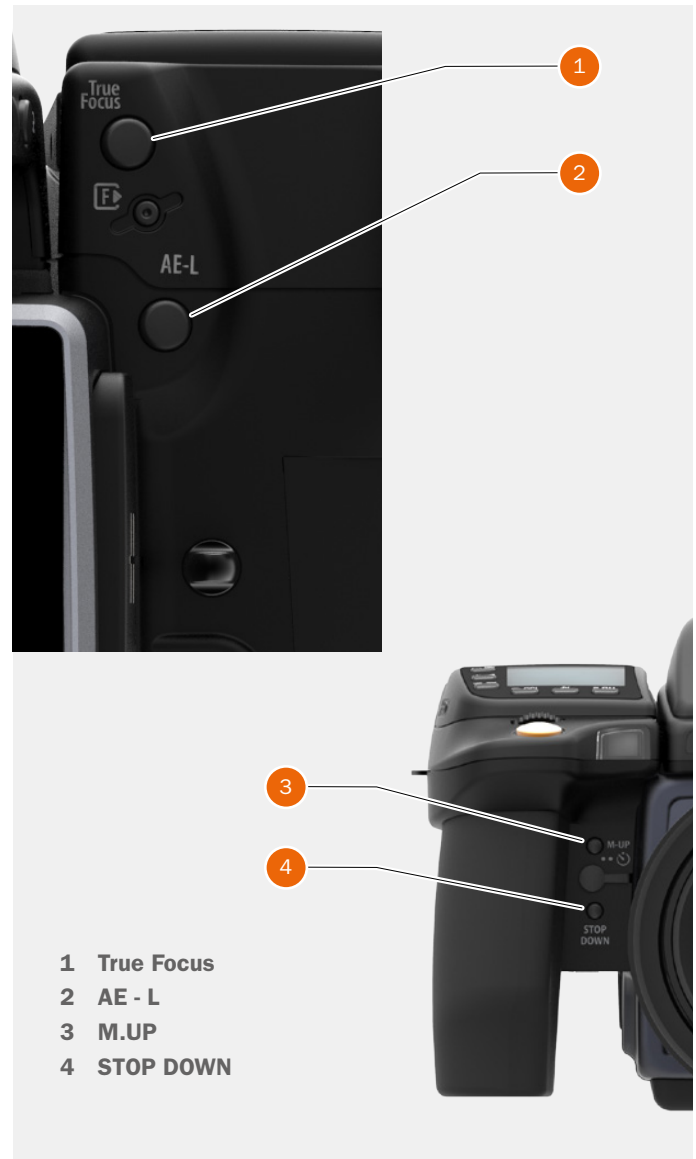

Cycle Light Meter mode

Selects next light metering mode.

Expose

Provides alternative to shutter release button.

4.3 CONNECT TO A COMPUTER

- 1 Connect a USB 3 cable to the USB port on the computer.
- 2 Open the hinged cover on the camera.
- 3 Connect the USB 3 cable to the USB port on the camera.

Note!

When connected to a computer, the following applies:

- The destination medium and location are controlled from Phocus.
- All exposure settings, including ISO, aperture and exposure time, are controlled from Phocus if you choose to expose from Phocus. In addition extra tools such as Live Video, remote focus control etc. are available. See Phocus user manual for full description.

Note!

Please note that the buttons on the unit have no function in this mode.

When initiating a shot from Phocus, the computer sends a signal to the sensor unit, which triggers the shutter (and strobe/flash, if any). The back then sends the capture over the USB connection to the computer, where it is displayed on the computer screen and saved as a 16-bit 3F file in the currently selected folder on the computer hard disk.

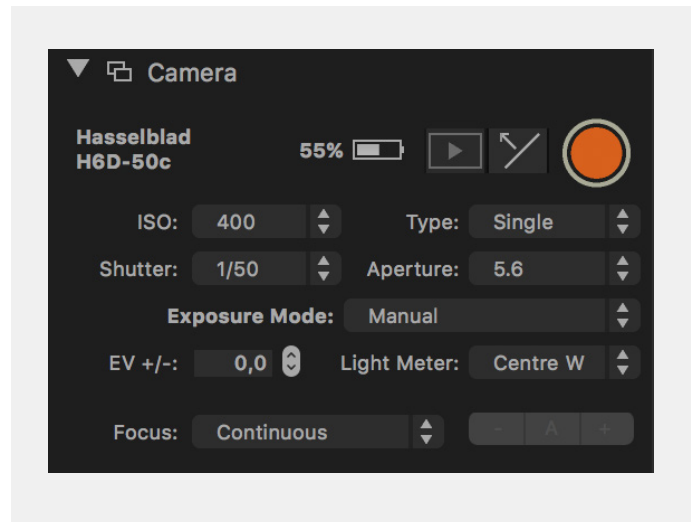

To Prepare

4.4 CAMERA INTERVAL SETTINGS

MAIN MENU > CAMERA SETTINGS >
INTERVAL

Press the Camera icon on the Sensor unit display. The Camera Settings Menu will appear.

Select the Interval Settings Menu.

Swipe right or press Menu / EXIT button to get back to Main Menu.

Camera Menu

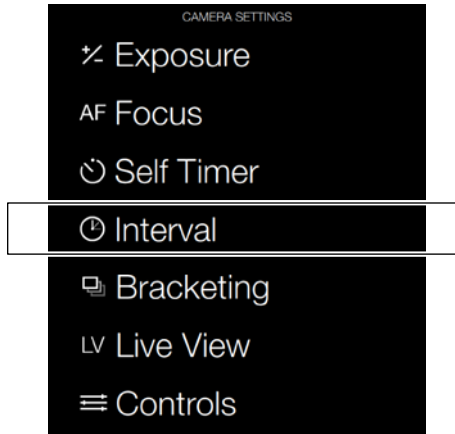

Interval Settings Menu

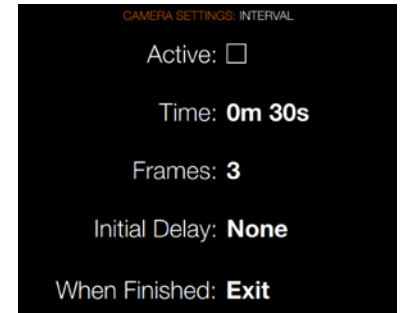

Interval Settings Menu

Active

On / Off.

Time

Select time between exposures in minutes and seconds.

Frames

Select number of Frames.

Initial Delay

Select initial Delay.

When Finished

Settings for Action When Finished.

4.5 SET DATE AND TIME

MAIN MENU > GENERAL SETTINGS > DATE AND TIME

Main Menu

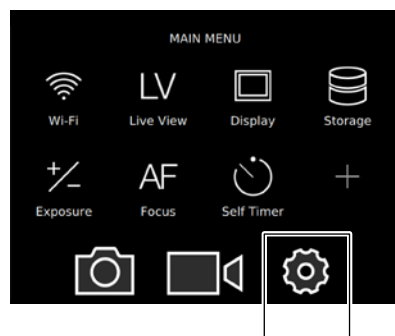

General Settings icon

General Settings Menu

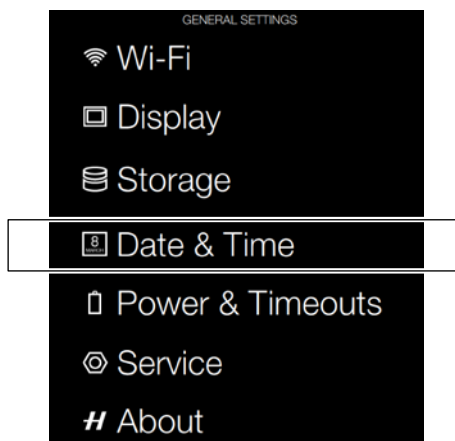

Date and Time Menu

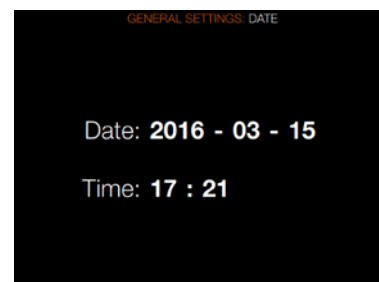

Set Date and Time

- 1 Press the General Settings icon on the Sensor unit display.
- 2 The General Settings Menu will appear.
- 3 Press the Date and Time icon.

Swipe right or press Menu / EXIT button to get back to Main Menu.

Date and Time Menu Settings

Date

Set Date by changing year, month and day using the pop up menus.

Time

Set Time by changing hour and minute using the pop up menus.

To Prepare

4.6 SET LANGUAGE

MAIN MENU > GENERAL SETTINGS > LANGUAGE

Main Menu

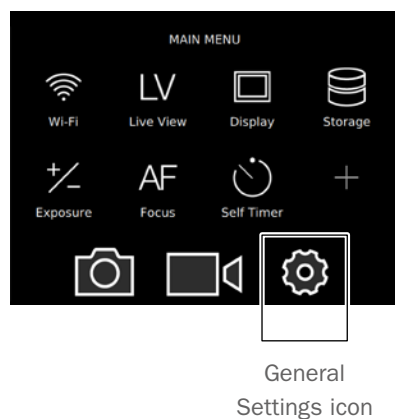

General Settings Menu

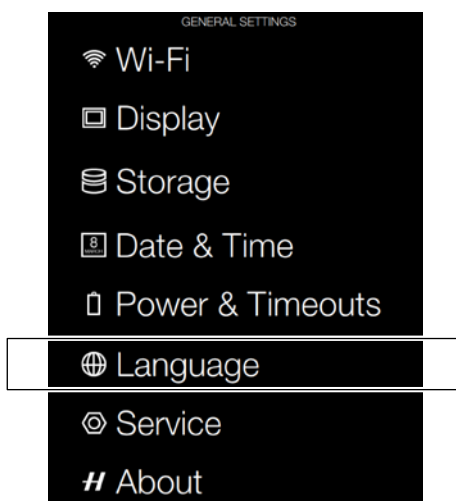

Language Menu

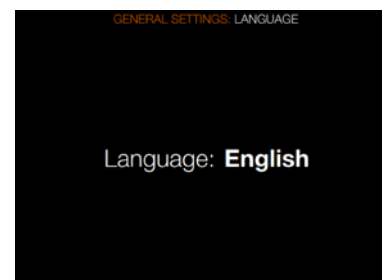

Language Menu Settings

More language options will be added in a future Firmware release.

Available Language:

- English

- 1 Press MENU button on the Sensor Unit Display.
- 2 Navigate to General Settings.
- 3 Navigate to Language.
- 4 Select Language.
- 5 Close the pop up Menu by a click outside the pop up.

Note!

If the sensor unit has been set to a language you don't understand (a rented camera, for example), see Chapter Troubleshooting for solution.

To Prepare

4.7 SET BRIGHTNESS OF THE DISPLAY

MAIN MENU > GENERAL SETTINGS > DISPLAY

Main Menu



General Settings icon

General Settings Menu

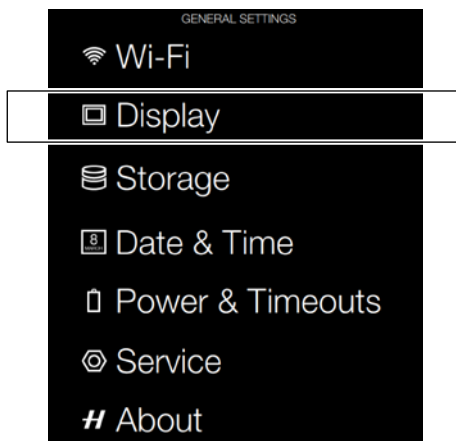

Display Menu

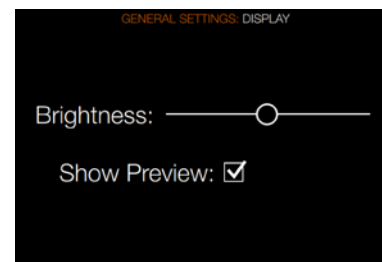

Set Display Brightness

- 1 Press the Settings icon on the Sensor Unit Display.
- 2 The General Settings Menu will appear.
- 3 Select Display.

Swipe right or press Menu / EXIT button to get back to Main Menu.

Display Menu Settings

Brightness

Slide Left or Right to change Brightness.

Show Preview

Select On / Off. On displays a preview of the capture after every exposure.

4.8 INSERT A MEMORY CARD (CFast OR SD)

There are two types of memory cards that can be used with the H6D camera. CFast card and SD card.

Insert CFast card

- 1 Open the CFast and SD card slot cover on the sensor unit by pushing it to the left or towards the back of the camera. The slot cover will then rotate out 90 degrees.
- 2 Insert a thumb in the recess and then slide it to the left. Behind the cover, there is a slot for the CFast card (A).
- 3 Hold the CFast card so that the connector holes face into the slot and you can read the brand label when you are behind the camera. Gently press the CFast card into the slot. If you encounter resistance, ensure you are not holding the card backwards or upside down.
- 4 If the card can be easily inserted nearly all the way into the back, you are inserting it correctly. Press the card another couple of millimetres firmly into place.
- 5 Close the slot cover by rotating it back and pushing it in place towards the front of the camera to lock it into position.



Insert SD card

- 1 When the card slot cover door is opened, mount the SD card in the SD card slot (B).
- 2 Close the slot cover by rotating it back and pushing it in place towards the front of the camera to lock it into position.

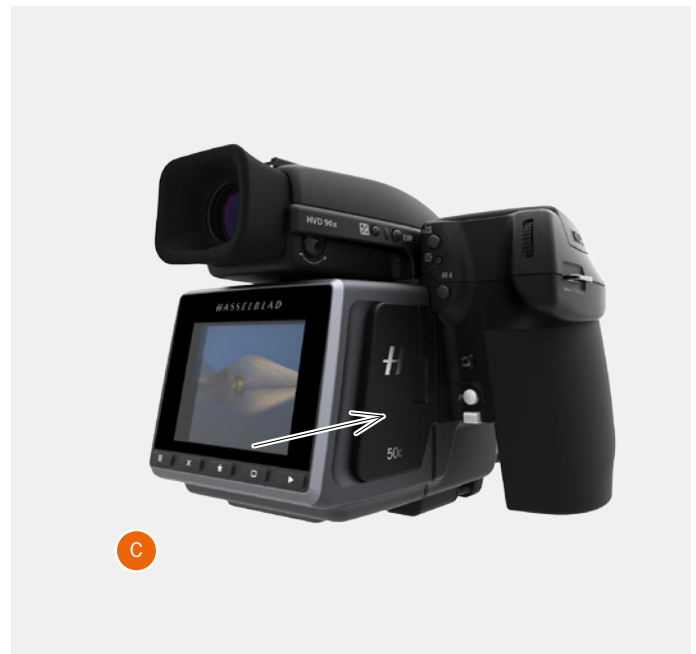

4.9 REMOVE A MEMORY CARD (CFAST OR SD)

Remove CFast card

- 1 Open the CFast and SD card slot cover on the sensor unit (A) by pushing it to the left or towards the back of the camera. The slot cover will then rotate out 90 degrees.
- 2 Press the CFast card (B) a little way in and then release it. The CFast card will then move out from the CFast card slot (B).
- 3 Grab the card and pull it away from the sensor unit.
- 4 Close the slot cover (D) by rotating it back and pushing it in place towards the front of the camera to lock it into position.

Remove SD card

- 1 Open the memory card slot cover on the sensor unit (A).
- 2 Press the SD card (C) a little way in and then release it. The SD card will then move out from the SD card slot (C).
- 3 Grab the card and pull it away from the sensor unit.
- 4 Close the slot cover (D) by rotating it back and pushing it in place towards the front of the camera to lock it into position.

Note!

Do not remove a memory card from the sensor unit if the 'ready' light is blinking (placed in the lower right corner on the Sensor Unit Display), as this will corrupt the files on the card and result in data loss. The card will also need to be reformatted.



To Prepare

4.10 FORMAT A CFAST CARD

MAIN MENU > GENERAL SETTINGS > STORAGE > FORMAT

The camera is only able to read and write to storage media that have been formatted correctly. New cards sometimes have no formatting, or you might want to convert a card that is currently using a format that the camera cannot read. In either case, you must reformat both CFast cards and SD cards in the sensor unit for H6D use.

There are two ways to format cards. The quickest way is to use the Format card button on the grip but if you prefer, you can also use the menu on the sensor unit.



FORMAT BUTTON

Press the Format button (A) on the camera grip. It is purposely recessed to avoid unintentional use, so use a ballpoint pen or similar. A prompt is displayed on the sensor unit for confirmation.

FORMAT MEMORY CARDS VIA SENSOR UNIT

MAIN MENU > GENERAL SETTINGS > STORAGE > FORMAT

Use the Rear scroll wheel or navigate via the touch screen and the dedicated 5 buttons under the Sensor Unit Display.

- 1 Press MENU.
- 2 Navigate to Storage
- 3 Navigate to Format
- 4 Navigate to Format CFast or SD card.
- 5 Confirm by pressing OK (Display button).

Note!

The H6D is capable of writing 78 MB/s to SD card and up to 400 MB/s to CFast cards.

Note!

All CFast and SD memory cards should be formatted in the sensor unit before using them the first time.



Storage Menu

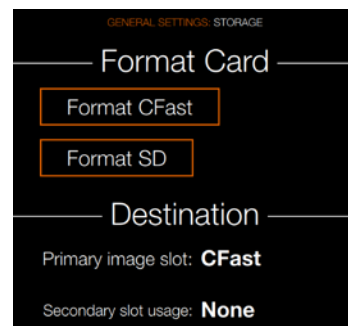

4.11 SET DRIVE MODE

There are two drive modes: Single drive and Continuous drive.

Long press on ISO button (D) toggles between Single drive and Continuous drive mode. It can also be set from Main Menu or Control Screen.

In Single mode, a capture is made when the shutter release button is pressed and the camera is made ready for the next capture.

To make the next capture however, you must first release the shutter release button and then press again.

In Continuous mode, the camera automatically makes captures and makes ready for the next capture in a continuous manner as long as you maintain pressure on the shutter release.

Please note the speed is dependent on the time taken to save the capture according to equipment.

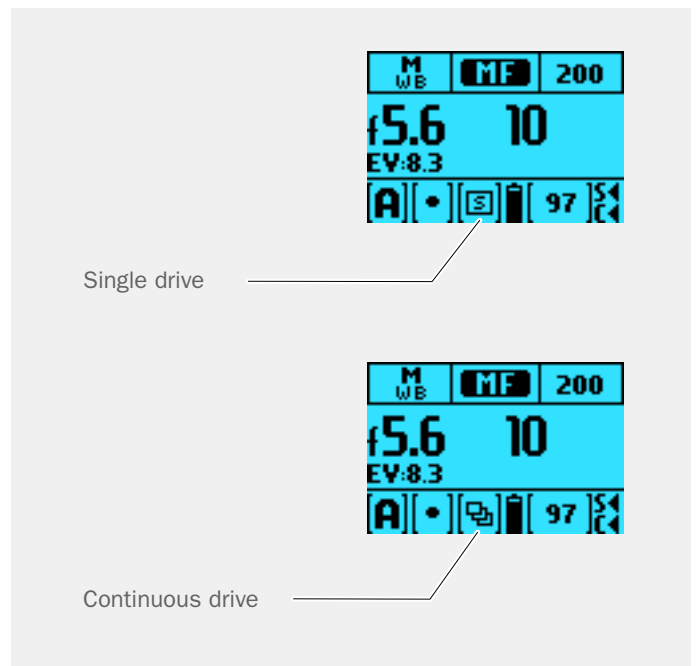

5.1 NAVIGATING THE MENUS

DESCRIPTION OF THE SENSOR UNIT MENU ITEMS

The H6D Sensor Unit Screen is Touch Sensitive and you can swipe with one finger in different directions to move up, down, forward and backward through the user interface.

Button	Screen function
1 MENU / (EXIT) button	Back to Main Menu
2 Soft button	Up
3 Image rating button	Select
4 Soft button	Down
5 Browse button	Go to image browse

1 MENU / (EXIT) button

This button opens the Main Menu. It is also used for other tasks (for example EXIT button) as you issue commands navigating the menu system.

2 Soft button

Function depends on screen information. Also acts as Delete Image button in Browse Mode.

3 Image rating button

Rate image 1-5 stars or green/yellow/red. Also works as soft button. Also toggles between 1-view and 9-view in Browse Mode.

4 Soft button

Function depends on screen information

5 Browse button

Starts display and shows the last image. The user can review images, browse and zoom. Preview images and zoom in to view close-ups of previews for focus checking. Zoom out to view several at once and finally to view and select folders and media.

By using the buttons on the control panel and the scroll wheels on the grip you can navigate through the various levels in the menu. Here is an overview of the setting options available.

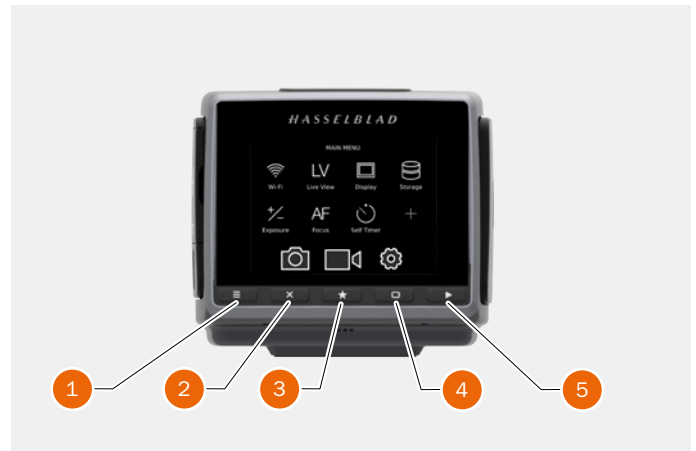

Control Screen

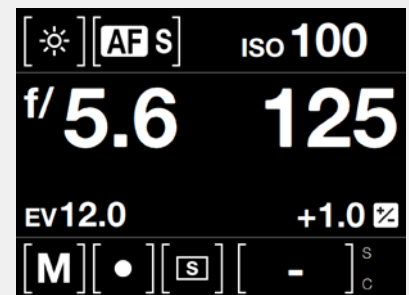

Main Menu

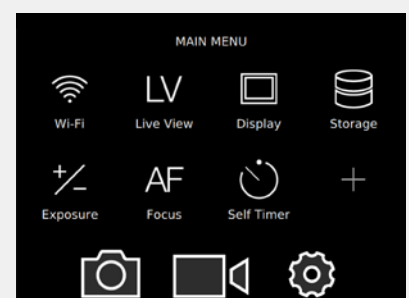

OVERVIEW OF MENUS AND SETTINGS ON SENSOR UNIT

The Sensor Unit Display can be controlled directly on the touch sensitive screen by pressing the menus and icons. You can scroll up, down and from left to right as described in previous chapters. You can also navigate the on screen menus by using the following buttons and scroll wheels:

- A Control buttons under the Sensor Unit Display for example Menu / Exit button
- B Front Scroll Wheel
- C Rear Scroll Wheel
- D True Focus Button
- E AE-L Button

The Main Menu on the Sensor Unit Displays:

Camera Settings, Video Settings and General Settings. Above them the Favourite Settings Short Cuts are displayed. You can add or delete these Short Cuts to access your most used functions directly from the Main Menu for better work flow.

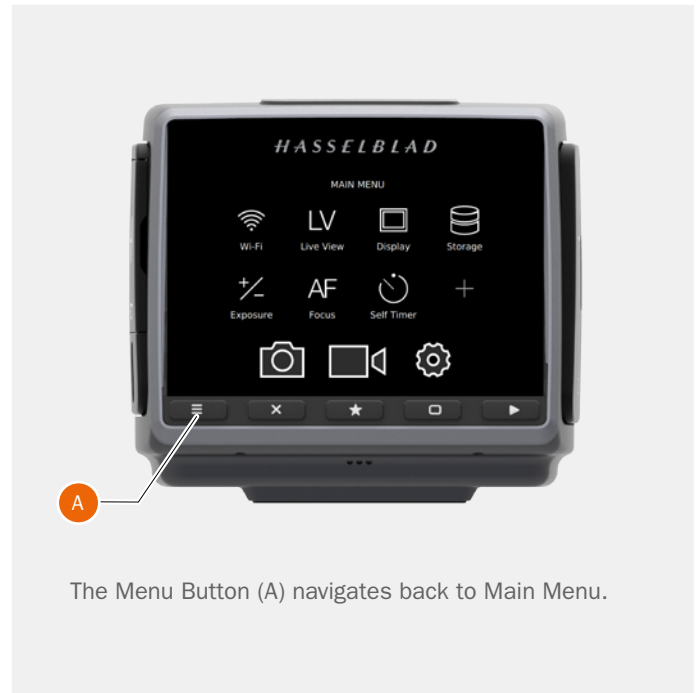

The Menu Button (A) navigates back to Main Menu.



TOUCH SCREEN NAVIGATION

The Touch Screen on the H6D Sensor Unit is similar to a Phone or Tablet with touch sensitivity. The following gestures can be used to navigate and control the camera:

Action	Function
Swipe Right	Move back / Move image right.
Swipe Left	Move image left. Only in Browse mode.
Swipe Down	Display Control Screen.
Swipe Up	Hide Control Screen.
Tap / Press	Select action / button / setting.
Double Tap	Zoom in to 100%. Double Tap again to Zoom out to full View.

Function	Action
Select	Tap / Press with one finger.
Display Control Screen	Swipe down from the top of the screen.
Hide Control Screen	Swipe up.
Move back	Swipe right.
Zoom in	Spread (move two fingers apart).
Zoom out	Pinch (move two fingers together).

Display Control Screen from Main Menu

- 1 Swipe down over Main Menu to display the Control Screen. Swipe down by starting on the upper part of the Sensor Unit Display near the top edge.
- 2 The Control Screen displays the Camera Settings.
- 3 The Control Screen is interactive, select any of the settings to make a quick adjustment within the Control Screen Interface.
- 4 Swipe Up to hide the Control Screen and display the Main Menu.

Swipe Right

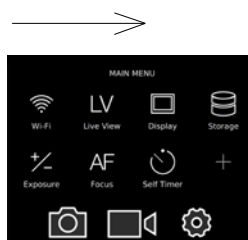

Swipe Left

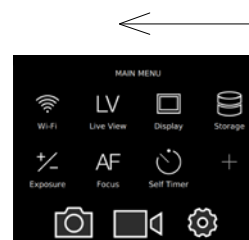

Swipe Down

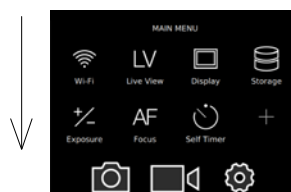

Swipe Up

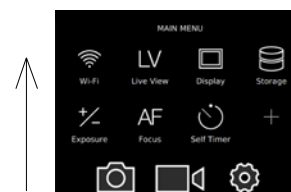

Swipe Down

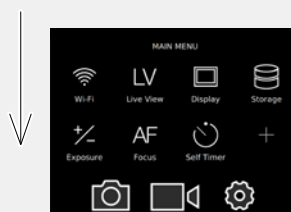

Main Menu

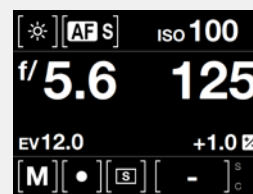

Control Screen

Swipe Up

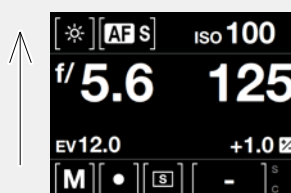

Control Screen

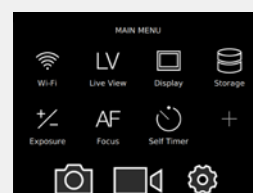

Main Menu

5.2 SENSOR UNIT DISPLAY NAVIGATION

MAIN MENU

In the Main Menu you will find the following options.

- 1 Camera Settings
- 2 Video Settings
- 3 General Settings

Wi-Fi
Live View mode
Display
Storage
Exposure
Focus
Self Timer

+ (Plus) Add your own function by selecting the + icon.

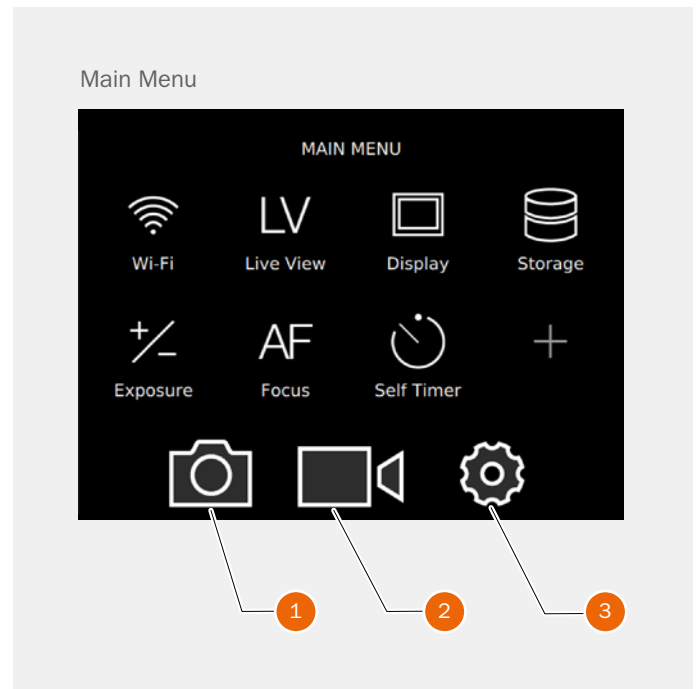

CONTROL SCREEN

Display Control Screen

Swipe down from the top of the display on the Sensor Unit Display or press the left soft button under the display you can always display the Control Screen.

Close the Control Screen

Swipe up from the top of the display on the Sensor Unit Display or press the left soft button again under the display you can always display the Control Screen.

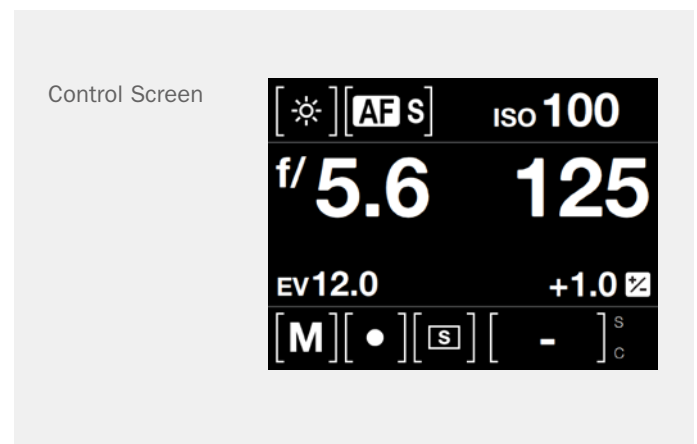

CONTROL SCREEN DESCRIPTION

The Control screen is a quick way to adjust settings. Tap / Select the desired function and change the setting directly in the Control Screen.

Locked Values on the Control Screen

P and Pv Mode

When you select P or Pv, the Aperture (5.6) and Shutter (125) are automatic and displayed in grey colour that indicates that you cannot change these settings.

A Mode

For Aperture priority (A) you can change the Aperture value and the Shutter value will be automatic and displayed in grey.

S Mode

For Shutter priority (S) you can change the Shutter value and the Aperture value will be automatic and displayed in grey.

Control Screen

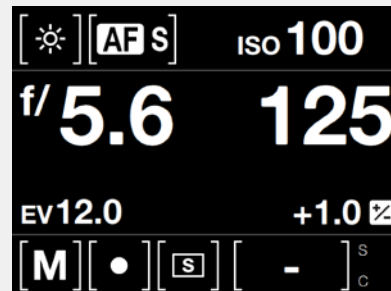

Control Screen

P Mode

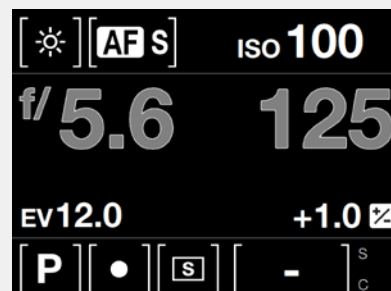

Control Screen

A Mode

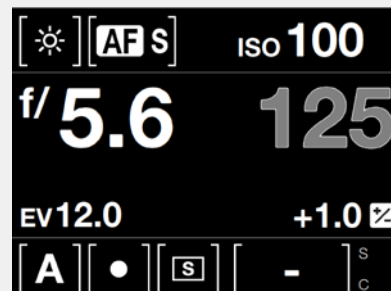

Control Screen

S Mode

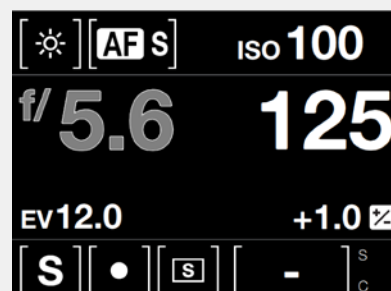

Settings on the Control Screen

White Balance

- Cloudy
- Shade
- Daylight
- Tungsten
- Flourescent
- Flash
- Manual

AF Focus

- AF-S Single Focus
- AF-C Continuous Focus
- AF-T True Focus
- MF Manual Focus

ISO

- Select ISO value.

Aperture

- Select Aperture value.

White Balance

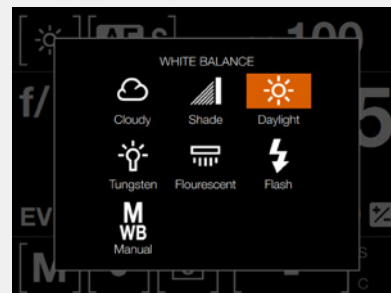

AF Focus

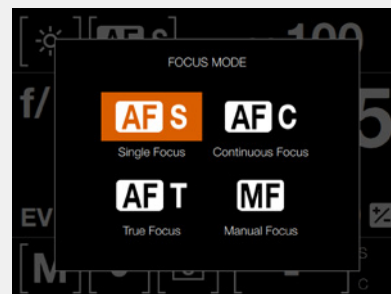

ISO

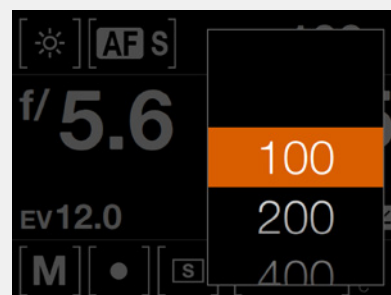

Aperture

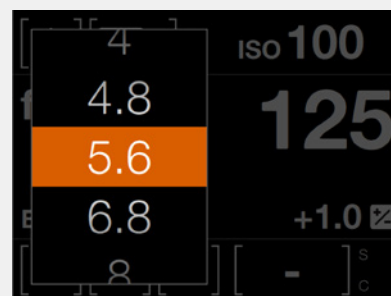

This Chapter continues on the next page.

Settings on the Control Screen

Shutter

- Select Shutter value.

Exposure Adjust

- Adjust Flash Exposure by sliding right (+) or left (-).
- Adjust Exposure by sliding right (+) or left (-).

Exposure Mode

- M Manual
- A Aperture Priority
- S Shutter Priority
- P Program
- Pv Program Variable

Metering Mode

- Center Weighted
- Spot Weighted
- Center Spot Weighted

This Chapter continues on the next page.

Shutter

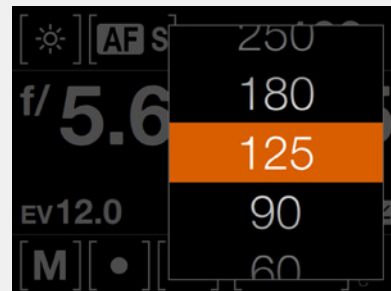

Exposure Adjust

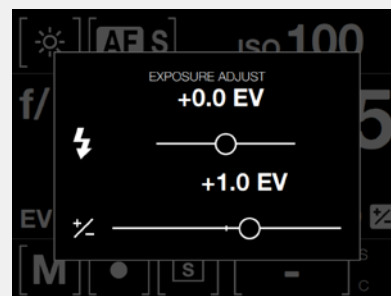

Exposure Mode

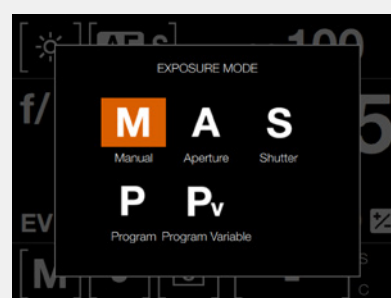

Metering Mode

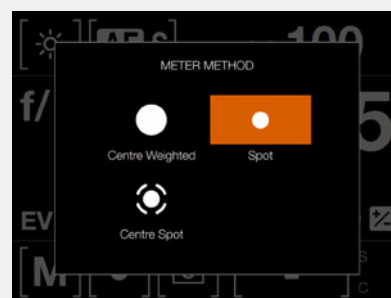

Settings on the Control Screen

Drive Mode

- Single Drive Mode
- Continuous Drive Mode

Remaining Captures

- Displays the number of remaining Captures.

Memory Card

- S for SD Card
- C for CFast Card

Drive Mode

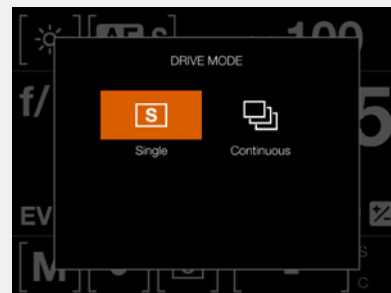

Remaining Captures

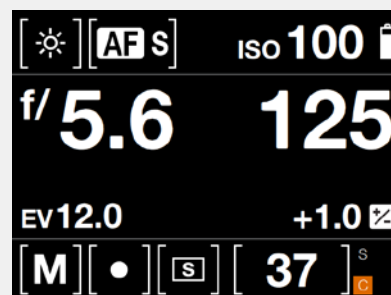

Memory Card

S - SD Card.

C - CFast Card.

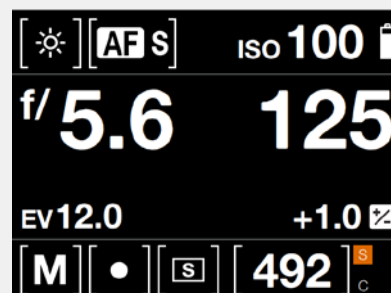

Settings on the Control Screen

ADD AND REMOVE FAVOURITE FUNCTIONS TO CONTROL SCREEN

- 1 Add a favourite function by selecting the + icon (1) on the Main Menu.
- 2 Remove a function from the Control Screen by a long press on the icon to be removed.

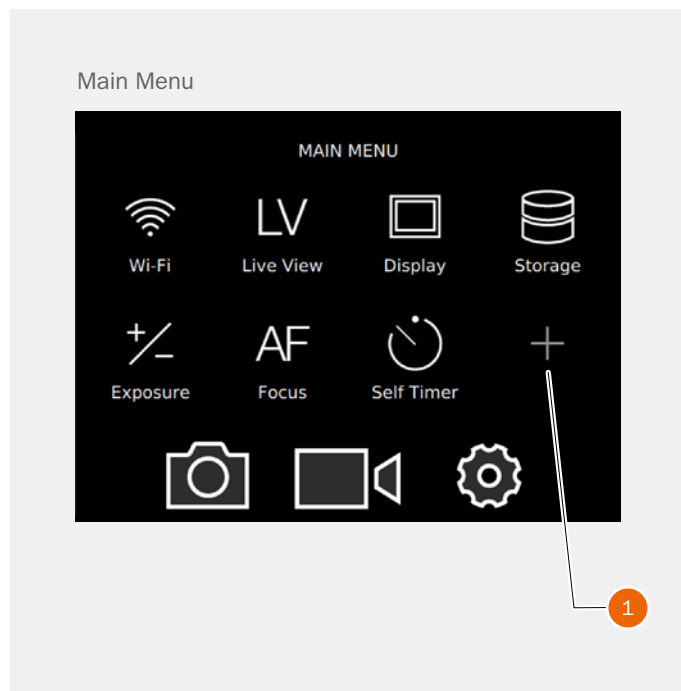

5.3 CAMERA SETTINGS MENU

Main Menu

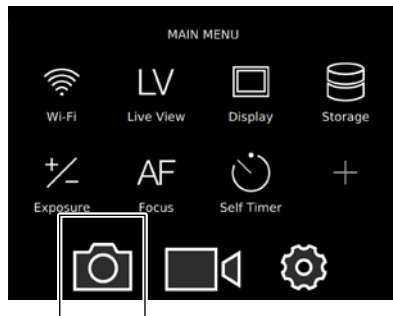

Camera icon

MAIN MENU > CAMERA SETTINGS

Press the Camera icon on the Sensor unit display. The Camera Settings Menu will appear.

Swipe right or press Menu / EXIT button to get back to Main Menu.

Camera Settings Menu

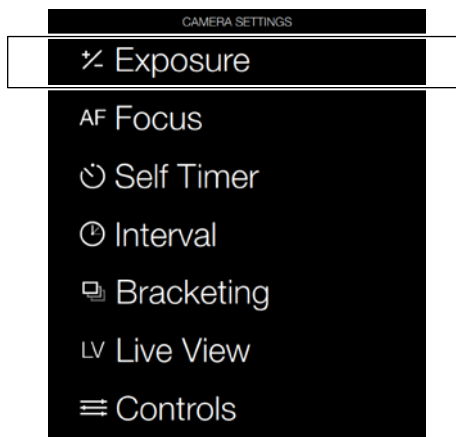

Exposure Settings Menu



5.4 CAMERA EXPOSURE SETTINGS

MAIN MENU > CAMERA SETTINGS > EXPOSURE

Press the Camera icon on the Sensor unit display. The Camera Settings Menu will appear.

Press the Exposure Settings Menu.

Swipe right or press Menu / EXIT button to get back to Main Menu.

Exposure Settings

Increment

Select the Increment setting.

Camera Menu

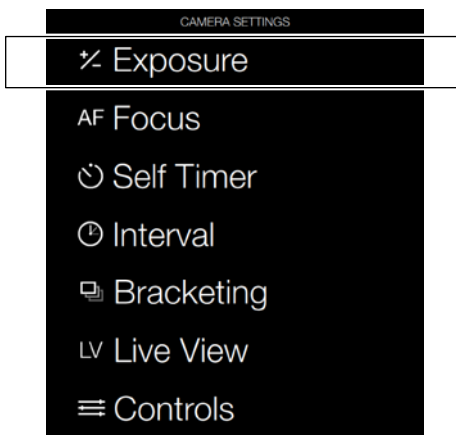

Exposure Settings Menu

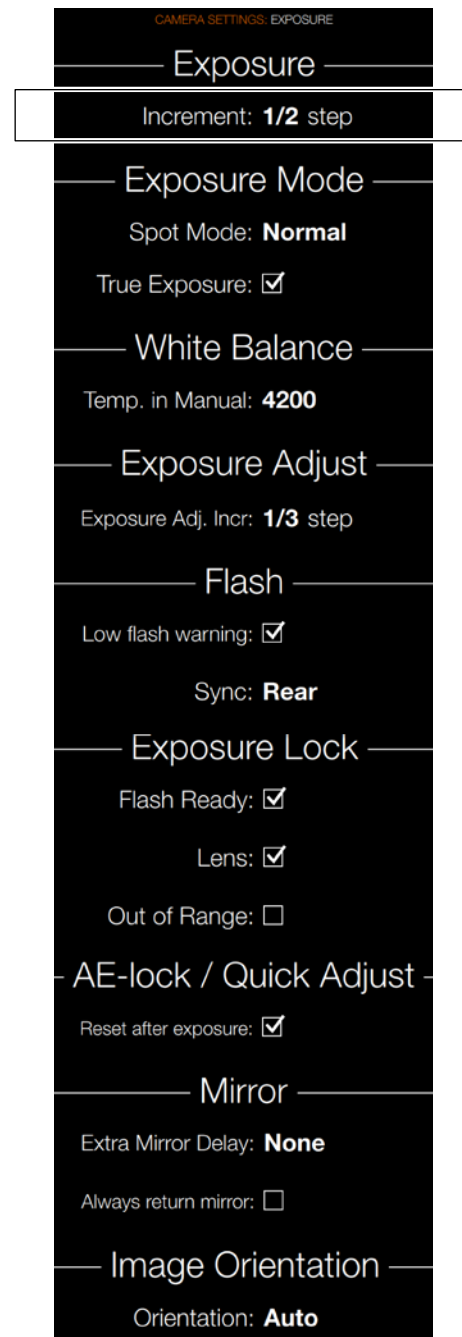

ISO AND WHITE BALANCE

ISO and White Balance are set either via the Grip, the Sensor Unit Display or, when tethered, via Phocus.

- On the grip, the WB (B) and ISO button (C) provides immediate access to ISO and White Balance settings. The front scroll wheel (A) and rear scroll wheel (D) are used to make the desired changes. These appears on the grip display, the sensor unit display and in the viewfinder.
- For the sensor unit display, settings are changed on the touch display or via the soft buttons under the display.
- In Phocus there is a specific tool to control camera settings.

The settings are automatically and simultaneously transferred from the grip to the sensor unit. Likewise all changes on the sensor unit are automatically transferred to the grip display.

Please note that the changes are only displayed on the sensor unit when the settings have been saved.

See more information about making manual white balance settings in the 'Sensor Unit Settings' section.



ISO AND WHITE BALANCE ON GRIP

ISO

- 1 Press ISO button (D).
- 2 Turn the Front scroll wheel (A) to select ISO setting.

White Balance WB

- 1 Press WB button (B).
- 2 Turn the Front scroll wheel (A) to select WB (Daylight, Shade, Cloudy, Flash, Fluorescent or Tungsten).
- 3 To set the Colour Temperature manually, scroll the Front Scroll Wheel until “M” is displayed. Then the colour temperature value is displayed at the bottom of the screen.

Note!

White Balance settings are technically not necessary for 3F/3FR files. The raw format files contain all the information required for correction in Phocus and/or other software, regardless of the original colour temperature of the light source or colour temperature setting of the camera at the time of exposure. If you intend to shoot RAW & JPEG or use Phocus for JPEG production and plan to deliver or print the JPEG files directly, then you should make a White Balance setting.

Note!

ISO and White Balance settings are made either on the grip or the sensor unit. The settings are automatically updated on both.

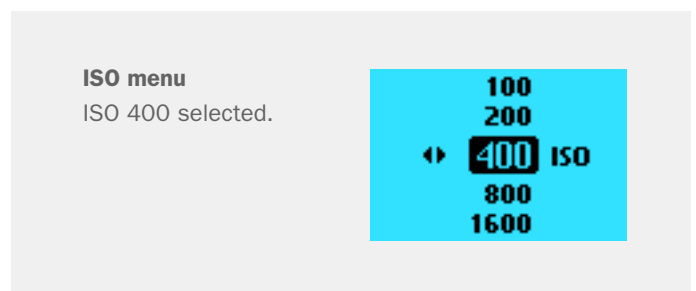
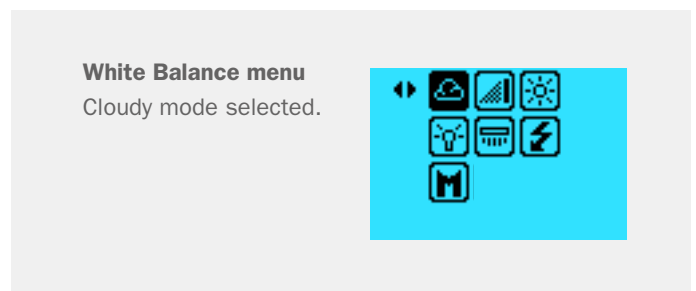
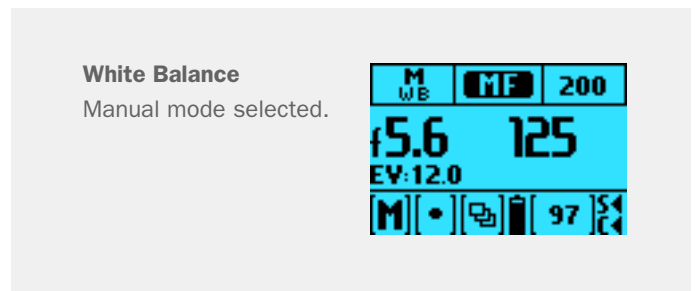

EXPOSURE SETTINGS MODES

MAIN MENU > CAMERA SETTINGS > EXPOSURE

Press the Camera icon on the Sensor unit display. The Camera Settings Menu will appear.

Press the Exposure Mode Settings Menu.

Swipe right or press Menu / EXIT button to get back to Main Menu.

Here you can only select the Spot Mode and set True Exposure On or Off.

To change the Exposure mode Swipe Down to display the Control Screen or press the EXP button on the Viewfinder.

Exposure are controlled either manually or by using one of four automatic modes. These have the following designations on the grip display:

- M – Manual
- A – Aperture (priority)
- S – Shutter (priority)
- P – Program
- Pv – Program variable

In each mode you can see both the aperture and the shutter speed information on the grip display, viewfinder display and if set, the sensor unit display.

In manual mode, aperture is set by the front scroll wheel and the shutter speed by the rear scroll wheel unless set otherwise in Camera Settings > Controls > Front Wheel.

In the automatic modes, the aperture and shutter speed settings are controlled by the camera, either partially or completely according to setting. Within this mode there are four choices.

Note!

Please see the Appendix for P and Pv mode charts that describe the aperture and shutter speed setting combinations.

Exposure Settings Menu

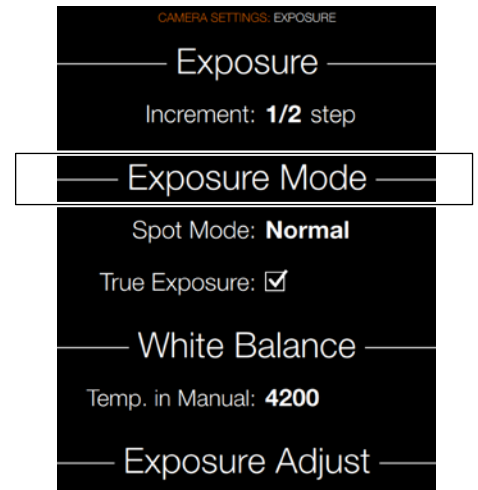

Grip Display View

Exposure settings on Grip Display.



SELECT METERING / EXPOSURE SETTING MODES

Proceed as follows with the camera in active mode:

- 1 Press the EXP button on the viewfinder.
- 2 Turn the Rear scroll wheel to make a Metering method selection and the Front scroll wheel to make an Exposure method selection.
- 3 Press the EXP button again or half press the exposure trigger button to leave the menu.

MANUAL EXPOSURE MODE

To change the Exposure mode Swipe Down to display the Control Screen or press the EXP button on the Viewfinder.

Manual mode provides total user control of the shutter and aperture settings. In this mode the shutter speed and aperture settings are manually chosen by turning the front and rear scroll wheels.

The standard exposure setting is obtained when the pointer over the exposure scale is positioned above the central index (in the viewfinder display).

Any deviation from this standard setting is displayed by:

- the pointer appearing elsewhere than above the central index
- by figures above the scale representing the amount of adjustment in EV's.

A '+ 0.7' above the scale in the display, would indicate a '0.7 EV overexposure' setting. Conversely, a '-2', for example, would indicate a '2EV underexposure' setting. Note that the appearance of a +/- symbol on the grip and viewfinder displays in manual mode means that a change has been made to the exposure compensation setting. See later section on Exposure compensation.

The actual aperture settings and shutter speeds are indicated to the right of the exposure scale in the conventional manner. (Note: 'full-stops', 'half-stops' and 'third-stops' are also displayed, according to setting (see increment setting). For example, a setting between f/8 and f/11 will appear as f/9,5 if 'half-stop' is chosen).

Exposure Modes

Grip Display.



Exposure Modes

Sensor Unit Display.



AUTOMATIC EXPOSURE MODE

To change the Exposure mode Swipe Down to display the Control Screen or press the EXP button on the Viewfinder.

Automatic exposure provides a choice of two ways to control the shutter speed and aperture settings semi-automatically and two ways fully automatically:

Aperture priority A

The aperture is manually chosen by you by turning the front scroll wheel, and the shutter speed is automatically chosen by the camera.

Shutter priority S

The shutter speed is manually chosen by you by turning the front scroll wheel, and the aperture is automatically chosen by the camera.

Programmed P

In this mode, an aperture/shutter combination is chosen by the camera according to the EV measured (metering method remains as your choice), though only within pre-set appropriate limitations to suit various requirements and applications.

Programmed variable Pv

This mode is very similar to Programmed, except with the additional parameters of lens focal length being automatically taken into account. For example, long shutter speeds will automatically be avoided with a long focal length lens (see illustration on the following page).

In Automatic mode the front scroll wheel selects alternative aperture/shutter combinations while maintaining the same EV and the rear scroll wheel alters the amount of exposure compensation. The compensation appears as a +/- symbol on the grip display and viewfinder display.

Note!

Aperture and shutter speed settings can both be changed even while the busy light on sensor unit is flashing.

Exposure Modes

Grip Display.



Exposure Modes

Sensor Unit Display.



AUTOMATIC EXPOSURE - P AND PV MODE

P Mode

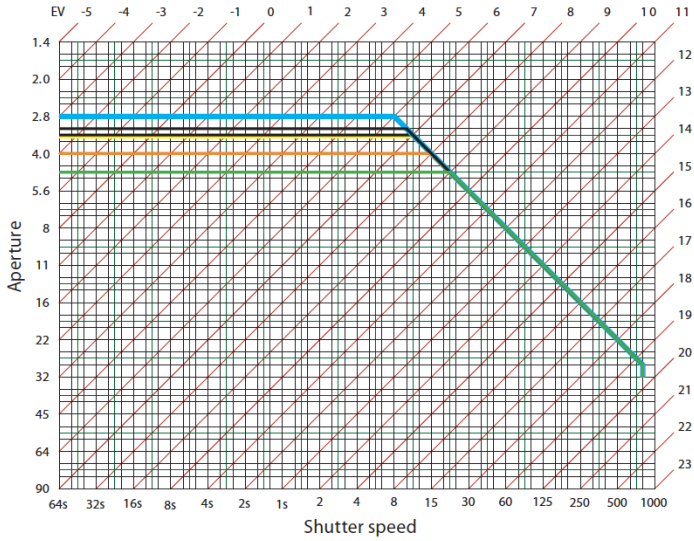
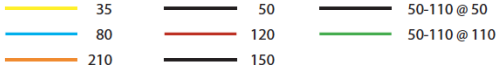

Pv Mode

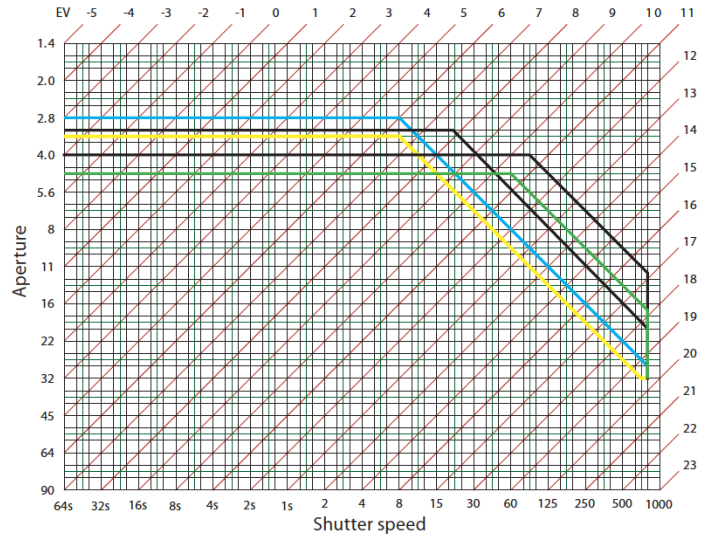
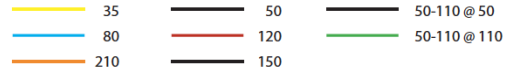

AE-L BUTTON

The AE-L button (A) has two main functions that can be incorporated in various working methods involving exposure locking. It also has an extra function for the flash measure capability (see AE-L section under Flash). The AE-L button can:

Lock an EV setting in manual and automatic modes

When the button is pressed, the light metering facility is locked to the EV setting at that moment. An L (=locked) symbol appears between the shutter speed and the aperture indication on the grip display and viewfinder display to confirm the status. Press the AE-L button again to unlock (a toggle function).

In the locked setting, the aperture and shutter speed become interlocked. In this way, a new aperture/shutter combination that still represents the same EV, can be rapidly chosen. For example, if the shutter is set to 1/125s and the aperture to f/8 and are locked together, you can access new EV-equivalent combinations of, for example, 1/30s at f/16 or 1/500s at f/4 just by moving the front scroll wheel.

In practice this means you can, for example, in auto mode position the metering area (spot setting) over an area in the subject that you determine to be equivalent to a mid-grey and lock it with the AE-L button. You can then recompose the picture with the metering zone positioned over an area much brighter or darker while still retaining the original exposure setting and choose a new combination of aperture and shutter speed settings.

Be used as a Zone System placement button

The AE-L button also allows the spot metering function to make zone placements. When the AE-L button is pressed, the metered area is saved as a mid-grey (Zone 5). When the spot area is then placed over another part of the scene, the new area is then compared to the saved area and the difference can be read off the scale seen in the viewfinder. For example, in a landscape situation you could meter the foreground, lock the reading with the AE-L button (thereby locking that area to be reproduced as the equivalent to a mid-grey 18%), point the camera at some rocks to see by how much darker they are compared to the foreground by the EV difference read off the scale.

If you have chosen Spot together with Zone display as well as one of the automatic modes A, S, P or Pv, point the spot marking at an area that you decide should be a Zone 5 and click the AE-L button. The meter will now display different parts of the subject as zone values in the viewfinder display, instead of EV deviations, as you move the spot marking over the subject. (Included are Lo and Hi to signify areas beyond the range of the sensor).

Alternatively you can choose to re-classify an area as another



Grip Display View

Lock

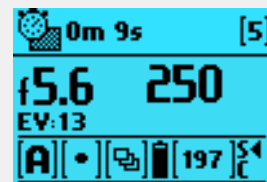

zone and then check the rest of the subject to see how other areas fall on the zone scale. Do this by following the above procedure and then turning the rear scroll wheel until you see the new desired zone value in the viewfinder display. You will also see the new exposure that will now produce that new zone. For example, you might have measured a rock at zone 5 but wish to make it darker. By moving the rear scroll wheel you could re-classify it as zone 4. You will then be able to see, for example, whether white clouds are now falling within the exposure range by their new zone classification.

Alternatively, you can also pre-set the initial zone reading in order to save time and effort where there is no freely available 'zone 5' subject for light measuring. For example, you might be on a sandy beach where you know that sand is normally classified as zone 6. You can pre-programme the zone placement by holding down the AE-L button while choosing the new zone value and turning the front scroll wheel until zone 6 appears. All new placements will then be zone 6.

FIXED EXPOSURE COMPENSATION SETTING

- 1 Press the '±' button on the viewfinder (A).
- 2 Turn the Front Scroll Wheel (B) to change the Flash compensation and the Rear Scroll Wheel (E) on the grip to increase or decrease the amount of Exposure Compensation in 1/3 EV steps.
- 3 The amount is displayed in the viewfinder as both an EV figure complete with a 'minus' or 'plus' prefix (A in illustration), and as a marker above a 'minus' to 'plus' scale.
- 4 Press (C - AF Button) to reset any compensation back to zero.
- 5 Press Save (D - ISO Button) to retain the setting.
- 6 A '±' symbol is then displayed between the aperture and shutter speed setting as confirmation of the setting.



Viewfinder Display View

Exposure compensation EV +1.3



Grip Display View

Flash Exposure

Camera Exposure

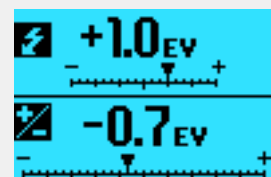

LIGHT METER EXPOSURE MODE

The Light Meter Exposure Mode can be changed on the Control Screen or by pressing the EXP button on the Viewfinder. Use the Rear Wheel to select.

Different Light Metering Modes

There are three reflective metering modes available.

Center Weighted

Center Spot

Spot

Exposure Settings Menu

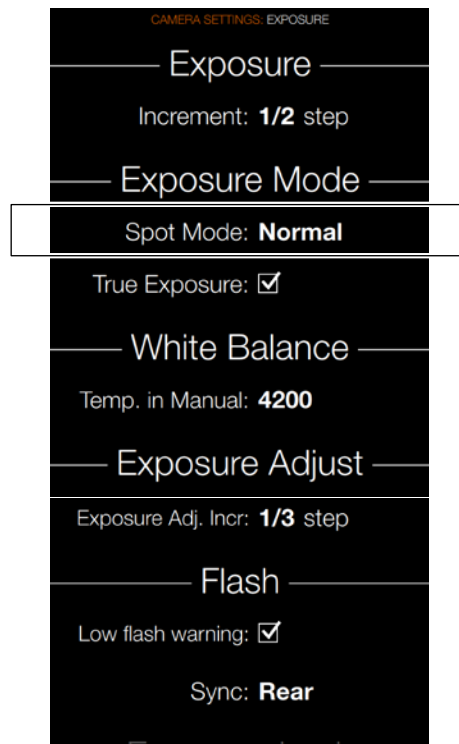

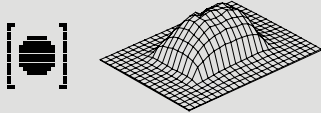
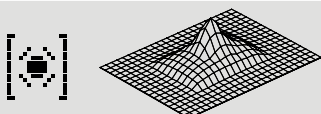
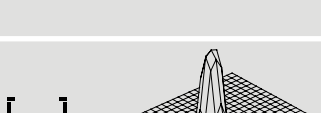
Light metering mode	Description	
Center Weighted		Used for light situations where there is no particular dominance of light or dark areas across the tonal range. Takes into account approximately 25% of the image seen in the viewfinder.
Center Spot		Emphasizes the central section of the focusing screen equivalent to approximately 25% of the image. This provides a balanced assessment and is a typical choice where the main subject is in the centre of the image.
Spot		The sensitive area is equivalent to approximately 2.5% of the image area (the central spot on the viewfinder screen). Any parts of the image outside of this area will not affect the exposure reading. This provides a very accurate measurement of specific tones. Typically used in the zone system and similar light measuring situations where maximum control is required. Also excellent for tonal comparison measurements. The spot mode can display 'zones' instead of EV's in the viewfinder display.

TRUE EXPOSURE

MAIN MENU > CAMERA SETTINGS > EXPOSURE > TRUE EXPOSURE

Press the Camera icon on the Sensor unit display. The Camera Settings Menu will appear.

Press the Exposure Settings Menu.

Select True Exposure Mode.

Swipe right or press Menu / EXIT button to get back to Main Menu.

True Exposure Settings

Select On or Off. Determines whether the exposure is automatically adjusted to create a true exposure setting. On allows the adjustment. Off retains the normal setting.

Note!

If using flash/strobe as the main light source and 1/800s or 1/1000 shutter speed (depending on lens type), remember to turn off the True Exposure option.

Exposure Settings Menu

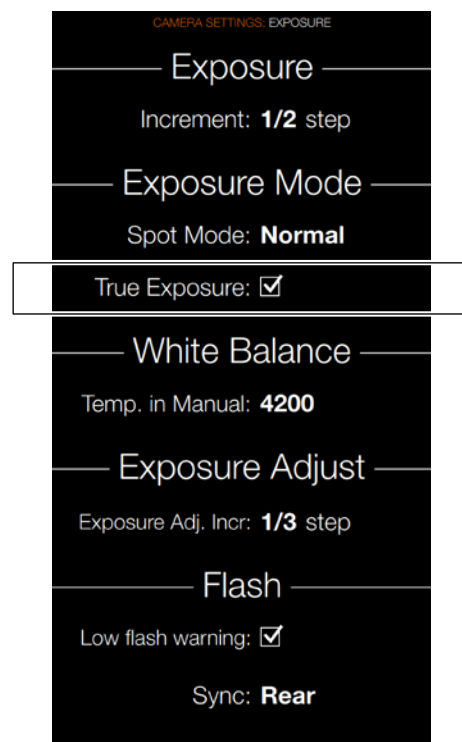

True Exposure explained

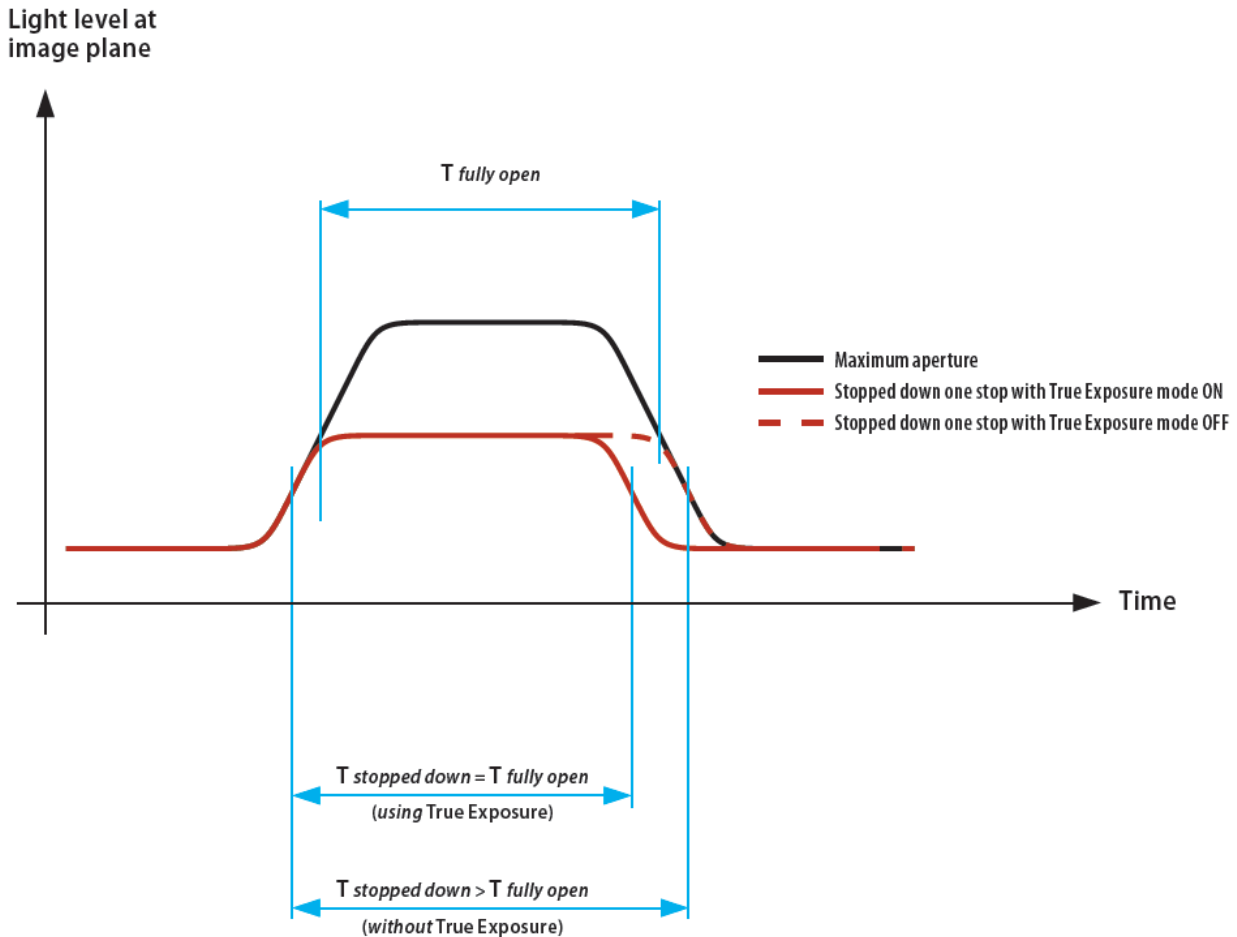

True Exposure is an HC/HCD lens function that allows the shutter speed to remain unaffected when stopping down. This effect is perhaps not so commonly understood as it is restricted specifically to integral lens shutters as opposed to focal plane shutters.

When a lens is stopped down, the effective shutter speed becomes longer, consequently affecting the set exposure. At slow shutter speeds the effect is minimal but at faster speeds, e.g. 1/500s, the effect becomes clearly visible. Automatic compensatory measures in speed setting adjustments are employed.

As compensation can only be put into effect where speeds can be adjusted, this prevents the possibility of adjusting the fastest speed of 1/800s. To counter this, compensatory adjustments

are therefore made to the aperture instead to retain the set exposure. This compensation is not always required and when using flash/strobe as the main light source it is actually undesirable because compensation will result in underexposure. Therefore, when using flash/strobe as the main light source, you should set True Exposure to OFF in Main Menu > Camera Settings > Exposure > True Exposure in the Camera Sensor Unit Display.

You can download a complete explanation of this situation from www.hasselblad.com.

WHITE BALANCE SETTINGS - PRESETS AND MANUAL

MAIN MENU > CAMERA SETTINGS > EXPOSURE > WHITE BALANCE

Set Temperature in Manual White Balance:

- 1 Press Camera Settings.
- 2 Choose Exposure.
- 3 Choose White Balance.
- 4 Set Temperature in Manual Mode.

White Balance can only be set from the Control Screen or on the Grip Menu.

Camera Menu

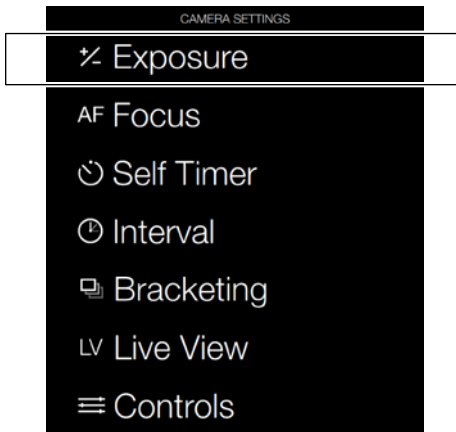

Exposure Settings Menu

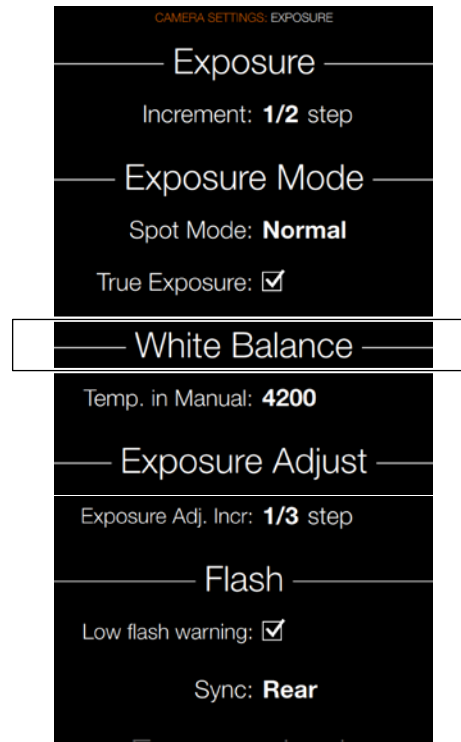

White Balance Options

There are six 'White Balance' presets plus a Manual setting to choose from.

- Cloudy
- Shade
- Daylight
- Tungsten
- Flourescent
- Flash
- Manual (M WB)

Control Screen View

White Balance Daylight mode selected.



Grip Display View

White Balance Manual mode selected.

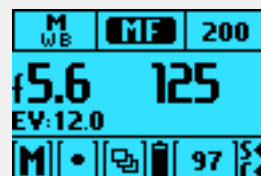

Grip Display View

White Balance menu with Cloudy mode selected.



WHITE BALANCE SETTING BY USING A “GREY CARD”

There are two ways to make manual white/grey balance settings using a ‘Grey card’ or ‘Qp card’. If colour accuracy is not critical, you can use any neutrally coloured area or surface close to a mid grey value (concrete, overcast sky, or even white paper, for example). It won’t be perfect but just try to ensure that it is as neutral as possible in colour value.

- Make the first shot a grey card/Qp card close-up and then make the adjustment in Phocus for the session.
- Use the integral white balance from the grey card function to make an in-camera setting for the session.

White balance settings are mirrored after being saved on the grip, sensor unit and in Phocus when tethered.

The most common work flow for using a Grey Card is to make a capture with the Grey Card present during the photo session. This capture will then be used in Phocus to neutralize all other captures in that same light.

EXPOSURE ADJUST

MAIN MENU > CAMERA SETTINGS > EXPOSURE > EXPOSURE ADJUST

Press the Camera icon on the Sensor unit display. The Camera Settings Menu will appear.

Press the Exposure Settings Menu.

Select Exposure Adjust.

Swipe right or press Menu / EXIT button to get back to Main Menu.

Exposure Adjust

Exposure Adjust Increment: Select Step.

Exposure Settings Menu

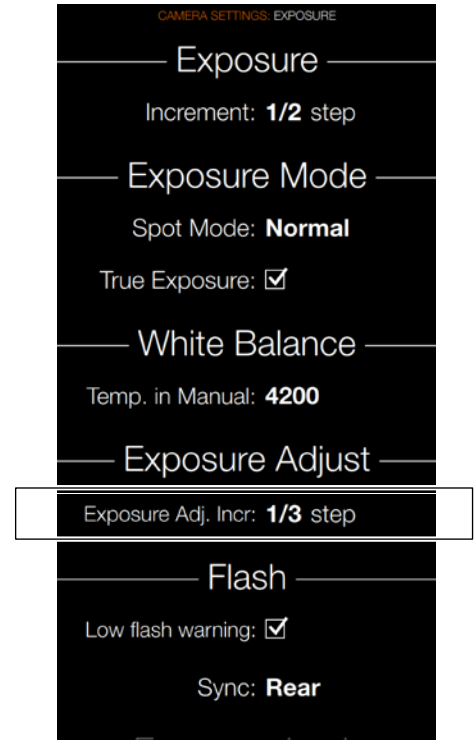

Adjust the Exposure on the Control Screen

- 1 Swipe Down on the Sensor Unit Display to access the Control Screen.
- 2 Select Exposure Adjust.
- 3 Adjust sliders to the left or right to change values.
- 4 Close the Exposure Adjust pop up by clicking outside of it
- 5 Swipe Up to exit Control Screen and return to Main Menu.

The following page explains how to adjust exposure on the Viewfinder +/- button.

Control Screen View

Exposure Adjust.

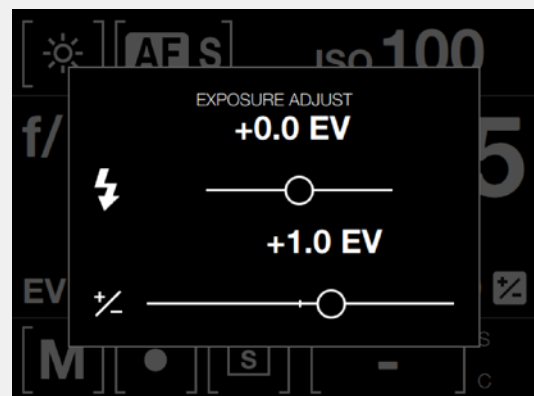

EXPOSURE COMPENSATION / QUICK ADJUST

The exposure compensation function, for both manual and automatic modes can be set from -5 to +5 EV, in 1/3, 1/2 or 1 EV increments and is visible above the scale in the viewfinder and as a ± symbol on the grip display.

The quickest way to make an adjustment in auto exposure mode is to use the rear scroll wheel (B).

Temporary compensation setting in an auto-exposure mode using the Quick Adjust function:

- 1 Select auto exposure mode (A).
- 2 Turn the rear scroll wheel (B) to select the chosen amount of compensation.

The amount is displayed in the viewfinder as both an EV figure complete with a ‘minus’ or ‘plus’ prefix and as a marker above a ‘minus’ to ‘plus’ scale.

Default settings provide 1/3 EV compensation and an immediate clearing of the setting after capture.



Viewfinder Display View
Exposure compensation EV +1.3

Grip Display View
Flash Exposure

Camera Exposure

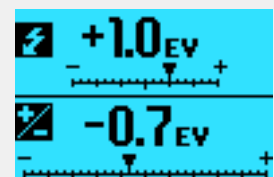

FLASH SETTINGS

MAIN MENU > CAMERA SETTINGS > EXPOSURE > FLASH

Press the Camera icon on the Sensor unit display. The Camera Settings Menu will appear.

Press the Exposure Settings Menu.

Select Flash.

Swipe right or press Menu / EXIT button to get back to Main Menu.

Flash

Low Flash warning

Select On or Off.

Sync

Select Flash Sync Settings.

- Normal.
- Rear.

This Chapter continues on next page.

Exposure Settings Menu

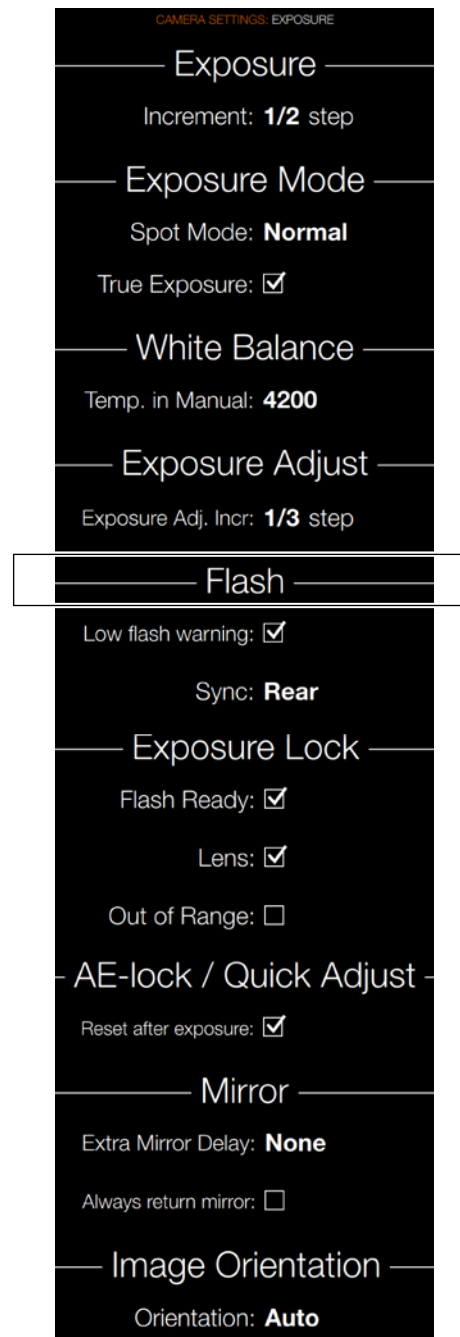

FLASH AND STROBE SETTINGS

The H6D can be used together with most flash units in manual mode. However, to make use of a TTL automatic function, it must be ensured that the flash unit is compatible with the SCA 3002 system. Connection is either by the PC socket or by the hot shoe (see warning below).

The viewfinder houses an integral fill-flash with a guide number of 12 and features OTF/TTL flash control. This flash is capable of providing enough illumination for many fill flash functions outdoors as well as simple indoor shots at shorter distances.

General information

When using the A or S setting together with flash, the exposure requirements of the camera will dominate which might produce slow shutter speeds indoors, for example, requiring the use of a tripod. If P or Pv is selected instead, a shutter speed of 1/60 or faster is automatically chosen by the camera enabling the camera to be hand held.

When using flash close up or when using larger aperture settings, remember that the flash unit's output has a specific minimum duration which might still be too great for correct exposure. Read the back's output specifications for further information regarding any potential restrictions.

It is possible to use the flash metering capability with external flash units of all kinds (TTL flashes must be set to Manual mode).

Rear sync is a useful feature used either for effect or to produce a more 'natural' look when combining long exposures involving light trails and flash.

When using suitable dedicated backs (compatible with SCA3002 compatible flash unit regarding the two functions, exposure compensation and shutter sync, is via the grip. The flash measure function can be used for flash units that are not SCA 3002 compatible or for SCA 3002 compatible backs at manual setting.

To change the balance between flash output and camera exposure requirements to produce a variety of effects, use the exposure compensation function. For various long exposure effects use the sync function. To make flash exposure tests use the flash measure function.

Notes and WARNINGS!

Only flash units specially adapted for use with the H6D should be connected to the hot shoe on the camera.

Note!

Do not attempt to connect a flash unit dedicated for use with another camera brand via the hot shoe. The flash unit and / or camera could be damaged.

Note!

If using flash/strobe as the main light source and 1/800s shutter speed, remember to turn off the True Exposure function.

As with all strobe/studio flash use, very particular attention should be taken to ensure correct connections and general handling practice. Potential dangers might increase when cameras are also connected to electronic peripherals (computers, lighting backs, etc.) and should diminish when IR and similar wireless flash release devices are used.

Victor Hasselblad AB cannot accept any responsibility whatsoever for accidents that might occur or damage caused when Hasselblad equipment is used in combination with third party backs of any description.

This Chapter continues on next page.

ACCESS TO FLASH CONTROLS

- 1 Activate the camera and press the + / - button on the Viewfinder once.
- 2 Turn the Front scroll wheel (1) to set the amount of compensation required from +3 EV through -3 EV.
- 3 Turn the Rear Scroll Wheel (2) to set whether the flash is triggered just after the shutter opens or just before the shutter closes go to Camera Settings/Exposure/Flash and set Sync to Normal or Rear.
- 4 To set Flash Measure program a button in Camera Settings/Controls to “Flash Measure”. Then trigger Flash Measure using this button. A specific screen on the grip display request you to press the AE-L button in order to make a reading.
- 5 When set to Flash Measure, a specific screen requests you to press the AE-L button in order to make a reading.

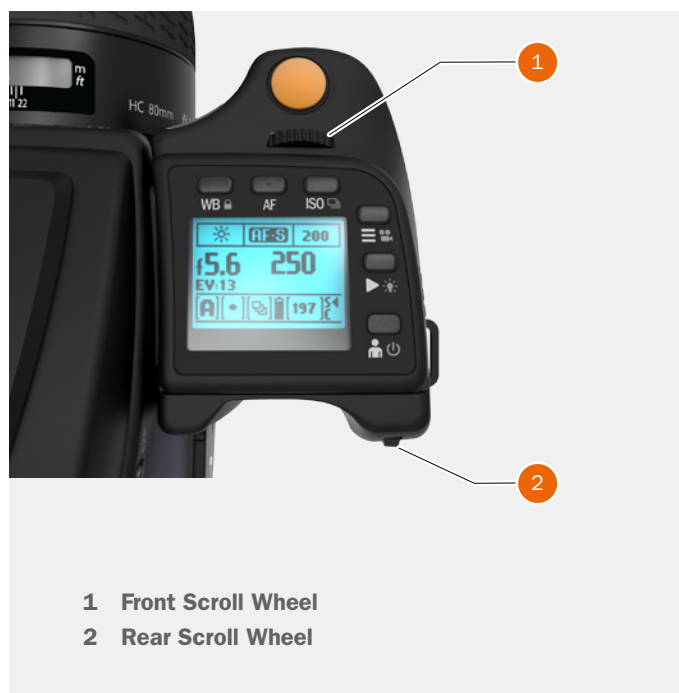

INTEGRAL FLASH

The integral flash unit features the following specifications:

Guide no. 12

Coverage 56° horizontal, 44° vertical

Maximum light fall-off at side centres - 1EV (50%)

Colour temperature (full flash) 5,000 – 5,600° K

To raise the flash unit into its operative position, slide the flash-back catch backwards in the direction of the flash symbol. To return the flash unit into its closed position, push down on the top of the back until it clicks back into place. The flash unit is automatically activated when it is in the operative position and de-activated when returned to its stored position.

The green LED flash symbol blinks in the viewfinder when the flash unit is charging and remains stationary when fully charged. The flash output can also be adjusted for optimum light balance in fill-flash situations.

Using the integral flash:

- 1 Slide the flash-back catch backwards in the direction of the flash symbol.
- 2 On the Camera Sensor Unit Display select Camera > Exposure and scroll down to Flash..
- 3 Choose between Normal or Rear sync.
- 4 Exit the Main Menu to Save and make an exposure.
- 5 If the settings were incorrect to match the output of the flash unit, the viewfinder display shows a red triangle alongside a flashing green 'flash' symbol plus a warning message - 'Low flash'. The grip display will also show a warning message - 'Low flash'.

Conventional measures should then be taken to correct the situation, move closer to the main subject, use a larger aperture setting or use a higher ISO setting.

Note!

Do not use the integral flash together when another external TTL flash unit is connected (and used in TTL or A mode).

Note!

For full coverage with the integral flash, use 80mm or longer lenses (without a lens shade).



SEPARATE FLASH UNIT CONNECTION

Separate flash units can be electrically connected either by way of the hot shoe accessory holder (see previous warnings) on the top of the viewfinder (1) or via a cord to the PC connection port (2) on the left hand side of the camera body. Slave unit switches / transmitters can also be connected on unit the (see specific user manuals for details).

Keep the plastic safety cover in place in the hot shoe (1) when not in use.



FLASH MEASURE OF SEPARATE FLASH UNIT

You can measure the effect of an attached flash unit (with PC connected flash units and SCA3902 compatible flash units set to M mode), where the camera acts as a flash meter. The aperture setting can be adjusted and more trial exposures made until the information on the grip display is satisfactory.

To use flash measure:

- 1 Assign a button as FLASH button.
- 2 Press the Assigned button on to access the flash option screen.
- 3 Turn the Rear control wheel until Flash measure appears.
- 4 Make preliminary required aperture setting by turning the front control wheel.
- 5 Press the AE-L button. The camera will close the aperture, raise the mirror and fire the flash. Light reflected from the flash lit subject will be reflected off a white spot on the auxiliary shutter to the meter sensor.
- 6 Deviations from a normal exposure are displayed as differences in EV on the grip display and the viewfinder display. If 'High' or 'Low' appears, change the aperture accordingly and make a new test reading.
Change the aperture until Diff EV: 0 appears, or the desired amount of deviation from the normal exposure.

Diff EV

Low = more than 2 EV below.

Diff EV

High = more than 2 EV above.

Note!

The 'Low Flash' warning can be disabled in Main Menu on the Sensor Unit Display Settings.

EXPOSURE LOCK

MAIN MENU > CAMERA SETTINGS > EXPOSURE > EXPOSURE LOCK

Press the Camera icon on the Sensor unit display. The Camera Settings Menu will appear.

Press the Exposure Settings Menu.

Scroll down to Exposure Lock.

Swipe right or press Menu / EXIT button to get back to Main Menu.

Exposure Lock

Flash Ready

Select On or Off.

Lens

Select On or Off. If Lens is selected, it is not possible to expose without the Lens mounted.

Out of Range

Select On or Off.

Exposure Lock Settings Menu

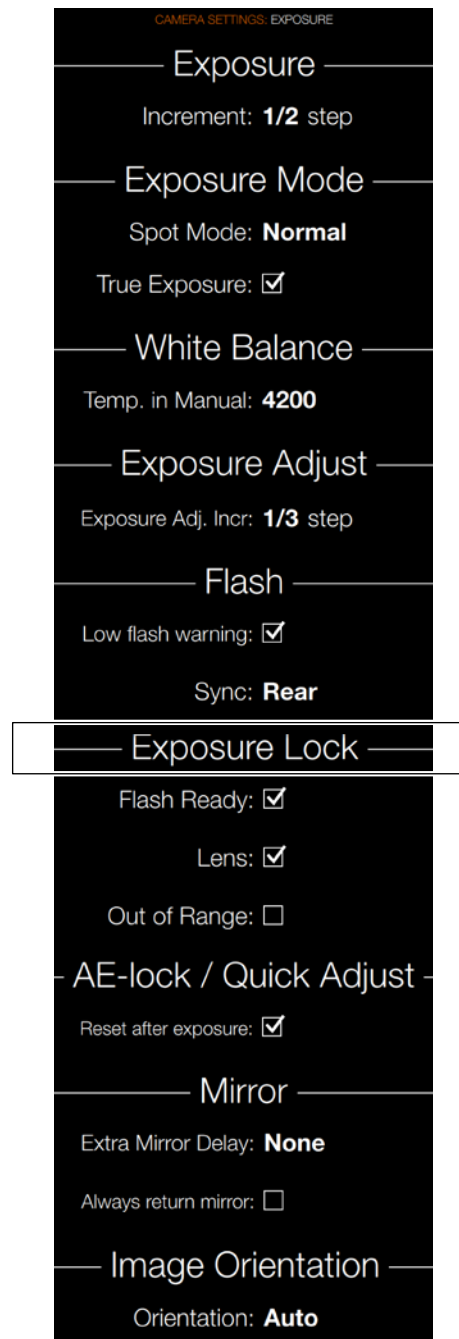

AE-LOCK / QUICK ADJUST

MAIN MENU > CAMERA SETTINGS > EXPOSURE > AE-LOCK / QUICK ADJUST

Press the Camera icon on the Sensor unit display. The Camera Settings Menu will appear.

Press the Exposure Settings Menu.

Scroll down to AE-Lock / Quick Adjust.

Swipe right or press Menu / EXIT button to get back to Main Menu.

AE-Lock / Quick Adjust

Reset after exposure

Select On or Off.

AE-Lock / Quick Adjust Menu

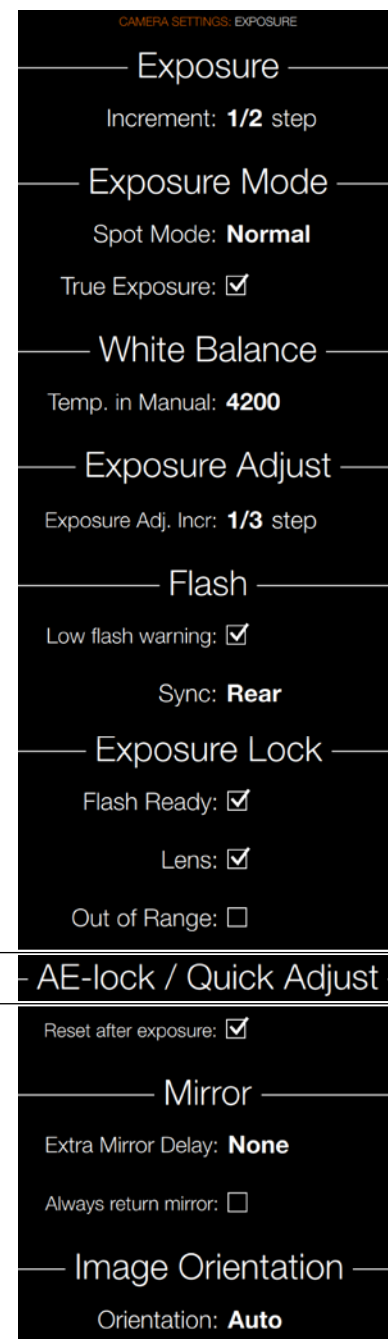

MIRROR SETTINGS

MAIN MENU > CAMERA SETTINGS > EXPOSURE > MIRROR SETTINGS

Press the Camera icon on the Sensor unit display. The Camera Settings Menu will appear.

Press the Exposure Settings Menu.

Select Mirror Settings.

Swipe right or press Menu / EXIT button to get back to Main Menu.

Mirror Settings

Extra Mirror Delay

Select Extra Mirror Delay Settings.

- None
- 25 ms
- 50 ms
- 100 ms
- 200 ms

Always Return Mirror

Select On or Off.

Mirror Settings Menu

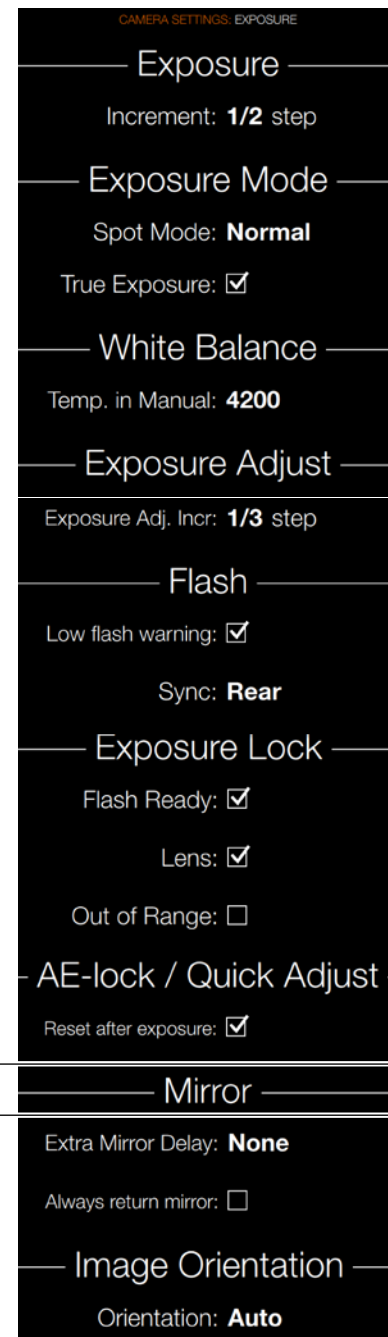

IMAGE ORIENTATION

MAIN MENU > CAMERA SETTINGS > EXPOSURE > IMAGE ORIENTATION

Press the Camera icon on the Sensor unit display. The Camera Settings Menu will appear.

Press the Exposure Settings Menu.

Select Image Orientation Settings.

Swipe right or press Menu / EXIT button to get back to Main Menu.

Image Orientation

Sets the viewing orientation of captures when they appear in Phocus. To avoid unintentional orientation changes when the camera is pointing straight up or down, the orientation setting can be locked.

Optional Settings

- Auto.
- Lock at 0 degrees.
- Lock at 90 degrees.
- Lock at 180 degrees.
- Lock at 270 degrees.

Image Orientation Settings Menu

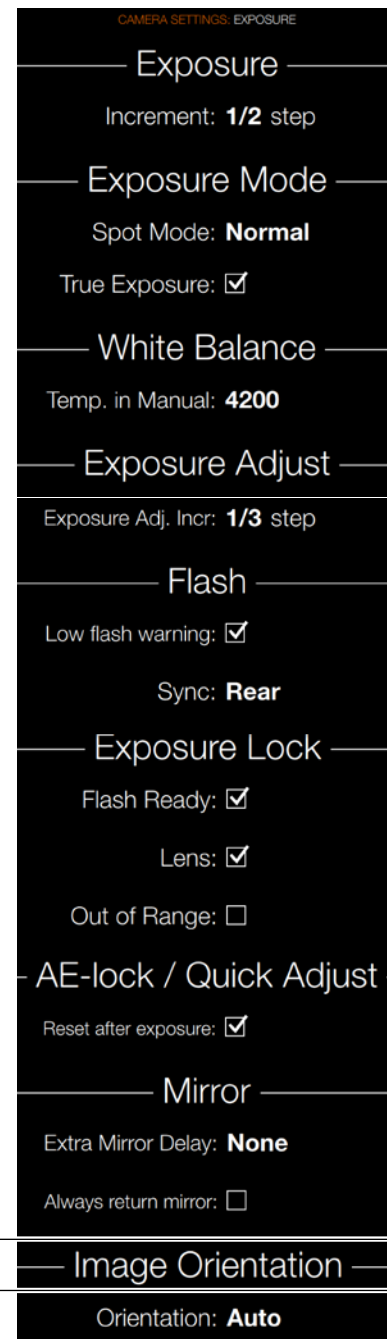

5.5 CAMERA FOCUS SETTINGS

MAIN MENU > CAMERA SETTINGS > FOCUS

Select the Camera icon on the Sensor unit display. The Camera Settings Menu will appear.

Press the Focus Settings Menu.

Swipe right or press Menu / EXIT button to get back to Main Menu.

Camera Menu

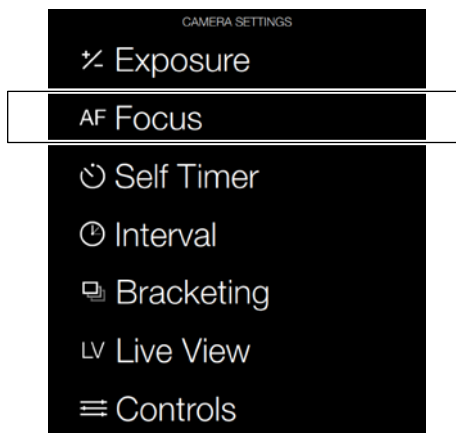

Focus Settings Menu

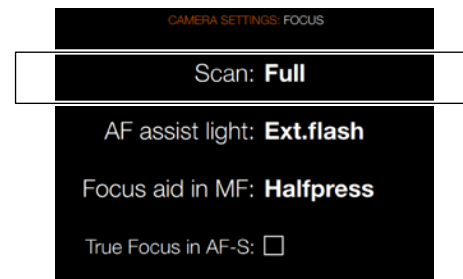

Focus Settings Menu Contents

Scan

Settings for Scan Range (for Macro Lens only).

- Near
- Far
- Full

AF assist light

Autofocus assist light.

- Camera
- Ext. Flash
- Off

Focus aid in MF

This is a focus aid in Manual Focus Mode MF. Indicates how the focus aid arrowhead LED symbols appear in the viewfinder display in manual focus mode.

- Always. Always makes them visible all of the time when camera is active.
- Half press. Half press makes them visible when the shutter release button is pressed half way.
- Off. Off disables them completely.

True Focus in AF-S

Select True Focus in AF-S mode.

- On or Off.

FOCUSING DISTANCE CALCULATION

There are two distance scales (in feet and metres) visible through the window on the upper part of the lens barrel. The focusing distance is read off the chosen scale from the central lens index (A).



STOP DOWN / DEPTH OF FIELD PREVIEW

A visual depth-of-field preview can be made by pressing the STOP DOWN button (B) while viewing the image in the viewfinder.

Depth-of-field is calculated as follows:

- 1 Focus the lens as required.
- 2 Make an exposure reading (auto or manual) and note the aperture setting.
- 3 Find the markings on either side of the central index that correspond to the chosen aperture.
- 4 From these two markings, read off on the required lens distance scale the two corresponding distances.
- 5 The depth-of-field (at that particular aperture and focus setting) is the area included between these two distances.

In the example given here, the focusing distance is set at nearly 3 metres. At an aperture of f/22, the depth-of-field would therefore extend from just over 2 m to approximately 4.5 m. Note that depth of field is not an absolute. Perception of it depends on several factors and so it should be seen only as a rough guide.

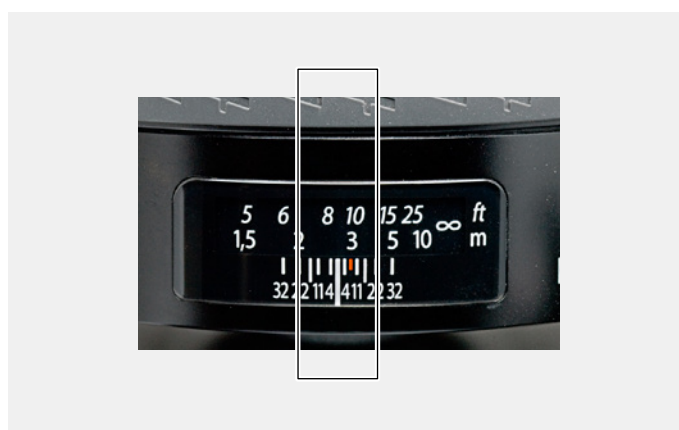

INFRARED FOCUS SETTING

As infrared rays form an image at a plane different to that formed by visible light, the normal focus settings do not apply.

Proceed as follows in manual focus mode:

- 1 Focus the lens.
- 2 Note the distance setting at the central lens index.
- 3 Realign this distance setting against the infrared mark (coloured red) instead of to the central lens index.

If the distance is calculated, a manual distance setting with use of the distance scales together with the infrared mark is made. Please contact your Hasselblad dealer for information about sensor units adapted solely for infrared photography.



FOCUS ASSIST

The camera also features a LED focus assist. Two arrowheads are displayed to the right of the viewfinder display (except for lenses with a maximum aperture of f/6.7 or smaller). The arrowheads provides confirmation of a precision focus setting and are a useful aid when making a setting with eyesight only.

Manual focus setting

When the left arrowhead appears alone it means the focus setting is too far beyond the chosen distance (the area framed within the central zone in the viewfinder) and when the right arrowhead appears alone it means the focus setting is too close. Focus is correct when both arrowheads appear together. If the focus cannot be established, then both arrowheads flash.

Automatic focus setting

Focus is correct when both arrowheads are visible together. Focus is incorrect if only one arrowhead is visible. If the focus cannot be established, then both arrowheads flash.

Note!

The autofocus range on the HC 4/120 Macro lens can be limited by a specific setting on the camera allowing for near range, far range or full range. This information is displayed on the grip display together with that particular lens, in the Sensor Unit Display and in the Viewfinder Display. Further information can be found in the “H-system Lenses & H-system Lens Accessories” booklet that accompanies each lens. The booklet can also be downloaded from the Hasselblad website. Also, see note here regarding HCD lenses!

Note!

HCD lenses were formulated for use with the smaller size sensors in the H-series, resulting in a reduced coverage for the larger sensors used in some models. So, if you use HCD lenses, be aware of the restrictions (vignetting and diminished quality at the edges). As notification of this situation, an auto crop function is employed and an HCD crop icon appears on the right hand side of the viewfinder display when an HCD lens is fitted. When in Phocus, however, the auto crop function can be turned off in Preferences if you wish.

Note!

Lens corrections can be applied when captures are imported into Phocus. Guided by the information in the meta data included with each individual capture, the DAC (digital lens correction) tool uses lens-model specific calculations to adjust for chromatic aberration, distortion and vignetting. Not only model specifications but also capture parameters are taken into consideration for analysis. This extremely capable refinement of captures should not be overlooked when processing files! See Phocus user manual for details.

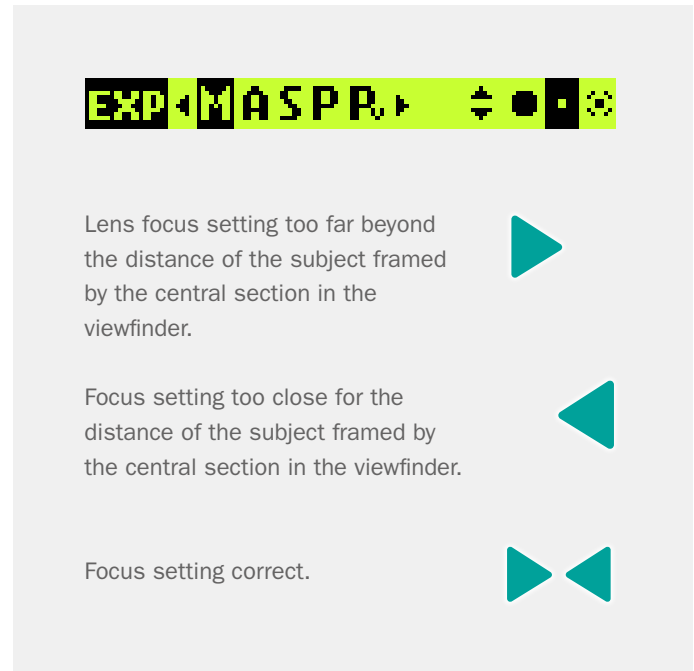

Info!

For users who prefer manual focus control but would like the benefits of autofocus, one method is to set the AE-L button (or any customizable button) to AF (Single) drive. The main subject can then be centred and the AE-L pressed, to ensure correct focus. The camera reverts immediately to manual focus control when the button is released. Therefore, you can recompose the picture without having to maintain pressure on the release button in order to retain the newly automatically made focus setting (AF-T can also be used).

Info!

The True Focus function can also be combined with other autofocus modes for specific situations.

Info!

To expand your range of lenses, consider using a CF adapter to allow you to use most of the lenses from the Hasselblad V-system.

Note!

The autofocus function is not possible with certain combinations of lenses and accessories. However, a warning is displayed which disappears after confirmation.

MANUAL FOCUS

There is both a Manual focus mode setting and a manual override capability.

In Manual focus mode, focusing is carried out by rotating the focus ring on the lens. The focus setting remains until changed as with a conventional non-autofocus lens. This means that pressing the shutter release button will not activate a focus setting change as it does in autofocus. To change back to autofocus, press the AF button (B) and select AF-S, AF-C or AF-T.

MANUAL OVERRIDE IN AUTOFOCUS MODE

Manual override is always possible in automatic focus mode without any need to make a new setting. Just rotate the focusing ring in the conventional manner. As the lens barrel does not rotate in autofocus mode, you can hold the focusing ring for instant manual adjustments. However, to retain the new manual focus adjustments, you must maintain the pressure on the shutter release button. You can instantly return to the automatic focusing mode by releasing the pressure on the shutter release button first and then pressing the release button halfway again. The instant manual override function produces a convenient way of working. You can take advantage of autofocus while retaining an instantly adjustable manual focus check if preferred for pinpoint accuracy without making any changes in the settings.

With manual override in autofocus mode you can manually alter a focus setting that has been made, by rotating the lens barrel and without having to change modes. As long as the shutter release button is kept at the half-press position, the new focus setting is maintained.

To reactivate the autofocus function, release the shutter release button and press again.

AUTO / MANUAL FOCUS SETTING

- 1 Press AF Button (B).
- 2 Turn the Front Scroll Wheel (A) to select Manual, Single Shot, Continuous, True Focus..
- 3 Press AF Button (B) to Save.

Note!

In manual focus, the infinity and closest distance marks on the lens scale can appear to be positioned beyond the central index. This is only an apparent effect and does not change the focusing range of the lens.



A Front Scroll Wheel
B AF Button

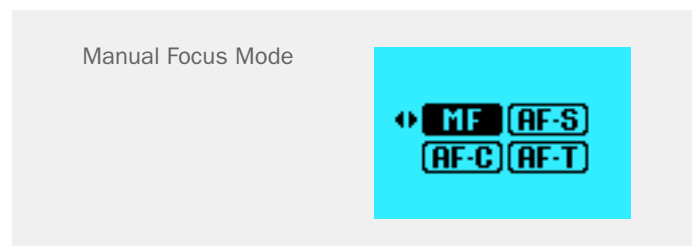

AUTOFOCUS

Autofocus modes Single Shot or Continuous are activated by pressing the shutter release to the half-press position.

The operative range is from EV 1 to EV 19 at ISO 100.

The point of focus is determined according to the vertical and horizontal areas (see illustration) within the central rectangular zone on the focusing screen.

Alternatively, an attached flash unit that has a similar facility (a Metz 54/70, for example) can also be used. This feature can be altered in settings.

True Focus is also classified as an autofocus function and is normally activated by its own button on the grip. See later section.

AF Assist light

When light levels are too low or the contrast of the subject is too low, AF assist light is automatically activated if selected. The operative distance is approximately up to six metres from the camera.

AUTOFOCUS CHECK IN MANUAL MODE

See the following section for a description of how to use the advantages of a quick autofocus check while remaining in Manual mode.

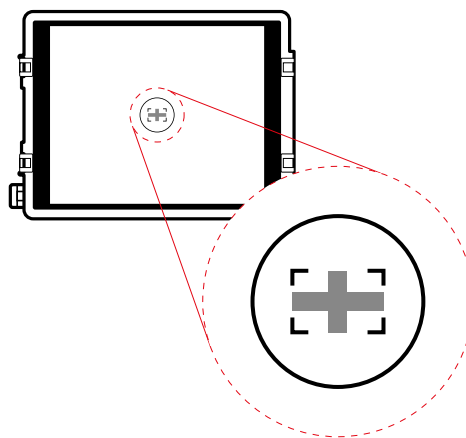

SINGLE SHOT FOCUS

At Single Shot setting (AF S), the shutter release will be blocked until the camera finds the optimum focus setting. This ensures that no captures are made that are not finely focused. However, this delay is normally only a fraction of a second in good lighting conditions with a clear focusing pattern.

Note though that in this mode the lens will focus at one distance and will remain focused at that distance while pressure remains on the shutter release button. In this way, you can focus on a nearby object, temporarily positioned within the focusing zone on the viewing screen and then without releasing pressure on the shutter release button, recompose knowing that the focus remains on the object chosen even though it is now outside the focusing zone. Releasing the pressure on the shutter release button and pressing again half way would now change the focus setting to the distance of the object within the focusing zone.

See Manual override in autofocus mode for a useful way of working with manual and autofocus settings in a combined manner.

CONTINUOUS FOCUS

At Continuous setting (AF C), the shutter can be released rapidly before the lens is focused in order to capture a split-second shot (in Single Shot, a capture cannot be made until the camera has had time to focus). However, the camera will continue to focus if a moving subject is within the focusing zone or if you recompose, even though the shutter release button is half pressed.

One method to use this feature when photographing in fast changing situations is to keep the shutter release button pressed down. The lens focus continuously, and by momentarily releasing the pressure on the shutter release and then immediately pressing again, you minimize the amount of time needed for the lens to check focus ensuring a split second shot with optimum focus.

AF-S Single Shot Mode



AF-C Continuous Mode



5.6 CAMERA TRUE FOCUS

The True Focus setting (AF-T) is generally used in specific circumstances to automatically correct for camera angle/focus setting discrepancies, but it can also be combined with other autofocus settings.

To exploit True Focus correctly, a few important points should be studied in order to obtain a full understanding of how and when to use it. Basically, there are four variables to pay attention to:

- proximity of camera to subject,
- focal length of lens,
- aperture setting and
- movement of camera and/or subject after setting.

The closer you remain to the ideal situation with regard to these variables, the more noticeable the effect of True Focus will be.

- The closer you are to the subject, the worse the original problem becomes. Consequently, the need for True Focus solution becomes greater and its application thereby becomes more noticeable.
- Short focal length (wide-angle) lenses naturally decrease camera to subject distances and therefore, following the point in (a), produce a greater need for True Focus adjustments.
- Smaller aperture increase the depth of field and therefore would lessen the need for a True Focus solution. However, smaller apertures produce a different visual effect, so True Focus therefore allows the exploitation of the shallow depth of field (produced by larger apertures) without the fear of unwanted focus restrictions.
- The calculations involved in True Focus use, amongst other things, camera to subject distances to calculate the required amount of adjustment. It therefore follows that if the camera or the subject move after the initial setting has been made, the calculations will not be applicable anymore. So, to ensure the optimum correction, both the photographer and the subject should restrict movement as much as possible. Please note that with some lenses (particularly longer length lenses) just a few centimetres movement can essentially ruin the result.

True Focus can be used with longer lenses, smaller apertures but the further you come from situations similar to the 'ideal' as described above, the less the effect will be until it has no visible effect at all. Please remember that although True Focus can noticeably improve a demanding shoot it will only work effectively in the specific circumstances it was designed for.

AF-T True Focus Mode



TRUE FOCUS AND ABSOLUTE POSITION LOCK

The obvious situation that would most benefit from using True Focus would be a fashion shoot with a fairly wide angle lens at a large aperture setting and where the central area of the image is clothing while retaining focus on the model's face. Ideally a fairly controlled and static flow should be planned. A change of pose by the model should take place only after captures. The photographer must also resist crouching down, or leaning forwards or backwards too much before capture.

With the lens at its widest aperture setting, a normal autofocus setting is made on the model's face (A), and the camera focus locked. The composition is then changed to include more of the clothing (B), but the locked focus setting now extends beyond the model's face at (B) according to the laws of geometry. This will naturally result in an image where much of the subject closest to the camera and the model's face will be unsharp. Solutions involving manual focus / focus lock / resetting of multi-point sensors are distracting to work flow and prone to error. Making a True Focus setting at (A) will ensure that focus is automatically adjusted in accordance with the change of camera angle.

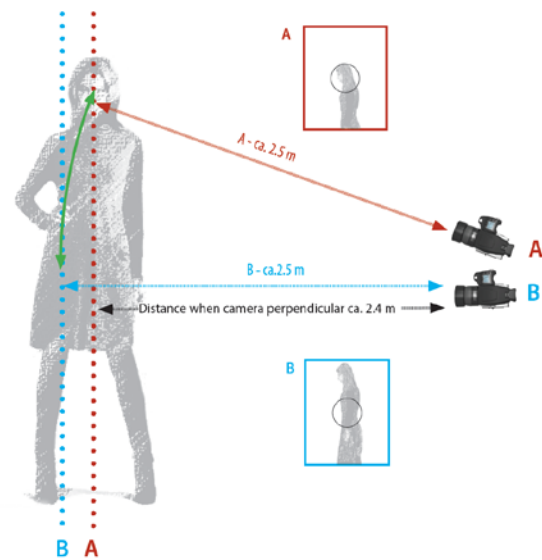

True Focus uses yaw rate technology and by way of the Absolute Position Lock (APL) processor, logs camera movement as the basis for an extremely rapid compensatory focus reset without any shutter lag. The H6D's firmware then further perfects the focus using the precise data retrieval system found on all HC/HCD lenses.

A
A normal autofocus setting is made on the model's face and locked.

The focus setting is approximately 2.5m.

B
When the camera is rotated back down, B, the locked focusing distance of 2.5m, according to the laws of geometry, extends beyond a perpendicular line drawn down from the face, creating unsharpness.

If a True Focus setting instead of a normal autofocus setting is now made at A and the composition is changed back to B again, the camera will automatically calculate and adjust the focus of 2.5m to approximately 2.4m, which is the actual perpendicular distance. The model's face remains sharp.

TRUE FOCUS AND CAMERA HANDLING

To obtain the maximum benefit from True Focus work within the requirements of the system. This might need a little practice but it will improve the accuracy of the measurements and thereby provide better results.

- 1 Remain as still as possible when making the first True Focus measurement and wait for the audio signal or ready light to show green again before continuing. This will not only speed up the process but also increase accuracy.
- 2 When recomposing the shot stay in the same position as closely as possible. That is, try to avoid moving your head or body forwards or backwards as this will move the camera away from the measured position.

In the upper example to the right, the photographer has swung the camera from the first measurement to recompose the shot as normal. But as you can see that the camera has now moved away from the original position.

The lower example illustrates essentially the same situation except this time the camera is rotated around its central axis, rather than swung. Practice shows that this method retains the original position more accurately and therefore results in better focusing accuracy.



Incorrect rotation of camera away from original position.



Correct rotation of camera around its own center.

FOCUS CHECKING

An effective way of checking the focus of individual captures is to assign for example Mirror Up or Stop Down button to Focus Confirm.

In browse mode or after a capture you can either double tap on the Sensor Unit Display to zoom in to 100% or spread two fingers apart to zoom in. To zoom out you can double tap again or pinch two fingers together.

5.7 CAMERA TRUE FOCUS METHODS

ACTIVATED BY SHUTTER RELEASE - TRUE FOCUS RETAINED

MAIN MENU > GENERAL SETTINGS > CAMERA > TRUE FOCUS

In this mode the Autofocus function is effectively converted into the True Focus function. Focus is set by half pressing the shutter release button (A).

- 1 On the Sensor Unit Display, select Camera Settings.
- 2 Select Focus.
- 3 Select True Focus in AF-S On.
- 4 Aim camera to the important area of the subject and half press the shutter release button (A).
- 5 Wait for the True Focus icon to appear in the viewfinder and the audio confirmation signal.
- 6 Maintain the half-press (A) and recompose the picture. Press fully to make the capture. The True Focus icon disappears from the viewfinder. True Focus function is retained.

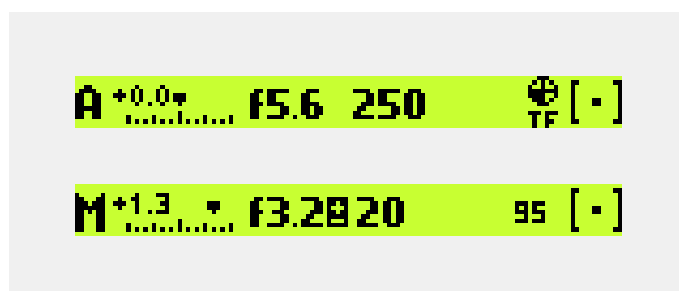

TEMPORARILY ACTIVATED - AUTOFOCUS RETAINED

MAIN MENU > GENERAL SETTINGS

In this mode the True Focus function is activated by pressing an assigned button. This produces a 'one-shot' setting where the camera reverts to its original Autofocus setting after capture. Useful if you want to quickly switch back and forth between True Focus and normal Autofocus.

- 1 Program the buttons in the Main Menu on the Sensor Unit Display.
- 2 Aim camera at important area in subject and press the selected button (the grip display now indicates AF-T mode).
- 3 Wait for the True Focus icon to appear in the viewfinder.
- 4 Recompose the picture and press Shutter Release button (A) (camera does not refocus because it is temporarily in AF-T mode). The True Focus icon disappears from the viewfinder. Camera reverts to AF-S.
- 5 Note that camera reverts to AF-S if the focusing ring on the lens is moved.

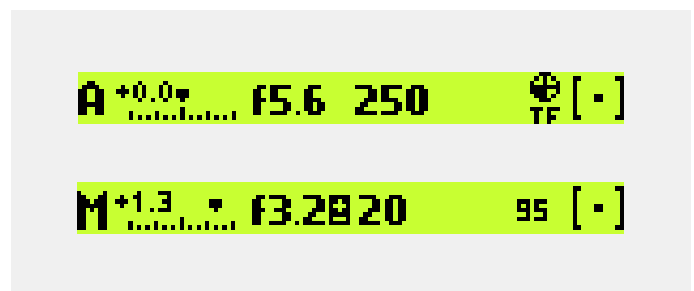

ACTIVATED BY TRUE FOCUS - AUTOFOCUS DEACTIVATED

In this mode the True Focus function is activated by pressing the True Focus button. Normal autofocus is de-activated, therefore pressing the shutter release button will not reset the focus. This method is useful when many shots are required with the same focus setting.

- 1 Press AF button (C). Select True Focus with the Front scroll wheel (B). Save.
- 2 Aim camera to the important area of the subject and press True Focus button (F).
- 3 Wait for the True Focus icon to appear in the viewfinder. Recompose the picture and press shutter release button (A).

Note!

The True Focus adjustment is applied to all following captures until True Focus button is pressed again (when a new adjustment is made).

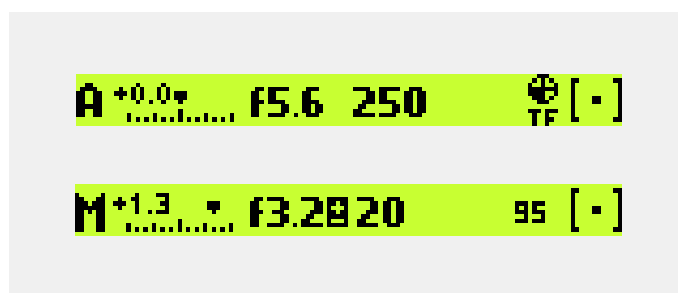

ACTIVATED BY AN ASSIGNED BUTTON - MANUAL FOCUS RETAINED

In this mode the True Focus function is activated by pressing an assigned button. This produces a 'one-shot' setting where the camera reverts to its original Manual focus setting after capture.

Pressing the shutter release button (A) will not reset the focus. This method is useful when many shots are required with the same focus setting.

- 1 Press MENU, select General Settings, select the desired button to reassign with the Front scroll wheel (M.UP button in this example). Select True Focus with the Rear scroll wheel. Save.
- 2 Aim camera at important area in subject and press the selected button.
- 3 Ensure that the True Focus icon appears in the viewfinder. Recompose the picture and press shutter release button. The True Focus icon disappears from the viewfinder. Camera reverts to Manual focus setting.

Note!

The True Focus adjustment is applied to all following captures until the True Focus button is pressed again (when a new adjustment is made).



Viewfinder Display View

True Focus TF symbol visible

M +1.3 • f3.2 20 95 [-]

5.8 CAMERA SELF TIMER

MAIN MENU > CAMERA SETTINGS > SELF TIMER

Press the Camera icon on the Sensor unit display. The Camera Settings Menu will appear.

Press the Self Timer Settings Menu.

Swipe right or press Menu / EXIT button to get back to Main Menu.

Camera Menu

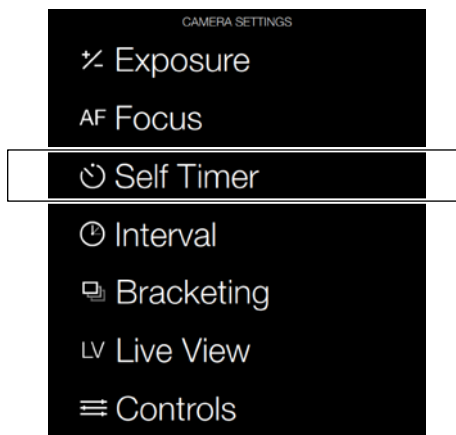

Self Timer Settings Menu

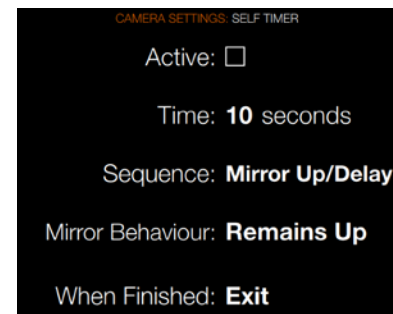

Self Timer Settings Menu

Active

On / Off

Time

Select time in seconds. Select between 2 - 60 seconds.

Sequence

Delay / Mirror Up.
Mirror Up / Delay.

Mirror behaviour

Mirror moves up.
Mirror remains up.

When Finished

Exit or Stay.

Grip Display View
Self Timer Settings



5.9 CAMERA INTERVAL SETTINGS

MAIN MENU > CAMERA SETTINGS >
INTERVAL

Press the Camera icon on the Sensor unit display. The Camera Settings Menu will appear.

Select the Interval Settings Menu.

Swipe right or press Menu / EXIT button to get back to Main Menu.

Camera Menu

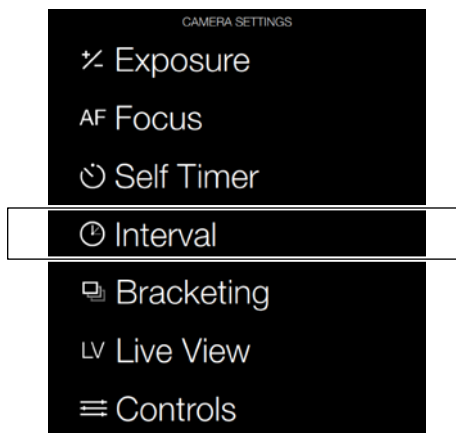

Interval Settings Menu

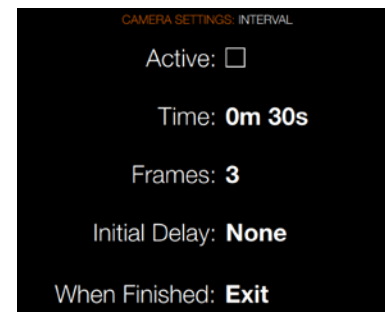

Interval Settings Menu

Active

On / Off.

Time

Select time between Exposures in minutes and seconds.

Frames

Select number of Frames from 2 - 99 or no limit.

Initial Delay

Select initial Delay. None or Interval time 60 s, 10 s, 2 s.

When Finished

Settings for Action When Finished. Exit or Stay.

5.10 CAMERA BRACKETING SETTINGS

MAIN MENU > CAMERA SETTINGS > BRACKETING

Press the Camera icon on the Sensor unit display. The Camera Settings Menu will appear.

Press the Bracketing Settings Menu.

Swipe right or press Menu / EXIT button to get back to Main Menu.

Camera Menu

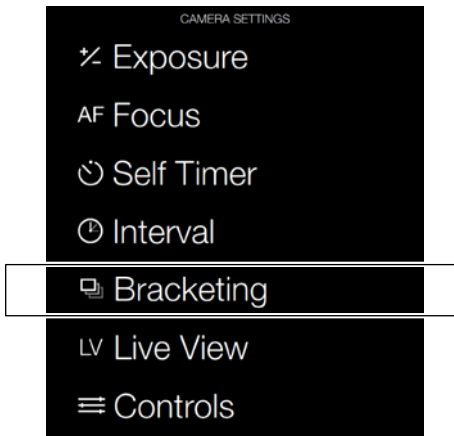

Bracketing Settings Menu



Bracketing Settings Menu

Active

On / Off.

Amount

Select Amount of Bracketing.

Frames

Select number of Frames.

Parameter

Aperture or Shutter speed.

Selects either the shutter speed or the aperture as the parameter which changes in a bracketing sequence when in Manual exposure mode.

Shutter speed selects changes in shutter speed.

Aperture selects changes in aperture settings.

Sequence

Select the sequential order of the over- or underexposures.

A: 0 + -

B: 0 - +

C: + 0 -

D: - 0 +

BRACKETING FUNCTION

The bracketing function provides an automatic series of captures, one at the standard exposure setting (Manual or Auto) and the others with pre-determined deviations in EV from the standard exposure. This is particularly useful for images containing a very wide tonal range, for example. First you make an assessment concerning the number of extra frames required, the order in which they should be taken, and by how much the EV deviation there should be and the setting made accordingly. The first metered exposure (Manual or Auto) is the EV that determines the calculations for the bracketing sequence. Note the difference in operation between Single and Continuous drive settings:

- At the Single setting you must press the shutter release button separately for every separate capture until the sequence is finished.

- At the Continuous setting you can either maintain the pressure on the button to take all frames without stopping or you can release the pressure on the button and press again to continue to the end of the sequence without losing any frames within the set sequence.

5.11 CAMERA LIVE VIEW SETTINGS

MAIN MENU > CAMERA SETTINGS > LIVE VIEW

Press the Camera icon on the Sensor unit display. The Camera Settings Menu will appear.

Press the Live View Settings Menu.

Swipe right or press Menu / EXIT button to get back to Main Menu.

Self Live View Settings Menu

Start

Start Live View Mode.

Camera Menu

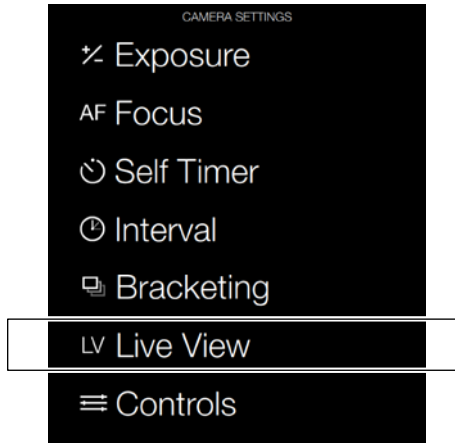

Live View Settings Menu

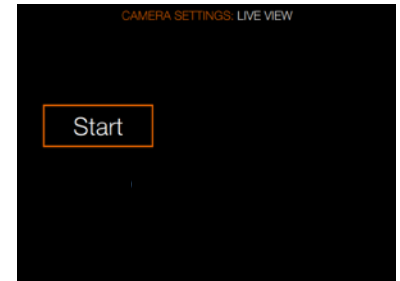

This Chapter Continuous on the next page.

LIVE VIEW

This feature is useful for accurate focusing, composition and depth of field preview.

- 1 Select Camera Settings > Live View.
- 2 Press Start to activate Live View.
- 3 Press button D to toggle overlay forward.
- 4 Press button B returns on step.
- 5 Button A, C, and E to Exit Live View.

Live View Settings

Overlay

Select Overlay Displayed during Live View. Scroll between options with button (B) and (D).

- Exposure Information
- Grid
- None

ZOOMING IN LIVE VIEW

- 1 Double click on Sensor Unit Display to Zoom in to Actual Pixel Size (100%) to that specific area.
- 2 Double click again to Zoom out to Display the entire Capture.
- 3 You can move the image to view different areas by swiping.

FOCUS IN LIVE VIEW

- 1 Double click on Sensor Unit Display to Zoom in to selected Focus Area.
- 2 Adjust Focal Point manually on the Lens.
- 3 Double click again to Zoom out to Display the entire Capture.

Note!

Live View demands higher power consumption than normal operation. Working with Live View will shorten the usage time of the Camera when on battery only power supply.

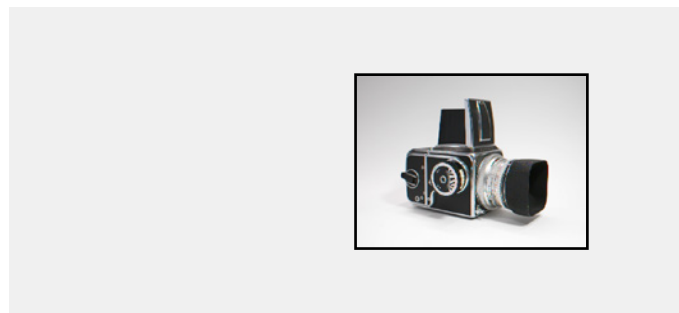
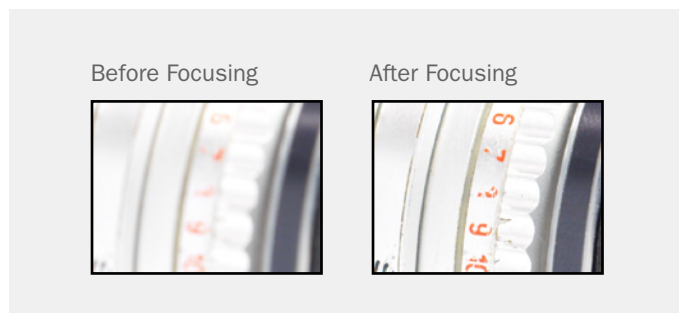
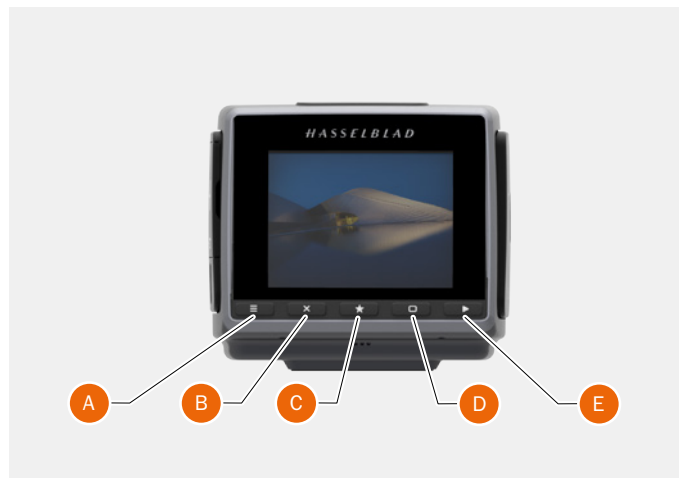

LIVE VIEW WITH HDMI EXTERNAL SCREEN

Connect an external Video Screen via HDMI.

Note!

Live View demands higher power consumption than normal operation. Working with Live View will shorten the usage time of the Camera when on battery only power supply.

5.12 CAMERA CONTROLS SETTINGS

MAIN MENU > CAMERA SETTINGS > CONTROLS

Press the Camera icon on the Sensor unit display. The Camera Settings Menu will appear.

Press the Controls Settings Menu.

Swipe right or press Menu / EXIT button to get back to Main Menu.

Camera Menu

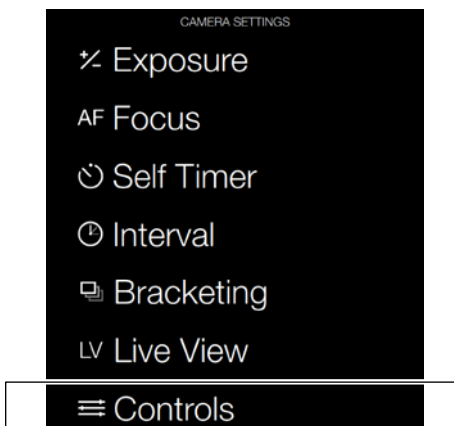

Controls Settings Menu

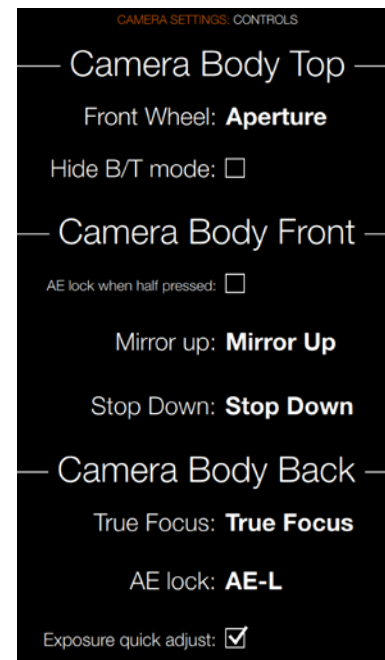

Camera Controls Settings Menu

Camera Body Top

Front Wheel

-Aperture
Shutter Speed

Normal Aperture

Normal
Light Meter

Allows choice of aperture indication display (in Manual mode only).

Normal selects conventional display (f5.6, f8, etc).

Light meter selects 'light meter' type display (f5.6, f8, etc).

Hide B/T mode

Select On / Off.

Camera Body Front

AE lock when half pressed

Select On / Off.

Mirror Up

Settings for Mirror Up button.

Stop Down

Settings for Stop Down button.

Camera Body Back

True Focus

Settings for True Focus.

AE Lock

Settings for AE Lock.

Exposure quick

Select On / Off.

5.13 VIDEO SETTINGS MENU

Main Menu

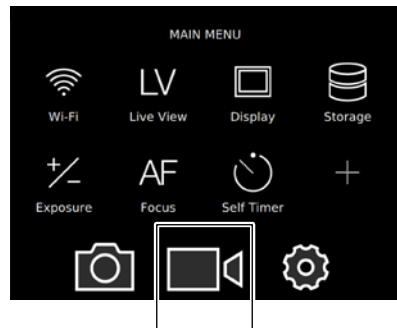

Video icon

Video Settings Menu

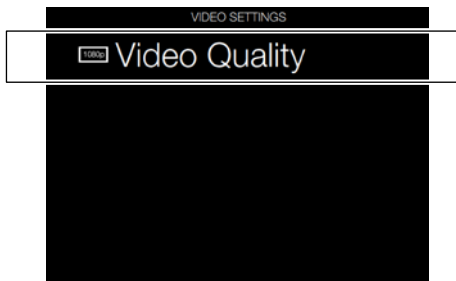

Video Quality Settings

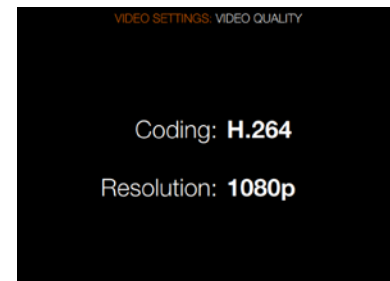

MAIN MENU > VIDEO SETTINGS

Press the Video icon on the Sensor unit display. The Video Settings Menu will appear.

Select the Video Settings Menu.

Swipe right or press Menu / EXIT button to get back to Main Menu.

VIDEO SETTINGS

In this release it is not possible to change the Coding or Resolution Settings. In a future firmware release there will be more options.

Coding

Video Quality Coding Settings.

Resolution

Video Quality Resolution Settings.

5.14 VIDEO QUALITY SETTINGS

MAIN MENU > VIDEO SETTINGS >
VIDEO QUALITY

Press the Video icon on the Sensor unit display. The Video Settings Menu will appear.

Press the Video Quality icon.

Swipe right or press Menu / EXIT button to get back to Main Menu.

Video Settings Menu

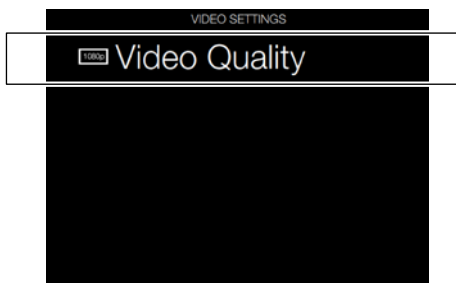

Video Quality Settings

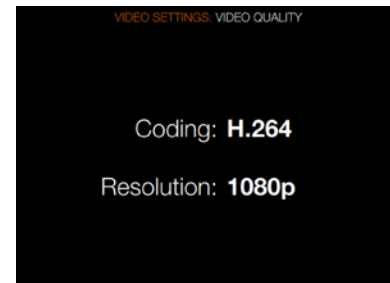

VIDEO QUALITY SETTINGS

In this release it is not possible to change the Coding or Resolution Settings. In a future firmware release there will be more options.

Coding

Video Quality Coding Settings
- H.264

Resolution

Video Quality Resolution Settings.

Video Coding

H.264 Video Coding.

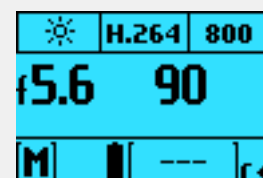

5.15 VIDEO RECORDING

To Record Video

- 1 Enter Video mode by a long press on the Video icon (1) on the Grip Display.
- 2 The Video Control Screen is displayed.
- 3 Start the Live Video Stream by pressing the Live Video icon.
- 4 The Video Stream is displayed on the Sensor Unit Display.
- 5 Start Recording by pressing the Exposure Trigger Button (2) or by pressing the red recording icon on the sensor unit display.
- 6 Stop the Recording by pressing the Exposure Trigger Button (2) or by pressing the stop icon on the sensor unit display.



- 1 Video Mode Button
- 2 Exposure Trigger Button

Video Control Screen

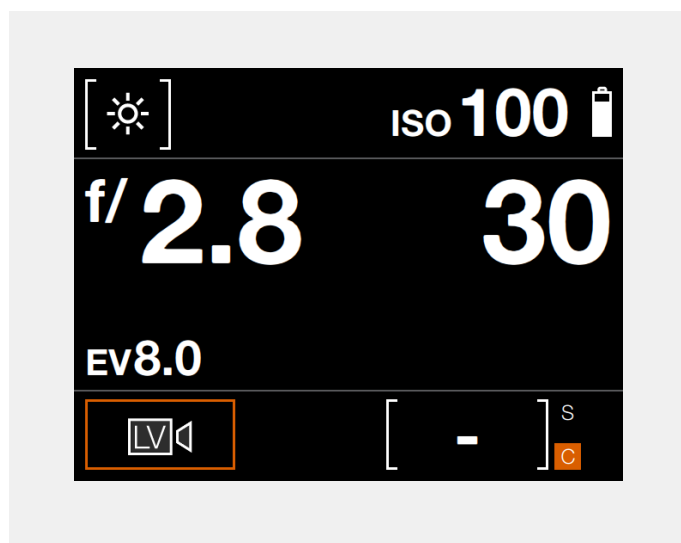

Video Display when capturing video



5.16 GENERAL SETTINGS MENU

Main Menu



General Settings Menu

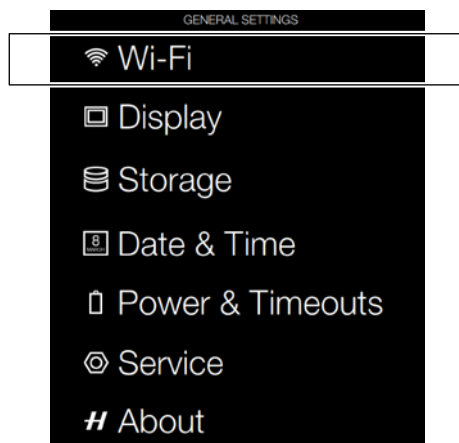

Wi-Fi Settings Menu

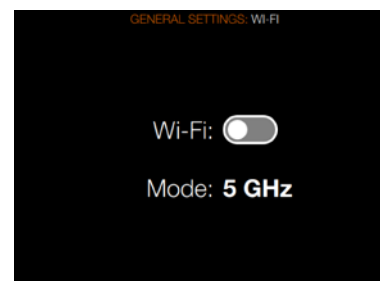

MAIN MENU > GENERAL SETTINGS

Press the Settings icon on the Sensor unit display. The General Settings Menu will appear.

Swipe right or press Menu / EXIT button to get back to Main Menu.

Wi-Fi Settings Menu Options

There are 2 options:

- 2.4 GHz.
- 5 GHz.

Continues on the next Page.

GENERAL SETTINGS WI-FI

The Wi-Fi mode allows the Hasselblad Phocus Mobile application on an Apple iPhone, iPad or iPod to function in the same way as when a camera is tethered to a computer.

MAIN MENU > GENERAL SETTINGS > WI-FI

- 1 Press MENU.
- 2 Select General Settings in the main menu on the Sensor Unit Display.
- 3 Select Wi-Fi.
- 4 Settings:
 - Wi-Fi: On or Off
 - Modes: 2.4 GHz or 5 GHz.

Note!

Some regions do not allow 5 GHz Wi-Fi.

Share Photos on Mobile Phocus App

When working with the Phocus Mobile App on your iPhone/iPad/iPod you can select the Share button in Phocus Mobile and share the photo in a text message, e-mail or on Facebook. You can also select Save as Image.

Note!

No images are stored on the iPhone/iPad/iPod. If you want to send a Photo via e-mail, use the Share function in Phocus Mobile or take Screen shot function on the iPhone/iPad.

WI-FI MODES

The Wi-Fi function has one mode of operation – Direct Access.

- Direct Access is when the camera creates a new Wi-Fi network and an iPhone/iPad/iPod is connected to it. The name of the network contains the camera serial number:

For example: “H6D-50c SQ34000123”

Wi-Fi Settings Menu

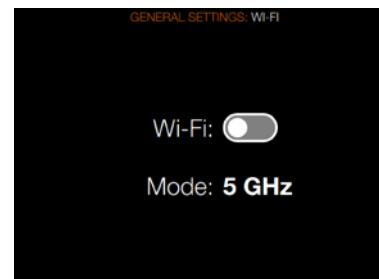

5.17 GENERAL SETTINGS DISPLAY

MAIN MENU > GENERAL SETTINGS >
DISPLAY

- 1 Press the Settings icon on the Sensor unit display.
- 2 The General Settings Menu will appear.
- 3 Select Display.

Swipe right or press Menu / EXIT button to get back to Main Menu.

General Settings Menu

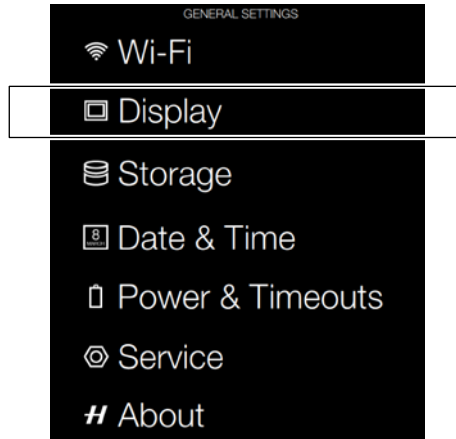

Display Menu



Display Menu Settings

Brightness

Slide Left or Right to change Brightness.

Show Preview

Select On / Off. On displays a preview of the capture after every exposure.

5.18 GENERAL SETTINGS STORAGE

MAIN MENU > GENERAL SETTINGS > STORAGE

- 1 Press the Settings icon on the Sensor unit display.
- 2 The General Settings Menu will appear.
- 3 Press the General Settings Storage icon.

Swipe right or press Menu / EXIT button to get back to Main Menu.

General Settings Menu

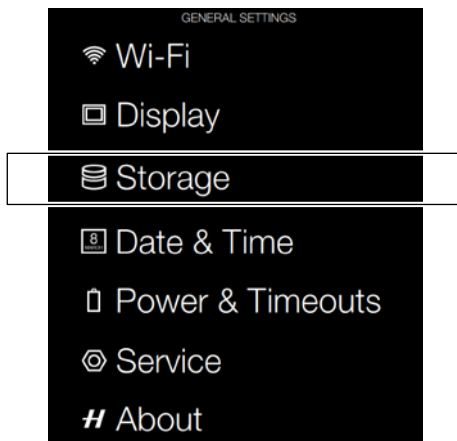

Storage Menu

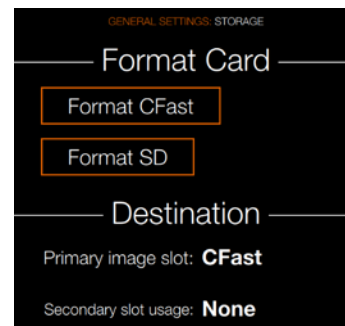

Storage Menu Settings

Format Card

- Format CFast.
- Format SD.

Image Destination

- Primary slot: CFast or SD.
- Secondary slot usage.

Format Card

Select Card to Format. CFast or SD Card.
Select Exit to Exit without formatting.

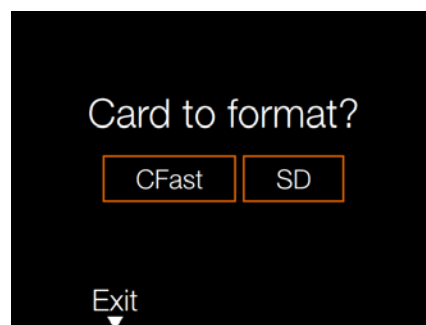

Format CFast Card Dialogue

Select Format to Format CFast Card.
All content will be erased.
Select Exit to Exit without formatting.

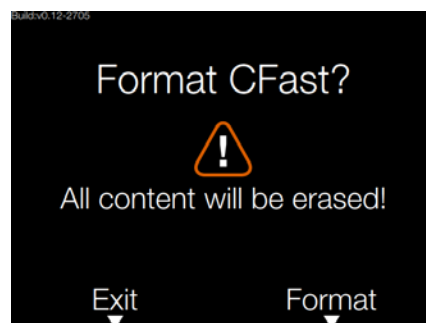

FORMAT CFAST AND SD CARDS

MAIN MENU > GENERAL SETTINGS > STORAGE > FORMAT CFast

The camera is only able to read and write to storage media that have been formatted correctly. New cards sometimes have no formatting, or you might want to convert a card that is currently using a format that the camera cannot read. In either case, you must reformat both CFast cards and SD cards in the sensor unit for H6D use.

There are two ways to format cards. The quickest way is to use the Format card button on the grip but if you prefer, you can also use the menu on the sensor unit.

FORMAT BUTTON

Press the Format button (A) on the camera grip. It is purposely recessed to avoid unintentional use, so use a ballpoint pen or similar. A prompt is displayed on the sensor unit for confirmation. It is also possible to press the format button with a hard press with a fingertip.

FORMAT MEMORY CARDS VIA SENSOR UNIT

MAIN MENU > GENERAL SETTINGS > STORAGE > FORMAT SD

- 1 Press MENU.
- 2 Navigate to Storage (use the Rear scroll wheel or navigate via the touch screen).
- 3 Navigate to Format Card (use the Rear scroll wheel or navigate via the touch screen).
- 4 Click on the button Format CFast or Format SD.
- 5 Confirm by pressing Format.

Swipe right or press Menu / EXIT button to get back to Main Menu.

Note!

All CFast and SD memory cards should be formatted in the sensor unit before using them the first time.

Note!

Only UDMA/type 4/60MBs (or 400x) cards or better are recommended for H6D use.



Storage Menu

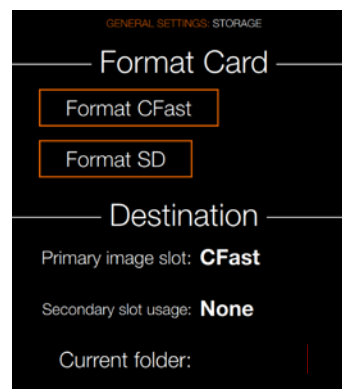

IMAGE AND VIDEO DESTINATION

MAIN MENU > GENERAL SETTINGS >
STORAGE > IMAGE DESTINATION

Destination Settings.

- 1 Press the Settings icon on the Sensor unit display.
- 2 The General Settings Menu will appear.
- 3 Press the General Settings Storage icon.
- 4 Select Image Destination.

Swipe right or press Menu / EXIT button to get back to Main Menu.

General Settings Menu

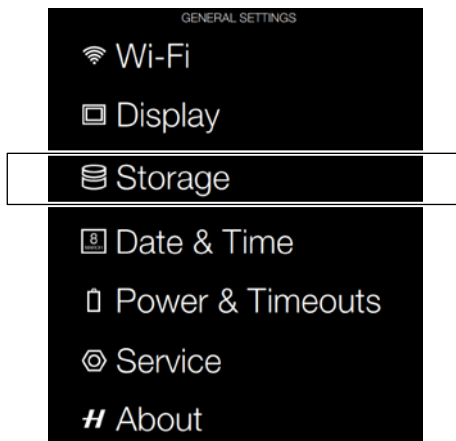

Storage Menu

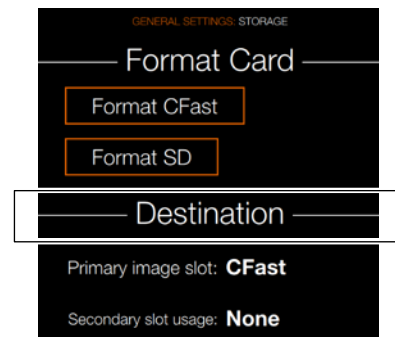

Image Destination

- Primary slot: CFast or SD.
- Secondary slot usage:
 - None.
 - Overflow.

If Overflow is selected the camera will automatically switch to the secondary card when the primary card is full.

5.19 GENERAL SETTINGS DATE AND TIME

MAIN MENU > GENERAL SETTINGS >
DATE AND TIME

- 1 Press the General Settings icon on the Sensor unit display.
- 2 The General Settings Menu will appear.
- 3 Press the Date and Time icon.

Swipe right or press Menu / EXIT button to get back to Main Menu.

General Settings Menu

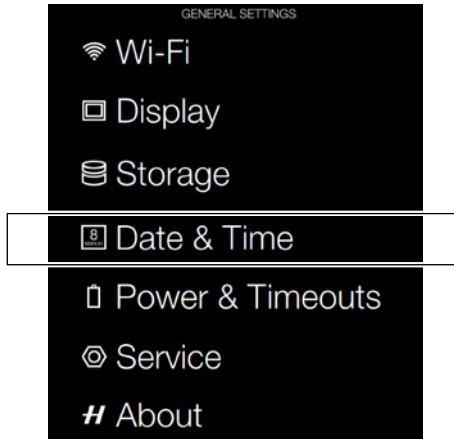

Date and Time Menu

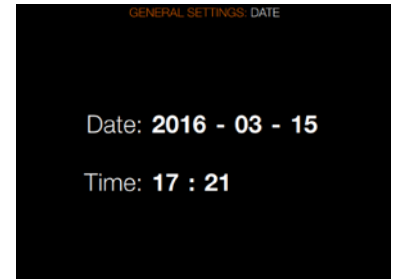

Date and Time Menu Settings

Date

Set Date by changing year, month and day using the pop up menus.

Time

Set Time by changing hour and minute using the pop up menus.

5.20 GENERAL SETTINGS POWER AND TIMEOUTS

MAIN MENU > GENERAL SETTINGS >
POWER AND TIMEOUTS

The H6D Camera can be set to automatically turn off the Sensor Unit Display after a set amount of seconds to save battery for example.

It can also be set to Power Off after 10, 30 or 60 minutes.

- 1 Press the General Settings icon on the Sensor unit display.
- 2 The General Settings Menu will appear.
- 3 Press the General Settings Power and Timeouts icon.
- 4 Adjust the time values by pressing the value and adjust the value in the pop up menus.

Swipe right or press Menu / EXIT button to get back to Main Menu.

General Settings Menu

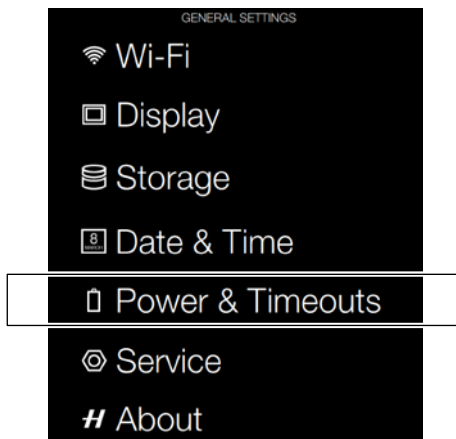

Power and Timeouts Menu

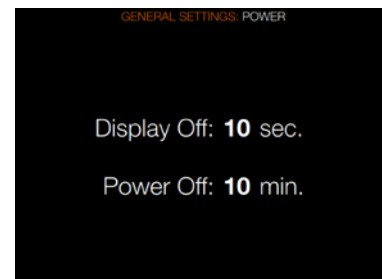

Power and Timeouts Menu

Display Off

Select Display Off Settings.

Power Off

Select Display Power Off Settings.

SET DISPLAY OFF MODE

MAIN MENU > GENERAL SETTINGS > DISPLAY > POWER MODES AND TIMEOUTS

- 1 Press the General Settings icon on the Sensor unit display.
- 2 The General Settings Menu will appear.
- 3 Press the General Settings Power and Timeouts icon.
- 4 Select Display Off.

In this mode the camera turns off the grip and sensor unit displays but remains ready to be immediately reactivated to the ON mode.

The time intervals are:

- 10 seconds.
- 20 seconds.
- 30 seconds.
- 60 seconds.
- Never.

POWER OFF

MAIN MENU > GENERAL SETTINGS > DISPLAY > POWER MODES AND TIMEOUTS > POWER OFF

Sets the amount of elapsed time before the camera enters complete power off mode. See 'Power Modes' section in this manual for further details.

Power Off options

- Power Off after 5 minutes.
- Power Off after 10 minutes.
- Power Off after 30 minutes.
- Power Off: Never

RE-ACTIVATE CAMERA FROM DISPLAY OFF/POWER MODE

Do any of the following actions:

- Press the Shutter release button half way.
- Press the Stop down button.
- Click the ON.OFF button.
- Press the Mirror up button.

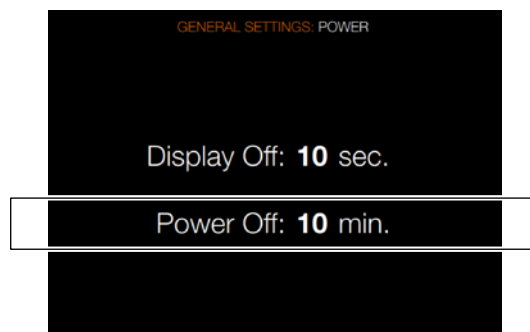
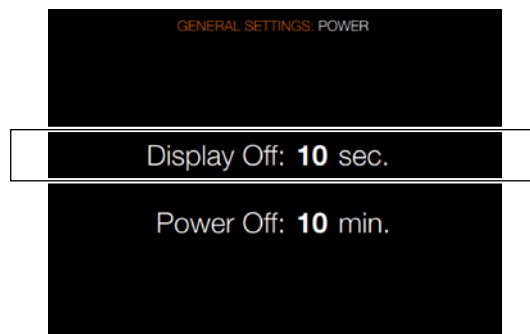

5.21 GENERAL SETTINGS LANGUAGE

MAIN MENU > GENERAL SETTINGS > LANGUAGE

- 1 Press the General Settings icon on the Sensor unit display.
- 2 The General Settings Menu will appear.
- 3 Press the General Settings Language icon.

Swipe right or press Menu / EXIT button to get back to Main Menu.

Language Menu Settings

More language options will be added in a future Firmware release.

Available Language:

- English

- 1 Press MENU button on the Sensor Unit Display.
- 2 Navigate to General Settings.
- 3 Navigate to Language.
- 4 Select Language.
- 5 Close the pop up Menu by a click outside the pop up.

Note!

If the sensor unit has been set to a language you don't understand (a rented camera, for example), see Chapter Troubleshooting for solution.

General Settings Menu

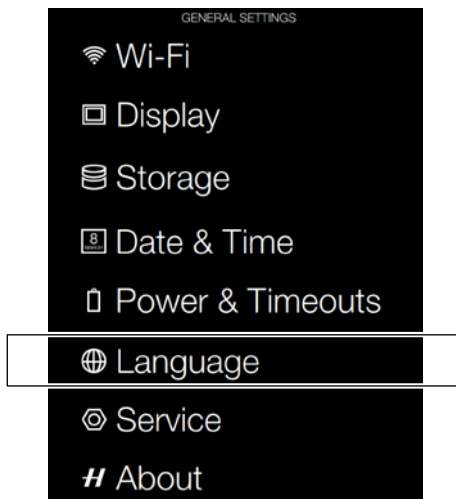

Language Menu

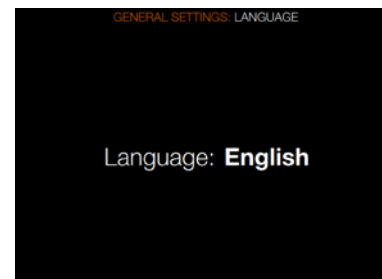

5.22 GENERAL SETTINGS SERVICE

MAIN MENU > GENERAL SETTINGS > SERVICE

- 1 Press the General Settings icon on the Sensor unit display.
- 2 The General Settings Menu will appear.
- 3 Press the General Settings Service icon.

Swipe right or press Menu / EXIT button to get back to Main Menu.

General Settings Menu

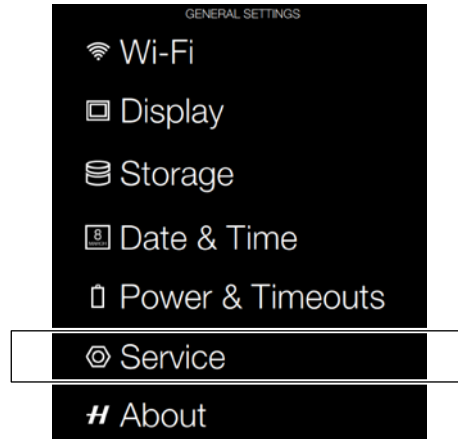

Service Menu

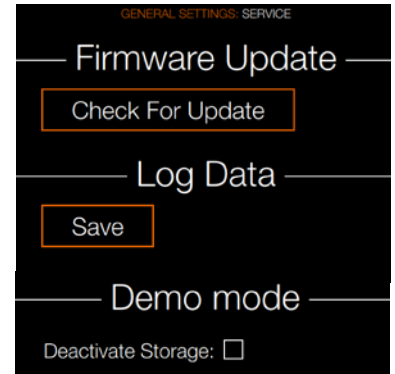

Service Menu Settings

Check For Update

Log Data

Press Save to Log Data for Service.

Demo Mode

Deactivate Storage: Select the check box and a dialogue screen is displayed. Select Deactivate to deactivate storage.

Note!

The Demo Mode is only intended for Retail Demo Purpose.

Note!

The Storage Deactivation is only active until the camera is restarted.

How to save Log Data:

- 1 Press MENU.
- 2 Navigate to General Settings.
- 3 Navigate to Service.
- 4 Navigate to Log Data.
- 5 Press the Save button.
- 6 Save Log Data saves a log file on the CFast card or SD card.
- 7 Save the chosen selection by pressing EXIT (MENU button).

5.23 GENERAL SETTINGS CHECK FOR UPDATE

MAIN MENU > GENERAL SETTINGS >
CHECK FOR UPDATE

- 1 Press the Settings icon on the Sensor unit display.
- 2 The General Settings Menu will appear.
- 3 Press the General Settings Check for Update button.

Swipe right or press Menu / EXIT button to get back to Main Menu.

General Settings Menu

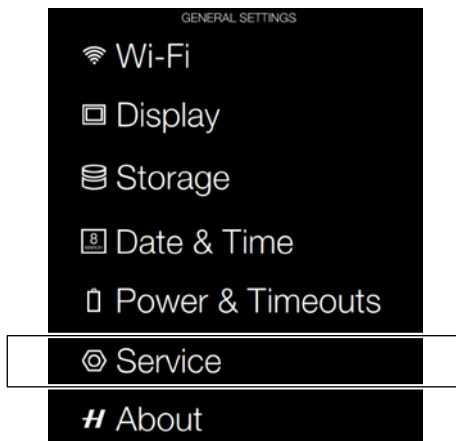

Check for Update Menu

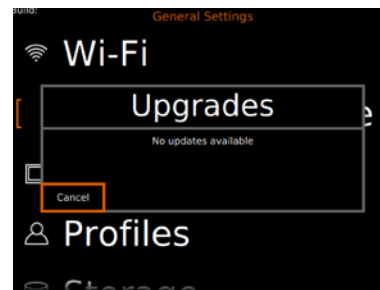

Check for Update Menu Settings

When connected to internet you can check for Firmware Upgrades.

5.24 GENERAL SETTINGS ABOUT

MAIN MENU > GENERAL SETTINGS >
ABOUT

- 1 Press the General Settings icon on the Sensor unit display.
- 2 The General Settings Menu will appear.
- 3 Press the General Settings About icon.

Swipe right or press Menu / EXIT button to get back to Main Menu.

General Settings Menu



About Menu

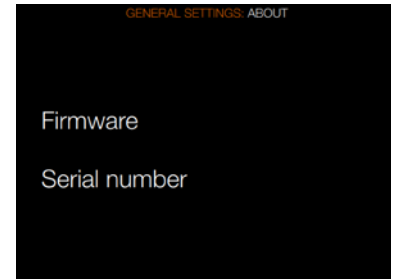

Firmware

The About box will tell you which firmware version is present so you can see if you have the latest firmware (can be downloaded from the Hasselblad website). The serial number is also displayed in case Hasselblad Support need to know it for problem solving.

5.25 GRIP DISPLAY NAVIGATION

BUTTONS AND CONTROLS ON GRIP DISPLAY

Press the buttons that surrounds the display and turn the scroll wheels to navigate the menu and access the settings on the grip. Note that some of the buttons have several functions which is indicated by the designation that appears closest to that particular button when navigating. For example, the Menu button (F) also acts as a Video button. The Play button (G) also acts as Illumination On for the Grip Display. The ON / OFF button (H) also acts as the Profiles button.

List of the various terms describing the various actions that appear on the grip display:

Quick save - half press shutter release button.

Escape - press ESC button (H). Terminates an action and returns to the main screen. Does not save any settings.

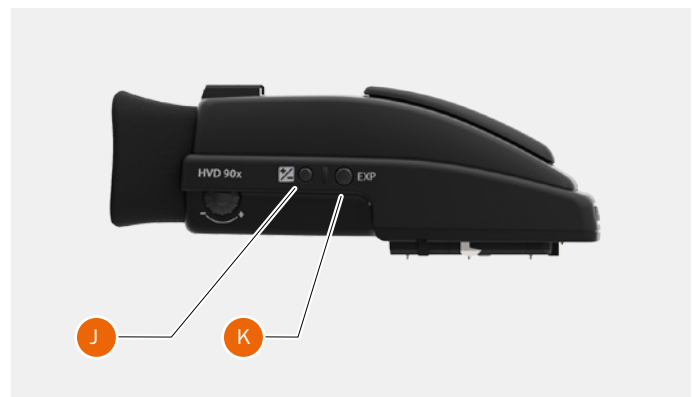

- A Shutter release button
- B Front scroll wheel
- C WB button
- D AF button
- E ISO
- F MENU / Video button
- G PLAY / Illumination
- H ON / OFF (Profiles) button
- I Rear scroll wheel
- J Exposure and flash compensation button
- K Exposure mode / Metering mode

TO ADJUST SHUTTER AND APERTURE ON GRIP

Note!

In manual mode both the shutter and aperture are electronically controlled and are adjusted by the scroll wheels on the grip.

Note!

There are no separate manual setting rings on the lenses or camera body. The settings are displayed both on the grip display and in the viewfinder display.

How to adjust shutter and aperture

- 1 Turn the front scroll wheel (A) to adjust the shutter and aperture.
- 2 Turn the rear scroll wheel (B) to adjust the shutter and aperture.



In Manual mode (M):

- Front wheel = Aperture.
- Rear wheel = Shutter speed.

In Aperture priority (A) mode:

- Front wheel = Aperture.
- Rear wheel = Quick exposure adjustment of Shutter speed.

In Shutter priority (S) mode:

- Front wheel = Shutter Speed.
- Rear wheel = Quick exposure adjustment of Aperture.

In P or Pv mode:

- Front wheel = Aperture/shutter speed combination.
- Rear wheel = Quick exposure adjustment.

See under Light Metering and Exposure Control/Exposure Method for a complete description.

GRIP DISPLAY NAVIGATION

Main Screen

This is the Main Screen of the Camera Grip Display. These are the most important camera settings. The top row displays WB, AF and ISO. The middle displays Aperture, Shutter Speed, EV (Exposure Value) and Exposure Compensation values are displayed. At the bottom of the screen Exposure Mode, Light Meter Method, Drive Mode, Battery Level, Exposure Counter and Status of the memory cards are displayed.

Menu

Normally the front and rear wheels are used to control aperture and shutter-speed values. If you would like to use the wheels to navigate the menus of the Sensor Unit, first press the MENU button. Then the Menu symbol is shown in the center of the display.

As long as the Menu Mode is active it is possible to use the wheels to navigate the menu system of the Sensor Unit. If you want to leave the Menu Mode (and use the wheels for aperture and shutter-speed) press the Menu button again or half-press the exposure trigger button.

White Balance (WB)

Press the WB button above the Grip Display to show the WB Menu. Select WB mode by scrolling left or right with the front wheel. Get back to the Main Screen by half-press or by clicking the WB button again.

White Balance Manual (WB)

To set the Colour Temperature manually, scroll the Front Scroll Wheel until "M" is displayed. Then the colour temperature value is displayed at the bottom of the screen.

ISO

Press the ISO button to show the ISO menu. Use the Front Scroll Wheel to scroll up and down between available ISO numbers. Half-press or click the ISO button once again to leave the menu.

Main Screen

Grip Display Main Screen.

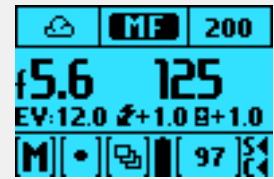

Menu

Grip Display Menu symbol on Screen.



WB

Grip Display White Balance (WB) Screen.



WB Manual

Grip Display Manual White Balance (WB) Screen.



ISO

Grip Display Manual ISO Screen. ISO 400 displayed.

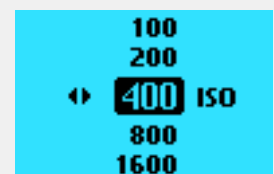

Auto Focus (AF)

Press the AF button above the Grip Display to show the AF menu. Select AF mode by scrolling the Front Scroll Wheel left or right until the desired mode is selected.

Auto Focus (AF) with Macro Lens 120mm

When the 120mm Macro Lens is used the AF menu displays an additional setting – Focus Range. To limit the large focus range of the Macro Lens can improve the AF performance significantly. It is possible to select one of the three modes below for Focus Range.

The first limits the AF to scan the close-up range only (less than 1 meter).

The second scans far away distances only (between 1 meter and infinity).

The third option is to scan the Full Range.

Browse

To easily reach Image Browse mode, click the Browse (Play) button to right of the Grip Display. The Browse Mode is activated and it is possible to browse images using the wheels. To Exit Browse Mode half-press or press the Browse button again.

Video Display

In Video Mode the Grip Displays some essential settings for example White Balance (WB M selected), Focus (MF Manual Focus Selected), ISO (200), Play icon, Pv and Spot Metering.

Auto Focus (AF)

Grip Display Auto Focus (AF) Screen.



Close-up Scan



Far Away Scan



Full Range Scan

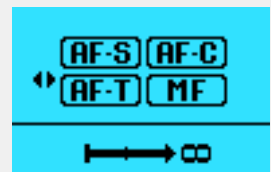

Browse

Grip Display Browse Screen.



Video Display

Display when in Video Mode.



+/- Button on Viewfinder

Press the +/- button on the Viewfinder to reach the Exposure Adjust menu. Use the Front Scroll Wheel to set the exposure compensation for flash and the rear wheel to set the exposure compensation. The exposure compensation can be set between -5.0 and 5.0 stops and the flash compensation between -3.0 and 3.0 stops. Leave the menu by half press or by pressing the +/- button again.

+/- Button

Grip Display +/- Button on Viewfinder Screen.

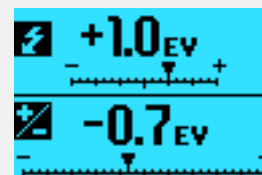

EXP Button on Viewfinder

Press the EXP button on the Viewfinder to the menu for Exposure Mode and Light Meter Mode. Set the Exposure Mode using the front wheel and the Light Meter Mode using the rear wheel. Leave the menu by half press or pressing the EXP button again.

EXP Button

Grip Display EXP Button on Viewfinder Screen.



Exposure Modes

- M = Manual
- A = Aperture priority
- S = Shutter priority
- P = Program
- Pv = Program (variable)

Light Meter Modes

- Center Weighted
- Spot
- Center Spot

5.26 VIEWFINDER DISPLAY NAVIGATION

TYPICAL VIEWFINDER DISPLAY

Viewfinder Display Visual User Interface

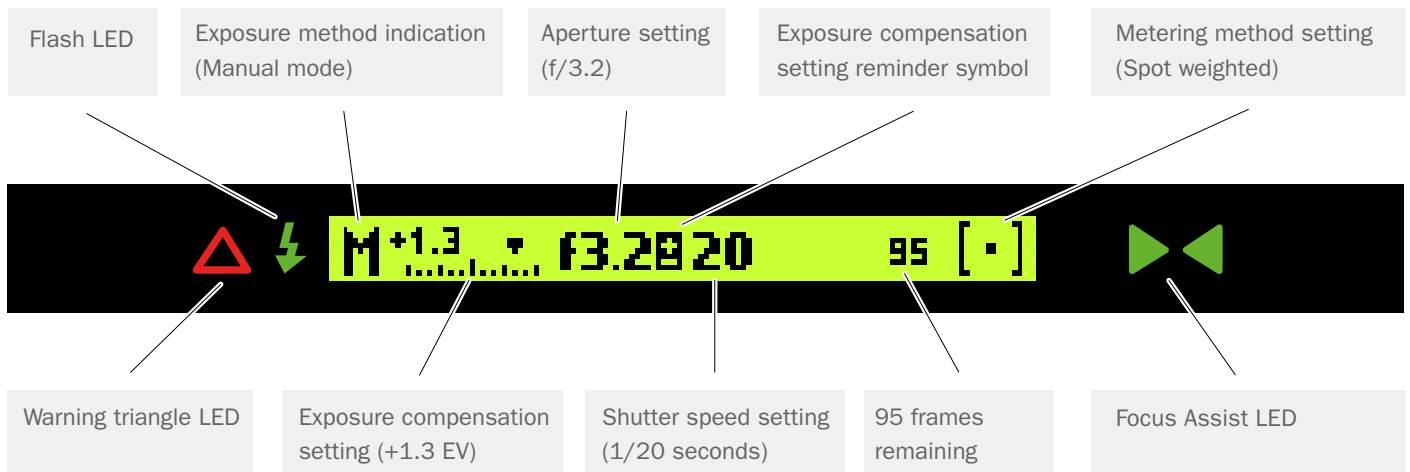

Note!
The LED's will only be visible when activated by the camera or a setting.

VIEWFINDER DISPLAY NAVIGATION OVERVIEW

How to Navigate the Viewfinder Display

Select WB, AF, or ISO near the Grip Display or Exposure Compensation mode and Exposure and Metering Modes on the right side of the Viewfinder.

- 1 Turn the front scroll wheel (A) to adjust settings.
- 2 Turn the rear scroll wheel (B) to adjust settings.

On the right side of the Viewfinder you can select:

- + / - button Exposure Compensation
- EXP button Exposure and Metering Modes



ISO, WB and AF modes

ISO Change ISO mode by scrolling the Front Scroll Wheel (A) left or right.

WB Mode Change WB mode by scrolling the Front Scroll Wheel (A) left or right.

AF Mode Change AF mode by scrolling the Front Scroll Wheel (A) left or right.

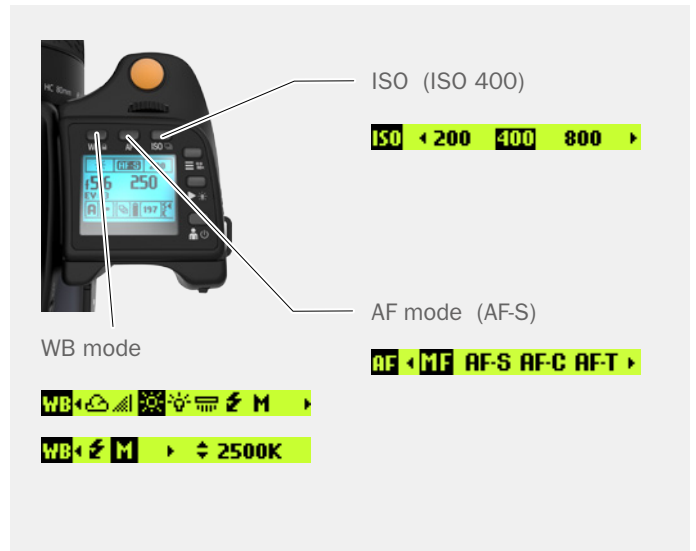

Exposure and metering mode examples

- M = Manual
- A = Aperture priority
- S = Shutter priority
- P = Program
- Pv = Program (variable)

- Center Weighted
- Center Spot
- Spot

Change Exposure by scrolling the Front Wheel (A) up and down.
Change Metering mode by scrolling the Rear Scroll Wheel (B) up or down.

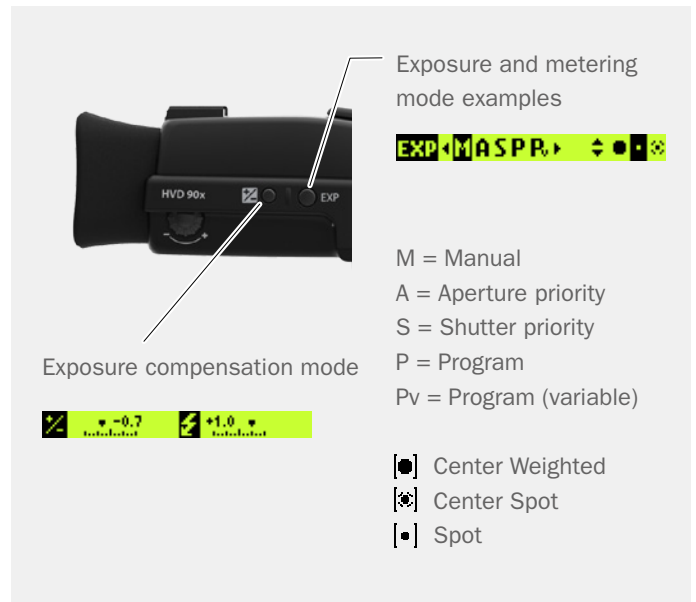

VIEWFINDER DISPLAY EXAMPLES

Main Menu

This is the Main Menu Screen of the Viewfinder Display. It shows the most important exposure information.

To the left the exposure mode is displayed, Manual Mode in this case. The scale with an arrow shows the exposure compensation setting. In the center of the display the aperture and shutter speed are displayed. If an exposure compensation is set, a sign with a plus and minus is displayed between the aperture and shutter speed value. Second from the right the exposure counter is shown. To the far right the light meter mode is displayed, Spot meter mode in this case.

Main Menu

Normally the Front and Rear Scroll Wheels are used to control aperture and shutter speed values. If you would like to use the wheels to navigate the menus of the Sensor Unit, first press the MENU button. Then the menu symbol is shown in the center of the display to remind you that the camera is now in menu mode.

As long as the menu mode is active it is possible to use the wheels to navigate the menu system of the sensor unit. If you would like to leave the menu mode, and use the wheels for aperture and shutter speed, press the menu button again or half-press the exposure trigger button.

Browse

To reach Image Browse Mode, press the Browse (play) button on the right side of the Grip Display. Then the Browse Mode is activated and it is possible to Browse Images on the Sensor Unit using the wheels. To exit Browse Mode half-press or press the Browse button again.

ISO Settings

Press the ISO button to display the ISO Settings Menu. Use the Front Scroll Wheel to scroll left and right between available ISO numbers. Half-press or press the ISO button once again to leave the menu.



M +1.3 f3.2 20 95 [•]

Main Menu, Manual mode selected.



Main Menu Icon.



Browse Mode icon.



ISO ← 200 400 800 →

ISO settings, ISO 400 selected.

Exposure settings

Press the EXP button on the Viewfinder to display the Exposure Mode and Light Meter Mode menu.

Set the Exposure Mode using the Front Scroll Wheel and the Light Meter Mode using the Rear Scroll Wheel. Leave the Menu by half-pressing or by pressing the EXP button again.

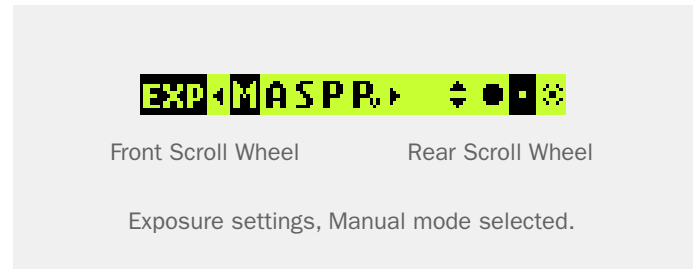

Exposure Settings, adjust screen

Displays the Camera Exposure Settings to the left and the Flash Exposure Settings to the right.

Press the +/- button on the Viewfinder to reach the Exposure Adjust menu. Use the Front Scroll Wheel to set the Exposure Compensation for Flash and the Rear Scroll Wheel to set the Exposure Compensation. The Exposure Compensation can be set between -5.0 and 5.0 stops and the flash compensation between -3.0 and 3.0 stops. Leave the menu by half-press or by pressing the +/- button again.

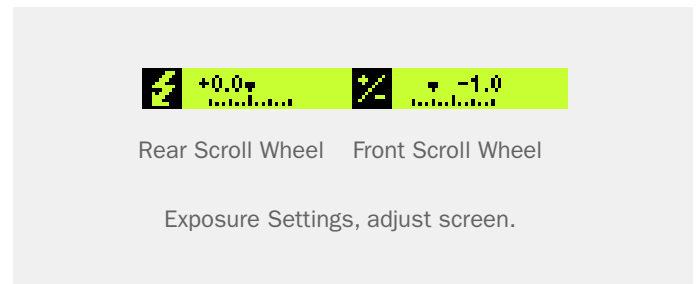

White balance WB settings

Press the WB button above the Grip Display to show the WB Settings Display. Select WB mode by scrolling left or right with the Front Scroll Wheel. Return to the main screen by a half-press or press the WB button again.

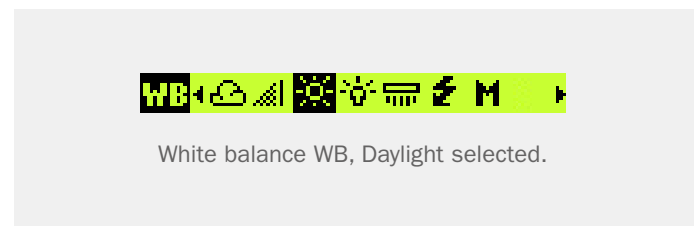

White balance WB mode, Manual

To set the Colour Temperature manually, scroll the Front Scroll Wheel until "M" is displayed. Then the Colour Temperature value is displayed in the right upper part of the screen. Change the value by scrolling the Rear Scroll Wheel up or down. It is possible to set values between 2000 K and 10000 K, in steps of hundred K. Leave the WB menu by half-press or by pressing the WB button again.

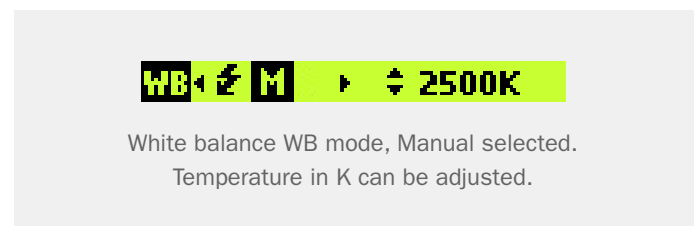

Autofocus Settings

Press the AF button above the Grip Display to show the AF menu. Select AF mode by scrolling the Front Scroll Wheel left or right until the desired mode is selected.



Autofocus Settings, AF-S selected.

AF with Macro 120mm

When the 120mm Macro Lens is used the AF menu displays an additional setting – Focus Range. It is possible to select one of the three modes below for Focus Range.

The first limits the AF to scan only the close-up range (less than 1 meter).

The second option scans only far away distances (between 1 meter and infinity).

The third option is to scan the full range. The Macro Lens has a large focus range and to limit the scan range can improve the AF performance significantly.



Macro Autofocus settings, Close-up Scan.



Macro Autofocus settings, Far Away Scan.



Macro Autofocus settings, Full Range Scan.

Information Screen

This is the Information Screen with Storage medium missing displayed.



Information Screen, Storage medium missing.

Frame Count

This is the Frame Count with more than 1000 frames left displayed. 1k9 = 1900 images left.



Frame Count, more than 1000. 1k9 = 1900.

5.27 REMOVE / ATTACH VIEWFINDER

REMOVE THE VIEWFINDER

Caution!

Be careful when you attach/detach the components to/from the camera. This will help prevent damage to the data bus connections.

Caution!

Use the grip or strap when you lift and handle to camera. This will help prevent damage to the camera.

- 1 Hold the Viewfinder in your right hand.
- 2 Press and hold down the Viewfinder release button (A).
- 3 Lift the rear of the Viewfinder up and away from the camera body.

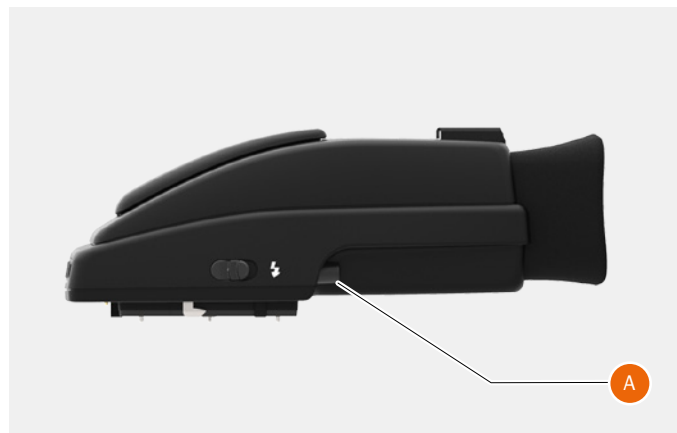

ATTACH THE VIEWFINDER

Caution!

Be careful when you attach/detach the components to/from the camera. This will help prevent damage to the data bus connections.

Caution!

Use the grip or strap when you lift and handle to camera. This will help prevent damage to the camera.

- 1 Hold the Viewfinder at a slight angle and rest it on the top of the camera.
- 2 Slide the Viewfinder forward until the front locating pin is in position in the recess in the front edge of the viewfinder screen aperture (B) on camera body.
- 3 Press the rear part of the Viewfinder firmly downwards until it clicks into place.
- 4 Make sure that both sides of the Viewfinder are seated correctly and that it has been firmly attached and locked into position.



ADJUST THE EYEPIECE

No corrective lenses are needed to adjust the eyepiece to suit most requirements. The dioptre range is from -5 to +3.5D. Eyeglass wearers can rapidly and accurately change the settings according to whether they wish to wear eyeglasses for viewing or not.

- 1 Hold the camera in your left hand.
- 2 Point the camera at the sky or a similar smoothly toned area.
- 3 Turn the adjustment wheel (A) until the markings on the Viewfinder screen reach the optimum sharpness for your eyesight.



CHANGE FOCUSING SCREEN

The H6D is fitted with a Spherical Acute-Matte D Focusing Screen for extreme brightness, clarity and even illumination. An optional accessory screen with a grid pattern is also available.

To change the Focusing Screen, remove the viewfinder to access the Focusing Screen.

To remove the screen, place the tip of a ballpoint pen or similar in the Focusing Screen removal lug and pull upwards. To replace the Screen, position the right side of the Screen in place so that it sits correctly in the recess. Place the tip of a ballpoint pen or similar in the Focusing Screen replacement indentation and press downwards until the Screen snaps into position. Try to avoid touching either surface of the Screen with bare fingers.

Note!

Do not attempt to clean the Focusing Screen by immersing it in water, or use any kind of cleaning fluid. If the Screen becomes damp, do not use hot air to dry it. Use a soft cloth on the upper surface only. Seek advice from an Authorized Hasselblad Service Center if the Screen becomes particularly soiled. Remember that particles or greasy marks on the Screen might impair the viewfinder image but have no effect on the recorded image.

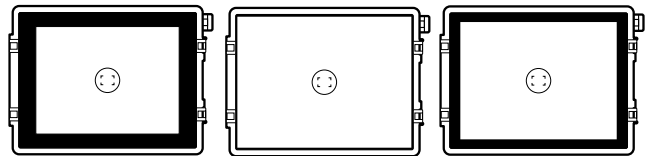

Focusing Screens showing the difference in masking and composition frame marking. Type varies according to sensor size. See under Accessories for other types (with grid pattern, for example).

5.28 PREVIEW, HISTOGRAM AND BROWSING

PREVIEW MODES

Use the Rear Scroll Wheel to scroll through the available preview modes when in Browse Mode or single click on the Meta Data information to change Preview Mode.

- Standard Preview: Displays a Preview Image with the most important settings. Note that the information covers some of the image. Go to Full Screen mode to see the complete Capture area.
- Histogram: Displays a Preview Image with a Histogram.
- Full Screen Preview: Displays the preview only with no frame or settings information.

Two additional screens are also available, accessible from the Histogram screen:

- Combined Histogram: Displays a Preview Image with a combined histogram of the three components red, green and blue.
- Capture Details Mode: Displays a Preview Image with camera settings details in a layer in front of the Preview Image.

Histogram and Combined Histogram can be accessed by navigating to Histogram mode.

- 1 Press one time on the desired Mode.
- 2 Scroll Up or Down with the Rear Wheel when in Browse Mode to change Mode.
- 3 When in Browse Mode, Tap once in the lower part of the Sensor Unit Display. Step through the different Modes.

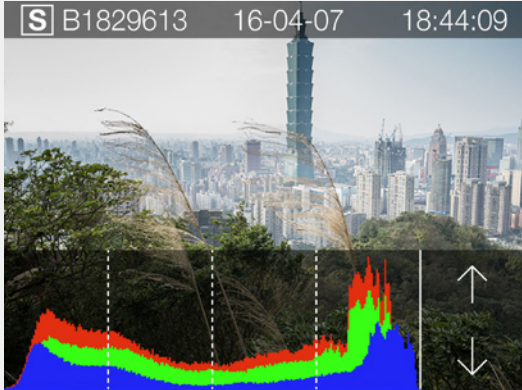

Change Preview and Histogram Mode by a single press on desired Mode or use the Rear Scroll Wheel.



Histogram

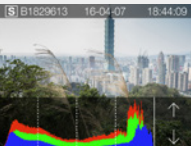

Luminance Histogram

Standard Preview	Histogram	Full Screen Preview
		

The Standard Preview displays information described on the next page.

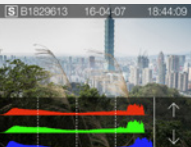

The Full Screen Preview displays the Full Capture View without other information.

STANDARD PREVIEW

The Standard Preview is displayed when you first turn on the camera and is probably the view you will use most often.

It displays a preview of your most recent capture and basic information about the settings.

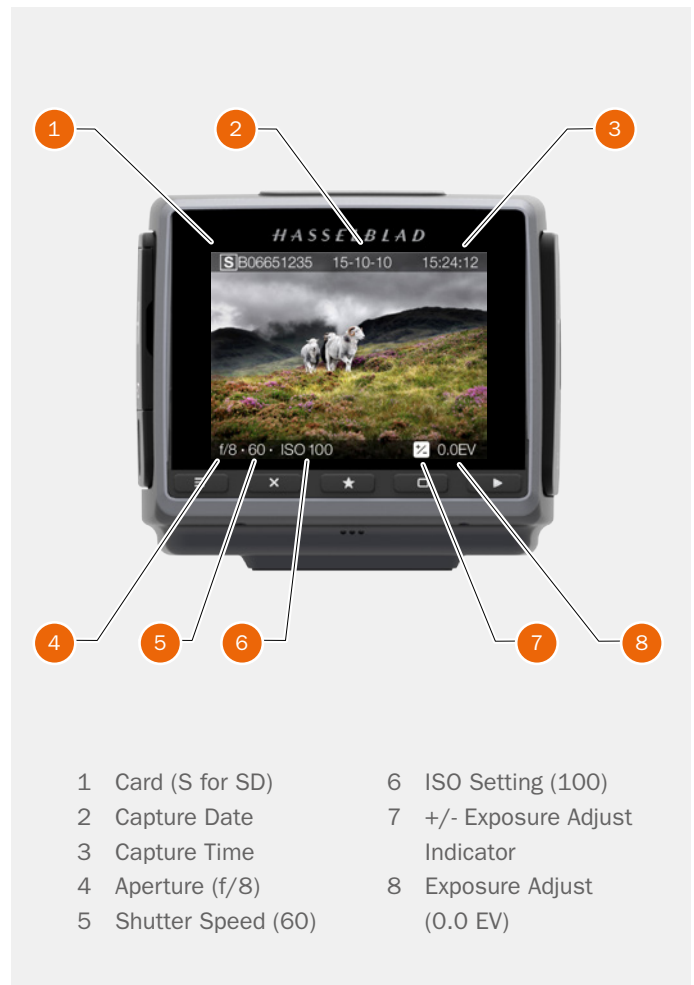

9 VIEW MODE

To display 9 View Mode, press the AE-L button when in Browse Mode. In this Mode you can see an overview of up to 9 captures. If you have more than 9 captures, swipe down at the right side of the Display to scroll through all captures. Select one capture for further information.

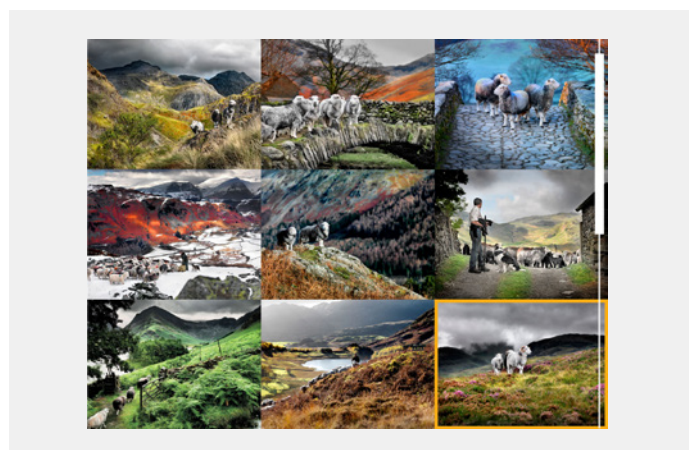

HISTOGRAM TYPES

There are different types of Histogram representations available. Histogram Mode, Capture Details Mode, Combined Histogram Mode and Separate Histogram RGB Mode.

HISTOGRAM MODE

Histogram mode displays RGB Histogram with separate RGB channels visible. The RGB details are stored with the capture file, and can be referred to in Phocus and other applications.

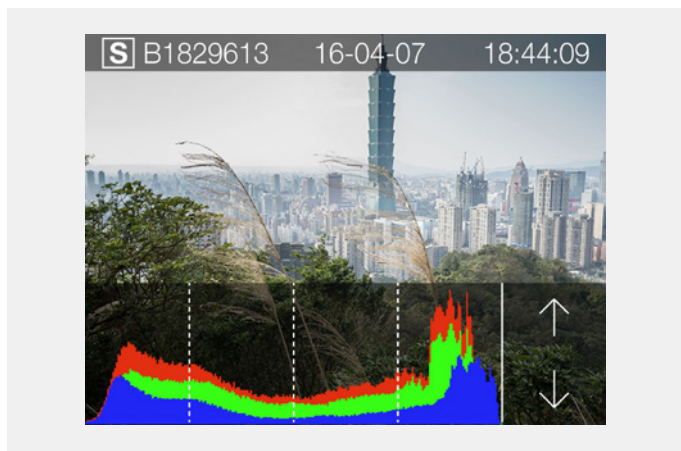

LUMINANCE HISTOGRAM MODE

In Luminance Histogram mode, the RGB channels displays the the luminosity Histogram. The RGB info is represented by a White Combined RGB Graph.

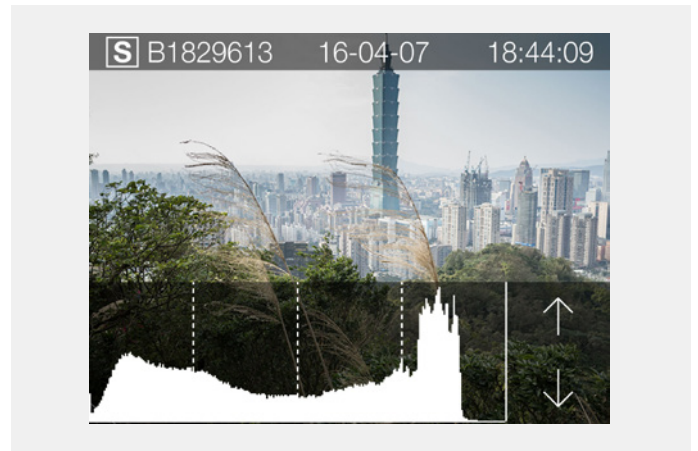

CAPTURE DETAILS MODE

This mode displays SD Card (S), Date (16-04-07), Time (18:44:09), selected Aperture (f/11), Shutter Speed (60), ISO (200), EV Settings (+/- 0.0), Mode (M), Focus Method (Spot), White Balance (Daylight) and Lens info (50mm).

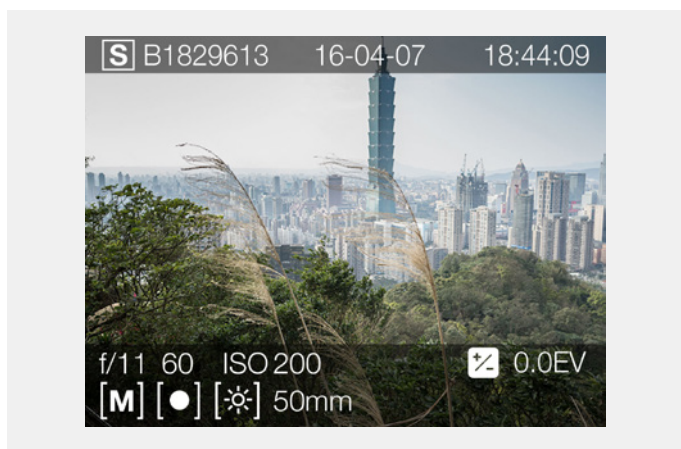

SEPARATE HISTOGRAM RGB MODE

In Separate Histogram RGB Mode, the individual RGB channels are displayed. The Red R channel first, the Green G channel in the middle and the Blue B channel below the Red and Green channels.

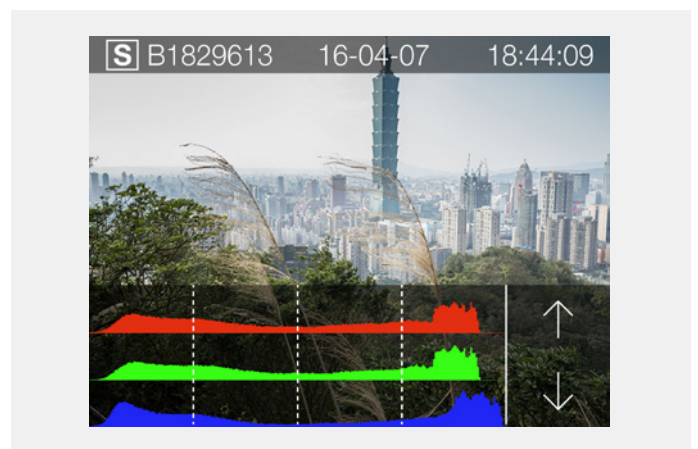

HISTOGRAM MODE - EXPOSURE

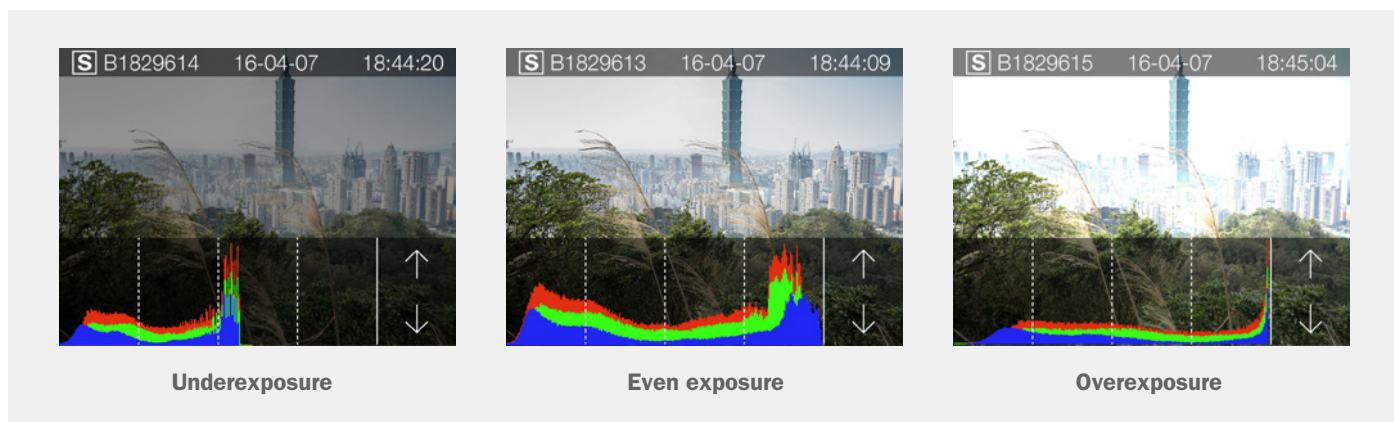

Histogram Exposure

The Histogram provides a graph that indicates the total number of pixels at each brightness level, with brightness in range from black on the left to white on the right. It is a valuable tool for evaluating captures.

A well exposed shot usually has a full range of levels, while underexposed and overexposed Captures tend to show levels concentrated at the left or right part of the scale.

The histogram is only an indicator that should be interpreted. There are several situations in which a 'bad' histogram will match an exposure that could be perfect for the intended effect.

Study the Histogram examples and the explanations below.

Underexposure

Histogram display concentrated on the left with few pixels elsewhere indicates a likely underexposure. Many details will be lost in the shadows.

Even exposure

Histogram display spread across the full range indicates a likely good exposure. There may still be a few pixels at the extremes, indicating a few spectral highlights and saturated shadows, but this is often normal in a good exposure.

Overexposure

Histogram display concentrated on the right with few pixels elsewhere indicates a likely overexposure. Many details will be lost in the highlights.

BROWSING

Press Play button (B) on the Grip Display or on the Sensor Unit (G) to enter Browse mode.

In Browse mode use the Front Scroll Wheel on the Grip (A) to Browse captures in a folder.

In Browse mode on the Sensor Unit Menu, swipe right or left to Browse captures.

Delete Capture with the Soft Button (D).

Zoom out to Folder View to select another folder to Browse.

Browse button (B) and (G)

Starts display and shows the last image. The user can review images, browse and zoom. Preview images and zoom in to view close-ups of previews for focus checking. Zoom out to view several at once and finally to view and select folders and media.

This is also a selection button for value setting on the Sensor Unit Menu.

Image rating button (E)

Rate image 1-5 stars or green/yellow/red. Also works as soft button.

Press Menu button (C) to return to Main Menu.

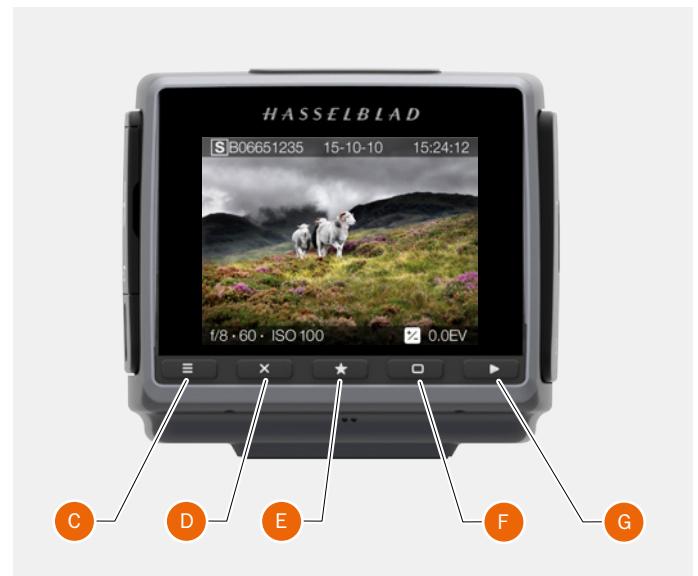

Select Card to Browse

You can select CFast Card or SD Card to Browse Captures.

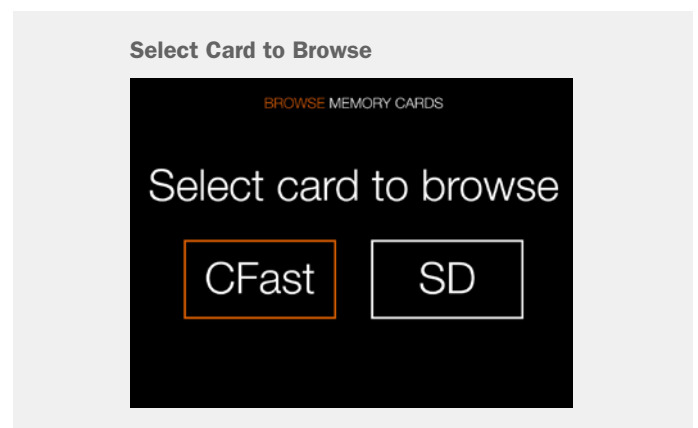

ZOOM IN AND OUT

The Touch Screen on the H6D Sensor Unit is similar to a Phone or Tablet with touch sensitivity. The following gestures can be used to navigate and control the H6D Camera:

Function	Action
Zoom in	Spread (move two fingers apart).
Zoom out	Pinch (move two fingers together).
Select	Tap / Press with one finger.
Move back	Swipe right.
Display Control Screen	Swipe down from the top of the screen.
Hide Control Screen	Swipe up.
Action	Function
Double Tap	Zoom in to 100%. Double Tap again to Zoom out to full View.
Swipe Right	Move back / Move image right.
Swipe Left	Move image left. Only in Browse mode.
Swipe Down	Display Control Screen.
Swipe Up	Hide Control Screen.
Tap / Press	Select action / button / setting.

9 View Mode

9 View Mode displays an overview of up to 9 captures. Scroll down to display all Captures in the Folder.

Folder View

Folder View displays the list of folders saved. The highlighted folder is the current folder and contains the images you are browsing. Navigate to another folder and then zoom in to reveal its contents if desired.

Zoomed View



Standard Preview



9 View Mode



Folder View

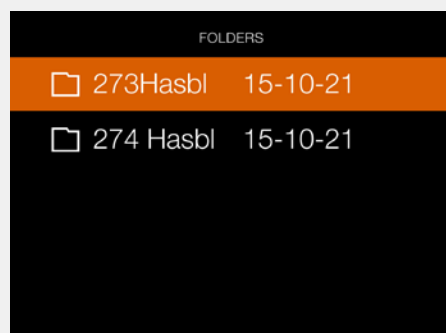

5.29 PHOCUS

Phocus is the Capture Processing and File Management application aimed primarily at Hasselblad 3F file handling.

Phocus Mobile offers remote viewing and control when shooting tethered. Phocus mobile is free to download at the APPLE App Store for both iPhone and iPad.

FEATURES IN PHOCUS

Professional Image Quality

- Hasselblad Natural Colour Solution (HNCS).
- Lens corrections for H and V system lenses (DAC).

Specialized Tools

- Advanced Tethered Camera Controls.
- Phocus Mobile*.
- Scene calibration & reproduction tools.
- Leading edge Moiré removal.
- Highlight recovery, shadow fill, clarity and dust spot removal tools.
- Camera Configuration and Capture Sequencer.
- Easy-to-use interface.
- Extensive customization options for individual work flow scenarios.
- Import/Export of Image Adjustments, Keywords, Work flow settings.
- High quality printing.
- Slide show.
- RAW file support from more than 150 DSLR cameras.

Any File from Anywhere

Phocus allows you to import image files and work in the same intuitive processing environment, no matter where your files are coming from. You can browse, handle, adjust, and process all kinds of RAW and non-RAW formats.

Phocus supports RAW files from more than 150 cameras, including Canon, Nikon, Leica, Sony, Fuji, Olympus **. The most common file formats can be processed for example TIFF, JPEG, DNG, and PNG.

Ultimate Image Quality

Phocus combines Hasselblad Natural Colour Solution (HNCS) with Digital Auto Correction (DAC) to provide high digital image quality in the images you create. With Phocus, the moiré effect that can occur on even extremely high resolution images is effectively removed automatically and directly on the raw data, leaving the image quality intact and saves time



in post production work. Tethered shooting is efficient with Phocus Remote camera controls providing a number of remote functions. For example remote focusing, live view, aperture and exposure time controls.

PHOCUS MOBILE

Phocus Mobile is available for iPhone®, iPad® and iPod Touch®. It enables you to connect wireless to a computer running Phocus and to remotely browse your high-resolution RAW, JPEG and TIFF images. This provides a solution for working with clients in the studio, enabling each person to view images on an individual iOS device, rather than all gathering around a single computer. Phocus Mobile also allows users to remotely operate and trigger a tethered camera, giving control of many parameters, all neatly presented in a virtual camera display. This feature is very convenient for remote control of the camera when it's located in a difficult to access position.

* Phocus Mobile is available for free download in the Apple App Store.

** Full list available at <http://www.apple.com/aperture/specs/raw.html>

Note!

Phocus is a license free software with unlimited installations and there is no registration needed.

PHOCUS AND HASSELBLAD CAPTURE FILES

The H6D can capture files and store them as Hasselblad RAW format files or Hasselblad RAW + JPEG formats simultaneously. (not applicable to 60 Mpix / 50MS/200MS models).

Hasselblad RAW files are initially stored in the 3FR format which is a proprietary Hasselblad format for the temporary storage of captures. A 3FR file contains the complete digitized raw image exactly as it was captured by the camera. 3FR information requires further computing power (typically by way of Phocus) to obtain complete development. If developed in Phocus, 3FR files become Hasselblad 3F files – denoted by each file now bearing the suffix “.fff”. If developed by other RAW processors, the 3FR files are not converted to 3F but can be exported directly to TIFF, PSD etc. according to requirements. However, when working tethered – which necessitates using Phocus – 3FR files are automatically processed and stored in the background on a computer appearing as 3F files on the hard disk ready for selective adjustment and export. 3FR files stored on a CFast card can be processed to completion using:

- Hasselblad Phocus
- Adobe Camera Raw
- Adobe Lightroom
- Apple Aperture

Capture files can be stored as 3FR files (from a CFast or SD card) for later processing in Phocus or other software, or they can be stored as 3F files (as a result of tethered shooting or 3FR files processed and converted in Phocus). In all cases if you keep the original 3FR/3F files, you will also retain the possibility of reprocessing them in the future in later versions of Phocus or other software to take advantage of eventual improvements and developments.

Mixed formats

Phocus can also process most other capture formats, generic and proprietary. This means you can include other formats in your normal Phocus work flow if you choose. Or if you prefer, you can include Hasselblad files in Adobe / Apple work flows as stated above.

Note!

Using Phocus is the most comprehensive method. The Phocus and Adobe methods can produce almost identical results (in most cases, but not all) regarding RAW conversion so it is a matter of personal choice regarding which method would best suit your preferred ways of working. Alternatively you can use Apple Aperture though you should take note that the benefits of DAC and HNCS etc., will be lost in this case.



5.30 LENSES AND FOCUS MODES

REMOVE THE LENS

Caution!

Be careful when you attach/detach the components to/from the camera. This will help prevent damage to the data bus connections.

Caution!

Do not insert fingers into the camera body. This can cause damage to the equipment.

- 1 Hold the lens with one hand and hold the camera body (A) still.
- 2 Push the lens removal button (B).
- 3 Rotate the lens counter clockwise.
- 4 Push the lens (C) away from the camera body.
- 5 Attach the protection cover lid (D) on the camera body directly.
- 6 Attach a lens protection lid on the detached lens to prevent damage.
- 7 Store the lens with both lens protection lids on and the lens hood (E) inverted over the lens instead of in front of the lens.



ATTACH THE LENS

Caution!

Be careful when you attach/detach the components to/from the camera. This will help prevent damage to the data bus connections.

Caution!

Do not insert fingers into the camera body. This can cause damage to the equipment.

- 1 Push the lens removal button (A) and remove protection cover lid (B) from the camera body.
- 2 Rotate the lens so that the red mark on the lens (C) lines up with the red mark (D) on the camera body.
- 3 Mount the lens into the camera body (E) and then turn the lens clockwise to lock its position.
- 4 Make sure the lens is locked to the camera body before using or moving the camera.



REMOVE THE LENS CAP

- 1 Insert thumb and index finger into the recesses (A).
- 2 Pinch the recesses (A) together.
- 3 Remove the front lens cap.



ATTACH THE LENS CAP

- 1 Insert thumb and index finger into the recesses (A).
- 2 Attach the front lens cap on the lens until it snaps into place.



REMOVE THE LENS SHADE

All lenses are supplied with lens shades that additionally provides extra protection for transport and storage when mounted in reverse.

- 1 Turn the lens shade (A) counter-clockwise.
- 2 Remove the lens shade (A).

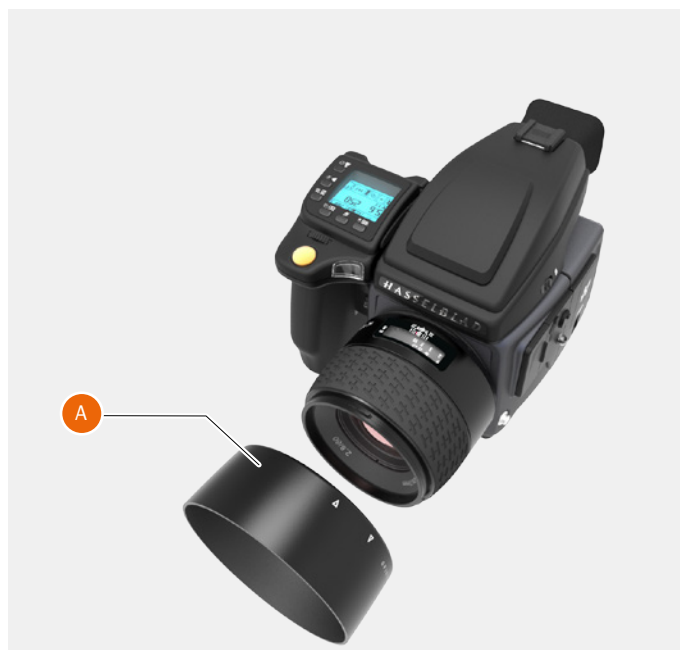

ATTACH THE LENS SHADE

All lenses are supplied with lens shades that additionally provides extra protection for transport and storage when mounted in reverse.

- 1 Place the lens shade on the lens.
- 2 Make sure that the index on the lens shade (A) aligns with the index on the front of the lens (B).
- 3 Turn the lens cap clockwise until it snaps into place.



FILTERS

The filters have a threaded fitting (67/77/95 mm, according to lens) and are rotated clockwise into place. As there is no rotation of the front section of the lens when the focus is changed, the filter do not rotate either. This is particularly useful when using polarizing or graduated filters where the orientation is critical.



TO SET FOCUS DISTANCE

- 1 Estimate the distance to the target.
- 2 Inspect the focus distance scale (A) and turn the manual focus ring (B) to adjust the focus distance.

Note!

There are two distance scales (in feet and metres) visible through the window on the upper part of the lens barrel.

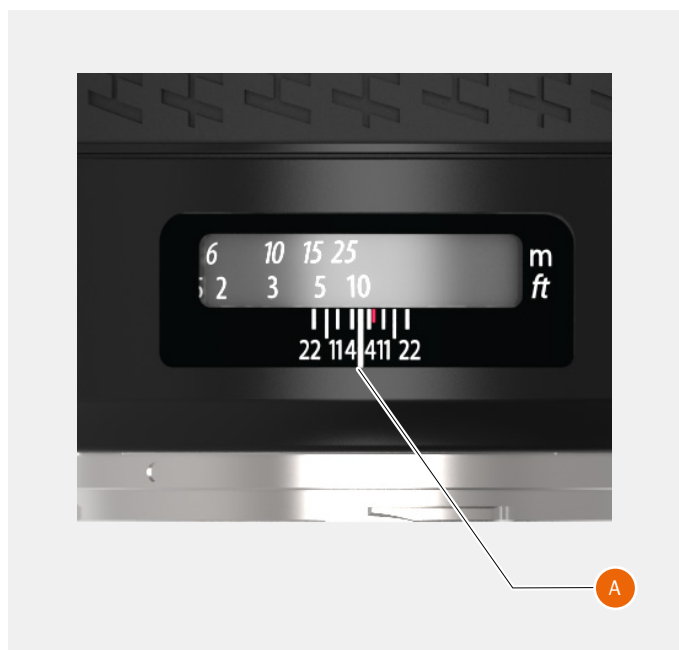

5.31 BATTERY

CHARGE THE BATTERY

Note!

The battery will become fully charged after approximately 6 hours before first use.

- 1 Remove the battery from the camera (A).
- 2 Insert the jack plug from the battery charger into the socket on the battery grip (B).
- 3 Insert the battery charger into a standard (100–240V~/50–60 Hz) domestic socket.

During the charging procedure, the lamp on the charger shows the following:

- Standby (no battery connected)
- Charging
- Ready



CHECK THE BATTERY STATUS

- 1 On the Sensor Unit Menu Control Screen select the Battery symbol in the upper right corner.

The Grip Screen displays:

- The firmware version (A).
- The number of captures taken since the last battery recharge/change (B).
- A rechargeable-battery status icon (C) that provides a quick visual check as well as a figure estimate in percent.

Note!

Remember that these are only estimates and that there are a number of factors affecting remaining battery charge, ambient temperature for example, as well as general practice.

Note!

You can save battery consumption by changing the Display Off/Sleep/Power Off settings as well as the brightness settings of the display.

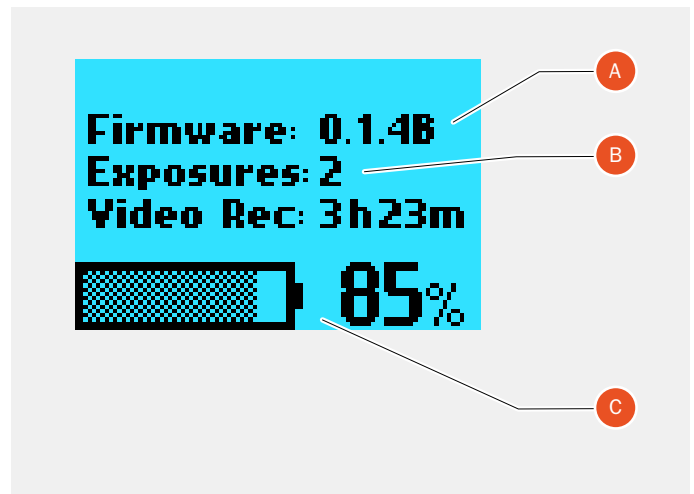
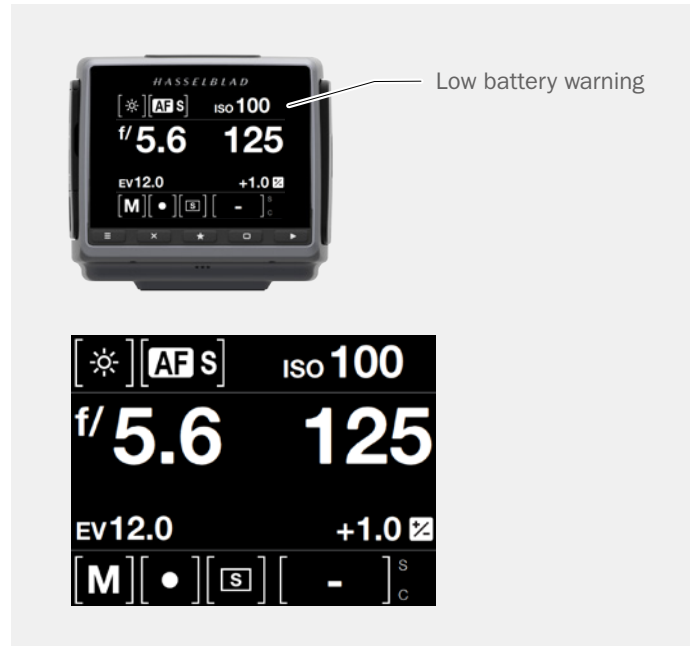

5.32 PROTECTIVE BASEPLATE

REMOVE THE PROTECTIVE BASEPLATE

- 1 Lift the securing catch while pushing the plate towards the lens.



ATTACH THE PROTECTIVE BASEPLATE

- 1 Slip it over the camera foot until it stops and the securing catch snaps into place.



5.33 STORE THE CAMERA

Caution!

Before you connect the sensor unit to the H6D camera after storage, always replace the protective CMOS/filter cover. This will prevent damage to the equipment.

Caution!

If you leave the camera unused for a long period, remove the batteries. This will prevent damage to the equipment.

Caution!

Keep camera and equipment away from moisture. If your camera becomes wet, disconnect from electric power and let camera dry before further use. This will help prevent damage to the equipment.

Caution!

Store the equipment in a dry environment. This will help prevent damage to the equipment.

6.1 ACCESSORIES CONNECTIVITY DIAGRAM

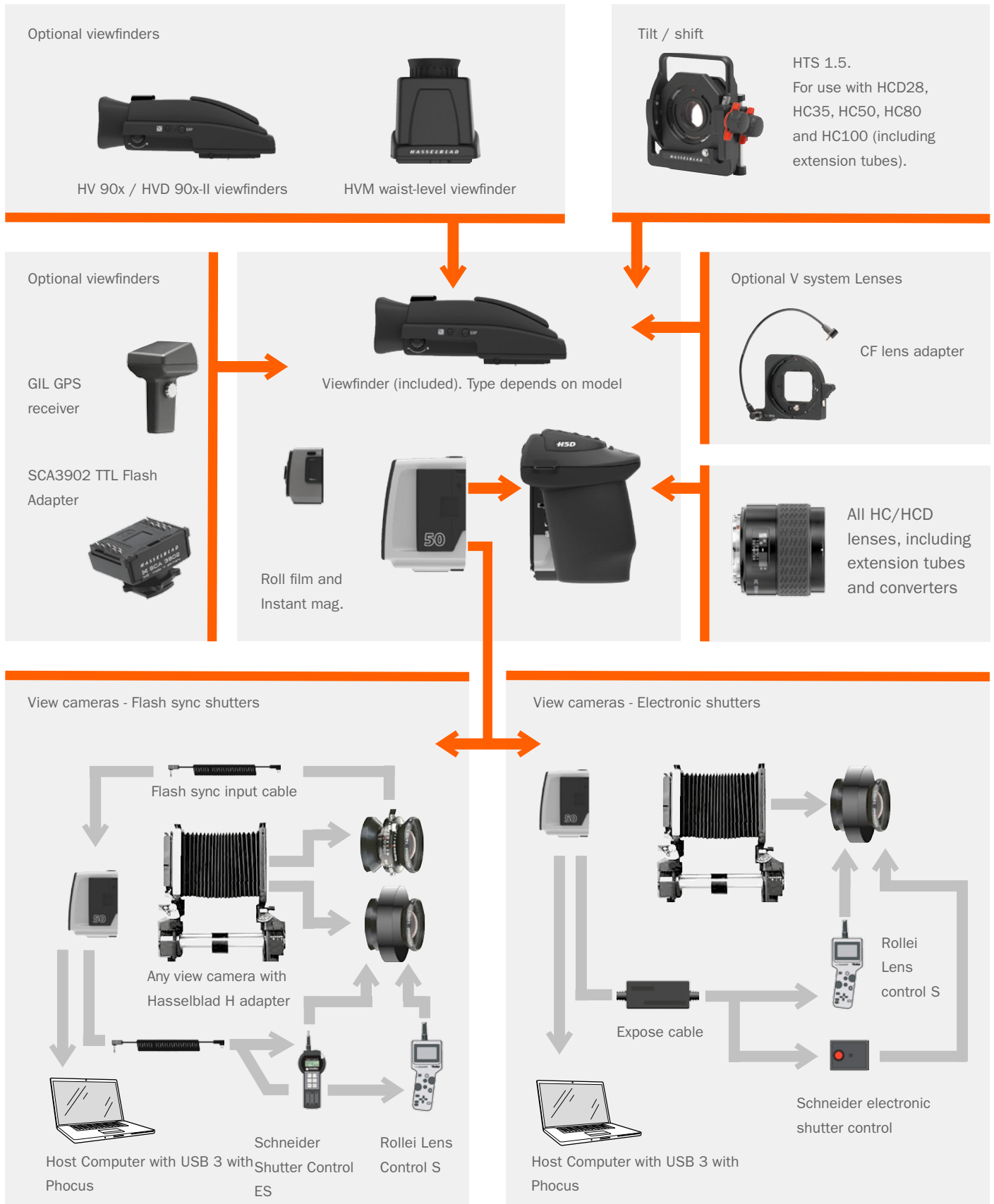

6.2 HC LENS RANGE



HCD 4.8/24mm



HCD 4/28mm



HC 3.5/35mm



HC 3.5/50-11mm



HC 2.8/80mm



HC 2.2/100mm



HC Macro 4/120-11mm



HC 3.2/150mm



HC 4/210mm



HC 4.5/300mm



HC 3.5-4.5/50-110mm



HCD 4.0-5.6/35-90mm

V system C type lenses with optional CF lens adapter



6.3 OPTIONAL HC LENS ACCESSORIES

HTS 1.5

(3043400)

The HTS 1.5 is a tilt and shift adapter designed for the HCD28mm, HC35mm, HC50mm, HC80mm and the HC100mm lenses. It not only solves technical challenges but also provides exciting opportunities for creative solutions.



CF ADAPTER

(3043500)

The CF adapter allows almost all lenses from the V-system to be used on H system camera bodies. This adapter expands the potential lens range for H cameras by more than a dozen different focal lengths.



H 13, 26 AND 52 EXTENSION TUBES

(3053513, 3053526 and 3053542)

The Extension tubes attach between the lens and the body to reduce the close focusing distance for close up photography. They are available in three sizes: 13 mm, 26 mm and 52 mm. As the H6D has a TTL light metering system, exposure compensation is automatic.



CONVERTER H 1.7X

(3023717)

The Converter attaches between the lens and the body to increase the focal length by a factor of 1.7. This provides a convenient way to expand your range of lenses. The Converter H 1.7 X features the same outstanding optical and mechanical quality as all the lenses in the Hasselblad H system. The optical design consists of 6 elements in 4 groups.



MACRO CONVERTER H

(5023720)

The Macro Converter is designed to improve the close range performance of wide angle H system lenses. Although primarily aimed for use in conjunction with the HC 50-II lens for optimum performance, it can also be used with any of the of the other H system wide angle lenses.



6.4 OPTIONAL ACCESSORIES

HVM WAIST LEVEL VIEWFINDER

(3053328)

The HVM waist level viewfinder allows a comfortable lower viewing angle either for effect or where eye contact with the subject is desirable in portrait photography, for example. Autofocus function of all lenses fully retained. Intended for horizontal format shooting and not suitable for vertical format use.



PRO SHADE V/H 60 – 95

(3040740)

An adjustable bellows lens shade that provides highly efficient protection against stray light. Its compact, flat folding design saves space in the equipment case. With adapters it fits all HC lenses and virtually all V system lenses. Also features a filter holder for glass, gelatin, or plastic filters.



PRO SHADE ADAPTERS

(3043415, 3043417, 3043419)

67mm, 77mm and 95mm adapters with bayonet mount for HC lenses. Features lock to provide positive and secure attachment.



GIL (GLOBAL IMAGE LOCATOR)

(3053300)

The Hasselblad GIL (3053300) provides automatic creation and storage of GPS information for all H-system digital cameras. The data is tagged to each individual image file and can be read directly by Phocus. The back requires no extra external battery or power source and works seamlessly in the background for ease of use.



TRIPOD QUICK COUPLING H

(3043326)

Mounted on a tripod, this accessory facilitates rapid attachment and removal of the camera. The camera is firmly held in an exact and repeatable position. Two integrated spirit levels make horizontal positioning of the camera easy. The Tripod quick coupling H fits 1/4" and 3/8" tripod threads and has a safety catch.



FLASH ADAPTER SCA 3902

(3053393)

For connecting flashes compatible with the SCA 3002 system to the Hasselblad H6D.



UV-SKY FILTERS

Absorbs UV radiation and reduces blue haze without affecting colours. Also protects the front lens surface. Particularly recommended when the camera is used in harsh conditions. Available in three sizes to suit various lenses.

67mm: 3053470, 77mm: 3053474 and 95mm: 3053478



POLA FILTERS

Reduces non-specular reflections and glare. Increases colour saturation in general. Can intensify a blue sky. Available in three sizes.

67mm: 3053482, 77mm: 3053486 and 95mm: 3053490



SUPPORT STRAP WITH QUICK PLATE H

(3045154)

Improves comfort and security with hand held photography. Complete with quick plate H.



CAMERA STRAP H

(3053616)

Extra wide camera strap with anti slip backing. Supplied with the camera.



FOCUSING SCREENS

All focusing screens are of the Spherical Acute-Matte D type with or without grid and central markings for spot (\varnothing 7.5 and AF metering area. Grid patterns provide aid in technical, architectural, documentation and other similar fields.

H6D-50c (3043336), H6D-50c Grid (3043338)

H6D-100c (3043332), H6D-100c Grid (3043334)

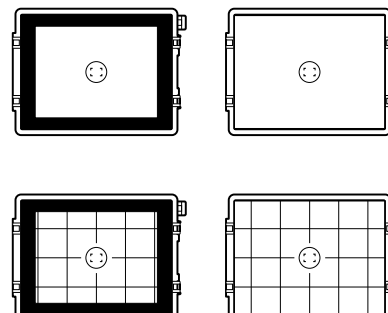

RELEASE CORD H

(3043370)

Remote release cord with a cable length of 0.5 m.



HVM CORRECTION LENS HOLDER

(3053348)

Lens holder for custom made eyesight correction (lenses available from opticians). To be used for optimal viewing comfort and accuracy.



HVD 90X / HV 90X & 90X-II VIEWFINDERS

(3053330, 3053326, 3053334)

90 degrees reflex viewfinder, providing 100% field of view even when wearing eyeglasses. Includes built-in fill flash and multi-mode light metering system.



ANGLE FINDER H

(S100A12359A00)

Angle finder for the HV 90x and the HVD 90x viewfinders. Enables vertical viewing angle regardless of camera position. Requires a minor modification to the viewfinder eyepiece.



DC POWER GRIP

(3043350)

Removable H-camera grip with AC power adapter for supplying camera power from domestic mains supplies.



6.5 HM 16-32 FILM MAGAZINE

The Hasselblad HM 16-32 film magazine is a sophisticated semi-independent unit within the H system. It has its own power supply for individual information storage, LCD panel, illumination, etc. It features: automatic 120/220 compatibility, automatic wind on/wind off, automatic film advance, LCD information panel, integral dark slide, customizable data imprinting, illuminated LCD, bar code recognition, count-up or countdown film frame reminder choice and multi shot option.



Parts and components

- 1 LCD panel
- 2 LCD illumination button
- 3 Change up button
- 4 Change down button
- 5 Function selector
- 6 Film plane index
- 7 Dark slide key
- 8 Dark slide indicator
- 9 Film tab holder
- 10 Film holder key
- 11 Magazine settings lock
- 12 Data bus interface

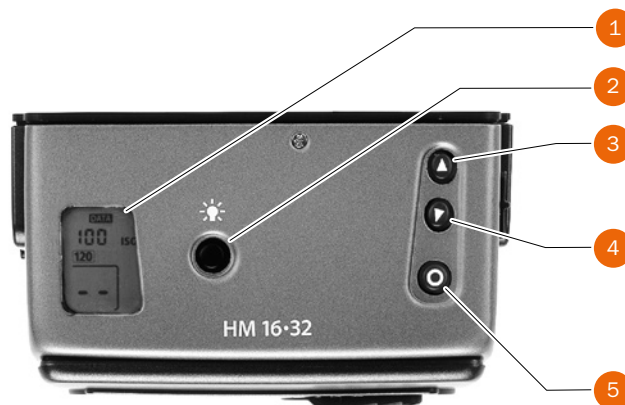

Note!

Information is transmitted and received between the Magazine and the camera body, so ensure the data bus connection is kept clean and not damaged in any way. It is advisable to fit the magazine protective cover when storing a film magazine to protect both the data bus connection and the dark slide.

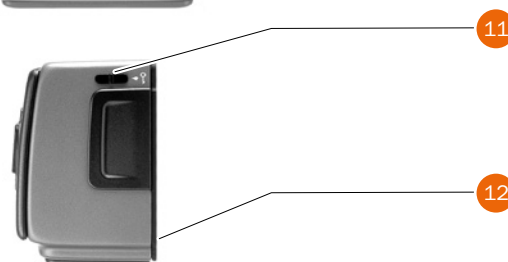
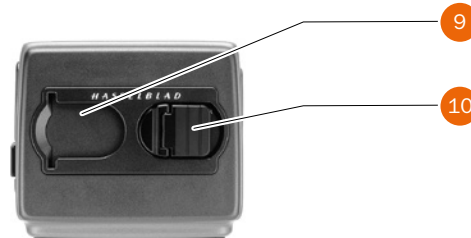
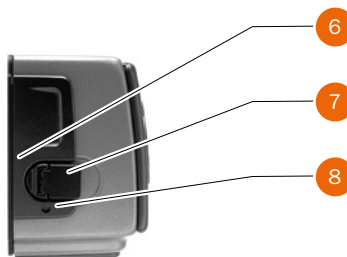

LCD Panel

The various functions are accessed by repeatedly pressing the function selector button (loop menu) and changes made by the 'change-up' and 'change-down' buttons. Any settings are automatically saved. At very low temperatures the LCD will require a few seconds to display new settings.

LCD illumination button

The LCD can be illuminated by pressing the display illumination button, which is accessible when the magazine is not attached to the camera. The LCD will remain illuminated all the time you keep the button depressed, up to a maximum of 10 seconds. After 10 seconds has expired, you must release the pressure on the button and press again to obtain a further 10 second period of illumination. Remember that using the illumination function very often will noticeably shorten the life of the battery in the magazine. When the magazine is attached to the camera, the button on the magazine is inaccessible but you can still illuminate the LCD by pressing the illumination button on the grip instead.

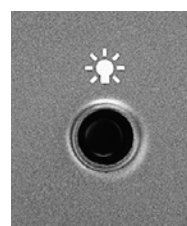
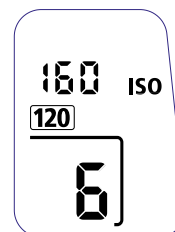

Accessories

Change Up / Change Down Button

Can alter the settings 'upwards'. For example, to increase the film speed setting. Toggle action.

Can alter the settings 'downwards'. For example, to decrease the film speed setting. Toggle action.



Function Selector

Selects the four functions that can be changed on the magazine. The functions are on a menu loop so that repeated pressing of the selector button will successively access all functions in turn. After a time-out of five seconds of non-activity, the display returns to the main screen.

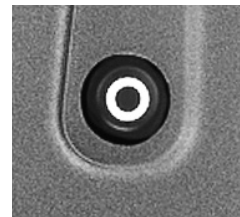

Note!

Changes can only be made when the settings lock switch is in the unlocked position.

Film Plane Index

Provides a measuring point for the actual position of the film plane in the magazine. Used for calculations in critical applications.



Dark slide Key

Withdraws and replaces the dark slide. Fold out the key and turn it counter-clockwise 360° (towards the open symbol) to withdraw it and clockwise 360° (towards the closed symbol) to replace it.



Note!

The dark slide can only be withdrawn when the magazine is attached to the camera.

Dark slide Indicator

Indicates whether the dark slide is in place or withdrawn:

RED = stop ! = exposure CANNOT be made
(magazine can be removed from camera)

WHITE = ok ! = exposure CAN be made
(magazine cannot be removed from camera)

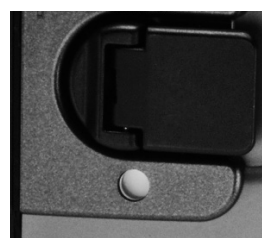

If you attempt to make an exposure when the dark slide is closed, however, you will receive a warning message in the viewfinder and grip LCD's – 'The dark slide is closed'.

Accessories

Film Tab Holder

Holds an ID tab from the film roll pack as a reminder of the type of film loaded. Remember to change it if you change film type!



Film Holder Key

Secures the film holder in the magazine. Fold out the key and turn counter-clockwise 90° to remove the film holder and turn clockwise 90° to lock the film holder in place.



Magazine Settings Lock

All settings can be locked to avoid inadvertent changes. To change the settings, slide the settings lock (see illustration) to the right until it stops. After the changes have been made, slide the settings lock to the left (see symbol on magazine) again to secure the new settings.



Data bus Interface

Data interface between magazine and camera. Ensure the contacts are kept clean and protected from damage. Keep the protective cover on when the magazine is being stored or transported.



Battery

The magazine uses a battery to retain information and settings when unattached from the camera. When attached to the camera body, the magazine takes its power requirements from the camera batteries. The magazine battery will normally be effective for 1-2 years depending on use (off camera illumination, for example). When the battery is in a very low condition, (approx. 1 month of use left), a low battery symbol appears on the magazine LCD as a warning. The magazine will continue to function with no battery power left as long as it remains attached to the camera body. However, when detached, the settings will not be stored.

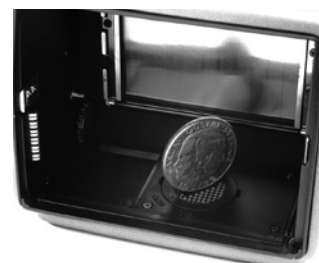

Battery Replacement

Release the film holder by folding out the film holder key and rotating it 90° in a counter-clockwise direction. Withdraw the film holder completely. On the bottom plate on the inside of the film magazine housing you will find a slotted circular battery cover. Insert a small coin or similar into the slot and rotate the cover about 20° in a counter-clockwise direction. The cover will be freed and the battery can be removed. Replace with a fresh CR2032 / 3V lithium (or equivalent) battery. Observe the polarity and ensure the positive (+) face is uppermost and replace the cover (ensure the retaining lugs are inserted in the battery compartment slots), locking it into place by rotating it in a clockwise direction until it stops. If you inadvertently



insert the battery incorrectly, the film magazine will not be damaged though it will not function. Try to avoid touching the surface of the battery with your bare fingers as sweat residue can decrease the electrical conductivity of the battery casing and might cause corrosion. After battery replacement, the magazine's parameters return to the default settings (Bar code, 120, Data-on, Count up).

Attach and Remove the Magazine

You cannot remove a magazine from the camera body if the magazine dark slide is not in place, (when the magazine dark slide indicator on the magazine shows white). Neither can you withdraw the magazine dark slide when the magazine is not attached to the camera. Both these restrictions therefore prevent accidental film loss caused by fogging.

Attachment

Position the magazine retention groove onto the magazine support on the camera body ensuring that they are correctly positioned. Swing the magazine towards the camera body and firmly press into place with a click. If there is resistance, the magazine retaining catch on the camera has probably been inadvertently released. In that case, push the release button again to reset the catch. You can attach and remove the magazine with or without the film holder in place. If you just want to change to a new film, you can remove and reload the film holder without having to remove the whole magazine.



Removal

Ensure that the dark slide indicator on the magazine shows red (signifying that the dark slide is closed). Firstly push the lever of the magazine release button to the right (fig. 4/1) and while maintaining that position press the centre of the button firmly inwards towards the camera body (fig. 4/2) to finally release the magazine.



- Ensure you press on the centre of the button, not on the lever.
- You cannot remove a magazine if the dark slide is not closed.
- If the film holder is inadvertently removed mid-film, then exposed frames will naturally be lost due to light fogging. However, if the film holder is reinserted, the film will automatically be advanced by three frames to position fresh unexposed film. The film counter will also correspondingly add on three frames to the original number recorded before the film holder was removed.

Press the function selector (button) repeatedly to successively access:

- A Film speed (ISO / Bar Code)
- B Film length (120/220/ Number of frames)
- C Data (on/off)
- D Frame counter (count down / count up)
- E Low-battery warning symbol

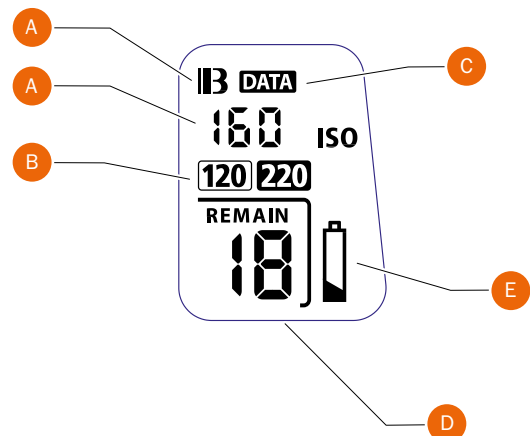

Film Speed Setting / Bar code

The film speed (ISO / ASA) can be set automatically or manually. Automatic setting uses a Bar code (only some films have this feature, notably Fujifilm). This is the default setting.

Film settings (ISO / film length) are automatic only if the magazine is set at Bar code automatic. That is, a bar coded film cannot override a manual film speed setting but a manual setting can override the film speed of a bar coded film.

Films without a bar code must have their speed set manually. A manual setting must also be made if you want to override the speed setting of a bar coded film.

To access Manual setting:

- 1 Ensure the magazine settings lock is in the unlocked position.
- 2 Press the button until a figure (or bar code symbol) appears together with ISO.
- 3 Press either the or the button to reach the required setting.
- 4 The new setting will be saved automatically after a time out of five seconds.
- 5 Return the LCD settings lock to the locked position.

Note!

If you use both standard and bar coded films (or overridden bar coded films), check that you have changed the settings accordingly.

Film Length / Number of Frames

Both 120 and 220 films can be used. 120 film will produce 8 (for use with 'half length' 120 films only) or 16 frames and 220 film will produce 32 frames. If the film has a bar code, then film length setting (and film speed setting) is automatic. The LCD will automatically show the bar code symbol and the appropriate film length. (Note that film speed can be overridden with bar coded films, but not film length).

If, however, the film has no bar code then proceed as follows:

To access film type setting:

- 1 Ensure the magazine settings lock is in the unlocked position.
- 2 Press the button until the 120 or 220 symbol appears.
- 3 Press either the or the button to change the desired setting.
- 4 The new setting will be saved automatically after timeout.
- 5 Return the magazine settings lock to the locked position.



EXAMPLE

32F_r
220



Film Speed

Film Length

Data

Frame Counter

Data Imprint Setting

Data imprinting can be activated or deactivated through the magazine menu.

Access data setting:

- 1 Ensure the magazine settings lock is in the unlocked position.
- 2 Press the button until the Data symbol appears.
- 3 Press either the or the button to reach On or Off.
- 4 The new setting will be saved automatically after a time out of five seconds.
- 5 Return the magazine settings lock to the locked position.

Note!

Operation and changes made to the data imprinting function are accessed through the camera menu. Please see separate section for full details.

Frame Counter Setting

The frame counter can be set to show either how many unexposed frames remain on a film or how many frames have already been exposed. The LCD shows your choice of setting by adding the word Remain as a reminder of the number of frames remaining or 'countdown'. Absence of this word implies the opposite, namely, 'count-up', so it denotes the number of the next frame to be used (for example, the figure 4 means three frames have already been exposed). This information is also automatically displayed on the grip LCD and viewfinder LCD though only as a figure above a symbol.

Access frame counter setting:

- 1 Ensure the magazine settings lock is in the unlocked position.
- 2 Press the button until Remain appears.
- 3 Press either the button or the button to reach the desired setting (toggle function).
'on' will show the number of frames remaining on the roll.
'off' will show the number of the next frame in the series.
- 4 The new setting will be saved automatically after a time out of five seconds.
- 5 Return the magazine settings lock to the locked position.

Low Battery Symbol

The low-battery symbol only appears on the magazine LCD when the battery needs changing.

Example

- 120 film length set manually
- the film speed (ISO160) has been set manually
- 5 frames already been exposed (with regular 120 film, 11 frames remain)
- the battery is functional

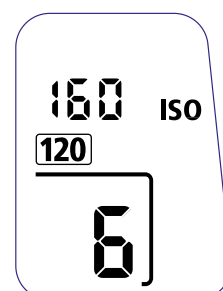
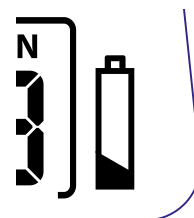
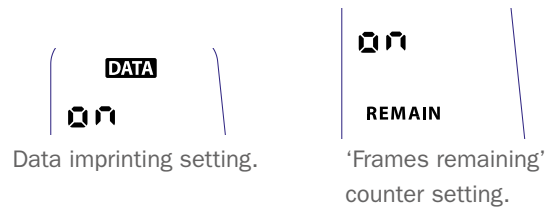

Film Loading

The film magazine can be loaded either on or off the camera. Regularly check the interior of the magazine and remove dust, particles or any scraps of paper from previous rolls of film. Load and unload film magazines away from direct light sources.

- 1) Fold out the film holder key and turn it counter-clockwise 90° A. Withdraw the film holder completely B.
- 2) Place an empty take-up spool in the upper spool holder by placing one end over the fixed stud in the holder and the other end underneath the sprung spool retaining arm. Rotate the spool a little if necessary until it clicks into position.
- 3) Completely remove the retaining paper band from a new roll of film and place it in the lower spool holder. See diagram for correct orientation. Ensure you do not place the film spool the wrong way around!
- 4) Pull 8–10 cm (3–4 in.) of paper backing from the film roll and insert the tongue of the backing paper into the slot in the take-up spool. Turn the spool one complete turn to ensure the tongue is firmly held in place by the overlying paper backing.
- 5) Re-insert the film holder into the main body of the film magazine ensuring the correct orientation. Press firmly inwards towards the magazine and pay particular attention to see that both sides are level with the magazine body A before turning the film holder key clockwise 90° to lock the film holder in place and fold the key back into its stored position B. You might find that increased pressure on the left hand side of the film holder will more easily ensure a positive and correct positioning in the magazine. If the camera is active or in standby mode the film will be wound automatically by the camera to position the first frame (this function can be changed in 'Custom options' so that the film is advanced only when the shutter release button is pressed the first time).

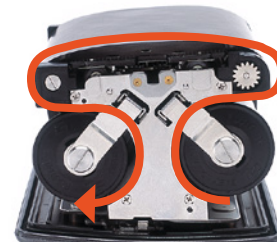

Beeper

The beeper sounds immediately after last-but-one frame has been exposed. This function can be turned off in Options.

Film Wind On and Off

Wind on: See 'Film wind-on' under Custom Options for a setting choice. Wind off: When the last frame has been exposed, the film will automatically be wound off. However, to wind off a film sooner, press the film wind off button. Use a ballpoint pen or similar to activate it. You must also confirm the message on the grip LCD before the film winds off.



Unloading a film

Remove the film holder in the same manner as when loading a film. Grip the exposed roll of film firmly and remove. Ensure the paper backing is wound tightly and that it is sealed with the band properly (the band may need to be moistened to activate the adhesive depending on type). Store exposed films away from strong light sources and contact with sharp objects. Move the remaining empty spool to the take-up spool compartment.



Problem	Possible cause	Suggested correction
Error message	-	See chapter 7.1 Error Messages.
Camera is deactivated	<p>The camera can be affected by a discharge of electricity. This can happen when the area around the control buttons on the grip accidentally touches a conductive cord or material connected to earth.</p> <p>This can deactivate the camera and does not cause any damage.</p>	Press the red ON - OFF button on the grip to activate the camera.
Wrong language	If the sensor unit has been set to a language you don't understand (on a rented camera, for example), you can navigate to your preferred language by following the actions and appearance in the illustrations here.	See chapter 7.2 To Change Language On Sensor Unit From Unknown Language.
Dark or coloured spots or lines in your images	Dirt or particles on the surface of the camera lens	See chapter 7.3 To Clean The Lens Glass.
	Dirt or particles on the surface of the sensor unit's infrared (IR) filter	See 7.4 To Clean the sensor unit filter.
Temperature warning icon appears	<p>Rapidly taken captures make heavy demands on the processor in the sensor unit which in turn produces heat. This can in combination with high ambient temperature result in noise in the image files.</p> <p>At ca. 60°C a warning dialogue appears notifying that the sensor unit is temporarily shutting down to allow the sensor unit to cool.</p>	Let the sensor unit cool down for at least 20 minutes.
Time and date settings on the sensor unit does not work	Time and date settings on the sensor unit (which are included with files and folder labels) are updated automatically through a USB3/Phocus connection. These settings are retained for about two consecutive weeks by a small rechargeable cell that is automatically recharged by the main battery or USB3 with regular use.	Leave the sensor unit ON for 12 hours.

7.1 ERROR MESSAGES

If any error message is shown, do as follows:

Caution!

Be careful when you attach/detach the components to/from the camera. This will help prevent damage to the data bus connections.

- 1 Detach the components from the camera.
- 2 Attach the components to the camera again.

If the error message still shows, do as follows:

- 3 Detach the battery grip.
- 4 Wait 10 seconds.
- 5 Attach the battery grip again.
The camera's processor have now been reset.

If the error message still shows, do as follows:

- 6 Write down the error message.
- 7 Contact your local Hasselblad Authorized Service Center.

7.2 CHANGE LANGUAGE ON SENSOR UNIT FROM UNKNOWN LANGUAGE

MAIN MENU > GENERAL SETTINGS > LANGUAGE

- 1 Press the General Settings icon on the Sensor unit display.
- 2 The General Settings Menu will appear.
- 3 Navigate to the menu item with a Globe icon (number 6 on the list from the top, Language).
- 4 Scroll down to select your Language.

Swipe right or press Menu / EXIT button to get back to Main Menu.

General Settings Menu

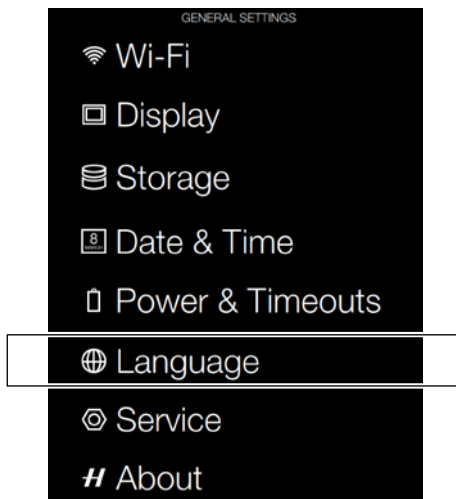

Language Menu

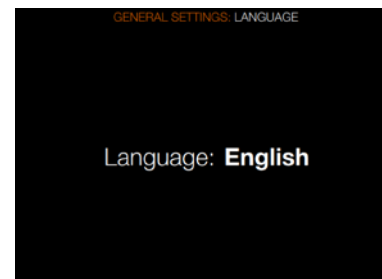

7.3 CLEAN THE LENS GLASS

REMOVE DUST

Caution!

Do not touch the glass surface with your fingers. This can cause damage to the equipment.

If there is dust on the lens glass, do as follows:

- 1 Remove the dust with a blower brush or very soft lens brush.

REMOVE SMEAR

Caution!

Do not touch the glass surface with your fingers. This can cause damage to the equipment.

If there is smear on the lens glass, do as follows:

- 1 If you are not sure how to remove the smear, contact your local Hasselblad Authorized Service Center.
- 2 Clean the lens glass with a high quality lens cleaning solution on a tissue.

7.4 CLEAN THE SENSOR UNIT FILTER

Caution!

Be careful when you attach/detach the components to/from the camera. This will help prevent damage to the data bus connections.

Caution!

When you remove the sensor unit, keep foreign objects away from the camera opening. The camera opening is very sensitive. This will help prevent damage to the equipment.

- 1 Remove USB 3 cable if connected.
- 2 Rotate the sensor unit release button to the right.
- 3 Maintain the position and press the centre of the button firmly inwards towards the camera body (X) to finally release the magazine.
- 4 Carefully clean the outside surface of IR filter by using clean compressed air.

Caution!

If you use canned compressed air to clean the glass of IR filter, read the instructions very carefully before use. This will help prevent damage to the filter.

If compressed air did not remove all the problems on the filter, use an E-wipe. Do as follows:

- 5 Tear at the notch to break seal.
- 6 Remove an E-wipe from the package and fold the tissue to match the width of the IR filter.
- 7 Apply firm pressure using two or three fingers at the edge of the wipe to ensure an even, firm contact with filter surface.
- 8 Wipe the surface in one unbroken motion.

Note!

Do not use same side of the E-wipe twice as you will be likely to reapply particles removed in the first pass.

- 9 Attach the sensor unit again to the camera immediately after cleaning.
- 10 Capture a number of images.
- 11 Inspect the images.

If you still see spots on your images, you may have dust either on the inside of the IR filter or on the CMOS itself. Do as follows:



Caution!

Do not try to remove the glass IR filter from the front of the sensor (due to dust or similar). This can cause damage to the equipment. Always contact your local Hasselblad Authorized Service Center.

Contact your local Hasselblad Authorized Service Center.

User Guide for Hasselblad H6D

The information in this User Guide is furnished for informational use only, is subject to change without notice, and should not be construed as a commitment by Victor Hasselblad AB.

The H6D Product Images in this User Guide were not taken with a Hasselblad H6D. They are produced in 3D as visualization. They are used for illustrative purposes only and are not intended to represent the image quality produced by a Hasselblad H6D.

The text in this manual cannot be reprinted or reused without the express permission of Victor Hasselblad AB.

The images in this manual cannot be reprinted or reused without the express permission of the photographers who took them.

All text in this User Guide: © Victor Hasselblad AB.
All images in this User Guide not credited to a specific photographer: © Victor Hasselblad AB.

Victor Hasselblad AB assumes no responsibility or liability for any errors or inaccuracies that may appear in this manual. Victor Hasselblad AB assumes no responsibility or liability for loss or damage incurred during or as a result of using Hasselblad software or products.

Hasselblad, Imacon, Ixpress, Phocus, Phocus Mobile and FlexColor are trademarks of Victor Hasselblad AB.

Adobe and Adobe Photoshop are trademarks of Adobe Systems, Inc. Macintosh, Mac OS, iPhone®, iPad® and iPod Touch® .

InfoLithium is a registered trademark of Sony Corporation. Canon, Nikon, Leica, Sony, Fuji and Olympus are trademarks of their respective corporations. Qp Card is a trademark of Qp Card AB. E-Wipe is a trademark of Photosol Inc.

Copyright © 2016

Victor Hasselblad AB

All rights reserved.