

User's Manual

TPC-2A-PLUS (090708)

i-Mobile Technology Corporation

Copyright

This publication, including all photographs, illustrations and software, is protected under international copyright laws, with all rights reserved.

Neither this manual, nor any of the material contained herein, may be reproduced without the express written consent of the manufacturer.

Disclaimer: The manufacturer makes no representations or **warranties** with respect to the contents hereof and specifically disclaim any implied warranties of merchantability or fitness for any particular purpose. The manufacturer is not liable for technical and editorial error for this guide. The manufacturer reserves the right to revise or make changes to this publication without notice or obligation of the manufacturer to notify any person of such revision or changes.

Software Licenses

The software included with the product and referenced in this document is furnished under a License Agreement. This Agreement specifies permitted and prohibited uses of this product.

General Guidelines

- ◆ Read all of the instructions carefully.
- ◆ Save the instructions for future use.
- ◆ To ensure follow all warnings and instructions marked in the product documentation and within the computer.
- ◆ Except as explained elsewhere in this manual, do not attempt to service the computer yourself. Opening or removing covers might expose you to dangerous voltage points or other risks. Refer all servicing of marked components to qualified personnel.

Power Cord Requirements

The power cord you received with this computer conforms to local specifications for use in the country where you purchased it. Power cord use in other countries may require an additional adapter and/or separate power cord. For additional information on local power requirements, contact an authorized dealer, reseller, or service provider.

About the AC Adapter

The AC adapter will automatically recognize any compatible power supply connected to the computer. The AC adapter can also be used to recharge the battery, which begins immediately after the AC Adapter cord is connected. A green LED will light to confirm charging is in progress. The ideal range for safe operation of the computer is from 100 ~ 240V AC.



1. AC Power Cord / 2. AC Adapter / 3. DC (Direct Current) Cord

Warning :

- Using the AC adapter to power other devices can damage the adapter or the device. This AC adapter is only designed for use with the product.
- Be sure to only use the AC adapter that comes provided with this product or a compatible option from the manufacturer. Other adapters may cause damage to the computer and will not be covered under the warranty.
- Grasp the adapter plug and not the cord, when unplugging the adapter from an electrical outlet.
- If the power cord becomes damaged (exposed or frayed, etc.), replace with a new AC adapter. Using a damaged cord may cause an electrical shock and may result in fire.
- Power off and unplug the AC adapter from the computer before unplugging it from the electrical outlet.

Battery (Lithium-Ion)

NOTE: Refer to following hazard statement within the service and operating documentation or on the adjacent label to the battery.

1. English

CAUTION: DANGER OF EXPLOSION IF BATTERY IS INCORRECTLY INSTALLED. REPLACE ONLY WITH SAME OR EQUIVALENT TYPE RECOMMENDED BY THE MANUFACTURER. DISCARD OF USED BATTERIES IN ACCORDANCE WITH THE MANUFACTURER'S INSTRUCTIONS.

2. French

IL Y A DANGER D'EXPLOSION S'IL Y A REMPLACEMENT INCORRECT DE LA BATTERIE. REMPLACER UNIQUEMENT AVEC UNE BATTERIE DU MÊME TYPE OU D'UN TYPE RECOMMANDÉ PAR LE CONSTRUCTEUR. METTRE AU RÉBUT LES BATTERIES USAGÉES CONFORMÉMENT AUX INSTRUCTIONS DU FABRICANT.

3. German

VORSICHT ! Explosionsgefahr bei unsachgemäßen Austausch der Batterie.
Ersatz nur durch denselben oder einem vom Hersteller empfohlenem ähnlichen Typ.
Entsorgung gebrauchter Batterien nach Angaben des Herstellers.

4. Swedish

Explosionsfara vid felaktigt batteribyte.
Använd samma batterityp eller en ekvivalent typ som rekommenderas av apparattillverkaren. Kassera använt batteri enligt fabrikantens instruktion.

5. Danish

Lithiumbatteri- Eksplosionsfare ved fejlagtig håndtering.
Udskiftning må kum ske med batteri af samme fabrikat og type.
Lever det brugte batteri tilbage til leverandoren.

6. Norwegian

Eksplosjonsfare ved feilaktig skifte av batteri.
Benytt samme batteritype eller en tilsvarende type anbefalt av apparatfabriknten.
Brukte batterier kasseres i henhold til fabrikantens instruksjoner.

7. Finnish

Paristo voi räjähtää, jos se on virheellisesti asennettu.
Vaihda paristo ainostaan laitevalmistajan suosittelemaan tyyppiin.
Hävitä käyteet paristo valmistajan ohjeiden mukaisesti.

FCC Statement

This equipment has been tested and found to comply with the limits for a Class B digital device, pursuant to part 15 of the FCC Rules. These limits are designed to provide reasonable protection against harmful interference in a residential installation. This equipment generates, uses, and can radiate radio frequency energy, and if not installed and used in accordance with the instructions, may cause harmful interference to radio communications. However, there is no guarantee that interference will not occur in a particular installation. If this equipment does cause harmful interference to radio or television reception, which can be determined by turning the equipment off and on, the user is encouraged to try to correct the interference by one or more of the following measures:

- ◆ Reorient or relocate the receiving antenna.
- ◆ Increase the separation between the equipment and receiver.
- ◆ Connect the equipment into an outlet on a circuit different from that to which the receiver is connected.
- ◆ Consult the dealer or an experienced radio/TV technician for help.

Use of shielded cord is required to comply with Class B limits in Subpart B of Part 15 of the FCC rules. Do not make any changes or modifications to the equipment unless otherwise specified in the manual. If such changes or modifications should be made, you could be required to stop operation of the equipment.

FCC Caution:

1. The device complies with Part 15 of the FCC rules. Operation is subject to the following two conditions :
 - (1) This device may not cause harmful interference.
 - (2) This device must accept any interference received, including interference that may cause undesired operation.
2. This Transmitter must not be co-located or operating in conjunction with any other antenna or transmitter.
3. FCC RF Radiation Exposure Statement
This device has been tested for compliance with FCC RF Exposure (SAR) limits. The equipment complies with FCC RF radiation exposure limits set forth for an uncontrolled environment.
4. Changes or modifications to this unit not expressly approved by the party responsible for compliance could void the user authority to operate the equipment.

Table of Contents

BEFORE USING YOUR COMPUTER	1
Product Features	2
Installation Guidelines	3
CHAPTER 1	5
GETTING STARTED	5
Unpacking the Product	6
Packing List	6
Power Supply	7
Using the Battery	7
Using the AC adapter	9
The Back Stand	10
The Stylus Pen	11
Performing Mouse Clicks and Other Procedures with the Stylus Pen ..	11
For Optimal Performance from the Stylus Pen	12
The CMOS Camera	12
CHAPTER 2	13
SYSTEM OVERVIEW	13
Front View of the Computer	14
Right Side View of the Computer	17
Left Side View of the Computer	18
Top View of the Computer	19
Bottom View of the Computer	19
Rear View of the Computer	20
CHAPTER 3	21
PROTECTING AND MAINTAINING	21
Caring for Your Computer	22
Routine Care	22
Caring for the Battery	22
Caring for the AC Adapter	23

Caring for the Touch Screen Display	23
The System BIOS Utility	24
Configuring DRAM, HDD	25
Connecting to a Local Area Network (LAN).....	26
Adjusting the Video Resolution.....	27
Changing the Video Resolution of the Computer	27
Changing the Video Resolution of an External Display	27
CHAPTER 4	28
SPECIFICATIONS & SOFTWARE	28
Specifications and Standard Features.....	29
Software.....	32
Using the Bluetooth Utility, BlueSoleil™	32
Enabling Bluetooth Devices	35
Using the Smart Panel to Calibrate and Rotate the Screen	37
Using The Front Panel Hot Key Utility	39

Before Using Your Computer

Congratulations on your purchase of the product.

You will soon be in command of the worlds most lightweight, efficient and secure solution for managing all of your technology and mission critical data. Scale the computer and streamline the costs of day to day business operations and multimedia demands. Discover the computer's unparalleled in-the-field versatility for efficiently and reliably coordinating a myriad of tasks without costing a fortune.

Chapter Preview:

- Product Features
- Installation Guidelines

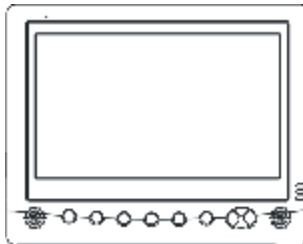

The Instructions Manual

Product Features

The product is a portable multimedia device empowering highly mobile users with wireless computing capabilities for day to day business and wireless applications. Its light weight and supreme portability combined with state-of-the-art multimedia capabilities provide exceptional writing, maneuvering, and on-your-feet computing. The product's primary features include:

- **Processor and OS (Operating System):** INTEL ATOM N270 Processor 1.6 GHz and Microsoft® Windows® XP Embedded / Vista OS, a stable platform, providing exceptional performance for highly mobile users under extreme and variable conditions.
- **Multimedia LCD Display:** 8.9-inch TFT (1024x600) LCD with Touch Screen Control Panel (LED back light / Sunlight readable) and Smart Panel Application enhancing user's ability to view data outdoors and under moving conditions.
- **Complete Connectivity from Anywhere:** The computer's built in Integrated Bluetooth®, IEEE 802.11b+g WLAN offers the mobile user the maximum opportunities to stay connected from anywhere, ensuring uninterrupted data sharing and synchronization. Limitless instant accesses to business critical information.
- **Integrated Ports and Adaptability:** Multiple I/O ports (3 x USB 2.0, Ethernet, external VGA port, PCI express Card/34) provide optimum versatility for any user's needs. Its ultra light weight and integrated wireless capability enable an effective mobile office. Multiple carrying options provide quick on-the-fly versatility while executing daily tasks comfortably and efficiently.

Note: Read the following Instructions Manual carefully before unpacking and setting it up. Refer to the Instructions Manual if you encounter any problems. Keep this Instructions Manual on hand for your reference.

Before Using Your Computer

Installation Guidelines

Read the following before assembling or disassembling the computer:

1. Follow all warnings and instructions marked on the product and within the Manual.
2. Before you begin cleaning the computer, make sure that you have unplugged all power cords and the device is Powered Off. Use a damp cloth for cleaning. Do not use liquids of any kind or aerosol cleaners.
3. Never place the computer on an unstable surface; it may fall, causing serious damage to it.
4. Avoid using a telephone (other than a cordless type) with the computer during an electrical storm. There may be remote risk of electric shock from lightning.
5. To ensure optimum performance and to protect the computer from overheating, ventilation slots must not be covered or obstructed in any way. The computer should never be placed near a radiator, heat register or in a built-in cabinet unless adequate ventilation is provided.
6. The computer should only be operated using the specified power indicated on the Warning Label located on the battery. If you are unsure of the type of power available to your locale, consult a dealer or the local power company.
7. If using an extension cord with the computer, make sure that the total ampere rating of the equipment plugged into the extension cord does not exceed the extension cord ampere rating. Also note that the total rating of all the devices plugged into the circuit does not exceed the fuse rating.
8. Never force objects of any kind into the computer's ventilation or housing slots as they may contact dangerous voltage points or spark resulting in electrical shock or a fire. Keep all liquids of any kind away from the computer.
9. Always disconnect all telephone lines & all power cords from the wall outlet before servicing or disassembling this product. Refer to the dealer or a qualified technician under the following conditions:

The Instructions Manual

- a. When the power cord or plug is damaged or frayed.
- b. If liquid has been spilled into the product.
- c. If the computer has been exposed to rain or water.
- d. If the computer does not operate normally when the operating instructions are followed. Adjust only those controls that are specified in the Operating Instructions or improper adjustment may require calibration again from a qualified technician.
- e. If the computer has been dropped or the housing has been damaged.
- f. If the computer experiences a distinct change in performance, indicating a need for service.

Getting Started

Chapter Preview:

- Unpacking and setting up the Product
- Packing list
- Power Supply
- The Back Stand
- The Stylus Pen
- The CMOS Camera

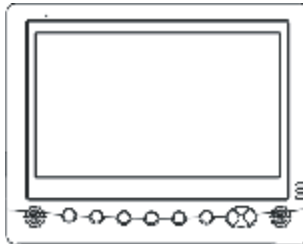

The Instructions Manual

Unpacking the Product

Before unpacking the product, prepare a suitable workspace for your computer. Make sure the workspace is level, stable and near an electrical outlet.

1. Open the box and remove the contents preserving the integrity of the box as you may need it and all of the packing materials for future shipping.
2. Inspect the contents for damage. If you find any irregularities or anything appears to be missing, contact your Dealer immediately. Check that the following components are included in the box:

Packing List

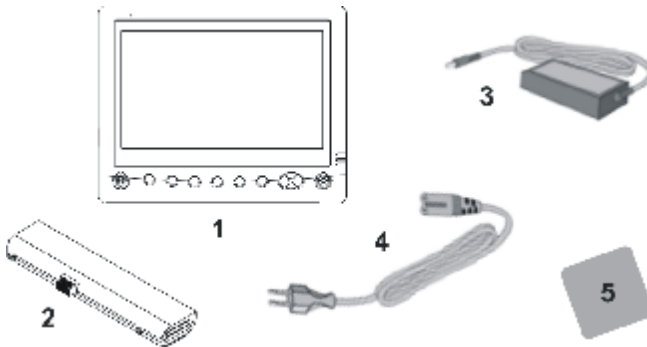

- | | |
|---|---|
| <input type="checkbox"/> 1. The Computer Unit | <input type="checkbox"/> 4. Power Cord |
| <input type="checkbox"/> 2. Battery | <input type="checkbox"/> 5. Panel Cloth |
| <input type="checkbox"/> 3. AC Power Adapter | |

Power Supply

The computer can be powered using either the built in battery or the AC Power Adapter plugged into any grounded AC power outlet.

Using the Battery

The primary source of power for the computer is a Lithium-Ion battery pack. The battery pack will first need to be installed on the underside of the computer. After following the battery installation instructions below, plug the AC adapter into any electrical outlet and the computer will begin recharging immediately. In the future, you should not have to access the battery pack unless you wish to replace it with a fresh one.

Note:

1. The Battery LED lights green when charging and will turn off when the battery is fully charged.
2. When charging the first time, it is recommended that the battery be allowed to charge for no less than eight hours.
3. It will take a longer time to complete the charging process, if the user is using the computer at the same time.

To install and remove the battery

pack:

Power down the computer using the Power Switch.

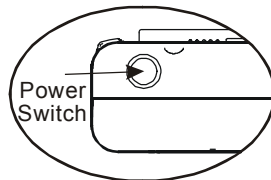

Installing the Battery:

1. Correctly align the battery and the notches in the battery bay. Firmly push the battery toward the computer until it clicks securely into place.
2. Turn the computer on using the power switch or begin recharging using the AC Adapter cord.

Removing/Replacing the Battery:

1. Push the slide while gently pushing the battery away from the battery bay. The battery will release from the computer and allow you to remove it.
2. Carefully lift the battery out.

Caring for the Battery

- Do not heat, tamper or place the battery in water or near a fire.
- Do not subject the battery to unusual forces such as hitting it, stepping on it or dropping it.
- Do not attempt to open or service the battery pack.
- Only replace the battery with the same model or one of compatible design.

Using the AC Adapter

When connecting the computer to external power:

1. Plug the DC power cord into the DC jack on the computer.
2. Plug the 3-prong AC power adapter cord into a grounded electrical outlet.

Use the AC adapter to power the computer or recharge the battery when it is low.

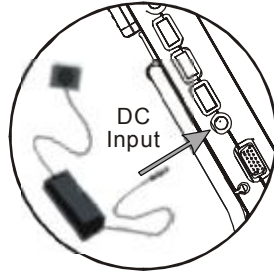

Caring for the AC Adapter

- Be sure to only use the AC adapter that comes provided with this product or a compatible option from the manufacturer. Other adapters may cause damage to the computer and will not be covered under the warranty.
- Grasp the adapter plug and not the cord, when unplugging the adapter from an electrical outlet.
- If the power cord becomes damaged (exposed or frayed, etc.), replace with a new AC adapter. Using a damaged cord may cause an electrical shock and may result in fire.
- Power off and unplug the AC adapter from the computer before unplugging it from the electrical outlet.

The Back Stand

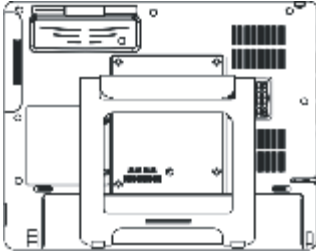

Fig. 1

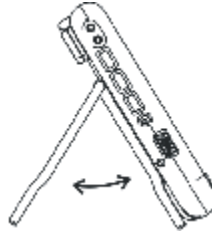

Fig. 2

Opening the Back Stand

1. Unfold the back stand (refer to fig. 2).
2. Place the computer on a flat and stable surface carefully leaning it onto the stand, ensuring that the back stand is securely in place.

Detaching the Back Stand

Fold the stand against the back cover of the computer (refer to Fig. 2).

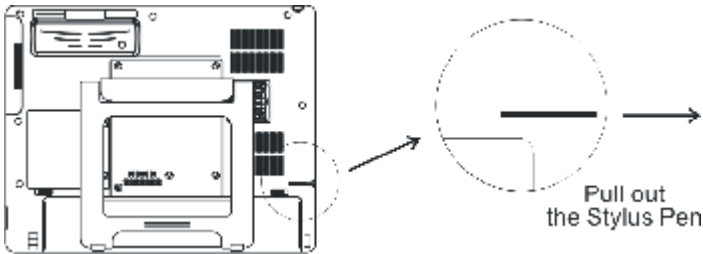

The Stylus Pen

The stylus pen emulates all of the functions of a standard mouse and can be effortlessly used in place of a mouse and a standard keyboard. The stylus pen tucks into a designated holder on the lower left side of the computer.

Performing Mouse Clicks and Other Procedures with the Stylus Pen

To select an item or open a menu on the screen as you usually left click on an external mouse:

- Tap the item or menu with the tip of the stylus pen

To double-click an item on the screen as you normally double click an external mouse:

- Tap the item twice with the tip of the stylus pen. (You need to lift the stylus pen from the screen quickly between taps.)

To select an item as you normally right click on an external mouse:

- Press the tip of the stylus pen on the item and hold it until the pop-up menu appears, then tap the choice.

You can also use the stylus pen to write characters, symbols and draw pictures using additional handwriting software, for example, Windows XP Painter.

The Instructions Manual

The five basic stylus pen operations and their external mouse equivalents can be quickly referenced in the table below:

Stylus Pen	External Mouse
Point	Point
Tap	Click
Double-tap	Double-click
Tap and hold	Right-click
Drag	Drag

For Optimal Performance from the Stylus Pen

- Hold the stylus pen in the same way that you would hold a pen or pencil when writing on paper.
- Hold the computer securely when mobile and using the stylus pen.
- Lift and tap the stylus pen quickly between double taps. Avoid using the stylus pen to push the computer buttons.
- For the most reliable operations, hold the stylus pen and tap vertically, perpendicular to the LCD display.

The CMOS Camera

Supporting auto reverse function.
Refer to the right diagram, the user can rotate the camera for taking pictures.

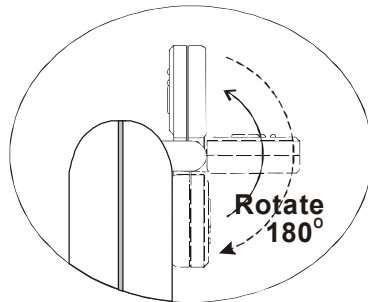

System Overview

This chapter contains six illustrations, highlighting each external component and its respective functions.

Chapter Preview:

- Front view of the Computer
- Right side view of the Computer
- Left side view of the Computer
- Top view of the Computer
- Bottom view of the Computer
- Rear view and Build In Back Stand

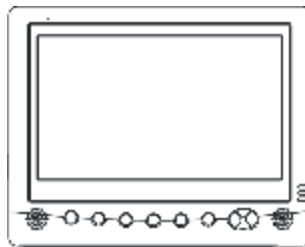

Front View of the Computer

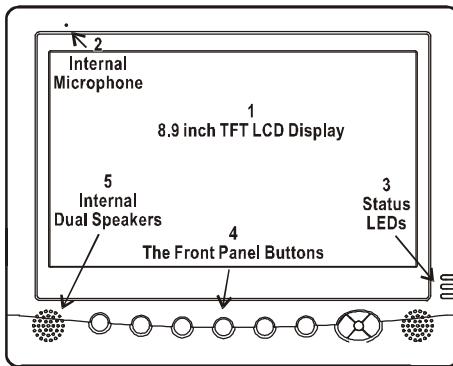

1. 8.9 inch TFT (1024x600) LCD Display with Touch Screen Control Panel:

Data can be entered the computer module using the stylus pen or a soft/USB/wireless keyboard. A soft keyboard can be located by tapping the keyboard icon in the bottom right on the desktop. Data can also be entered via a USB keyboard plugged into the USB port on the left side of the computer. The computer's USB ports support most USB keyboards and pointing devices.

2. Internal Microphone:

Effortless input of monaural sound recording.

3. Status LEDs:

LED Indicator	Relevant Component	Description
Orange (Flashing)	Hard Drive	Disk Accessing
Green (Off)	Battery	Battery Available
Green (Solid)	Battery	Battery Charging
Blue (Solid)	Power	System Powered On

4. Front Panel Buttons:



The above 10 quick access buttons are used for navigating applications in the Microsoft Windows XP environment (or relevant OS) and to setup the System BIOS Utility in DOS mode (alternative function).



















- **The Quick Reference table below illustrates the Button, its alternative Function, and a brief Function Description while in the System BIOS Utility in DOS Mode**

Button	Keyboard Function	Description in Bios Utility
1	<Delete>	Launch CMOS Setup Utility
2	<Y>	“Yes” Confirmation
3	<N>	“No” Confirmation
4	<PgDn>	Change Value
5	<PgUp>	Change Value
6	<Esc>	Exit / Return
7	<<=>	Move / Select Item
8	<↓>	Move / Select Item
9	<Enter>	Selection Confirmation
10	<↑>	Move / Select Item
11	<=>	Move / Select Item

- **Navigating applications in Microsoft® Windows® XP Environments**

Use the quick reference table below to identify each button’s default setting. Users can define each quick access button by invoking the Key Define Utility (Hot Key definition section). The quick launch icon appears in the Windows systems tray, in the lower-right corner of the Windows desktop.

The Instructions Manual

Level	Button	Label	Brief Description of Function
1	1		Rotate Key to Next Level
	2		Enable / Disable Touch Screen Function
	3		LCD Back Light Control Utility
	4		Invokes On-Screen Keyboard
	5		Scroll Page Up
	6		Scroll Page Down
2	1		Rotate Key to Next Level
	2		Warm Start: <Ctrl><Alt><Delete>
	3		Invokes Volume Control Utility
	4		Invokes Window Media Player
	5		Voice Recording Start/Stop
	6		Enables/Disables Wireless Function
3	1		Rotate Key to Next Level
	2		Invokes User Defined Program
	3		Invokes User Defined Program
	4		Invokes User Defined Program
	5		Screen Resolution 1024x768 ↔ 1024x600
	6		Screen Rotation

Level	Button	Label	Brief Description of Function
All Levels	7	<←>	Left Arrow
	8	<↓>	Down Arrow
	9	<Enter>	Enter
	10	<↑>	Up Arrow
	11	<→>	Right Arrow

5. Internal Dual Speakers:

The computer's built-in dual speakers support audio applications for all media software. Volume and equalizer control can be adjusted via the OS or additional multimedia application software. Sound will mute when headphones are detected.

Right Side View of the Computer

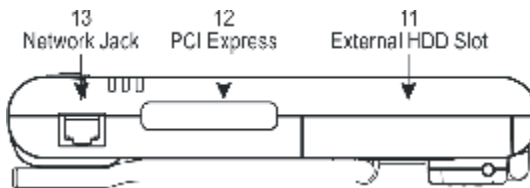

11. External Hard Drive Slot:

2.5" 16G Solid State Drive (SSD)

12. PCI Express Card/34 Slot:

PCI Express Card/34

13. Network Jack (RJ45):

Interfaces with an Ethernet 10/100/1000 Mbps Base-T network connection.

Left Side View of the Computer

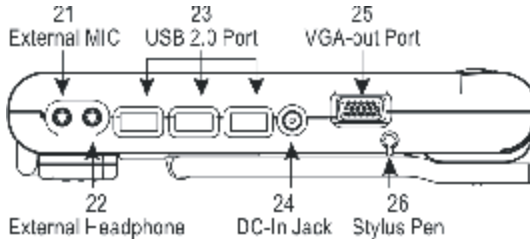

21. External Microphone Jack:

For recording or voice-control functions, an additional microphone plugs in here.

22. External Headphone (out) Jack:

Connect devices such as headphones or speakers to this jack.

23. USB 2.0 Ports:

Permits hot plugging of USB peripheral devices to the computer. The USB ports support most USB mouse and keyboard devices.

24. DC-in Jack:

Plug the DC (Direct Current) end of the AC Adapter into this jack for external power and battery recharging. Before plugging in the power cord, you must first verify that the external power voltage is appropriate for your geographical area.

25. VGA-Out Port:

Connects an external (VGA) display monitor to the computer.

26. Stylus Pen:

A stylus pen is used to activate the touch screen display and functions in the same way as an external mouse. The stylus pen is partially visible from the left side of the computer and can be located by pulling it from its secure housing. Only use the tip of the stylus pen when interacting with the LCD display to prevent damage to the display surface.

Top View of the Computer

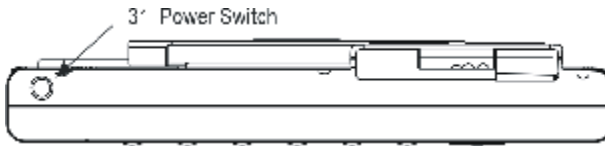

31. Power Switch:

Powers the computer ON and OFF. Press and hold for 4 seconds to initiate Power OFF.

Bottom View of the Computer

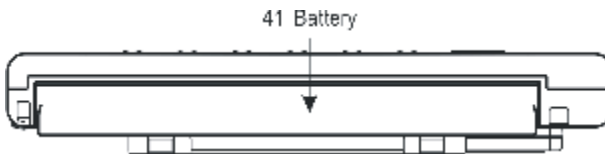

41. Battery Pack:

A 6-cell 5200mAh removable Lithium-Ion battery pack comes standard with the computer. Each cell comes equipped with short circuit, over-charge, over-discharge, over-current and abuses protection.

Rear View of the Computer

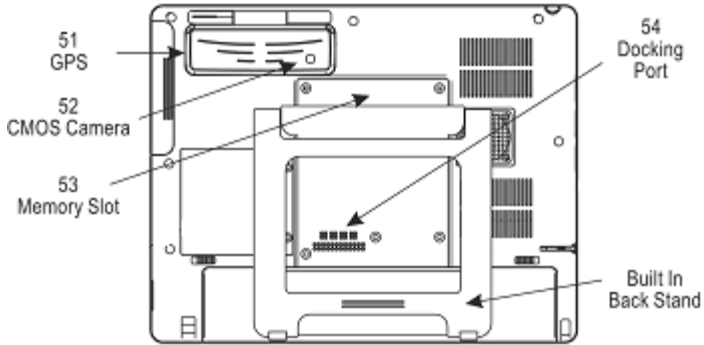

51. GPS: (optional)

Support 20-channel GPS.

52. CMOS Camera: (optional)

The built-in 1.3M pixels CMOS camera module supports auto reverse function. Images can be captured and disseminated instantaneously. Images will reverse automatically as soon as the camera rotates more than 100 degrees.

53. Memory Slots:

Allow users to expand memory up to 2 GB.

54. Docking Ports:

The battery charger port. The USB ports support most USB mouse and keyboard devices.

Protecting & Maintaining

Chapter Preview:

- Caring for your Computer
- The System BIOS Utility
- Configuring DRAM, HDD
- Connecting to a Local Area Network
- Adjusting the Resolutions for the Computer's Display and an External Display

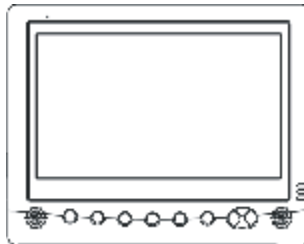

Caring for Your Computer

To guarantee a long life for the computer and to ensure it functions optimally, pay particular attention to the following recommended maintenance guidelines.

Routine Care

Follow these guidelines to keep the computer working properly:

- Do not attempt to disassemble or modify the computer in any way.
- Do not place anything on top of the device or its LCD display to prevent damage to the screen.
- Avoid using and storing the computer in locations where static or electrical interference can damage the internal components.
- Avoid using and storing the computer in locations exposed to extreme temperature fluctuations, likely condensation, or direct sunlight.
- Keep the device away from moisture such as exposure to liquids or precipitation.
- Only operate the device with the battery pack installed, even when using external power. This ensures the computer will have the sufficient power to maintain and save data when disconnected from the external power source.
- Store the device in its docking station when not in use.

Caring for the Battery

- Do not heat, tamper or place the battery in water or near a fire.
- Do not subject the battery to unusual forces such as hitting it, stepping on it or dropping it.
- Do not attempt to open or service the battery pack.
- Only replace the battery with the same model or one of compatible design.

Caring for the AC Adapter

- Be sure to only use the AC adapter that comes provided with this product or a compatible option from the manufacturer. Other adapters may cause damage to the computer and will not be covered under the warranty.
- Grasp the adapter plug and not the cord, when unplugging the adapter from an electrical outlet.
- If the power cord becomes damaged (exposed or frayed, etc.), replace with a new AC adapter. Using a damaged cord may cause an electrical shock and may result in fire.
- Power off and unplug the AC adapter from the computer before unplugging it from the electrical outlet.

Caring for the Touch Screen Display

- Never spray liquids of any kind directly onto the display screen or allow excess liquid to drip into the device.
- Never place anything on the display screen that could cause damage to the LCD display, for example, drinks and food.
- Never scratch the surface of the LCD display with any sharp or damaging objects.
- Avoid exposing the computer to direct sunlight or excessive ultraviolet radiation for an extended period of time.
- To clean the exterior of the device, wipe the screen and the housing with a soft, damp cloth moistened with water. Never use soap or other cleaning products on the LCD screen. It may discolor the outer coating and damage screen visibility.

The System BIOS Utility

AWARD BIOS

The computer operates using AWARD Basic Input / Output System (BIOS). Individual explanations are available on the system BIOS screen.

BIOS Setup Utility

The Setup Utility enables you to change the most important system settings, adjusting the system's internal clock and the preferred boot device, etc. Unnecessary changes to the system settings may cause the computer to become unstable or compromise its performance.



Initiating and Navigating the Setup Utility

- Press button #1 on the front panel of the computer or the <Delete> key on an external keyboard during system startup before the OS (Operating System) begins to load.
- Refer to the Front Panel Button descriptions in Chapter 2 for navigating applications in the System BIOS Utility.
- Read detail navigating information on the bottom of the display screen for every button and keystroke.
- Read each field or item descriptions on the right hand side of the display screen.

Configuring DRAM, HDD

- **Configuring DRAM**

1. Remove these 5 screws.
2. Dismount the back stand.

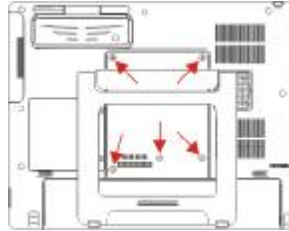

- **Configuring HDD**

1. Remove the screw.
2. Dismount the HDD Holder.



Connecting to a Local Area Network (LAN)

Users can connect to local area networks (LANs). LANs give users access to network resources, such as printers and file servers on the corporate network, and possibly to the Internet.

To connect to a LAN :

1. Check that the existing LAN supports Ethernet 10 Base-T (10Mbps), 100 Base-T (10Mbps) or 1000 Base-TX (100Mbps) connections.
2. Plug the LAN cable (not supplied) into the built-in Network Jack (LAN Port). The cable must have an RJ-45 connector.
3. Windows automatically detects and sets up a LAN connection. To edit settings, open Network and Dial-up Connections in Control Panel.

See Windows Help for information about setting up and using LAN connections. Contact the network administrator for network information.

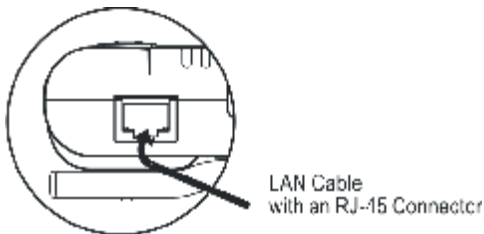

Adjusting the Computer's and External Displays' Resolution

- **Changing the Video Resolution of the Computer**

1. Choose one of the two options to open the Display Properties dialog box:
 - 1.1. Click the right button of the mouse on the desktop and select *Properties* from the menu. **or,**
 - 1.2. Click the Start button and select Control Panel. Double click the Display icon.
2. Select the *Settings* tab. Select the *Advanced* option.
3. Select the *Adapter* option. Select the *List All Modes*.
4. Confirm the desired display mode (ex. 1024x600/ True Color (32 bits)/ 60Hertz).

- **Changing the Video Resolution of an External Display**

1. Plug the VGA cord into the VGA output port. Plug the other end of the cord into the external CRT Display or Projector.
2. Use one of the following two options to open *Monitor Properties* in the dialog box:
 - 2.1. Click the right button of the mouse on the desktop and select *Properties* from the menu. **or,**
 - 2.2. Click the Start button and select Control Panel. Double click the Display icon.
3. Select *Settings*. Select *S3 Display*.
4. Configure the Display Device and apply the new settings to the external display.
 - 4.1. Set the Display Device to *CRT* disabling the LCD.
 - 4.2. Select *Apply* to confirm the new settings.
5. Select a new video resolution (ex. 1024 x 768) for the external CRT.

Note: Correct operation will disable the LCD and enable the external display.

CHAPTER 4

Specifications & Software

Chapter Preview:

- Specifications and Standard Features
- Software

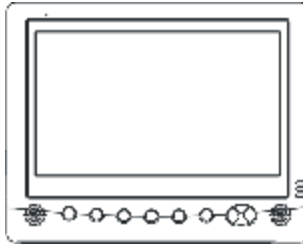

Specifications and Standard Features

Processor

INTEL ATOM N270 Processor 1.6 G

Chipset

INTEL 945GSE (Integrated North & South bridge)

Operating System

Microsoft® Windows® XP Embedded / Vista
Option: Linux / WIN CE

System BIOS

AWARD BIOS

Memory

1G DDR II DRAM 200 pin (533-MHz / MAX 2G)

Display

- ◆ 8.9-inch TFT (1024x600) LCD Touch Panel
 - ◆ Simulation to 1024x768 by Hot Key
 - ◆ LED Back Light / Sunlight Readable
-

Pointing Device

Touch Panel Screen and Stylus Pen Input Device

Storage

16G Solid State Drive (SSD)
Option: 2.5" 160-GB SATA Hard Drive

Communication

- ◆ 10/100/1000 Mbps Base-T Ethernet LAN
-

Wireless Connectivity

- ◆ Wireless LAN : IEEE 802.11b+g
 - ◆ Integrated Bluetooth®
-

The Instructions Manual

CMOS Camera

- ◆ 1.3M Pixels CMOS Camera Module
 - ◆ Support Auto Reverse Function
-

GPS (optional)

- ◆ Support 20-channel GPS
-

Multimedia

- ◆ Internal microphone and dual speakers (HD Audio On-board Sound, 24Bit Stereo, Full Duplex)
 - ◆ External volume on/off controls via hot key setting
-

Battery

6-cell 5200mAh Removable Lithium-Ion Battery Pack. Short circuit, over-charge, over-discharge, over-current and abuses protected.

Power Supply

External AC Adapter (175g / AC Input 100~240V, 50/60Hz, 2 Pin Inlet 8-Shape / DC Output 16V, 3.75A, 5.5x2.5x10 S Type) includes Power Cord.

Included Accessories

Stylus pen, panel cloth, power cord and adapter.

Interfaces

RJ45 Port		Ethernet LAN
3x USB 2.0 Ports		Series A Connectors
PCI Express Card/34 Slot		PCI Express Card/34
External Microphone In Port		2.5mm Receptacle
External Headphone		2.5mm Receptacle
VGA Port		D-Sub 15 pin
DC Power In		2.5mm Center Pin
LED Status Indicators :		
HDD LED (Orange)	Flashing	– Disk Accessing
Battery LED (Green)	Off	– Battery Available
	Solid	– Battery Charging
Power LED (Blue)	Solid	– System Powered On

CHAPTER 4 – Specifications & Software

Mobility Dimensions : 240mm x 190mm x 26mm
Warranty : ONE year limited warranty parts.

Environmental Specifications

- ◆ Operating temperature : -10° to 40°C (14° to 104°F)
 - ◆ Storage temperature : -20° to 75°C (-4° to 167°F)
-

Certification of System FCC / CE / CB

Software

Using The Bluetooth Utility: BlueSoleil™

BlueSoleil allows the computer to wirelessly access a variety of Bluetooth enabled digital devices, such as cameras, mobile phones, headsets, printers, and GPS receivers. Users can also create networks and exchange data with other Bluetooth enabled computers or PDAs.

When launching BlueSoleil from the desktop, six menus will appear:

- ◆ File Menu
- ◆ View Menu
- ◆ My Bluetooth Menu
- ◆ My Services Menu
- ◆ Tools Menu
- ◆ Help Menu

● File Menu

Hide	Hide the BlueSoleil Window. Connections are still maintained.
Always on Top	Keeps the BlueSoleil Window on top.
Exit	Exit BlueSoleil.

● View Menu

Main Window	Show the BlueSoleil Main Window.
Service Window	Show the BlueSoleil Service Window.
Arrange Devices	Arrange remote devices by Device Name, Address or Type.
Refresh Devices	Refresh the list of remote devices detected by BlueSoleil.

Note: If you select *Refresh Devices*, the list of previously detected devices will not be cleared. To initiate a new device search and clear the list, press *F5*.

● My Bluetooth Menu

Bluetooth Device Discovery	Search for other Bluetooth enabled devices within range.
Bluetooth Service Discovery	Browse for relevant services of the selected remote device.
Security	Configure security settings for the local device.
Device Properties	Configure properties for the local device.

● My Services Menu

Start Service	Begin the selected local Bluetooth service.
Stop Service	End the selected local Bluetooth service.
Status	View the status of the selected local Bluetooth service.
Properties	Configure the properties for the local Bluetooth service.

● Tools Menu

My Bluetooth Shortcuts	Select a shortcut to connect or delete.
Find Device	Search for a device by Device Name and Address and click <i>Find</i> . The specified device will appear highlighted in the Main Window.
Add New Device	Add a remote device by entering the Bluetooth device address.
Add Device from History	Add a remote device from the history list. Delete the selected device from the history.
Configurations	
Quick Connect	Assign a remote device to automatically connect with a Bluetooth serial port whenever an application opens a specified port. Remove a device from the selected port.
Unplug HID	Remove Human Interface Devices from BlueSoleil.

My Bluetooth Device

Note: For the connected HID, BlueSoleil will reconnect in the instance of connection loss, except however, the unplugged HID.
Recommended for advanced users only.

- **Help Menu**

Contents and Index F1 Access BlueSoleil Help Online.
About BlueSoleil Information about your computer's version of BlueSoleil.

Enable Bluetooth Devices

Step 1. Press the Bluetooth Setting Button of the Device.

Step 2. Select *My Bluetooth* and scroll down to *Bluetooth Device Discovery* to find out all of your available Bluetooth devices.



Step 3. BlueSoleil will display all available devices on the screen.



Right-click the corresponding remote device icon and select *Pair Device* from the menu. Make sure the Bluetooth Setting Button of the Device is active, if not, retry.

Step 4. Type the Passkey and click *OK* to confirm.



After the Bluetooth device has been successfully configured with the computer, the remote device icon will display a red checkmark.

The Instructions Manual

Step 5. Double-click the remote device icon and select *Connect* and then *Bluetooth Human Interface Device Service* from the menu. Be sure the Bluetooth Setting Button on the Device is active, if not, retry.



Step 6. BlueSoliel will display the link between local and remote devices indicating that the connection was successful.

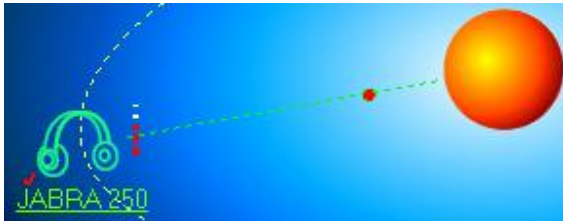





Using The Smart Panel to Calibrate and Rotate The Screen



Select the icon  in the Windows system tray or *Start Menu -> All Programs -> Hot Key & Smart Panel Utilities -> Hot Key & Smart Panel Utilities* to launch the program.

The following will appear:



-  Rotates the screen 90° counter clockwise.
-  Rotates the screen 90° clockwise.
-  Rotates the screen 180° degrees.
-  Screen calibration

The Instructions Manual

Tap or click  or select the icon  on the desktop to launch the Calibration program and the following panels will appear.

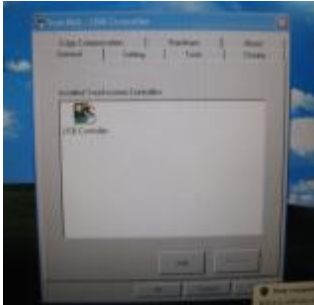

Select *Tool*, then select *4 Point Calibration*. A red flashing X will appear in the lower-left corner of the screen, then tap or click the X and hold it until the green X appears. Follow the same steps to finish the other three red X calibration.

Note: Make sure to calibrate the screen before your first screen rotation.

● The First Installation

The following panel will appear if the user installs the software setup procedure oneself. Users have to install Microsoft .NET Framework before the first installation of Hot Key & Smart Panel Utilities.



Select "Yes" to install Microsoft .NET Framework immediately or users can download Microsoft .NET Framework from Microsoft website later.

Using The Front Panel Hot Key Utility

Select the icon  in the Windows system tray or *Start Menu -> All Programs -> Hot Key & Smart Panel Utilities -> Hot Key & Smart Panel Utilities* to launch the program.

The following Primary Panel will appear:



Switches to next level functions.

The following Secondary Panel will appear:



Switches to next level functions.

The following Third Panel will appear:



Switches to next level functions.

The Instructions Manual

- **Launch a Program via Primary, Secondary and Third Panels**

Tap the icon twice to launch the program.

- **Primary Level Functions :**



Switches to next level functions



Enable / Disable Touch Screen Function



LCD Back Light Control Utility



Invokes On-Screen Keyboard



Scroll Page Up



Scroll Page Down

- **Secondary Level Functions :**



Switches to next level functions



System Warm Reboot (<Ctrl> + <Alt> + <Delete>)



Invokes Volume Control Utility



Invokes Windows Media Player



Record Audio (Start / Stop)



Enables/Disables Wireless Function

- **Third Level Functions :**



Switches to next level functions



Invoke User Defined Program



Invoke User Defined Program



Invoke User Defined Program



Screen Resolution
1024x768 ↔ 1024x600



Screen Rotation

-  **User Defined Program Function Setting**

Right-click icon  in the Windows system tray to enter the setting menu.

The following panel will appear:

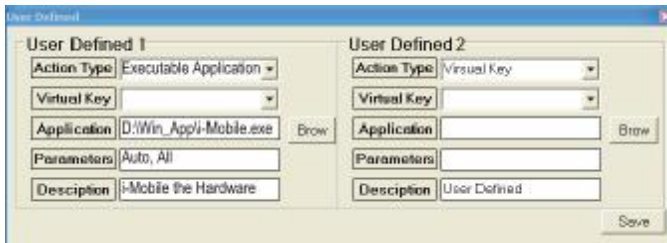

Action Type : Enable “Virtual Key” or “Executable Application”

Virtual Key : Use top-down menu to select a simulating function

Application : Use Brow to select an executable application

Parameters : Specify the parameters for the above application

Description : Describe the function of the above application

Save : Save the User Defined Information

- **The First Installation**

Please refer to the descriptions of “The First Installation” for “Using the Smart Panel to Calibrate and Rotate the Screen”.