

User Manual



Copyright ©2007 iControl Networks, Inc. All rights reserved.

No reproduction in whole or in part without prior written approval. iControl Networks, iControl, and iControl logo design are pending trademarks of iControl Networks. All other trademarks are the property of their respective owners. Information contained herein is subject to change without notice. The only warranties for iControl products and services are set forth in the express warranty statements accompanying such products and services. Nothing herein should be construed as constituting an additional warranty. iControl Networks shall not be liable for technical or editorial errors or omissions contained herein. All rights reserved.

Document ID:13004.02.026

Table Of Contents

Your iControl Personal Web Portal Explained	11
Tabs and Windows	12
Summary tab	12
Status window	12
Pictures window	14
Alarm History window	15
Today's Schedule window	16
Notifications tab	16
Automations tab	16
Schedules tab	17
System tab	17
Changing Modes	19
Updates Button	21
History	23
Your iControl Devices	25
Your iControl Box	25
Your iControl Box	25
Your iControl Box	25
Your Camera	26
Your Camera	26
Your Camera	27
Setting Up the Camera(s) That Came with Your Starter Kit	27
Adding an Additional Camera to Your System	28
Editing Your Camera's Settings	29
Taking Pictures Manually	31
Taking Pictures as Part of an Automation, Notification, or Schedule	33
Sending Pictures	33
Deleting Pictures	35
Focusing Your Camera	35
Managing Pictures	39
About Your Wireless Settings	41
Your Carbon Monoxide Detector	43
Installing Your Carbon Monoxide Detector	43
Using Your Carbon Monoxide Detector	46
Your Door/Window Sensor	46
Installing your Door/Window Sensor	47
Checking Installation of Your Door/Window Sensor	48
Using Your Door/Window Sensor	49
Your Freeze Sensor	50
Mounting Your Freeze Sensor	50
Your Keychain Remote	51
Your Keychain Remote	51
Your Keychain Remote	52
Modifying The Actions of Your Keychain Remote Buttons	53

Table Of Contents

Your Lamp Module	56
Your Lamp Module	56
Your Lamp Module	57
Installing Your Lamp Module	58
Physical Installation of Your Lamp Module	61
Setting the Brightness of Lighting	62
Adding Your Keychain Remote.....	63
Your Motion Sensor.....	66
Your Motion Sensor	66
Your Motion Sensor	66
Mounting your Motion Sensor	66
Using Your Motion Sensor	69
Your Panic Pendant	70
Your Panic Pendant.....	70
Your Panic Pendant.....	71
Your Smoke/Heat Sensor.....	71
Your Smoke/Heat Sensor	71
Your Smoke/Heat Sensor	72
Managing Your iControl Devices.....	73
Renaming Devices	73
Deleting a Device	74
Automations.....	77
Automations	77
Sample Automations Window	77
Automations	78
Sample Automations Window	78
Adding and Editing Automations	80
Common Tasks.....	91
Commonly Used Terms.....	91
Turn Up the Heat in the AM, Down During the Day, Up in the Evening.....	91
Send Me a Notification When the Panic Pendant Goes Off	94
Managing Your System from a Mobile Device	95
Logging In	95
The Change Mode Screen	96
The Pictures Screen.....	97
Change Premise Screen	99
Frequently Asked Questions	101
The iControl Gateway.....	102
Can I plug the iControl box into an uninterruptible power supply or a surge protector?.....	102
What if the iControl box Power light does not turn on?	103
What if I do not have a router or similar device?.....	103
What is the phone jack for?	103
When do the LEDs blink?	103
The iControl System.....	103
What Kind of Broadband do I need?.....	103

Printed Documentation

When I tried using QuikControl why didnt anything happen?	103
How can I tell my iControl box is communicating with the iControl servers?	104
What do I do if I cant see the device I just installed?	104
What should I do if my device just seems to keep installing the dot is still yellow?.....	104
Notifications.....	105
Camera	105
What do I need for my wireless Camera to work?	105
My Camera is out of focus. What do I do?	105
What if my camera hasnt been discovered and has a yellow dot next to it?	105
What do I do if I cant see any images or video from the camera I just installed?	105
How do I use WEP (Wireless Equivalent Privacy) on my Wireless camera?	106
What is the cameras resolution?.....	106
Door/Window Sensor	106
What should I do if my Door/Window sensor has a red dot next to it on the System page of my iControl Portal?	106
Why does my Door/Window sensor always report itself as open?.....	106
How far away can I install my iControl Door/Window sensor from the iControl box?.....	107
Keychain Remote	107
What are the default actions of the buttons?	107
The Keychain Remote is doing something it is not supposed to do. What should I do?	107
My Keychain Remote isnt doing anything. I press buttons repeatedly.....	107
Why doesnt my Keychain Remote lamp button doesnt turn the lamp on or off?.....	107
I used the Keychain Remote and the light level is different now. Why?.....	108
If I buy another Lamp module, can my Keychain Remote control it?	108
Powerline Lamp Module.....	108
My lamp module isnt installing, what should I do?	108
What kinds of lights can I use the Lamp module with?	108
Can I use it on a lamp wired into a 3-way or 4-way wall switch?	109
Can I use a 3-way light?	109
Can I plug a Lamp module into an uninterruptible power supply (UPS)?...	109
Can I plug a Lamp module into a power strip with a surge protector or into a surge protector?.....	109
How far away can I install a Lamp module from the iControl box?	109
What does the black button on the bottom of the Lamp module do?	109
Motion Sensor	109
How do I test that a Motion Sensor is covering the area I hope it does monitor?.....	109

Table Of Contents

Why doesnt the motion sensor detect when I leave the room and come back?	110
Will the Motion Sensor sense my pets?	110
Why is there nothing in the picture that was taken as a result of the motion detector being activated?.....	110
How far away can I install my iControl Motion sensor from the iControl box?	110
Thermostat	110
What type of system will the iControl thermostat work with?	110
Index	113

Your iControl Personal Web Portal Explained

After you log in to your iControl System, the first page you will see of your personal web portal is the iControl Summary page. This is where you begin using your iControl System. This webpage is divided into four major windows: Status, Pictures, Alarm History, and Today's Schedule. The Status window shows you the current state of your devices and System. The Pictures window displays recent pictures. The Alarm History window shows the recent changes in devices, and the Today's Schedule window shows you the schedules that will run today. By selecting the tabs at the top of the page (Summary, Notifications, Automations, Schedules, and System), you can access the rich functionality of the System. The following is an example of the iControl Summary page.



Printed Documentation



The interface of the iControl Summary page includes five tabs (Summary, Notifications, Automations, Schedules, and System) and a menu bar with six buttons (History, Update (green arrows), QuikControl, Mode, Help, and My Account).

Tabs and Windows



The tabs displayed on the iControl Summary page open a series of windows.

Summary tab

The Summary tab consists of the following windows:

Status window

The Status window shows you the overall System status and the current mode of the System. In this example, the System is in Home mode (your System can be in Home, Sleep, or Away mode). The Status light is always one of three colors:

-  Green System operating normally (no alarm conditions).
-  Yellow Alarm conditions on one or more devices (e.g., Front Door open).
-  Red The iControl box is offline.

Your iControl Personal Web Portal Explained



The lower part of the Status window, labeled ‘Current States’, lists the current state of all devices installed in your iControl System (e.g., the Front Hall Lamp Light is Off).

However, certain devices will not be listed as they do not have states. In the current Starter Kit, only cameras are such devices. Also, your location may have more iControl devices installed than those showing in the Current States window. You can view these devices by clicking on the up or down arrows or the small box inside the scroll bar on the right of the Status window.

If a yellow triangle (⚠) displays next to the current state of a device, this device has recognized a change that creates an alarm condition. In our example, the yellow triangle next to ‘Front Door – Open’ indicates that the Door/Window sensor has recognized the change from ‘Closed’ to ‘Open’.

The following table shows the possible states and the alarm conditions of iControl devices.

Device	Possible State(s)	Example	Generates a yellow triangle when:
Carbon Monoxide detector	Ok or Alarm	‘Alarm’ indicates the presence of carbon monoxide.	Alarm
Door/Window sensor,	Open or Closed	‘Open’ indicates the	Open

Printed Documentation

Micro Door/Window sensor, Recessed Door/Window sensor		door or window is open.	
Freeze sensor	Ok or Freeze	'Freeze' indicates that the air temperature is below 41 degrees.	Temperature is below 41 degrees.
Keychain Remote	Lights On/Off, Take Picture, Change mode.	Press the appropriate button to trigger the System to change mode.	Not applicable.
Lamp module	On, Off, Brightness at 10% to 100%	50%– set the Lamp module to dim the controlled light to 50% brightness.	Not applicable.
Motion sensor	Occupied or Empty	'Occupied' means a person is in the monitored area.	Occupied
Panic Wristwatch and Hanging Pendant	Ok or Alarm	'Alarm' indicates the user has pressed the panic button to request help	Alarm
Smoke and Heat sensor	Ok or Alarm	'Alarm' indicates the presence of smoke or temperatures above 135 degrees.	Alarm
Thermostat	Degrees between 32° F and 120° F	67° F	Not applicable.
Water sensor	Ok or Alarm	'Alarm' indicates the presence of water.	Water detected.

Note: This User Manual will discuss devices which may not be in your particular Starter Kit. More devices are available as accessories from iControl at www.iconcontrol.com. The term 'Gateway' – which appears on the System page and elsewhere – is interchangeable with the term 'iControl box'.

Pictures window

Your iControl Personal Web Portal Explained

In this window, you can see the most recent pictures from each of your iControl cameras. If you place the cursor over a picture, the name of the camera will display, such as 'Store - Rear Wired Camera'. You can also expand a picture by clicking on it. In the expanded view, you can delete the picture, take a new picture, email the picture, view thumbnails of recent pictures, or watch live video (if port forwarding is enabled). You can also focus the camera if you are viewing the picture on your local network.

The Pictures window can be customized to show a different set of pictures for each camera. See [My Account](#).



Alarm History window

This window shows recent alarms generated by your iControl devices. An alarm occurs whenever a device detects a change. Your Door/Window sensor may, for instance, detect an open door, or your Motion sensor may detect a person entering the monitored room.

For each change, the Alarm History window displays the time of the alarm and the device's name. In our example, the Back Hallway Motion Sensor generated an alarm condition at four different times (2:59PM, 2:29PM, 1:37PM, and 1:18PM).

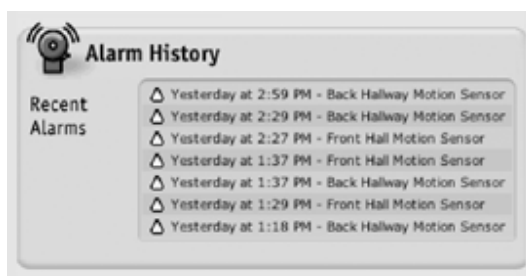

Next to each item in the Alarm History window is a yellow triangle (▲), indicating an alarm condition. You can place your cursor on any triangle to see the device state that

Printed Documentation

caused the alarm condition. You can click on any device's name to see the device's alarm history.

The Door/Window sensor and the Motion sensor are only two examples of iControl alarm devices. Additional alarm devices, such as a Thermostat and Freeze, Water, Smoke, and Carbon Monoxide sensors, are available as optional accessories.

Today's Schedule window

This window shows the events scheduled to occur today. You can place your cursor on any rightpointing arrow beside a time to see the time window within which an action is scheduled to repeat.

To learn more, see [Schedules](#).

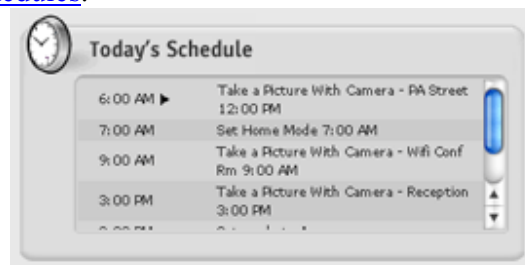

Notifications tab

The iControl System can email and/or SMS you and any number of staff or family members when an event happens. For example, the System can automatically send you and your staff an email when the front door of the store opens in the morning so that you know the store opened on time. You and your parent's caregiver can get an SMS if your parent does not enter the kitchen in the morning for breakfast. You can get an email when someone comes into your vacation home. For detailed information on how to create and use notifications, see [Notifications](#).

Automations tab

Automations allow you to set up your devices to perform an action automatically whenever another device recognizes a change. For example, you can program your camera to take a picture of whoever comes through the door when a warehouse door opens. If a Motion sensor detects a person entering the kitchen at night, you can have the lights come on. For detailed information on how to add and use automations, see [Adding](#)

[and Editing Automations](#) in [Automations](#).

Schedules tab

You can schedule actions for your devices to perform at particular times of the day and days of the week. You can also schedule actions to repeat or occur randomly. You can, for example, have lights come on and stay on from 8PM to 11PM every night. Alternatively, you can have the lights turn on and off randomly during that time period. A camera can be scheduled to take a picture every two hours so you can check on store traffic. A thermostat at your parent's house or vacation home can be set to turn up during the breakfast and dinner hours and down during the day and in the evening. For detailed information on how to add and use schedules, see [Adding and Editing a Schedule](#) in [Schedules](#).

System tab

You can access the complete list of devices installed in your iControl System via the System tab. You can check to see if all of the installed devices are working properly. A green dot indicates that the System is operating properly, while a yellow dot indicates that the System is still installing the device or is not in communication with it. A red dot indicates that the device is offline, possibly because it is unplugged. You can add and delete devices, change their name, and confirm or change their device ID. You can also see the history of the device (when it was installed or deleted, for example). For detailed information on how to use the System tab, see [Managing Your iControl Devices](#).

Changing Modes

Your System can operate in Home, Sleep, or Away mode. Modes allow you to make system-wide changes. Some possible uses are:

- **Home mode** can be used when you are home and do not want to receive notifications whenever someone goes in or out of a door or room. You could also set up schedules or automations that cause the cameras to take pictures only when the System is in Away mode.
- **Sleep mode** allows you to have notifications for Motion sensors be inactive while notifications for Door/Window sensors that may be on external doors or windows remain active.
- **Away mode** can be used when you are traveling or away from your location.

You can change your System's mode in several ways. You can set the desired mode by clicking on the 'Mode' button in the blue menu bar. You can also change the mode through schedules. For example, you can schedule your System to go into Sleep mode at 11PM each night. Or, you can press the 'Lock' button on your Keychain Remote to change the mode to Away.

To change the mode via your iControl Summary page, follow these steps:

1. Click on the 'Mode' button in the blue menu bar. You will see a drop-down menu which shows the current mode marked with a green arrow.

Printed Documentation

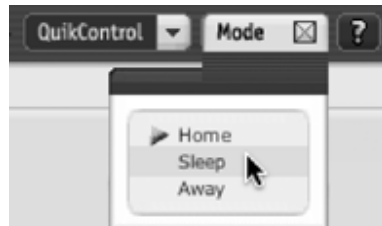

2. Select the mode in which you wish to put your iControl System by clicking on Home, Sleep, or Away. After choosing the mode, you will see a new window appear indicating when the change will take effect.

To change the mode from your Keychain Remote:

1. Press and hold the 'Lock' or 'Unlock' button on your Keychain Remote. You need to hold the button for one to two seconds until the LED flashes, indicating the command was sent. The change will take effect in a few moments. The range of the Keychain Remote is 100 feet, so you can use it within 100 feet of your iControl box.
2. By pressing the 'Lock' button, you can change to Away mode, and by pressing the 'Unlock' button you can change to Home mode, as shown in the following image:

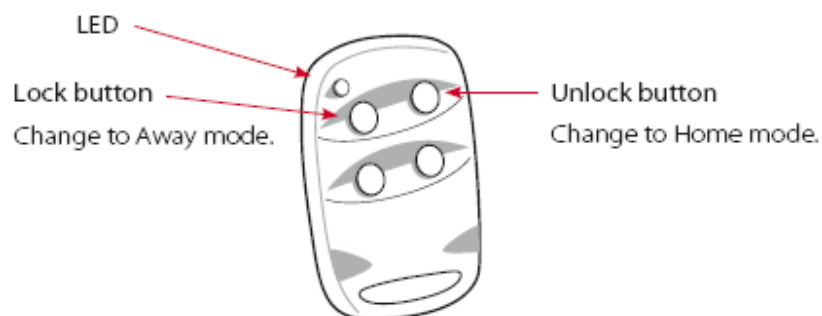

Note: For more information on how to change these default settings and use the other buttons on your Keychain Remote, see [Your Keychain Remote](#).

Updates Button

The Updates button  shows the latest changes you have made to your iControl System. The updates that are shown in this window are:

- Temperature, mode, and fan setting changes on any thermostats
- QuikControl commands to take a picture
- QuikControl commands to change the brightness level or turn on or off any lighting controlled by a Lamp module
- Changes to the System mode

The following screen shows examples of these updates.

1. Click on the QuikControl button.
2. Place your cursor over the device you wish to control to open the QuikControl window.
3. Select the change you want to occur such as 'Lamp Set Brightness Level' or 'Take a picture'.

Printed Documentation

4. Click the 'Close' button in the window. The iControl System automatically estimates how long it will take the change to occur. In this example, the change will take one minute or less.

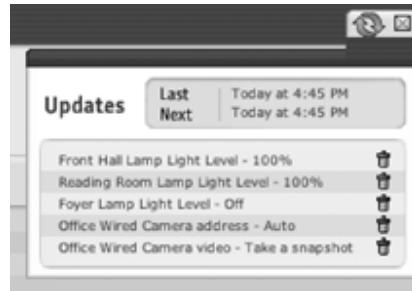

History

Your iControl History window records and reports all of the notifications generated; automations, schedules, and alarms triggered; pictures taken; and mode and device-status changes that occurred in the last 30 days (or the last hour, day, or week). The History window is context-sensitive, which means you will see different categories of information (e.g. Notifications, Pictures, etc.), depending on how you get there. Once there, you can change categories freely. Furthermore, in the All category, you can select to view only events pertaining to a single device.

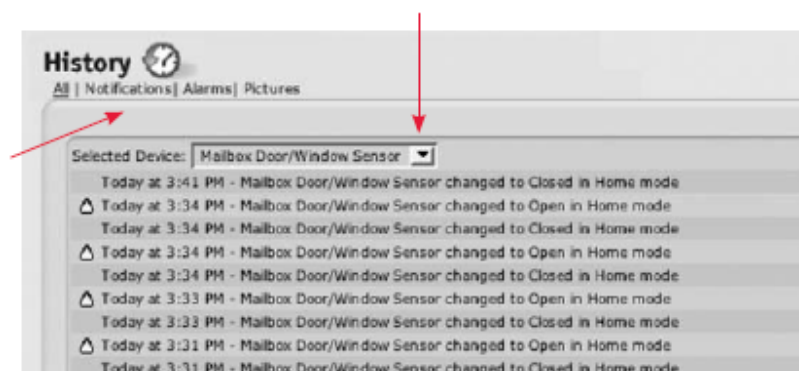

Click here to filter by device.

Click here to filter by category.

You can access the History window in a variety of ways.

From the Summary page, you can access the History window by clicking on:

- the 'History' button in the blue menu bar. When you access the History window in this way, you are presented with all notifications, automations, schedules, alarms, pictures, logins, and mode and device-state changes for the last day. Click on the right to see views from the last hour, 7 days, or 30 days.

Printed Documentation

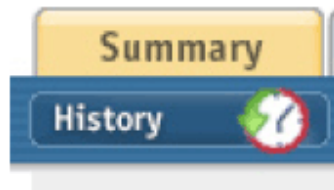

- a device listed in the Status or Alarm History windows. When you place your cursor over a device name (e.g. 'Door/Window Sensor'), a clickable link is revealed. Clicking on the link will take you to the History window with only events pertaining to that device presented.

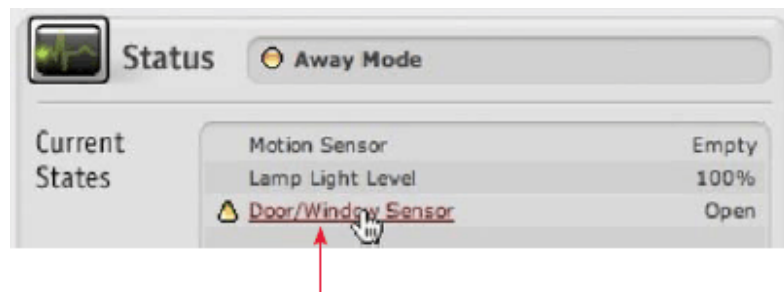

Click here to view only events pertaining to the Door/Window sensor.

- the Alarm History or Pictures icons. This will take you to the History window with either the Alarms or Pictures category selected.

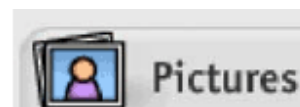
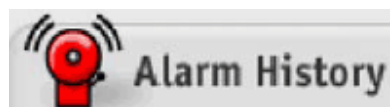

Clicking on the 'History' button from the Notifications, Automations, or Schedules windows will take you to the History window with the corresponding category selected.

Your iControl Devices

Your iControl Box

Your iControl Box

The appearance of your iControl box will vary, depending on when you purchased your iControl System. Please refer to the images below to determine which box your System uses. If you have a v1 iControl box, continue with [v1 iControl Box](#). If you have a v2 iControl box, skip to [v2 iControl Box](#).



v1 iControl box



v2 iControl box

Your iControl Box

The appearance of your iControl box will vary, depending on when you purchased your iControl System. Please refer to the images below to determine which box your System uses. If you have a v1 iControl box, continue with [v1 iControl Box](#). If you have a v2 iControl box, skip to [v2 iControl Box](#).

Printed Documentation



v1 iControl box



v2 iControl box

Your Camera

Your Camera

You can use your iControl Wired or Wireless camera to take pictures (images) or see live video from your location. Your iControl System provides you a number of ways to manually or automatically take pictures.

This section provides you guidance on how to:

- Setting up the camera(s) that came with your starter kit
- Add an iControl Wireless camera to your System
- Add an iControl Wired camera to your System
- Use your camera to take pictures manually or automatically
- Manage and send pictures taken with your camera

Note: If you wish to watch live video remotely from your location, you will need to configure your router for port forwarding.

Your Camera

You can use your iControl Wired or Wireless camera to take pictures (images) or see live video from your location. Your iControl System provides you a number of ways to manually or automatically take pictures.

This section provides you guidance on how to:

- Setting up the camera(s) that came with your starter kit
- Add an iControl Wireless camera to your System
- Add an iControl Wired camera to your System
- Use your camera to take pictures manually or automatically
- Manage and send pictures taken with your camera

Note: If you wish to watch live video remotely from your location, you will need to configure your router for port forwarding.

Setting Up the Camera(s) That Came with Your Starter Kit

Printed Documentation

When you log in to your personal web portal, the Setup Assistant will walk you through setting up each camera that came with your Starter Kit. Simply follow the steps in the Setup Assistant and you should be up and running in no time.

Determining Your Camera Type



iControl Wireless Camera

There are two different types of cameras available for use with the iControl System.

The wired camera will not have an antenna, and requires an ethernet connection to a local router/cable modem or similar device.

The wireless camera does have an external antenna (see image) and can use the wireless setting from the local router/cable modem or similar device.

Adding an Additional Camera to Your System

Information You'll Need

To begin setting up your additional camera, please have the following information from your router or similar device:

- IP Address to access your wireless router's administration page

- The username and password to log in to your router

- If you have a wireless camera you will also need:
 - Your wireless network's SSID. This is also sometimes called your network name.
 - Your wireless network's Security Mode. This is the type of encryption used by your wireless network.
 - Your encryption key, this is based on the security mode you're using and may be blank if you're using an open network.

Managing Your iControl Devices

iControl recommends using WPA encryption on your wireless network, which has been shown to be far more secure than WEP. For more information on wireless security and finding your wireless settings please see [About Your Wireless Settings](#).

Adding the Camera

Now you are ready to add your camera to your network. Follow these steps:

1. Go to the System Tab of your iControl Portal, and click the button labeled *Add Device*.
2. Choose 'IP Camera' from the drop down menu. The Camera Assistant will launch automatically to walk you through adding and configuring your camera.



3. Customize your system's Automations and Schedules to use your new camera.

Editing Your Camera's Settings

Printed Documentation

To edit your camera's settings, simply log in to your iControl Portal, click on the System tab, and choose the camera you wish to make changes to. Clicking edit will automatically launch a camera assistant, allowing you to:

- Rename your camera
- Edit your installation type, allowing you to choose between automatically assigned or manually assigned IP addresses and ports.
- Update the wireless settings if you have a wireless camera

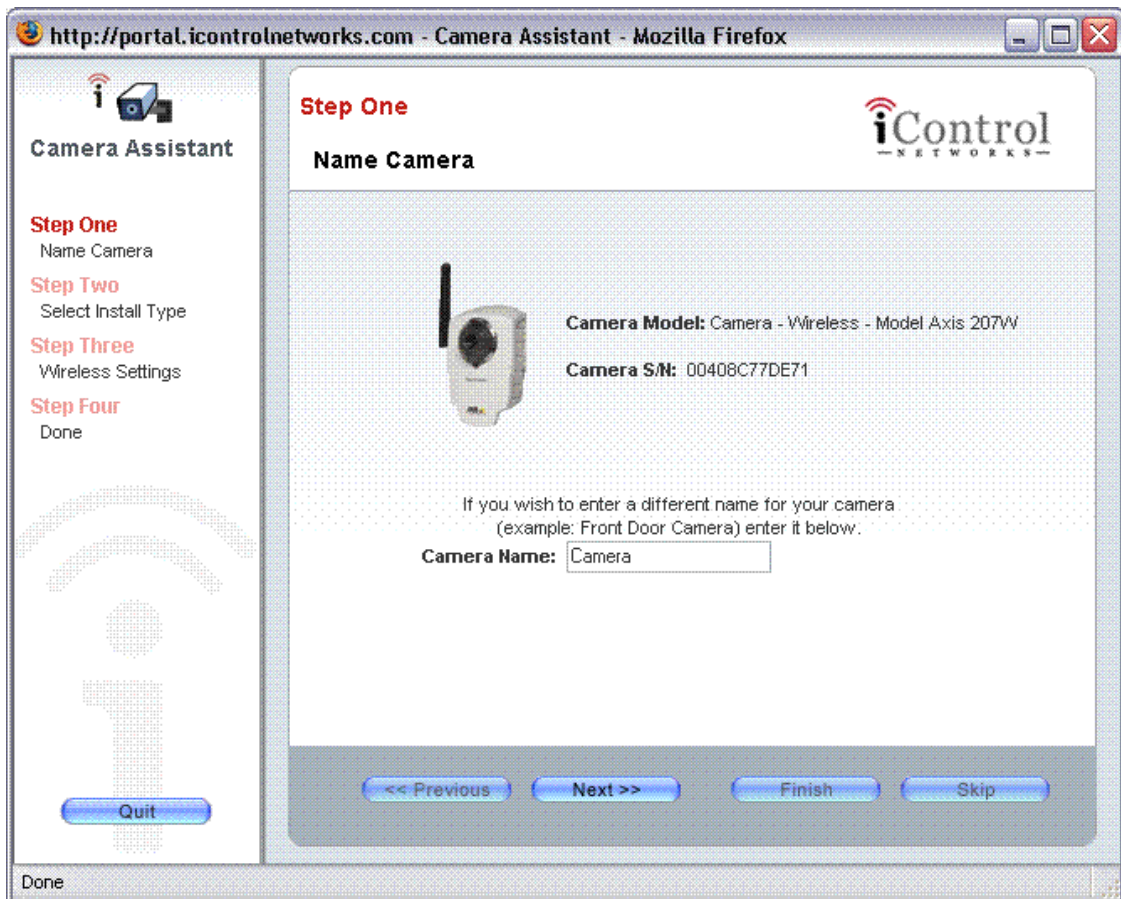

Taking Pictures Manually

You can take pictures manually using the 'QuikControl' button or the Pictures window on your Summary page. To take a picture using the QuikControl button, follow these steps:

1. Click on the 'QuikControl' button in the blue menu bar. You will see a drop-down menu displaying your camera(s), and lamp(s) (as shown).

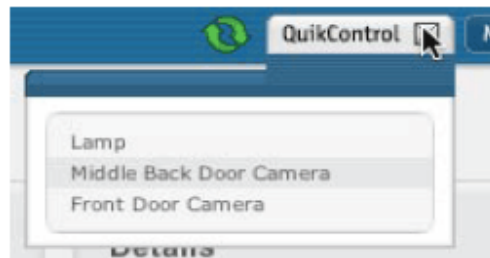

2. Select the camera you have chosen to take a picture. (In our example, the camera's name is 'Front Door Camera'.) You will then see the following window:



3. Click on the 'Take Picture' button in the QuikControl window. A window will appear telling you how long it will take for the System to take the picture (e.g., 'within a minute'). Click on the 'Close' button to close the window.

Printed Documentation

4. Refresh your browser after the time indicated. The new picture will appear in the Pictures window of your Summary page. If you click on it, you will see an expanded view of your picture.

You can also take pictures from the Pictures window of the Summary page. To do so, follow these steps:

1. Click on the Summary tab.
2. In the Pictures window, select a picture taken with the camera of your choice. A window will come up with an expanded version of the picture.
3. Click on the 'Take Picture' button to take a new picture. A window will appear telling you how long it will take for the System to take the picture (e.g., 'within a minute'). Click on the 'Close' button to close the window.
4. Refresh your browser after the time indicated. The new picture will appear in the Pictures window of your Summary page. If you click on it, you will see an expanded view of your picture.



Click here to take a picture.

Taking Pictures as Part of an Automation, Notification, or Schedule

A picture can be included with a notification as an email attachment. It will be the picture most recently taken by the selected camera. For more details on notifications, see [Notifications](#). You can have pictures taken automatically as part of an automation. For more details on automations, see [Automations](#).

You can schedule pictures to be taken automatically at different times of the day, on different days of the week, and in different modes. For more details on how to set up schedules, see [Schedules](#).

Sending Pictures

You can send pictures to anyone – friends, family, caregivers, business associates, etc. To do so, follow these steps:

1. Click on the Summary tab.
2. Click on the picture you wish to send by email. This will bring up an expanded view of the picture.
3. Click on the 'Email Picture' button at the bottom of the expanded window.

Printed Documentation



Click here to email the picture.

You will then see the Email Picture window in which you can compose your email.

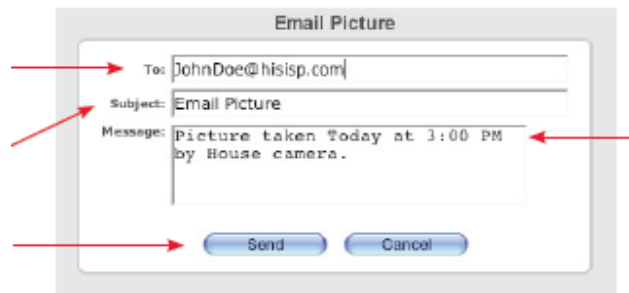

Type in one or more email addresses, separated by commas.

Enter a subject for the email in the Subject field.

Click here to email the picture.

A default message appears. You can edit it.

4. Click on the 'Send' button to send the email.

Deleting Pictures

To delete a picture, click on it in the Pictures window. You will now see an expanded view of the picture. Click on the 'Delete This Picture' button in the lower portion of the window as shown here:

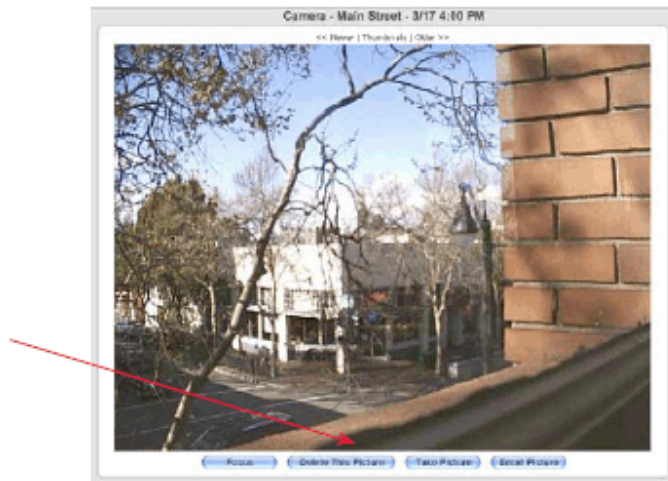

Click here to delete the picture

You can only delete one picture at a time. Note that you cannot delete the most recent picture taken by a camera.

Focusing Your Camera

To focus your camera, you will use its focus ring (the black ring encircling the lens) and the focus feature accessed via the Summary page or the System page. **To use the focus feature, you need to be at your location.**

From the Summary page,

1. Placing your cursor over a picture (without clicking) will bring up a small window showing the name of the camera that took the picture.

Printed Documentation



Click on any picture from the camera you want to focus. This will bring up an expanded view of the picture.



Click here to bring up a window displaying what your camera sees.

2. Click on the 'Focus' button in the lower portion of the window. This will open the 'Main Street Camera Focus Utility' window:

Managing Your iControl Devices



Click here to see real time images from your camera.

3. Go to your camera and gently turn the focus ring (shown in the following illustration) until the image is in focus. Do NOT over twist the focus ring. Your System will immediately update this window so you can quickly see how each adjustment improves the image.

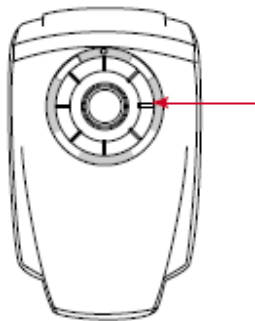

Focus ring: This black ring encircles the camera lens.

Turning the ring clockwise focuses the camera on objects further away and turning the ring counterclockwise focuses the camera on nearer objects. Do not over twist the focus ring.

4. Continue to adjust the focus ring until you find the image satisfactory.
5. When you're done, click the 'Close' button.

Printed Documentation

From your System page,

1. Click on the name of the camera you wish to focus. The following window will appear:

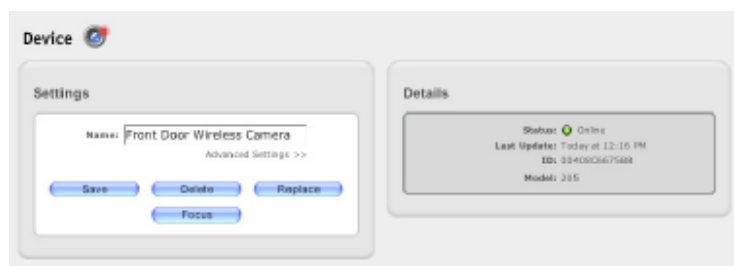

2. Click on the 'Focus' button. This will open the 'Main Street Camera Focus Utility' window:



Click here to see real time images from your camera.

Managing Your iControl Devices

3. Go to your camera and use the camera's focus ring to sharpen the image. Your System will immediately update this window so you can quickly see how each adjustment improves the image.
4. Continue to adjust the focus ring until you find the image satisfactory.
5. When you're done, click the 'Close' button.

Note: You can only access the Camera Focus Utility when you are on the same network as your iControl box. You cannot access it when you are away from your iControl box location, such as on the road or at work.

Managing Pictures

You iControl service enables you to retain all the pictures taken by each of your cameras for up to 30 days. You can use the pictures in many ways--to capture activities of family to share with others, to show friends your home or vacation house, to document the arrival of service workers, or to show your staff the conditions in a store or office. To see your archived pictures, follow these steps:

1. Go to your Summary page.
2. Click on any picture in the Pictures window to bring up an expanded view of the picture (as shown). Click on 'Older' to see a less recent picture, 'Newer' to see a more recent picture, or 'Thumbnails' to see archived pictures.

Printed Documentation

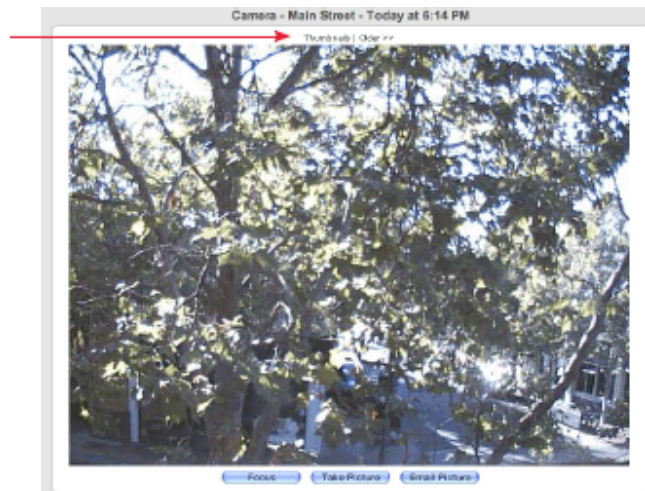

Click on 'Thumbnail' to see archived pictures from this camera.

3. Click on 'Thumbnail' to view your archived pictures from this camera. Click on 'Newer' or 'Older' to navigate through the thumbnail screens. You can also click on any thumbnail to see an expanded view of that picture.

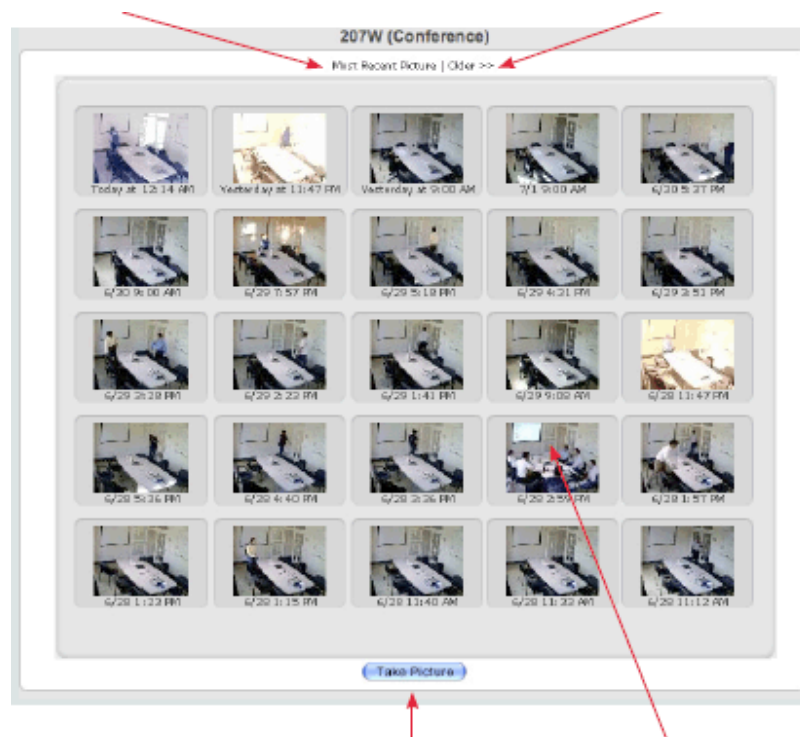

Click here to see an expanded view of the most recent picture.

Click here to see more archived pictures.

Managing Your iControl Devices

[Click here to take a picture .](#)

[Click on a thumbnail to see an expanded view of that picture.](#)

The iControl Service archives pictures for up to 30 days. To preserve a picture longer than 30 days, use your browser's commands to save it to your hard drive. In Windows, right-click the picture to bring up a menu which includes a 'Save Image' option. On a Macintosh, control-click the image to bring up the menu.

About Your Wireless Settings

Wireless Security

iControl supports 3 types of wireless security: Open, WEP and WPA.

An **OPEN** wireless network means that there is no security on it at all. This means that anyone with an 802.11 wireless enabled device may be able to connect to your home network. By default most home routers are set to OPEN wireless.

WEP encryption uses a HEX key (all numbers 0-9 and/or letters a-f only) in order to encrypt the traffic on your wireless network. While it does offer more protection than OPEN, WEP has been shown to be easily broken, and is therefore not considered very secure.

There are several types of **WPA** security. WPA and WPA2 Encryption are both supported by iControl Cameras, but only if you're using the "personal" mode. While terminology may differ from router to router, iControl will support both methods using the shared passphrase, or PSK. Radius servers or enterprise mode are not supported by iControl.

Finding your Wireless Settings

To find your wireless settings, including your SSID, Security Mode, and encryption key, follow these steps:

1. Go to a browser and enter the router's IP address (usually in the form of 192.168.1.1 or 192.168.0.1). Consult your router's manual for the router's IP address.

Printed Documentation

2. To log in to your router to find the SSID, Security mode, and encryption key, you will need the router's username and password. Check your router's manual, as you may have recorded the username and password there. Or, you may have used the default username and password provided in the router's manual. Some manufacturers use admin as the default username or password and leave the other item blank.
3. Obtain the WEP key and Security mode for your network. Here is an example of a page from a Linksys wireless router showing the information you need to gather. Consult your router manual for more details on how to access this information within the router's setup pages.

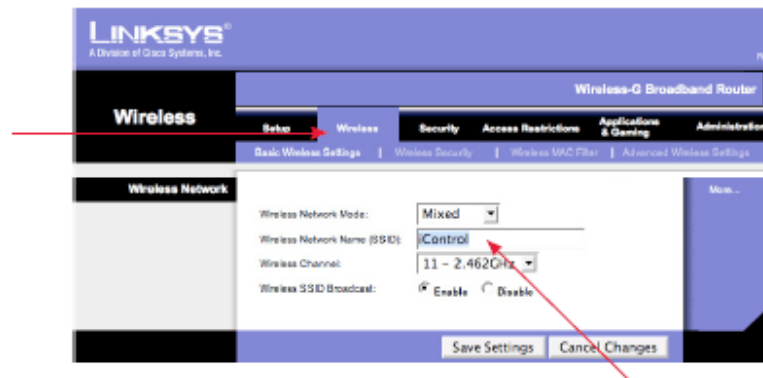

Click here to find your SSID.

SSID here is "Control". As a home user, you may have created a name. Consult your IT person for the SSID in a business.

4. While still in your router's administration pages, access your SSID.

Managing Your iControl Devices

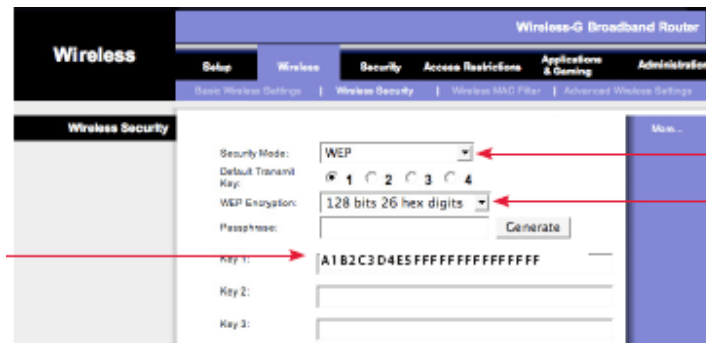

Here is the WEP key that you will need to record and use.

Here is the Security mode you will need to record and use.

Your Carbon Monoxide Detector

Installing Your Carbon Monoxide Detector

To install your Carbon Monoxide detector, follow these steps:

From the Summary page,

1. Click on the System tab.
2. Click on the 'Add Device' button  to open the Add Device window.

Printed Documentation

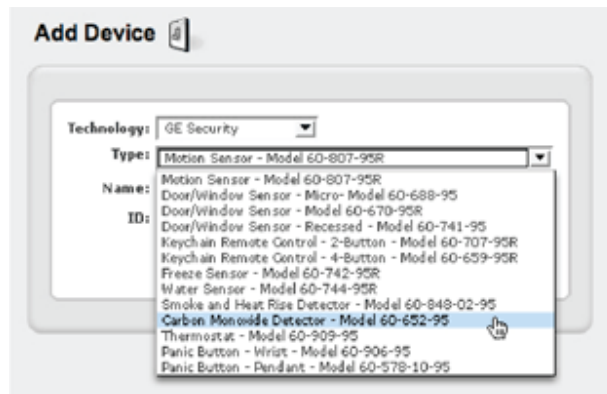

3. Choose the technology for the device ('GE Security').
4. Choose the device type ('Carbon Monoxide Detector – Model 60-652-95').
5. Create a name for the device such as 'Basement CO'.
6. Enter the six-digit ID number of the device (e.g., '045CD8'). The ID is found on the back of the Carbon Monoxide detector. It is a combination of six letters and numbers, preceded by the letters 'DL'. (You can enter the letters in lower- or upper-case.) Do not enter the letters 'DL' or use the letters and numbers next to the letters 'TX'.

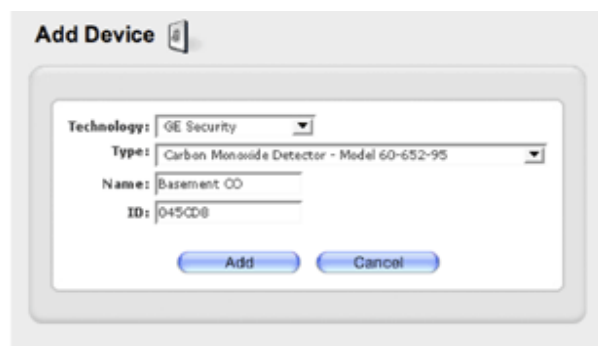

Managing Your iControl Devices

7. Click on the 'Add' button. You will be returned to the System window and your newly-added CO detector will appear in the list of devices.
8. Next, physically install the device by simply plugging the sensor in to any wall outlet. Once installed, the green Power LED comes on immediately. If it does not, check that the outlet is not controlled by a wall switch—iControl recommends using an outlet not controlled by a wall switch, as this may result in the device being inadvertently turned off.

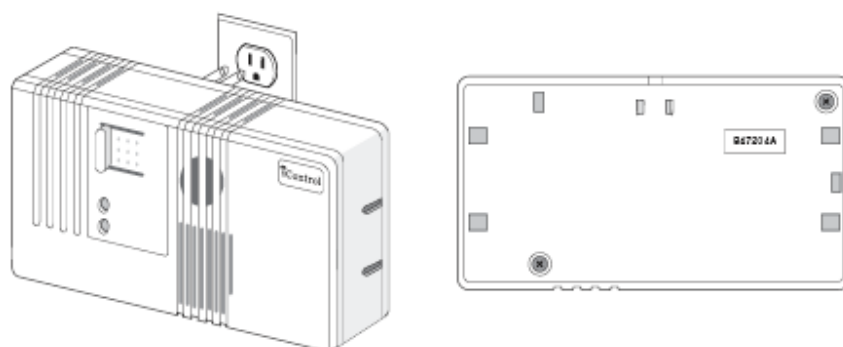

The iControl box discovers the CO detector within about 70 minutes of its initial installation. As soon as your System 'sees' your Carbon Monoxide detector, the yellow dot adjacent to its name on your System page will turn green. If the yellow dot next to the name of the alarm does not turn green, repeat the installation process, making sure to enter the correct device type and ID.

After installation, test the device by pressing the 'Test/Reset' button. The device should chirp loudly and the red LED should flash red. You should also see an alarm in the Alarm History window on your Summary page.

Note: The CO detector should not be used as a smoke or fire detector and is not suitable for installation in hazardous locations, as defined by public building codes.

To operate properly, a CO detector needs to be placed with the following considerations in mind:

- Place within 100 feet of your iControl box.

Printed Documentation

- The CO detector is for indoor use only.
- Do not install the device above or below heating vents, above cooking surfaces, or within five feet of open flames; next to windows, exterior doors, or in locations where furniture or draperies may block the unit; or near automobile exhaust pipes.
- The device only measures the carbon monoxide levels at its installed location. Dangerous gas levels could still be present in other areas.

Using Your Carbon Monoxide Detector

Once you have installed a Carbon Monoxide detector in your location, it will appear on the Summary page of your personal web portal. The status of your CO detector in the Current States area of your Status window will be either 'OK' or 'Alarm'.

When CO rises to dangerous levels, the CO detector will sound in your location and you will see 'Alarm' and a yellow alarm-condition triangle beside the device in the Current States area of your Status window, as well as an alarm in the Alarm History window.

Note: If the reset button is pressed within 15 seconds of the initial alarm, the CO detector will not transmit the alarm signal to the iControl box.

You can have a notification sent to you when the alarm triggers. For details on how to add a notification, see [Notifications](#).

See **Frequently Asked Questions** for important details on your Carbon Monoxide detector.

Your Door/Window Sensor

Installing your Door/Window Sensor

If your iControl Starter Kit includes a Door/Window sensor, it is pre-configured for your System at the factory; you may skip to the instructions in the next section on how to mount your sensor.

You only need to add a Door/Window sensor to your System if you buy additional sensors or want to add back a Door/Window sensor you have deleted from the System.

You can install your Door/Window sensor in moments. The following steps explain how to add a sensor to your System.

1. Click on the System tab.
2. Click on the 'Add Device' button  to open the Add Device window.

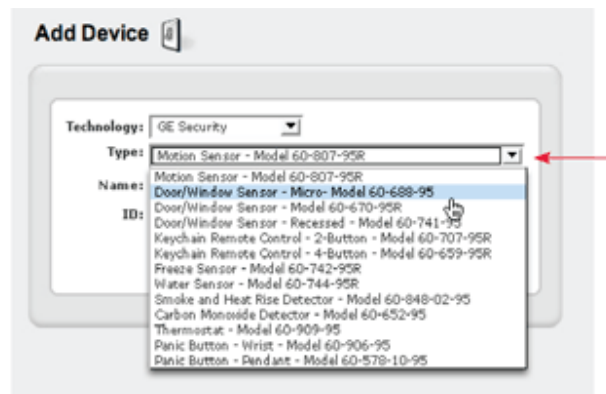

Click on the dropdown arrow in the Type window and choose the desired Door/Window Sensor.

3. Choose the technology for the device ('GE Security').

Printed Documentation

4. Choose the device type ('Door/Window Sensor – Micro— Model 60-688-95', 'Door/Window Sensor – Model 60-670-95R', or 'Door/Window Sensor – Recessed— Model 60-741-95').
5. Create a name for the device such as 'Front Door Sensor'.
6. Enter the six-digit ID number of the device (e.g., '69FAA6'). The ID is found on the back of the Door/Window sensor. It is a combination of six letters and numbers, preceded by the letters 'DL'. (You can enter the letters in lower- or upper-case.) Do not enter the letters 'DL' or use the letters and number next to the letters 'TX'.

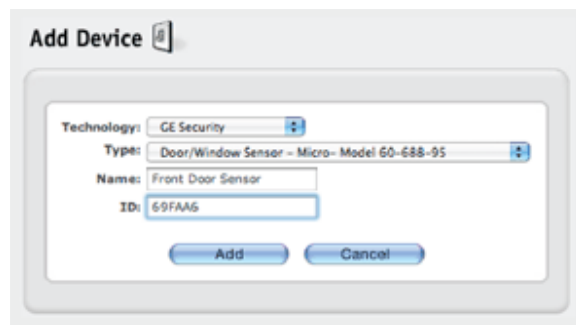

The screenshot shows a dialog box titled "Add Device" with a help icon. It contains the following fields and values:

- Technology: GE Security
- Type: Door/Window Sensor - Micro- Model 60-688-95
- Name: Front Door Sensor
- ID: 69FAA6

At the bottom of the dialog are two buttons: "Add" and "Cancel".

7. Click on the 'Add' button. You will be returned to the System window and your newly-added sensor will appear in the list of devices.

Checking Installation of Your Door/Window Sensor

After mounting your Door/Window sensor, go back to your computer, click on the System tab, and check to see if a green dot appears next to the name of the Door/Window sensor.

Once the sensor is added to your System and mounted, the iControl box will discover it

Managing Your iControl Devices

within about 70 minutes. If you want to activate it more quickly, open and close the door or window once. You do not have to press any buttons on the iControl box to install the sensor; the iControl System installs it automatically.

Using Your Door/Window Sensor

You can check the status of your Door/Window sensor in the Status window or the Alarm History window on your iControl Summary page.

The Status window lists the current states of all devices installed in your iControl System. In the following illustration, the Door/Window sensor is named 'Mailbox Door/Window Sensor'. Its current state is 'Open'. This Door/Window sensor recognizes that the Mailbox Door is open. A Door/Window sensor has two states: 'Open' and 'Closed'. When it is open, there is a yellow triangle 🚩 to the left of its name, indicating an alarm condition.

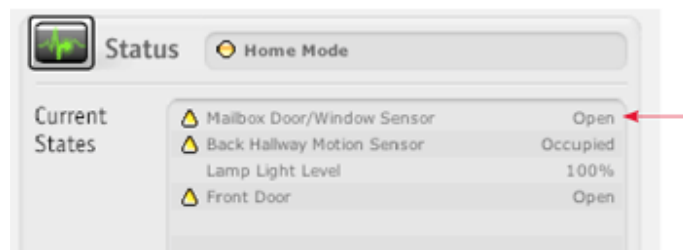

Mailbox Door/Window Sensor open

The Alarm History window displays the status of a device if the device generated a recent alarm. The following illustration shows the Alarm History window after the Mailbox has been opened a few times. You now have a record of when the Mailbox was opened. If you set up an automation to take a picture when the Mailbox is opened, the iControl System will provide you a picture of who opened the Mailbox.

Printed Documentation

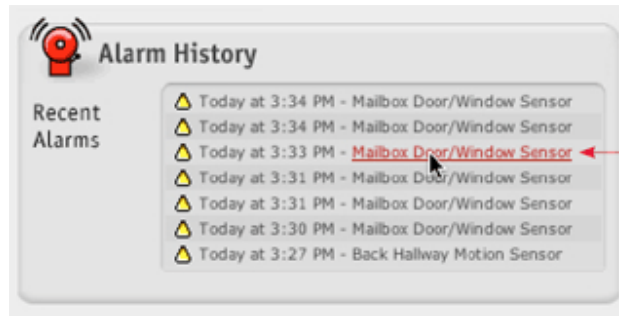

Click here to see additional information about the alarm.

Your Freeze Sensor

Mounting Your Freeze Sensor

Next, physically install the device. You can install your Freeze sensor with either double-stick tape or screws. If you are using screws, you will need to remove the cover, screw the Freeze sensor base to a surface, and then replace the cover.

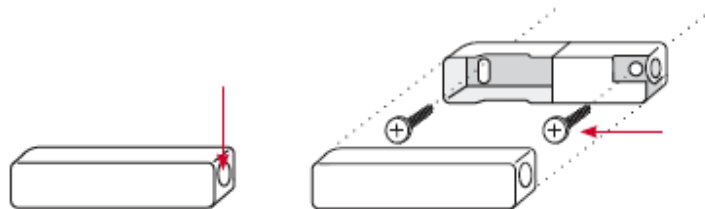

Press here to open

Mount using screws

Note: To operate properly, your Freeze sensor needs to be placed with the following considerations in mind:

- Place it within 100 feet of your iControl box.

Managing Your iControl Devices

- Place it in an area likely to get cold before any other area in the building, to ensure early warning.
- Mount it on an interior wall where there is free air movement and not on an outside wall or near a basement floor.

- Do not place the sensor in the same room as a furnace, water heater, or any other heat source that may stay warm after the heating fails.

- Keep away from areas with extensive metal or electrical wiring that may prevent sensor signals from reaching your iControl box and areas where it may be exposed to moisture.

Once the sensor is added to your System and installed, the iControl box will discover it within about 70 minutes. As soon as your System ‘sees’ your Freeze sensor, the yellow dot adjacent to its name on your System page will turn green, indicating that your sensor is activated. If you want to activate the sensor more quickly, apply ice to it so that its temperature drops to 41°. Note that it will take some time for the sensor to cool to 41° (even with direct contact with ice).

Your Keychain Remote

Your Keychain Remote

Your iControl Keychain Remote is a useful tool that allows you to control various device actions, such as turning on lights, changing the System mode from Away to Home as you approach the house, or changing the System mode from Home to Away as you drive off to work.

Printed Documentation

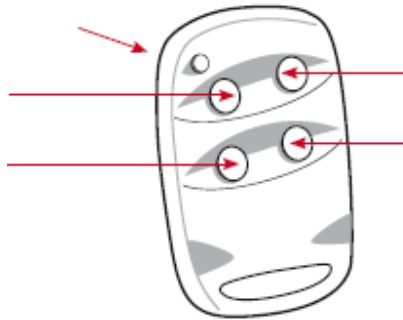

Keychain Remote LED.

Lock button.

Change to Away mode.

Light button.

Press once to toggle a light controlled by an iControl Lamp module.

Unlock button.

Change to Home mode.

Star button.

Press once to take a picture from your iControl camera.

The Keychain Remote also comes in a two-button version, with only Lock and Unlock buttons.

Note: The buttons on your Keychain Remote are pre-configured with the functionality described in the figure above. Each button allows you to change a System mode or change a device state. All buttons are configurable through your iControl personal web portal.

Your Keychain Remote

Your iControl Keychain Remote is a useful tool that allows you to control various device actions, such as turning on lights, changing the System mode from Away to Home as you approach the house, or changing the System mode from Home to Away as you drive off to work.

Managing Your iControl Devices

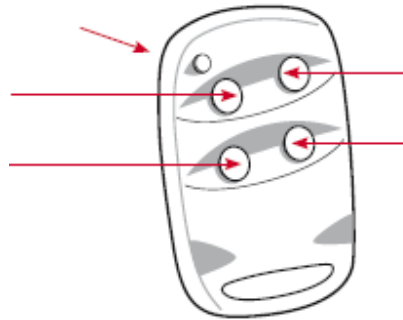

Keychain Remote LED.

Lock button.

Change to Away mode.

Light button.

Press once to toggle a light controlled by an iControl Lamp module.

Unlock button.

Change to Home mode.

Star button.

Press once to take a picture from your iControl camera.

The Keychain Remote also comes in a two-button version, with only Lock and Unlock buttons.

Note: The buttons on your Keychain Remote are pre-configured with the functionality described in the figure above. Each button allows you to change a System mode or change a device state. All buttons are configurable through your iControl personal web portal.

Modifying The Actions of Your Keychain Remote Buttons

Your Keychain Remote buttons have the following default settings:

Both Keychain Remotes:

- Lock button: Put System in Away Mode.
- Unlock button: Put System in Home Mode.

Printed Documentation

For the 4-button Keychain Remote:

- Light button: Toggle a Lamp module.
- Star button: Take a picture.

You can modify the actions of your Keychain Remote buttons. Let's say you have a Keychain Remote named 'Mom's Keychain Remote'. Mom wants the Star button – instead of taking a picture – to put the System into Sleep mode.

To modify the action of the Keychain Remote Star button:

1. Click on the Automations tab to open the Automations window (as shown).



Each button on Moms Keychain Remote appears here with its setting.

Note: Because the Light button toggles, it has two settings associated with it: Keychain Remote Lamp On and Keychain Remote Lamp Off.

Managing Your iControl Devices

2. Click on the pencil icon to the right of 'Mom's Keychain Remote Star Button'. This will bring up the Edit Automation window.

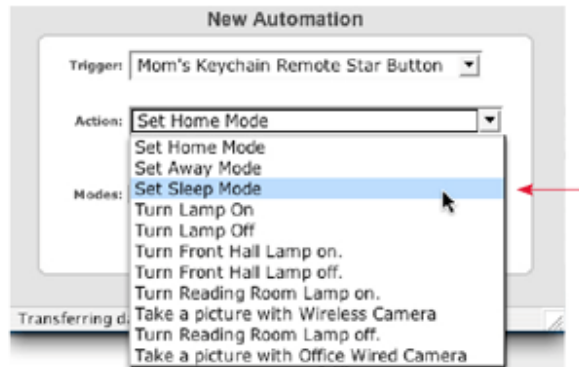

Click on the down arrow, and select an action.

3. Click on the Action drop-down menu to choose a new action – 'Set Sleep Mode' in this example.

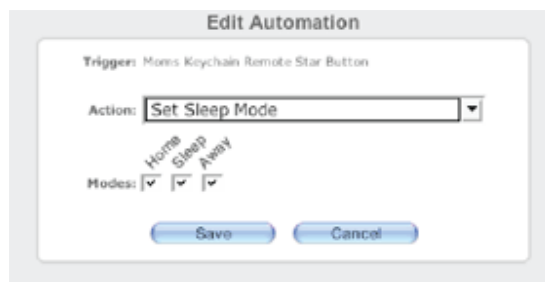

4. Select the mode(s) in which you want the Keychain Remote to switch your System into Sleep mode – all modes, in this example. When someone presses Mom's Keychain Remote Star button, the System will automatically switch into Sleep Mode, regardless of whether the System is in Home, Sleep, or Away mode.
5. Click on the 'Save' button to save the change.

Printed Documentation

You can always refer to your History window to see which Keychain Remote buttons were pressed, what mode the System was in, and what mode the System was changed to. Click on the 'History' button in the blue menu bar to bring up the History window, then click on the Mode Changes category.

Your History window shows that the System switched from Home into Sleep mode when the Star button was pressed. When the System was already in Sleep mode, pressing the Star button had no effect:



Nothing changes if you try to change to Sleep mode when the System is already in Sleep mode.

Note: You can set any button on your Keychain Remote to perform multiple actions. For example, you can set your Star button to both take a picture and turn on a light in the house. Here's an example of when pressing the Star button causes two actions.



Here, pressing the Star button will take a picture and turn on a light.

Your Lamp Module

Your Lamp Module

Managing Your iControl Devices

Your iControl Lamp module provides a convenient automated lighting solution for your home or business. A lamp can be turned on or off from your Keychain Remote, your personal web portal, via automation, or with a schedule. For example, you can have lights turn on or off based on room occupancy, motion, or time of use. You can schedule the lights controlled by a Lamp module to come on and off, depending on the time of the day and day of the week. You can even set the brightness of your lamp so the Lamp module can also serve as a dimmer.

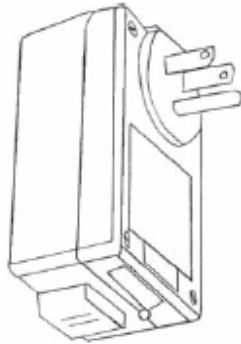

Powerline Lamp Module



Z-Wave Lamp Module

Your Lamp Module

Your iControl Lamp module provides a convenient automated lighting solution for your home or business. A lamp can be turned on or off from your Keychain Remote, your personal web portal, via automation, or with a schedule. For example, you can have lights turn on or off based on room occupancy, motion, or time of use. You can schedule the lights controlled by a Lamp module to come on and off, depending on the time of the day and day of the week. You can even set the brightness of your lamp so the Lamp module can also serve as a dimmer.

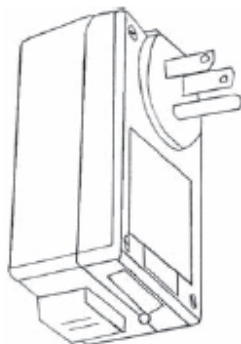

Powerline Lamp Module



Z-Wave Lamp Module

Printed Documentation

Installing Your Lamp Module

Installing Your Lamp Module

The Lamp module is easy to install. If your iControl Starter Kit includes a Lamp module, it is preconfigured for your System at the factory; you may skip to the instructions in the next section on how to physically install your module.

Installing Your Lamp Module

The Lamp module is easy to install. If your iControl Starter Kit includes a Lamp module, it is preconfigured for your System at the factory; you may skip to the instructions in the next section on how to physically install your module.

Installing Your Powerline Lamp Module

To install a Powerline Lamp module, follow these steps:

1. Click on the System tab of your personal web portal.
2. Click on the 'Add Device' button to open the Add Device window.



Managing Your iControl Devices

Click on the dropdown arrow in the Technology window and choose 'LonWorks Powerline'.

3. Choose the technology for the device ('LonWorks Powerline').
4. Choose the device type. Only one device is available ('Lamp Module Model 6101-0000').
5. Create a name for the device such as 'Reading Room Light'.
6. Enter the 12-digit ID number of the device (e.g., '006035019f63'). The ID, found on the bottom of the Lamp module, is a combination of twelve letters and numbers preceded by the words "Neuron ID". (You can enter the letters in lower- or upper-case.) Do NOT enter the colons separating the pairs of numbers or letters.

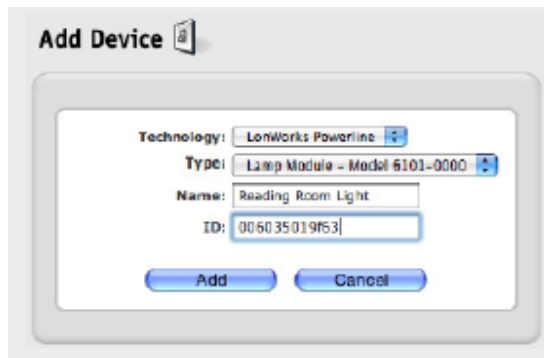

The screenshot shows a dialog box titled "Add Device". It contains the following fields and values:

- Technology: LonWorks Powerline
- Type: Lamp Module - Model 6101-0000
- Name: Reading Room Light
- ID: 006035019f63

At the bottom of the dialog are two buttons: "Add" and "Cancel".

7. Click on the 'Add' button. You will be returned to the System window and your newly-added module will appear in the list of devices.

Installing Your Z-Wave Lamp Module

To install a Z-Wave Lamp module, follow these steps:

1. Click on the System tab of your personal web portal.
2. Click on the Add Device button to open the Add Device window.
3. Choose the technology for the device (Z-Wave).
4. Click the Launch Assistant button and follow the directions to complete the installation of your Z-Wave Lamp module.

Troubleshooting Tips for Installing Your Z-Wave Lamp Module

Initial installation of the Z-Wave Lamp Module is done in a low powered mode. Because of this, the iControl Box may have trouble locating the Z-Wave device. If you're experiencing this difficulty please try the following steps:

1. Confirm that the Z-Wave Lamp Module you're trying to install is within two to three feet of the iControl Box. After initial installation is complete, the Lamp Module May be moved to its final location.
2. Try changing the orientation of the iControl Box. This can mean turning the iControl Box on its side, or moving it lower or higher in relation to the Z-Wave Lamp Module. Z-Wave is an RF frequency so imagine that you're moving an antenna to improve reception.

3. Be sure that the Z-Wave Lamp Module has not been associated with another iControl System. Once installed, Z-Wave modules can't be moved between systems.

Physical Installation of Your Lamp Module

Next, physically install your Lamp module. Lamp modules are suited to controlling only indoor lamps and light fixtures using between 40- and 300-watt incandescent light bulbs. They do not operate properly with fluorescent light bulbs. To install your Lamp module, follow these steps:

1. Choose the light you wish to control (one light per module).
2. Plug in the Lamp module.
3. Plug the power cord from the light into the Lamp module (as shown).

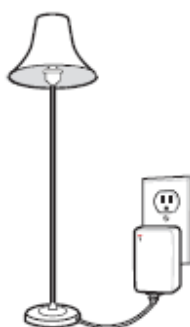

Note: To operate properly, a Lamp module needs to be placed with the following considerations in mind:

Printed Documentation

- Install it within 100 feet of the iControl box.
- Powerline Lamp modules DO NOT work if plugged into power strips equipped with a surge protector or uninterruptible power supplies.
- If a wall switch controls the power outlet, the wall switch must be turned on and left in the On position.
- The Lamp module is not recommended for 3-way lights or lights controlled by 3-way wall switches.

Setting the Brightness of Lighting

You can set the brightness of your lighting, using the Lamp module as a dimmer. To do so, follow these steps:

1. From your iControl Summary page, either click on the current level of the Lamp module you want to set in the Current States area of the Status window or select the Lamp module you want to adjust from the QuikControl menu. This will bring up the QuikControl menu for that Lamp module.

Managing Your iControl Devices



Place your cursor over the 100% and click on it.

2. Click on the down arrow, and choose the desired brightness level (e.g., 50%) from the list.

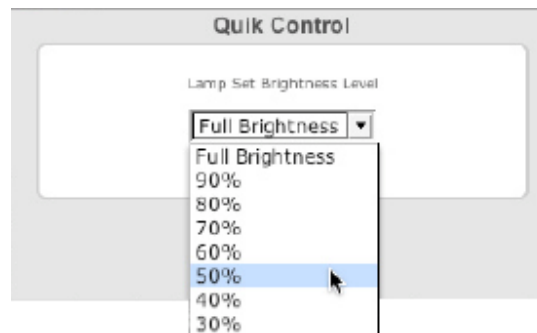

3. Click on the 'Set' button to save the change.

Adding Your Keychain Remote

Printed Documentation

You can control your Lamp module in five ways:

- with your Keychain Remote (such as pressing the Light button as you approach your location or while in your location)
- via your personal web portal (where you can use QuikControl to turn on or off lights and set brightness levels)
- from your mobile portal (where you can turn on or off lights and set brightness levels)
- with an automation (such as automatically turning on the lights when the Door/Window sensor indicates 'Open')
- with a schedule (turning lights on or off at particular times, randomly, or on a repeating basis.)

To control the Lamp module from your Keychain Remote:

Press the Light button to toggle the state of a light controlled by a Lamp module. Pressing the Light button on the Keychain Remote alternately sends 'Light Button On' and 'Light Button Off' signals to your iControl System. So if you use the Keychain Remote Light button to turn your lights on, then the next signal the Keychain Remote Light button will send is 'Light Button Off'. However, you may not experience the desired result. If, for example – after turning the lights on with the Keychain Remote Light button – you turn the lights off manually, using QuikControl, or with an automation or schedule, then pressing the Keychain Remote Light button will send the 'Light Button Off' signal and no change will occur. Pressing the Light button a second time will send the 'Light Button On' signal, and the lights will turn on.

A 'Light Button On' signal will always turn (or leave) the lights on to full brightness and a 'Light Button Off' signal will always turn (or leave) the lights off, irrespective of the brightness level of the lamp when the signal is received.

Note: The Keychain Remote that comes with your Starter Kit is pre-configured to control

Managing Your iControl Devices

the Lamp module in the kit. If you purchase additional Lamp modules or Keychain Remotes, you will need to add an automation to enable the Keychain Remote to turn on or off existing or newly-purchased Lamp modules.

To control the Lamp module from your personal web portal:

1. Click on the 'QuikControl' button in the blue menu bar.
2. From the QuikControl drop-down menu, select the appropriate Lamp module.
3. In the 'Set Brightness Level' drop-down menu, select the desired brightness (e.g., 50%).
4. Click on the 'Set' button to save the change. The new light level will take effect in a few seconds, after the iControl System has received the requested change.

To learn how to control the Lamp module via a schedule, see [Schedules](#). To learn how to control the Lamp module via an automation, see [Automations](#).

To check the status of your Lamp module:

- Click on the Summary tab.
- In the Current States area of your Status window, scroll down the list to locate your Lamp module. You will see the brightness level of the Lamp module to the right of its name. Note that you can adjust this level by clicking on it.

Your Motion Sensor

Your Motion Sensor

Your iControl Motion sensor detects movement within a specific area by sensing the infrared energy emitted from a body as it moves across the sensor's field of view. When motion is detected, the sensor transmits an alarm signal to your iControl box, which in turn communicates with the iControl servers, and then the alarm appears in your personal web portal.

Your Motion Sensor

Your iControl Motion sensor detects movement within a specific area by sensing the infrared energy emitted from a body as it moves across the sensor's field of view. When motion is detected, the sensor transmits an alarm signal to your iControl box, which in turn communicates with the iControl servers, and then the alarm appears in your personal web portal.

Mounting your Motion Sensor

Now you can physically install your Motion sensor. Generally, your Motion sensor must be inclinemounted in a corner 7.5 feet high, aiming at the target area (as shown).

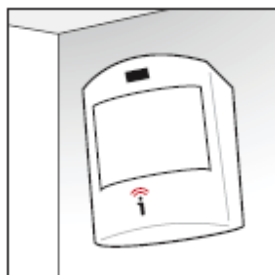

To operate properly, your Motion sensor needs to be placed with the following considerations in mind:

Managing Your iControl Devices

- Install it only in an indoor space.
- The sensor can monitor an area approximately 35 feet long by 40 feet wide or about 1200 square feet.
- Mount the sensor so it 'sees' the area to be monitored. It is best to mount it approximately 7.5 feet high on a wall.
- Mount the sensor on a rigid, interior wall or rigid, insulated outside wall, facing in.
- Place the sensor within 100 feet of your iControl box.
- Windows in monitored area should be closed, as the device can sense motion outside.
- Children and pets over 40 lbs. can trigger the sensor, if they climb on furniture or other objects in the monitored area. Children and pets under 40 lbs. may not be detected by the sensor.
- Do not aim the sensor at windows, fireplaces, air conditioners, heaters, or forced-air heating vents.
- Do not place the sensor in direct sunlight.
- Do not mount the sensor near metal ductwork or other large metallic surfaces that may interfere with signals from the sensor.

Printed Documentation

To mount your Motion sensor, you will need the screws that come with the sensor, a pencil, a ruler, a drill, and a screwdriver. The following diagrams show the sequence of the installation process:

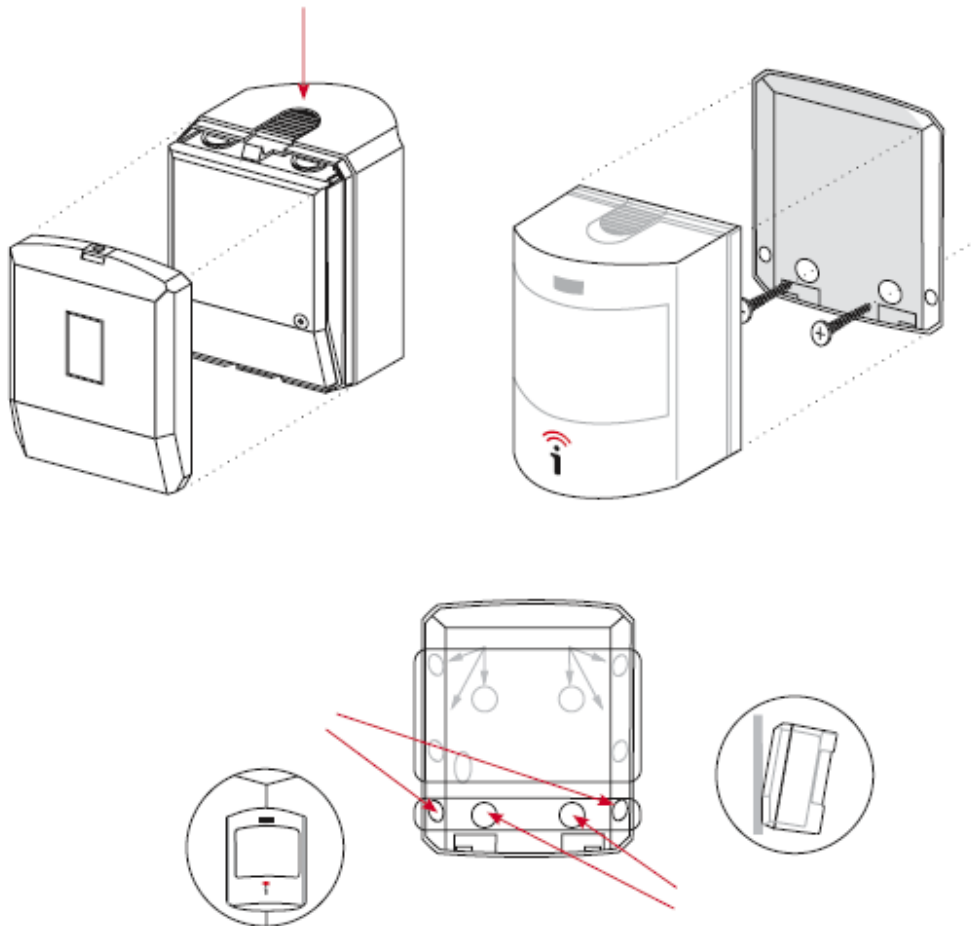

Press Down Here to detach back. Optional screw. Unscrew if present.

Mount Motion sensor back to wall with 3/4" long screw and wall anchors. Snap the sensor body onto back.

For corner mount, drill here.

For wall mount, drill here.

When a Motion sensor is first installed, the sensor does an automatic test, and the LED found on the upper front of the sensor turns red for five to ten seconds. The Motion sensor requires an additional 60 seconds when there is no motion in the monitored area to complete its test. This is the only time the LED turns red during normal operation. The

LED does NOT turn on whenever it detects people coming and leaving the area.

Using Your Motion Sensor

To check the status of your Motion sensor, click on your Summary tab. In the Current States area of your Status Window, locate your Motion sensor. The status of your Motion sensor is either 'Occupied' or 'Empty'. The term 'Occupied' means that the Motion sensor has detected a person moving in the area that it monitors and a yellow alarm-condition triangle appears next to the sensor's name. The term 'Empty' means that it has NOT detected a person moving in the area that it monitors in the last five minutes.

If a person enters a monitored area, the Motion sensor recognizes the change within two to three seconds and reports that the area is occupied through your iControl System, which in turn displays 'Occupied' next to the sensor's name on your iControl Summary page within 30 seconds.

If a person leaves the monitored area, the Motion sensor 'waits' about five minutes before reporting that the area is 'Empty'. This delay allows the Motion sensor to confirm that the person has left the room, and also prevents unnecessary multiple 'Occupied' event alarms. If a person does not move, the Motion sensor can report that the area is 'Empty'. The yellow alarm-status triangle next to the sensor's name in the Current States area of the Status window disappears when the status changes to 'Empty'.

You can use your Motion sensor as part of any automation. When the Motion sensor detects a room is occupied, the iControl System can change modes, take a picture, or turn lights on or off. Here are two examples:

- When someone arrives at a home or office (where the Motion sensor monitors the area the
- If a person comes to a front door or a particular room (where there is a Motion sensor and a light), the iControl System can have a light come on when the Motion Sensor detects that person.

For details on how to create automations, see [Automations](#).

You can also use your Motion sensor with notifications. Here are a couple of examples:

Printed Documentation

- Add a Custom notification such that when a Motion sensor detects movement, an email or SMS message is sent to one or more people.
- Add an iWatch notification such that if the Motion sensor remains in the 'Empty' state, a notification is sent. You may have a store that should open at 9AM, and if no one is present inside the store to manage it, you can receive a notification with a custom message that alerts you that the store is not staffed.

For details on how to create notifications, see [Notifications](#).

Your Panic Pendant

Your Panic Pendant

The Panic pendant is a water-resistant, wireless, battery-powered device used for communicating immediately with family members, caregivers, or anyone else when the person wearing the device presses the Panic button. The Notify Lists feature found on the Notification tab is an excellent means to enable you to specify any number of family members, caregivers, medical staff, or neighbors to be on the list of people contacted when the Panic button is pressed (see [Notify Lists](#)).

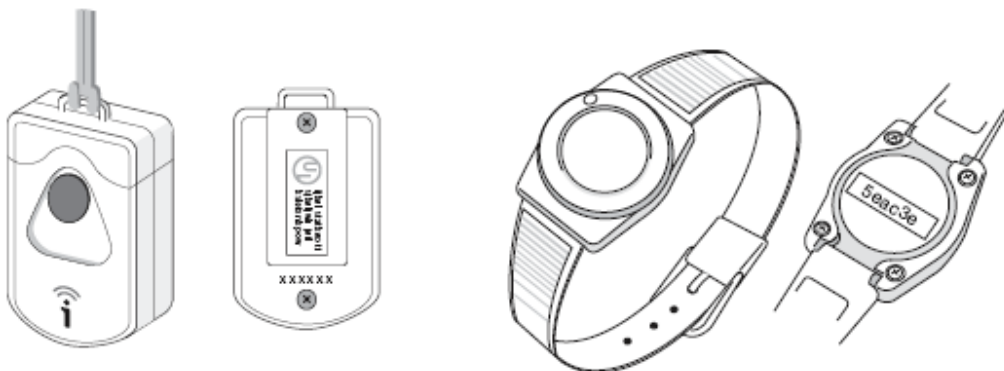

The Panic pendant comes in two types: a hanging version worn around the neck and a wristwatch version. Both can be affixed to a belt or placed in a pocket.

Your Panic Pendant

The Panic pendant is a water-resistant, wireless, battery-powered device used for communicating immediately with family members, caregivers, or anyone else when the person wearing the device presses the Panic button. The Notify Lists feature found on the Notification tab is an excellent means to enable you to specify any number of family members, caregivers, medical staff, or neighbors to be on the list of people contacted when the Panic button is pressed (see [Notify Lists](#)).

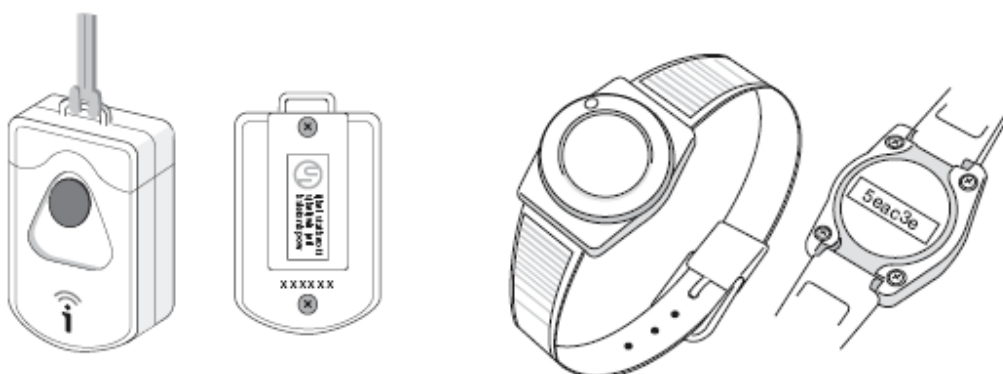

The Panic pendant comes in two types: a hanging version worn around the neck and a wristwatch version. Both can be affixed to a belt or placed in a pocket.

Your Smoke/Heat Sensor

Your Smoke/Heat Sensor

Your iControl Smoke/Heat sensor detects heat and smoke in your location. It can be used in garages, offices, storage areas, bedrooms, basements, and warehouses, and is

Printed Documentation

especially useful where space heaters are used. If smoke or heat are present, the device's siren activates and it communicates with your iControl box. You quickly receive an alarm on your iControl web portal. The Smoke/Heat sensor has an indicator light that turns red in an alarm condition.

Your Smoke/Heat Sensor

Your iControl Smoke/Heat sensor detects heat and smoke in your location. It can be used in garages, offices, storage areas, bedrooms, basements, and warehouses, and is especially useful where space heaters are used. If smoke or heat are present, the device's siren activates and it communicates with your iControl box. You quickly receive an alarm on your iControl web portal. The Smoke/Heat sensor has an indicator light that turns red in an alarm condition.

Managing Your iControl Devices

Renaming Devices

You may change device names at any time to suit your needs. You may use numbers, upper and lower case letters, and characters such as apostrophes.

To rename a device, follow these steps:

1. Click on the System tab.
2. Click on the name of the device you wish to change (e.g., 'Wireless Camera'). You will see the Device window.

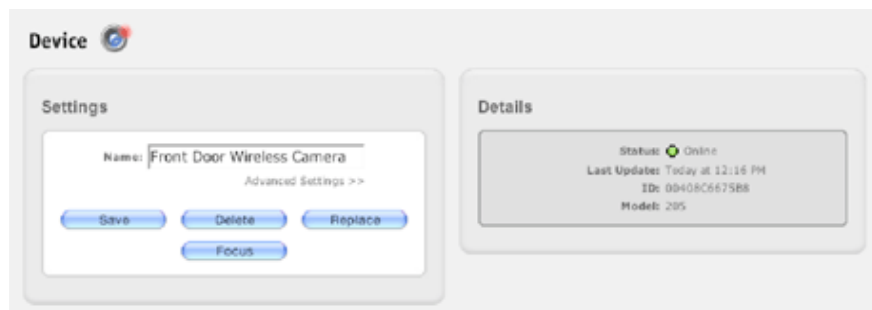

3. In the Name field, replace the old name (e.g., 'Wireless Camera') with a new name (e.g., 'Front Door Wireless Camera').
4. Click on the 'Save' button to save the new name. You will now see the new device name listed in the System window.

Deleting a Device

You can also delete any camera, Lamp module, or other device from your System. To delete a device from your iControl System:

- Click on the System tab.
- Place your cursor over the name of the device you wish to delete (e.g. 'Wireless Camera'), and click on it. You will see the Device window (as shown) with the device to be deleted.

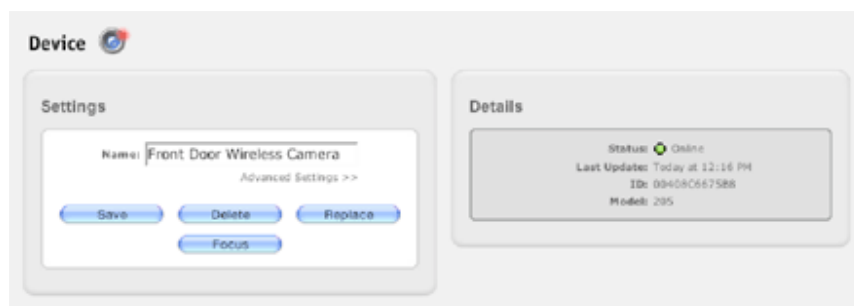

- Click on the 'Delete' button to open the Delete Device window.
- Click on 'Yes' below the message: 'Are you sure that you want to delete the device Wireless Camera?'
- Click on the 'OK' button below the confirmation message: 'Delete device succeeded' in the Device window.



Note: If you attempt to delete a device that is incorporated into an automation,

notification, or schedule, the following dialog box will appear:



You should either replace the device or delete any automations, notifications, or schedules that use it. Click on 'OK' to exit this window.

Automations

Automations

Automations link a change in one device with the action of another device. For example, you may program an iControl camera to take a picture if a Door/Window sensor detects an open door. You can create any number of automations and specify in which modes they will operate.

Sample Automations Window

Here is a sample Automations window taken from an iControl System that has automations for a Motion sensor, a Door/Window sensor, and a Keychain Remote.

Trigger	Action	Home	Sleep	Away		
Motion Sensor Occupied	Turn Lamp Module on.	✓				
Motion Sensor Empty	Turn Lamp Module off.	✓	✓			
Door/Window Sensor Open	Take a picture with Aaron's Forest Cam	✓	✓	✓		
Keychain Remote						
Keychain Remote Lamp On	Take a picture with Aaron's Forest Cam	✓	✓	✓		
Keychain Remote Star Button	Take a picture with Aaron's Forest Cam	✓		✓		
Keychain Remote Locked	Set Away Mode	✓	✓			
Keychain Remote Unlocked	Set Home Mode	✓	✓	✓		

An automation consists of a change in one device (called a ‘trigger’) and the resulting action of another device. Devices such as Door/Window sensors, Keychain Remotes, and Motion sensors trigger when a door is opened, a button on a Keychain Remote is pressed, or a room is occupied. These devices can cause actions such as a camera taking a picture or a Lamp module turning lights on or off.

As suggested by the sample Automation window, there is a range of features to choose from in designing your automations. The following bullets and screen shots provide illustrative examples of the kinds of automations you can create.

Printed Documentation

- Automate one device to cause another to take an action. Here, when a Motion sensor detects a family room is occupied, we want the Lamp module to turn on a light.

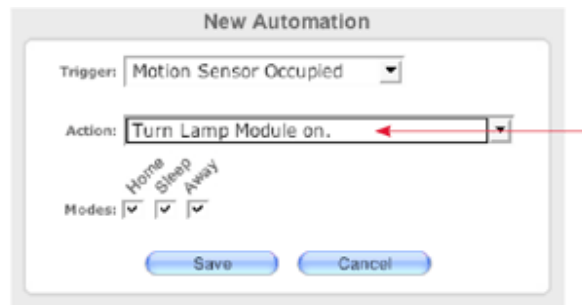

When a Motion sensor senses a room is occupied, a Lamp module turns a light on.

- Have automations occur in selected modes. When someone opens the door at the tree nursery while the business is open or closed, we want a record of who came in. So, when the Door/Window sensor's state changes to 'Open', an automation will cause Aaron's Forest Cam to take a picture of who comes through the door.

If you have multiple devices, you can select which camera, thermostat, or lamp module will respond. Not all devices of a particular type need to act in the same manner.

Automations

Automations link a change in one device with the action of another device. For example, you may program an iControl camera to take a picture if a Door/Window sensor detects an open door. You can create any number of automations and specify in which modes they will operate.

Sample Automations Window

Here is a sample Automations window taken from an iControl System that has automations for a Motion sensor, a Door/Window sensor, and a Keychain Remote.

Trigger	Action	Home	Sleep	Away	
Motion Sensor Occupied	Turn Lamp Module on.	✓			
Motion Sensor Empty	Turn Lamp Module off.		✓	✓	
Door/Window Sensor Open	Take a picture with Aaron's Forest Cam	✓	✓	✓	
Keychain Remote					
Keychain Remote Lamp On	Take a picture with Aaron's Forest Cam	✓	✓	✓	
Keychain Remote Star Button	Take a picture with Aaron's Forest Cam	✓		✓	
Keychain Remote Locked	Set Away Mode		✓	✓	
Keychain Remote Unlocked	Set Home Mode	✓		✓	

An automation consists of a change in one device (called a ‘trigger’) and the resulting action of another device. Devices such as Door/Window sensors, Keychain Remotes, and Motion sensors trigger when a door is opened, a button on a Keychain Remote is pressed, or a room is occupied. These devices can cause actions such as a camera taking a picture or a Lamp module turning lights on or off.

As suggested by the sample Automation window, there is a range of features to choose from in designing your automations. The following bullets and screen shots provide illustrative examples of the kinds of automations you can create.

- Automate one device to cause another to take an action. Here, when a Motion sensor detects a family room is occupied, we want the Lamp module to turn on a light.

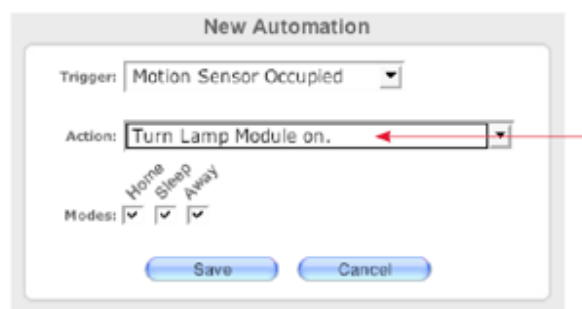

When a Motion sensor senses a room is occupied, a Lamp module turns a light on.

- Have automations occur in selected modes. When someone opens the door at the tree nursery while the business is open or closed, we want a record of who came in. So, when the Door/Window sensor’s state changes to ‘Open’, an automation will cause Aaron’s Forest Cam to take a

Printed Documentation

picture of who comes through the door.

If you have multiple devices, you can select which camera, thermostat, or lamp module will respond. Not all devices of a particular type need to act in the same manner.

Adding and Editing Automations

To add or edit a new automation (e.g., turning on the lights when the Motion sensor detects that an area such as a hallway, lobby, or kitchen is occupied), follow these steps:

1. Click on the Automations tab.
2. Click on the 'Add Automation' button on the right-hand side of the window to add an automation, or on a pencil icon to edit an existing automation. Clicking on the 'Add Automation' button, will open a New Automation window.
3. Choose the trigger for the automation by clicking on the down arrow. (In our example, 'Motion Sensor Occupied' was chosen as a trigger for the automation.)

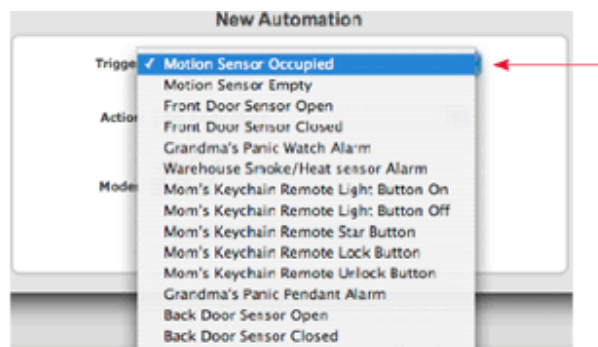

Down arrow gives you access to all the devices in your System that can trigger an automation.

Common Tasks

The following table lists the triggers and actions associated with specific iControl devices. 'NA' means that there is not a trigger or action associated with that device. Triggers and actions for a device will appear in the Trigger and Action drop-downs of the New Automation window if that device was added to your system.

Device	Trigger	Action
Camera	NA	Take a picture
Carbon Monoxide detector	Alarm	NA
Door/Window sensors	Open or Closed	NA
Freeze sensor	Alarm	NA
Keychain Remote	Depends upon the button. Defaults are: Lock-change to Away Mode; Unlock-change to Home Mode; Star-Take a picture; Light Bulb-Toggle lighting	NA
Lamp module	NA	Turn On, Turn Off
Motion sensor	Occupied or Empty	NA
Panic Pendant, Panic Wristwatch	Alarm	NA
Smoke and Heat sensor	Alarm	NA
System	NA	Set Away Mode, Home Mode, Sleep Mode
Thermostat	NA	Set Thermostat Fan, Set Thermostat Heat Setpoint, Set Thermostat Cool Setpoint
Water sensor	Alarm	NA

Printed Documentation

4. Choose the action to be taken by clicking on the down arrow. (In our example, 'Turn Lamp Module On' was chosen so that the lights will come on when the Motion sensor sees that the area is occupied.)

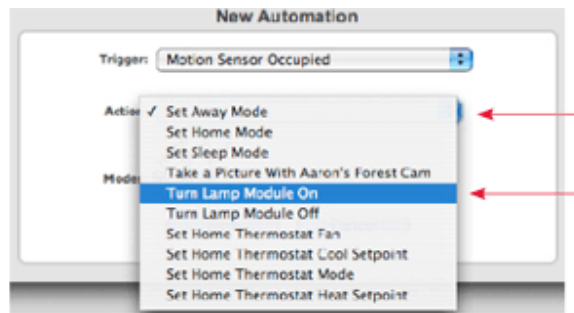

Click on this down arrow.

Choose 'Turn Lamp Module On'.

Note: If you have multiple devices of the same type, each device will be shown in the list to let you choose from among them.

5. Under Modes, check each mode in which you want the picture to be taken (e.g., all modes).

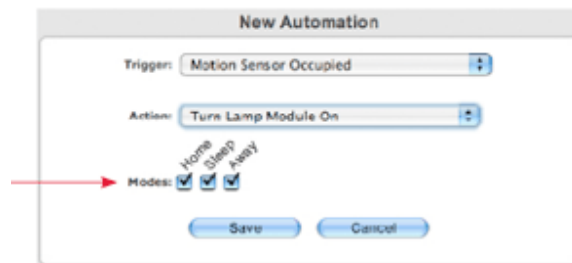

Choose in which mode(s) you want the automation to occur.

Common Tasks

6. Click on the 'Save' button to save your automation.

Common Tasks

Commonly Used Terms

The following briefly defines the terms commonly used in the iControl System:

- **Alarms:** An alarm is displayed in your Alarms window of your Summary page when the device changes state such as when a Motion sensor detects that a room is occupied or unoccupied.
- **Automations:** Automations link a change in one device with the action of another device such as when a Door/Window sensor detects a door open, a camera takes a picture.
- **Modes:** Your system can operate in one of three modes: Home, Sleep, or Away. Modes allow you to have your devices behave differently depending upon the mode. By putting your System in Away mode, you can activate all your sensors; by placing your System in Home mode, you can 'turn off' your sensors when you are around your house or business.
- **Notifications:** You can have the iControl service send you emails and/or SMS messages when, for example, a Door/Window sensor opens or a camera takes a picture.
- **Notify Lists:** A list you create of the people you want notified via email and/or SMS when an event occurs—a Motion sensor detects movement, a picture is taken, etc.
- **QuikControl:** A shortcut to change modes, control lighting, change a thermostat, or take a picture.

Turn Up the Heat in the AM, Down During the Day, Up in the Evening

To have your System turn up the heat in the morning, turn it down during the day, turn it up in the evening, and turn it down again at night, create two schedules following these steps:

Printed Documentation

1. First, set the heat setpoint of your Thermostat. Click the 'QuikControl' button in the blue menu bar and select 'Home Thermostat' (the name you gave your Thermostat). In the new QuikControl Home Thermostat window that appears, use the drop-down menus to select your desired heat and cool setpoints. Here, we chose '68°' as the heat setpoint and '72°' as the cool setpoint. We want the heat to come on so 'Heat' is selected. We want the fan to circulate the heat but we want the fan to shut off when the heat turns off, so we selected 'Auto' under Fan.

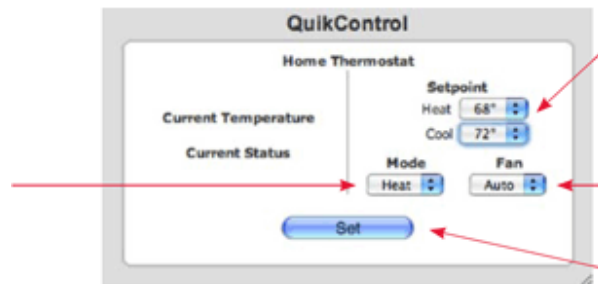

Select heating as the mode.

Choose the temperature at which you want the heat to come on.

Set fan to 'Auto' to turn it on when heating and off when heating is complete.

Click on 'Set' to save your settings.

2. Click on the 'Set' button to save your choices.
3. Click on the Schedules tab to go to the Schedules window.
4. Click on the 'Add Schedule' button.
5. In the Name box, give the schedule a name such as 'Weekday Home Thermostat Schedule - AM'.
6. Click on '>> to' to reveal some additional options.
7. Use the drop-down menus to select 7:00AM as your start time and 8:30AM as your end time.
8. We'll have this schedule operate only on weekdays, so make sure the Mon-Fri checkboxes are checked and the Sat and Sun checkboxes are unchecked.

Edit Schedule

Name: Weekday Home Thermostat Schedule-AM

Start: 7:00 AM

End: 8:30 AM

Repeat: Do Not Repeat

Randomize:

Days: Sun Mon Tue Wed Thu Fri Sat

Start Action: Set Home Thermostat Mode to Heat

End Action: Set Home Thermostat Mode to Off

Modes: Home Sleep Away

Save Cancel

Edit Schedule

Name: Weekday Home Thermostat Schedule-PM

Start: 4:30 PM

End: 11:00 PM

Repeat: Do Not Repeat

Randomize:

Days: Sun Mon Tue Wed Thu Fri Sat

Start Action: Set Home Thermostat Mode to Heat

End Action: Set Home Thermostat Mode to Off

Modes: Home Sleep Away

Save Cancel

9. Under Start Action, select 'Set Home Thermostat Mode' and 'Heat'.
10. Under End Action, select 'Set Home Thermostat Mode' and 'Off'.
11. We only want this schedule to operate in Home mode, so make sure there is a check in the Home mode checkbox and that there aren't checks in the Sleep and Away mode checkboxes.
12. Click on the 'Save' button to save the schedule. You will be returned to the Schedules window, where your new schedule will appear in the list of schedules.
13. Now repeat Steps 3 through 11, using 'Weekday Home Thermostat Schedule - PM' as the name of your schedule, 4:30PM as the start time, 11:00PM as the end time, 'Set Thermostat Mode' and 'Heat' as the Start Action, and 'Set Thermostat Mode' and 'Off' as the End Action. Your

Printed Documentation

schedules will activate at the scheduled times, if the System is in Home mode at those times.

To schedule your thermostat to cool your home, you can use the same procedure, selecting 'Cool' instead of 'Heat' in Step 8 and adjusting the start and end times.

Send Me a Notification When the Panic Pendant Goes Off

To have a notification sent to you when the button is pushed on a Panic pendant, create a custom notification following these steps:

1. Click on the Notifications tab to go to the Notifications window.
2. Click on the 'Add Notification' button.
3. The 'Create a new Custom Notification' option is already selected, so click the 'OK' button.
4. Under Trigger, select 'panic wrist Alarm'.
5. Under Notify, select 'When Grandma presses button'. You will be notified the next time Grandma presses her Panic button.
6. We want this notification to operate in all modes, so make sure there are checks in the Home, Sleep, and Away mode checkboxes.

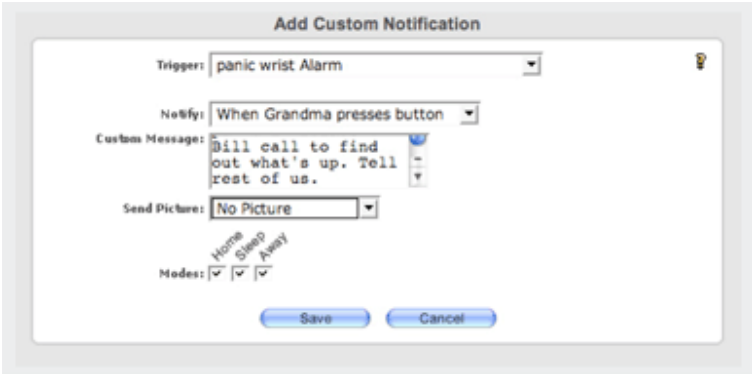

The screenshot shows a dialog box titled "Add Custom Notification". It contains the following fields and options:

- Trigger:** A dropdown menu with "panic wrist Alarm" selected.
- Notify:** A dropdown menu with "When Grandma presses button" selected.
- Custom Message:** A text area containing the message: "Bill call to find out what's up. Tell rest of us."
- Send Picture:** A dropdown menu with "No Picture" selected.
- Modes:** Three checkboxes labeled "Home", "Sleep", and "Away", all of which are checked.
- Buttons:** "Save" and "Cancel" buttons at the bottom.

Managing Your System from a Mobile Device

Logging In

To log in, go to <http://mobile.icontrol.com>, enter the same username and password you use to access your personal web portal from your computer, and tap on 'Sign In'. Note, your username and password are case sensitive.

Note: The term 'tap' is used to indicate when to select items on a screen or in a drop-down menu. Different mobile devices employ a scroll wheel, buttons, or a stylus and may use the term 'press', 'tap', or 'click'. This manual uses the term 'tap' to refer to all these selection processes.

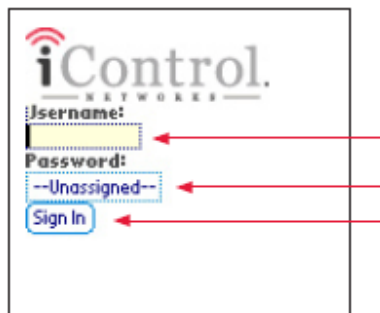

Type in your username.

Type in your password.

Tap on 'Sign In' to complete your login.

On your mobile device, your personal web portal looks like the image below. From here, you can view the status of your devices, change modes, take and view pictures, manage your thermostat(s), and view recent alarms.



Printed Documentation

View Status See the status of all of your devices as well as the temperature of your location (if you have a thermostat installed). From this screen, you can change lighting levels or adjust your thermostat.

Change Mode Change your System mode (e.g., from Home to Away or Away to Sleep).

Pictures Take or view pictures from any of your cameras.

Thermostat Adjust the settings of your thermostat(s), change mode (e.g., heating to cooling), or adjust the fan (on, off, or auto).

View Alarms View alarms from the past two days.

Change Premise Switch among multiple locations (for users with access to multiple iControl Systems). Change Premise will appear only if you have more than one location with an iControl System.

Sign Out Log off from your mobile personal web portal.

The Change Mode Screen

To change your System mode from your mobile portal, simply tap on the desired mode from the Change Mode screen.

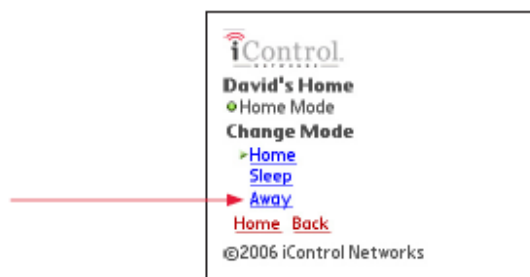

Change the mode of your System by tapping on the desired mode.

You will then see the following confirmation message in a new screen:



You will need to wait a few moments and refresh your browser to see that your System has changed to 'Away' mode. You will also see a green arrow next to 'Away' in the Change Mode screen.

The Pictures Screen

From this screen you can:

- take pictures using any of your cameras
- view thumbnails of all your pictures

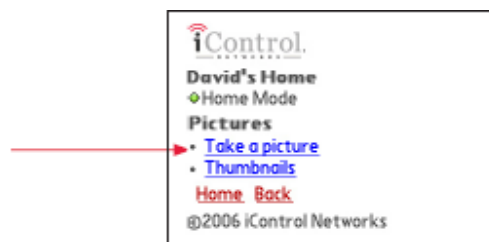

Tap to take a picture.

If you have more than one camera, tap on the first camera name that appears to reveal the name of your other cameras.

Printed Documentation

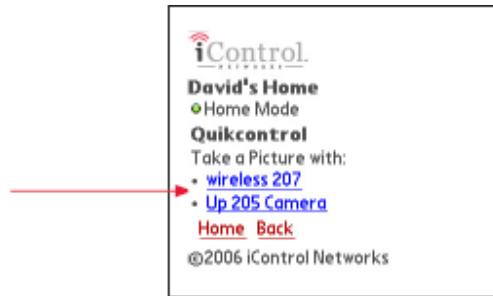

Tap to select the camera you want to use.

You will see a message indicating when the picture will be taken.

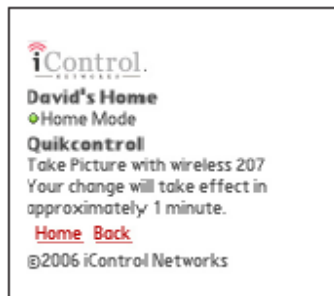

You can also view thumbnails of previously taken pictures. Tap on 'Thumbnails' from the Manage Pictures screen.

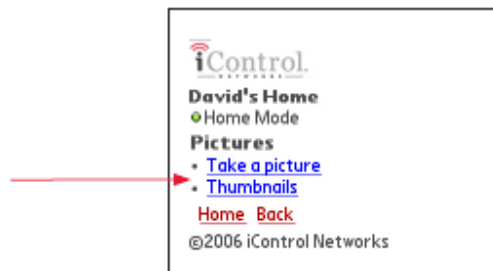

Tap on 'Thumbnails' to see archived pictures.

This will bring up a screen similar to the following one:

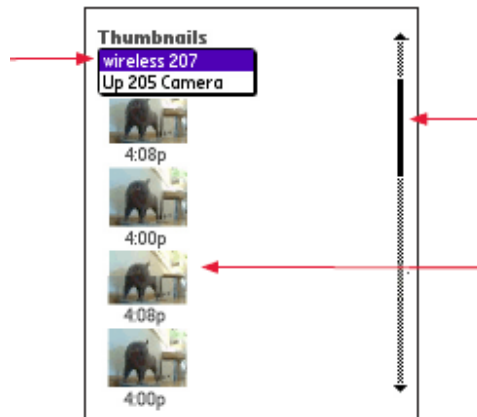

Tap on the camera's name to see the associated Thumbnails. Here we chose 'wireless 207'.

Scroll to see more wireless 207 thumbnails.

Shows the four most recent pictures.

You will see the four most recent pictures from your camera. Scroll to the bottom of the screen and tap on 'Older>>' to view older pictures from this camera.

Change Premise Screen

If you have access to more than one premise with an iControl System, you will see the Change Premise screen. For example, if you have a System in your office and another in your home, the Change Premise menu item lets you easily switch between them. Click on the Premise name shown to reveal other premises and then tap on name of the premise you want to manage.



Frequently Asked Questions

The iControl Gateway

- Can I plug the iControl box into an uninterruptible power supply or a surge protector?
- What if the iControl box Power light does not turn on?
- What if I do not have a router or similar device?
- What is the phone jack for?
- When do the LEDs blink?
- The iControl System
- What Kind of Broadband do I need?
- When I tried using QuikControl why didnt anything happen?
- How can I tell my iControl box is communicating with the iControl servers?
- What do I do if I cant see the device I just installed?
- What should I do if my device just seems to keep installing the dot is still yellow?

Notifications

- Why did I unexpectedly receive an iWatch Exception notification as an email or SMS?

Camera

- What do I need for my wireless Camera to work?
- My Camera is out of focus. What do I do?
- What if my camera hasnt been discovered and has a yellow dot next to it?
- What do I do if I cant see any images or video from the camera I just installed?
- How do I use WEP (Wireless Equivalent Privacy) on my Wireless camera?
- What if my network uses security other than WEP?
- What is the cameras resolution?

Door/Window Sensor

- What should I do if my Door/Window sensor has a red dot next to it on the System page of my iControl Portal?
- Why does my Door/Window sensor always report itself as open?
- How far away can I install my iControl Door/Window sensor from the iControl box?

Keychain Remote

Printed Documentation

- What are the default actions of the buttons?
- The Keychain Remote is doing something it is not supposed to do. What should I do?
- My Keychain Remote isnt doing anything. I press buttons repeatedly.
- Why doesnt my Keychain Remote lamp button doesnt turn the lamp on or off?
- I used the Keychain Remote and the light level is different now. Why?
- If I buy another Lamp module, can my Keychain Remote control it?

Lamp Module

- My lamp module isnt installing, what should I do?
- What kinds of lights can I use the Lamp module with?
- Can I use it on a lamp wired into a 3-way or 4-way wall switch?
- Can I use a 3-way light?
- Can I plug a Lamp module into an uninterruptible power supply (UPS)?
- Can I plug a Lamp module into a power strip with a surge protector or into a surge protector?
- How far away can I install a Lamp module from the iControl box?
- What does the black button on the bottom of the Lamp module do?

Motion Sensor

- How do I test that a Motion Sensor is covering the area I hope it does monitor?
- Why doesnt the motion sensor detect when I leave the room and come back?
- Will the Motion Sensor sense my pets?
- Why is there nothing in the picture that was taken as a result of the motion detector being activated?
- How far away can I install my iControl Motion sensor from the iControl box?

Thermostat

- What type of system will the iControl thermostat work with?

The iControl Gateway

Can I plug the iControl box into an uninterruptible power supply or a surge protector?

No. We do not recommend using uninterruptible power supplies or surge protectors.

What if the iControl box Power light does not turn on?

Make sure that the power cord is fully inserted into the power jack of the iControl box. If the Power LED in the front of the box still does not turn on, there may be a problem with your electrical connection. In rare instances, the iControl box or power supply may be faulty.

What if I do not have a router or similar device?

A router or similar device that does DHCP is required so that the iControl Gateway and associated devices are able to get IP addresses. You will plug the router or similar device into your broadband modem.

What is the phone jack for?

A phone dial-up option will be available in a future version of the product.

When do the LEDs blink?

During normal operation, the Power LED should stay on steady green. The Device LED turns on briefly when the iControl box is communicating with iControl devices. The Status LED is on when there is communication between the iControl servers and the iControl box. The LAN LED blinks rapidly when there is communication between the router and the iControl box.

The iControl System**What Kind of Broadband do I need?**

The iControl System will work with any broadband connection that does not have a high amount of latency. Unfortunately this means that most Satellite broadband connections will not work with the iControl System.

When I tried using QuikControl why didnt anything happen?

When you select an action with QuikControl, a dialog box tells you how long it will take for the change to occur. Usually this time is between 30 seconds to 3 minutes, depending on a number of factors, including how recently your gateway communicated with the iControl server.

During the indicated time window, the iControl servers receive your request, communicate with your iControl box, and then initiate the local devices to act. Finally, your Summary page is updated with the new settings or status. This

Printed Documentation

whole process may take a few minutes, and you may need to update your Summary page by clicking refresh to see that the desired action has taken place.

How can I tell my iControl box is communicating with the iControl servers?

When looking at the System tab on the iControl portal, a green dot should appear next to Gateway. If the dot is red, make sure that the iControl box is connected to your router via an Ethernet cable and check that the iControl box has power. (The Power LED on the front panel of the iControl box is green when it has power). Next, check to see if your router and DSL or cable modem are working, and make sure that you have access to the Internet. If you can browse the Internet, your modem and Internet connection are working. Refresh your browser window and log in if necessary. If the dot is still red, reset your iControl box by pressing the reset button on the back of the box (it is recessed, you may need a paperclip in order to do this). If the problem persists, contact support@icontrol.com.

What do I do if I cant see the device I just installed?

Click on the System tab and see if there is a red dot next to the devices name in the System window. If so, confirm that the device type and ID are entered correctly. Click on the devices name, and then look on the right hand side of the resulting page. There will be a field labeled ID, the number in this field should match the Serial Number (S/N) printed on the label of the device.

What should I do if my device just seems to keep installing the dot is still yellow?

1. Confirm that the device is plugged in (if it has a power supply).
2. Confirm that the device type and ID shown on the Device page match the type and serial number of the actual device. (Go to your System tab and click on a device name to bring up the Device page.)
3. Activate the device. If it is a Motion sensor, wave your hand in front of it to force it to communicate its status. If it is a Door/Window sensor, open and close the door. If it is a Keychain Remote, press a button. For Water and Freeze sensors, apply water or ice. For a CO detector or Smoke/Heat sensor, press the Test button. For a Panic pendant or wristwatch, press the Panic button. Then wait a few moments for your iControl box to discover the device and change the dot to green.
4. If it is a camera, see Section 10.4, About your Camera, or visit the related FAQ.
5. Confirm that your iControl box has a green dot next to it. If it does not, unplug and plug back in the power supply to the iControl box. Wait a few minutes for the System to restore itself. You will see the devices details, including its type and ID. Make sure that the type and ID match those for

the device itself. Chapter 8 and Appendix C provide detailed information on how to accurately enter the correct device type and ID.

Notifications

Why did I unexpectedly receive an iWatch Exception notification as an email or SMS? You may have set an iWatch Monitor notification at some point in the past. This creates a notification to have a message sent to you when something does NOT happen. You can see your notifications by clicking on the Notifications tab in the iControl Portal.

Camera

What do I need for my wireless Camera to work?

The wireless camera uses an 802.11 connection to connect with the iControl Gateway. This means that if you purchase an iControl wireless camera, you will need an existing wireless router in order to supply a wireless network.

My Camera is out of focus. What do I do?

Follow the instructions in Section 8.2.9 of the User Manual, Focusing Your Camera.

What if my camera hasnt been discovered and has a yellow dot next to it?

Please see the troubleshooting steps in the next question.

What do I do if I cant see any images or video from the camera I just installed?

Follow these steps:

1. Make sure that power is connected to the camera via the Axis power supply, and if it is a wired camera, that the camera is connected to your router with an Ethernet cable.
2. Verify that the Serial Number of the physical camera matches the Serial Number attempting to be discovered by the system. To do this, go to the System tab in the iControl Portal and click on the camera that is attempting to install. On the right is a number labeled ID. This number should match the S/N on the back of camera.

If these do not match, and there are other cameras in your system, check to see if the ID matches one of those. If the ID and the S/N numbers dont

Printed Documentation

match and this is your only camera, perform a replace operation on the left panel.

3. If none of the above steps have solved the problem, perform a factory reset of the camera. To factory reset the camera perform the following steps:
 - Disconnect power to the camera.
 - Depress and hold the button on the back of the camera.
 - While holding the button, connect power to the camera. Continue to hold the button.
 - Hold the button until the LED ring on the front of the camera turns amber.
 - Wait until the LED ring turns solid green. The camera is now reset to factory settings.
 - Wait one to three minutes for the camera to be discovered by your iControl System.
4. If the problem continues, contact support@icontrol.com.

How do I use WEP (Wireless Equivalent Privacy) on my Wireless camera?

See Section 8.2.1 in the iControl User Manual for more details.

What is the cameras resolution?

The iControl Camera takes pictures at 640x480 and all video are presented at 320x240 or 640x320 depending upon your preference.

Door/Window Sensor

What should I do if my Door/Window sensor has a red dot next to it on the System page of my iControl Portal?

Try the following steps, in this order:

1. Open and close the window or door that it is mounted on. Wait a few moments and see if the dot turns green. Repeat once, if necessary.
2. If the problem persists, confirm that the devices type and ID are correctly entered in the System.

Why does my Door/Window sensor always report itself as open?

1. The sensor may be installed incorrectly, verify that the arrows on the sensor and the sensor magnets are aligned.

2. Re-position the sensor and the sensor magnet so that the space between them is smaller. There needs to be a magnetic field between the two pieces, and they may be too far apart. Wait a few moments to see if the dot turns green. If the problem persists, re-position the sensors again.

How far away can I install my iControl Door/Window sensor from the iControl box?

100 feet.

Keychain Remote

What are the default actions of the buttons?

See Section 8.6 in the iControl Users Manual.

The Keychain Remote is doing something it is not supposed to do. What should I do?

Click on the Automations tab. For each Keychain Remote, you will see the settings for each button. You may have re-configured the buttons to change their function.

My Keychain Remote isnt doing anything. I press buttons repeatedly.

The Keychain Remote needs a few moments to communicate via infrared with your iControl box. When you press a button, hold it for a second or two, the LED on the Keychain Remote should turn green and then after about one minute, your System initiates the action you wish.

Why doesnt my Keychain Remote lamp button doesnt turn the lamp on or off?

Pressing the Light button on the Keychain Remote 4-button version alternately sends Light Button On and Light Button Off signals to your iControl System. So if you use the Keychain Remote Light button to turn your lights on, then the next signal the Keychain Remote Light button will send is Light Button Off. However, you may not experience the desired result. If, for example after turning the lights on with the Keychain Remote Light button you turn the lights off manually, using QuikControl, or with an automation or schedule, then pressing the Keychain Remote Light button will send the Light Button Off signal and no change will occur. Pressing the Light button a second time will send the Light Button On signal, and the lights will turn on.

I used the Keychain Remote and the light level is different now. Why?

A Light Button On signal will always turn (or leave) the lights on to full brightness and a Light Button Off signal will always turn (or leave) the lights off, irrespective of the brightness level of the lamp when the signal is received.

If I buy another Lamp module, can my Keychain Remote control it?

Yes. The Keychain Remote that comes with your Starter Kit is configured from the factory to control the Lamp module that comes with the kit. If you purchase additional Lamp modules or Keychain Remotes, you will need to add an automation to enable the Keychain Remote to turn on or off existing or newly purchased Lamp modules.

Powerline Lamp Module

Shipped with version 1 systems only.

My lamp module isnt installing, what should I do?

There are four things to try in this situation.

1. Check the outlet youve plugged the lamp module in to. Make sure that it is working correctly and isnt controlled by a switch.
2. Check if your iControl gateway is currently receiving its power from a UPS (uninterruptible power supply) or a power strip with surge protection. If it is plug it in directly to a wall outlet or power strip without surge protection.
3. Check the ID on the lamp module and make sure it matches the one installed on your system.
 - o To do this, look at the label on the back side of the lamp module, the physical ID is printed below the second bar code and is 12 characters long. This ID should match the one that is listed on the iControl Portal for your device. It can be viewed by logging onto your portal, clicking on System Tab and clicking on the lamp module youre troubleshooting. If the ID listed is not the same as the one on the devices label, you can click on the replace button, and enter the ID of the lamp module you have in your kit (12 digits, no punctuation).
4. If none of the above solves the problem, try connecting the lamp module to another circuit in your house.

What kinds of lights can I use the Lamp module with?

You can use it on any light that uses a 40-watt to 300-watt incandescent light bulb. It does not work with fluorescent light bulbs or incandescent light bulbs less than 40 watts or greater than 300 watts.

Can I use it on a lamp wired into a 3-way or 4-way wall switch?

No.

Can I use a 3-way light?

No.

Can I plug a Lamp module into an uninterruptible power supply (UPS)?

No, the iControl Lamp Module does not work properly when plugged into a UPS.

Can I plug a Lamp module into a power strip with a surge protector or into a surge protector?

No, the iControl Lamp module does not work properly when plugged into such a power supply.

How far away can I install a Lamp module from the iControl box?

100 feet.

What does the black button on the bottom of the Lamp module do?

It is used for iControl testing purposes only.

Motion Sensor

How do I test that a Motion Sensor is covering the area I hope it does monitor?

Follow these steps to do a walk test:

1. Remove your Motion sensor from the mounting plate, then re-attach it.
2. Walk across the room, and wait for the Motion sensor light to turn red.
3. Stop, stand still, and wait for the Motion sensor light to turn off.
4. Repeat Steps 2 and 3, until the entire monitored area has been tested.

5. Leave the room for at least 60 seconds. After 60 seconds without motion, the walk test mode time expires. After the walk test is finished, the light on the Motion sensor no longer activates when motion is detected.

Why doesnt the motion sensor detect when I leave the room and come back?

The Motion Sensor has a built in four-minute delay. If after four minutes, it has not detected motion, it changes from Occupied to Empty. If motion occurs during that four-minute period, it remains in an Occupied state, as reported on the Summary Pages Current States window. If motion occurs after the four-minute window, it changes from Empty to Occupied as shown in the Current States window and a new alarm is generated in the Alarm History window.

Will the Motion Sensor sense my pets?

The Motion Sensor cannot detect pets weighing less than 40 pounds. This also means that it will not sense children weighing less than 40 pounds. However, in some cases, pets and children will trip the Motion sensor if they walk very close to the sensor itself.

Why is there nothing in the picture that was taken as a result of the motion detector being activated?

The Motion sensor has a 2 - 3 second delay before communicating with the iControl box. The camera may miss the person walking through the cameras field of view. The remedy is to reposition the camera and Motion sensor to account for this delay. For example, point the camera along a corridor that takes a couple of seconds to traverse, and position the motion sensor so that motion is detected as the person enters that corridor.

How far away can I install my iControl Motion sensor from the iControl box?

100 feet.

Thermostat

What type of system will the iControl thermostat work with?

The iControl thermostat is an HAI single stage heating and cooling thermostat. It has 5-wires, and requires 24 volts of AC power. Generally your existing thermostat should have 3 to 5 wires connected to it in order for our thermostat to be compatible.

The iControl thermostat is known to not work with

- heat-pump systems
- radiant or baseboard heat, since these are often 120v or 240v systems.
- Two wire systems, these are generally analog and do not supply enough power to work with the iControl Thermostat.

Index

1	
120v	95
2	
2007 iControl Networks.....	3
240v systems	95
3	
320x240	95
4	
4-button Keychain Remote	47
6	
640x320	95
640x480	95
A	
AC.....	95
access.. 5, 17, 22, 29, 35, 74, 89, 93, 95	
History window	17
IP Address.....	22
Action.... 5, 46, 47, 71, 72, 74, 85, 95	
System initiates	95
Activate	95
device.....	95
Add	37
Add Automation	74
Add Device	22, 37, 41, 52, 54
Add Device window.....	37, 41, 52, 54
Add Notification' button	88
Add Schedule	85
adding	22, 41, 52, 57, 63
Additional	22
Custom.....	63
iWatch	63
Your Keychain RemoteYou	57
Admin.....	35
Alarm History 5, 17, 37, 40, 43, 95	
Alarm History window .. 5, 17, 37, 40, 43, 95	
Alarm History window displays.. 5, 43	
status.....	43
Alarm History window shows	5
Alarm'.....	88
alarm-condition	40, 63
Alarms .. 5, 17, 37, 40, 43, 60, 63, 65, 66, 74, 85, 88, 89, 95	
Motion Sensor generated	5
sensor transmits	60
Alarms window	85
All	17
All modes	74
All rights reserved.....	3
Allows.....	46
AM.....	85
appear .. 5, 13, 25, 27, 29, 37, 40, 41, 43, 47, 52, 60, 63, 68, 74, 85, 89, 91, 95	
Summary page	40
Appear indicating	13
Appear telling	25
Appendix	95
Approach.....	46
house.....	46
Auto.....	85
Automations5, 13, 17, 22, 27, 43, 47, 50, 51, 57, 63, 68, 71, 72, 74, 85, 95	
Click.....	95
Automations link.....	85
Automations tabAutomations	5
Automations WindowHere.....	71, 72
AutomationsAutomations link .. 71, 72	
change.....	71, 72
Away 5, 13, 29, 44, 46, 47, 85, 88, 89, 90, 95	
Change	13, 46
Home	46, 89
Sleep	89
Away Mode 5, 13, 46, 47, 74, 85, 88, 90	
Away mode checkboxes.....	85, 88
Axis	95
B	
Back	37, 43
Carbon Monoxide	37
Back Hallway.....	5

Printed Documentation

Basement CO	37	Home	13, 46
Battery	64, 65	Home Mode	74
Blue menu bar	17	ModesYour	13
Brightness.....	5, 50, 51, 56, 57, 95	System.....	46
set	56	System mode.....	46
Brightness level.....	57, 95	Check	43
lamp	57, 95	see.....	43
Broadband	95	status	43
Kind	95	Checking	
Browse.....	95	Installation	43
Internet.....	95	Choose 'IP Camera	22
Business	50, 51	Choose 'Turn.....	74
Buttons.....	25, 27, 29, 52, 54	Click	
C		Automations.....	95
Came	21	Clickable.....	17
Camera 5, 13, 20, 21, 22, 23, 25, 27,		Closed .. 5, 25, 29, 43, 60, 71, 72, 74,	
29, 33, 46, 67, 68, 71, 72, 74, 85,		95	
89, 91, 95		CO.....	37, 40, 95
Camera Assistant.....	22	iControl box discovers	37
Camera Focus Utility.....	29	Commonly Used TermsThe	85
Camera hasnt	95	Computer	43
Camera matches.....	95	Condition triangle appears	63
Serial Number	95	Configurable.....	46
Camera takes	71, 72, 85	Contextsensitive	17
picture	71, 72, 85	Control.....	57
Camera There.....	21	Control various	46
Camera's name.....	91	Convenient automated	50, 51
CameraYou.....	20, 21	iControl Lamp module provides 50,	
Carbon Monoxide.....	5, 37, 40, 74	51	
back.....	37	Cool.....	85
Carbon Monoxide detector.....	37, 40	Copyright.....	3
installed	40	Counterclockwise	29
Carbon Monoxide sensors	5	Create	85, 88
Caregivers	27, 64, 65	Current States .. 5, 40, 43, 56, 57, 63,	
Change device names	67	95	
Change Mode	5, 63, 85, 89, 90	Current States window	5, 95
Change Mode Change.....	89	Custom Message	63
Change Mode screen.....	90	custom notification	88
Change Mode ScreenTo change ..	90	Custom notification following these	
Change Premise	89, 93	steps	88
Change Premise screen	93	Custom Notification'	63, 88
Change Premise Switch.....	89	D	
changing	13, 46, 71, 72, 74	Day.....	33, 85
AutomationsAutomations link ...	71,	Down During.....	85
72		Default settings	47
Away	13, 46	following.....	47

- Delete This Picture..... 29
- Deleting..... 29, 68
 - DeviceYou 68
 - Pictures 29
 - PicturesTo delete 29
- Desired brightness 57
 - select..... 57
- Desired mode 90
 - simply tap 90
- Determining 21
 - Your..... 21
- Device detects 5
- Device generated..... 43
- Device name 5, 95
- device presses..... 64, 65
 - Panic button 64, 65
- Device recognizes..... 5
- Device window..... 67, 68
- Devices 5, 17, 21, 22, 37, 40, 41, 43, 44, 46, 52, 54, 60, 64, 65, 66, 67, 68, 71, 72, 74, 85, 89, 95
 - Activate 95
 - ID number 37, 41, 52
 - Renaming..... 67
- Devices employ..... 89
- DevicesYou..... 67
 - Renaming..... 67
- DeviceYou 68
 - Deleting 68
- DHCP..... 95
- Didnt 95
- dimmer..... 50, 51, 56
- Directions to..... 54
 - follow 54
- DL 37, 41
- Do NOT..... 52
- Doesnt 95
- Dont 95
- Door5, 13, 17, 25, 37, 41, 43, 57, 63, 71, 72, 85, 95
 - iControl Starter Kit includes..... 41
- Door/Window ... 5, 13, 17, 41, 43, 71, 72, 74, 85, 95
- Door/Window sensor.... 5, 41, 43, 74, 95
- Door/Window Sensor' 17
- Down..... 74, 85
- Down again 85
- Down During 85
 - Day 85
- Drive off..... 46
 - work..... 46
- Dropdown..... 41, 52
- Drops..... 44
 - 41..... 44
- DSL 95
- Ductwork 60
- During..... 95
- E**
- E.g.. 5, 25, 37, 41, 52, 56, 57, 67, 74, 89
- Easy 52
 - install 52
- edit 23, 27, 47, 74
 - new automation 74
- Editing AutomationsTo 74
- Editing Your Camera's Settings..... 23
- email..... 5, 27, 63, 85, 95
 - get..... 5
 - send..... 5
- email and/or SMS..... 5, 85
- Email attachment 27
- Emails 85
- Empty 5, 63, 74, 95
- enable 5, 33, 57, 64, 65, 95
- End Action..... 85
- enter 5, 27, 35, 37, 41, 52, 63, 89, 95
 - router's IP 35
- Etc..... 27
- Ethernet..... 21, 95
- Etters..... 67
- EveningTo 85
- Examples of iControl alarm devices 5
- Exception notification 95
- F**
- Factory 41
- Family..... 27
- Family members..... 64, 65
- Fan..... 85
- FAQ..... 95
- find 22, 29, 35
 - SSID 35

Printed Documentation

First page	5
Focusing	29
Your CameraTo focus	29
Focusing Your Camera	95
Follow these steps	37, 52, 54
Following.....	47, 54, 95
default settings	47
directions to	54
instructions in Section 8.2.9	95
Form	35
192.168.1.1	35
Freeze.....	5, 44, 74, 95
Frequently Asked Questions	95
Fri checkboxes.....	85
Friends.....	27
Front	25, 41
Front Door.....	5, 67
G	
Gateway.....	5, 95
GE Security.....	37, 41
Grandma.....	88
Green dot appears next	43
name	43
H	
HAI.....	95
Hanging Pendant	5
Heat 5, 37, 44, 60, 65, 66, 74, 85, 89, 95	
Turn Up	85
Heat SensorYour iControl	65, 66
Help	5
History window.....	17, 47
History window records.....	17
History, Update	5
History' button.....	17, 47
HistoryYour	17
Home ... 5, 13, 33, 35, 46, 47, 50, 51, 63, 74, 85, 88, 89, 93	
Change.....	13, 46
Home Mode	5, 13, 46, 47, 74, 85
change	74
Unlock-change	74
Home mode checkbox	85
Home Thermostat'	85
House	46
approach	46
I	
IContro Portal	22
iControl... 3, 5, 13, 17, 19, 20, 21, 23, 29, 33, 35, 37, 40, 41, 43, 44, 46, 50, 51, 52, 55, 56, 57, 60, 63, 65, 66, 68, 71, 72, 74, 85, 89, 93, 95	
iControl box 5, 13, 19, 29, 37, 40, 43, 44, 55, 60, 65, 66, 95	
IControl box discovers.....	37
CO	37
IControl box Power.....	95
IControl Box The appearance	19
IControl Gateway	95
iControl Lamp Module .46, 50, 51, 95	
IControl Lamp module provides ...50, 51	
convenient automated	50, 51
IControl Networks.....	3
IControl Personal Web Portal	
ExplainedAfter	5
IControl Portal	23, 95
IControl Service.....	33
iControl Starter Kit.....	41, 52
IControl Starter Kit includes.....	41, 52
Door.....	41
iControl Summary.... 5, 13, 43, 56, 63	
iControl Summary page5, 13, 43, 56, 63	
iControl System 5, 13, 19, 20, 21, 43, 57, 63, 68, 71, 72, 85, 89, 93, 95	
IControl User Manual	95
Icontrol.com.....	89
ID.....	3, 5, 37, 41, 52, 95
ID number	37, 41, 52
device	37, 41, 52
Immediately	64, 65
Inc	3
Inclinemounted	60
Included.....	27
Indicator light.....	65, 66
Information You'll Need To	22
infrared energy emitted	60
sensing	60
Installation	23, 37, 43, 54, 55, 60
Installed.....	37, 40
Carbon Monoxide detector	40

- Your Carbon Monoxide
 - DetectorTo install..... 37
- Installing..... 37, 52, 54
 - easy..... 52
 - Your..... 52
 - Your Powerline..... 52
 - Your Z..... 54
- Instructions..... 41
 - skip..... 41
- Instructions in Section 8.2.9..... 95
 - Follow..... 95
- Interchangeable..... 5
- Internet..... 95
 - browse..... 95
- InTo log..... 89
 - Logging..... 89
- IP23, 35, 95
- IP Address..... 22
 - access..... 22
- Is occupied..... 85
- Is smaller..... 95
- Isnt..... 95
- IT35
- iWatch..... 63, 95
 - Add..... 63
- K**
- Keychain Remote... 5, 13, 46, 47, 50, 51, 57, 71, 72, 74, 95
- Keychain Remote 4-button..... 95
- Keychain Remote buttons..... 47
- Keychain Remote ButtonsYour..... 47
- Keychain Remote isnt..... 95
- Keychain Remote Lamp Off..... 47
- Keychain Remote Lamp On..... 47
- Keychain Remote Light button 57, 95
- Keychain Remote needs..... 95
- Keychain Remote Star button..... 47
- Keychain RemoteYour..... 46
- Kind..... 95
 - Broadband..... 95
- L**
- Lamp.... 5, 25, 47, 50, 51, 52, 54, 55, 56, 57, 68, 71, 72, 74, 95
 - brightness level..... 57, 95
- Lamp module ... 5, 47, 50, 51, 52, 54, 55, 56, 57, 68, 71, 72, 74, 95
 - Lamp module isnt..... 95
 - Lamp Module Model 6101..... 52
 - Lamp module needs..... 55
 - Lamp Module On..... 74
 - Lamp module to dim..... 5
 - Lamp module turning..... 71, 72
 - Lamp module youre..... 95
 - Lamp modules DO NOT..... 55
 - Lamp ModuleYour..... 50, 51
 - LAN..... 95
 - Last 30 days..... 17
 - Launch Assistant..... 54
 - Lbs..... 60
 - LED..... 13, 37, 46, 60, 95
 - Let's say you..... 47
 - Light Bulb-Toggle..... 74
 - Light button..... 46, 47, 57, 95
 - Light Button Off..... 57, 95
 - Light Button On..... 57, 95
 - LightingYou..... 56
 - Lights..... 46
 - Lights On..... 5
 - Linksys..... 35
 - Location..... 40, 65, 66
 - Lock..... 13, 46, 47
 - Log..... 5, 89
 - InTo log..... 89
 - login..... 17, 89
 - logins..... 17, 89
 - LonWorks Powerline..... 52
 - M**
 - Macintosh..... 33
 - Mailbox..... 43
 - Mailbox Door..... 43
 - Mailbox Door/Window Sensor..... 43
 - Main Street Camera Focus Utility.. 29
 - Make..... 95
 - Manage..... 33
 - PicturesYou..... 33
 - Manage Pictures..... 91
 - ManuallyYou..... 25
 - Match..... 95
 - Serial Number..... 95
 - Micro..... 5
 - Micro Door/Window..... 5
 - Micro— Model 60..... 41

Printed Documentation

mobile portal	57, 90	Newer	33
Mode Changes	47	Next section	41
Model 60	37, 41	Night	85
Modes .. 5, 13, 17, 27, 47, 71, 72, 74, 85, 88, 90, 95		NOT	29, 60, 63, 95
ModesYour	13	notification sent	40, 88
Changing	13	Notification When	88
Modifying	47	Notifications 5, 13, 17, 27, 40, 63, 64, 65, 68, 85, 88, 95	
The	47	Notifications generated	17
ModuleThe	52	Notifications tabThe	5
ModuleTo	52	Notifications Why	95
Mom's	47	Notifications window	88
Mon	85	Notify	64, 65, 85, 88
Monitor notification	95	Notify Lists	64, 65, 85
Monitored room	5	Now	22
More	93	O	
Motion .. 5, 13, 50, 51, 60, 63, 71, 72, 74, 85, 95		Obtain	35
Motion Sensor .. 5, 13, 60, 63, 71, 72, 74, 85, 95		WEP key	35
Motion sensor back	60	Occupied	5, 63, 71, 72, 74, 85, 95
Motion sensor detecting 5, 63, 71, 72		Occur today	5
Motion sensor detects movement .	60	Occurred	17
Motion Sensor generated	5	Off	5, 85
alarm	5	offline	5
Motion sensor light	95	OK	40, 68, 88
Motion sensor needs	60	Older	33, 91
Motion sensor recognizes	63	On weekdays	85
Motion sensor requires	60	Open	5, 43, 57, 71, 72
Motion SensorNow	60	Operate	13
Motion SensorYour	60	Other device	68
Mounting	41, 44	P	
Your	44	Panic	5, 64, 65, 74, 88, 95
moves across	60	Panic button	64, 65, 88, 95
sensor's field	60	Panic pendant	64, 65, 74, 88, 95
My Account	5	Panic Pendant Goes OffTo	88
N		Panic PendantThe	64, 65
NA	74	Panic Wristwatch	5, 74
Name	43, 67, 85	Part	27
green dot appears next	43	Person	64, 65
Needs	67	Personal web	89
Neuron ID	52	Personal web portal	5, 40
new automation	74	pertaining	
edit	74	Door/Window	17
New Automation window	74	Physical	55
open	74	Physically	44
		Physically install	55, 60

- Pictures 5, 13, 17, 20, 21, 25, 27, 29, 33, 43, 46, 47, 63, 71, 72, 74, 85, 89, 91, 95
 - camera takes..... 85
 - camera taking..... 71, 72
 - Deleting 29
- Pictures ScreenFrom 91
- Pictures Take 89
- Pictures taken 17, 33
 - retain all..... 33
- Pictures window 5, 25, 27, 29, 33
- PicturesTo delete 29
 - Deleting 29
- PicturesYou 27, 33
 - Managing 33
 - Sending 27
- Please 95
- plug 37, 55, 95
- PM 85
- Possible State 5
- Power..... 95
- Power LED..... 37, 95
- Powered device used..... 64, 65
- Powerline 52, 55
- Powerline Lamp ModuleShipped .. 95
- Pre 41
- Preconfigured 52
- premise 93
- Press..... 95
 - Test button 95
- Press Down Here..... 60
- Pressing..... 47, 95
 - Star button..... 47
- Purchased..... 19
- pushed 88
 - Panic pendant 88
- Q**
- QuikControl..... 5, 25, 56, 57, 85, 95
- QuikControl menu 56
- R**
- Reading Room Light 52
- Rear 5
- Recessed 5, 41
- red dot..... 5, 95
- Renaming 67
 - Devices 67
- DevicesYou 67
- Repeat Steps 95
- reports all 17
 - notifications generated..... 17
- Requires 24 95
- Reset..... 37
- Resistant 64, 65
- Retain all 33
 - pictures taken 33
- Rightpointing 5
- S**
- S/N' 95
- Sat..... 85
- Satellite broadband 95
- Save 47, 67, 74, 85
- Save Image 33
- Schedule windowThis window shows the..... 5
- ScheduleA picture 27
- schedules ... 5, 13, 17, 27, 50, 51, 57, 68, 85, 95
- Schedules following these steps ... 85
- Schedules tabYou 5
- Schedules window 5, 17, 85
- Schudules 22
 - use..... 22
- Screen..... 91
- Section 10.4 95
- Security 22, 35, 37, 41, 95
- Security Mode 22, 35
- See..... 5, 43, 93
 - check 43
- See Frequently Asked Questions .. 40
- See Section 8.2.1 95
- See Section 8.6 95
- Seein 5
- Select 57
 - desired brightness 57
- Send Me 88
- Send Picture..... 20, 21, 27
- Sending 27
 - PicturesYou 27
- sensing..... 60
 - infrared energy emitted 60
- sensor .. 5, 13, 17, 37, 41, 43, 44, 57, 60, 63, 65, 66, 71, 72, 74, 85, 95

Printed Documentation

Sensor detects heat	65, 66
Sensor needs	44
Sensor transmits	60
alarm	60
sensor's field	60
moves across	60
SensorNext	44
Sensor's field	60
view	60
Serial Number	95
camera matches	95
match	95
Service enables	33
Set	21, 47, 56, 57, 85
brightness	56
Up	21
Set Away Mode	74
Set Brightness Level	57
Set Thermostat Cool Setpoint	74
Set Thermostat Fan	74
Set Thermostat Heat Setpoint	74
Setpoint	85
Setpoints	85
Setup Assistant	21
Sign In	89
Sign Out Log	89
Simply tap	90
desired mode	90
Skip	41
instructions	41
Sleep	5, 13, 47, 74, 85, 88, 89
Sleep Mode	13, 47, 74
Smoke	5, 37, 65, 66, 74, 95
Smoke/Heat	65, 66
SMS	5, 63, 85, 95
So make	85
So that	95
Solution	50, 51
specific area	60
SSID	22, 35
Star button	46, 47
pressing	47
when pressing	47
Start Action	85
Star-Take	74
Starter Kit	5, 20, 21, 57, 95
Status ...	5, 17, 40, 43, 56, 57, 63, 89, 95
Alarm History window displays ..	43
check	43
Using Your Motion SensorTo	
check	63
Status changes	17, 63
Status window ...	5, 40, 43, 56, 57, 63
Status window lists	43
Steps	85
Store	5
Subject	27
Such	46
Suit	67
time	67
Summary ...	5, 17, 25, 27, 29, 33, 37, 40, 57, 63, 85, 95
Summary page	25, 40, 95
Summary tab	5, 25, 27, 57, 63
Summary tabThe	5
Sun checkboxes	85
System .	5, 13, 19, 20, 21, 22, 23, 25, 29, 37, 41, 43, 44, 46, 47, 52, 54, 67, 68, 74, 85, 89, 90, 93, 95
System initiates	95
action	95
System mode	5, 13, 46, 89, 90
changing	46
System operating	5
System page	5, 29, 37, 44, 95
System tab .	5, 22, 23, 37, 41, 43, 52, 54, 67, 68, 95
System tabYou	5
System turn	85
System window	37, 41, 52, 67, 95
T	
Take	5
Take pictures	20, 21, 25
Take pictures manually	25
Technology	37, 41, 52, 54
terms commonly used	85
Test	37
Test button	95
press	95
The	
Modifying	47

- The Front Hall Lamp Light 5
- The lights 74
- The Motion sensor 74
- Thermostat Adjust..... 89
- Thermostats 5, 71, 72, 74, 85, 89, 95
- Thumbnail screens..... 33
- Thumbnails 5, 33, 91
- Time..... 67
- suit..... 67
- To 50..... 5
- Today's 5
- Today's Schedule 5
- trigger.... 5, 17, 40, 60, 71, 72, 74, 88
- trip..... 95
- Try..... 95
- Turn 74, 85
- Turn Off..... 74
- Turn On..... 74
- Turn Up..... 85
- Heat..... 85
- TX 37, 41
- Type... 21, 22, 23, 27, 37, 41, 52, 64, 65, 71, 72, 74, 89, 95
- Type need..... 71, 72
- U**
- Uninterruptible..... 55, 95
- Unlock..... 13, 46, 47, 74
- Unlock-change..... 74
- Up
- Setting..... 21
- UPS 95
- use. 5, 13, 19, 20, 21, 22, 29, 33, 35, 37, 41, 50, 51, 57, 63, 67, 68, 85, 89, 91, 95
- Schudules 22
- Use its focus 29
- Useful tool..... 46
- User Manual 5, 95
- username..... 22, 35, 89
- Username and password you 89
- Using Your Carbon Monoxide
- DetectorOnce 40
- Using Your Door 43
- Using Your Motion SensorTo check
- 63
- status..... 63
- V**
- v1 iControl..... 19
- v2 iControl..... 19
- Vary..... 19
- View 60
- sensor's field..... 60
- View Alarms View..... 89
- View Status See..... 89
- W**
- wait..... 63, 90, 95
- wants.. 13, 29, 41, 43, 44, 47, 56, 68, 71, 72, 74, 85, 88, 91, 93
- Keychain Remote 47
- Star button 47
- Water..... 5, 44, 64, 65, 74, 95
- Water sensor 5, 74
- water-resistant..... 64, 65
- Wave 54
- Wave Lamp ModuleTo 54
- Ways 57
- Webpage..... 5
- Weekday 85
- WEP 35, 95
- WEP key 35
- When Grandma..... 88
- When pressing 47
- Star button 47
- Why doesnt 95
- Why?A..... 95
- Window sensor. 5, 13, 17, 41, 43, 57, 71, 72, 85, 95
- Window Sensor If..... 41
- Window SensorAfter..... 43
- Window SensorYou..... 43
- Windows..... 29, 33
- WindowsThe 5
- Wired..... 5, 20, 21, 44, 95
- Wireless ... 20, 21, 22, 23, 35, 64, 65, 67, 68, 91, 95
- Wireless Equivalent Privacy 95
- Wireless setting..... 21
- Wireless Settings 35
- Wires connected 95
- Within a minute 25
- Work..... 46
- drive off..... 46

Printed Documentation

WPA.....	35	Adding	57
Y		Your Lamp ModuleNext.....	55
Yes.....	68, 95	Your Powerline	52
Your		Installing	52
Determining	21	Your schedules	85
Installing	52	Your Starter KitWhen	21
Mounting	44	Your System.....	22
Your CameraTo focus.....	29	Your Z	54
Focusing.....	29	Installing	54
Your Carbon Monoxide DetectorTo		Youve	95
install	37	Z	
Installing	37	Z 54	
Your Door	43	Z-Wave.....	54
Your Keychain RemoteYou.....	57		

IC Warning statement
RSS-GEN 7.1.5: 只要filing IC,
都要放下列這段

Operation is subject to the following two conditions: (1) this device may not cause interference, and (2) this device must accept any interference, including interference that may cause

FCC Warning statement

This equipment has been tested and found to comply with the limits for a Class B digital device, pursuant to part 15 of the FCC rules. These limits are designed to provide reasonable protection against harmful interference in a residential installation. This equipment generates, uses and can radiate radio frequency energy and, if not installed and used in accordance with the instructions, may cause harmful interference to radio communications. However, there is no guarantee that interference will not occur in a particular installation. If this equipment does cause harmful interference to radio or television reception, which can be determined by turning the equipment off and on, the user is encouraged to try to correct the interference by one or more of the following measures:

- Reorient or relocate the receiving antenna.
- Increase the separation between the equipment and receiver.
- Connect the equipment into an outlet on a circuit different from that to which the receiver is connected.
- Consult the dealer or an experienced radio/TV technician for help.

You are cautioned that changes or modifications not expressly approved by the party responsible for compliance could void your authority to operate the equipment.

This device complies with Part 15 of the FCC Rules. Operation is subject to the following two conditions: (1) this device may not cause harmful interference and (2) this device must accept any interference received, including interference that may cause undesired operation

FCC RF Radiation Exposure Statement:

1. This Transmitter must not be co-located or operating in conjunction with any other antenna or transmitter.
2. This equipment complies with FCC RF radiation exposure limits set forth for an uncontrolled environment. This equipment should be installed and operated with a minimum distance of 20 centimeters between the radiator and your body.

IC Warning statement

RSS-GEN 7.1.5:

Operation is subject to the following two conditions: (1) this device may not cause interference, and (2) this device must accept any interference, including interference that may cause undesired operation of the device.

RSS-GEN 7.1.4:

User Manual for Transmitters with Detachable Antennas

The user manual of transmitter devices equipped with detachable antennas shall contain the following information in a conspicuous location:

This device has been designed to operate with the antennas listed below, and having a maximum gain of [1.8] dB. Antennas not included in this list or having a gain greater than [1.8] dB are strictly prohibited for use with this device. The required antenna impedance is [50] ohms.

RSS-GEN 7.1.5

To reduce potential radio interference to other users, the antenna type and its gain should be so chosen that the equivalent isotropically radiated power (e.i.r.p.) is not more than that permitted for successful communication.