



invoxia

Welcome / Bienvenue
NVX220

U.S. Federal Communications Commission (FCC) Compliance Statement

The changes or modifications not expressly approved by the party responsible for compliance could void the user's authority to operate the equipment.

To comply with the FCC RF exposure compliance requirements, this device and its antenna must not be co-located or operating to conjunction with any other antenna or transmitter.

This device complies with part 15 of the FCC Rules. Operation is subject to the following two conditions:

- (1) This device may not cause harmful interference, and
- (2) this device must accept any interference received, including interferences that may cause undesired operation.

Note: This equipment has been tested and found to comply with the limits for a Class B digital device, pursuant to part 15 of the FCC Rules.

These limits are designated to provide reasonable protection against harmful interferences in a residential installation. This equipment generates, uses and can radiate radio frequency energy and, if not installed and used in accordance with the instructions, may cause harmful interference to radio communications. However, there is no guarantee that interference will not occur in a particular installation. If this equipment does cause harmful interferences to radio or television reception, which can be determined by turning the equipment off and on, the user is encouraged to try to correct the interference by one or more of the following measures:

- Reorient or relocate the receiving antenna.
- Increase the separation between the equipment and receiver.
- Connect the equipment into an outlet on a circuit different from that to which the receiver is connected.
- Consult the dealer or an experienced radio/TV technician for help.

FCC Radiation Exposure Statement

This equipment complies with FCC radiation exposure limits set forth for an uncontrolled environment . This equipment should be installed and operated with minimum distance 20cm between the radiator & your body.

This transmitter must not be co-located or operating in conjunction with any other antenna or transmitter.

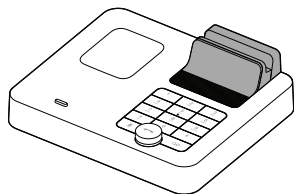

NVX220 base

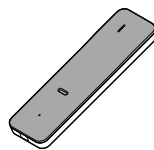

Handset

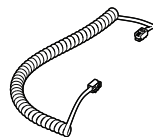

Handset cord

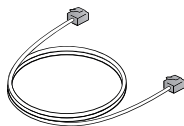

Ethernet cable

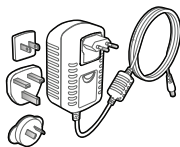

AC adapter

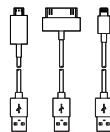

Lightning, 30 pin
and micro-USB cables

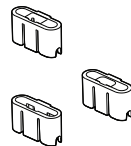

Lightning, 30 pin
and micro-USB cable adapters

Your NVX220 Phone

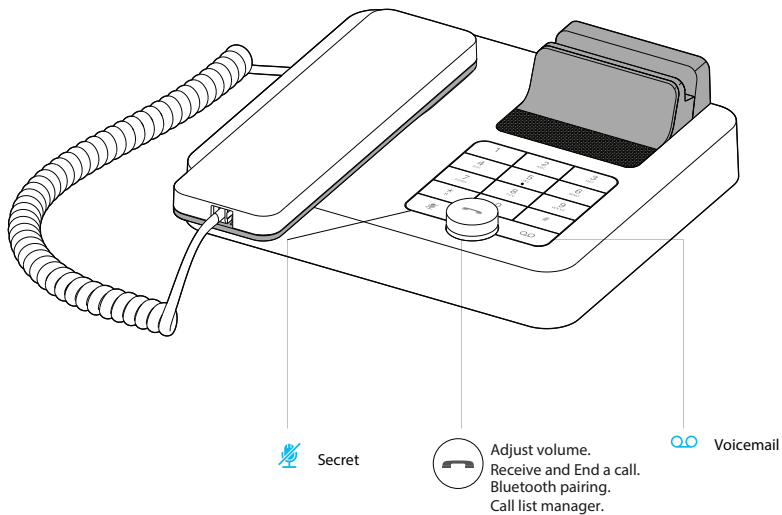

Designed and produced by invoxia, Paris

Positioning

Place your phone near your network socket (and near your mains supply socket if you are using a mains power adapter).

Connecting the base

This phone is powered by PoE (Power over Ethernet), if your network is compatible, or through your mains AC 100-240V supply.

1. Insert the cable suitable to your smartphone into the matching cable adapter.

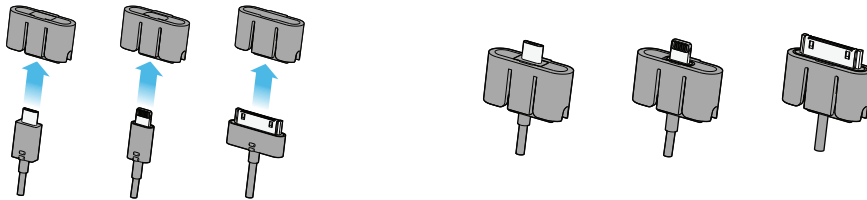

2. The cables may be placed at two levels for smartphones and tablets with cases.

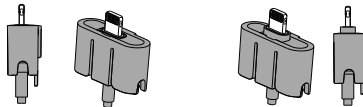

2. Slightly push the smartphone/tablet cradle rear part.
Place the cable and cable adapter in the special pocket of the receptacle.

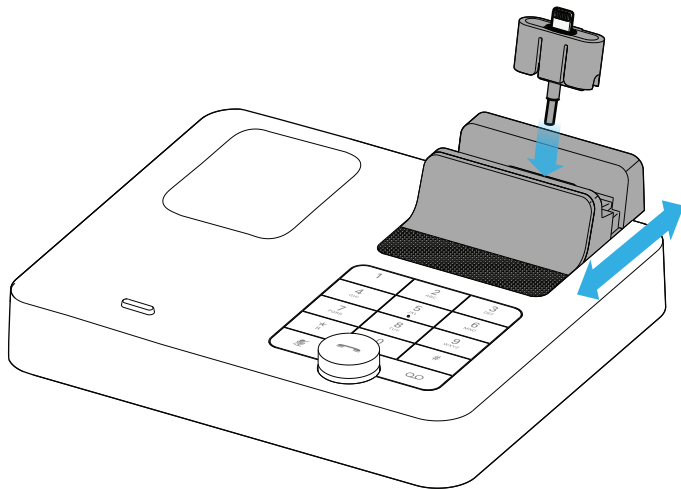

3. Plug the USB connector to the USB port under the device.

Plug one end of the Ethernet cable into the LAN connector at the back of the base and into your network telephone socket (PC port is to connect to your computer to provide Internet).

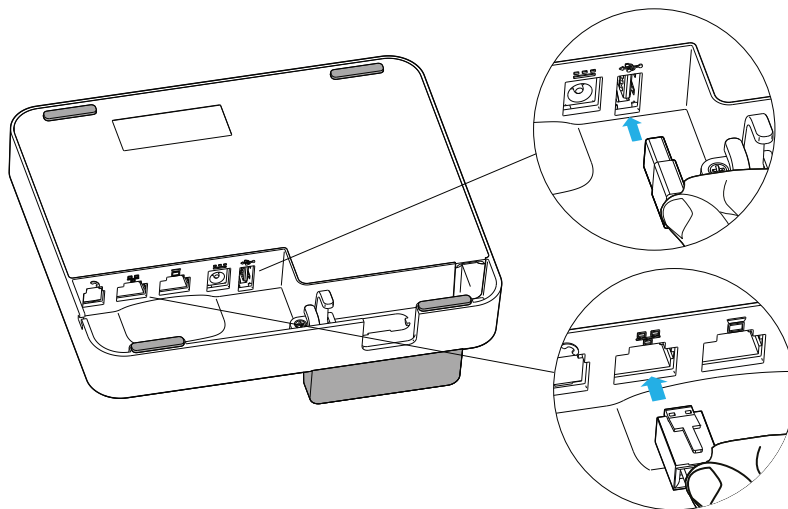

4. If you are using the mains supply, plug the mains power adapter into the back of the base and into a wall mount socket.

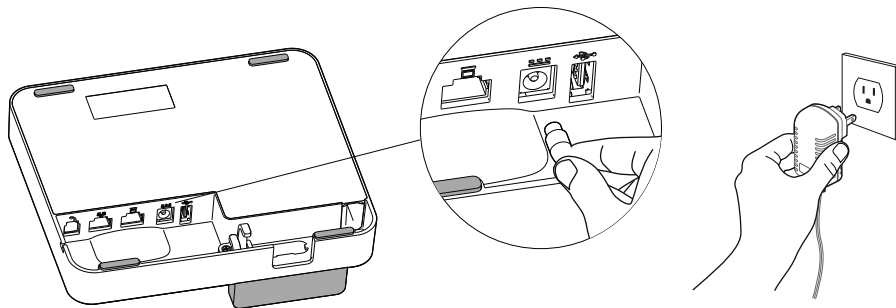

Installing the handset

1. Plug the cord of the handset into the handset and into the RJ11 port under the base.

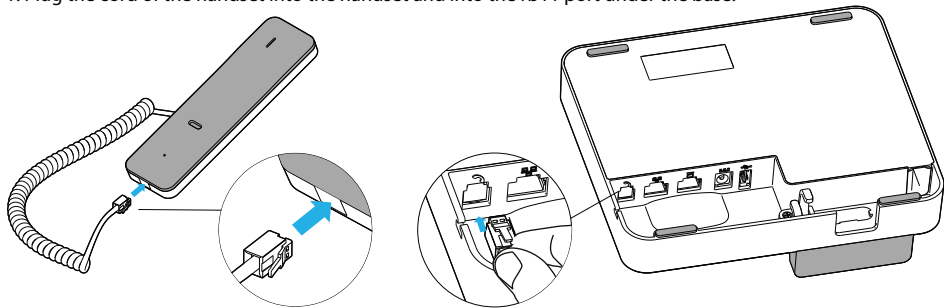

2. Slide the cord into place through the interstice under the base on the right.

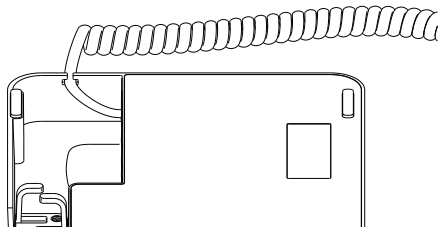

3. Slide the cords into place through the interstices under the base.

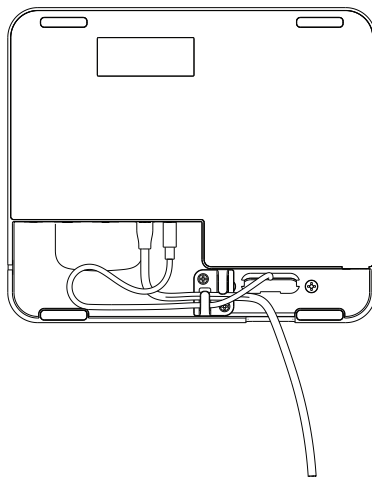

Guided by a need for simplicity shared with all smartphones and tablets, and for your own efficiency, we have built an App for your convenience.

This invoxia app let you configure and use the NVX220.



1. Dock your smartphone or pair your smartphone or tablet via Bluetooth.
2. Download the invoxia app.
3. Follow the instructions on your device to configure your invoxia phone based on your network provider's settings.
4. Once the installation is complete, you're ready to enjoy the full power of your invoxia phone.

You'll now easily find your Contacts, Recents, Keypad and Voicemail as well as easily transfer a call, make a conference call, swap between calls, etc.

Bluetooth 1st connection

With iOS 6, be sure your Bluetooth is activated first.

- Dock or connect via USB your iPhone/iPod/iPad. The Bluetooth connection is then automatic!
- For any devices, long push the volume button until you hear a sound signal. A «Pairing mode: invoxia is waiting for connection» message allows you to pair your NVX220 in your device Bluetooth menu. A final sound confirms the pairing.

Multiple connections: Pairing a new device / Reconnect a device

With iOS 6, be sure your Bluetooth is activated first.

- For any devices, long push the volume button until you hear a sound signal. A «Pairing mode: invoxia is waiting for connection» message allows you to pair your NVX220 in your device Bluetooth menu. A final sound confirms the pairing.
- Connecting a previously paired device is easy from its Bluetooth menu. The last connected device is the controlling device.

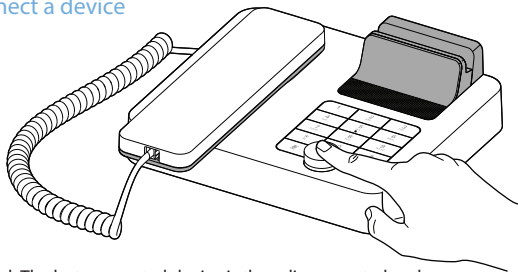

Disconnect a paired device

- Long push the volume button until hearing a double-sound signal. The last connected device is then disconnected and auto-connection is stopped. A «Disconnecting» message and sound signal confirms the disconnection.
- In your invoxia app, go to Settings > Bluetooth , you can tap «Unpair».

Unpair all the connected devices

- Long push the volume button until hearing a three-sound signal. A «Clearing all subscriptions» message confirms it.
- ⚠ Also forget the NVX220 from your device Bluetooth menu in order to complete future pairings between these devices.

Need help ?

Please visit the www.invoxia.com website for more information. You can review your NVX220 phone full user guide at www.invoxia.com/en/support.

«Made for iPod», «Made for iPhone», and «Made for iPad» mean that an electronic accessory has been designed to connect specifically to iPod, iPhone, or iPad, respectively, and has been certified by the developer to meet Apple performance standards.

Apple is not responsible for the operation of this device or its compliance with safety and regulatory standards.

Please note that the use of this accessory with iPod, iPhone, or iPad may affect wireless performance.

www.invoxia.com

© 2013 invoxia. All rights reserved.

Reproduction in whole or in part is prohibited without the prior written consent of the copyright holder.

Invoxia®, Experience your phone™, In Vivo Acoustic® are registered trademarks, names and logos are the property of invoxia.

iPod, iPhone, iPad, Lightning are trademarks of Apple Inc., registered in the U.S. and other countries.

Bluetooth™ is a trademark of Bluetooth SIG Inc.

Android is a trademark of Google Inc.

Printed in China.

Non contractual document.

