

KODAK PIXPRO AZ401

DIGITAL CAMERA

User Manual



BEFORE YOU START

Declaration of Conformity

Responsible Party: JK Imaging Ltd.

Address: JK Imaging Ltd., 17239 So. Main Street, Gardena, CA 90248 USA

JK Imaging Europe, 71 Clarendon Road, Watford, WD17 1DS, UK

Company Website: kodakpixpro.com

For Customers in the U.S.A.

Tested to Comply with FCC Standards FOR HOME OR OFFICE USE

This device complies with part 15 of the FCC Rules. Operation is subject to the following two conditions: (1) This device may not cause harmful interference, and (2) this device must accept any interference received, including interference that may cause undesired operation.

For Customers in Europe

 "CE" mark indicates that this product complies with the European requirements for safety, health, environment and customer protection. "CE" marked cameras are intended for sales in Europe.

 This symbol [crossed-out wheel bin WEEE Annex IV] indicates separate collection of electrical waste and electronic equipment in the European countries. Please do not throw the equipment into domestic refuse. Please use the return and collection systems available in your country for proper, safe disposal of this product.

 Batteries: Please dispose of used batteries at designated collection centers.

 Packaging: Please follow local regulations for the recycling of packaging.

About this Manual

Thank you for purchasing this KODAK PIXPRO Digital Camera. Please read this manual carefully and keep it in a safe place for future reference.

- JK Imaging reserves all rights of this document. No part of this published manual may be reproduced, transmitted, transcribed, stored in a retrieval system or translated into any language or computer language, in any form, by any means, without the prior written permission of JK Imaging.
- All trademarks mentioned in this manual are used for identification purposes only and are properties of their respective owners.
- This manual provides you with instructions on how to use your new KODAK PIXPRO Digital Camera. Every effort has been made to ensure that the contents of this manual are accurate, however JK Imaging reserves the right to make changes without notice.
- Throughout this manual, the following symbols are used to help you locate information quickly and easily:



Indicates useful information.

- In the instructions below, the following symbols may be used throughout this manual on how to operate the camera. This is to facilitate better understanding.

[Item properties] : The optional properties in the camera interface are indicated by the symbol [] .

SAFETY NOTES

Safety Notes for this Camera

- Do not drop the camera or allow it to hit solid objects.
- Do not attempt to disassemble or repair the camera.
- Do not use or store the camera in dusty places or on a beach to prevent dust or sand from entering the camera, causing possible damage to it.
- Do not use or store the camera in a hot environment or under direct sunlight.
- Do not use or store the camera near a powerful magnetic field, for example near a magnet or transformer.
- Avoid touching the lens of the camera.
- Do not expose the camera to direct sunlight for a long period of time.
- To prevent the camera from being damaged by moisture, do not use or store the camera in very humid environments, such as in rain or near bodies of water.
- If water accidentally comes in contact with the camera, turn the camera off, remove the battery and the memory card, and dry it within 24 hours.
- When you take the camera from a cold place to a warmer environment, condensation may occur. Please wait for a reasonable period of time before you turn it on.
- Before you remove the battery and memory card, the camera should be turned off.
- When you clean the body of the camera, do not use abrasive, alcohol-based or organic cleaner.
- Use a professional lens wiping cloth and dedicated cleaner to wipe and clean the lens.
- Download your photos and remove the memory card when you are going to store the camera for a long period of time.
- If this camera is not in use for a long time, please keep it in a dry and clean condition.
- Our company will not pay compensation for any failure of playback of pictures or videos caused by improper operation.

Safety Notes for Battery

- If battery fluid leaks inside the camera, contact our customer service department. If battery fluid leaks onto your skin, rinse your skin with clean water and seek immediate medical attention.
- Disposal of used batteries should be carried out in accordance with the local (national or regional) regulations.
- To prevent the battery from being damaged, do not drop the battery or allow it to hit solid objects or to be scratched by the objects.
- Do not let the battery come in contact with metal objects (including coins) to avoid short circuiting, discharging, excessive heat, or possible leakage.
- Do not attempt to disassemble the battery.
- Do not expose the battery to water. Always keep the battery contacts dry.
- Do not heat the battery or throw it into a fire to avoid a possible explosion.
- Do not store the battery in a hot environment or in direct sunlight.
- When the camera is stored for a long period of time, remove the battery and keep it in a dry place that is not accessible to infants and children.
- In a colder environment, the performance of the battery could be noticeably reduced.
- When you install the battery, install it according to the positive and negative markings on the battery compartment. Never force it into the battery compartment.

Safety Notes for Memory Card

- We suggest buying only well-known, name brand memory cards to ensure peak performance.
- Format the memory card using the camera before you use it or insert a new one.
- Do not drop the memory card or allow it to hit solid objects to avoid damaging it.
- Do not attempt to disassemble or repair the memory card.
- Do not expose the memory card to water. Always keep it dry.
- Do not remove the memory card when the camera is turned on. Otherwise, the memory card could be damaged.
- Do not directly edit the data on the memory card. Copy the data to your PC before you edit them.
- When the camera is stored for a long period of time, be sure to download your photos and remove the memory card. Store it in a dry environment.
- Do not modify the name of the files or folders of the memory card using your PC. Modifying the file names may cause the files to not be recognized on the camera or a possible error may occur.
- A photo taken with the camera will be stored in the folder that is automatically generated on the memory card. Do not store photos that are not taken using this camera in these folders as the pictures cannot be recognized during the playback.
- When you insert a memory card, make sure the notch of the card matches the markings on the top of the card slot.

Other Safety Notes

- Do not disconnect the power or turn the product off during the update process. Doing so may cause incorrect data to be written and the product may not power on later.
- Do not hang the neck strap of the camera around the neck of a child.
- When using your product on an airplane, observe the relevant rules specified by the airline.
- Due to the limitations of manufacturing technology, the LCD may have a few dead or bright pixels. These pixels do not affect the quality of the photos or video.
- Do not expose the LCD to water. In a humid environment, only wipe it with a soft and dry cleaning cloth.
- If the LCD is damaged, pay particular attention to the liquid crystal in the screen. If any of the following situations arise, take the recommended immediate action indicated below:
 1. If liquid crystal comes in contact with your skin, please wipe with a dry cloth, wash thoroughly with soap, and rinse with plenty of clean water.
 2. If liquid crystal gets into your eye, flush the eye immediately with plenty of clean water for at least 15 minutes and then seek for medical assistance.
 3. If liquid crystal is swallowed, immediately flush your mouth thoroughly with clean water and induce vomiting. Seek for medical assistance.

CONTENTS

BEFORE YOU START	1	MODE OVERVIEW	20
SAFETY NOTES	3	Display Setting	20
CONTENTS	7	LCD Screen Display	21
GETTING READY	11	Overview of the screen icons in photo shooting mode	21
Accessories Included	11	Overview of the screen icons in movie mode	23
Install lens cap and neck strap	12	Overview of the screen icons in playback mode	24
Part Names	13	Using the Mode Dial	25
Installing Battery and Memory Card	15	Auto Mode	26
Turn On / Off the Camera	17	Program AE	27
How to take pictures	17	Shutter Priority	27
Set your Language, Date/Time after the first power-on	18	Aperture Priority	28
Resetting your Language	18	Manual Mode	28
Set your Language, Date/Time	18	Face Beautifier	29
Resetting Date/Time	19	Panorama Mode	30
		Scene Mode	31
		Auto Scene Mode (ASCN)	33

Custom Settings.....	34	PLAYBACK	47
BASIC OPERATION.....	36	Viewing Photos and Videos	47
Using the Zoom Function.....	36	Thumbnail View	48
Focus Setting.....	37	Using Zoom Playback (for still pictures only).....	49
Macro Mode.....	38	Photos and Video Deletion	50
Self-timer Setting	39	Slideshow	51
Flash Mode	40	USING THE MENUS.....	52
White Balance Setting.....	41	Photo Setup Menu.....	52
Continuous Shot	42	Expo Metering (Exposure Metering).....	52
EV Setting	43	Image Size.....	53
Exposure Compensation	43	OIS.....	53
ISO.....	44	Cont. AF.....	54
Shutter Adjustment.....	44	HDR.....	54
Aperture Adjustment	45	Face Beautifier	55
Using Quick Recording	45	Scene.....	55
i Button Function Menu.....	46	Photo Shooting Setting Menu	57

Quality	57	Rotate	68
AF-Assist Beam	58	Resize	69
Digital Zoom	58	i button playback function.....	70
Date Imprint	59	Playback Setting Menu	71
Quick Review	59	Protect	72
Custom Settings	60	Delete	73
Face Detection	60	DPOF (Digital Print Order Format)	74
Movie Menu	61	Trim.....	74
Expo Metering (Exposure Metering)	61	Setup Menu	75
Video Quality.....	62	Sound Settings.....	75
OIS	62	Power Saver.....	76
Movie Setting Menu	63	Power Saver.....	76
Custom Settings	64	Language.....	76
Digital Zoom.....	64	World Time	76
Playback Menu	65	Date/Time.....	77
Playback	66	LCD Brightness.....	77
HDR.....	66	Battery Type	77
Touch-up	67		

Format	78
File Settings.....	78
Copy to Card.....	79
File Numbering.....	79
Reset.....	80
FW Version.....	80

CONNECTIONS..... 81

Connecting to a Computer.....	81
Setting the USB Mode	81
Transferring files to your computer.....	82
Video System	83
Set Eye-Fi Card Connection Mode .	84
Supported HDMI Connections	85
Connecting HDMI-Ready TV.....	85
Setting the USB Mode	86
Connecting to a PictBridge Compatible Printer	86

Connecting to your Printer.....	87
Print (with Date)	88
Using the PictBridge Menu	88
Print (without Date).....	89
Print Index	90
Print DPOF Images	91
Exit.....	91

APPENDICES92

Specifications.....	92
Prompts and Warning Messages	96
Troubleshooting	100

GETTING READY

Accessories Included

Your camera box should contain the camera model you purchased along with the following accessories. If anything is missing or appears to be damaged, please contact your retailer.

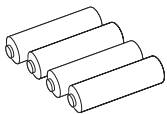

AA alkaline battery ×4



Neck strap

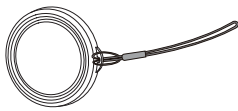

Lens cap with cord



Quick start guide



Warranty card



Service card

Install lens cap and neck strap

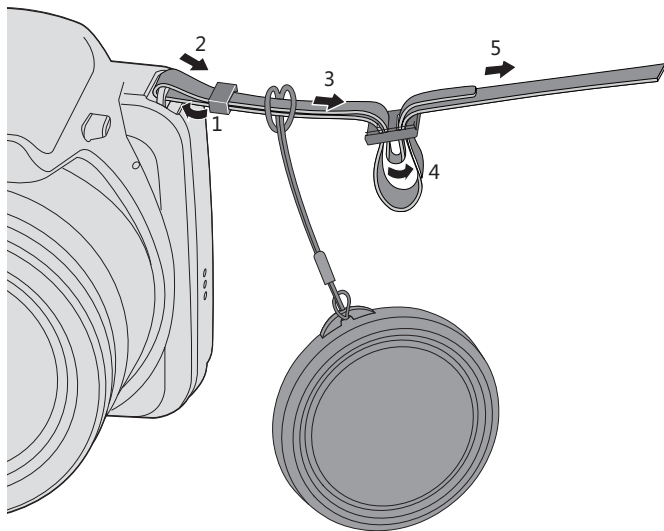

Part Names

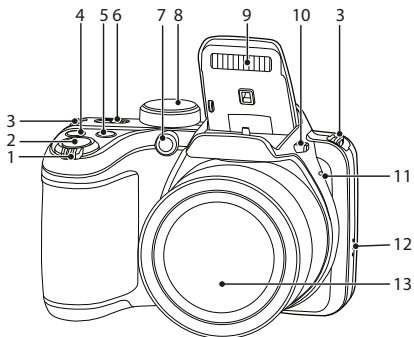

1. Zoom Lever
2. Shutter Button
3. Strap Eyelet
4. Exposure Compensation Button
5. Continuous Shot Button
6. Power Switch
7. AF Assist Beam/Self-timer Lamp
8. Mode Dial
9. Flash Lamp
10. Flash Button
11. Microphone
12. Speaker
13. Lens

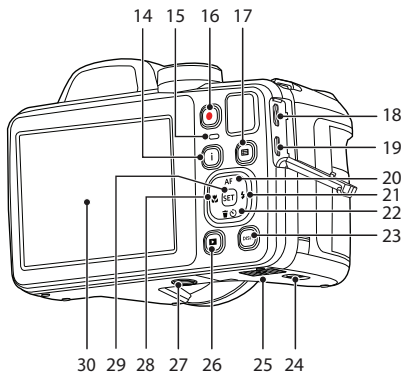

- 14. i Button
- 15. Indicator Lamp
- 16. Fast Video Recording Button
- 17. Menu Button
- 18. Micro USB Port
- 19. Micro HDMI Port
- 20. AF Button/Up Button
- 21. Flash Button/Right Button
- 22. Delete Button/Self-timer Button/
Down Button
- 23. Display Button
- 24. Battery Cover Switch
- 25. Battery Cover
- 26. Playback Button
- 27. Tripod Socket
- 28. Macro Button/Left Button
- 29. SET Button
- 30. LCD

Installing Battery and Memory Card

1. Open the battery cover according to ①,②,③.

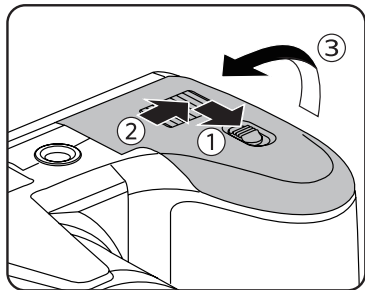

2. Insert the batteries into the battery slot in the correct position as shown in the following diagram:

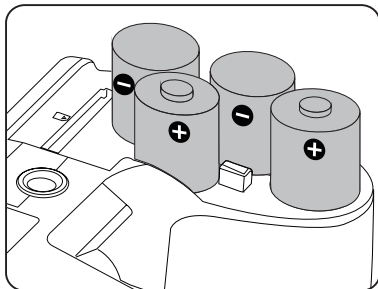

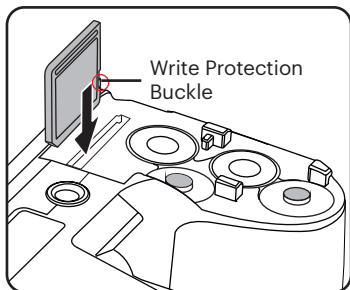

3. Insert the memory card into the memory card slot as shown in the diagram below:

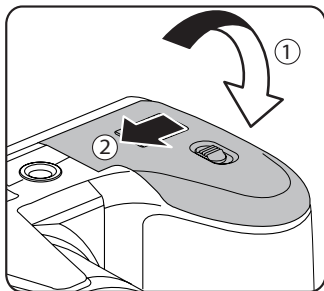

4. Close the battery cover according to ①,②.



 The memory card (SD/SDHC) is optional and not included in all camera packaging. It needs to be purchased separately. Please use an original memory card which is Class 4 or higher and has a capacity of 4GB to 32GB.

 To remove your memory card, open the battery cover, gently press the memory card to eject it and remove it carefully.

Turn On / Off the Camera

Slide the power switch to turn on/off the camera.

Power Switch

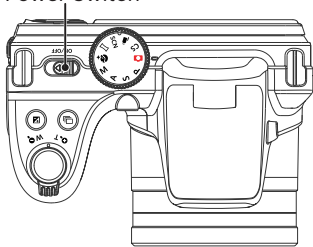

When the power is off, press and hold the  button to power on and enter playback mode.

How to Take Pictures

1. Hold the camera with both hands , not blocking the flash and lens by fingers.
2. Aim the camera at the object and then frame with the LCD.
3. Use the zoom lever to select Tele or Wide positions to zoom in or out on your subject.
4. Press the shutter button half way to focus on the subject. When the focus frame turns green, press the shutter button completely down to take the picture.

Set your Language, Date/Time

Set your Language, Date/Time after the first power-on

1. When you turn the camera on for the first time, the language selection screen appears.
 2. Press the arrow buttons to select your desired language.
 3. After you press the **SET** button to confirm the selection, the Date/Time settings screen appears.
 4. Press the left/right arrow buttons to select the Date/Time to be adjusted: Time is displayed in YYYY.MM.DD HH:MM.
 5. Press the up/down arrow buttons to adjust the value for the selected Date/Time.
 6. Press the **SET** button to confirm the time settings and the snapshot screen appears.
1. Press the **SET** button, press the up/down arrow buttons to select **SET**, and press the **SET** button to enter the menu.
 2. Press the up/down arrow buttons to select **☾**, and press the **SET** button or right arrow button to enter the menu.
 3. Press the up/down arrow buttons to select [Language] and press the **SET** button or right arrow button to enter the menu.
 4. Press the arrow buttons to select your desired language and press the **SET** button to confirm.
 5. Press the **SET** button and the snapshot screen appears.

Resetting your Language



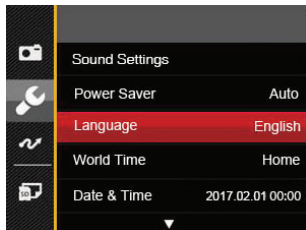



After you set your language for the first time, follow the instructions below to reset your language.







Resetting Date/Time

After you set your Date/Time for the first time, follow the instructions below to reset date and time.

1. Press the  button, press the up/down arrow buttons to select , and press the  button to enter the menu.
2. Press the up/down arrow buttons to select , and press the  button or right arrow button to enter the menu.
3. Press the up/down arrow buttons to select [Date & Time] and press the  button or right arrow button to enter the menu.
4. Press the left/right arrow buttons to select the Date/Time to be adjusted: Time is displayed in YYYY.MM.DD HH:MM.

5. Press the up/down arrow buttons to press the value for your selected block. After you finish your settings, press the  button to confirm.
6. Press the  button and the following snapshot screen appears.

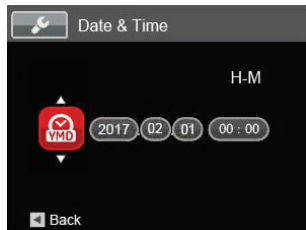
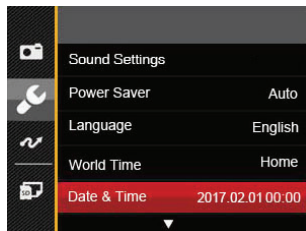

MODE OVERVIEW

Display Setting

Press the **DISP.** button to display the settings: Classic, Full, Off.

Classic: Displays the camera parameters on screen

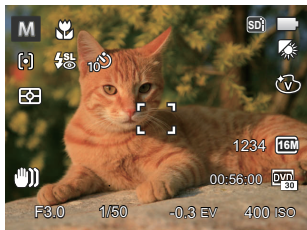

Off: Does not display any additional icons on screen

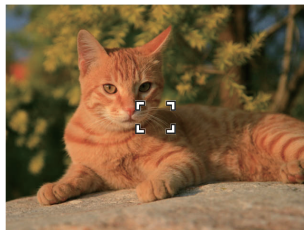

Full: Camera parameters with Grid and Histogram

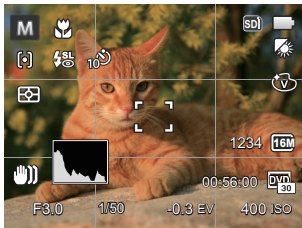





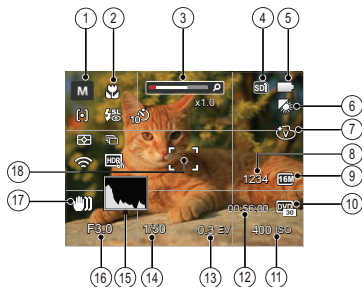



LCD Screen Display

Overview of the Screen Icons in Photo Shooting Mode





1 Shooting mode icons

- | | |
|--|---|
|  Auto Mode |  Face Beautifier |
|  Program AE |  Panorama Mode |
|  Shutter priority |  Scene Mode |
|  Aperture priority |  Custom Settings |
|  Manual Mode | |

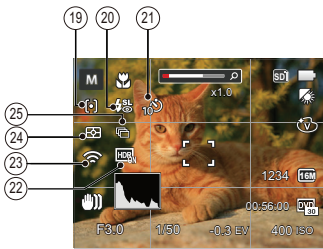





- 2 Macro mode
- 3 Zoom Display (By turning the zoom lever)
- 4 Memory card/Built-in memory
- 5 Battery status
- 6 White balance (Adjustable in **PSAM** mode)
- 7 Color Effect (Adjustable in **PSAM** mode)
- 8 Number of remaining shots
- 9 Image size
- 10 Video quality
- 11 ISO value (Adjustable in **PSAM +** mode)
- 12 Remaining recording time
- 13 Exposure compensation (EV value) (Adjustable in **PSA +** mode)
- 14 Shutter speed (Adjustable in **SM** mode)
- 15 Histogram
- 16 Aperture value (Adjustable in **AM** mode)
- 17 Image stabilization
- 18 Focus frame



19 AF mode

-  Single-AF
-  Multi-AF
-  Object Tracking

20 Flash mode

-  Force Off
-  Flash Auto
-  Force Flash
-  Slow Sync.
-  Slow Sync. + Red-Eye
-  Red-Eye Reduction

21 Self-timer

-  Self-timer Off
-  Self-timer 2 sec
-  Self-timer 10 sec
-  Self-timer Smile





22 HDR (Adjustable in **PSAM** mode)

23 Eye-Fi ON (with signal)

24 Expo metering

-  AiAE
-  Spot
-  Center

25 Continuous Shot

-  Single
-  Continuous Shot
-  3 Shots
-  Time-Lapse (30sec/ 1min/ 5min/ 10min)

Overview of the Screen Icons in Movie Mode

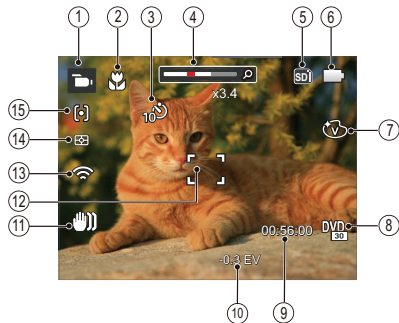

1 Movie mode icons

2 Macro mode

3 Self-timer



Self-timer Off



Self-timer 10 sec

4 Zoom display (by turning the zoom lever)

5 Memory card/Built-in memory

6 Battery status

7 Color effect

8 Video quality

9 Remaining recording time

10 Exposure compensation (EV value)

11 Image stabilization

12 Focus frame

13 Eye-Fi ON (with signal)

14 Expo Metering



AiAE



Spot



Center

15 AF mode



Use an SD memory card with Class 4 or higher for the video recording.



Optical Zoom and Digital Zoom can be adjusted (160X in total). Digital Zoom can be adjusted to 4X .



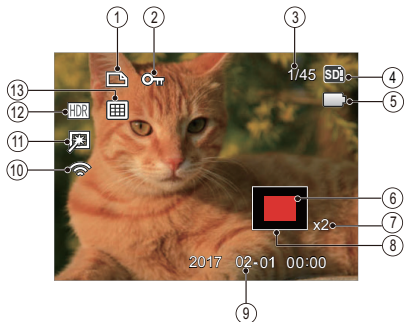

Overview of the Screen Icons in Playback Mode



- 1 DPOF file
- 2 File protection
- 3 Memory space (indicating the current number of photos and total number of photos)
- 4 Memory card/Built-in memory
- 5 Battery status
- 6 Zoom magnification area
- 7 Image zoom ratios
- 8 Image zone
- 9 Shooting date
- 10 Eye-Fi ON (with signal)
- 11 Touch-up
- 12 HDR
- 13 Date folder

Using the Mode Dial

This camera provides a convenient mode dial that allows you to manually switch among different modes with ease. The available modes are listed below:

Mode Name	Icon	Description
Auto Mode		In this mode, the optimal conditions for taking pictures will be set based on the subject and environment. It is the most commonly used mode for taking pictures.
Program AE	P	Under different scenes, the user can switch the ISO and EV value according to personal preference, the camera can automatically set the shutter speed and aperture value.
Shutter priority	S	Setting allows you to choose a specific shutter speed so the camera will adjust the aperture automatically to ensure correct exposure.
Aperture priority	A	Allows you to choose a specific aperture and the camera will automatically adjust the shutter speed to match it.
Manual Mode	M	Many of the camera settings can be configured manually in this mode.
Face Beautifier		This mode automatically enhances facial features with skin softening touches and eye brightening capabilities.
Panorama Mode		You can take a panoramic photo in this mode.
Scene Mode	SCN	Choose from 12 different pre-set scene types and effects for your photos.
Movie Mode		Record videos.
Custom Settings	CS	The user can store the frequently used shooting modes and parameters and switch to this mode for quick adjustment.

Auto Mode



Auto mode is the easiest mode to take photos. While operating in this mode, the camera automatically optimizes numerous camera settings to adjust your photos and videos for the best possible results.

Follow these steps:

1. Turn the power switch to turn on the camera.
2. Turn the mode dial to .
3. Compose your picture in the LCD and press the shutter button halfway down to focus on the subject.
4. The LCD will show a green focus frame when the subject is in focus.
5. Press the shutter button all the way down to take pictures.

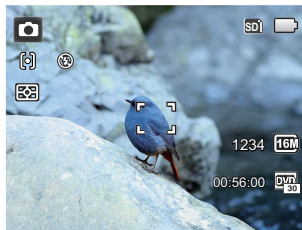

Program AE **P**

When **P** (Program AE) mode is selected, you can adjust the EV value and ISO value.

1. Turn the mode dial to **P** and press the  button to configure settings.

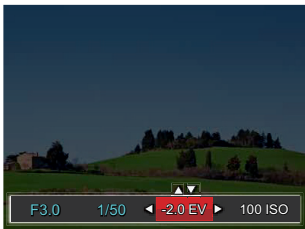

2. Press the left/right arrow buttons to select an adjustment item.
3. Press the up/down arrow buttons to adjust the parameters.
4. Press the  button to engage the settings and enter the shooting screen.

Shutter Priority **S**

When **S** (Shutter priority) is selected, you can adjust the shutter speed, ISO value and EV value. The camera automatically sets the aperture value based on the shutter speed value and ISO value to get the most appropriate exposure value.

1. Turn the mode dial to **S** and press the  button to configure settings.





2. Press the left/right arrow buttons to select an adjustment item.
3. Press the up/down arrow buttons to adjust the parameters.
4. Press the  button to confirm the settings and enter the shooting screen.

Aperture Priority **A**

When selecting **A** (Aperture priority) mode, you can adjust the aperture size / EV value and ISO value. Selecting a large aperture opening will emphasize the point of focus and show a blurry background and foreground. A small aperture opening will keep both the background and main object in clear focus.

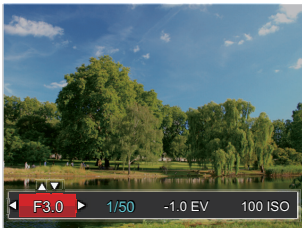
1. Turn the mode dial to **A** and press the  button to configure settings.



2. Press the left/right arrow buttons to select an adjustment item.
3. Press the up/down arrow buttons to adjust the parameters.
4. Press the  button to confirm the settings and enter the shooting screen.

Manual Mode **M**

When selecting manual (**M**) mode, you can set the aperture / shutter speed manually and ISO value.





1. Turn the mode dial to **M** and press the  button to configure settings.





2. Press the left/right arrow buttons to select an adjustment setting.
3. Press the up/down arrow buttons to adjust the parameters.
4. Press the  button to confirm the settings and enter the shooting screen.

Face Beautifier

In portrait mode, the camera is set to automatically adjust camera exposure for realistic portrayal of skin tones.

1. Turn the mode dial to select face beautifier mode ().
2. Press the  button and press the up/down arrow buttons to select  .
3. Press the left/right arrow buttons to select face beautifier effects and press the  button to confirm and return to photo shooting mode.

Beautifier mode has 3 effects:

-  Effect 1: Skin Soften
-  Effect 2: Skin Soften + Eye Brightening
-  Effect 3: Skin Soften + Eye Brightening + Eye Enlargement



Panorama Mode

With panorama mode, you can take a series of pictures which will be stitched automatically into a ultra-wide panoramic picture by the camera.

Follow the steps below:

1. Turn the mode dial to panorama mode ().
2. Press the arrow buttons to select a shooting direction. (The right direction is used as default if you do not make any choice) 2 seconds later, the camera is ready to take pictures. You can also press the **SET** button or half press the shutter button to be ready to take pictures.
3. Compose the first view of the panoramic picture on the LCD and press the Shutter button to capture the image.

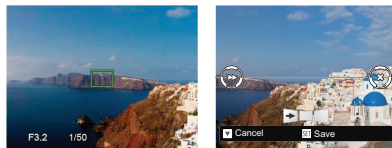

4. When you finish shooting the first photo, two target icons will display on the LCD at left and right sides. Move the camera to the right until the round target icon is directly positioned over the square box. The box will turn green when they overlap and the camera will automatically take the next picture. Repeat the same steps for additional shots. Up to 4 frames can be stitched together.
5. If continuous pictures are less than 4 shots, press the **SET** button and the camera will stitch the pictures automatically. Press the playback button to enter playback mode to see the effect.
6. If you take 4 pictures, the camera will automatically stitch the pictures. Press the playback button to enter playback mode to see the effect.

During shooting, the flash, self-timer, macro modes and exposure compensation are not available. Focus adjustment is also not available at this time.

In the process of shooting in the panoramic mode, when the LCD shows “Improper alignment. Please try again.”, it means that in the process of camera moving, the moving angle is off the green line, shooting can't be done. You will have to try again.

In order to guarantee the shooting effect in the panoramic mode, please keep moving horizontally and reduce the shake in the process of camera movement.

In panorama mode, up to 4 photos can be captured when the image size is set at 2MP.







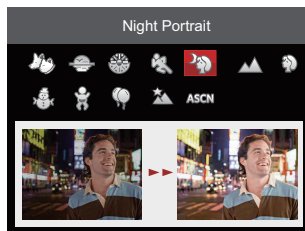





Scene Mode SCN

You can select an appropriate mode from the 12 scene modes according to the type of environment you are shooting. The camera then configures the most appropriate settings automatically.

1. Turn the mode dial to the scene mode, then the LCD will display as below:









2. Press the arrow buttons to select a scene, and press the **SET** button to confirm.
3. If any need of changing the scene, please press the **MENU** button and then the **SET** button and finally the arrow buttons to reselect the scene.

Scene	Description
 Pet Mode	Rapidly identify pet (dog/cat), capture the dynamic moment of pet.
 Sunset	For sunsets. Capture subjects in strong sunlight.
 Fireworks	For fireworks at night. The use of a tripod is recommended.
 Sport	For fast-moving subjects. Capture sharp, action shots with minimal blur. This mode is not recommended for shooting indoors.
 Night Portrait	For portraits against night scenery.
 Landscape	For landscapes and outdoor shots. Vivid reproduction of green and blue.
 Portrait	Most suitable for capturing people with focus on their face.
 Snow	For snow scenes. Reproduce natural, clear white scenes.
 Children	Turns off flash automatically. Avoids disturbing subject, suitable for taking photos of children.
 Party	Suitable for taking indoor party pictures, even under the complicated lighting conditions.
 Night Landscape	For night scenes. The use of tripod is recommended.
 Auto Scene	Identifies the scene automatically: Person, Backlighting, Landscape, Macro, Night Scene, Night Scene Person, Auto.

Auto Scene Mode (ASCN)

In “ASCN” scene mode, the camera can detect different environments intelligently and automatically select the best scene and photo settings for you.

“ASCN” can intelligently detect the following scenes:

Mode Name	Description
 Landscape Mode	For landscapes, will automatically adjust the exposure and reproduce vivid green and blue colors.
 Portrait Mode	Most suitable for capturing people with focus on their faces.
 Night Portrait	When you take portraits at night, or in low light conditions, will automatically adjust the exposure for people and night scenes.
 Backlit Portrait	When the sun or any other light source is behind you, will automatically adjust the foreground exposure to produce the best pictures possible.
 Night Landscape Mode	For night scenes, will automatically increase the ISO value to compensate for low light.
 Macro Mode	The Macro setting is ideal for shooting small objects or close-up photos.
 Auto Mode	The camera will automatically adjust the exposure and focus to ensure the best possible pictures.

Custom Settings CS

The user can store the frequently used shooting modes and parameters and switch to this mode for quick adjustment.

Settings under CS mode (unset state or state after reset):

1. Turn the mode dial to select the **CS** mode, and enter the setup screen, as shown in the figure below:



2. As shown in the above figure, press the left/right arrow buttons to select a capture mode that you want to define as **CS**, and press the **SET** button to enter the shooting screen.
3. As shown in the above figure, press the **SET** button, and choose whether to continue the **CS** mode setting or rotate the mode dial to skip.

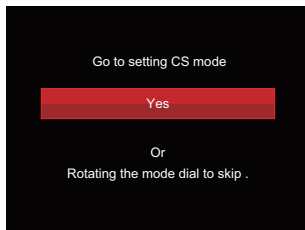

For setting under other modes (use this method to select a different custom setting):

1. Select any mode to be stored.
2. Set your desired parameters in the current mode.
3. Press the **SET** button, press the up/down arrow buttons to select **SET**, and press the **SET** button to enter the menu.
4. Press the up/down arrow buttons to select **CS**, and press the **SET** button or right arrow button to enter the menu.

5. Press the down arrow button select [Custom Settings] and press the  button or the right arrow button to enter the menu.

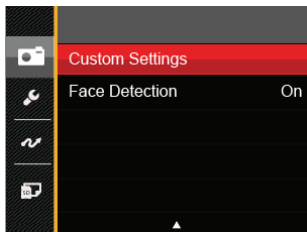

6. Select [Yes] to save or [No] to cancel.

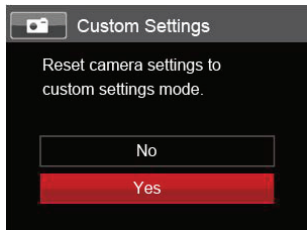

7. Turn the mode dial to switch to the custom settings (**CS**).
8. The photo settings you stored the last time are invoked.



When the **CS** mode is used for the first time, there is no preset parameter stored in the **CS** mode.



Under the **CS** mode, if you need to retain or modify the set parameters (except the parameters in ) in restart or all modes. Please enter the [Custom Settings] menu and select [Yes] after setup. Otherwise, the parameter settings are not retained in the case of switching on/off or mode switching.



If you want to remove the parameter setting of [Custom Settings] , please see the reset function on page 80 to operate.

BASIC OPERATION

Using the Zoom Function

Your camera is equipped with two types of zoom functions: Optical Zoom and Digital Zoom. Toggle the zoom lever of the camera to zoom in or out of the subject while taking pictures.

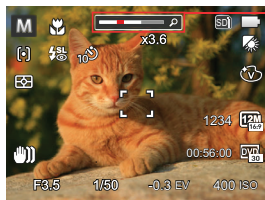
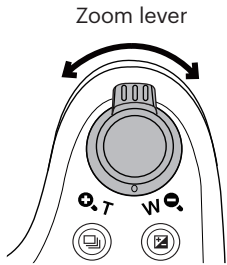

Zoom indicator

When the optical zoom reaches the threshold as digital zoom, release and turn the zoom lever to T to switch between the optical zoom and digital zoom.

Focus Setting

In different photo shooting modes, you can select different focus methods.

1. Press the up arrow button (**AF**) to display the settings screen.



2. Press the left/right arrow buttons to select the following 3 modes:



Single-AF

The focus frame appears on the center of the LCD to focus on the subject.



Multi-AF

The camera automatically focuses the subject in a wide area to find the focus point.



Object Tracking

Smart tracking of the object in motion under the focusing shooting.

3. Press the **SET** button to confirm the settings and exit the menu.





Once enabled, object tracking will only work when lens is focused on the object.

Macro Mode

The macro setting is ideal for shooting small objects or close-up photos. This mode allows you to focus on subjects very close to the camera.

1. Press the left arrow button () to enter the macro menu.



2. Press the left/right arrow buttons to select the following 2 modes:
 -  Macro Off
Select this option to disable macro.
 -  Macro On
Select this option to make focusing on the object closer to the lens (At the W side, the shooting distance should be more than 1.6 cm).
3. Press the  button to confirm the settings and exit the menu.



Self-timer Setting

Using this function can take photos at regular time. The camera can be set to shoot after 2 seconds, 10 seconds since pressing the shutter or shoot after smile.

1. Press the down arrow button () to enter the self-timer menu.



2. Press left/right arrow buttons to select the following 4 modes:



-  Self-timer Off
Disables the Self-timer.
-  Self-timer 2 sec
A single picture is shot 2 seconds after the shutter button is pressed.

-  Self-timer 10 sec
A single picture is shot 10 seconds after the shutter button is pressed.

-  Self-timer Smile
Press the shutter button and a picture will be taken immediately after a smile is detected.

3. Press the  button to confirm the settings and exit the menu.

 When enabling the self-timer, pressing the shutter or the or down arrow button can disable the self-timer and return to the shooting screen while keeping the self-timer setting.

 When enabling the smile detection, pressing the shutter button or  button can disable the self-timer without keeping the self-timer-smile setting.

Flash Mode

The flash provides supplemental light for the scene. The flash is usually used when shooting against the light to highlight the object; it is also suitable for metering and shooting in darker scenes to improve the exposure.







1. Press the flash button  to pop up the flash.



2. Press the right arrow button () to enter the flash settings menu.



3. Press the left/right arrow buttons to select the following 6 modes:

-  Force Off
Flash is turned off.
-  Flash Auto
Camera flash goes off automatically based on existing light conditions.
-  Force Flash
The flash will engage with each shot even if there is enough available light to take the photo without flash.
-  Slow Sync.
This allows you to take pictures of people at night that clearly show both your subjects and the night time backdrop. The use of a tripod is recommended when shooting with this setting.
-  Slow Sync. + Red-Eye
Use this mode for slow synchro shots with red-eye reduction.
-  Red-Eye Reduction
The camera emits a brief pre-flash before the picture is taken to reduce red-eye effects.

4. Press the **(SET)** button to confirm the settings and exit the option.

White Balance Setting









The white balance function allows adjustment of the color temperature for different light sources (Adjustable in **PSA M** mode).

Follow the steps below to set white balance of the camera:

1. Press the **SET** button to enter white balance menu.



2. Press the left/right arrow buttons to select the following 8 modes:

-  AWB
 -  Daylight
 -  Cloudy
 -  Fluorescent
 -  Fluorescent CWF
 -  Incandescent
 -  Manual WB (Fully press the shutter button to detect the white balance value)
 -  Color Temp. (1900K-10000K)
Press the direction buttons up / down to "Adjust the K value";
Press the direction button Left to exit the K value.
3. Press the **SET** button to confirm the settings and exit the menu.



Continuous Shot



Follow the steps below to configure the continuous shot settings:

1. Press the  to enter the continuous shot menu.



2. Press the left/right arrow buttons to select the following 4 modes:

-  Single
-  Continuous Shot

-  3 Shots
-  Time-Lapse
Take pictures based on the preset interval (30sec/ 1min/ 5min/ 10min).

3. Press the  button to confirm the settings and exit the menu.
4. Press the shutter button to start continuous shooting.

-  The flash is disabled in this mode in order to achieve quick succession of shots.

EV Setting

The EV function menu of the camera includes functions, such as EV adjustment, ISO, Shutter Adjustment, Aperture Adjustment, etc. Using the appropriate function settings can improve your pictures.

To select the best setting for optimum photos, follow these steps:

1. Press the  button to display the settings screen.
2. Press the left/right arrow buttons to select the setting options.

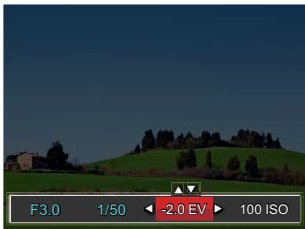

3. Press the up/down arrow buttons to adjust the option values.
4. Press the  button to complete the setting and enter shooting mode.

Exposure Compensation

Set up to adjust the picture brightness. In the case of a very high contrast between the photographed object and the background, the brightness of the picture can be appropriately adjusted. (Adjustable in **PSA**  mode)

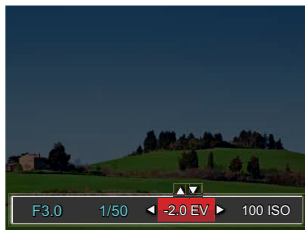

The adjustable range of exposure value is from EV -2.0 to EV+2.0.

ISO

The ISO function allows you to set the sensitivity of the camera's light sensor based on the brightness of the scene. To improve the camera's sensor performance in darker environments, a higher ISO value is required. A lower ISO value is needed when shooting in brighter conditions.

Pictures taken at higher ISO settings will generally have more noise than those taken at lower ISO settings. (Adjustable in **PSAM** + mode)

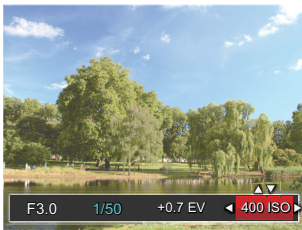

The camera's ISO settings include: Auto, 80, 100, 200, 400, 800, 1600 and 3200.

Shutter Adjustment

For shutter speed, the camera may automatically set the aperture value corresponding to the manually set shutter speed so as to obtain a most suitable exposure value. The movement of object may be shown by adjusting the shutter speed. High shutter value can make you clearly capture the movement of fast moving object while low shutter value can allow you to take a picture for fast moving object with a strong sense of movement. (Adjustable in **SM** mode)

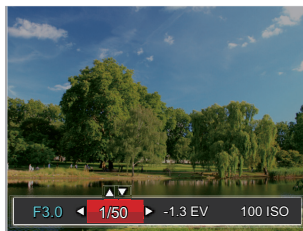

Aperture Adjustment

You can adjust the aperture size value. Selecting a large aperture opening will emphasize the point of focus and show a blurry background and foreground. A small aperture opening will keep both the background and main object in clear focus. (Adjustable in **AM** mode)

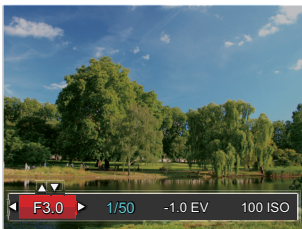

Using Quick Recording

In shooting mode, press the recording shortcut button  to begin recording video.

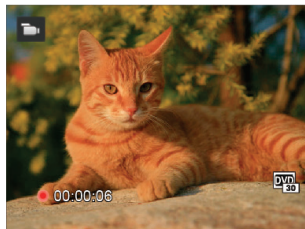

After finishing, press the recording shortcut button or the shutter button to stop and store the video. The camera will return to shooting mode automatically.

i Button Function Menu



Mode: **PSAM** 



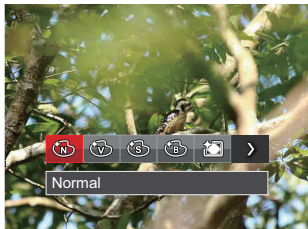

The image color setting allows you to select different effects.

1. Press the **i** button to select the image color setting menu.
2. Press the left/right arrow buttons to select the image color setting options.







There are 7 image color options in photo shooting mode **PSAM**:

-  Normal
-  Vivid

-  Sepia
-  Black and White
-  Vignetting
-  Salon
-  Dreamy



There are 4 image color options in movie mode :

-  Normal
-  Vivid
-  Sepia
-  Black and White

PLAYBACK

Viewing Photos and Videos

To view photos and videos on LCD:

1. After pressing the  button, the last photo or video clip taken will be displayed on the LCD.
2. Use the left/right navigation buttons to scroll through the photos or video clips stored in the internal memory or on the memory card.
3. To play a selected video clip, press the  button to enter the movie playback mode.

An operation guide appears on the screen when playing back a video. Press the appropriate buttons to enable the corresponding functions.

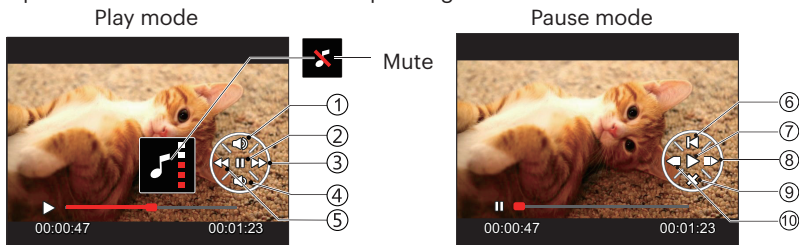

1	Increase volume
2	Pause
3	Fast forward
4	Decrease volume
5	Rewind

6	Back to the beginning of the video
7	Play
8	Play video forward
9	Cancel playback
10	Play video backward

Thumbnail View

When in playback mode, rotate the zoom lever counter clockwise to the **W** position to display thumbnail images of the photos and videos on the screen.

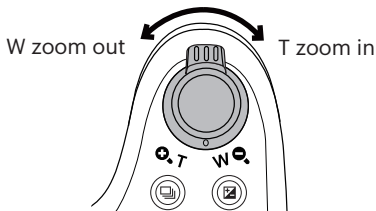

1. Slide the zoom lever to switch between 3x3 and 4x4 thumbnails.

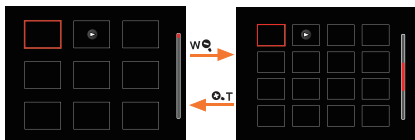



2. Press the arrow buttons to select a picture or video clip to view and press the **SET** button to restore it to the original size.

If the **▶** indicator appears on the LCD, then a movie file is currently being displayed.

Using Zoom Playback (for still pictures only)

When playing back photos, you can also use the zoom slider to zoom in on the photos 2 to 8 times.

1. Press the  button to switch to playback mode.
2. Press the left/right arrow buttons to select a picture to be zoomed in.
3. Rotate the zoom lever clockwise to () to zoom in.
4. The bottom right corner of the screen will display the number of times and area of the photo zooming operation.

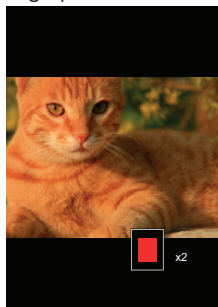
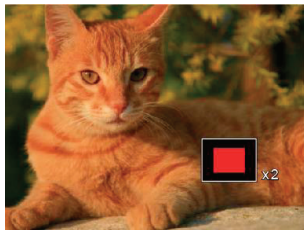





5. Press the arrow buttons to navigate and select a part of the image to be zoomed in.
6. Press the  button to return the image to its original scale.





Movie images cannot be magnified.

Photos and Video Deletion

In playback mode, press the down arrow button   to delete your photos and videos.
To delete photos or videos:

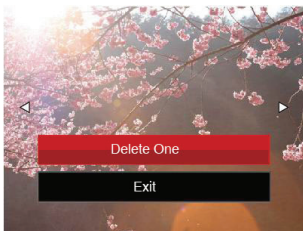
1. Press the  button to switch to playback mode.
2. Press the left/right arrow buttons to select the photos and videos to be deleted.
3. Press the down arrow button   and the deletion screen is displayed.



4. Press the up/down arrow buttons to select [Delete One] or [Exit] and press the  button to confirm.





Erased photos/video clips cannot be recovered.





Please refer to page 73 for instructions on deleting more than one image at a time.

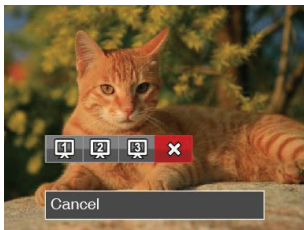

Slideshow

You can use this setting to view the pictures taken by the method of slide playing.

1. Press the  button to enter playback screen.
2. Press the  button to enter the slide option (except for video file).
3. Press the left/right arrow buttons to select slideshow playing or [Cancel] to return to the playback screen.





4. Press the  button to confirm the setting.

-  Pictures rotate automatically during a slide show.
-  Slide playing function supports movie playing.

USING THE MENUS

Photo Setup Menu

Mode:  **PSAM** +  **SCN**

1. In photo shooting mode, press the  button to enter the photo shooting menu.
2. Press the up/down arrow buttons to select the photo shooting menu to be set.
3. Press the left/right arrow buttons to select the photo shooting menu to be set and press the  button to confirm.



Refer to the following pages for more details about each setting.

Expo Metering (Exposure Metering)

Use this setting to select the "target" size of the camera's field of view to be metered.



There are 3 options:

- AiAE (Artificial Intelligence AE): tAutomatically selects the central and peripheral metering, to calculate the reasonable value of metering by weighting.
- Spot : Metering targets a small area in the center of the camera's field of view.
- Center: Metering targets a slightly larger area in the center of the cameras field of view.

Image Size

The size setting refers to the image resolution in pixels. A higher image resolution allows you to print that image in larger sizes without degrading the image quality.

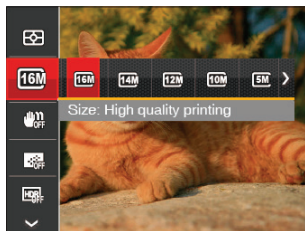

- The bigger the number of recorded pixels is, the better the image quality becomes. As the number of recorded pixels lessen, you will be able to record more images on a memory card.

OIS

This mode can help reduce photo blur caused by unintentional hand shake, or low light.



- Use this image stabilization mode in dark environments.
- Shooting in a windy or unstable environment (such as a moving vehicle) may cause blurred images.
- Using a tripod, suggest the image stabilizer is deactivated.

Cont. AF

Enable the continuous AF to be able to continuously focus automatically when taking pictures.



There are 2 options:

- Off
- On

HDR

With the HDR function, pictures that are overexposed may be corrected to optimize the highlights and lowlights captured to more accurately represent the actual scene. (Use of tripod is recommended)



There are 2 options:

- Off
- On





In the scenario with high light contrast (too dark or too light), this function can be used to shoot satisfactory photos.

Face Beautifier

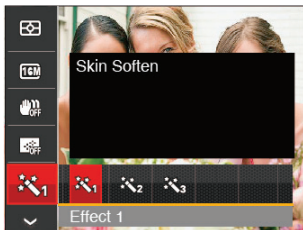
Set the effect of the face beautifier mode.



Face beautifier mode has 3 effects:

-  Effect 1: Skin Soften
-  Effect 2: Skin Soften + Eye Brightening
-  Effect 3: Skin Soften + Eye Brightening + Eye Enlargement

Scene

Select the scene mode under the SCN mode.

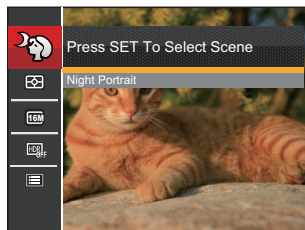

- Shooting menu in the shooting mode (O: Optional X: Not optional)

















Options	Shooting Modes					
		P	S	A	M	
	O	O	O	O	O	O
	O	O	O	O	O	O
	O	O	O	O	O	O
	O	O	O	O	O	O
	O	O	O	O	O	X
	X	X	X	X	X	O

Photo Shooting Setting Menu

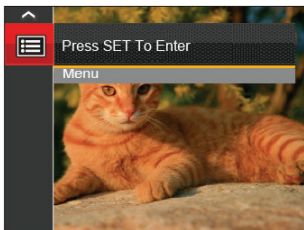
Mode: **PSAM** +   **SCN**

1. Press the  button in photo shooting mode and press the up/down arrow buttons to select .



2. Press the  button to enter the menu.
3. Press the up/down arrow buttons to select , and press the  button or right arrow button to enter the menu.
4. Press the up/down arrow buttons to select the item to be set and press the  button or right arrow button to enter the menu.
5. Press the up/down arrow buttons to select an option and press the  button to confirm.

Quality

The quality setting can be used to adjust the image compression ratio.

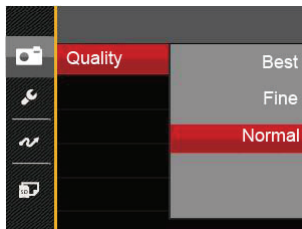

There are three options for picture quality:

- Best (16M Average File Size: 4.0MB)
- Fine (16M Average File Size: 2.6MB)
- Normal (16M Average File Size: 2.2MB)

AF-Assist Beam

In a darker environment, AF assist beam can be turned on for better focus.

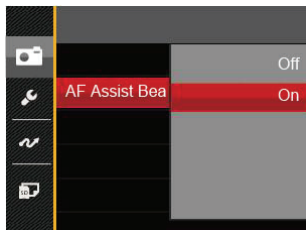

Digital Zoom

This setting is for adjusting digital zoom. If this function is disabled, only optical zoom can be used.

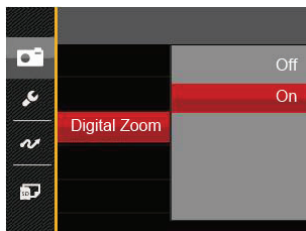

Date Imprint

Include a Date/Time stamp on the photo image.

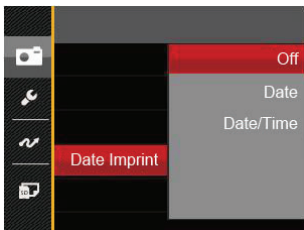

- Off
- Date
- Date / Time

Quick Review

This option allows quick review of the photos immediately after they are taken. Each photo is displayed on the LCD based on the selected time.

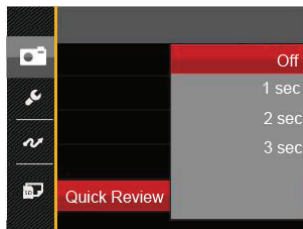

There are 4 options:

- Off
- 1 sec
- 2 sec
- 3 sec

Custom Settings

Custom settings stores the current photo shooting mode and its parameters. The stored mode and parameters are directly invoked in custom settings mode.

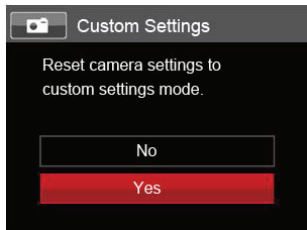

There are 2 options:

- No
- Yes

Face Detection

For detecting and focusing on faces to make all faces as clear as possible in photo mode.

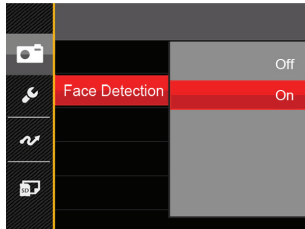



There are 2 options:

- Off
- On

Movie Menu

Mode: 

1. Turn the mode dial, select the  mode and press the  button to enter the movie menu.

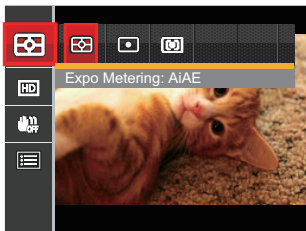

2. Press the up/down arrow buttons to select the movie menu to be set.
3. Press the left/right arrow buttons to select the movie menu to be set and press the  button to confirm.

Expo Metering (Exposure Metering)

Use this setting to select the "target" size of the camera's field of view to be metered.

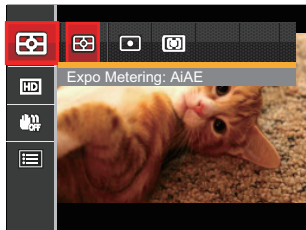

There are 3 options:

- AiAE (Artificial Intelligence AE): Automatically selects the central and peripheral metering, to calculate the reasonable value of metering by weighting.
- Spot: Metering targets a small area in the center of the camera's field of view.
- Center: Metering targets a slightly larger area in the center of the camera's field of view.

Video Quality

Set the image resolution used during video recording.

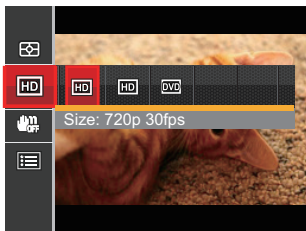

The speed requirements for reading and writing high image pixel images to memory card are as follows:

No.	Image Pixel	Frame	Recommendation	Recording time (4GB) About
1	1280x720 *	30	Class 6	58 minutes
2	1280x720	15	Class 4	61 minutes
3	640x480	30	Class 4	69 minutes

 * The longest recording time is 29 minutes at one time.

 When recording in higher pixel resolutions for extended periods of time, this can cause the camera to generate heat. This is not a camera malfunction.

OIS

This mode can help reduce photo blur caused by hand shake, low light and slow shutter speed.

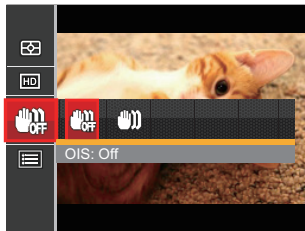







 Use this image stabilization mode in dark environments.

 Shooting in a windy or unstable environment (such as a moving vehicle) may cause blurred images.



 Using a tripod, suggest the image stabilizer is deactivated.

Movie Setting Menu

Mode: 

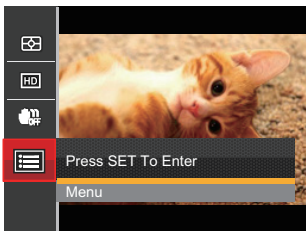
1. Turn the mode dial and select  to enter the video recording screen.
2. Press the  button, press the up/down arrow buttons to select , and press the  button to enter the menu.
4. Select the items to be set and press the  button or the right arrow button to enter the menu.
5. Press the up/down arrow buttons to select an option and press the  button to confirm.



3. Press the up/down arrow buttons to select , and press the  button or right arrow button to enter the menu.

Digital Zoom

This setting is for adjusting digital zoom. If this function is disabled, only optical zoom can be used.

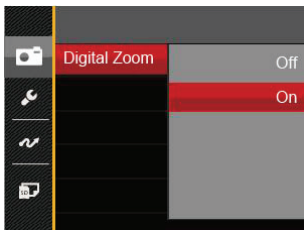



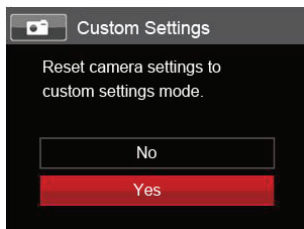

Custom Settings

Custom settings stores the current movie shooting mode and its parameters. The stored mode and parameters are directly invoked in custom settings mode.



Playback Menu

Mode: 

1. Press the  button to display the playback screen and press  button to enter the menu.
2. Press the up/down arrow buttons to select the playback to be set and press the  button to enter.
3. Press the left/right arrow buttons to select an option and press the  button to confirm.

Photo

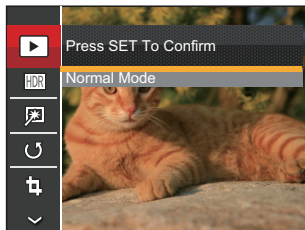



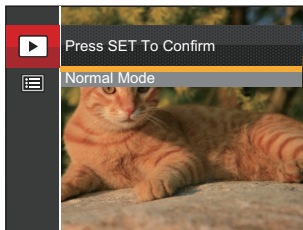

Video





Refer to the following pages for more details about each setting.

Playback

1. Press the  button, select the  settings, and press the  button to display the settings screen.
2. Press the left/right arrow buttons to select from the following 2 functions:

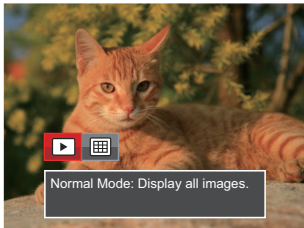
-  Normal Mode: Display all images.
-  Date Mode: Arranged by date.





3. Press the  button to confirm the setting.

 The date folder is displayed in date order based on camera's date/time settings.

HDR

With the HDR function, pictures that are overexposed may be corrected to optimize the highlights and lowlights captured to more accurately represent the actual scene.

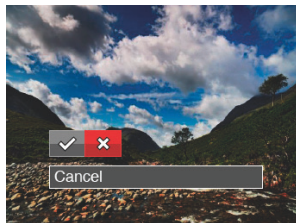

1. In playback mode, press the left /right arrow buttons to select the photos to be edited.
2. Press the  button, select the  settings, and press the  button to display the settings screen.
3. Press the left/right arrow buttons to select whether HDR is used.



 : HDR  : Cancel

4. After using the HDR function, the image will be saved as a new file and the original file is still stored in the memory.

Touch-up

1. In playback mode, press the left /right arrow buttons to select the photos to be edited.
2. Press the  button, select the  settings, and press the  button to display the settings screen.
3. Press the left/right arrow buttons to select Touch-up options or [Cancel] to return to the playback screen.



 : Red-Eye Reduction

 : Skin Soften

 : Eye Brightening

 : Eye Enlargement

 : Cancel



4. Press the  button to confirm the setting.





The Touch-up mentioned here is the individual beautification for three effects, beauty mode allows you to select from single, two, or all three effects combined.

Rotate

You can use this setting to change the orientation of the picture.

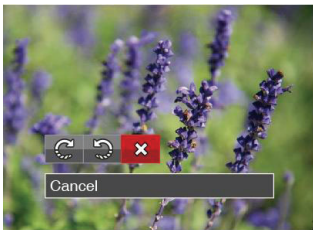
1. In playback mode, press the left /right arrow buttons to select the photos to be edited.
2. Press the  button, select the  settings, and press the  button to display the settings screen.
3. Press the left/right arrow buttons to select the rotation direction or [Cancel] to return to the playback Screen.



 : Turn Right  : Turn Left

 : Cancel

4. Press the  button to confirm the setting.





Videos and panoramic pictures cannot be rotated.





The rotated picture file will replace the original photo.

Resize

This setting allows you to resize a picture to a particular resolution and saves it as a new picture.

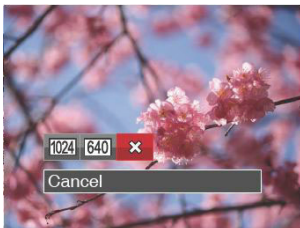
1. In playback mode, press the left/right arrow buttons to select the photos to be edited.
2. Press the  button, select the  settings and press the  button to display the settings screen.
3. Press the left/right arrow buttons to select [1024] or [640] or select [Cancel] to return to the playback Screen.



 : Resize to 1024x768

 : Resize to 640x480

 : Cancel

4. Press the  button to confirm the setting.

i Button Playback Function

This setting allows you to change the picture color effect. The file is saved as a new photo and stored in memory together with the original photo.

1. In playback mode, press the left/right arrow buttons to select the photos to be edited.
2. Press the **i** button to select the image color setting menu.
3. Press the left/right arrow buttons to select the corresponding menu or [Cancel] to return to the playback screen.

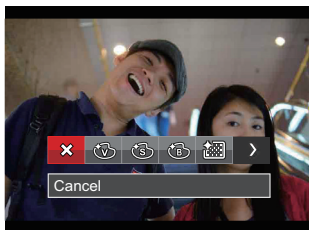





4. Press the **SET** button to confirm the setting.

There are 8 options:



- Cancel
- Vivid
- Sepia
- Black and White
- Grainy
- Vignetting
- Salon
- Dreamy

Playback Setting Menu

Mode: 

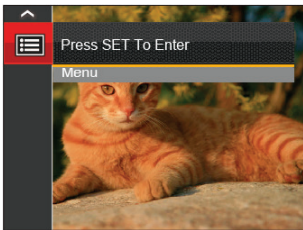
1. Press the  button to show the playback screen, press the  button, and press the up/down arrow buttons to select .
2. Press the  button to enter the menu.



3. Press the up/down arrow buttons to select , and press the  button or right arrow button to enter the menu.
4. Press the up/down arrow buttons to select the item to be set and press the  button or right arrow button to enter the menu.

5. Press the up/down arrow buttons to select an option and press the  button to confirm.

Refer to the following pages for more details about each setting.

Protect

To prevent any pictures or videos from being accidentally erased, use this setting to lock one or all of the files.

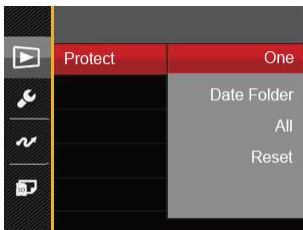

To lock or unlock the photo and video files:

1. Press the up/down arrow buttons to select [Protect] and press the **SET** button or right arrow button to enter the sub-menu.
2. Press the up/down arrow buttons to select the sub-menu and press the **SET** button or right arrow button to show the settings screen.

There are 4 sub menus available:

- One
Lock the selected photo or video if they are unprotected; unlock the selected photo or video if they are protected.
 - Date Folder
Protect all photos in the Date Folder.
 - All
Lock all photos or videos.
 - Reset
Cancel all locked photos or videos.
3. Press the up/down arrow buttons to select an option and press the **SET** button to confirm.

Delete

You can delete one or all photo/video files.

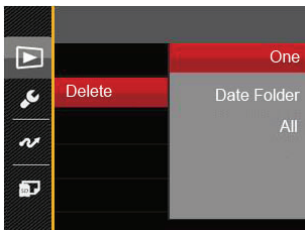

To delete photo or video files:

1. Press the up/down arrow buttons to select [Delete] and press the **SET** button or right arrow button to enter the submenu.
2. Press the up/down arrow buttons to select the submenu and press the **SET** button or right arrow button to show the settings screen.

There are 3 sub menus available:

- One
Delete one photo or video.
 - Date Folder
Delete all photos in the Date Folder.
 - All
Delete all photos or videos.
3. Press the up/down arrow buttons to select an option and press the **SET** button to confirm.



The “” indicator means a file is protected. File protection must be removed first before a file can be deleted.



Deleting files will cause DPOF settings to be reset.



When a single photo is protected in the date folder, the protected photo will be kept and other photos will be deleted.

DPOF (Digital Print Order Format)

The DPOF feature allows you to compile and select a group of pictures that you would like to print and will save your selection on the memory card so that you can use the memory card to print without having to individually specify the photos you want to print.

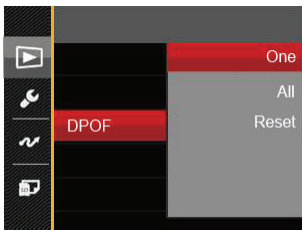

The printer that supports DPOF is needed for printing.

Trim

The Trim setting allows you to crop photos and save them as new pictures.

1. Press the up/down arrow buttons to select [Trim] and press the **SET** button or right arrow button to enter the menu.
2. Select [Yes] to confirm trim. Select a part to be trimmed using the zoom lever and arrow buttons to trim a photo.

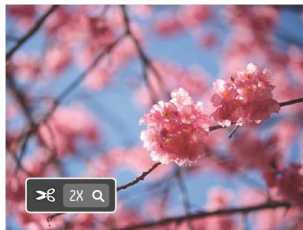

3. Press the **SET** button and the [Save Change?] prompt appears. Select [✓] to change and save the picture. Select [✗] to cancel changes and return to the trim prompt screen.



The image cannot be clipped/trimmed again once it has been clipped to 640X480.

Setup Menu

Mode : PSAM SCN

1. Press the button in any mode and press the up/down buttons to select .
2. Press the button to enter the menu.
3. Press the up/down arrow buttons to select , and press the button or right arrow button to enter the menu.

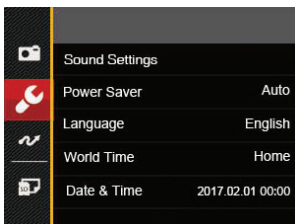

4. Press the up/down arrow buttons to select the item to be set and press the button or right arrow button to enter the menu.
5. Press the arrow buttons to select an option and press the button to confirm.

Refer to the following pages for more details about each setting.

Sound Settings

To change this setting:

1. Select [Sound Settings] in the basic settings menu. Press the button or right arrow button to enter the menu.
2. Press the left/right arrow buttons to select an option.

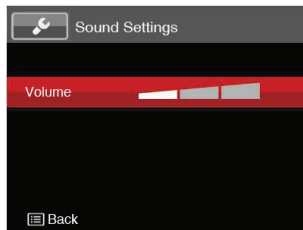

3. Press the button to confirm.

Power Saver

This setting allows you to save power and get the maximum possible running time for your camera's batteries. Follow the steps below to turn the LCD and camera off automatically after a consecutive period of inactivity.

1. Select [Power Saver] in the basic settings menu. Press the **SET** button or right arrow button to enter the menu.
2. Press the up/down arrow buttons to select an option.

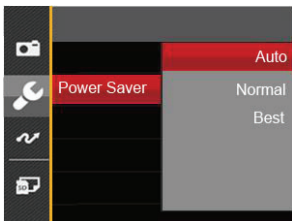

3. Press the **SET** button to confirm.



Power Saver	LCD power off time	Turn off time
Auto	3 min	5 min
Normal	1 min	3 min
Best	30 s	1 min

Language

Refer to the “Resetting your language” section on page 18.

World Time

The zone setting is a useful function for your overseas trips. This feature enables you to display the local time on the LCD while you are abroad.

1. Select [World Time] in the basic settings menu. The world time screen appears.
2. Press the up/down arrow buttons to select the departure place () and destination () fields.
3. Press the left/right arrow buttons to select a city located in the same time zone as that of the field. Press the **SET** button to confirm settings.

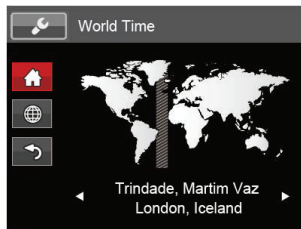

Date/Time

Refer to the “Resetting Date/Time” section on page 19.

LCD Brightness

Use this setting to adjust the brightness of your LCD.

1. Select [LCD Brightness] in the basic settings menu. Press the **SET** button or right arrow button to enter the menu.
2. Press the up/down arrow buttons to select an option.

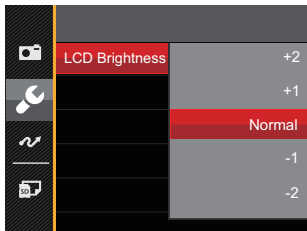

3. Press the **SET** button to confirm.

Battery Type

Please choose the right type of battery before using.

1. Select [BATTERY TYPE] in the basic settings menu. Press the **SET** button or right arrow button to enter the menu.
2. Press the up/down arrow buttons to select an option.

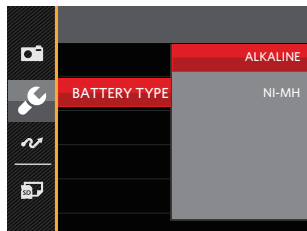







3. Press the **SET** button to confirm.

File Settings

Format

Please note: formatting enables you to delete all contents in the memory card and built-in memory, including protected photo and movie files.

To use this setting:



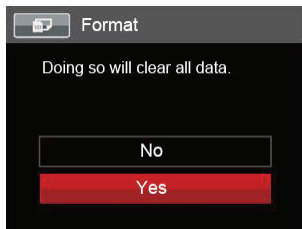



1. Press the  button, press the up/down arrow buttons to select  and press the  button to enter the menu.
2. Press the up/down arrow buttons to select  and press the  button or right arrow button to enter the menu.
3. Press the up/down arrow buttons to select [Format] and press the  button or right arrow button to enter the menu.
4. Press the up/down arrow buttons to select [Yes] or [No] and press the  button to confirm.
5. If you select [Yes] the camera formats its memory.



-  If there is no memory card in the camera, the built-in memory will be formatted; if there is a memory card, it will be formatted only.

Copy to Card

Use this setting to copy the files stored in the internal memory to a memory card.



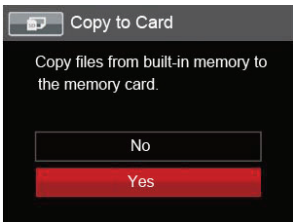



1. Press the  button, press the up/down arrow buttons to select  and press the  button to enter the menu.
2. Press the up/down arrow buttons to select  and press the  button or right arrow button to enter the menu.
3. Press the up/down arrow buttons to select [Copy to Card] and press the  button or right arrow button to enter the menu.
4. Press the up/down arrow buttons to select [Yes] or [No] and press the  button to confirm.



If there is no card available in the camera, this function will not be displayed.

File Numbering







After you take a picture or video clip, the camera will save it with a sequential number. You can use this to reset the file numbering to 0001.

1. Press the  button, press the up/down arrow buttons to select  and press the  button to enter the menu.
2. Press the up/down arrow buttons to select  and press the  button or right arrow button to enter the menu.
3. Press the up/down arrow buttons to select [File Numbering] and press the  button or right arrow button to enter the menu.
4. Press the up/down arrow buttons to select [Yes] or [No] and press the  button to confirm.



Reset





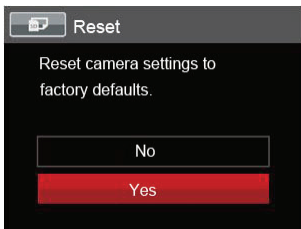

Use this setting to restore the camera to its original default settings.

1. Press the  button, press the up/down arrow buttons to select  and press the  button to enter the menu.
2. Press the up/down arrow buttons to select  and press the  button or right arrow button to enter the menu.
3. Press the up/down arrow buttons to select [Reset] and press the  button or right arrow button to enter the menu.
4. Press the up/down arrow buttons to select [Yes] or [No] and press the  button to confirm.



FW Version

Use this setting to view the current camera firmware version.

1. Press the  button, press the up/down arrow buttons to select  and press the  button to enter the menu.
2. Press the up/down arrow buttons to select  and press the  button or right arrow button to enter the menu.
3. Press the up/down arrow buttons to select [FW Version] and press the  button or right arrow button to enter the menu.
4. When there is a new firmware version in the memory card, select [Yes] to update.









CONNECTIONS

Connecting to a Computer

You can use a micro USB cable(which should be purchased separately) to connect the camera and copy (transmit) photos to a computer, printer or other device.

Setting the USB Mode

The camera's USB port can be set to connect with either a computer or a printer. The following steps will allow you to ensure that the camera is correctly configured to connect with a PC.

1. Press the  button, press the up/down arrow buttons to select  and press the  button to enter the menu.
2. Press the up/down arrow buttons to select  and press the  button or right arrow button to enter the menu.
3. Press the up/down arrow buttons to select [USB] and press the  button or right arrow button to enter the menu.
4. Press the up/down arrow buttons to select [PC] and press the  button to confirm.

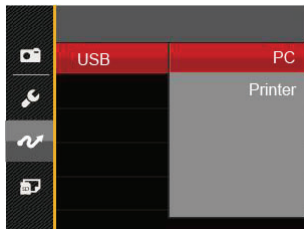

Transferring files to your computer

The computer will automatically detect the camera as a removable drive. Double-click the My computer icon on the desktop to locate the removable drive and to copy folders and files in the drive to a directory on your PC as you would copy any typical folder or file.





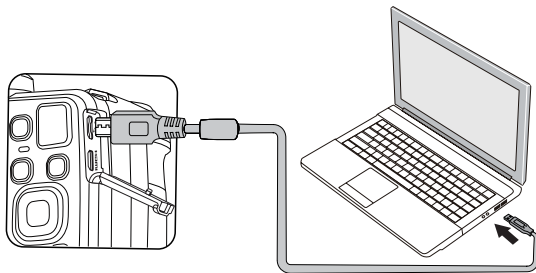

Follow the steps below to connect the camera to a computer.

1. Make sure the computer is turned on.
2. Connect one end of the micro USB cable to the USB/AV OUT port on your camera.
3. Connect the other end of the micro USB cable to an available USB port on your computer.
4. After the transmission is complete, disconnect the micro USB cable according to the instructions specifying how to safely remove USB devices.



Video System

You can use the AV cable (which should be purchased separately) to connect the camera and the television for realizing the video output. Connect one end of the AV cable to AV port of the camera, connect the other end to AV-OUT port of the television. Adjust the format of the video output system according to your requirements, and the steps are as follows:

1. Press the  button, press the up/down arrow buttons to select  and press the  button to enter the menu.
2. Press the up/down arrow buttons to select  and press the  button or right arrow button to enter the menu.
3. Press the up/down arrow buttons to select [TV-System] and press the  button or right arrow button to enter the menu.
4. Press the up/down arrow buttons to select [NTSC] or [PAL] and press the  button to confirm.

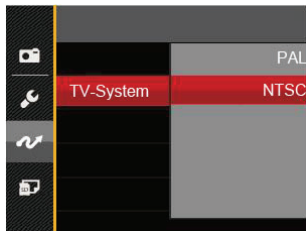







The video output system would change accordingly based upon the changes of the selected language.

NTSC: English, Chinese (Traditional), Japanese, French, Korean, Russian, Vietnamese, Greek, Hungarian

PAL: German, Spanish, Italian, Chinese (Simplified), Portuguese, Swedish, Danish, Finnish, Indonesia, Norwegian, Dutch, Turkish, Polish, Thai, Croatian, Czech, Arabic, Hindi

Set Eye-Fi Card Connection Mode

This camera supports the wireless connection for Eye-Fi card, Enable Eye-Fi connection by following below steps.

1. Press the  button, press the up/down arrow buttons to select  and press the  button to enter the menu.
2. Press the up/down arrow button to select  and press the  button or right arrow button to enter the menu.
3. Press the up/down arrow buttons to select [Eye-Fi] and press the  button or right arrow button to enter the menu.
4. Press the up/down arrow buttons to select [On] or [Off] and press the  button to confirm.

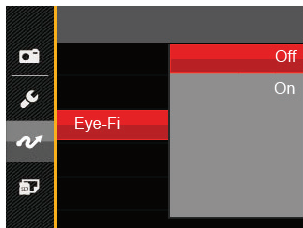

If the Eye-Fi card is not available in the camera, this feature is not displayed.



Supported HDMI Connections

HDMI (High Definition Multimedia Interface), is a fully digital audio/video transmission interface, through which uncompressed audio and video signals are transmitted.

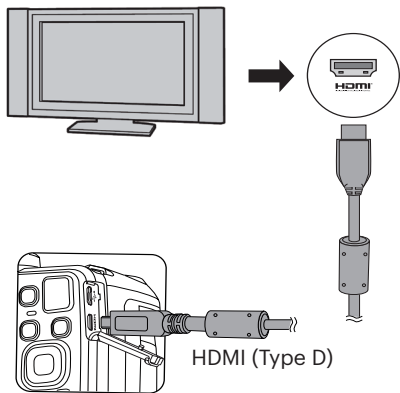
Direct transmission of digital video signals to your TV reduces conversion loss and improves image quality.



Connecting HDMI-Ready TV

1. Use the cable with high resolution output terminal (which should be purchased separately) to connect the camera to the television which meets HDMI standard.
 2. The camera will be automatically detected by the TV.
 3. After connecting via HDMI, the camera enters Playback Mode.
-  Make sure the camera and the TV are both turned on before connecting.
 -  Refer to your TV instruction manual for information on what resolution sizes it will support. The resolution and output formats that are not supported will be grayed out on the camera's LCD.







Connecting to a PictBridge Compatible Printer

PictBridge technology allows printing of the photos saved in the memory card by the printer.



To find out if a printer is PictBridge compatible, simply look for the PictBridge logo on the packaging or check the owner's manual for specifications. With the PictBridge function on your camera, you can print the captured photos directly to a PictBridge compatible printer using the micro USB cable, without the need for a PC.

Setting the USB Mode

The camera's USB port can be set to connect with either a PC or a Printer, the following steps will ensure that the camera is correctly configured to connect with a Printer.

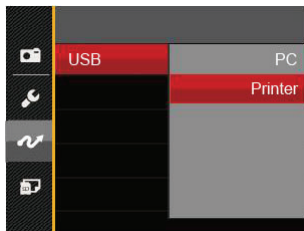
1. Press the  button, press the up/down arrow buttons to select  and press the  button to enter the menu.
2. Press the up/down arrow buttons to select  and press the  button or right arrow button to enter the menu.
3. Press the up/down arrow buttons to select [USB] and press the  button or right arrow button to enter the menu.
4. Press the up/down arrow buttons to select [Printer] and press the  button to confirm.



-  After the camera is reset, it will switch to PC mode automatically from USB mode.
-  See “Using the PictBridge Menu” section on page 88.

Connecting to your Printer

1. Make sure the printer is turned on.
2. Connect one end of the micro USB cable to the USB port on your camera.
3. Connect the other end of the micro USB cable to the USB port on the printer.

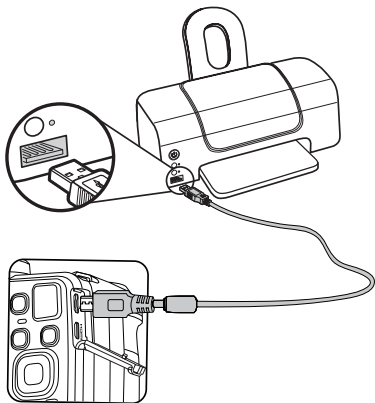

If the camera is not connected to a PictBridge compatible printer, the following error message will appear on the LCD.

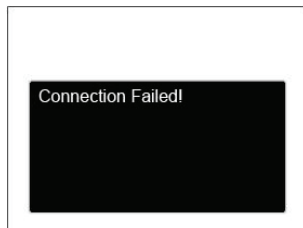

The error message above will also appear if the USB mode is set incorrectly, in which case you should disconnect the micro USB cable, check the USB mode settings, ensure that the Printer is turned on, and then try connecting the micro USB cable again.

Using the PictBridge Menu

After setting the USB mode to Printer, the PictBridge menu will appear.

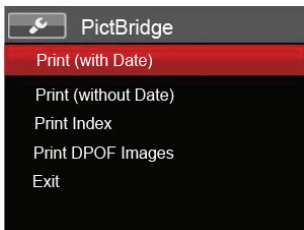

Press the up/down arrow buttons to select a menu item and press the **SET** button or right arrow button to enter the item.

Refer to the following sections for more detailed information on each setting.

Print (with Date)

If you have set the date and time on your camera, the date and time will be recorded and saved with each photo you take.

1. In the PictBridge menu, select [Print (with Date)] and the screen as shown below appears.

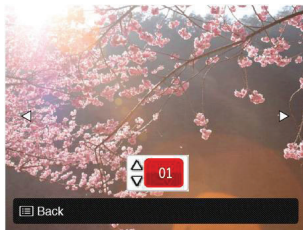

2. Press the left/right arrow buttons to select a photo to be printed.

3. Press the up/down arrow buttons to select the number of copies for the currently displayed photo.
4. Press the **SET** button and the following screen will appear.

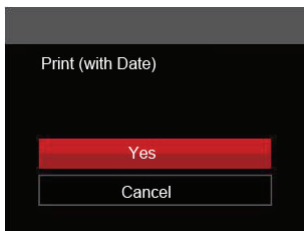

5. Select [Yes] and press the **SET** button to confirm; select [Cancel] to cancel printing.

Print (without Date)

Use this setting to print the photos without dates on them.

1. In the PictBridge menu, select [Print (without Date)] and the screen as shown below appears.

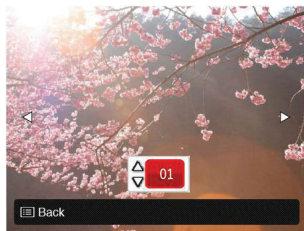

2. Press the left/right arrow buttons to select a photo to be printed.
3. Press the up/down arrow buttons to select the number of copies for the currently displayed photo.
4. Press the **SET** button and the following screen will appear.

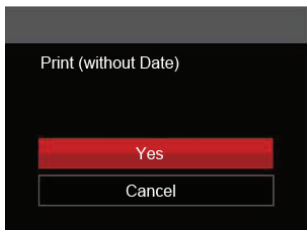

5. Select [Yes] and press the **SET** button to confirm; select [Cancel] to cancel printing.

Print Index

You can print all photos in the camera via this function.

1. In the PictBridge menu, select [Print Index] and the screen as shown below appears.

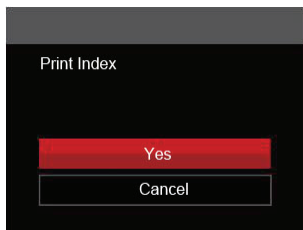

2. Select [Yes] and press the **SET** button to confirm; select [Cancel] to cancel printing.

Print DPOF Images

To use DPOF printing, you must select your photos for printing using the DPOF settings beforehand. See “DPOF” section on page 74.

1. In the PictBridge menu, select [Print DPOF Images] and the screen as shown below appears.

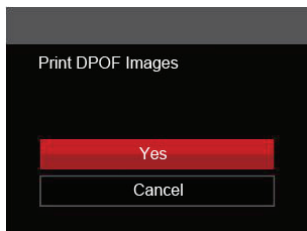

2. Select [Yes] and press the **SET** button to confirm; select [Cancel] to cancel printing.

Exit

Select [Exit] to exit the PictBridge menu. At this time, the message [Remove USB Cable!] appears on the screen.



Disconnect the micro USB cable from the camera and printer.

APPENDICES

Specifications



Design and specifications are subject to change without notice.

Image Sensor	Type	1/2.3"CCD
	Effective Pixels	16.15 Megapixels
	Total Pixels	16.44 Megapixels
Lens	Focal Length	4.3mm (Wide) — 172mm (Tele)
	35mm film equivalent	24mm (Wide) — 960mm (Tele)
	F number	F3.0 (Wide) — F6.8 (Tele)
	Lens Construction	11 groups 15 elements
	Optical Zoom	40x
	Focusing Range	Normal: (Wide) 50cm - ∞ , (Tele) 200cm - ∞ ; Macro: 1.6cm - ∞ (Wide Only)
Autofocus System		TTL Autofocus
Anti-Handshake		Optical Image Stabilization
Digital Zoom		4x Digital Zoom (Combined Zoom: 160x)

Number of Recording Pixels	Still Image	(4:3) 16MP: 4608×3456 10MP: 3648×2736 5MP: 2592×1944 3MP: 2048×1536 0.3MP: 640×480	(3:2) 14MP: 4608×3072	(16:9) 12MP: 4608×2592 2MP: 1920×1080
	Movie	1280×720 (30fps), 1280×720 (15fps), 640×480 (30fps)		
Image Compression		Best, Fine, Normal		
DCF, DPOF (Ver1.1) Support		Yes		
File Format	Still Image	Exif 2.3 (JPEG)		
	Movie	MOV [Image: H.264; Audio: Linear PCM (Monaural)]		
Shooting Modes		Auto Mode, Program AE, Shutter priority, Aperture priority, Manual Mode, Face Beautifier, Panorama Mode, Scene Mode, Movie Mode, Custom Settings		
Scene Mode		Pet Mode, Sunset, Fireworks, Sport, Night Portrait, Landscape, Portrait, Snow, Children, Party, Night Landscape, Auto Scene		
Detection Features		Face, Smile, Blink, Cat, Dog		
Photo Touch-up		Red-Eye Reduction, Skin Soften, Eye Brightening, Eye Enlargement		

HDR	Yes
Video Panorama	Up to 180°(Horizontal)
LCD Display	3.0 inch (460k Pixels)
ISO Sensitivity	Auto, ISO80/100/200/400/800/1600/3200(4M)
AF Method	Single AF, Multi-AF (TTL 9-point), Object Tracking, Face-Detection
Exposure Metering Method	Artificial Intelligence AE (AiAE), Center-Weighted Average, Spot (Fixed to Center of Frame), Face AE
Exposure Control Method	Program AE (AE-Lock Available), Shutter Prior AE, Aperture Prior AE
Exposure Compensation	±2EV in 1/3 Step Increments
Shutter Speed	1/2000 ~ 30 Seconds
Continuous Shooting	Yes
Playback Modes	Single, Index (9/16 Thumbnails), Slide Show, Date, Zoom (Approx. ×2 ~ ×8)
White Balance Control	AWB, Daylight, Cloudy, Fluorescent, Fluorescent CWF, Incandescent, Manual WB, Color Temp. (1900K ~ 10000K)

Flash	Flash Method	Pop-up (Manual)
	Flash Modes	Force Off, Flash Auto, Force Flash, Slow Sync., Slow Sync. + Red-Eye, Red-Eye Reduction
Recording Media		Internal Memory: Approx. 8MB
		SD/SDHC Card (Up to 32GB Support) [MMC Card not supported]
Multi-Language Support		27 Languages
Jacks		AV-OUT/USB 2.0 (Micro 5 pin USB), HDMI (Type D)
Eye-Fi Support		Yes
Power		AA Alkaline Battery(×4), AA Ni-MH Battery(×4) (Not Included)
Shooting Capability (Battery Performance)		Approx. 280 Shots of AA Alkaline Battery (Based on CIPA Standards)
Operation Environment		Temperature: 0 ~ 40°C, Humidity: 0 ~ 90%
Dimensions (W×H×D)		Approx. 114.3×81.6×84.4mm (Based on CIPA Standards)
Mass		Approx. 436g (Body only)

Prompts and Warning Messages

Message	Description	Solution
Warning! Battery exhausted.	The camera battery is used up. It is a warning indicating that the camera is going to shut down.	Replace with new batteries. The camera will shut down in 2 seconds.
Lens obstruction, Restart Camera.	The lens is jammed or some foreign object is preventing the lens from functioning properly.	Turn off the camera and restart it to reset the lens.
Suggest using tripod.	When continuous exposure mode (Sunset, Fireworks, Night Portrait, Night Landscape) is enabled, this prompt message is displayed when the photo shooting screen is displayed for the first time.	The message will disappear after 2 seconds
Built-in memory error!	An error occurs in built-in memory.	Try shutting down the camera and turning it on again. The message will disappear after 2 seconds.
Improper alignment. Please try again.	The offset is too big for panorama shooting.	Retry taking the panoramic picture. The message will disappear after 2 seconds.
Warning! Do not turn off your camera during update!	The message appears during the firmware update process.	The message disappears after the camera update and restart.

Message	Description	Solution
Remove USB Cable!	Indicates that you can disconnect the USB cable.	The message disappears after you disconnect the USB cable.
Connection Failed!	Failure to connect to your PC, printer, TV (with HDMI).	Remove USB cable and retry connection.
Write Protect !	The SD card is locked.	Remove SD card and switch the lever on the side of card to UNLOCK. The message will disappear after 2 seconds.
Card Full !	Indicates that the SD card is full.	Replace SD card with another that has available memory. The message will disappear after 2 seconds.
Memory Full !	Indicates that the camera memory is full.	It disappears after 2 seconds.
Card Error !	During power-on, the SD card cannot be recognized or a read/write error occurs.	Format the SD card. WARNING: Formatting the SD card will erase all data on the card. Copy the data from the SD card to another storage, such as a computer. Otherwise, all data will be erased after the format. The message will disappear after 2 seconds.

Message	Description	Solution
Card is not formatted.	When an error occurs in the memory card, the message "Not Formatted" appears.	Format the memory card. WARNING: Formatting the SD card will erase all data on the card. Copy the data from the memory card to another storage, such as a computer. Otherwise, all data will be erased after the format. The message will disappear after 2 seconds.
Slow access	When a memory card lower than Class 4 is used to record a HD movie, the writing speed will be slower and recording will not continue.	Replace the memory card with a higher Class over 4. The message will disappear after 2 seconds.
Cannot write to SD card.	The photo shooting or video recording has been interrupted so recording cannot continue.	Turn off the camera. Then unload and reload the SD card and turn on the camera to retry. Also check if SD card is full or in a locked position.
No Red-Eye Detected!	Red eyes have not been detected in the image.	The message will disappear after 2 seconds.
This image cannot be edited.	The file format does not support editing or the edited file cannot be edited again.	The message will disappear after 2 seconds.

Message	Description	Solution
Exceeded maximum folder number.	This indicates that the SD card exceeded the maximum number of folders (999). This could cause a long read time during the camera's power up.	Copy the data to your PC, format the memory card using the camera.
Too many pictures for fast processing.	During the playback by date, the images exceed specifications so that it is not possible to play by date.	The message disappears after 2 seconds and the camera returns to the normal playback mode.
Unable to recognize files.	The format of the file to be viewed is not supported or the file is corrupted so it cannot be properly read.	This image message disappears only after the file is deleted.
No Picture!	When you press the play button, no image files exist in the camera or memory card.	The message disappears 2 seconds later to return to the photo shooting screen.
Protected! Undeleteable!	The file is protected. The message appears when you delete it.	Remove SD card and switch the lever on the side of card to UNLOCK. Place back into the camera and try again. The message will disappear after 2 seconds.

Troubleshooting

Problem	Possible causes	Solution
Camera does not turn on	<ul style="list-style-type: none">■ The battery has been depleted.■ The battery is not inserted correctly.	<ul style="list-style-type: none">■ Recharge the battery.■ Correctly reinstall the battery.
Camera turns off suddenly during operation	<ul style="list-style-type: none">■ The batteries have been depleted.	<ul style="list-style-type: none">■ Recharge the battery.
The picture is blurred	<ul style="list-style-type: none">■ Camera shakes while taking a picture.	<ul style="list-style-type: none">■ Turn on OIS feature.■ Please use tripod for high magnification (above 15X) optical zoom.
Images and video files cannot be saved	<ul style="list-style-type: none">■ The memory card is full.■ The memory card is locked.	<ul style="list-style-type: none">■ Use another memory card or delete unnecessary files.■ Unlock the memory card.
Images will not print from the connected printer	<ul style="list-style-type: none">■ The camera is not connected to the printer correctly.■ The printer is not PictBridge compatible.■ The printer is out of paper or ink.■ The printer paper is jammed.	<ul style="list-style-type: none">■ Check the connection between the camera and printer.■ Use a PictBridge compatible printer.■ Load paper into the printer or replace the ink cartridge in the printer.■ Remove the jammed paper.

Problem	Possible Causes	Solution
Saving data to memory card is slow	<ul style="list-style-type: none"> ■ Using a memory card below Class 4 may result in slower recording times. 	<ul style="list-style-type: none"> ■ Use an memory card with write Class higher than 4 to improve performance.
Cannot write to the memory card	<ul style="list-style-type: none"> ■ The memory card has been locked. 	<ul style="list-style-type: none"> ■ Release the write lock of the memory card or replace with another card.
Too many movies to process	<ul style="list-style-type: none"> ■ The number of pictures or folders in the memory card exceed the specifications, so the playback of data folder can not be displayed. 	<ul style="list-style-type: none"> ■ Delete unwanted files.
The flash  flashes on the LCD.	<ul style="list-style-type: none"> ■ Current shooting environment requires flash. 	<ul style="list-style-type: none"> ■ Turn on flash.

The Kodak trademark, logo and trade dress are used under license from Kodak.

© 2017 JK Imaging Ltd. All Rights Reserved.

JK Imaging Ltd., 17239 So. Main Street, Gardena, CA 90248 USA

JK Imaging Europe, 71 Clarendon Road, Watford, WD17 1DS, UK

kodakpixpro.com

Made in Myanmar

