

Starfrit

DIGITAL KITCHEN SCALE



INSTRUCTIONS FOR USE

SPECIFICATIONS

- Glass weighing platform
- Also measures volume of milk and water
- Unit conversion feature
- Weight: grams, pounds and ounces
- Volume: milliliter and fluid ounces
- Automatic conversion feature imperial / metric
- Zero and tare functions
- Low battery and overload indicators
- Auto-off after two minutes or manual-off
- Capacity: 11 lb / 5 kg
- Accuracy: 0.1 oz / 1 g

BATTERIES



- Requires 2 AAA batteries (included).
- Remove isolation sheet before use.

TO REPLACE BATTERIES

- Open battery case cover underneath the scale.
- Take out the used batteries and install new ones. Make sure to respect the polarity.
- Close battery case cover.

LCD SCREEN

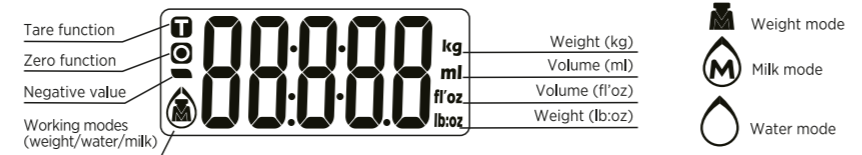

BUTTONS



Turn ON / Turn OFF / Zero and Tare functions



Mode and unit conversion

WORKING MODES / UNIT CONVERSION

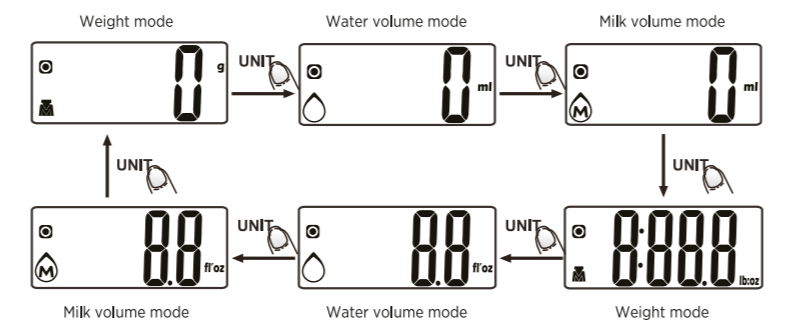

Press **UNIT** button to switch the mode and unit.

WEIGHING MODE

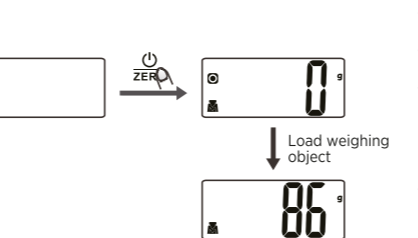

- Place the scale on a solid and flat surface.
- Press **ZERO** button to turn on the scale.
- Wait until LCD screen shows "0" to start weighing. Press **UNIT** button to convert to weight mode if needed.
- Load weighing object on scale. LCD will show the weight reading.

VOLUME WEIGHING MODE

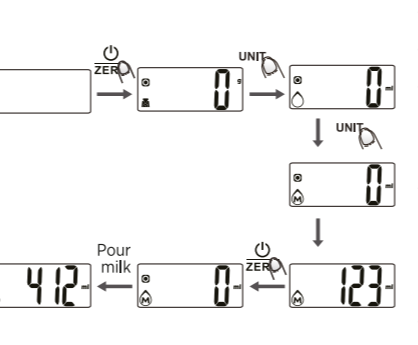

- Place the scale on a solid and flat surface.
- Press **ZERO** button to turn on the scale.
- Wait until LCD screen shows "0" to start weighing. Press **UNIT** button to convert to scale to water or milk mode.
- Place a bowl or container on the weighing platform. LCD screen indicates the weight of the bowl or container. Press **ZERO** button to reset the LCD screen at "0".
- Pour liquid (water or milk) into the bowl or container. LCD screen indicates the volume of the liquid (water or milk).

ZERO AND TARE FUNCTIONS

The zero and tare functions allow you to weigh items consecutively without having to remove the article already on the platform. For example, if you are using a bowl, these functions allow you to weigh the content of the bowl without counting the weight of the bowl. Press **ZERO** to use these functions.

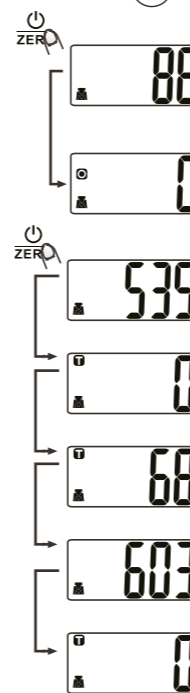

• Zero function

When sum of all loads on scale is less than 7 oz (200 g), the LCD will show "0 g" each time **ZERO** button is pressed. Icon "o" will show on left of LCD, indicating zero function is activated. The maximum capacity of the scale will not be reduced by the stated weight if it is 7 oz (200 g) or less.

• Tare function

When sum of all loads on scale is over 7 oz (200 g), the LCD will show "0 g" each time **ZERO** button is pressed. Icon "T" will show on left upper corner of LCD, indicating tare function is activated. Maximum weight capacity is reduced by tare amount.

Under this condition, if you press **ZERO** button, you will see the total weight of all loads.

AUTO SHUT OFF & MANUALLY SHUT OFF

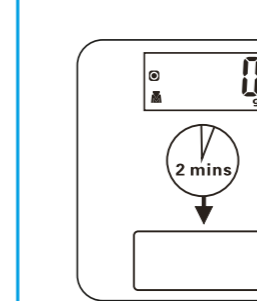

Auto shut-off occurs if display shows "0" or shows the same weight reading for 2 minutes

To maximize batteries life, it is recommended to shut off manually the scale. Press **ZERO** button for 3 seconds and the scale will turn off.

LOW BATTERY & OVERLOAD INDICATORS

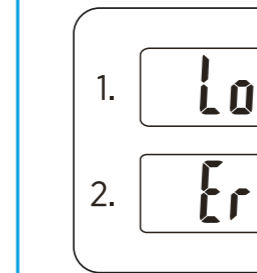

- 1. Low battery power**
Please replace batteries.
- 2. Overload**
Remove item to avoid damage. Maximum capacity for this scale is 11 lb / 5 kg.

ADVISE FOR USE & CARE

1. Always use the scale on a hard flat surface.
2. Clean the scale with a slightly damp cloth.
3. Avoid contact with water. DO NOT immerse the scale in water.
4. All plastic parts should be cleaned immediately after contact with fats, spices, vinegar and strongly flavored/colored food. Avoid contact with acid citrus juices.
5. DO NOT use chemical or abrasive cleaning agents.
6. Not for commercial use.

Starfrit.com

facebook.com/starfrit

SUBSCRIBE TO THE NEWSLETTER TO LEARN MORE ABOUT OUR PROMOTIONS!