

# 9000 Series Premium Exit Devices

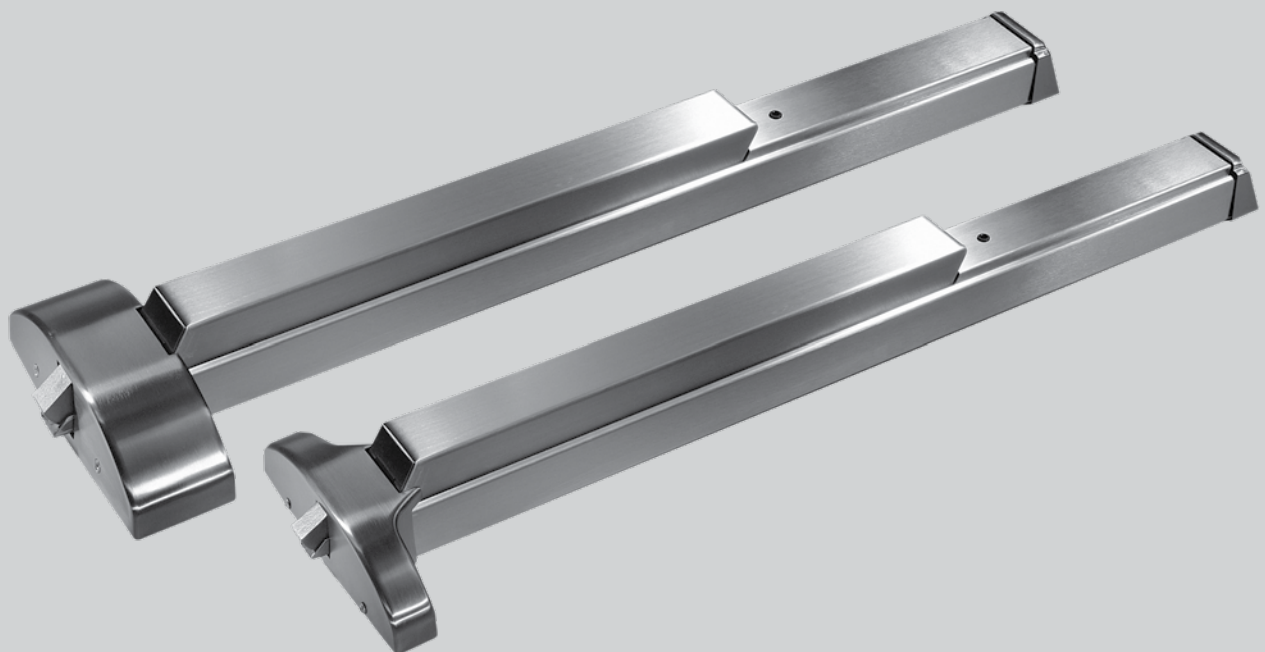

# 9000 Series Premium Exit Devices

**3** Overview

**4** Certification/Specifications

**5** Data & Features

**6** Options

**6** ANSI Functions

**9** Ordering Guide

**9** Handing

## Applications & Listings

**10** Single Doors

**11** Pair of Doors with Removable Mullions

**11** Pair of Doors

## Wide Stile Exit Devices

**14** 9100/F9100 Concealed Vertical Rod

**18** 9300/F9300 Wide Stile Rim

**22** 9400/F9400 Surface Vertical Rod

**26** 9500/F9500 Mortise Lock

**29** Accessories

**30** Optional Electronic Functions

**31** DE9000 Certification & Specifications

**32** DE9000 Delayed Egress Features

**33** Auxiliary Equipment

**33** Trim Options

**34** Lever & Knob Styles

**35** Wide Stile Y Escutcheon Trim

**36** Sectional Trim

**37** 3" Wide Plate Trim

**38** 2" Wide Stile Plate Trim

**39** Wide Stile Pull Trim

**40** Wide Stile Trim

**49** Cylinder Specifications

**50** Mullions

## Narrow Stile Exit Devices

**52** 9600/F9600 Concealed Vertical Rod

**54** 9700/F9700 Narrow Stile Rim

**56** 9800/F9800 Surface Vertical Rod

**58** Accessories

**59** Optional Electronic Functions

**60** DE9000 Certification & Specifications

**61** DE9000 Delayed Egress Features

**62** Auxiliary Equipment

**62** Trim Options

**63** Lever & Knob Styles

**64** Narrow Stile Z Trim

**65** Narrow Stile Pull Trim

**66** Narrow Stile Trim

**69** Cylinder Specifications

**70** Mullions

dormakaba USA quality and environmental management systems in Reamstown, PA and Steeleville, IL are certified to ISO 9001:2015 and ISO 14001:2015.



# 9000 Series Premium Exit Devices



**Premium exit devices available in wide or narrow stile for high impact applications such as schools, universities, and other institutional or commercial buildings.**

9000 Series exit devices reliably secure egress doors in compliance with all applicable fire/life safety code requirements. Wide and narrow stile exit devices for high-impact applications are available in rim, mortise, and surface or concealed rod configurations in both fire and panic-rated versions. The DE9000 Series delayed egress exit device is available when security and safety are a concern.

9000 Series exit devices offer the specifier a selection of true architectural finishes and a full complement of electrified options, including alarmed exit, delayed egress exit, electric latch retraction, and device monitoring.

## Wide Stile

The 9000 Series wide stile exit device features a heavy-duty cast chassis for superior durability, while the smooth reduced projection touchbar assembly minimizes catch hazards. The partial length touchpad permits field installation of options such as cylinder dogging and exit alarm. A full complement of free wheeling lever trim is available in a wide range of architectural finishes.

## Narrow Stile

The 9000 Series narrow stile exit device with a shortened touchbar is the ultimate solution when narrow stile doors require an exit device.

The heavy-duty cast chassis design permits installation on narrow stile doors where a standard device may not fit. The smooth projection touchbar assembly minimizes catch hazards. The partial length touchpad permits field installation of options

such as cylinder dogging and exit alarm.

9000 Series narrow stile exit devices are available in a wide range of models and offer a full complement of free wheeling lever trim to meet most narrow stile door applications.

## Delayed Egress

The DE9000 Series delayed egress exit device maximizes features for uncompromising security and safety and offers ease of installation, job site function flexibility, and years of trouble free service.



The DE9000 is intended for low level egress security applications such as healthcare facilities, assisted living centers, hospitals, or retail. For applications requiring higher levels of egress security such as juvenile detention centers, developmentally challenged adult incarceration facilities, or other types of more

challenging environments, it is recommended that a standard exit device be used in conjunction with EMDE Series delayed egress magnetic door locks.

- Wide stile touchbar and rail, chassis, latch bolt covers, and end cap are fabricated and finished in true base metal. Narrow stile is the same except chassis cover is always brass and finished to match device.
- End cap for touchbar assembly furnished in complementary finish.
- Some models handed depending on outside operating trim and function.
- Most devices easily field-reversible.
- Fasteners provided for metal and wood door applications.
- Free wheeling, vandal-resistant trim standard.

# 9000 Series Wide & Narrow Stile Exit Devices

## Certification

- Certified/listed to ANSI/BHMA 156.3, Grade 1 for exit devices. 
- U.L. and C.U.L. listed under their continuing reinspection programs and conforms to standard U.L. 10C positive pressure testing. 
- Complies with NFPA 101 life safety code. Fire rated devices comply with NFPA 80 fire doors and windows.
- Devices, trim, pulls, and levers comply with the Americans for Disabilities Act, 1994, and ICC A117.1 for accessible and usable buildings and facilities. 
- Contributes to U.S. Green Building Council, LEED MR Credits 2.1, 4.1, 4.2 and 5.1.
- Listed with the California Department of Forestry and Fire Protection, Office of the State Fire Marshal (wide stile devices only).
- Hurricane-code approved to Miami-Dade County Florida and Florida State Building Code acceptance (9300, 9400, 9500, 9700).
- Meets the requirements of the California Building Code (2013) Sec. 11B-309.4 (9300BF, 9500BF, 9700BF).

## Specifications

- All devices to have heavy-duty cast chassis.
- All device touchbar, rail, and cover assemblies shall be constructed of heavy gauge solid wrought materials for true architectural finishes or color coated finishes.
- The partial-length touchpad assembly accommodates field installation of options such as cylinder dogging and exit alarm.
- Non-labeled units to have hex-key dogging standard. Fire rated versions available for labeled applications.

- Surface vertical rod devices shall have pullman type top latch bolts and round slidebolt bottom latches.
- All devices to have deadlocking latch bolts with 3/4" throw.
- All units shall offer a full range of free wheeling operational trim, except mortise devices.
- All units shall offer optional rigid and clutch-style trim, where applicable.
- All devices to be furnished with appropriate mounting hardware including both wood and machine screws, as well as sex nuts where required.

## Optional Specifications

- Non-labeled devices to have cylinder dogging. Mortise cylinder included. Specify **CD**.
- All surface/concealed vertical rod devices to have pullman type bottom latch bolt. Specify **P**.
- All surface/concealed vertical rod devices to have extended top rod up to 10'. Specify **ETR** for 8', 9', or 10'.
- All surface/concealed vertical rod devices to be furnished less bottom rod. Specify **LB**.
- Devices to have motorized latch bolt retraction to provide remote access from the secure side of door. Can also be used to electrically dog/hold the exit push bar in a retracted position during non-secure hours (latch bolt is retracted). Specify **MLR**. (**MLR** is powered by the PS610 or PS532 power supply)
- Devices to have electric latch bolt retraction to provide remote access from the secure side of door. Can also be used in conjunction with low energy/automatic door operator. Specify **ES**. (**ES must be powered by PS-501 power supply and use ES-105 power transfer**)
- Devices to have electric latch retraction option for battery back-up power supply (requires PS406BB or PS-BB power supply and ES105 power transfer). Specify **E-**.
- Devices to have a controlled delayed egress while simultaneously sounding a local and remote audible alarm. After the delay time has elapsed, unrestricted emergency egress is available. Specify **DE**. (Not available with 9400 or 9800, requires ES100 power supply, ES105 power transfer, and FL)
- Devices to have a latch monitor to report the latch bolt status. Specify **LM**.
- Devices to be furnished with two switches in the touchbar to provide notification when touchbar is depressed. Specify **MS**.
- Devices to have latch monitor with monitor switches in touchbar. Specify **LM/MS**. Devices to have latch monitor with monitor switches and a bypass to permit authorized exit. Specify **LM/MS BP**.
- Devices to have one of the following exit alarm options: battery-powered exit alarm (**BA**), battery-powered exit alarm with a 4-minute reset (**BAR**), or direct hard-wired exit alarm (**DA**).
- Devices to use a vision lite shim kit to raise the device from the door surface to accommodate glass light molding. Specify **GK9000** (wide stile) or **GK9200** (narrow stile).
- All devices for labeled wood or composite doors to be furnished with sex bolts. Specify **SNB**.

- All concealed vertical rod devices installed in aluminum doors to be furnished with appropriate brackets for aluminum door applications. **See page 6 (A)**.
- All devices to use tamper-resistant security screws. Specify **T**.
- All devices to be furnished with rigid trim. Specify **R** after trim.
- All devices to be furnished with clutch-style lever trim. Specify **C** after lever trim.

## Finishes

### Architectural Finishes

- Brass: 605 (Bright) or 606 (Satin)
- Bronze: 611 (Bright), 612 (Satin), or 613 (Oxidized Satin)
- Nickel: 619 (Satin)
- Black: 693
- Chrome: 625 (Bright) or 626 (Satin)
- Stainless: 629 (Bright) or 630 (Satin)

### Powder Coated Finishes

- Aluminum: 689
- Bronze: 691 (Dull) or 695 (Dark Duranodic)
- Black: 693
- Gold: 696
- Clear Powder Coat available over 630 – Stainless Steel Specify **PC**
- Anti-Microbial: Specify **AM**

## Warranty

For details, refer to **Limited Warranty** on our website at [go.dormakaba.com/Terms-DA](http://go.dormakaba.com/Terms-DA)

## NOTE:

\* No dogging available.

\*\* The 9000 Series narrow stile bar lengths are designed for use on narrow stile aluminum entrance doors with a 1/2" blade stop frame. Other applications may require field cutting the bar.



9000 Series Data & Features	Model 9100	Model 9300	Model 9400	Model 9500	Model 9600	Model 9700	Model 9800
Wide Stile Exit Device	●	●	●	●	N/A	N/A	N/A
Narrow Stile Exit Device	N/A	N/A	N/A	N/A	●	●	●
U.L. Listed for Hazard	●	●	●	●	●	●	●
U.L. Listed for Labeled Fire Doors (prefix F) *	○	○	○	○	○	○	○
Extended Life Cycle Testing	●	●	●	●	●	●	●
Latch Bolt Load Rated	N/A	●	N/A	N/A	N/A	●	N/A
Size <b>A</b> Doors (34"-48") (touchpad 24-5/8")	○	○	○	○	N/A	N/A	N/A
Size <b>B</b> Doors (28"-36") (touchpad 18-5/8") Default Wide	●	●	●	●	N/A	N/A	N/A
Size <b>C</b> Doors (25"-30") (touchpad 15-5/8")	○	○	○	○	N/A	N/A	N/A
Size <b>D*</b> Doors (25"-30", can be field cut 24") (touchpad 15-7/8")	○	○	○	○	N/A	N/A	N/A
Size <b>AA</b> Doors (32-1/2"-48")** (touchpad 24-5/8")	N/A	N/A	NA	N/A	○	○	○
Size <b>BB</b> Doors (27"-36")** (touchpad 18-5/8") Default Narrow	N/A	N/A	NA	N/A	●	●	●
Size <b>CC</b> Doors (23-1/2"-36")** (touchpad 15-5/8")	N/A	N/A	NA	N/A	○	○	○
Door Height up to 7' Default Vertical Rod	●	N/A	●	N/A	●	N/A	●
Door Height up to 8' (Specify 8')	○	N/A	○	N/A	○	N/A	○
Door Height up to 10' (over 8', specify actual door height and ETR)	○	N/A	○	N/A	○	N/A	○
Door Thickness 1-3/4" to 2-1/4"	●	●	●	●	●	●	●
Door Thickness 2-1/4" to 3-1/2"	N/A	N/A	N/A	N/A	○	○	○
Device Non-Handed	N/A	●	N/A	N/A	N/A	N/A	N/A
Device Handed but Field Reversible	●	N/A	●	N/A	●	N/A	●
Device Handed, Not Reversible	N/A	N/A	N/A	●	N/A	●	N/A
Hex Key Dogging (non-listed units only)	●	●	●	●	●	●	●
Cylinder Dogging (non-listed units only)	○	○	○	○	○	○	○
Round Bottom Slide Bolt (-) Default	●	N/A	●	NA	●	N/A	●
Deadlocking Pullman Type Bottom Latch Bolt (specify P)	○	N/A	○	N/A	○	N/A	○
Less Bottom Rod (specify LB)	○	N/A	○	N/A	○	N/A	○
Full Length Touch Bar (Not Available DE) (Specify FL)	○	○	○	○	○	○	○
Motorized Latch Bolt Retraction (specify MLR)	○	○	○	○	○	○	○
Electric Latch Bolt Retraction (specify ES)	○	○	○	N/A	○	○	○
Monitor Switch in Touchbar (specify MS)	○	○	○	○	○	○	○
Latch Bolt Monitor (specify LM)	○	○	○	○	○	○	○
Latch Monitor/Monitor Switch (specify LM/MS)	○	○	○	○	○	○	○
Latch Monitor/Monitor Switch with Bypass (specify LM/MS BP)	○	○	○	○	○	○	○
Exit Alarm (specify BA, BAR or DA)	○	○	○	○	○	○	○
Delayed Egress 15 sec (specify DE)	○	○	N/A	○	○	○	N/A
Clutch Style Lever Trim (specify C) Note: Clutch option available to C, R, G & T lever styles only	○	○	○	○	○	○	○
Rigid Lever Trim (specify R)	○	○	○	○	○	○	○
Motorized Dogging (specify MLR)	○	○	○	○	○	○	○
Glass Lite Shim Kit (wide stile, specify GK9000)	○	○	○	○	N/A	N/A	N/A
Glass Lite Shim Kit (narrow stile, specify GK9200)	N/A	N/A	N/A	N/A	○	○	○
Security Screws (specify T)	○	○	○	○	○	○	○
Sex Nuts (Specify SNB/Quantity)	○	○	○	○	○	○	○
Aluminum Door Latch Brackets. Specify A (9100/9600) or NS (9600)	○	N/A	N/A	N/A	○	N/A	N/A
Hurricane Code Rated (specify HC)	N/A	○	○	○	N/A	○	○
California Building Code compliant for maximum 5 lb operating force (specify BF)	N/A	○	N/A	○	N/A	○	N/A

● – Standard Feature ○ – Optional Feature N/A – Not Applicable \*\* See **NOTES** on previous page.

# Options

<b>BA</b>	Battery Powered Exit Alarm	<b>LM/MS</b>	Latch Monitor/Monitor Switch
<b>BAR</b>	Battery Powered Exit Alarm, (4) minute reset	<b>LM/MS BP</b>	Latch Monitor/Monitor Switch with Bypass
<b>DA</b>	Direct Wired Exit Alarm	<b>DE</b>	Delayed Egress, 15 sec (9100, 9300, 9500, 9600, 9700)
<b>CD</b>	Cylinder Dogging	<b>D3</b>	Delayed Egress, 30 sec (9100, 9300, 9500, 9600, 9700) requires special approval from authority having jurisdiction)
<b>MLR</b>	Motorized Latch Retraction / Electric Dogging	<b>DECBC</b>	Delayed Egress, CBC compliant
<b>ES</b>	Latch Retraction (9100, 9300, 9400, 9600, 9700, 9800)	-	Slide Bolt (9100, 9400, 9600, 9800)
<b>ETR</b>	Top Rod Extension (9100, 9400, 9600, 9800)	<b>P</b>	Pullman Bottom Latch, vertical rod only (9100, 9400, 9600, 9800)
<b>GK9000</b>	Vision Lite Shim Kit (Wide Stile)	<b>SNB</b>	Sex Nuts, specify quantity
<b>GK9200</b>	Vision Lite Shim Kit (Narrow Stile)	<b>A</b>	Wide Stile Aluminum Door Brackets (9100, 9600)
<b>LB</b>	Less Bottom Rod (9100, 9400, 9600, 9800)	<b>NS</b>	2-1/8" Narrow Stile Aluminum Door Bracket (9600 only)
<b>LM</b>	Latch Monitor	<b>WD</b>	Narrow Stile Wood or Hollow Steel Door Bracket (9600 only)
<b>MS</b>	Monitor Switch	<b>FL</b>	Full Length Touch Bar
<b>HC</b>	Hurricane Code Rated (9300, 9400, 9500, 9700, 9800)	<b>BF</b>	Barrier Free, CBC compliant (9300, 9500, 9700)

# ANSI Functions

<b>ANSI Function</b>	<b>Function Description</b>	<b>Type 1 Rim Exit Device</b>	<b>Type 2 Surface Vertical Rod Exit Device</b>
<b>01</b>	Exit Only – No Trim	<b>9300 or F9300</b>	<b>9400 or F9400</b>
<b>02</b>	Entrance by trim when actuating bar is locked down.	<b>9300 x (trim)</b> V102 / V302 PTT02 / PRT02 Yx02R / YK02R	<b>9400 x (trim)</b> V102 / V302 PTT02 / PRT02 Yx02R / YK02R
<b>03</b>	Entrance by trim when latch bolt is retracted by key. Key removable only when locked.	<b>9300 or F9300 x (trim)</b> VO03 / V103 / V303, YO03 NPT03 / PTT03 / PRT03 Yx02R / YK02R 9x03J / 9x03 / 9K03 / 9K03J POF03HDA	<b>9400 or F9400 x (trim)</b> VO03 / V103 / V303, YO03 NPT03 / PTT03 / PRT03 Yx03R / YK03R 9x03 / 9x03J / 9K03 / 9K03J
<b>05</b>	Entrance by thumbpiece. Key locks or unlocks thumbpiece.	<b>9300 or F9300 x (trim)</b> HTT05/HRT05	<b>9400 or F9400 x (trim)</b> HTT05/HRT05
<b>06</b>	Entrance by thumbpiece only when released by key. Key removable only when locked.	<b>9300 or F9300 x (trim)</b> HTT06/HRT06	<b>9400 or F9400 x (trim)</b> HTT06/HRT06

<b>ANSI Function</b>	<b>Function Description</b>	<b>Type 1 Rim Exit Device</b>	<b>Type 2 Surface Vertical Rod Exit Device</b>
<b>08</b>	Entrance by knob or lever. Key locks or unlocks knob or lever.	<b>9300 or F9300 x (trim)</b> Yx08 / YK08 Yx08C 9x08 / 9x08J / 9K08 / 9K08J	<b>9400 or F9400 x (trim)</b> Yx08 / YK08 Yx08C 9x08 / 9x08J / 9K08 / 9K08J
<b>08x08</b>	Entrance by lever. OS or IS key locks or unlocks lever.	<b>F9300 x (trim)</b> Yx08x08 / YK08x08	
<b>09</b>	Entrance by knob or lever only when released by key. Key removable only when locked.	<b>9300 or F9300 x (trim)</b> Yx09 / YK09 Yx09C	<b>9400 or F9400 x (trim)</b> Yx09 / YK09 Yx09C
<b>22</b>	Entrance by thumbpiece (no cylinder). Trim always active.	<b>9300 or F9300 x (trim)</b> HRT22/HTT22	<b>9400 or F9400 x (trim)</b> HRT22/HTT22
<b>23</b>	Entrance by knob or lever (no cylinder). Trim always active.	<b>9300 or F9300 x (trim)</b> Yx23 / YK23 9x23 / 9K23	<b>9400 or F9400 x (trim)</b> Yx23 / YK23 9x23 / 9K23

<b>ANSI Function</b>	<b>Function Description</b>	<b>Type 3 Mortise Exit Device</b>	<b>Type 7/8 Wood/Metal Door Concealed Vertical Rod Exit Device</b>
<b>01</b>	Exit Only – No Trim	<b>9500 or F9500</b>	<b>9100 or F9100</b>
<b>02</b>	Entrance by trim when actuating bar is locked down.	<b>9500 x (trim)</b> V102M / V302M PTT02M / PRT02M Yx02R / YK02R	<b>9100 x (trim)</b> V102CV / V302CV PTT02CV / PRT02CV Yx02R / YK02R
<b>03</b>	Entrance by trim when latch bolt is retracted by key. Key removable only when locked.	<b>9500 or F9500 x (trim)</b> VO03M / V103M / V303M, YO03M NPT03M / PTT03M / PRT03M Yx03MR / YK03MR	<b>9100 or F9100 x (trim)</b> VO03CV / V103CV / V303CV, YO03 NPT03CV / PTT03CV / PRT03CV Yx03R / YK03R 9x03 / 9x03J / 9K03 / 9K03J
<b>05</b>	Entrance by thumbpiece. Key locks or unlocks thumbpiece.	<b>9500 or F9500 x (trim)</b> HTT05M / HRT05M	<b>9100 or F9100 x (trim)</b> HTT05CV / HRT05CV
<b>06</b>	Entrance by thumbpiece only when released by key. Key removable only when locked.		<b>9100 or F9100 x (trim)</b> HTT06CV / HRT06CV
<b>08</b>	Entrance by knob or lever. Key locks or unlocks knob or lever.	<b>9500 or F9500 x (trim)</b> Yx08M / YK08M Yx08MC	<b>9100 or F9100 x (trim)</b> Yx08 / YK08 Yx08C 9x08 / 9R08J / 9K08 / 9K08J
<b>09</b>	Entrance by knob or lever only when released by key. Key removable only when locked.		<b>9100 or F9100 x (trim)</b> Yx09 / YK09 Yx09C
<b>22</b>	Entrance by thumbpiece (no cylinder). Trim always active.	<b>9500 or F9500 x (trim)</b> HRT22M / HTT22M	<b>9100 or F9100 x (trim)</b> HRT22CV / HTT22CV
<b>23</b>	Entrance by knob or lever (no cylinder). Trim always active.	<b>9500 or F9500 x (trim)</b> Yx23M / YK23M	<b>9100 or F9100 x (trim)</b> Yx23 / YK23

**NOTE:** When a trim designation includes an x (such as Yx23), replace x with the letter or number assigned to the chosen lever style. For example, YR23 specifies lever style R. See page 34 for details.

<b>ANSI Function</b>	<b>Function Description</b>	<b>Type 4 Rim Exit Device</b>	<b>Type 5 Surface Vertical Rod Exit Device</b>	<b>Type 6 Wood/Metal Door Concealed Vertical Rod Device</b>
<b>01</b>	Exit Only – No Trim	<b>9700 or F9700</b>	<b>9800 or F9800</b>	<b>9600 or F9600</b>
<b>02</b>	Entrance by trim when actuating bar is locked down.	<b>9700 x (trim)</b> OP02 ZP02 Zx02R / ZK02R	<b>9800 x (trim)</b> OP02 ZP02 ZxR02R / ZK02R	<b>9600 x (trim)</b> OP02 ZP02 Zx02R / ZK02R
<b>03</b>	Entrance by trim when latch bolt is retracted by key. Key removable only when locked.	<b>9700 or F9700 x (trim)</b> ZO03 ZP03 Zx03R / ZK03R	<b>9800 or F9800 x (trim)</b> ZO03 ZP03 Zx03R / ZK03R	<b>9600 or F9600 x (trim)</b> ZO03 ZP03 Zx03R / ZK03R
<b>08</b>	Entrance by knob or lever. Key locks or unlocks knob or lever.	<b>9700 or F9700 x (trim)</b> Zx08 / Zx08C / ZK08	<b>9800 or F9800 x (trim)</b> Zx08 / Zx08C / ZK08	<b>9600 or F9600 x (trim)</b> Zx08 / Zx08C / ZK08
<b>09</b>	Entrance by knob or lever only when released by key. Key removable only when locked.	<b>9700 or F9700 x (trim)</b> Zx09 / Zx09C / ZK09	<b>9800 or F9800 x (trim)</b> Zx09 / Zx09C / ZK09	<b>9600 or F9600 x (trim)</b> Zx09 / Zx09C / ZK09
<b>11</b>	Entrance by thumbturn. Key locks or unlocks thumbturn.	<b>9700 or F9700 x (trim)</b> ZP11	<b>9800 or F9800 x (trim)</b> ZP11	<b>9600 or F9600 x (trim)</b> ZP11
<b>12</b>	Entrance by thumbturn when unlocked by key. Key removable only when trim is locked.	<b>9700 or F9700 x (trim)</b> ZP12	<b>9800 or F9800 x (trim)</b> ZP12	<b>9600 or F9600 x (trim)</b> ZP12
<b>23</b>	Entrance by knob or lever (no cylinder). Trim always active.	<b>9700 or F9700 x (trim)</b> Zx23 / ZK23	<b>9800 or F9800 x (trim)</b> Zx23 / ZK23	<b>9600 or F9600 x (trim)</b> Zx23 / ZK23
<b>25</b>	Entrance by thumbturn and pull (no cylinder). Thumbturn always active.	<b>9700 or F9700 x (trim)</b> ZP25	<b>9800 or F9800 x (trim)</b> ZP25	<b>9600 or F9600 x (trim)</b> ZP25

**NOTE:** When a trim designation includes an x (such as Zx23), replace x with the letter or number assigned to the chosen lever style. For example, ZR23 specifies lever style R. See page 63 for details.

## How to order 9000 Series exit devices

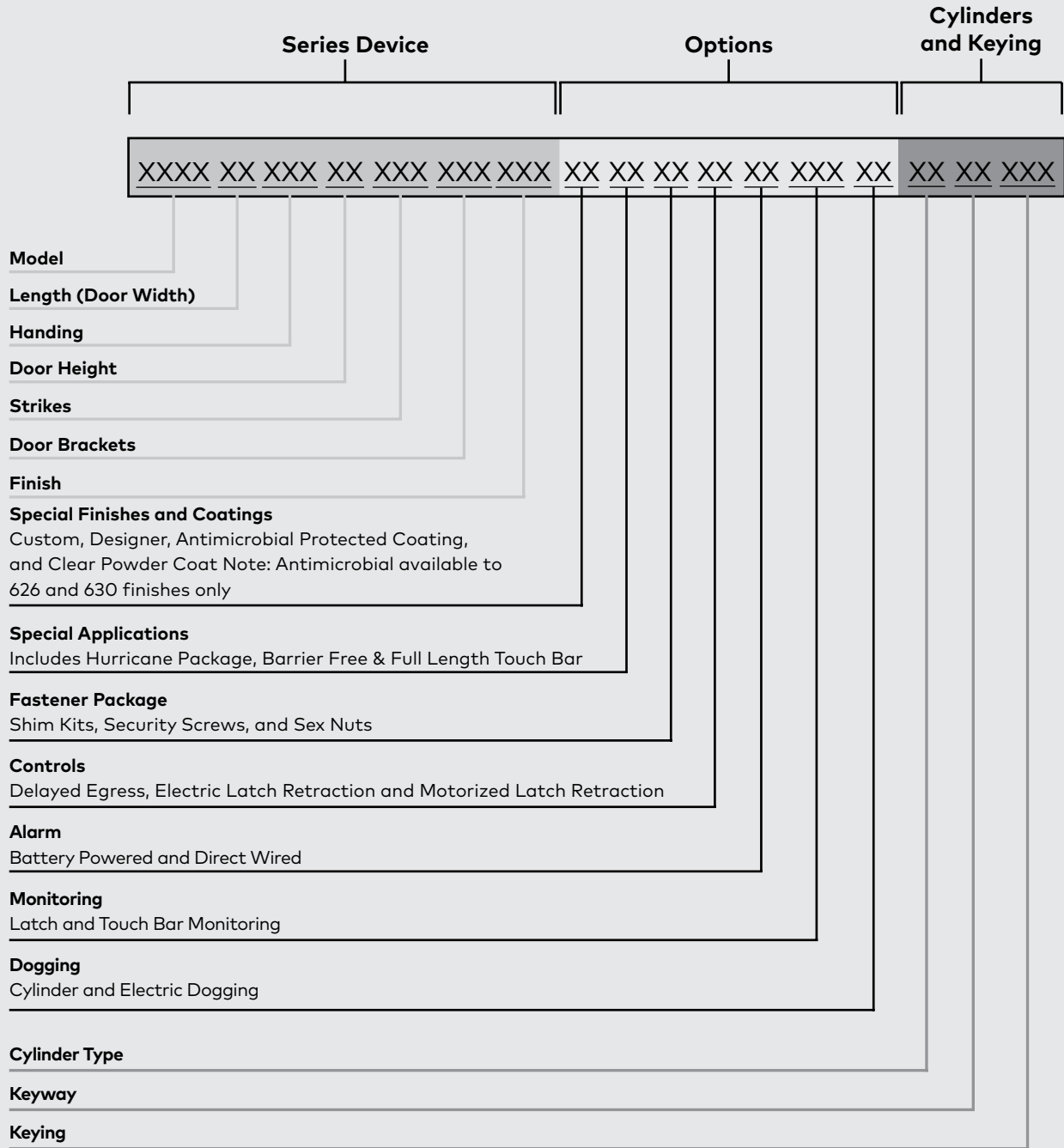

**Patented Key control**  
**D100** is the keyway for our patented **SC** serialized key control system. **SC** is internet based and provides added layers of security. For more information, contact your local sales representative or Technical Service at 800-523-8488.

### Handing

**Right-Hand Reverse Bevel (RHR)**  
 Outside

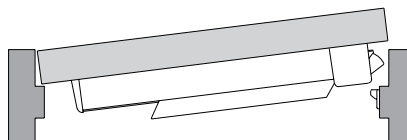

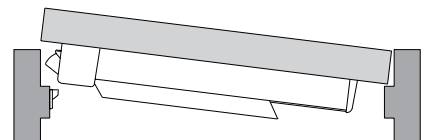

Push Side

**Left-Hand Reverse Bevel (LHR)**  
 Outside





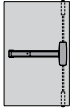
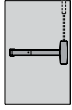
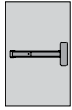
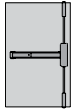
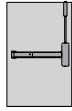

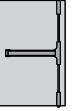
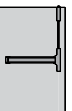

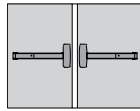
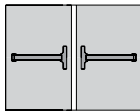
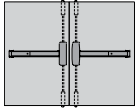
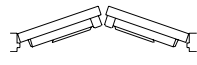
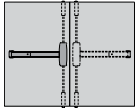

Push Side

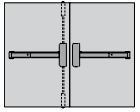
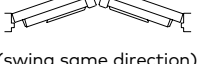
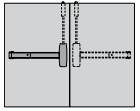
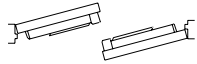
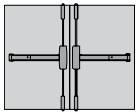
# Applications & Listings

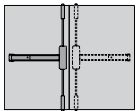
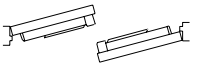
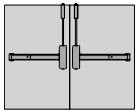
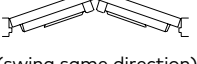

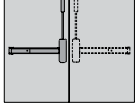
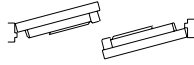
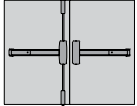
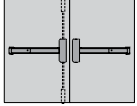
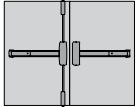
Model	Door Material	Max. Door Opening	Door Ratings	Applications	
<b>Single Doors</b>					
Concealed Vertical Rod <b>9100</b>	Wood/Steel	4' x 10'	Devices are panic listed only	Concealed (2) point latching	
Concealed Vertical Rod <b>F9100</b>	Steel	4' x 10'	3 Hour		
	Wood	4' x 10'	1-1/2 Hour		
Concealed Vertical Rod (Less Bottom Rod) <b>9100 LB</b>	Wood/Steel	4' x 10'	Devices are panic listed only	Concealed (1) point latching	
Concealed Vertical Rod (Less Bottom Rod) <b>F9100 LB</b>	Steel	4' x 10'	3 Hour		
	Wood	4' x 10'	1-1/2 Hour		
Rim <b>9300</b>	Wood/Steel	4' x 8'	Devices are panic listed only	Surface applied (1) point latching	
Rim <b>F9300</b>	Steel	4' x 8'	3 Hour		
	Wood	4' x 8'	1-1/2 Hour		
Surface Vertical Rod <b>9400</b>	Wood/Steel	4' x 10'	Devices are panic listed only	Surface applied (2) point latching	
Surface Vertical Rod <b>F9400</b>	Steel	4' x 10'	3 Hour		
	Wood	4' x 10'	1-1/2 Hour		
Surface Vertical Rod (Less Bottom Rod) <b>9400 LB</b>	Wood/Steel	4' x 10'	Devices are panic listed only	Surface applied (1) point latching	
Surface Vertical Rod (Less Bottom Rod) <b>F9400 LB</b>	Steel	4' x 10'	3 Hour		
	Wood	4' x 10'	1-1/2 Hour		
Mortise <b>9500</b>	Wood/Steel	4' x 10'	Devices are panic listed only	Mortised (1) point latching	
Mortise <b>F9500</b>	Steel	4' x 10'	3 Hour		
	Wood	4' x 8'	1-1/2 Hour		
	Wood	4' x 10'	*1/3 Hour		
Rim <b>9700</b>	Wood/Steel	4' x 8'	Devices are panic listed only	Surface applied (1) point latching	
Rim <b>F9700</b>	Steel	4' x 8'	3 Hour		
	Wood	4' x 8'	1-1/2 Hour		
Surface Vertical Rod <b>9800</b>	Wood/Steel	4' x 10'	Devices are panic listed only	Surface applied (2) point latching	
Surface Vertical Rod <b>F9800</b>	Steel	4' x 10'	3 Hour		
	Wood	4' x 10'	1-1/2 Hour		
Surface Vertical Rod (Less Bottom Rod) <b>9800 LB</b>	Wood/Steel	4' x 10'	Devices are panic listed only	Surface applied (1) point latching	
Surface Vertical Rod (Less Bottom Rod) <b>F9800 LB</b>	Steel	4' x 10'	3 Hour		
	Wood	4' x 10'	1-1/2 Hour		

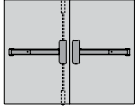
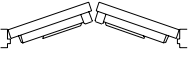
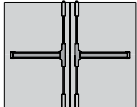
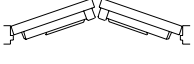
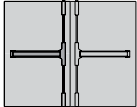
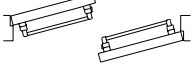
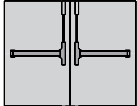
\* Designates minimum U.L. listing for wood doors over 8' in height. Listings for 90 minutes or greater may be applicable through other listing agencies dependent upon the wood door manufacturer's current listing. Contact wood door manufacturer for details.

Model	Door Material	Max. Door Opening	Door Ratings	Applications	
<b>Pair of Doors with Removable Mullion</b>					
Rim x Rim <b>9300 x 9300</b>	Wood/Steel	8' x 8'	Devices are panic listed only	(2) independent active doors with removable mullion (1) point latching	
Rim x Rim <b>F9300 x F9300</b>	Steel	8' x 8'	3 Hour		
	Wood	8' x 8'	1-1/2 Hour		
Rim x Rim <b>9700 x 9700</b>	Wood/Steel	8' x 8'	Devices are panic listed only	(2) independent active doors with removable mullion (1) point latching	
Rim x Rim <b>F9700 x F9700</b>	Steel	8' x 8'	1-1/2 Hour		
	Wood	8' x 8'	1-1/2 Hour		
<b>Pair of Doors</b>					
Concealed Vertical Rod <b>9100 x 9100</b>	Wood/Steel	8' x 10'	Devices are panic listed only	(2) independent doors with (2) point latching	
Concealed Vertical Rod <b>F9100 x F9100</b>	Steel	8' x 10'	1-1/2 Hour <sup>2</sup>	 (swing same direction)	
	Wood	8' x 8'	1-1/2 Hour		
	Wood	8' x 10'	1-1/2 Hour		
Concealed Vertical Rod <b>9100 x 9100</b>	Wood/Steel	8' x 10'	Devices are panic listed only	(2) independent doors with (2) point latching	
Concealed Vertical Rod <b>F9100 x F9100</b>	Steel	8' x 10'	3 Hour	 (swing opposite direction)	
	Wood	8' x 8'	1-1/2 Hour		
	Wood	8' x 10'	1-1/2 Hour		
Concealed Vertical Rod (Less Bottom Rod) <b>9100 LB x 9100 LB</b>	Wood/Steel	8' x 10'	Devices are panic listed only	(2) independent doors with (1) point latching	
Concealed Vertical Rod (Less Bottom Rod) <b>F9100 LB x F9100 LB</b>	Steel	8' x 10'	1-1/2 Hour <sup>1,2</sup>	 (swing same direction)	
	Wood	8' x 10'	1-1/2 Hour <sup>1</sup>		
Concealed Vertical Rod (Less Bottom Rod) <b>9100 LB x 9100 LB</b>	Wood/Steel	8' x 10'	Devices are panic listed only	(2) independent doors with (1) point latching	
Concealed Vertical Rod (Less Bottom Rod) <b>F9100 LB x F9100 LB</b>	Steel	8' x 10'	3 Hour <sup>1</sup>	 (swing opposite direction)	
	Wood	8' x 10'	1-1/2 Hour <sup>1</sup>		
Surface Vertical Rod <b>9400 x 9400</b>	Wood/Steel	8' x 10'	Devices are panic listed only	(2) independent doors with (2) point latching	
Surface Vertical Rod <b>F9400 x F9400</b>	Steel	8' x 10'	1-1/2 Hour <sup>2</sup>	 (swing same direction)	
	Wood	8' x 8'	1-1/2 Hour		
	Wood	8' x 10'	1-1/2 Hour		
Surface Vertical Rod <b>9400 x 9400</b>	Wood/Steel	8' x 10'	Devices are panic listed only	(2) independent doors with (2) point latching	
Surface Vertical Rod <b>F9400 x F9400</b>	Steel	8' x 10'	3 Hour	 (swing opposite direction)	
	Wood	8' x 8'	1-1/2 Hour		
	Wood	8' x 10'	1-1/2 Hour		
Surface Vertical Rod (Less Bottom Rod) <b>9400 LB x 9400 LB</b>	Wood/Steel	8' x 10'	Devices are panic listed only	(2) independent doors with (1) point latching	
Surface Vertical Rod (Less Bottom Rod) <b>F9400 LB x F9400 LB</b>	Steel	8' x 10'	1-1/2 Hour <sup>1,2</sup>	 (swing same direction)	
	Wood	8' x 10'	1-1/2 Hour <sup>1</sup>		

Model	Door Material	Max. Door Opening	Door Ratings	Applications
<b>Pair of Doors (Continued)</b>				
Surface Vertical Rod (Less Bottom Rod) <b>9400 LB x 9400 LB</b>	Wood/Steel	8' x 10'	Devices are panic listed only	(2) independent doors with (1) point latching 
Surface Vertical Rod (Less Bottom Rod) <b>F9400 LB x F9400 LB</b>	Steel	8' x 10'	3 Hour <sup>1</sup>	 (swing opposite direction)
	Wood	8' x 10'	1-1/2 Hour <sup>1</sup>	
Rim x Surface Vertical Rod <b>9300 x 9400</b>	Wood/Steel	8' x 8'	Devices are panic listed only	(2) independent doors with (1) and (2) point latching  (swing same direction)
Rim x Concealed Vertical Rod <b>9300 x 9100</b>	Wood/Steel	8' x 8'	Devices are panic listed only	(2) independent doors with (1) and (2) point latching  (swing same direction)
Mortise x Surface Vertical Rod <b>9500 x 9400</b>	Wood/Steel	8' x 10'	Devices are panic listed only	(2) independent doors with (1) and (2) point latching 
Mortise x Surface Vertical Rod <b>F9500 x F9400</b>	Steel	8' x 10'	3 Hour	 (swing same direction)
	Wood	8' x 8'	1-1/2 Hour	
	Wood	8' x 10'	1-1/2 Hour	
Mortise x Concealed Vertical Rod <b>9500 x 9100</b>	Wood/Steel	8' x 10'	Devices are panic listed only	(2) independent doors with (1) and (2) point latching 
Mortise x Concealed Vertical Rod <b>F9500 x F9100</b>	Steel	8' x 10'	3 Hour	 (swing same direction)
	Wood	8' x 8'	1-1/2 Hour	
	Wood	8' x 10'	1-1/2 Hour	
Concealed Vertical Rod <b>9600 x 9600</b>	Wood/Steel	8' x 10'	Devices are panic listed only	(2) independent doors with (2) point latching 
Concealed Vertical Rod <b>F9600 x F9600</b>	Steel	8' x 10'	1-1/2 Hour <sup>2</sup>	 (swing same direction)
	Wood	8' x 8'	1-1/2 Hour	
	Wood	8' x 10'	1-1/2 Hour <sup>3</sup>	
Concealed Vertical Rod <b>9600 x 9600</b>	Wood/Steel	8' x 10'	Devices are panic listed only	(2) independent doors with (2) point latching 
Concealed Vertical Rod <b>F9600 x F9600</b>	Steel	8' x 10'	1-1/2 Hour	 (swing opposite direction)
	Steel	8' x 8'	1-1/2 Hour	
	Wood	8' x 10'	1-1/2 Hour <sup>3</sup>	
Concealed Vertical Rod (Less Bottom Rod) <b>9600 LB x 9600 LB</b>	Wood/Steel	8' x 10'	Devices are panic listed only	(2) independent doors with (1) point latching 
Concealed Vertical Rod (Less Bottom Rod) <b>F9600 LB x F9600 LB</b>	Steel	8' x 10'	1-1/2 Hour <sup>1,2</sup>	 (swing same direction)
	Wood	8' x 10'	1-1/2 Hour <sup>1,3</sup>	

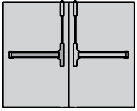
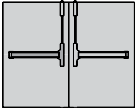
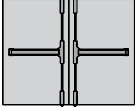
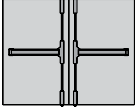
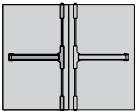
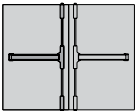
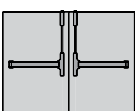
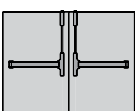
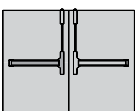
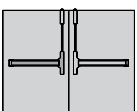

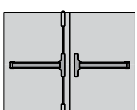
Model	Door Material	Max. Door Opening	Door Ratings	Applications	
Concealed Vertical Rod (Less Bottom Rod) <b>9600 LB x 9600 LB</b>	Wood/Steel	8' x 10'	Devices are panic listed only	(2) independent doors with (1) point latching	
Concealed Vertical Rod (Less Bottom Rod) <b>F9600 LB x F9600 LB</b>	Steel	8' x 10'	3 Hour <sup>1</sup>	(swing opposite direction)	
	Wood	8' x 10'	1-1/2 Hour <sup>1,3</sup>		
Surface Vertical Rod <b>9800 x 9800</b>	Wood/Steel	8' x 10'	Devices are panic listed only	(2) independent doors with (2) point latching	
Surface Vertical Rod <b>F9800 x F9800</b>	Steel	8' x 10'	1-1/2 Hour <sup>2</sup>	(swing same direction)	
	Wood	8' x 8'	1-1/2 Hour		
	Wood	8' x 10'	1-1/2 Hour <sup>3</sup>		
Surface Vertical Rod <b>9800 x 9800</b>	Wood/Steel	8' x 10'	Devices are panic listed only	(2) independent doors with (2) point latching	
Surface Vertical Rod <b>F9800 x F9800</b>	Steel	8' x 10'	3 Hour	(swing opposite direction)	
	Wood	8' x 8'	1-1/2 Hour		
	Wood	8' x 10'	1-1/2 Hour <sup>3</sup>		
Surface Vertical Rod (Less Bottom Rod) <b>9800 LB x 9800 LB</b>	Wood/Steel	8' x 10'	Devices are panic listed only	(2) independent doors with (1) point latching	
Surface Vertical Rod (Less Bottom Rod) <b>F9800 LB x F9800 LB</b>	Steel	8' x 10'	1-1/2 Hour <sup>1,2</sup>	(swing same direction)	
	Wood	8' x 10'	1-1/2 Hour <sup>3</sup>		
Surface Vertical Rod (Less Bottom Rod) <b>9800 LB x 9800 LB</b>	Wood/Steel	8' x 10'	Devices are panic listed only	(2) independent doors with (1) point latching	
Surface Vertical Rod (Less Bottom Rod) <b>F9800 LB x F9800 LB</b>	Steel	8' x 10'	3 Hour <sup>1</sup>	(swing opposite direction)	
	Wood	8' x 10'	1-1/2 Hour <sup>1,3</sup>		
Rim x Surface Vertical Rod <b>9700 x 9800</b>	Wood/Steel	8' x 8'	Devices are panic listed only	(2) independent doors with (1) and (2) point latching	
Rim x Concealed Vertical Rod <b>9700 x 9600</b>	Wood/Steel	8' x 8'	Devices are panic listed only	(swing same direction)	
Rim x Concealed Vertical Rod <b>9700 x 9600</b>	Wood/Steel	8' x 8'	Devices are panic listed only	(swing opposite direction)	

# 9100/F9100 Wide Stile Concealed Vertical Rod Exit Devices







































The 9100 Concealed Vertical Rod and the F9100 Series Concealed Vertical Rod Fire Exit Devices are excellent choices























where barrier-free codes, aesthetics, or the potential for vandalism require concealment of the vertical rod. They are panic

and fire-listed (three-hour steel fire door applications) and feature a simplified adjustment mechanism that provides ease of

installation and reduced service requirements.

**Specify Door Brackets**  
**A – Wide stile aluminum**

Model	Function	Operation	Trim Model	
9100 F9100	01	Exit Only (no trim)		
9100 F9100	DT	Dummy Trim	VODTCV 	NPTDTCV  YODT 
9100	02	Entrance by trim when actuating bar is locked down.	V102CV  V302CV 	PTT02CV  PRT02CV  YP02 
9100 F9100	03	Entrance by trim when latch bolt is retracted by key. Key removable only when locked.	VO03CV  V103CV  V303CV 	NPT03CV  PTT03CV  PRT03CV  YO03  YP03 
CD9100	04	Entrance by trim when latch bolt is retracted by key or set in a retracted position by key.	VO03CV  V103CV  V303CV 	NPT03CV  PTT03CV  PRT03CV  YO03 
9100 F9100	05	Entrance by thumbpiece. Key locks or unlocks thumbpiece.	HTT05CV  HRT05CV 	
9100 F9100	06	Entrance by thumbpiece only when released by key. Key removable only when locked.	HTT06CV  HRT06CV 	
9100 F9100	08	Entrance by knob or lever. Key locks or unlocks knob or lever.	YK08  Yx08 	
9100 F9100	09	Entrance by knob or lever only when released by key. Key removable only when locked.	YK09  Yx09 	
9100 F9100	11	Entrance by thumbturn and pull. Key locks or unlocks thumbturn.	Y011  YP11 	
9100 F9100	12	Entrance by thumbturn and pull only when released by key. Key removable only when locked.	Y012  YP12 	
9100	22	Entrance by thumbpiece (no cylinder). Trim always active.	HTT22CV  HRT22CV 	
9100 F9100	23	Entrance by knob or lever (no cylinder). Knob or lever always active.	YK23  Yx23 	

Trim Model				
YK02R		Yx02R		
YK03R		Yx03R		9K03  9x03  9x03J 
				9K03J 
YK03R		Yx03R		9K03  9x03  9K03J  9x03J 
Yx08C		9K08  9K08J 	9x08  9x08J 	
		Yx09C		
9K23		9x23		

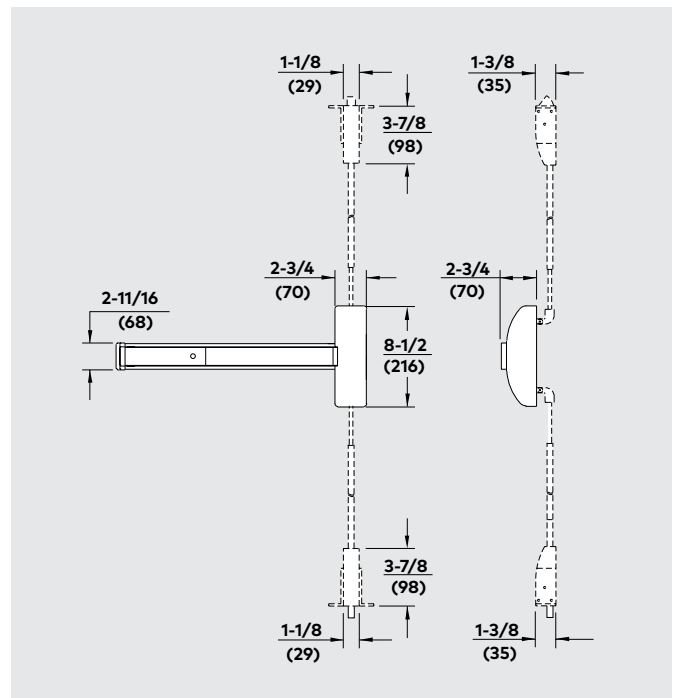

**NOTE:** When a trim designation includes an x (such as Yx23), replace x with the letter or number assigned to the chosen lever style. For example, YR23 specifies lever style R. See page 34 for details.

Standard Strikes

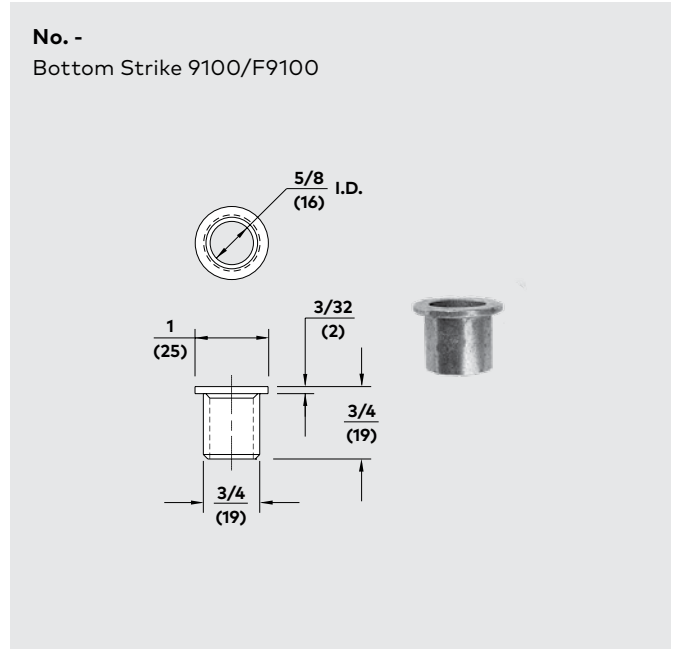
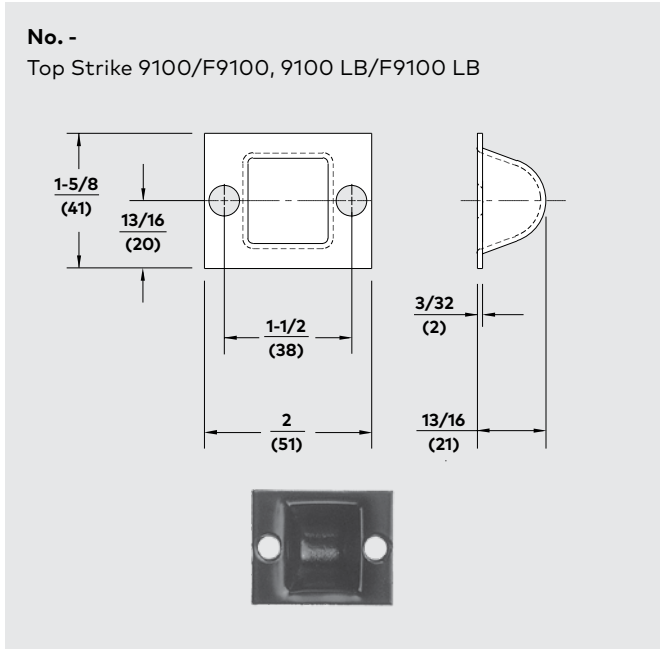

Optional Strikes

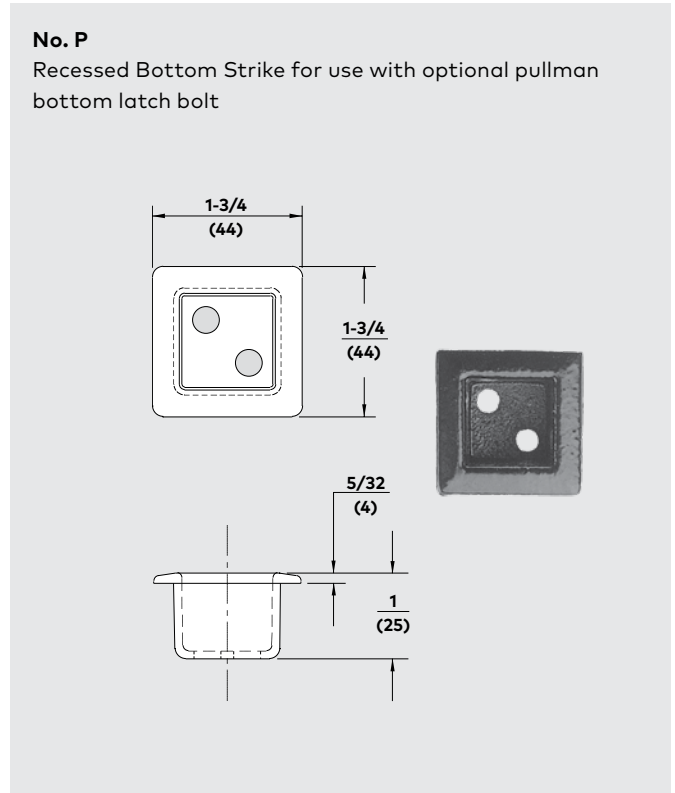
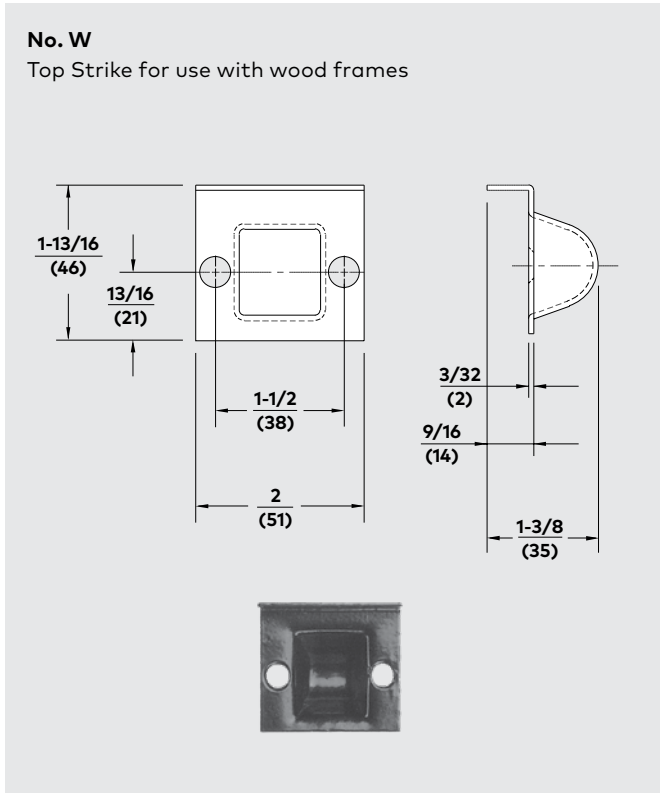

### Optional Strikes

**No. F**

Flat Bottom Strike;  
optional for use with standard bottom slidebolt

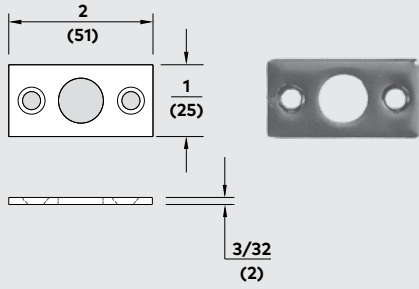

### Minimum Stile & Vertical Reference

**Pair Concealed Vertical Rod**

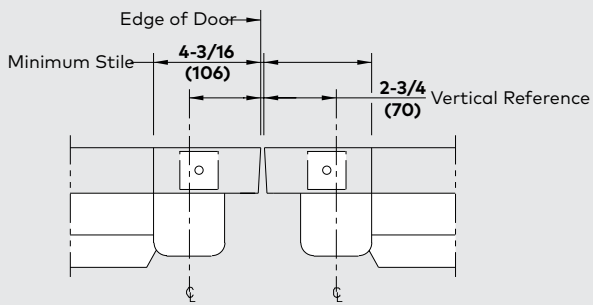

**Concealed Vertical Rod x Mortise**

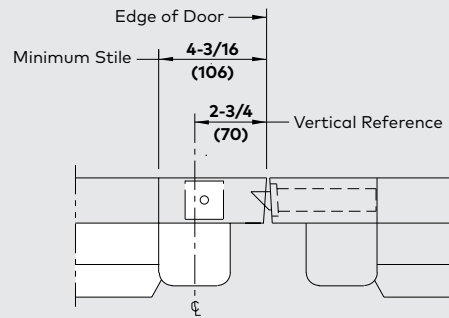



































# 9300/F9300 Wide Stile Rim Exit Devices

The 9300 and F9300 present a simple, heavy-duty, easily installed solution where high quality panic and fire-listed

hardware is needed. The patented exit devices in the 9300 and F9300 Series are available in a full range of

finishes and trim options. The F9300 Series devices carry an "A" label for three-hour steel fire door applications.



Model	Function	Operation	Trim Model
9300 F9300	01	Exit Only (no trim)	
9300 F9300	DT	Dummy Trim	VODT  NPTDT  YODT 
9300	02	Entrance by trim when actuating bar is locked down.	V102  V302  PTT02  PRT02  YP02 
9300 F9300	03	Entrance by trim when latch bolt is retracted by key. Key removable only when locked.	VO03  V103  V303  NPT03  PTT03  PRT03  YO03  YP03 
9300 F9300	05	Entrance by thumbpiece. Key locks or unlocks thumbpiece.	HTT05  HRT05 
9300 F9300	06	Entrance by thumbpiece only when released by key. Key removable only when locked.	HTT06  HRT06 
9300 F9300	08	Entrance by knob or lever. Key locks or unlocks knob or lever.	YK08  Yx08 
9300 F9300	08x08	Entrance by lever. Outside or inside key locks or unlocks lever.	YK08x08  Yx08x08 
9300 F9300	09	Entrance by knob or lever only when released by key. Key removable only when locked.	YK09  Yx09 
9300 F9300	11	Entrance by thumbturn and pull. Key locks or unlocks thumbturn.	Y011  YP11 
9300 F9300	12	Entrance by thumbturn and pull only when released by key. Key removable only when locked.	Y012  YP12 
9300	22	Entrance by thumbpiece (no cylinder). Trim always active.	HTT22  HRT22 
9300 F9300	23	Entrance by knob or lever (no cylinder). Knob or lever always active.	YK23  Yx23 







Trim Model

---



---

YK02R  Yx02R 

YK03R  Yx03R  9K03  9x03   
 9K03J  9x03J   
 POF03HDA 

Yx08C  9K08  9x08   
 9K08J  9x08J 

Yx09C 

9K23  9x23 

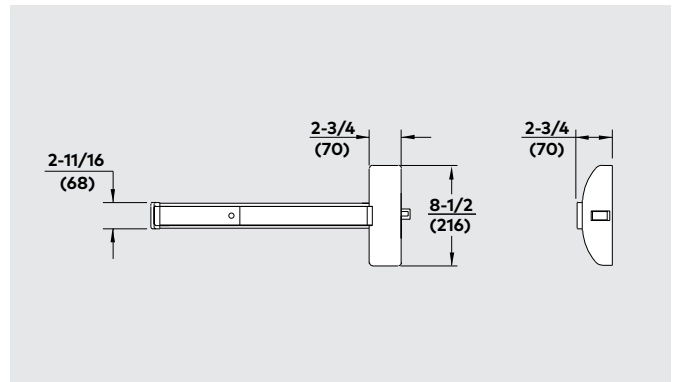

**NOTE:** When a trim designation includes an x (such as Yx23), replace x with the letter or number assigned to the chosen lever style. For example, YR23 specifies lever style R. See page 34 for details.

Standard Strike

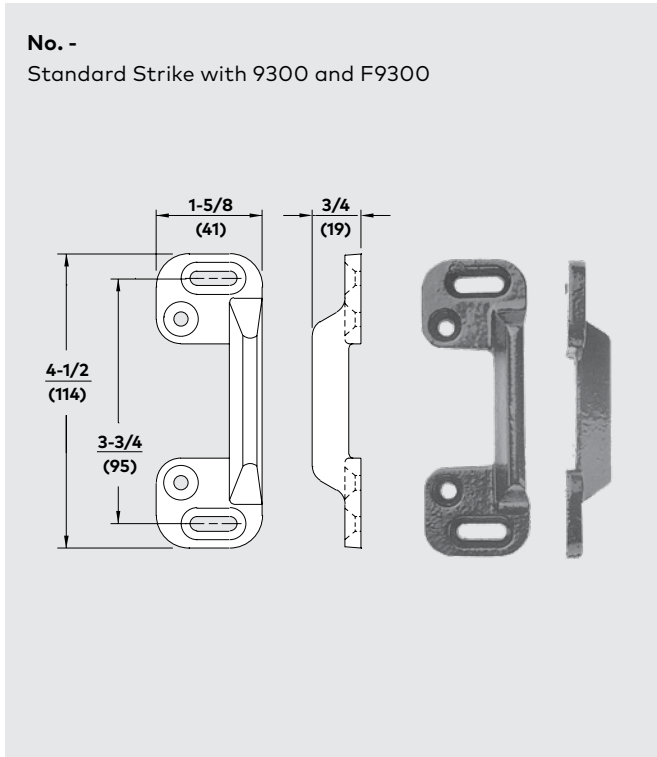

Optional Strike

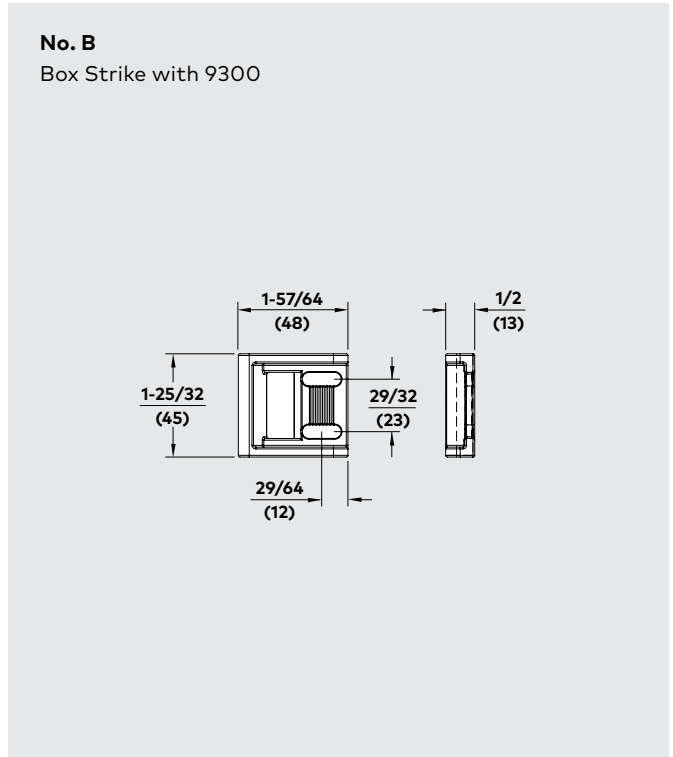

Optional Strikes

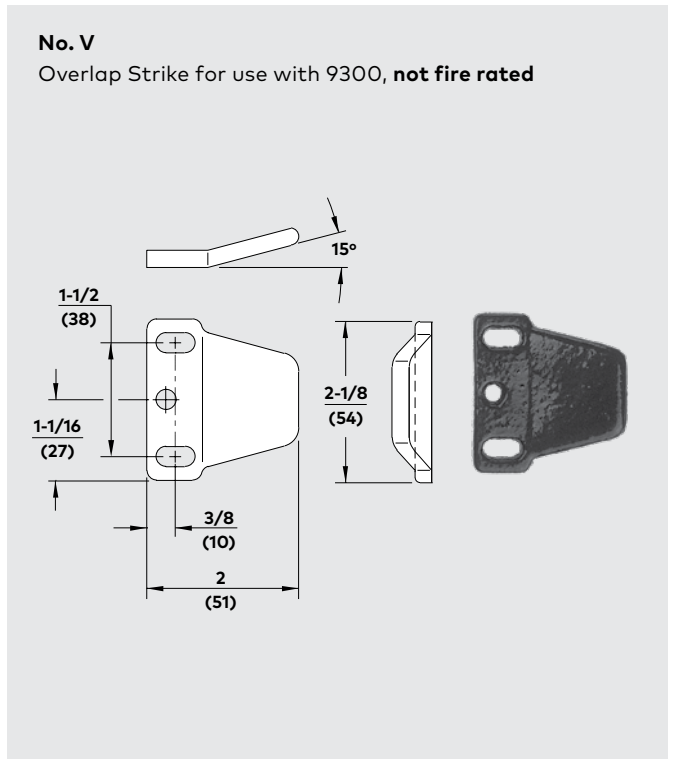
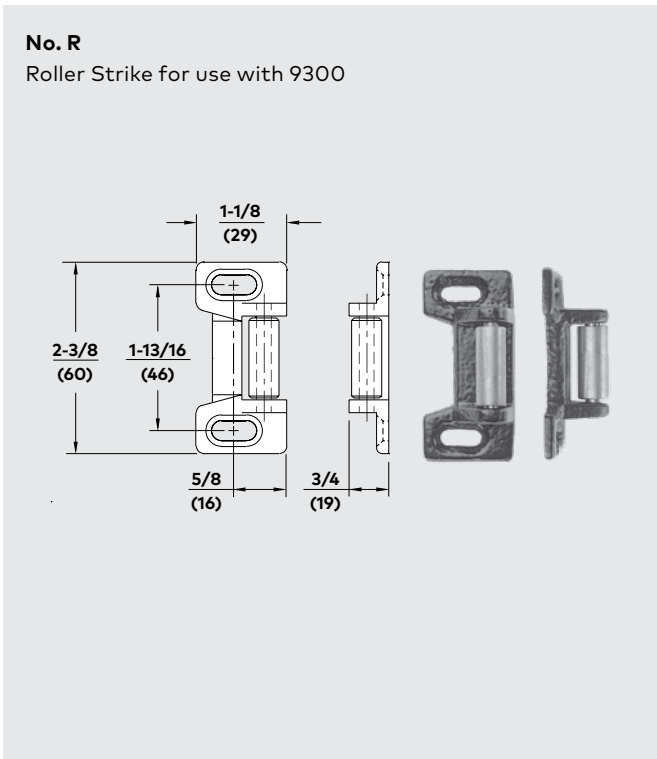



Minimum Stile & Vertical Reference

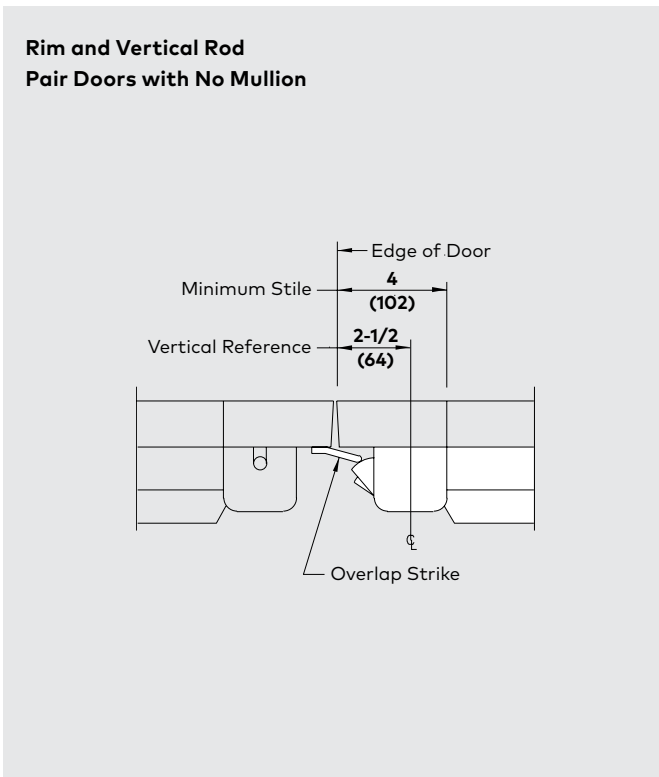
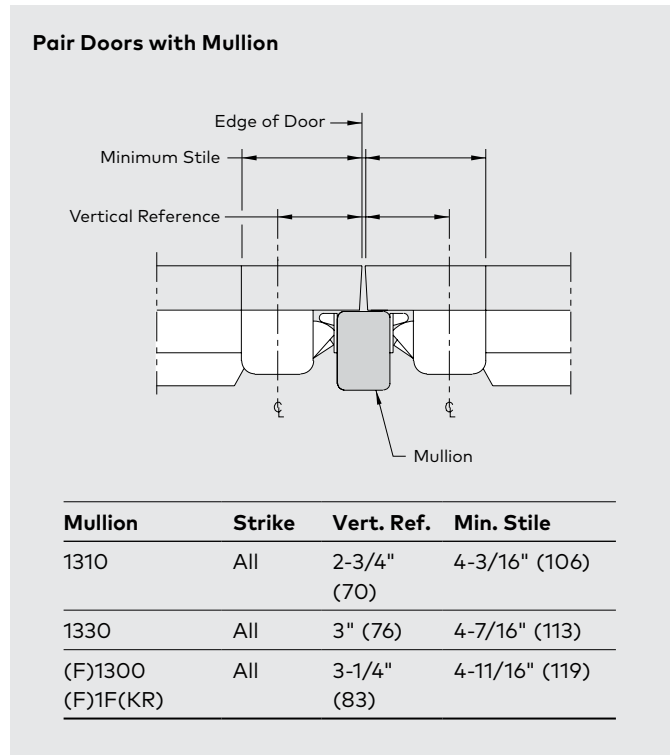
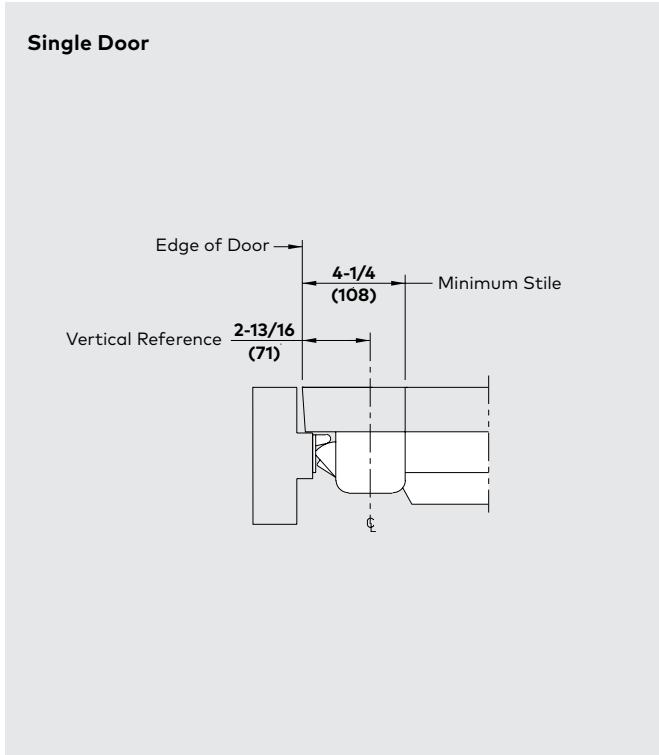





























# 9400/F9400 Wide Stile Surface Vertical Rod Exit Devices















The 9400 and F9400 provide heavy-duty, secure, two-point latching at the top and bottom of the opening. Both the 9400

and F9400 Series feature a patented latch design for reliable, secure operation. The F9400 devices are U.L.-listed

for three-hour steel fire door applications.

Model	Function	Operation	Trim Model
9400 F9400	01	Exit Only (no trim)	
9400 F9400	DT	Dummy Trim	VODT  NPTDT  YODT 
9400	02	Entrance by trim when actuating bar is locked down.	V102  V302  PTT02  PRT02  YP02 
9400 F9400	03	Entrance by trim when latch bolt is retracted by key. Key removable only when locked.	VO03  V103  V303  NPT03  PTT03  PRT03  YO03  YP03 
9400 F9400	05	Entrance by thumbpiece. Key locks or unlocks thumbpiece.	HTT05  HRT05 
9400 F9400	06	Entrance by thumbpiece only when released by key. Key removable only when locked.	HTT06  HRT06 
9400 F9400	08	Entrance by knob or lever. Key locks or unlocks knob or lever.	YK08 
9400 F9400	09	Entrance by knob or lever only when released by key. Key removable only when locked.	YK09 
9400 F9100	11	Entrance by thumbturn and pull. Key locks or unlocks thumbturn.	Y011  YP11 
9400 F9100	12	Entrance by thumbturn and pull only when released by key. Key removable only when locked.	Y012  YP12 
9400	22	Entrance by thumbpiece (no cylinder). Trim always active.	HTT22  HRT22 
9400 F9400	23	Entrance by knob or lever (no cylinder). Knob or lever always active.	YK23 

Trim Model

YK02R		Yx02R			
YK03R		Yx03R		9K03 9K03J	 
Yx08		Yx08C		9K08 9K08J	 
Yx09		Yx09C			
Yx23		9K23		9x23 	

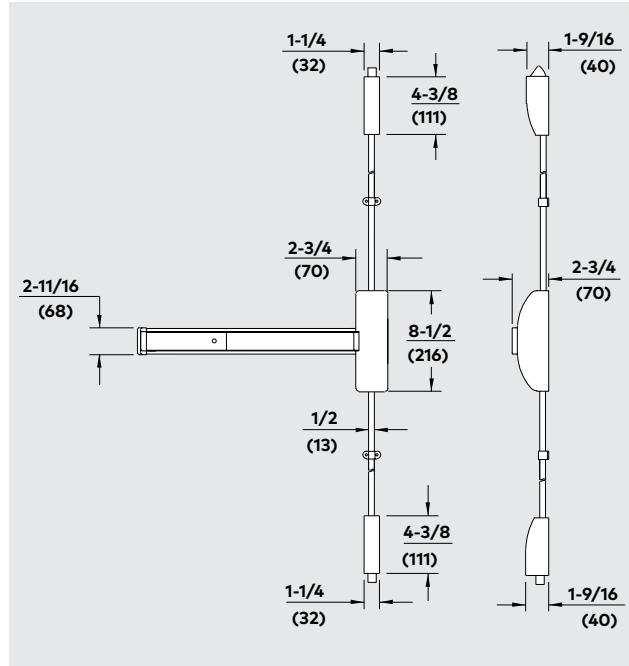

**NOTE:** When a trim designation includes an x (such as Yx23), replace x with the letter or number assigned to the chosen lever style. For example, YR23 specifies lever style R. See page 34 for details.

Standard Strikes

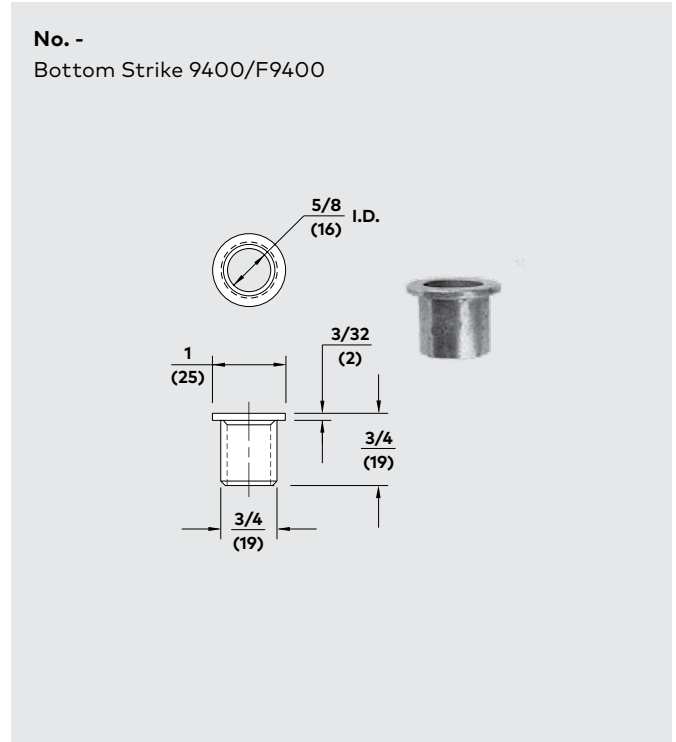
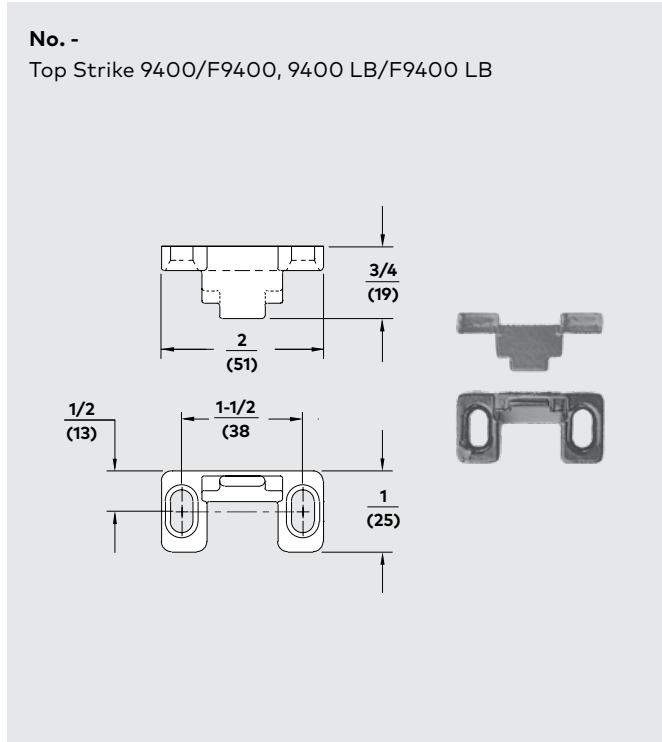

Optional Strikes

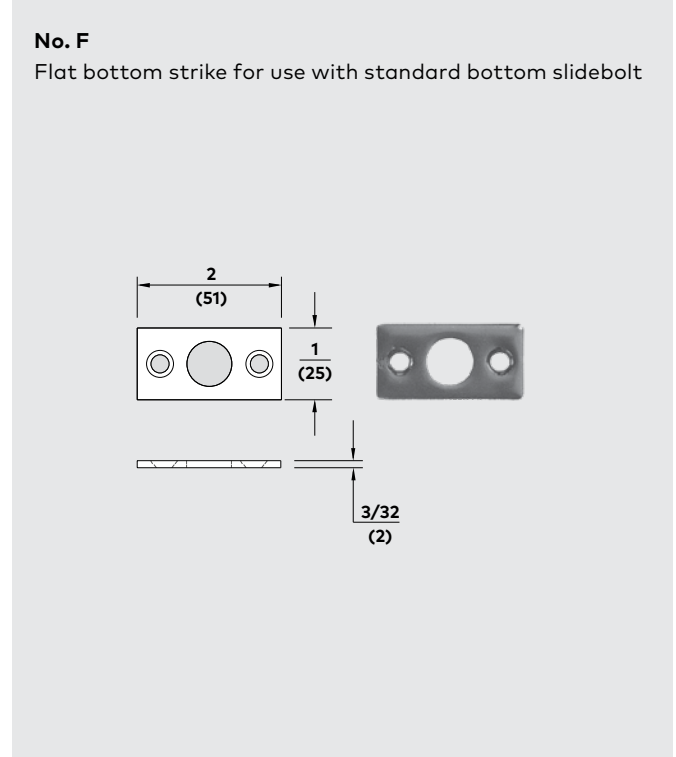
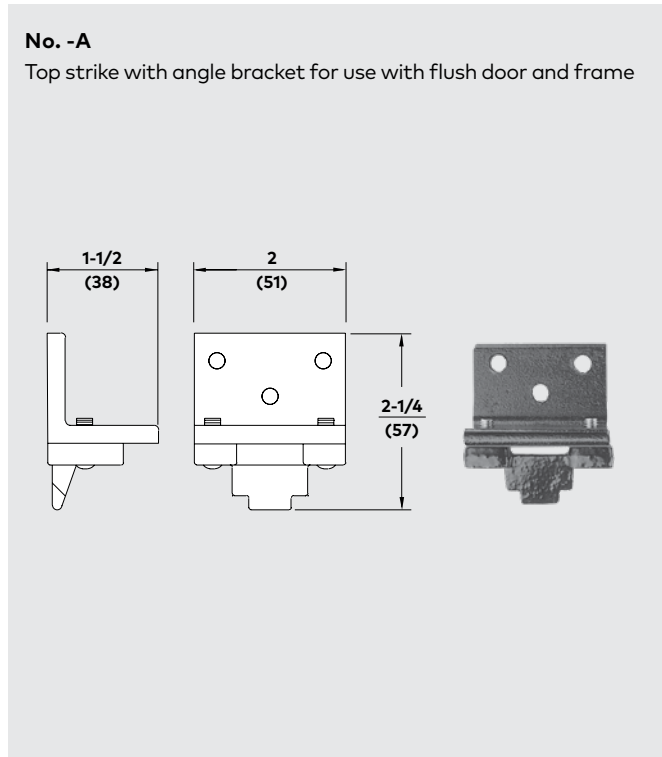

### Optional Strikes

#### No. R

Surface mount bottom strike for use with optional pullman bottom latch

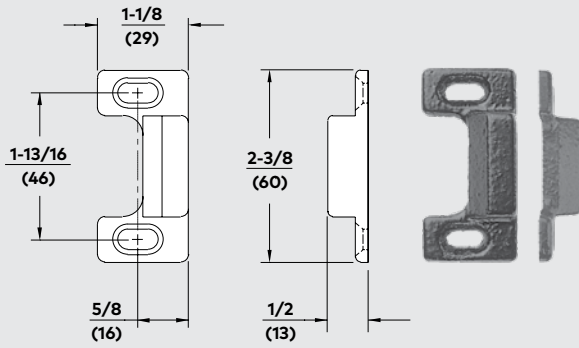

#### No. P

Recessed bottom strike for use with optional pullman bottom latch bolt

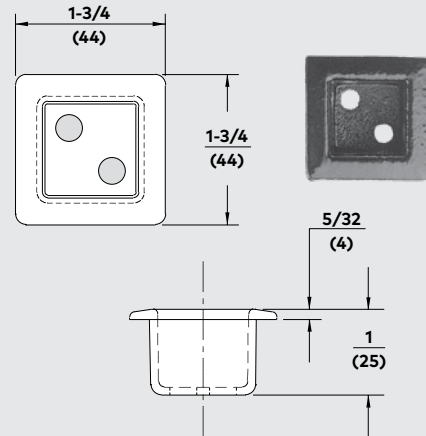

### Minimum Stile & Vertical Reference

#### Vertical Rod x Mortise

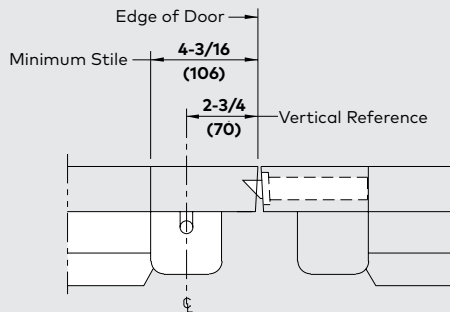

#### Pair Vertical Rod

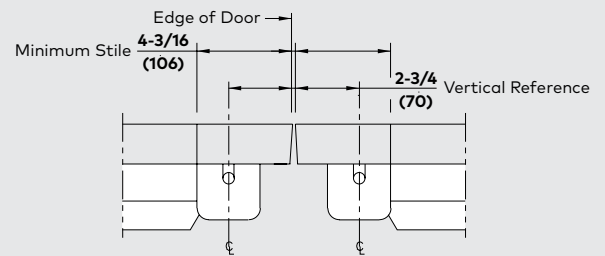



















# 9500/F9500 Wide Stile Mortise Lock Exit Devices

The 9500 and F9500 include a heavy-duty, high quality deadlocking mortise lock that provides a high level of security

and exceptional durability. The F9500 Series devices are U.L.-listed for three-hour steel fire door applications.

New mortise lock chassis with several new benefits including easier and faster to field reverse.

Model	Function	Operation	Trim Model
9500 F9500	01 <sup>1</sup>	Exit Only (no trim)	
9500 F9500	DT <sup>1</sup>	Dummy Trim	VODT  NPTDT  YODT 
9500	02 <sup>1</sup>	Entrance by trim when actuating bar is locked down.	V102M  V302M  PTT02M  PRT02M 
9500 F9500	03 <sup>2</sup>	Entrance by trim when latch bolt is retracted by key. Key removable only when locked.	VO03M  V103M  V303M  NPT03M  PTT03M  PRT03M  YO03M 
9500 F9500	05 <sup>3</sup>	Entrance by thumbpiece. Key locks or unlocks thumbpiece.	HTT05M  HRT05M 
9500 F9500	08 <sup>1</sup>	Entrance by knob or lever. Key locks or unlocks knob or lever.	YK08M 
9500	22 <sup>3</sup>	Entrance by thumbpiece (no cylinder). Trim always active.	HTT22M  HRT22M 
9500 F9500	23 <sup>1</sup>	Entrance by knob or lever (no cylinder). Knob or lever always active.	

<sup>1</sup> Uses 08 function lock case

<sup>2</sup> Uses 03 function lock case—  
Uses 08 Lock case with #13 cam to achieve 03 function.

<sup>3</sup> Uses 05 function lock case

**NOTES:**

- When a trim designation includes an x (such as Yx23), replace x with the letter or number assigned to the chosen lever style. For example, YR23 specifies lever style R. See pages 34-35 for details.
- When ordering a 9500 device without trim, specify the handing and device function so the correct mortise lock can be supplied.

Trim Model

YPO2



YK02R



Yx02R



YPO3



YK08M



Yx03MR



Yx08M



Yx08MC



YK23M



Yx23M

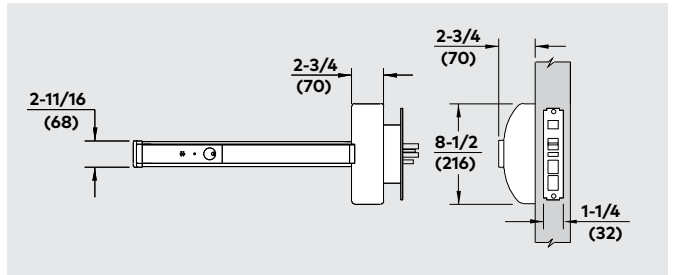

Standard Strike

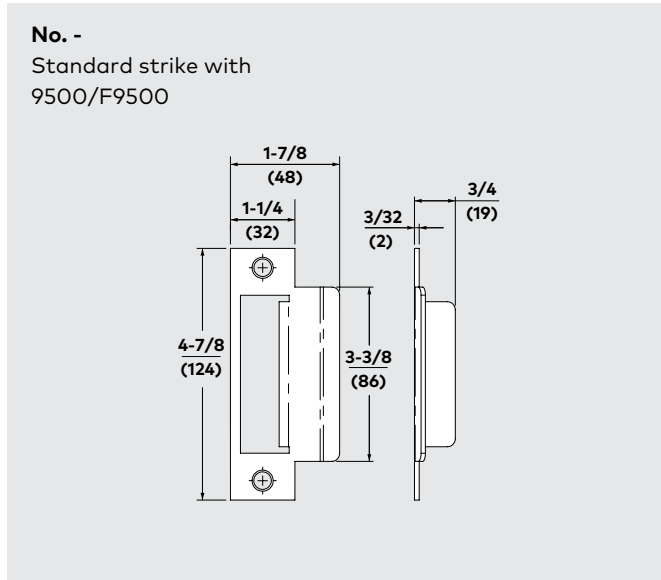

Optional Strike

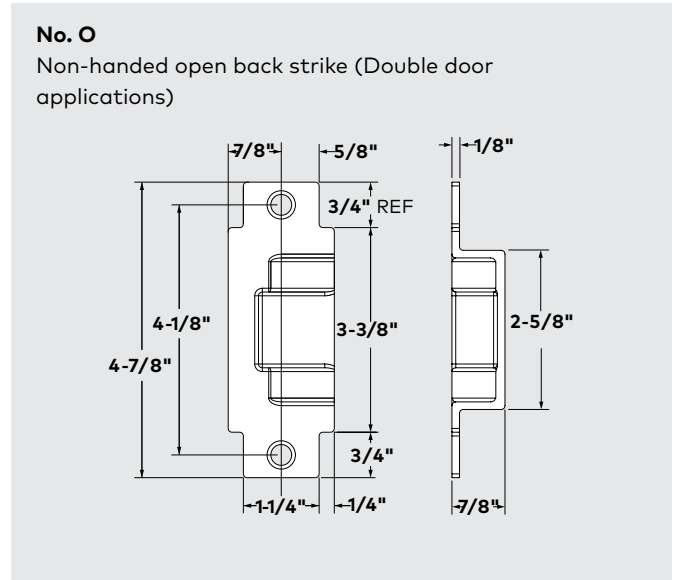

Mortise Lock

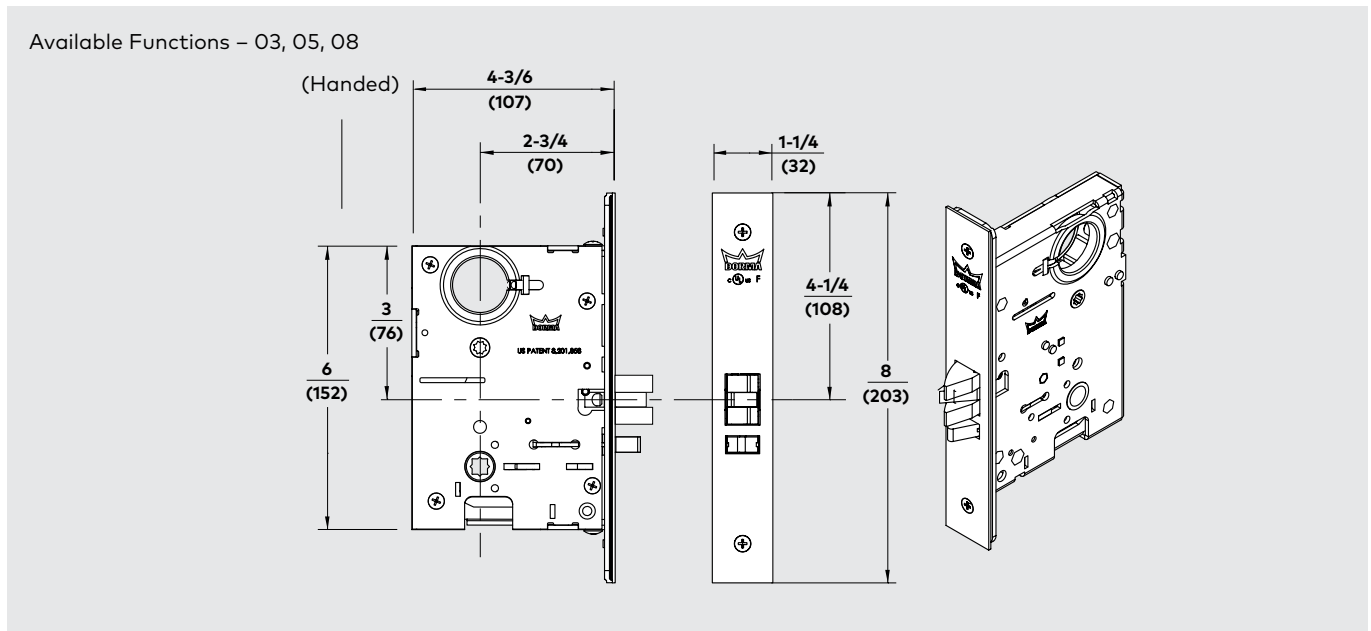

Vertical Reference

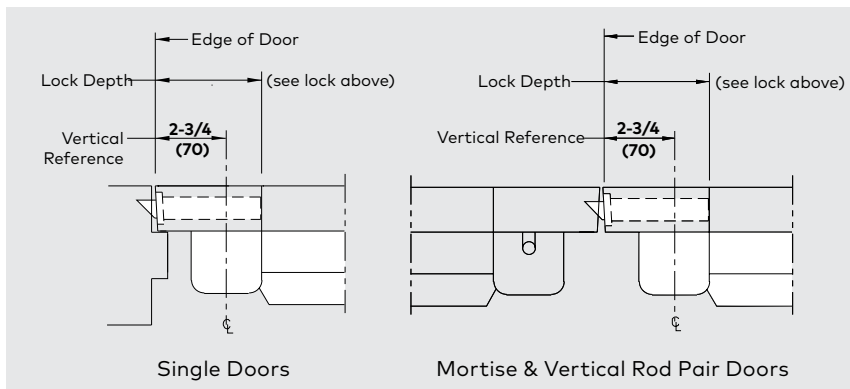



# Accessories

## Non-functioning Exit Devices

The non-functioning exit device looks exactly like the 9000 Series, but has no latching mechanism. Units can be furnished in standard **A, B, or C** width or cut to special size when door width is specified. Order any applicable trim for push/pull function. Choose the type of operation required.

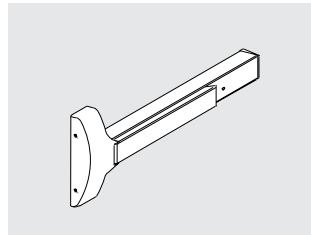

## Rigid Touchbar Device

Touchpad is permanently fixed and immobile.

**9035** – Wide Stile.

## Moveable Touchbar Device

Same as rigid touchbar device, but touchbar is moveable. Similar to standard 9000 Series device.

**9036** – Wide Stile.

## Moveable Touchbar Device with Microswitch

Same as moveable touchbar device, but includes microswitch that can be used to control electromagnetic locks, electric strikes, or other electronic appliances.

**9036MS** – Wide Stile.

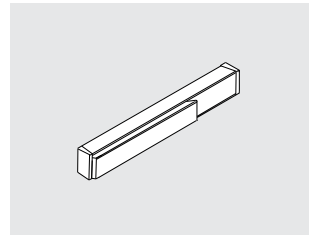

## Dummy Bar

The dummy bar is designed as a companion to 9000 Series devices. Units consist of the touchbar assembly only and do not include the device chassis or chassis cover. Door width must be specified.

## Rigid Dummy Bar

Touchbar only. Touchpad is permanently fixed and immobile.

**9030** – Wide Stile.

## Dummy Bar with Microswitch

Touchbar is moveable and activates included microswitch. Can be used to control electromagnetic locks, electric strikes, or other electronic appliances.

**9030MS** – Wide Stile.

## Vision Lite Shim Kit

Contains two 1/8" thick shims. Permits shimming of the exit device maximum 1/4" off door face without affecting U.L. listing.

Designed to accommodate glass lite installed in door. Furnished Bright Zinc Plated (BZP). Optional finishes available, consult factory.

**GK9000** – Wide Stile.

## Conversion Kits

The following conversion kits are the same as options detailed elsewhere in this brochure, but in kit form with required components and installation instructions for field installation/retrofit.

**MS Kit** – Monitor Switch in Touchbar Kit

**BA Kit** – Battery Powered Exit Alarm Kit

**BAR Kit** – Battery Powered Exit Alarm, 4 Minute Reset Kit

**DA Kit** – Direct Wired Alarm Kit

**CD Kit** – Cylinder Dogging Kit (less cylinder)

## Security Screws

For applications where tamper-resistant security screws are required, specify **T**.

**NOTE:** Special screw bits are required.

9100/F9100	3 packs
9100/F9100 w/trim	1 pack
9300	3 packs
F9300	4 packs
9300/F9300 w/trim	1 pack
9400/F9400	6 packs
9400/F9400 w/trim	4 packs
9500/F9500	3 packs
9500/F9500 w/trim	1 pack

## Sex Nuts

The chart above serves as a simple reference when specifying 9000 Series exit devices and trim.

# Optional Electric Functions

## Motorized Latch Bolt Retraction

Specify **MLR**. A motor concealed in the touchbar assembly provides retraction of the latch bolt by drawing in the touch bar to allow access from the secure side of the door. MLR can also be used to electrically dog/hold the exit push bar in a retracted position during non-secure hours (latch bolt is retracted). Remote control can be accomplished with switching devices such as key switches and card readers that provide a normally open electrical contact. The motor is rated at 24 VDC, .88 AMP. The motor draws approximately 400 milliamp during continuous operation. Use of either PS610RF or PS532RF is recommended to power one or two MLR devices respectively. The 9000 MLR can also be powered with ED900 Low Energy ADA Operator.

## Electric Latch Bolt Retraction

Specify **ES**. A solenoid concealed in the touchbar assembly provides instantaneous retraction of the latch bolt to allow access from the secure side of the door. Remote control can be accomplished with switching devices such as key switches and card readers that provide a normally open electrical contact. The solenoid is rated for 24 VDC, 14–18 AMP continuous duty, 24 VDC, 14–18 AMP inrush for 200 milliseconds, 1 AMP holding current. **Requires PS501 power supply.**

## Battery Back-up

Battery Back-up power supply options are available when using either the PS406BB or PS462BB power supplies. Specify **E-** when ordering Electric Latch Bolt Retraction exit device.

## Requires PS501 power supply & ES105 power transfer.

Not available with **C** or **CC** size devices, or 9500 mortise exit devices.

## Monitor Switch

Specify **MS**. Two micro switches in the touchbar assembly functioning as form C contacts provide local and/or remote notification of two separate appliances when the touchbar is depressed. Each switch is rated for .5 AMP @ 28 VDC maximum.

## Latch Monitor

Specify **LM**. A microswitch attached to the device chassis provides local and/or remote notification of the exit device rods without depressing the touchbar. The single-pole, double-throw switch is rated at .50 AMP @ 28 VDC maximum.

## Latch Monitor with Monitor Switch

Specify **LM/MS**. A combination of Latch Monitor and Monitor Switch functions in one device.

## Latch Monitor with Monitor Switch & Bypass

Specify **LM/MS BP**. Same as LM/MS above, but an additional single-pole, double-throw switch is triggered by a mortise cylinder for alarm bypass. Cylinder furnished.

## Motorized Dogging

Specify **MLR**. This feature can be used to electrically dog/hold the exit push bar in a retracted position during non-secure hours. (Latch bolt is retracted.)

## PS Series Power Supplies

The **ES100 Power Supply** is capable of powering and controlling (1) DE9000 Series Exit Device.

- Input: 120 V
- Input Circuit Protection: 1.3 A fuse
- Output: 24 VDC, 6 A surge for 0.5 seconds, .65 A continuous, per zone
- Output Circuit Protection: 3 A push to reset circuit



- breaker
- Enclosure: 8" H x 8" W x 4" D NEMA 1 Type enclosure for indoor use with hinged cover and knock-outs

The **PS501 Power Supply** is capable of powering and controlling (2) 9000 Series Exit Devices with the ES Electric Latch Bolt Retraction feature. Also has the capability of powering (2) additional 9000 Series Exit Devices with an optional card. Specify option **ES2 CARD**.

- Input: 120 volts
- Input circuit protection: 1 AMP circuit breaker
- Output: 36 VDC, 14–18 AMP surge, 2 AMP @ 5 volt continuous, per zone, unregulated, unfiltered
- Output circuit protection: 4 AMP fuse
- Enclosure: 8" H x 8" W x 4" D NEMA 1 Type enclosure for indoor use with hinged cover and knock-outs.

The **PS532RF Power Supply** is capable of powering and controlling (2) or **PS610RF** can power and control (1) 9000 Series Exit Device with the MLR Motorized Latch Bolt Retraction feature.

**NOTE:** The PS5352RF or PS610RF can be used with the ES105 power transfer cable, 75200 electric intermediate, or electric through wire hinges when rated to carry a minimum of 1 AMP continuous power. Power transfer device wires may require doubling or tripling depending on wire gage supplied.

- Input: 115VAC/60hz
- Output: PS532RF – 2.0A @ 24VDC, Class 2  
PS610RF – 1.0A @ 24VDC, Class 2
- Enclosure: PS532 – 14" H x 16" W x 6.5" D PS610 – 12.5" H x 12.5" W x 4" D

The **ES105** is a power transfer with stainless steel housing and flexible tube. Secure and inconspicuous channel to bring power from the frame to the door. Narrow, shallow channel easily mortises into door edges. Accepts up to 5/16" diameter wire bundle. Accommodates doors that swing open 120°. Unit is concealed when the door is closed. Suitable for wood, aluminum, or steel applications.



## Finish

Stainless: 630 (Satin)

# DE9000 Series Delayed Egress Exit Devices

## Certification

- Certified/listed to ANSI/BHMA 156.3, Grade 1 for exit devices.
- U.L. and C.U.L. listed under their continuing reinspection programs and conforms to standard U.L. 10C positive pressure testing.
- Complies with NFPA 101 life safety code. Fire rated devices comply with NFPA 80 fire doors and windows. Field selectable to comply with IBC 2012
- Devices, trim, pulls, and levers comply with the Americans with Disabilities Act, 1994, and ICC A117.1 for accessible and usable buildings and facilities.
- Contributes to U.S. Green Building Council, LEED MR Credits 2.1, 4.1, 4.2 and 5.1.
- Listed with the California Department of Forestry and Fire Protection, Office of the State Fire Marshal (wide stile devices only).
- Hurricane-code approved to Miami-Dade County Florida and Florida State Building Code acceptance (9300, 9400, 9500, 9700).



## Specifications

- All devices shall be DE9000 Series delayed exit devices with ES105 power transfer and ES100 powersupply.
- Devices shall be rim, mortise, or concealed vertical rod.
- Devices to have a nuisance alarm with a steady tone to limit inadvertent activation. Depressing and holding the touchbar beyond the nuisance alarm period must initiate a 15 second delay with an intermittent tone.
- Following the irreversible 15 second delay alarm period, the device must release and continue an indefinite steady tone alarm until reset.
- All devices must be capable of rearming by turning the key switch on the device to **rearm** or by using the alternate remote rearm capability. The same key switch must disarm the device for authorized egress.
- All devices must provide two sets of relay contacts that activate when the device is in an irreversible alarm to control remote audible/visual alarms included in control consoles.
- All devices must have an LED indicator light for conveying the status of the device.
- Internal locking feature is required to further enhance security when subjected to forced opening.
- Devices must provide an input for use with an external door position switch to prohibit doors from being held open while the device is armed.
- The device must alarm simultaneously with the activation of the door position switch.
- When power is cut to the devices, they must release and function as typical exit devices in the event of a fire or emergency situation.
- All devices to have heavy-duty cast chassis.
- All device touchbar, rail, and cover assemblies shall be constructed of heavy gauge solid wrought materials for true architectural finishes or color coated finishes where applicable.
- Fire rated versions shall be available for labeled applications.
- All concealed vertical rod devices shall have pullman type top latch bolts and round slidebolt bottom latches.

- All devices to have deadlocking latch bolts with 3/4" throw where applicable.
- All units shall offer a full range of free wheeling operational trim, except mortise devices.
- All units shall offer optional rigid and clutch style trim, where applicable.
- All devices to be furnished with appropriate mounting hardware including both wood and machine screws, as well as sex nuts where required. An adhesive sign with an operation directive must be supplied.
- All concealed vertical rod devices installed in aluminum doors to be furnished with appropriate brackets for aluminum door applications. Specify **A** (DE9100 only).
- All devices to use tamper-resistant security screws for attaching the end cap, chassis cover, and strikes. Specify **T**.

## Finishes

### Architectural Finishes

- Brass: 605 (Bright) or 606 (Satin)
- Bronze: 611 (Bright), 612 (Satin), or 613 (Oxidized Satin)
- Nickel: 619 (Satin)
- Black: 693
- Chrome: 625 (Bright) or 626 (Satin)
- Stainless: 629 (Bright) or 630 (Satin)

### Powder Coated Finishes

- Aluminum: 689
- Bronze: 691 (Dull) or 695 (Dark Duranodic)
- Black: 693
- Gold: 696
- Clear Powder Coat available over 630 – Stainless Steel Specify **PC**
- Anti-Microbial: Specify **AM**

## Optional Specifications

- All devices to be furnished with a 30 second irreversible delay alarm. Written approval from the authority having jurisdiction required. Specify **30**.
- All devices for CBC compliant applications to include special CBC door label. Specify **CBC**.
- All concealed vertical rod devices to have pullman type bottom latch bolt. Specify **P**.
- All surface/concealed vertical rod devices to have extended top rod up to 10'. Specify **ETR** for 8', 9', or 10'.
- All devices to use a glass lite shim kit to raise the device from the door surface to accommodate glass light molding. Specify **GK9000**.
- All devices for labeled wood or composite doors to be furnished with sex bolts. Specify **SNB**.
- All devices to be furnished with rigid trim. Specify **R** after trim number.
- All devices to be furnished with clutch style lever trim. Specify **C** after lever trim number.

# DE9000 Delayed Egress Features

## Delayed Egress

The DE9000 is alarmed and the touchbar will not activate the latch bolt for 15 seconds (30 second factory option available). This provides a controlled delayed egress while simultaneously sounding a local and remote audible alarm. After the delay time, unrestricted emergency egress is available.

## Nuisance Alarm

The nuisance alarm, with a steady warning tone, deters inadvertent activation of the device when the touchbar is depressed. Releasing the touchbar before the predefined nuisance alarm time of 1 or 3 seconds terminates the alarm, and the device returns to the armed mode. Depressing the touchbar longer than the predefined time will initiate the 15 second irreversible delay cycle. The 1 or 3 second nuisance alarm time is included in the 15 second irreversible delay time. The nuisance alarm time is field-selectable for three seconds or one second by a dip switch.

**A 30 second delay option is available set at the factory. Written approval is required from the authority having jurisdiction.**

## Local or Remote Alarm

Device has an internal 85 dB alarm which will sound indefinitely in the alarm state until the device is reset. Additionally, a form C relay is provided for activating remote audible/visual signaling of control console or third party console, security panel, or other audible/visual signaling device.

## Indicator LED

Status for the DE9000 can be determined by the indicator LED which is visible in varied lighting conditions. When the device is disarmed for an extended time in the **bypass** mode, the LED will maintain a slow green flash. When activated for **authorized egress**, the LED displays a rapid green flash until the device automatically rearms. In the armed state, the LED maintains a solid green. When the touchbar is depressed for exit, the nuisance alarm will sound while the LED remains solid green. In the 15 second irreversible delay cycle, the LED turns solid yellow. In the alarm state, the LED is solid red.

## Key Switch Control

This integral key switch provides the means to locally rearm the device from the alarm state, disarm for authorized egress, and set the device for the bypass feature. A mortise cylinder is supplied with the device.

## Remote Authorized Egress

This function allows override of the device in the armed state. The device will unlock for egress and automatically rearm to the delayed egress mode in 10 seconds. The field-selectable reset time allows up to a 20 second reset. Typical activation devices include remote consoles, key switches, or card readers. This input is controlled with a momentary action normally open switch.

## Remote Rearm

Remote rearming of the device is allowed from the alarm state. Typical activation devices include remote consoles or key switches. This input is controlled with a momentary action normally open switch. Consult local authority having jurisdiction when using this feature.

## Door Position Input

An input for use with an external door position switch is provided. This input switch is a maintained action normally closed contact. The device alarms simultaneously with the contact opening. The door is prohibited from being forced or held open unauthorized while the device is armed. The field-selectable authorized egress and bypass functions ignore the door position input for authorized exit or entrance.

## Electrical Specifications

### Input Power

24 VDC @ .5 A continuous (5 A inrush for 350 ms).

**Power must be provided by an ES100 power supply.**

### Door Position Input

Requires a normally closed contact.

### Pigtail provided for the following:

Input power, remote authorization egress, remote bypass/rearm, relay contacts for audible/visual console, door position switch input, fire alarm contacts, and pairs of doors.

## DE9000 Exit Device

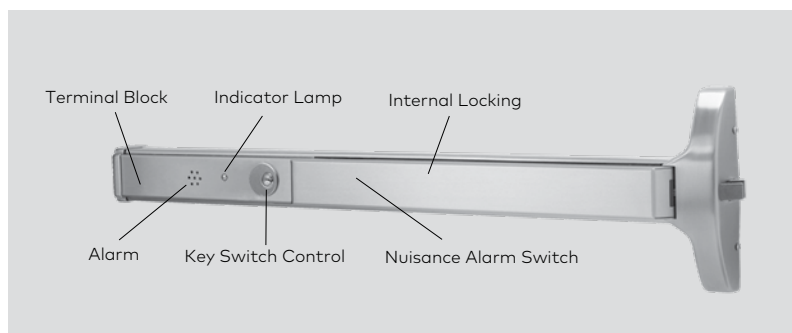

# Auxiliary Equipment

## Alarms

The 9000 Series exit devices are available with an integral battery powered alarm. The 102 decibel alarm contained in the panic device touchbar and rail assembly activates when the touchbar is depressed and sounds continuously until the device is reset or the battery is completely discharged. Alternatively, a factory-furnished option allows the alarm to sound for four (4) minutes, then automatically rearm.

Furnished with and controlled by a lock cylinder and key, the unit allows ten (10) seconds to exit through the door after arming the alarm, indicated by an intermittently flashing red LED light in the touchbar. A yellow LED in the touchbar will flash until manually reset by key to indicate an unauthorized exit even if the alarm has automatically reset.

The unit is furnished with a 9 volt, industrial-grade battery concealed in the end cap assembly for easy replacement. A tamper-proof switch will activate the alarm if unauthorized removal of the battery is attempted. Option is available for 12 or 24 volt direct power wiring.

- Specify **BA** for battery alarm device.
- Specify **BAR** for 4 minute auto reset battery alarm device.
- Specify **DA** for direct hard-wired option.
- Size **A** device fits 48" wide door and can be cut to fit 39" wide doors.
- Size **B** device fits 36" wide door and can be cut to fit 33" wide doors.
- Size **C** device fits 30" wide door.

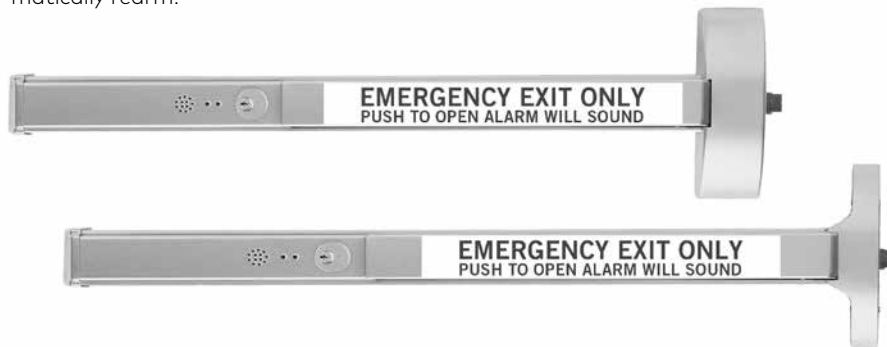

## Trim Options

### Clutch Lever Trim

Free wheeling, vandal-resistant lever standard, except on 9500 mortise devices. Although mandated to meet ADA requirements, lever handles are especially subject to vandalism and damage. The **clutch** option for lever trim includes an internal slip clutch mechanism which allows the lever handle to break away without damage or violating security when excessive force is applied. The lever can be lifted back to horizontal to reset it.

Note: Clutch option available to C, R, G & T lever styles only

An internal dead stop limits the break away to 55° of lever handle rotation. Specify **C** to trim designation. Specify hand.

**Rigid Trim** – Rigid lever and knob option. Specify **R** to trim designation.

**Retrofit** – For Von Duprin 98/99 Series Rim Devices. Specify **R1** (narrow and wide plate trim only).

**Electrified Trim** – Electrified **Y** style trim with integral locking/unlocking option. Trim can be used with models 9100/F9100, 9300/F9300 and 9400/F9400. Available as fail-secure or fail-safe. Specify **EU** (fail-secure) or **EL** (fail-safe) following trim designation. Available for the 09 function only. **Electrified trim options must use an ES100 power supply to prevent permanent damage to the electronics. Two devices can be powered by an ES100 device.**

Electrified option also available with the 9500/F9500 mortise device which utilizes an electrified mortise lock design to unlock hub of chassis. Specify following exit device designation, i.e. 9500EL (FAIL-SAFE) or 9500EU (FAIL-SECURE). Available for all styles of trim with an 08 function. This option is not field interchangeable between fail-secure and fail-safe. **Electrified mortise locks must use a PS610RF power supply to prevent permanent damage to the electronics. Two devices can be powered by a PS610RF device.**

# Lever & Knob Styles for Y Wide Stile Trim



**Finishes**

**Architectural Finishes**

- Brass: 605 (Bright) or 606 (Satin)
- Bronze: 611 (Bright), 612 (Satin), or 613 (Oxidized Satin Oil Rubbed)
- Nickel: 619 (Satin)
- Chrome: 625 (Bright) or 626 (Satin)
- Stainless: 629 (Bright) or 630 (Satin)

**Powder Coated Finishes**

- Aluminum: 689
- Bronze: 691 (Dull) or 695 (Dark Duranodic)
- Black: 693
- Gold: 696

**Clear Powder Coating**

Clear Powder Coat available over 630 – Stainless Steel  
Specify PC

**Antimicrobial Protected Coating**

Specify AM  
Note: Antimicrobial available to 626 and 630 finishes only

# 9000 Series Wide Stile Y Escutcheon Trim

- Heavy-duty, vandal-resistant escutcheon.
- Corrosion-resistant, stainless steel offered standard.
- Hundreds of lever and pull styles and finish combinations to satisfy the most demanding interior design requirement.
- Choose from 14 ANSI/BHMA standard architectural finishes, or dozens of our Custom RAL colors, or, for those unique interior designs, our Designer Color special color matching system.
- Antimicrobial protected coating when ultra clean environments are specified  
Note: Antimicrobial available to 626 and 630 finishes only
- Clear powder coating for outdoor or highly corrosive environments that need added protection. Also minimizes the appearance of fingerprints.
- Conventional rim or mortise cylinders included standard.
- Configurable with SFIC to accommodate the patented SC key control system.
- All standard devices and trim are designed for 1-3/4" -2-1/4" thick doors. For door thickness greater than 2-1/4", select door thickness option.
- Under U.S. law, qualifies for Made in U.S.A. of U.S. and imported parts.
- Steeleville, IL manufacturing facility certified to ISO 9000 and ISO 14001.



YK



YC



YP

Y Series Trim (Specify)					Door Thickness	Retrofit	Special Finish Coating	Cylinders & Keying			
Escutcheon	Knob, Pull, or Lever	Function	Handing	Electric Locking *	Finish			Cylinder Type	Keyway	Keying	
					<b>630</b>			<b>D</b>	<b>SC</b>	<b>KD</b>	
Y	A	DT	RHR	LFSC	605	Ext3	AM	R1	C	CA	KD
	C	O2	LHR	LFSF	606	Ext4	*PC		D	CD	KA2
Handed -	D	O2R			611				J	CE	KA4
Handed -	K	O3			612				L	<b>D100</b>	NSK
	F	O3R			613				T	GA	MKD
	G	O3MR			619				R	RA	CMK
	R	O8			625				X6	RB	SKD
	T	O8M			626				X7	SC	OBIt
	O	O8C	- Handed		629					SE	
	P	O8MC	- Handed		630					SF	
Handed -	N	O8O8	- Double Cylinder		689					YA	
	V	O9			691					YG	
	L109	O9C	- Handed		693						
	L110	11			695						
Handed -	L112	12			696						
	L114	23			Custom						
	L117				Designer						
	L118										

Suffix **M** required for 9500 mortise  
 Suffix **C** and **LHR/RHR** required for clutch  
 Note: Clutch option available to C, R, G & T lever styles only

Suffix **R** required for rigid lever

\*Clear Powder Coat over 630 Stainless Steel

1. R1 available for 9300 series devices only.

- Default

**\*Patented Key Control**  
 D100 is the keyway for our patented SKC serialized key control system. SKC is internet based and provides added layers of security. For more information, contact your local sales representative or Technical Service at 800-523-8483.

**\* EU/ EL on 09/ 09C Only**

# 9000 Series Sectional Trim

- Hundreds of lever and knob styles and finish combinations to satisfy the most demanding interior design requirement.
- Choose from 14 ANSI/ BHMA standard architectural finishes, or dozens of Custom RAL colors, or, for those unique interior designs, our Designer Color special color matching system.
- Antimicrobial protected coating when ultra clean environments are specified. Note: Antimicrobial available to 626 and 630 finishes only

- Clear powder coating for outdoor or highly corrosive environments that need added protection. Also minimizes the appearance of fingerprints. Conventional key-in-lever/knob cylinder included standard.
- Configurable with SFIC to accommodate patented SC key control system

- All standard devices and trim are designed for 1-3/4"–2-1/4" thick doors. For door thickness greater than 2-1/4", consult Technical Service. Under U.S. law, qualifies for Made in U.S.A. of U.S. and imported parts.
- Steeleville, IL manufacturing facility certified to ISO 9000 and ISO 14001.



9R



9K

Sectional Trim (Specify)			Special Finish Coating	Cylinders and Keying		
Knob or Lever	Function	Finish		Cylinder Type	Keyway	Keying
		<b>626</b>		<b>D</b>	<b>SC</b>	<b>KD</b>
9C	02	605	AM	C	CA	KD
9G	03	606	*PC	D	CD	KA2
9K	08	611		J	CE	KA4
9R	23	612		L	<b>*D100</b>	NSK
		613		T	GA	MKD
		619			RA	CMK
		625			RB	SKD
		<b>626</b>			SC	OBit
		630			SE	
		689			SF	
		691			YA	
		693			YG	
		695				
		696				
		Custom				
		Designer				

□ – Default

**\*Patented Key Control**  
**D100** is the keyway for our patented **SKC** serialized key control system. **SKC** is internet based and provides added layers of security. For more information, contact your local sales representative or Technical Service at 800-387-4938.

\*Clear Powder Coat over 630 Stainless Steel



# 9000 Series 3" Wide Plate Trim

- Heavy-duty, 3" x 16" stainless steel plate and pull offered standard.
- Choose from 14 ANSI/ BHMA standard architectural finishes, or dozens of Custom RAL colors, or, for those unique interior designs, our Designer Color special color matching system.
- Antimicrobial protected coating when ultra clean environments are specified. Note: Antimicrobial available to 626 and 630 finishes only
- Clear powder coating for outdoor or highly corrosive environments that need added protection. Also minimizes the appearance of fingerprints.
- Conventional rim or mortise cylinders included standard
- Configurable with SFIC to accommodate the patented SC key control system.
- All standard devices and trim are designed for 1-3/4" -2-1/4" thick doors. For door thickness greater than 2-1/4", consult Technical Service.
- Under U.S. law, qualifies for Made in U.S.A. of U.S. and imported parts.
- Steeleville, IL manufacturing facility certified to ISO 9000 and ISO 14001.

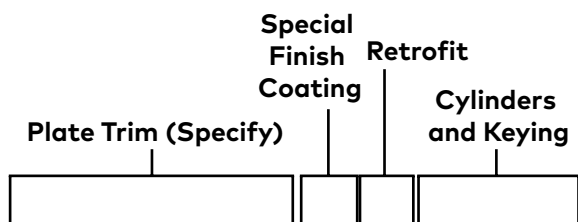

Plate Type	Function	Finish	Special Finish Coating	Retrofit	Cylinder Type	Keyway	Keying
		<b>630</b>			<b>D</b>	<b>SC</b>	<b>KD</b>
HRT	DT	630	AM	R1 <sup>1</sup>	T	CA	KD
HTT	DTCV	689	*PC		J	CD	KA2
NPT	02	691			C	CE	KA4
PRT	02CV	693			L	<b>*D100</b>	NSK
PTT	03	695			D	GA	MKD
80	03CV	696			G	RA	CMK
	03M	Custom			R	RB	SKD
	05	Designer			F	SC	OBit
	05CV				X6	SE	
	05M				X7	SF	
	06					YA	
	06CV					YG	
	22						
	22CV						
	22M						

- Default

Suffix **CV** required for 9100 CVR  
 Suffix **M** required for 9500 mortise

**\*Patented Key Control**  
**D100** is the keyway for our patented **SKC** serialized key control system. **SKC** is internet based and provides added layers of security. For more information, contact your local sales representative or Technical Service at 800-387-4938.

\*Clear Powder Coat over 630 Stainless Steel

1. R1 available for 9300 series devices only.

# 9000 Series 2" Wide Stile Plate Trim

- Heavy-duty, 2" x 16" stainless steel plate and pull offered standard.
- Choose from 14 ANSI/ BHMA standard architectural finishes, or dozens of Custom RAL colors, or, for those unique interior designs, our Designer Color special color matching system.
- Antimicrobial protected coating when ultra clean environments are specified. Note: Antimicrobial available to 626 and 630 finishes only.
- Clear powder coating for outdoor or highly corrosive environments that need added protection. Also minimizes the appearance of fingerprints.
- Conventional rim or mortise cylinders included standard.
- Configurable with SFIC to accommodate the patented SC key control system.
- All standard devices and trim are designed for 1-3/4" - 2-1/4" thick doors. For door thickness greater than 2-1/4", consult Technical Service.
- Under U.S. law, qualifies for Made in U.S.A. of U.S. and imported parts.
- Steeleville, IL manufacturing facility certified to ISO 9000 and ISO 14001.



Plate Trim (Specify)		Special Finish Coating	Retrofit	Cylinders and Keying			
Plate Type	Function	Finish		Cylinder Type	Keyway	Keying	
		<b>630</b>		<b>D</b>	<b>SC</b>	<b>KD</b>	
VO	DT	605	AM	R <sup>1</sup>	T	CA	KD
V1	DTCV	606	*PC		J	CD	KA2
V3	02	611			C	CE	KA4
	02CV	612			L	<b>D100</b>	NSK
	03	613			D	GA	MKD
	03CV	619			G	RA	CMK
	03M	625			R	RB	SKD
		626			F	SC	OBit
		<b>630</b>			X6	SE	
		689			X7	SF	
		691				YA	
		693				YG	
		695					
		696					
		Custom					
		Designer					

Suffix **CV** required for 9100 CVR  
 Suffix **M** required for 9500 mortise

 - Default

**\*Patented Key Control**  
**D100** is the keyway for our patented **SKC** serialized key control system. **SKC** is internet based and provides added layers of security. For more information, contact your local sales representative or Technical Service at 800-387-4938.

\*Clear Powder Coat over 630 Stainless Steel

1. R1 available for 9300 series devices only.

# 9000 Series Wide Stile Pull Trim

- Heavy-duty stainless steel offered standard.
- Choose from 14 ANSI/ BHMA standard architectural finishes, or dozens of Custom RAL colors, or, for those unique interior designs, our Designer Color special color matching system.
- Antimicrobial protected coating when ultra clean environments are specified. Note: Antimicrobial available to 626 and 630 finishes only.
- Clear powder coating for outdoor or highly corrosive environments that need added protection. Also minimizes the appearance of fingerprints.
- Conventional rim or mortise cylinder included standard.
- Configurable with SFIC to accommodate the patented SC key control system.
- All standard devices and trim are designed for 1-3/4"–2-1/4" thick doors. For door thickness greater than 2-1/4", consult Technical Service.
- Under U.S. law, qualifies for Made in U.S.A. of U.S. and imported parts.
- Steeleville, IL manufacturing facility certified to ISO 9000 and ISO 14001.



OP



VRF



POF



9PO

Pulls (Specify)			Special Finish Coating	Cylinders and Keying			
Pull Type	Function	Handing	Finish		Cylinder Type	Keyway Keying	
			630		D	SC	KD
OP	02	RHR	605	AM	T	CA	KD
POF	03HDA	LHR	606	*PC	J	CD	KA2
VRF	02SPM		611		C	CE	KA4
9PBO <sup>1</sup>	03SPM		612		L	<b>D100</b>	NSK
	03		613		D	GA	MKD
			619		G	RA	CMK
			625		R	RB	SKD
			626		F	SC	OBit
			630		X6	SE	
			689		X7	SF	
			691			YA	
			693			YG	
			695				
			696				
			Custom				
			Designer				

 – Default

**\*Patented Key Control**  
 D100 is the keyway for our patented SKC serialized key control system. SKC is internet based and provides added layers of security. For more information, contact your local sales representative or Technical Service at 800-387-4938.

\*Clear Powder Coat over 630 Stainless Steel

1. 9PO not applicable on 9500 Device. 03 Function only. Not available in 693 finish.

# Wide Stile Plate/Pull Trim

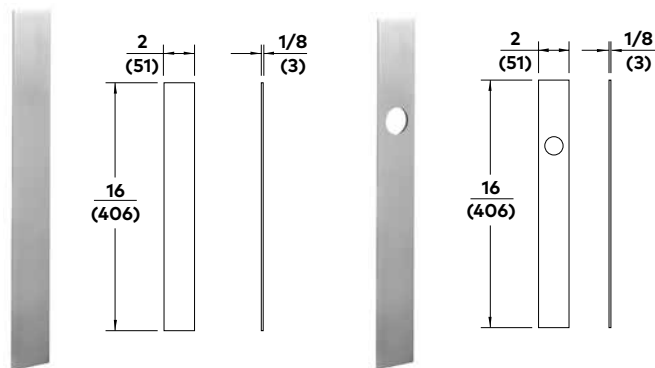

Trim Descriptions	Exit Only	2" Wide Flat Plate Dummy Trim	2" Wide Flat Plate with Cylinder Hole
Trim Designation	No Trim	VODT, VODTCV	VO03, VO03CV
Handing	—	—	—
Function	01	DT	03
Cylinder (default)	—	—	80R40SC – Rim
Cylinder (optional SFIC)	—	—	87R40BA – 7-pin

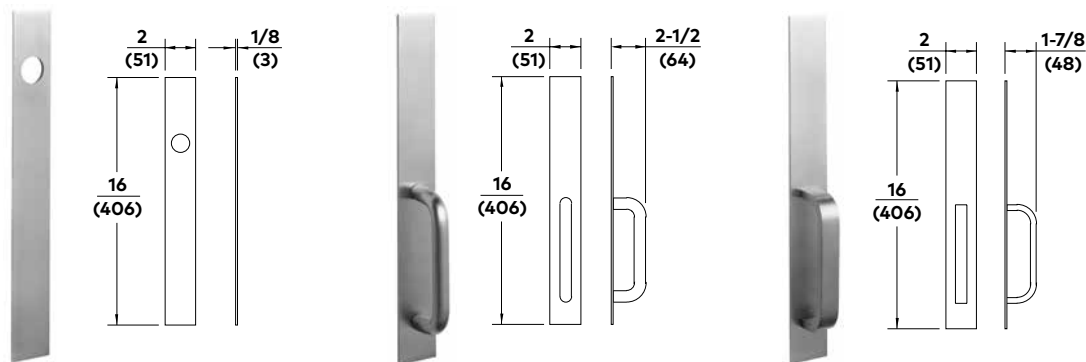

Trim Descriptions	2" Wide Flat Plate with Cylinder Hole (mortise)	2" Wide Flat Plate Tubular Pull	2" Wide Flat Plate Rectangular Pull
Trim Designation	VO03M	V102, V102CV	V302, V302CV
Handing	—	—	—
Function	03	02	02
Cylinder (default)	90A10SC118 – Mortise * 90A13SC118 – Mortise **	—	—
Cylinder (optional SFIC)	97B10BA138 – 7-pin * 97B13BA138 – 7-pin **	—	—

**NOTES:**

\* Devices shipped **before** November 2014

\*\* Devices shipped **after** November 2014

See chart on page 49 for more information

# Wide Stile Plate/Pull Trim

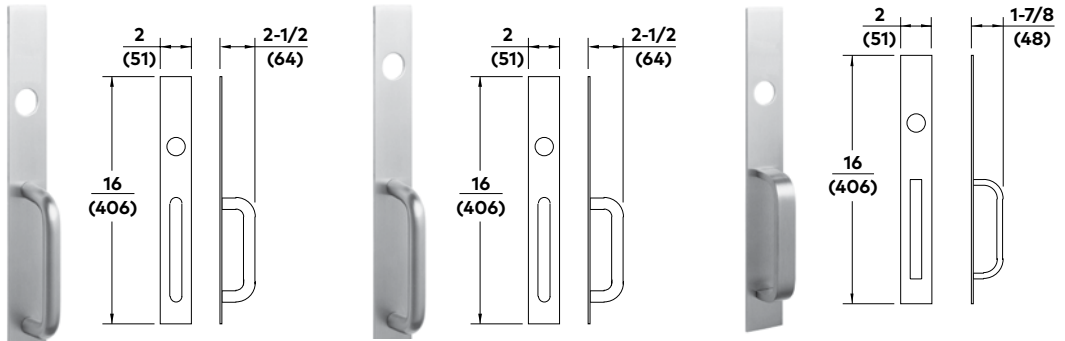

Trim Descriptions	2" Wide Flat Plate Tubular Pull with Cylinder Hole	2" Wide Flat Plate Tubular Pull with Cylinder Hole (mortise)	2" Wide Flat Plate Rectangular Pull with Cylinder Hole
Trim Designation	V103, V103CV	V103M	V303, V303CV
Handing	—	—	—
Function	O3	O3	O3
Cylinder (default)	80R40SC – Rim	90A10SC118 – Mortise * 90A13SC118 – Mortise **	80R40SC – Rim
Cylinder (optional SFIC)	87R40BA – 7-pin	97B10BA138 – 7-pin * 97B13BA138 – 7-pin **	87R40BA – 7-pin

**NOTES:**

\* Devices shipped **before** November 2014

\*\* Devices shipped **after** November 2014

See chart on page 49 for more information

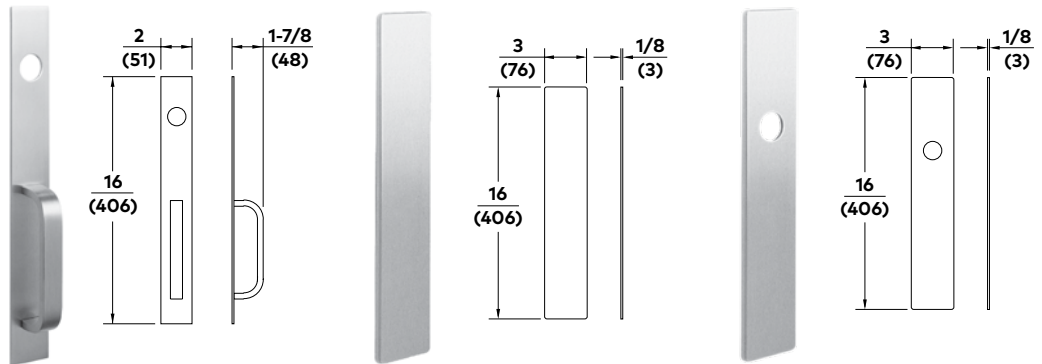

Trim Descriptions	2" Wide Flat Plate Rectangular Pull with Cylinder Hole (mortise)	3" Wide Flat Plate Dummy Trim	3" Wide Flat Plate with Cylinder Hole
Trim Designation	V303M	NPTDT, NPTDCV	NPTO3, NPTO3CV
Handing	—	—	—
Function	O3	DT	O3
Cylinder (default)	90A10SC118 – Mortise * 90A13SC118 – Mortise **	—	80R40SC – Rim
Cylinder (optional SFIC)	97B10BA138 – 7-pin * 97B13BA138 – 7-pin **	—	87R40BA – 7-pin

**NOTES:**

\* Devices shipped **before** November 2014

\*\* Devices shipped **after** November 2014

See chart on page 49 for more information

# Wide Stile Plate/Pull Trim

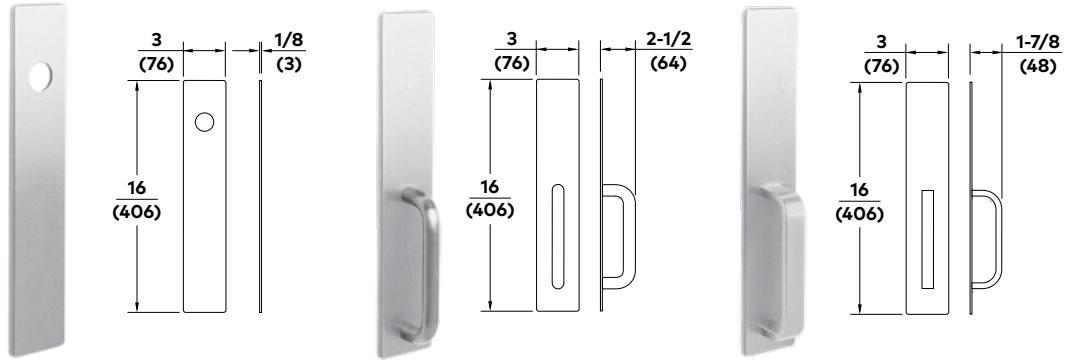

Trim Descriptions	3" Wide Flat Plate with Cylinder Hole (mortise)	3" Wide Flat Plate Tubular Pull	3" Wide Flat Plate Rectangular Pull
Trim Designation	NPT03M	PTT02, PTT02CV	PRT02, PRT02CV
Handing	—	—	—
Function	O3	O2	O2
Cylinder (default)	90A10SC118 – Mortise * 90A13SC118 – Mortise **	—	—
Cylinder (optional SFIC)	97B10BA138 – 7-pin * 97B13BA138 – 7-pin **	—	—

**NOTES:**

\* Devices shipped **before** November 2014

\*\* Devices shipped **after** November 2014

See chart on page 49 for more information

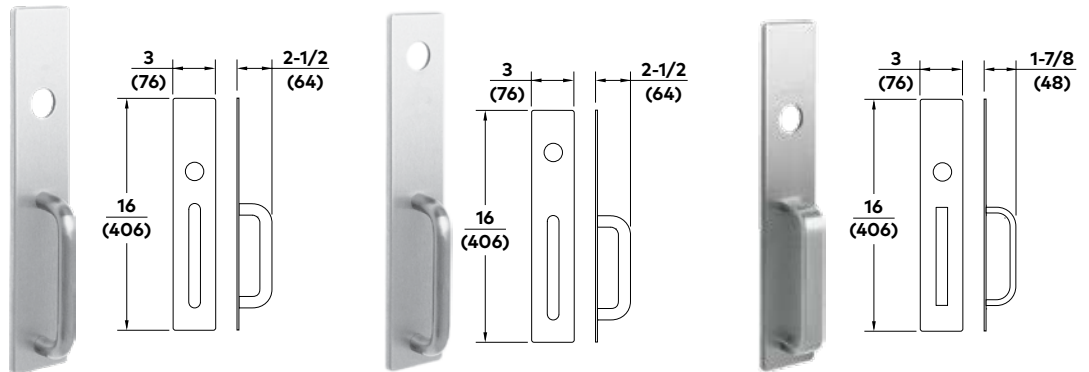

Trim Descriptions	3" Wide Flat Plate Tubular Pull with Cylinder Hole	3" Wide Flat Plate Tubular Pull with Cylinder Hole (mortise)	3" Wide Flat Plate Rectangular Pull with Cylinder Hole
Trim Designation	PTT03, PTT03CV	PTT03M	PRT03, PRT03CV
Handing	—	—	—
Function	O3	O3	O3
Cylinder (default)	80R4OSC – Rim	90A10SC118 – Mortise * 90A13SC118 – Mortise **	80R4OSC – Rim
Cylinder (optional SFIC)	87R40BA – 7-pin	97B10BA138 – 7-pin * 97B13BA138 – 7-pin **	87R40BA – 7-pin

**NOTES:**

\* Devices shipped **before** November 2014

\*\* Devices shipped **after** November 2014

See chart on page 49 for more information

# Wide Stile Plate/Pull Trim

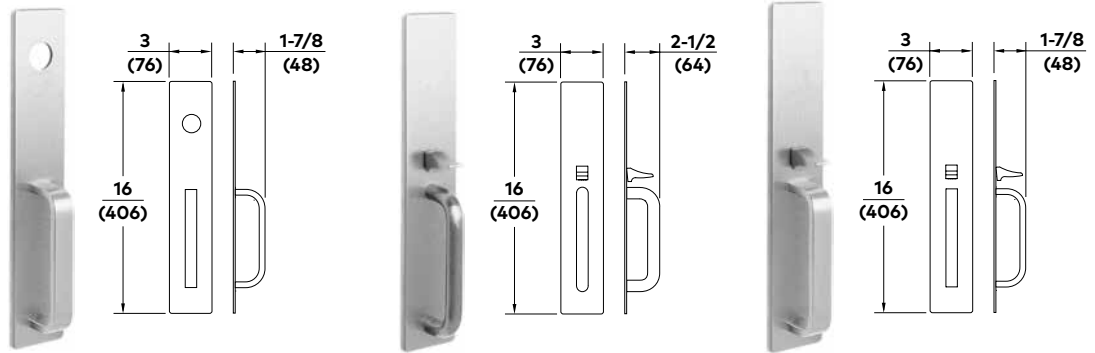

Trim Descriptions	3" Wide Flat Plate Rectangular Pull with Cylinder Hole (mortise)	3" Wide Flat Plate Tubular Pull with Thumbpiece	3" Wide Flat Plate Rectangular Pull with Thumbpiece
Trim Designation	PRT03M	HTT22, HTT22CV, HTT22M	HRT22, HRT22CV, HRT22M
Handing	—	—	—
Function	O3	22	22
Cylinder (default)	90A10SC118 – Mortise * 90A13SC118 – Mortise **	—	—
Cylinder (optional SFIC)	97B10BA138 – 7-pin * 97B13BA138 – 7-pin **	—	—

**NOTES:**

\* Devices shipped **before** November 2014

\*\* Devices shipped **after** November 2014

See chart on page 49 for more information

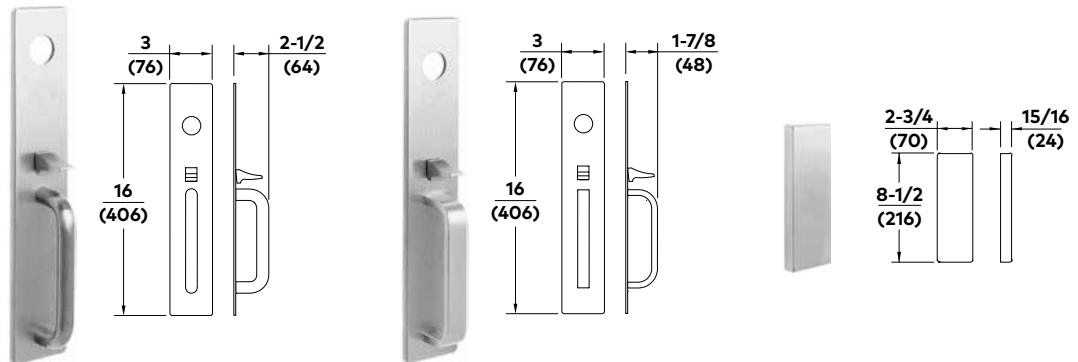

Trim Descriptions	3" Wide Flat Plate Tubular Pull with Thumbpiece and Cylinder Hole	3" Wide Flat Plate Rectangular Pull with Thumbpiece and Cylinder Hole	Raised Escutcheon Plate Dummy Trim
Trim Designation	HTT05, HTT05CV, HTT05M, HTT06, HTT06CV	HRT05, HRT05CV, HRT05M, HRT06, HRT06CV	YODT
Handing	—	—	—
Function	O5 or O6 (HTT06, HTT06CV)	O5 or O6 (HRT06, HRT06CV)	DT
Cylinder (default)	90A10SC118 – Mortise	90A10SC118 – Mortise	—
Cylinder (optional SFIC)	97A10BA138 – 7-pin	97A10BA138 – 7-pin	—

# Wide Stile Escutcheon Trim

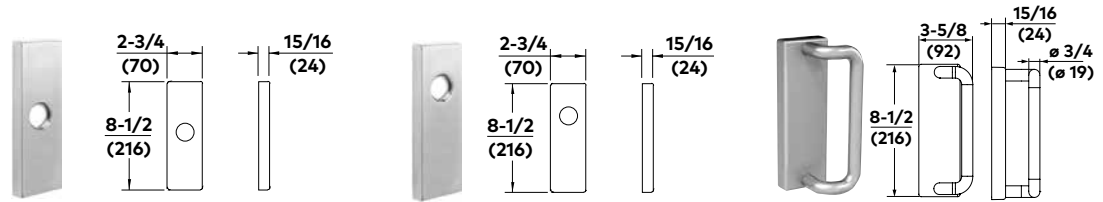

Trim Descriptions	Raised Escutcheon Plate with Cylinder Hole	Raised Escutcheon Plate with Cylinder Hole (mortise)	Raised Escutcheon Plate Tubular Pull
Trim Designation	YO03	YO03M	YP02
Handing	—	—	—
Function	O3	O3	O2
Cylinder (default)	80R40SC – Rim	90X10SC158 – Mortise * 90A13SC118 – Mortise **	—
Cylinder (optional SFIC)	87R40BA – 7-pin	97D10BA134 – 7-pin * 97B13BA138 – 7-pin **	—

**NOTES:**

\* Devices shipped **before** November 2014

\*\* Devices shipped **after** November 2014

See chart on page 49 for more information

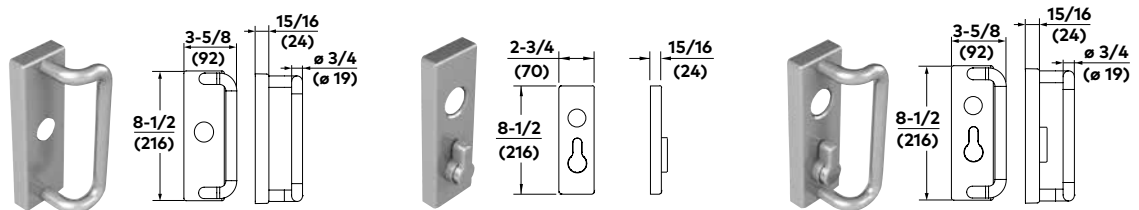

Trim Descriptions	Raised Escutcheon Plate Tubular Pull with Cylinder Hole	Raised Escutcheon Plate with Cylinder Hole and Thumbturn	Raised Escutcheon Plate Tubular Pull with Cylinder Hole and Thumbturn
Trim Designation	YP03	YO11, YO12	YP11, YP12
Handing	—	—	—
Function	O3	11 or 12	11 or 12
Cylinder (default)	80R40SC – Rim	90X13SC118 – Mortise	90X13SC118 – Mortise
Cylinder (optional SFIC)	87R40BA – 7-pin	97X09BA138 – 7-pin	97X09BA138 – 7-pin



# Wide Stile Escutcheon Trim

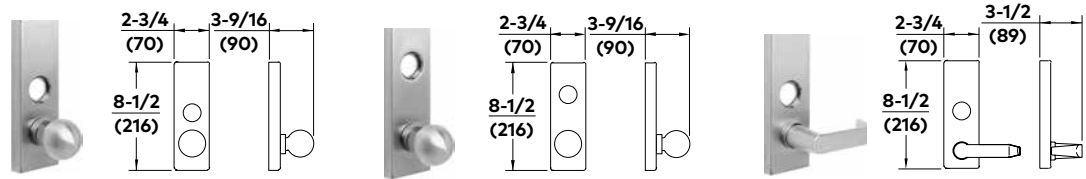

Trim Descriptions	Raised Escutcheon Plate Knob with Cylinder Hole (rigid trim)	Raised Escutcheon Plate Knob with Cylinder Hole (mortise x rigid trim)	Raised Escutcheon Plate Rectangular Lever with Cylinder Hole (rigid trim) (R trim shown)
Trim Designation	YK03R	YK03MR	Yx03R
Handing	—	—	—
Function	03	03	03
Cylinder (default)	80R40SC – Rim	90X10SC158 – Mortise * 90A13SC118 – Mortise **	80R40SC – Rim
Cylinder (optional SFIC)	87R40BA – 7-pin	97D10BA134 – 7-pin * 97B13BA138 – 7-pin **	87R40BA – 7-pin

**NOTES:**

\* Devices shipped **before** November 2014

\*\* Devices shipped **after** November 2014

See chart on page 49 for more information

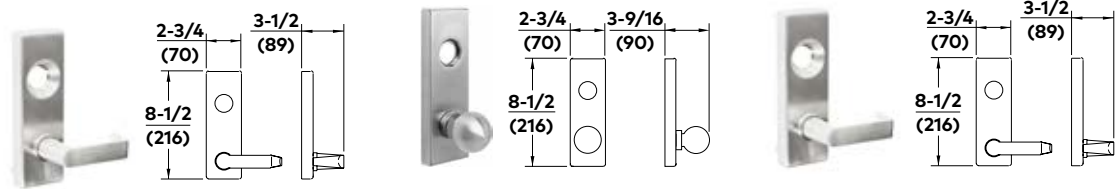

Trim Descriptions	Raised Escutcheon Plate Rectangular Lever with Cylinder Hole (mortise x rigid trim) (R trim shown)	Raised Escutcheon Plate Knob with Cylinder Hole	Raised Escutcheon Plate Rectangular Lever with Cylinder Hole (R trim shown)
Trim Designation	Yx03MR	YK08M	Yx08M, Yx08MC
Handing	—	—	Specify Hand YR08MC
Function	03	08	08
Cylinder (default)	90X10SC158 – Mortise * 90A13SC118 – Mortise **	90X10SC158 – Mortise * 90A12SC118 – Mortise **	90X10SC158 – Mortise * 90A12SC118 – Mortise **
Cylinder (optional SFIC)	97D10BA134 – 7-pin * 97B13BA138 – 7-pin **	97D10BA134 – 7-pin * 97B12BA138 – 7-pin **	97D10BA134 – 7-pin * 97B12BA138 – 7-pin **

**NOTES:**

\* Devices shipped **before** November 2014

\*\* Devices shipped **after** November 2014

See chart on page 49 for more information

When a trim designation includes an x (such as Yx03R), replace x with the letter or number assigned to the chosen lever style. For example, YR03R specifies lever style R. See page 34 for details.

# Wide Stile Escutcheon Trim

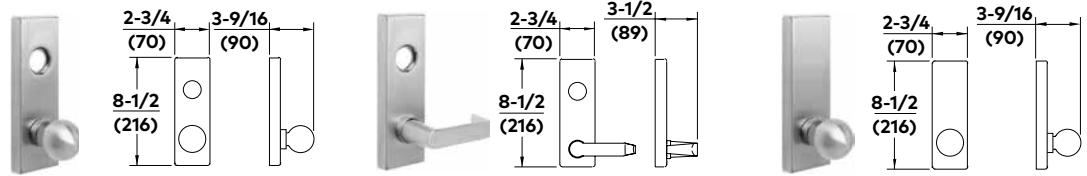

Trim Descriptions	Raised Escutcheon Plate Knob with Cylinder Hole	Raised Escutcheon Plate Rectangular Lever with Cylinder Hole (R trim shown)	Raised Escutcheon Plate Knob
Trim Designation	YK08, YK09, YK08x08*	Yx08, Yx08C, Yx08x08*, YxR09, Yx09C	YK02R, YK23, YK23M
Handing	—	Specify Hand YR08C, YR08x08, YR09C	—
Function	O8 or O9	O8 or O9	O2 or 23
Cylinder (default)	90X10SC118 – Mortise	90X10SC118 – Mortise	—
Cylinder (optional SFIC)	97X10BA138 – 7-pin	97X10BA138 – 7-pin	—

\*Yx08x08 \*trim requires push-side rim cylinder (ordered separately).

Cylinder: 80R20SC - Rim  
87R20BA - 7-pin IC

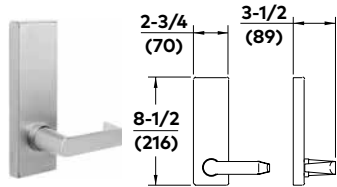

Trim Descriptions	Raised Escutcheon Plate Rectangular Lever (R trim shown)
Trim Designation	Yx02R, Yx23, Yx23M
Handing	—
Function	O2 or 23
Cylinder (default)	—
Cylinder (optional SFIC)	—

**NOTE:** When a trim designation includes an x (such as Yx23), replace x with the letter or number assigned to the chosen lever style. For example, YR23 specifies lever style R. See page 34 for details.

# Wide Stile Sectional Trim

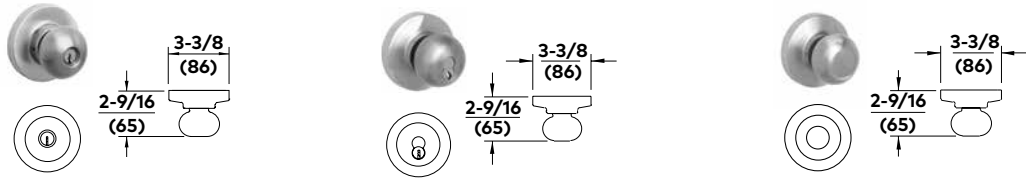

Trim Descriptions	Key-in-Knob	Key-in-Knob Interchangeable Core	Knob Interchangeable Core
<b>Trim Designation</b>	9K03, 9K08	9K03J, 9K08J	9K23
<b>Handing</b>	—	—	—
<b>Function</b>	03 or 08	03 or 08	23
<b>Cylinder (default)</b>	Includes key-in-lever/ knob cylinder 7013SC KD	Accepts SFIC	—
<b>Cylinder (optional SFIC)</b>	—	77BAxxx – 7-pin	—

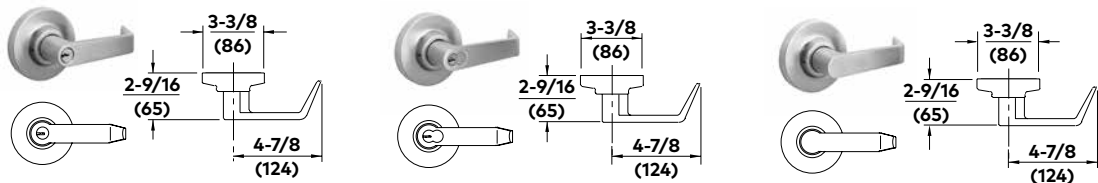

Trim Descriptions	Key-in-Rectangular Lever* (R trim shown)	Key-in-Rectangular Lever Interchangeable Core* (R trim shown)	Rectangular Lever* (R trim shown)
<b>Trim Designation</b>	9x03, 9x08	9x03J, 9x08J	9x23
<b>Handing</b>	—	—	—
<b>Function</b>	03 or 08	03 or 08	23
<b>Cylinder (default)</b>	Includes key-in-lever/ knob cylinder 7013SC KD	Accepts SFIC	—
<b>Cylinder (optional SFIC)</b>	—	77BAxxx – 7-pin	—

\* Sectional Trim is available with R, C, or G Levers only; See page 36 for ordering.

## NOTES:

- Key-in-knob and key-in-lever trim are field-reversible for handing.
- When a trim designation includes an x (such as 9x08), replace x with the letter or number assigned to the chosen lever style. For example, 9R08 specifies lever style R. See page 34 and 36 for details.

# Wide Stile Vandal Resistant Pull Trim

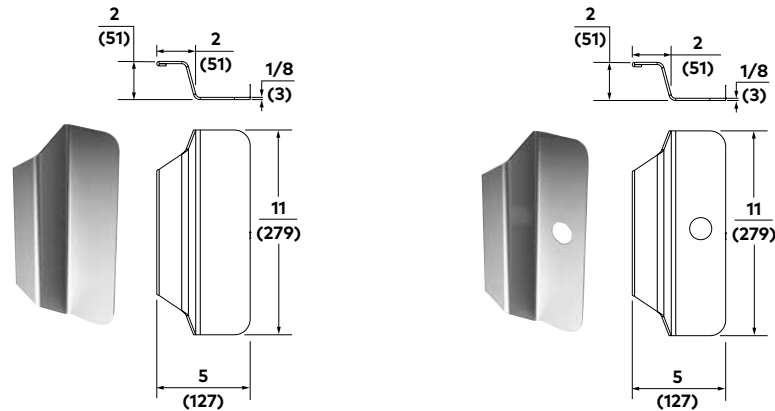

Trim Descriptions	Heavy-Duty Offset Pull	Heavy-Duty Offset Pull with Cylinder Hole
Trim Designation	VRFO2SPM	VRFO3SPM
Handing	Specify Hand	Specify Hand
Function	O2	O3
Cylinder (default)	—	80R40SC – Rim
Cylinder (optional SFIC)	—	—

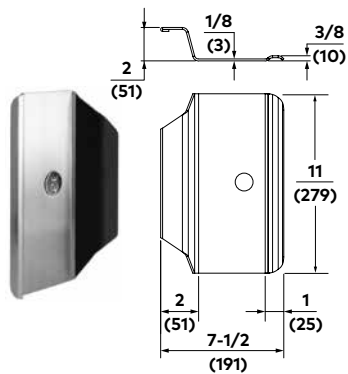

Trim Descriptions	Heavy-Duty Offset Pull
Trim Designation	POF03HDAJ
Handing	Specify Hand
Function	O3
Cylinder (default)	80R40SC – Rim
Cylinder (optional SFIC)	—

# Cylinder Specification

## Rim Cylinders

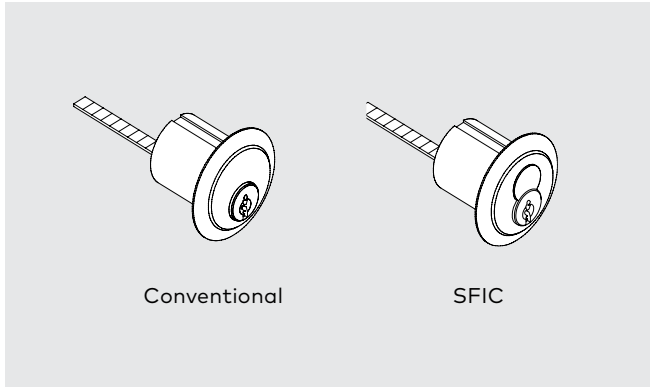

## Mortise Cylinders

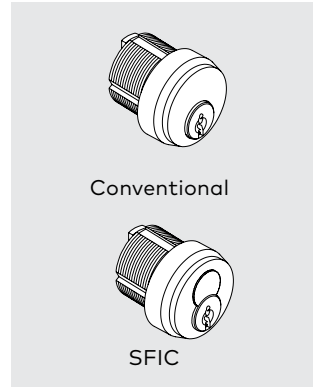

## Key-in-Lever Cylinders

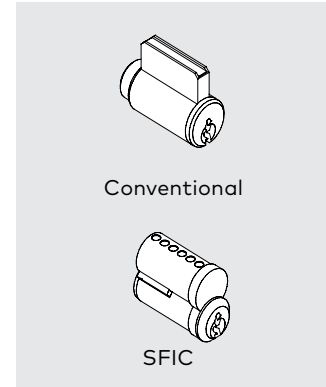

Application	ANSI Function	Cylinder Type	Conventional (Default)	Cam	SFIC 7-Pin
<b>Cylinders for 9100/F9100 Concealed Vertical Rod, 9300/F9300 Rim, and 9400/F9400 Surface Vertical Rod Wide Stile Devices</b>					
Sectional Trim (Key-in-Lever)	03, 08	Key-in-lever	7013SC	NA	77BA
Wide Plate Trim	03	Rim	80R40SC	NA	87R40BA
Wide Plate Trim	05, 06	Mortise	90A10BA118	#10	97A10BA138
Narrow Plate Trim	03	Rim	80R40SC	NA	87R40BA
Y Escutcheon Trim	03	Rim	80R40SC	NA	87R40BA
Y Escutcheon Trim	08	Mortise	90X10SC118	#10	97C10BA138
Y Escutcheon Trim	09	Mortise	90X10SC118	#9	97C10BA138
<b>Cylinders for 9500/F9500 Mortise Devices shipped prior to 11/14</b>					
Wide Plate Trim	03, 05	Mortise	90A10SC118	#10	97B10BA138
Wide Plate Trim	03	Mortise	90A10SC118	#10	97B10BA138
Y Escutcheon Trim	03, 08	Mortise	90X10SC158	#10	97D10BA134
<b>Cylinders for 9500/F9500 Mortise Devices shipped 11/14 or after</b>					
Wide Plate Trim	03	Mortise	90A13SC118	#13	97B13BA138
Wide Plate Trim	05	Mortise	90A12SC118	#12	97B12BA138
Narrow Plate Trim	03	Mortise	90A13SC118	#13	97B13BA138
Y Escutcheon Trim	03	Mortise	90X13SC118	#13	97C13BA138
Y Escutcheon Trim	05, 08	Mortise	90X12SC118	#12	97C12BA138
<b>Cylinders for Device Options</b>					
CD, BA, BAR, DE, D3, DECBC, DA, LMM-P	—	Mortise	90X10SC118	#10	97D10BA138
<b>Cylinders for Mullions</b>					
1FKR Key Removable Mullion	—	Mortise	90X01SC118	#1	97D01BA138
1FS Mullion Storage Kit	—	Mortise	90X01SC118	#1	97D01BA138

# Mullions

Removable mullions are used with paired doors where a full-width opening is only occasionally required.

Doors are fitted with rim exit devices and normally function as single doors. Available in 8' or 10' lengths.

## 1310 Aluminum Mullion

- Meets demands of heaviest use areas.
- Durable extrusion.
- Supplied with wood/machine screws and anchors.

**1310-8** — 8' mullion  
**1310-10** — 10' mullion  
**WS1310-8** — 8' mullion with weatherstrip  
**WS1310-10** — 10' mullion with weatherstrip

**Finish**  
 Aluminum: 628 (Satin)  
 Bronze: 695 (Dark)

## 1330 Steel Mullion

- Ideal for high-abuse areas such as schools.
- Meets demands of heaviest use areas.
- Heavy-gauge, smooth-surface steel construction.
- Attractive tube shape with rounded corners.
- Supplied with wood/machine screws and anchors.

**1330-8** — 8' mullion  
**1330-10** — 10' mullion

**Finish**  
 Prime: 600

## F1300 Steel Mullion

- For use with U.L. listed fire exit devices.
- Meets demands of heaviest use areas.
- Large top and bottom fittings for extra strength.
- Heavy-duty tube with rounded corners.
- Standard 8' length.
- Supplied with wood/machine screws and anchors.

**F1300-8** — 8' fire rated mullion  
**1300-8** — 8' non-fire rated mullion  
**1300-10** — 10' non-fire rated mullion

**Finish**  
 Prime: 600

**F1FKR Key Removable Steel Mullion**

- Easily removable with key.
- Keying is standard 1-1/8" mortise cylinder with O1 (AR) cam.
- For use with U.L. listed fire exit devices.
- Meets demands of heaviest use areas.
- Large top and bottom fittings for extra strength.
- Heavy-duty tube with rounded corners.
- Standard 8' length.
- Supplied with wood/machine screws and anchors.
- Includes conventional default mortise cylinder: 90X01SC118 626.

**F1FKR-8** — 8' fire-rated key removable mullion  
**1FKR-8** — 8' non fire-rated key removable mullion  
**1FKR-10** — 10' non fire-rated key removable mullion  
**1FKR-EL-8** — 8' non-fire rated wired key removable mullion  
**1FKR-EL-10** — 10' non-fire rated wired keyed removable mullion

**Finish**  
 Prime: 600

Optional SFIC:  
 97D01BA138 — 7-pin

**HC1300 Steel HC Mullion**

- For use with pairs of hurricane-rated rim devices on openings up to 8'0" x 8'0".
- 80 psf design pressure rating positive/negative deflection with HC9300 rim device.
- Tested to Miami-Dade TAS 201, 202, 203.
- Large top and bottom fittings for extra strength.
- Heavy-duty tube with rounded corners.
- Standard 8' length.
- Supplied with appropriate screws and anchors.

**HC1300-8** — Heavy-duty 5/16" wall HC mullion\*

**Finish**  
 Prime: 600

\*For other HC mullions, consult factory.

**1FS Mullion Storage Kit**

- For use with 1F key removable steel mullion.
- Locking cylinder can be keyed into master key system.
- Includes conventional default mortise cylinder: 90X01SC118 626.

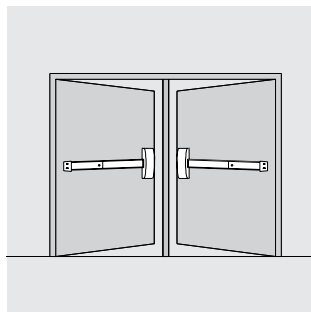

Optional SFIC:  
 97D01BA138 — 7-pin

# 9600/F9600 Narrow Stile Concealed Vertical Rod Exit Devices

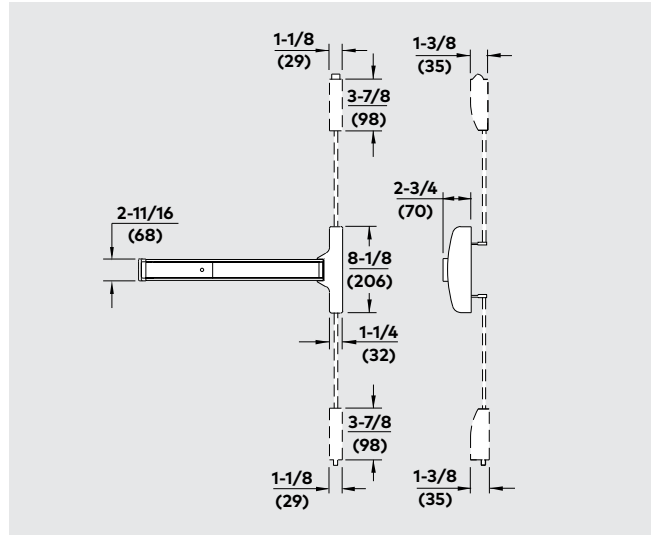

**Specify Door Brackets**

- NS** – 2-1/8" narrow stile aluminum (default)
- WD** – Narrow stile wood or hollow steel

Model	Function	Operation	Trim Model			
9600 F9600	01	Exit Only (no trim)				
9600 F9600	DT	Dummy Trim	ZODT			
9600	02	Entrance by trim when actuating bar is locked down.	OP02	ZP02	ZK02R	Zx02R
9600 F9600	03	Entrance by trim when latch bolt is retracted by key. Key removable only when locked.	ZO03*	ZP03	ZK03R	Zx03R
9600 F9600	08	Entrance by knob or lever. Key locks or unlocks knob or lever.			ZK08	Zx08 Zx08C
9600 F9600	09	Entrance by knob or lever only when released by key. Key removable only when locked.			ZK09	Zx09 Zx09C
9600 F9600	11	Entrance by thumbturn and pull. Key locks or unlocks thumbturn.	Z011	ZP11		
9600 F9600	12	Entrance by thumbturn and pull only when released by key. Key removable only when locked.	Z012	ZP12		
9600 F9600	23	Entrance by knob or lever (no cylinder). Knob or lever always active.			ZK23	Zx23
9600 F9600	25	Entrance by thumbturn and pull (no cylinder). Thumbturn always active.		ZP25		

\* Pull by others.

**NOTE:** When a trim designation includes an x (such as Zx23), replace x with the letter or number assigned to the chosen lever style. For example, ZR23 specifies lever style R. See page 63 for details.



Standard Strikes

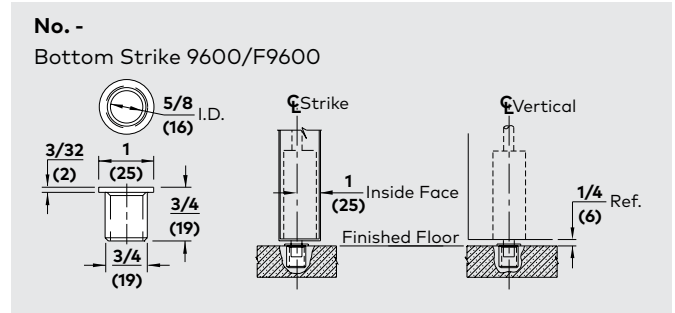
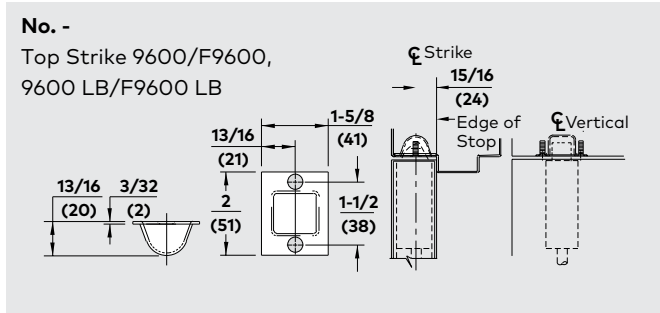

Optional Strikes

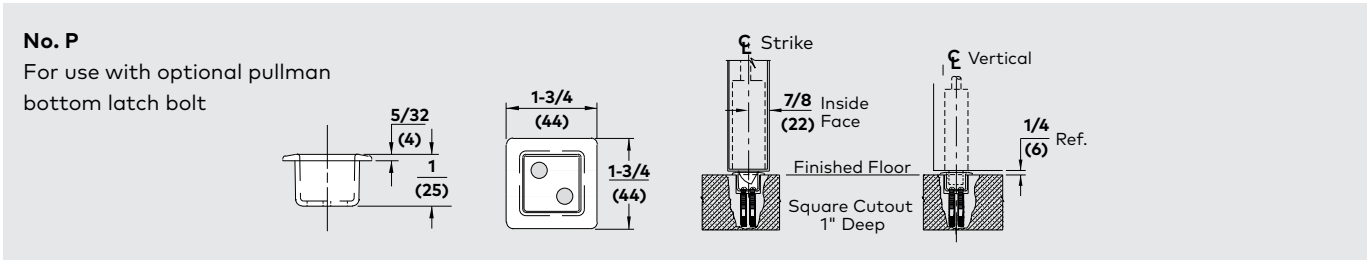
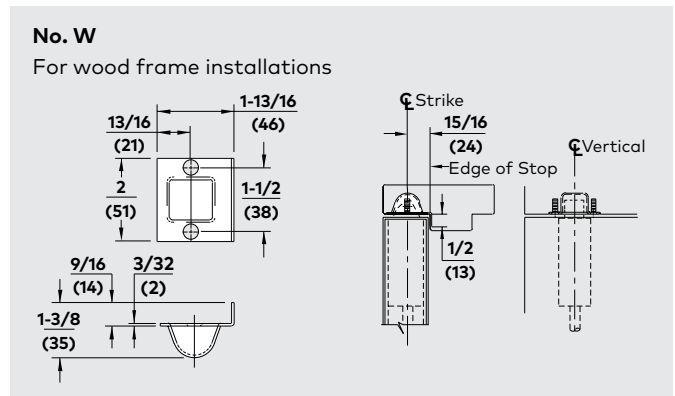
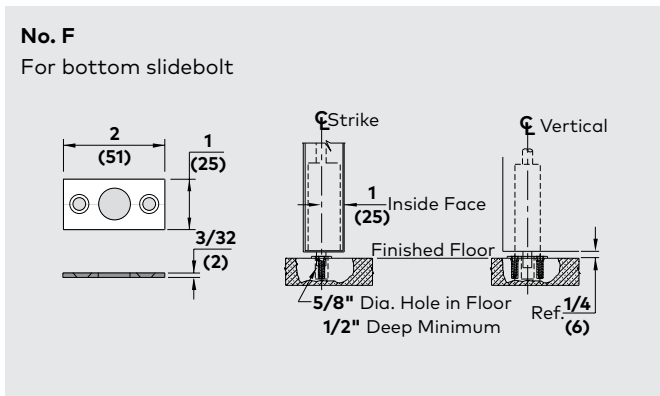

Minimum Stile & Vertical Reference

Vertical Rod x Vertical Rod

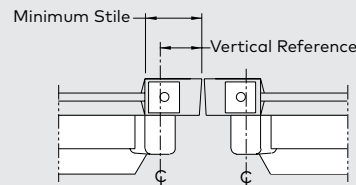

Vertical Rod x Rim

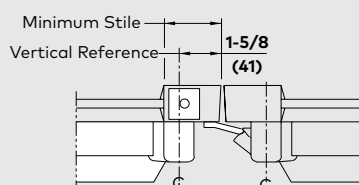

Not Fire Rated

9600	Vertical Reference	Minimum Stile
No Trim/OP02	1-1/4 (32)	1-7/8 (48)
Z Trim	1-1/4 (32)	2-1/16 (52)

F9600	Vertical Reference	Minimum Stile
No Trim/OP02	2-3/4 (70)	3-3/16 (81)
Z Trim	2-3/4 (70)	3-3/16 (81)

9600	Minimum Stile
No Trim/OP02	2-3/16 (56)
Z Trim	2-7/16 (62)

# 9700/F9700 Narrow Stile Rim Exit Devices

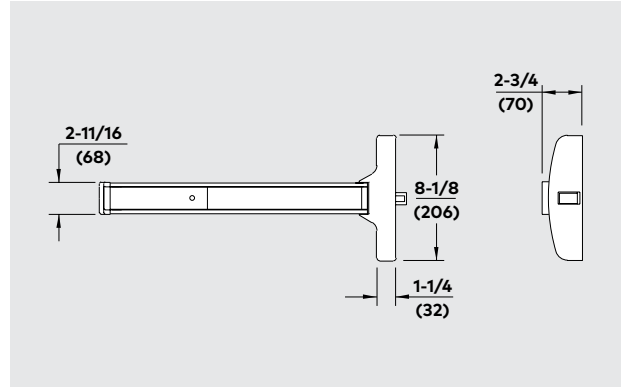

Model	Function	Operation	Trim Model
9700 F9700	01	Exit Only (no trim)	
9700 F9700	DT	Dummy Trim	ZODT
9700	02	Entrance by trim when actuating bar is locked down.	OP02  ZP02  ZK02R  Zx02R
9700 F9700	03	Entrance by trim when latch bolt is retracted by key. Key removable only when locked.	ZO03*  ZP03  ZK03R  Zx03R
9700 F9700	08	Entrance by knob or lever. Key locks or unlocks knob or lever.	ZK08  Zx08  Zx08C
9700 F9700	09	Entrance by knob or lever only when released by key. Key removable only when locked.	ZK09  Zx09  Zx09C
9700 F9700	11	Entrance by thumbturn and pull. Key locks or unlocks thumbturn.	ZO11  ZP11
9600 F9600	12	Entrance by thumbturn and pull only when released by key. Key removable only when locked.	ZO12  ZP12
9700 F9700	23	Entrance by knob or lever (no cylinder). Knob or lever always active.	ZK23  Zx23
9700 F9700	25	Entrance by thumbturn and pull (no cylinder). Thumbturn always active.	ZP25

\* Pull by others.

**NOTE:** When a trim designation includes an x (such as Zx23), replace x with the letter or number assigned to the chosen lever style. For example, ZR23 specifies lever style R. See page 63 for details.

Standard Strikes

**No. B**  
Standard strike with 9700

Strike	Vertical Ref./ Min. Stile	No Trim/ OP02	Trim
B	Vertical Ref.	1-3/8 (35)	1-3/8 (35)
	Min. Stile	2-7/16 (62)	2-9/16 (65)

All dimensions based on 1/2" (13) stop height

**No. -**  
Standard strike with F9700

Strike	Vertical Ref./ Min. Stile	No Trim/ OP02	Trim
-	Vertical Ref.	1-1/2 (38)	1-1/2 (38)
	Min. Stile	2-9/16 (65)	2-11/16 (68)

All dimensions based on 1/2" (13) stop height

Optional Strikes

**No. R**  
Roller strike

Strike	Vertical Ref./ Min. Stile	No Trim/ OP02	Trim
R	Vertical Ref.	1-1/2 (38)	1-1/2 (38)
	Min. Stile	2-9/16 (65)	2-11/16 (68)

All dimensions based on 1/2" (13) stop height

**No. V**  
Overlap strike

Not Fire Rated	
9700	Minimum Stile
No Trim/OP02	2-3/16 (56)
Z Trim	2-7/16 (62)

# 9800/F9800 Narrow Stile Surface Vertical Rod Exit Devices

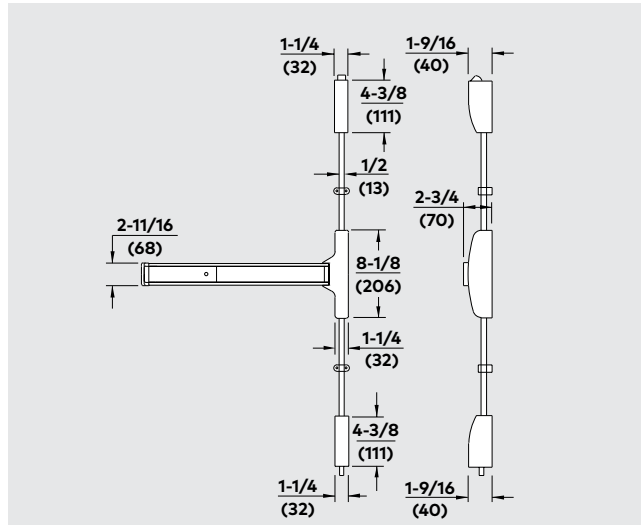

Model	Function	Operation	Trim Model
9800 F9800	01	Exit Only (no trim)	
9800 F9800	DT	Dummy Trim	ZODT
9800	02	Entrance by trim when actuating bar is locked down.	OP02  ZP02  ZK02R  Zx02R
9800 F9800	03	Entrance by trim when latch bolt is retracted by key. Key removable only when locked.	ZO03*  ZP03  ZK03R  Zx03R
9800 F9800	08	Entrance by knob or lever. Key locks or unlocks knob or lever.	ZK08  Zx08  Zx08C
9800 F9800	09	Entrance by knob or lever only when released by key. Key removable only when locked.	ZK09  Zx09  Zx09C
9800 F9800	11	Entrance by thumbturn and pull. Key locks or unlocks thumbturn.	Z011  ZP11
9800 F9800	12	Entrance by thumbturn and pull only when released by key. Key removable only when locked.	Z012  ZP12
9800 F9800	23	Entrance by knob or lever (no cylinder). Knob or lever always active.	ZK23  Zx23
9800 F9800	25	Entrance by thumbturn and pull (no cylinder). Thumbturn always active.	ZP25

\* Pull by others.

**NOTE:** When a trim designation includes an x (such as Zx23), replace x with the letter or number assigned to the chosen lever style. For example, ZR23 specifies lever style R. See page 63 for details.

Standard Strikes

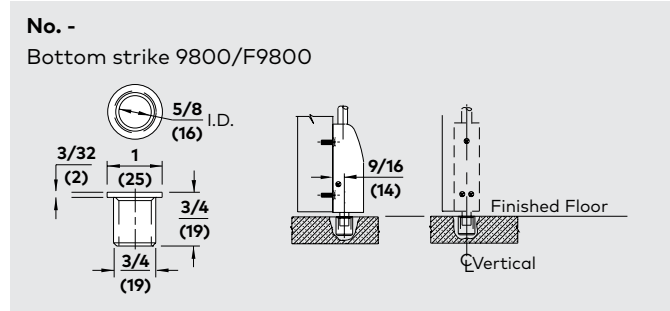
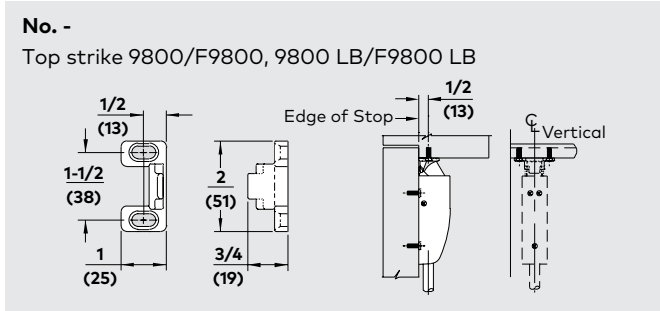

Optional Strikes

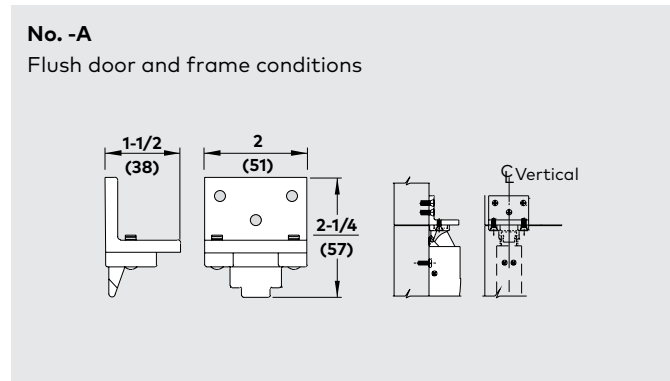
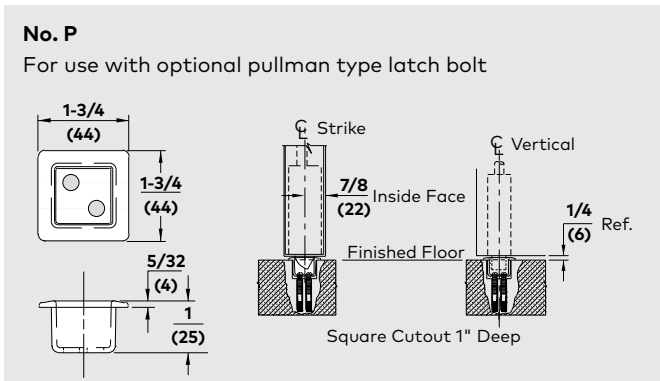
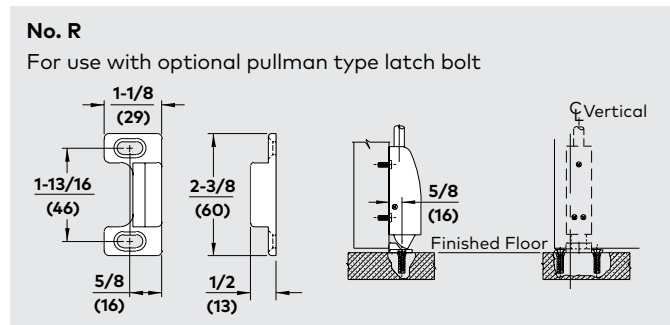
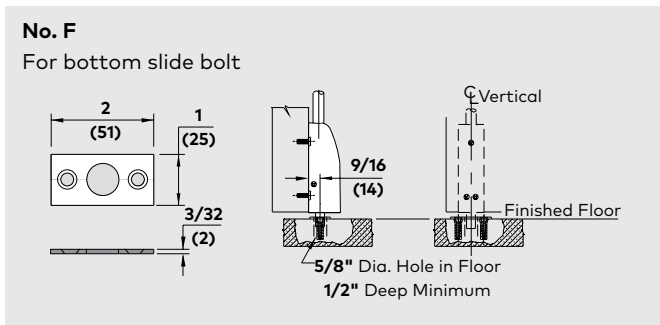

Minimum Stile & Vertical Reference

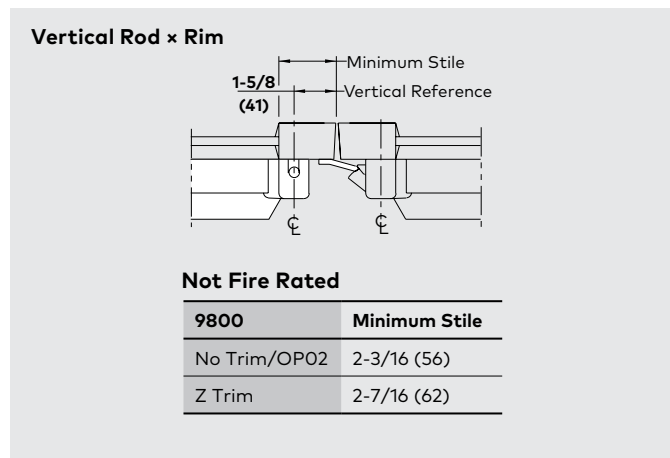
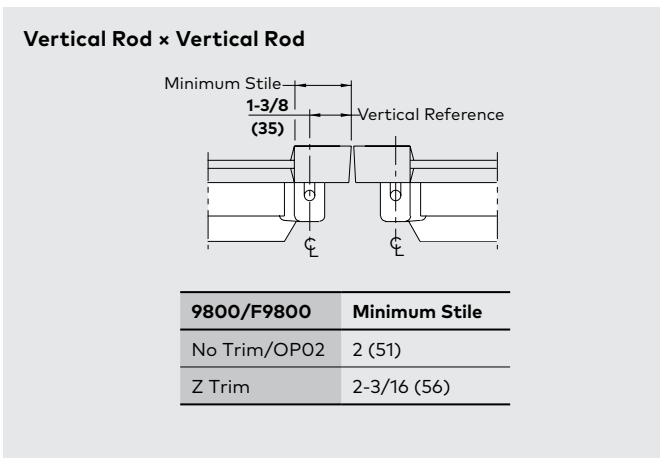

# Accessories

## Non-functioning Exit Devices

The non-functioning exit device looks exactly like the 9000 Series, but has no latching mechanism. Units can be furnished in standard **AA**, **BB**, or **CC** width or cut to special size when door width is specified. Order any applicable trim for push/pull function. Choose the type of operation required.

## Rigid Touchbar Device

Touchpad is permanently fixed and immobile.

**9235** – Narrow Stile

## Moveable Touchbar Device

Same as rigid touchbar device, but touchbar is moveable. Similar to standard 9000 Series device.

**9236** – Narrow Stile

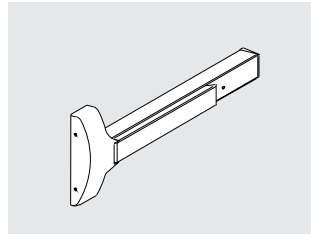

## Moveable Touchbar Device with Microswitch

Same as moveable touchbar device, but includes microswitch that can be used to control electromagnetic locks, electric strikes, or other electronic appliances.

**9236MS** – Narrow Stile

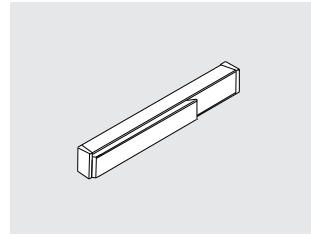

## Dummy Bar

The dummy bar is designed as a companion to 9000 Series devices. Units consist of the touchbar assembly only and do not include the device chassis or chassis cover. Door width must be specified.

## Rigid Dummy Bar

Touchbar only. Touchpad is permanently fixed and immobile.

**9230** – Narrow Stile

## Dummy Bar with Microswitch

Touchbar is moveable and activates included microswitch. Can be used to control electromagnetic locks, electric strikes, or other electronic appliances.

**9230MS** – Narrow Stile

## Vision Lite Shim Kit

Contains two 1/8" thick shims. Permits shimming of the exit device maximum 1/4" off door face without affecting U.L. listing.

Designed to accommodate glass lite installed in door. Furnished Bright Zinc Plated (BZP). Optional finishes available, consult factory.

**GK9200** – Narrow Stile

## Conversion Kits

The following conversion kits are the same as options detailed elsewhere in this brochure, but in kit form with required components and installation instructions for field installation/retrofit.

**MS Kit** – Monitor Switch in Touchbar Kit

**BA Kit** – Battery Powered Exit Alarm Kit

**BAR Kit** – Battery Powered Exit Alarm, 4 Minute Reset Kit

**DA Kit** – Direct Wired Alarm Kit

**CD Kit** – Cylinder Dogging Kit (less cylinder)

## Security Screws

For applications where tamper-resistant security screws are required, specify **T**.

**NOTE:** Special screw bits are required.

9600/F9600	2 packs
9600/F9600 w/trim	1 pack
9700/F9700	2 packs
9700/F9700 w/trim	1 pack
9800/F9800	5 packs
9800/F9800 w/trim	4 packs

## Sex Nuts

The chart above serves as a simple reference when specifying 9000 Series exit devices and trim.

# Optional Electric Functions

## Motorized Latch Retraction

Specify **MLR**. A motor concealed in the touchbar assembly provides retraction of the latch by driving in the touch bar to allow access from the secure side of the door. MLR can also be used to electrically dog/hold the exit push bar in a retracted position during non-secure hours (latch is retracted). Remote control can be accomplished with switching devices such as key switches and card readers that provide a normally open electrical contact. The motor is rated at 24 VDC, .88 AMP. The motor draws approximately 400 milliamp during continuous operation. Use of either PS610RF or PS532RF is recommended to power one or two MLR devices respectively. The 9000 MLR can also be powered with the ED900 Low Energy ADA Operator.

## Electric Latch Retraction

Specify **ES**. A solenoid concealed in the touchbar assembly provides instantaneous retraction of the latch to allow access from the secure side of the door. Remote control can be accomplished with switching devices such as key switches and card readers that provide a normally open electrical contact. The solenoid is rated for 24 VDC, 14–18 AMP continuous duty, 24 VDC, 14–18 AMP inrush for 200 milliseconds, 1 AMP holding current.

**Requires PS501 power supply.**

## Battery Back-up

Battery Back-up power supply options are available when using either the PS406BB or PS462BB power supplies. Specify **E-** when ordering Electric Latch Retraction exit device.

## Requires PS501 power supply and ES105 power transfer.

Not available with **C** or **CC** size devices, or 9500 mortise exit devices.

## Monitor Switch

Specify **MS**. Two micro switches in the touchbar assembly functioning as form C contacts provide local and/or remote notification of two separate appliances when the touchbar is depressed. Each switch is rated for .5 AMP @ 28 VDC maximum.

## Latch Monitor

Specify **LM**. A microswitch attached to the device chassis provides local and/or remote notification of the exit device rods without depressing the touchbar. The single-pole, double-throw switch is rated at .50 AMP @ 28 VDC maximum.

## Latch Monitor with Monitor Switch

Specify **LM/MS**. A combination of Latch Monitor and Monitor Switch functions in one device.

## Latch Monitor with Monitor Switch and Bypass

Specify **LM/MS BP**. Same as LM/MS above, but an additional single-pole, double-throw switch is triggered by a mortise cylinder for alarm bypass. Cylinder furnished.

## Motorized Dogging

Specify **MLR**. This feature can be used to electrically dog/hold the exit push bar in a retracted position during non-secure hours. (Latch is retracted.)

## PS Series Power Supplies

The **ES100 Power Supply** is capable of powering and controlling (1) DE9000 Series Exit Device.

- Input: 120 V

- Input Circuit Protection: 1.3 A fuse
- Output: 24 VDC, 6 A surge for 0.5 seconds, .65 A continuous, per zone



- Output Circuit Protection: 3 A push to reset circuit breaker
- Enclosure: 8" H x 8" W x 4" D NEMA 1 Type enclosure for indoor use with hinged cover and knock-outs

The **PS501 Power Supply** is capable of powering and controlling (2) 9000 Series Exit Devices with the ES Electric Latch Retraction feature. Also has the capability of powering (2) additional 9000 Series Exit Devices with an optional card. Specify option **ES2 CARD**.

- Input: 120 volts
- Input circuit protection: 1 AMP circuit breaker
- Output: 36 VDC, 14–18 AMP surge, 2 AMP @ 5 volt continuous, per zone, unregulated, unfiltered
- Output circuit protection: 4 AMP fuse
- Enclosure: 8" H x 8" W x 4" D NEMA 1 Type enclosure for indoor use with hinged cover and knock-outs

The **PS532RF** Power Supply is capable of powering and controlling (2) or **PS610RF** can power and control (1) 9000 Series Exit Device with the MLR Motorized Latch Retraction feature.

**NOTE:** The PS5352RF or PS610RF can be used with the ES105 power transfer cable, 75200 electric intermediate, or electric through wire hinges when rated to carry a minimum of 1 AMP continuous power. Power transfer device wires may require doubling or tripling depending on wire gage supplied.

- Input: 115VAC/60hz
- Output: PS532RF – 2.0A @ 24VDC, Class 2 PS610RF – 1.0A @ 24VDC, Class 2
- Enclosure: PS532 – 14" H x 16" W x 6.5" D PS610 – 12.5" H x 12.5" W x 4" D

The **ES105** is a power transfer with stainless steel housing and flexible tube. Secure and inconspicuous channel to bring power from the frame to the door. Narrow, shallow channel easily mortises into door edges. Accepts up to 5/16" diameter wire bundle. Accommodates doors that swing open 120°. Unit is concealed when the door is closed. Suitable for wood, aluminum, or steel applications.



## Finish

Stainless: 630 (Satin)

# DE9000 Series Delayed Egress Exit Devices

## Certification

- Certified/listed to ANSI/BHMA 156.3, Grade 1 for exit devices. 
- U.L. and C.U.L. listed under their continuing reinspection programs and conforms to standard U.L. 10C positive pressure testing. 
- Complies with NFPA 101 life safety code. Fire rated devices comply with NFPA 80 fire doors and windows. Field selectable to comply with IBC2012
- Devices, trim, pulls, and levers comply with the Americans with Disabilities Act, 1994, and ICC A117.1 for accessible and usable buildings and facilities. 
- Contributes to U.S. Green Building Council, LEED MR Credits 2.1, 4.1, 4.2 and 5.1.
- Listed with the California Department of Forestry and Fire Protection, Office of the State Fire Marshal (wide stile devices only).
- Hurricane-code approved to Miami-Dade County Florida and Florida State Building Code acceptance (9300, 9400, 9500, 9700).

## Specifications

- All devices shall be DE9000 Series delayed exit devices with ES105 power transfer and ES100 power supply.
- Devices shall be rim, mortise, or concealed vertical rod.
- Devices to have a nuisance alarm with a steady tone to limit inadvertent activation. Depressing and holding the touchbar beyond the nuisance alarm period must initiate a 15 second delay with an intermittent tone.
- Following the irreversible 15 second delay alarm period, the device must release and continue an indefinite steady tone alarm until reset.
- All devices must be capable of rearming by turning the key switch on the device to **rearm** or by using the alternate remote rearm capability. The same key switch must disarm the device for authorized egress.
- All devices must provide two sets of relay contacts that activate when the device is in an irreversible alarm to control remote audible/visual alarms included in control consoles.
- All devices must have an LED indicator light for conveying the status of the device.
- Internal locking feature is required to further enhance security when subjected to forced opening.
- Devices must provide an input for use with an external door position switch to prohibit doors from being held open while the device is armed.
- The device must alarm simultaneously with the activation of the door position switch.
- When power is cut to the devices, they must release and function as typical exit devices in the event of a fire or emergency situation.
- All devices to have heavy-duty cast chassis.
- All device touchbar, rail, and cover assemblies shall be constructed of heavy gauge solid wrought materials for true architectural finishes or color coated finishes where applicable.
- Fire rated versions shall be available for labeled applications.

- All concealed vertical rod devices shall have pullman type top latch bolts and round slidebolt bottom latches.
- All devices to have deadlocking latch bolts with 3/4" throw where applicable.
- All units shall offer a full range of free wheeling operational trim, except mortise devices.
- All units shall offer optional rigid and clutch style trim, where applicable.
- All devices to be furnished with appropriate mounting hardware including both wood and machine screws, as well as sex nuts where required. An adhesive sign with an operation directive must be supplied.
- All devices to be furnished with clutch style lever trim. Specify **C** after lever trim number.
- All concealed vertical rod devices installed in aluminum doors to be furnished with appropriate brackets for aluminum door applications. Specify **A** (DE9100 only).
- All devices to use tamper-resistant security screws for attaching the end cap, chassis cover, and strikes. Specify **T**.

## Finishes

### Architectural Finishes

- Brass: 605 (Bright) or 606 (Satin)
- Bronze: 611 (Bright), 612 (Satin), or 613 (Oxidized Satin)
- Nickel: 619 (Satin)
- Black: 693
- Chrome: 625 (Bright) or 626 (Satin)
- Stainless: 629 (Bright) or 630 (Satin)

### Powder Coated Finishes

- Aluminum: 689
- Bronze: 691 (Dull) or 695 (Dark Duranodic)
- Black: 693
- Gold: 696
- Clear Powder Coating: Specify **P**
- Anti-Microbial: Specify **AM**

## Warranty

For details, refer to **Limited Warranty** on our website at [go.dormakaba.com/Terms-DA](http://go.dormakaba.com/Terms-DA)

## Optional Specifications

- All devices to be furnished with a 30 second irreversible delay alarm. Written approval from the authority having jurisdiction required. Specify **30**.
- All devices for CBC compliant applications to include special CBC door label. Specify **CBC**.
- All concealed vertical rod devices to have pullman type bottom latch bolt. Specify **P**.
- All surface/concealed vertical rod devices to have extended top rod up to 10'. Specify **ETR** for 8', 9', or 10'.
- All devices to use a glass lite shim kit to raise the device from the door surface to accommodate glass light molding. Specify **GK9000**.
- All devices for labeled wood or composite doors to be furnished with sex bolts. Specify **SNB**.
- All devices to be furnished with rigid trim. Specify **R** after trim number.



# DE9000 Delayed Egress Features

## Delayed Egress

The DE9000 is alarmed and the touchbar will not activate the latch bolt for 15 seconds (30 second factory option available). This provides a controlled delayed egress while simultaneously sounding a local and remote audible alarm. After the delay time, unrestricted emergency egress is available.

## Nuisance Alarm

The nuisance alarm, with a steady warning tone, deters inadvertent activation of the device when the touchbar is depressed. Releasing the touchbar before the predefined nuisance alarm time of 1 or 3 seconds terminates the alarm, and the device returns to the armed mode. Depressing the touchbar longer than the predefined time will initiate the 15 second irreversible delay cycle. The 1 or 3 second nuisance alarm time is included in the 15 second irreversible delay time. The nuisance alarm time is field-selectable for three seconds or one second by a dip switch. **A 30 second delay option is available set at the factory. Written approval is required from the authority having jurisdiction.**

## Local or Remote Alarm

Device has an internal 85 dB alarm which will sound indefinitely in the alarm state until the device is reset. Additionally, a form **C** relay is provided for activating remote audible/visual signaling of the control console, security panel, or other audible/visual signaling device.

## Indicator LED

Status for the DE9000 can be determined by the indicator LED which is visible in varied lighting conditions. When the device is disarmed for an extended time in the **bypass** mode, the LED will maintain a slow green flash. When activated for **authorized egress**, the LED displays a rapid green flash until the device automatically rearms. In the armed state, the LED maintains a solid green. When the touchbar is depressed for exit, the nuisance alarm will sound while the LED remains solid green. In the 15 second irreversible delay cycle, the LED turns solid yellow. In the alarm state, the LED is solid red.

## Key Switch Control

This integral key switch provides the means to locally rearm the device from the alarm state, disarm for authorized egress, and set the device for the **bypass** feature. A mortise cylinder is supplied with the device.

## Remote Authorized Egress

This function allows override of the device in the armed state. The device will unlock for egress and automatically rearm to the delayed egress mode in 10 seconds. The field-selectable reset time allows up to a 20 second reset. Typical activation devices include remote consoles, key switches, or card readers. This input is controlled with a momentary action normally open switch.

## Remote Rearm

Remote rearming of the device is allowed from the alarm state. Typical activation devices include remote consoles or key switches. This input is controlled with a momentary action normally open switch. Consult local authority having jurisdiction when using this feature.

## Door Position Input

An input for use with an external door position switch is provided. This input switch is a maintained action normally closed contact. The device alarms simultaneously with the contact opening. The door is prohibited from being forced or held open unauthorized while the device is armed. The field-selectable authorized egress and bypass functions ignore the door position input for authorized exit or entrance.

## Electrical Specifications

### Input Power

24 VDC @ .5 A continuous (5 A inrush for 350 ms).

**Power must be provided by an ES100 power supply.**

## Door Position Input

Requires a normally closed contact.

## Pigtail provided for the following:

Input power, remote authorization egress, remote bypass/rearm, relay contacts for audible/visual console, door position switch input, fire alarm contacts, and pairs of doors.

## DE9000 Exit Device

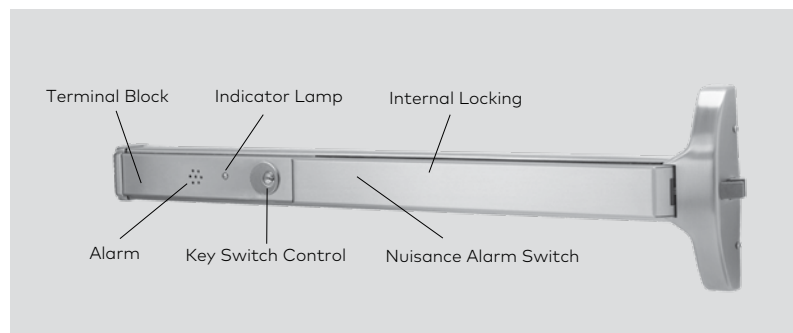

# Auxiliary Equipment

## Alarms

The 9000 Series exit devices are available with an integral battery powered alarm. The 102 decibel alarm contained in the panic device touchbar and rail assembly activates when the touchbar is depressed and sounds continuously until the device is reset or the battery is completely discharged. Alternatively, a factory-furnished option allows the alarm to sound for four (4) minutes, then automatically rearm.

Furnished with and controlled by a lock cylinder and key, the unit allows ten (10) seconds to exit through the door after arming the alarm, indicated by an intermittently flashing red LED light in the touchbar. A yellow LED in the touchbar will flash until manually reset by key to indicate an unauthorized exit even if the alarm has automatically reset.

The unit is furnished with a 9 volt, industrial-grade battery concealed in the end cap assembly for easy replacement. A tamper-proof switch will activate the alarm if unauthorized removal of the battery is attempted. Option is available for 12 or 24 volt direct power wiring.

- Specify **BA** for battery alarm device.
- Specify **BAR** for 4 minute auto reset battery alarm device.
- Specify **DA** for direct hard-wired option.
- Size **AA** device fits 48" wide door and can be cut to fit 37-1/2" wide doors.
- Size **BB** device fits 36" wide door and can be cut to fit 31-1/2" wide doors.
- Size **CC** device fits 36" wide door and can be cut to fit 28-1/2" wide doors.

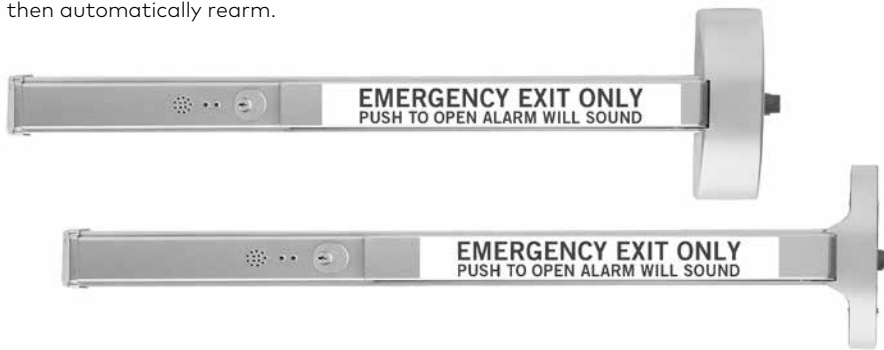

## Trim Options

**Clutch Lever Trim** – Free wheeling, vandal-resistant lever standard, except on 9500 mortise devices. Although mandated to meet ADA requirements, lever handles are especially subject to vandalism and damage. The **clutch** option for lever trim includes an internal slip clutch mechanism which allows the lever handle to break away without damage or violating security when excessive force is applied. The lever can be lifted back to horizontal to reset it.

An internal dead stop limits the break away to 55° of lever handle rotation. Specify **C** to trim designation. Specify hand.

**Rigid Trim** – Rigid lever and knob option. Specify **R** to trim designation.

**Retrofit** – For Von Duprin 98/99 Series Rim Devices. Specify **R1** (narrow and wide plate trim only).

# Lever & Knob Styles for Z Narrow Stile Trim

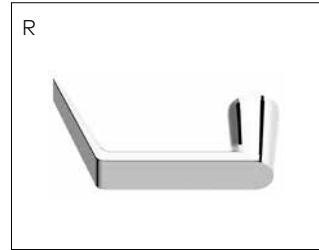
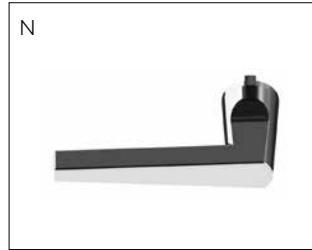
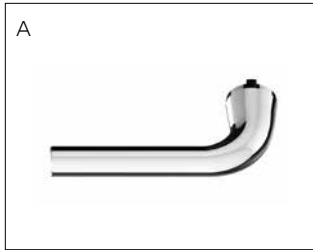

**Finishes**

**Architectural Finishes**

- Brass: 605 (Bright) or 606 (Satin)
- Bronze: 611 (Bright), 612 (Satin), or 613 (Oxidized Satin Oil Rubbed)
- Nickel: 619 (Satin)
- Chrome: 625 (Bright) or 626 (Satin)
- Stainless: 629 (Bright) or 630 (Satin)

**Powder Coated Finishes**

- Aluminum: 689
- Bronze: 691 (Dull) or 695 (Dark Duranodic)
- Black: 693
- Gold: 696

**Clear Powder Coating**

Specify \*PC

**Antimicrobial Protected Coating**

Specify AM

Note: Antimicrobial available to 626 and 630 finishes only

\*Clear Powder Coat over 630 Stainless Steel

# 9000 Series Narrow Stile Z Trim

- Heavy-duty, vandal-resistant escutcheon.
- Corrosion-resistant, stainless steel offered standard
- Hundreds of lever and pull styles and finish combinations to satisfy the most demanding interior design requirement.
- Choose from 14 ANSI/BHMA standard architectural finishes, or dozens of Custom RAL colors, or, for those unique interior designs, our Designer Color special color matching system.
- Antimicrobial protected coating when ultra clean environments are specified. Note: Antimicrobial available to 626 and 630 finishes only.
- Clear powder coating for outdoor or highly corrosive environments that need added protection. Also minimizes the appearance of fingerprints.
- Conventional rim or mortise cylinders included standard.
- Configurable with SFIC to accommodate the patented SC key control system.
- **EP** European profile cylinder available with functions 08 and 09.
- All standard devices and trim are designed for 1-3/4"–2-1/4" thick doors. For door thickness greater than 2-1/4", select door thickness option.
- Under U.S. law, qualifies for Made in U.S.A. of U.S. and imported parts.
- Steeleville, IL manufacturing facility certified to ISO 9000 and ISO 14001.



ZK



ZR



ZP

Z Series Trim (Specify)				Door Thickness			Special Application Package Cylinders and Keying			
Escutcheon	Knob, Pull, or Lever	Function	Handing	Finish				Cylinder Type	Keyway	Keying
Z	A	DT	RHR	630	Ext3	AM	TGD	D	CA	KD
	C	02	LHR	606	Ext4	*PC		J	CD	KA2
Handed –	D	02R		611				C	CE	KA4
	K	03		612				L	<b>D100</b>	NSK
Handed –	F	03R		613				D	GA	MKD
	G	08		619				G	RA	CMK
	R	08C	– Handed	625				R	RB	SKD
	T	09		626				F	SC	OBit
	O	09C	– Handed	629				X6	SE	
	P	11		630				X7	SF	
Handed –	N	12		689					YA	
	V	23		691					YG	
	L109	25		693						
	L110			695						
Handed –	L112		Suffix C and LH/RH required for clutch	696						
	L114		Suffix R required for rigid lever	Custom						
	L117			Designer						
	L118									

**\*Patented Key Control**  
**D100** is the keyway for our patented **SKC** serialized key control system. **SKC** is internet based and provides added layers of security. For more information, contact your local sales representative or Technical Service at 800-387-4938.

\*Clear Powder Coat over 630 Stainless Steel

# 9000 Series Narrow Stile Pull Trim

- Heavy-duty stainless steel offered standard.
- Choose from 14 ANSI/ BHMA standard architectural finishes, or dozens of Custom RAL colors, or, for those unique interior designs, our Designer Color special color matching system
- Antimicrobial protected coating when ultra clean environments are specified. Note: Antimicrobial available to 626 and 630 finishes only.
- Clear powder coating for outdoor or highly corrosive environments that need added protection. Also minimizes the appearance of fingerprints.
- All standard devices and trim are designed for 1-3/4"-2-1/4" thick doors. For door thickness greater than 2-1/4", consult Technical Service.
- Under U.S. law, qualifies for Made in U.S.A. of U.S. and imported parts.
- Steeleville, IL manufacturing facility certified to ISO 9000 and ISO 14001.



OP



9PO

Pull (Specify)		Special Finish Coating
Pull Type	Function	Finish
		<b>630</b>
OP	02	605 AM
9BPO <sup>1</sup>	03	606 *PC
		611
		612
		613 <input type="checkbox"/> – Default
		619
		625
		626
		<b>630</b>
		689
		691
		693
		695
		696
		Custom
		Designer

1. 9PO not applicable on 9500 Device. 03 Function only. Not available in 693 finish

\*Clear Powder Coat over 630 Stainless Steel

# Narrow Stile Trim

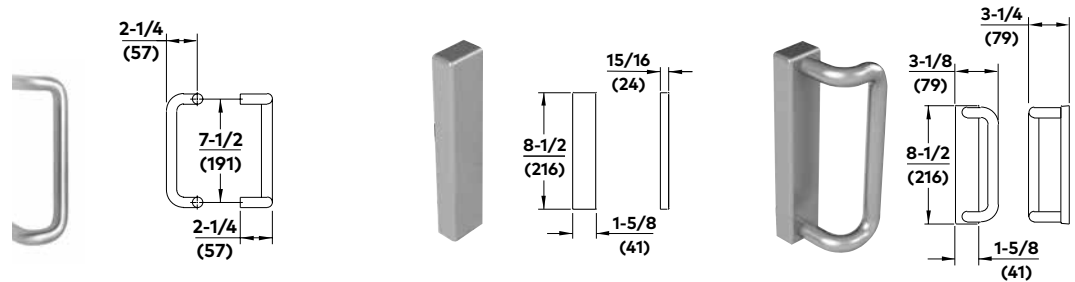

Trim Descriptions	Tubular Pull	Raised Escutcheon Plate Dummy Trim	Raised Escutcheon Plate Tubular Pull
Trim Designation	OP02	ZODT	ZP02
Handing	—	—	—
Function	O2	DT	O2
Cylinder (default)	—	—	—
Cylinder (optional SFIC)	—	—	—

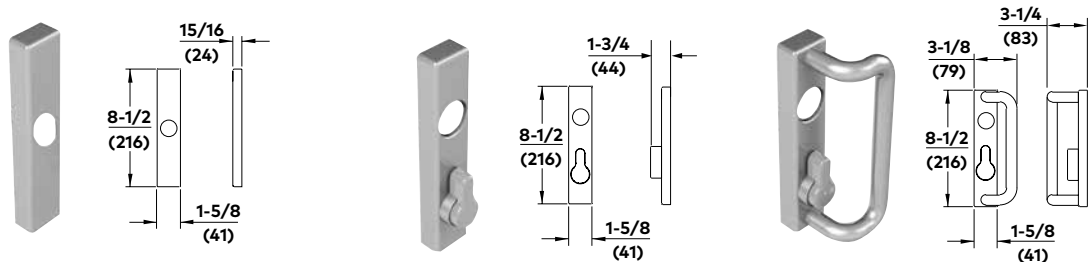

Trim Descriptions	Raised Escutcheon Plate with Cylinder Hole (pull by others)	Raised Escutcheon Plate with Cylinder Hole and Thumbturn	Raised Escutcheon Plate Tubular Pull with Cylinder Hole and Thumbturn
Trim Designation	ZO03	ZO11, ZO12	ZP11, ZP12
Handing	—	—	Specify Hand
Function	O3	11 or 12	11 or 12
Cylinder (default)	80R40SC – Rim	90X13SC118 – Mortise	90 × 13 SC118 – Mortise
Cylinder (optional SFIC)	87R40BA – 7-pin	97X09BA138 – 7-pin	97 × 09 BA138 – 7-pin

# Narrow Stile Trim

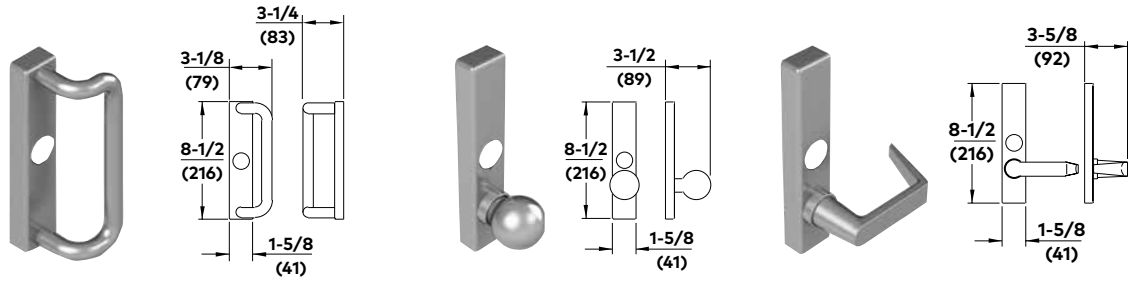

Trim Descriptions	Raised Escutcheon Plate Tubular Pull with Cylinder Hole	Raised Escutcheon Plate Knob with Cylinder Hole (rigid trim)	Raised Escutcheon Plate Rectangular Lever with Cylinder Hole (rigid trim) (R trim shown)
Trim Designation	ZP03	ZK03R	Zx03R
Handing	Specify Hand	—	—
Function	O3	O3	O3
Cylinder (default)	80R40SC – Rim	80R40SC – Rim	80R40SC – Rim
Cylinder (optional SFIC)	87R40BA – 7-pin	87R40BA – 7-pin	87R40BA – 7-pin

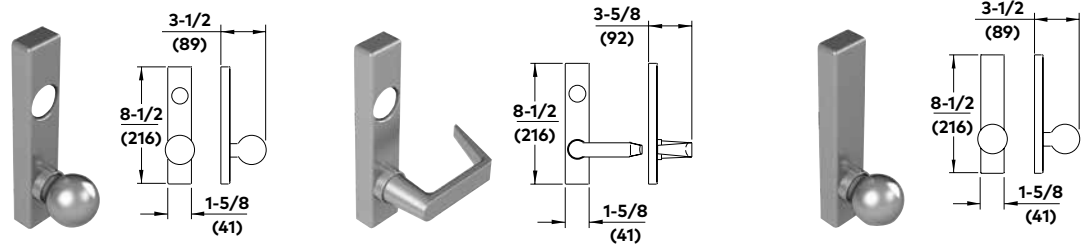

Trim Descriptions	Raised Escutcheon Plate Knob with Cylinder Hole	Raised Escutcheon Plate Rectangular Lever with Cylinder Hole (R trim shown)	Raised Escutcheon Plate Knob (ZK02R rigid trim)
Trim Designation	ZK08, ZK09	Zx08, Zx08C, Zx09, Zx09C	ZK02R, ZK23
Handing	—	—	—
Function	O8 or O9	O8 or O9	O2 or 23
Cylinder (default)	90X13SC118 – Mortise	90X13SC118 – Mortise	—
Cylinder (optional SFIC)	97X09BA138 – 7-pin	97X09BA138 – 7-pin	—

**NOTE:** When a trim designation includes an x (such as, Zx08), replace x with the letter or number assigned to the chosen lever style. For example, ZR08 specifies lever style R. See pages 63 for details.

# Narrow Stile Trim

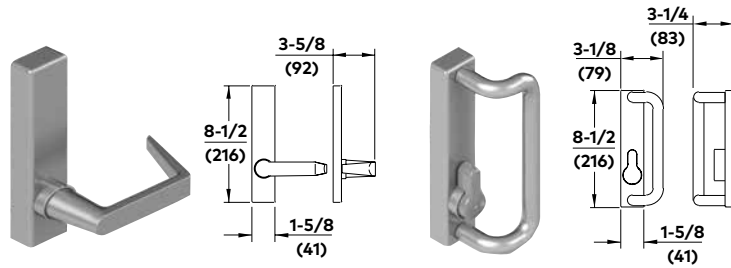

Trim Descriptions	Raised Escutcheon Plate Rectangular Lever (Zx02R rigid trim) (R trim shown)	Raised Escutcheon Plate Tubular Pull with Thumbturn
Trim Designation	Zx02R, Zx23	ZP25
Handing	—	—
Function	O2 or 23	25
Cylinder (default)	—	—
Cylinder (optional SFIC)	—	—

**NOTE:** When a trim designation includes an x (such as, Zx23), replace x with the letter or number assigned to the chosen lever style. For example, ZR23 specifies lever style R. See page 63 for details.



# Cylinder Specifications

## Rim Cylinders

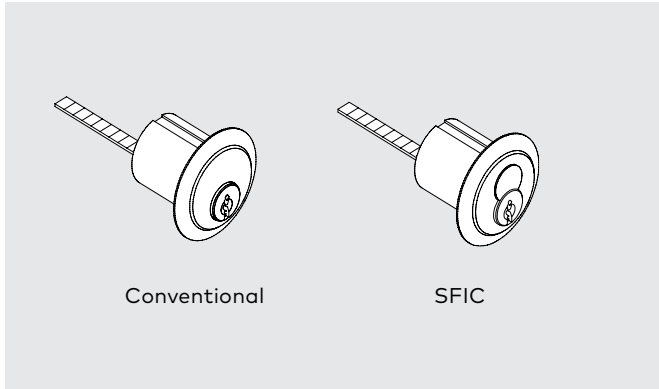

## Mortise Cylinders

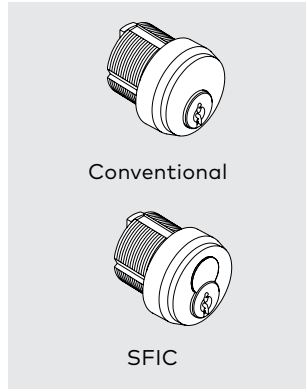

## Key-in-Lever Cylinders

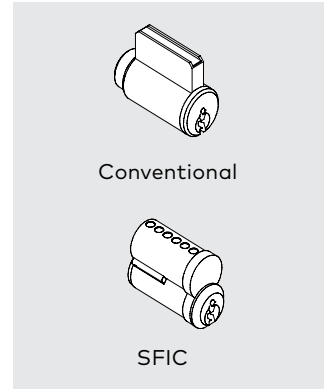

Application	ANSI Function	Cylinder Type	Conventional (Default)	SFIC 7-Pin
<b>Cylinders for 9600/F9600 Concealed Vertical Rod, 9700/F9700 Rim, and 9800/F9800 Surface Vertical Rod Devices</b>				
Z Escutcheon Trim	03, 04	Rim	80R40SC	87R40BA
Z Escutcheon Trim	08, 11	Mortise	90X13SC118	97C13BA138
Z Escutcheon Trim	09, 12	Mortise	90X09SC118	97C09BA138
<b>Cylinders for Device Options</b>				
CD, BA, BAR, DE, D3, DECBC, DA, LMM-P		Mortise	90X10SC118	97D10BA138
<b>Cylinders for Mullions</b>				
1FKR Key Removable Mullion		Mortise	90X01SC118	97D01BA138
1FS Mullion Storage Kit		Mortise	90X01SC118	97D01BA138

# Mullions

Removable mullions are used with paired doors where a full-width opening is only occasionally required.

Doors are fitted with rim exit devices and normally function as single doors. Available in 8' or 10' lengths.

## 1310 Aluminum Mullion

- Meets demands of heaviest use areas.
- Durable extrusion.
- Supplied with wood/machine screws and anchors.

**1310-8** — 8' mullion  
**1310-10** — 10' mullion  
**WS1310-8** — 8' mullion with weatherstrip  
**WS1310-10** — 10' mullion with weatherstrip

**Finish**  
 Aluminum: 628 (Satin)  
 Bronze: 695 (Dark)

## 1330 Steel Mullion

- Ideal for high-abuse areas such as schools.
- Meets demands of heaviest use areas.
- Heavy-gauge, smooth-surface steel construction.
- Attractive tube shape with rounded corners.
- Supplied with wood/machine screws and anchors.

**1330-8** — 8' mullion  
**1330-10** — 10' mullion

**Finish**  
 Prime: 600

## F1300 Steel Mullion

- For use with U.L. listed fire exit devices.
- Meets demands of heaviest use areas.
- Large top and bottom fittings for extra strength.
- Heavy-duty tube with rounded corners.
- Standard 8' length.
- Supplied with wood/machine screws and anchors.

**F1300-8** — 8' fire rated mullion  
**1300-8** — 8' non-fire rated mullion  
**1300-10** — 10' non-fire rated mullion

**Finish**  
 Prime: 600

**F1FKR Key Removable Steel Mullion**

- Easily removable with key.
- Keying is standard 1-1/8" mortise cylinder with O1 (AR) cam.
- For use with U.L. listed fire exit devices.
- Meets demands of heaviest use areas.
- Large top and bottom fittings for extra strength.
- Heavy-duty tube with rounded corners.
- Standard 8' length.
- Supplied with wood/machine screws and anchors.
- Includes conventional default mortise cylinder: 90X01SC118 626.

**F1FKR-8** — 8' fire-rated key removable mullion  
**1FKR-8** — 8' non fire-rated key removable mullion  
**1FKR-10** — 10' non fire-rated key removable mullion  
**1FKR-EL-8** — 8' non-fire rated wired key removable mullion  
**1FKR-EL-10** — 10' non-fire rated wired keyed removable mullion

**Finish**  
 Prime: 600

Optional SFIC:  
 97D01BA138 — 7-pin

**HC1300 Steel HC Mullion**

- For use with pairs of hurricane-rated rim devices on openings up to 8'0" x 8'0".
- 80 psf design pressure rating positive/negative deflection with HC9300 rim device.
- Tested to Miami-Dade TAS 201, 202, 203.
- Large top and bottom fittings for extra strength.
- Heavy-duty tube with rounded corners.
- Standard 8' length.
- Supplied with appropriate screws and anchors.

**HC1300-8** — Heavy-duty 5/16" wall HC mullion\*

**Finish**  
 Prime: 600

\*For other HC mullions, consult factory.

**1FS Mullion Storage Kit**

- For use with 1F key removable steel mullion.
- Locking cylinder can be keyed into master key system.
- Includes conventional default mortise cylinder: 90X01SC118 626.

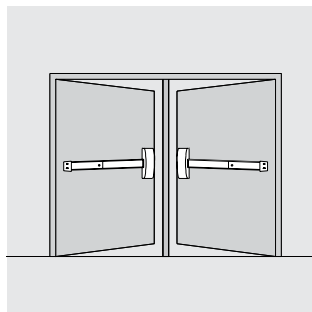

Optional SFIC:  
 97D01BA138 — 7-pin

[www.dormakaba.us](http://www.dormakaba.us)



dormakaba USA, Inc.  
6161 E. 75th St.  
Indianapolis, IN 46250  
800.523.8483  
[www.dormakaba.us](http://www.dormakaba.us)

dormakaba Canada, Inc.  
65 Struck Court  
Cambridge, ON Canada N1R 8L2  
Tel: 800-265-6630  
[sales\\_RCI@dormakaba.com](mailto:sales_RCI@dormakaba.com)  
[www.dormakaba.us](http://www.dormakaba.us)

