

***Mercury Core
User Guide***

ISSUE 1.0

The Copyright of the information and drawings in this document is the property of Trilogy Communications Limited and is neither to be reproduced in whole or in part, nor disclosed to a third party, without the prior written consent of Trilogy Communications Limited.

The information in this document has been carefully compiled and checked for accuracy. However, Trilogy Communications Limited accepts no responsibility for inaccuracies which may occur and, further, reserves the right to make changes to specification or design without prior notice.

Comments or correspondence concerning this manual should be addressed to the Publications Manager at the address given on the front cover of this document.

DOCUMENT NUMBER

70090621.docx

ISSUE 1.0

Issue	Date	Reason for Change	Approved
1.0	2 September 2020	Release – v5.2.1.38	

Acronyms and Abbreviations

Acronyms and Abbreviations	
AEB	Audio Expansion Board
AGC	Automatic Gain Control
API	Application Programming Interface
AVB	Analogue Voice Bridge
BDM	Background Debug Module
BIOS	Basic Input/Output System or Basic Integrated Operating System
BMP	Windows Bitmap
COR	Carrier Operated Relay
COTS	Commercial Off-the-Shelf
CTCSS	Continuous Tone-Coded Squelch System
DDI	Direct Dial-In
DEP	Data Execution Prevention
DHCP	Dynamic Host Configuration Protocol
DMA	Direct Memory Access
DNS	Domain Name Server
DSCP	Differentiated Services Code Point
DSP	Digital Signal Processor / Digital Signal Processing
DTMF	Dual-Tone Multi-Frequency
E&M	Ear and Mouth
EC	Echo Cancellation
EDHS	Enterprise Domain Host Subscriber
ENCAP	Encapsulation
ENG	Electronic News Gathering
FIFO	First In -- First Out
FPGA	Field Programmable Gate Array
FXO	Foreign Exchange Office
FXS	Foreign Exchange Station
GPI	General Purpose Input
GPIO	General Purpose Input Output
GPO	General Purpose Output
GUI	Graphical User Interface
HJB	Headset Junction Box
HP	Hyper Terminal
HTTP	Hypertext Transfer Protocol
ICO	Icon file
ID	Identity
IEC	International Electrotechnical Commission
IEEE	Institute of Electrical and Electronics Engineers
IFB	Interruptible FoldBacks
IGMP	Internet Group Management Protocol
IP	Internet Protocol
JRE	Java Runtime Environment

Acronyms and Abbreviations	
LAN	Local Area Network
MAC	Media Access Control
MCF	Mercury Configuration File
MCU	Mercury Communicator Unit
MIDS	Multifunctional Information Distribution System
MIU	Mercury Interface Unit
MMU	Mini Mercury Unit
MTBF	Mean Time Between Failure
NATO	North Atlantic Treaty Organization
NAT/PAT	Network Address Translation /Port Address Translation
NetBIOS	Network Basic Input/Output System
NSA	National Security Agency
OCC	Open Collector
PABX	Private Automatic Branch Exchange
PBX	Private Branch Exchange
PCI	Peripheral Component Interconnect
PHB	Per-Hop Behaviour
POTS	Plain Old Telephone Service
PSTN	Public Switch Telephone Network
PSU	Power Supply Unit
PTT	Push to Talk
QoS	Quality of Service
RAM	Random Access Memory
RH	Relative Humidity
RIB	Radio Interoperability Board
RJ45	Registered Jack 45
RLL	Reliable Link Layer
ROM	Read-Only Memory
RTP	Real-time Transport Protocol
SDK	Software Development Kit
SDRAM	Synchronous Dynamic Random-Access Memory
SIP	Session Initiation Protocol
SNG	Satellite News Gathering
SRAM	Static Random-Access Memory
SVGA	Super Video Graphics Array
TBC	Talkback Controller
TCP	Transmission Control Protocol
TCP/IP	Transmission Control Protocol / Internet Protocol
TEB	Telephone Expansion Board
TFTP	Trivial File Transfer Protocol
TTL	Transistor-Transistor Logic
UAC	User Access Control
UDP	User Datagram Protocol

Acronyms and Abbreviations	
UPS	Uninterruptible Power Supply
USB	Universal Serial Bus
VAD	Voice Activity Detector/Detection
VID	VLAN ID
VIF	Voice Information Field
VLAN	Virtual Local Area Network
VoIP	Voice over Internet Protocol
VOX	Voice Operated Transmission
VPAN	Virtual Panel
VPN	Virtual Private Network
WAN	Wide Area Network
WMF	Windows Metafile

CONTENTS

1. INTRODUCTION	12
1.1 OVERVIEW	12
1.2 RELATED DOCUMENTS	12
1.3 TECHNICAL SUPPORT	13
1.4 WARRANTY	13
2. SYSTEM INSTALLATION	14
2.1 UNPACKING	14
2.2 EARTHING REQUIREMENTS	14
2.3 MAINS CONNECTION AND SAFETY.....	14
2.4 NETWORK PLAN AND IP ADDRESSES	15
2.5 TRILOGY EDHS ADDRESS	16
2.6 NEXT STEPS.....	16
3. MERCURY NETWORK HOSTS	17
3.1 OVERVIEW	17
3.2 CHOOSING THE APPROPRIATE HOST.....	17
4. MERCURY INTERFACE UNIT (MIU).....	18
4.1 OVERVIEW	18
4.2 MIU VERSIONS.....	18
4.3 EXPANSION OPTIONS	19
4.4 INSTALLATION PREREQUISITES AND REQUIREMENTS.....	19
4.5 RACK MOUNTING	20
4.6 CONNECTIONS.....	20
4.7 INTERNAL NETWORK SWITCH.....	20
4.8 REAR PANEL DETAIL	21
5. MERCURY COMMUNICATOR UNIT (MCU)	22
5.1 OVERVIEW	22
5.2 STANDARD INDICATORS, CONTROL AND CONNECTORS (FRONT).....	22
5.3 STANDARD INDICATORS, CONTROLS AND CONNECTORS (REAR)	23
5.4 INSTALLATION REQUIREMENTS	24
5.5 CONNECTING THE MCU.....	24
6. MERCURY SOFTWARE AND INSTALLATION.....	25
6.1 OVERVIEW AND CONCEPTS.....	25
6.2 MERCURY SOFTWARE COMPONENTS	26
6.3 INSTALLATION PROCEDURE: CONFIGURATION EDITOR WITH SERVED DATABASE	27
6.4 INSTALLATION PROCEDURE: MERCURY HOST WITH VIRTUAL PANELS.....	30
6.5 SOFTWARE UPGRADE	34
6.6 ADDING ADDITIONAL MERCURY SOFTWARE COMPONENTS.....	36
6.7 UNINSTALLATION PROCEDURE.....	37
6.8 FIREWALL	37
7. DATABASE AND THE DATABASE SUPERVISOR.....	38
7.1 OVERVIEW AND CONCEPTS	38
7.2 MERCURY DATABASE.....	38
7.3 DATABASE INSTALLATION	39
7.4 DATABASE PC/SERVER – SPECIFICATIONS	39
7.5 MERCURY DB SUPERVISOR.....	40
7.6 MERCURY DB SUPERVISOR FIELD DEFINITIONS	44

8. CONFIGURATION EDITOR BASICS	47
8.1 OVERVIEW	47
8.2 BEFORE YOU START	48
8.3 INSTALLING THE CONFIGURATION EDITOR	48
8.4 CREATING A CONFIGURATION	48
8.5 USING THE CONFIGURATION EDITOR	49
8.6 CONFIGURATION CREATION AND MANAGEMENT.....	54
8.7 DATABASE SETTINGS AND PREFERENCES	58
8.8 ADMINISTRATOR PASSWORD	61
8.9 ACTIVE CLIENTS	62
8.10 EDITOR BASICS	63
8.11 GATEWAY FIELD DEFINITIONS	64
9. CONFIGURATION EDITOR ENTERPRISE.....	67
9.1 OVERVIEW	67
9.2 USING THE ENTERPRISE EDITOR.....	68
9.3 ENTERPRISE EDITOR - GENERAL	69
9.4 ENTERPRISE EDITOR - DOMAINS	70
9.5 ENTERPRISE EDITOR – GEMINI RINGS	72
9.6 ENTERPRISE EDITOR - GROUPS	73
9.7 ENTERPRISE EDITOR - CONFERENCES	74
9.8 ENTERPRISE EDITOR - SIP CONNECTIONS	75
9.9 ENTERPRISE EDITOR - IFBS	76
9.10 ENTERPRISE EDITOR – DIMMING LOCATIONS.....	76
9.11 ENTERPRISE EDITOR - TONES.....	77
9.12 ENTERPRISE EDITOR - FIELD DEFINITIONS	78
10. CONFIGURATION EDITOR DOMAIN	82
10.1 OVERVIEW	82
10.2 USING THE DOMAIN EDITOR	83
10.3 DOMAIN EDITOR - GENERAL	85
10.4 DOMAIN EDITOR - SIP PROXY AND REDIRECT	90
10.5 DOMAIN EDITOR CODEC PROFILES.....	91
10.6 DOMAIN EDITOR - FIELD DEFINITIONS	92
11. CONFIGURATION EDITOR HOST.....	95
11.1 OVERVIEW	95
11.2 USING THE HOST EDITOR	96
11.3 HOST EDITOR TABS.....	97
11.4 HOST EDITOR - GENERAL.....	98
11.5 HOST EDITOR - AUDIO	100
11.6 HOST EDITOR - SUBSCRIBERS	102
11.7 HOST EDITOR – PORTS.....	105
11.8 HOST EDITOR - RIB	106
11.9 HOST EDITOR - VOX.....	107
11.10 HOST EDITOR - VIRTUAL PORTS.....	108
11.11 HOST EDITOR - SIP ALIASES.....	109
11.12 HOST EDITOR - GPIO	111
11.13 HOST EDITOR - ALLOW/BLOCK LISTS.....	113
11.14 HOST EDITOR - FIELD DEFINITIONS.....	115
11.15 DCSP DETAILS.....	128
12. CONFIGURATION EDITOR SUBSCRIBER INTRODUCTION	129

12.1	OVERVIEW	129
12.2	USING THE SUBSCRIBER CONFIGURATION EDITOR.....	130
12.3	CONFIGURING SUBSCRIBERS	130
12.4	KEY MODES	131
13.	CONFIGURATION EDITOR SUBSCRIBER HARDWARE PANEL	133
13.1	OVERVIEW	133
13.2	HARDWARE PANEL EDITOR TABS	133
13.3	HARDWARE PANEL EDITOR - GENERAL	134
13.4	HARDWARE PANEL EDITOR - IRIS	135
13.5	HARDWARE PANEL EDITOR – SOURCES.....	136
13.6	HARDWARE PANEL EDITOR – SOURCE LAYOUT	138
13.7	HARDWARE PANEL EDITOR - SPECIAL	141
13.8	HARDWARE PANEL EDITOR - GPIO	142
13.9	HARDWARE PANEL EDITOR - PHONE NUMBER LIST.....	143
13.10	HARDWARE PANEL EDITOR - CONTRIBUTORS.....	144
13.11	HARDWARE PANEL EDITOR - FIELD DEFINITIONS	145
14.	CONFIGURATION EDITOR SUBSCRIBER FOREIGN EXCHANGE OFFICE (FXO)	152
14.1	OVERVIEW	152
14.2	VIEWING A LIST OF FXO PORTS	153
14.3	FXO SUBSCRIBER EDITOR TABS	153
14.4	FXO SUBSCRIBER EDITOR – GENERAL.....	154
14.5	FXO SUBSCRIBER EDITOR – SIP OPTIONS	155
14.6	FXO SUBSCRIBER EDITOR – GPIO	156
14.7	FXO SUBSCRIBER EDITOR - PHONE CTRL. LIST	157
14.8	FXO SUBSCRIBER EDITOR - CONTRIBUTORS.....	158
14.9	FXO SUBSCRIBER EDITOR - FIELD DEFINITIONS	159
15.	CONFIGURATION EDITOR SUBSCRIBER FOREIGN EXCHANGE STATION (FXS)	162
15.1	OVERVIEW	162
15.2	VIEWING A LIST OF FXS PORTS	163
15.3	FXS SUBSCRIBER EDITOR TABS	163
15.4	FXS SUBSCRIBER EDITOR – GENERAL.....	164
15.5	FXS SUBSCRIBER EDITOR – SIP OPTIONS	165
15.6	FXS SUBSCRIBER EDITOR – GPIO	166
15.7	FXS SUBSCRIBER EDITOR - PHONE CTRL. LIST	167
15.8	FXS SUBSCRIBER EDITOR - CONTRIBUTORS.....	168
15.9	FXS SUBSCRIBER EDITOR - FIELD DEFINITIONS	169
16.	CONFIGURATION EDITOR SUBSCRIBER EAR AND MOUTH (E&M).....	172
16.1	OVERVIEW	172
16.2	VIEWING A LIST OF E&M PORTS.....	173
16.3	E&M SUBSCRIBER EDITOR TABS.....	173
16.4	E&M SUBSCRIBER EDITOR – GENERAL	174
16.5	E&M SUBSCRIBER EDITOR – SIP OPTIONS.....	175
16.6	E&M SUBSCRIBER EDITOR – GPIO.....	176
16.7	E&M SUBSCRIBER EDITOR - PHONE CTRL. LIST.....	177
16.8	E&M SUBSCRIBER EDITOR - CONTRIBUTORS	178
16.9	E&M SUBSCRIBER EDITOR - FIELD DEFINITIONS	179
17.	CONFIGURATION EDITOR SUBSCRIBER 4-WIRE.....	182
17.1	OVERVIEW	182
17.2	4-WIRE - SUBSCRIBER EDITOR - GENERAL.....	183

17.3	4-WIRE - SUBSCRIBER EDITOR - CONTRIBUTORS	184
17.4	4-WIRE – SUBSCRIBER EDITOR - FIELD DEFINITIONS	185
18.	CONFIGURATION EDITOR SUBSCRIBER RADIO PORT AND RADIO PHONE.....	186
18.1	OVERVIEW	186
18.2	RADIO PORT EDITOR - GENERAL	187
18.3	RADIO PORT EDITOR - RIB.....	188
18.4	RADIO PORT EDITOR - VOX.....	188
18.5	RADIO PORT EDITOR - CONTRIBUTORS	189
18.6	RADIO PHONE EDITOR - GENERAL.....	190
18.7	RADIO PHONE EDITOR - RIB	191
18.8	RADIO PHONE EDITOR – SIP OPTIONS.....	191
18.9	RADIO PHONE EDITOR - SOURCES.....	192
18.10	RADIO PHONE EDITOR - PHONE NUMBER LIST	194
18.11	RADIO PHONE EDITOR - CONTRIBUTORS	195
18.12	RADIO PORT EDITOR - FIELD DEFINITIONS	196
18.13	RADIO PHONE EDITOR - FIELD DEFINITIONS.....	200
19.	CONFIGURATION EDITOR VIRTUAL PANEL SUBSCRIBER	205
19.1	OVERVIEW	205
19.2	VIRTUAL PANEL EDITOR TABS.....	206
19.3	KEY SETS	207
19.4	VIRTUAL PANEL EDITOR - FIELD DEFINITIONS.....	208
20.	CONFIGURATION EDITOR GROUPS	213
20.1	OVERVIEW	213
20.2	USING THE GROUP EDITOR	214
20.3	GROUP EDITOR - FIELD DEFINITIONS	216
21.	CONFIGURATION EDITOR CONFERENCES.....	217
21.1	OVERVIEW	217
21.2	USING THE CONFERENCE EDITOR	219
21.3	CONFERENCE EDITOR - DETAILS.....	220
21.4	CONFERENCE EDITOR - 4-WIRE SOURCES.....	221
21.5	CONFERENCE EDITOR - ADDITIONAL HOSTS	222
21.6	CONFERENCE EDITOR - PANEL MEMBERS.....	223
21.7	CONFERENCE EDITOR - PHONE MEMBERS.....	223
21.8	CONFERENCE EDITOR - FIELD DEFINITIONS	224
22.	CONFIGURATION EDITOR SIP AND SIP CONNECTIONS.....	226
22.1	OVERVIEW	226
22.2	USING THE SIP CONNECTION EDITOR	227
22.3	SIP EDITOR - DETAILS AREA.....	228
22.4	SIP EDITOR - PANEL MEMBERS AREA.....	229
22.5	SIP EDITOR - PHONE CONTROL AREA	229
22.6	SIP EDITOR - HOST ALIASES AREA.....	230
22.7	SIP EDITOR - FIELD DEFINITIONS.....	231
23.	CONFIGURATION EDITOR IFB	233
23.1	IFB EDITOR - OVERVIEW	233
23.2	VIEWING A LIST OF IFBS.....	234
23.3	USING THE IFB EDITOR	235
23.4	IFB EDITOR - DETAILS	236
23.5	IFB EDITOR - SOURCES.....	236

23.6	IFB EDITOR - DESTINATIONS	237
23.7	IFB EDITOR - INTERRUPTS.....	238
23.8	IFB EDITOR - KEY INTERRUPTS.....	239
23.9	IFB EDITOR - FIELD DEFINITIONS	240
24.	CONFIGURATION EDITOR ROUTES.....	242
24.1	OVERVIEW	242
24.2	USING THE ROUTES EDITOR	243
24.3	ROUTES EDITOR - FIELD DEFINITIONS	245
25.	CONFIGURATION EDITOR GPIO PROCESSES	246
25.1	OVERVIEW	246
25.2	USING THE GPIO PROCESSES EDITOR.....	247
25.3	GPIO PROCESS EDITOR - GPI > ROUTE AND/OR GPO	248
25.4	GPIO PROCESS EDITOR - ROUTE > GPO STATEMENTS.....	250
25.5	GPIO PROCESS EDITOR - ROUTE > ROUTE STATEMENTS.....	251
25.6	GPIO PROCESS EDITOR - FIELD DEFINITIONS	252
26.	CONFIGURATION EDITOR PHONE NUMBERS.....	254
26.1	OVERVIEW	254
26.2	USING THE PHONE NUMBER EDITOR.....	255
26.3	PHONE NUMBERS	256
26.4	PHONE SETS.....	257
26.5	PHONE CONTROLS	258
26.6	SIP NUMBERS	259
26.7	PHONE NUMBER EDITOR - FIELD DEFINITIONS	260
27.	CONFIGURATION EDITOR PHONE SETS	262
27.1	OVERVIEW	262
27.2	USING THE PHONE SETS EDITOR.....	263
27.3	PHONE SET EDITOR - DETAILS	263
27.4	PHONE SET EDITOR - IP PHONE SOURCES	264
27.5	PHONE SET EDITOR - FIELD DEFINITIONS.....	265
28.	CONFIGURATION EDITOR ACCESS MANAGEMENT	266
28.1	INTRODUCTION.....	266
28.2	LAUNCHING THE ACCESS MANAGEMENT CONSOLE.....	266
28.3	CREATING ROLES	267
28.4	CREATING ADMINISTRATORS.....	268
28.5	ASSOCIATING ROLES AND ADMINISTRATORS.....	269
28.6	USING ROLES AND ADMINISTRATORS	270
29.	MERCURY TALKBACK CONTROLLER	271
29.1	OVERVIEW	271
29.2	USING THE TBC	272
29.3	TBC – MENU OPTIONS.....	274
29.4	TBC MENU DATABASE SETTINGS	276
29.5	TBC MENU PREFERENCES.....	277
29.6	TBC – DIALOGUE.....	278
29.7	TBC – FIRMWARE.....	281
29.8	COMMAND LINE FILES	282
29.9	TBC - FIELD DEFINITIONS	283
30.	MERCURY VIRTUAL PANEL WEB SERVER	290
30.1	OVERVIEW	290

30.2	USING THE WEB SERVER	291
30.3	WEB SERVER INTERFACE	292
30.4	MESSAGE LOGGING.....	293
30.5	PREFERENCES AND SUPERVISOR SETTINGS.....	294
30.6	WEB SERVER CLIENT LIST	296
30.7	WEB SERVER EVENT LOG	297
30.8	WEB SERVER SOCKET MESSAGES.....	298
30.9	WEB SERVER - FIELD DEFINITIONS	299
31.	TECHNICAL DATA MIU 700-25-06	302
31.1	INTRODUCTION.....	302
31.2	SPECIFICATION.....	302
31.3	700-25-06 FRONT PANEL LAYOUT.....	304
31.4	700-25-06 REAR PANEL LAYOUT.....	305
31.5	700-25-06 - REAR PANEL – CONNECTORS	306
32.	TECHNICAL DATA MIU 700-25-04	308
32.1	INTRODUCTION.....	308
32.2	SPECIFICATION.....	308
32.3	700-25-04 FRONT PANEL LAYOUT.....	310
32.4	700-25-04 REAR PANEL LAYOUT.....	311
32.5	700-25-04 - REAR PANEL – CONNECTORS	312
33.	TECHNICAL DATA MIU OPTIONS	314
33.1	AUDIO EXPANSION BOARD – 700-11-01	314
33.2	RADIO INTERFACE BOARD – 700-16-03.....	316
33.3	TELEPHONE EXPANSION BOARD, E&M – 700-15-02.....	318
33.4	TELEPHONE EXPANSION BOARD, FXO – 700-15-03	319
33.5	TELEPHONE EXPANSION BOARD, FXS – 700-15-04	320
33.6	AUXILIARY POWER OUTPUT OPTION - 700-25-112	320
33.7	6 CHANNEL MIXER / DA OPTION - 700-10-00	321
33.8	GENERAL PURPOSE INTERFACE CARD 700-12-01 (700-25-04 MIU ONLY)	322
34.	TECHNICAL DATA MCU 700-30-00	326
34.1	SPECIFICATIONS	326
34.2	FRONT PANEL LAYOUT	327
34.3	REAR PANEL LAYOUT	329
35.	TECHNICAL DATA OTHER EQUIPMENT	332
35.1	BELTPACKS.....	332
35.2	RT EQUIPMENT	332
36.	MERCURY TERMINOLOGY	333

1. INTRODUCTION

1.1 OVERVIEW

Mercury is a multichannel voice communications platform that operates on Local Area Networks (LANs), Wide Area Networks (WANs), over terrestrial or satellite-based Internet Protocol (IP) networks. Users access the system via control panels which are either hardware or software-based. Unlike traditional communications technologies, users can participate in multiple communications simultaneously - including direct, conference, and monitor-only call types. Also, radios, telephones, and other communications technologies can be linked to the system to provide users with a unified communications control panel.

Any number of Mercury users can be linked together to create a communications platform with incomparable flexibility, capacity and efficiency.

All Mercury products are designed to operate with standards-based IT and network technologies; no special routers, switches or gateways are required. Security and Quality of Service (QoS) are implemented at the network level and standards-based encryption devices, including Virtual Private Networks (VPNs), can be used transparently. Administration of the Mercury system takes place from centralized or decentralized points on the network and administrators are given precise control over the relevant system and network parameters.

A Mercury system comprises of a Master Database, one or more Mercury Interface Units (MIUs), or Mercury Communicator Units (MCUs) connected over a standard IP network. These devices, known as “Mercury hosts”, have varying capacities to suit the different user and operational requirements. Connected users can participate in, or monitor, multiple voice conversations simultaneously. This greatly simplifies and speeds up complex communications workflow across the Enterprise.

Hosts are peer-to-peer devices that can be flexibly deployed over a distributed architecture via a distributed, single common database. Peer-to-peer operation of the Mercury system allows for centralized and decentralized operation. Each Mercury device is self-contained and has everything that it needs to operate independently of other devices. If a portion of the network, or its devices, are unavailable, the rest of the system operates without them. If different segments of the network are disconnected the devices within each segment of the network continue to operate. This can extend right down to a single Mercury device that has no network connectivity at all. The device will still operate normally for any user interfaces or external interfaces that are connected directly to it.

1.2 RELATED DOCUMENTS

Document	Description
70090621	<i>Mercury Core User Guide - This Document</i>
70090625	Mercury Core Quick Start Guide
70090628	Intercom Control Panels (Hardware Panels)

1.3 TECHNICAL SUPPORT

UK & International

Please contact Trilogy at the UK headquarters.

Trilogy Communications Ltd.
Cambridge Research Park
2000 Beach Drive
Cambridge CB25 9TP
United Kingdom
Tel: +44 (0) 1223 815 000
Email: support@trilogycomms.com
Web: www.trilogycomms.com

Alternatively, please contact your reseller. Contact details may be found at www.trilogycomms.com

1.4 WARRANTY

Conditions of the warranty may vary according to your terms of purchase. Please consult your sales documentation or if in doubt, contact your original supplier or Trilogy at the offices above, quoting the date of purchase and unit serial number.

2. SYSTEM INSTALLATION

2.1 UNPACKING

Carefully unpack the equipment from its transit material and check each item for signs of damage. Check the contents of the boxes against our despatch note and your original order to ensure that you have received the correct parts.

If the unit has been damaged or does not match your order, immediately contact Trilogy Communications at the address given at the front of this guide.

2.2 EARTHING REQUIREMENTS

Each chassis is provided with a single 4mm-earthing stud on the rear panel. Incoming mains earth from the IEC connector is internally bonded to both the chassis and technical 0V to meet safety requirements and performance specifications. The stud allows the addition of an earth strap in rack installations.

2.3 MAINS CONNECTION AND SAFETY

Important Power Supply Cord Used as Disconnect Means

CAUTION: THE POWER SUPPLY CORD IS USED AS THE MAIN DISCONNECT DEVICE. ENSURE THAT THE SOCKET-OUTLET IS LOCATED / INSTALLED NEAR THE EQUIPMENT AND IS EASILY ACCESSIBLE.

ATTENTION: LE CORDON D'ALIMENTATION EST UTILISÉ COMME INTERRUPTEUR GÉNÉRAL. LA PRISE DE COURANT DOIT ÊTRE SITUÉE OU INSTALLÉE À PROXIMITÉ DE L'ÉQUIPMENT ET ÊTRE FACILE D'ACCÈS.

The power supplies within the unit are a switched-mode design and will cope automatically with a wide input voltage range (see specification within each section). There are no user-accessible fuses on the power supply. The power supplies are crowbar protected against short circuits of the electronics.

Each power supply has its own, dedicated, IEC mains plug. These should be wired according to the instructions provided with a mating mains socket using a suitable cable. See above for earthing requirements.

Mains cable conductors are to be three-core (two-wire with ground), wire gauge 18 AWG (cross-sectional area 0.75mm²) Jacket to be type SJT.

Covers are only to be removed by trained personnel. Shock hazard exists with covers removed; therefore, disconnect the mains supply before removal. Interconnection between circuit boards and panels are all safety extra-low voltage (SELV) as defined by IEC/EN/CSA/UL 60950-1-200X. The equipment signal connections must only be connected to SELV circuits to prevent hazards from an improper connection.

2.4 NETWORK PLAN AND IP ADDRESSES

The Mercury Hosts will normally be connected to an IP network. This allows them to communicate with each other and to connect to the PC running Gateway Configuration Editor software. However, once correctly configured, a single Mercury Host can operate in isolation.

Each Mercury Host requires the following static IP addresses:

- The first is for the Windows platform and is set from Windows Network Settings.
- The second is used by the IP audio card within the Mercury Host and is set by the configuration data.
- MIU 700-25-06 and MCU hosts require two additional static addresses for the networked DSP.

Your laptop or PC must use an address in the same subnet (“range”) as the Mercury Host. If it is not convenient to adjust the address of your PC then the default addresses used by the Mercury Host must be changed, as described later. Make a note of the values which you plan to use – extend the table if you have more than one Mercury Host. The table below is an example.

	First Mercury Host	Second Mercury Host	Laptop / PC
Mercury Host Identity (EDH address)	0.1.1	0.1.2	n/a
Windows Platform	192.168.200.200	192.168.200.204	192.168.200.230
Mercury Host IP Audio	192.168.200.201	192.168.200.205	n/a
DSP Address 1	192.168.200.202	192.168.200.206	n/a
DSP Address 2	192.168.200.203	192.168.200.207	n/a
Subnet Mask	255.255.255.0	255.255.255.0	255.255.255.0
IP gateway address	not set	not set	not set

Any mistakes or inconsistencies in these values may lead to unpredictable audio behaviour. For example, if you declare an IP gateway address on your PC, this must also be declared within your Mercury Configuration.

There are some important points to note:

1. Unless purchased as “factory pre-configured”, a system comprising multiple Mercury Hosts will normally **all** be delivered with identical settings, matching the first Mercury Host shown above. These are:
 - A basic configuration pre-loaded, with static IP settings as noted in the above table.
 - The Windows network adaptor settings set to DHCP (dynamic) mode. This is a temporary step to minimise the risk of network address clashes and is not normally suitable for deployment. Change this during first power-up using standard Windows techniques.
2. The Mercury Host identity or EDH address is explained fully in section 2.5. Briefly, it is a unique ID generated by the database, which must then be set on the TBC application, running on the Mercury host during the first power-up, as described in section 29.9.2.

If your system exceeds a “small system”, typically more than three hosts, you must also choose a location to install the database. Please see section 7 - *Database and the Database Supervisor* for more guidance.

2.5 TRILOGY EDHS ADDRESS

Every item in the Mercury system is given a unique address using the Trilogy defined EDHS system. It is a more comprehensive method than an IP address and is used to identify every element within the communication system. It is a hierarchical scheme standing for Enterprise Domain Host Subscriber and results in a four-part address with format E.D.H.S.

- Enterprise defines the entire system – the top level. It is currently “reserved” and always set to 0.
- Domains correspond (roughly) to a networking domain. There must be at least one domain in an Enterprise, but all domains are held within the Enterprise. If parts of the overall communication system are connected to different IP networks, then multiple domains must be created. Domains are also useful as a convenient means of grouping elements of the system. For example, a system distributed around two adjacent buildings but sharing a common network.
- Hosts are the MIU or MCU, and they are held within the domain(s).
- Subscribers are attached to MIU ports, so represent an individual user interface, panel, telephone, radio or audio signal.

Conferences and other software-defined entities such as IFBs and Groups, also have a unique EDHS address.

2.6 NEXT STEPS

Before starting work on the system configuration, we will look at the MIU (Mercury Interface Unit) and MCU (Mercury Communicator Unit) hosts.

3. MERCURY NETWORK HOSTS

3.1 OVERVIEW

Mercury uses peer-to-peer architecture to allow flexible network design to optimize functionality, reliability and security. A Mercury system comprises one or more Mercury Host devices connected over a standard Internet Protocol (IP) network. Mercury hosts have varying capacities to suit different operational requirements. Refer to Technical Data, starting at section 31 for detailed specifications of these host types.

A Mercury system is scalable to support a wide range of subscribers. It can be assembled using a building block approach using a combination of the different types of Mercury host, depending on end-user needs.

3.2 CHOOSING THE APPROPRIATE HOST

The choice of host is dependent on the proposed use of the Mercury system as a whole.

Mercury Interface Unit

The Mercury Interface Unit (MIU) has provision for up to four interface cards, each with four or eight ports, giving a maximum capacity of 32 ports in a single unit. It also allows for radio interoperability and telephone interoperability.

Mercury Communicator Unit

The Mercury Communicator Unit (MCU) is an attractive free-standing or desk-mounted unit that deploys state-of-the-art technology to offer a reliable, low-power communications solution.

4. MERCURY INTERFACE UNIT (MIU)

4.1 OVERVIEW

The MIU offers the highest capacity of the available hosts. It acts as a versatile audio processing unit and Voice over Internet Protocol (VoIP) gateway which allows a wide range of external devices to be connected.

These user interfaces and devices include:

- Mercury Virtual Panels
- Mercury Hardware Panels
- External 4-wire or 2-wire audio devices
- Radios
- Telephony equipment
- Recording and logging systems
- Interoperability with Session Initiation Protocol (SIP) and H.323 IP telephony devices

The MIU is a 2RU, 19-inch wide rack-mountable unit containing a power supply, Windows processor board and Mercury card (the VoIP mixing engine). A second, redundant power supply may be added if desired. Each MIU can fit up to four expansion boards, each with four or eight ports (dependent on type) in addition to two built-in ports, giving a maximum capacity of 34 ports in a single unit (when four audio expansion boards are installed in an MIU). Note that these expansion boards can be mixed and matched within an MIU, as required.

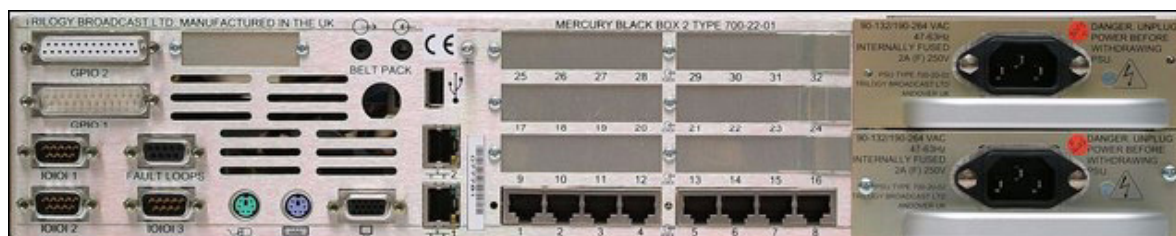
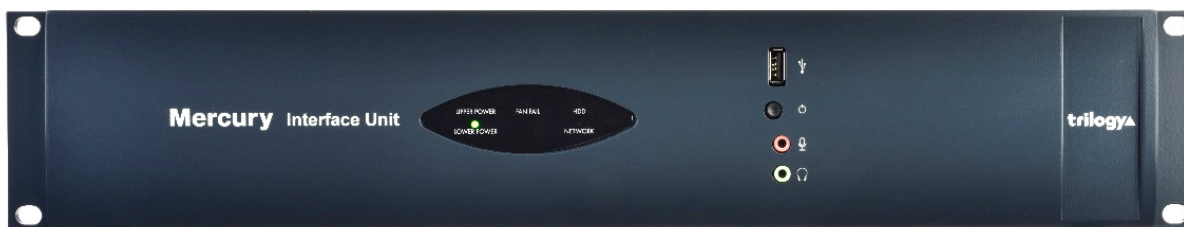

4.2 MIU VERSIONS

The following two MIU variants are covered in this User Guide:

- 700-25-06 - only available with Windows 10 Operating System.
- 700-25-04 - with Operating System Windows 7 or Windows 10.

The OS of earlier versions of the MIU cannot be upgraded but it may be possible to include such hardware as part of a communications network. Please contact Trilogy for more information.

4.3 EXPANSION OPTIONS

Key options include:

- 8 port Audio Expansion Board (AEB)
- 8 port Radio Interoperability Board (RIB)
- 4 port Telephone Interface Board (TEB) types
- Foreign Exchange Office (FXO)
- Foreign Exchange Station (FXS)
- Ear and Mouth (E&M)

In addition to the four expansion slots, in the 700-25-04 MIU only, there is provision for other cards to be added, which further enhances the capacity and flexibility of the MIU:

- General Purpose Interface (GPI) Board 700-12-01.
- Digital Signal Processing (DSP) Expansion Module 700-13-03.

The latest MIU, 700-25-06, has built-in GPI and DSP, provided on the internal PCI card so the GPI and DSP options are not applicable. See sections 31 and 32 for connector pin-outs and specifications. For the latest information on available options, please contact your supplier.

4.4 INSTALLATION PREREQUISITES AND REQUIREMENTS

The MIU is a 19-inch rack mounting format unit (2RU) which contains a Power Supply Unit (PSU), processor board and Mercury PCI card. An additional redundant PSU can be fitted if required.

To install an MIU you will need:

- One International Electrotechnical Commission (IEC) mains cable for each PSU in the MIU (maximum two).
- Keyboard, mouse and monitor if setting up the MIU for the first time. An SVGA monitor capable of displaying at least 800 x 600 resolution is suggested.
- A single RJ45 network connector for connecting the MIU to its peers and the Database Supervisor over TCP/IP.
- Any custom cabling for applications, including radio interfacing or audio 4-wire ports.
- Custom GPI cabling for external GPI interfacing if required.
- Telephone handsets for connection to the shared ports on TEBs if fitted.
- Telephone cabling for connecting TEB boards to a local or remote Private Automatic Branch Exchange (PABX) if fitted.
- Appropriate tools if expansion boards are to be fitted.

4.5 RACK MOUNTING

The MIU is 19" rack-mounted and occupies 2U. The depth (excluding mating connectors) is 375 mm.

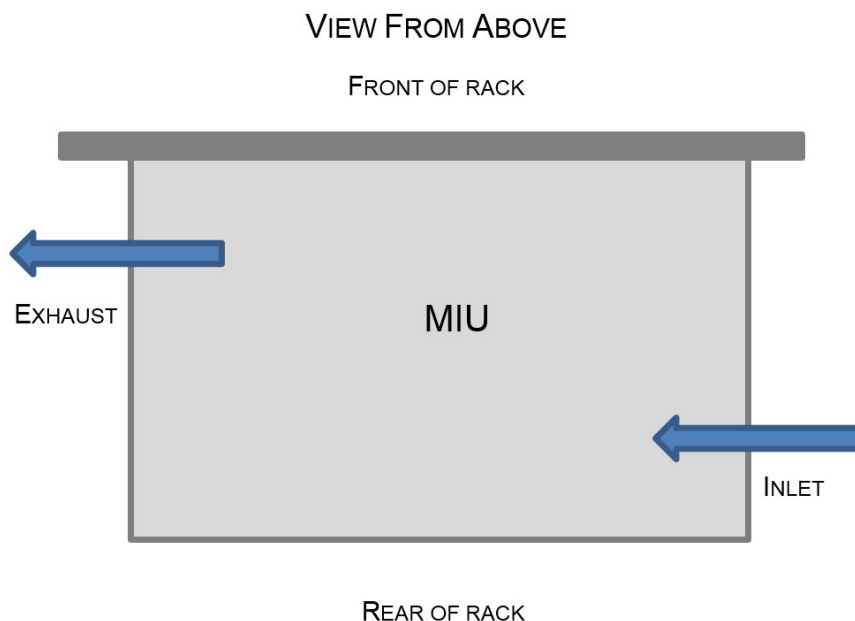

Care should be taken with cooling and ventilation within the equipment bay. The air inlet is on the right side of the chassis, towards the rear, as viewed from behind. The air outlet is on the left side, close to the front. Take care not to obscure the vents. Refer to the image above or contact Trilogy for further details.

4.6 CONNECTIONS

1. Connect a monitor, mouse and keyboard to the SVGA and PS2 / USB sockets on the MIU. These are required only for the initial set-up of the MIU.
2. Connect the subscribers to the expansion board ports on the back of the MIU.
3. Insert one or more power cable(s) into the power socket(s) and connect the other end to a mains supply.
4. The lower RJ45 network socket ("1") on the back of the MIU is connected to the IP network. **It is important to configure the MIU IP address(es) correctly before making this connection to avoid any possible network IP address conflicts.** See the information below concerning the internal network switch.

4.7 INTERNAL NETWORK SWITCH

A set of switches on the internal PCI riser board allows the internal network switch to be bypassed.

Default Mode

The MIU provides a single combined network connection via the lower RJ45 connection on the rear panel (labelled "1"). To enable this mode, the internal switches are all set towards the front panel.

Alternate Mode

If all the internal switches are set towards the rear panel, then two physical network connections are required.

- The upper connector labelled "2" is to the system motherboard network interface.
- The Mercury card interfaces via the lower connector labelled "1".

4.8 REAR PANEL DETAIL

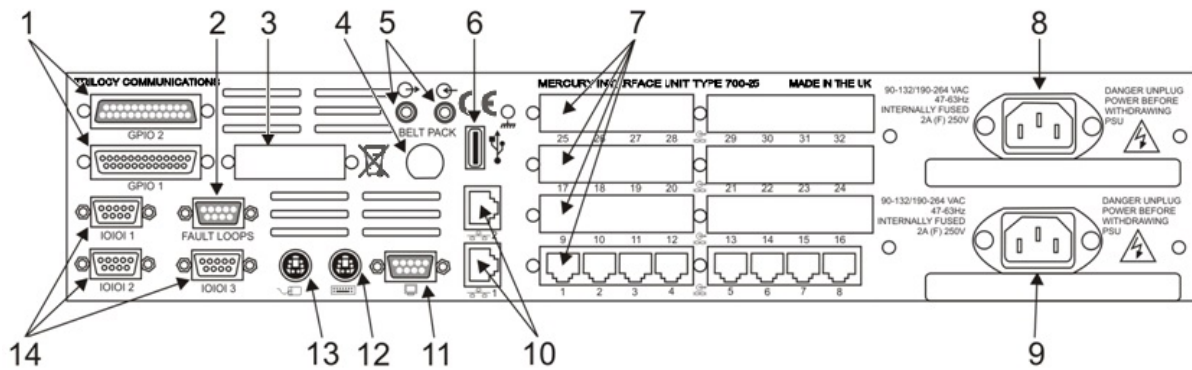

Item	Description	Control/connector type
1	GPIO 2 & GPIO 1	D25
2	Fault Loops	D9 female
3	Camera Mix Board (Optional)	
4	Belt Pack (Optional)	
5	Sound card audio	3.5 mm Jack socket.
6	USB	Standard USB Series A socket.
7	Expansion Boards	Up to four (4) boards may be fitted.
8	Second Mains Input	IEC
9	First Mains Input	IEC
10	Network 1 and 2	RJ45 8P8C; 10/100Base-TX.
11	Monitor SVGA	D15 high-density female.
12	Keyboard	PS/2.
13	Mouse	PS/2.
14	Serial	Three (3) serial ports; two (2) RS232 and one (1) RS232/422 on D9 male connectors.

See sections 31 and 32– Technical Data for connector pin-outs and specification.

5. MERCURY COMMUNICATOR UNIT (MCU)

5.1 OVERVIEW

The Mercury Communicator Unit (MCU) is a powerful operator station with a peer-to-peer architecture that enables the device to function independently. It can be either powered locally or through Power over Ethernet (PoE), and it connects to interfaces including a virtual panel, headsets, GPIs for PTT and auxiliary line-level stereo inputs.

5.2 STANDARD INDICATORS, CONTROL AND CONNECTORS (FRONT)

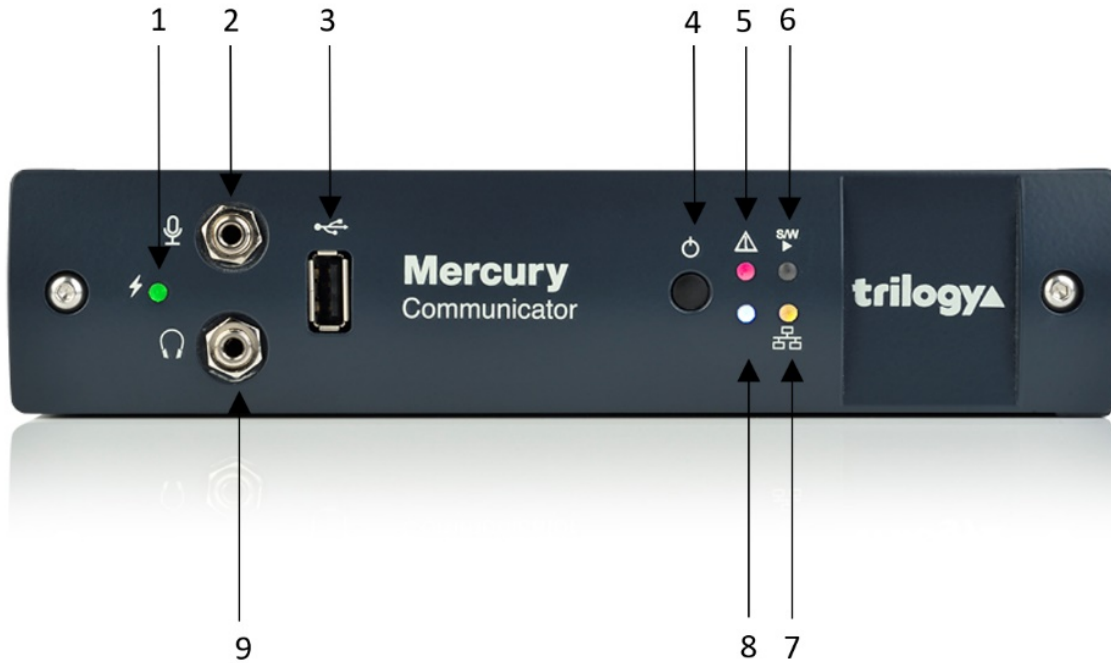

Item	Description
1	System status LED
2	Audio loudspeaker connector (3.5 mm Jack socket)
3	USB 2.0 (currently disabled)
4	Shutdown / Restart button
5	System operation/Input power status LED (green/red)
6	Software status LED (green/red)
7	Network link status LED (yellow)
8	Indicator: not used
9	Audio headphone connector (3.5 mm Jack socket)

System status LED:

- Flashing - Power button has been pressed and the unit is waiting for Windows to shutdown OR temperature has exceeded set limit (default 70°C) OR firmware upgrade is in progress
- Red – Initial state (before connection with TBC)
- Off – Connection made with TBC

Audio connectors – Two 3.5 mm stereo jack connectors:

- Secondary microphone input
- Secondary headphone output

USB connector: USB 2.0 Type A female connector used to upload security certification codes.

Pushbutton switch (recessed): Provides system shutdown.

System Operation/Input Power Status LED:

- Green – Normal operation with correct DC input voltage present
- Red – Standby operation with correct DC input voltage present
- Off – No power present

Software status LED:

- Green – Network connection made after Talkback Controller (TBC) configuration load
- Yellow – Connection made with TBC
- Red – Initial state (before connection with TBC)
- Off – Firmware is non-operational

Network link status LED (RJ45 or SFP):

- Yellow – Network link present
- Flashing – Network link present, and actively transmitting or receiving
- Off – No network link present

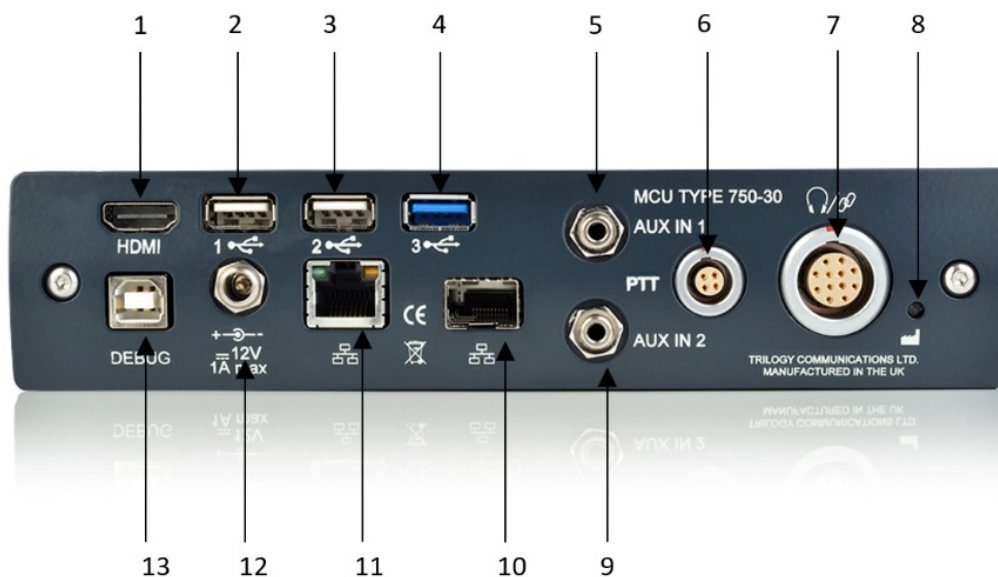
5.3 STANDARD INDICATORS, CONTROLS AND CONNECTORS (REAR)

Item	Description
1	Video output – HDMI Type A
2,3,4	USB Type A
5	Audio input channel 1 - 3.5mm stereo jack connector
6	Auxiliary PTT – Lemo 4-pin connector
7	Customer Interface Adapter (CIA) – Lemo 12-pin connector used to connect a dynamic headset, PTT and GPIO
8	Factory reset button (recessed): restores the default configuration
9	Audio input channel 2 - 3.5mm stereo jack connector
10	Network connector
11	Gigabit Network
12	Power connector – 2.5 mm DC jack connector
13	SPY Debug USB – USB 2.0 Type B female connector

5.4 INSTALLATION REQUIREMENTS

The MCU contains a Power Supply Unit (PSU), processor board and audio card. The MCU may be freestanding or installed under a desk. For the latter arrangement, the mounting bracket is fitted to the underside of the desk using self-tapping screws. The MCU then slides into the bracket from the front.

To install an MCU you will need:

- One International Electrotechnical Commission (IEC) mains cable.
- USB keyboard and mouse if setting up the MCU for the first time.
- An HDMI monitor capable of displaying at least 800 x 600 resolution.

A single network connector for connecting the MCU to its peers and the Database Supervisor over TCP/IP.

5.5 CONNECTING THE MCU

1. The MCU can be freestanding or installed under a desk.
2. Connect a monitor, mouse and keyboard to the HDMI and USB sockets on the back of the MCU. These are required only for the initial set-up of the MCU.
3. Connect the headsets to the connectors on the front of the MCU. Three MCU variants are available allowing different headsets to be connected.
4. Insert a power cable into the power socket and connect the other end to a mains supply.
5. The RJ45 network socket on the back of the MCU is connected to the IP network. **It is important to configure the MCU IP address(es) correctly before making this connection to avoid any possible network IP address conflicts.**

Full details of connections and specification are in section 34 - Technical Data | MCU | 700-30-00.

6. MERCURY SOFTWARE AND INSTALLATION

6.1 OVERVIEW AND CONCEPTS

The Mercury software suite comprises several individual software components which are packaged and presented in a single software installer. Components required for a particular situation may be selected either from a preset scenario or by selecting components individually for a custom installation.

Mercury host hardware is supplied with all software pre-installed but the instructions in this section may be used to assist should a reinstallation be required.

The key software installation task for an administrator is to set up the database and configurations editor. Careful consideration should be given to the hardware requirements and settings required to complete this. Please read section 7 before commencing installation.

The installer is also used to update an existing installation. When the installer runs, it checks for any existing installed components and advises if more up to date versions are available. The update process proceeds into steps whereby the existing installation is removed and then a reinstallation is completed. During this process, you will be presented with the option to either remove or retain existing settings: for security, the presented default is to remove settings.

The installer may also be used to add additional components to an existing installation, but it cannot be used to remove components. If for any reason you wish to remove components from an existing installation, you must first uninstall completely and start again.

NOTE: The Installer requests elevated permissions when it runs, so you can only install as an administrator; therefore, everything is installed with the correct level of permissions and can be installed into any directory.

6.2 MERCURY SOFTWARE COMPONENTS

The table below lists the range of software components included with the Mercury software installer. There is a brief description of each component.

Component	Description
Gateway Configuration Editor	The Configuration Editor is used to model and implement the structure of your Mercury system.
Database Supervisor	The Mercury database holds the Master configuration for all domains and hosts on the Mercury system. The database is managed by the Mercury DB Supervisor application. This is a middleware application that provides an interface between the database and the Mercury software running on the hosts. Like the TBC (below) it also comprises two components – Windows service and lightweight GUI.
Virtual Panel Web Server	The Virtual Panel Web Server is a middleware application used to connect the Talkback Controller (TBC) to one or more Virtual Panels. Like the TBC (below) it also comprises two components – Windows service and lightweight GUI.
Gemini Software	The current software and firmware for the Gemini host. This may or may not be different from that provided with a previous product build, so please check version numbers before attempting to carry out an upgrade. During installation, files are copied to a location on the PC, ready for future use.
TBC (Talkback Controller)	The TBC application, installed on each Mercury host, manages all the audio routes in real-time for Mercury hosts connected over IP. The application is made up of two parts: <ul style="list-style-type: none"> • A Windows service which starts automatically when the host boots. • A graphical component (GUI) which allows status monitoring of the TBC. This is a Windows executable (exe) which starts when a user is logged on to Windows. This is controlled by a shortcut in the “Startup” menu folder.
Virtual Panel	The Virtual Panel provides users with a single control panel from which they can communicate with other users in their security enclave or reach across security levels and domains to conduct voice communications.
Panel Software	The current software for IRIS panels. During installation, files are copied to a location on the PC, ready for future use.
Tools	Tools are intended for use exclusively by System Administrators and are designed to check, validate and repair specific aspects of the configuration database.

During installation, select components as appropriate. The following sections outline two typical scenarios:

- Section 6.3 - Installation Procedure: Configuration Editor with Served Database. This would normally be the administration PC for a Mercury system.
- Section 6.4 - Installation Procedure: Mercury Host with Virtual Panels. This applies to all Host types but is only required if software re-installation is necessary.

6.3 INSTALLATION PROCEDURE: CONFIGURATION EDITOR WITH SERVED DATABASE

Run the Mercury Installation Program. The Welcome screen appears:

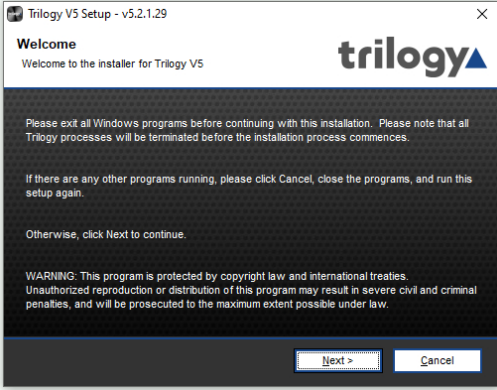
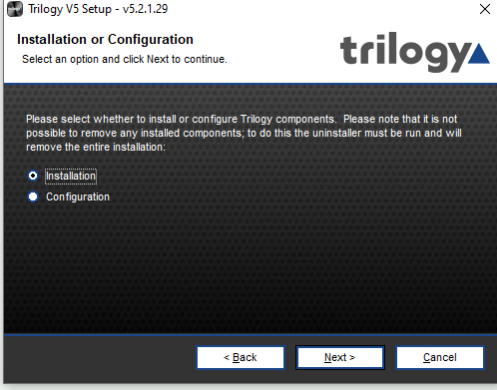
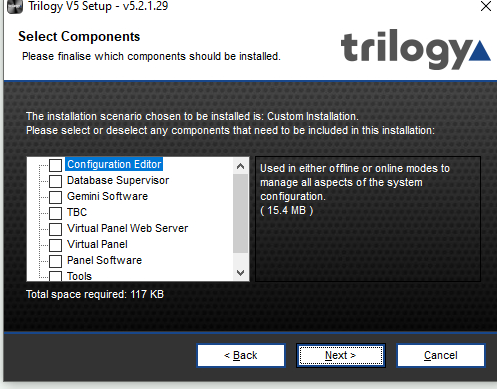
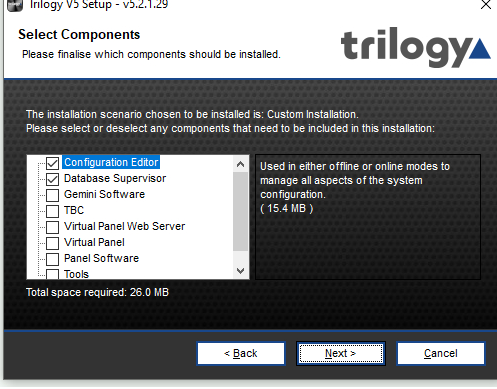
	<p>Press Next to commence.</p>
	<p>This screen will only appear if you have previously installed Mercury components. Make sure the Installation radio button is selected.</p> <p>Press Next to continue.</p>
	<p>The Custom Installation screen now shows all available components. For a new installation, none are marked.</p> <p>Press Next to continue.</p>
	<p>Two components have been selected:</p> <ul style="list-style-type: none"> • Gateway Configuration Editor • Database Supervisor <p>Press Next to continue.</p>

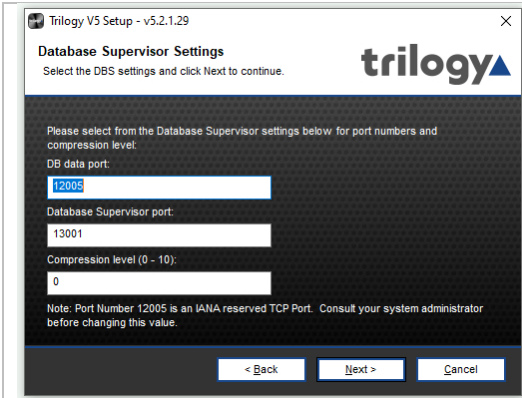

Change the DB Supervisor Settings, if required. Consult your System Administrator before changing these settings.

Press **Next** to continue.

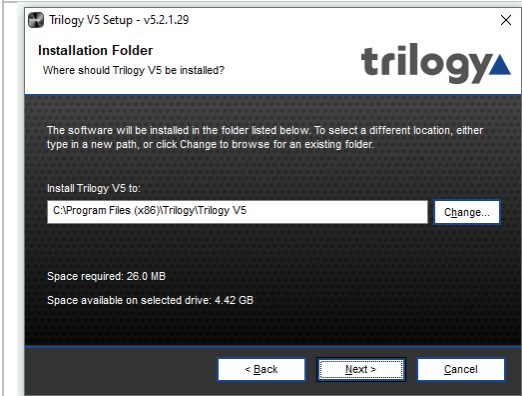

Select the Installation Folder. This is pre-set but can be changed if components have not already been installed.

Press **Next** to continue.

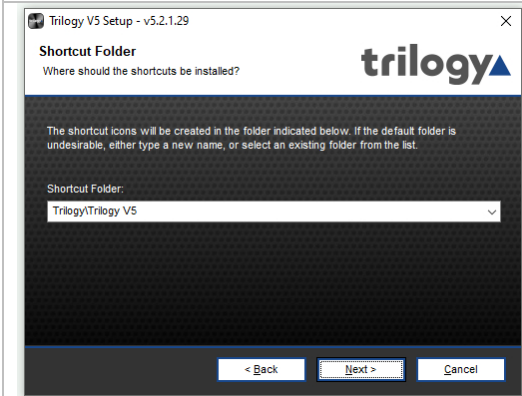

Select the Shortcut Folder. Again, this folder is pre-set but can be changed, if required if components have not already been installed.

Press **Next** to continue.

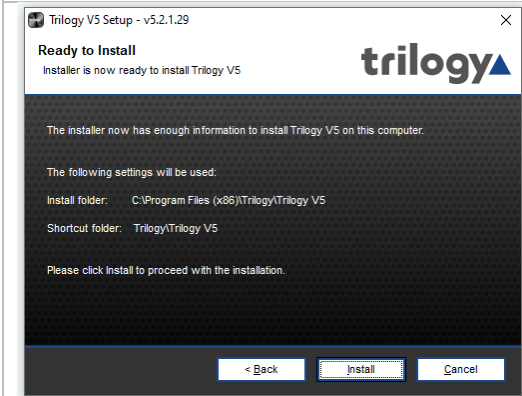

Review the settings you have selected, and then press **Install** to begin copying files.

	<p>The progress bars indicate that files are being copied to destination folders.</p>
	<p>Press Finish to close the Mercury Installation.</p>

6.4 INSTALLATION PROCEDURE: MERCURY HOST WITH VIRTUAL PANELS

Run the Mercury Installation Program. The Welcome screen appears:

	<p>Press Next to commence.</p>
	<p>This screen will only appear if you have previously installed Mercury components. Make sure the Installation radio button is selected.</p> <p>Press Next to continue.</p>
	<p>The Custom Installation screen now shows all available components. For a new installation, none are marked.</p> <p>Press Next to continue.</p>
	<p>Two components have been selected:</p> <ul style="list-style-type: none"> • TBC • Virtual Panel Web Server (including Virtual Panel) <p>Press Next to continue.</p>

		<p>Select the Host Type, Domain ID and Host ID. The Domain and Host IDs make up part of the Enterprise Domain Host Subscriber (EDHS) address.</p> <p>Press Next to continue.</p>
		<p>Set the subscriber ID of the virtual panel. The virtual panel subscriber ID defaults to the internal audio port of the hardware. This is usually two ports higher than the number of physical ports fitted to the hardware. For example, with an 8 port MIU (single AEB), this would be set as shown to "10".</p> <p>Press Next to continue.</p>
		<p>Enter the Hostname or IP Address of the database location.</p> <p>Press Next to continue.</p>
		<p>Consult your System Administrator before changing these settings. These settings will be applied to local components (e.g. TBC and VP Web Server) and must match those used when the Database was installed.</p> <p>Press Next to continue.</p>

	<p>Enter the TCP port value for the Virtual Panel Web Server.</p> <p>Press Next to continue.</p>
	<p>Select the Installation Folder. This is pre-set but can be changed if components have not already been installed.</p> <p>Press Next to continue.</p>
	<p>Select the Shortcut Folder. Again, this folder is pre-set but can be changed, if required if components have not already been installed.</p> <p>Press Next to continue.</p>
	<p>Review the settings you have selected, and then press Install to begin copying files.</p>

	<p>The progress bars indicate that files are being copied to destination folders.</p>
	<p>The installation has successfully completed. Press Finish to close the Mercury Installation Program.</p>

6.5 SOFTWARE UPGRADE

The Mercury software installer may also be used to upgrade an existing installation. When the installer runs, it checks for any current installation and performs a version check. If the current version is out of date, an upgrade may be carried out.

	<p>Press Yes to continue.</p>
	<p>Press Next to continue.</p>
	<p>Data entered during the original installation is held locally on each host. At this stage, you can decide whether to delete or reuse such data. For a software upgrade, the box is normally left unchecked.</p> <p>Press Next to continue.</p>
	<p>Press Uninstall to continue.</p>

	<p>The uninstallation phase is now complete. Press Finish to move to the 2nd phase where the software will be replaced with the new version.</p>
	<p>Please select whether to perform a Quick or Customised upgrade. A quick upgrade will use the settings from your previous installation whereas a customised upgrade will allow you to change the settings before installation. For a software version upgrade, the Quick option is the normal choice.</p> <p>Press Next to continue.</p>
	<p>The progress bars indicate that files are being copied to destination folders.</p>
	<p>The upgrade has successfully completed. Press Finish to close the Mercury Installation Program.</p>

6.6 ADDING ADDITIONAL MERCURY SOFTWARE COMPONENTS

NOTE: the installer cannot be used to remove individual Mercury components. To do this, all existing components must be uninstalled and then a new installation carried out.

Run the Mercury Installation Program. The Welcome screen appears:

	<p>Press Next to commence.</p>
	<p>Make sure the Installation radio button is selected.</p> <p>Press Next to continue.</p>
	<p>The Custom Installation screen now shows all available components. Existing components are marked: select additional components as required.</p> <p>Press Next to continue.</p>
<p>The process now follows the Installation Procedures described in previous sections.</p>	

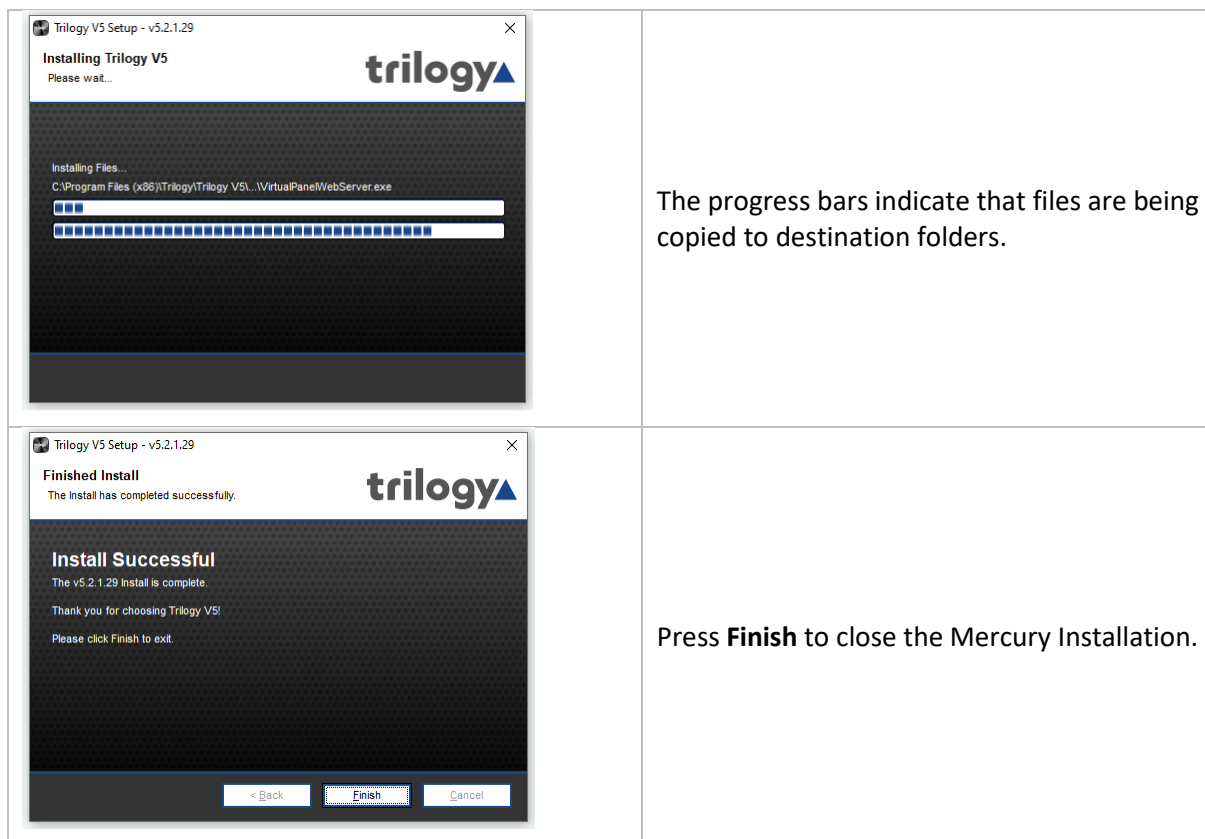

6.7 UNINSTALLATION PROCEDURE

An uninstall tool is included, alongside the installer. A shortcut to launch the uninstaller will be found in the Windows Start menu, listed under Trilogy. If you cannot find the shortcut, type “Add or Remove Programs” into the Windows search bar, then find Trilogy Mercury V5 from the list.

For the uninstall steps, see the first part of section 6.5 Software Upgrade on page 34. If you do not intend to replace the software, then check the box “Remove Application Data”.

6.8 FIREWALL

Following the installation of the software as described above it will be necessary to open several ports on the computer firewall. It is beyond the scope of this document to describe in detail how to do this due to the range of operating systems, use of Windows or third-party firewall applications, and the different permissions which may be granted to Windows users or administrators.

The most common scenario is the Windows firewall, and this requires the following rules to be added for inbound ports:

- TCP 12005
- TCP 12006
- TCP 13001

Please contact your IT Administrator or Trilogy Technical Support for further assistance.

7. DATABASE AND THE DATABASE SUPERVISOR

7.1 OVERVIEW AND CONCEPTS

The Mercury database holds the Master configuration for all domains and hosts on the Mercury system. The configuration details in the database are managed using the Configuration Editor, an application that provides a Graphical User Interface (GUI) to visualize and interact with the database. Any changes to the configuration are saved to the database and these changes are then retrieved by each host in the Mercury system individually.

The database is managed by the Mercury DB Supervisor application. This is a middleware application that provides an interface between the database and the Mercury software suite running on the hosts.

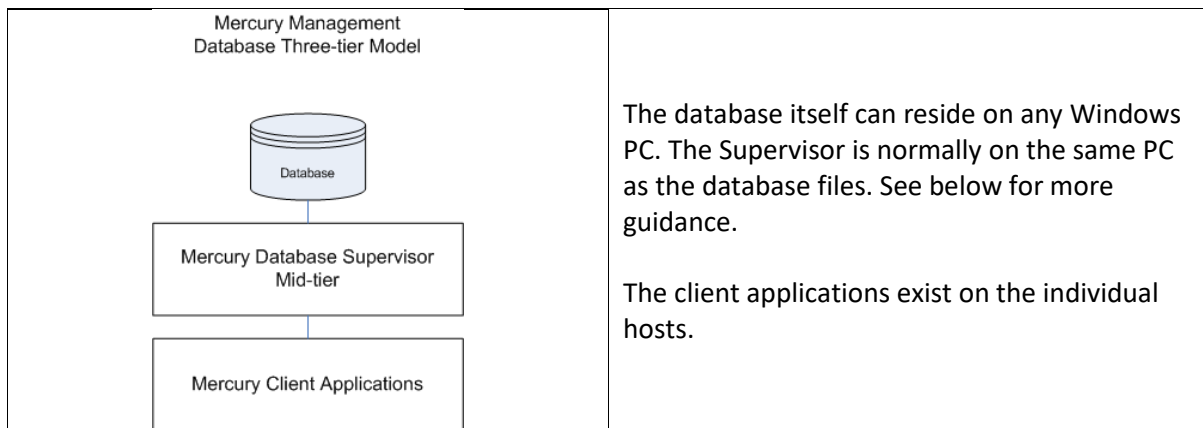

A Mercury system can only have one database, which contains the source files that define the configuration of the entire Mercury system. If part of the system needs updating, such as a function change on one of the panels, the Configuration Editor is used to make the change and update the database. The changed database configuration is then disseminated to each host in the system over open database connections and cached locally. The changes are then (or later, at a convenient time) made active on each recipient host (i.e. the working files on the host are replaced with the revised, cached version).

When this sequence is complete and the revised configuration is operating correctly, the Configuration Editor may be closed. Furthermore, the database may also be shut down or disconnected since all hosts are running from their local cache. However, hosts will (correctly) display a warning message, advising that connection to the database has been lost.

7.2 MERCURY DATABASE

Regardless of the scale of the system, from single MIU to multi-site, there must only be one instance of the database. An important aspect of planning is to consider the correct location of the database. On delivery, every MIU has the database pre-installed, which allows it to start and run cleanly during the setup phase. For anything other than a single or small MIU based system, a different approach is needed, and some guidelines are offered below. It is not recommended to install the Gateway Configuration Editor on an MIU.

Scale of system	Database
Single MIU	Yes
Small system, 3 or fewer MIU (Note 1)	Yes
Larger system, 4 MIU or more (Note 2)	No

Note 1 -- The database must only be active on one MIU: any other MIUs should have the database disabled or removed, and then connect as clients to the single database.

Note 2 -- As the database increases in size and complexity it will place additional demands on the platform. For 4 or more hosts we suggest a separate PC or rack-mounted server, with all hosts connecting as clients.

7.3 DATABASE INSTALLATION

The database should ideally be installed on a separate, fast PC on the network. If the system that you are installing has many users, you should consider installing the database on a Windows-based server. The database may reside on an MIU host for “small” systems, which are defined as having three or fewer hosts. However, the Configuration Editor will not run on an MIU due to memory and graphics limitations.

The main database component is the Mercury DB Supervisor which always runs as a Windows Service. The database is administered using the Mercury DB Supervisor GUI. This application automatically starts when you start Windows on the PC or server. The database [service] will continue to run without interruption if the GUI application is shutdown.

You will see a Mercury DB Supervisor icon in the system tray. Right-click on this icon and select Restore to open the Mercury DB Supervisor GUI. The Mercury DB Supervisor can be suspended or resumed from this form if required. This action does not stop/start the underlying Windows service.

Full installation details are provided in section 6 - Mercury Software and Installation.

7.4 DATABASE PC/SERVER – SPECIFICATIONS

Application	Minimum	Recommended
OS	Windows 7	Windows 10 (64-bit pref.)/ Windows Server 2012
CPU	2 GHz	2 GHz
RAM	2 GB	8 GB
HDD space	100 MB	100 MB

----- Served Database plus Configuration Editor -----

7.5 MERCURY DB SUPERVISOR

The Mercury DB Supervisor comprises two components:

- Windows service which starts automatically on startup.
- GUI application which also runs automatically from a shortcut placed in the Windows Start-Up folder during installation and is normally minimized to the System Tray.

The GUI application is used by the System Administrator to:

- View a list of connected Mercury clients (see page 41).
- View and manage database sessions (see page 42).
- View a log of events (for example, starting and stopping the service, connecting and disconnecting clients) (see page 42).
- Specify database settings (see page 42).



When the GUI is running, a small additional icon (left) is displayed in the Windows system tray. On double-clicking the icon, the Database Supervisor GUI is displayed.

Normally, you will not have to make any changes to the settings, but if you do you must ensure that you also update the Database Settings in the Configuration Editor.

The Mercury DB Supervisor GUI provides visibility of the Mercury database; if it is shut down you will not be able to view the database and make changes to your database settings. If the Mercury DB Supervisor GUI is shut down, the database itself is still running as a service and the communication system will function as normal.

Closing and Restoring the Mercury DB Supervisor GUI

The Mercury DB Supervisor GUI application will be started automatically, via a shortcut to the application in the Windows Start-Up menu, added during installation.

Closing the Mercury DB Supervisor GUI application does not affect the Mercury database which always runs as a Windows service. The Mercury DB Supervisor GUI icon always appears in the system tray and the GUI may be displayed by right-clicking the icon and selecting Restore.

NOTE: If inadvertently shut down, to re-start the Mercury DB Supervisor GUI application, click on Database Supervisor in the Windows Start-up menu.

Mercury DB Supervisor GUI Status Indicator

An indicator in the bottom left corner of the GUI form shows the current status.



Database Supervisor is running correctly.

Database Supervisor is not running. Either it has been suspended or the Windows Service has not started.

7.5.1 Mercury DB Supervisor GUI Menu Options

The Mercury DB Supervisor GUI menu options are as follows:

Server Menu	
Menu Option	Description
Load Configuration	This allows a Mercury configuration file which has been created elsewhere, to be “pushed” to all currently connected database clients without using Gateway Configuration Editor.
Change IP Address	This feature is no longer supported.
Start/Stop Supervisor	Suspend or Resume operation of the Supervisor. The current status is shown by the indicator – see above. While stopped, all clients will be disconnected which may cause unexpected results, requiring clients to be restarted. This action does not start or stop the underlying Windows service.
Close	Closes the DB Supervisor GUI and minimizes it to the system tray. This does not affect the operation of the Database Supervisor Service: all connections will be maintained without disruption.
Shutdown	Shuts down the DB Supervisor GUI only. This does not affect the operation of the Database Supervisor Service: all connections will be maintained without disruption.

Help Menu	
Menu Option	Description
About	Displays version information.

7.5.2 Mercury DB Supervisor Clients

The Mercury DB Supervisor – Clients tab shows a list of active Mercury clients. Refer to section 7.6.1 for a description of the information on this tab.

To view a list of Mercury clients:

Right-click on the Mercury DB Supervisor icon in the system tray and select Restore to display the Mercury DB Supervisor.

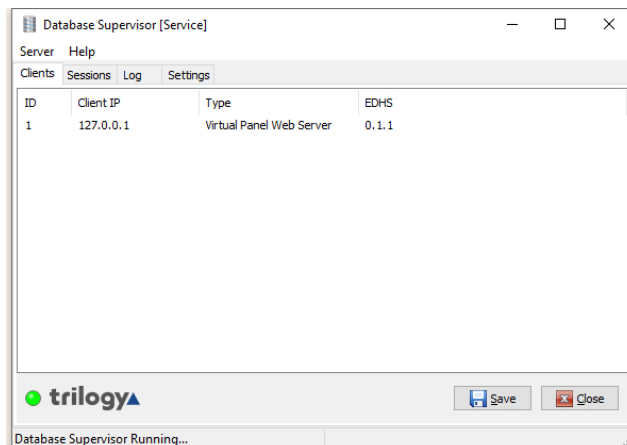

The **Clients** tab is selected by default. Refer to section 7.6 - *Mercury DB Supervisor Field Definitions* for a description of the information on this tab.

7.5.3 Mercury DB Supervisor Database Sessions

The Mercury DB Supervisor – Sessions tab lists details of the user running the DB Server service.

- **Session** – A data transaction between the database and the client.
- **Connection** – A Transmission Control Protocol (TCP) connection between the Database Server and the client. Can be host to multiple sessions.

To view database sessions:

Right-click on the Mercury DB Supervisor icon in the system tray and select Restore to display the Mercury DB Supervisor.

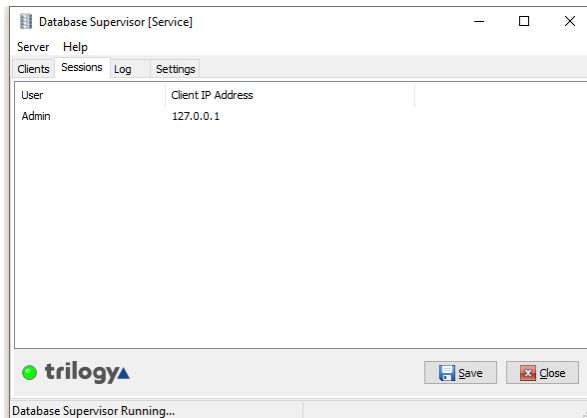

Click the **Sessions** tab to show the User and Client IP Address for all connected clients.

Refer to section 7.6 - *Mercury DB Supervisor Field Definitions* for a description of the information on this tab.

7.5.4 Mercury DB Supervisor Log

The Mercury DB Supervisor – Log tab shows a list of all database-related events. These events include initialization of the Database Server, Database Supervisor, configuration and client connections.

Checking the log can provide useful information if you have problems connecting to the database.

To view, save and clear the log:

Right-click on the Mercury DB Supervisor icon in the system tray and select Restore to display the Mercury DB Supervisor.

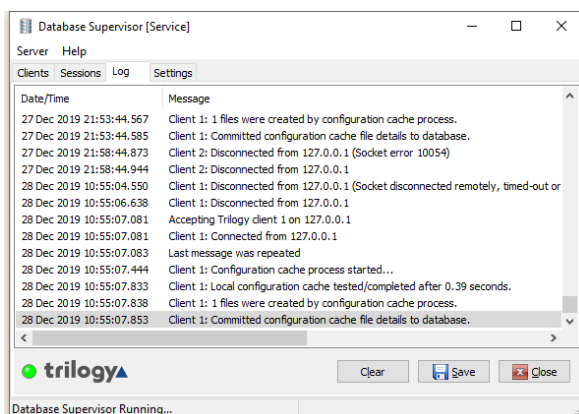

Click the **Log** tab to view the current contents of the log.

Refer to section 7.6 - *Mercury DB Supervisor Field Definitions* for a description of the information on this tab.

To clear the log, click the **Clear** button.

7.5.5 Mercury DB Supervisor Settings

The Mercury DB Supervisor – Settings tab allows you to specify various parameters that control the operation of the DB Supervisor and database.

NOTE: Ensure that you have closed all client applications before you apply any changes to the Supervisor settings. To do this click **Start / Stop** on the Server menu of the Mercury DB Supervisor.

To change the DB Supervisor settings:

Right-click on the Mercury DB Supervisor icon in the system tray and select Restore to display the Mercury DB Supervisor.

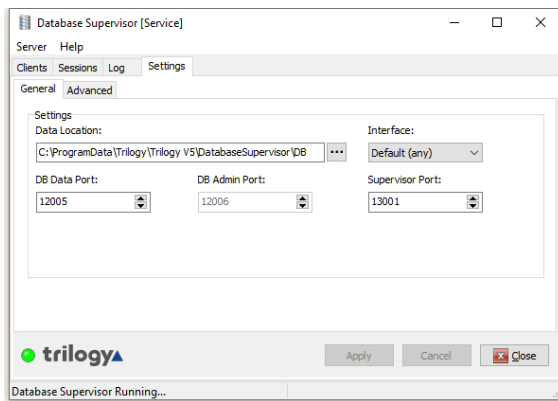

Click the Settings tab to show the General settings for the DB Supervisor.

Make the required changes.

Refer to section 7.6 - *Mercury DB Supervisor Field Definitions* for a description of the information on this tab.

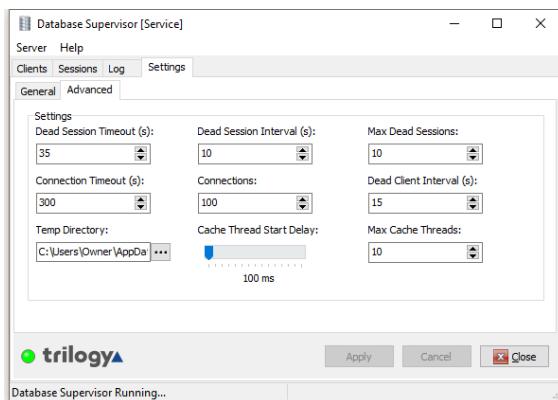

Click the Advanced tab to make changes to the advanced settings, if required.

Refer to section 7.6 - *Mercury DB Supervisor Field Definitions* for a description of the information on this tab.

Click **Apply** to save the changes.

7.6 MERCURY DB SUPERVISOR FIELD DEFINITIONS

7.6.1 Mercury DB Supervisor – Clients tab

Display Item	Description
ID	Shows the ID of the connection. This is dynamically assigned by the DB Server when a connection is established. The ID usually starts at 1 and goes up in sequence. However, if a connection is dropped the counter can roll back and use the dropped ID if one needs to be reassigned. The ID cannot be changed manually.
Client IP	Shows the Internet Protocol (IP) address of the connected client.
Type	Shows the type of client connected.
EDHS	Shows the Enterprise Domain Host Subscriber (EDHS) address of the connected client. The Configuration Editor displays as 0.0.0.0

7.6.2 Mercury DB Supervisor – Sessions tab

Display Item	Description
User	Shows the name of the client user. For example, the operator name logged into the Configuration Editor.
Client IP Address	The IP address of the client that is 'attached' to the DB Supervisor.

7.6.3 Mercury DB Supervisor – Log tab

Display Item	Description
Date/Time	The date and time of the log entry.
Message	The text of the message recorded in the log.

7.6.4 Mercury DB Supervisor – Settings – General

Field	Description
Data Location	Shows the path to the database files. Click  to change this location if required (NOT RECOMMENDED).
Interface	If the computer running the DB Server has two network cards, this setting allows the Administrator to choose the network interface from which the database will run. Changing this will set the DB Server to listen on the selected IP address. Database clients must change their DB Server setting to this IP address to connect to the database. Default = Any.
DB Data Port	The IP port that the DB Master (or Slave) uses for data connections. Changing the value changes the IP port number that the database accepts incoming connections on. The value must be changed if: IP Port 12005 is in use elsewhere on the network by another application. Network security deems that another port is used, or Network Address Translation /Port Address Translation (NAT/PAT) requires another port to be used. If this value is changed, all clients (including slaves) must be configured to connect to the new port value. Default = 12005
DB Admin. Port	This is the port used by the Configuration Editor to access the DB Supervisor. The value cannot be changed. Default = 12006
Supervisor Port	The IP port on which the Database Master (or Slave) listens for connection control data. Changing the value changes the IP port number that the database accepts incoming connections on. This value needs changing if: IP Port 13001 is in use elsewhere on the network by another application. Network security deems that another port must be used, or NAT/PAT requires another port to be used. If this value is changed, all clients (including slaves) must be configured to connect to the new port value. Default = 13001

7.6.5 Mercury DB Supervisor – Settings – Advanced

Field	Description
Dead-session timeout	The time it takes for a database transaction session to timeout upon client or network failure. This should be left as the default setting. Increasing the value in poor network conditions may help prevent premature session timeouts. This value should only be modified by an experienced Administrator. Default = 35 seconds. Maximum = 240 seconds. Minimum = 35 seconds.
Dead-session interval	The time interval between successive checks for dead sessions. It should only be modified by experienced Administrators. Default = 10 seconds. Maximum = 60 seconds. Minimum = 5 seconds.
Max. dead sessions	The maximum number of dead sessions that can occur before dead sessions are pruned. This should only be changed if there are a large number of concurrent connections to the database. The value can be increased in cases of poor network performance. It should only be modified by experienced Administrators. Default = 10. Maximum = 50. Minimum = 1.
Connection timeout	The time allowed for an idle TCP/IP connection to timeout. The value is in seconds. Default = 300 s. Maximum = 300 s. Minimum = 60 s.
Connections	The number of concurrent client connections the Supervisor can handle. Adjusting this will change the maximum number of clients that can connect to a Database Server. This should not be changed unless there are many client connections, and database errors are received in the Database Log page and client application logs. The DB Sessions tab lists the current connections to the Database Server and gives a good indication should the maximum connection limit be approached. Default = 100. Maximum = 1000. Minimum = 1.
Dead Client Interval	Default 15 s, Maximum 120 s, Minimum 10 s.
Temp. directory	The Database Supervisor stores temporary files in this location. Trilogy recommends you accept the default offered.
Cache Thread Start Delay	Default = 100 ms Min = 100 ms, Max = 1500 ms.
Max Cache Threads	Default = 10. Min = 1, Max = 50.

8. CONFIGURATION EDITOR | BASICS

8.1 OVERVIEW

The Configuration Editor is used to model and implement the structure of your Mercury system. To begin defining the structure and connectivity of the system, you need to put in place all the required Domains, Conferences, Groups and IFBs that are required. This is done using the Enterprise Editor.

A unique addressing system is used in the Mercury system. This is known as the Enterprise Domain Host Subscriber (EDHS) system. The host is the main element of the system. Subscribers make use of the host's facilities to provide audio communications. Hosts are grouped into logical groups, called domains. These are predominantly groupings of convenience, allowing a system to be segregated into separate areas. There is a close analogy between this definition of domains and Internet Protocol (IP) network domains, since it may be appropriate to run each area, or building, on a different subnet.

The Enterprise level sits above the domains, allowing domains to be grouped into a larger entity. Every host in the system has its own unique EDHS address which is assigned by the Configuration Editor and entered during host installation. This makes it possible to cross-reference an EDHS address to an IP address; while the IP address may change, but the EDHS remains constant. User interfaces can be configured to allow communications between EDHS entities.

Once all basic objects have been defined in your Enterprise, you must then configure the domains and add hosts using the Domain Editor. Subscribers can then be added to the defined hosts using the Host Editor, while the host settings, including the IP addresses of the audio card and the host itself, can be defined. Routes are added using the Routes Editor. These routes can be used when defining General Purpose Input Output (GPIO) processes. Subscribers are configured using the Panel Configuration Editor. The Conference Editor is used to specify members of a conference and to define all the hosts that may need to take part in a conference at some time.

Once the complete configuration has been defined and saved, it is transferred to the hosts and the subscribers on the system using open database connections. Uploading the settings sends them to their destinations where they are cached. To make these changes active (i.e. replace the working files with the cached version), you must instate or activate the changes. A configuration can be changed at any time to reflect changes in the Enterprise and transferred to the hosts before being instated or activated.

8.2 BEFORE YOU START

Typically, one computer is designated as the configuration management computer. Any changes that are made to the configuration of the Enterprise using this computer are then transferred to all other hosts within the Enterprise. Refer to the *Mercury Database* section in this User Guide for more information on database configuration.

Unless a separate PC or server is specified to host the Mercury database, the configuration software and database run on the same machine. The configuration software can, later, be installed on other machines in the Enterprise, if required.

If you are running a 'served' Configuration Editor, you should always ensure that the Database Supervisor software is running on the Master machine. This is installed as a service within Windows and should, therefore, start automatically. You can check that the Database Supervisor is running as follows:

- Look for the **Database Supervisor** icon in the system tray. Right-click on the icon and choose **Restore**. If the supervisor is running, the indicator at the bottom left corner of the form (next to the Trilogy logo) is green.
- If the indicator is red, see *Mercury DB Supervisor* on page 40.

8.3 INSTALLING THE CONFIGURATION EDITOR

The Configuration Editor is usually installed on the same PC as the database. However, it can also be installed on other PCs on the network, if required. If you install the Configuration Editor on another PC, you must provide the IP address or hostname of the PC that is running the database.

NOTE: We recommend that you read section 7 - *Database and the Database Supervisor* in this manual before installing the database and the Configuration Editor.

8.3.1 Installation (Served Configuration Editor Scenario)

To install the database and Configuration Editor, please see *Mercury Software and Installation*, section 6 of this manual.

8.4 CREATING A CONFIGURATION

The Configuration Editor provides you with a view on the underlying database tables and allows you to add, delete and maintain records in the database.

To create a configuration that models your Enterprise:

- Make sure you understand the structure of your Enterprise in terms of domains so you can create a plan that includes details of the hosts and subscribers in the Enterprise.
- Input the information from your plan using the Configuration Editor. The Configuration Editor provides a logical tree view of the items that you need to configure. We recommend that you start at the top level and work logically down through the various elements, such as domains and groups, which together make up a configuration. The configuration can be tested and deployed incrementally if required.
- Save the configuration information and transfer this to all destinations within your Enterprise.

8.5 USING THE CONFIGURATION EDITOR

8.5.1 Starting the Configuration Editor

To start the Configuration Editor, select it from the **Program** list, available on your Windows Start menu: (Trilogy >> Mercury v5 >> Configuration Editor).



We recommend that you also place a shortcut to the Configuration Editor on the desktop of the computer.

8.5.2 Software Features

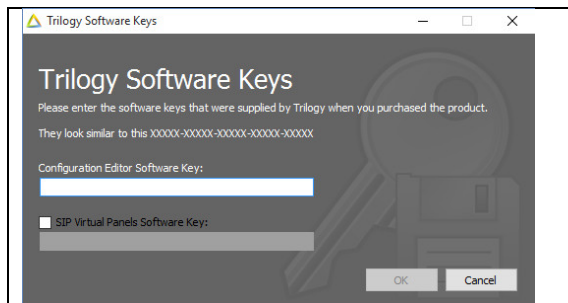

When run for the first time, Gateway will prompt you for a feature unlock code. The code is supplied with your original purchase CD and you should keep this safe for any future re-installation. Additional paid-for features may be unlocked by entering a new code.

8.5.3 Connecting to the database

If you are using a served Configuration Editor, you must ensure that the Mercury DB Supervisor is running, and the location of the database is correct.

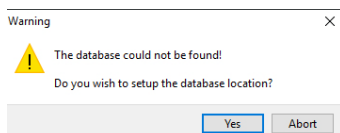

If not, you will see this message.

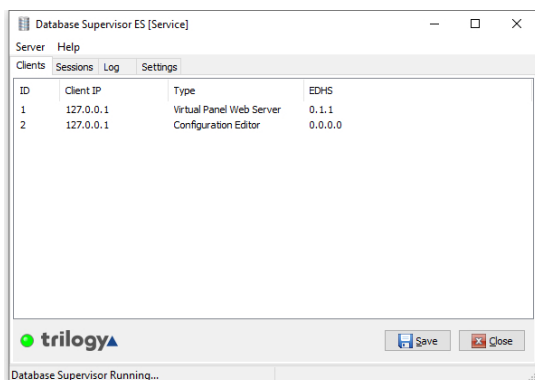

To verify that the Database Supervisor is running, right-click on the icon in the System Tray and choose **Restore**. Alternatively, double click the icon.

Check the indicator at the bottom left corner of the dialogue.

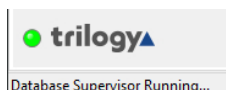

Database Supervisor is running correctly.

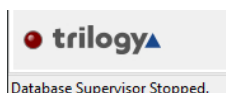

Database Supervisor is not running. Either it has been suspended or the Windows Service has not started.

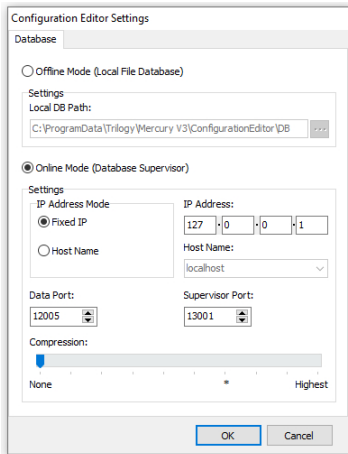

When you have confirmed that the supervisor is running, click **Yes** on the warning message to specify the location of the database.

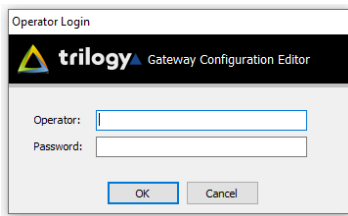

If the database is running and the settings are correct, you will be prompted to log in. Enter the Operator and Password then click **OK**. **NOTE:** Operator and Password are case-sensitive. The default password for the *Admin* operator is *trilogy*.

8.5.4 The Configuration Editor Interface

The Configuration Editor is divided into six main areas as shown below:

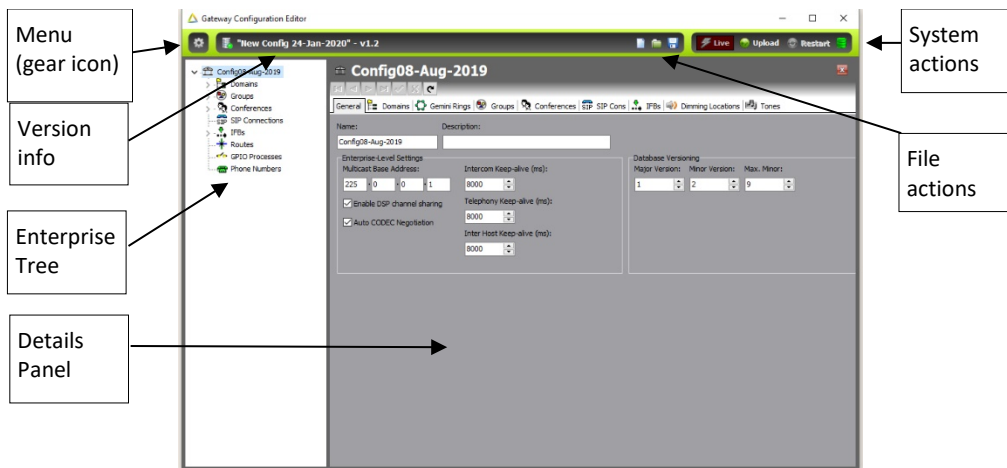

Menu (Gear Icon)

Click on the gear icon to open the menu. Options let you create a new configuration, import or save a configuration, set preferences and view specific parts of the Enterprise. The menu options are described in detail later.

Version Info

This is the filename of the currently loaded configuration. If you “Save” the current configuration to incorporate any changes, this is the file (and location) which will be used. The version number (v5.9 in the example) will increment each time changes are saved.

Enterprise Tree

The Enterprise tree shows an expandable view of the container objects that make up the entire configuration.



A plus sign next to an item indicates that it can be expanded to show more items; a minus sign indicates that it can be collapsed.

Details Panel

If you select an item within the Enterprise tree, details of that item will be shown in the Details panel. For example, select a domain from within the Enterprise tree to display a list of the hosts specified for that domain, in the Details panel. Double-click an item in the Details panel to open an Editor window and make changes.

System Actions





Descriptions of the Configuration Editor system action buttons are provided below.

Button	Description
	Start a configuration upload , ensuring that all hosts are synchronised. Uploading the settings sends them to their destinations where they are cached. Upload the settings when you have completed or modified a configuration.
	Restart (activates) configuration changes. The working files on each host are replaced with the cached versions. Note that this button may not be enabled if you have selected to automatically instate settings. This button is not enabled if you are working with a local database.

Database Status Icon



The database status is shown in the System Actions area of the Configuration Editor main screen. The icon is also a button which, when clicked, displays the Active Clients dialogue.

The icons are:

-  The configuration has been changed.
-  The configuration upload is in progress.
-  Changes have been uploaded to hosts but not restarted.
-  The configuration is in the process of being restarted.
-  The configuration has been restarted.

File Actions

Descriptions of the Configuration Editor file action buttons are provided below.

Button	Description
	Starts a new (empty) configuration. The current configuration will be lost unless you save it before creating a new configuration. A warning is given, and you need to click Yes to continue.
	Loads a previously saved configuration (.trilogy archive). The current configuration will be overwritten. A warning is given: click Yes to continue.
	Saves the current configuration to the current file and location. This can be loaded back into the Configuration Editor later if required. It is important to save a configuration, particularly before you upgrade the software.

8.5.5 Menu Options

The menu options accessed from the gear icon of the main Configuration Editor screen are detailed in the following section. The top level has 6 entries, detailed below.

NOTE: The options will vary depending on whether you are using a local file system database or a served database.

File	
Option	Description
New	Starts a new (empty) configuration. The current configuration will be lost unless you save it before creating a new configuration.
Load Configuration...	Loads a previously saved configuration. The current configuration will be overwritten.
Save Configuration...	Saves the current configuration as a file to the current location. This can be loaded back into Gateway later if required.
Save Configuration As...	Saves the current configuration as a file with a choice of location. This can be loaded back into Gateway later if required.
Switch to Live Mode	Switches from the default “online” mode of operation (upload followed by a restart) to a “live” mode which allows minor changes to be made without the need for a restart. This is a paid-for option, enabled by keycode within Gateway.
Start Configuration Upload	Upload the current configuration data to all hosts. The data is cached at each host, pending the “restart” command (see below). If the preference to “auto restart” is checked, then upload and restart are seamlessly linked. Note: upload is a background task.
Restart with Configuration Changes	Restart the host(s), after upload. The host will restart using the new (uploaded) data. Note: this is a disruptive task.
Exit (Alt + F4)	Close the Configuration Editor.

View	
Option	Description
Active Clients	Opens the Active Clients’ Status window.
Trilogy Positioning System	This option is not currently available.
Expand Configuration View	Expands all branches of the Enterprise tree.
Collapse Configuration View	Collapse all branches of the Enterprise tree.
Refresh Configuration View (F5)	Refresh the configuration view to reflect recent changes.
Configuration Search (F3)	Type the name of any entity within the configuration. Highlight the result then click Launch to view that entity in the main window.

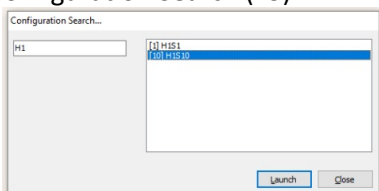

Setup	
Option	Description
Database Settings...	Opens the Database Settings dialogue. Here you can change network settings, including the IP address of the Database Supervisor.
Preferences...	Opens the Preferences dialogue. Here you can change some of the settings that relate to the operation of the Configuration Editor.
Entity Filter...	To simplify the visual appearance of what can become a complex GUI, unused entities may be hidden from view. For example, control panel types which have not been purchased for your project.
Enter Software Keys...	Features within Gateway are unlocked using software keys, purchased from Trilogy. To enable a feature not currently activated, purchase an additional key and enter it here.

Tools	
Option	Description
Recalculate All Conference Best Profiles	Select this option to recalculate the best profiles for conferences. This can take some time depending on the number of conferences in your Enterprise.
Configuration Gateway CE Version...	Allows a previously saved configuration file to be selected and an information dialog displayed indicating the Gateway version and date/time the configuration was last saved.
Launch Access Management Console	Opens the Access Management console, used to manage user roles and Administrators. See section 28.
Gemini Upgrade	Allows for bulk upgrades of multi-host systems (Gemini only).
Change Password	Opens the Change Password dialogue. Use this option to change your login password.

Window	
Option	Description
Close Editor	Closes the currently open editor and returns the application to the opening screen.

Help	
Option	Description
About	Shows the version number of both the individual application and the product.

8.6 CONFIGURATION CREATION AND MANAGEMENT

You can create a new configuration at any time. However, if you do not save (archive) your current configuration, all changes will be **lost** when you create a new configuration.

If you want to keep a configuration that you are working on (and possibly come back to later), ensure that you save the configuration before you create a new one (refer to *Saving and Loading Configuration Settings* on page 55 for more information).

NOTE: If you are using the Release Candidate Workflow, refer to page 62 for details of creating, saving and loading configurations.

8.6.1 To create a new configuration

Click the **Start a new empty configuration** button . The message (right) is shown.

NOTE: The message will not be shown if the current configuration has previously been saved.

Click **Yes** to confirm that you want to create a new configuration. A progress bar will display while the new configuration is created.

Click **Cancel** if you want to save or keep the current configuration.

Refer to *Saving and Loading Configuration Settings* on page 55 for more information.

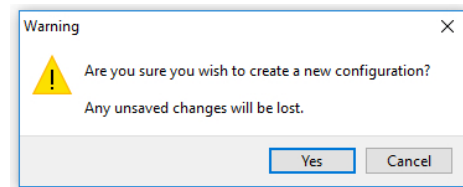

Processing ...

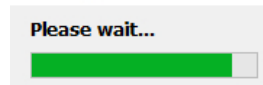

NOTE: A default configuration (or Enterprise) is created with a single domain and two conferences. The Enterprise tree shows an expandable view on the configuration that has been created. The name of the Enterprise includes the creation date. The configuration must be changed to match your specific requirements.

8.6.2 Saving and Loading Configuration Settings

It is good practice to save a configuration, with the date and time that it was saved in the filename, at various stages of its development. If you save a configuration regularly, you can load it back if you need to.

Saving a Configuration

A configuration can be saved at any time.

NOTE: The configuration data is important, and we would recommend that you also copy it to removable media or ensure that it is backed up with your other data.

To save a configuration:

- Click the **Save...** button .
- The Windows File Save... dialogue is displayed, with the filename and location set to the values used at the previous Load operation.
- If this is the first “save” operation for a new configuration, enter a name for the configuration file and select the folder into which you want to save the configuration.
- Click the Save button.

If you have previously saved a configuration with the same name in the specified folder, click **Yes** if you wish to overwrite the old file.

Loading a Configuration

When you load a configuration, it will overwrite the currently loaded configuration.

To load a previously saved configuration:

Click Load...  to load an existing configuration. The message (right) is shown.

NOTE: The message will not be shown if the current configuration has previously been saved.

Click **Yes** to confirm that you want to create a new configuration. Browse for and select the configuration that you want to load.

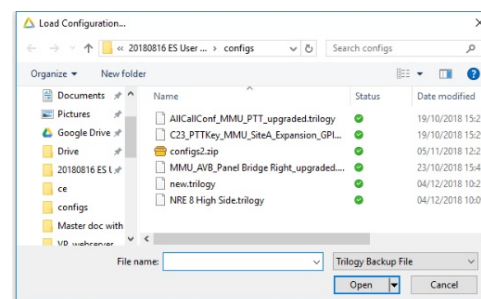
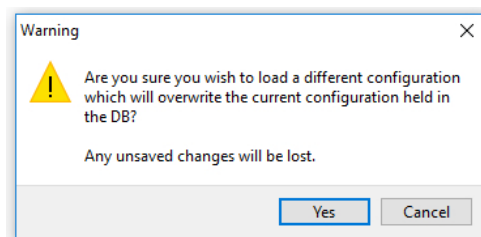

A progress bar will display while the new configuration is loaded.

Click **Cancel** if you want to save or keep the current configuration.

8.6.3 Uploading Configuration Data

Once you have completed developing your configuration, or have completed the details for a specific host, you can send the changes to the hosts in your system, and subsequently to each subscriber.

Uploading is the first stage of this process when data is transferred to all relevant hosts and cached. To make these changes active during the second stage, (i.e. replace the working files with the cached version), you must instate or activate the changes. Always keep in mind that although the first stage happens in the background, the second stage is disruptive.

NOTE: An administrative setting, on a host-by-host basis, determines the priority of the database cache processing to give control over the amount of CPU usage during an instate operation – this minimizes the potential interruption to audio communications. Refer to the Configuration Editor – Hosts and the Host Editor for more information on this setting.

Updating a Configuration

To update a configuration, ensure that you change your database settings so that you are working in Served/Remote Database mode.

Click **Upload** . The process ensures that all hosts are synchronised.

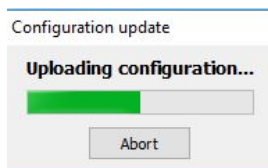

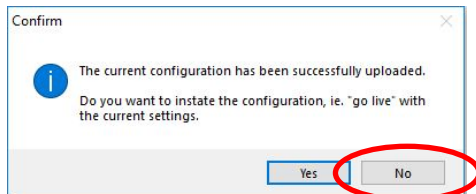

The configuration update progress dialogue is displayed.

When the revised data has been transferred, you can choose whether to instate and go live with the configuration or instate the changes later.

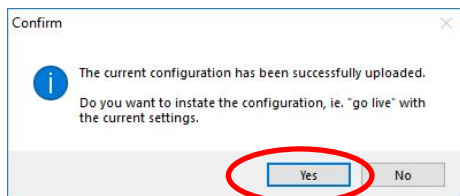

If you press **No**, you can restart the system later by clicking the yellow **Restart** button which will then be enabled.



To restart with a new configuration:
Click **Yes** on the Mercury Config Editor dialogue box or (later) click the **Restart** button .

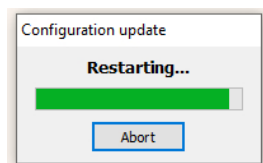

The dialogue shows the progress of the update.

Configuration Update Messages



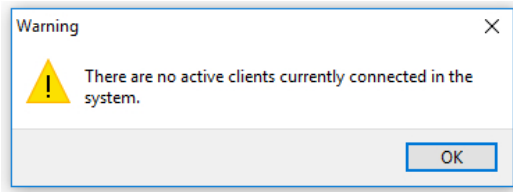

When you are updating a configuration the following message boxes may be displayed:



No active clients are running therefore update cannot take place.

Understanding the Status of a Configuration

The database icon which is shown in the top-right of the Configuration Editor window shows the version of the database and its status.

-  The configuration has been changed.
-  The configuration update is in progress.
-  Changes have been uploaded to hosts but not restarted.
-  The configuration is in the process of being restarted.
-  The configuration has been restarted.

NOTE: You can specify when the database version is incremented on the Database Management tab in the Enterprise Editor and specify whether the version is incremented when a database is imported into the Configuration Editor. Refer to the *Configuration Editor – Enterprises and the Enterprise Editor* section in this User Guide for more details.

8.6.4 Active Clients

Best-practice is to monitor the upload and instate process closely using the Active Clients dialogue. Refer to page 62 for more information.

8.6.5 Uploading and Instating on a Per-Host Basis

In addition to uploading and instating a configuration for all hosts on the system, you can upload and instate hosts on an individual basis from the Active Clients window. Refer to page 62 for more information.

8.7 DATABASE SETTINGS AND PREFERENCES

Once you have connected to the database, you will not usually have to change the database settings provided that the IP address of the database machine does not change. If this is allocated by Dynamic Host Control Protocol (DHCP), you may need to change the settings and specify the name of the host PC should the IP address change.

NOTE: You can specify 127.0.0.1 in the IP address field if you want to use the Local Host.

8.7.1 Changing Database Settings

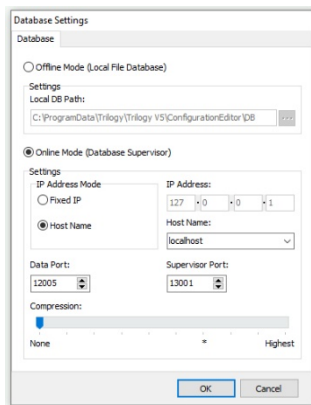

On the **Setup** menu, select **Database Settings...** to open the dialogue.

- Make the required changes to the settings. Refer to section 8.11.1 for details of the fields and settings.
- Click **OK** to save your settings.

If the settings are not correct, you will receive an error:

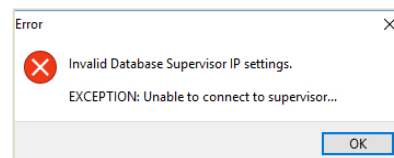

- Click **OK** in this box and review the database settings. If you still cannot connect to the database, ensure that the Database Supervisor is running and that the IP address or hostname is correct. Also, check that no hardware or software firewall is preventing the connection.

8.7.2 Using a Local Database

You can use a local database rather than connecting to a database on the network. If you do this, you must also specify the same local database in the Supervisor Settings for the Talkback Controller (TBC). Refer to *Mercury Talkback Controller* in section 29 of this User Guide for details.

A local database is used to develop the configuration when using the Release Candidate Workflow.

NOTE: If you have installed an Offline Configuration Editor, the local database setting will be selected by default.

To use a local database:

- On the **Setup** menu, select **Database Settings...** to open the dialogue.
- Click **Local Database**. The following warning is displayed:

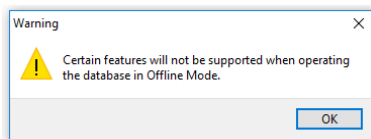

Click **OK** on this message to continue.

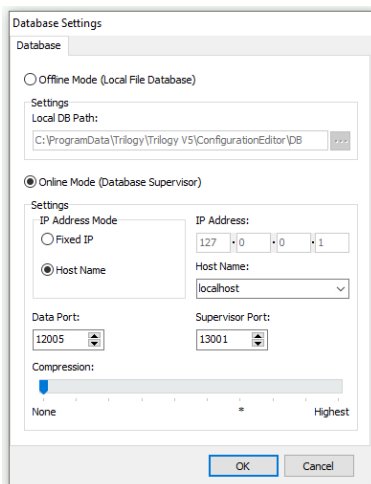

If necessary, specify the database folder. By default, this is:

C:\ProgramData\Trilogy\Mercury V5\ConfigurationEditor\DB

Click Browse  to select a different output folder for the local database.

Click **OK** and the Configuration Editor will connect to the local files and prompt you to log in.

Connection to the local file system database is indicated by a change to the header colour, from green to blue on Gateway, as shown below.



8.7.3 Preferences

The connection preferences can be changed to allow individual customisation of the application. On the **Setup** menu, select **Preferences...** to open the Preferences dialogue. There are three tabs, shown below.

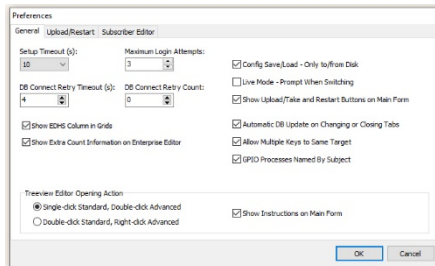

Refer to section 8.11.2 for details of settings that can be changed.

Click **OK** to save the changes.

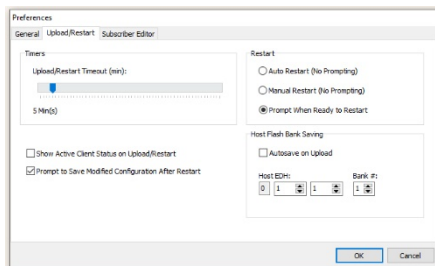

Refer to section 8.11.3 for details of settings that can be changed.

Click **OK** to save the changes.

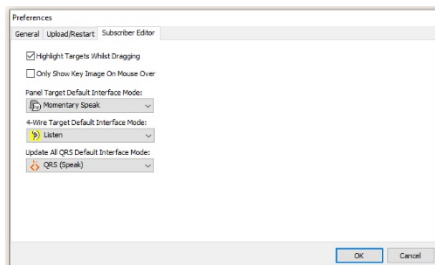

Refer to section 8.11.4 for details of settings that can be changed.

Click **OK** to save the changes.

8.8 ADMINISTRATOR PASSWORD

The default password for the **Admin** user is **trilogy**.

Other Local Administrators may be created (see section 28 - *Configuration Editor / Access Management*) and these will each have their password which can be changed using the Change Password option.

8.8.1 Changing the Administrator Password

If security is an issue, you can change the Administrator Password to ensure that the configuration cannot be accessed by unauthorised users.

To change the administrator password:

On the Gateway **Tools** menu, click **Change Password**. The Change Password dialogue is displayed.

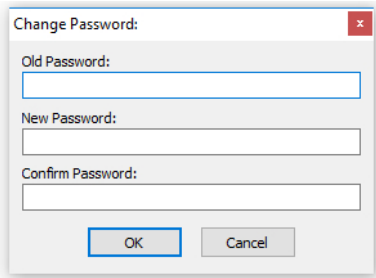

Enter old and new passwords.

Re-enter the new password for confirmation.

Click **OK**.

IMPORTANT: If you change the Admin user password and subsequently cannot remember the new one, you will need to reinstall the Database and Configuration Editor to reset the password back to default.

8.9 ACTIVE CLIENTS

The **Active Clients** option, on the **View** menu, lets you view a list of hosts that are currently connected to the database. These hosts will receive configuration updates if you carry out a configuration update (see page 56).

NOTE: This option is **not** available if you are using an Offline Configuration Editor connected to a local database.

8.9.1 Viewing Active Clients

Viewing active clients is also a useful troubleshooting tool since it shows:

- Hosts that are currently connected to the Mercury system.
- The configuration version that attached hosts are running.
- Whether the configuration is loaded and current.
- The EDHS address of each connected host.
- The IP address of each connected host.

To view active clients:

- On the **View** menu, click **Active Clients** to open the Active Clients' Status window.

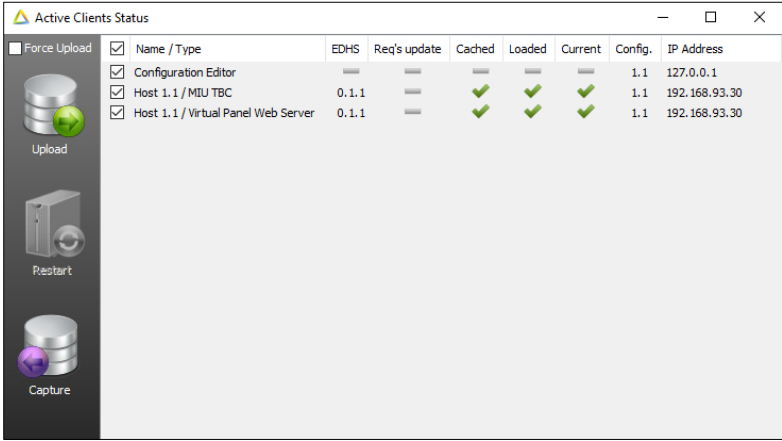

<input type="checkbox"/> Force Upload	<input checked="" type="checkbox"/>	Name / Type	EDHS	Req's update	Cached	Loaded	Current	Config.	IP Address
<input checked="" type="checkbox"/>	<input checked="" type="checkbox"/>	Configuration Editor	---	---	---	---	---	1.1	127.0.0.1
<input checked="" type="checkbox"/>	<input checked="" type="checkbox"/>	Host 1.1 / MIU TBC	0.1.1	---	✓	✓	✓	1.1	192.168.93.30
<input checked="" type="checkbox"/>	<input checked="" type="checkbox"/>	Host 1.1 / Virtual Panel Web Server	0.1.1	---	✓	✓	✓	1.1	192.168.93.30

8.9.2 Uploading and Restarting Active Clients

You can upload and restart hosts on an individual basis from the Active Clients window.









To upload and restart active clients:

- On the **View** menu, click **Active Clients** to open the Active Clients' Status window.
- Use the checkboxes adjacent to each Client and check/uncheck as appropriate. By default, all are checked.
- Press **Upload** to upload the configuration to the host.
- Press **Restart** to activate the configuration.

8.10 EDITOR BASICS

Once you have opened the Enterprise Editor, you will notice a series of buttons at the top of the window. You will see the same set of buttons on every Editor window in the system. Some of these buttons may be unavailable (for example if there is only one record in a list) and some may only be enabled when you make changes to the details.

The functions of the basic set of buttons on an Editor window are explained below:

Button	Usage
	Moves to the first record in a list.
	Moves to the previous record.
	Moves to the next record.
	Moves to the last record in the list.
	Posts (writes) the changes to the database.
	Cancels the changes made to the current record since the last post. If you have added a new record, this record will be removed.
	Refreshes the view and posts any changes.
	Moves the selected item up. Not available in the Enterprise Editor.
	Moves the selected item down. Not available in the Enterprise Editor.

8.10.1 Using Images

Images can be used to identify callers on Virtual Panels. The following image formats are accepted by Gateway and are then converted internally to JPG format: BMP, JPG, WMF and ICO.

You can either select individual records in a list or select more than one record at a time.

8.10.2 Selecting Records in Lists

- To select more than one record, hold down the **Ctrl** key and click the records that you want to select.
- To select records that are listed consecutively, click on the first one, hold down the **Shift** key and click the last one.

8.10.3 Deleting Records

Records can be deleted from the database if required. When you delete records from the database, you can either delete the required records individually (using the red - button) or delete them all at the same time (using the **Clear All** option of the right-click menu).

IMPORTANT: When you select **Clear All**, all records in the list will be permanently deleted from the configuration. Use this option with care.

8.11 GATEWAY FIELD DEFINITIONS

8.11.1 Gateway | Setup | Database Settings – Database tab

Field	Description
Offline Mode (Local File Database)	Select this radio button if the database is running locally. You will need to specify the location of the database files.
Online Mode (Database Supervisor)	Select this radio button if the database is located on a remote PC (specified in the Fixed IP or Host Name field).
IP Address Mode	Radio buttons select the mode of the IP connection to the PC hosting the database. Select either Fixed IP or Host Name .
IP Address	This field is used to specify the static IP address of the PC hosting the database. This is the preferred method.
Host Name	This field is used to specify the name of the PC hosting the database. It must be completed if the database is hosted on a PC with an IP address that is assigned by DHCP. This method is not recommended.
Data Port	The IP port that the DB Master (or Slave) uses for data connections. Changing this value changes the IP port number on which the database accepts incoming connections. This needs to be changed if: IP Port 12005 is in use elsewhere on the network by another application. Network security deems that another port should be used, or Network Address Translation /Port Address Translation (NAT/PAT) requires that another port is used. Changing this value also means that all clients (including slaves) must be configured to connect to the new port value. Default = 12005
Supervisor Port	The IP port that the Database Master (or Slave) listens for connection control data on. Changing this value changes the IP port number on which the database accepts incoming connections. This must be changed if: IP Port 13001 is in use elsewhere on the network by another application. Network security deems that another port should be used, or NAT/PAT requires that another port is used. Changing this value also means that all clients (including slaves) must be configured to connect to the new port value. Default = 13001
Compression	Compresses each transaction exchanged between server and clients by an adjustable amount. Useful on networks with limited bandwidth. The asterisk on the scale is a suggested starting point, giving a good compromise between CPU usage (to compress the data) and bandwidth saved.

8.11.2 Gateway | Setup | Preferences – General tab

Field / Display Item	Description
Setup Timeout	The time, in seconds, in which the Configuration Editor will timeout on a connection to the Database Supervisor. Options are: Never -- Windows TCP timeout. Numerical Value in seconds -- Override Windows timeout. Range 1–60 seconds. Default = 10 seconds.
Maximum Login Attempts	Specifies the maximum number of login attempts before the application automatically closes. Default = 4. Range = 1–10.
DB Connect Retry Timeout (s)	Specifies the database connection retry timeout, in seconds. Default = 4 seconds. Range = 1–5 seconds.
DB Connect Retry Count	Specifies the number of times a database connection will be retried if not successful. Default = 4. Range = 1–5.
Show EDHS Column in grids	If checked will display an EDHS column in the Hosts grid on the Domain General tab. Default = checked.
Show extra count information on Enterprise Editor	If checked will display extra count columns in top level grids for: <ul style="list-style-type: none"> • Groups – Sources, Triggers, Destinations • Conferences – 4-Wires, Panels, Phones • IFBs – Sources, Triggers Destinations Default = unchecked. (Note: Checking the checkbox on larger configs might involve a longer delay to compute the count data)
Treeview Editor Opening Action	2 option radio buttons: <ul style="list-style-type: none"> • Single-click basic – Double-click advanced • Double-click basic – Right-click advanced
Config save/load only to/from disk	If unchecked, as a configuration is saved, the user is prompted to create an additional backup to a host. If checked, then the configuration is saved to disk only. Default = checked.
Live mode – prompt when switching	If checked, will prompt the user when switching to/from Live Mode. Default = unchecked.
Show Upload/Take and Restart buttons on main form	If checked, will display the Upload/Take and Restart buttons on the main form task bar. Default = checked.
Automatic DB update on changing or closing tabs	If checked, will automatically update database records and fields when changing tab data and closing the tab without prompting the user. If unchecked the user will be shown a prompt dialog. Default = checked.
Allow multiple keys to same target	If checked, then it is possible to configure more than one key on a panel to the same destination. If left unchecked it is only possible to have one key to any given subscriber on a panel. Default = checked.
GPIO processes named by subject	Relates to GPIO process screens and causes the GPIO routing statement name to be derived from the statement itself, instead of using a default, potentially unfriendly, name. Default = checked.
Show Instructions on Main Form	If checked will display instructions on the main form background regarding the mouse clicks to access the Standard or Advanced editors. Default = checked.

8.11.3 Gateway | Setup | Preferences – Upload/Restart tab

Field/Display Item	Description
Upload/Restart Timeout	Global timeout when carrying out the Upload/Restart process. If the process cannot be completed (e.g. due to poor network connection), attempts will stop after this time. Range: 1 minute – 60 minutes. Default = 5 minutes.
Show Active Client status on Upload/Restart	Displays the Active Clients' Status window when updating Mercury hosts with a new or modified configuration. This, in turn, displays the progress of the delivery of the configuration to all hosts, and when complete, restarts with the new version. Default = checked.
Prompt to Save Modified Configuration after restart	If checked will prompt the user to save the current configuration file after a configuration has been restarted. Default = checked.
Restart	3 options selected by radio buttons: <ul style="list-style-type: none"> • Auto Restart (no prompt) • Manual Restart (no prompt) • Prompt when ready to restart – default selection
Host Flash Bank Saving	Automatic Save on Upload [checkbox] – default = off Controls define the EDH and bank of the desired "save" location

8.11.4 Gateway | Setup | Preferences – Subscriber Editor tab

Field/Display Item	Description
Highlight Targets while Dragging	If checked will display a dotted line on the subscriber sources layout tab as targets are dragged and dropped on the visual display. Default = checked.
Only show key image on mouse over	If checked the subscriber sources layout tab will only show the key type icons as the mouse moves over the active key area on the visual display. Default = unchecked.
Panel Target Default Interface Mode	Default key type to assign when adding panel targets to a subscriber panel. Default = Momentary Speak
4-wire Target Default Interface Mode	Default key type to assign when adding 4-Wire targets to a subscriber panel. Default = Listen
Update All QRS Default Interface Mode	Default QRS key type to assign when adding QRS keys to a subscriber panel. Default = QRS (Speak)

9. CONFIGURATION EDITOR | ENTERPRISE

9.1 OVERVIEW

The Enterprise Editor is one of a series of Editors that you will use to define the structure and components of your Mercury system. It is the 'top-level Editor and is used to define the overall structure of your Enterprise.

Use it to add and delete domains, conferences, groups, IFBs, SIP connections, zones, areas and ring tones.

Once these have been created, use the relevant Editor to configure the various Mercury objects. Refer to the appropriate chapter of this Configuration Guide for full configuration details:

NOTE: You can create your configuration in any order, but we would recommend that you create the physical structure first (domains - hosts - subscribers) and then add in virtual entities such as groups, conferences etc.

Before you start creating your configuration and defining the Enterprise, it is important that you fully understand the structure of the Enterprise that you want to model using Gateway. Taking time before you start avoids problems later.

TIP: Mercury objects are generally created (and deleted) either one level above in the Enterprise tree or on the overview page for that entity. For example, domains are created and deleted using the Enterprise Editor but configured using the Domain Editor.

9.2 USING THE ENTERPRISE EDITOR

9.2.1 Opening the Enterprise Editor

To open the Standard Enterprise Editor:

- Single-click on the Enterprise name to open the standard editor.
- This offers fields to edit the Enterprise name and to adjust the database version numbering plan.

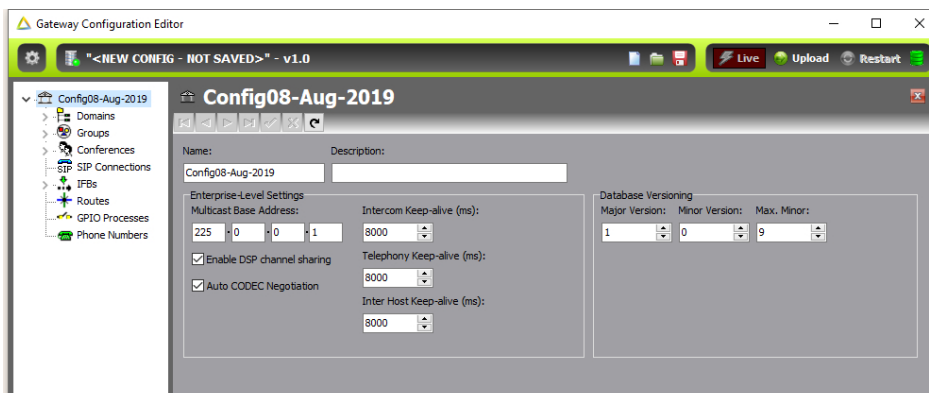

To open the Advanced Enterprise Editor:

- Double-click on the Enterprise name to open the advanced editor.
- This offers multiple tabs as described below.

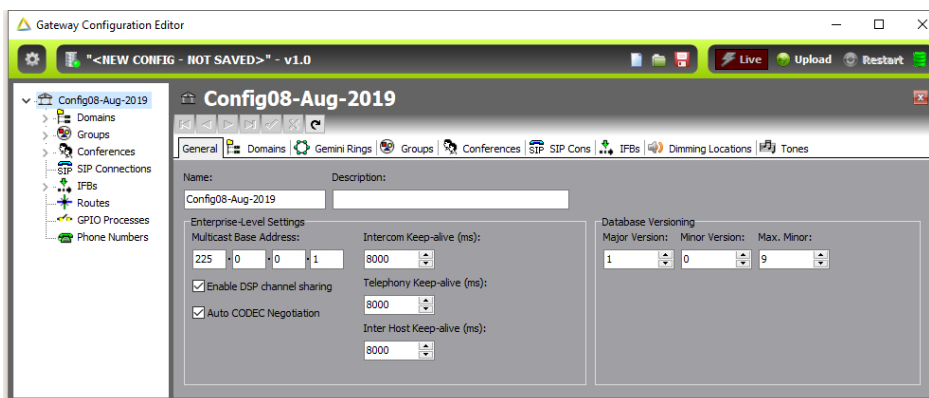

9.2.2 The Enterprise Editor Tabs

The Enterprise Editor has the following tabs which are used to define the basic structure of your Enterprise:

- **General** tab, to change basic details relating to the Enterprise.
- **Domains** tab, to add and configure domains.
- **Gemini Rings** tab, to manage Gemini HSL connections
- **Groups** tab, to add groups to the Enterprise.
- **Conferences** tab, to add conferences to the Enterprise.
- **SIP Cons** tab, to add SIP connections to the Enterprise.
- **IFBs** tab, to add IFBs to the Enterprise.
- **Dimming Locations** tab to define Dimming Locations.
- **Tones** tab, to define custom ring tones for use in Gateway.

9.3 ENTERPRISE EDITOR - GENERAL

The Enterprise Editor - General tab lets you specify basic details about an Enterprise, including its name, description and the first multicast base address.

9.3.1 Changing Enterprise Details

You can change the basic details relating to your Enterprise, as required. For example, you may wish to rename the Enterprise or enter a description.

To change Enterprise details:

Open the Enterprise Editor. The **General** tab is selected by default.

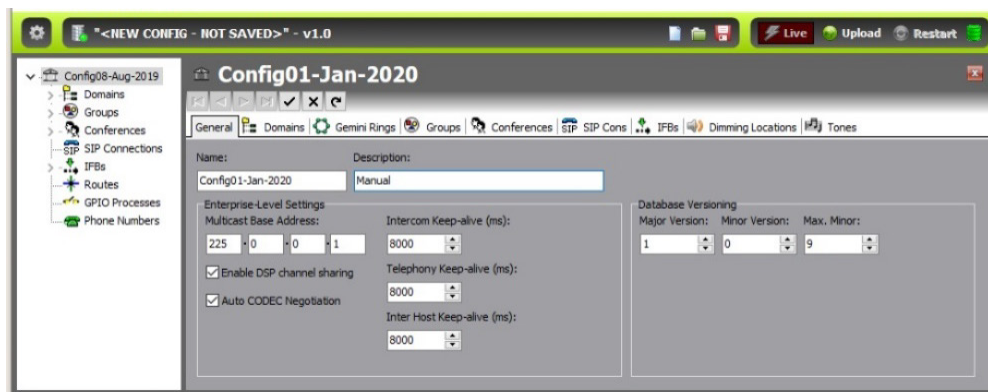

Make the required changes to the Enterprise details.

Click to post changes to the database.

MORE INFORMATION: Refer to section 9.12.1 for a description of the fields on the Enterprise Editor - Details tab.

9.4 ENTERPRISE EDITOR - DOMAINS

A domain is a collection of hosts that share a common IP network (network ID, subnet mask and default gateway). The Enterprise Editor - Domains tab is used to add domains to your Enterprise, make changes to existing domains and to delete any domains that are no longer part of the Enterprise.

Buttons at the top of the **Domains** tab let you:

- Add a new domain. (Hosts and subscribers will need to be manually added).
- Delete a selected domain (after confirmation).

9.4.1 Adding a Domain

A domain is a logical grouping of hosts. Domains are predominantly groupings of convenience, allowing a system to be segregated into separate areas. There are two ways to add a new domain: you can either add a blank domain or duplicate an existing domain.

NOTE: Your default configuration will contain one domain. More can be added, as required.

To add a domain:

Open the Enterprise Editor and click the **Domains** tab.

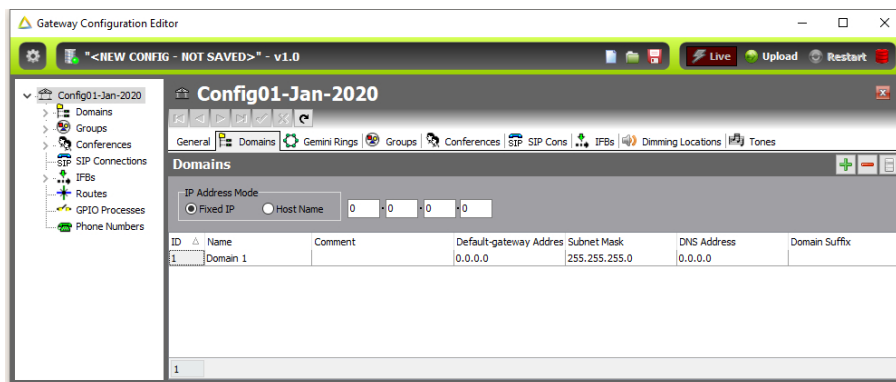

Click **Add**. The **Enter Number** dialogue is displayed.

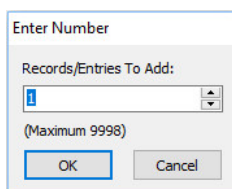

Specify how many domains you want to add then click **OK** to create them.

New domains are given a default name which can be changed, if required, to match the structure of your network.

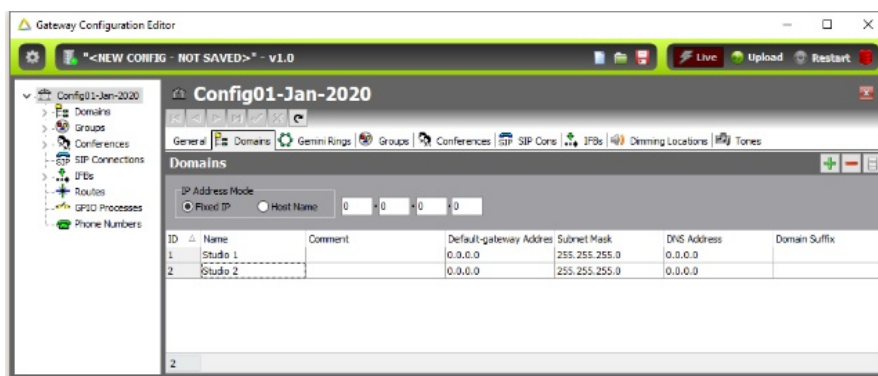

9.4.2 Duplicating a Domain

Duplicating a domain adds the domain and automatically duplicates the hosts and subscribers under the selected domain.

To duplicate a domain:

- Open the Enterprise Editor and click the **Domains** tab.
- Select that domain that you want to duplicate.
- Right-click and select **Duplicate** from the context menu.
- Specify how many domains you want to add (based on the selected domain).
- Click **OK** to duplicate the domain and its hosts and subscribers.

9.4.3 Changing a Domain

You can change the name of a domain and add and change comments which can be used to describe the domain in more detail. The IP default gateway address cannot be changed. This is specified using the Domain Editor.

To change domain details:

- Open the Enterprise Editor and click the **Domains** tab.
- Change the name of the domain and add or change comments, as required.
- Click to post changes to the database.

MORE INFORMATION: Refer to section 9.12.2 - *Enterprise Editor - Domains tab* for a description of the fields.

9.4.4 Deleting a Domain

Domains can be deleted if they are no longer required. It is advisable to take a copy of the configuration before deleting a domain so that you can load in the original configuration should this be required later.

You can delete selected domains (using the Delete button) or delete all domains at the same time (using the right-click option).

IMPORTANT: Deleting a domain will also delete all the hosts that have been added to that domain.

9.5 ENTERPRISE EDITOR – GEMINI RINGS

A Gemini Ring is used to define the interconnection of multiple Gemini hosts using the HSL (High Speed Link) connection. HSL allows Gemini to provide programme quality audio to hosts connected in this way. The ring should be circular and closed, so the last host in the chain must connect back to the first in the chain. The actual physical sequence of connections is not important.

Gemini hosts are assigned to rings using the Host editor: the Enterprise merely defines the existence of any rings.

NOTE: MIU and MCU hosts cannot be added to rings.

The Enterprise Editor – Gemini Rings tab is used to add rings to your Enterprise, modify existing rings and to delete any rings that are no longer part of the Enterprise.

Buttons at the top of the rings tab let you:

- Add a new Gemini Ring.
- Delete a selected Gemini Ring (after confirmation).

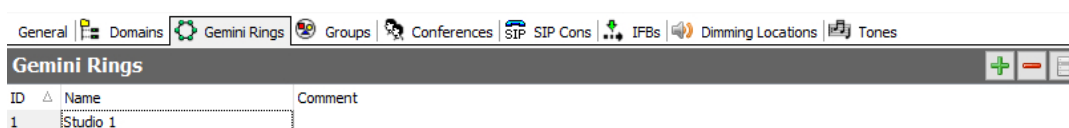

9.5.1 Managing Gemini Rings

By default, an Enterprise will not contain any Gemini Rings. They can be added, as needed. Follow the same process as outlined previously to add, delete, or edit the details of Gemini Rings.

Click to post changes to the database.

IMPORTANT: When you delete Gemini Rings, any Gemini hosts which had been assigned to that ring will now be independent but will continue to communicate over IP.

9.6 ENTERPRISE EDITOR - GROUPS

A group is a collection of user-defined subscribers. The Enterprise Editor - Groups tab is used to add groups to your Enterprise and to delete any groups that are no longer part of the Enterprise.

Buttons at the top of the Groups tab let you:

- Add a new group.
- Delete a selected group (after confirmation).

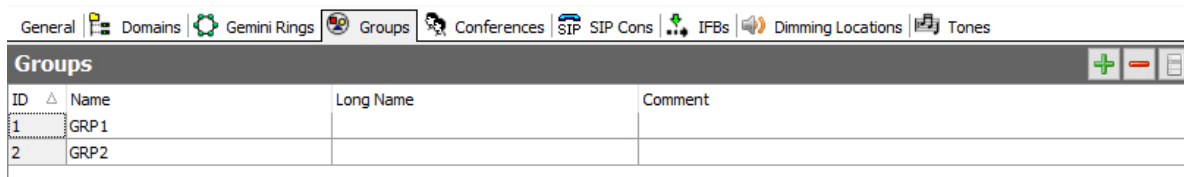

ID	Name	Long Name	Comment
1	GRP1		
2	GRP2		

9.6.1 Managing Groups

By default, an Enterprise will contain two groups which are added when the configuration is created. More can be added, as needed. Follow the same process as outlined in the previous section to add, delete, or edit the details of Groups.

Click to post changes to the database.

IMPORTANT: When you delete groups, all references to the deleted groups will be lost. Any keys targeting deleted groups will be automatically removed from panels.

9.7 ENTERPRISE EDITOR - CONFERENCES

A conference is a special type of group. It sets up communication between a group of subscribers where each subscriber has the choice of whether to join in, listen-only, or switch off.

Panels and 4-wires can be included in a conference. Multicasting is used to minimise bandwidth usage.

The maximum number of active speaking conference members may be limited to further control bandwidth and IP channel usage or for other operational reasons.

Panel members are simply added by targeting a key at the conference.

Each speaking Mercury host will multicast audio and each listening host can receive multiple audio streams if many people speak.

NOTE: Conferences use multicast audio whereas groups do not. However, not all networks support multicast. Mercury conferences will not function on networks that do not support multicast.

The Enterprise Editor - Conferences tab is used to add conferences to your Enterprise, modify existing conferences and to delete any conferences that are no longer required.

Buttons at the top of the Conferences tab let you:

- Add a new conference.
- Delete a selected conference (after confirmation).

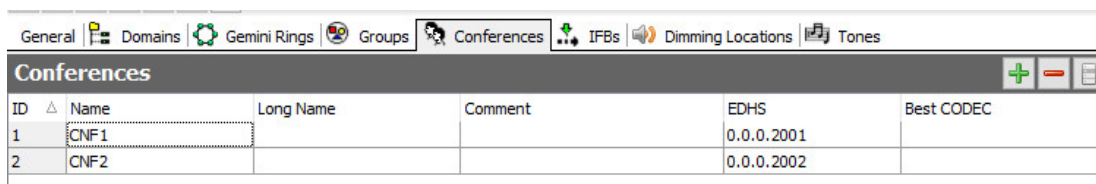

ID	Name	Long Name	Comment	EDHS	Best CODEC
1	CNF1			0.0.0.2001	
2	CNF2			0.0.0.2002	

9.7.1 Managing Conferences

By default, an Enterprise will contain two conferences which are added when the configuration is created. More can be added, as needed. Follow the same process as outlined previously to add, delete, or edit the details of Conferences.

Click to post changes to the database.

IMPORTANT: When you delete conferences, all references to the deleted conferences are lost. Any keys targeting deleted conferences are automatically removed from panels.

9.8 ENTERPRISE EDITOR - SIP CONNECTIONS

SIP is an open, standards-based protocol for negotiating voice and multimedia calls over a network. The addition of SIP provides Mercury with the capability to make and receive SIP VoIP calls to any configured, basic SIP devices that may be present on the network.

A SIP connection is an object used to identify a SIP entity that exists outside of Mercury.

Buttons at the top of the SIP Con's tab let you:

- Add a new SIP connection.
- Delete a selected SIP connection (after confirmation).

9.8.1 Managing SIP Connections

By default, an Enterprise will not contain any SIP connections. If you intend to use SIP, you must add the required number of connections using the Enterprise Editor.

IMPORTANT: When you delete SIP connections, all references to the deleted connection will be lost. Any keys targeting deleted SIP connections will be automatically removed from panels.

9.9 ENTERPRISE EDITOR - IFBs

An IFB is an audio route that can be broken into or interrupted by a third party, replacing the original audio with the third-party panel microphone. It comprises the IFB destination (usually a 4-wire port) and the IFB interrupt that generates the control signal and interrupting audio. There is one additional audio signal which is the standing feed which is present before the interrupt takes place. This is referred to as the IFB Source.

The Enterprise Editor - IFBs tab is used to add IFBs to your Enterprise, modify existing IFBs and to delete any IFBs that are no longer part of the Enterprise.

Buttons at the top of the IFBs tab let you:

- Add a new IFB.
- Delete a selected IFB (after confirmation).

ID	Name	Long Name	Comment	EDHS
1	IFB 1			0.0.0.4001

9.9.1 Managing IFBs

By default, an Enterprise will contain one IFB which is added when the configuration is created. More can be added, as needed. Follow the same process as outlined previously to add, delete, or edit the details of IFBs.

Click to post changes to the database.

IMPORTANT: When you delete IFBs, all references to the deleted IFBs will be lost. Any keys targeting deleted IFBs will be automatically removed from panels.

9.10 ENTERPRISE EDITOR – DIMMING LOCATIONS

ID	Name	Comment	Master Location
1	Studio 1		<input type="checkbox"/>

Dimming Locations are only available with Gemini hosts and are explained in Broadcast specific manuals.

9.11 ENTERPRISE EDITOR - TONES

Use the Enterprise Editor - Tones tab to define custom ring tones for use in Gateway. Tones are a combination of none, one, two or four different tones with a configurable up and down period (amplitude). Up to 16 tones can be defined.

The requirements are:

- Sequences have two phases (frequencies) and a repeat/continuous attribute as follows:
 - Phase1.** Zero, one or two tones from the four available tones can be selected. The amplitude of each tone can be set separately, between +12 dB and -60 dB. The selected tones can be gated on for a configurable period, between 0 and 10,000 ms.
 - Phase2.** Zero, one or two tones from the four available tones can be selected. The amplitude of each tone can be set separately, between +12 dB and -60 dB. The selected tones can be gated on for a configurable period, between 0 and 10,000 ms.
- The sequence can be set to repeat until turned off (as used, for example, for phone ringing) or as a once-off (as used, for example, as a call alert; e.g. a “bing-bong”).

9.11.1 Changing a Tone

Tones can be changed, as required. They cannot be added or deleted.

To change a tone:

Open the Enterprise Editor and click the **Tones** tab.

Tones											
ID	Description	Repeat	Frequency 1				Frequency 2				
			First	Second	Amp.	Dur.	First	Second	Amp.	Dur.	
1	Tone 1	<input type="checkbox"/>	620 Hz	None	0	300	440 Hz	None	0	200	
2	US Busy	<input checked="" type="checkbox"/>	480 Hz	620 Hz	0	500	None	None	0	500	
3	US Ring	<input checked="" type="checkbox"/>	440 Hz	480 Hz	0	2000	None	None	0	4000	
4	US On-hold	<input checked="" type="checkbox"/>	440 Hz	None	0	300	None	None	0	5000	
5	Tone 5	<input checked="" type="checkbox"/>	880 Hz	620 Hz	0	1000	440 Hz	480 Hz	0	500	
6	Tone 6	<input type="checkbox"/>	880 Hz	440 Hz	0	5000	None	None	0	1000	
7	Tone 7	<input type="checkbox"/>	620 Hz	480 Hz	0	3000	None	None	0	1000	
8	EU Busy	<input checked="" type="checkbox"/>	440 Hz	None	0	250	None	None	0	250	
9	EU Ring	<input checked="" type="checkbox"/>	440 Hz	None	0	1000	None	None	0	4000	
10	EU On-hold	<input checked="" type="checkbox"/>	440 Hz	None	0	500	None	None	0	8000	
11	Tone 11	<input type="checkbox"/>	880 Hz	None	0	500	440 Hz	None	0	500	
12	Tone 12	<input type="checkbox"/>	880 Hz	None	0	500	440 Hz	None	0	500	
13	Tone 13	<input type="checkbox"/>	880 Hz	None	0	500	440 Hz	None	0	500	
14	Tone 14	<input type="checkbox"/>	880 Hz	None	0	500	440 Hz	None	0	500	
15	Tone 15	<input type="checkbox"/>	880 Hz	None	0	500	440 Hz	None	0	500	
16	Tone 16	<input type="checkbox"/>	880 Hz	None	0	500	440 Hz	None	0	500	

Make the required changes to the frequency settings and click to post changes to the database.

9.12 ENTERPRISE EDITOR - FIELD DEFINITIONS

9.12.1 Enterprise Editor - General tab

Field/Display Item	Description
Name	A default name is given to the Enterprise when it is created (this name is based on the date the configuration is created). The name can be changed to something more descriptive if required. The name is for information only. Maximum length = 54 characters.
Description	A description of the Enterprise. This description is for information only. Maximum length = 70 characters.
Multicast base address	Multicast addresses are used so devices can transmit audio traffic via a single multicast address to multiple hosts, rather than via individual IP connections. They can be used by conferences. Multicast addresses fall in the range of 224.0.0.0 to 239.255.255.255. The base address must be entered in this field, which is used by the first Mercury host. Each subsequent host has a value 32 times higher in the last IP octet than the preceding host. The multicast base address can be set on a per-host basis in the range 224.0.1.0 to 238.0.0.0.
Enable DSP channel sharing	When checked, optimizes the use of DSP channels and will share DSP channels where possible. Default = Checked.
Auto CODEC Negotiation	When checked, automatically negotiates the best codec to use. Default = Checked.
Intercom Keep-alive (ms)	The period in which all hosts in the Enterprise will contact each other with a "heartbeat" network message. A setting of zero disables this functionality. Recommended setting and default = 8000 ms. Minimum = 5000 ms, maximum = 120000 ms (120 s)
Telephony Keep-alive (ms)	Like Intercom keep-alive but used for calls to FXO, FXS and E&M devices, rather than for intercom calls. Recommended setting and default = 8000 ms. Minimum = 5000 ms, maximum = 120000 ms (120 s)
Inter-Host Keep-alive (ms)	The period between keep-alive packets sent to maintain a data connection between hosts. Recommended setting and default = 8000 ms. Minimum = 5000 ms, Maximum = 120000 ms (120 s)
Major version	Configuration version numbers have the following format: X.Y X is the major version of the current configuration. This usually starts at 1 and increments each time the minor revision (Y) reaches a certain value (see below). Using version control for a particular configuration allows a reference or a backup configuration that is known to be "good" to be identified. It can also be used to catalogue changes. The major version can be changed as required.
Minor version	The minor version is incremented each time a configuration update is sent to the TBCs running on the Mercury hosts.
Max. Minor	When the minor version reaches the value specified here it is reset to zero and the major version is incremented.

9.12.2 Enterprise Editor - Domains tab

Field/Display Item	Description
ID	A number to identify the domain. This cannot be changed.
Name	The name of the domain. Defaults to Domain 1, 2, etc. but can be changed. A descriptive domain name is recommended; names do not have to be unique. Maximum length = 20 characters.
Comment	Comments relating to the selected domain. To add comments, select the domain (click once on the line), click in this field and enter your comments. Maximum length = 255 characters.
Default gateway address	The IP gateway address, if this has been entered for the selected domain. To set or edit the IP gateway address, highlight the row, then enter the address in the edit boxes alongside the radio buttons.
Subnet Mask	The subnet mask set for this domain. This may be entered here, at the Enterprise level, or using the Domain Editor.
DNS Address	The IP address of a Domain Name Server assigned for this domain. This may be entered here, at the Enterprise level, or using the Domain Editor.
Domain Suffix	The Domain Name Suffix appended to a hostname to define a fully qualified domain name (FQDN). This field can be set when IP Address Mode is set to Host Name. This may be entered here, at the Enterprise level, or using the Domain Editor.

9.12.3 Enterprise Editor – Gemini Rings tab

Field/Display Item	Description
ID	A number to identify the ring. This cannot be changed.
Name	The name of the ring. Defaults to Gemini Ring 1, Gemini Ring 2, etc. but can be changed. The name does not have to be unique. Maximum length = 20 characters.
Comment	Comments relating to a selected ring. To add comments, select the record (click once on the line), click in this field and enter your comments. Maximum length = 255 characters.

9.12.4 Enterprise Editor - Groups tab

Field/Display Item	Description
ID	A number to identify the group. This cannot be changed.
Name	The name of the group. Defaults to GRP1, GRP2, etc. but can be changed. The name does not have to be unique. Maximum length = 20 characters.
Long Name	An alternative name which, if set, will be used on control panels with displays supporting 8 characters.
Comment	Comments relating to a selected group. To add comments, select the group (click once on the line), click in this field and enter your comments. Maximum length = 255 characters.

9.12.5 Enterprise Editor - Conferences tab

Field/Display Item	Description
ID	A number to identify the conference. This cannot be changed.
Name	The name of the conference. Defaults to CNF1, CNF2, etc. but can be changed. The name does not have to be unique. Maximum length = 20 characters.
Long Name	An alternative name which, if set, will be used on control panels with displays supporting 8 characters.
Comment	Comments relating to a selected conference. To add comments, select the conference (click once on the line), click in this field and enter your comments. Maximum length = 255 characters.
EDHS	Shows the EDHS address of the conference. This is allocated automatically. Addresses 2xxx are reserved for conferences.
Best CODEC	Read-only field displays the Best CODEC as selected on the Conference Editor.

9.12.6 Enterprise Editor – SIP Con's tab

Field/Display Item	Description
ID	A number to identify the SIP connection. This cannot be changed.
Name	The name of the SIP connection. Defaults to SIP1, SIP2, etc., but can be changed. The SIP name does not have to be unique. Maximum length = 20 characters.
Comment	Comments relating to a selected SIP connection. To add comments, select the SIP (click once on the line), click in this field and enter your comments. Maximum length = 255 characters.
EDHS	Shows the EDHS address of the SIP connection. This is allocated automatically. Addresses 6xxx are reserved for SIP connections.

9.12.7 Enterprise Editor - IFBs tab

Field/Display Item	Description
ID	A number to identify the IFB. This cannot be changed.
Name	The name of the IFB. Defaults to IFB1, IFB2, etc. but can be changed. The IFB name does not have to be unique. Maximum length = 20 characters.
Long Name	An alternative name which, if set, will be used on control panels with displays supporting 8 characters.
Comment	Comments relating to a selected IFB. To add comments, select the IFB (click once on the line), click in this field and enter your comments. Maximum length = 255 characters.
EDHS	Shows the EDHS address of the IFB. This is allocated automatically. Addresses 4xxx are reserved for IFBs.

9.12.8 Enterprise Editor – Dimming Locations tab

Field/Display Item	Description
ID	A number to identify the Dimming Location. This cannot be changed.
Name	The name of the Dimming Location. Defaults to Dimming Location 1, Dimming Location 2, etc. but can be changed. The Dimming Location name does not have to be unique. Maximum length = 20 characters.
Comment	Comments relating to a selected Dimming Location. To add comments, select the Dimming Location (click once on the line), click in this field and enter your comments. Maximum length = 255 characters.
Master Location	A Dimming Location can be configured as a 'Master Location'. Panels within a master location are those which will not have routes dimmed when a complex howround scenario occurs.

9.12.9 Enterprise Editor - Tones tab

Field/Display Item	Description
ID	An ID used to identify the tone. This cannot be changed.
Description	User description for the tone. Maximum length = 32 characters.
Repeat	Repeat tone or a single "bing-bong".
Frequency 1	First: First tone for phase 1.
	Second: Second tone for phase 1.
	Amp: The amplitude of the tone.
	Dur: The duration of the tone.
Frequency 2	First: First tone for phase 1.
	Second: Second tone for phase 1.
	Amp: The amplitude of the tone.
	Dur: The duration of the tone.

10. CONFIGURATION EDITOR | DOMAIN

10.1 OVERVIEW

A domain is a logical grouping of hosts. These are predominantly groupings of convenience, allowing a system to be segregated into separate areas. Mercury hosts on different IP networks must reside on different Mercury domains to each other.

Domains are added to an Enterprise using the Enterprise Editor or on the overview page for all Domains.

Once domains have been added, use the Domain Editor to configure each domain to add or delete hosts, and specify the IP address of the network gateway if you have more than one IP domain.

As explained earlier, the basic domain editor should provide sufficient control for most day-to-day tasks: the advanced editor is used initially and will be described here.

10.2 USING THE DOMAIN EDITOR

10.2.1 Viewing a List of Domains

All of the domains that are added using the Enterprise Editor are grouped together under ‘Domains’ in the Enterprise tree.

To view a list of domains:

- Expand the Enterprise tree in Gateway.
- Single-click on Domains.

The details panel now lists all the domains that have been defined and allows some basic tasks to be performed.

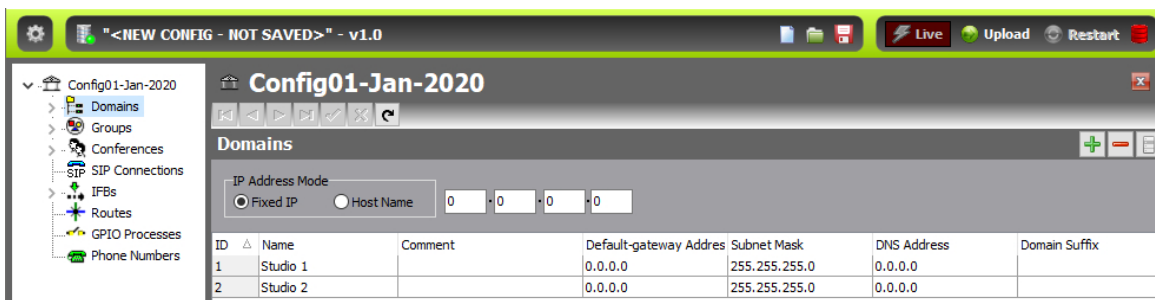

10.2.2 Viewing a Summary of Hosts within a Domain

Hosts are added to a domain using the Domain Editor. You can quickly view a list of hosts in a domain by selecting the domain in the Enterprise tree.

To view a list of hosts in a domain:

- Click the “right arrow” next to Domains in the Enterprise tree to list the available domains.
- Single-click on the first domain - Studio 1.

The basic editor lists all the hosts within the selected domain and allows most routine tasks to be performed. In this instance, there are two 32 Port MIU hosts.

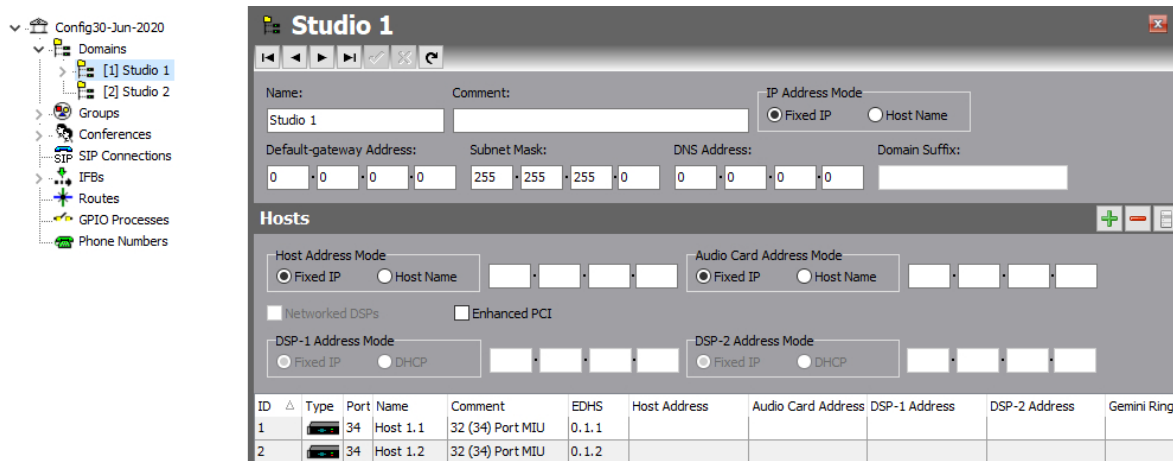

10.2.3 Opening the Domain Editor

Domains are maintained using the Domain Editor.

To open the Domain Editor:

- Expand **Domains** in the Enterprise tree.
- Double-click on the requisite domain to open the advanced Domain Editor. By default, the General tab is displayed.

ID	Type	Port	Name	Comment	EDHS	Host Address	Audio Card Address	DSP-1 Address	DSP-2 Address	Gemini Ring	Cmdr. #
1	Host	34	Host 1.1	32 (34) Port MIU	0.1.1						100
2	Host	34	Host 1.2	32 (34) Port MIU	0.1.2						101

10.2.4 The Domain Editor Tabs

The Domain Editor has three tabs which are outlined below.

General

The General tab shows the name of the domain, as specified when the domain was added to the Enterprise. This name can be changed, and a comment can also be added if required. Edit as required then press the tick to post changes to the database.

The General tab is also used to add and maintain hosts in the selected domain. Hosts can also be swapped, adopted and duplicated. Any hosts that are not required can be deleted.

The General tab is also used to set the IP address of the IP gateway when multiple domains are present in the Enterprise.

SIP Proxy/Redirect

The SIP Proxy/Redirect tab is used to add and maintain SIP Proxy/Redirect Servers. Up to five servers may be defined. Servers that are no longer required can be deleted.

CODEC Profiles

The CODEC Profiles tab is used to make changes to CODEC profiles used by hosts in the domain.

10.3 DOMAIN EDITOR - GENERAL

The Domain Editor - General tab shows the name of the selected domain, as specified using the Enterprise Editor, and any comments that have already been entered for that domain.

10.3.1 Changing Domain details

- The name of a domain can be changed, as required. Comments can also be added. Change the name of the domain or add a comment if required.
- Click to post changes to the database.

10.3.2 Managing Hosts

The Domain Editor - General tab shows a list of all hosts currently defined for the selected domain. Buttons at the top of the Hosts tab let you:

- Add hosts of specified types to the domain.
- Delete one or more hosts from the domain.

The right-click context menu allows you to:

- Swap the EDHS address of the selected host with that of another host in the domain.
- Adopt a host from another domain. This removes the host from the first domain and adds it to the second domain. The EDHS address is automatically updated when a host is adopted. Use the Adopt function when you are migrating hosts.
- Duplicate a host that is already part of the domain. Duplicate hosts when you are expanding the configuration and adding new hardware.

10.3.3 Adding Hosts to a Domain

Hosts can be added to a domain by adding a new host record, by adopting a host from another domain or by duplicating a host that already exists.

NOTE: Duplicating or adopting a host will include any subscribers already defined on that host in the new one.

To add a host to the domain:

- Open the Domain Editor and click the **General** tab.

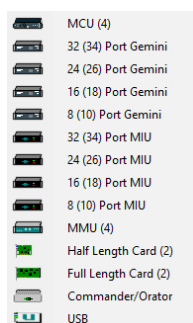

Click the green + button and select the host type from the pop-up list.

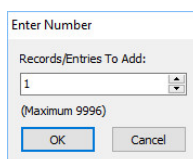

Specify the number of hosts of the selected type that you wish to add.

- Click **OK** to add the host(s). You can edit the name or add a comment if required.
- Click to post changes to the database.

10.3.4 Adopting Hosts

Hosts can also be adopted from another domain. When you adopt a host, it is removed from the other domain and added to the current domain. All host settings are retained when a host is adopted.

To adopt a host:

Open the Domain Editor and click the **General** tab.

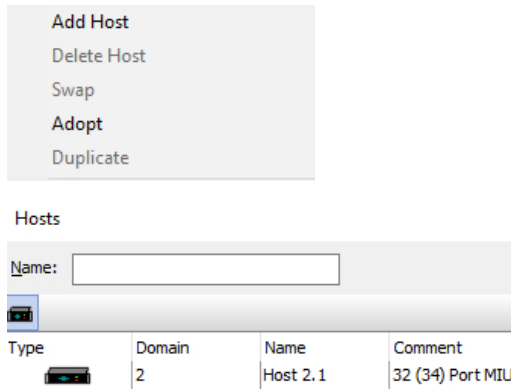

Right-click in the free space below the list of hosts, to display the context menu. Select “Adopt” and a list of hosts currently available for adoption will be displayed. This is a list of hosts in other domains.

Select the required host and click **Apply** at the bottom of the list box. The host will now move across to the other domain.

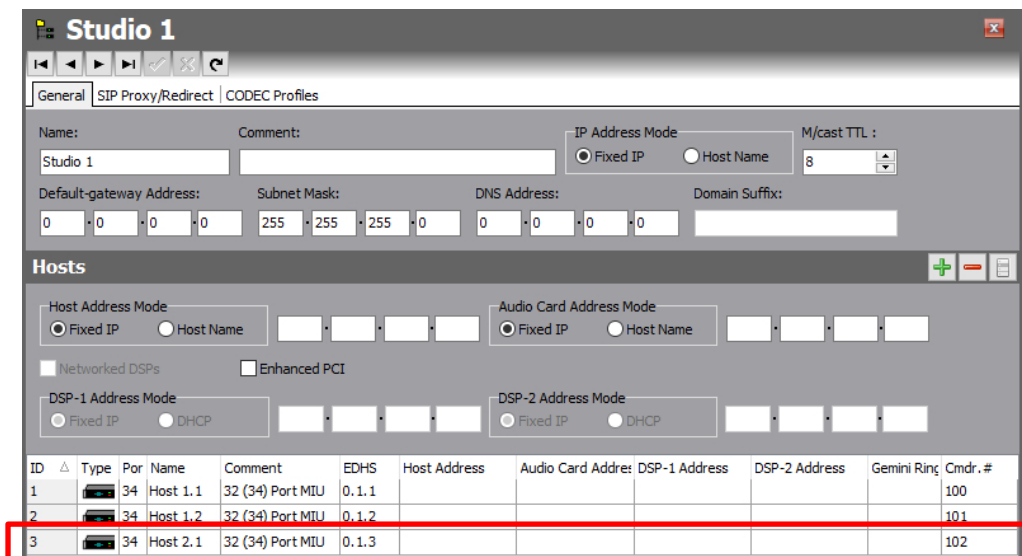

The EDHS address of the adopted host is automatically corrected to reflect its new domain. The name, however, has not changed and should be edited to avoid confusion.

Domain 1 now contains 3 hosts.

10.3.5 Duplicating Hosts

Another way to add a new host to your configuration is to duplicate a host that is already in the domain.

NOTE: The following parameters are duplicated when you duplicate a host: port types, subscribers and subscriber settings, port settings, virtual ports, telephony board termination settings and audio trunking ports.

To duplicate a host:

- Open the Domain Editor and click the **General** tab.
- Right-click on the host you wish to duplicate and select the **Duplicate** option from the context menu.
- In the “enter number” dialogue box, choose the number of duplicate copies you wish to create, and press **OK**.

EDHS numbers are corrected automatically. The example below shows one additional duplicate copy of named Host 2.1, which has been automatically named as Host 1.4.

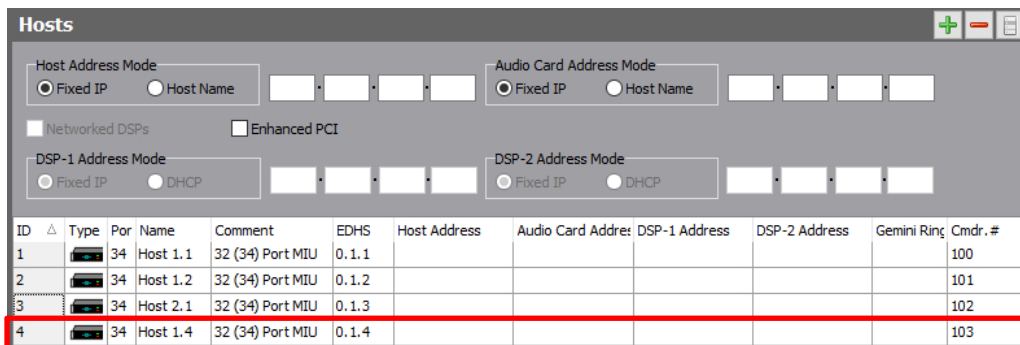

ID	Type	Por	Name	Comment	EDHS	Host Address	Audio Card Address	DSP-1 Address	DSP-2 Address	Gemini Ring	Cmdr. #
1	34	34	Host 1.1	32 (34) Port MIU	0.1.1						100
2	34	34	Host 1.2	32 (34) Port MIU	0.1.2						101
3	34	34	Host 2.1	32 (34) Port MIU	0.1.3						102
4	34	34	Host 1.4	32 (34) Port MIU	0.1.4						103

10.3.6 Changing Host Details

You can change host details, as required. The fields that you can change are - Name, Comment, the Host (Windows) IP Address, Audio Card IP Address. If the host is fitted with Networked DSP, it must first be enabled, then the two additional IP addresses may be added or edited.

To change host details:

- Open the Domain Editor and click the **Hosts** tab.
- Make the required changes.
- To change IP addresses, highlight the host and then enter new addresses in the edit boxes.
- Click to post changes to the database.

10.3.7 Changing Host Type

The host type can be changed but be aware that settings that you have made in the Host Editor may be lost.

To change the host type:

- Open the Domain Editor and click the **General** tab.
- Click in the **Type** field, click the “down” arrow and then select the required host type.
- Make any other changes, as required.
- Click to post the changes. A warning box is displayed.

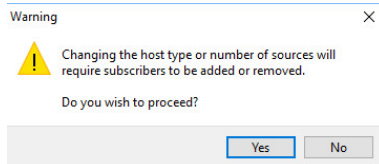

Click **Yes** to confirm that you want to change the host type.

NOTE: If you change the host type, any subscribers that have been allocated to ports that are **not** available on the new host type will be lost. You may also lose host-specific configuration settings, GPIO settings and trunking. For example, a subscriber on port two on an MIU will still be on port two if the host is changed to an MCU. However, if the subscriber is on port 10 on the MIU, it will be deleted if the host is changed to an MCU. After changing a host type, always check all related settings carefully.

Swapping Host EDHS

You can swap the EDHS address of one host with another in the domain.

To swap a host:

- Open the Domain Editor and click the **Hosts** tab.
- Highlight the host that you want to swap with another host in the system.
- Right-click to display the context menu and select **Swap**. A warning message is displayed.

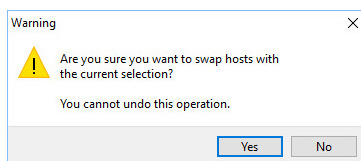

Click **Yes** to continue and open the Hosts dialog box.

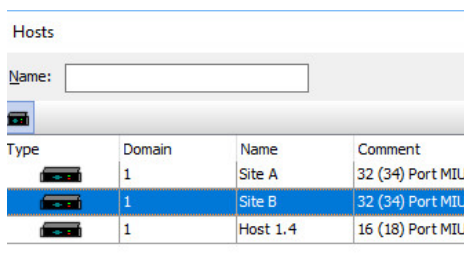

This dialog shows a list of all hosts, except the host initially highlighted in step 2 above, including their domain number, ID, name and any comments that have been entered.

Select the required host on the Hosts list and click **Apply**.

If you swap with a host that is in another domain, the EDHS address is automatically corrected to reflect its new domain.

10.3.8 Deleting Hosts

Any hosts that are no longer required in your configuration can be deleted. To delete a host, select it on the Hosts tab and click the red - button.

10.3.9 IP Address parameters

The Domain Editor - General tab is used to specify the IP address and subnet mask of the default gateway used to connect to other domains within the enterprise. Edit values in the area highlighted below and post any changes to the database.

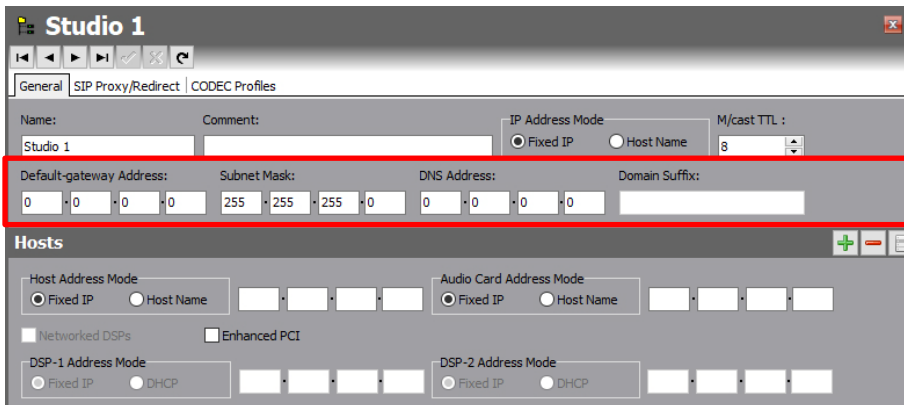

The same form is used to set the IP addresses of each host within the domain. Highlight the host in question and edit values in the area shown below in red. When complete, post edits to the database.

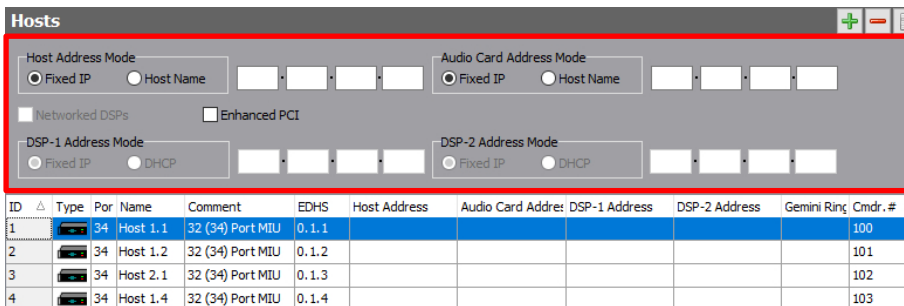

NOTE: Remember that Mercury host types require 2 IP addresses – the first for the Windows OS, the second exclusively for the Mercury Audio Card. The 700-25-06 MIU and MCU require 2 additional IP addresses for the networked DSP. The additional fields for DSP 1 & 2 are enabled by ticking both checkboxes – **Enhanced PCI** and **Networked DSPs**.

10.4 DOMAIN EDITOR - SIP PROXY AND REDIRECT

A SIP Proxy Server receives “call” requests from a User-Agent and forwards these requests to one or more addresses to locate the destination of the call. Messages forwarded by the Proxy Server may be modified and any responses are returned to the calling User-Agent as appropriate.

A SIP Redirect Server receives “call” requests from a User Agent, locates the destination and returns a “redirect” response to the User-Agent with the destination address.

10.4.1 Adding SIP Proxy/Redirect Servers to a Domain

One SIP Proxy/Redirect Server per IP address (per Proxy) or DNS address may be defined. You must provide a server IP address or name, user ID and password.

NOTE: You can select a host for each Proxy/Redirect Server. If you do this, the specified user ID and password will be used by that host to register with the Proxy/Redirect Server. Different hosts can, therefore, register with the server using different credentials using this approach. If you do not specify a host, all hosts in the domain will connect using the same user ID and password.

To add a SIP Proxy/Redirect Server to the domain:

- Open the Domain Editor and click the **SIP Proxy/Redirect** tab.
- Click the green + button to add a new row to the server list.
- Click in **Server URI** and enter the name or IP address of the server.

To specify a host for the Proxy/Redirect Server:

- Click in the Assoc. Host field, click , select the required host and click **Apply**. The **Type** field icon is automatically filled in.
- Click in **User ID** and enter the username for Proxy/Redirect authentication.
- Click in **User Password** and enter the password for Proxy/Redirect authentication.
- Click to post changes to the database.

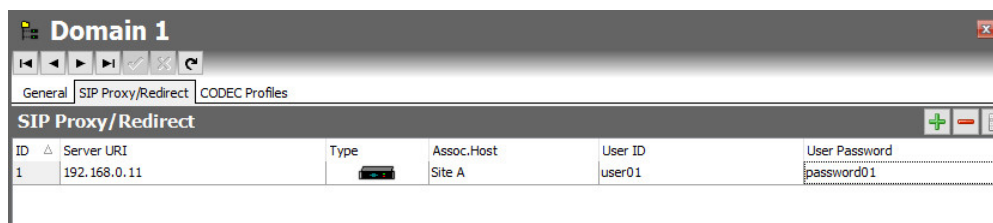

10.4.2 Changing SIP Proxy/Redirect Server Details

You can change the IP address or name of a SIP Proxy/Redirect Server, as required. User ID and User Password can also be changed. An associated host can be specified, changed or deleted depending on requirements.

To change SIP Proxy/Redirect server details:

- Open the Domain Editor and click the **SIP Proxy/Redirect** tab.
- Make the required changes to the **Server URI**, **User ID** and/or **User Password**.
- Specify, change or delete the associated host, as required.
- Click to post changes to the database.

10.4.3 Deleting SIP Proxy/Redirect Servers

Any SIP Proxy/Redirect Servers that are no longer required can be deleted. You can delete selected servers (using the Delete button).

10.5 DOMAIN EDITOR | CODEC PROFILES

The Domain Editor - CODEC Profiles tab is used to make changes to CODEC profiles used by audio, intercom and telephony hosts in the domain.

10.5.1 Changing CODEC Profiles

To change a CODEC profile:

Open the Domain Editor and click the **CODEC Profiles** tab.

CODEC Profiles													
ID	Data Rate	Codec	16Khz	Pkt. Size	Adapt	Play-out Buffer Settings			VAD		Echo Cancel		
						Nominal	Maximum	Abs.Max	On	Threshold	On	Non Linear	
0	96.0	G.722	<input checked="" type="checkbox"/>	10	<input checked="" type="checkbox"/>	20	40	160	<input type="checkbox"/>	Auto	<input type="checkbox"/>	<input type="checkbox"/>	
1	96.0	G.711A	<input type="checkbox"/>	10	<input checked="" type="checkbox"/>	20	40	145	<input checked="" type="checkbox"/>	Auto	<input type="checkbox"/>	<input type="checkbox"/>	
2	96.0	G.711μ	<input type="checkbox"/>	10	<input checked="" type="checkbox"/>	20	40	145	<input checked="" type="checkbox"/>	Auto	<input type="checkbox"/>	<input type="checkbox"/>	
3	80.0	G.722	<input checked="" type="checkbox"/>	20	<input checked="" type="checkbox"/>	40	80	160	<input type="checkbox"/>	Auto	<input type="checkbox"/>	<input type="checkbox"/>	
4	80.0	G.711A	<input type="checkbox"/>	20	<input checked="" type="checkbox"/>	40	80	145	<input checked="" type="checkbox"/>	Auto	<input type="checkbox"/>	<input type="checkbox"/>	
5	80.0	G.711μ	<input type="checkbox"/>	20	<input checked="" type="checkbox"/>	40	80	145	<input checked="" type="checkbox"/>	Auto	<input type="checkbox"/>	<input type="checkbox"/>	
6	74.7	G.722	<input checked="" type="checkbox"/>	30	<input checked="" type="checkbox"/>	60	120	160	<input type="checkbox"/>	Auto	<input type="checkbox"/>	<input type="checkbox"/>	
7	74.7	G.711A	<input type="checkbox"/>	30	<input checked="" type="checkbox"/>	60	120	145	<input checked="" type="checkbox"/>	Auto	<input type="checkbox"/>	<input type="checkbox"/>	
8	74.7	G.711μ	<input type="checkbox"/>	30	<input checked="" type="checkbox"/>	60	120	145	<input checked="" type="checkbox"/>	Auto	<input type="checkbox"/>	<input type="checkbox"/>	
9	64.0	G.726 (32k)	<input type="checkbox"/>	10	<input checked="" type="checkbox"/>	20	40	290	<input checked="" type="checkbox"/>	Auto	<input type="checkbox"/>	<input type="checkbox"/>	
10	48.0	G.726 (32k)	<input type="checkbox"/>	20	<input checked="" type="checkbox"/>	40	80	290	<input checked="" type="checkbox"/>	Auto	<input type="checkbox"/>	<input type="checkbox"/>	
11	42.7	G.726 (32k)	<input type="checkbox"/>	30	<input checked="" type="checkbox"/>	60	120	290	<input checked="" type="checkbox"/>	Auto	<input type="checkbox"/>	<input type="checkbox"/>	
12	40.0	G.729AB	<input type="checkbox"/>	10	<input checked="" type="checkbox"/>	20	40	500	<input checked="" type="checkbox"/>	Auto	<input type="checkbox"/>	<input type="checkbox"/>	
13	24.0	G.729AB	<input type="checkbox"/>	20	<input checked="" type="checkbox"/>	40	80	500	<input checked="" type="checkbox"/>	Auto	<input type="checkbox"/>	<input type="checkbox"/>	
14	18.7	G.729AB	<input type="checkbox"/>	30	<input checked="" type="checkbox"/>	60	120	500	<input checked="" type="checkbox"/>	Auto	<input type="checkbox"/>	<input type="checkbox"/>	
15	16.0	G.729AB	<input type="checkbox"/>	40	<input checked="" type="checkbox"/>	80	160	500	<input checked="" type="checkbox"/>	Auto	<input type="checkbox"/>	<input type="checkbox"/>	
16	14.4	G.729AB	<input type="checkbox"/>	50	<input checked="" type="checkbox"/>	100	200	500	<input checked="" type="checkbox"/>	Auto	<input type="checkbox"/>	<input type="checkbox"/>	
17	13.3	G.729AB	<input type="checkbox"/>	60	<input checked="" type="checkbox"/>	120	240	500	<input checked="" type="checkbox"/>	Auto	<input type="checkbox"/>	<input type="checkbox"/>	
18	12.6	G.729AB	<input type="checkbox"/>	70	<input checked="" type="checkbox"/>	140	280	500	<input checked="" type="checkbox"/>	Auto	<input type="checkbox"/>	<input type="checkbox"/>	
19	12.0	G.729AB	<input type="checkbox"/>	80	<input checked="" type="checkbox"/>	160	320	500	<input checked="" type="checkbox"/>	Auto	<input type="checkbox"/>	<input type="checkbox"/>	
20	11.6	G.723(6.3k)	<input type="checkbox"/>	60	<input checked="" type="checkbox"/>	120	240	500	<input checked="" type="checkbox"/>	Auto	<input type="checkbox"/>	<input type="checkbox"/>	
21	9.7	G.723(5.3k)	<input type="checkbox"/>	60	<input checked="" type="checkbox"/>	120	240	500	<input checked="" type="checkbox"/>	Auto	<input type="checkbox"/>	<input type="checkbox"/>	

Make the required changes to the supplied default settings. You cannot change the Data Rate, Codec name, Frequency or Packet Size.

Click to post changes to the database.

To change the settings back to their defaults, select a profile, right-click to show the context menu and select the **Default** option.

10.6 DOMAIN EDITOR - FIELD DEFINITIONS

10.6.1 Domain Editor - General tab

Field/Display Item	Description
Top Section	
Name	The name of the domain. This is usually defined when the domain is first added to the Enterprise using the Enterprise Editor but can be changed here if required. The name does not have to be unique. Maximum length = 20 characters.
Comment	Comments relating to a selected domain. To add comments, select the domain (click once on the line), click in this field and enter your comments. Maximum length = 255 characters.
IP Address Mode	Fixed IP must be selected.
M/cast TTL	Sets the maximum number of permitted router hops for multicast traffic. Any packets exceeding this value en-route are discarded. Range is from 1 to 255, with a default = 8.
Default gateway IP Address	The IP address of the gateway. On a Mercury network with more than one domain, this is the IP address of the router in the current domain which provides access to other domains. It may be left as 0.0.0.0 in a single domain network.
Subnet Mask	The subnet mask set for this domain. This may also be entered at the Enterprise level.
DNS Address	Not normally required if Fixed IP addressing is in use.
Domain Suffix	Not normally required if Fixed IP addressing is in use.
Host section	
Host Address Mode	Host Address is defined by either Fixed IP or Host Name, selected by radio buttons. The adjacent entry field changes format accordingly. Fixed IP mode is advised.
Audio Card Address Mode	As above, for the Mercury audio card.
Networked DSPs	Used for 700-25-06 MIU and MCU host types only. Default = unchecked.
Enhanced PCI	Used for 700-25-06 MIU only. Default = unchecked.
DSP-1 Address Mode	Address mode may be either Fixed IP or DHCP, selected by radio buttons. The adjacent IP entry field is only active for Fixed IP mode which is preferred.
DSP-2 Address Mode	As above, for Networked DSP-2.
Grid section	
ID	A numerical identifier for the hosts that have been defined. This is set by the system and cannot be changed manually.
Type	Shows an icon representing the host type. To change the type, click on this field, click  and select the required host type from the list.
Ports	The number of ports on the selected host type. Cannot be changed without changing the host type.

Field/Display Item	Description
Name	The default name for the host. This can be changed, if required and does not have to be unique. The name specified appears on the dynamic call selection list. Maximum length = 20 characters.
Comment	Any comments that have been added relating to this host. To add a new comment, click in the field and enter your comment. Maximum length =255 characters.
EDHS	The EDHS address assigned to the host by the Mercury system. The EDHS address cannot be changed.
Host Address	Shows the IP address (or hostname) of the host.
Audio Card Address	The IP address of the audio card.
DSP-1 Address	The IP address of DSP-1.
DSP-2 Address	The IP address of DSP-2.
Gemini Ring	For Gemini hosts only. Click in the field and select a pre-defined Ring.
Cmdr#	The Commander address, which is required when networking with legacy Commander/Orator systems. The address can be changed by clicking in the field and selecting the required address from the drop-down list. If Commander/Orator networking is not being used this value has no effect.

10.6.2 Domain Editor - SIP Proxy/Redirect tab

Field/Display Item	Description
Server URI	The IP address or name of the SIP Proxy/Redirect Server.
Type	Displays an icon which identifies the type of associated host.
Associated Host	If this field is left blank, the user ID and password specified for the Proxy/Redirect Server is used for all hosts in the domain. If a host is selected, the specified user ID and password will be used by that host to register with the Proxy/Redirect Server. Different hosts can, therefore, register with the Proxy/Redirect Server using different credentials.
User ID	The username for Proxy/Redirect Server authentication.
User Password	The password (corresponding to the entered username) for Proxy/Redirect Server authentication.

10.6.3 Domain Editor - CODEC Profiles tab

Field/Display Item	Description
ID	A number to identify the profile. The ID cannot be changed.
Data Rate	Shows the bandwidth of the profile. The Data Rate cannot be changed.
Codec	Shows the codec name. The name cannot be changed.
16 kHz	Shows whether the profile is a 16 kHz profile. This setting cannot be changed.
Pkt. Size	Shows the packet size. This setting cannot be changed.

Field/Display Item	Description
Play-out Buffer Settings	<p>Adapt When selected, (which is the default setting) this forces the Mercury card to create an input and output buffer for handling audio traffic. This introduces a fail-safe buffer into streaming audio data over an IP network at the expense of latency.</p> <p>Nominal A dynamic input buffer that controls the throughput of packet transfers. Like a flow control buffer, it sits in the middle of the buffer (1/2 size of maximum delay) and moves up/down depending on incoming packet data.</p> <p>Maximum An input buffer - the maximum number of voice packets stored in the DSP before send.</p> <p>Abs. Max The absolute maximum input buffer.</p>
VAD	<p>On Enables Voice Activity Detection (VAD).</p> <p>Threshold A system-wide threshold setting used to differentiate a speaking voice from background noise. This saves system resources by preventing background noise from consuming those resources. If the input level is higher than the configured value, the input is then presented on a given input port. By default, this is set to Auto, which provides control of the value to an internal system algorithm. Range -30 to 0 dB, or Auto.</p>
Echo Cancel	<p>On Cancels any electrical echoes resulting from mismatched line impedances on the analogue port using the IP channel. Typically, this would be needed if an external telephone interface was in use. Cannot be enabled for 16 kHz profiles.</p> <p>Non-Linear Employs an alternate algorithm to prevent system-generated sidetone at user stations for all ports on this host.</p>

11. CONFIGURATION EDITOR | HOST

11.1 OVERVIEW

A host is a constituent part of a domain. It is the focal point for all user input. A host is a dedicated piece of hardware, such as an MIU or MCU.

Hosts are added to domains using the Domain Editor. See section 10 - Configuration Editor | Domain in this Configuration Guide for details.

Once hosts have been added, you must add the panels and other subscribers to the correct port on the host and specify the various host settings using the Host Editor.

Panels and subscribers are then configured using the Subscriber Configuration Editor. See section 12 - *Configuration Editor | Subscriber* in this Configuration Guide.

11.2 USING THE HOST EDITOR

11.2.1 Viewing a List of Subscribers

Locate the host you wish to configure (Site A) in the Enterprise tree.

To view a list of subscribers:

- Expand the Enterprise tree in Gateway.
- Click the “right arrow” next to the selected domain until any hosts contained within the domain are visible in the tree
- Single-click on the relevant host.
- The basic Host Editor is now displayed.

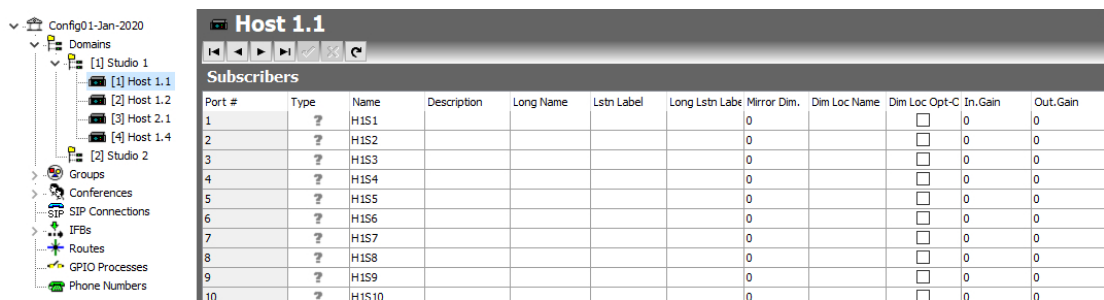

The basic editor allows configuration of most day to day tasks and corresponds to the Subscribers tab of the Advanced Editor which is described below.

11.2.2 Opening the Advanced Host Editor

To open the Host Editor:

- Expand the Enterprise tree until the “Site A” host is visible.
- Double-click on the host to open the Advanced Host Editor.

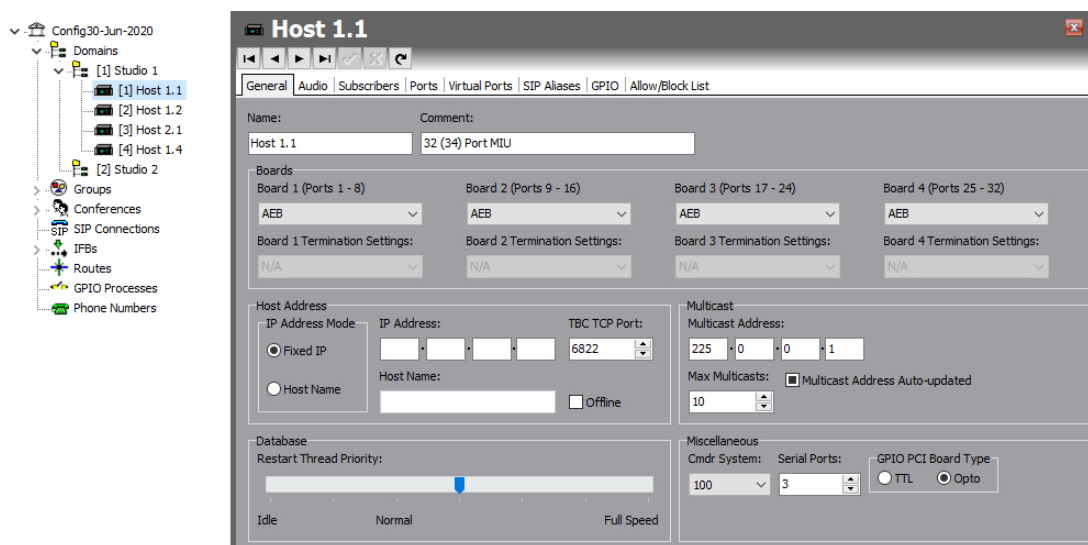

- The Advanced Editor opens at the General tab.

11.3 HOST EDITOR TABS

The Host Editor tabs are used to maintain basic details about the host, to work with subscribers and to specify subscriber and host settings.

General

The General tab shows the name of the host (specified when the host is added to the domain), which can be changed. A comment can also be added if required. This tab is also used to specify which expansion boards have been fitted into an MIU.

Audio

The Audio Card tab is used to specify the audio settings for the selected Mercury host.

Subscribers

The Subscribers tab is used to add and maintain the panels and subscribers that are connected to the ports on the selected host.

Ports

The Ports tab is used to specify the settings for the ports on the selected host. Note that the number and types of ports will vary according to the type of host selected.

RIB

If any RIB expansion cards have been declared as fitted in this host, this additional tab is displayed.

VOX

If any RIB expansion cards have been declared as fitted in this host, this additional tab is displayed.

Virtual Ports

The Virtual Ports tab is used to assign targets to virtual ports.

SIP Aliases

The SIP Aliases tab is used to associate a SIP connection with a URL (or alias). When a caller attempts to connect to that URL (or alias) on a host, the SIP connection corresponding to the alias is 'activated'. Once activated, a SIP connection key on any panel connected to the host can be targeted to answer the call.

GPIO

The GPIO tab is used to define GPIOs on the selected host. These are used elsewhere in the system. GPIOs are control signals received from, or sent to, third-party equipment.

Allow/Block List

The Allowed/Blocked List tab permits Administrators to set either an exclusive list of IP addresses that a host will accept IP connections from (Allowed) or a specific list of IP addresses that will not be allowed to connect (Blocked). Note that only one of these lists should be populated per host. If the Allowed list contains at least one entry, all IP connection attempts to the relevant host will not be accepted unless the source IP address is on the Allowed list.

11.4 HOST EDITOR - GENERAL

The Host Editor - Details tab shows the name of the selected host and any comments that have been entered.

If you are using an MIU, you must also specify which expansion boards have been installed. Ports are labelled on the back of the MIU:

- 1–8: Bottom Board, Slot 1
- 9–16: 2nd Board from the Bottom, Slot 2
- 17–24: 3rd Board from the Bottom, Slot 3
- 25–32: Top Board

Boards that may be fitted into the MIU are:

- Audio Expansion Board (AEB)
- TEB - Ear and Mouth (E&M)
- TEB - Foreign Exchange Office (FXO)
- TEB - Foreign Exchange Station (FXS)
- E1
- RIB
- RIB Panel

The information must be entered accurately on the General tab so that Digital Signal Processing (DSP) channels are assigned properly.

The screenshot shows the 'General' tab of the Host Editor. At the top, there are navigation tabs: General, Audio, Subscribers, Ports, Virtual Ports, SIP Aliases, GPIO, and Allow/Block List. The 'General' tab is selected. Below the tabs, there are two input fields: 'Name:' with the value 'Host 1.1' and 'Comment:' with the value '32 (34) Port MIU'. A section titled 'Boards' contains four columns for Board 1 (Ports 1-8), Board 2 (Ports 9-16), Board 3 (Ports 17-24), and Board 4 (Ports 25-32). Each column has a dropdown menu for the board type (all set to 'AEB') and a dropdown for 'Termination Settings' (all set to 'N/A'). Below this is the 'Host Address' section with radio buttons for 'Fixed IP' (selected) and 'Host Name'. It includes fields for IP Address, TBC TCP Port (6822), and Host Name, along with an 'Offline' checkbox. The 'Multicast' section has a 'Multicast Address' field (225.0.0.1), a 'Max Multicasts' dropdown (10), and a checked 'Multicast Address Auto-updated' checkbox. The 'Database' section features a 'Restart Thread Priority' slider ranging from 'Idle' to 'Full Speed', with the slider currently positioned at 'Normal'. The 'Miscellaneous' section includes a 'Cmdr System' dropdown (100), a 'Serial Ports' dropdown (3), and a 'GPIO PCI Board Type' section with radio buttons for 'TTL' and 'Opto' (selected).

11.4.1 Changing Host Details

You can change most parameters related to the host.

If you are configuring an MIU, you **must** specify the types of boards that you have installed in the MIU.

IMPORTANT: There is no hardware confirmation check performed by the MIU. If the hardware configuration does not match the system configuration database, unpredictable behaviour will result, including the Mercury host not connecting to the network. Also, if you change existing board types, a warning message will be displayed.

IMPORTANT: The host IP address(es) would normally be set at Domain level when the host was added: if not, you should do it now. If you do not complete this step, a warning message will be shown. The system cannot operate correctly until IP settings are in place.

WARNING: If you selected a RIB and subsequently change to another board type and save the changes, you will receive the following warning alerting you that VOX GPIO records automatically created for the RIB will be deleted if you proceed.

Click to post changes to the database.

If you have selected a TEB, a warning message will advise that the first suitable coding profile will be automatically selected. Click **OK** to continue.

MORE INFORMATION: Refer to section 11.14.1 - *Host Editor - General tab* for a description of the fields on this tab.

11.5 HOST EDITOR - AUDIO

The Host Editor - Audio tab is used to specify the IP and audio settings for the Mercury hardware. The CODEC profiles for intercom and multicast will default to 0 unless you have installed a TEB or E1 board into an MIU host, in which case they will default to 1.

The tab is used to set the DSCP values on the host if QoS (Quality of Service) is implemented at the domain level.

The tab is also used to specify the number of DSP channels that are allocated to telephony on the selected host. The CODEC profile used for telephony is also set on this tab if you have a TEB installed in the MIU that you are configuring.

The other key setting is the IP address of the host's Mercury card. This must be a fixed IP address. This will normally have been set when the host was added at domain level but if not, you should do it now.

General **Audio** Subscribers Ports Virtual Ports SIP Aliases GPIO Allow/Block List

Audio Card Address

IP Address Mode: Fixed IP DHCP/DNS

IP Address: . . .

Host Name:

SIP

Transport: UDP TCP

SIP Call Port:

RTP/RTCP Port:

SIP DTMF Mode:

Associate Aliases With Outgoing SIP

Networked DSPs

Networked DSPs

DSP-1 IP Address Mode: Fixed IP DHCP

DSP-1 IP Address: . . .

DSP-2 IP Address Mode: Fixed IP DHCP

DSP-2 IP Address: . . .

Enhanced PCI

Jitter Mode:

VAD Packet Mode:

VAD Threshold (dB):

VAD Linger (ms):

VAD Window (ms):

Audio UDP Ports

Intercom Control:

Intercom Audio:

Telephony Control:

Telephony Audio:

Audio Ports

Loopback Audio on Missing Ports

Local Ports Audio Mode:

Mono Dual DI/4-Wire

N/A N/A

Enable MIX / DA 2

Network QoS

Enable 802.1Q

VLAN ID:

DSCP (Audio):

Level:

DSCP (Control):

Audio Quality

Intercom CODEC Profile:

Configure Independent Multicast CODEC

Multicast CODEC Profile:

Enable TEB & Configure Independent CODEC

TEB CODEC Profile:

Telephony

Echo Cancel Mode:

Ringing Timeout (s): First Digit Timeout (ms):

IP Phones Allocated:

TTMU

Ack Wait Time (ms):

Total Resend Time (ms):

TSMU

Ack Wait Time (ms):

Total Resend Time (ms):

Inter-Host (TBC to TBC)

Conn. Retry Time (ms):

GWIN

Ack Wait Time (ms):

Total Resend Time (ms):

11.5.1 Changing Audio Settings

Once the IP address of the Mercury card is set, you can change other audio card settings, as required. The configuration of the local ports is set normally to dual channel. Audio may be looped back on any unconnected ports, which is useful for testing the system before it is installed, or for advanced routing. A bandwidth profile can be picked to suit the conditions. It should be noted that not all settings give good results, so care should be taken if this is to be changed. If in doubt use the default.

To change audio settings:

- Open the Host Editor and click the Audio tab. The audio settings for the host are displayed.
- Make the required changes.
- Click to post changes to the database.

11.5.2 MIU Default Settings

The Gateway Configuration Editor does not distinguish between model variants of the 700-25 series MIU. The settings below will automatically default to the lower specification “compatibility mode” when a new MIU is added to the configuration. Operationally, this allows a higher spec 700-25-06 to quickly replace the older model (700-25-04) without making any changes to the configuration. For a long-term replacement, or permanent addition of a 700-25-06, the settings may be optimised as described below.

- Networked DSPs: compatibility mode is OFF (unchecked). For 700-25-06, set to ON and add DSP 1&2 IP Addresses.
- Enhanced PCI: compatibility mode is OFF (unchecked). For 700-25-06, set to ON.

MORE INFORMATION: Refer to section 11.14.2 - *Host Editor - Audio tab* for a description of the fields on this tab.

11.6 HOST EDITOR - SUBSCRIBERS

The Host Editor - Subscribers tab is used to add and maintain the subscribers that are connected to the host. Subscribers include:

- 4-wire.
- Hardware Panels.
- Virtual Panels.
- Telephone Expansion Boards (TEBs).
- Radios and radio phones.
- Virtual 4-wire.
- Patch Panels.

NOTE: Radio and radio phone ports can only be declared if a RIB is installed in an MIU. FXO, FXS and E&M ports can only be declared if the relevant board is installed in an MIU.

11.6.1 Adding a Subscriber

When adding subscribers to the host, you must take note of where each subscriber will be physically attached to the ports on the host.

A Virtual Panel is typically “attached” to the last port on the host, although it can be attached anywhere. The location must be specified in the Virtual Panel Settings.

An MIU can have 8/16/24/32 + 2 ports and can address up to 32 panels, provided that 4 AEBs are installed. Port 33 is not generally used. Port 34 can be used for a Virtual Panel. Any expansion board can be installed in any slot.

To add a subscriber:



- Open the Host Editor and click the **Subscribers** tab.
- Click in the **Type** field and click  to show a pop-up list of subscriber types.



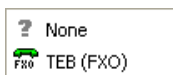











Note that the available types will depend on the host and port selected. Radio port and radio phone are only available for a RIB.



If you select an E&M, FXS or FXO, you can only add the relevant telephone subscriber.

- Select the required subscriber type. If you have installed a TEB, you can only declare four ports on the board.
- Complete the other fields for each port, as required. **Name** defaults to the name of the panel or subscriber and may be altered.
- To add a picture to identify the subscriber on a Virtual Panel, click in the **Picture** field and then click  to browse for and select an image file.
- Click  to post changes to the database.
- Add additional subscribers, as required.

General Audio Subscribers Ports Virtual Ports SIP Aliases GPIO Allow/Block List													
Subscribers													
Port #	Type	Name	Description	Long Name	Lstn Label	Long Lstn L	Mirror Din	Picture	Dim Loc Nai	Dim Loc Opt-Oi	Cmdr EDI+	Cmdr Name	Owner Host
1		H1S1					-16			<input type="checkbox"/>			
2		H1S2					-12			<input type="checkbox"/>			
3		H1S3					-12			<input type="checkbox"/>			
4		H1S4					-12			<input type="checkbox"/>			
5		H1S5					-12			<input type="checkbox"/>			
6		H1S6					0			<input type="checkbox"/>			

MORE INFORMATION: Refer to section 11.14.3 - *Host Editor - Subscribers tab* - for a description of the fields on this tab.

11.6.2 Changing Subscriber Details

Subscriber details can be changed. For example, you can change or add a listen label for a port or place a port under zone control.

To change subscriber details:



- Open the Host Editor and click the **Subscribers** tab.
- Make the required changes to the details for each subscriber.
- Click  to post changes to the database.

11.6.3 Changing Subscriber Type

You can add additional subscribers to the free ports on your host or change the subscribers that you have previously added.

NOTE: If you have added key assignments to a panel subscriber and then change the subscriber type, your key assignments may be affected.

To change subscriber type:

- Open the Host Editor and click the **Subscribers** tab.
- Locate the subscriber in the list, click in the **Type** field and click .
- Select the required subscriber type from the subscriber list.
- Make any other changes, as required.
- Click  to post the changes. A warning is displayed.

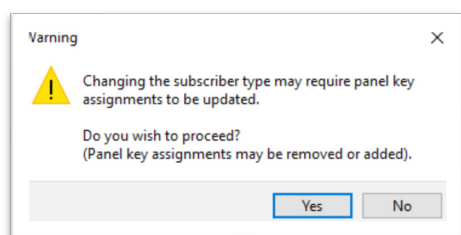



Click **Yes** to confirm that you want to change the subscriber type.

11.6.4 Deleting a Subscriber

Subscribers can be removed from ports, as required.

To delete a subscriber:

- Open the Host Editor and click the **Subscribers** tab.
- Locate the subscriber in the list, click in the **Type** field and then click  to show a list of subscriber types.
- Select **None**.
- Click  to post the changes. A warning is displayed.

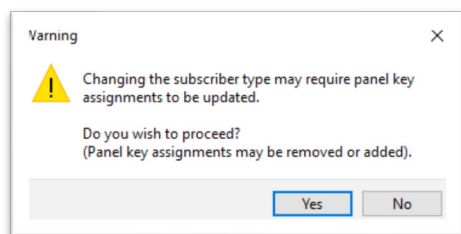

Click **Yes** to confirm that you want to remove the subscriber.

11.7 HOST EDITOR – PORTS

The Host Editor – Ports tab is used to maintain the settings for a specific audio or telephone port.

11.7.1 Changing Port Settings

The settings for each port on a host can be changed, as required. For example, you can change the gain settings, audio levels and thresholds and enable operator recording. The settings for each port can be different.

To change port settings:

- Open the Host Editor and click the **Ports** tab. The settings for the defined subscribers are displayed.

General Audio Subscribers Ports Virtual Ports SIP Aliases GPIO Allow/Block List											
Ports											
Port #	Type	Name	In.Gain	Out.Gain	Ns.Gating	Ns.Threshold	In.Pres	Out.Pres	Op.Rec	Op.Rec Type	M/Cast Addr
1		H1S1	0	0	<input type="checkbox"/>	-10	-10	-10	<input type="checkbox"/>	Spk/Lstn	
2		H1S2	0	0	<input type="checkbox"/>	-10	-10	-10	<input type="checkbox"/>	Spk/Lstn	
3		H1S3	0	0	<input type="checkbox"/>	-10	-10	-10	<input type="checkbox"/>	Spk/Lstn	
4		H1S4	0	0	<input type="checkbox"/>	-10	-10	-10	<input type="checkbox"/>	Spk/Lstn	
5		H1S5	0	0	<input type="checkbox"/>	-10	-10	-10	<input type="checkbox"/>	Spk/Lstn	
6		H1S6	0	0	<input type="checkbox"/>	-10	-10	-10	<input type="checkbox"/>	Spk/Lstn	
7	?	H1S7	0	0	<input type="checkbox"/>	-10	-10	-10	<input type="checkbox"/>	Spk/Lstn	
8	?	H1S8	0	0	<input type="checkbox"/>	-10	-10	-10	<input type="checkbox"/>	Spk/Lstn	

- Select the required port and make changes.
- To enable operator recording, select the **Op. Rec** checkbox and then select the channel that you want to use for recording from the **M/Cast Addr** drop-down list. A third-party external recorder is required; please contact Trilogy for more details.
- Click to post changes to the database.

MORE INFORMATION: Refer to section 11.14.4 - *Host Editor - Ports tab* for a description of the fields on the Host Editor - Port Settings tab.

11.8 HOST EDITOR - RIB

This additional tab is only displayed if one or more RIBs have been declared as fitted in this MIU host. Only RIB ports are shown in the grid. All of these settings, plus a few extra ones are also provided at the Subscriber level but the grid allows an easy way to check for any discrepancies. There are two tabs – **Standard** and **Enhanced**.

General | Audio | Subscribers | Ports | **RIB** | VOX | Virtual Ports | SIP Aliases | GPTD | Allow/Block List

RIB		Standard		Enhanced																							
Port #	Type	Name	Audio In			Audio Out			Input (COR)				Output (PTT)				Sidetone Suppression (SFST)										
			In.Delay	In.Filter	I/P Boost	Out.Dela	Out.Filter	O/P Atten	Enabled	Trigger VOX	Mode Unmute	Polarity	Attack	Release	Name	Comment	Enabled	Trigger VOX	Polarity	Attack	Release	Name	Comment	Enabled	Delay	Level	
17	Radio		0	0	<input type="checkbox"/>	0	0	<input type="checkbox"/>	<input type="checkbox"/>	<input checked="" type="checkbox"/>	COR	Unmute	Normally ...	0	0	GRI-0.1.1:17		<input checked="" type="checkbox"/>	Route	Normally ...	0	0	GRO-0.1.1:17		<input type="checkbox"/>		0.0
18	RadPh		0	0	<input type="checkbox"/>	0	0	<input type="checkbox"/>	<input type="checkbox"/>	<input type="checkbox"/>	COR	Unmute	Normally ...	0	0	GRI-0.1.1:18		<input type="checkbox"/>	Route	Normally ...	0	0	GRO-0.1.1:18		<input type="checkbox"/>		0.0
19	?	HIS19	0	0	<input type="checkbox"/>	0	0	<input type="checkbox"/>	<input type="checkbox"/>	<input type="checkbox"/>	COR	Unmute	Normally ...	0	0	GRI-0.1.1:19		<input type="checkbox"/>	Route	Normally ...	0	0	GRO-0.1.1:19		<input type="checkbox"/>		0.0
20	?	HIS20	0	0	<input type="checkbox"/>	0	0	<input type="checkbox"/>	<input type="checkbox"/>	<input type="checkbox"/>	COR	Unmute	Normally ...	0	0	GRI-0.1.1:20		<input type="checkbox"/>	Route	Normally ...	0	0	GRO-0.1.1:20		<input type="checkbox"/>		0.0
21	?	HIS21	0	0	<input type="checkbox"/>	0	0	<input type="checkbox"/>	<input type="checkbox"/>	<input type="checkbox"/>	COR	Unmute	Normally ...	0	0	GRI-0.1.1:21		<input type="checkbox"/>	Route	Normally ...	0	0	GRO-0.1.1:21		<input type="checkbox"/>		0.0
22	?	HIS22	0	0	<input type="checkbox"/>	0	0	<input type="checkbox"/>	<input type="checkbox"/>	<input type="checkbox"/>	COR	Unmute	Normally ...	0	0	GRI-0.1.1:22		<input type="checkbox"/>	Route	Normally ...	0	0	GRO-0.1.1:22		<input type="checkbox"/>		0.0
23	?	HIS23	0	0	<input type="checkbox"/>	0	0	<input type="checkbox"/>	<input type="checkbox"/>	<input type="checkbox"/>	COR	Unmute	Normally ...	0	0	GRI-0.1.1:23		<input type="checkbox"/>	Route	Normally ...	0	0	GRO-0.1.1:23		<input type="checkbox"/>		0.0
24	?	HIS24	0	0	<input type="checkbox"/>	0	0	<input type="checkbox"/>	<input type="checkbox"/>	<input type="checkbox"/>	COR	Unmute	Normally ...	0	0	GRI-0.1.1:24		<input type="checkbox"/>	Route	Normally ...	0	0	GRO-0.1.1:24		<input type="checkbox"/>		0.0

General | Audio | Subscribers | Ports | **RIB** | VOX | Virtual Ports | SIP Aliases | GPTD | Allow/Block List

RIB		Standard		Enhanced												
Port #	Type	Name	Intel Squelch Filter		DTMF		Adapt. Speech Filter		Audio In		Speech In Noise		CTCSS On		Audio Out	
			<input type="checkbox"/>	<input type="checkbox"/>	<input type="checkbox"/>	<input type="checkbox"/>	<input type="checkbox"/>	<input type="checkbox"/>	Noise Reduction	Speech In Noise	CTCSS On	CTCSS Freq.				
17	Radio		<input type="checkbox"/>	<input type="checkbox"/>	<input type="checkbox"/>	<input type="checkbox"/>	<input type="checkbox"/>	<input type="checkbox"/>	12.0	<input checked="" type="checkbox"/>	<input type="checkbox"/>	67.0 Hz				
18	RadPh		<input type="checkbox"/>	<input type="checkbox"/>	<input type="checkbox"/>	<input type="checkbox"/>	<input type="checkbox"/>	<input type="checkbox"/>	12.0	<input checked="" type="checkbox"/>	<input type="checkbox"/>	67.0 Hz				
19	?	HIS19	<input type="checkbox"/>	<input type="checkbox"/>	<input type="checkbox"/>	<input type="checkbox"/>	<input type="checkbox"/>	<input type="checkbox"/>	12.0	<input checked="" type="checkbox"/>	<input type="checkbox"/>	67.0 Hz				
20	?	HIS20	<input type="checkbox"/>	<input type="checkbox"/>	<input type="checkbox"/>	<input type="checkbox"/>	<input type="checkbox"/>	<input type="checkbox"/>	12.0	<input checked="" type="checkbox"/>	<input type="checkbox"/>	67.0 Hz				
21	?	HIS21	<input type="checkbox"/>	<input type="checkbox"/>	<input type="checkbox"/>	<input type="checkbox"/>	<input type="checkbox"/>	<input type="checkbox"/>	12.0	<input checked="" type="checkbox"/>	<input type="checkbox"/>	67.0 Hz				
22	?	HIS22	<input type="checkbox"/>	<input type="checkbox"/>	<input type="checkbox"/>	<input type="checkbox"/>	<input type="checkbox"/>	<input type="checkbox"/>	12.0	<input checked="" type="checkbox"/>	<input type="checkbox"/>	67.0 Hz				
23	?	HIS23	<input type="checkbox"/>	<input type="checkbox"/>	<input type="checkbox"/>	<input type="checkbox"/>	<input type="checkbox"/>	<input type="checkbox"/>	12.0	<input checked="" type="checkbox"/>	<input type="checkbox"/>	67.0 Hz				
24	?	HIS24	<input type="checkbox"/>	<input type="checkbox"/>	<input type="checkbox"/>	<input type="checkbox"/>	<input type="checkbox"/>	<input type="checkbox"/>	12.0	<input checked="" type="checkbox"/>	<input type="checkbox"/>	67.0 Hz				



To change RIB settings:

- Open the Host Editor and click the **RIB** tab. The **Standard** settings for any defined radio ports are displayed.
- Select the required port and make changes.
- Click to post changes to the database.

MORE INFORMATION: Refer to section 11.14.5 - *Host Editor - RIB – Standard and Enhanced* for a description of the fields on this tab.

11.9 HOST EDITOR - VOX

This additional tab is only displayed if one or more RIBs have been declared as fitted in this MIU host. Only RIB ports are shown in the grid. All of the settings, plus a few extra ones are also provided at the Subscriber level but the grid allows an easy way to check for any discrepancies.

General Audio Subscribers Ports RIB VOX Virtual Ports SIP Aliases GPIO Allow/Block List												
VOX												
Port #	Type	Name	Input VOX						Output VOX			
			Name	Comment	Attack	Release	Level	Name	Comment	Attack	Release	Level
17		Radio	Audio1		0	10	-10	GAO-0.1.1:17		0	10	-10
18		RadPh	GAI-0.1.1:18		0	10	-10	GAO-0.1.1:18		0	10	-10
19	?	H1S19	GAI-0.1.1:19		0	10	-10	GAO-0.1.1:19		0	10	-10
20	?	H1S20	GAI-0.1.1:20		0	10	-10	GAO-0.1.1:20		0	10	-10
21	?	H1S21	GAI-0.1.1:21		0	10	-10	GAO-0.1.1:21		0	10	-10
22	?	H1S22	GAI-0.1.1:22		0	10	-10	GAO-0.1.1:22		0	10	-10
23	?	H1S23	GAI-0.1.1:23		0	10	-10	GAO-0.1.1:23		0	10	-10
24	?	H1S24	GAI-0.1.1:24		0	10	-10	GAO-0.1.1:24		0	10	-10

To change VOX settings:

- Open the Host Editor and click the **VOX** tab.
- Select the required port and make changes.
- Click to post changes to the database.

MORE INFORMATION: Refer to section 11.14.6 - *Host Editor - VOX tab* for a description of the fields on this tab.

11.10 HOST EDITOR - VIRTUAL PORTS

Virtual ports allow audio to be routed to an IP channel directly, or for an IP channel to be routed to subscribers or conferences directly. A virtual 4-wire port might be included in a conference and by this means all active participants of the conference will be mixed and sent as outgoing unicast audio on the virtual 4-wire's IP channel. If a virtual 4-wire is then declared on another host, and included in a different conference the two conferences may be interconnected (using a unicast IP channel rather than the multicast channel conferences utilise) by setting up a fixed route with the virtual 4-wire in the first conference as a source and the virtual 4-wire in the second conference as the destination.

The following port numbers can be assigned as virtual 4-wire ports:

- MIU: ports 35 to 66.

11.10.1 Adding a Virtual 4-Wire Port

Virtual 4-wire ports can be added to the host, as required. The number of ports that can be declared depends on the host type.

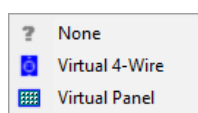

To add a virtual 4-wire port:

- Open the Host Editor and click the **Virtual Ports** tab.
- Click in the **Type** field and click  to show a pop-up list of subscriber types.



Select **Virtual 4-Wire** or **Virtual Panel**.

Add a description of the virtual port, if required.

Virtual Ports				
ID	Type	Name	Description	
35		H1S35	Virtual 4 wire	
36		H1S36	Virtual Panel	
37		H1S37		



Click  to post changes to the database.

MORE INFORMATION: Refer to section 11.14.7 - *Host Editor - Virtual Ports tab* for a description of the fields.

11.10.2 Deleting a Virtual 4-Wire Port

You can delete a virtual 4-wire port by declaring that there is no subscriber attached to a specific virtual port.

To delete a virtual 4-wire port:

- Open the Host Editor and click the **Virtual Ports** tab.
- Locate the port in the list, click in the **Type** field and then click  to show a list of subscriber types.
- Select **None**.
- Click  to post changes to the database.

11.11 HOST EDITOR - SIP ALIASES

SIP is an open, standards-based protocol for negotiating voice and multimedia calls over a network. The addition of SIP provides Mercury with the capability to make and receive SIP VoIP calls to any configured, basic SIP devices that may be present on the network.

A SIP connection is an object used to identify a SIP entity that exists outside of Mercury. SIP connections are added at Enterprise level using the Enterprise Editor. SIP connections are associated with a URL (or alias) using the Host Editor. When a caller attempts to connect to that URL (or alias) on a host, the SIP connection corresponding to the alias is 'activated'. Once activated, a SIP connection key on any panel connected to the host can be targeted to answer the call.

NOTE: SIP aliases are listed on the Host Aliases tab in the SIP Connection Editor. Buttons at the top of the SIP Aliases tab let you:

- Add a SIP alias.
- Delete a selected SIP alias.
- Delete all SIP aliases at the same time.

11.11.1 Adding a SIP Alias

You can define an alias for a SIP connection that has been defined using the Enterprise Editor. Required entries are the SIP connection for which you want to create an alias. Registrar and challenge details can be added if these are required for the selected connection.

To add a SIP alias:

- Open the Host Editor and click the **SIP Aliases** tab.

SIP Aliases												
Name	SIP Connection		Registrar				Challenge		Preferred CODECs			
	Type	Name	Server	User	Password	Port	Expires	User	Password	Profile 1	Profile 2	Profile 3
Alias_1	SIP	SIP1	192.168.1.59	Alias_1	pass	5060	3600			0 = 96...	1 = 96...	2 = 96...

Click the **Add** button to add a new **SIP Alias** entry.

SIP Connections

Name:

Name:

Comment:

1

Apply Cancel

The SIP connections dialogue is now displayed. These are created using the Enterprise Editor. Click the **Panel Sources** button to show a list of FXO and FXS sources. Select the required SIP connection, FXO or FXS source and click **Apply**.

SIP Aliases												
Name	SIP Connection		Registrar				Challenge		Preferred CODECs			
	Type	Name	Server	User	Password	Port	Expires	User	Password	Profile 1	Profile 2	Profile 3
Alias_1	SIP	SIP1	192.168.1.59	Alias_1	pass	5060	3600			0 = 9...	1 = 96...	2 = 9...
Alias_2	SIP	SIP2				5060	3600					

- Complete the Registrar and Challenge details, as required. To do this click in the required field and type the server name, username or password.
- Click to post changes to the database.

MORE INFORMATION: Refer to section 11.14.8 - *Host Editor - SIP Aliases tab* for a description of the fields.

11.11.2 Changing a SIP Alias

Once a SIP alias has been defined, you can change or add registrar and challenge details and change the listen port and expiry time for registration.

To change SIP alias details:

- Open the Host Editor and click the **SIP Aliases** tab.
- Make the required changes to the alias details.
- Click to post changes to the database.

11.11.3 Deleting a SIP Alias

SIP aliases can be deleted if they are not required. You can either delete a selected alias (using the Delete button) or delete all aliases at the same time (using the right-click context menu).

11.12 HOST EDITOR - GPIO

The **Host Editor - GPIO** tab is used to assign all GPI inputs and outputs for the selected host. The types that can be defined vary by host type:

MIU 700-25-04

- *EITHER* --2 standard GP inputs and 2 outputs.
- *OR* -- 16 expansion GPI inputs and 16 outputs (an Advantech option board must be fitted in the MIU).
- Up to 34 audio (VOX) inputs and up to 34 outputs.

MIU 700-25-06

- 16 standard GPI inputs and 16 outputs.
- Up to 34 audio (VOX) inputs and up to 34 outputs.

MCU

- 3 standard GP inputs and 1 output.
- Up to 6 audio (VOX) inputs and up to 6 outputs.

NOTE: If an option board is declared as a RIB, the relevant GPIO database entries are created automatically and cannot be changed. RIB GPIOs are not visible in Gateway. If an imported configuration includes defined RIB GPIOs, the configuration will be updated to declare a RIB as being fitted in the associated expansion board slot. To change parameters relating to RIB card setup and GPIO attack/hold times, etc., see section 18 - *Configuration Editor | Subscriber | Radio Port and Radio Phone*.

Buttons at the top of the tab let you:

- Add a GPIO of the selected type.
- Delete a selected GPIO.

11.12.1 Adding a GPIO

Ensure that you select the correct type of GPIO for the selected host type.

The types of GPIO that can be added are - Expansion GPI/GPO, Audio (VOX) Input/Output, Standard GPI/GPO.

To add a GPIO:

- Open the Host Editor and click the **GPIO** tab to display the currently defined inputs/outputs. You can change the input/output type to show inputs/outputs of different types.
- Select the type of input/output that you want to add from the **Type** drop-down list.
- Click **Add** to open the Enter Number dialogue. The maximum number of inputs/outputs of the selected type that you can add is shown.
- Specify how many inputs/outputs you wish to add and click **OK**.
- Make any changes to the settings for the input/output, if required. The settings that can be changed depend on the input/output type.
- Click to post changes to the database.

GPIO						
Type: Audio (VOX) Output						
ID	Name	Comment	Attack (ms)	Release (ms)	Level	Port
	GAO-0.1.1:A	Internal port A audio output VOX trigger	10	750	-10	A
	GAO-0.1.1:B	Internal port B audio output VOX trigger	10	750	-10	B
	GAO-0.1.1:1	Port 1 audio output VOX trigger	10	750	-10	1
	GAO-0.1.1:2	Port 2 audio output VOX trigger	10	750	-10	2

MORE INFORMATION: Refer to section 11.14.9 - *Host Editor - GPIO tab* for a description of the fields.

11.12.2 Deleting a GPIO

Any GPIOs that are no longer required can be removed from the host. You can either remove a selected GPIO (using the Delete button) or remove all GPIOs at the same time (using the right-click context menu). To remove a GPIO, you must first select the type of GPIO and then highlight the GPIO row.

IMPORTANT: Deleting GPIOs will automatically delete any GPIO processes that are based on the deleted GPIO.

11.13 HOST EDITOR - ALLOW/BLOCK LISTS

The Host Editor - Allow/Block List tab is used to define allowed and blocked IP addresses. At the hardware level, you can set a list of IP addresses that are filtered to prevent or allow calls being received from certain IP addresses. This applies to all calls received at a host regardless of whether the destination is a panel, 4-wire, radio, telephone, etc.

IMPORTANT: Call blocking will only work if you have defined a static host IP address rather than a hostname.

Call blocking using allow or block lists works independently of any other control mechanism that might otherwise permit or disallow audio routes, such as access levels, GPI functions, PTT etc. Blocking is achieved at the IP stack level of the card firmware.

- Allow lists are the most prohibitive and secure. They define the IP addresses from which the host will accept IP traffic. The card will discard any packets from IP addresses not on the allow list.
- Block lists define the IP addresses from which the host will not accept IP traffic. The card will discard any packets from IP addresses on the block list.
- If block list and allow list are both empty, then every IP address is allowed.
- If an IP address is on both lists, the block list takes precedence and blocks rather than allows the address.

Buttons at the top of the Allow/Block List tab let you:

- Add an IP address to an allow or block list.
- Delete an IP address from an allow or block list.

11.13.1 Adding an IP Address to the Allow/Block List

IP addresses can be added to an allowed or blocked list as required. When adding an address, you must choose whether you want to allow or block intercom and phone traffic or SIP traffic.

To add an address:

- Open the Host Editor and click the **Allow/Block List** tab to display any addresses that have already been defined.
- From the Type drop-down list, select Block (Int.Com/Phn), Allow (Int.Com/Phn), Block (SIP IP), Allow (SIP IP).
- Click **Add** to add a new record.
- Click in the **IP** field and click  to display the **Enter IP Address** dialogue.

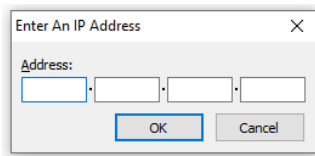

The dialog box titled "Enter An IP Address" has a close button (X) in the top right corner. It contains a label "Address:" followed by four input fields separated by dots, representing an IP address. Below the input fields are two buttons: "OK" and "Cancel".

Enter the IP Address that is to be allowed or blocked and click **OK**.

- Enter a description of the IP address, if required.
- Click to post changes to the database.

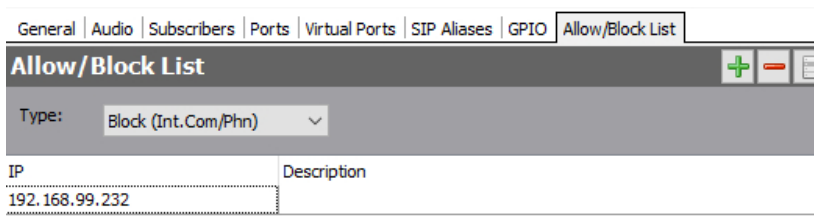

The interface shows a tabbed menu with "Allow/Block List" selected. Below the menu is a header "Allow/Block List" with a green plus icon, a red minus icon, and a refresh icon. A "Type:" dropdown menu is set to "Block (Int.Com/Phn)". Below this is a table with two columns: "IP" and "Description". The first row of the table has the IP address "192.168.99.232" in the "IP" column and is highlighted.

11.13.2 Deleting an Allowed or Blocked IP Address

IP addresses can be removed from allowed or blocked lists, as required. You can either remove selected addresses (using the Delete button) or remove all addresses at the same time (using the right-click context menu). To remove an address, you must first select from the **Type** list and then highlight the address row.

11.14 HOST EDITOR - FIELD DEFINITIONS

11.14.1 Host Editor - General tab

Field/Display Item	Description
Name	The name of the host. This is usually defined when the host is added to the enterprise using the Domain Editor. See the “Domains and the Domain Editor” chapter in this Configuration Guide for details. The hostname can be changed using the Host Editor if required. The hostname does not have to be unique. Maximum length = 20 characters.
Comment	Comments relating to a selected host. To add comments, click in this field and type your comments. Maximum length = 255 characters.
Boards: Board 1: (Ports 1-8)	The expansion board type the TBC is to expect at ports 1-8. Expansion boards must be installed in order, from one to four. If there is only one board installed in an MIU, it must occupy the Board 1 position, if there are two, they must occupy positions 1 and 2, etc. ONLY AVAILABLE FOR AN MIU.
Boards: Board 1: Termination Settings	These settings only apply to FXO and FXS. E&M termination settings are specified in the Panel Editor for the specific E&M port. Available options when enabled are Japan, CTR21, 600-R, 900-R. Default CTR21.
Boards: Board 2: (Ports 9-16)	This field is used to specify what expansion board type the TBC is to expect at ports 9-16. ONLY AVAILABLE FOR AN MIU.
Boards: Board 2: Termination Settings	See description for Board 1 (above)
Boards: Board 3: (Ports 17-24)	This field is used to specify what expansion board type the TBC is to expect at ports 17-24. ONLY AVAILABLE FOR AN MIU.
Boards: Board 3: Termination Settings	See description for Board 1 (above)
Boards: Board 4: (Ports 25-32)	This field is used to specify what expansion board type the TBC is to expect at ports 25-32. ONLY AVAILABLE FOR AN MIU.
Boards: Board 4: Termination Settings	See description for Board 1 (above)
Host Address: IP Address Mode	Fixed IP The IP address is fixed and should be entered in the IP address field. Host Name Mercury peers contact this host using the hostname entered here.
Host Address: IP Address	Specifies the IP address of the host if Fixed IP is selected.
Host Address: Host Name	Specifies the hostname of the computer as an alternative to its IP address.
Host Address: TBC TCP Port	The TCP listen port used to accept TBC-to-TBC peer communications. Default 6822, minimum 1, maximum 65535. Must be the same on all hosts.

Field/Display Item	Description
Host Address: Offline	If checked, a host may be declared “out of service”, allowing it to remain within the configuration but preventing error messages which would otherwise be present. Default = unchecked.
Multicast: Multicast Address	The multicast base address. The first multicast used in a pool of addresses is defined by the total number of DSP channels available for conferences in the system. Change this to suit the network environment in which the MIUs are used.
Multicast: Multicast address auto-updated	Check this box for all host multicast addresses to be automatically updated whenever the base address changes. Default = unchecked.
Multicast: Max. Multicasts	The maximum number of multicasts allowed. Default = 10
Database Restart Thread Priority	This setting determines the priority of the database cache processing to give control over the amount of CPU usage during restart operations. This minimizes the potential interruption to audio communications. The range is from Idle (low) to Full Speed (high).
Miscellaneous: Cmdr System	A Commander ID is needed only if Commander networking is used. Gateway automatically creates an ID for each Mercury host. This ID is required by the Pathfinder software, which operates as the Configuration Editor for Commander/Orator systems. Cannot be blank. If Commander/Orator networking is not being used this value has no effect.
Miscellaneous: Serial Ports	The total number of serial ports available for use by Commander networking. Range 0-3.
Miscellaneous: GPIO PCI Board Type	Radio buttons select either TTL or Opto.

11.14.2 Host Editor - Audio tab



Field/Display Item	Description
Audio Card Address: IP Address Mode	The IP address mode. Radio buttons allow a choice of Fixed IP or DHCP. Use of Fixed IP mode is recommended.
Audio Card Address: IP Address	The IP address of the audio card. Enter the relevant address in the space provided.
Audio Card Address: Host Name	The Host Name of the audio card. Used to connect to peer audio cards if DHCP IP Mode is selected.
SIP: Transport	Select the protocol to be used for SIP calls. Radio buttons allow a choice of TCP or UDP. Default = UDP.
SIP: SIP Call Port	Specifies the Transport Control Protocol (TCP)/User Datagram Protocol (UDP) port number used to send/receive SIP messages. Default = 5060.
SIP: RTP/RTCP Port	Specifies the first RTP port number to be allocated for SIP calls. Default = 10000.
SIP: Associate Aliases with Outgoing SIP	When checked, no phone number lookup is necessary (provided an alias for the number is defined within the Registrar/Proxy SIP Server) when placing a call. This option is useful when a Registrar Server also acts as a Proxy/Redirect Server. When a call is made, the domain of the SIP Proxy Server is used. For example, calling 111 will be sent as 111@proxyserver-domain.com Default = unchecked.

Field/Display Item	Description	
SIP: SIP DTMF Mode	Selects the method for sending and receiving DTMF using SIP:	
	Selection	Method
	None (default)	DTMF transferred using RTP audio
	Info	DTMF transferred using SIP INFO packet: signal=<digit>
	Info w/duration (VP)	DTMF transferred using SIP INFO packet: signal=<digit> duration=<duration in ms>
	RTP (RFC2833)	DTMF transferred using special RTP (RFC2833) packets
Networked DSPs: Networked DSPs	Used for 700-25-06 MIU and MCU host types only. Default = unchecked.	
Networked DSPs: Enhanced PCI	Used for 700-25-06 MIU only. Default = unchecked.	
Networked DSPs: DSP- 1 Address Mode	Address mode may be either Fixed IP or DHCP, selected by radio buttons. The adjacent IP entry field is only active for Fixed IP mode which is preferred.	
Networked DSPs: DSP- 2 Address Mode	As above, for DSP-2.	
Networked DSPs: Jitter Mode	Optimization factor that defines how the jitter buffer tracks to changing network conditions. <ul style="list-style-type: none"> • 0 -- Static jitter buffer (default) • 1-12 -- Dynamic jitter buffer. 	
Networked DSPs: VAD Packet Mode	Defines what packets to send when VAD detects "silence" in the audio. Select either CNG (Comfort Noise) or DTX (No Packets)	
Networked DSPs: VAD Threshold (dB)	The threshold below which "silence" is detected in the audio. Default -35 dB	
Networked DSPs: VAD Linger (ms)	How long to wait after speech before silence can be detected. Default 500 ms	
Networked DSPs: VAD Window (ms)	VAD Analysis Window size (1 to 30 ms) Default 3 ms	
Audio UDP Ports: Intercom Control	Default = 2076	
Audio UDP Ports: Intercom Audio	Default = 2077	
Audio UDP Ports: Telephony Control	Default = 2078	
Audio UDP Ports: Telephony Audio	Default = 2079	
Audio Ports: Loopback audio on missing ports (MIU only)	When checked, causes the routing engine to automatically loop back any audio routed to configured ports that are not physically fitted to the host. This is done when testing and in some advanced configurations to enable routing of sources to address other sources in the configuration that may not have physical addresses.	

Field/Display Item	Description
Audio Ports: Local ports audio mode (MIU only)	Defines the behaviour of the two audio ports built into the Mercury audio card (analogue ports A and B). These local ports are only available for audio use if defined in the system configuration. It is possible to customise the behaviour of the headset port on a card in the following ways. Mono Analogue ports A and B are joined together. Dual Analogue ports A and B are separated. DI/4 wire Overrides microphone with Aux line. This is known as “Trunk mode”.
Audio Ports: Primary HSet type (MCU only)	Select Auto, BOSE or Plantronics
Audio Ports: Primary HSet mode (MCU only)	Select Electret or Dynamic
Audio Ports: Headphone Mode (MCU only)	Select Left or Both
Audio Ports: Secondary HSet mode (MCU only)	Select Electret or Dynamic
Network QoS: Enable 802.1Q	Tick the checkbox to enable Network QoS
Network QoS: VLAN ID	When QoS is enabled, the VLAN may be set in the range 0 to 4095.
Network QoS: Level	Select the required QoS level from the list. Range 000(0) to 111 (7)
Network QoS: DSCP (Audio)	Differential Services Codepoints (RFC2474) may be independently set for voice data, on a per-host basis. Select the required DCSP setting for audio from the drop-down list.
Network QoS: DSCP (Control)	Differential Services Codepoints (RFC2474) may be independently set for control data, on a per-host basis. Select the required DCSP setting from the drop-down list.
Audio Quality: Intercom CODEC Profile	The bandwidth profile used for intercom.
Audio Quality: Configure independent multicast CODEC	Select this checkbox to allow the multicast CODEC profile to be changed.
Audio Quality: Multicast CODEC Profile	The bandwidth profile used for multicast. Click  to calculate the best CODEC profile for conferences.
Audio Quality: Enable TEB and Configure Independent CODEC	Select this checkbox to enable telephone support. The CODEC profile can then be changed. Telephone support must be enabled if a TEB is installed and activated on other hosts that interoperate with TEB hosts.
Audio Quality: TEB CODEC profile	The bandwidth profile used for telephony. Telephony modules can only support 8 kHz sample rate. If using telephony, G722 CODECs may NOT be used. G722 CODECs use 16 kHz sampling: the other profiles use 8 kHz sampling.
Telephony: Echo Cancel Mode	Four modes are available: <ul style="list-style-type: none"> • Acoustic and Line • Disabled • Line (hybrid) - default • Acoustic

Field/Display Item	Description
Telephony: Ringing Timeout (s)	Time in seconds after which an un-answered call will clear down. Range 5 s – 120 s. Default = 60 s.
Telephony: First Digit Timeout (ms)	Determines how long the TBC will wait for valid phone control digits when receiving a call on a TEB port. After this timeout period, the call is “forwarded” to any panels with keys targeting that TEB (i.e. the yellow tally flashes indicating an incoming call). Default = 5000 ms. Minimum = 1000 ms. Maximum = 30000 ms.
Telephony: IP Phones Allocated	The number of DSP channels that are allocated for panels to talk to telephones (FXO) on this host only (i.e. outgoing calls). DSP channels must be reserved for this operation.
TTMU: Ack Wait Time (ms)	Period to wait for an ACK to be received for a packet sent using the TTMU (intercom) protocol. If no ACK is received in this period, then the packet is resent. Default 100
TTMU: Total Resend Time (ms)	Period to continue to resend a packet which has not received an ACK. If this period expires and no ACKs have been received, the connection is ended. Default 4000
TSMU: Ack Wait Time (ms)	Period to wait for an ACK to be received for a packet sent using the TSMU (telephony) protocol. If no ACK is received in this period, then the packet is resent. Default 100
TSMU: Total Resend Time (ms)	Period to continue to resend a packet which has not received an ACK. If this period expires and no ACKs have been received, the connection is ended. Default 4000
Inter-Host (TBC to TBC) Conn retry time (ms)	The period between attempts to re-establish a data connection between hosts. Default 1500
GWIN: Ack Wait Time (ms)	Period to wait for an ACK to be received for a packet sent using the GWIN (interhost data) protocol. If no ACK is received in this period, then the packet is resent. Default 100.
GWIN: Total Resend Time (ms)	Period to continue to resend a packet which has not received an ACK. If this period expires and no ACKs have been received, the connection is ended. Default 4000.

11.14.3 Host Editor - Subscribers tab

Field/Display Item	Description
Port #	Shows the port number on the host. The number and type of port vary according to the type of expansion board and host selected. This cannot be changed.
Type	Shows an icon corresponding to the panel/ subscriber type. To specify or change the panel/subscriber, click in this field and click the  button. Select the required subscriber from the pop-up menu. The list of available panels/subscribers depends on the host and expansion board type fitted in the MIU.
Name	The name of the panel or subscriber that is configured on the relevant port. The name can be changed. It is used by default by all other panels with keys that target this subscriber. The name is also used to construct names for routes defined in the Route Editor. Maximum length = 20 characters.
Description	Descriptive comments relating to a specific subscriber. Maximum length = 255 characters.
Long Name	If text is entered, this will be used as an alternate to the Name field, on panels with displays supporting 8 characters. If left blank, the Name field will always be used.
Lstn Label	The listen label is the name displayed on a panel that is listening to the given subscriber. This label overrides the target name, but only when the key targeting the subscriber is a listen-only key type. Maximum length = 20 characters.
Long Lstn Label	If text is entered, this will be used as an alternate to the Lstn Label field, on panels with displays supporting 8 characters. If left blank, the Lstn Label field will always be used.
Mirror Dim	If two-way (Speak & Listen) communication is open between this and another subscriber, then the panel speaker is dimmed by the amount specified here (in dB). This helps prevent howl around. For this to function at its best, it is advisable to enable it on both subscribers. The default value depends on the subscriber attached to the port.
Picture	Assigns a picture to a subscriber so that Virtual Panel Desktop or Square users see that picture when speaking or listening to the subscriber, which can help identify the caller. Click  to browse for and select an image file.
Dim Loc Name	Dimming Location Name is used to select a suitable dimming location if defined and according to the physical placement of hardware panels.
Dim Loc Opt-out	Dimming Location Opt-out checkbox is used to allow specific subscribers to opt-out (i.e. not follow) the rules generated by location-based dimming.
CmdrEDHS	Shows the EDHS of the destination trunk. A trunk is a static route that is established when the associated hosts boot, and audio is permanently routed from one 'trunked' port to the other. This field also shows the EDHS of the Commander/Orator host, if the port has been selected as a Commander/Orator port.

Field/Display Item	Description
CmdrName	Shows the name of the destination trunk. This field also shows the name of the Commander/Orator host, if the port has been selected as a Commander/Orator port.
Owner Host	When making a route from a panel an “owner” is set, usually the panel itself, which then locks the route from being changed by any other panel or TBC. To allow two panels to change a route an owner host must be specified. Two panels with the same owner host can control the same route (because route requests effectively appear to come from the same owner).

11.14.4 Host Editor - Ports tab

Field/Display Item	Description
Port #	The number of the port on the selected host. The number and type of port vary according to the type of host selected. This cannot be changed.
Type	Shows an icon corresponding to the subscriber type. To specify or change the subscriber, click in this field and click  . Select the required subscriber.
Name	Shows the port’s name. The name can be changed if required.
In.Gain	A fixed gain (in dB) that is applied to all incoming audio on this port, regardless of subscriber type. Default = 0 dB. Range 12.0 to -34.5 dB, Mute available. Click and select the required value from the drop-down list.
Out.Gain	A fixed gain (in dB) that is applied to all outgoing audio on this port, regardless of subscriber type. Default = 0 dB. Range 12.0 to -34.5 dB, Mute available. Click and select the required value from the drop-down list.
Ns.Gating	Noise gating will mute the input audio if the input audio level is below the configured level (Ns.Threshold) for ≥5 seconds and unmute again immediately if the input audio level exceeds the set threshold. The level needs to be set according to the requirements of the specific installation. To enable noise gating, select the checkbox.
Ns.Threshold	The audio level below which input audio is muted if Ns. Gating has been enabled. Default = -10 dB. Range -10 dB to -50 dB.
In.Pres	This is the audio threshold used to indicate input audio presence on a panel key, when that panel key is configured to display input audio presence (Signal Presence). Default = -10 dB. Range 0dB to -50dB.
Out.Pres	This is the audio threshold used to indicate output audio presence on a panel key, when that panel key is configured to display output audio presence (Signal Presence). Default = -10 dB. Range 0 dB to -50 dB

Field/Display Item	Description
Op. Rec	Select the checkbox to enable recording. By default, recording is disabled for all ports. When enabled on a port, audio outgoing to the port, and incoming from the port will be mixed and made available as a single record multicast stream. Operator recording can function on all 34 ports of an MIU simultaneously.
Op. Rec Type	Controls whether Speak, Listen or Both Directions are sent to the multicast stream to be recorded.
M/Cast Addr	A multicast channel used for recording operator audio from this Mercury host port. Note that an external recording device is required. By allocating the same multicast address to multiple ports, audio to and from those ports will be mixed and streamed on the single multicast address. When multicast addresses are selected for recording, they will no longer be available for use by conferences.

11.14.5 Host Editor - RIB – Standard and Enhanced

RIB Settings are provided here, using the Host Editor, and at Subscriber level where additional settings are also available.

Please refer to section 18 - *Configuration Editor | Subscriber | Radio Port and Radio Phone* on page 186 for more information.

Standard Settings	
Field/Display Item	Description
Port #	The number of the port on the selected host. The number and type of port vary according to the type of host selected. This cannot be changed.
Type	Shows an icon corresponding to the subscriber type. This cannot be changed here.
Name	Shows the port's name. This cannot be changed here.
Audio In: Input Delay (ms)	Audio delay in ms applied to incoming audio on the selected port. Not frequently used but can be applied to ensure any routes being driven by a COR input are established before audio from a radio is delivered.
Audio In: Input Filter (@3 kHz)	Applies the described filter to the audio incoming to the port.
Audio In: Input Boost	Can be switched on for a gain boost to the incoming audio. Default = unchecked.
Audio Out: Output Delay (ms)	Delay applied to outgoing audio. Commonly used so that the radio base unit is in "transmit" mode before audio arrives so that the destination doesn't miss vital audio. Default = 0 ms.
Audio Out: Output Filter (@3 kHz)	Applies the described filter to the audio outgoing from the port.
Audio Out: Attenuation	Audio level reduction applied to the outgoing signal. Default = unchecked.

Standard Settings	
Field/Display Item	Description
INPUT COR: Enabled	When enabled, Mercury will use the configuration of the following settings to enable or disable audio from the radio port to other subscribers. For example, a panel permanently listening to the radio port will see a flashing tally until the COR signal is received, then the tally will become solid and audio will be heard – this reflects processing going on in the background where the actual route is being muted or inhibited. Default = unchecked.
INPUT COR: Trigger	Can select between COR and VOX to control when Mercury will apply the configured action. COR – electrical input coming into the RIB port itself (default). VOX – Detection of audio incoming to the port, allowing action to be performed while audio is present.
INPUT COR: Mode	Controls whether all listen routes to the radio port are muted or inhibited when the COR trigger is off. Default = unmute.
INPUT COR: Polarity	Inverts the sense of COR trigger. Not recommended for use with VOX but used if radio base unit provides the appropriate electrical signal. Default = Normally open.
INPUT COR: Attack (ms)	Configures how long the trigger condition must be true before the action will be implemented. Default = 0 ms.
INPUT COR: Release (ms)	Configures how long the action continues to be applied once the trigger condition is false. Default = 0 ms.
INPUT COR: Name	The GPI Input used for COR signalling, associated with this port. This is created and named automatically when the RIB is declared. The name may be edited here.
INPUT COR: Comment	A comment relating to the above COR GPI Input.
OUTPUT PTT: Enabled	When enabled, Mercury will turn on the associated output signal for the selected radio port when a configured trigger is true. The following fields configure how the action is triggered and performed. Default = unchecked.
OUTPUT PTT: Trigger	Two options used to trigger the output to be switched on. Route – Whenever a speak route is made to the port, the output signal is switched on (default). VOX – Whenever audio is outgoing from the point, the output signal is switched on.
OUTPUT PTT: Polarity	Inverts the sense of the PTT output. Default = Normally open.
OUTPUT PTT: Attack (ms)	Configures how long the trigger condition must be true before the action will be implemented. Default = 0 ms.
OUTPUT PTT: Release (ms)	Configures how long the action continues to be applied once the trigger condition is false. Default = 0 ms.
OUTPUT PTT: Name	The GPI Output used for PTT control, associated with this port. This is created and named automatically when the RIB is declared. The name may be edited here.

Standard Settings	
Field/Display Item	Description
OUTPUT PTT: Comment	A comment relating to the above PTT GPI Output.
Sidetone Suppression (SFST): Enabled	When enabled, the audio from the radio will be dimmed or delayed when the trigger condition is true. Default = unchecked.
Sidetone Suppression (SFST): Delay (ms)	The amount of delay used when SFST is enabled. Default = 0 ms.
Sidetone Suppression (SFST): Level (dB)	The attenuation applied when SFST is enabled. Default = 0 dB.

Enhanced Settings	
Field/Display Item	Description
Port #	The number of the port on the selected host. The number and type of port vary according to the type of host selected. This cannot be changed.
Type	Shows an icon corresponding to the subscriber type. This cannot be changed here.
Name	Shows the port's name. This cannot be changed here.
Audio In: Intelligent Squelch Filter	Attempts to remove the static blips that can occur from radio units. Default = unchecked.
Audio In: DTMF Detection	Turn this on if you want the radio to be able to drive an FXO port, should the appropriate route be made for it. Default = unchecked.
Audio In: Adaptive Speech Filter	Applies noise reduction processing to the incoming audio. Default = unchecked.
Audio In: Noise Reduction	The amount of noise reduction applied if the adaptive speech filter (above) is enabled. Default = 12 dB.
Audio In: Speech in Noise	Enable Speech in Noise Detector(SND). Default = checked.
Audio Out: CTCSS Tone	Enable Continuous Tone-Coded Squelch System (CTCSS). Default = unchecked.
Audio Out: CTCSS Frequency (Hz)	CTCSS frequency if CTCSS Tone is enabled. Default = 67 Hz.

11.14.6 Host Editor - VOX tab

VOX Settings are provided here, using the Host Editor, and at Subscriber level where additional settings are also available.

Please refer to section 18 - *Configuration Editor | Subscriber | Radio Port and Radio Phone* on page 186 for more information.

Field/Display Item	Description
Port #	The number of the port on the selected host. The number and type of port vary according to the type of host selected. This cannot be changed.
Type	Shows an icon corresponding to the subscriber type. This cannot be changed here.
Name	Shows the port's name. This cannot be changed here.
Input VOX: Name	The Input VOX control, associated with this port. This is created and named automatically when the RIB is declared. The name may be edited here.
Input VOX: Comment	A comment relating to the above VOX control.
Input VOX: Attack (ms)	Length of time the incoming audio is above the threshold before the VOX trigger is turned on. Recommend approx. 500ms, so that little blips of background noise don't register but not so long that the trigger misses the start of any audio. Default = 0 ms.
Input VOX: Release (ms)	Length of time the trigger stays on after audio has dropped below the threshold. Used to avoid the trigger turning off when there are short pauses or breaths when speaking. Default = 0 ms.
Input VOX: Level (dB)	The threshold that audio must be above for the VOX trigger to turn on. Default = -10 dB.
Output VOX: Name	The Output VOX control, associated with this port. This is created and named automatically when the RIB is declared. The name may be edited here.
Output VOX: Comment	A comment relating to the above VOX control.
Output VOX: Attack (ms)	As Input VOX (above), but for the RIB port audio output
Output VOX: Release (ms)	As Input VOX (above), but for the RIB port audio output
Output VOX: Level (dB)	As Input VOX (above), but for the RIB port audio output

11.14.7 Host Editor - Virtual Ports tab

Field/Display Item	Description
ID	Shows the ID of the port. The total number of IDs will be equal to the maximum number of IP channels on the host. The ID cannot be changed.
Type	Shows an icon corresponding to the subscriber type. To specify or change the subscriber, click in this field and click  . Select None, Virtual 4-Wire or Virtual Panel from the pop-up menu.
Name	The name of the subscriber configured on the relevant port. The name can be changed. It is used by default by all panels on keys that target that given subscriber. The name is also used to construct names for routes defined in the Route Editor. Maximum length = 20 characters.
Description	Descriptive comments relating to a specific Virtual 4-wire. Maximum length = 255 characters.

11.14.8 Host Editor - SIP Aliases tab

Field/Display Item	Description
Name	The SIP Alias name can be changed, as required.
SIP Connection: Type	Shows an icon representing a SIP connection.
SIP Connection: Name	The name of the SIP Connection, previously created at Enterprise level.
Registrar	The details used by the Mercury SIP endpoint when registering with a SIP Registrar Server. Server: The IP or DNS server name. User: The username (defaults to the alias name) required to authenticate. Password: The password required to authenticate (optional). Port: The port that the SIP Registrar Server is listening on. Expires: The expiry time for registration (seconds).
Challenge	Used for incoming call authentication. When a SIP Proxy or SIP device (e.g. telephone) attempts to call this SIP endpoint a challenge username/password is required by the calling device. User: The username used for the challenge. Password: The password used for the challenge.
Preferred CODECs	Codecs, in priority order, that will be used to establish audio.

11.14.9 Host Editor - GPIO tab

Field/Display Item	Description
Type	This list is used to select the type of GPI inputs and outputs displayed in the grid below. List content changes according to the host type.
ID	Not used.
Name	The name of the GPI input or output. By default, when GPIs are added, a distinguishable name is automatically given that describes the GPI type and port number. The name does not have to be unique. Maximum length = 20 characters. A & B are the local audio ports commonly referred to as onboard. GII/GIO Onboard GPIO ports. GPI/GPO 1-16 The GPIOs on the 16-port expansion card (700-25-04 MIU) GAI/GAO 1-32 GPI/GPO fired on voice activity detection 'VOX'.
Comment	Any comment relating to this GPIO. Add a new comment in the space provided.
Attack	The wait time before a GPIO is said to have occurred, i.e., setup time (debounce). Minimum value is 0 ms, Maximum is 5000 ms, in steps of 10 ms.
Release	The wait time before a GPIO is said to have been released i.e., hold time. Minimum value is 10 ms, Maximum is 5000 ms, in steps of 10 ms.
Level	The level above which a GPIO will consider the GPIO is related to voice rather than noise. (Audio Input and Output only.)
Port	Port identifier of the Audio (VOX) Input/Output GPIO (not editable)

11.14.10 Host Editor - Allow/Block List tab

Field/Display Item	Description
Type	Select the type of IP address that you want to allow or block.
IP	The IP address to be allowed or blocked.
Description	The description of the IP address.

11.15 DCSP DETAILS

A Differentiated Services Codepoint (DSCP) is comprised of the upper six bits of the ToS byte in IP packets. In the switch default QoS configuration, some codepoints are configured with default 802.1p priority settings for Assured- Forwarding and Expedited Forwarding, while others are unused and listed with no-override as the priority. There are 64 possible codepoints.

DSCP Name	DSCP Number	PHB Name	PHB Number	Drop Probability Name	Drop Probability Number
BE0	DSCP0	BE	000	None	00
BE1	DSCP2	BE	000	Low	01
BE2	DSCP4	BE	000	Medium	10
BE3	DSCP6	BE	000	High	11
AF10	DSCP8	AF1	001	None	00
AF11	DSCP10	AF1	001	Low	01
AF12	DSCP12	AF1	001	Medium	10
AF13	DSCP14	AF1	001	High	11
AF20	DSCP16	AF2	010	None	00
AF21	DSCP18	AF2	010	Low	01
AF22	DSCP20	AF2	010	Medium	10
AF23	DSCP22	AF2	010	High	11
AF30	DSCP24	AF3	011	None	00
AF31	DSCP26	AF3	011	Low	01
AF32	DSCP28	AF3	011	Medium	10
AF33	DSCP30	AF3	011	High	11
AF40	DSCP32	AF4	100	None	00
AF41	DSCP34	AF4	100	Low	01
AF42	DSCP36	AF4	100	Medium	10
AF43	DSCP38	AF4	100	High	11
EF0	DSCP40	EF	101	None	00
EF1	DSCP42	EF	101	Low	01
EF2	DSCP44	EF	101	Medium	10
EF3	DSCP46	EF	101	High	11
IC0	DSCP48	IC	110	None	00
IC1	DSCP50	IC	110	Low	01
IC2	DSCP52	IC	110	Medium	10
IC3	DSCP54	IC	110	High	11
NC0	DSCP56	NC	111	None	00
NC1	DSCP58	NC	111	Low	01
NC2	DSCP60	NC	111	Medium	10
NC3	DSCP62	NC	111	High	11

12. CONFIGURATION EDITOR | SUBSCRIBER | INTRODUCTION

12.1 OVERVIEW

The Mercury system can be exposed to users by a variety of Virtual Panels (PC users) or Hardware Panels (non-PC users). These panels can be provided to individual users anywhere on the network. Subscribers are added to a host using the Host Editor. Once they have been added, you must configure the panel type subscribers, define the targets of the panel keys and specify settings. To do this, use the Panel Configuration Editor.

Configuring a panel or subscriber allocates targets to each key on the selected panel. Some subscribers, for example, a 4-wire source, require no configuration, whereas others require you to input details of the targets, key modes and key settings.

Depending on the type of expansion board fitted to an MIU, different subscriber types are supported such as radios or telephones. The subscriber editor appearance and complexity varies greatly according to type and each is dealt with in later chapters.

If you have defined globally available phone numbers using the Phone Number Editor, you can allocate selected numbers to a panel for recall later. See section 26 - *Configuration Editor | Phone Numbers* for more information.

12.2 USING THE SUBSCRIBER CONFIGURATION EDITOR

12.2.1 Viewing a Summary of Subscribers on a Host

You can view a list of all subscribers that are attached to a specific host by selecting the host in the Enterprise tree.

To view a list of subscribers:

- Expand the Enterprise tree in Gateway.
- As the tree expands, a list of subscribers is shown in the tree, below the host.

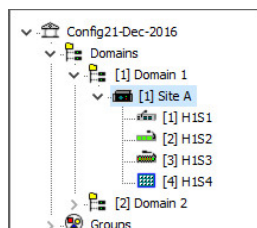

To launch the subscriber editor

As with other areas of Gateway, single-click on the icon in the tree to launch the basic editor – double-click to launch the advanced editor.

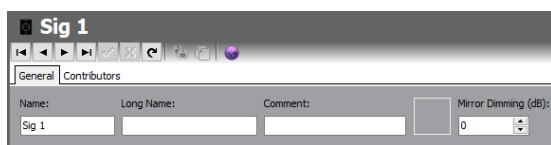

This is the simplest of the subscriber editors, 4-wire. See the list below and later sections for more information.

12.3 CONFIGURING SUBSCRIBERS









- To configure a hardware panel, see section 13 - *Configuration Editor | Subscriber | Hardware Panel* in this manual.
- To configure an FXO subscriber, see section 14 - *Configuration Editor | Subscriber | Foreign Exchange Office (FXO)* in this manual.
- To configure an FXS subscriber, see section 15 - *Configuration Editor | Subscriber | Foreign Exchange Station (FXS)* in this manual.
- To configure an E&M subscriber, see section 16 - *Configuration Editor | Subscriber | Ear and Mouth (E&M)* in this manual.
- To configure a 4-wire subscriber, see section 17 - *Configuration Editor | Subscriber | 4-wire* in this manual.
- To configure a radio port or radio phone, see section 18 - *Configuration Editor | Subscriber | Radio Port and Radio Phone* in this manual.
- To configure a Virtual Panel, see section 19 - *Configuration Editor | Virtual Panel Subscriber* in this manual.









12.4 KEY MODES

Both hardware and virtual panels have keys to allow the operator to communicate with other subscribers. On hardware panels, the keys are frequently bi-directional; that is, they have “up” and “down” switch actions. On virtual panels, this is partially replicated by the use of “short press” and “long press” on screen. Communication between subscribers can require “just listening”, “just speaking” or an interactive mix of the two. All these factors lead to a wide variety of key modes being offered, some appropriate for general use, others tailored to fit very specific needs.

To simplify the process for system administrators, Gateway applies certain logical rules as keys are added to panels.

- A default key mode will automatically be set. This will be correct for many circumstances but can be adjusted if found to be sub-optimal as testing proceeds.
- The range of alternate key modes offered is filtered so that inappropriate types are removed. For example, if the key target is a phone subscriber, only the three “phone” keys shown below will be offered.

Icon	Name	Description
	Speak	Operates as a latching speak key if you briefly press the key, otherwise, it is a momentary speak, making a route only for the duration of the keypress. The upwards and downwards action of a lever-action key is identical.
	Latching / Momentary Speak	A momentary speak if the key is pressed downwards and is always latching in the upwards direction.
	Listen	Operates as a latching listen key if you briefly press the key, otherwise, it is a momentary listen, making a route only for the duration of the keypress. The upwards and downwards action of a lever-action key is identical. Not normally used for communications with panels, but useful for 4-wires.
	Speak/Listen	Operates as a latching key if you briefly press, otherwise it has a momentary action, making a route only for the duration of the keypress. Downwards keypress is for speaking and the upwards press for listening.
	Combined Speak/Listen	Operates as a latching key making both speak and listen routes if you briefly press the key, otherwise, it is a momentary action, making the routes only for the duration of the keypress. The upwards and downwards action of a lever-action key is identical.
	Momentary Speak	A speak key that only ever has a momentary action, making a speak route only for the duration of the keypress. The upwards and downwards action of a lever-action key is identical.
	Speak/Not Listen	Operates like the Speak/Listen key, with the downward motion speaking, upwards listen, and a choice of momentary or latching depending on the duration of the keypress. However, when the speak route is made, the listen route is temporarily suspended for the duration of the speak route.
	Listen/Momentary Speak	As per Speak/Listen, with the downwards motion for speaking and the upwards motion for listening, but only the listen action will latch if pressed briefly.
	Default Speak	As the standard Speak key, but the key defaults to being on – i.e. the speak route made – when the system starts.

Icon	Name	Description
	Default Listen	As the standard Listen key, but the key defaults to being on – i.e. the listen route made – when the system starts.
	Default Listen, Momentary Speak	Upwards keypress to listen – down keypress to speak. Listen is “on” when the system starts.
	Default Listen, Default Speak	Upwards keypress to listen – down keypress to speak. Both listen and speak are “on” when the system starts.
	Phone (Combined Lstn/Spk)	On establishing a call, the key is latched listen, latched speak, hands-free. An upwards keypress puts the call on/off hold, down keypress clears the call.
	Phone (Listen/Speak)	On establishing a call, the key is latched listen, press to speak. The speak mode is either a quick press down to latch or press and hold down for momentary speak. An upwards keypress opens a menu and gives the option to put the call on hold or clear the call.
	Phone (Lstn /MomentarySpk)	On establishing a call, the key is latched listen, momentary press down to speak. An upwards keypress opens a menu and gives the option to put the call on hold or clear the call.
	Tone	Used to send a momentary burst of tone to a target destination, in situations where normal voice conversation is difficult.
	QRS (Speak)	A “quick response” key that allows a reply to the most recent incoming call to be made without first having to locate the specifically configured key for that caller on the panel. The reply may be latched or momentary depending on the length of the keypress.
	QRS (Momentary Speak)	As QRS (Speak) except the speak route can only ever be momentary.

13. CONFIGURATION EDITOR | SUBSCRIBER | HARDWARE PANEL

13.1 OVERVIEW

A Hardware Panel is added to a host using the Host Editor. Once you have added the panel, you must define the key targets, key modes and key settings using the Panel Configuration Editor.

- For more information on adding panels to a host, see section 11 *Configuration Editor | Host* in this Configuration Guide.
- For basic information about opening the Subscriber Editor and an explanation of key modes, see section 12 *Configuration Editor | Subscriber | Introduction* in this Configuration Guide.

As with other areas of the Gateway application, basic and advanced editors are provided. The basic editor provides an intuitive drag and drop interface, making it straightforward to add, delete and edit key targets. The basic editor appears within the advanced editor as the **Sources Layout** tab.

13.2 HARDWARE PANEL EDITOR TABS

The advanced Hardware Panel editor comprises 7 or 8 tabs, outlined below.

- General
- IRIS (only displayed for IRIS panel subscribers)
- Sources
- Sources Layout
- Special
- GPIO
- Phone No. List
- Contributors

These are considered in the following sections.

13.3 HARDWARE PANEL EDITOR - GENERAL

The Panel Configuration - General tab is used to specify basic details about a Hardware Panel.

The screenshot shows the 'General' tab of the Hardware Panel Editor. At the top, there are tabs for 'General', 'Sources', 'Sources Layout', 'Special', 'GPIO', 'Phone No.List', and 'Contributors'. The 'General' tab is active. The interface is organized into several sections:

- Name/Comment Section:** Fields for Name (H1S1), Long Name, Comment, and Mirror Dimming (dB) (-16).
- Audio Section:**
 - Microphone:** Gain (dB) set to 0. Cut Switch options: No Panel Mic. Cut, Panel Mic. Cut (selected), Mic./Headset Changeover. Compressor/Limiter is checked.
 - Loudspeaker:** Mute (Cut Switch) and Hold-off are unchecked. Mute Input GPI is empty. Coarse REN/X-Point Adjustment (2dB per click) is unchecked.
 - X-Point Adj.:** Minimum is unchecked. Gain (dB) is set to -12.
 - Binaural:** Right Channel and Remote Direction (Left) are visible.
- On Air/Busy Section:** Input GPI is empty. Host PTT GPI is empty. PTT Key is unchecked.
- Ports Section:** 1st and 2nd GPI Com Ports are empty. Gain Port is empty. Gain on Input is unchecked.
- Timings Section:**
 - Key Latch Time (ms): 500
 - Tally Holdup (s): 7
 - X-Point Adj. Timeout (s): 10
 - QRS Timeout (s): 10
 - Latency Hold Up (s): 0
 - Listen Label Flash (s): 3
 - IP Call Timeout (Mins): Never
- Miscellaneous Section:** Total Pages is 2. Change Conference Labels on 4-Wire, Fast Keys on Startup, and Flash Tally for Tally Holdup are unchecked. Allow Listen Key Types on Assignment is checked.

13.3.1 Changing Panel Details

You can change the name of the panel and enter a comment to provide further information about the panel. A picture can be added to identify the panel on a Virtual Panel. Further fields provide control over the operation of the panel cut switch, microphone gain the number of available shift pages and other aspects of behaviour.

NOTE: The name of the Hardware Panel is the target name which is allocated when the Hardware Panel is added to the host using the Host Editor. The default name will usually be edited as appropriate. This is the name which other people will see when they speak to you.

To change panel details:

- Select a Hardware Panel from the list of panels/subscribers attached to a host and open the Panel Configuration Editor. The **General** tab is selected by default.
- Make changes as required. If you change the name of the panel, the name will be updated if the panel has been added as a target on another subscriber or panel.
- Click to post changes to the database.

MORE INFORMATION: Refer to section 13.11.1 *Subscriber Configuration – Hardware Panel -- General tab* for a description of the fields on this tab.

13.4 HARDWARE PANEL EDITOR - IRIS

This tab is only displayed when the Subscriber is one of the supported ClearCom IRIS panels. It carries settings unique to this type of panel.

The screenshot shows the 'IRIS' tab selected in a configuration editor. The interface is divided into two main sections: 'IRIS Display' and 'IRIS Headset'. The 'IRIS Display' section contains four settings: 'Dimming Timeout (s)' set to 15, 'Dimming Level' set to 'Very Low', 'Screensaver Timeout (s)' set to 60, and 'Screensaver Mode' set to 'Scroll'. The 'IRIS Headset' section contains three settings: 'Port' set to 'Front (HS1)', 'Mic Type' set to 'Dynamic Unbalanced', and 'Sidetone Gain (dB)' set to '-12'. At the top of the interface, there are several tabs: 'General', 'IRIS', 'Sources', 'Sources Layout', 'Special', 'GPIO', 'Phone No.List', and 'Contributors'.

13.4.1 Changing IRIS panel settings

- Select a Hardware Panel from the list of panels/subscribers attached to a host and open the Panel Configuration Editor. The **General** tab is selected by default – click on the **IRIS** tab.
- Make changes as required.
- Click to post changes to the database.

MORE INFORMATION: Refer to section 13.11.1 *Subscriber Configuration – Hardware Panel -- General tab* for a description of the fields on this tab.

13.5 HARDWARE PANEL EDITOR – SOURCES

The Subscriber Configuration - Sources tab may be used to assign sources to a Hardware Panel. You can assign a full range of sources to the panel by selecting a source type as the target for the specific key on the panel. For most users, the Source Layout tab provides the same functionality in a more convenient drag and drop format.

13.5.1 Defining Key Targets

Hardware Panels have from 8 to 32 buttons/keys and a shift button/key which allows further “layers” of sources to be defined. Each source type that you add will have a default speak/listen mode, which can be changed if required.



NOTE: You can change the number of shift pages on the General tab to provide access to up to 4 pages if required.

To add a panel key target:

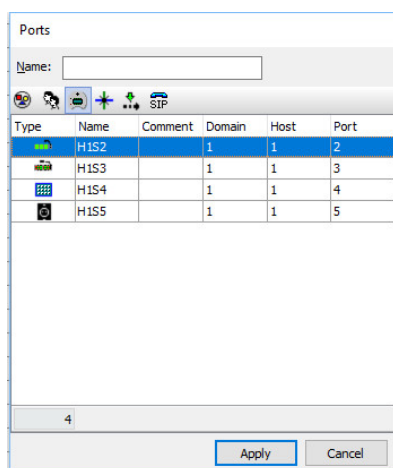
- Select a Hardware Panel from the list of panels/subscribers attached to a host and open the Subscriber Configuration Editor.
- Click the **Sources** tab.
- Click in the **Target** field next to the ID of the key that you want to assign.
- Click  and select the required target from the Panels/Sources dialogue. You can change the target type to a Group, Conference, GPIO/ Audio Route, IFB or SIP connection by clicking the appropriate “mini” button at the top of the dialogue.



Click **Apply** to assign the target and return to the main form.

- Add a user-label (U/Label), if required. L/Label defaults to the name of the target and cannot be changed; if a U/Label is entered, then this is used instead of the L/ Label.
- Click in the Mode field, click  and select the operation type for the key. The provided default is usually the correct mode.
- To display a picture on a receiving Virtual Panel when the key is activated, click in the Alt. Picture field, click  and select the required image.
- Change other settings, if required. You can dim the panel loudspeaker when the target subscriber speaks to the panel user (Dimming) and adjust the incoming (listen) crosspoint gain for the targeted source (Xpt Gain).
- If you do not want users to be able to change this key locally to choose a new destination, clear the Assign checkbox.
- Add additional key targets, as required.
- Click  to post changes to the database.

ID	Type	Target	Lstn Label	UJ Label	Mode	QRS Stack S	Shift Page #	Lstn Type	Lstn Name	Alt.Pictur	LS Dim	Assig	Autodial	Phone Na	Number
1		H1S2	H1S2			0	0				0	<input checked="" type="checkbox"/>			
2		H1S3	H1S3			0	0				0	<input checked="" type="checkbox"/>			
3		H1S4	H1S4			0	0				0	<input checked="" type="checkbox"/>			
4		H1S35	H1S35			0	0				0	<input checked="" type="checkbox"/>			
5						0	0				0	<input checked="" type="checkbox"/>			

MORE INFORMATION: Refer to section 13.11.3 - *Subscriber Configuration – Hardware Panel – Sources tab* for a description of the fields on this tab.

13.5.2 Changing a Key Target

Key targets (sources) on a Hardware Panel can be changed, as required. To do this, change the target for the relevant port.

To change a key target:

- Select a Hardware Panel from the list of panels/subscribers attached to a host and open the Panel Configuration Editor.
- Click the Sources tab.
- Click in the Target field next to the ID of the key that you want to change.
- Click and select the required target.
- Change the other settings, as needed.
- Click to post changes to the database.

13.5.3 Deleting a Key Target

You can delete a key target (source) by clearing the target for a specific port.

To delete a target:

- Select a Hardware Panel from the list of panels/subscribers attached to a host and open the Panel Configuration Editor.
- Click the Sources tab.
- Click in the Target field of the source that you want to delete.
- Press the Delete or Backspace key on your keyboard.
- The target is immediately deleted, and the action cannot be undone.

13.6 HARDWARE PANEL EDITOR – SOURCE LAYOUT

The Subscriber Configuration – Source Layout tab provides an easy to use, intuitive interface to assign sources to Hardware Panel. You can assign a full range of sources to the panel by selecting a source type as the target for the specific key on the panel. The Source Layout tab also serves as the basic hardware panel editor, opened by single-clicking on a hardware panel from the enterprise tree.

13.6.1 Defining Key Targets

Hardware Panels have from 8 to 32 buttons/keys and a shift button/key which allows further sources to be defined. Each source type that you add will have a default speak/listen mode, which can be changed if required.

NOTE: You can change the number of shift pages on the General tab to provide access to up to 4 pages if required.

To add a panel key target:

Ensure the tree view on the left is fully expanded to show the configured subscribers. Single-click on the first of your panels to launch the panel editor. If using the advanced editor, double-click then select the **Source Layout** tab.

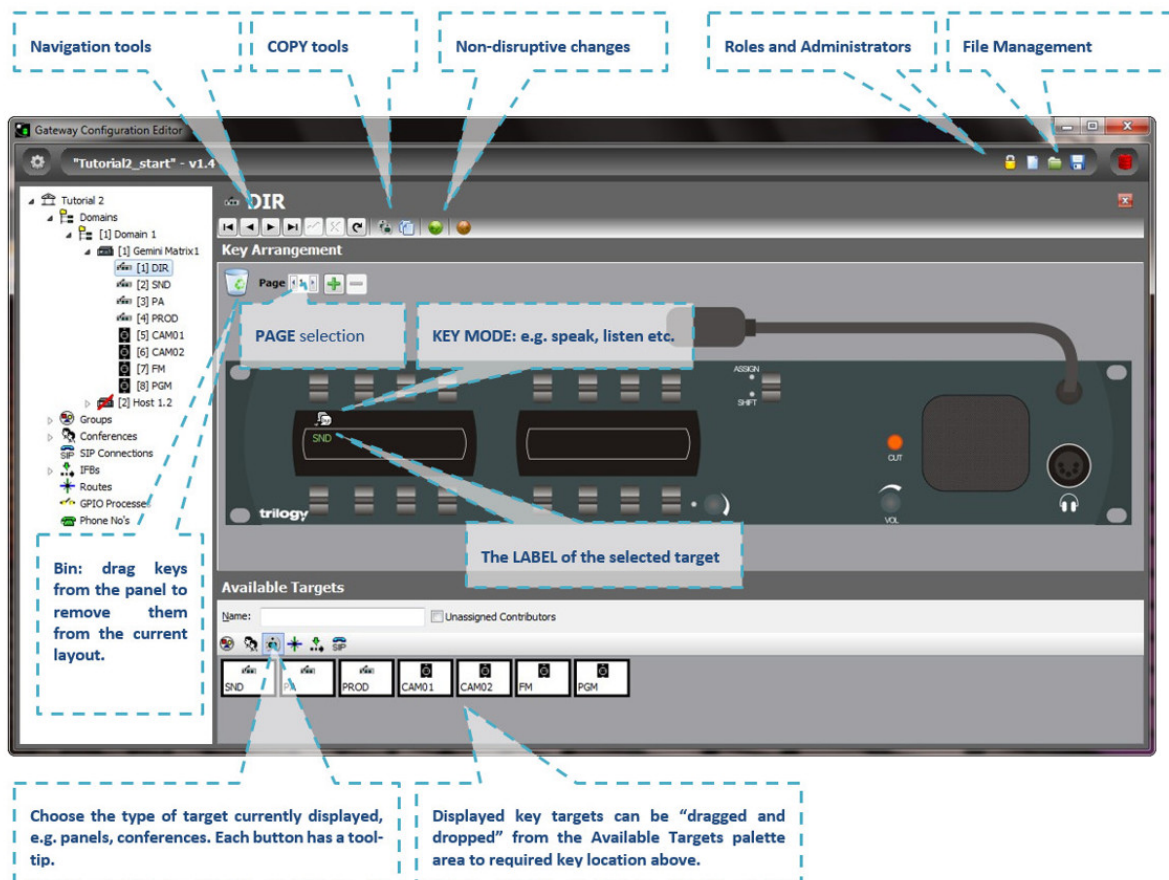

To add keys to a control panel, simply click on one of the available targets from the palette area in the lower part of the screen. Now drag and drop this target on to the required key location area of the panel. As you reach the correct “drop” point, a small rectangle will be highlighted.

- You can also rearrange the layout of keys on the panel using the same drag and drop mechanism.
- To speed up the process, you can select multiple targets from the palette using the normal Windows control and shift key functions. As you drop these multiple targets onto the panel, any existing assignments will be overwritten.
- Many of the Trilogy control panels use lever keys which have both an up and a down action. This allows much greater flexibility since every key can be programmed with several **modes**. For example:
 - Press upwards to open a latched speaking route (i.e. hands-free). Press downwards for a momentary route (i.e. press-to-talk).
 - Press upwards to listen to a 4-wire circuit (e.g. a camera). Press downwards to speak to that 4-wire.
- The key mode is preset and will be intelligently set according to the type of target you have selected. To edit the preset mode, click on the Settings icon near the top right corner of the panel pane.

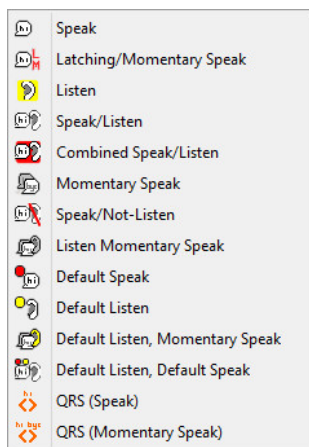

To edit the mode of a key once it has been assigned, left-click on the key icon. A pop-up selection will appear. The most widely used modes are described.

- **Speak.** This key operates as a latching speak key if you briefly press the key, otherwise, it is a momentary speak, making a speak route only for the duration of the keypress.
- **Latching /Momentary Speak.** This key will always be a momentary speak if the key is pressed downwards and is always latching in the upwards direction. To turn off the latched speak, press up for a second time.
- **Speak/listen.** Has the latching/momentary characteristics of the **speak** key, but the downwards-Listen motion is for speaking and the upwards motion for listening.
- **QRS.** The QRS is a smart “quick response” key that allows a reply to the most recent incoming call to be made without first having to locate the specifically configured key for that caller on the panel. The label of a QRS key will change from < > to show the identity of the caller.

Gateway offers an array of key types, all of which may be selected from the dialogue that pops up. An explanation of all the available key types is given later.

NOTE: Panel-to-panel intercom almost always uses *speak* keys, with *no need* for corresponding listen keys at panels. Communications with 4-wires almost always need a listen key but may need a speak/listen key.

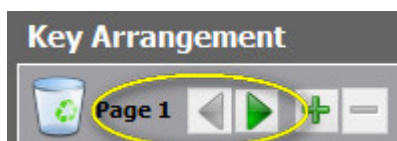

Editor Shift Page Selection

NOTE: additional “shift” pages are also available, increasing the number of key targets that a given panel may have – the available pages can be easily selected within Gateway and by the panel operator. Additional shift pages may be added using the Advanced Editor but try to avoid adding too many or operators may become confused.

13.7 HARDWARE PANEL EDITOR - SPECIAL

The **Special** tab is used to specify special key features including the PTT action of a key on the panel.













13.7.1 Changing Special Panel Settings

Special panel settings can be changed, as required. For example, you can enable signal presence which indicates when a key on the panel has audio, set the maximum number of speaks and listens for conferences and enable ringing for a telephony source on the panel.

To change special panel settings:

- Select a Hardware Panel from the list of panels/subscribers attached to a host and open the Panel Configuration Editor.
- Click the **Special** tab.

NOTE: Details of any targets that have been defined on the Sources tab are displayed. You can add additional sources by clicking in the **Target** field on the **Special** tab.

Special																
ID	Type	Target	Mode	Signal Pre:	GPO Or	Push To Talk (PTT)		Interlock			Conf.	Telephony/SIP				
						Panel GPI	Action	Key Se	Max.Lis	Max.Sp	Priority	Ringin	Tone	Hold/Dialpa	Disable Key	Auto Ans(S
1		H1S1		<input type="checkbox"/>	<input type="checkbox"/>	n/a	n/a	n/a	n/a	n/a	n/a	<input type="checkbox"/>		<input type="checkbox"/>	<input type="checkbox"/>	<input type="checkbox"/>
2		H1S2		<input type="checkbox"/>	<input type="checkbox"/>	n/a	n/a	n/a	n/a	n/a	n/a	<input type="checkbox"/>		<input type="checkbox"/>	<input type="checkbox"/>	<input type="checkbox"/>
3		H1S4		<input type="checkbox"/>	<input type="checkbox"/>	n/a	n/a	n/a	n/a	n/a	n/a	<input type="checkbox"/>		<input type="checkbox"/>	<input type="checkbox"/>	<input type="checkbox"/>
4		H1S7		<input type="checkbox"/>	<input type="checkbox"/>	n/a	n/a	n/a	n/a	n/a	n/a	<input type="checkbox"/>		<input type="checkbox"/>	<input type="checkbox"/>	<input type="checkbox"/>
5		Radio		<input type="checkbox"/>	<input type="checkbox"/>	n/a	n/a	n/a	n/a	n/a	n/a	<input type="checkbox"/>		<input type="checkbox"/>	<input type="checkbox"/>	<input type="checkbox"/>
6		Telephone 1		<input type="checkbox"/>	<input type="checkbox"/>	n/a	n/a	n/a	n/a	n/a	n/a	<input type="checkbox"/>		<input type="checkbox"/>	<input type="checkbox"/>	<input type="checkbox"/>
7	?			<input type="checkbox"/>	<input type="checkbox"/>	n/a	n/a	n/a	n/a	n/a	n/a	<input type="checkbox"/>		<input type="checkbox"/>	<input type="checkbox"/>	<input type="checkbox"/>

- Adjust the special settings for each target, as required.
- Click to post changes to the database.

MORE INFORMATION: Refer to section 13.11.4 - *Subscriber Configuration – Hardware Panel – Special tab* for a description of the fields on this tab.

13.8 HARDWARE PANEL EDITOR - GPIO

The GPIO tab is used to define GPI inputs and outputs for a Hardware Panel. Once defined, these may be used to create routes and GPI processes as explained in sections 24 and 25 of this manual.

- The maximum permitted number of GPIOs on a Hardware Panel varies by model. Buttons at the top of the GPIO tab let you:
 - Add a new GPI input or output.
 - Delete a selected GPI input or output.
 - Delete all at the same time (after confirmation).

13.8.1 Adding a GPI Input or Output to a Hardware Panel

You can add up to three GPI inputs and three GPI outputs (two may be defined on a desktop panel). These will be automatically named by the system. A comment can be added to provide more information if required.

To add a GPI input or output:

- Select a Hardware Panel from the list of panels/subscribers attached to a host and open the Configuration Editor.
- Click the GPIO tab.
- Select the Inputs or Outputs radio button, as appropriate.
- Click the green + button to add an input or output.
- Enter a comment, if required.
- Click to post changes to the database.

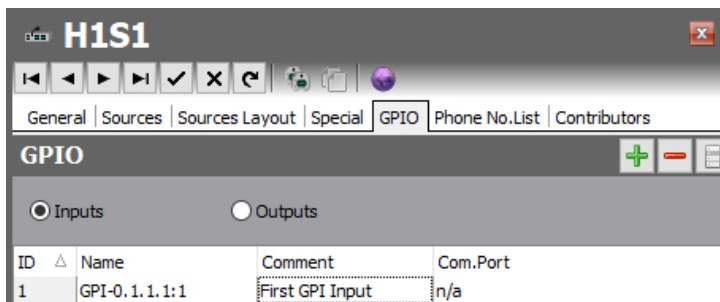

MORE INFORMATION: Refer to section 13.11.5 Subscriber Configuration – Hardware Panel – GPIO tab for a description of the fields on this tab.

13.8.2 Deleting GP Inputs and Outputs

Any GP inputs or outputs that are not required on Hardware Panels can be deleted. You can either delete selected inputs/outputs (using the Delete button) or delete all inputs/outputs at the same time (using the Clear All right-click option).

IMPORTANT: If you delete a GPIO it will be removed from any GPIO processes that have been configured to use the selected GPIO. The process will not be deleted but will not function as expected.

13.9 HARDWARE PANEL EDITOR - PHONE NUMBER LIST

If you have defined globally available phone or SIP numbers using the Phone Number Editor, these can be added to the configuration and then recalled on a Hardware Panel.

- Phone numbers are outgoing digits that may be used by panels as speed- dials when accessing FXO, FXS or E&M ports. The digits are dialed as DTMF when the call is placed.
- SIP numbers are outgoing digit sequences that map to either fully formed URIs or are digits that are passed to a Proxy Server where they are fully resolved.

Buttons at the top of the tab let you:

- Add a phone/SIP number.
- Delete a selected phone/SIP number.

13.9.1 Adding a Number to a Hardware Panel

To add a number to a Hardware Panel, you must first ensure that you have created the required numbers using the Phone Number Editor. See the “Phone Numbers and the Phone Number Editor” chapter in this Configuration Guide for more information on phone and SIP numbers.

NOTE: Phone and SIP numbers are available globally within the system and the same number can be added to more than one panel. When you add phone or SIP numbers you select from the list of numbers added using the Phone Number Editor and as such you cannot make changes to these numbers on the Subscriber Configuration - Phone No. List tab.

To add a number:

- Select a Hardware Panel from the list of panels/subscribers attached to a host and open the Subscriber Configuration Editor.
- Click the **Phone No. List** tab.

Name	Telephone Number
Support	0800123123
Reception	937

2

Apply Cancel

Click **Add** to open the Phone Numbers list. Both phone numbers and SIP numbers (previously defined using the Phone Number Editor) are shown.

General Sources Sources Layout Special GPIO Phone No. List Contributors

Phone Number List + -

Targets Remote SIP

Name	Telephone Number
Support	0800123123

Select the number that you want to add (to select more than one number, hold down the Ctrl key) and click **Apply** to add the number(s) to the panel.

13.9.2 Removing Numbers from a Hardware Panel

Any numbers that are not required on a Hardware Panel can be deleted from the Phone No. List tab, if required. You can either delete selected numbers (using the **Delete** button) or delete all numbers at the same time (via the right-click context menu).

NOTE: Deleting numbers from a Hardware Panel does not delete the numbers from the global Phone Number Editor or from other panels which may be using the numbers.





MORE INFORMATION: Refer to section 13.11.6 Subscriber Configuration – Hardware Panel – Phone No. List tab for a description of the fields on this tab.

13.10 HARDWARE PANEL EDITOR - CONTRIBUTORS

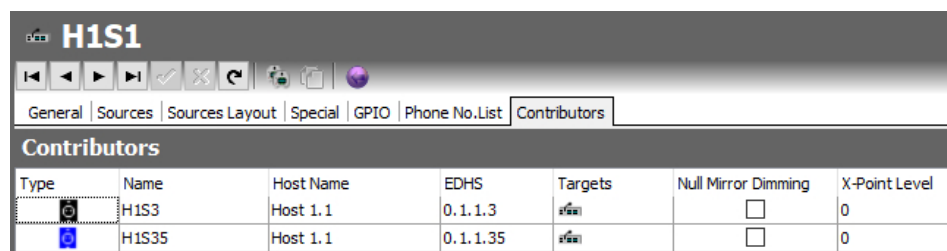
The Hardware Panel – Contributors tab shows a list of reverse key target assignments. The list shows other panels which have keys targeting the current panel.

In the example below, panel H1S1 has been selected.



Type	Name	Host Name	EDHS	Targets	Null Mirror Dimming	X-Point Level
	H1S3	Host 1.1	0.1.1.3		<input type="checkbox"/>	0
	H1S35	Host 1.1	0.1.1.35		<input type="checkbox"/>	0

Thus, panels H1S3 and H1S35 have keys which are “contributing to” the audio heard at panel H1S1.

Most fields are read-only but the following may be adjusted:

- **Null Mirror Dimming.** Mirror dimming is normally automatically applied when 2 subscribers have open bi-directional routes. The audio level in both directions is reduced by a pre-determined amount to reduce the risk of acoustic feedback. With certain types of subscriber such as headsets or telephones, due to the physical layout, the risk is minimal and the mirror dimming can be overridden.
- **X-Point level.** This field provides a convenient means of fine-tuning audio contributing to the output at this specific location. For example, if a panel operator finds that audio from a specific subscriber is consistently too loud, a small negative adjustment may be applied here without affecting any other party.

Click  to post changes to the database.

13.11 HARDWARE PANEL EDITOR - FIELD DEFINITIONS

13.11.1 Subscriber Configuration – Hardware Panel -- General tab

Field/Display Item	Description
Name	The name of the Hardware Panel. This is usually defined when the panel is added to the host using the Host Editor but may also be changed here. Maximum length = 20 characters.
Long Name	If text is entered, this will be used as an alternate to the Name field, on panels with displays supporting 8 characters. If left blank, the Name field will always be used.
Comment	Comments relating to the selected subscriber. Add your comments in the space provided.
Picture 	A picture may be assigned to help identify the Subscriber. To assign, or change an existing picture, click the picture and browse to select an image file. The picture will only be displayed on Virtual Panels. Default as shown on left.
Mirror Dimming	Mirror dimming helps to reduce acoustic feedback. Range 0 to -60 dB. Default = -8 dB (rack-mounted panels) and -12 dB (desktop panel).
Audio: Mic. Gain	The amount of gain that can be applied to the microphone or input associated with this panel. Default (recommended) = 0 dB. Values +3, 0, -6, -12 dB available.
Audio: Microphone Cut	Defines the action of the Cut key/button on Hardware Panels. No panel mic Cut - Disables microphone cut on a panel. Panel mic Cut (the default) - Pressing the button cuts the microphone completely. Mic/Headset Changeover - Pressing the button transfers Audio/Mic to the headset jack of the panel.
Audio: Microphone Compressor/Limiter	Enable the panel mic compressor/limiter circuitry. Default (recommended) = checked.
Audio: Loudspeaker: Mute (Cut Switch)	When checked, mutes the loudspeaker when the Cut key/button is pressed. Default = unchecked.
Audio: Loudspeaker: Hold-off	Presets the volume at which a panel speaker will operate at its the lowest possible value. Default = unchecked.
Audio: Loudspeaker: Mute Input GPI	Configuration of a GPI input to be used to mute the Loudspeaker when active.
Audio: XPoint Adj: Minimum	Check to enable minimum crosspoint gain adjustment level for routes to this panel. This prevents panel operators from inadvertently muting specific incoming audio.
Audio: XPoint Adj: Gain (dB)	If enabled, levels of -6, -12 (default), -18, -24 and -30dB are available.
Audio: Coarse Ren Adjustment (2dB per click)	Changes the dB steps used when adjusting the XPT level using a REN.
Audio: Tone on Audio Route	Configuration of an audio tone that is played out every time a call is received.
Audio: Binaural: Right Channel	For panels which support binaural audio, select a Host port to supply the right-channel audio.

Field/Display Item	Description
Audio: Binaural: Remote Direction	For panels which support binaural audio, select from Left (default), Right or Both. Binaural audio routes originating from a remote panel speaking to the binaural panel will be directed as specified.
On Air/Busy: Input GPI	Allows the configuration of a GPI input that will prevent routes from being made to the panel whilst On Air. Essentially an external “Do Not Disturb” switch.
QRS: Always update all QRS keys	When selected, the QRS label changes whenever any route to the panel is made regardless of whether there is a button to make the connection or not. Connections can, therefore, be ‘viewed’ from any page.
QRS: Allow stack size edit	Only enabled when “always update all QRS keys” is enabled.
PTT: Host GPI	Defines which Host GPI input will be used to provide PTT functionality for the Hardware Panel.
PTT: Host PTT GPI	Not used on Hardware Panel types.
PTT: PTT Key	Not used on Hardware Panel types.
Ports: GPI Com Ports 1 & 2	Not used on Hardware Panel types.
Ports: Gain Port	Not used on Hardware Panel types.
Ports: Gain on Input	Not used on Hardware Panel types.
Timing: Key latch time (ms)	Used to determine the keypress time at the panel that differentiates between a momentary and latching action. Default = 500 ms. Range = 100–5000 ms.
Timing: Tally Holdup (s)	The timeout of a yellow listen tally if another panel speaks to the user and then hangs up. A listen tally is displayed after hang-up for this timeout value. Default = 7 s. Range = 1–60 s.
Timing: X-Point Adjustment Timeout	The amount of time you can adjust the XPT level using a REN after a call is placed/received. Default = 10 s. Range = 1 – 60 s.
Timing: QRS time-out(s)	The timeout value for the last calling subscriber to be displayed on the QRS key/button. Default = 10 s. Range = Never, 2–60 s.
Timing: Latency hold up (s)	Applies to ‘Fast Keys’. These work by establishing the IP channel needed when the key is first pressed and thereafter simply make/break local audio crosspoints each time the key is pressed/released. If the key is not pressed for the “latency hold up” period, the IP route is torn down. Default = 0 seconds. Range = 0–3600 seconds.
Timing: Listen Label Flash (s)	Amount of time to flash the label when using Listen Label functionality. Default = 3 s. Range 1 – 60 s. or Disable.
Timing: IP Call Timeout (Mins)	Time after which an un-answered IP call will clear down. Default = Never. Range = Never 5 10 20 30 45 60 min.
Misc: Total Pages	Specifies the number of pages available on the panel. This includes the main page. Default = 2 (i.e.1 shift page). Minimum = 1 (i.e. no shift page) Maximum = 4 (i.e. 3 shift pages).
Misc: Change Conference Labels on 4-Wire	Keys assigned to conferences can be set so that they change their label when a subscriber joins a conference. If the subscriber is a 4-wire it is often a permanent “standing feed” into the conference, so the default conference label will always be overridden to show the 4-wire name. This setting disables such behaviour so the label will not change for 4-wire sources. Default = unchecked

Field/Display Item	Description
Misc: Fast keys on Startup	If checked, any fast key IP routes needed are made at TBC start-up in anticipation of them being needed straight away. If unchecked (default), they are not made until required.
Misc: Flash Tally for Tally Holdup	If checked, the tally indicator flashes after a call has ended, during the hold-up period. If unchecked (default), the tally remains solid.
Misc: Allow Listen Keys on Assignment	If checked, allow Listen keys to be assigned using the Assign feature on a panel. Default = checked. Uncheck to prevent panel snooping.

13.11.2 Subscriber Configuration – Hardware Panel -- IRIS tab

Field/Display Item	Description
Display: Dimming Timeout (s)	The display will dim after a preset time. Dimming may also be disabled but this is not recommended. Default = 15 s. Range 5 – 120 s.
Display: Dimming Level	Three settings are available: Medium, Low, Very Low (default).
Display: Screensaver Timeout (s)	The display will enter screensaver mode after a preset time. Default = 60 s. Range 5 – 3600 s.
Display: Screensaver Mode	Two modes are available: Scroll (default), Blank.
Headset: Port	Select the connection port for the headset, either Front (HS1) or Rear (HS2). Default = Front (HS1)
Headset: Mic. Type	Select from: <ul style="list-style-type: none"> • Electret • Dynamic Unbalanced (default) • Dynamic Balanced
Headset: Sidetone Gain (dB)	Range 0 to -30. Default = -12 dB.

13.11.3 Subscriber Configuration – Hardware Panel – Sources tab

Field/Display Item	Description
ID	A number which corresponds to a key/button on the Hardware Panel. IDs prefixed by P2 (to P32) are keys/buttons on the shifted pages.
Type	The key's target subscriber type indicated by an icon.
Target	The key's target subscriber name. This cannot be changed here but can be changed by opening the target in the relevant editor.
Lstn/Label	Listen Label. This is the name of the target that will be displayed on the panel. It cannot be changed but can be overridden if you specify a U/Label.
U/Label	User Label. A customisable user label. If this is specified, it will be used instead of the L/Label. Type the label that you want to use into this field.
Mode	The key's operation type. To change the operation type, click in the field and then click  to choose the required mode.
QRS Stack Size	For QRS keys only, sets the size of the QRS stack. If the stack size is exceeded, the oldest calls are thrown away.
Shift Page #	On panels with multiple shift pages, allows a key to be defined to "jump" straight to a specific shifted page. This can bypass the normal multiple press panel Shift key process.
Lstn/Type	Displays the icon associated with the listen key's target or IFB listener.
Lstn Name	Allows a panel to "split" a key so that the listen and speak are attached to two different targets. If the key is targetting an IFB and a listener has been defined, this field will show the name of the defined listener.
Alt. Picture	Displays a picture when the key is activated. This is useful for showing the operator a graphical representation of the caller on a Virtual Panel.
LS Dim	Dims the panel loudspeaker when the target subscriber speaks to the panel user. This loudspeaker dimming dims ALL incoming audio. Default = 0 dB. Range is 0 to -28 dB in 2 dB steps, or -100 dB.
Assign	When checked, allows the panel operator to customise this key, choosing a new destination (Subscriber, Conference, Group or Route) and Type (Speak, Listen etc.). If you clear this checkbox, users will not be able to change this key. Restricting keypresses is useful to prevent panels from talking to certain subscribers. Default = Selected.
Autodial	Specifies a dial sequence that is automatically dialled when a phone key/button is pressed on the panel. Applicable to telephony and SIP connections only.
Phone Name	Allows an existing phone control entry to be assigned to the key.
Number	Displays the phone number of the assigned phone control name.

13.11.4 Subscriber Configuration – Hardware Panel – Special tab

Field/Display Item	Description
ID	A number which corresponds to a key/button on the Hardware Panel. IDs prefixed by P2 (to P32) are keys/buttons on the shifted pages.
Type	The target subscriber type.
Target	The target subscriber name.
Mode	The key's operation type. This varies depending on the panel type being configured.
Signal Pres.	If checked, allows a panel user to see when a specific key has audio via a slow flashing yellow tally on the key. The user can then elect to listen to it or not. (Conference, 4-wire, telephony and radio keys only). Default = unchecked.
GPO On	When checked, the GPO will be on when the key is pressed.
Push To Talk (PTT): Panel GPI	The host COM port (1 or 2) to be used as a PTT trigger.
Push To Talk (PTT): Action	Defines the PTT action for the key. Can be set to Mute, Unmute, Inhibit or Uninhibit. Mute prevent the user from being heard by the listen user. It does not tear down the route; it simply mutes the volume when the key is pushed.
Interlock: Key Set	Groups keys together to provide some sort of interaction between the keys in the set. Default = n/a. Range 1–256.
Interlock: Max. Listens	The maximum listens per given key set group. This is key-driven to prevent more than the defined number of listens. For example, if this is set to 1, then only one key on the set may listen at any one time. Default = n/a. Range 1–256. Can only be set if you have specified a key set.
Interlock: Max. Speaks	The maximum speaks per given key set group. This is key-driven to prevent more than the defined number of simultaneous speaks. For example, if this is set to 1, then only one key on the set may speak at any one time. Default = n/a. Range 1–256. Can only be set if you have specified a key set.
Conference Priority	Only editable if the key is targeting a conference. Gives that key a priority to the specified conference, so that if the conference hits its max speak limit, panels will be blocked from speaking based on their priority. For example, if a conference has max speaks of 3 and two priority 1 and one priority 2 panels are already talking, a priority 3 panel will have to wait for one of the speakers to break their route. However, if a priority 1 panel tried to make a route to the conference then the priority 2 panel would be removed.
Telephony/SIP: Ringing	Enables ringing for an E&M, FXS, FXO, SIP connection or telephone. Only one 'ringing source' can be selected. Default = unchecked.
Telephony/SIP: Tone	If ringing has been enabled, click  and select the required ringing tone.

Field/Display Item	Description
Telephony/SIP: Hold/Dialpad	If checked, this allows you to place an FXO call on hold and then use the Dialpad to DDI. Additionally, checking this field prevents a user from ending a call inadvertently as they are forced to select End from the displayed key menu to end the call. Default = unchecked.
Telephony/SIP: Disable Keypad	If checked, the hardware or software implemented dialpad is disabled when making calls using this key. The user is forced to select entries from the panel phone number list and cannot free dial. Default = unchecked.
Telephony/SIP: Auto Ans (SIP)	If checked, any incoming SIP calls are automatically answered at the panel, giving a more intercom like experience for the operator. Default = unchecked.

13.11.5 Subscriber Configuration – Hardware Panel – GPIO tab

Field/Display Item	Description
Inputs / Outputs	Radio buttons select whether GPI inputs or outputs are shown in the grid below.
ID	The ID of the GPI in the database.
Name	The name of the GPI. The system auto-generated name may be edited. Maximum length = 20 characters.
Comment	Comments relating to the GPI. You can add comments in the space provided, as required. Maximum length = 255 characters.

13.11.6 Subscriber Configuration – Hardware Panel – Phone No. List tab

Field/Display Item	Description
Name	The name of the phone number entry previously defined using the global Phone Number Editor. Cannot be changed here.
Telephone Number	The phone number entry previously defined using the global Phone Number Editor. Cannot be changed here.

13.11.7 Subscriber Configuration – Hardware Panel – Contributors tab

Field/Display Item	Description
Type	An icon indicating the type of subscriber contributing, e.g. another panel, radio or telephone.
Name	The name of the contributing subscriber.
Host Name	The name of the host, to which the contributing subscriber is connected.
EDHS	Full EDHS address of the contributor.
Targets	Place the mouse cursor over the icon and text will show the method of contribution. For example, direct, conference or group.
Null Mirror Dimming	Tick the box to override the application of mirror dimming for this subscriber pair.
X-Point level	The gain level of the contributing “source” to this subscriber. Default = 0 dB. Range -60 to +12 dB.

14. CONFIGURATION EDITOR | SUBSCRIBER | FOREIGN EXCHANGE OFFICE (FXO)

14.1 OVERVIEW

Foreign Exchange Office (FXO) Telephony ports require the correct expansion board to be fitted to a Mercury Interface Unit (MIU). The FXO board supports up to 4 telephone ports which must be connected to either PTT telco analogue provided circuits or a suitable in-house PABX.

The addition of an FXO board limits the range of supported coding profiles and Gateway will automatically select a suitable coding profile on this host. However, if you are designing a multi-host Mercury system you must take account of this and adjust the coding profile of other hosts. Any incompatibilities will cause warning messages until resolved.

A Foreign Exchange Office (FXO) subscriber is added to a host using the Host Editor. Once you have added an FXO subscriber, you must define the phone controls (if used), GPIs and operational settings using the FXO Subscriber Configuration Editor.

- For more information on adding FXO ports and telephones to a host, see section 11 *Configuration Editor | Host* in this Configuration Guide.
- For basic information about opening the Subscriber Editor and an explanation of key modes, see section 12 *Configuration Editor | Subscriber | Introduction* in this Configuration Guide.

14.2 VIEWING A LIST OF FXO PORTS

When suitable hardware has been added and FXO Subscribers added using the Host Editor, you can view a list by expanding the Enterprise Tree. The example below shows an MIU with an FXO board fitted in expansion slot 2 and 4 defined telephone lines connected to ports 9,11,13 and 15.

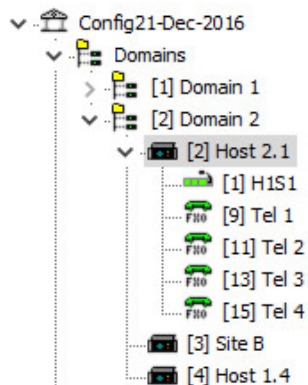

NOTE: Only odd-numbered ports appear in the editor. The even-numbered ports provide a power fail loop-through telephone connection and do not require any configuration.

To open the advanced FXO Subscriber editor, double-click on the required telephone symbol.

14.3 FXO SUBSCRIBER EDITOR TABS

The advanced editor comprises five tabs, outlined below.

- General
- SIP Options
- GPIO
- Phone Controls
- Contributors

These are considered in the following sections.

14.4 FXO SUBSCRIBER EDITOR – GENERAL

The FXO - General tab is used to specify basic details about the FXO subscriber.

14.4.1 Changing FXO Details

You can change the name of an FXO subscriber and enter a comment to provide further information about the FXO subscriber. A picture can be added to identify the FXO subscriber on a Virtual Panel.

NOTE: The name of the subscriber is the name allocated when the FXO subscriber is added to the host using the Host Editor.

- Select an FXO subscriber from the list of subscribers attached to a host and double-click to open the FXO Subscriber Editor. The **General** tab is selected by default.

The screenshot shows the 'FXO Subscriber Editor - General' window. At the top, there are navigation icons and a toolbar. Below that, there are tabs for 'General', 'SIP Options', 'GPIO', 'Phone Ctrl.List', and 'Contributors'. The 'General' tab is active. The form contains the following fields and controls:

- Name:** Tel 1
- Long Name:** Telephone 1
- Comment:** 251
- Mirror Dimming (dB):** 0
- Miscellaneous:**
 - Signal Type:** loop-start
 - Termination:** (empty)
 - Country:** US
 - Ring Cadence:** 0
 - Ring Frequency (Hz):** 25
 - CPC Detect (ms):** 600
 - Polarity Detect (ms):** 20
 - DTMF OFF time (ms):** 100
 - DTMF ON time (ms):** 100
 - Ring-down
 - Auto Answer
 - Trailing edge DTMF

- Make the required changes. If you change the name of the FXO subscriber, the target name will be updated wherever FXO subscriber has been added as a contributor to a control panel.
- To add a picture to identify the FXO subscriber on a Virtual Panel, click the picture and browse for and select the required image file.
- Some telephony parameters are also presented on this tab and these must be set appropriately for your installation.
- Click to post changes to the database.

14.5 FXO SUBSCRIBER EDITOR – SIP OPTIONS

The SIP Options tab is used to edit SIP specific details of the FXO subscriber.

To change SIP Options:

- Select an FXO subscriber from the list of subscribers attached to a host and double-click to open the FXO Subscriber Editor. Click on the SIP Options tab.

The screenshot shows the 'SIP Options' tab in the FXO Subscriber Editor. The interface includes the following elements:

- Free Dial Settings (SIP):**
 - Assume SIP on Free-dial
 - EOL Mode:** Radio buttons for None, Use EOL Digit, and Fixed Length.
 - Seq. Digits:** A numeric input field with the value '3' and a dropdown arrow.
 - EOL Character:** A dropdown menu.
- Preferred SIP Codecs:** A grid of six dropdown menus labeled Profile 1 through Profile 6.

- Click to post changes to the database.

14.6 FXO SUBSCRIBER EDITOR – GPIO

The GPIO tab is used to define a GPI input for the selected FXO subscriber. GPIO routing statements are explained in section 25 *Configuration Editor | GPIO Processes* of this manual.

The GPI that you add to a subscriber is an input that changes when the phone subscriber that it is connected to goes OFF and ON hook. For example, if a key on a Virtual or Hardware Panel is assigned to the phone target (with a GPI defined) and Signal Presence is selected on the panel setup, then the key on the panel will flash whenever the phone port goes OFF hook. This key will stop flashing when the phone port goes ON hook.

A maximum of one GPI can be added on an FXO subscriber. Buttons at the top of the GPIO tab let you:

- Add a GPI.
- Delete a GPI.

14.6.1 Adding a GPI Input

You can add one GPI input. This will be automatically named by the system. A comment can be added to provide more information if required.

- Select an FXO subscriber from the list of subscribers attached to a host and open the Panel Configuration Editor.
- Click the GPIO tab.
- Click the green + button to add the input.

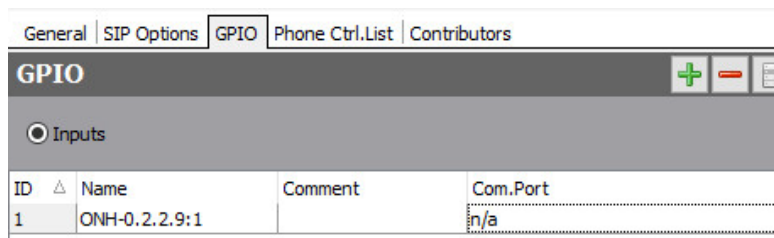

- Change the name and add a comment relating to the GPI, if required.
- Click to post changes to the database.

14.6.2 Deleting GPI Inputs

The GPI input defined for an FXO subscriber can be deleted if required. To delete the GPI, highlight the row and click the red - button.

IMPORTANT: If you delete the GPI it will be removed from any GPIO processes that have been configured to use the selected GPI. The process will not be deleted but will not function as expected.

14.7 FXO SUBSCRIBER EDITOR - PHONE CTRL. LIST

If you have defined phone controls using the Phone Number Editor, these can be added to the configuration and then used to direct a call to the configured subscriber. SIP numbers, defined using the Phone Number Editor, can also be added to the FXO subscriber if required.

Buttons at the top of the Phone Ctrl. List tab allow you to:

- Add a phone control or SIP number.
- Delete a selected phone control or SIP number.

14.7.1 Adding a Phone Control to an FXO Subscriber

Phone controls are incoming DDI digits that are used to direct an answered call directly to a configured subscriber, for example, a conference, Virtual Panel or radio phone. See section 26 *Configuration Editor / Phone Numbers* for more information on adding phone controls.

14.7.2 Adding a SIP Number to an FXO Subscriber

SIP numbers are numbers that can be used to call a SIP connection. They are outgoing digit sequences that map to either fully formed URIs or are digits that are passed to a Proxy Server where they are fully resolved. See section 26 *Configuration Editor / Phone Numbers* for more information on adding SIP numbers.



NOTE: When you add phone controls or SIP Numbers, you select from the global list previously edited using the Phone Number Editor and as such, you cannot make any changes to the details here.

To add a phone control or SIP Number:

- Select an FXO subscriber from the list of panels/subscribers attached to a host and open the FXO Subscriber Editor.
- Click the Phone Ctrl. List tab.
- Press the radio button (“Targets” or “Remote SIP”) according to the type of item you wish to add.
- Click **Add** to open the Phone Numbers list.
- Select the number that you want to add and click **Apply**.

Examples are shown below.



General | SIP Options | GPIO | Phone Ctrl.List | Contributors

Phone Number List   

Targets Remote SIP

Name	Telephone Number	Type	Target
PC1	123456		H1S5

General | SIP Options | GPIO | Phone Ctrl.List | Contributors

Phone Number List   

Targets Remote SIP

Name	Telephone Number	Address
SIP 34	82345	192.168.9.9





14.7.3 Removing Phone Controls and SIP Numbers from an FXO Subscriber

Any phone controls or SIP numbers that are no longer required can be removed from the FXO subscriber. Remove phone controls or SIP numbers individually using the red – (Delete) button.

NOTE: Deleting phone controls or SIP numbers from the selected FXO subscriber does not delete these numbers from the global lists maintained by the Phone Number Editor or from other subscribers.

14.8 FXO SUBSCRIBER EDITOR - CONTRIBUTORS

The Contributors tab shows a list of reverse key target assignments. The list shows panels which have keys targeting the current FXO subscriber.

Contributors						
Type	Name	Host Name	EDHS	Targets	Null Mirror Dimming	X-Point Level
	H1S1	Host 1.1	0.1.1.1		<input type="checkbox"/>	0
	H1S2	Host 1.1	0.1.1.2		<input type="checkbox"/>	0

This example shows FXO Subscriber Tel 1.

Thus, panels H1S1 and H1S2 have keys which target TEL 1, allowing those 2 panels to make and receive phone calls.

Most fields are read-only but the following may be adjusted:

- **Null Mirror Dimming.** Mirror dimming is normally automatically applied when 2 subscribers have open bi-directional routes. The audio level in both directions is reduced by a pre-determined amount to reduce the risk of acoustic feedback. With certain types of subscriber such as headsets or telephones, due to the physical layout, the risk is minimal and the mirror dimming can be overridden.
- **X-Point level.** This field provides a convenient means of fine-tuning audio contributing to the output at this specific location. For example, if a panel operator finds that audio from a specific subscriber is consistently too loud, a small negative adjustment may be applied here without affecting any other party.

Click to post changes to the database.

14.9 FXO SUBSCRIBER EDITOR - FIELD DEFINITIONS

14.9.1 FXO Configuration - General tab

Field/Display Item	Description
Name	The name of the FXO subscriber. This is usually defined when the FXO subscriber is added to the host using the Host Editor. See the "Hosts and the Host Editor" chapter in this Configuration Guide. The name can be changed here if required. Maximum length = 20 characters.
Long Name	If text is entered, this will be used as an alternate to the Name field, on panels with displays supporting 8 characters. If left blank, the Name field will always be used.
Comment	Comments relating to the FXO subscriber. Add your comments in the space provided.
Picture 	A picture may be assigned to help identify the Subscriber. To assign, or change an existing picture, click the picture and browse to select an image file. The picture will only be displayed on Virtual Panels. Default as shown on left.
Mirror Dimming	Mirror dimming helps to reduce acoustic feedback. Range 0 to -60 dB. Default = 0 dB.
Misc: Signal Type	Specifies the telephony signal type. Choices are loop start (default) or ground start.
Misc: Termination	Specifies FXO/FXS line termination: CTR21 (Default), 900R, 600R JAPAN.
Misc: Country	Specifies the country of use. Default: US.
Misc: Ring Cadence	Not used on FXO subscribers
Misc: Ring Frequency (Hz)	Not used on FXO subscribers
Misc: CPC Detect (ms)	Detection period for a CPC supervisory signal to be present to end a call, preset to 600 ms.
Misc: Polarity Detect (ms)	Detection period for a polarity reversal signal to be present to end a call, Preset to 20 ms.
Misc: DTMF Off time (ms)	50 – 2000 ms, default 100 ms
Misc: DTMF On time (ms)	50 – 2000 ms, default 100 ms
Misc: Auto-Answer	When checked, causes an FXO port to auto-answer an incoming call and then treat the port as a normal 4-wire. Ensure it is not checked if you wish to use DTMF via phone controls to create routes within the system. Default = unchecked.
Misc: Trailing Edge DTMF	If checked, report a DTMF signal at the end of a tone, instead of when detected. Default = unchecked.

14.9.2 FXO Configuration - SIP Options tab

Display Item	Description
Assume SIP on free dial	Default = Unchecked.
EOL Mode	3 options selected by radio buttons: None, Use EOL Digit, Fixed Length.
Seq. Digits	The number of digits to be entered by the caller to make an ongoing SIP call if EOL fixed length mode is selected.
EOL Character	Specifies the "end digit" (<i>typically * or #</i>) to delimit a number dialled to make an ongoing SIP call if EOL digit mode is selected (e.g. 1234#)
Preferred SIP Codec 1 - 6	Specifies codecs (in priority order) to be used when establishing an ongoing SIP call.

14.9.3 FXO Configuration - GPIO tab

Field/Display Item	Description
ID	The ID of the GPI in the database.
Name	The name of the GPI. By default, this is the subscriber EDHS prefixed with OFH (Off Hook) and suffixed with the GP pin value. For example, OFH-0.1.1.3:1 Names do not have to be unique. Maximum length = 20 characters.
Comment	Comments relating to the GPI. You can add comments in the space provided, as required. Maximum length = 255 characters.
Com. Port	Not applicable.

14.9.4 FXO Configuration - Phone Ctrl. List tab

Display Item	Description
Targets	Click this radio button to view or add a phone control.
Remote SIP	Click this radio button to view or add a SIP number.
Name	The name of the phone control as defined using the global Phone Number Editor. This cannot be changed here.
Telephone Number	The phone control number as defined using the global Phone Number Editor. This cannot be changed here.
Type	Target: An icon showing the target for the phone control.
Target	Target: The name of the target. This cannot be changed here.
Address	Remote SIP: The IP address or URL corresponding to the SIP number. This cannot be changed here.

14.9.5 FXO Configuration - Contributors tab

Field/Display Item	Description
Type	An icon indicating the type of subscriber contributing, e.g. another panel, radio or telephone.
Name	The name of the contributing subscriber.
Host Name	The name of the host, to which the contributing subscriber is connected.
EDHS	Full EDHS address of the contributor.
Targets	Place the mouse cursor over the icon and text will show the method of contribution. For example, direct, conference or group.
Null Mirror Dimming	Tick the box to override the application of mirror dimming for this subscriber pair.
X-Point level	The gain level of the contributing "source" to this subscriber. Default = 0 dB. Range -60 to +12 dB.

15. CONFIGURATION EDITOR | SUBSCRIBER | FOREIGN EXCHANGE STATION (FXS)

15.1 OVERVIEW

Foreign Exchange Station (FXS) Telephony ports require the correct expansion board to be fitted to a Mercury Interface Unit (MIU). The FXS board supports up to 4 telephone ports which must be connected to Analogue telephone handsets.

The addition of an FXS board limits the range of supported coding profiles and Gateway will automatically select a suitable coding profile on this host. However, if you are designing a multi-host Mercury system you must take account of this and adjust the coding profile of other hosts. Any incompatibilities will cause warning messages until resolved.

A Foreign Exchange Station (FXS) subscriber is added to a host using the Host Editor. Once you have added an FXS subscriber, you must define the phone controls (if used), GPIs and operational settings using the Panel Configuration Editor.

- For more information on adding FXS ports and telephones to a host, see section 11 *Configuration Editor | Host* in this Configuration Guide.
- For basic information about opening the Subscriber Editor and an explanation of key modes, see section 12 *Configuration Editor | Subscriber | Introduction* in this Configuration Guide.

15.2 VIEWING A LIST OF FXS PORTS

When suitable hardware has been added and FXS Subscribers added using the Host Editor, you can view a list by expanding the Enterprise Tree. The example below shows an MIU with a single FXS board fitted in the second expansion position and 4 defined FXS subscribers on ports 9,11,13 and 15.

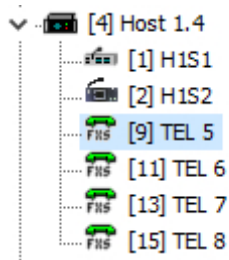

NOTE: Only odd-numbered ports appear in the editor. The even-numbered ports provide a power fail loop-through connection and do not require any configuration.

To open the advanced FXS Subscriber editor, double-click on the required telephone symbol.

15.3 FXS SUBSCRIBER EDITOR TABS

The advanced editor comprises five tabs, outlined below.

- General
- SIP Options
- GPIO
- Phone Ctrl List
- Contributors

These are considered in the following sections.

15.4 FXS SUBSCRIBER EDITOR – GENERAL

The FXS - General tab is used to specify basic details about the FXS subscriber.

15.4.1 Changing FXS Details

You can change the name of an FXS subscriber and enter a comment to provide further information about the FXS subscriber. A picture can be added to identify the FXS subscriber on a Virtual Panel.

NOTE: The name of the subscriber is the name allocated when the FXS subscriber is added to the host using the Host Editor.

- Select an FXS subscriber from the list of subscribers attached to a host and double-click to open the FXS Subscriber Editor. The **General** tab is selected by default.

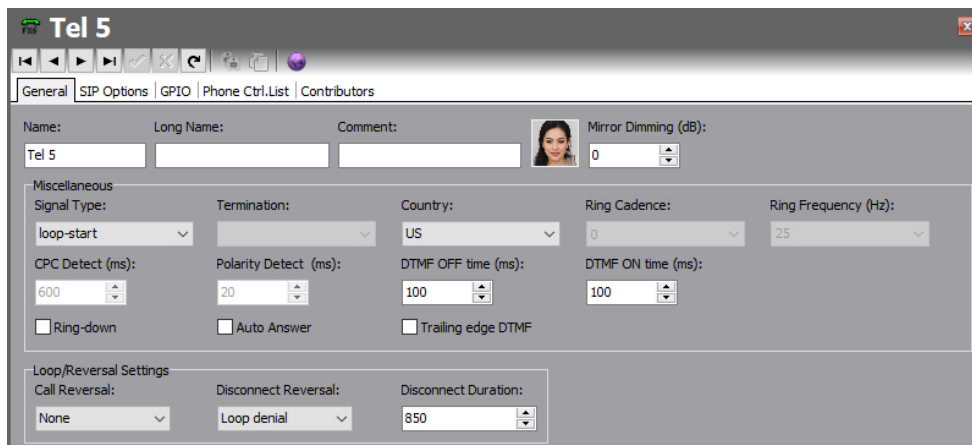

- Make the required changes. If you change the name of the FXS subscriber, the target name will be updated if the FXS subscriber has been added as a target on a panel.
- To add a picture to identify the FXS subscriber on a Virtual Panel, click the picture and browse for and select the required image file.
- Some telephony parameters are also presented on this tab and these must be set appropriately for your installation.
- Click to post changes to the database.

15.5 FXS SUBSCRIBER EDITOR – SIP OPTIONS

The SIP Options tab is used to edit SIP specific details of the FXS subscriber.

To change SIP Options:

- Select an FXS subscriber from the list of subscribers attached to a host and double-click to open the FXS Subscriber Editor. Click on the SIP Options tab.

General | SIP Options | GPIO | Phone Ctrl.List | Contributors

Free Dial Settings (SIP)

Assume SIP on Free-dial

EOL Mode

None

Use EOL Digit

Fixed Length

Seq. Digits: 3

EOL Character: [dropdown]

Preferred SIP Codecs

Profile 1: [dropdown]

Profile 2: [dropdown]

Profile 3: [dropdown]

Profile 4: [dropdown]

Profile 5: [dropdown]

Profile 6: [dropdown]

- Click to post changes to the database.

15.6 FXS SUBSCRIBER EDITOR – GPIO

The GPIO tab is used to define a GPI input for the selected FXS subscriber. GPIO routing statements are explained in section 25 *Configuration Editor | GPIO Processes* of this manual.

The GPI that you add to a subscriber is an input that changes when the phone subscriber that it is connected to goes OFF and ON hook. For example, if a key on a Virtual or Hardware Panel is assigned to the phone target (with a GPI defined) and Signal Presence is selected on the panel setup, then the key on the panel will flash whenever the phone port goes OFF hook. This key will stop flashing when the phone port goes ON hook.

A maximum of one GPI can be added to an FXS subscriber. Buttons at the top of the GPIO tab allow you to:

- Add a GPI.
- Delete a GPI.

15.6.1 Adding a GPI Input

You can add one GP input. This will be automatically named by the system. A comment can be added to provide more information if required.

- Select an FXS subscriber from the list of subscribers attached to a host and open the Panel Configuration Editor.
- Click the GPIO tab.
- Click the green + button to add the input.

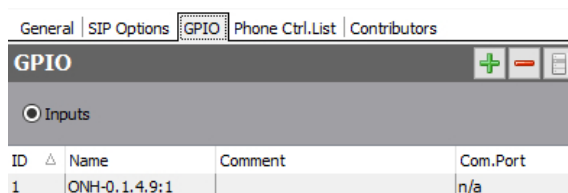

- Change the name and add a comment relating to the GPI, if required.
- Click to post changes to the database.

15.6.2 Deleting GPI Inputs

The GPI input defined for an FXS subscriber can be deleted if required. To delete the GPI, highlight the row and click the red - button.

IMPORTANT: If you delete the GPI it will be removed from any GPIO processes that have been configured to use the selected GPI. The process will not be deleted but will not function as expected.

15.7 FXS SUBSCRIBER EDITOR - PHONE CTRL. LIST

If you have defined phone controls using the Phone Number Editor, these can be added to the configuration and then used to direct a call to the configured subscriber. SIP numbers, defined using the Phone Number Editor, can also be added to the FXS subscriber if required.

Buttons at the top of the Phone Ctrl. List tab let you:

- Add a phone control or SIP number.
- Delete a selected phone control or SIP number.

15.7.1 Adding a Phone Control to an FXS Subscriber

Phone controls are incoming DDI digits that are used to direct an answered call directly to a configured subscriber, for example, a conference, Virtual Panel or radio phone. See section 26 *Configuration Editor | Phone Numbers* for more information on adding phone controls.

15.7.2 Adding a SIP Number to an FXS Subscriber



SIP numbers are numbers that can be used to call a SIP connection. They are outgoing digit sequences that map to either fully formed URIs or are digits that are passed to a Proxy Server where they are fully resolved. See section 26 *Configuration Editor | Phone Numbers* for more information on adding SIP numbers.



NOTE: When you add phone controls or SIP numbers you select from the list of global list previously edited using the Phone Number Editor and as such you cannot make any changes to the details here.

To add a phone control or SIP Number:

- Select an FXS subscriber from the list of panels/subscribers attached to a host and open the FXS Subscriber Editor.
- Click the Phone Ctrl. List tab.
- Press the radio button (“Targets” or “Remote SIP”) according to the type of item you wish to add.
- Click **Add** to open the Phone Numbers list.
- Select the number that you want to add and click **Apply**.

Examples are shown below.

General SIP Options GPIO Phone Ctrl.List Contributors			
Phone Number List   			
<input checked="" type="radio"/> Targets <input type="radio"/> Remote SIP			
Name	Telephone Number	Type	Target
Central	0800654321	5	H1S4

General SIP Options GPIO Phone Ctrl.List Contributors		
Phone Number List   		
<input type="radio"/> Targets <input checked="" type="radio"/> Remote SIP		
Name	Telephone Number	Address
SIP 34	82345	192.168.9.9





15.7.3 Removing Phone Controls and SIP Numbers from an FXS Subscriber

Any phone controls or SIP numbers that are no longer required can be removed from the FXS subscriber. Remove phone controls or SIP numbers individually using the red – (Delete) button.

NOTE: Deleting phone controls or SIP numbers from the selected FXS subscriber does not delete these numbers from the global lists maintained by the Phone Number Editor or from other subscribers.

15.8 FXS SUBSCRIBER EDITOR - CONTRIBUTORS

The Contributors tab shows a list of reverse key target assignments. The list shows panels which have keys targeting the current FXS subscriber.

Contributors						
Type	Name	Host Name	EDHS	Targets	Null Mirror I	X-Point Level
	H1S1	Host 1.4	0.1.4.1		<input type="checkbox"/>	0
	H1S2	Host 1.4	0.1.4.2		<input type="checkbox"/>	0

This example shows FXS Subscriber Tel 5.

Thus, panels H1S1 and H1S2 have keys which are “pointing at” TEL 5, allowing those 2 panels to make and receive phone calls with the handset connected as Tel 5.

Most fields are read-only but the following may be adjusted:

- **Null Mirror Dimming.** Mirror dimming is normally automatically applied when 2 subscribers have open bi-directional routes. The audio level in both directions is reduced by a pre-determined amount to reduce the risk of acoustic feedback. With certain types of subscriber such as headsets or telephones, due to the physical layout, the risk is minimal and the mirror dimming can be overridden.
- **X-Point level.** This field provides a convenient means of fine-tuning audio contributing to the output at this specific location. For example, if a panel operator finds that audio from a specific subscriber is consistently too loud, a small negative adjustment may be applied here without affecting any other party.

Click to post changes to the database.

15.9 FXS SUBSCRIBER EDITOR - FIELD DEFINITIONS

15.9.1 FXS Configuration - General tab

Field/Display Item	Description
Name	The name of the FXS subscriber. This is usually defined when the FXS subscriber is added to the host using the Host Editor. See the "Hosts and the Host Editor" chapter in this Configuration Guide. The name can be changed here if required. Maximum length = 20 characters.
Long Name	If text is entered, this will be used as an alternate to the Name field, on panels with displays supporting 8 characters. If left blank, the Name field will always be used.
Comment	Comments relating to the FXS subscriber. Add your comments in the space provided.
Picture 	A picture may be assigned to help identify the Subscriber. To assign, or change an existing picture, click the picture and browse to select an image file. The picture will only be displayed on Virtual Panels. Default as shown on left.
Mirror Dimming	Mirror dimming helps to reduce acoustic feedback. Range 0 to -60 dB. Default = 0 dB.
Misc: Signal Type	Specifies the telephony signal type. Default = loop start.
Misc: Termination	Specifies FXO/FXS line termination: CTR21 (Default), 900R, 600R JAPAN.
Misc: Country	Specifies the country of use. Default: US.
Misc: Ring Cadence	Specifies varying ring cadence ids 0 to 12 (country dependant)
Misc: Ring Frequency (Hz)	Frequency of ringing signal, 15.6Hz to 62Hz (Preset to 25 Hz)
Misc: CPC Detect (ms)	Not used on FXS subscribers
Misc: Polarity Detect (ms)	Not used on FXS subscribers
Misc: DTMF Off time (ms)	50 – 2000 ms, default 100 ms
Misc: DTMF On time (ms)	50 – 2000 ms, default 100 ms
Misc: Auto-Answer	When checked, causes an FXS port to auto-answer an incoming call and then treat the port as a normal 4-wire. Make sure it is not checked if you wish to use DTMF via phone controls to create routes within the system. Default = unchecked.
Misc: Trailing Edge DTMF	If checked, report a DTMF signal at the end of a tone, instead of when detected. Default = unchecked.
Loop Reversal Settings: Call reversal	Select from: <ul style="list-style-type: none"> • None (default) • Local • Remote • Local & Remote
Loop Reversal Settings: Disconnect Reversal	Select from: <ul style="list-style-type: none"> • Loop Denial (default) • Polarity Reversal
Loop Reversal Settings: Disconnect Duration	Range 0 – 65535, default = 850

15.9.2 FXS Configuration - SIP Options tab

Display Item	Description
Assume SIP on free dial	Default = unchecked
EOL Mode	3 options selected by radio buttons: None, Use EOL Digit, Fixed Length.
Seq. Digits	The number of digits to be entered by the caller to make an ongoing SIP call if EOL fixed length mode is selected
EOL Character	Specifies the "end digit" (<i>typically * or #</i>) to delimit a number dialed to make an ongoing SIP call if EOL digit mode is selected (e.g. 1234#)
Preferred SIP Codec 1 - 6	Specifies codecs (in priority order) to be used when establishing an ongoing SIP call

15.9.3 FXS Configuration - GPIO tab

Field/Display Item	Description
ID	The ID of the GPI in the database.
Name	The name of the GPI. By default, this is the subscriber EDHS prefixed with OFH (Off Hook) and suffixed with the GP pin value. For example, OFH-0.1.1.3:1 Names do not have to be unique. Maximum length = 20 characters.
Comment	Comments relating to the GPI. You can add comments in the space provided, as required. Maximum length = 255 characters.
Com. Port	Not applicable.

15.9.4 FXS Configuration - Phone Ctrl. List tab

Display Item	Description
Targets	Click this radio button to view or add a phone control.
Remote SIP	Click this radio button to view or add a SIP number.
Name	The name of the phone control as defined using the global Phone Number Editor. This cannot be changed here.
Telephone Number	The phone control number as defined using the global Phone Number Editor. This cannot be changed here.
Type	Target: An icon showing the target for the phone control.
Target	Target: The name of the target. This cannot be changed here.
Address	Remote SIP: The IP address or URL corresponding to the SIP number. This cannot be changed here.

15.9.5 FXS Configuration - Contributors tab

Field/Display Item	Description
Type	An icon indicating the type of subscriber contributing, e.g. another panel, radio or telephone.
Name	The name of the contributing subscriber.
Host Name	The name of the host, to which the contributing subscriber is connected.
EDHS	Full EDHS address of the contributor.
Targets	Place the mouse cursor over the icon and text will show the method of contribution. For example, direct, conference or group.
Null Mirror Dimming	Tick the box to override the application of mirror dimming for this subscriber pair.
X-Point level	The gain level of the contributing "source" to this subscriber. Default = 0 dB. Range -60 to +12 dB.

16. CONFIGURATION EDITOR | SUBSCRIBER | EAR AND MOUTH (E&M)

16.1 OVERVIEW

Ear and Mouth (E&M) Telephony ports require the correct expansion board to be fitted to a Mercury Interface Unit (MIU). The E&M board supports up to 4 central office or trunk ports to connect to Private Branch Exchange (PBX)/line devices.

The mode is software selectable for E&M type I, II, III, IV and V signalling (including BT SSDC5).

The addition of an E&M board limits the range of supported coding profiles and Gateway will automatically select a suitable coding profile on this host. However, if you are designing a multi-host Mercury system you must take account of this and adjust the coding profile of other hosts. Any incompatibilities will cause warning messages until resolved.

An Ear and Mouth (E&M) subscriber is added to a host using the Host Editor. Once you have added an E&M subscriber, you must define the phone controls (if used), GPIs and operational settings using the E&M Subscriber Configuration Editor.

- For more information on adding E&M ports and telephones to a host, see section 11 *Configuration Editor | Host* in this Configuration Guide.
- For basic information about opening the Subscriber Editor and an explanation of key modes, see section 12 *Configuration Editor | Subscriber | Introduction* in this Configuration Guide.

16.2 VIEWING A LIST OF E&M PORTS

When suitable hardware has been added and E&M Subscribers added using the Host Editor, you can view a list by expanding the Enterprise Tree. The example below shows an MIU with an E&M board fitted in expansion slot 1 and four E&M telephones connected to ports 1,3,5 and 7.

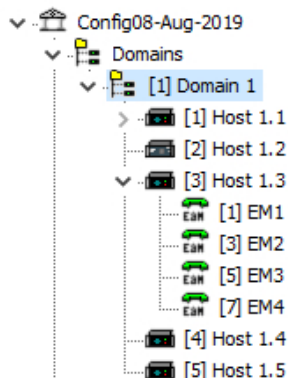

NOTE: Only odd-numbered ports appear in the editor. The even-numbered ports provide a power fail loop-through telephone connection and do not require any configuration.

To open the advanced E&M Subscriber editor, double-click on the required telephone symbol.

16.3 E&M SUBSCRIBER EDITOR TABS

The advanced E&M subscriber editor comprises five tabs, listed below.

- General
- SIP Options
- GPIO
- Phone Control List
- Contributors

These are considered in the following sections.

16.4 E&M SUBSCRIBER EDITOR – GENERAL

The E&M - General tab is used to specify basic details about the E&M subscriber.

16.4.1 Changing E&M Details

You can change the name of an E&M subscriber and enter a comment to provide further information about the E&M subscriber. A picture can be added to identify the E&M subscriber on a Virtual Panel.

NOTE: The name of the subscriber is the name allocated when the E&M subscriber is added to the host using the Host Editor.

- Select an E&M subscriber from the list of subscribers attached to a host and double-click to open the E&M Subscriber Editor. The **General** tab is selected by default.

The screenshot shows the 'E&M Subscriber Editor - General' window. At the top, there are navigation buttons and tabs for 'General', 'SIP Options', 'GPIO', 'Phone Ctrl.List', and 'Contributors'. The 'General' tab is active. Below the tabs, there are input fields for 'Name' (containing 'EM 1'), 'Long Name', and 'Comment'. To the right of these fields is a 'Mirror Dimming (dB)' dropdown menu set to '0'. Below this is a 'Miscellaneous' section with several dropdown menus and checkboxes. The dropdowns are: 'Signal Type' (Immediate start), 'Termination' (Type I), 'Country' (US), 'Ring Cadence' (0), and 'Ring Frequency (Hz)' (25). Below these are four more dropdowns: 'CPC Detect (ms)' (600), 'Polarity Detect (ms)' (20), 'DTMF OFF time (ms)' (100), and 'DTMF ON time (ms)' (100). At the bottom of the miscellaneous section are two checkboxes: 'Auto Answer' and 'Trailing edge DTMF', both of which are unchecked.

- Make the required changes. If you change the name of the E&M subscriber, the target name will be updated wherever E&M subscriber has been added as a contributor to a control panel.
- To add a picture to identify the E&M subscriber on a Virtual Panel, click the picture and browse for and select the required image file.
- Some telephony parameters are also presented on this tab and these must be set appropriately for your installation.
- Click to post changes to the database.

16.5 E&M SUBSCRIBER EDITOR – SIP OPTIONS

The SIP Options tab is used to edit SIP specific details of the E&M subscriber.

To change SIP Options:

- Select an E&M subscriber from the list of subscribers attached to a host and double-click to open the E&M Subscriber Editor. Click on the SIP Options tab.

General | SIP Options | GPIO | Phone Ctrl.List | Contributors

Free Dial Settings (SIP)

Assume SIP on Free-dial

EOL Mode

None

Use EOL Digit

Fixed Length

Seq. Digits: 3

EOL Character: [Dropdown]

Preferred SIP Codecs

Profile 1: [Dropdown] Profile 2: [Dropdown] Profile 3: [Dropdown]

Profile 4: [Dropdown] Profile 5: [Dropdown] Profile 6: [Dropdown]

- Click to post changes to the database.

16.6 E&M SUBSCRIBER EDITOR – GPIO

The GPIO tab is used to define a GPI input for the selected E&M subscriber. GPIO routing statements are explained in section 25 *Configuration Editor | GPIO Processes* of this manual.

The GPI that you add to a subscriber is an input that changes when the phone subscriber that it is connected to goes OFF and ON hook. For example, if a key on a Virtual or Hardware Panel is assigned to the phone target (with a GPI defined) and Signal Presence is selected on the panel setup, then the key on the panel will flash whenever the phone port goes OFF hook. This key will stop flashing when the phone port goes ON hook.

A maximum of one GPI can be added on an E&M subscriber. Buttons at the top of the GPIO tab allow you to:

- Add a GPI.
- Delete a GPI.

16.6.1 Adding a GPI Input

You can add one GPI input. This will be automatically named by the system. A comment can be added to provide more information if required.

- Select an E&M subscriber from the list of subscribers attached to a host and open the Panel Configuration Editor.
- Click the GPIO tab.
- Click the green + button to add the input.

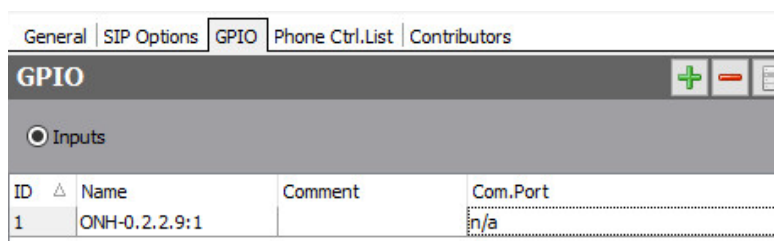

- Change the name and add a comment relating to the GPI, if required.
- Click to post changes to the database.

16.6.2 Deleting GPI Inputs

The GPI input defined for an E&M subscriber can be deleted if required. To delete the GPI, highlight the row and click the red - button.

IMPORTANT: If you delete the GPI it will be removed from any GPIO processes that have been configured to use the selected GPI. The process will not be deleted but will not function as expected.

16.7 E&M SUBSCRIBER EDITOR - PHONE CTRL. LIST

If you have defined phone controls using the Phone Number Editor, these can be added to the configuration and then used to direct a call to the configured subscriber. SIP numbers, defined using the Phone Number Editor, can also be added to the E&M subscriber if required.

Buttons at the top of the Phone Ctrl. List tab let you:

- Add a phone control or SIP number.
- Delete a selected phone control or SIP number.

16.7.1 Adding a Phone Control to an E&M Subscriber

Phone controls are incoming DDI digits that are used to direct an answered call directly to a configured subscriber, for example, a conference, Virtual Panel or radio phone. See section 26 *Configuration Editor / Phone Numbers* for more information on adding phone controls.

16.7.2 Adding a SIP Number to an E&M Subscriber

SIP numbers are numbers that can be used to call a SIP connection. They are outgoing digit sequences that map to either fully formed URIs or are digits that are passed to a Proxy Server where they are fully resolved. See section 26 *Configuration Editor / Phone Numbers* for more information on adding SIP numbers.

NOTE: When you add phone controls or SIP Numbers, you select from the global list previously edited using the Phone Number Editor and as such, you cannot make any changes to the details here.

To add a phone control or SIP Number:

- Select an E&M subscriber from the list of panels/subscribers attached to a host and open the E&M Subscriber Editor.
- Click the Phone Ctrl. List tab.
- Press the radio button (“Targets” or “Remote SIP”) according to the type of item you wish to add.
- Click **Add** to open the Phone Numbers list.
- Select the number that you want to add and click **Apply**.

Examples are shown below.

General SIP Options GPIO Phone Ctrl.List Contributors			
Phone Number List + -			
<input checked="" type="radio"/> Targets <input type="radio"/> Remote SIP			
Name	Telephone Number	Type	Target
Central	0800654321	5	H1S4

General SIP Options GPIO Phone Ctrl.List Contributors		
Phone Number List + -		
<input type="radio"/> Targets <input checked="" type="radio"/> Remote SIP		
Name	Telephone Number	Address
SIP 34	82345	192.168.9.9





16.7.3 Removing Phone Controls and SIP Numbers from an E&M Subscriber

Any phone controls or SIP numbers that are no longer required can be removed from the E&M subscriber. Remove phone controls or SIP numbers individually using the red – (Delete) button.

NOTE: Deleting phone controls or SIP numbers from the selected E&M subscriber does not delete these numbers from the global lists maintained by the Phone Number Editor or from other subscribers.

16.8 E&M SUBSCRIBER EDITOR - CONTRIBUTORS

The Contributors tab shows a list of reverse key target assignments. The list shows panels which have keys targeting the current E&M subscriber.

Contributors						
Type	Name	Host Name	EDHS	Targets	Null Mirror Dimming	X-Point Level
	H1S1	Host 1.1	0.1.1.1		<input type="checkbox"/>	0
	H1S2	Host 1.1	0.1.1.2		<input type="checkbox"/>	0

This example shows E&M Subscriber EM1.

Thus, panels H1S1 and H1S2 have keys which target EM1, allowing those 2 panels to make and receive calls.

Most fields are read-only but the following may be adjusted:

- **Null Mirror Dimming.** Mirror dimming is normally automatically applied when 2 subscribers have open bi-directional routes. The audio level in both directions is reduced by a pre-determined amount to reduce the risk of acoustic feedback. With certain types of subscriber such as headsets or telephones, due to the physical layout, the risk is minimal, and the mirror dimming can be overridden.
- **X-Point level.** This field provides a convenient means of fine-tuning audio contributing to the output at this specific location. For example, if a panel operator finds that audio from a specific subscriber is consistently too loud, a small negative adjustment may be applied here without affecting any other party.

Click to post changes to the database.

16.9 E&M SUBSCRIBER EDITOR - FIELD DEFINITIONS

16.9.1 E&M Configuration - General tab

Field/Display Item	Description
Name	The name of the E&M subscriber. This is usually defined when the E&M subscriber is added to the host using the Host Editor. See the “Hosts and the Host Editor” chapter in this Configuration Guide. The name can be changed here if required. Maximum length = 20 characters.
Long Name	If text is entered, this will be used as an alternate to the Name field, on panels with displays supporting 8 characters. If left blank, the Name field will always be used.
Comment	Comments relating to the E&M subscriber. Add your comments in the space provided.
Picture 	A picture may be assigned to help identify the Subscriber. To assign, or change an existing picture, click the picture and browse to select an image file. The picture will only be displayed on Virtual Panels. Default as shown on left.
Mirror Dimming	Mirror dimming helps to reduce acoustic feedback. Range 0 to -60 dB. Default = 0 dB.
Misc: Signal Type	Specifies the telephony signal type. Choices are loop start (default) or ground start.
Misc: Termination	Not used on E&M subscribers
Misc: Country	Specifies the country of use. Default: US.
Misc: Ring Cadence	Not used on E&M subscribers
Misc: Ring Frequency (Hz)	Not used on E&M subscribers
Misc: CPC Detect (ms)	Not used on E&M subscribers
Misc: Polarity Detect (ms)	Not used on E&M subscribers
Misc: DTMF Off time (ms)	50 – 2000 ms, default 100 ms
Misc: DTMF On time (ms)	50 – 2000 ms, default 100 ms
Misc: Auto-Answer	When checked, causes an E&M port to auto-answer an incoming call and then treat the port as a normal 4-wire. Ensure it is not checked if you wish to use DTMF via phone controls to create routes within the system. Default = unchecked.
Misc: Trailing Edge DTMF	If checked, report a DTMF signal at the end of a tone, instead of when detected. Default = unchecked.

16.9.2 E&M Configuration - SIP Options tab

Display Item	Description
Assume SIP on free dial	Default = Unchecked
EOL Mode	Not applicable to E&M configuration.
Seq. Digits	Not applicable to E&M configuration.
EOL Character	Not applicable to E&M configuration.
Preferred SIP Codec 1 - 6	Specifies codecs (in priority order) to be used when establishing a call between the SIP/TEB devices.

16.9.3 E&M Configuration - GPIO tab

Field/Display Item	Description
ID	The ID of the GPI in the database.
Name	The name of the GPI. By default, this is the subscriber EDHS prefixed with OFH (Off Hook) and suffixed with the GP pin value. For example, OFH-0.1.1.3:1 Names do not have to be unique. Maximum length = 20 characters.
Comment	Comments relating to the GPI. You can add comments in the space provided, as required. Maximum length = 255 characters.
Com. Port	Not applicable.

16.9.4 E&M Configuration - Phone Ctrl. List tab

Display Item	Description
Targets	Click this radio button to view or add a phone control.
Remote SIP	Click this radio button to view or add a SIP number.
Name	The name of the phone control as defined using the global Phone Number Editor. This cannot be changed here.
Telephone Number	The phone control number as defined using the global Phone Number Editor. This cannot be changed here.
Type	Target: An icon showing the target for the phone control.
Target	Target: The name of the target. This cannot be changed here.
Address	Remote SIP: The IP address or URL corresponding to the SIP number. This cannot be changed here.

16.9.5 E&M Configuration - Contributors tab

Field/Display Item	Description
Type	An icon indicating the type of subscriber contributing, e.g. another panel, radio or telephone.
Name	The name of the contributing subscriber.
Host Name	The name of the host, to which the contributing subscriber is connected.
EDHS	Full EDHS address of the contributor.
Targets	Place the mouse cursor over the icon and text will show the method of contribution. For example, direct, conference or group.
Null Mirror Dimming	Tick the box to override the application of mirror dimming for this subscriber pair.
X-Point level	The gain level of the contributing "source" to this subscriber. Default = 0 dB. Range -60 to +12 dB.

17. CONFIGURATION EDITOR | SUBSCRIBER | 4-WIRE

17.1 OVERVIEW

A 4-wire subscriber is added to a host using the Host Editor. Once you have added the subscriber, you must configure it using the subscriber editor.

Unlike other subscriber types, there are no targets, key modes and key settings required to define for a 4-wire subscriber.

- For more information on adding 4-wire subscribers to a host, see section 11 *Configuration Editor | Host* in this Configuration Guide.
- For basic information about opening the Subscriber Editor and an explanation of key modes, see section 12 *Configuration Editor | Subscriber | Introduction* in this Configuration Guide.

A 4-wire is two pairs of balanced Analogue audio input and output signals, generally associated with a single item of external equipment. This is connected using a total of four wires:

- audio in +
- audio in –
- audio out +
- audio out -

Since the 4-wire connects to an external device there are very few editable parameters.

17.2 4-WIRE - SUBSCRIBER EDITOR - GENERAL

The 4-wire - Subscriber Configuration - General tab is used to specify basic details about the 4-wire subscriber.

17.2.1 Changing 4-Wire Details

You can change the name of the 4-wire and enter a comment to provide further information about the subscriber. A picture can be added to identify the 4-wire subscriber on a Virtual Panel.

NOTE: The name of the subscriber is the target name which is allocated when the 4-wire is added to the host using the Host Editor.

- Select a 4-wire port from the list of panels/subscribers attached to a host and open the editor. The General tab is selected by default.
- Make the required changes. If you change the name of the 4-wire, the target name will be updated wherever this 4-wire has been added as a target on a panel.

- Click to post changes to the database.

17.3 4-WIRE - SUBSCRIBER EDITOR - CONTRIBUTORS

The Contributors tab shows a list of reverse key target assignments. The list shows panels which have keys targeting the current 4-wire subscriber.

In the example below, 4-wire Subscriber H1S3 has been selected.

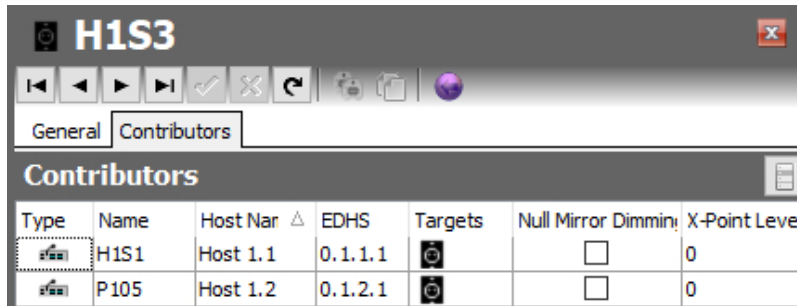

Type	Name	Host Name	EDHS	Targets	Null Mirror Dimming	X-Point Level
	H1S1	Host 1.1	0.1.1.1		<input type="checkbox"/>	0
	P105	Host 1.2	0.1.2.1		<input type="checkbox"/>	0

Thus, panels H1S1 and P105 have keys which are “pointing at” the 4-wire allowing those 2 panels to send audio (speak) to the 4-wire. Note that if the panels have keys just to listen to the 4-wire, they are no longer contributing, so will not appear in this list.

Most fields are read-only but the following may be adjusted:

- **Null Mirror Dimming.** Mirror dimming is normally automatically applied when 2 subscribers have open bi-directional routes. The audio level in both directions is reduced by a pre-determined amount to reduce the risk of acoustic feedback. With certain types of subscriber such as headsets or telephones, due to the physical layout, the risk is minimal and the mirror dimming can be overridden.
- **X-Point level.** This field provides a convenient means of fine-tuning audio contributing to the output at this specific location. For example, if a panel operator finds that audio from a specific subscriber is consistently too loud, a small negative adjustment may be applied here without affecting any other party.

Click to post changes to the database.

17.4 4-WIRE – SUBSCRIBER EDITOR - FIELD DEFINITIONS

17.4.1 General tab

Field/Display Item	Description
Name	The name of the 4-wire. This is usually defined when the 4-wire is added to the host using the Host Editor. See the “Hosts and the Host Editor” chapter in this Configuration Guide. The name can be changed using the Panel Configuration Editor if required. Maximum length = 20 characters.
Long Name	If text is entered, this will be used as an alternate to the Name field, on panels with displays supporting 8 characters. If left blank, the Name field will always be used.
Comment	Comments relating to the selected 4-wire subscriber. Add your comments in the space provided.
Picture 	A picture may be assigned to help identify the Subscriber. To assign, or change an existing picture, click the picture and browse to select an image file. The picture will only be displayed on Virtual Panels. Default as shown on left.
Mirror Dimming	Mirror dimming helps to reduce acoustic feedback. Range 0 to -60 dB. Default = 0 dB.

17.4.2 Contributors tab

Field/Display Item	Description
Type	An icon indicating the type of subscriber contributing, e.g. another panel, radio or telephone.
Name	The name of the contributing subscriber
Host Name	The name of the host, to which the contributing subscriber is connected.
EDHS	Full EDHS address of the contributor.
Targets	Place the mouse cursor over the icon and text will show the method of contribution. For example, direct, conference or group.
Null Mirror Dimming	Tick the box to override the application of mirror dimming for this subscriber pair.
X-Point level	The gain level of the contributing “source” to this subscriber.

18. CONFIGURATION EDITOR | SUBSCRIBER | RADIO PORT AND RADIO PHONE

18.1 OVERVIEW

A Radio Port or Radio Phone is added to a host using the Host Editor. Once you have added the port or phone, you must configure it using the Subscriber - Radio Configuration Editor.

- For more information on adding a Radio Port or Radio Phone subscriber to a host, see section 11 *Configuration Editor | Host* in this Configuration Guide.
- For basic information about opening the Subscriber Editor and an explanation of key modes, see section 12 *Configuration Editor | Subscriber | Introduction* in this Configuration Guide.

The Radio Phone port type is designed for users equipped with DTMF enabled handsets. With extra programming, these handsets can be used to make direct contact with other Mercury subscribers by keying a pre-arranged DDI style short code. Users of these handsets can contact other radio channels and phone subscribers (FXS directly; FXO by reaching the port, then dialling more digits), call a Virtual or Hardware Panel directly or join a conference. The radio base (connected to the MIU) typically does not require any modification—it just passes the DTMF straight through to the RIB port. When a Radio Port is added, the following tabs appear in the editor:

- General
- RIB
- VOX
- Contributors

When a Radio Phone is added, the following tabs appear in the editor:

- General
- RIB
- SIP Options
- Sources
- Phone No. List
- Contributors

18.2 RADIO PORT EDITOR - GENERAL

The General tab is used to specify basic details.

18.2.1 Changing Radio Port Details

You can change the name of the subscriber and enter a comment to provide further information. A picture can be added to identify the subscriber on a Virtual Panel.

To change radio port details:

- Select a radio port from the list of subscribers attached to a host and open the Radio Configuration Editor. The **General** tab is selected by default.
- Make the required changes. If you change the name, the target name will be updated wherever the radio port has been added as a source on a panel.
- To add a picture to identify this radio port on a Virtual Panel, click the picture and browse for and select the required image file.

The screenshot shows the 'Radio' configuration window with the 'General' tab active. The 'Name' field is 'Radio'. The 'Long Name' and 'Comment' fields are empty. The 'Mirror Dimming (dB)' field is set to 0. Under 'COR/PTT Logic', the following options are checked: 'COR Active on HIGH', 'PTT Active on HIGH', and 'SFST Follows PTT'. The 'COR Overrides PTT' checkbox is unchecked.

- Click to post changes to the database.

18.3 RADIO PORT EDITOR - RIB

The RIB tab is used to specify more advanced details about the radio port.

To change radio port details:

- Select a radio port from the list of panels/subscribers attached to a host and open the Radio Configuration Editor. Select the RIB tab.
- Make the required changes.

General | **RIB** | VOX | Contributors

Audio In
 Input Delay (ms): 0 | Input Filter (@3kHz): [Dropdown] | Input Boost | DTMF Detection | Noise Reduction: 12db | Speech In Noise
 Intel. Squelch Filter | Adapt. Speech Filter

Audio Out
 Output Delay (ms): 0 | Output Filter (@3kHz): [Dropdown] | Attenuation | CTCSS Tone | CTCSS Frequency (Hz): 67.0

Carrier Operated Relay (COR)
 Enabled | Trigger: COR | Mode: Unmute | Polarity: Normally Open | Attack (ms): 0 | Release (ms): 0

Push To Talk (PTT)
 Enabled | Trigger: Route | COR Overrides PTT | Polarity: Normally Open | Attack (ms): 0 | Release (ms): 0

Sidetone Suppression (SFST)
 Enabled | SFST Trigger: Route | Attenuation Level (dB): 0 | Attenuation Delay (ms): 0

- Click to post changes to the database.

18.4 RADIO PORT EDITOR - VOX

The VOX tab is used to specify the VOX settings for the radio port.

To change radio port settings:

- Select a radio port from the list of panels/subscribers attached to a host and open the Radio Configuration Editor.
- Click the **VOX** tab.
- Make the required changes to the settings.

General | RIB | **VOX** | Contributors

Input VOX
 Attack (ms): 0 | Release (ms): 0 | Level (dB): -10

Output VOX
 Attack (ms): 0 | Release (ms): 0 | Level (dB): -10





- Click to post changes to the database.

18.5 RADIO PORT EDITOR - CONTRIBUTORS

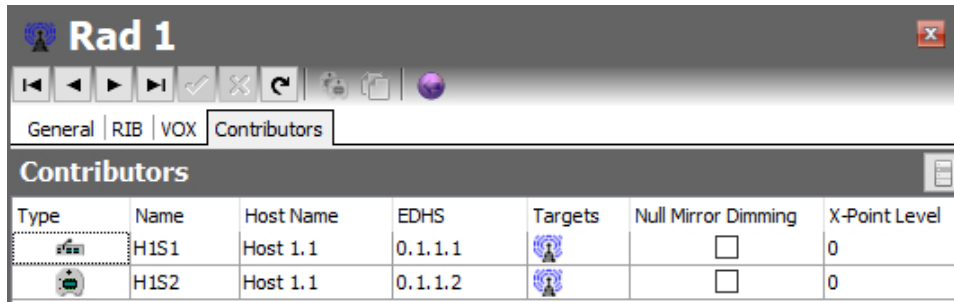
The Contributors tab shows a list of reverse key target assignments. The list shows panels which have keys targeting the current Radio Port.

In the example below, Subscriber Rad 1 has been selected.



Type	Name	Host Name	EDHS	Targets	Null Mirror Dimming	X-Point Level
	H1S1	Host 1.1	0.1.1.1		<input type="checkbox"/>	0
	H1S2	Host 1.1	0.1.1.2		<input type="checkbox"/>	0

Thus, panels H1S1 and H1S2 have keys which are “pointing at” the radio allowing those 2 panels to send audio (speak) to the radio. Note that if the panels have keys just to listen to the radio, they are no longer contributing, so will not appear in this list.

Most fields are read-only but the following may be adjusted:

- **Null Mirror Dimming.** Mirror dimming is normally automatically applied when 2 subscribers have open bi-directional routes. The audio level in both directions is reduced by a pre-determined amount to reduce the risk of acoustic feedback. With certain types of subscriber such as headsets or telephones, due to the physical layout, the risk is minimal and the mirror dimming can be overridden.
- **X-Point level.** This field provides a convenient means of fine-tuning audio contributing to the output at this specific location. For example, if a panel operator finds that audio from a specific subscriber is consistently too loud, a small negative adjustment may be applied here without affecting any other party.

Click to post changes to the database.

18.6 RADIO PHONE EDITOR - GENERAL

The General tab is used to specify basic details about the radio phone.

18.6.1 Changing Radio Phone Details

You can change the name of the subscriber and enter a comment to provide further information.

A picture can be added to identify the subscriber on a Virtual Panel.

To change radio phone details:

- Select a radio phone from the list of subscribers attached to a host and open the Subscriber Editor. The **General** tab is selected by default.
- Make the required changes. If you change the name of the radio phone, the target name will be updated wherever the radio phone has been added as a source on a panel.
- To add a picture to identify the radio phone on a Virtual Panel, click the picture and browse for and select the required image file.

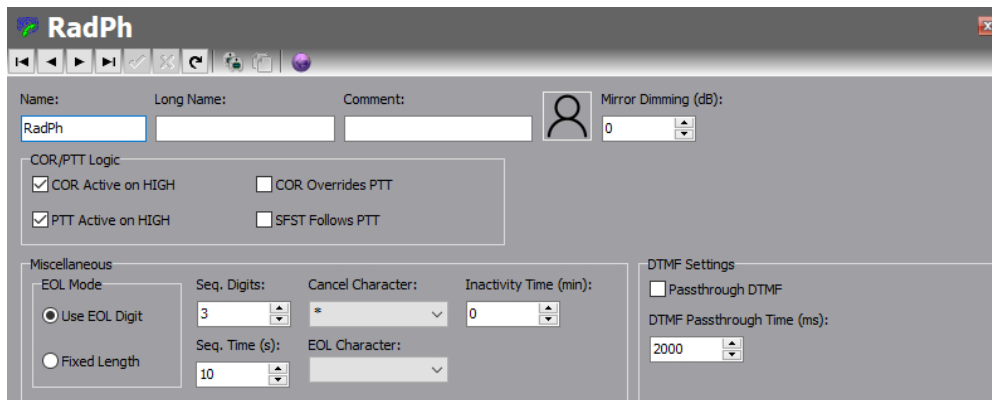

The screenshot shows the 'RadPh' Subscriber Editor window. The 'Name' field is 'RadPh'. The 'Long Name' and 'Comment' fields are empty. There is a profile picture icon and a 'Mirror Dimming (dB)' dropdown set to 0. The 'COR/PTT Logic' section has four checkboxes: 'COR Active on HIGH' (checked), 'COR Overrides PTT' (unchecked), 'PTT Active on HIGH' (checked), and 'SFST Follows PTT' (unchecked). The 'Miscellaneous' section has 'EOL Mode' with 'Use EOL Digit' selected and 'Fixed Length' unselected. 'Seq. Digits' is 3, 'Cancel Character' is *, 'Inactivity Time (min)' is 0, 'Seq. Time (s)' is 10, and 'EOL Character' is empty. The 'DTMF Settings' section has 'Passthrough DTMF' unchecked and 'DTMF Passthrough Time (ms)' set to 2000.

- Click  to post changes to the database.

18.7 RADIO PHONE EDITOR - RIB

The RIB tab is used to specify more advanced details about the radio phone.

To change radio phone details:

- Select a radio phone from the list of subscribers attached to a host and open the Subscriber Editor. Select the **RIB** tab.
- Make the required changes.

- Click to post changes to the database.

18.8 RADIO PHONE EDITOR – SIP OPTIONS

The SIP Options tab is used to specify SIP related options.

To change radio phone details:

- Select a radio phone from the list of subscribers attached to a host and open the Subscriber Editor. Select the **SIP Options** tab.
- Make the required changes.

- Click to post changes to the database.

18.9 RADIO PHONE EDITOR - SOURCES

The Sources tab is used to assign sources to a radio phone. Each source is automatically allocated a DDI. Phone controls can also be added to a radio phone. For more information on phone controls, see section 26 *Configuration Editor / Phone Numbers* chapter in this Configuration Guide.

18.9.1 Adding a Source

Up to 256 sources to be defined for each radio phone. Each source type that you add will have a default speak/listen mode and DDI. If you add phone controls, the configured phone control number will be used.

To add a source:

Sources								
ID	Type	Target	Mode	QRS Stack	Shift Page	DDI	Phone Nai	Number
1		H1S1		0	0	1		
2		H1S3		0	0	2		
3	?			0	0			
4	?			0	0			

Select a radio phone from the list of panels/subscribers attached to a host and open the Subscriber Editor.

Click the **Sources** tab.

Type	Name	Comment	Domain	Host	Port
	H1S1		1	1	1
	H1S2		1	1	2
	H1S3		1	1	3
	H1S4		1	1	4
	H1S5		1	1	5
	Tel 5		1	1	9
	Tel 6		1	1	11
	Tel 7		1	1	13
	Tel 8		1	1	15
	Radio		1	1	17
	H2S1		2	2	1
	Tel 1		2	2	9
	Tel 2		2	2	11

Click in the **Target** field and click to open the **Ports** dialogue.

To change the target type, click the Groups, Conferences, GPIO/Audio Routes, IFBs or SIP Connections button and make your selection.



Select the required panel/source (to select more than one panel/source, hold down the **Ctrl** key) and click **Apply**.

Return to the main editor.

- To change the mode, click in the **Mode** field, click and select the required mode. The default mode is usually correct.
- Change the DDI, if required. The DDI automatically increments when sources are added.
- To add a phone control, click in the **Ph. Book Name** field and click to open the Panels/Sources dialogue.
- Select the required phone control from the list and click **Apply**. Note that the **Ph. Book Number** field is automatically populated with the phone control number. The DDI field is filled in automatically with the phone control number if you are using Fixed Length as the EOL Mode.
- Add additional sources, as required.
- Click to post changes to the database.

18.9.2 Changing a Source

Source types on radio phone can be changed, as required. To do this, change the target for the relevant port.

- Select a radio phone from the list of subscribers attached to a host and open the Radio Configuration Editor.
- Click the **Sources** tab.
- Click in the **Target** field next to the ID of the key that you want to re-assign.
- Click  and select the required target.
- Change the other settings, as needed.
- Click  to post changes to the database.

18.9.3 Deleting a Source

Any sources that are no longer required can be deleted.

- Select a radio phone from the list of panels/subscribers attached to a host and open the Panel Configuration Editor.
- Click the **Sources** tab.
- Click in the **Target** field and press the **Delete or Backspace** key on your keyboard.

18.10 RADIO PHONE EDITOR - PHONE NUMBER LIST

If you have defined SIP numbers using the global Phone Number Editor, these can be added to the configuration and then dialled on the radio phone.

Buttons at the top of the Phone No. List tab let you:

- Add a SIP number.
- Delete a selected SIP number.

18.10.1 Adding a Number to a Radio Phone

SIP numbers are outgoing digit sequences that map to either fully formed SIP URIs or are digits that are passed to a Proxy Server to be fully resolved.

NOTE: You cannot make any changes to the SIP number details here.

To add a number to a radio phone:

- Select a radio phone from the list of panels/subscribers attached to a host and open the Panel Configuration Editor.
- Click the **Phone No. List** tab. Any numbers that have already been added are shown.
- Click **Add** to open the Phone Numbers list.

Name	Telephone Number
SIP101	101
SIP102	102

Select the phone number that you want to add (to select more than one number, hold down the **Ctrl** key) and click **Apply** to add the number(s) to the radio phone.

Return to the main editor.

Name	Telephone Number
SIP101	101

The phone number has now been added.

18.10.2 Removing Numbers from a Radio Phone





Any SIP numbers that are not required on the radio phone can be deleted if required. You can delete selected numbers using the red - button.

18.11 RADIO PHONE EDITOR - CONTRIBUTORS

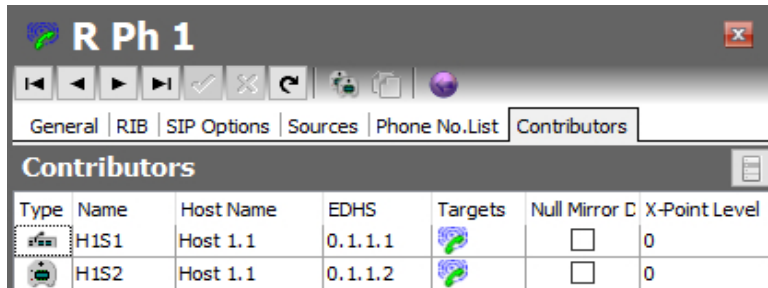
The Contributors tab shows a list of reverse key target assignments. The list shows panels which have keys targeting the current radio phone subscriber.

In the example below, subscriber R Ph 1 has been selected.



Type	Name	Host Name	EDHS	Targets	Null Mirror D	X-Point Level
	H1S1	Host 1.1	0.1.1.1		<input type="checkbox"/>	0
	H1S2	Host 1.1	0.1.1.2		<input type="checkbox"/>	0

Thus, panels H1S1 and H1S2 have keys which are “pointing at” the radio phone, allowing those 2 panels to send audio (speak) to the radio phone. Note that if the panels have keys just to listen to the radio phone, they are no longer contributing, so will not appear in this list.

Most fields are read-only but the following may be adjusted:

- **Null Mirror Dimming.** Mirror dimming is normally automatically applied when 2 subscribers have open bi-directional routes. The audio level in both directions is reduced by a pre-determined amount to reduce the risk of acoustic feedback. With certain types of subscriber such as headsets or telephones, due to the physical layout, the risk is minimal and the mirror dimming can be overridden.
- **X-Point level.** This field provides a convenient means of fine-tuning audio contributing to the output at this specific location. For example, if a panel operator finds that audio from a specific subscriber is consistently too loud, a small negative adjustment may be applied here without affecting any other party.

Click to post changes to the database.

18.12 RADIO PORT EDITOR - FIELD DEFINITIONS**18.12.1 Configuration (Radio Port) - General tab**

Field/Display Item	Description
Name	The name of the radio port. This is usually defined when the radio port is added to the host using the Host Editor. See the “Hosts and the Host Editor” chapter in this Configuration Guide. The name can be changed using the Panel Configuration Editor if required. Maximum length = 20 characters.
Long Name	If text is entered, this will be used as an alternate to the Name field, on panels with displays supporting 8 characters. If left blank, the Name field will always be used.
Comment	Comments relating to the selected radio port. Add your comments in the space provided.
Picture 	A picture may be assigned to help identify the Subscriber. To assign, or change an existing picture, click the picture and browse to select an image file. The picture will only be displayed on Virtual Panels. Default as shown on left.
Mirror Dimming	Mirror dimming helps to reduce acoustic feedback. Range 0 to -60 dB. Default = 0 dB.
COR active on HIGH	Select this checkbox to allow the radio port to override COR activity. Default = checked.
PTT active on HIGH	Allows the active state of the PTT to be configured as either logical 1 (high-level signal) or logical 0 (low-level signal). Default = checked.
COR overrides PTT	Select this checkbox to keep transmitting and enter more digits when dialling an FXO port. If this box is not checked, you will not be able to enter more digits when dialling an FXO port after a dial tone is received. Default = unchecked.
SFST follows PTT	SFST = Safety of Flight Side Tone. With this setting turned on, any changes to output applied by SFST will be driven by the PTT Output state. It has the same effect as turning on SFST and select PTT on the RIB tab. Used when PTT is VOX rather than Route driven. Default = unchecked.

18.12.2 Configuration (Radio Port) - RIB tab

Field/Display Item	Description
Audio In: Input Delay (ms)	Audio delay in ms applied to incoming audio on the selected port. Not frequently used but can be applied to ensure any routes being driven by a COR input are established before audio from a radio is delivered.
Audio In: Input Filter (@3 kHz)	Applies the described filter to the audio incoming to the port.
Audio In: Input Boost	Can be switched on for a gain boost to the incoming audio. Default = unchecked.
Audio In: Intelligent Squelch Filter	Attempts to remove the static blips that can occur from radio units. Default = unchecked.
Audio In: DTMF Detection	Turn this on if you want the radio to be able to drive an FXO port, should the appropriate route be made for it. Default = unchecked.
Audio In: Adaptive Speech Filter	Applies noise reduction processing to the incoming audio. Default = unchecked.
Audio In: Noise Reduction	The amount of noise reduction applied if the adaptive speech filter (above) is enabled. Default = 12 dB.
Audio In: Speech in Noise	Enable Speech in Noise Detector(SND). Default = checked.
Audio Out: Output Delay (ms)	Delay applied to outgoing audio. Commonly used so that the radio base unit is in "transmit" mode before audio arrives so that the destination doesn't miss vital audio. Default = 0 ms.
Audio Out: Output Filter (@3 kHz)	Applies the described filter to the audio outgoing from the port.
Audio Out: Attenuation	Audio level reduction applied to the outgoing signal. Default = unchecked.
Audio Out: CTCSS Tone	Enable Continuous Tone-Coded Squelch System (CTCSS). Default = unchecked.
Audio Out: CTCSS Frequency (Hz)	CTCSS frequency if CTCSS Tone is enabled. Default = 67 Hz.
COR: Enabled	When enabled, Mercury will use the configuration of the following settings to enable or disable audio from the radio port to other subscribers. For example, a panel permanently listening to the radio port will see a flashing tally until the COR signal is received, then the tally will become solid and audio will be heard – this reflects processing going on in the background where the actual route is being muted or inhibited. Default = unchecked.
COR: Trigger	Can select between COR and VOX to control when Mercury will apply the configured action. COR – electrical input coming into the RIB port itself (default). VOX – Detection of audio incoming to the port, allowing action to be performed while audio is present.
COR: Mode	Controls whether all listen routes to the radio port are muted or inhibited when the COR trigger is off. Default = unmute.

Field/Display Item	Description
COR: Polarity	Inverts the sense of COR trigger. Not recommended for use with VOX but used if radio base unit provides the appropriate electrical signal. Default = Normally open.
COR: Attack (ms)	Configures how long the trigger condition must be true before the action will be implemented. Default = 0 ms.
COR: Release (ms)	Configures how long the action continues to be applied once the trigger condition is false. Default = 0 ms.
PTT: Enabled	When enabled, Mercury will turn on the associated output signal for the selected radio port when a configured trigger is true. The following fields configure how the action is triggered and performed. Default = unchecked.
PTT: Trigger	Two options used to trigger the output to be switched on. Route – Whenever a speak route is made to the port, the output signal is switched on (default). VOX – Whenever audio is outgoing from the point, the output signal is switched on.
PTT: COR Overrides PTT	If enabled, then if COR is true, PTT cannot be triggered. This can be useful with certain radio base stations. Default = unchecked.
PTT: Polarity	Inverts the sense of the PTT output. Default = Normally open.
PTT: Attack (ms)	Configures how long the trigger condition must be true before the action will be implemented. Default = 0 ms.
PTT: Release (ms)	Configures how long the action continues to be applied once the trigger condition is false. Default = 0 ms.
Sidetone Suppression: Enabled	When enabled, the audio from the radio will be dimmed or delayed when the trigger condition is true. Default = unchecked.
Sidetone Suppression: SFST Trigger	Two options to control when SFST is applied. Route – When any speak route is made to the radio port, SFST is applied (default). PTT – When PTT is turned on, SFST is applied. Normally used when PTT has been set to be triggered by VOX.
Sidetone Suppression: Attenuation Level (dB)	The attenuation applied when SFST is enabled. Default = 0 dB.
Sidetone Suppression: Attenuation Delay (ms)	The amount of delay used when SFST is enabled. Default = 0 ms.

18.12.3 Configuration (Radio Port) - VOX tab

Field/Display Item	Description
Input VOX: Attack (ms)	Length of time the incoming audio is above the threshold before the VOX trigger is turned on. Recommend approx. 500ms, so that little blips of background noise don't register but not so long that the trigger misses the start of any audio. Default = 0 ms.
Input VOX: Release (ms)	Length of time the trigger stays on after audio has dropped below the threshold. Used to avoid the trigger turning off when there are short pauses or breaths when speaking. Default = 0 ms.
Input VOX: Level (dB)	The threshold that audio must be above for the VOX trigger to turn on. Default = -10 dB.
Output VOX: Attack (ms)	As Input VOX (above), but for the RIB port audio output
Output VOX: Release (ms)	As Input VOX (above), but for the RIB port audio output
Output VOX: Level (dB)	As Input VOX (above), but for the RIB port audio output

18.12.4 Configuration (Radio Port) - Contributors tab

Field/Display Item	Description
Type	An icon indicating the type of subscriber contributing, e.g. another panel, radio or telephone.
Name	The name of the contributing subscriber
Host Name	The name of the host, to which the contributing subscriber is connected.
EDHS	Full EDHS address of the contributor.
Targets	Place the mouse cursor over the icon and text will show the method of contribution. For example, direct, conference or group.
Null Mirror Dimming	Check the box to override the application of mirror dimming for this subscriber pair. Default = unchecked.
X-Point level	The gain level of the contributing "source" to this subscriber. Default = 0dB.

18.13 RADIO PHONE EDITOR - FIELD DEFINITIONS**18.13.1 Configuration (Radio Phone) - General tab**

Field/Display Item	Description
Name	The name of the radio port. This is usually defined when the radio port is added to the host using the Host Editor. See the “Hosts and the Host Editor” chapter in this Configuration Guide. The name can be changed using the Panel Configuration Editor if required. Maximum length = 20 characters.
Long Name	If text is entered, this will be used as an alternate to the Name field, on panels with displays supporting 8 characters. If left blank, the Name field will always be used.
Comment	Comments relating to the selected radio port. Add your comments in the space provided.
Picture 	A picture may be assigned to help identify the Subscriber. To assign, or change an existing picture, click the picture and browse to select an image file. The picture will only be displayed on Virtual Panels. Default as shown on left.
Mirror Dimming (dB)	Mirror dimming helps to reduce acoustic feedback. Default = 0 dB. Range 0 to -60 dB.
COR/PTT Logic: COR active on HIGH	Select this checkbox to allow the radio port to override COR activity. Default = checked.
COR/PTT Logic: PTT active on HIGH	Allows the active state of the PTT to be configured as either logical 1 (high-level signal) or logical 0 (low-level signal). Default = checked.
COR/PTT Logic: COR overrides PTT	Check this box to continue transmitting and enter more digits when dialling an FXO port. If not checked, you will not be able to enter more digits when dialling an FXO port after a dial tone is received. Default = unchecked.
COR/PTT Logic: SFST follows PTT	SFST = Safety of Flight Side Tone. When enabled, any changes to output applied by SFST will be driven by the PTT Output state. It has the same effect as turning on SFST and select PTT on the RIB tab. Used when PTT is VOX rather than Route driven. Default = unchecked.
EOL Mode	The mode used to identify the end of a line. Two modes are available: Use EOL Digit - end of line is identified with a preselected character (EOL Character). Fixed Length - end of line is identified after a preset number of digits has been entered (Seq. Digits). Default = Use EOL Digit.
Seq. Digits	The number of digits used to identify an end of line. Used if Fixed Length is selected as the EOL Mode. Default = 3.
Seq Time (s)	The length of time the RIB will wait for a digit sequence to be entered before timing out. Default = 10 seconds.
Cancel Character	The character used to cancel an input. Default = *.
EOL Character	The end of line character. This character will be used if Use EOL Digit is selected as the EOL Mode.

Field/Display Item	Description
Inactivity Time (min)	If a call is not cancelled, the radio will still be active and cannot be called. A timeout can be specified which will automatically cancel a call if no PTT or COR is detected within the specified period. Default = 0 min.
Passthrough DTMF	Check this box to pass DTMF digits to an outside line when connecting to an FXO port. Default = unchecked.
DTMF Passthrough time (ms)	Default = 2000 ms.

18.13.2 Configuration (Radio Phone) - RIB tab

Field/Display Item	Description
Audio In: Input Delay (ms)	Audio delay in ms applied to incoming audio on the selected port. Not frequently used but can be applied to ensure any routes being driven by a COR input are established before audio from a radio is delivered.
Audio In: Input Filter (@3 kHz)	Applies the described filter to the audio incoming to the port.
Audio In: Input Boost	Can be switched on for a gain boost to the incoming audio. Default = unchecked.
Audio In: Intelligent Squelch Filter	Attempts to remove the static blips that can occur from radio units. Default = unchecked.
Audio In: DTMF Detection	Turn this on if you want the radio to be able to drive an FXO port, should the appropriate route be made for it. Default = unchecked.
Audio In: Adaptive Speech Filter	Applies noise reduction processing to the incoming audio. Default = unchecked.
Audio In: Noise Reduction	The amount of noise reduction applied if the adaptive speech filter (above) is enabled. Default = 12 dB.
Audio In: Speech in Noise	Enable Speech in Noise Detector(SND). Default = checked.
Audio Out: Output Delay (ms)	Delay applied to outgoing audio. Commonly used so that the radio base unit is in "transmit" mode before audio arrives so that the destination doesn't miss vital audio. Default = 0 ms.
Audio Out: Output Filter (@3 kHz)	Applies the described filter to the audio outgoing from the port.
Audio Out: Attenuation	Audio level reduction applied to the outgoing signal. Default = unchecked.
Audio Out: CTCSS Tone	Enable Continuous Tone-Coded Squelch System (CTCSS). Default = unchecked.
Audio Out: CTCSS Frequency (Hz)	CTCSS frequency if CTCSS Tone is enabled. Default = 67 Hz.

Field/Display Item	Description
COR: Enabled	When enabled, Mercury will use the configuration of the following settings to enable or disable audio from the radio port to other subscribers. For example, a panel permanently listening to the radio port will see a flashing tally until the COR signal is received, then the tally will become solid and audio will be heard – this reflects processing going on in the background where the actual route is being muted or inhibited. Default = unchecked.
COR: Trigger	Can select between COR and VOX to control when Mercury will apply the configured action. COR – electrical input coming into the RIB port itself (default). VOX – Detection of audio incoming to the port, allowing action to be performed while audio is present.
COR: Mode	Controls whether all listen routes to the radio port are muted or inhibited when the COR trigger is off. Default = unmute.
COR: Polarity	Inverts the sense of COR trigger. Not recommended for use with VOX but used if radio base unit provides the appropriate electrical signal. Default = Normally open.
COR: Attack (ms)	Configures how long the trigger condition must be true before the action will be implemented. Default = 0 ms.
COR: Release (ms)	Configures how long the action continues to be applied once the trigger condition is false. Default = 0 ms.
PTT: Enabled	When enabled, Mercury will turn on the associated output signal for the selected radio port when a configured trigger is true. The following fields configure how the action is triggered and performed. Default = unchecked.
PTT: Trigger	Two options used to trigger the output to be switched on. Route – Whenever a speak route is made to the port, the output signal is switched on (default). VOX – Whenever audio is outgoing from the point, the output signal is switched on.
PTT: COR Overrides PTT	If enabled, then if COR is true, PTT cannot be triggered. This can be useful with certain radio base stations. Default = unchecked.
PTT: Polarity	Inverts the sense of the PTT output. Default = Normally open.
PTT: Attack (ms)	Configures how long the trigger condition must be true before the action will be implemented. Default = 0 ms.
PTT: Release (ms)	Configures how long the action continues to be applied once the trigger condition is false. Default = 0 ms.
Sidetone Suppression: Enabled	When enabled, the audio from the radio will be dimmed or delayed when the trigger condition is true. Default = unchecked.
Sidetone Suppression: SFST Trigger	Two options to control when SFST is applied. Route – When any speak route is made to the radio port, SFST is applied (default). PTT – When PTT is turned on, SFST is applied. Normally used when PTT has been set to be triggered by VOX.

Field/Display Item	Description
Sidetone Suppression: Attenuation Level (dB)	The attenuation applied when SFST is enabled. Default = 0 dB.
Sidetone Suppression: Attenuation Delay (ms)	The amount of delay used when SFST is enabled. Default = 0 ms.

18.13.3 Configuration (Radio Phone) – SIP Options tab

Field/Display Item	Description
Free Dial Settings (SIP)	The mode used to identify the end of a line for free dial SIP settings. When enabled, the digits dialled will be sent to the configured Proxy Server rather than matched against the phone number list. For example, dialling digits 1234 will cause a call to 1234@proxy_server_ip_address to be attempted, rather than a lookup of 1234 in the phone number list. This can be used if the SIP Server allows Mercury to use its dial plan obviating the need to replicate the dial plan in Mercury. Default = None. Three modes are available: <ul style="list-style-type: none"> • None - Free dial settings are not enabled. • Use EOL Digit - The end of line is identified with a preselected character (EOL Character). • Fixed Length - The end of line is identified after a preset number of digits has been entered (Seq. Digits).
Seq. Digits	The number of digits used to identify an end of line. Used if Fixed Length is selected as the EOL Mode. Default = 3.

18.13.4 Configuration (Radio Phone) - Sources tab

Field/Display Item	Description
ID	The ID of the source in the database.
Type	Shows an icon to identify the source type, for example, a telephone icon, hardware panel icon or conference icon.
Target	The target that is associated with the DDI.
Mode	The key's operation type. This varies depending on the panel type being configured. The mode for FXS, FXO, telephone and radio phone defaults to Phone Action Key. This means that the radio phone will target a phone device with phone-action attributes, for example, it will ring a target.
DDI	The DDI code which will be used to direct a call to the configured subscriber. This is automatically populated by the system. If you are adding a phone control, the DDI field is populated with the phone control number if you are using Fixed Length as the EOL Mode. Note that if this number is longer or shorter than the EOL setting (Seq. Digits) for the radio, then the DDI will be lengthened (with '0s' or truncated.
Ph. Book Name	Click  and select a phone control from the list.
Ph. Book Number	Shows the phone control number if a phone control has been selected.

18.13.5 Configuration (Radio Phone) - Phone No. List tab

Display Item	Description
Name	The name of the SIP number as defined using the Phone Number Editor. Cannot be changed here.
Telephone Number	The SIP number as defined using the Phone Number Editor. Cannot be changed here.

18.13.6 Configuration (Radio Phone) - Contributors tab

Field/Display Item	Description
Type	An icon indicating the type of subscriber contributing, e.g. another panel, radio or telephone.
Name	The name of the contributing subscriber
Host Name	The name of the host, to which the contributing subscriber is connected.
EDHS	Full EDHS address of the contributor.
Targets	Place the mouse cursor over the icon and text will show the method of contribution. For example, direct, conference or group.
Null Mirror Dimming	Check the box to override the application of mirror dimming for this subscriber pair. Default = unchecked.
X-Point level	The gain level of the contributing "source" to this subscriber. Default = 0dB.

19. CONFIGURATION EDITOR | VIRTUAL PANEL SUBSCRIBER

19.1 OVERVIEW

Virtual Panels are PC applications that provide a Graphical User Interface (GUI) for Mercury users. They allow users to communicate with each other or provide a console for operators to manage talk groups with external devices.

A Virtual Panel is added to a host using the Host Editor. Once you have added the panel, you must define the sources, key modes and key settings using the Subscriber Editor.

- For more information on adding a Virtual Panel subscriber to a host, see section 11 *Configuration Editor | Host* in this Configuration Guide.
- For basic information about opening the Subscriber Editor and an explanation of key modes, see section 12 *Configuration Editor | Subscriber | Introduction* in this Configuration Guide.

19.2 VIRTUAL PANEL EDITOR TABS

The Subscriber - Virtual Panel Editor has six tabs:

- General
- Sources
- Special
- GPIO
- Phone No. List
- Contributors

With the following exceptions, these are the same as the Hardware Panel Editor which is described in section 13 - Configuration Editor | Subscriber | Hardware Panel.

- There is no Source Layout tab. Key targets may only be assigned on the grid style “Sources” tab. This is because the shape and size of the Virtual Panel are configured at the panel itself, not by the editor. Hence Gateway does not provide a graphical view of the panel.
- The Special tab has additional fields to allow the configuration of Key Sets. See section 19.3 for an explanation.
- The Virtual Panel does not provide any GPI Outputs.



19.3 KEY SETS

19.3.1 Using Key Sets







Key Sets allow the definition of a linked group of keys on a virtual panel. Normally, keys are not part of a set and operate individually, with no relation to other keys on the panel. If several keys are added to the same set, they form an interlocked set. A common application is to allow only a single speak button to be active on a panel at a time, such that the selection of a second speak button deselects the first.

Adding keys to a set

As explained above, by default, keys are not part of a set. The Key Set value is part of the Special tab and will normally be set to none or n/a. To add a key to a set, highlight the key and select a value in the keyset column. To produce an interlocking set, several keys are assigned the same value.

Additional settings ensure that only one speak route is available at any time. The value in the Max. Speaks column must be set to 1.

In the example below, the first 2 keys are part of set 1.

Special										
ID	Type	Target	Mode	Signal Pres.	GPO On	Push To Talk		Interlock		
						Panel GPI	PTT	Key Set	Max.Listens	Max.Speaks
1		H1S1		<input type="checkbox"/>	<input type="checkbox"/>	n/a	n/a	1	n/a	1
2		H1S2		<input type="checkbox"/>	<input type="checkbox"/>	n/a	n/a	1	n/a	1
3		H1S3		<input type="checkbox"/>	<input type="checkbox"/>	n/a	n/a	n/a	n/a	n/a

NOTE: To complete the application, one further setting is required. This is on the Virtual Panel itself, under the **Preferences** menu. On the **General** tab, a checkbox entitled “Automatically Break Routes in keysets” must be checked. This ensures that when a second button is pressed, the first one is automatically deselected.

MORE INFORMATION: See section 19.4.3 - *Subscriber Configuration – Virtual Panel – Special tab* for a description of the fields on this tab.

19.4 VIRTUAL PANEL EDITOR - FIELD DEFINITIONS

19.4.1 Subscriber Configuration – Virtual Panel -- General tab

Field/Display Item	Description
Name	The name of the Virtual Panel. This is usually defined when the panel is added to the host using the Host Editor but may also be changed here. Maximum length = 20 characters.
Long Name	If text is entered, this will be used as an alternate to the Name field, on panels with displays supporting 8 characters. If left blank, the Name field will always be used.
Comment	Comments relating to the selected subscriber. Add your comments in the space provided.
Picture 	A picture may be assigned to help identify the Subscriber. To assign, or change an existing picture, click the picture and browse to select an image file. The picture will only be displayed on Virtual Panels. Default as shown on left.
Mirror Dimming	Mirror dimming helps to reduce acoustic feedback. Range 0 to -60 dB. Default = -8 dB (rack-mounted panels) and -12 dB (desktop panel).
Panel Password	Enter a password to allow the operator to open the Virtual Panel. If left blank, the password prompt is not displayed.
Audio: Microphone: Gain (dB)	The amount of gain that can be applied to the microphone or input associated with this panel. Default (recommended) = 0 dB. Range 12 to -9 dB in 1 dB intervals.
Audio: Microphone: Cut Switch	Not applicable to Virtual Panels.
Audio: Microphone: Compressor / Limiter	Always enabled.
Audio: Loudspeaker: Mute (Cut Switch)	Not applicable to Virtual Panels.
Audio: Loudspeaker: Hold-off	Not applicable to Virtual Panels.
Audio: Loudspeaker: Mute Input GPI	Not applicable to Virtual Panels.
Audio: XPoint Adj: Minimum	Not applicable to Virtual Panels.
Audio: XPoint Adj: Gain (dB)	Not applicable to Virtual Panels.
Audio: Coarse Ren Adjustment (2dB per click)	Not applicable to Virtual Panels.
Audio: Tone on Audio Route	Configuration of an audio tone that is played out every time a call is received.
Audio: Binaural: Right Channel	Not applicable to Virtual Panels.
Audio: Binaural: Left Channel	Not applicable to Virtual Panels.
On Air/Busy GPI	Not applicable to Virtual Panels.

Field/Display Item	Description
QRS: Always update all QRS keys	When checked, the QRS label changes whenever any route to the panel is made regardless of whether there is a button to make the connection or not. Connections can, therefore, be 'viewed' from any page. Default = unchecked.
QRS: Allow stack size edit	Only enabled when "always update all QRS keys" is checked.
PTT: PTT Host GPI	Defines which Host GPI input will be used to provide PTT functionality for the Virtual Panel.
PTT: PTT Key	If checked will display a PTT key on the Virtual Panel to be used to trigger the PTT functionality. Default = unchecked
Ports: GPI Com Ports 1 & 2	The COM port used to connect the physical switch that will act as GPI 1 and GPI 2 for the Virtual Panel. Default is unassigned.
Ports: Gain Port	Specifies the Hardware or Virtual Panel that will control the port gain on this Virtual Panel.
Ports: Gain on Input	When selected, controls input gain. When not selected, controls output gain.
Timings: Key Latch Time (ms)	Used to determine the period at the panel that differentiates between a momentary and latching keypress. Default = 500 ms. Range = 100–5000 ms.
Timings: Tally Holdup (s)	The timeout of a yellow listen tally if another panel speaks to the user and then hangs up. A listen tally is displayed after hang-up for this timeout value. Default = 7 s. Range = 1–60 s.
Timings: X-Point Adjustment Timeout	The amount of time you can adjust the XPT level using a REN after a call is placed/received. Fixed at 10 s.
Timings: QRS time-out (s)	The timeout value for the last calling subscriber to be displayed on the QRS key/button. Default = 10 s. Range = Never, 2–60 s.
Timings: Latency hold up (s)	Applies to 'Fast Keys'. These work by establishing the IP channel needed when the key is first pressed and thereafter simply make/break local audio crosspoints each time the key is pressed/released. If the key is not pressed for the "latency hold up" period, the IP route is torn down. Default = 0 seconds. Range = 0–3600 seconds.
Timings: Listen Label Flash (s)	Not applicable to Virtual Panels.
Timings: IP Call Timeout (Mins)	Time after which an un-answered IP call will clear down. Default = Never. Range 5 – 60 min.
Miscellaneous: Total Pages	Specifies the number of pages available on the panel. This includes the main page. Default = 2 (i.e.1 shift page). Minimum = 1 (i.e. no shift page) Maximum = 4 (i.e. 3 shift pages).
Miscellaneous: Change Conference Labels on 4-Wire	Keys assigned to conferences can be set so that they change their label when a subscriber joins a conference. If the subscriber is a 4-wire it is often a permanent "standing feed" into the conference, so the default conference label will always be overridden to show the 4-wire name. This setting disables such behaviour so the label will not change for 4-wire sources. Default = unchecked
Miscellaneous: Fast keys on Startup	If checked, any fast key IP routes needed are made at TBC start-up in anticipation of them being needed straight away. If unchecked (default), they are not made until required. Default = unchecked.
Miscellaneous: Flash Tally for Tally Holdup	If checked, the tally indicator flashes after a call has ended during the hold-up period. If unchecked (default), the tally remains solid.

Field/Display Item	Description
Miscellaneous: Allow Listen Keys on Assignment	If checked, allow Listen keys to be assigned using the Assign feature on a panel. Default = checked. Uncheck to prevent panel snooping.

19.4.2 Subscriber Configuration – Virtual Panel – Sources tab

Field/Display Item	Description
ID	A number which corresponds to a key/button on the Virtual Panel. IDs prefixed by P2 (to P32) are keys/buttons on the shifted pages.
Type	The key's target subscriber type indicated by an icon.
Target	The key's target subscriber name. This cannot be changed here but can be changed by opening the target in the relevant editor.
Lstn/Label	Listen Label. This is the name of the target that will be displayed on the panel. It cannot be changed but can be overridden if you specify a U/Label.
U/Label	User Label. A customisable user label. If this is specified, it will be used instead of the L/Label. Type the label that you want to use into this field.
Mode	The key's operation type. To change the operation type, click in the field and then click  to choose the required mode.
QRS Stack Size	For QRS keys only, sets the size of the QRS stack. If the stack size is exceeded, the oldest calls are thrown away.
Shift Page #	On panels with multiple shift pages, allows a key to be defined to "jump" straight to a specific shifted page. This can bypass the normal multiple press panel Shift key process.
Lstn/Type	Displays the icon associated with the listen key's target or IFB listener.
Lstn Name	Allows a panel to "split" a key so that the listen and speak are attached to two different targets. If the key is targetting an IFB and a listener has been defined, this field will show the name of the defined listener.
Alt. Picture	Displays a picture when the key is activated. This is useful for showing the operator a graphical representation of the caller on a Virtual Panel.
LS Dim	Dims the panel loudspeaker when the target subscriber speaks to the panel user. This loudspeaker dimming dims ALL incoming audio. Default = 0 dB. Range is 0 to -28 dB in 2 dB steps, or -100 dB.
Assign	When checked, allows the panel operator to customise this key, choosing a new destination (Subscriber, Conference, Group or Route) and Type (Speak, Listen etc.). If you clear this checkbox, operators will not be able to change this key. Restricting keypresses is useful to prevent panels from talking to certain subscribers. Default = Checked.
Autodial	Specifies a dial sequence that is automatically dialled when a phone key/button is pressed on the panel. Applicable to telephony and SIP connections only.
Phone Name	Allows an existing phone control entry to be assigned to the key.
Number	Displays the phone number of the assigned phone control name.
Admin. TEB	Default = unchecked.

19.4.3 Subscriber Configuration – Virtual Panel – Special tab

Field/Display Item	Description
ID	A number which corresponds to a key/button on the Virtual Panel. IDs prefixed by P2 (to P32) are keys/buttons on the shifted pages.
Type	The target subscriber type.
Target	The target subscriber name.
Mode	The key's operation type. This varies depending on the panel type being configured.
Signal Pres.	If checked, allows a panel user to see when a specific key has audio via a slow flashing yellow tally on the key. The user can then elect to listen to it or not. (Conference, 4-wire, telephony and radio keys only). Default = unchecked.
GPO On	When checked, the GPO will be on when the key is pressed.
PTT: Panel GPI	The host COM port (1 or 2) to be used as a PTT trigger.
PTT: Action	Defines the PTT action for the key. Can be set to Mute, Unmute, Inhibit or Uninhibit. Mute prevent the user from being heard by the listen user. It does not tear down the route; it simply mutes the volume when the key is pushed.
Interlock: Key Set	Groups keys together to provide some sort of interaction between the keys in the set. Default = n/a. Range 1–256.
Interlock: Max. Listens	The maximum listens per given key set group. This is key-driven to prevent more than the defined number of listens. For example, if this is set to 1, then only one key on the set may listen at any one time. Default = n/a. Range 1–256. Can only be set if you have specified a key set.
Interlock: Max. Speaks	The maximum speaks per given key set group. This is key-driven to prevent more than the defined number of simultaneous speaks. For example, if this is set to 1, then only one key on the set may speak at any one time. Default = n/a. Range 1–256. Can only be set if you have specified a key set.
Conf. Priority	Only editable if the key is targeting a conference. Gives that key a priority to the specified conference, so that if the conference hits its max speak limit, panels will be blocked from speaking based on their priority. For example, if a conference has max speaks of 3 and two priority 1 and one priority 2 panels are already talking, a priority 3 panel will have to wait for one of the speakers to break their route. However, if a priority 1 panel tried to make a route to the conference then the priority 2 panel would be removed.
Telephony/SIP: Ringing	Enables ringing for an E&M, FXS, FXO, SIP connection or telephone. Only one 'ringing source' can be selected. Default = unchecked.
Telephony/SIP: Tone	If ringing is enabled, click  and select the required ringing tone.
Telephony/SIP: Hold/Dialpad	Not used on Virtual Panel types. Default = unchecked.
Telephony/SIP: Disable Keypad	Not used on Virtual Panel types. Default = unchecked.
Telephony/SIP: Auto Ans (SIP)	If checked, any incoming SIP calls are automatically answered at the panel, giving a more intercom like experience for the operator. Default = unchecked.

19.4.4 Subscriber Configuration – Virtual Panel – GPIO tab

Field/Display Item	Description
Inputs (radio button)	Only GPI inputs are available for Virtual Panels and are shown in the grid below.
ID	The ID of the GPI input in the database.
Name	The name of the GPI input. The auto-generated name may be edited. Maximum length is 20 characters.
Comment	Comments relating to the GPI. You can add comments in the space provided, as required. Maximum length is 255 characters.
Com Port	Not used on Virtual Panel types. Defaults to n/a

19.4.5 Subscriber Configuration – Virtual Panel – Phone No. List tab

Field/Display Item	Description
Name	The name of the phone number entry previously defined using the global Phone Number Editor. Cannot be changed here.
Telephone Number	The phone number entry previously defined using the global Phone Number Editor. Cannot be changed here.

19.4.6 Subscriber Configuration – Virtual Panel – Contributors tab

Field/Display Item	Description
Type	An icon indicating the type of subscriber contributing, e.g. another panel, radio or telephone.
Name	The name of the contributing subscriber.
Host Name	The name of the host, to which the contributing subscriber is connected.
EDHS	Full EDHS address of the contributor.
Targets	Place the mouse cursor over the icon and text will show the method of contribution. For example, direct, conference or group.
Null Mirror Dimming	Check the box to override the application of mirror dimming for this subscriber pair. Default = un-checked.
X-Point level	The gain level of the contributing “source” to this subscriber. Default = 0 dB. Range -60 to +12 dB.

20. CONFIGURATION EDITOR | GROUPS

20.1 OVERVIEW

A group is a user-defined collection of subscribers. Pressing a single key on a panel enables communication with all members (targets) of the group. A group call makes multiple unicast routes and can be used as an alternative to a conference in operating environments where multicast is not feasible.

Groups are similar to conferences, as a single panel key or button can be used to talk to multiple targets, and both can be used within GPIO logic statements. However, whereas a user opts to listen to a conference to receive audio, groups are treated as direct calls; when a user speaks to a group, all members of the group automatically listen.

Groups use multiple unicast VoIP to remote members in a Mercury intercom system. As many channels as receiving hosts are used by the originating host.

A typical application is where multiple control panels are deployed within a large operations control room. An outsider, calling into that control room, cannot see which positions are currently manned. The solution is to create a group containing all panels in the control room and provide the “outsider” with a key to that group. After the initial group call, the reply will come from a currently manned position and the conversation can continue on a 1:1 basis.

Another way to consider the group is as a “macro”. On a panel, instead of pressing six separate keys to call six people simultaneously, create a group and add the six “members”. The panel can then be configured with one key instead of six.

Groups are added to a configuration using the Enterprise Editor. See section 9.6 “*Enterprise Editor - Groups*” in this manual for further details. Groups may also be added using the Groups Overview form. Once groups have been added, the Group Editor is used to manage the members of each group.

20.2 USING THE GROUP EDITOR

20.2.1 Viewing a List of Groups

You can view a list of all groups that have been defined in the Enterprise by selecting the Groups node in the Enterprise tree. The same form allows additional groups to be added, or any not required to be deleted.

- Expand the Enterprise tree in Gateway.
- Single-click on **Groups**.
- The Details panel lists the groups that have been defined. A new configuration contains two, empty Groups.

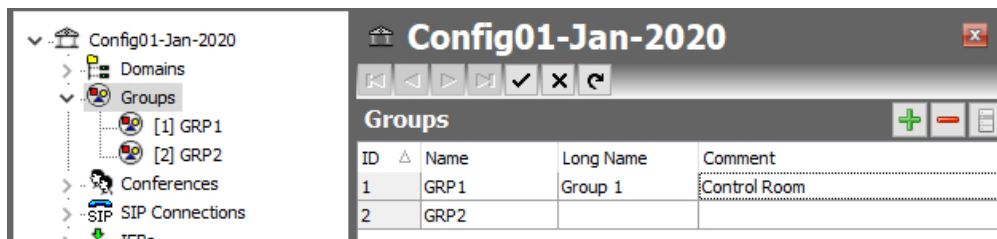

20.2.2 Opening the Group Editor

The Group Editor is used to specify basic details about a group and to maintain the group. As usual, there are Basic and Advanced editors.

- Expand the Enterprise tree in Gateway.
- Click the “right-arrow” next to Groups in the Enterprise tree to show a list of groups.
- Double-click on the required group to open it in the Group Editor.

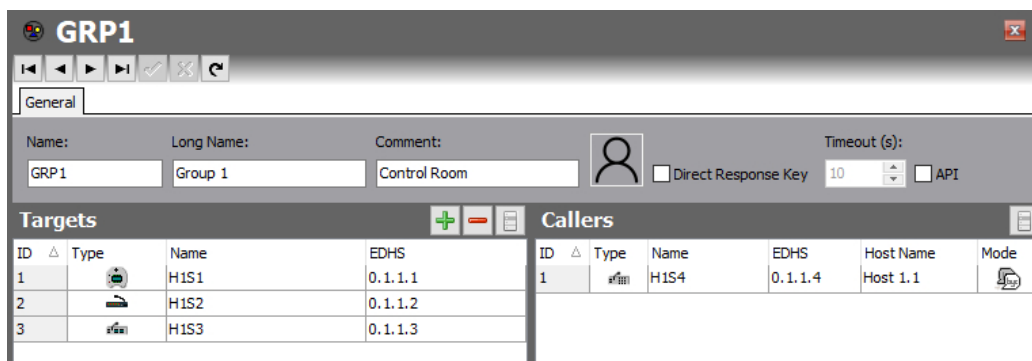

20.2.3 Group Editor

The Group Editor has a single tab and the layout is almost identical for both the basic and advanced editors. There are just three additional settings on the Advanced editor, highlighted below.

The screenshot shows the 'GRP1' Group Editor interface. At the top, there are navigation buttons and a 'General' tab. Below the tab, there are input fields for 'Name' (GRP1), 'Long Name' (Group 1), and 'Comment' (Control Room). To the right of these fields is a profile picture icon. Further right, there is a 'Timeout (s):' field set to 10, which is circled in red. Next to it are checkboxes for 'Direct Response Key' and 'API'. Below these fields are two tables: 'Targets' and 'Callers'. The 'Targets' table has columns for ID, Type, Name, and EDHS, with three rows: H1S1 (0.1.1.1), H1S2 (0.1.1.2), and H1S3 (0.1.1.3). The 'Callers' table has columns for ID, Type, Name, EDHS, Host Name, and Mode, with one row: H1S4 (0.1.1.4, Host 1.1).

The left pane of the editor, headed “**Targets**” comprises the members of the Group. As is evident from the + and – buttons, members must be added to (or removed from) the Group.

The right pane of the editor, headed “**Callers**” is read-only. This lists those panels who are outside the group but who have a key to speak to the group.

The name, long name and comment may be edited as usual. A picture may be assigned to help identify the Group. To assign, or change an existing picture, click the picture and then browse for and select an image file. The picture is only displayed on Virtual Panels.

Click to post changes to the database.

20.3 GROUP EDITOR - FIELD DEFINITIONS

20.3.1 Group Editor - General tab

Field/Display Item	Description
Name	The name of the group. This is usually defined using the Enterprise Editor when the group is added to the Enterprise. The name can be changed using the Groups Editor if required. Names do not have to be unique. Maximum length = 20 characters.
Long Name	If text is entered, this will be used as an alternate to the Name field, on panels with displays supporting 8 characters. If left blank, the Name field will always be used.
Comment	Any comments relating to the selected group. To add comments, select the group (click once on the line), click in this field and enter your comments. Maximum length = 255 characters.
Picture 	A picture may be assigned to help identify the Group. To assign, or change an existing picture, click the picture and browse to select an image file. The picture will only be displayed on Virtual Panels. Default as shown on left.
Direct Response Key	Check the box to enable a direct response key for this group. Default = unchecked.
Direct Response Key Timeout (s)	When the group is enabled as a direct response group the direct response behaviour once activated requires a timeout to revert a group key to default group key behaviour. Default = 10 seconds.
API	Check the box to enable API control. Default = unchecked.
Targets: Type	The type of panel or source (identified by an icon).
Targets: Name	The name of the panel or source (as specified in the Panel Configuration Editor). This cannot be changed here. See "Panel and Subscriber Configuration" for more information.
Targets: EDHS	The EDHS address of the panel or source. This provides a quick reference to the location of the group members. This cannot be changed here.
Callers: Type	An icon representing the type of panel. (Read-only).
Callers: Name	The key number on the panel to which the group has been allocated. (Read-only).
Callers: EDHS	The EDHS address of the group member. (Read-only).
Callers: Host Name	The name of the host to which the group member is connected. (Read-only).
Callers: Mode	An icon representing the type of key configured on the caller panel. (Read-only).

21. CONFIGURATION EDITOR | CONFERENCES

21.1 OVERVIEW

Conferences provide a many-to-many communication facility where each participant hears a mix of everyone currently active in the conference, minus their audio contribution (mix-minus).

Typically, a conference will involve multiple panel subscribers and 4-wire audio ports (including, for example, radio and/or telephone channels).

A 4-wire source is a balanced pair of analogue audio input and output signals, generally associated with a single item of external equipment. This is connected using a total of four wires:

- audio in +
- audio in -
- audio out +
- audio out -

Panels can also take part in conferences, provided they have been specified as sources using the Subscriber Configuration Editor. See section 13 “*Configuration Editor | Subscriber | Hardware Panel*” in this manual. Panel users will be given keys to the conference, allowing them to select whether they speak and/or listen to the conference.

4-wire members will default to being permanent speakers and listeners: a 4-wire port will always be heard by any panel member listening to the conference, and the 4-wire port will always receive audio from any other speaking member of the conference. GPI routing can be used to provide real-time control of the speak/ listen status of 4-wire ports.

Where subscribers are local to a given Mercury host, all audio connections are made and broken by the host's audio mixing engine, but when a subscriber is on a different host, IP audio channels must be used to transport audio between the hosts. In a multi-host, multi-subscriber system, it is possible to rapidly use up all available IP channels.

Multicast

Mercury usually allocates a unicast IP channel (i.e. a point-to-point connection that conveys audio uniquely between two hosts) for inter-host communications. Conferences, however, use multicast IP audio. This allows a single IP channel to place audio onto the network without requiring a specific destination IP address (i.e. host) to be specified. Once notified of the presence of the multicast audio, multiple hosts may then listen to the same audio data: this provides a dramatic reduction in the number of IP channels required.

Multicast requires the use of multiple, special IP addresses. A single, unique, “multicast address” is used for each multicasting source in the system, and these are configurable within Gateway.

Multicast places special demands on the network infrastructure: specifically, multicast will not (by default) pass-through IP routers and is certainly not possible on the public Internet. Care must be taken when considering the use of conferences and consultation with the network administrator is recommended.

Multicast allows a subscriber to use just a single IP channel to send audio to all other hosts involved in the conference. However, multiple IP channels are still required to receive audio from other hosts, and at least one channel will be needed for every active, speaking host in a conference.

As an example, a conference involving five hosts, with subscribers of each host concurrently speaking and listening will require:

- Each host to allocate a single speak channel, to multicast audio to the other four hosts
- Each host to allocate four IP channels to receive audio from the other four hosts.
- Each host, therefore, requires one *transmit* IP channel, but four *receive* IP channels.

Simplistically, multicast can dramatically reduce the number of transmit IP channels required but does not reduce the number of receive IP channels required. A conference can only have up to 48 members defined, although they do not have to be all active at the same time.

If a large conference is configured, it is possible to rapidly run out of IP channels at a host should too many people speak at once. To provide control of this, each conference has a facility to restrict the maximum number of speaking members. Note that this does not restrict the number of listen channels between subscribers on the same host: such communication is free and unblocked unless a key for that conference is not on a user panel.

Conferences may be given a name, used as the default label on panel keys. A selectable option allows this label to dynamically change on panel displays to show the name of the most recent conference caller. There is a per-conference setting to enable/disable this function completely, and a per-panel setting to disable it for 4-wire sources (only applicable to Hardware Panels). Also, Virtual Panels display the current number of speakers and listeners for the conference in the volume control/picture pop-up.

Conferences are similar to groups, as a single panel key or button can be used to talk to multiple targets, and both can be used within GPIO logic statements. However, conferences use multicast to transmit VoIP to remote members in a Mercury Intercom system, thus saving DSP channels.

A host must also be pre-configured (using the Hosts Editor) to take part in conference audio, particularly if users are using definable keys to conferences. A conference must have at least one speaker and one listener to be deemed as active and passing audio. A group is active as soon as the first listen or speak is made.

Conferences are added and deleted at Enterprise level using the Enterprise Editor. The Conference Editor is then used to specify basic details about a conference and to maintain conference 4-wire sources, telephone ports and panel members.

NOTE: It is possible to create a route using the Routes Editor that potentially creates an audio route to or from a conference from a given subscriber (e.g. a panel, radio etc.) that is not defined as a normal member of the conference. Care must be taken that the host on which the subscriber is based has another subscriber already in that conference or is defined on the Additional Hosts page for that conference in the Conference Editor. For this route to be established it must either be defined as fixed or have a GPIO logic process defined in the GPIO Processes Editor.

21.2 USING THE CONFERENCE EDITOR

21.2.1 Viewing a List of Conferences

All of the conferences that are added using the Enterprise Editor are listed under 'Conferences' in the Enterprise tree.

- Expand the Enterprise tree in Gateway.
- Click on Conferences.

The Details panel lists all the conferences that have been defined and allows additional conferences to be added or existing ones deleted. Basic details of each conference can be edited. The same options are provided at the Enterprise level.

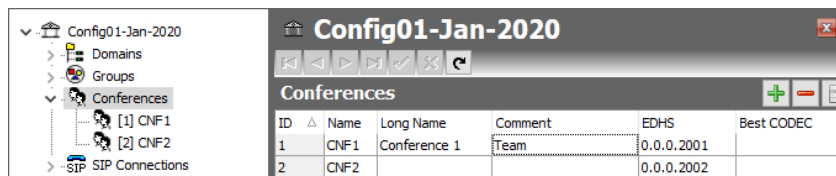

To open the Conference Editor:

- Expand Conferences in the Enterprise tree as shown above.
- Double-click on the required conference to open the Advanced editor.

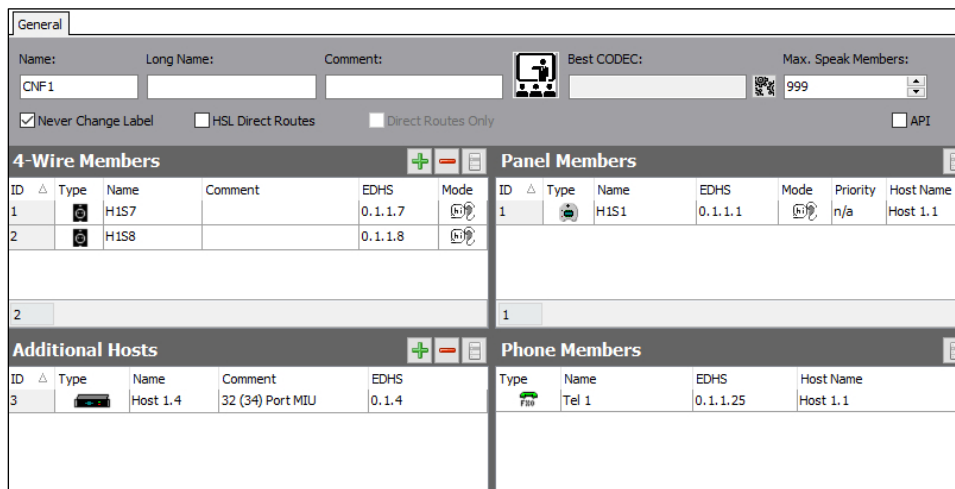

21.2.2 Areas of the Conference Editor

The Conference Editor has five areas which are used to configure a conference. The layout allows a conference to be viewed in a single form. Differences between the basic and advanced editors are highlighted below and information about each area is in later sections.

- Details (top of form). Available in both editor versions except for the items below which are only present in the Advanced editor.
 - Max Speaking Members
 - Never Change Label
 - HSL Direct Routes
 - Only Direct Routes
- 4-Wire members
- Panel Members (read-only)
- Additional Hosts (only in Advanced editor)
- Phone Members (read-only)

21.3 CONFERENCE EDITOR - DETAILS

The name, long name and description (comment) of a conference can be changed, as required. The name and description are entered when the conference is created. A picture can be added to identify the conference on a Virtual Panel. The long name appears on hardware panels with displays supporting >5 characters.

To change conference details:

- Open the Conference Editor.
- Make the required changes.
- Click to post changes to the database.

21.4 CONFERENCE EDITOR - 4-WIRE SOURCES

The Conference Editor - 4-Wire Sources area is used to maintain the list of 4-wire sources (4-wire, radio port, telephone, virtual port) for the conference. Sources can be added or deleted, as required. You can define how the 4-wire is used in the conference as a speaking member, a listening member or both.

Buttons at the top of the Conference Editor - 4-Wire Sources tab let you:

- Add a 4-wire source to the conference.
- Delete a selected 4-wire source.

To add a 4-wire source to a conference:

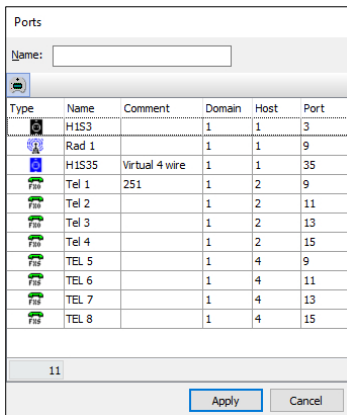

- Open the Conference Editor and click the **4-Wire Sources** tab.
- Click the **green +** button to open the Panels/Sources dialogue.



The screenshot shows a dialog box titled "Ports" with a "Name:" input field and a table of sources. The table has columns for Type, Name, Comment, Domain, Host, and Port. The sources listed are:

Type	Name	Comment	Domain	Host	Port
HIS3	HIS3		1	1	3
Rad 1	Rad 1		1	1	9
HIS35	HIS35	Virtual 4 wire	1	1	35
Tel 1	Tel 1	251	1	2	9
Tel 2	Tel 2		1	2	11
Tel 3	Tel 3		1	2	13
Tel 4	Tel 4		1	2	15
TEL 5	TEL 5		1	4	9
TEL 6	TEL 6		1	4	11
TEL 7	TEL 7		1	4	13
TEL 8	TEL 8		1	4	15

At the bottom of the dialog, there is a "11" label and "Apply" and "Cancel" buttons.

- Select the required source from the list and click **Apply**.
- To add or change comments, click in the **Comments** field and type your comments.
- Change the mode, if required. To do this, click in the Mode field and then click  to display a pop-up window listing the available modes. Select the required mode.
- Click  to post changes to the database.

Deleting a 4-wire Source

4-wire sources for the conference can be deleted, as required. You can either delete selected sources (using the Delete button) or delete all sources for the conference at the same time (using the right-click context menu).

NOTE: Deleting 4-wire sources from a conference does not delete the 4-wire sources from the database.

21.5 CONFERENCE EDITOR - ADDITIONAL HOSTS

The Conference Editor - Additional Hosts tab lists all the hosts that may want to join a conference at some time. This enables the TBCs for each host to be able to communicate with each other and participate in the conference.

If panels attached to a host have no keys to conferences, then the TBC on the host makes no provision for conferences, does not organise any host-to-host communication and ignores multicast packets of conferences that the host is not interested in. To allow for local key assignments targeting a conference, additional hosts must be specified to inform the host TBC that conferences may be used in the future.

NOTE: This is a powerful feature and may result in panels speaking/listening to a conference to which they are not invited so should be used with care.

Buttons at the top of the Additional Hosts tab let you:

- Add additional hosts.
- Delete selected additional hosts.

21.5.1 Adding an Additional Host

Any other hosts in any of the domains in your configuration can be added as additional hosts for the selected conference.

- Open the Conference Editor.

Type	Domain	Name	Comment
	1	Host 1.2	32 (3-4) Port MI
	1	Host 2.1	32 (3-4) Port MI
	1	Host 1.4	32 (3-4) Port MI

Click the **green +** button to open the Hosts dialogue.

Select the required host(s) and click **Apply** to add the hosts.

Return to the main editor form.

- To add or change comments, click in the Comment field and enter any text.
- Click to post changes to the database.

Additional hosts can be deleted if required. When deleting additional hosts, you can delete selected hosts (using the Delete button) or delete all additional hosts at the same time (using the right-click context menu). Deleting additional hosts from a conference does not delete the host records from the database.

21.6 CONFERENCE EDITOR - PANEL MEMBERS

Panel Members						
ID	Type	Name	EDHS	Mode	Priority	Host Name
1		H1S1	0.1.1.1		n/a	Host 1.1

This area of the editor is read-only. If a conference has been specified as a key target on a Hardware or Virtual Panel, then details of the panel are displayed here.

The two panels listed (H1S4 and H1S36) are both able to listen and / or speak to the conference, as indicated by the mode icon. No details may be edited here: the Subscriber – Panel editor should be used to remove or edit these keys.

21.7 CONFERENCE EDITOR - PHONE MEMBERS

If a phone control has been allocated to a conference **and** the phone control has then been added to the phone control list for an FXO, or FXS port then details of the subscriber are displayed on the Conference Editor - Phone Members tab.

Phone Controls				
Name	Number	Mode	Type	Source
PC1	123456			H1S5
CNF1	789			CNF1

This is the original phone control defined in the global Phone Control list.

Phone Number List			
<input checked="" type="radio"/> Targets <input type="radio"/> Remote SIP			
Name	Telephone Number	Type	Target
PC1	123456		H1S5
CNF1	789		CNF1

Now, this number has been allocated to a phone port, Tel 1. This is shown in the Subscriber – FXO editor, Phone Control List tab.

Phone Members			
Type	Name	EDHS	Host Name
	Tel 1	0.1.1.25	Host 1.1

Phone controls targeting conferences that have been added to FXS or FXO ports are shown on the Conference Editor - Phone Members tab. None of the information shown here can be changed.

21.8 CONFERENCE EDITOR - FIELD DEFINITIONS

21.8.1 Conference Editor - Details area

Field/Display Item	Description
Name	The name of the conference. This is usually defined using the Enterprise Editor when the conference is added to the Enterprise. The name can be changed using the Conference Editor if required. The name does not have to be unique. Maximum length = 20 characters.
Long Name	If text is entered, this will be used as an alternate to the Name field, on panels with displays supporting 8 characters. If left blank, the Name field will always be used.
Comment	Comments relating to a selected conference. To add comments, click in this field and enter your comments. Maximum length = 255 characters.
Picture 	A picture may be assigned to help identify the Conference. To assign, or change an existing picture, click the picture and browse to select an image file. The picture will only be displayed on Virtual Panels. Default as shown on left.
Best CODEC	Surveys the configured codecs across all hosts and attempts to pick the best Codec for the conference that is compatible with those Hosts.
Max Speak Members	Sets the maximum number of active speakers permitted at any time. Range 1 to 1632: default 999
Never Change Label	Toggles the display of membership messages on panels (last speaking member) in a Virtual Panel.
HSL Direct Routes	Only available if using Gemini units configured with HSL.
Direct Routes Only	Only available if using Gemini units configured with HSL.
API	Check the box to enable API control. Default = unchecked.

21.8.2 Conferences Editor - 4-Wire Sources area

Field/Display Item	Description
ID	Auto-generated database ID number.
Type	The type of source (identified by an icon).
Name	The name of the source (as specified on the Host Editor).
Comment	Any comments that have been added regarding this source. Click in this field to add or change comments. Maximum length = 255 characters.
EDHS	The EDHS address of the source. This cannot be changed.
Mode	The mode for the source. This can be changed if required. To change the mode, select the source and click to the left of the icon to display the  button. Click this and select the required mode: Speak The 4-wire is always speaking to the conference. If there is at least one other active conference member (permanent or otherwise) the audio will always flow from this port. This is the default setting. Listen The 4-wire is always listening to the conference. Speak/Listen The 4-wire is always speaking and listening to the conference.

21.8.3 Conferences Editor - Additional Hosts area

Field/Display Item	Description
ID	Auto-generated database ID number.
Name	The name of the host (as specified by the Host Editor)
Type	The type of host (identified by an icon).
Comment	Any comments that have been added regarding this host. Add your comments here if required.
EDHS	The EDHS address of the host. This cannot be changed.

21.8.4 Conference Editor - Panel Members area (read-only)

Display Item	Description
ID	Auto-generated database ID number.
Name	The name of the source.
Type	An icon representing the type of source.
Key	The key number on the panel to which the conference has been allocated.
EDHS	The EDHS address of the source.

21.8.5 Conference Editor - Phone Members area (read-only)

Display Item	Description
Name	The name of the subscriber on the panel.
Type	The subscriber type (FXO, FXS or E&M).
EDHS	The EDHS address of the subscriber.
Host	The name of the host (as specified by the Host Editor)

22. CONFIGURATION EDITOR | SIP AND SIP CONNECTIONS

22.1 OVERVIEW

Session Initiation Protocol (SIP) is an open, standards-based protocol for negotiating voice and multimedia calls over a network. The addition of SIP provides Mercury with the capability to make and receive SIP VoIP calls to any configured, basic SIP devices that may be present on the network. A **SIP Connection** is an object used to identify a SIP entity that exists outside of Mercury. SIP Connections are added at Enterprise level using the Enterprise Editor.

SIP Connections are associated with a URL (or alias) using the Host Editor. When a caller attempts to connect to that URL (or alias) on a host, the SIP Connection corresponding to the alias is 'activated'. Once activated, a SIP Connection key on any panel connected to the host can be targeted to answer the call.

A SIP Connection may have a list of phone controls associated with it. These phone controls determine how an incoming call is connected when an alias targeting the SIP Connection is called from a remote SIP/radio phone. The types of control objects that can be connected to within a SIP call include conferences, routes and simple intercom connections to and from the SIP/radio phone. A DTMF dial sequence (phone number) is required to be entered at the remote SIP/radio phone to control which of the given subscribers are targeted. Only those control subscribers listed can be targeted.

The SIP Connection Editor is used to change the name of a SIP Connection and to associate a picture with the connection. Phone controls can be added and deleted, as required. A list of panel members in the SIP Connection Editor lists all panels that have keys targeting the SIP Connection.

22.2 USING THE SIP CONNECTION EDITOR

22.2.1 Viewing a List of SIP Connections

You can view a list of all SIP Connections that have been defined by selecting and expanding SIP Connections in the Enterprise tree.

The basic and advanced editors carry the same information.

NOTE: If the SIP Connections node does not show the “right-arrow” in the Enterprise tree, then no SIP Connections have been defined.

To view a list of SIP Connections:

- Expand Gateway Enterprise tree.
- Click on SIP Connections.

The Details panel lists all the SIP Connections that have been defined. Some basic details can be edited, and SIP Connections can be added or removed using the toolbar buttons. The same details are provided at Enterprise level. SIP Connections can also be added or deleted in both places.

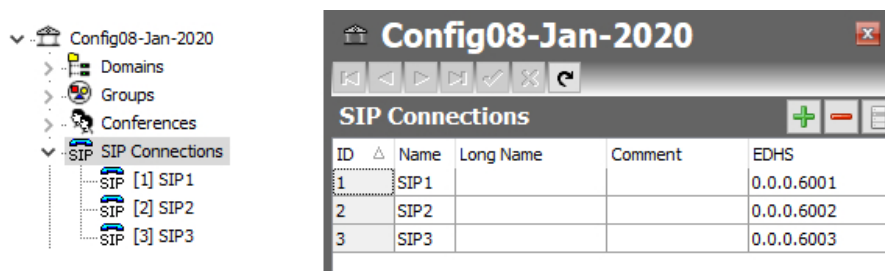

To open the SIP Connection Editor:

- Expand the Enterprise tree in Gateway.
- Click the right-arrow next to **SIP Connections** in the Enterprise tree to show a list of connections.
- Double-click on the required connection to open it in the SIP Connection Editor. The basic and advanced editors carry the same information.

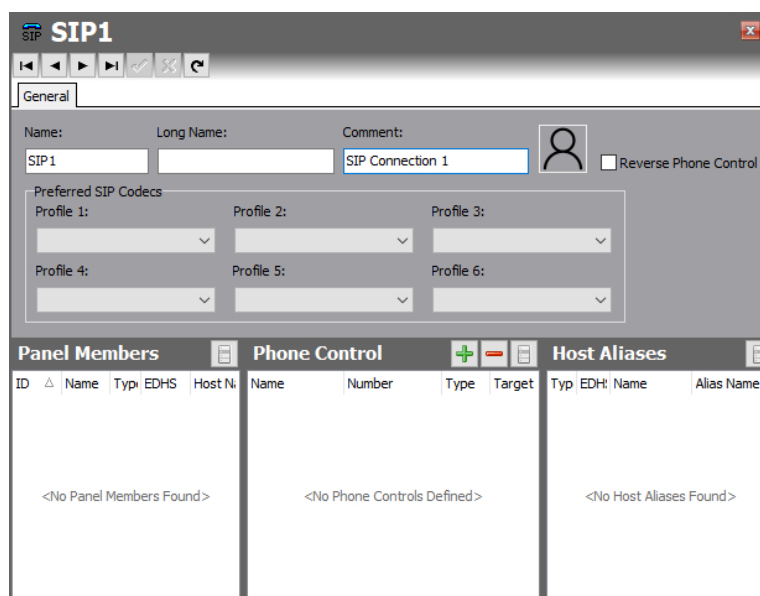

The SIP Connection Editor is divided into four areas, described below.

Details area (top of screen)

The Details area is used to specify basic SIP Connection details.

Panel Members area

The Panel Members area shows a list of panels that have the SIP Connection assigned to a panel key.

Phone Control area

The Phone Control area is used to add and delete phone controls.

Host Aliases area

The Host Aliases area shows details of any aliases that have been defined for the SIP Connection using the Host Editor.

22.3 SIP EDITOR - DETAILS AREA

The SIP Connection Editor - Details area shows the name of the selected SIP Connection and any comments that have been entered relating to it.

NOTE: SIP Connections are added or deleted using the Enterprise Editor or on the SIP Connections overview.

22.3.1 Changing SIP Connection Details

You can change the name and description (comment) for the selected SIP Connection, as required. A picture can be specified for the connection.

To change SIP Connection details:

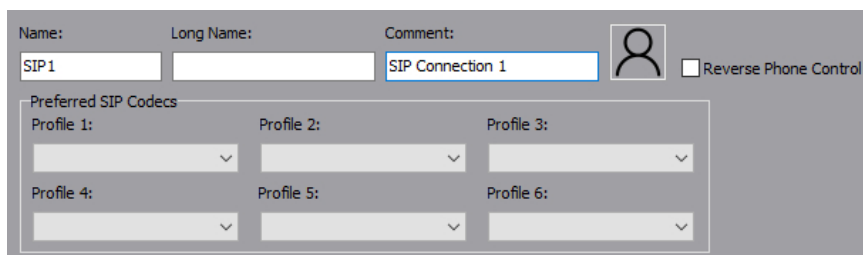

The screenshot shows a web form for editing SIP connection details. At the top, there are three text input fields: 'Name' containing 'SIP1', 'Long Name' (empty), and 'Comment' containing 'SIP Connection 1'. To the right of the 'Comment' field is a small square icon with a person silhouette and a checkbox labeled 'Reverse Phone Control'. Below these fields is a section titled 'Preferred SIP Codes' containing six dropdown menus arranged in two rows of three, labeled 'Profile 1' through 'Profile 6'. Each dropdown menu has a downward-pointing arrow.

Open the SIP Connection Editor. The **Details** area (above) is at the top of the form.

- Make the required changes to the name or comments.
- To add a picture to identify the SIP Connection on a Virtual Panel, click the image box and browse for and select the required image file.
- Preferred SIP Codecs may also be defined here.
- Click to post changes to the database.

22.4 SIP EDITOR - PANEL MEMBERS AREA

If a SIP Connection has been specified as a key on a panel then details of the panel are displayed in the SIP Connection Editor - Panel Members area. This is at the left side of the SIP Connections Editor form.

Panel Members				
ID	Name	Type	EDHS	Host Name
5	H1S2		0.1.1.2	Site A

In the screenshot above, SIP1 has been allocated to a key on panel H1S2. The information shown here is read-only.

22.5 SIP EDITOR - PHONE CONTROL AREA

The SIP Connection Editor - Phone Control area shows any phone controls that have been associated with the selected SIP Connection. New phone controls can be associated, and existing ones can be removed, as required. Phone controls are incoming digits that are used to direct a call, once answered, to the configured subscriber.

Phone Control			
Name	Number	Type	Target
Central	0800654321		CNF1

Buttons at the top of the Phone Control tab allow you to:

- Add a new phone control.
- Remove a phone control.

22.5.1 Associating Phone Controls

Phone controls can be associated with a SIP Connection, as required. When you add a phone control you select from the enterprise-wide list of phone controls created and maintained using the Phone Number Editor. See section 26 - *Configuration Editor | Phone Numbers* in this manual for details. Phone controls targeting TEB ports or phone sets cannot be selected.

To add a phone control:

- Open the SIP Connection Editor: the Phone Control area is centre screen.
- Click the **green +** button to open the dialogue.
- Select the required phone controls and click **Apply**.

NOTE: You cannot edit any details of phone controls here.

22.5.2 Removing Phone Controls

Phone controls that are not required for a SIP Connection can be removed. You can delete individual controls (using the Delete button) or delete all controls associated with the selected SIP Connection at the same time (using the right-click context menu).

NOTE: When you delete phone controls from a selected SIP Connection they are not deleted from other connections or the global phone control list maintained by the Phone Number Editor.

22.6 SIP EDITOR - HOST ALIASES AREA

If an alias has been defined for a SIP Connection using the Host Editor (see section 11.11 - *Host Editor - SIP Aliases*) then details of the alias are shown here.

22.6.1 Viewing Host Aliases

You can view details of a Host alias on the SIP Connection Editor - Host Aliases area. None of the information shown here can be changed.

To view Host Aliases:

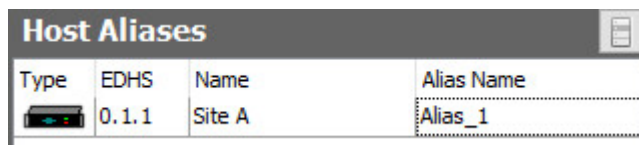

The screenshot shows a table titled "Host Aliases" with the following data:

Type	EDHS	Name	Alias Name
	0.1.1	Site A	Alias_1

Open the SIP Connection Editor:
Host Aliases area is to the right side of the form.

22.7 SIP EDITOR - FIELD DEFINITIONS

22.7.1 SIP Editor - Details area

Field/Display Item	Description
Name	The name of the SIP Connection. This is usually defined using the Enterprise Editor when the connection is added to the Enterprise. The name can be changed here if required. The name does not have to be unique. Maximum length = 20 characters.
Long Name	If text is entered, this will be used as an alternate to the Name field, on panels with displays supporting 8 characters. If left blank, the Name field will always be used.
Comment	Comments relating to a selected connection. To add comments, click in this field and enter your comments. Maximum length = 255 characters.
Picture 	A picture may be assigned to help identify the SIP Connection. To assign, or change an existing picture, click the picture and browse to select an image file. The picture will only be displayed on Virtual Panels. Default as shown on left.
Reverse Phone Control	This option can be enabled, and the SIP Connection associated with a Conference and a Phone number, so that when the Conference is activated a SIP call will be automatically dialled to the configured number. This connects the Conference with an external SIP third party. Contact Trilogy for more information.
Preferred CODEC 1–6	Specifies a list of up to 6 CODECs, in order of preference, to negotiate when making an outgoing SIP call.

22.7.2 SIP Editor - Panel Members area (read-only)

Display Item	Description
Name	The name of the source.
Type	An image of source type.
EDHS	The EDHS address of the source.
Host Name	The name of the host within the specified domain.

22.7.3 SIP Editor - Phone Control area

Display Item	Description
Name	The name of the phone control as defined using the Phone Number Editor.
Number	The number associated with the phone control.
Type	An icon showing the type of panel or subscriber that the phone control is targeting.
Target	The name of the panel or subscriber that the phone control is targeting.

22.7.4 SIP Editor - Host Aliases area (read-only)

Display Item	Description
Type	An icon to identify the host type.
EDHS	The EDHS address of the host on which the alias was defined.
Name	The name of the host on which the alias was defined.
Alias Name	The name of the SIP Connection alias as defined using the Host Editor.

23. CONFIGURATION EDITOR | IFB

23.1 IFB EDITOR - OVERVIEW

Interruptible Foldbacks (IFBs) are audio routes which can be broken into, or interrupted, by a third party. In the typical example shown below, the original source audio is replaced by the panel microphone audio when the panel operator presses a key.

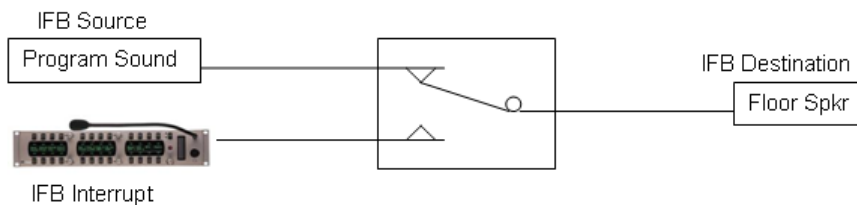

An IFB comprises three components:

- **IFB Destination** – usually a 4-wire subscriber.
- **IFB Source** – the “normal” feed sent to the IFB destination.
- **IFB Interrupt** – provides both the control signal (or “trigger”) and interrupting audio.

In the example shown, the speaker on the studio floor is normally relaying program sound. When the sound operator presses his speak key on the panel to the “Floor”, the program sound audio is switched away and replaced with the sound operator’s microphone.

More complex IFBs can be configured using the IFB Editor with the following features available:

- Multiple return audio sources.
- Multiple IFB interrupt sources.
- Cutting or dimming of IFB audio by a pre-selected level.
- Prioritisation of IFB triggers to allow individual triggers to override other triggers within the IFB group.

In common with other parts of the application, there are both basic and advanced IFB Editors. The advanced editor provides a tabular style view whereas the basic editor takes a pictorial approach and will be described in this chapter.

23.2 VIEWING A LIST OF IFBs

All the IFBs added using the Enterprise Editor are listed under 'IFBs' in the Enterprise tree. As seen in the image below, IFBs may also be added or deleted on the IFBs Overview form.

To view a list of IFBs:

Expand the Enterprise tree in Gateway and click on **IFBs**. The Details panel lists all the IFBs that have been defined.

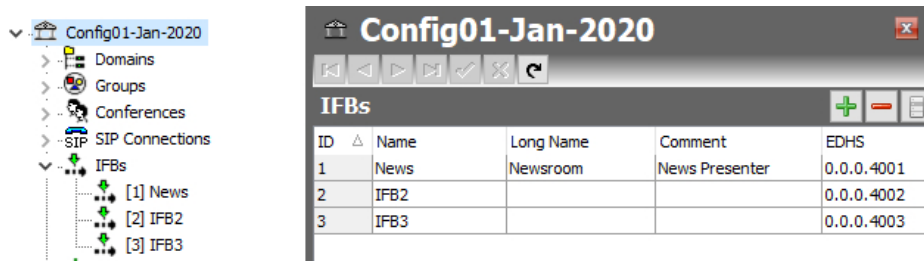

Use the green + button to add further IFBs and the red – button to delete selected IFBs. The Name, Long Name and any Comment may be edited here.

Click to post changes to the database.

23.3 USING THE IFB EDITOR

23.3.1 Opening the IFB Editor

IFBs are maintained using the IFB Editor. In common with other parts of the application, there are both basic and advanced IFB Editors. The advanced editor provides a tabular style view whereas the basic editor takes a pictorial approach and will be described here.

To open the Basic IFB Editor:

- Expand the **IFBs** branch of the Enterprise tree. Currently defined IFBs are now displayed.
- Single-click on an IFB – for this example “News” – IFB1.

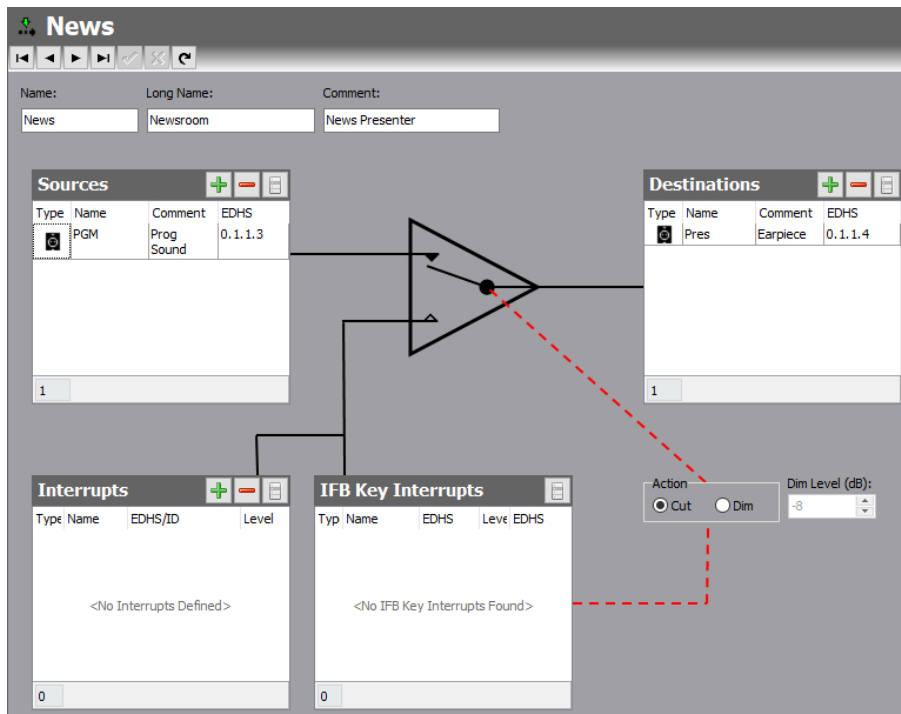

23.3.2 The IFB Editor Form

The IFB Editor form (above) provides a visual interpretation of the IFB action. Signal flow is from left (source) to right (destination) with the interrupt occurring in the centre switch. The form has five areas which are used to maintain basic details about the IFB, to add and delete IFB sources, destinations and triggers, to add and delete GPI triggers, to view panels/sources that have the selected IFB assigned and to allocate a listener to the trigger.

23.4 IFB EDITOR - DETAILS

The name, long name and any comment that has been entered about the IFB may be edited here.

23.4.1 Changing IFB Details

Edit the details as required. You can also specify the switch action (Cut or Dim) of the IFB interrupt.

- Open the IFB Editor.
- Make the required changes.
- Specify the interrupt action by selecting either **Cut** or **Dim**. If **Dim** is selected, specify the amount of attenuation (0 to -61 dB), required.
- Click to post changes to the database.

23.5 IFB EDITOR - SOURCES

The IFB Editor - Sources dialogue shows any sources that have been defined. New sources can be added, and existing ones deleted, as required. In most applications, only a single source will be present.

Buttons at the top of the IFB Sources dialogue allow you to:

- Add a panel/source as an IFB source.
- Delete a selected IFB source.

23.5.1 Adding Sources

IFB sources are added by selecting from a list of subscribers.

To add an IFB source:

- Open the IFB Editor.
- In the **Sources** dialogue, click the **green +** button to open the pop-up dialogue.
- Select the required source and click **Apply**.
- Click to post changes to the database.

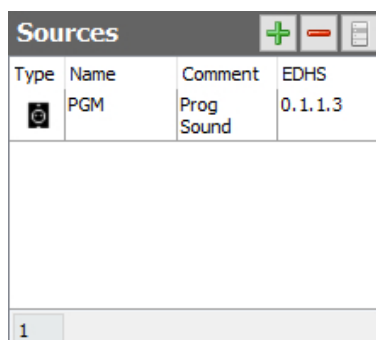

Type	Name	Comment	EDHS
	PGM	Prog Sound	0.1.1.3

23.5.2 Deleting IFB Sources

Sources no longer required for the operation of the IFB can be deleted. You can either delete selected route sources (using the **red -** button) or delete all sources at the same time (using the right-click context menu).

23.6 IFB EDITOR - DESTINATIONS

The IFB Editor - Destination dialogue shows any destinations that have been defined. New destinations can be added, and existing ones deleted, as required. Only a single destination is permitted.

Buttons at the top of the IFB Destination dialogue allow you to:

- Add a Subscriber as an IFB destination.
- Remove the IFB destination.

23.6.1 Adding an IFB Destination

IFB destinations are added by selecting from a list of Subscribers.

- Open the IFB Editor.
- In the Destinations dialogue, click the **green +** button to open the pop-up dialogue.
- Highlight the destination and click **Apply**.
- Click to post changes to the database.

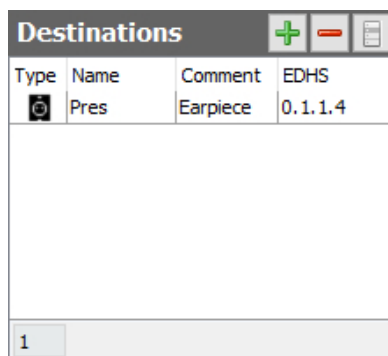

Type	Name	Comment	EDHS
	Pres	Earpiece	0.1.1.4

23.6.2 Deleting the IFB Destination

The current IFB Destination must be deleted using the **red –** button, before adding an alternative destination.

23.7 IFB EDITOR - INTERRUPTS

The IFB Interrupts dialogue shows any interrupts that have been defined. New interrupts can be added, and existing ones deleted, as required.

Buttons at the top of the IFB Editor - Interrupts dialogue allow you to:

- Add an IFB interrupt. Three different types of interrupt are presented:
 - Subscriber (panel, radio, telephone etc.)
 - GPI Input
 - GPI Output
- Delete a selected IFB interrupt.
- Delete all panel/source IFB triggers (after confirmation, from right-click context menu).

23.7.1 Adding IFB Interrupts

Interrupts are added by selecting from a pop-up dialogue.

To add an IFB Interrupt:

- Open the IFB Editor.

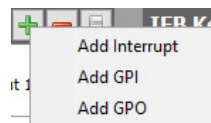

In the Interrupts dialogue, click the **green +** button and a sub-menu will appear.

Choose the required type of interrupt – the dialogue displayed next will be populated accordingly. The three different options are shown below and the selection procedure for each is the same.

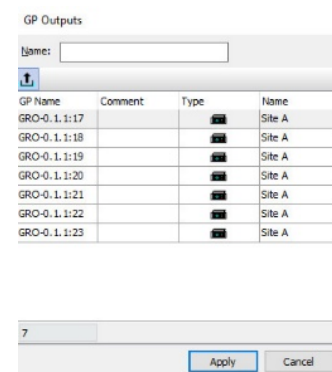
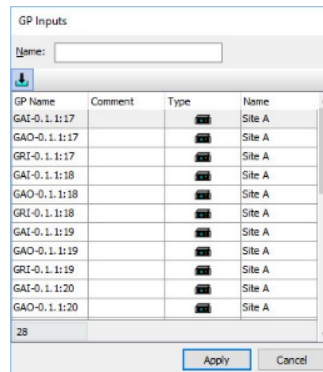
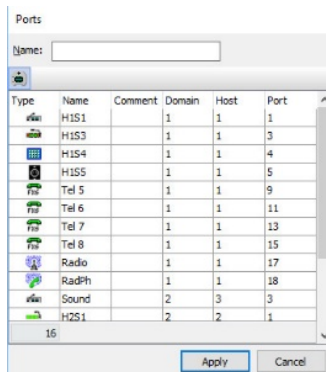

- Select the required interrupt or trigger. To add multiple items, hold down the **Ctrl** key when selecting. Click **Apply** and return to the previous editor.
- To change the level, click in the **Level** field and select the priority (1-3) from the drop-down list. The lower the number the higher the priority. If more than one panel wishes to talk to the IFB destination, the panel with the highest priority (lower number) will always take precedence. The default priority is 3.
- Click to post changes to the database.

Interrupts			
Type	Name	EDHS/ID	Level
	H1S1	0.1.1.1	3
	GRO-0.1.1:17	0.1.1 (Output 19)	3
	GAI-0.1.1:17	0.1.1 (Input 19)	3

This example shows an interrupt of each type added to IFB1.

23.7.2 Deleting IFB Interrupts

Interrupts that are no longer required for the IFB can be deleted. You can either delete a highlighted interrupt (using the **Red** - button) or delete all interrupts at the same time (using the Clear All item on the right-click context menu).

23.8 IFB EDITOR - KEY INTERRUPTS

The IFB Key Interrupts dialogue shows any panels that have been configured **directly** with an IFB as a key target. The information here is primarily read-only: IFB Key Interrupts cannot be added or removed here, only as part of panel configuration. See section 13 *Configuration Editor | Subscriber | Hardware Panel* for more information.

IFB Key Interrupts				
Type	Name	EDHS	Level	EDHS
	Sound	0.2.3.3	3	

This image shows the Sound panel with EDHS 0.2.3.3 that has a key targeting IFB1. The only parameter which can be adjusted here is the IFB Trigger level.

IFB Key Interrupts				
Type	Name	EDHS	Level	EDHS
	Sound	0.2.3.3	3	
	DIR	0.2.3.4	1	

When a panel is used to provide the interrupt, this is frequently the fastest and easiest way to set up an IFB. The second image shows the same IFB with 2 panels having key interrupts – Sound and Director. Director has been set with a higher priority, trigger level 1, which means that the Director will override Sound should they speak simultaneously.

23.9 IFB EDITOR - FIELD DEFINITIONS

23.9.1 IFB Editor - Details

Field/Display Item	Description
Name	The name of the IFB. This is initially defined using the Enterprise Editor when the IFB is added to the Enterprise. The name can be changed here if required. The name does not have to be unique. Maximum length = 20 characters.
Long Name	If text is entered, this will be used as an alternate to the Name field, on panels with displays supporting 8 characters. If left blank, the Name field will always be used.
Comment	Comments relating to a selected IFB. To add comments, click in this field and enter your comments. Maximum length = 255 characters.
Action: Cut	Specifies the IFB interrupt action – cuts the source audio.
Action: Dim	Specifies that the IFB interrupt action – dims the source by the amount specified.
Dim Level (dB)	If Action is set to dim, the source is dimmed by the amount specified. Default = 0 dB. Range 0 to -61 dB.
Auto Route Owner	The default IFB route owner host is the destination subscriber host. Specifying an alternate auto route owner host changes the host responsible for managing the IFB logic. Default = blank.
API	Check the box to enable API control. Default = unchecked.

23.9.2 IFB Editor - Sources

Field/Display Item	Description
Type	An icon to represent the selected source.
Name	The name of the selected source. This cannot be changed.
Comment	Comments entered using the Subscriber Editor.
EDHS	The EDHS address of the selected source. This cannot be changed.
Auto Make	When checked, the auto make option ensures the route between the IFB source EDHS and the destination EDHS is made at host Startup or after a config push. If unchecked, and the IFB action is cut when the IFB interrupts are triggered, an inhibited route will be created for the IFB source EDHS to destination EDHS route. Auto made routes are owned either by the destination EDHS host or the Auto Route Owner host (if specified). Default = checked

23.9.3 IFB Editor - Destinations

Field/Display Item	Description
Type	An icon to represent the selected destination
Name	The name of the selected destination. This cannot be changed.
Comment	Comments entered using the Subscriber Editor.
EDHS	The EDHS address of the selected destination. This cannot be changed.

23.9.4 IFB Editor - Interrupts

Field/Display Item	Description
Type	An icon that represents the selected interrupt. This may be a panel, or a GPI input/output.
Name	The name of the selected interrupt.
Comment	Comments entered using the Subscriber Editor.
EDHS/ID	The EDHS address or ID of the selected interrupt.
Level	Defines the priority of the IFB; the lower the number the higher the priority. If more than one source wishes to trigger the IFB, the source with the highest priority (lower number) will always take precedence. Click in this field and select the required level (1-3).
On	Editable only for GPIO type IFB interrupts. Changes whether the GPIO input or output IFB interrupt is triggered when the GPIO is either on/high or off/low. Default = checked.

23.9.5 IFB Editor – Key Interrupts

Field/Display Item	Description
Type	Shows an icon to represents the selected panel/ source.
Name	The name of the selected panel/source that has a key targeting the IFB.
EDHS	The EDHS address of the selected panel/source.
Level	Defines the priority of the trigger, the lower the number the higher the priority. Click in this field and select the required level (1-3). Default = 3.
Type	Displays the icon associated with the IFB key's listener.
Listener	Allows a panel to "split" a key so that the listen and speak are attached to two different targets. If the key is targeting an IFB and a listener has been defined, this field will show the name of the defined listener.
EDHS	Displays the EDHS of the IFB key's listener.

24. CONFIGURATION EDITOR | ROUTES

24.1 OVERVIEW

A route is a defined audio path created by declaring a source and a destination pair. Routes can be created, broken or inhibited by a GPI, another route, or by a panel key directly. Routes are created and maintained using the Routes Editor.

To create a route, you must specify a **source** (which can be a panel/subscriber or conference) and a **destination** (which can also be a panel/subscriber or conference). You cannot route one conference to another.

By default, once created, a route does not normally pass any audio. It is “merely” a definition, awaiting further action. Such a route is “not made”.

Routes can be defined as “fixed” and made automatically when the TBC starts. Fixed routes cannot be broken during system operation – only by editing the configuration.

Routes that are idle can also be set to break automatically if required.

Once created, routes can then be used elsewhere in the system, for example when creating GPIO processes.

If you delete a route using the Routes Editor, any associated GPIO processes defined using the specified route will also be deleted automatically.

24.2 USING THE ROUTES EDITOR

24.2.1 Opening the Routes Editor

Routes are created and maintained using the Routes Editor.

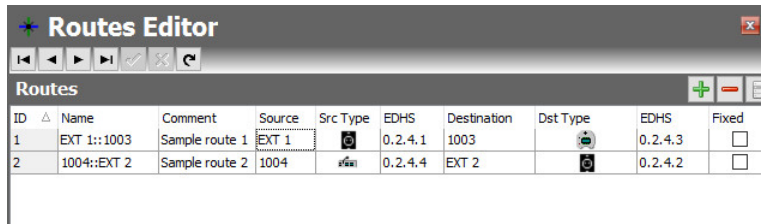

ID	Name	Comment	Source	Src Type	EDHS	Destination	Dst Type	EDHS	Fixed
1	EXT 1::1003	Sample route 1	EXT 1		0.2.4.1	1003		0.2.4.3	<input type="checkbox"/>
2	1004::EXT 2	Sample route 2	1004		0.2.4.4	EXT 2		0.2.4.2	<input type="checkbox"/>

Click on **Routes** in the Enterprise tree to open the Routes Editor. The basic Routes Editor will open: in this instance the basic and advanced editors are identical.

The Routes Editor shows all routes that have been defined. In the example above, 2 routes have been defined. The routes can be ordered natively (the order in which they were added) or by name. Click the appropriate column heading, ID or Name, to order the routes by your preferred method. Buttons at the top of the Sources tab let you:

- Add a new route.
- Delete a route.

Other options are available from the right-click context menu.

24.2.2 Adding a Route

New routes can be added, as required. You can also swap source and destination for existing routes as well as change sources and destinations.

To add a route:

- Open the Routes Editor.
- Click the **green +** button. A single blank entry is created, and the **Source** field is highlighted.
- Click within the **Source** field to display a list of 'source' panels/sources, or click to show a list of 'source' conferences. Select the required panel/source or conference and then click **Apply**.
- Click in the **Destination** field and click to display a list of 'destination' panels/sources, or click to show a list of 'destination' conferences.
- Select the required destination panel/source or conference and then click **Apply**. Note that you cannot route a conference to a conference.
- To specify that the route is fixed (and made automatically when the TBC starts), select the **Fixed** checkbox. Note that if you check this box, the route cannot be controlled by any other process such as a GPI Input.
- Click to post the route to the database.
- **Note** - the name field is completed automatically in the format *Source::Destination* but may be edited.

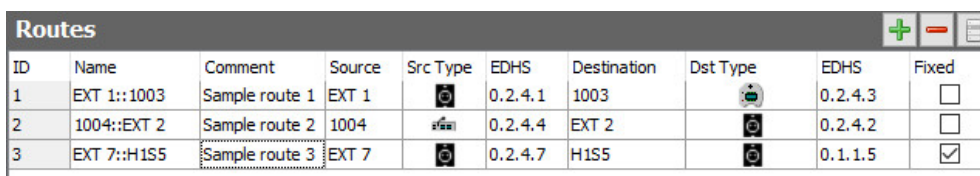

ID	Name	Comment	Source	Src Type	EDHS	Destination	Dst Type	EDHS	Fixed
1	EXT 1::1003	Sample route 1	EXT 1		0.2.4.1	1003		0.2.4.3	<input type="checkbox"/>
2	1004::EXT 2	Sample route 2	1004		0.2.4.4	EXT 2		0.2.4.2	<input type="checkbox"/>
3	EXT 7::H1S5	Sample route 3	EXT 7		0.2.4.7	H1S5		0.1.1.5	<input checked="" type="checkbox"/>

Sample route 3, shown above, is a fixed route between two 4-wire ports.

24.2.3 Swapping a Route

A route can be swapped (i.e. direction reversed) if the sources and destinations have been defined the wrong way around.

To swap a route:

- Open the Routes Editor.
- Select the route that you want to reverse (e.g. Sample route 3).
- Click **Swap** from the right-click context menu to swap source and destination.

Routes + -									
ID	Name	Comment	Source	Src Type	EDHS	Destination	Dst Type	EDHS	Fixed
1	EXT 1::1003	Sample route 1	EXT 1		0.2.4.1	1003		0.2.4.3	<input type="checkbox"/>
2	1004::EXT 2	Sample route 2	1004		0.2.4.4	EXT 2		0.2.4.2	<input type="checkbox"/>
3	H1S5::EXT 7	Sample route 3	H1S5		0.1.1.5	EXT 7		0.2.4.7	<input checked="" type="checkbox"/>



24.2.4 Deleting a Route

Routes that are no longer required can be deleted. You can delete individual routes (using the **red -** button) or delete all routes at the same time (using the context menu).

IMPORTANT: When you delete a route, any GPIO processes that use the deleted route will also be deleted.

24.3 ROUTES EDITOR - FIELD DEFINITIONS

24.3.1 Routes Editor

Field/Display Item	Description
ID	Non-editable field. Increments in line with route creation.
Name	The name of the route (<i>Source::Destination</i>). This can be changed if required. The route name does not have to be unique. Maximum length = 64 characters.
Comment	Any comment relating to the route. You can add a comment if required. Maximum length = 255 characters.
Source	The name of the route source. Click in this field and click  to specify the source.
Src Type	Shows an icon that represents the route source type (e.g. panel, 4-wire etc.).
EDHS	The EDHS address of the route source. This cannot be changed.
Destination	The name of the route destination. Click in this field and click  to specify the destination.
Dst Type	Shows an icon that represents the route destination type (e.g. panel, 4-wire etc.).
EDHS	The EDHS address of the route destination. This cannot be changed.
Fixed	Fixed routes are routes that are made immediately when the TBC starts. They remain made, unless inhibited, for as long as the TBC managing them is running. They are used when a route with no other mechanism to make the route is required.

25. CONFIGURATION EDITOR | GPIO PROCESSES

25.1 OVERVIEW

The GP Inputs/Output Processes Editor is used to define the rules by which routes are made and broken within a Mercury system.

Before you can create GPIO statements, you must create routes within the system using the Routes Editor (see section 24 - *Configuration Editor | Routes* in this manual). You can define more routes that you ultimately use, but you cannot create GPIO statements without first having created one or more routes.

Normally a route is merely a declaration of interest in a specific signal path. It comprises a source and destination pair: the declaration of a route does not necessarily imply that any audio signal is present.

GPI inputs and outputs which are used in conjunction with routes are declared at host level using the Host Editor (see section 11.12 - *Host Editor - GPIO* in this manual).

NOTE: Subject to support by appropriate hardware, you can also define GPIs at panel and subscriber level, and these will also be available globally for use in GPIO processes.

25.2 USING THE GPIO PROCESSES EDITOR

25.2.1 Opening the GPIO Processes Editor

GPIO processes are maintained using the GPIO Processes Editor.

Click on the **GPIO Processes** branch in the Enterprise tree to open the **GPIO Processes Editor**. The basic editor will open: the advanced editor is identical.

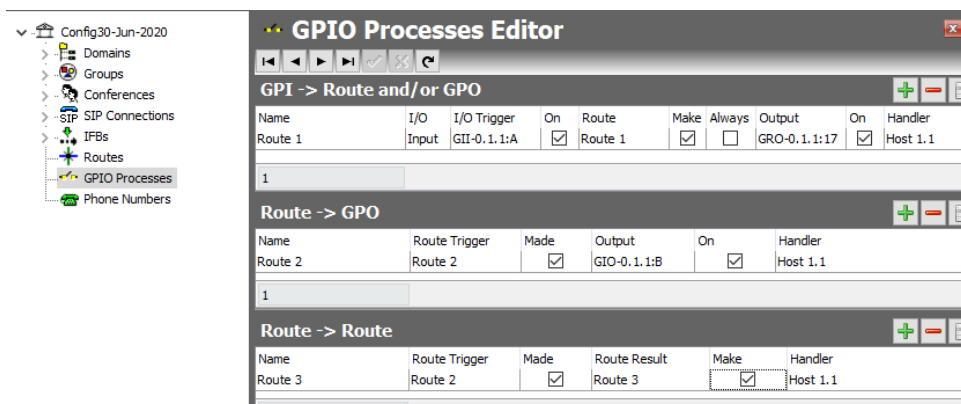

25.2.2 Understanding the GPIO Processes Editor

25.2.3 GPIO Processes Editor

The GPIO Processes Editor has three areas which are described below. Each area may be used independently to build a different rule variant. The example above shows 3 rules, one of each type.

The best way to read entries in the editor is as a series of logical statements.

IF [trigger action] [is true / false] **THEN** [result] **AND** [optional extra result]

GPI > Route and/or GPO

Select a GPI input or output trigger for a specified route and inhibit/uninhibit or make/break the route. An additional action may be selected to fire a GP output.

Route > GPO

The Route > GPO statement lets you select a route which when made, triggers a selected GPO.

Route > Route

The Route > Route statement lets you select a route trigger and specify a route result.

25.3 GPIO PROCESS EDITOR - GPI > ROUTE AND/OR GPO

The GPIO > Route section is used to specify a GPI input or output trigger to control a specific route.

NOTE: To define route triggers, ensure that you have defined the required GPIs on the correct host using the Host Editor and the required routes using the Routes Editor. The building blocks must be ready for use.

Buttons at the top of the GPIO > Route tab let you:

- Add a GPIO trigger for a route.
- Delete a selected GPIO route trigger.

25.3.1 Adding a GPIO > Route Statement

A GPI input or output can be defined as a trigger for a route. The logic is as follows:

IF 'I/O trigger' is [On/Off]
THEN [Make/Inhibit] 'Route' [Always]
AND [Make/Break] 'Optional GP Output'
USING TBC 'Handler'

Where:

- [On/Off] = whether the trigger is on or off.
- [Make] = make or break the route.
- [Inhibit] = inhibit or uninhibit the route.
- [Always] = creates a fixed crosspoint that is always on (if selected).

To add a GPIO > route statement:

- Open the GPIO Processes Editor. The **GPIO > Route** statements appear at the top of the editor.
- Click **Add** to add a single new record.

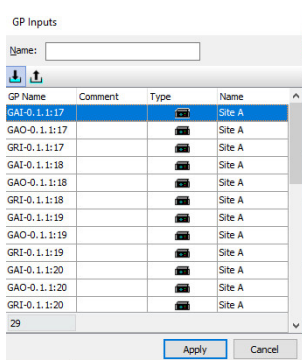

Click in the **I/O Trigger** field and click to open the GPI dialogue. Use the two buttons just above the grid to toggle between inputs and outputs. Inputs are selected by default.

Select the required trigger and click **Apply**.

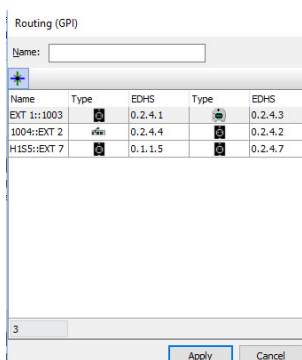

Click in the **Route** field and click to open the Routes dialogue box.

Select the required route and click **Apply**.

- Tick the requisite checkboxes to specify the logic for the process.
- Optionally, to also trigger an output, click in the **Output** field click  to open the GPI Outputs dialog. Select the required output and click **Apply**.
- Click to post changes to the database.
- You can name the statement either before or after posting to the database. If you leave the name field blank a name will automatically be created.
- The result is shown below.

GPI -> Route and/or GPO									
Name	I/O	I/O Trigger	On	Route	Make	Always	Output	On	Handler
Route 1	Input	GII-0.1.1:A	<input checked="" type="checkbox"/>	Route 1	<input checked="" type="checkbox"/>	<input type="checkbox"/>	GRO-0.1.1:17	<input checked="" type="checkbox"/>	Host 1.1

25.3.2 Deleting a GPIO > Route Statement

GPIO > Route statements can be deleted, as required. You can either delete selected statements (using the red - button) or delete all GPIO > route statements that have been defined at the same time using the right-click context menu.

NOTE: Deleting the logic statements does not delete the underlying GPIs or routes from the database.

25.4 GPIO PROCESS EDITOR - ROUTE > GPO STATEMENTS

The Route > GPO section is used to select a route that will trigger a selected GP Output. Buttons at the top of the Route > GPO tab let you:

- Add a route that will trigger a GP Output.
- Delete a selected statement.

25.4.1 Adding a Route > GPO Statement

A route can be used as a trigger for a specified GPO. The logic is as follows:

IF 'Route' is [On/Off]



THEN [Make/Inhibit] 'GPO' ON



USING TBC 'Handler'

Where:

- [On/Off] = whether the route is made or not.
- [Make] = make or break the GPO.
- [Inhibit] = inhibit or uninhibit the GPO.

To add a route > GPO statement:

- Open the GPIO Processes Editor. The **Route > GPO** section is centre screen.
- Click **Add** to add a single new record.
- Click in the **Route Trigger** field and click  to open the Routes dialogue. Select the required route trigger and click **Apply**.
- Click in the **Output** field and click  to open the GP Outputs dialogue. Select the required output and click **Apply**.
- Tick the requisite checkboxes to specify the logic for the process.
- Click to post changes to the database.
- You can name the statement either before or after posting to the database. If you leave the name field blank a name will automatically be created.
- The result is shown below.

Route -> GPO   					
Name	Route Trigger	Made	Output	On	Handler
Route 2	Route 2	<input checked="" type="checkbox"/>	GIO-0.1.1:B	<input checked="" type="checkbox"/>	Host 1.1

25.4.2 Deleting a Route > GPO Statement

Route > GPO statements can be deleted, as required. You can either delete selected statements (using the **red -** button) or delete all Route > GPO statements that have been defined by using the right-click context menu.

NOTE: Deleting the logic statements does not delete the underlying GPOs or routes from the database.

25.5 GPIO PROCESS EDITOR - ROUTE > ROUTE STATEMENTS

The Route > Route section is used to specify a route trigger and route result. Buttons at the top of the Route > Route tab let you:

- Add a route that will trigger a route result.
- Delete a selected statement.

25.5.1 Adding a Route > Route Statement



A route can be defined as a trigger for another route to be made or broken. The logic is as follows:



IF 'Route Trigger' is [On/Off]
THEN [Make/Inhibit] 'Route Result'
USING TBC 'Handler'

Where:

- [On/Off] = whether the route trigger is on or off.
- [Make] = make or break the route.
- [Inhibit] = inhibit or uninhibit the route.

To add a route > route statement:

- Open the GPIO Processes Editor. The **Route > Route** statements are at the bottom of the screen.
- Click **Add** to add a single new statement record.
- Click in the **Route Trigger** field and click  to open the Routes dialogue. Select the required route trigger and click the **Apply** button.
- Click in the **Route Result** field and click  to open the Routes dialogue. Select the required route result and click **Apply**.
- Tick the requisite checkboxes to specify the logic for the process.
- Click  to post changes to the database.
- You can name the statement either before or after posting to the database. If you leave the name field blank a name will automatically be created.
- The result is shown below.

Route -> Route   					
Name	Route Trigger	Made	Route Result	Make	Handler
Route 3	Route 2	<input checked="" type="checkbox"/>	Route 3	<input checked="" type="checkbox"/>	Host 1.1

25.5.2 Deleting a Route > Route Statement

Route > Route statements can be deleted, as required. You can either delete selected statements (using the **red -** button) or delete all Route > Route statements that have been defined by using the right-click context menu.

NOTE: Deleting the logic statements does not delete the underlying routes from the database.

25.6 GPIO PROCESS EDITOR - FIELD DEFINITIONS

25.6.1 GPIO Processes Editor - GPIO > Route section

Field/Display Item	Description
Name	A system-generated name based on the route result. This can be changed to allow easy identification of the process. The name does not have to be unique. Maximum length = 20 characters.
I/O	Shows the type of input/output selected in the I/O Trigger field.
I/O Trigger	The GPI input or output used to trigger the route defined in the Route field.
On	If checked, the GPIO trigger is on and the routing function is performed. If un-checked, the GPIO trigger is off and the routing function is not performed.
Route	Specifies the route to be made.
Make	If checked, defines the route as being made. If un-checked, the route is inhibited.
Always	If checked, creates the route as a fixed crosspoint that is always on.
Output	Allows a GPO to be triggered as a result of a GPI.
On	Flips the logic of the GPO configured in the Output field.
Handler	Shows the host that will be handling the GPIO. This is the host on which the selected route was defined.

25.6.2 GPIO Processes Editor - Route > GPO section

Field/Display Item	Description
Name	A system-generated name based on the route trigger. This can be changed to allow easy identification of the process. The name does not have to be unique. Maximum length = 20 characters.
Route Trigger	The route used to trigger the GPI Output defined in the Output field. If more than one GPI Output needs to be controlled from a single trigger condition, multiple statements are required, with the same trigger.
Made	If checked, the route is made. If un-checked, the route is not made.
Output	Allows a GPI Output to be triggered as a result of a route being made or not made.
On	If checked, makes the selected GPI Output. If un-checked, does not make the selected GPI Output.
Handler	Shows the host that will be handling the GPI. This is the host on which the route trigger was defined.

25.6.3 GPIO Processes Editor - Route > Route section

Field/Display Item	Description
Name	A system-generated name based on the route result. This can be changed to allow easy identification of the process. The name does not have to be unique. Maximum length = 20 characters.
Route Trigger	The route used to trigger the second route defined in the Route Result field.
Made	If checked, the route is made. If un-checked, the route is not made.
Route Result	The resultant route.
Make	If checked, this defines the route as being made. If un-checked, this defines the route as being inhibited.
Handler	Shows the host that will be handling the GPIO. This is the host on which the route trigger was defined.

26. CONFIGURATION EDITOR | PHONE NUMBERS

26.1 OVERVIEW

The Phone Numbers Editor is used to add, change or delete frequently used, globally available phone and SIP numbers.

Numbers added to the phone and SIP number lists can be added to panels (see section 13 - *Configuration Editor | Subscriber | Hardware Panel* in this manual) and then used locally.

The Phone Numbers Editor is also used to define phone sets and phone controls.

- Phone sets are logical groupings of panels that display a ringing tally when an incoming call is detected on the phone line to which the panels have a key.
- Phone controls are incoming DDI digits that are used to direct an answered call to the appropriate panel, conference, FXS, FXO or E&M port, route or phone set.

In common with the other areas of the Gateway application, both basic and advanced editors are provided. In this instance they are identical, and the basic version will be described.

26.2 USING THE PHONE NUMBER EDITOR

26.2.1 Opening the Phone Number Editor

Phone numbers, SIP numbers, phone controls and phone sets are maintained using the Phone Number Editor.

- Click on **Phone Numbers** in the Enterprise tree to open the Phone Number Editor.
- The Details panel is divided into 4 on-screen areas, as shown in the image below.

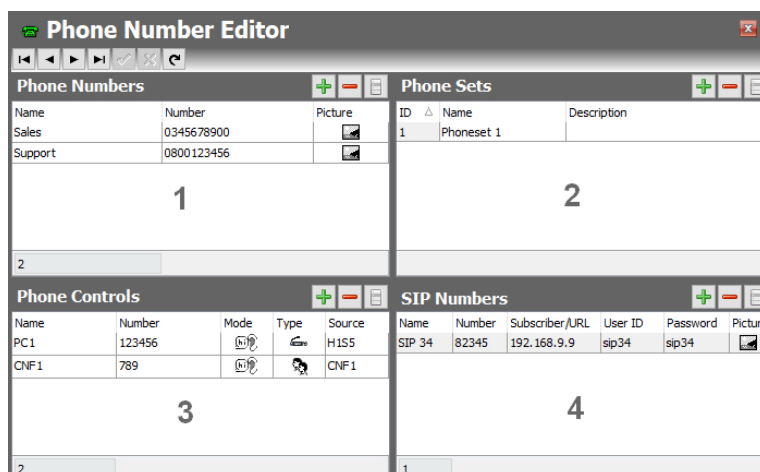

Details of areas 1, 3 and 4 are contained fully on this screen and are described in following sections. Phone Sets, shown in area 2, are added on this screen and basic details may be edited. Membership of Phone Sets is managed with the separate Phone Set Editor and Phone Sets are listed separately under the Enterprise Tree.

26.2.2 The Phone Number Editor Areas

The editor has four areas which are used to maintain phone numbers, SIP numbers, phone controls and phone sets in the global directory.

Area 1 | Phone Numbers

The Phone Numbers area is used to add and delete phone numbers.

Area 2 | Phone Sets

The Phone Sets area is used to define phone sets.

Area 3 | Phone Controls

The Phone Control area shows a list of all phone numbers that have been added to call conferences, FXO, FXS or E&M ports and routes.

Area 4 | SIP Numbers

The SIP Numbers area is used to add and delete SIP numbers.

26.3 PHONE NUMBERS

The Phone Number Editor - Phone Numbers area shows a list of all phone numbers that have been added. Phone numbers are outgoing digits that may be used by panels as speed dials when accessing FXO, FXS or E&M ports. Digits are dialed as DTMF when the call is placed.

Buttons at the top let you:

- Add a new phone number.
- Delete a phone number.

26.3.1 Adding a Phone Number

Phone numbers can be added, as required. To add a phone number, provide a name and number. A picture can be specified for each number if required.

- Open the Phone Number Editor. The **Phone Numbers** area is located top left.
- Click the **Add** button. A new row is added to the phone number list.
- Click in **Name** and enter the name of the contact.
- Click in **Number** and enter the number field for that contact.
- To add a picture for the contact, click in **Picture** then click  and browse for and select the required image file.



Name	Number	Picture
Sales	0345123456	
Support	0800123123	

- Click  to post the number to the database.

26.3.2 Deleting a Phone Number

Phone numbers that are not required can be deleted. You can either delete individual numbers using the **red** - button or delete all numbers at the same time using the right-click context menu.

IMPORTANT: Deleting either individual numbers or all numbers from the global directory will also delete them from local panel listings.

26.4 PHONE SETS

Phone sets are a logical grouping of panels that display a ringing tally when an incoming call is detected on the phone line to which the panels have a key. Any of the panels in the phone set can answer the incoming call.

Buttons at the top of the Phone Number Editor - Phone Sets area let you:

- Add a new phone set.
- Delete a phone set.

26.4.1 Adding a Phone Set

Phone sets can be added to the configuration, as required. Each phone set is given a default name, which can be changed. An optional description may be added.

- Open the Phone Number Editor. The **Phone Sets** area is located top right of the form.
- Click the **Add** button.
- Specify how many sets you wish to add and click **OK**.
- If you want to change the default name, select a phone set and click in **Name** and enter the name of the phone set.
- Click in **Description** and enter a description (optional).
- Click to post the phone set to the database. The phone set you added is listed under **Phone Numbers** in the Enterprise tree.

ID	Name	Description
1	Phoneset 1	Sample phone set

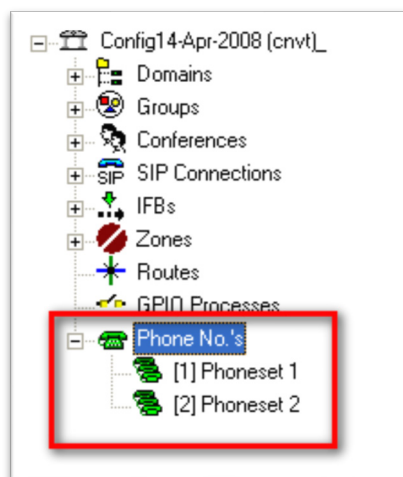

Click the right arrow next to **Phone Numbers** in the Enterprise tree to view any phone sets that have been defined. Currently, the phone set has no members. Click on a phone set to open it in the **Phone Set Editor**. Details of the Phone Set Editor are in section 27 - *Configuration Editor | Phone Sets*.

26.4.2 Deleting a Phone Set

Any phone sets that are not required can be deleted. You can either delete individual phone sets using the red - button or delete all phone sets at the same time using the right-click context menu.

26.5 PHONE CONTROLS



The Phone Number Editor - Phone Control area shows a list of all phone numbers that have been added to call panels, conferences, FXO, and FXS ports, routes and phone sets. Phone controls are incoming DDI digits that are used to direct an answered call to the appropriate panel, conference, FXS, FXO or E&M port, route or phone set.

Buttons at the top of the Phone Number Editor - Phone Control area let you:

- Add a new phone control.
- Delete a phone control.

26.5.1 Adding a Phone Control

To add a phone control, specify a name, number and source name. The mode defaults to Speak/Listen but can be changed to either Speak or Listen, as required.

- Open the Phone Number Editor. The **Phone Control** list is located lower left of the screen.
- Click the **Add** button. A new row is added to the phone control list.
- Click in **Name** and enter the name of the control. If you leave this blank, the name will default to the name of the selected Source.
- Click in **Number** and enter the number corresponding to the control.
- Click in **Source** then click  and browse to and choose the required conference, panel, GPIO/audio route or phone set.
- Click in **Mode** and then click  to change the mode, if required.
- Click to post the phone control to the database.

Phone Controls				
Name	Number	Mode	Type	Source
Central	0800654321			CNF1

26.5.2 Deleting a Phone Control

Phone controls that are not required can be deleted. You can either delete individual phone controls using the red - button or delete all phone controls at the same time using the right-click context menu.

IMPORTANT: Deleting phone controls from the configuration will affect local panel listings.

26.6 SIP NUMBERS

The Phone Number Editor - SIP Numbers area shows a list of all SIP numbers that have been added. Each SIP number record includes a reference name, quick dial number, subscriber URL or SIP address and an authentication user ID and password. SIP numbers are outgoing digit sequences that map to fully formed URIs or digits that are passed to a Proxy Server to be resolved fully.

Buttons at the top let you:

- Add a new SIP number.
- Delete a SIP number.

26.6.1 Adding a SIP Number

SIP numbers can be added, as required. To add a SIP Number, provide a name and number. Authentication details can also be added if these are needed by the connection. A picture can be specified for each number if required.

- Open the Phone Number Editor. The **SIP Numbers** area is located lower left.
- Click the **Add** button. A new row is added to the SIP number list.
- Click in **Name** and enter the reference name for the number.
- Click in **Number** and enter the quick dial number for that contact.
- Click in **Subscriber/URL** and enter the SIP address. This can be an IP address or URL. If you leave this field blank, it will default to the reference name that you specify.
- Click in **User ID** and enter the required user ID, if required.
- Click in **Password** and enter the authentication password, if required.
- To add a picture for the SIP number, click in **Picture** then click  and browse to and choose the required image file.



Name	Number	Subscriber/URL	User ID	Password	Picture
SIP 34	82345	192.168.9.9	sip34	sip34	

- Click  to post the record to the database.

26.6.2 Deleting a SIP Number

SIP numbers that are not required can be deleted. You can either delete individual numbers using the red - button or delete all numbers at the same time using the right-click context menu.

IMPORTANT: Deleting either individual numbers or all numbers from the global list will also delete them from local panel listings.

26.7 PHONE NUMBER EDITOR - FIELD DEFINITIONS



26.7.1 Phone Number Editor - Phone Numbers

Field/Display Item	Description
Name	The name of the 'contact'. The name can be changed, as required. The name does not have to be unique.
Number	The phone number. The number can be changed, as required. The number string can include the digits 0 1 2 3 4 5 6 7 8 9 * # , Maximum length is 20 digits/special characters.
Picture	Shows the picture that has been assigned to the number. To assign a picture, or change an existing picture, click the ellipsis and then browse for and select the required image file. Visible on Virtual Panels only.

26.7.2 Phone Number Editor - Phone Sets

Field/Display Item	Description
ID	The ID of the phone set. This cannot be changed.
Name	The name of the phone set. The name can be changed, as required.
Description	An optional description of the phone set.

26.7.3 Phone Number Editor - Phone Controls

Field/Display Item	Description
Name	The name of the control. The name can be changed, as required.
Number	The phone control number. The number can be changed, as required.
Mode	The mode defaults to Speak/Listen but can be changed by clicking on the icon and then clicking  .
Type	Shows an icon that represents the source.
Source	Click in this field and then click  to select or change the source (conferences, panel sources, GPIO audio routes or phone sets).

26.7.4 SIP Number Editor - SIP Numbers

Field/Display Item	Description
Name	The reference name of the SIP number. The name can be changed, as required. The name does not have to be unique.
Number	The quick dial number. The number can be changed, as required. The number string can include the digits 0-9, *, # and , Maximum length is 20 digits/special characters.
Subscriber/URL	The SIP address. Enter an IP address or URL. If you leave this field blank, it will default to the Name when you save the record.
User ID	The authentication user ID for the SIP number.
Password	The authentication password for the SIP number (and user ID).
Picture	Shows the picture that has been assigned to the number. To assign a picture, or change an existing picture, click the ellipsis and then browse for and select the required image file. Visible on Virtual Panels only.

27. CONFIGURATION EDITOR | PHONE SETS

27.1 OVERVIEW

Phone Sets are logical groupings of panels that will display a ringing tally when an incoming call is detected on the phone line to which the panels have a key. Any of the panels in the phone set can answer the incoming call.

Phone Sets are created using the Phone Number Editor. See section 26.4 for details.

The Phone Set Editor is then used to add, change and delete IP phone sources from phone sets. In common with the other areas of the Gateway application, both basic and advanced editors are provided. In this instance they are identical, and the basic version will be described.

27.2 USING THE PHONE SETS EDITOR

27.2.1 Opening the Phone Sets Editor

Phone Sets are maintained using the Phone Sets Editor.

To open the Phone Sets Editor:

- Click the right arrow next to Phone Numbers in the Enterprise tree to show a list of phone sets.
- Click on the required phone set to open it in the Phone Sets Editor.



All relevant information is now shown in the details panel.

Details

The Details fields are used to set the name of a phone set or to add or change the comment about a phone set.

IP Phone Sources

The IP Phone Sources fields are used to add and delete IP phone sources that define which panels ring when a specific number is called.

27.3 PHONE SET EDITOR - DETAILS

To change phone set details:

- Open the Phone Sets Editor.
- Change the name of the phone set and enter a comment, if required.
- Click to post changes to the database.

27.4 PHONE SET EDITOR - IP PHONE SOURCES

27.4.1 Adding IP Phone Sources to a Phone Set

An IP phone source is a panel that will ring if a specific phone is dialed. This allows you to define which panels will display an incoming call and subsequently which users will see that call. Once answered by an IP phone source panel, all other panels in the phone set will stop ringing.

NOTE: A panel will only be available for inclusion in a phone set if it has a key targeting a TEB or SIP Connection.

To add an IP phone source:

- Open the Phone Sets Editor.
- Click the **green +** button to open the Panels/Sources dialogue.

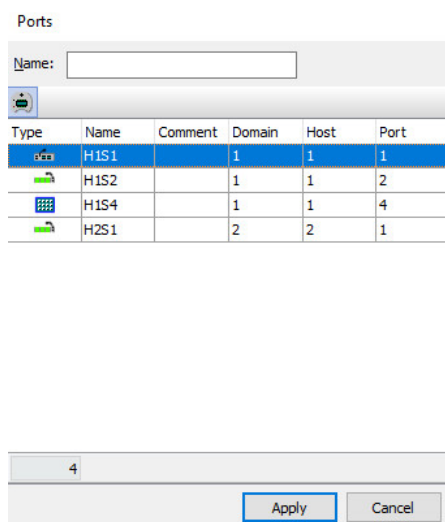

Select the panels/sources that you want to add and click **Apply**.

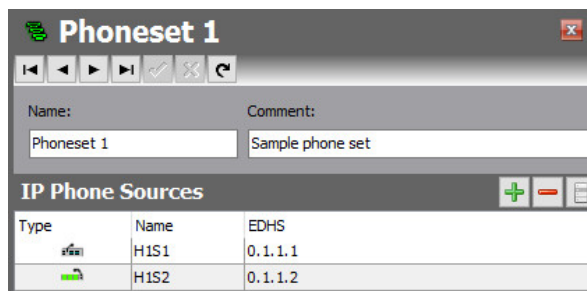

The panels/sources are now part of the sample phone set.

27.4.2 Deleting IP Phone Sources

IP phone sources that are not required in the phone set can be removed. You can remove individual sources using the **red -** button or delete all sources at the same time using the right-click context menu. The underlying IP Phone sources are not affected.

27.5 PHONE SET EDITOR - FIELD DEFINITIONS

27.5.1 Phone Sets Editor - Details

Field/Display Item	Description
Name	The name of the phone set. The name can be changed, as required. The name does not have to be unique. The maximum length for a phone set name is 64 characters.
Comment	Any comments entered when the phone set was created using the Phone Number Editor. Comments may be added or changed. Maximum length = 255 characters.

27.5.2 Phone Sets Editor - IP Phone Sources

Field/Display Item	Description
Type	An icon showing the type of source selected, e.g. Virtual Panel.
Name	The name of the selected source. Cannot be changed.
EDHS	The EDHS address of the selected source. Cannot be changed.

28. CONFIGURATION EDITOR | ACCESS MANAGEMENT

28.1 INTRODUCTION

The default set-up for a system using the Gateway editor is for a single system administrator to have overall control of the configuration management, whether this consists of a single matrix frame, or multiple frames arranged in a complex network. Although this may be suitable for smaller installations, it is unlikely to be appropriate for a large, multi-studio arrangement. In such instances, the Gateway “Access Management Console” can be used to create multiple administrators and grant them control over segments of the intercom network. In this section, we will examine this feature and demonstrate a typical example.

28.2 LAUNCHING THE ACCESS MANAGEMENT CONSOLE

The Access Management Console is only available to the top-level system administrator. When the top-level administrator has logged in, the console is launched from the Tools menu as shown below. As explained earlier, the credentials for the top-level administrator are **Admin | trilogy**.

When Gateway is first installed, only the top-level system administrator is provided: no roles or additional administrators are present. Our first task is to create several roles based on a system encompassing two studios. The example below shows a new configuration with two Gemini hosts named Studio A and Studio B.

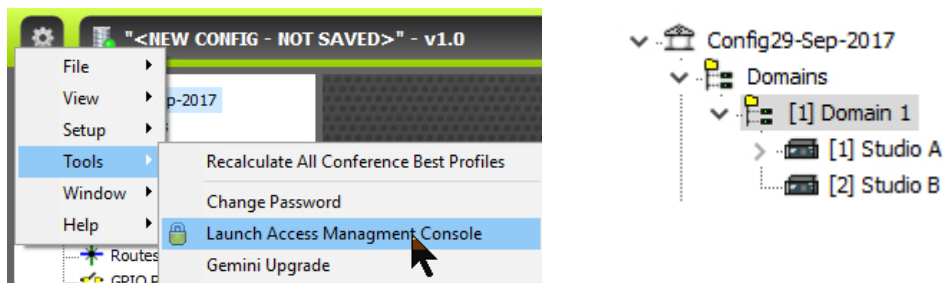

28.3 CREATING ROLES

Firstly, we will create three new roles:

- Senior Administrator
- Studio A administrator
- Studio B administrator

After logging in as the top-level administrator, switch to the Access Management Console as described above. Click the **green +** button to create a new role. Highlight this new role by clicking on the name in the centre of the circle, and then edit the name of the role within the text box by double-clicking in the top row.

Repeat this operation until three roles have been created as shown below.

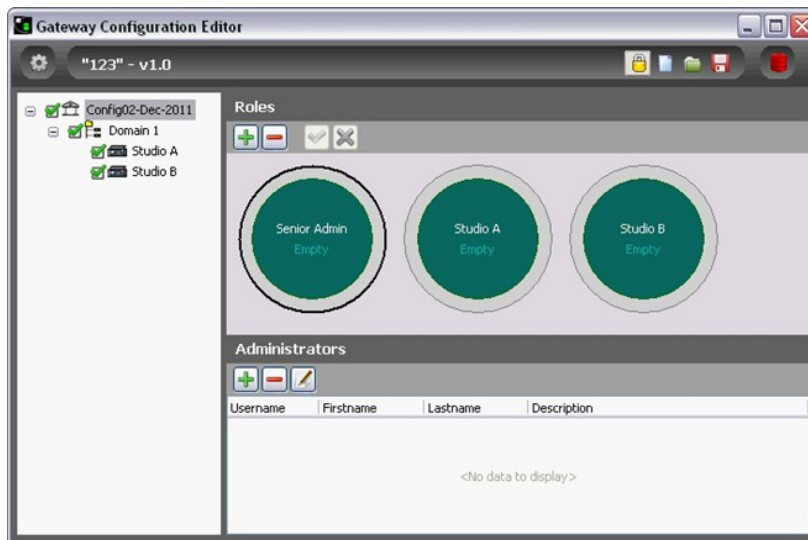

Highlight the Senior Administrator role by clicking on the name in the centre of that circle: the circumference of the circle changes to black to indicate that the role is currently selected.

The permissions allocated to this new role are indicated in the tree view on the left side of the screen: where permission has been granted, a green tick is shown adjacent to a Host. The permissions currently granted to the Senior Administrator are appropriate (see image above).

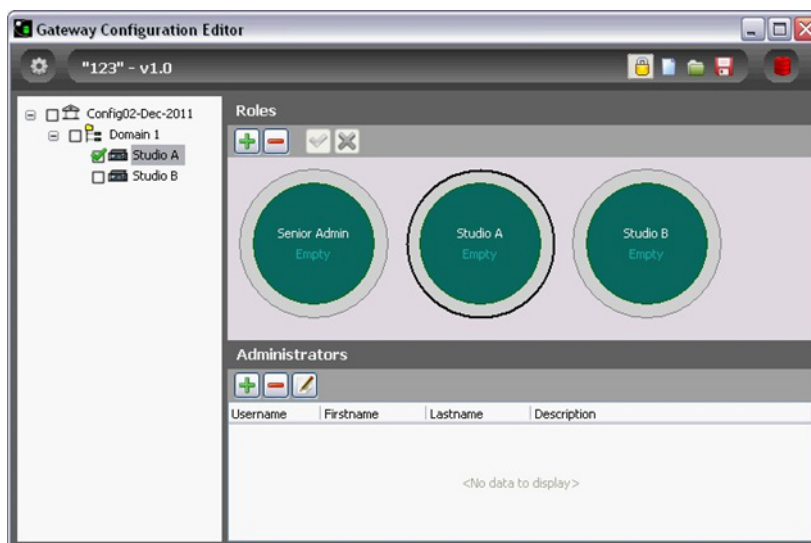

Repeat this process for Studio A and Studio B administrators and uncheck the permission boxes for each one as appropriate. These are shown after adjustment for Studio A (see image on left).

28.4 CREATING ADMINISTRATORS

The next stage is to create several administrators and then to assign them to specific roles. Each administrator is simply a set of login credentials plus a description, but they have no authority or permissions until assigned to a role. To create a new administrator, click on the green “+” icon in the lower pane of the Editor. Enter the details of each new administrator in the edit box and press the tick when complete. To edit the details of an administrator, highlight the list entry and click the edit button on the Administrators toolbar.

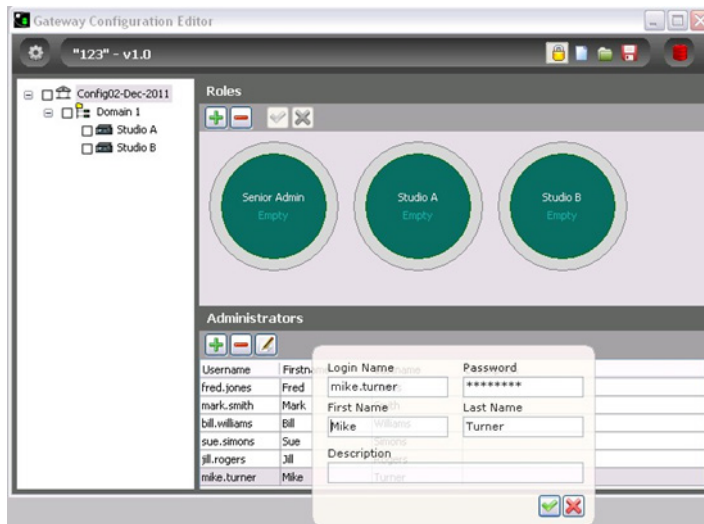

This image shows six new administrators -- they are not currently assigned to any roles.

28.5 ASSOCIATING ROLES AND ADMINISTRATORS

The final step is to assign the operators to specific roles. To do this, simply highlight an administrator from the list and drag the cursor into the appropriate role “circle”.

The following rules and conditions apply:

- each role may have one or more administrators
- each administrator may be assigned to one or more roles
- a role without any administrators serves no purpose
- an administrator who is not assigned to any roles also serves no purpose

The screen below shows the six administrators who have now been assigned to specific roles in the configuration of the Gemini network. The number in the centre of each role circle indicates the number of administrators currently assigned to that role. Position the mouse cursor over the centre of the circle to see a list of the names of current administrators in that role.

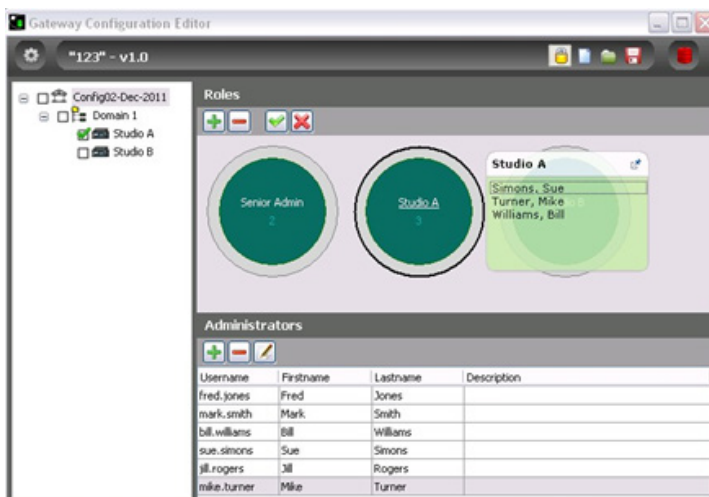

NOTE: if additional hosts are added later, they are automatically added to every current role with the permissions set to “on”. Although these settings may be appropriate for the overall system administrator, minor roles such as Studio A and Studio B (above) must be edited to remove these new hosts as appropriate.

28.6 USING ROLES AND ADMINISTRATORS

It is important to realise that although multiple administrators may be created for a system, they cannot log-in simultaneously. To avoid data conflicts, only one administrator may log-in at a specific point in time. If a second administrator attempts to log-in, the following will result:

- The person already logged in will see a pop-up message to advise that someone else is attempting to connect. He can choose to block the second person or allow him to connect. If he chooses to allow the other person, he must then exit Gateway. If he ignores this message, he will be forcibly disconnected after 30 seconds. This allows for the situation where a PC has been left unattended.
- The second person, attempting to connect will see a pop-up message to advise that another operator is already logged in. He can then choose to abandon his attempt to log-in or wait for the other person to respond. If there is no response from the other party, then the second person will be allowed to connect around 30 seconds later.

29. MERCURY TALKBACK CONTROLLER

29.1 OVERVIEW

The Talkback Controller (TBC) is the host application at the heart of the Mercury system. It runs as a service on the host Windows machine.

The TBC performs the following functions:

- Manages the peer-to-peer socket connections between Mercury hosts, including conferences.
- Acts as the decision-making engine to set-up and tear-down Internet Protocol (IP) audio routes and local audio crosspoints.
- Acts as the interface to the host Mercury hardware.
- Implements conditional routing rules. These allow the Administrator to establish and enforce business-appropriate rules to support the workflow requirements of operators and to control external devices, for example, Push-to-Talk (PTT) and Carrier-Operated Relay (COR) radio connections and PTT microphone switches.
- Sends status information to other TBCs.
- Accepts the socket connection and communicates with the DB Supervisor for system management.

All Mercury hosts are supplied with the TBC application pre-installed. but if it is necessary to re-install the host software, please see section 6 - *Mercury Software and Installation*.

29.2 USING THE TBC

The TBC comprises two components:

- Windows service which starts automatically on start-up.
- GUI application which also runs automatically from a shortcut placed in the Windows Start-Up folder during installation and is normally minimized to the System Tray.

The GUI application is used by the System Administrator to:

- Check the current status of the Host where the TBC is running.
- View a log of events, for example, starting and stopping the service, connecting and disconnecting clients.
- Check the type of expansion cards installed in the host.
- View a list of panels currently connected to this host.
- View a list of connected Mercury clients.
- View Connections.
- View Audio Routes.
- Specify TBC settings.

Normally, you will not have to make any changes to the settings, but if you do you must ensure that you also update the Database Settings in the Configuration Editor.

The TBC GUI provides visibility of the TBC; if the GUI is shut down you will not be able to view the TBC status or make changes to your TBC settings. If the TBC GUI is shut down, the TBC itself is still running as a service and the Host will function as normal.

29.2.1 Closing and Restoring the TBC GUI

The TBC GUI application will be started automatically, via a shortcut to the application in the Windows Start-Up menu, added during installation. Closing the TBC GUI application does not affect the TBC which always runs as a Windows service. The TBC GUI icon appears in the system tray and the GUI may be displayed by right-clicking the icon and selecting **Restore**.

NOTE: If inadvertently shut down, to re-start the TBC GUI application, click on **TBC** in the Windows Start-up menu.

29.2.2 Starting and Stopping the TBC service

The TBC is installed to run as a service. The service can be started or stopped manually if required.

NOTE: You should not have to start and stop the TBC during normal operations.

To manually start the TBC service:



- Open the Computer Management console.
- Open the Services window and select the **Mercury TBC service**.
- Click the **Start the service** link. Note the TBC icon now turns green.

To manually stop the TBC (service):

- Open the Computer Management console.
- Open the Services window and select the **Mercury TBC service**.
- Click the **Stop the service** link to stop the service.

29.2.3 TBC Status – System Tray

You can quickly determine the status of the TBC by looking at the colour of the TBC icon in the system tray. If this icon is green, this indicates that the TBC is operating correctly, but if the icon does not remain green, there is a problem with the application – the colour of the icon should help determine the nature of the problem.

Colour		Description
Red		TBC is not operational.
Yellow		TBC is connected to host hardware but not yet operational.
Green		The application is operating correctly.

When the TBC GUI is first started, it runs minimised and visible as an icon in the system tray, adjacent to the clock in the lower right portion of the screen. The icon will appear in one of three colours, dependent on the current state.

The red and yellow states are a normal part of the boot-up sequence and may be displayed for up to one minute while the hardware and software initialise, and the configuration is loaded. To display the TBC GUI on-screen, double click the icon in the System Tray. If the MIU is not operating correctly, please see the TBC troubleshooting tips in section 29.2.4.

29.2.4 TBC Troubleshooting

Problems with the TBC are indicated by the status icon remaining red or yellow in the period beyond initialisation and boot up. Most commonly, this will occur if a mismatch occurs between different areas of the hardware and software. If possible, examine the TBC log for more information. Review any changes which may have been made recently to the system, especially to IP settings. Using Gateway, check and compare the IP addresses set under Windows networking and within your configuration file. The default values for an MIU delivered from Trilogy are given below.

	Windows	VoIP audio card
IP Address	192.168.99.99	192.168.99.100
Subnet Mask	255.255.255.0	255.255.255.0
Default Gateway	[not set]	[not set]
Host (EDH) address	0.1.1	

29.3 TBC – MENU OPTIONS

TBC Menu | TBC

Menu Option	Description
Reload Config	Reloads the configuration information and restarts the TBC.
Reset	Forces the TBC to reset using the currently cached configuration data.
Database Settings...	Opens the DB Supervisor and TBC Settings dialogue. Refer to section 29.9 for a description of the information on this dialogue.
Preferences...	Opens the Preferences dialogue. Refer to section 29.9 for a description of the information on this dialogue.
Close	Minimizes the TBC GUI to the system tray.
Exit	Exit the TBC GUI completely.

TBC Menu | Support

Menu Option	Description
Message / Pipe Logs	Independently enables message and/or pipe logging.
Debug/ Remote Logging	Enables debug logging.
Priority Class	<p>Priority Class is the term Windows uses to identify the “priority” of a process or task. Tasks or processes usually launch with Normal priority. Increasing the priority to High increases the likelihood that the application will get a slice of the CPU above other lower priority applications.</p> <p>Use High priority when many applications are running and there is a chance that TBC performance could be affected by other applications using excessive amounts of CPU time.</p> <p>The TBC will remember the priority setting and re-apply it for every restart.</p>
Download new firmware	<p>Downloads and installs new firmware to the Mercury host PCI card.</p> <p>Load firmware Live</p> <p>The TBC uses the firmware like a file system and the firmware application processes and stores the new image in flash.</p> <p>TFTP-load new firmware</p> <p>Downloads and installs new firmware to the Mercury host using TFTP. The firmware application both loads an image into its file system and then processes and stores the new image in flash.</p> <p>RAM load</p> <p>Installs new firmware to the Mercury host from a RAM file. The TBC loads a firmware-application image into the Mercury card RAM directly. The firmware is then reset and the bootloader processes and stores the firmware-application image in flash.</p>
Run Command Line File	Run a command-line file to execute various commands.
Restart on firmware reset	When checked, TBC will restart after upgrading the audio card firmware. Default = Not checked.
Clear EC Flash	This is part of a Tech Support application which allows custom EC (echo-cancellation) settings to be loaded into FXO and FXS TEBs. This may be appropriate in environments where noise is a factor. Please contact Trilogy for more information.

TBC Menu | Help

Menu Option	Description
About	Displays version information.

29.4 TBC MENU | DATABASE SETTINGS

This dialogue specifies the location of the database and the EDHS address of the host. You should not need to change these unless you install the database on another machine or change the EDHS address of the host.

29.4.1 Changing Supervisor and TBC Settings

Database settings are specified when the host is installed. They can be changed if required.

On the TBC menu, select **Database Settings...** to open the DB Supervisor and TBC Settings dialogue. The Database tab is selected by default.

Make any changes as required. Refer to section 29.9.1 for a description of the information on this screen and click **OK** to save.

If the settings are not correct, you will receive an error message. Click **OK** and review the database settings. If you still cannot connect to the database, ensure that the Database Supervisor is running and that the IP address or hostname is correct.

29.4.2 Specifying the EDHS Address of the Host

The EDHS address is specified when the host software is installed. This will not normally need to be changed provided it is correctly selected on installation.

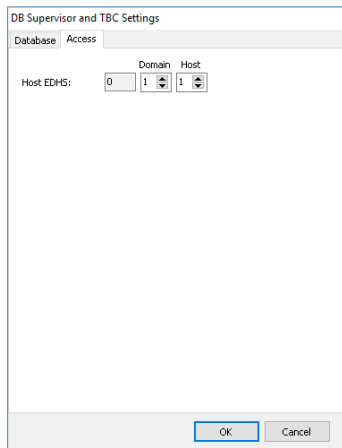

On the TBC menu, select **Database Settings...** to open the DB Supervisor and TBC Settings dialogue. Select the **Access** tab.

Make any changes as required. Refer to section 29.9.2 - *Database Settings – Access* for a description of the information on this screen and click **OK** to save.

29.5 TBC MENU | PREFERENCES

TBC Preferences allow you to specify which TBC tabs are displayed, specify firmware locations and TFTP server details and change database-related settings.

29.5.1 Changing TBC Preferences

The TBC General and Run-time Options can be changed, as required.

To change the TBC preferences:

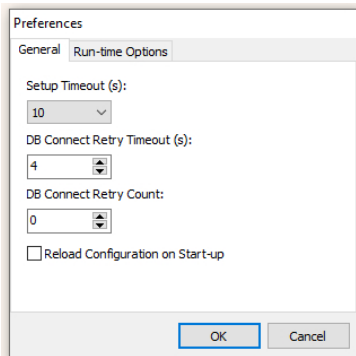

On the TBC menu, select Preferences... to open the Preferences dialogue. The General tab is selected by default.

Change the settings, as required. Refer to section 29.9.3 for a description of the information on this screen.

Click **OK** to save the changes or select the Run-time Options tab to make further changes.

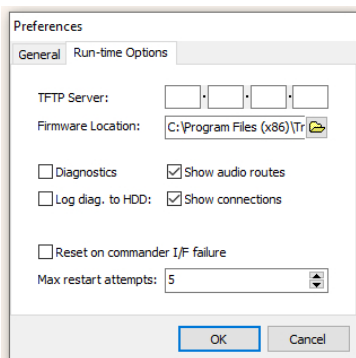

Make the required changes to the Run-time Options preferences. Refer to section 29.9.4 for a description of the information on this screen.

Click **OK** to save the changes.

29.6 TBC – DIALOGUE

Right-click on the Mercury TBC icon and select **Restore** to restore the TBC form to your desktop (if necessary). The Status tab is selected by default.

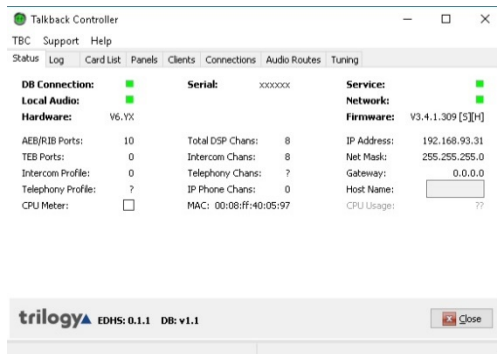

This tab is primarily used for system diagnosis and maintenance and is selected by default.

If the TBC is operating correctly, the four indicators (DB Connection, Local Audio, Service, and Network) will be green. CPU usage can be monitored by selecting the CPU Meter checkbox.

Refer to section 29.9.5 for a description of the information on this screen.

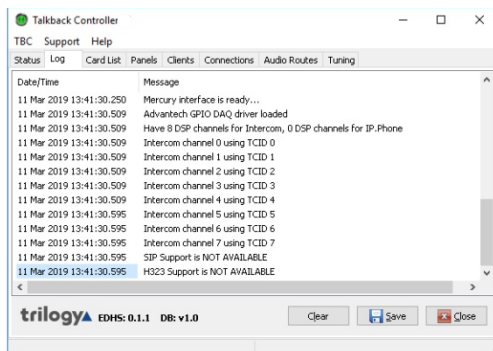

Click the **Log** tab. The TBC Log displays details of the various processes and activities related to the TBC. Log entries can be arranged by date/time. The most recent entries are shown at the bottom of the list. The log can be saved for diagnostic purposes if required.

Refer to section 29.9.6 for a description of the information on this screen.

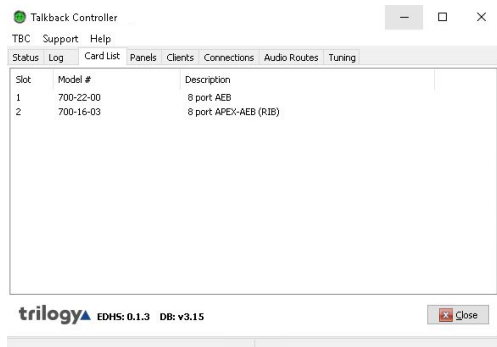

Click the **Card List** tab. A list of the cards fitted in the host is displayed.

Refer to section 29.9.7 for a description of the information on this screen.

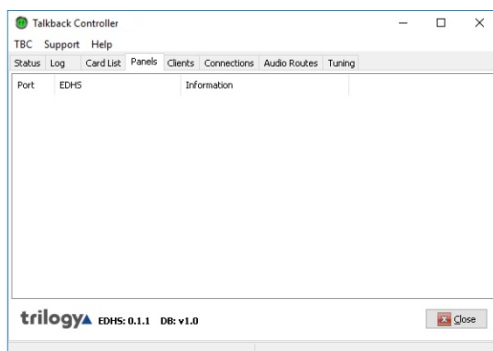

Click the **Panels** tab. This shows details of any panels or radios that are active and connected to the Mercury host.

Refer to section 29.9.8 for a description of the information on this screen.

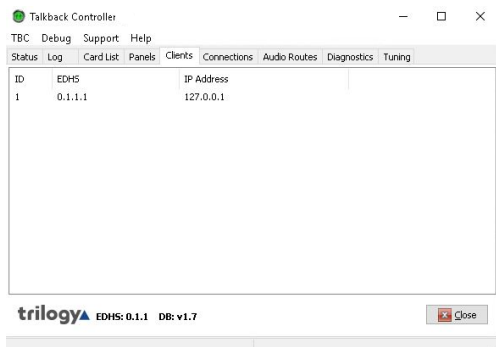

Click the Clients tab. The TBC Clients tab shows details of any clients of this TBC.

Refer to section 29.9.9 for a description of the information on this screen.

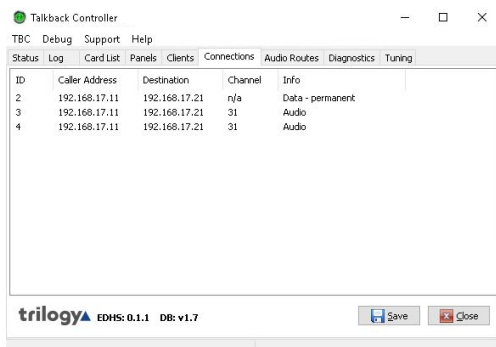

The TBC **Connections** tab shows details of any connections to other TBCs in the system.

Refer to section 29.9.10 for a description of the information on this screen.

NOTE: This tab will only be displayed if enabled in the TBC Preferences.

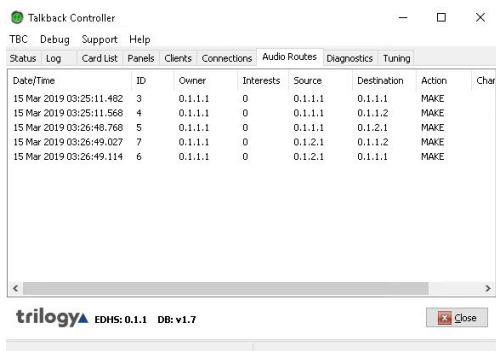

The TBC **Audio Routes** tab shows details of audio routes for calls that are in progress.

Refer to section 29.9.11 for a description of the information on this screen.

NOTE: This tab will only be displayed if enabled in the TBC Preferences.

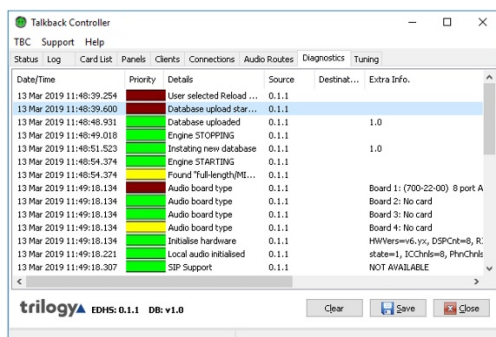

The TBC **Diagnostics** tab shows a list of events that can help identify problems with the Mercury system.

NOTE: This tab will only be displayed if **Diagnostics** has been selected in **TBC Preferences** and **Log diag. to HDD** has *not* been selected.

Refer to section 29.9.12 for a description of the information on this screen.

Click **Save** to save the diagnostics.

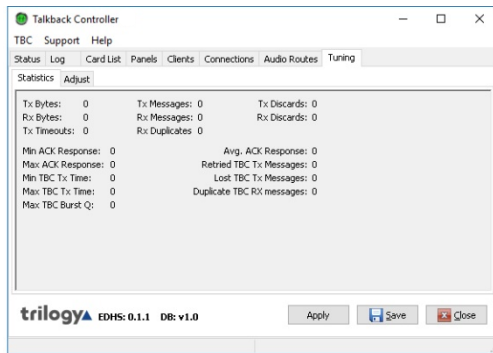

The Tuning tab has 2 sub-tabs: Statistics and Adjust. Statistics can be viewed or saved, as required. Note that the information displayed is from the last reset.

Refer to section 29.9.13 for a description of the information on this screen.

Click **Save** to save the statistics.

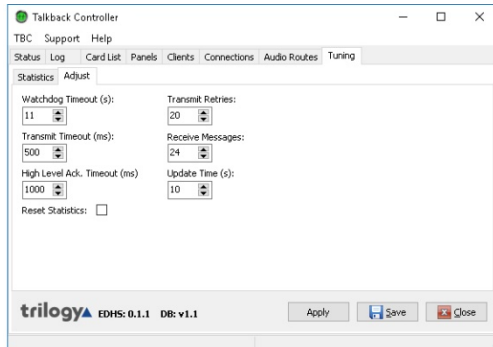

The **Tuning** tab has 2 sub-tabs: Statistics and **Adjust**. This lets you adjust various settings related to the performance of the TBC.

Changing these settings can cause your Mercury system to fail or not operate correctly.

Refer to section 29.9.14 for a description of the information on this screen.

WARNING: Do not adjust these settings without prior consultation with Trilogy Technical Support.

29.6.1 Saving and Clearing the TBC Log

The TBC activity log can be saved or cleared, as required.

To save the log:

- Open the TBC Log.
- Click **Save**. The log will be saved in the *Program Files\Mercury v3\TBC* folder with a default name of *Events.log*, although you can change the folder and name, as required.

To clear the TBC log:

- Open the TBC Log.
- Click **Clear** to clear the log.

29.7 TBC – FIRMWARE

Firmware is the embedded software which is saved in non-volatile memory on the Mercury host PCI card. The firmware is closely associated with the TBC application and will normally be updated as one part of an overall upgrade process.

In addition to managing connections between Mercury hosts and panels, the TBC can be used to update the Mercury firmware. Updating firmware is required to ensure that the version on the PCI card matches the TBC version.

There are three methods of updating the firmware:

- **RAM load** – The TBC loads a firmware application image into the Mercury card RAM directly. The firmware is then reset and the bootloader processes and stores the firmware application image in flash. RAM load is essential if you are trying to load a “new” compressed image because there is more flash than system RAM. This is the preferred upgrade method.
- **Load firmware live** – The TBC uses the firmware like a file system and the firmware application processes and stores the new image in flash. This upgrade method is present for legacy use only and should only be used when advised by Trilogy Technical Support.
- **TFTP-load new firmware** – The firmware application both loads an image into its file system and then processes and stores the new image in flash. This upgrade method is present for legacy use only and should only be used when advised by Trilogy Technical Support.

NOTE: RAM load will only work if the bootloader supports this process. If you are updating for the first time, use the Load Live process to update the bootloader.

29.7.1 Downloading New Firmware (RAM Load)

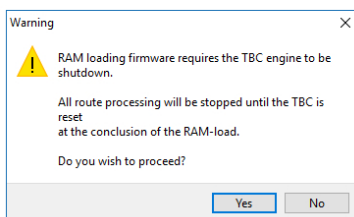

On the TBC Support menu, select Download new firmware and then RAM load. A warning message is displayed. Click **Yes** to proceed.

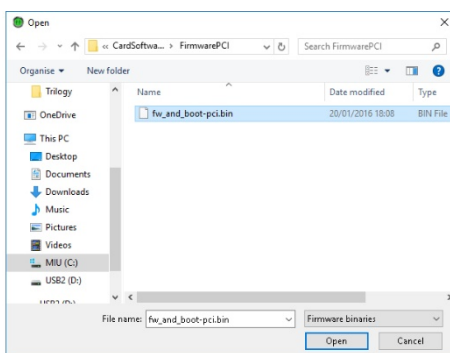

Browse to the folder containing the updated firmware binary file.

Select the required file and click **Open**.

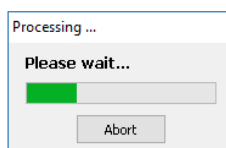

The update will now proceed without any further warning – this progress message is displayed.

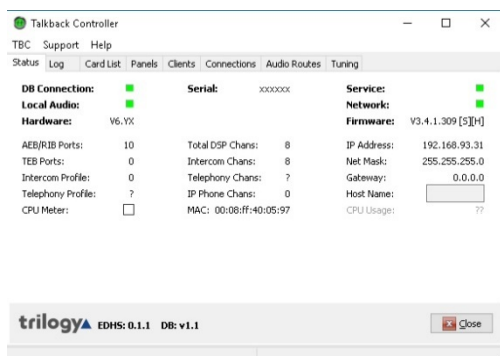

On completion, the TBC will automatically restart, and the TBC Status form will display normal operation.

29.7.2 Downloading New Firmware (Load Firmware Live)

To download and install new firmware:

This upgrade method is present for legacy use only and should only be used when advised by Trilogy Technical Support.

29.7.3 Downloading New Firmware (TFTP-load)

To download and install new firmware:

This upgrade method is present for legacy use only and should only be used when advised by Trilogy Technical Support.

29.8 COMMAND LINE FILES

Command-line files allow you to send commands directly to the firmware when starting the TBC. This is useful for hosts that do not have direct communications links to the audio card.

IMPORTANT: This function should only be used in conjunction with Trilogy Technical Support.

29.9 TBC - FIELD DEFINITIONS

29.9.1 Database Settings – Database

Field	Description
Offline Mode (Local File Database)	Select this radio button if the database is running locally. You will need to specify the location of the database files.
Online Mode (Database Supervisor)	Select this radio button if the database is located on a remote PC (specified in the Fixed IP or Host Name field).
IP Address Mode	Radio buttons select the mode of the IP connection to the PC hosting the database. Select either Fixed IP or Host Name .
IP Address	This field is used to specify the static IP address of the PC hosting the database. This is the preferred method.
Host Name	This field is used to specify the name of the PC hosting the database. It must be completed if the database is hosted on a PC with an IP address that is assigned by DHCP. This method is not recommended.
Data Port	The IP port that the DB Master (or Slave) uses for data connections. Changing this value changes the IP port number on which the database accepts incoming connections. This needs to be changed if: IP Port 12005 is in use elsewhere on the network by another application. Network security deems that another port should be used, or Network Address Translation /Port Address Translation (NAT/PAT) requires that another port is used. Changing this value also means that all clients (including slaves) must be configured to connect to the new port value. Default = 12005
Supervisor Port	The IP port that the Database Master (or Slave) listens for connection control data on. Changing this value changes the IP port number on which the database accepts incoming connections. This must be changed if: IP Port 13001 is in use elsewhere on the network by another application. Network security deems that another port should be used, or NAT/PAT requires that another port is used. Changing this value also means that all clients (including slaves) must be configured to connect to the new port value. Default = 13001
Compression	Compresses each transaction exchanged between server and clients by an adjustable amount. Useful on networks with limited bandwidth. The asterisk on the scale is a suggested starting point, giving a good compromise between CPU usage (to compress the data) and bandwidth saved.

29.9.2 Database Settings – Access

Field	Description
Host EDHS > Domain	The ID of the domain. This must match the ID specified in the Configuration Editor.
Host EDHS > Host	The ID of the host. This must match the ID specified in the Configuration Editor.
Client Server Interface	The network interface on which the TBC will listen. This is used in multi-homed systems. Options are [Default (Any) 127.0.0.1 "IP Address"] where "IP Address" is the current address of the interface. Additional interfaces will also be listed.

29.9.3 Preferences – General

Field	Description
Setup Timeout	The time in which the TBC will timeout on a connection to the Database Supervisor. The available options are: Never – Windows TCP timeout. Numerical Value in seconds – Override windows timeout. Default = 10 s.
DB Connect Retry Timeout (s)	Specifies the database connection retry timeout. Default = 4 s. Range 1–5 s.
DB Connect Retry Count	Specifies the number of times a database connection will be retried if not successful. Default = 0. Range 0–5.
Reload Configuration on Start-up	Default = un-checked.

29.9.4 Preferences –Run-time Options

Field	Description
TFTP Server	Allows you to enter the IP address of the TFTP server.
Firmware Location	Specifies the location of the updated firmware. Click the browse button to specify a different location.
Diagnostics	Enables TBC diagnostics and displays the Diagnostics tab. Default = no
Log diag. to HDD	Enables/disables the logging of diagnostic information to disk. Default = no
Show audio routes	Displays the Audio Routes tab on the TBC. Default = yes
Show connections	Displays the Connections tab on the TBC. Default = yes
Reset on Commander I/F failure	Default = un-checked.
Max restart attempts	Default = 5. Range = 0 – 99

29.9.5 TBC Status

Display Item	Description
DB Connection	An indicator to show the status of the connection to the database. Green = connected; Red = not connected.
Serial	Serial number of the MIU chassis.
Service	An indicator to show the status of the TBC Service. Green = running; Red = not running.
Local Audio	An indicator to show the status of the local audio access ports and Digital Signal Processing (DSP) channels. Green = operating correctly; Red = not working correctly. If the indicator remains Red for more than one minute after the TBC starts, either the system configuration does not contain valid information for the host (hardware does not match configuration) or the hardware has failed.
Network	An indicator to show the status of the network. Green = connected; Red = not connected.
Hardware	The firmware hardware version.
Firmware	The firmware software version.
AEB/RIB Ports	The physical number of Audio Expansion Board (AEB)/Radio Interoperability Board (RIB) ports.
TEB Ports	The number of Telephone Expansion Board (TEB) ports detected.
Intercom Profile	The coding profile used for intercom. Specified using the Configuration Editor.
Telephony Profile	The coding profile used for telephony. Specified using the Configuration Editor.
Total DSP Chans	The total number of DSP channels available on the installed hardware.
Intercom Chans	The number of DSP channels allocated to intercom.
Telephony Chans	The number of DSP channels allocated to telephony (TEB).
IP Phone Chans	The number of DSP channels allocated to IP.
IP Address	The IP address of the Mercury card.
Net Mask	The subnet mask.
Gateway	The IP address of the gateway.
Host Name	Only used when DHCP is configured.
CPU Meter	Select this checkbox to enable the CPU Usage field.
MAC	MAC Address of the MIU.
CPU Usage	Shows the CPU usage (when enabled).

29.9.6 TBC Log

Display Item	Description
Date/Time	The date and time of the log entry.
Message	The log entry.

29.9.7 TBC Card List

Display Item	Description
Slot	Shows the slot number in the MIU (1–4)
Model #	Shows the model number of the card installed in the slot.
Description	Shows a description of the installed card.

29.9.8 TBC Panels

Display Item	Description
Port	The port to which the panel is attached.
EDHS	The EDHS address of the panel (as defined in the Configuration Editor).
Information	The number of keys and the panel type.
Version	The firmware version currently installed in the panel.

29.9.9 TBC Clients

Display Item	Description
ID	A number used to identify the client in the list.
EDHS	The EDHS address of the client.
IP Address	The IP address of the machine running the client.

29.9.10 TBC Connections

Display Item	Description
ID	A unique number to identify the connection
Caller Address	The IP address of the audio card starting the connection.
Destination	The IP or multicast address of the receiving party.
Channel	The channel number if the TBC is piggybacking on an audio route.
Info	Information showing the type of connection.

29.9.11 TBC Audio Routes

Display Item	Description
Date/Time	The date and time that the route was made.
ID	A unique identifier for the route.
Owner	The EDHS address of the route owner.
Interests	The number of parties interested in the route. This is a count of how many different TBCs are monitoring this route for GPI logic functionality; most routes will have an interest of 0 in a simple configuration.
Source	The EDHS address of the call initiator.
Destination	The EDHS address of the call target.
Action	The route action.

29.9.12 TBC Diagnostics

Display Item	Description
Date/Time	The date and time of the event.
Priority	The relative importance of the event. There are four colours: Red = critical Maroon = high Yellow = medium Lime = low To sort the events and identify those with critical importance, click on the Priority column heading.
Details	Details of the event.
Source	The EDHS address of the source of the event.
Destination	The EDHS address of the destination of the event.
Extra Info.	Additional information relating to the event.

29.9.13 TBC Tuning – Statistics

Display Item	Description
Tx Bytes	The number of bytes transmitted (Tx) by the firmware.
Rx Bytes	The number of bytes received (Rx) by the firmware.
Tx Timeouts	The number of timeouts detected by the firmware (messages transmitted and not acknowledged).
Tx Messages	The number of messages transmitted and completed.
Rx Messages	The number of messages received.
Rx Duplicates	The number of messages with the same sequence number that has been received.
Tx Discards	The number of messages discarded because they failed to be accepted by the TBC.
Rx Discards	The number of messages received and discarded because their sequence number was incorrect.
Min ACK Response	The fastest time (ms) the firmware was able to acknowledge a message.
Max ACK Response	The slowest time taken for the firmware to acknowledge a message.
Min TBC Tx Time	The fastest time taken for the TBC to receive a message acknowledgement.
Max TBC Tx Time	The slowest time taken for the TBC to receive a message acknowledgement.
Max TBC Burst Q	The maximum number of receive messages received by the TBC at any one instant. This would normally be 0 as messages are received by the TBC as soon as they are queued by the firmware. A non-zero burst queue would indicate that the TBC was not able to receive a single message at some point and a backlog occurred as messages from the firmware had to be banked up. This might indicate the TBC is labouring due to heavy CPU usage or the firmware is very busy sending a lot of messages.
Avg. ACK Response	The average time taken for the TBC to receive a message acknowledgement.
Retried TBC Tx Messages	The number of transmission messages retried by the TBC.
Lost TBC Tx Messages	The number of messages sent but not acknowledged.
Duplicate TBC Tx Messages	The number of duplicate messages received. It is normal for some messages to be received multiple times but a high number of duplicate messages (more than 10) could indicate a problem with one of the hosts not responding to messages in a timely fashion.

29.9.14 TBC Tuning – Adjust

Display Item	Description
Watchdog Timeout (s)	The number of seconds before the card will reset itself. If this setting is changed to 0, then the card will never timeout while waiting for a timeout of a watchdog message between the TBC and Peripheral Component Interconnect (PCI) card. Default = 11 s.
Transmit Timeout (ms)	The number of milliseconds the TBC will wait for an acknowledgement following transmission before timeout. Default = 500 ms. Minimum 10 ms, Maximum 65535 ms.
High-Level Ack. Timeout (ms)	The number of milliseconds before the TBC timesouts when waiting for a reply from another TBC. Default = 1000 ms. Minimum 1000 ms, Maximum 65535 ms.
Reset Statistics	Select this checkbox to reset the statistics.
Transmit Retries	The number of times the TBC will send the same message before timeout. Default = 20, Minimum 1, Maximum 999.
Receive Messages	The number of messages of the same type received by the TBC before it considers the communication dead. If the TBC is slow to get back to the firmware, this number should be increased. Default = 24. Minimum 1, Maximum 999.
Update Time (s)	The interval in seconds between updating the statistics. Default = 10 ms. Minimum 5 ms, Maximum 99 seconds.

30. MERCURY VIRTUAL PANEL WEB SERVER

30.1 OVERVIEW

The Virtual Panel Web Server is a middleware application used to connect the Talkback Controller (TBC) to a Virtual Panel. It should only be installed if using Virtual Panels. Only one instance is needed per host. It can be deployed on all Host types: MIU and MCU.

The Web Server only permits connections from specific Internet Protocol (IP) addresses. The addresses which the Web Server will or will not recognize (allow/block lists) are defined at host level. These addresses are separate to and independent of the host-level IP allow/block lists. Refer to the Configuration Editor – Hosts and the Host Editor section of this User Guide for more information on Web Server allow/block lists.

Mercury software is installed before delivery in line with customer requirements but if it is necessary to re-install the software, please see section 6 - *Mercury Software and Installation*.

30.2 USING THE WEB SERVER

The Web Server comprises two components:

- Windows service which starts automatically on start-up.
- GUI application which also runs automatically from a shortcut placed in the Windows Start-Up folder during installation and is normally minimized to the System Tray.

The GUI application is used by the System Administrator to:

- View a list of clients (panels) currently connected to this server.
- Check the current status of the web server.
- View a log of events, for example, starting and stopping the service, connecting and disconnecting clients.
- Specify settings (see page).

Normally, you will not have to make any changes to the settings – they will be defined during installation.

The GUI provides visibility of the web server; if the GUI is shut down you will not be able to view the web server status or make changes to your web server settings. If the GUI is shut down, the web server itself is still running as a service and any connected client panels will function as normal.

30.2.1 Closing and Restoring the Web Server GUI

The GUI application will be started automatically, via a shortcut to the application in the Windows Start-Up menu, added during installation.

Closing the GUI application does not affect the Web Server which always runs as a Windows service. The GUI icon always appears in the system tray and the GUI may be displayed by right-clicking the icon and selecting **Restore**.

NOTE: If inadvertently shut down, to re-start the Web Server GUI application, click on Virtual Panel Web Server in the Windows Start-up menu.

30.2.2 Starting and Stopping the Web Server Service

The web server is installed to run as a service. This can be started or stopped manually if required.

NOTE: You should not have to start and stop the service during normal operations.

To manually start or stop the Web Server (service):

- Go to Control Panel >> Administrative Tools >> Services.
- Scroll down and highlight Trilogy Virtual Panel Web Server.
- Click Start the service or Stop the service as appropriate.
- An additional link provides a service re-start: stop followed immediately by start.

30.3 WEB SERVER INTERFACE

The Virtual Panel Web Server menu options are described in this section.

Virtual Panel Web Server | Server Menu

Menu option	Description
Reload Config	Reloads the configuration information and restarts the Virtual Panel Web Server.
Reset	Forces the Virtual Panel Web Server to reset using the currently cached configuration data.
Start/Stop Server	“Resume” or “Suspend” the server. This action does not start or stop the underlying service but has the same effect. Requests from Virtual Panels are ignored when the Web Server is stopped in this way.
Close	Minimizes the Web Server GUI to the system tray.
Shutdown	Exit and shut down the Web Server GUI. This does not affect the underlying service.

Virtual Panel Web Server | Setup Menu

Menu option	Description
Database Settings...	Opens the Database Settings dialogue.
Preferences...	Opens the Preferences dialogue.

Virtual Panel Web Server | Help Menu

Menu option	Description
About	Displays version information for the application and the product.

30.4 MESSAGE LOGGING

The Message Logging feature enables application log views. Note that this is separate from the logging options enabled within the Configuration Editor.

30.4.1 Enabling Message Logging

Message logging can be enabled to capture messages from the browser to Web Server, from the Web Server to the browser, from the Java engine to the Web Server and Web Server to Java engine.

To enable message logging:

- Right-click on the **Virtual Panel Web Server** icon in the System Tray and select **Restore** to restore to your desktop (if necessary).
- Select the Socket Messages tab.

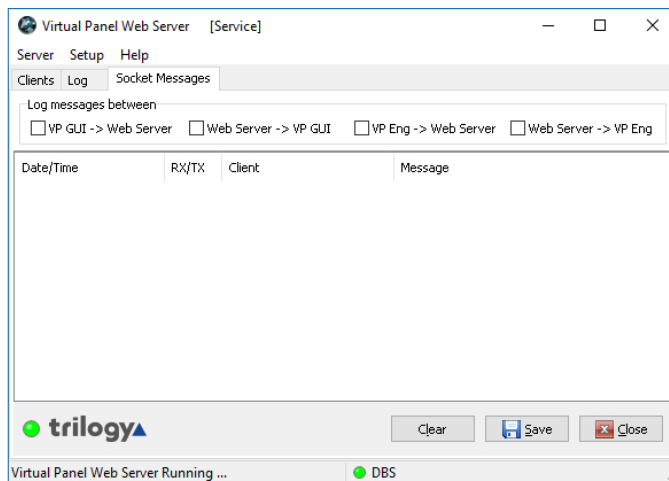

- Choose the type of messages you want to log, by selecting the appropriate checkboxes. More than one option can be enabled. Refer to section 30.9.7 for an explanation of the logging options.

30.5 PREFERENCES AND SUPERVISOR SETTINGS

The Preferences and Supervisor Settings should not normally need to be changed. You may need to change the Supervisor Settings if you install the Mercury database on another machine or change the EDHS address of the host. Right-click on the Virtual Panel Web Server icon and select **Restore** to restore the Web Server GUI to your desktop.

30.5.1 Changing Database Preferences

Database preferences specify timeouts for connection to the database.

On the Virtual Panel Web Server Setup menu, select **Preferences...** to open the dialogue.

Change the database connection preferences, as required. Refer to section 30.9.1 for an explanation of the fields on this tab.

Click **OK** to save the changes.

30.5.2 Changing Supervisor Settings

The Virtual Panel Web Supervisor Settings specify the location of the database, the EDH address of the host, and the interface and port for the Web Server. You should not need to change these unless you install a database on another machine or change the EDH address of the host.

On the Setup menu, select **Supervisor ...** to open the dialogue.

The **Database** tab is selected by default. Make the required changes to the database settings. Refer to section 30.9.2 for a description of the information displayed on this tab.

Continue to the next tab or click **OK** to save the changes.

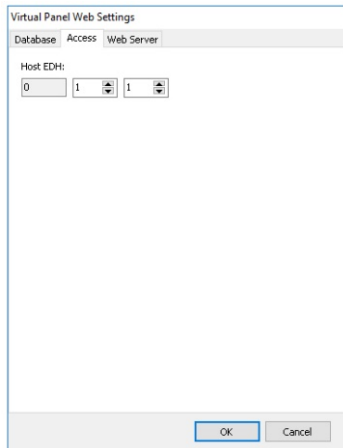

Click the **Access** tab.

The EDHS address is specified when the host software is installed and will not normally need to be changed. Refer to section 30.9.3 for more information on the available fields.

Continue to the next tab or click **OK** to save the changes.

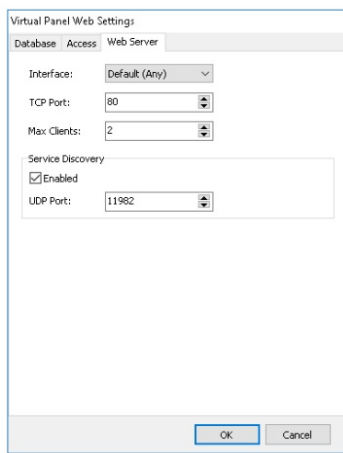

The settings specify the TCP port that the server listens on for clients and the maximum number of clients that can connect to the Web Server. Service Discovery relates to Android/iOS Virtual Panels only.

Refer to section 30.9.4 for a description of the settings that can be changed.

Click **OK** to save the changes.

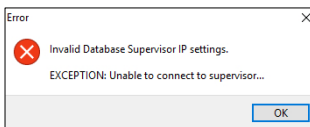

If the settings are incorrect, this error will be displayed.

Click **OK** on this dialogue and review the database settings. If you still cannot connect to the database, ensure that the Database Supervisor is running and that the IP address or hostname is correct.

30.6 WEB SERVER CLIENT LIST

The **Clients** tab on the Virtual Panel Web Server is selected by default and displays the IP addresses of attached clients. Refer to section 30.9.5 for a description of the information displayed on this tab.

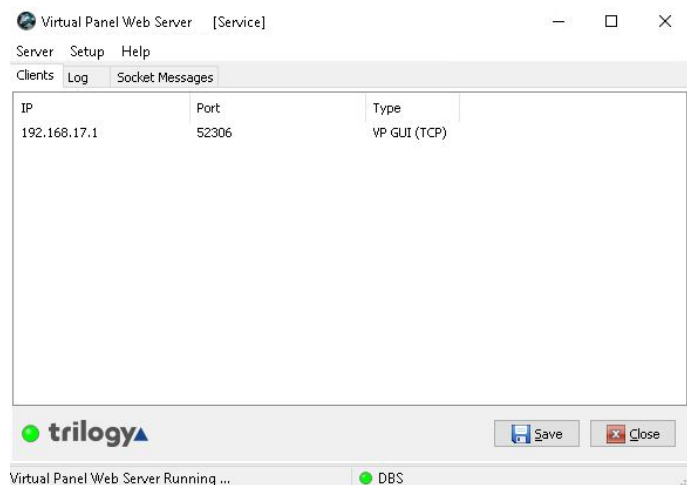

30.7 WEB SERVER EVENT LOG

Click the **Log** tab. The Web Server Log displays details of the various processes and activities related to the Virtual Panel Web Server. Refer to section 30.9.6 for a description of the information displayed on this tab.

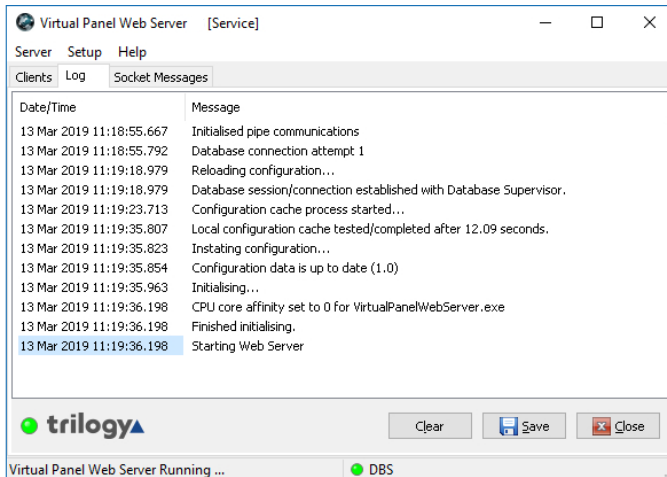

30.7.1 Clearing and Saving the Web Server Log

The event log can be cleared if required.

To clear the Web Server Event Log:

- Open the Web Server Event Log.
- Click **Clear** to clear the log.

To save the Web Server Event Log:

- Open the Web Server Event Log.
- Click **Save** to open the normal Windows Save dialogue.
- Select a location and enter a filename to complete the process.

30.8 WEB SERVER SOCKET MESSAGES

Click the **Socket Messages** tab. The tab shows any messages received or transmitted by the Web Server. Refer to section 30.9.7 for a description of the information displayed on this tab.

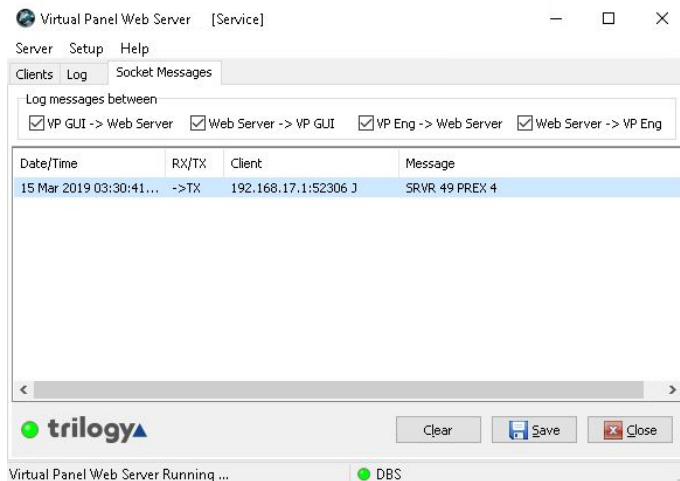

30.8.1 Clearing and Saving the Socket Messages Log

The socket messages log can be cleared if required.

To clear the socket messages log:

- Open the socket messages log.
- Click the **Clear** button to clear the log.

To save the socket messages log:

- Open the socket messages log.
- Click **Save** to open the normal Windows Save dialogue.
- Select a location and enter a filename to complete the process.

30.9 WEB SERVER - FIELD DEFINITIONS**30.9.1 Web Server Preferences – General**

Field/Display Item	Description
Setup Timeout (s)	The time in which the Web Server will time out on a connection to the Database Supervisor. Available options are: Never Windows TCP timeout Numerical Value in seconds Override windows timeout. Default = 10 s. Range 1–60 s.
DB Connect Retry Timeout (s)	Specifies the database connection retry timeout. Default = 4 s. Range 1–5 s.
DB Connect Retry Count	Specifies the number of times a database connection will be retried if not successful. Default = 4. Range 0–5.
Reload Configuration on Start-Up	Check the box to Reload Configuration on Start-Up.
Max. Log Lines	The maximum number of lines shown in the log window before truncation. Default = 1. Range = 1–1000.
Enable Online LEDs	Keys on a virtual panel display an "online LED" as part of the key graphics, if the source for that key is also a virtual panel. <ul style="list-style-type: none"> • If the supervisor is not running, the LED is grey. • If the supervisor is running and the virtual panel for the key's source is online, the LED is green, else it is red. For some customer scenarios, the supervisor is not running. In this case, display of the "online LED" may be disabled, as the grey LED would indicate that something is not working correctly. Default = checked.

30.9.2 Web Server Settings: Database

Field	Description
Offline Mode (Local File Database)	Select this radio button if the database is running locally. You will need to specify the location of the database files.
Online Mode (Database Supervisor)	Select this radio button if the database is located on a remote PC (specified in the Fixed IP or Host Name field).
IP Address Mode	Radio buttons select the mode of the IP connection to the PC hosting the database. Select either Fixed IP or Host Name .
IP Address	This field is used to specify the static IP address of the PC hosting the database. This is the preferred method.
Host Name	This field is used to specify the name of the PC hosting the database. It must be completed if the database is hosted on a PC with an IP address that is assigned by DHCP. This method is not recommended.
Data Port	The IP port that the DB Master (or Slave) uses for data connections. Changing this value changes the IP port number on which the database accepts incoming connections. This needs to be changed if: IP Port 12005 is in use elsewhere on the network by another application. Network security deems that another port should be used, or Network Address Translation /Port Address Translation (NAT/PAT) requires that another port is used. Changing this value also means that all clients (including slaves) must be configured to connect to the new port value. Default = 12005
Supervisor Port	The IP port on which the Database listens for connection control data. Changing this value changes the IP port number on which the database accepts incoming connections. This must be changed if: IP Port 13001 is in use elsewhere on the network by another application. Network security deems that another port should be used, or NAT/PAT requires that another port is used. Changing this value also means that all clients (including slaves) must be configured to connect to the new port value. Default = 13001
Compression	Compresses each transaction exchanged between server and clients by an adjustable amount. Useful on networks with limited bandwidth. The asterisk on the scale is a suggested starting point, giving a good compromise between CPU usage (to compress the data) and bandwidth saved.

30.9.3 Web Server Settings: Access

Field/Display Item	Description
Domain	The ID of the domain. This must match the ID specified in the Configuration Editor.
Host	The ID of the host. This must match the ID specified in the Configuration Editor.

30.9.4 Web Server Settings: Web Server

Field/Display Item	Description
Interface	The network interface on which the Web Server will listen. This is used in multi-homed systems.
TCP Port	The listen TCP port through which the web browser connects to the Web Server. The default listen port is 80. This port may be blocked by antivirus software which prevents the Virtual Panel applet from running. If this occurs, either change the port to something other than 80 or add an exception if your antivirus software allows you to do so.
Max clients	The maximum number of clients that are accepted by the Web Server.
Service Discovery	Android/iOS VPs can automatically connect to a VP Web Server if Service Discovery is enabled in the Web Server. The remote VPs also need to be configured for service discovery and define a common UDP port. [Enabled (Default = checked) UDP Port (Default = 11982)]

30.9.5 Web Server Client List

Field/Display Item	Description
IP	The IP address of the connected Virtual Panel.
Port	The port number.
Type	The type of connection.

30.9.6 Web Server Event Log

Field/Display Item	Message
Date/Time	Displays the date and time of the log entry.
Message	Displays the log entry.

30.9.7 Web Server Socket Messages

Field/Display Item	Description
VP GUI-> Web Server	Logs messages sent from the VP GUI to the Web Server.
Web Server -> VP GUI	Logs messages sent from the Web Server to the VP GUI.
VP Eng -> Web Server	Logs messages sent by the Virtual Panel engine to the Web Server.
Web Server -> VP Eng	Logs messages sent from the Web Server to the Virtual Panel engine.

Field/Display Item	Description
Date/Time	The date and time of the message.
RX/TX	Indicates whether the message was received (RX) or sent (TX).
Client	The client that sent the message.
Message	The message text.

31. TECHNICAL DATA | MIU | 700-25-06

31.1 INTRODUCTION

The MIU offers the highest capacity of the available hosts. It acts as a versatile audio processing unit and IP gateway which allows a wide range of external devices to be connected.

This User Guide includes information regarding MIU models 700-25-06 and 700-25-04. Full details for the 700-25-04 are in section 32. For information about earlier variants, please contact Trilogy. The 700-25-06 was introduced in 2019, with an updated motherboard, CPU and additional RAM. Windows 10 is the only supported operating system.

31.2 SPECIFICATION

Integrated User Interface	Virtual Panel (optional installation)
Operating System	Windows 10 64-bit.
Input / Output Connections (Standard)	<p>Auxiliary Audio: Mic In, Headphone Out on the front panel; Line In, Aux Out on the rear panel.</p> <p>PS/2 Ports: Two (2) for keyboard and mouse (used for setup only).</p> <p>Serial Ports: Three (3) (2 RS-232, 1 RS-232/422).</p> <p>Graphics: SVGA (800x600 or better) - used for set-up only.</p> <p>USB Ports: Two (2) USB 2.0 Series A sockets. (1 front, 1 rear).</p> <p>Ethernet: Mode 1: 2 x Independent Connections (NET and AUX.NET) for control of voice traffic; Mode 2: 1 x Combined Connection (AUX.NET) via internal switch.</p>
Physical Characteristics	<p>Height: 89 mm or 3.5 in.</p> <p>Depth: 370 mm or 14.5 in excluding connectors and power supply handle; 408 mm or 16 in including connectors and power supply handle.</p> <p>Width: 483 mm or 19.01 in including rackmount ears; 450 mm or 17.01 in excluding rackmount ears.</p> <p>Weight: Up to 6 kg or 13.5 lbs. fully equipped.</p>
Electrical Characteristics	<p>125W Commercial Power Supply.</p> <p>Nominal Input Voltage: 100 – 240 V AC.</p> <p>Maximum AC Input: 90 – 264 V AC.</p> <p>Frequency: 47-63 Hz.</p> <p>MTBF: 35,500 hours (see note below)</p> <p>Connector Type: IEC Mains Connector with Retainer.</p> <p>Single or (optional) dual PSU configuration. Internally Fused.</p>

Environmental Characteristics	<p>Temperature, Operating: 0 to 50 °C.</p> <p>Temperature, Non-Operational/Storage: -20 to 85 °C.</p> <p>Humidity, Operating: Relative Humidity 0 to 90 %, non-condensing.</p> <p>Altitude: 10,000 m.</p> <p>Shock: 800 g@1ms.</p> <p>Vibration: 5.0 g (22 to 500 Hz).</p>
Regulatory Compliance	<p>Emissions: EN55032:2015 & FCC CFR 47: Part 15 Class A EN 61000-3-2:2014 & EN 61000-3-3:2013</p> <p>Immunity: EN 55035:2017</p> <p>Safety: IEC 60950-1:2005/A2:2013 UL/IEC 60950-1 2nd Edition CAN/CSA C22.2 No.60950-1-07+Am1:2011 + Am2:2014 ANSI/UL 60950-1-2014</p>
GPI Input x 16	<p>Current sinking type (also referred to as ground closure type)</p> <p>Activation $\leq 1.0V$ (wrt interface system 0V); $\leq 6 K\Omega$ (contact to interface system ground)</p> <p>Deactivation $\geq 2.0V$ (wrt interface system 0V)</p> <p>Maximum input voltage +60V</p>
GPI Output x 16	<p>Opto-isolated, 8 with common ground, 8 floating type</p> <ul style="list-style-type: none"> • Max. load voltage +60 VDC • Max. load current 250 mA • Max. power dissipation 450 mW

MTBF: this is a representative figure based on the typical MIU assembly as an Operator Workstation. This configuration comprises a single AEB and a single PSU. Please contact Trilogy if you require a figure for a specific arrangement.

31.3 700-25-06 FRONT PANEL LAYOUT

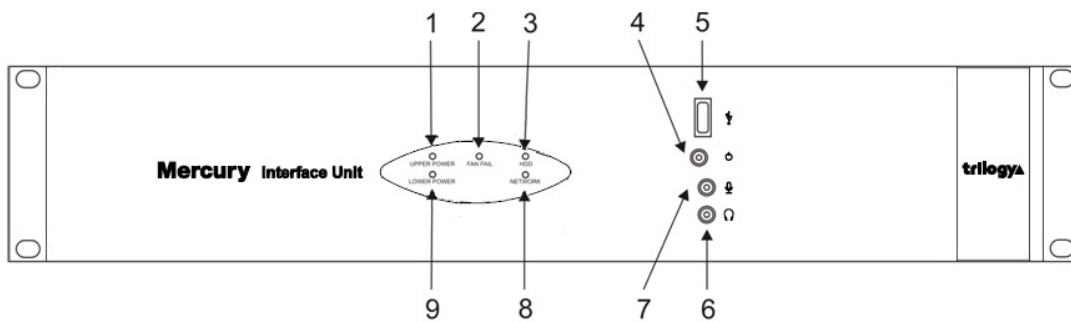

Item	Description	Control/connector type
1	Upper Power	Red = mains present, Green = system running.
2	Fan Fault Indication	Red = fan slow or halt.
3	Hard Disk Activity	Yellow.
4	Shutdown / Restart	Push-button.
5	USB	Standard USB Series A socket.
6	Headset	3.5 mm Jack socket.
7	Microphone	3.5 mm Jack socket.
8	Network	Orange, flashing with network activity.
9	Lower Power	Red = mains present, Green = system running.

31.4 700-25-06 REAR PANEL LAYOUT

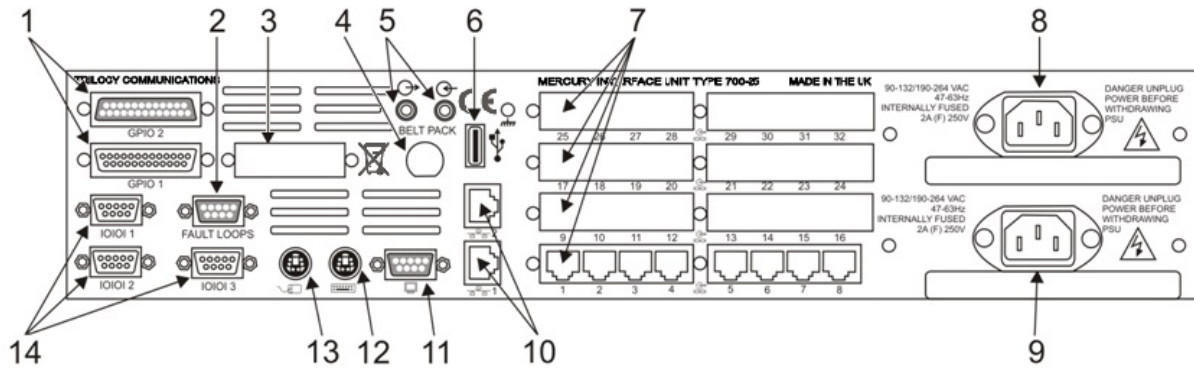

Item	Description	Control/connector type
1	GPIO 2 & GPIO 1	D25
2	Fault Loops	D9 female
3	Camera Mix Board (Optional)	
4	Belt Pack (Optional)	
5	Sound card audio	3.5 mm Jack socket.
6	USB	Standard USB Series A socket.
7	Expansion Boards	Up to four (4) boards may be fitted.
8	Second Mains Input	IEC
9	First Mains Input	IEC
10	Network 1 and 2	RJ45 8P8C; 10/100Base-TX.
11	Monitor SVGA	D15 high-density female.
12	Keyboard	PS/2.
13	Mouse	PS/2.
14	Serial	Three (3) serial ports; two (2) RS232 and one (1) RS232/422 on D9 male connectors.

31.5 700-25-06 - REAR PANEL – CONNECTORS**Fault Loop**

A single fault loop output is provided on a D9 female chassis mounted connector. Both power supplies and the internal fan are monitored. The state of this fault loop is defined below.

Condition	State
All OK	Short circuit (closed)
Fan Fail	Alternating open / closed
PSU 1 present but failed	Open circuit
PSU 2 present but failed	Open circuit

If a power supply is not physically present in the MIU chassis, this does not contribute to the fault condition.

D9 Chassis Socket	
Pin	Function
1	Ground
2	Loop OP -
6	Loop OP +
3,4,5,7,8,9	No connection

Notes:

1. An opto-driven transistor output stage is used.
2. The output is rated 40V, 160mA. Do not exceed!

700-25-06 GPI Connections – Inputs

D25 chassis plug			
Pin	Input	Pin	Input
1	0	14	1
2	2	15	3
3	4	16	5
4	6	17	7
5	Com 0 V	18	NC
6	6	19	9
7	10	20	11
8	12	21	13
9	14	22	15
10	Com 0 V	23	NC
11	Com 0 V	24	Com 0 V
12	+5 V Out	25	Com 0 V
13	+5 V Out		

Notes:

1. All pins labelled “NC” are not connected internally.
2. An Opto input is “made” by connecting the pin to 0 V.

700-25-06 GPI Connections – Outputs

Pin	Output	Pin	Output
1	OP 0	14	OP 1
2	OP 2	15	OP 3
3	OP 4	16	OP 5
4	OP 6	17	OP 7
5	0 V	18	OP 8 -ve
6	OP 8 +ve	19	OP 9 -ve
7	OP 9 +ve	20	OP 10 -ve
8	OP 10 +ve	21	OP 11 -ve
9	OP 11 +ve	22	OP 12 -ve
10	OP 12 +ve	23	OP 13 -ve
11	OP 13 +ve	24	OP 14 -ve
12	OP 14 +ve	25	OP 15 -ve
13	OP 15 +ve		

Note: All pins labelled “NC” are not connected internally.

Auxiliary Power Output Option

Auxiliary power, suitable for Trilogy wired Beltpacks, may be provided on the rear of each MIU. It is not fitted to the MIU by default and should be specified as part of the original purchase request. See section 33.6 - *Auxiliary Power Output Option - 700-25-112*.

6 Channel DA/Mixer Option

This optional board provides a mixing pad for up to 6 inputs from external devices, plus a 6-output audio distribution amplifier to supply talkback to a group of cameras or similar third-party devices. It is not fitted to the MIU by default and should be specified as part of the original purchase request.

The option is only available if the MIU is fitted with at least one 700-11-01 AEB. See section 33.7 - *6 Channel Mixer / DA Option - 700-10-00*.

700-25-06 - Rear Panel - Standard Connectors

All other rear panel connections follow established PC standards as outlined in the table below.

Function	Connector	Detail
Fast Ethernet	RJ45 8P8C	10/100Base-TX
VGA Video	D15 high-density female	VESA DDC standard
Serial Communication	D9 male (qty. 3)	RS232C 16550 UART compatible.
USB	Type-A USB receptacle	USB 2.0
Mains Input	IEC	

32. TECHNICAL DATA | MIU | 700-25-04

32.1 INTRODUCTION

The MIU offers the highest capacity of the available hosts. It acts as a versatile audio processing unit and IP gateway which allows a wide range of external devices to be connected.

This User Guide includes information regarding MIU models 700-25-06 and 700-25-04. Full details of the 700-25-06 are in section 31. For information about earlier variants, please contact Trilogy.

32.2 SPECIFICATION

Integrated User Interface	Virtual Panel (optional installation)
Operating System	Windows 10 64-bit (preferred). Windows 7 32 bit or Windows XP
Input / Output Connections (Standard)	<p>Auxiliary Audio: Mic In, Headphone Out on the front panel; CD In, Aux Out on the rear panel.</p> <p>PS/2 Ports: Two (2) for keyboard and mouse (used for setup only).</p> <p>Serial Ports: Three (3) (2 RS-232, 1 RS-232/422).</p> <p>Graphics: SVGA (800x600 or better) - used for set-up only.</p> <p>USB Ports: Two (2) USB 2.0 Series A sockets. (1 front, 1 rear).</p> <p>Ethernet: Mode 1: 2 x Independent Connections (NET and AUX.NET) for control of voice traffic; Mode 2: 1 x Combined Connection (AUX.NET) via internal switch.</p>
Physical Characteristics	<p>Height: 89 mm or 3.5 in.</p> <p>Depth: 370 mm or 14.5 in excluding connectors and power supply handle; 408 mm or 16 in including connectors and power supply handle.</p> <p>Width: 483 mm or 19.01 in including rackmount ears; 450 mm or 17.01 in excluding rackmount ears.</p> <p>Weight: Up to 6 kg or 13.5 lbs. fully equipped.</p>
Electrical Characteristics	<p>125W Commercial Power Supply.</p> <p>Nominal Input Voltage: 100 – 240 V AC.</p> <p>Maximum AC Input: 90 – 264 V AC.</p> <p>Frequency: 47-63 Hz.</p> <p>MTBF: 40,000 hours (see note below)</p> <p>Connector Type: IEC Mains Connector with Retainer.</p> <p>Single or (optional) dual PSU configuration.</p> <p>Internally Fused.</p>

Environmental Characteristics	<p>Temperature, Operating: 0 to 50 °C.</p> <p>Temperature, Non-Operational/Storage: -20 to 85 °C.</p> <p>Humidity, Operating: Relative Humidity 0 to 90 %, non-condensing.</p> <p>Altitude: 10,000 m.</p> <p>Shock: 800 g@1ms.</p> <p>Vibration: 5.0 g (22 to 500 Hz).</p>
Regulatory Compliance	<p>Emissions: EN55022:2006 incl. A1:2007 & A2:2010 EN55022:2010 & FCC CFR 47:Part 15:2013 Class A EN 61000-3-2:2006 incl. A1/A2: 2009 Class A EN 61000-3-3:2008</p> <p>Immunity: EN 55024:2010 / CISPR 24:1997</p> <p>Safety: IEC 60950-1:2005/A2:2013 UL/IEC 60950-1 2nd Edition CAN/CSA C22.2 No.60950-1-07+Am1:2011 + Am2:2014 ANSI/UL 60950-1-2014</p>
GPI	<p>GPI expansion fitted – 16 inputs plus 16 outputs via optional internal expansion board.</p> <p>No GPI expansion fitted - wired directly to the Mercury card and presents only 2 inputs plus 2 outputs.</p>

MTBF: this is a representative figure based on a typical MIU assembly as an Operator Workstation. This configuration comprises a single AEB a single PSU and DSP expansion. Please contact Trilogy if you require a figure for a specific arrangement.

32.3 700-25-04 FRONT PANEL LAYOUT

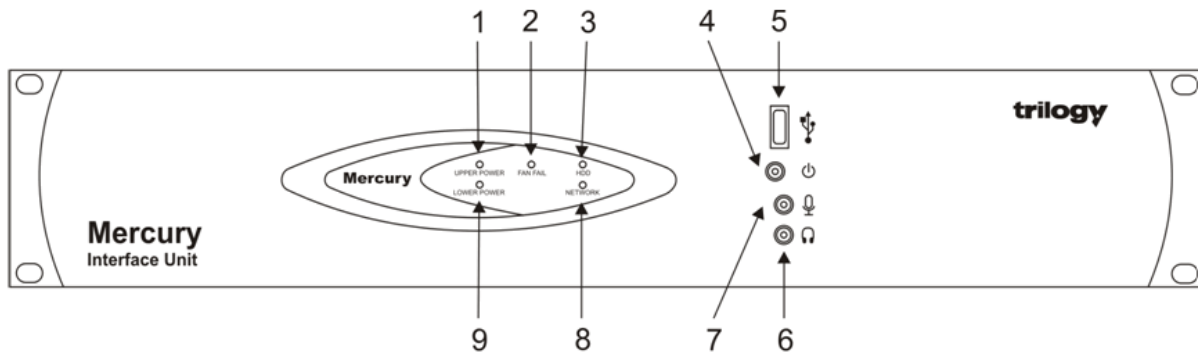

Item	Description	Control/connector type
1	Upper Power	Red = mains present, Green = system running.
2	Fan Fault Indication	Red = fan slow or halt.
3	Hard Disk Activity	Yellow.
4	Shutdown / Restart	Push-button.
5	USB	Standard USB Series A socket.
6	Headset	3.5 mm Jack socket.
7	Microphone	3.5 mm Jack socket.
8	Network	Orange, flashing with network activity.
9	Lower Power	Red = mains present, Green = system running.

32.4 700-25-04 REAR PANEL LAYOUT

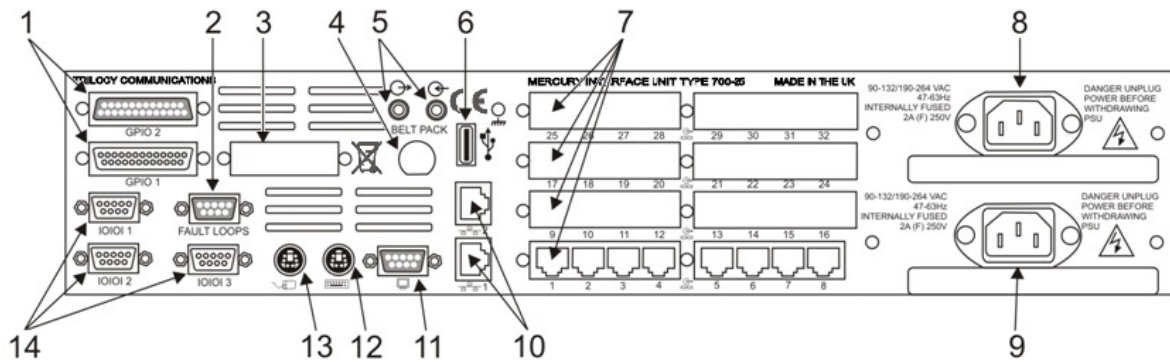

Item	Description	Control/connector type
1	GPIO 2 & GPIO 1	D25
2	Fault Loops	D9 female
3	Camera Mix Board (Optional)	
4	Belt Pack (Optional)	
5	Sound card audio	3.5 mm Jack socket.
6	USB	Standard USB Series A socket.
7	Expansion Boards	Up to four (4) boards may be fitted.
8	Second Mains Input	IEC
9	First Mains Input	IEC
10	Network 1 and 2	RJ45 8P8C; 10/100Base-TX.
11	SVGA	D15 high-density female.
12	Keyboard	PS/2.
13	Mouse	PS/2.
14	Serial	Three (3) serial ports; two (2) RS232 and one (1) RS232/422 on D9 male connectors.

32.5 700-25-04 - REAR PANEL – CONNECTORS**Fault Loop**

A single fault loop output is provided on a D9 female chassis mounted connector. Both power supplies and the internal fan are monitored. The state of this fault loop is defined below.

Condition	State
All OK	Short circuit (closed)
Fan Fail	Alternating open / closed
PSU 1 present but failed	Open circuit
PSU 2 present but failed	Open circuit

If a power supply is not physically present in the MIU chassis, this does not contribute to the fault condition.

D9 Chassis Socket	
Pin	Function
1	Ground
2	Loop OP -
6	Loop OP +
3,4,5,7,8,9	No connection

Notes:

1. An opto-driven transistor output stage is used.
2. The output is rated 40V, 160mA. Do not exceed!

700-25-04 GPI Connections – Inputs – Default (no GPI expansion option)

D25 Chassis Socket	
Pin	Function
6	GP In 1
13	Supply Out (+5V)
19	GP In 2
23	Supply In (+5V)
25	GP In Common
All Other	No connection

Notes:

1. Join pins 13 and 23 to locally power the logic inputs.
2. Short pin 6 to 25 to activate logic input 1.
3. Short pin 19 to 25 to activate logic input 2.

700-25-04 GPI Connections – Outputs – Default (no GPI expansion option)

D25 Chassis Socket	
Pin	Function
6	GP Out 1 +
7	GP Out 2 +
18	GP Out 1 -
19	GP Out 2 -
All Other	No connection

Notes:

1. Opto-driven transistor outputs are used. Correct polarity must be maintained.
 2. Outputs are rated 40V, 160mA. Do not exceed!
 3. Connect pin labelled 'Out -' to ground (normally*).
 4. Connect pin labelled 'Out +' to the input of external equipment, to be grounded.
- * Alternatively, connect pin labelled 'Out +' to external Power and Connect pin labelled 'Out -' to load to be driven (with the other side of load connected to ground).*

For details of the optional GPI expansion board, see section 33.8 - *General Purpose Interface Card 700-12-01 (700-25-04 MIU Only)*.

Auxiliary Power Output Option

Auxiliary power, suitable for Trilogy wired Beltpacks, may be provided on the rear of each MIU. It is not fitted to the MIU by default and should be specified as part of the original purchase request. See section 33.6 - *Auxiliary Power Output Option - 700-25-112*.

6 Channel DA/Mixer Option

This optional board provides a mixing pad for up to 6 inputs from external devices, plus a 6-output audio distribution amplifier to supply talkback to a group of cameras or similar third-party devices. It is not fitted to the MIU by default and should be specified as part of the original purchase request.

The option is only available if the MIU is fitted with at least one 700-11-01 AEB. See section 33.7 - *6 Channel Mixer / DA Option - 700-10-00*.

700-25-04 - Rear Panel - Standard Connectors

All other rear panel connections follow established PC standards as outlined in the table below.

Function	Connector	Detail
Fast Ethernet	RJ45 8P8C	10/100Base-TX
VGA Video	D15 high-density female	VESA DDC standard
Serial Communication	D9 male (qty. 3)	RS232C 16550 UART compatible.
USB	Type-A USB receptacle	USB 2.0
Mains Input	IEC	

33. TECHNICAL DATA | MIU | OPTIONS

The following option boards are currently available and up to 4 may be fitted to each MIU.

Option	Description
700-11-01	Audio Expansion Board (AEB), 8 channel
700-15-02	Telephone Expansion Board, E&M, 4 channel
700-15-03	Telephone Expansion Board, FXO, 4 channel
700-15-04	Telephone Expansion Board, FXS, 4 channel
700-16-03	Radio Interface Board (RIB), 8 channel (STD or ASF)

Option boards may be mixed and matched in any order within an MIU.

The Auxiliary Power Output Option - 700-25-112 and 6 Channel Mixer / DA Option - 700-10-00 are normally factory fitted; see sections 33.6 and 33.7.

For details of the optional GPI expansion board for the 700-25-04 MIU, see section 33.8 - *General Purpose Interface Card 700-12-01 (700-25-04 MIU Only)*.

33.1 AUDIO EXPANSION BOARD – 700-11-01

This module can be added to an MIU to provide 8 channels, capable of interfacing to 4-wire Analogue audio sources, and/or Mercury control panels. Each RJ45 connector provides balanced audio plus RS422 data for control panels. Software configurable input and output gain control is provided for each channel independently.

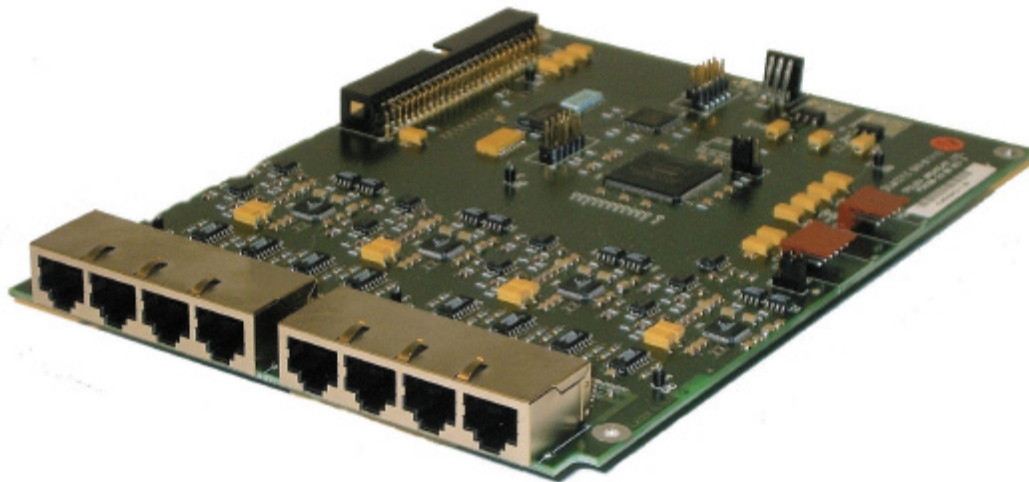

Specifications

Part Number	700-11-01
Maximum Number of Hardware Panels	Eight (8).
Maximum Number of Audio Expansion Boards per MIU	Four (4) for a total of 32 ports.

Audio Input	<p>Type: Balanced Audio on (8) RJ45 connectors.</p> <p>Input Impedance: Greater than 10 KΩ.</p> <p>Nominal Input Level: 0 dB.</p> <p>Maximum Input Level: +20 dB.</p> <p>Input Level Adjustment: Input adjustment, via software, allows input gain to be adjusted over the range of -9 dB to +12 dB.</p> <p>Absolute max input: Common Mode +/- 15 V.</p> <p>Voltage: Differential +/- 28 V.</p>
Audio Output	<p>Type: Electronically balanced audio on (8) RJ45 Connectors.</p> <p>Output Impedance: Less than 20 Ω.</p> <p>Nominal Output Level: 0 dB.</p> <p>Maximum Output Level: +20 dB.</p> <p>Output Level Adjustment: Output adjustment, via software, allows the gain to be adjusted over the range of +12 dB to -34.5 dB; mute option.</p>
Frequency Response	-3 dB points: Less than 25 Hz and greater than 3200 Hz (8 kHz sampling); Less than 25 Hz and greater than 6600 Hz (16 kHz sampling).
Distortion (THD + Noise)	< 0.05%.
Noise	< -65 dB un-weighted.
Panel Data	<p>Type: RS422 balanced data, direct-coupled.</p> <p>Data Rate: 230.4 kBaud, 8 data bits, 2 stop bits, 1 start bit, no parity.</p> <p>Protocol: Proprietary.</p> <p>Recommended Cable Type: Cat5e UTP.</p> <p>Max Cable Length: 300 meters.</p>
MTBF	355,000 hours.

RJ45 Pinout

Pin	Function	Pin	Function
1	RS422 Data In+	5	Audio In+
2	RS422 Data In-	6	RS422 Data Out-
3	RS422 Data Out+	7	Audio Out+
4	Audio In-	8	Audio Out-

33.2 RADIO INTERFACE BOARD – 700-16-03

This module can be added to MIU to provide eight channels capable of interfacing to radio devices. Each RJ45 connector provides balanced audio plus PTT and COR logic I/O. Each channel has independent, configurable audio delays available on both input and output of up to two (2) seconds, plus selectable audio filters.



Specifications

Part Number	700-16-03
Density	The maximum number of Radio Interface Boards per MIU is 4 (32 ports).
Audio Input	<p>Type: Balanced Audio on (8) RJ45 connectors.</p> <p>Input Impedance: Greater than 10 KΩ.</p> <p>Nominal Input Level: 0 dBu.</p> <p>Maximum Input Level: +20 dBu.</p> <p>Input Level Adjustment: Input adjustment, via software, allows input gain to be adjusted over the range of -29 dB to +12 dB.</p> <p>Audio Delay: Independent software adjustment on each channel 0-2000 ms in 25 ms steps.</p> <p>Filters: Audio inputs have selectable filters giving 3, 6 or 9 dB cut or boost at 3 kHz.</p>
Audio Output	<p>Type: Electronically balanced audio on (8) RJ45 connectors.</p> <p>Output Impedance: Less than 60 Ω.</p> <p>Output Level Adjustment: Output adjustment, via software, allows the gain to be adjusted over the range of +12 dB to -54 dB.</p> <p>Audio Delay: Independent software adjustment on each channel 0-2000 ms in 25 ms steps.</p>
Frequency Response	-3 dB points: Less than 25 Hz and greater than 3200 Hz (8 kHz sampling); Less than 25 Hz and greater than 6600 Hz (16 kHz sampling).

Distortion (THD + Noise)	< 0.05%.
Noise	< -65 dB un-weighted.
COR / Retransmit (GPI Input)	<p>Polarity: Software selectable.</p> <p>Type: Grounding contact - external equipment must provide ground closure.</p> <p>Input Voltage Range, "On": Less than 3.5 V wrt MIU 0 V.</p> <p>Input Voltage Range: Greater than -10 V, less than +60 V.</p> <p>Current drawn when input grounded: Less than 2 mA.</p> <p>Debounce (Attack) Time: Adjustable 0 – 19999 ms in 1 ms steps.</p>
PTT (GPI Output)	<p>Polarity: Software selectable.</p> <p>Type: Open drain - Radio Interface Board provides ground closure.</p> <p>Absolute Maximum Voltage: +60 V.</p> <p>Max Current: 150 mA.</p> <p>Hold Time: 0-5000 ms in 1 ms steps.</p>
VOX	<p>General: All audio inputs can use VOX rather than PTT, software selectable.</p> <p>Attack Time: Software adjustable 10-5000 ms in 1 ms steps.</p> <p>Release (Hang) Time: 750-5000 ms in 1 ms steps.</p> <p>Threshold: Software adjustable -10 to -50 dB.</p>
MTBF	121,000 hours.

RJ45 Pinout

Pin	Function	Pin	Function
1	COR (GPI) Input.	5	Audio In+.
2	COR/PTT Ground.	6	Audio Ground.
3	PTT (GPI) Output.	7	Audio Out+.
4	Audio In- (Must be grounded if unbalanced audio used).	8	Audio Out- (Must be grounded if unbalanced audio used).

33.3 TELEPHONE EXPANSION BOARD, E&M – 700-15-02

The Ear & Mouth (E&M) TEB provides:

- 4 x RJ45 E&M central office or trunk ports to connect to Private Branch Exchange (PBX)/line devices.
- Software selectable E&M type I, II, III, IV and V signalling (including BT SSDC5).

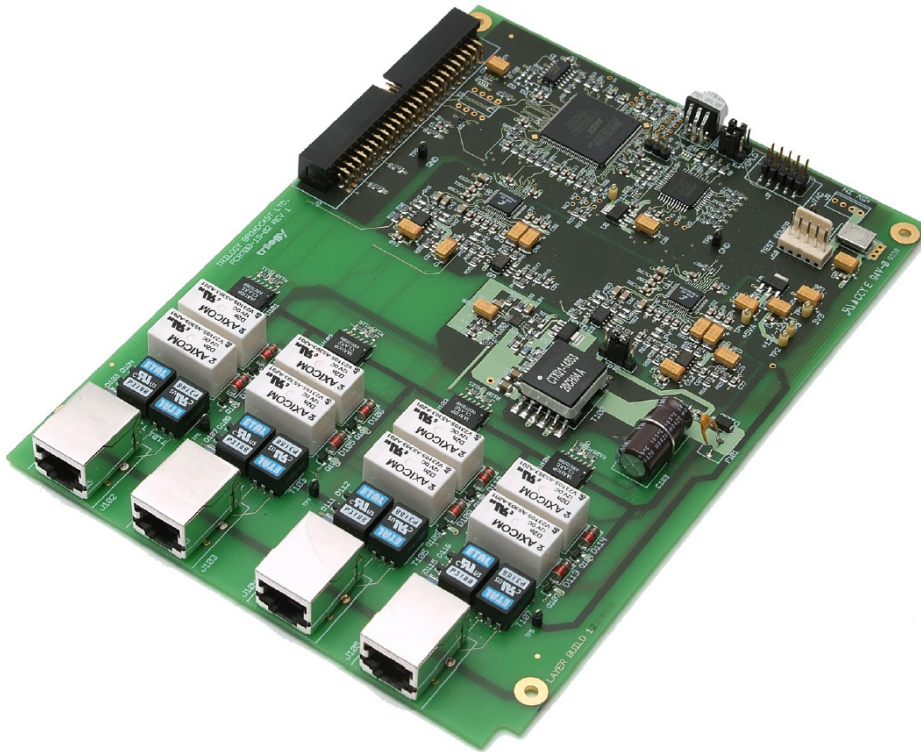

NOTE: This card generates -48 V for ring voltage. Power consumption estimate is less than 10 W.

RJ45 Pinout

Pin	Pin name
1	SB
2	M
3	R
4	R1
5	T1
6	T
7	E
8	SG

Internal Connectors

J9	Power In
1	+5V
2	+5V
3	0V
4	0V
J2	JTAG and Programming Port.
J1	50 Way interface to MIU.

33.4 TELEPHONE EXPANSION BOARD, FXO – 700-15-03

The Foreign Exchange Office (FXO) TEB provides:

- 4 x RJ12 FXO POTS ports to be connected to central office.
- 4 x RJ12 FXS POTS ports which (in the event of a power failure) will connect to the adjacent FXO port to enable emergency dial-out capability.
- Software Selectable Loop Start or Ground Start Signalling.
- Software Selectable Telephony Termination (CTR21, 600R, 900R, Japan).



NOTE: This card generates -48 V for ring voltage. Power consumption estimate is less than 10 W . When the MIU is off, the phone is linked directly to the line if connected. When the MIU is on, it can seize the line from the phone. If power fails, calls can still be made as the phone defaults to “connected”.

RJ12 Pinout

Pin	Function/Pin Name
1	NC
2	NC
3	Ring (Switched on phone connector)
4	Tip (Switched on phone connector)
5	NC
6	NC

All pins labelled “NC” are not connected internally.

Internal Connectors

J9	Power In
1	+5 V
2	+5 V
3	0 V
4	0 V
J2	JTAG and Programming Port.
J1	50 Way interface to MIU.

33.5 TELEPHONE EXPANSION BOARD, FXS – 700-15-04

The Foreign Exchange Station (FXS) TEB provides:

- 4 x FXS RJ12 POTS ports to be connected to telephones.
- Software Selectable Loop Start or Ground Start Signalling.
- Software Selectable Telephony Termination (CTR21, 600R, 900R, Japan).
- Software Configurable Ring Frequency -Software Configurable Ring Cadence.



NOTE: This card generates –48 V for ring voltage. Power consumption estimate is less than 10 W.

RJ12 Pinout

Pin	Function/Pin Name
1	NC
2	NC
3	Ring (Switched on phone connector)
4	Tip (Switched on phone connector)
5	NC
6	NC

All pins labelled “NC” are not connected internally.

Internal Connectors

J9	Power In
1	+5 V
2	+5 V
3	0 V
4	0 V
J2	JTAG and Programming Port.
J1	50 Way interface to MIU.

33.6 AUXILIARY POWER OUTPUT OPTION - 700-25-112

Auxiliary power, suitable for Trilogy wired Beltpacks, may be provided on the rear of each MIU. It is not fitted to the MIU by default and should be specified as part of the original purchase request. Internal fuses are self-resetting.

Connector type: Chassis mounted 3 pin Hirose socket	
Pin	Function
1	+12 VDC, ± 0.5 V, fuse protected at 450 mA.
2	Ground
3	-12 VDC, ± 0.5 V, fuse protected at 200 mA.

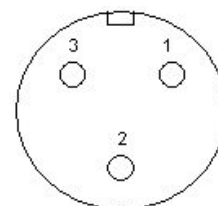

33.7 6 CHANNEL MIXER / DA OPTION - 700-10-00

This optional board provides a mixing pad for up to 6 inputs from external devices, plus a 6-output audio distribution amplifier to supply talkback to a group of cameras or similar third-party devices. It is not fitted to the MIU by default and should be specified as part of the original purchase request.

The option is only available if the MIU is fitted with at least one 700-11-01 AEB. The corresponding port is the last port of the uppermost (highest-numbered) AEB.

- Example 1: an MIU fitted with just two AEBs will have the Camera Mix port located at # 16.
- Example 2: an MIU fitted with three AEB plus a single FXO will place the Camera Mix at # 24.
- Example 3: an MIU fitted with two RIB plus two FXO – the Camera Mix is not supported.

To use the facility, the port must be configured in software as a 4 wire (audio only) circuit. Connect signals to *either* the D type connector, *or* the corresponding RJ45 matrix port, but not both.

Connector type: Chassis mounted D25 socket					
Pin	Function (audio +)			Pin	Function (audio -)
1	Screen/Chassis				
2	From Ext 1 audio +paired with.....	14	From Ext 1 audio -	MIU Input----
3	From Ext 2 audio +paired with.....	15	From Ext 2 audio -	
4	From Ext 3 audio +paired with.....	16	From Ext 3 audio -	
5	From Ext 4 audio +paired with.....	17	From Ext 4 audio -	
6	From Ext 5 audio +paired with.....	18	From Ext 5 audio -	
7	From Ext 6 audio +paired with.....	19	From Ext 6 audio -	
8	To Ext 1 audio +paired with.....	20	To Ext 1 audio -	
9	To Ext 2 audio +paired with.....	21	To Ext 2 audio -	
10	To Ext 3 audio +paired with.....	22	To Ext 3 audio -	
11	To Ext 4 audio +paired with.....	23	To Ext 4 audio -	
12	To Ext 5 audio +paired with.....	24	To Ext 5 audio -	
13	To Ext 6 audio +paired with.....	25	To Ext 6 audio -	

33.8 GENERAL PURPOSE INTERFACE CARD 700-12-01 (700-25-04 MIU ONLY)

This optional card is factory fitted on request and replaces the default provision described in section 32.5 - 700-25-04 - Rear Panel – Connectors on page 312. The option provides 16 GPI Inputs and 16 GPI Outputs for the 700-25-04 MIU:

- Sixteen inputs with grounding contact closure or 16 inputs Transistor-Transistor Logic (TTL).
- The assignment of GPIs can be flexibly configured through software.
- Eight outputs with floating ground Opto-isolator and eight outputs with Open Collector (OCC), or 16 outputs TTL.
- Two D25 connectors.

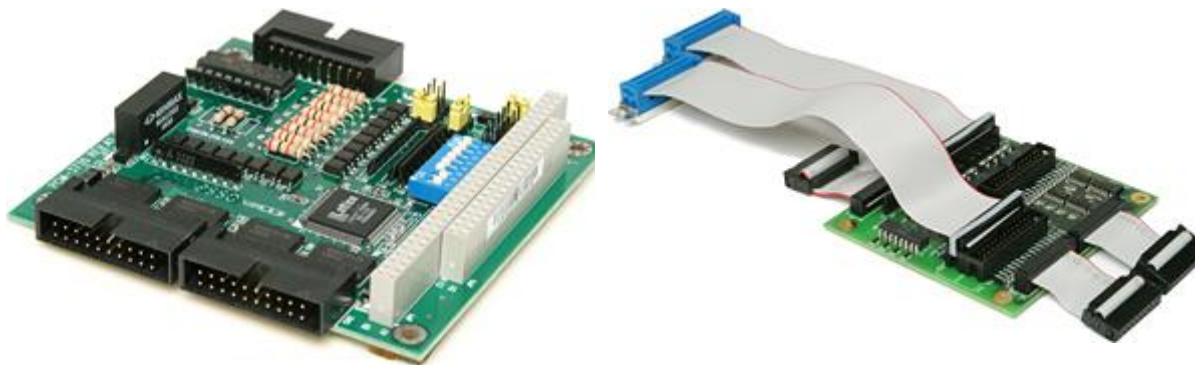

External Connections – Inputs

Opto Inputs			
D25 chassis plug connects to J1.			
Pin	Input	Pin	Input
1	0	14	1
2	2	15	3
3	4	16	5
4	6	17	7
5	Com 0 V	18	V+ (0-7)
6	6	19	9
7	10	20	11
8	12	21	13
9	14	22	15
10	Com 0 V	23	V+ (8-15)
11	Com 0 V	24	Com 0 V
12	+5 V Out	25	Com 0 V
13	+5 V Out		

Note:

“V+” pins must be connected to +5 V or an external supply (+5 to +12 V DC). An Opto input is “made” by connecting the pin to 0 V.

TTL Inputs			
D25 chassis plug connects to J4.			
Pin	Input	Pin	Input
1	0	14	1
2	2	15	3
3	4	16	5
4	6	17	7
5	Com 0 V	18	NC
6	6	19	9
7	10	20	11
8	12	21	13
9	14	22	15
10	Com 0 V	23	NC
11	Com 0 V	24	Com 0 V
12	+5 V Out	25	Com 0 V
13	+5 V Out		

External Connections – Outputs

Darlington & Opto Outputs			
D25 chassis socket connects to J6.			
Pin	Output	Pin	Output
1	Darl. 0	14	Darl. 1
2	Darl. 2	15	Darl. 3
3	Darl. 4	16	Darl. 5
4	Darl. 6	17	Darl. 7
5	Darl. 0 V	18	OP 8 -ve
6	OP 8 +ve	19	OP 9 -ve
7	OP 9 +ve	20	OP 10 -ve
8	OP 10 +ve	21	OP 11 -ve
9	OP 11 +ve	22	OP 12 -ve
10	OP 12 +ve	23	OP 13 -ve
11	OP 13 +ve	24	OP 14 -ve
12	OP 14 +ve	25	OP 15 -ve
13	OP 15 +ve		

Notes:

1. Darlington outputs are all returned to a separate 0 V (pin 5).
2. Opto outputs are fully floating and rated 40 V, 160 mA.

TTL Outputs			
D25 chassis socket connects to J8.			
Pin	Output	Pin	Output
1	0	14	1
2	2	15	3
3	4	16	5
4	6	17	7
5	Com 0 V	18	NC
6	6	19	9
7	10	20	11
8	12	21	13
9	14	22	15
10	Com 0 V	23	NC
11	Com 0 V	24	Com 0 V
12	NC	25	Com 0 V
13	NC		

700-12-01 GPI Card Layout

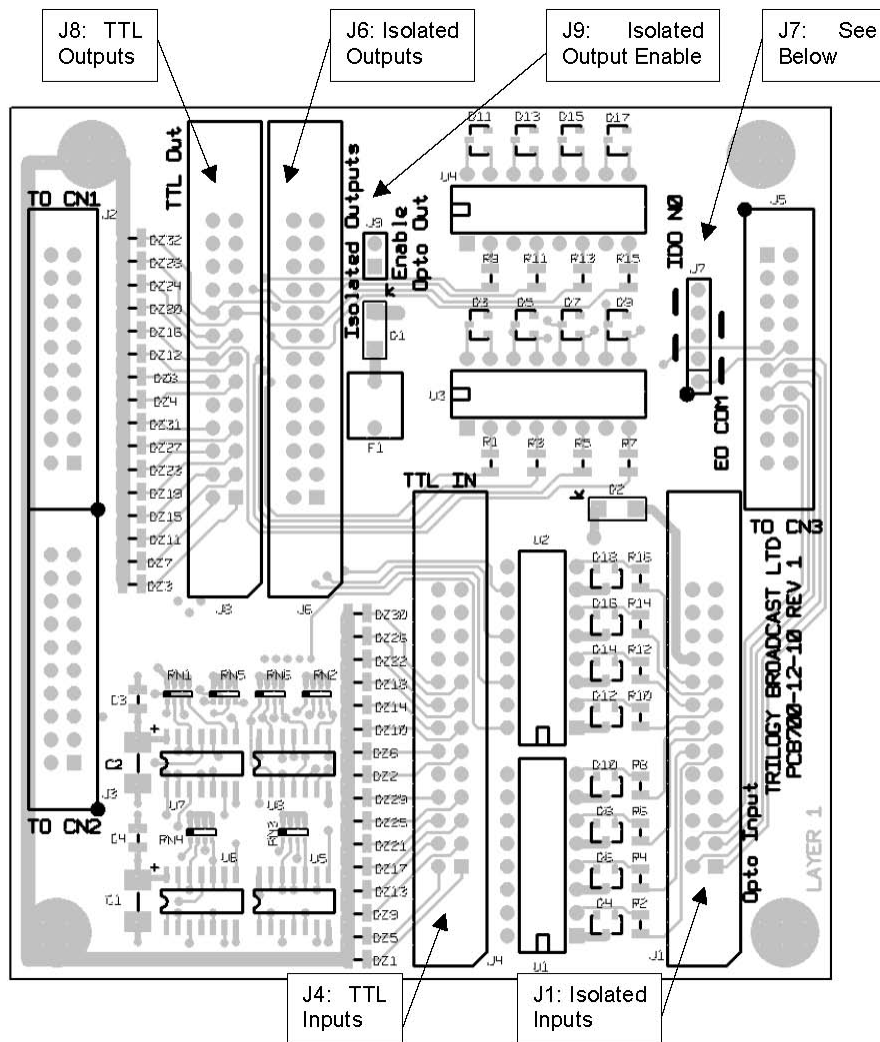

J7 Function

The purpose of J7 is to allow the internal protection diodes on the Darlington driver IC to be connected to the external supply for inductive loads. Setting the links for EO_COM provides this connection. Normally, pin 18 of J6 is OP8-, but to allow the use of pin 18 as EO_COM, pin 19 becomes the common negative output for OP8 as well as OP9. The default setting is "IDO NO".

J6 pin	'IDO NO'	EO_COM
18	OP 8 -ve	EO_COM
19	OP 9 -ve	OP 8 -ve & OP 9 -ve

J9 Function

To provide the maximum drive for TTL loads, J9 can be removed. This removes the power to the Opto isolated outputs, which would otherwise be drawing unnecessary current.

34. TECHNICAL DATA | MCU | 700-30-00

The Mercury Communicator Unit is an intelligent network-enabled operator station, utilizing leading-edge technology to allow Operator communications with other Mercury Operator stations and Mercury PORTABLE devices via the Mercury INTERFACE product.

34.1 SPECIFICATIONS

Part Number	750-30-00
Integrated User Interface	Virtual Panel
Physical Characteristics	Height: 43 mm or 1.7 in. Depth: 172 mm or 6.8 in Width: 208 mm or 8.2 in excluding desk fixing kit Weight: 0.9 kg
Power	Input: 100-240 Vac, 50//60 Hz, 0.6A Output: 12 Vdc (DC Symbol), 2.08A, 25 W max
Environmental Characteristics	Temperature: Operating: 0 to 40 °C. Temperature, Non-Operational/Storage: -20 to 60 °C. Humidity - Operating: 20-90% (non-condensing when operating at 40°C). Altitude: 10,000 meters non-pressurized. Vibration: In compliance with DEF STAN 00-35 (pt. 3) Ch 2-01 Sec 5.2 (Annex B). Shock: In compliance with DEF STAN 00-35 (pt. 3) Ch 2-03 Para 5.2 (table 1)
Regulatory Compliance	Emissions: EN55032:2015 & EN55024:2010+A1:2015 FCC CFR 47 Part 15.107 & 15.109 Class B EN 61000-3-2:2014 & EN 61000-3-3:2013 Immunity: EN 55024:2010 Safety: IEC 60950-1:2005/A2:2013 UL/IEC 60950-1 2nd Edition CAN CSA C22.2 NO 60950-1-07 (R2012)
Reliability	Mean Time Between Failure (MTBF) of 44,429.99 hours of operation at 40 degrees Celsius (in accordance with Task 203 of MIL-STD-785B; paragraph 2.4 of Task 100 of MILSTD-756B; and the Parts Count Analysis method of MIL-HDBK-217F (N1/2), Appendix A).

34.2 FRONT PANEL LAYOUT

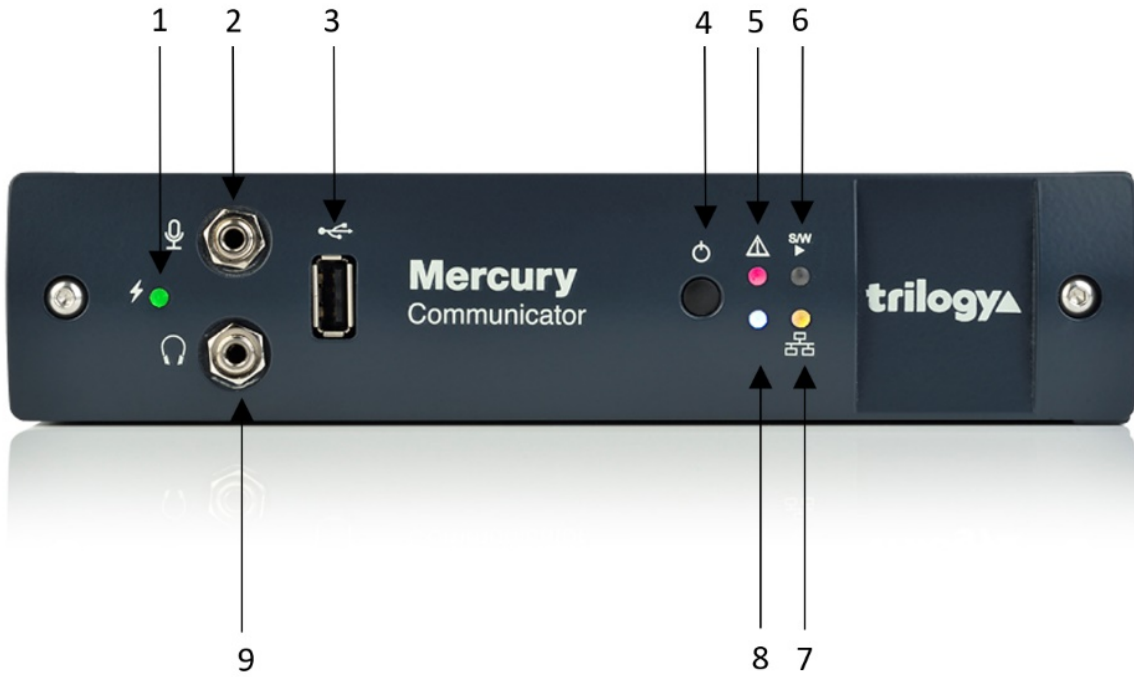

Item	Description	Control/connector type
1	System status	Red LED
2	Audio loudspeaker connector	3.5 mm Jack socket
3	USB connector	USB 2.0 (currently disabled)
4	Shutdown / Restart	Push-button
5	System operation/Input power status	Green/red LED
6	Software status	Green/red LED
7	Network link status	Yellow LED
9	Audio headphone connector	3.5 mm Jack socket

Front Panel Connector Wiring Details

The front panel connector wiring details are as follows:

Audio connectors (3.5 mm Jack Sockets)			
Microphone Input		Headset Output	
Pin	Signal	Pin	Signal
Tip	Audio signal	Tip	Headphone L channel
Ring	Bias voltage (+5V) through internal 2.2k Ω resistor	Ring	Headphone R channel
Sleeve	MIC Audio signal	Sleeve	Headphone Common

USB Connector

USB Type A socket

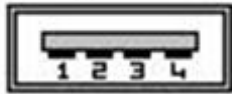

Pin	Signal
1	Vbus (+5V)
2	Data- (D-)
3	Data+ (D+)
4	Ground (GND)

34.3 REAR PANEL LAYOUT

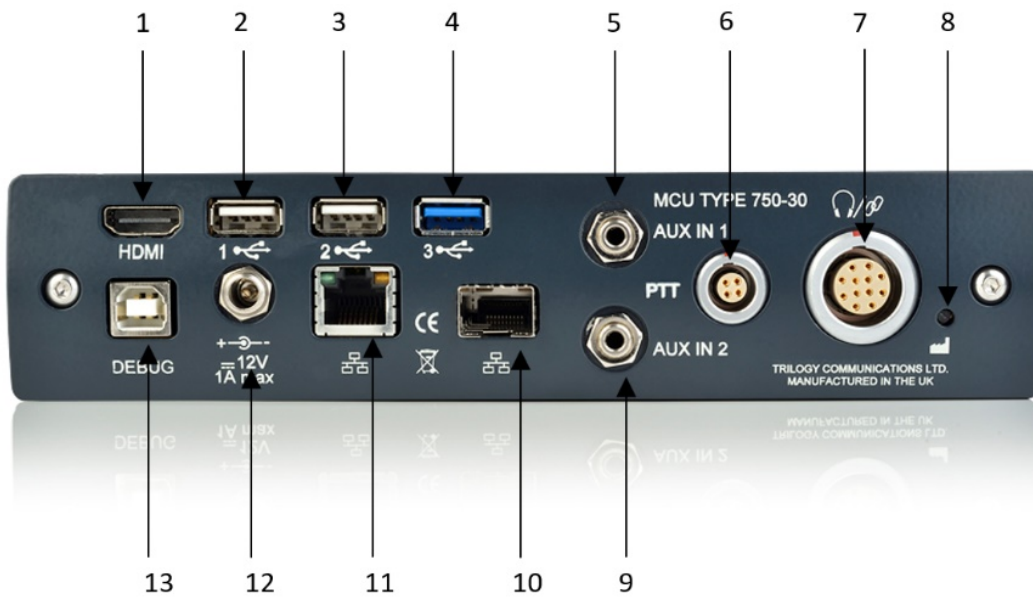

Item	Description	Control/connector type
1	Video output connector	HDMI
2	Mouse, keyboard, external storage connector	USB Type A
3	Mouse, keyboard, external storage connector	USB Type A
4	Mouse, keyboard, external storage connector	USB Type A
5	Audio input channel connector	3.5 mm stereo jack
6	Auxiliary PTT connector	Lemo 4-pin connector
7	Customer Interface Adapter (CIA) connector	Lemo 12-pin connector
8	Factory reset button	Recessed pushbutton
9	Audio input channel connector	3.5 mm stereo jack
10	Network connector	RJ45 jack connector
11	Gigabit Network connector	Optical SFP module providing a Gigabit Ethernet 1000Base-SX connection
12	Power connector	2.5 mm DC jack
13	SPY Debug connector	USB 2.0 Type B female connector

Rear Panel Connector Wiring Details

Video Connector

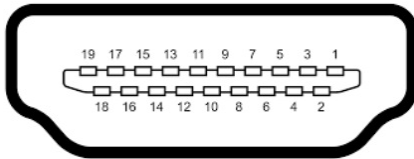

Pin	Signal	Pin	Signal
1	TMDS Data2+	2	TMDS Data2 Shield
3	TMDS Data2-	4	TMDS Data1+
5	TMDS Data1 Shield	6	TMDS Data1-
7	TMDS Data0+	8	TMDS Data0 Shield
9	TMDS Data0-	10	TMDS Clock+
11	TMDS Clock Shield	12	TMDS Clock-
13	CEC	14	-
15	SCL	16	SDA
17	DDC Ground	18	+5VDC (0.05A)
19	Hot Plug Detect		

USB Connectors

USB Type A socket

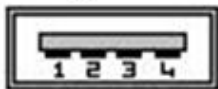

Pin	Signal
1	Vbus (+5V)
2	Data- (D-)
3	Data+ (D+)
4	Ground (GND)

SPY Debug Port

USB Type B Socket

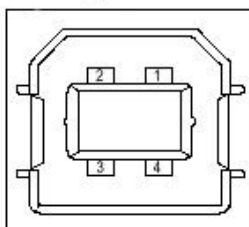

Pin	Signal
1	Vbus (+5V)
2	Data- (D-)
3	Data+ (D+)
4	Ground (GND)

Customer Interface Adapter (CIA) connector	
Pin	Signal
1	Headphone Common
2	Headphone Right channel
3	Headphone Common
4	Headphone Left channel
5	HS Type detect
6	PTT Input channel 2 (N.O.)
7	MIC Input + & excitation
8	MIC Input -
9	PTT Input channel 1 (N.O.)
10	PTT Common (Ground)
11	DC Power +10V to +12V
12	Chassis Ground (Cable shield)

Audio Input Channel Connectors	
Pin	Signal
Tip	Aux. Audio Input Left Channel
Ring	Aux. Audio Input Right Channel
Sleeve	Ground

Auxiliary PTT connector	
Pin	Signal
1	PTT Common (Ground)
2	PTT input channel 3 (N.O.)
3e	No Connection (Reserved for future GPO)
4	No Connection (Reserved for future GPO)

Under Desk Mounting Kit	
Part Number MCU	750-30-202-KIT
Description	The MCU may be freestanding or installed under a desk. The mounting bracket is fitted to the underside of the desk using self-tapping screws. The MCU then slides into the bracket from the front.

35. TECHNICAL DATA | OTHER EQUIPMENT

35.1 BELTPACKS

Belpacks may be connected to the matrix on ports configured as 4-wire. They require an external voltage supply, either +15V or $\pm 15V$ depending on the model. A 3 pin Hirose socket is provided on the rear of each matrix with $\pm 15V$ protected by an internal self-resetting fuse. See section 33.6 for connector details. The tables below show the different belpack types.

Type	No. of input channels (from the matrix)	Fixed Connector type	Mating Connector type required	Supply voltage required	Headset connector (socket)
410-50-12	1	XLR6 Male	XLR6 Female	+15V	XLR5 Female
410-50-13	2	Hirose 12 Way Plug RM15TRD-12P	Hirose 12 Way Socket RM15TPD-12S	$\pm 15V$	XLR5 Female

Notes:

- All Belpacks have one output channel (i.e. return to the matrix).
- The Belpack PTT (talk) switch is normally momentary action. The -12 and -13 types may be ordered with a latching talk switch, using part codes -12-L & -13-L.

The following tables give individual connector pin-outs for each model.

410-50-12 Single Channel Belpack to Matrix Connection	
Pin	Function
1,2 (+,-)	Audio output from belpack to matrix
3,4 (+,-)	Audio input to belpack from matrix
5	0V
6	+15V

410-50-13 Two Channel Belpack to Matrix Connection	
Pin	Function
1	Chassis
2,3 (+,-)	Audio 1 input to belpack (PTB)
4,5 (+,-)	Audio 2 input to belpack (Prog Snd)
6,7 (+,-)	Audio output from belpack to matrix
8	+15V
9	-15V
10	0V
11,12	n/c

410-50-12 & 410-50-13 Headset Connector (XLR5 Socket on Belpack)	
Pin	Function
1	Mic in (screen)
2	Mic in (signal)
3	Headset Ground
4	Headset Out
5	Headset Out

35.2 RT EQUIPMENT

Radio Talkback equipment may be supplied by Trilogy as part of a complete system. It is not manufactured by Trilogy and will be supplied with the original equipment manuals.

The usual configuration consists of one or more base stations and several portable transceivers. The base stations are connected to the matrix using normal 4-wire audio ports according to the pin-out information in section 33.1.

36. MERCURY TERMINOLOGY

TERM	DESCRIPTION
4-wire	A balanced pair of analogue audio input and output signals, generally associated with a single item of external equipment. This is connected using a total of four wires, audio in+, audio in -, audio out +, audio out -.
acoustic feedback	Feedback which occurs when a sound loop exists between an audio input and an audio output.
active client	A host that is connected to the Mercury database.
additional host	A host needs to be interested in a given conference. Assigning additional hosts enables the TBCs for each host to communicate with each other and participate in the conference.
audio crosspoint	A connection between a specific source and destination “pair” made in the analogue domain within an MIU.
Audio Expansion Board (AEB)	An expansion board that may be installed into an MIU. Provides eight RJ45 connectors for eight channels of 4-wire audio or intercom panels.
audio loopback	Loops ports when no connection is present. It enables the routing of services to address the sources in the configuration that might not have physical addresses.
audio trunking	See trunking.
bandwidth	A measure of how much data can be transferred in a fixed amount of time.
bandwidth profile	Settings that allow an Administrator to select a specific IP payload over a range of 10 kbps to 100 kbps.
bit	A single binary digit. It is the standard for quantifying data in computing.
byte	A unit of measurement that is equivalent to 8- bits.
cache	A collection of data duplicating original values stored elsewhere.
Carrier Operated Relay (COR)	An on/off signal sent from a radio to indicate that it is in receive mode.
client	A device, such as an IP phone, that makes or answers a call.
codec	A device or program capable of encoding and decoding on a digital data stream or signal.
coding profile	The name by which bandwidth profile was previously known.
command-line files	Files that can be used to send commands directly to the firmware when starting the TBC.
conference	A one-to-many or many-to-one communication facility provided by Mercury where each participant hears a mix of everyone currently active in the conference, minus their own audio contribution (mix-minus).
Conference Editor	Part of Gateway that is used to configure conferences.
configuration	A set of files that defines the overall structure of a Mercury system.
Configuration Editor	An application that is used to manage the configuration details in the database. It provides a GUI to allow users to visualise and interact with the database.
cut key	A key on a panel that can be configured to cut sound when pressed.
database	A shared collection of logically related data that specifies the configuration of a Mercury system.
data port	The IP port that the DB master or slave uses for data connections.
Database Supervisor	See Mercury DB Supervisor.

TERM	DESCRIPTION
dial plan	In Mercury, a dial plan determines the SIP URIs that a Mercury panel is allowed to dial and the incoming DDI digits that a Mercury host will recognise, and the Mercury subscribers that are associated with these DDI numbers.
Domain	A logical grouping of hosts. Used to identify a system within an organisation.
Domain Editor	Part of Gateway that is used to configure domains.
driver	A piece of software used to link the program and its associated hardware.
endpoint	A device, such as an IP phone, that makes or answers a call.
Enterprise	Used to identify an organisation. The Enterprise is the “top-level” of a configuration.
Enterprise Editor	Part of Gateway that is used to define the overall structure of your Enterprise.
fast inhibits	An enterprise-level setting in Gateway that forces all hosts to break DSP audio routes without contacting the remote host.
firmware	Software that is embedded in a hardware device.
fixed route	A route that is made immediately when the TBC starts. A fixed route remains made, unless inhibited, for as long as the TBC managing the route is running.
flash memory	A type of non-volatile computer memory that can be electrically erased and reprogrammed.
full-duplex	The transmission of data in two directions simultaneously. For example, a telephone is a full-duplex device because both parties can talk at once. In contrast, a walkie-talkie is a half-duplex device because only one party can transmit at a time.
FXO	An FXO (Foreign Exchange Office) is a device that, from the point of view of a telephone exchange, seems to be a regular telephone. As such, it should be able to accept ring signals, go on-hook and off-hook, and send and receive voice signals. Analogue telephone handsets, fax machines and (analogue) modems are FXO devices. FXO interfaces are also available for computers and networking equipment to allow these to interact directly with a Plain Old Telephone Service (POTS). These are commonly found in devices acting as gateways between VoIP systems and the PSTN. The FXO must be connected to the FXS interface. The FXS interface delivers the familiar dial tone and ring tone to the FXO and supplies the power for the FXO device to work.
FXS	An FXS (Foreign Exchange Station) is any device that, from the point of view of a telephone, seems to be a telephone exchange. As such, it should be able to supply power to the connected telephone, provide ring signals and dial tone, understand when the phone goes on-hook or off-hook, and send and receive voice signals.
gateway	A node (a router) on a computer network that serves as an access point to another network.
Gateway	The application used to manage the configuration details in the database. It provides a GUI to allow users to visualise and interact with the database.
General Purpose Input (GPI)	Allows the Mercury system to receive a signal from an external device using an on/off command.

TERM	DESCRIPTION
General Purpose Output (GPO)	Allows the Mercury system to send a signal to an external device using an on/off command.
General Purpose Input Output (GPIO)	Used to refer collectively to General Purpose Input and General Purpose Output. See above.
GPIO Processes Editor	Part of Gateway that is used to configure GP Inputs and Outputs.
group	A group is a collection of user-defined subscribers.
Group Editor	Part of Gateway that is used to configure groups.
Hardware Panel	A Mercury control panel that does not require a PC GUI to operate. Hardware panels are dedicated devices available in a range of offerings, with choice of form factor and size.
heartbeat	Network messages sent from all hosts in the enterprise to each other to determine whether hosts are available.
host	A host is a constituent part of a domain. It is the focal point for all user input. A host can be a dedicated piece of hardware, such as an MIU, or a PC with hardware added either internally (PCI card) or externally (USB adapter).
Host Editor	Part of Gateway that is used to configure Mercury hosts.
Interruptible Foldback (IFB)	An audio route which can be broken into, or interrupted, by a third party, replacing the original audio with the third party panel microphone.
IFB Editor	Part of Gateway that is used to configure IFBs.
initiator	The party initiating a call.
instate	Replace cached configuration files with new working files following a configuration update.
interest	A count of how many different TBCs are monitoring a route for GPI logic functionality. Most routes will have an interest of 0 in a simple configuration.
invited member	A panel or source that may be invited to participate in a conference.
IP address	A unique number that devices use to identify and communicate with each other on a computer network using the Internet Protocol standard.
IP phone	A panel that will ring if a specific phone is dialed.
logging	ASCII text files created on an MIU, recording communication activity.
master database	A database that holds the master configuration for all domains and hosts on the Mercury system.
Mercury	A system providing bi-directional audio communication in an IP environment.
Mercury DB Server	A service installed within Windows that runs the Mercury DB Supervisor.
Mercury DB Supervisor	A middleware application that provides an interface between the Mercury database and the Mercury software suite running on the hosts.
Mercury Communicator Unit (MCU)	A Mercury host. The Mercury Communicator Unit (MCU) is a powerful operator station with a peer-to-peer architecture that enables the device to function independently.
Mercury host	See host.
Mercury Installation Tool	An application that allows the location of the database and other host settings to be specified.

TERM	DESCRIPTION
Mercury Interface Unit (MIU)	A Mercury host. It can host many user interfaces and external devices. Up to four interface boards may be fitted, to serve 32 audio interface channels. It is suitable for system setups that support multiple users. It is fitted with a Mercury PCI card that provides two channels of audio input and output, and an optional GPIO card providing 16 GP Inputs and 16 GP Outputs.
minimise time	The time taken for an inactive panel to minimise.
mirror dimming	Used to help reduce acoustic feedback when full-duplex communication is taking place.
mix-minus	A feature of conferences where each participant hears a mix of everyone currently active in the conference, minus their own audio contribution.
multicast	The delivery of audio to a group of destinations simultaneously using the most efficient strategy to deliver the messages over each link of the Mercury system only once and only create copies when the links to the destinations split. Multicasting is used to minimise bandwidth usage and is transmitted as a single stream that can be listened to by multiple receivers.
Network Address Translation /Port Address Translation (NAT/PAT)	NAT/PAT translates TCP or UDP connections made to a host and port on an outside network to a host and port on an inside network.
network stack	A particular software implementation of a computer networking protocol suite.
noise gate	An electronic device or software logic that is used to control the volume of an audio signal.
non-volatile memory	Computer memory that can retain information even when the computer is not powered-up.
operator	An individual who can log in to Gateway with a username and password.
Opto	Optical coupling of signals used to isolate any power components.
panel	An interface that enables Mercury users to place and receive calls. Panels include Virtual Panels for PC users and Hardware Panels for non-PC users.
Panel Configuration Editor	Part of Gateway that is used to configure Mercury panels and subscribers.
panel member	A panel that has been specified as a source for a conference.
peer-to-peer operation	A network that relies primarily on the computing power and bandwidth of the participants in the network rather than concentrating it in a relatively low number of servers.
Peripheral Component Interconnect (PCI)	A connection socket for a peripheral designed for the local bus on a computer motherboard.
phone control	Incoming DDI digits that are used to direct an answered call directly to the configured subscriber.
phone number	Outgoing digits that may be used by panels as speed-dials when accessing FXO, FXS or E&M ports. The digits are dialled as DTMF when the call is placed.
Phone Number Editor	Part of Gateway that is used to store frequently used phone numbers. These numbers can be allocated to panels.
phone set	A logical grouping of panels that displays a ringing tally when an incoming call is detected on the phone line to which the panels have a key.

TERM	DESCRIPTION
Phone Sets Editor	Part of Gateway that is used to configure phone sets.
pinout	A term used in electronics to describe how an electrical connector is wired. Each pin of the connector has a purpose which is briefly described in the pinout.
Push-to-Talk (PTT)	An input on a radio that allows external equipment to actuate the transmit mode.
Radio Interoperability Board (RIB)	An expansion board that provides eight RJ45 connectors for direct connection to eight radios.
recipient	The party receiving a call.
route	A defined audio path created by defining a source and a destination. Routes can be created, broken or inhibited by a GPI, another route, or by a panel key directly.
route destination	The endpoint of a particular route.
route source	The normal feed to the route destination.
Routes Editor	Part of Gateway that is used to define and maintain routes.
serial trunking	See trunking.
service	An application that starts when Windows is booted and runs in the background as long as Windows is running.
Session Initiation Protocol (SIP)	An application-layer control (signalling) protocol for creating, modifying, and terminating sessions with one or more participants. These sessions include Internet telephone calls, multimedia distribution, and multimedia conferences.
sidetone	The sound picked up by a telephone's mouthpiece and reproduced by the earpiece of the same handset, providing audible confirmation that the phone is working correctly.
SIP address	The Uniform Resource Identifier (or Locator) of an endpoint. Of the form: sip:trilogy@trilogycomms.com or sip:0123456789@87.98.65.43
SIP alias	A URL (or alias) assigned to a SIP connection using the Host Editor. When a caller attempts to connect to that URL (or alias) on a host, the SIP connection corresponding to the alias is 'activated' Once activated, a SIP connection key on any panel connected to the host can be targeted to answer the call.
SIP connection	An object used to identify a SIP entity that exists outside of Mercury. SIP connections are added at Enterprise level using the Enterprise Editor.
SIP Connection Editor	Part of Gateway that is used to maintain SIP connections and assign phone controls to connections.
SIP number	Outgoing digit sequences that map to either fully formed URIs or are digits that are passed to a Proxy Server to be fully resolved.
SIP Proxy Server	Receives "call" requests from a SIP User Agent and forwards these requests to one or more addresses to locate the destination of the call.
SIP Redirect Server	Receives "call" requests from a SIP User Agent, locates the destination and returns a "redirect" response to the User Agent with the destination address.
SIP Registration Server	Receives "registration" messages from SIP User Agents announcing their presence in the network.
SIP URI	See SIP address.
SIP URL	See SIP address.
SIP User Agent	A SIP User Agent (or Endpoint) generally contains both User Agent Client and User Agent Server components.

TERM	DESCRIPTION
subscriber	Subscriber is the fourth level of the Mercury EDHS hierarchy, below Enterprise, Domain and Host. Both hardware and software-based control panels may be configured as subscribers to allow user interaction. 4-wire analogue audio signals are also configured as subscribers.
supervisor port	The IP port on which the database master or slave listens for control data.
subnet	A division of a network. Subnetting an IP network allows a single large network to be broken down into what appears (logically) to be several smaller ones.
subnet mask	A local bit mask (set of flags) that specifies which bits of the IP address specify a particular IP network or host within a sub network. An IP address of 128.66.12.1 with a subnet mask of 255.255.255.0 specifies a host 1 on subnet 128.66.12.0. The subnet mask determines the maximum number of hosts on a sub network.
Talkback Controller (TBC)	This host application is the heart of the Mercury system. It manages the peer-to-peer socket connections between Mercury hosts, manages IP audio routes and local audio crosspoints, and acts as the interface to the host Mercury hardware.
tally	A universal term for the speak and listen status lamps used to inform the user about open speak and listen routes to a target. Tallies are conveniently displayed near a key on hardware panels to clearly show the user the status of any audio routes.
Transistor-Transistor Logic (TTL)	The electrical characteristics of the interface.
trunking	A facility provided on the MIU that enables audio (and, if required, RS232 data) to be routed from one unit to another.
unicast	The delivery of audio to a single destination. A specific and unique connection is set up between the hosts. If the same data must be sent to multiple hosts, either multiple unicast connections are required, or multicast may be used.
Universal Serial Bus (USB)	An interface on the computer that enables you to connect a USB device. USB 1.0 is an external bus standard that enables data transfer rates of 12 Mbps (12 million bits per second). USB 2.0 has speeds equivalent to Firewire 1394 of 400 Mbps.
User Agent Client	Makes "calls" to other SIP devices.
User Agent Server	Receives "calls" from other SIP devices.
User Datagram Protocol (UDP)	One of the protocols for data transfer that is part of the TCP/IP suite of protocols. UDP is a "stateless" protocol, in that UDP makes no provision for acknowledgement of packets received.
Virtual Panel	PC applications that provide a GUI for Mercury users.
Voice Operated Transmission (VOX)	An on/off command that indicates the presence of an audio signal.