

blue
networks

X-50



VoIP Telephone
System for Small
Business

Installation Manual

1 Notices	9
<i>Revision Table</i>	9
<i>Hearing Aid Compatibility</i>	9
<i>UL/CSA Safety Compliance</i>	9
<i>Documentation Disclosure</i>	9
<i>FCC Statement</i>	10
<i>CE Declaration of Conformity</i>	10
<i>Environment</i>	10
<i>Copyright Notice</i>	10
<i>Trademarks</i>	11
2 Product Configuration	16
<i>LAN vs. WAN</i>	16
<i>Things to know about the product</i>	20
3 System Feature Description Table	29
<i>Access Control - Browser</i>	31
<i>Account Code</i>	31
<i>Agent (UCD) Logon/Logoff</i>	31
<i>Alarm</i>	31
<i>Alternate Attendant</i>	31
<i>Announcement Only Mailbox</i>	31
<i>Answer Position</i>	32
<i>Automated Attendant (Receptionist) (AA)</i>	32
<i>Automatic Daylight Savings (NTP)</i>	32
<i>Automatic Hold</i>	32
<i>Automatic Line Select (Hot Line)</i>	33
<i>Automatic Provisioning</i>	33
<i>Automatic Route Select (ARS)</i>	33
<i>Backlit Display</i>	33
<i>Basic Calling</i>	33
<i>Busy Call Back</i>	33
<i>Busy Lamp Field (BLF)</i>	33
<i>Call Abandon</i>	33
<i>Call Forward</i>	34
<i>Call Operator</i>	34
<i>Call Park</i>	34
<i>Call Pickup Group</i>	35
<i>Call Restriction</i>	35
<i>Call Routing</i>	35
<i>Call Waiting</i>	35
<i>Caller ID</i>	35
<i>Class of Service</i>	35
<i>Conference</i>	36
<i>Day & Night Service Mode</i>	36
<i>Daylight Savings</i>	36
<i>Default Setting</i>	36

<i>Direct Inward Dial (DID)</i>	36
<i>Direct Inward System Access (DISA)</i>	36
<i>Direct Telephone Line Access</i>	36
<i>Distinctive Ringing</i>	37
<i>Domain Name Server (DNS)</i>	37
<i>Emergency Call</i>	37
<i>Extension Password</i>	37
<i>E-mail Delivery of Voicemail Messages</i>	37
<i>FAX/Modem Detection</i>	37
<i>Flash</i>	37
<i>Flexible Numbering Plan</i>	38
X-50 to X-50	38
<i>Hot Dial Keypad</i>	38
<i>Last Number Redial</i>	38
<i>Least Cost Routing</i>	38
<i>Line Group</i>	39
<i>Live Call Record</i>	39
<i>Meet Me Page</i>	39
<i>Message Waiting Indication (MWI)</i>	39
<i>Music on Hold</i>	39
<i>Mutual Mailboxes (Group Mailbox)</i>	39
<i>Navigation Keys</i>	39
<i>Night Service</i>	40
<i>Numbering Plan</i>	40
<i>Off Hook Preference</i>	40
<i>Outside Calls</i>	40
<i>One Touch Record</i>	40
<i>Paging</i>	40
<i>Pause Insertion</i>	41
<i>Phantom Mailbox (Extension)</i>	41
<i>Phonebook</i>	41
<i>Power Failure Transfer</i>	41
<i>Programmable Buttons</i>	41
<i>Redial</i>	41
<i>Registration Server</i>	42
<i>Remote Management</i>	42
<i>Service Mode</i>	42
<i>SIP Trunk</i>	42
<i>Soft Interactive Keys</i>	42
<i>Speed Dial</i>	42
<i>Station Lock</i>	42
<i>Station Message Detailed Recording (SMDR)</i>	43
<i>System Speed Dial</i>	43
<i>System Time and Date</i>	43
<i>Time and Date in Display</i>	43
<i>Toll Restriction</i>	43
<i>Transfer</i>	43

<i>Traveling Class of Service</i>	43
<i>Trunk Group</i>	43
<i>Unified Call Distribution (UCD) or Hunt Group</i>	44
<i>UCD Reroute</i>	44
<i>Virtual Extension (Phantom)</i>	44
<i>Voice Mail</i>	44
<i>Wizard Setup</i>	45
4 Telephone Feature Description Table	47
<i>Agent Log On/Off - UCD Group</i>	53
<i>Alphanumeric Backlit Display</i>	53
<i>Automatic Hold</i>	54
<i>Busy Callback</i>	54
<i>Call Forward - Forking</i>	55
<i>Call Forward</i>	55
<i>Call Hold</i>	59
<i>Call Log</i>	59
<i>Call Park</i>	60
<i>Call Pickup</i>	60
<i>Call Waiting</i>	60
<i>Call Blocking</i>	61
<i>Conference - 3 Way</i>	61
<i>Class of Service - Traveling</i>	62
<i>Distinctive Ringing</i>	62
<i>Do Not Disturb (DND)</i>	63
<i>Extension Feature Reset</i>	63
<i>Feature (Flexible) Button Programming</i>	64
<i>Feature Button Reset</i>	66
<i>Hold Reminder</i>	66
<i>LCD & Interactive Buttons</i>	66
<i>Multi-Line Appearance</i>	67
<i>Mute</i>	67
<i>On-Hook Dialing</i>	68
<i>Paging</i>	68
<i>Paging Allow/Deny</i>	68
<i>Phonebook</i>	69
<i>Phone Lock/Unlock</i>	71
<i>Plug and Play</i>	71
<i>Reminder Tone</i>	71
<i>Service Mode</i>	72
<i>Telephone Line Flash</i>	72
<i>Transfer</i>	73
<i>Volume Control</i>	73
<i>Web Management</i>	73

5 Installation Planning	75
<i>Basics</i>	75
<i>Where to begin</i>	76
<i>Installing the X-50 VoIP Telephone System</i>	80
<i>Before Programming the X-50</i>	80
6 Getting Started	81
<i>Setup Wizard</i>	81
<i>Setup Wizard Tabs</i>	82
<i>WAN Port Settings</i>	83
7 Advanced Programming	101
<i>Device Information</i>	103
<i>Advanced Setup - WAN</i>	110
<i>Advanced - WAN</i>	110
<i>Advanced - NAT</i>	116
<i>Security</i>	123
<i>Quality of Service (QoS)</i>	132
<i>Routing</i>	136
<i>Dynamic DNS</i>	139
<i>Universal Plug and Play (UPnP)</i>	142
<i>File Server</i>	143
<i>Printer Server</i>	144
8 Wireless Programming	145
<i>Basic</i>	146
<i>Additional Networks</i>	148
<i>Security</i>	150
<i>Wireless Bridge</i>	156
<i>Advanced</i>	158
<i>Station Info</i>	161
<i>Power Saving</i>	162
<i>XBLUE Wireless Universal Adapter</i>	163
9 Voice	165
<i>Phone Extension</i>	166
<i>SIP Authentication</i>	167
<i>Extension Line Keys</i>	169
<i>Trunk</i>	171
<i>SIP Trunks</i>	173
<i>Direct Inward Dial</i>	176
<i>Trunk Groups</i>	177
<i>Answer Position</i>	179
<i>Call Routing Rules</i>	181
<i>Call Restriction Rules</i>	183
<i>System</i>	186
<i>Numbering Plan</i>	187
<i>Service Mode</i>	192

<i>Transmission</i>	193
<i>Internet Gateway Group - Voice Network</i>	196
<i>Station Message Detail Recording (SMDR)</i>	198
<i>SMDR Configuration</i>	199
<i>SMDR View</i>	200
<i>UCD Call Log</i>	201
<i>Voicemail</i>	202
<i>Auto Attendant</i>	203
<i>Single Digit Dialing Table</i>	204
<i>Voicemail</i>	206
<i>House Keeping</i>	207
<i>Phone Extension</i>	208
<i>Virtual Extension</i>	210
<i>Update MOH File</i>	211
<i>Holiday Settings</i>	212
<i>Advanced</i>	213
<i>STUN</i>	214
<i>Registered Phones</i>	215
10 Management	217
<i>Settings</i>	218
<i>Settings</i>	219
<i>Update</i>	220
<i>Restore Default</i>	221
<i>System Log</i>	222
<i>TR-069</i>	224
<i>Time Settings</i>	226
<i>Access Control</i>	230
<i>Passwords</i>	231
<i>PTC Configuration</i>	232
<i>Update Software</i>	233
<i>Reboot</i>	234
11 System Diagnostics	235
12 Getting to Know your Voice Mailbox	237
<i>Setting up your Voice Mailbox</i>	238
<i>Using your Voice Mailbox</i>	238
<i>Remote Message Pickup</i>	239
<i>Voicemail Administration</i>	241
13 Glossary	243
Index	253

Notes:

1 Notices and Conventions

Notices

Revision Table

Revision Date	Version	Supersedes	Description
September 2011	Version 1.0		Initial Release

Reproduction, publication, or duplication of this manual, or any part thereof, in any manner, mechanically, electronically, or photographically, is strictly prohibited. © Copyright 2010 by XBLUE Networks, LLC. All rights reserved.

Hearing Aid Compatibility

The X2020 telephone endpoints are hearing aid compatible, as defined in section 68.316 of Part 68 FCC Rules and Regulations.

UL/CSA Safety Compliance

The **X-50** system has met all safety requires, and found to be in compliance with the Underwriters Laboratories (UL) 60950-1

Documentation Disclosure

The information contained in this document is subject to change without notice and should not be construed as a commitment by XBLUE Networks, LLC. The information contained herein is supplied without representation or warranty of any kind. XBLUE Networks, reserves the right, without notice, to make changes to the equipment, equipment design, and documentation as advances in engineering and manufacturing methods warrant, and assumes no responsibility and shall have no liability of any kind arising from the supply or use of this document or the material contained herein.

Warning: This documented information is designed to assist in the installation of the new XBLUE products. XBLUE networks has done its best to give adequate warnings and cautions to advise both technical and non-technical individuals, but it is very important to use common sense when installing all electrical equipment.

- The use of this system may result in local, long distance, Internet access or data transfer charges, which are the sole responsibility of the user/owner of the equipment.

- Wireless access has been added for convenience, however, XBLUE does not warrant or guarantee, written or implied, that the wireless will work in every location. It is the responsibility of the owner to enable security to stop unwanted access to the network.

FCC Statement

This equipment generates, uses and can radiate radio frequency energy, and if not installed and used properly, that is, in strict accordance with the instruction manual, may cause interference to radio and television reception. This equipment has been tested and found to comply with the limits for a Class B computing device in Subject J of Part 15 of FCC rules, which are designed to provide reasonable protection against such interference when operated. However, there is not guarantee or warranty, written or implied, that interference will not occur in a particular installation. If this equipment causes or receives interference or fails to operate correctly, due to radio frequency interference (RFI) or electromagnetic interference (EMI), it will be fixed at the owners expense.

FCC Information

Provide the following information to the Telephone Company prior to connection the system to the network.

TABLE 1.1 FCC Information Table

Item	Specification
FCC Registration	D6XIG6600
Ringer Equivalence	0.5B
Networks Address Signalling	E
Service Order Code	9.0Y
Facility Interface Code	02LS2
Required Network Interface	RJ11 & RJ14 & RJ45

CE Declaration of Conformity

This equipment complies with the requirements relating to electromagnetic compatibility, EN55022 class B for ITE and EN 50082-1. This meets the essential protection requirements of the European Council Directive 89/336/EEC on the approximation of the laws of the Member States relating to electromagnetic compatibility.

Environment

All electronic equipment must be disposed of at an approved electronic recycling center.

Copyright Notice

All right reserved. No part of this publication may be reproduced, transmitted, transcribed, stored in retrieval system, photographically or translated into any language or computer language, in any form or by any means, electronic, mechanical, magnetic, optical, chemical, manual or otherwise, without the prior written premission of XLBUE Networks, LLC.



Trademarks

Windows Operating Systems 98/NT/2000/ME/XP/7™ are registered trademarks of Microsoft Corporation. All other company, brand and product names, like Netscape Navigator™ and Safari™ are trademarks or registered trademarks of their respective owners.

X-50™ is a registered trademark of XBLUE Networks, LLC.



WARNING

1. To avoid damage to yourself or the equipment read the installation instructions carefully before installing or powering up the system.
2. Opening the **X-50** system may cause damage to the installer or the equipment as well as void the manufactures warranty.
3. Do not install any equipment in direct sunlight or expose it to excessive heat or fire.
4. Do not install any equipment where it can get wet by rain or other moisture or water.
5. Do not install any equipment in an area where it can be subjected to high or low impact.
6. When cleaning the equipment (system and phone) use a fine damp cloth. Never use solvents such as trichloroethylene or acetone, which will perminately damage finish of any plastic surfaces. Never use a spray cleaner as it may infiltrate the equipment and cause serious damage.
7. The equipment is designed to work in temperatures ranging from 32 to 100 degrees, with a relitive humidity of less than 80 percent.
8. Do not install any equipment within 10 feet from a device that emits radio frequency equipment, such as TV's, radios or other audio or video equipment. Other equipment to avoid is microwaves or high pulse lighting such as photography equipment or other equipment that that may radiate electromagnetic fields.
9. Do not connect the LAN or WAN port to anything other than a ethernet network. Voltage from a telephone line may cause serious damage, which is not covered by the warranty.
10. Be sure that there is no power intruptions when performing a system upgrade. If the power fails during an upgrade, the system may need to be returned to have the software reloaded, at the owners expense.
11. Do not work on or install the system during a lightning storm. If possible, it is a good idea to unplug all connections to the system during a lightning storm. Lightning damage is not covered by the manufacturer's warranty.
12. It is a good idea install the equipment where it is out of reach of children.
13. Only plug the system into a standard 120 Volts AC \pm 10%.

Part Numbers

Below is a list of component part numbers:

TABLE 1.2 Component Part Numbers

SKU/Part Number	Description
47-9001	X-50 Telephone System Gateway
47-9002	X-2020 SIP Telephone Endpoint
47-9003	24 Button Sidecar, Electronic Dialing Module (EDM)
47-9004	8 Port 10/100 Ethernet Switch
47-9005	XBLUE Networks X-50 Universal Wireless Adapter
47-9006	6+ Foot Ethernet Cable

2 Introduction

The **X-50** IP Small Business System is a full featured Session Initiated Protocol (SIP) Voice over Internet Protocol (VoIP) Telephone System and Gateway, with an integrated auto attendant and voice mail system, which comes equipped with six FXO ports to accommodate six standard PSTN telephone lines, one FXS port, to accommodate one single line (analog) telephone or FAX machine and will support up to 24 SIP telephone endpoints. In addition, the **X-50** includes all of the standard gateway features, such as Firewall, Local Area Network (LAN) and Wide Area Network (WAN) Ports, plus an integrated SIP server and 802.11N Wireless Access just to name a few.

X-50 Callouts - Learning the **X-50** system

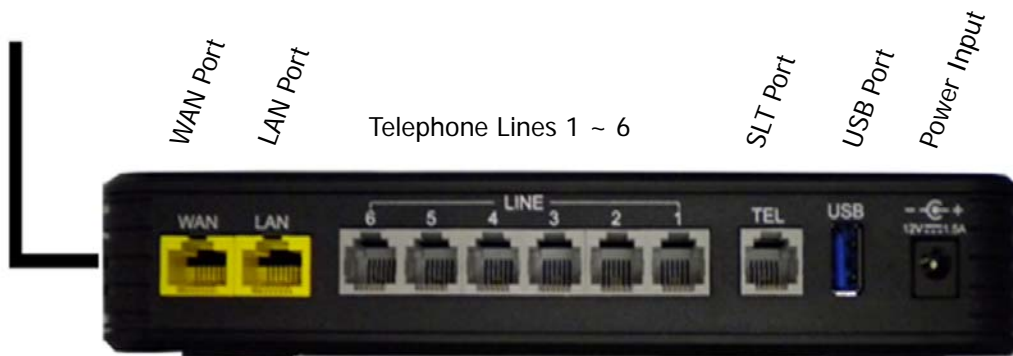

WPS Wireless Security Button



The **X-50** is extremely versatile in the way that it can be installed. It will work as a standalone small business telephone system with no connection to an existing Network or Internet...

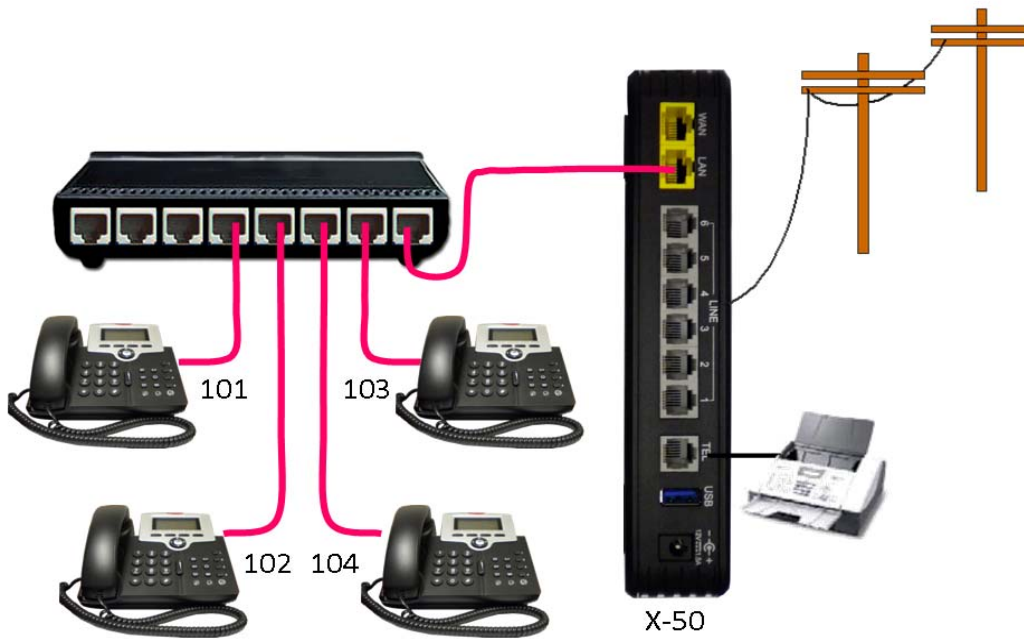

Connected to the Internet for email delivery and SIP Trunks ...

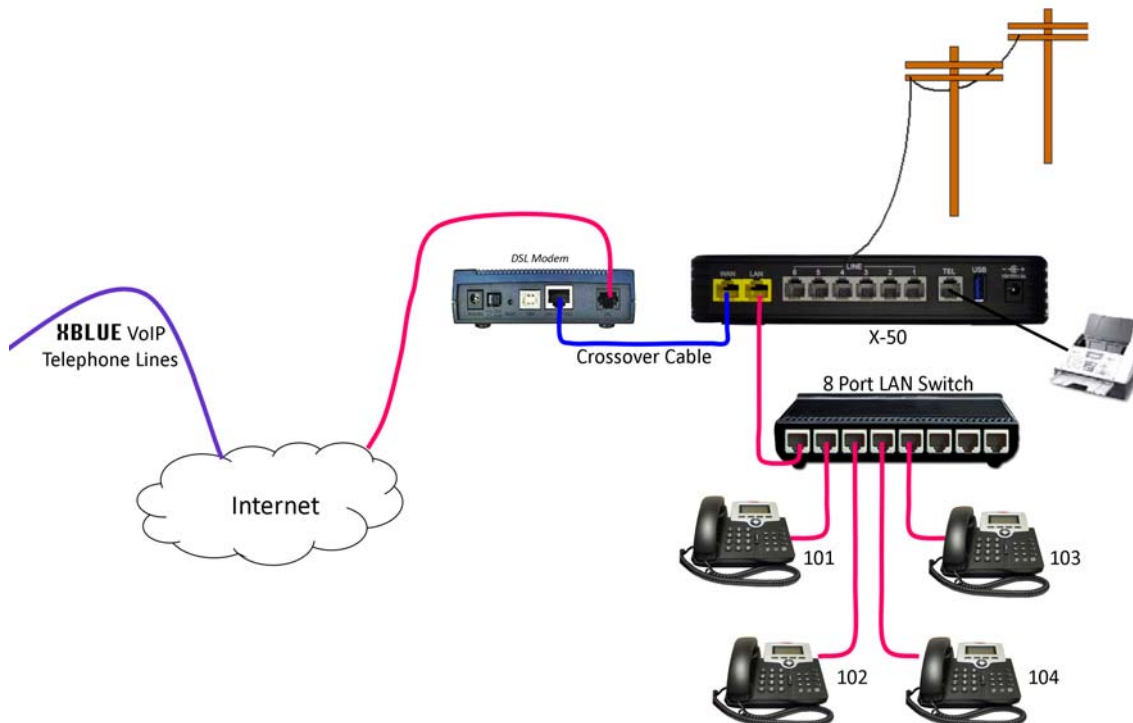

or with a static IP Address connect remote workers or create a voice (campus) network...

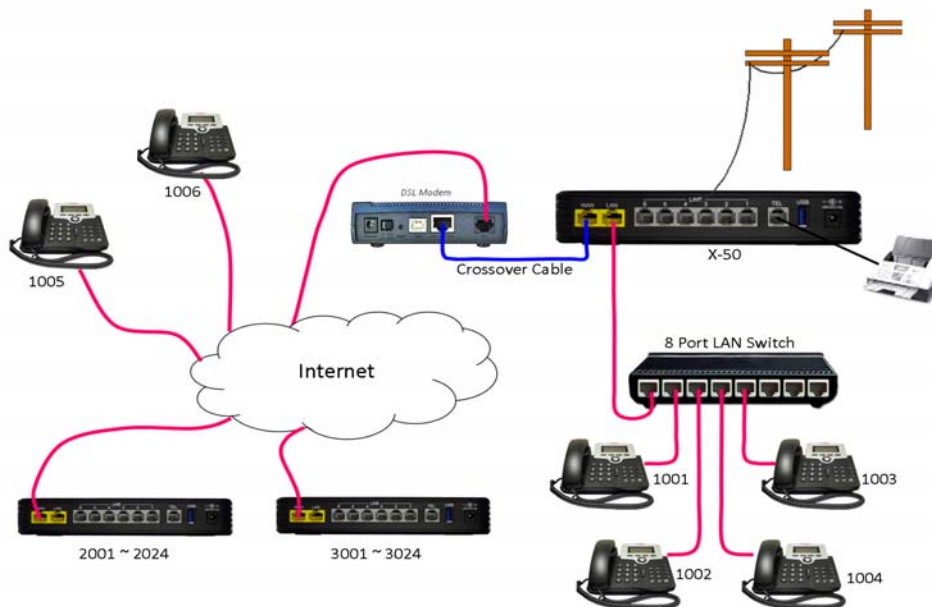

And it can be connected together with nine additional **X-50** systems creating a ten location voice communications network, also known as a "Campus Environment", each having up to 24 LAN or WAN SIP telephones endpoints.

2

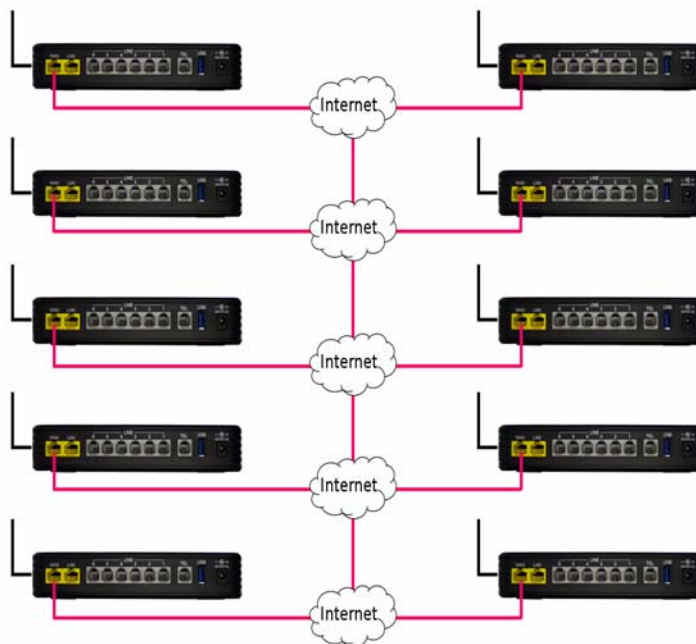

With a little networking knowledge, this system should be is easy to install and program.

Product Configuration

The **X-50** IP small business system is a fully functional VoIP Telephone System, Auto (Receptionist) Attendant and Voice Mail as well as a full featured Internet Gateway (IGW). A Gateway is used to join two disparate networks such as a Local Area Network (LAN) and a Wide Area Network (WAN).

LAN vs. WAN

In reality a "Network" is nothing more than the "network of wires", which is used to join computing devices. However, it has become common place to refer to the Local Area Network (LAN) as "the Network", which includes computers, computer devices and peripheral equipment such as network printers. The Local Area Network is also referred to as "the Intranet" meaning the "Internal Network". This manual may use these terms interchangeably.

The LAN port on the **X-50** is used when installing endpoints, such as the X2020 telephone or other computer devices within the same Subnet, which is generally a small geographical area like a single building. The WAN port is used when connecting endpoints that are not within the same Subnet, which is generally a larger geographical area or remote location such as a home office.

LAN

A Local Area Network (LAN) or Intranet is created when two or more computing devices are connected together to share information or access to another device. A network switch, or multiple network switches, can be used when connecting more than two devices. The LAN port of a **X-50** VoIP Telephone System is used to communicate with all of the connected devices and to connect these devices to other networks such as the PSTN or other WAN Devices.

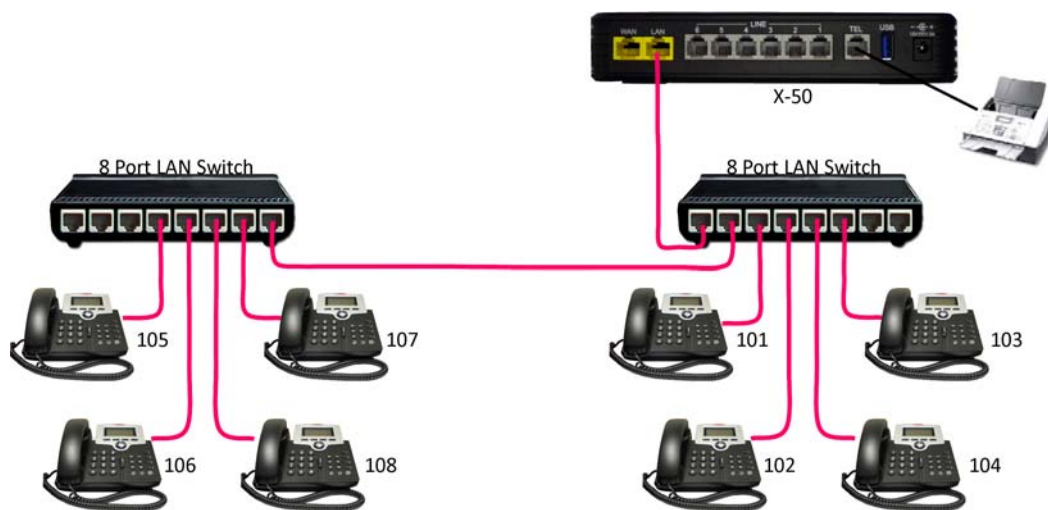

The **X-50** routes calls over a standard Intranet using a TCP/IP backbone, and does not require or rely on the Internet.

Therefore, it is possible to use the **X-50** as a standalone telephone system without connecting it to the Internet.

WAN

The WAN port is used when connecting a Gateway to the Internet Service Provider's (ISP) DSL/Cable modem. Once connected the Gateway allows remote devices to communicate with local devices connected to the LAN. Connecting the **X-50** VoIP Telephone System to the ISP using a DHCP address allows SIP Trunks to authentication and other features such as email delivery of voicemail messages. This does not require a "Fixed" or Static Class A or B IP Address, just access to the Internet.

E-mail Delivery

When using SIP Trunks or e-mail delivery of a voice mail messages and not using remote worker or creating a voice network, the WAN port of the **X-50** VoIP Telephone System is connected to a LAN port on the existing LAN. It can use a DHCP address or given an internal static IP Address.

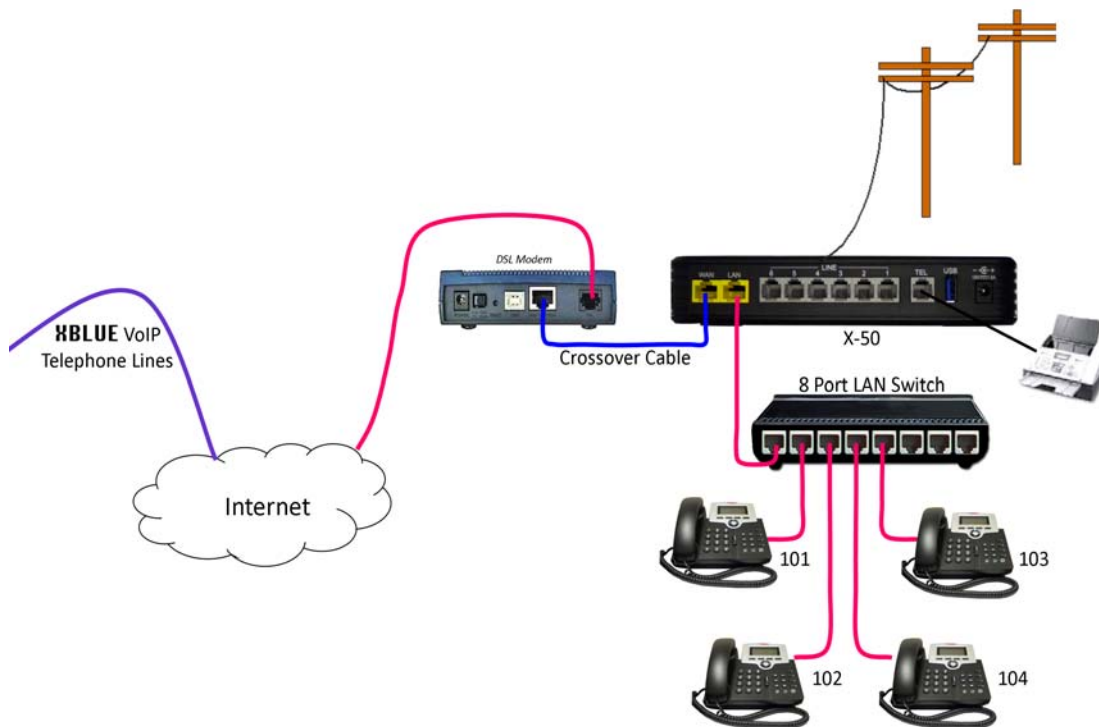

What does that say?

The WAN port can be programmed so that it connects to the Local Area Network (LAN), allowing it to "function" as both a WAN and LAN port. This allows the administrator to use Network Address Translation (NAT) to redirect outside Class A or B IP Addresses to an internal locations.

Remote Telephones

When connecting remote workers to the **X-50** VoIP Telephone System it must have a fixed or static class A or B IP Address. When creating a voice network (Campus Environment) the "Master" **X-50** VoIP Telephone System also must have a fixed or static class A or B IP Address. All other systems on the voice network can use Dynamic IP addresses. This may require the ISP's Gateway to be programmed as a Bridge or a concurrent bridge.

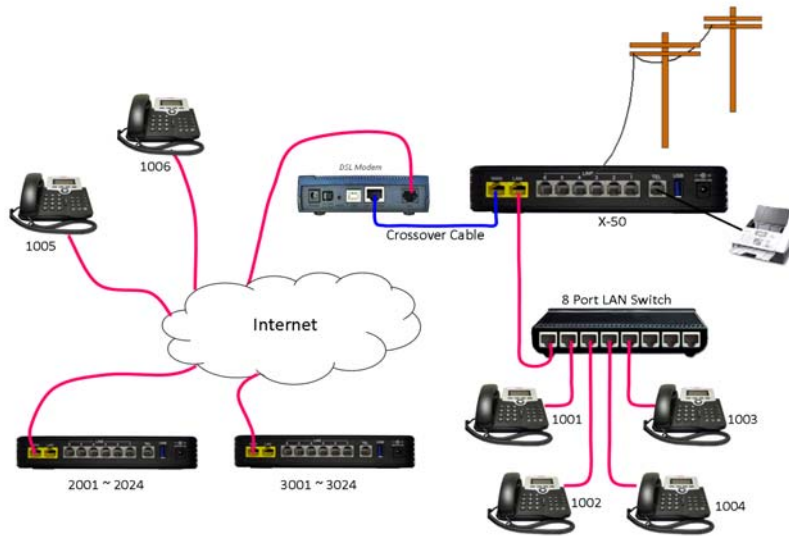

Remote telephones are directed to the static IP Address of the WAN port, which will have a Class A or Class B IP Address. Once registered, the WAN port of the **X-50** keeps the telephone endpoints active by sending "keep alive" packets to each of the remote telephone endpoints.

The Remote telephone should set the Session Timer to 20 seconds.



What does that say?

The Internet Service Provider (ISP) will program their DSL/Cable modem to be a bridge or a concurrent bridge allowing the **X-50** VoIP Telephone System to join the network parallel to the ISP's DSL/Cable modem. If needed, this also allows the **X-50** VoIP Telephone System to become the main router on the Local Area Network (LAN).

When connecting remote workers to a **X-50** system, it must have a static IP Address. When creating a voice network or "Campus Environment", only one of the **X-50** systems must have a static IP Address.

Any **X-50** with a static Class A or B IP Address will support remote workers, even if they are a node on a voice network.

Creating a Voice Network

Using the Internet and the WAN port, it is possible to connect multiple **X-50** systems together creating one large voice network "Campus Environment", with 3 or 4 digit dialing between each location. To keep it cost effective, only one **X-50** VoIP Telephone System requires a static Class A or B IP Address the rest can use DHCP Addresses. However, each location must have access to the Internet with enough bandwidth to support the number of calls to be processed. Creating this type of voice network requires a little preplanning to ensure that there enough bandwidth and no numbering conflicts.

Generally, it is a good idea to have a specific numbering sequence for each location. This can be as easy as routing specific groups of numbers, such as 100 to 149 for the "Master System", 150 to 199 for the second location, 200 to 299 for the third location, etc., or when using 4 digit dialing the numbering plan may resemble 1000 to 1499 for the Master System, 1500 to 1999 for the second location, 2000 to 2999 for the third location, etc. Another option is to use a "leading Digit", where the Master System is 1 + the extension number (1101, 1102, 1103, etc.), the second system is 2 + the extension number (2101, 2102, 2103, etc.), the third system is 3 + the extension number (3101, 3102, 3103, 3014, etc.).

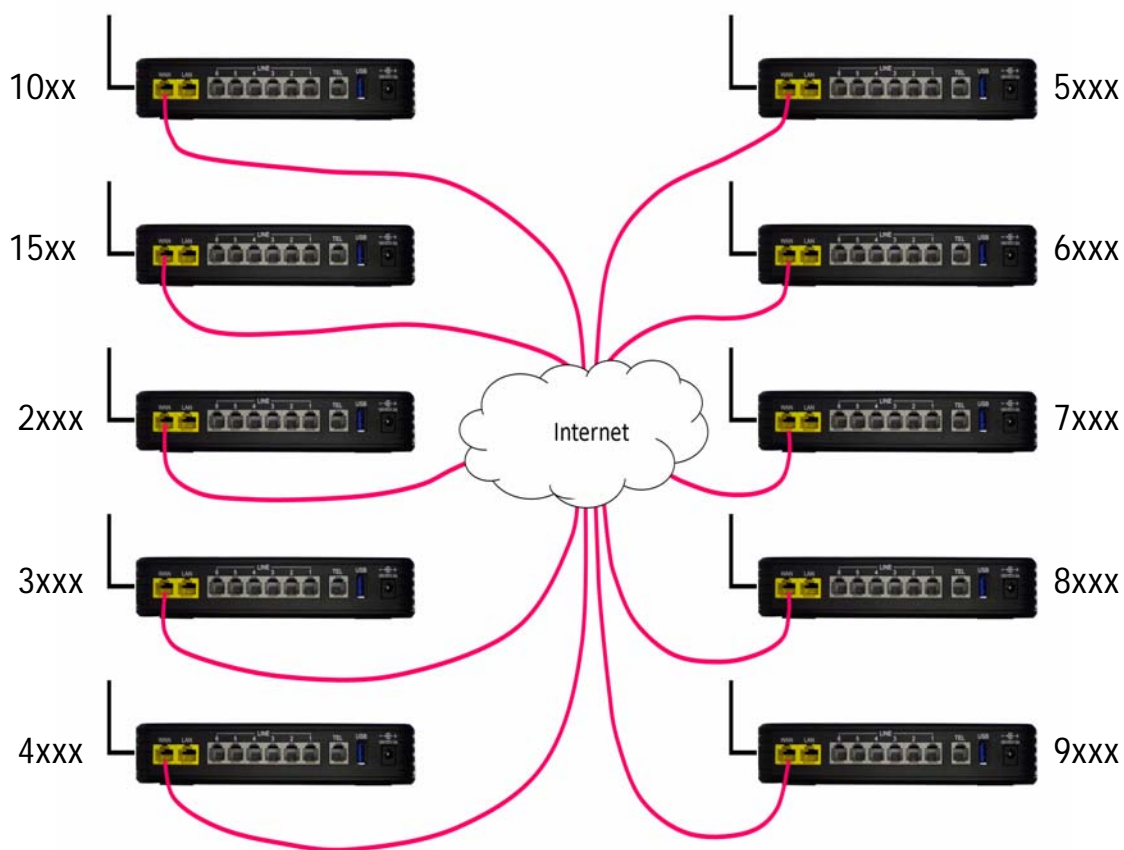

Things to know about the product

TABLE 2.1 Maximum Configuration

PSTN	SIP Trunk	SIP Extensions	Single Line Analog Extension
6 CO Lines	8 SIP Trunks	24 SIP Extensions	1
14 Total Telephone Lines		25 Total Extensions (24 SIP and 1 Analog)	

TABLE 2.2 Physical System Capacities

Capacity	Interface	Port	Description
1	LAN	RJ45	Local Area Network 10 base-T/100 base-TX
1	WAN	RJ45	Wide Area Network (for remote workers or offices) 10 base-t/100 base-TX/1000 base-T Gigabit Ethernet port
1	FXS	RJ11	Connected a Single Line (Analog) Telephone or FAX
6	FXO	RJ11	Allowing 6 simultaneously Telephone Calls
1	USB	USB	USB Interface to create a network or centralized printer
1	Wireless	802.x	LAN - 802.11a, 802.11b, 802.11g and 802.11n
24	SIP	RJ45	SIP telephone endpoint devices

TABLE 2.3 System Software Capacities

Capacity	Interface	Port	Description
8	SIP Trunks		Interface with up to 8 SIP Trunks
4	AA & VM		Interfaces with Auto Attendant and Voice Mail with 32 hours of storage
24	LAN/WAN	RJ45	Telephone Endpoints - Non Blocking
9	WAN	RJ45	Additional Office to Office - Voice Network (total 10)
14			Concurrent Telephone Line Calls (PSTN and SIP Trunks)
40			Call Routing Tables
25			Voice mailboxes associated with a telephone endpoint
40			Virtual Mailbox Extension without telephone endpoint
10			Single Digit Dialing Menus with Menu Tree Routing
10			Day - Outgoing System Greeting (OGM)
10			Lunch (Noon) - Outgoing System Greeting (OGM)
10			Night - - Outgoing System Greeting (OGM)
10			Holiday - Outgoing System Greeting (OGM)
10			Temporary - Outgoing System Message (OGM)

LED's on the **X-50** System**TABLE 2.4** LED Function

LED Name	LED	Status	Description
Power	Blue	On	Power is On
		Off	Power is Off
		Flashing	X-50 is rebooting
Wireless	Blue	On	Wireless LAN initialization successful
		Off	Wireless LAN not operational
"TEL" Port SLT Telephone	Blue	On	Single Line Telephone is Busy
		Off	Single Line Telephone is Idle
Line (1 - 6)	Blue	On	PSTN Line is Busy
		Off	PSTN Line is Idle
LAN	Blue	On	LAN is Connected
		Off	LAN is not Connected
		Blinking	Active LAN Traffic
WAN	Blue	On	WAN Connected
		Off	WAN is not Connected
		Blinking	Active WAN Traffic
	Red	ON	Ping the Default Gateway fail or DHCP fail

Notes:

2 System Specifications

TABLE 2.1 System Specification

Feature	
Main Processor	400 MHz Dual Core MIPS Processor Broadcom BCM6369
Processor SDRAM	External 64 MB
Processor Flash ROM	External 16 MB
Supplementary Processor	1x DSP Mindspeed M82351
System Flash (Voice Mail)	512 MB
Giga WAN PHY Chip	Broadcom BCM5481
Standards	IEEE 802.11 a/b/g/n, IEEE 802.3
Ports	1 - WAN, 1 - LAN, 1 FXS and 6 FXO
Buttons	Reset, WIFI On/Off and WPS
Ports	RJ-45 and RJ-11
LED's	Power, Wireless, Telephone, Lines (6), LAN and WAN
EMI/EMC	FCC Part 15 Class B

TABLE 2.2 Environmental

Operating Conditions	Specification
Operating Temperature	32° F to 95 ° F
Storage Temperature	32° F to 95 ° F
Operating Humidity	10% to 80% - Non Condensing
Storage Humidity	10% to 80% - Non Condensing
System Power	12 Volts - 1.5A

TABLE 2.3 IP PBX Configuration

Quantity	Interface	Connector	Description
6	FXO	RJ11	Allowing 6 simultaneously sessions
1	FXS	RJ11	For analog (single line) telephone
1	USB	USB	Print Server
1	LAN	RJ45	10/100 Local Area Network
1	WAN	RJ45	100/1000 Wide Area Network (for remote workers or offices)

TABLE 2.4 WiFi

Connector	Speed	Port	Description
Wireless	802.11 b, g and n	LAN Port	A Local Area Network allows network devices to share and access files through a wireless connection using 802.1x protocol. Generally, a LAN uses one DHCP Server, it is "small" in size (geographically) like a home or office, and it does not require any external ISP to transmit data between endpoints.
Antenna	5dbi single pole		

TABLE 2.5 Default LAN and WAN Ports

	IP Address	Description
LAN	192.168.10.1	Do not use IP Address 192.168.1.254 - it is reserved for the X-50 's DSP. Using this port will result in erratic operation.
WAN	DHCP	The WAN port is set to DHCP and will connect to an existing network and can be set to DHCP, Static or PPPoE.

TABLE 2.6 Physical Connectors

Connector	Speed	Port	Description
RJ45	10/100/1000 BaseT	WAN Port	A Wide Area Network (WAN) allows devices to share and access files through a series of wires known as a "Network". A WAN is used with multiple locations, and has no physical boundaries. It is actually possible to have a WAN that spans the globe.
RJ45	10/100 BaseT	LAN Port	A Local Area Network (LAN) allows network devices to share and access files through a series of wires known as a "Network". Generally, a LAN uses one DHCP Server, it is "small" in size (geographically) like a home or office, and it does not require any external ISP to transmission data between endpoints.

TABLE 2.7 X-50 System Capacities

Capacity	Interface	Port	Description
6	FXO	RJ11	Allowing 6 PSTN lines and simultaneously sessions
1	FXS	RJ11	Connected a Single Line (Analog) Telephone
1	USB	USB	Connect a printer to be shared by devices on the LAN
1	Wireless	LAN	LAN - 802.11b, 802.11g and 802.11n
1	LAN	RJ45	10/100 Local Area Network
1	WAN	RJ45	100/1000 Wide Area Network (for remote workers or offices)
8	SIP Trunks		Interface with up to 8 SIP Trunks
4	AA & VM		Interfaces with Auto Attendant and Voice Mail allowing it to process up to 4 simultaneous calls, which is shared with all telephone lines and endpoints
24	LAN/WAN	RJ45	Telephone Endpoints - Non Blocking
10	WAN	RJ45	Office to Office - Voice Network (Campus Environment)
14			Concurrent Calls (Telephone Lines and SIP Trunks)
40			Call Routing Tables
25			Telephone Endpoint voice mailboxes with Personal OutGoing Message (OGM)
40			Virtual Voice mailboxes with personal OutGoing Message (OGM)
10			Single Digit Dialing Menus with Menu Tree Routing
10			Day time OutGoing Message (OGM)
10			Lunch (Noon) - OutGoing Message (OGM)
10			Night time OutGoing Message (OGM)
10			Holiday OutGoing Message (OGM)
10			Temporary Outing Message (OGM)

TABLE 2.8 VoIP & Signalling Protocols

Signaling	Documented Protocol	Description
G.168	ITU-T G.168	Echo Canceller was designed and used to address and standardize the performance of echo cancellers in the PSTN.
G.711	ITU-T G.711	Highest Bandwidth/Lowest Compression - best voice quality. A voice encoder that compresses 64K bit stream to an 8K per second sampling rate, with a typical algorithmic delay of 0.125ms. G.711 is used when transmitting Music, FAX'es and DTMF tones because it is very reliable.
G.723.1	ITU-T G.723.1	Intermediate Bandwidth/Intermediate Compression - minimal reduction in voice quality. A voice encoder that compresses voice in 30ms frames, with a look-ahead of 7.5ms, with a typical algorithmic delay of 37.5ms. G.729a uses very low bandwidth because it samples at 8kHz/16-bit (240 Samples for 30ms frames).
G.729.a/b	ITU-T G.729a	Lowest Bandwidth/Highest Compression and least complex protocol, with a hybrid speech reproduction quality by use of an Algebraic Code Excited Linear Predication (ACELP) that reproduces a voice encoder that compresses voice in 10ms frames, with a look ahead of 5ms per frame, and atypical algorithmic delay of 15ms, per frame. It operates at 8k bits, and can be used with 6.4kbits and 11.8k bits, with a marginal reduction in voice quality.

TABLE 2.8 VoIP & Signalling Protocols

Signaling	Documented Protocol	Description
In/out Band	RFC 2833	In/Out Band is used to define the method of transporting DTMF tones to use on RTP connections. In-Band are tones that are "heard" by the distant party, and Out of Band tones are used for signaling.
MD5	RFC 3261	Message-Digest Algorithm 5 - is a widely used Cryptographic hash function (security) that uses 128 bit hash value.
QoS	RFC 2990	Quality of Service assigns different priorities to different data packets. Voice, for example, will receive a much higher priority than non-voice traffic, so it receives the highest priority. Therefore, QoS is used to prioritize specific packets, such as voice, within a packet-switched network. However, it does not guarantee voice quality.
T.38	ITU-T T.38	T.38 is the standard for transporting FAX transmissions, between G3 Fax devices, over an IP Network.
RTP	RFC 1889, 3550	Real-time Transport Protocol provides end-to-end network transport functions suitable for applications transmitting real-time data, such as audio, video, or simulation data, over multicast or unicast network servers. RTP is a standardize protocol for delivering audio and video over the Internet.
SDP	RFC 2327	Session Description Protocol is purely a protocol that negotiates between two endpoints to allow them to agree on a media type and format. It is intended for describing multimedia sessions, and to on a wide range of networks and networking environments.
SIP V2	RFC 3261	Session Initiated Protocol is an applications layer control (signaling) protocol that is outlined in the "Internet Official Protocol Standards" document number RFC 3261.
ToS	RFC 791, 1060, 1122, 1123, 1195, 1247, 1248, 1349, 2474, 3168	The Type of Service octet is part of the Internet Protocol header that specifies the priority of the attached datagram (message).
DTMF	RFC 4733	Dual Tone Multi-Frequency Tones - also known as touch tones® - Defined protocol for transmission of DTMF tones transmitted over a packet switching network.
AF Class	RFC 2597	One part of QoS, is Assured Forwarding Classes. This allows the administrator to divide the IP Packets into one of 12 different Classes. In the event that the network becomes congested, the packets with the highest Drop rate will be dropped.
EC	RFC 3246	Expedited Forwarding has the characteristics of low delay, low loss, and low jitter, making it suitable for Voice, Video and other real-time services.

TABLE 2.9 Internet Protocol

Protocol	Documentation	Description
IP Address	RFC 950	Defines the standards used to divide Class A, B and C using Subnets.
ARP	RFC 826, 3315	Address Resolution Protocol - allows devices to find a "host" device using the network layer (MAC Address).
RARP	RFC 903	Reverse Address Resolution Protocol - allows devices to find a "host" device using the network layer (MAC Address).
CHAP	RFC 1994	Challenge-Handshake Authentication Protocol - Negotiating protocol used with PPPoE. Also see MSCHAP and PAP
MSCHAP	RFC 2433, 2759	Microsoft's version of CHAP that allows mutual authentication between peers, by piggybacking challenge and response packets on a successful packet.
PAP	RFC 1334	Simple method for the peer to establish its identity using a 2-way un-encrypted handshake. Passwords are sent in ASCII format with no encryption. Also see CHAP, and MSCHAP.
DHCP Client	RFC 2131 - 2132	Dynamic Host Configuration Protocol is used by client devices, to obtain the correct settings, when joining a network.
DHCP Server	RFC 2132	Dynamic Host Configuration Protocol is used by server devices, to obtain or assign the correct settings, when joining a network.
DNS	RFC 1912	A Domain Name System is the "Phone Book" for the Internet. It translates "Human Relatable" names such as www.xbluenetworks.com into the numeric IP Address. The DNS can be a local or remote server, and it is a essential part of today's Internet.
HTTP	RFC 2616	Hypertext Transfer Protocol - is one of the communications protocols used to transfer information over a packet-switched network, such as an Intranet or the Internet. Typically, HTTP (at default using port 80) initiates or receives a request/response from a client to/from a server.
ICMP	RFC 792	Internet Control Message Protocol is one of the core protocols within Internet Protocol (IP). This protocol is a reactionary protocol only responding to error messages that are received.
IP	RFC 791	Internet Protocol allows devices to communicate over a package-switched network. This protocol provides an unreliable network, and makes no guarantees about sending or receiving a data package; it is a "best Effort" protocol. Therefore, other protocols such as "TCP" were created to make data transfer more reliable.
NAT	RFC 3022	Network Address Translation allows multiple hosts, on one private network, to access the Internet using one public IP Address.
NAPT	RFC 2663	Network Address Port Translation increases the efficiency of NAT by translating the "transport identifier", allowing a private host to multiplex into the transport identifiers to appear as a single Public IP Address.
PPPoE	RFC 2516	Point to Point over Ethernet allows users to "Virtually" create a direct connection between two devices over an Ethernet network.
SNTP	RFC 1305	Simple Network Time Protocol allows devices packet-switched networks to synchronize their time from a specific location.
NPT	RFC 867, 868	Network Time Protocol ensures that the time is synchronized all along the Packet Switching Network.
TCP	RFC 793	Transmission Control Protocol provides the reliability that Internet Protocol (IP) does not, making it suitable for applications such as File Transfer and E-mail.

TABLE 2.9 Internet Protocol

Protocol	Documentation	Description
Telnet	RFC 2946	TELNET is a reliable connection-oriented transport protocol, which is Client/Server based. At default TELNET uses Port 23.
TFTP	RFC 2349	Trivial File Transfer Protocol is a very basic and simple protocol which is loosely based on the FTP protocol.
UDP	RFC 768	Using User Datagram Protocol networked computers can send short messages known as datagrams. Although the delivery of a UDP packet is faster it is not as reliable as TCP packets.
RIP v1, v2	RFC 1058, 2453	Routing Information Protocol used in Local and Wide Area Networks to limit the number of hops allowed in a path from source to destination. Maximum number is 15 hops.
CLIP		Calling Line Identification Presentation

3 Feature Description

System Feature Description Table

TABLE 3.1 VoIP Module Features

Feature	Page	Feature	Page
Access Control	page 31	Least Cost Routing (Call Routing)	page 38
Account Codes (Traveling COS)	page 31	Line Group Assignment	page 39
Alarm (Station)	page 31	Live Call Record	page 39
Alternate Attendant	page 31	Meet Me Page	page 39
Announcement Mailbox	page 31	Message Waiting Indication	page 39
Answer Position	page 32	Music on Hold	page 39
Automated Attendant (Receptionist)	page 32	Mutual Mailboxes (Group Mailbox)	page 39
Automatic Daylight Savings (Internet)	page 32	Navigation Keys (Buttons)	page 39
Automatic Hold	page 32	Night Service (Automatic day/night)	page 40
Automatic Line Select	page 33	Numbering Plan	page 38
Automatic Provisioning (PnP)	page 33	Off Hook Preference	page 40
Automatic Route Select (Call Routing)	page 33	Outgoing Call	page 40
Backlit Display	page 33	One Touch Record	page 40
Basic Calling	page 33	Paging (All Call and Zone)	page 40
Busy Call Back	page 33	Pause	page 41
Busy Lamp Field (Busy Extension)	page 33	Phantom Mailbox (Extension)	page 41
Call Abandon	page 33	Phonebook (Personal)	page 41
Call Forwarding (6 types)	page 34	Phonebook (Public)	page 41
Call Operator	page 34	Power Fail Transfer	page 41
Call Park	page 34	Programmable Buttons (Telephone & Sidecar)	page 41
Call Pickup - Group	page 35	Redial	page 41
Call Restriction	page 35	Registration Server	page 42
Call Routing	page 35	Remote (Administration) Management	page 42
Call Waiting	page 35	Service Mode	page 42
Caller ID	page 35	SIP IP Trunk (Maximum 8)	page 42
Class of Service	page 35	Soft (Interactive) Keys	page 42
Conference	page 36	Speed Dial	page 42
Day & Night Service Mode	page 36	Station Lock	page 42
Daylight Savings Time	page 36	Station Message Detailed Recording	page 43

TABLE 3.1 VoIP Module Features

Feature	Page	Feature	Page
Default Setting	page 36	System Speed Dial	page 42
Direct Inward Dial	page 36	System Time & Date	page 43
Direct Inward System Access	page 36	Time and Date in Display	page 43
Distinctive Ringing	page 37	Toll Restriction	page 43
DNS Client	page 37	Transfer	page 43
Emergency Call	page 37		
Extension Password	page 37	Traveling Class of Service	page 43
E-mail Delivery of Voicemail Messages	page 37	Trunk Group	page 43
FAX Detection	page 37	Uniform Distribution/Hung Group (UCD)	page 44
Flexible Numbering Plan	page 38	UCD - Agent Login/Logout Call Reroute	page 44
X-50 to X-50	page 38	Virtual Mailbox (Extension)	page 44
Hot Dial Keypad	page 38	Voice Mail	page 44
Last Number Redial	page 38	Wizard Setup	page 45



Access Control - Browser

For security, the **X-50** is password protected with a programmable port, making it more secure. There are three different password levels, User, Administrator, and Support.

TABLE 3.2 Password levels

User Name	Password	Description
admin2583	000000	Unrestricted access to all programming parameters
user	user	View configuration settings and statistics
support	support	Run Diagnostics with technical support engineer on the phone

Only one Administrator can log into the **X-50** at one time. Additional attempts to enter the administration area will be denied until the original administrator has exited and three minutes have elapsed.

Account Code

Also known as "Traveling Class of Service" - This allows authorized users to make calls on restricted extensions. The systems recognizes the user when they enter a code and their password, and brings their less restrictive class of service to the new location. The user's Class of Service remains active for 60 seconds after the call is disconnected and then it returns to the original Class of Service.

Agent (UCD) Logon/Logoff

Agents (extensions) may dial a code, which temporarily takes them out of all UCD groups. Once the agent logs off, they will not receive any additional incoming UCD calls. This can be very helpful when an agent is out of the office or out to lunch. When the agent returns, they dial a code to log into all UCD groups. Once logged in, they start receiving UCD calls.

Alarm

Each **X2020** connected to the **X-50** VoIP Telephone System can set up to three telephone alarms, which can be programmed to play once or set to always. The user can select between 11 (0~10) different ring tones. After the alarm is reached, it can repeat up to 10 times at an interval of once every 1 to 5 minutes.

Alternate Attendant

A second extension may be programmed as the Alternate Attendant. The alternate answering position serves as a back up position to the primary attendant. Telephone line ringing will forward to the alternate answering position after the preprogrammed ring alternate position time.

Announcement Only Mailbox

Any physical or virtual voice mailbox can be programmed to be an announcement only mailbox. An announcement only mailbox may be used to make common announcements such as business hours, directions, mass schedules for Church, etc. These mailboxes can be accessed from the Automated Attendant or the Attendant can transfer a call directly to the announcement. After the announcement plays the call is disconnected.

Answer Position

Each of the six analog (PSTN) and eight SIP trunk lines can be programmed to ring at the Operator, Auto Attendant, Extension or UCD hunt group for both day and night. When set to operator - callers will ring the extension that is programmed as the operator in the system. When set to auto attendant - callers will ring one of the four auto attendant ports and be answered with the appropriate day, lunch, night, holiday or temporary outgoing message. When set to Extension - callers will ring the entered extension. When set to Universal Call Distribution (UCD) Group - all members of the group (up to 25 members can be entered into each group) will ring.

Automated Attendant (Receptionist) (AA)

The system comes standard with an integrated four port Automated Attendant (Receptionist) which can perform up to four simultaneous tasks. All telephone lines, extensions and virtual mailboxes share these four ports. When the Answer Position, for a telephone line, is set to "Automated Attendant" the call is immediately answered and is played a customizable prompt. In addition, there are 10 single digit dialing menus that can be used to route callers. Each menu has the ability to play five; day, lunch, night, holiday and temporary outgoing messages (OGM) based on the time of day or day of week. The **X-50** VoIP Telephone System also supports single digit dialing and menu trees.

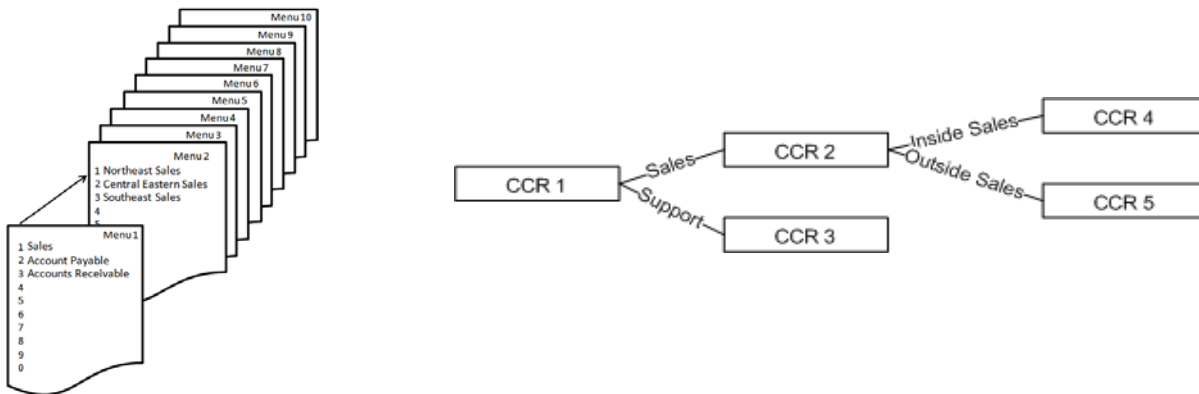

Automatic Daylight Savings (NTP)

When the **X-50** VoIP Telephone System is connected to the Internet it will automatically synchronize the date and time using Network Time Protocol (NTP). Therefore, when time changes for daylight savings, the system will automatically change.

Automatic Hold

Automatic hold allows extension users to press a preprogrammed extension button (DSS) to announce a call without pressing hold first. The telephone line call is automatically placed on hold. This allows busy extension users, such as the attendant, to answer multiple calls very quickly.

Automatic Line Select (Hot Line)

Users may select how their idle extension functions when lifting the handset or pressing the speaker button. An extension can be set to access a specific outside line, a line group, or intercom (ICM) automatically when going off hook or pressing the speaker button. In addition, Users can program a timer from 0 to 8 second, delay before the off hook action is taken.

Automatic Provisioning

The system comes standard with WAN Management Protocol (TR-069) which allows the system to use Auto-Configuration Server (ACS) to preform auto-configuration, provision, collection, and diagnostics.

Automatic Route Select (ARS)

See Call Routing

Backlit Display

The **X2020** SIP Telephone endpoint has a 6 line, 128 x 64 backlit display, which can be programmed go into sleep mode, or stay lit.

Basic Calling

There are two different types of calling; Intercom which are calls within the system and telephone line to an external location. When a dialed number is within the system numbering plan, it is considered an intercom call. If the number is not within the system numbering plan, but matches an entry in the routing tables the call will be routed over the appropriate telephone line or line group. Related Features: Numbering Plan and Call Routing.

Busy Call Back

Busy Call Back allows the user to dial a code when they call a busy extension to queue up for a call. When the called extension hangs up, the calling extension will ring, when calling extension lifts the handset, the called extension will be ringing.

Busy Lamp Field (BLF)

Busy Lamp Field also known as Direct Station Select (DSS) is a visual indication, usually a LED on a preprogrammed button, that shows when an extension or telephone is busy. The associated LED will be lit solid indicating that the extension or telephone line is busy.

Call Abandon

Call Abandon is a timed signal which is sent from the telephone company to the system to indicate that a telephone line had disconnected. This is especially helpful when callers disconnect the call while they are on hold. The system receives a timed disconnect signal, which matches the preprogrammed Call Abandon Time, from the telephone line provider and forces the telephone line on-hook.

Call Forward

At default, all extensions are forwarded to voicemail. However, they can also use several other types of call forwarding; Busy, Direct, Do Not Disturb, Follow me, Call forking, and Remote (External). These can be programmed using the web interface or by dialing the call forward code.

Busy Call Forward

Busy Call Forward, forwards all incoming calls to the forwarded destination only when the extension is busy. Extensions that are busy forwarded will not ring when a second call is presented to them. However, an alert tone is heard indicating that a new call is being routed to the forwarded destination.

Direct (Always) Call Forward

Direct Call Forward, forwards all incoming calls to the forwarded destination as soon as it is presented to the extension. An alert tone is heard indicating that a new call is being routed to the forwarded destination.

Do not Disturb Call Forward

DND call forward, forwards all incoming calls to the forwarded destination only when the extension is in DND. If the extension is put into DND and it is not DND forwarding, callers will get a busy signal.

Follow me Forward

The Follow Me Forward, feature allows internal extension users to re-forward their extensions to a new location. This is especially helpful when waiting for an important telephone call but must go to another destination, such as an impromptu meeting. An alert tone is heard indicating that a new call is being routed to the forwarded destination.

Call Forking Forwarding

Call Forking is used to ring two destinations at the same time. This feature will work for two extension number, without a SIP Trunk, but with a SIP Trunk, it can ring an extension and one or two external numbers.

Remote (External) Call Forward

Remote (External) Call Forward, allows extension users to forward their incoming calls to a remote destination such as a cellular or home telephone number. The extension user can change their forwarded destination from their extension.

Call Operator

The system supports both a primary and secondary operator which can be accessed from any SIP telephone endpoint or the analog port by dialing "0". Any extension, SIP telephone endpoint or FXS (analog port) can be assigned as the primary and secondary operator. The Operators are defined in the Numbering Plan.

Call Park

Park often called orbit, is a way of placing a call on hold where anyone within the system can access that call by dialing a park pickup code. The Park location is usually the same as the extension number.

Call Pickup Group

Any extension SIP telephone endpoint can dial star "*" to pick up a telephone line that is ringing at a different extension. If multiple telephone lines are ringing the oldest ringing line will be accessed.

Call Restriction

When making a telephone line call all digits dialed will be compared to the telephone's Class of Service and restriction table. The Call Restriction table allows the administrator to enter a range of digits (From - To), Trunk Access, Class of Service (COS). The **X-50** VoIP Telephone System has eight classes of service zero (0) which has no restrictions and seven which is the most restrictive. The Call Restriction Table is made up of two tables an allow table and a deny table. Each entry into either table is associated with a Class of Server. The combination of these entries make up the allow or deny table. There are 40 call restriction tables and they work in the following way:

1. If there are no entries in either the allow or deny tables, all calls are allowed. If there are entries in either table the calls are evaluated in the following order:
2. Deny Table - If the dialed digits match an entry in the deny table the call is denied. If the dialed digits do not match an entry in the deny table, the call is sent to the allow table.
3. Allow Table - If the digits match an entry in the allow table, the call is allowed. If the digits do not match an entry in the allow table, the call is denied.

Call Routing

When making a call all digits dialed will be compared to the rules entered in the Call Routing Table. The Call Routing Table is built using up to 40 different routing rules. Each call routing condition (rule) directs the dialed digits to a specific route and is made up of eight parameters, which include the "From" and "To" dialed digits, "Minimum" and "Maximum" number of digits to evaluate, number of digits to "Delete" or "Insert" before dialing the numbers over the "Destination" route (line group).

The call routing table is used to route calls over a voice network, which allows the administrator to route calls the most inexpensive way. For example, in a voice network with locations in Boston, Chicago, and San Francisco calls with a 617 area code, can be routed to the Boston location, thus avoiding toll charges.

Call Waiting

The Call Waiting Flash supports the CO line flash, which allows extension users to pick up a call after receiving a call waiting indication from the telephone line provider.

Caller ID

The system is equipped to received caller ID (requires a subscription) from the telephone line provider and will at default passed the information to a ringing telephone (SIP or Analog) extension.

Class of Service

Each extension in the system is assigned one day and one night class of service of service, which determines the extension's dialing privileges. There are eight different Classes of Service which are defined in the Call Restriction Table. A Class of Service (COS) of seven has the most restriction whereas a COS of zero (0) has no restrictions.

Conference

The systems can conference, join together, multiple Telephone (PSTN or SIP) Lines or extensions, or a combination of both, to the maximum of three connections so that multiple parties can speak together simultaneously.

Day & Night Service Mode

The system can run in either day or night mode and can be programmed to automatically switch between day and night mode.

Daylight Savings

The system supports manual or automatic synchronization of daylight savings. When set to automatic the system will automatically change from standard to daylight savings time. When set to manual, the administrator will have to enter the update manually.

Default Setting

Using the "Restore Default" feature found in "Management" the administrator can reset the system back to factory default. This will also reset some of the SIP Telephone endpoint parameters such as Line Keys, Call Forward Settings, Auto Answer, Phone Lock and Call waiting. However, it does not reset any system prompts that have been rerecorded.

Direct Inward Dial (DID)

Using the SIP Trunks, the system can support up to 50 Direct Inward Dial (DID) numbers. These numbers share with the connected (up to eight) SIP trunk positions. The system has a special DID Ring Table which allows the administrator to direct the incoming DID numbers to a specific extension, Auto Attendant, UCD group or voice mailbox. In addition, some DID can also be programming as Direct Outing Dialing (DOD) which can be programmed to send the DID number as its caller ID.

Direct Inward System Access (DISA)

DISA allows an incoming caller to enter a code into the auto attendant to gain access to system resources. At default this feature is disabled. Enabling this feature could cause unwanted long distance charges, which are the sole responsibility of the owner of the system.

Direct Telephone Line Access

Each extension can program any programmable button to be a direct access to a PSTN or SIP Trunk telephone line.

Distinctive Ringing

Telephone Line

Each telephone line (PSTN or SIP Trunk) can be programmed to ring with one of eleven different ring tones.

Extension

Each SIP Telephone endpoint can be programmed to ring with one of eleven different ring tones.

Domain Name Server (DNS)

A Domain Name Server is the “Phone Book” for the Internet. It translates “Human Relatable” names such as www.google.com from the numeric IP Address 64.233.187.99. The DNS can be a local or remote server, and it is a essential part of the Internet.

Emergency Call

The system, regardless of Class of Service, Call Routing, Call Restriction or Phone Lock programming, will not block any of the five emergency numbers that are programmed into the Emergency Call Table. At default, 911 is programmed into the table.

Note:

Numbers in the Emergency Call table cannot conflict with any numbers in the numbering plan. For example, when using 3 digit extension numbers do not use “911” as one of the extensions.

Extension Password

All extensions in the system are assigned a password that is used to access voice mail and when using the phone lock/unlock feature.

E-mail Delivery of Voicemail Messages

The voice mail has the ability to send a new voice mail message to a users E-mail address. The systems uses Simple Mail Transport Protocol (SMTP) to send the voice mail message as a standard WAV file, which can be reviewed by most smart phones or multimedia Personal Computers.

FAX/Modem Detection

The **X-50** supports both FAX (T.38) and Modem detection and auto-fallback to G711, from an analog telephone line to the Single Line Port.

Flash

The Flash key (or hook switch) on an analog telephone (Single Line Telephone) connected to the system can be used to activate features such as placing a call on hold, picking up the held call, or when transferring a call to another destination.

Flexible Numbering Plan

The **X-50** is preprogrammed with a default numbering plan which may be changed to suit customers' needs. When changing the numbering plan it is important to remember that the numbers entered cannot conflict with the numbers entered in the Emergency Call Table.

TABLE 3.3 Default Numbering Plan

Description	Default Numbers	Configure	
Start extension number	101		
End extension number	125		
FXS Phone Extension	125		
Operator speed-dial number	0		Day/Night Alternate Day/Night
AA/Voicemail Service Number	450		
Start Virtual Extension Number	830		
Start PSTN Line number	701		
Start IP Trunk Line Number	711		
Start Trunk Group Number	80		
All Paging number	400		
All Paging Range	LAN/WAN/Both		
Paging Group Start Number	401		(1) 401, (2) 402, (3) 403
UCD Group Start Number	430		(1) 430, (2) 431, (3) 432, (4) 433
System Speed Dial	600	600 through 699	
Start Call Park Number	731		

X-50 to X-50

Each **X-50** VoIP Telephone System can be one of ten systems that creates a voice network. Once connected, extensions will be able to dial directly to extensions on the network. For example, if an extension (111) in Boston wanted to call an extension (211) in San Francisco they would dial 211. In the call routing table 211 will be directed to the San Francisco Gateway and the call will be connected. Similarly, telephone line calls can be routed to remote gateways for cost effective call processing.

Hot Dial Keypad

The **X2020** telephone endpoints support hot dial keypad dialing, which allows a user to dial a telephone number without lifting the handset or pressing the speaker button.

Last Number Redial

Last Number Redial also known as Redial is used to press one button for quick access to the last thirty numbers dialed from that extension.

Least Cost Routing

See Call Routing

Line Group

Each telephone line in the **X-50** is assigned to one of four line or trunk groups, which are used to group similar trunks together. For example, all PSTN lines in group 1 and SIP trunks in group 2, etc.

Live Call Record

Also known as One Touch Record feature, which allows extension users to record the current conversation. Live Call Record is extremely helpful for remembering telephone numbers or addresses when a pen and paper are not readily available. The recording is placed in the user's personal mailbox so that they may listen at a more convenient time. This feature works with local (LAN) and remote (WAN) authenticated **X2020** telephones.

This feature may violate privacy laws if used in a manner that is inconsistent with requirements of these laws. Manufacturer assumes no responsibility with regard to the use of this feature. It is provided for the virtue of ethical use only. The User is responsible for using this feature appropriately considering all applicable laws.

Meet Me Page

Meet me page allows an extension user to dial a code from any extension within the system and be connected to the person that just completed a page. Once the call is established the paging port is released, and the two parties will converse privately.

Message Waiting Indication (MWI)

Whenever a new voice mail message is left of for a SIP telephone endpoint the light bar above the LCD Display will flash rapidly and the display will update to indicate that there is a message.

Music on Hold

The system has a prerecorded music on hold file that plays whenever a telephone line or SIP trunks is placed on hold.

Mutual Mailboxes (Group Mailbox)

A Mutual Mailbox is a special mailbox that can appear on multiple telephone extensions. This allows a group of extension users to share access to the same mailbox. When a new message is left in the mailbox, all extensions with the special mailbox button will light, indicating that there is a new voicemail message.

Navigation Keys

The **X2020** come equipped with "cell phone like" navigation keys, which are used to scroll through features, lists and programming parameters. They allow the user to go up, down, left, right, and the center key is used to select, say OK, or confirm the parameter entry.

Night Service

The **X-50** VoIP Telephone System can operate in two modes; day service and night service. Night service can be used to change the extension Class of Service as well as the system ring scheme and Auto Attendant message. Each extension is assigned a day and a night class of service, which can be used to specify day and night dialing privileges. Thus, controlling the amount of unauthorized calls placed at night.

Numbering Plan

See Flexible Numbering Plan

Off Hook Preference

Similar to Automatic Line Select and Hot Line, The analog (SLT) telephone and **X2020** extension users have the ability to select how their telephone will react when they lift the handset or press the speaker button. For example, the telephone can access a specific telephone line, line group, dial a specific or group of extensions, and even dial an outside telephone number.

Outside Calls

Once authenticated, an **X2020** telephone can dial a telephone number without going off hook, pressing the speaker button, or accessing a telephone line. In addition, the user can press the softkey under "Backsp" to delete a number if it is dialed incorrectly. Once the "Dial Time-out" timer expires, or the user presses the center navigation button (Check Button" the call is sent to the **X-50** for processing. The user can also press a preprogrammed telephone line button and dial the number directly.

One Touch Record

Also Known as Live Call Record - Extensions have the ability record the current conversation. One Touch record is extremely helpful for remembering telephone numbers or addresses when a pen and paper are not readily available. The recording is placed in the user's personal mailbox so that they may listen at a more convenient time. This feature works with local (LAN) and remote (WAN) authenticated **X2020** telephones.

This feature may violate privacy laws if used in a manner that is inconsistent with requirements of these laws. Manufacturer assumes no responsibility with regard to the use of this feature. It is provided for the virtue of ethical use only. The User is responsible for using this feature appropriately considering all applicable laws.

Paging

All Call Page

When doing an all call page, all LAN and WAN **X2020** telephones (within the same subnet) that are idle will receive the page announcement.

Zone Page

Each extension can be placed into one or more paging zones. This allows specific areas to make a page announcement without interrupting everyone on the system. When the page zone is dialed, all LAN and WAN **X2020** telephones (within the same subnet) that are idle will receive the page announcement.

Pause Insertion

Pause is a momentary delay in dialing when placing an outgoing PSTN or SIP Trunk Line from a stored number such as a speed bin. In addition, the **X-50** system will automatically enter a momentary pause when an international number is dialed. To insert a Pause when programming a speed dial bin, use either a "P" or "p".

Phantom Mailbox (Extension)

The **X-50** VoIP Telephone System has 40 special phantom or virtual mailbox extensions. They are used for personnel that do not require a physical telephone but need to be visible within the system. They can also be used as group mailboxes allowing multiple people to share the same mailbox.

Phonebook

There are two types of phonebook, Personal and Public. The Personal Phonebook is for the private use of the user that enters the number and the Public Phonebook can be accessed by all authenticated **X2020** telephones.

Private

Each extension has a phonebook for their exclusive use. The phonebook holds 200 numbers that are stored alphabetically by the name and can be grouped by Family, Friends, Colleague, and VIP. In addition, if incoming Caller ID matches one of these entries, they can be assigned to use a distinctive ringing tone.

Public

The Public Phonebook is a list that the administrator creates and maintains in a centralized location allowing all authenticated **X2020** telephones to link to the list. Each user has the ability to import the list and have access to the numbers.

Power Failure Transfer

In the event of a power failure, the first PSTN line will be automatically connected to the FXS port labeled "TEL" in the system.

Programmable Buttons

Each **X2020** telephone has the ability to program the four buttons labeled 1, 2, 3 and 4. At default, they are the first four PSTN telephone lines and the optional Sidecar has twenty-four (24) buttons which at default are extensions 101 through 125. Any of the buttons on the phone or the sidecar can be programmed to be feature, telephone line, speed bin, etc.

Redial

Redial also known as Last Number Redial is used to press one button for quick access to the last thirty numbers dialed from that extension.

Registration Server

The **X-50** VoIP Telephone System acts like a registrar server for both SIP telephone endpoints and SIP trunks, which eliminates any possibility of a numbering conflict.

Remote Management

The **X-50** VoIP Telephone System combines both Proxy and Registrar servers in its application. For a Registrar server, it acts as the front end to the location service for a domain, reading and writing mappings based on the contents of the Register requests. The location service is then typically constructed by a proxy server.

Service Mode

There are three service modes; Day, Night and Time. When the system is in day mode, the day greeting will play and the day class of service will be referenced when an extensions dials a number. Night mode, the night greeting will play and the night class of service will be referenced when an extension dials a number. If the system is set to Time mode, it will automatically switch between day and night modes and the associated classes of service, day and night.

SIP Trunk

The system can support up to 8 SIP uplink servers, known as SIP Trunks. These trunks, once authenticated, are treated as any other trunk (telephone line) in the system. In addition, to the normal programming such as Answer Position, Call Routing, Call Restriction, and Trunk Groups, the **X-50** also supports provisioning for Direct Inward Dial (DID) numbers over SIP trunks. SIP Trunks are also required when using the Call Forward feature Forking.

Soft Interactive Keys

There are four buttons under the **X2020** telephone display that change their function, to assist the user, as they use the telephone. For example, when the phone is idle, the left soft key shows "Menu", which changes when the speaker button is pressed to "NUM" and the third key shows "SPD".

Speed Dial

The **X2020** telephone has a special location with quick access for frequently dialed numbers. Unlike the Phonebook, these numbers are stored by location number 0~9 and can be accessed by pressing the down navigation key from an idle telephone.

Station Lock

Using an extension's password, users can lock their telephones. This helps reduce unauthorized users from using an extension that may have an unrestricted toll restriction. The use of station lock, may cause that extension to be restricted from calling 911!

Station Message Detailed Recording (SMDR)

This feature is used to monitor and report on incoming and/or outgoing telephone line (PSTN or SIP Trunk) calls and displays it chronologically by extension number. The SMDR information stores telephone line used, extension number, time and date, and the length of each call.

System Speed Dial

See Phonebook Public

System Time and Date

When connected to the Internet the system uses Network Time Protocol (NTP) to synchronize the time and date. In addition, the date and time can be set manually.

Time and Date in Display

The first line on the LCD of an idle **X2020** telephone shows the date and time. The Time format can be changed from the default, "USA Time 12 Hour" to "USA Time 24 Hour" or "European 12 and 24 Hour" format. When using the European format, the date will also change, after 1 minute, from MM/DD/YY to DD/MM/YY format.

Toll Restriction

The Call Restriction Table is used to define up to eight different classes of service which is used by both SIP telephone endpoints and SIP trunks. The Call Restriction Table is built "created" by using up to 40 different allow tables. Each table uses a "from" digit and a "to" digit to define the approved digits. If a number is dialed that is not between the "from" and the "to" digits, the call is denied and will not be placed.

Transfer

Calls that are answered by a SIP telephone endpoint may be transferred to another destination, such as a different extension, voicemail or an extension on another system within the voice network.

Traveling Class of Service

Also known as "Account Codes" - This allows authorized users to make calls on restricted extensions. The systems recognizes the user when they enter a code and their password, and brings their less restrictive class of service to the new location. The user's Class of Service remains active for 60 seconds after the call is disconnected and then it returns to the original Class of Service.

Trunk Group

All trunks are automatically placed into one of four trunk groups, which are used to group trunks (PSTN or SIP) with "like" programming such a local and long distance.

Unified Call Distribution (UCD) or Hunt Group

The system has four Uniformed Call Distribution (UCD) Groups (Hunt Groups), each can support up to 25 extensions. Each UCD can be programmed as an all ring, linear or distributive ring group and if unanswered calls can be rerouted to another destination such as a different menu and greeting, or directly to a voice mailbox.

- All Ring - Rings all extensions simultaneously
- Linear - The call is placed into queue and the system attempts to ring the first programmed member, if that member is busy, the next programmed extension is tried. If that one is busy, the third programmed member is tried and so on.
- Distributive - The call is placed into queue and the system finds the agent that is on-hook and idle the longest, and rings that member first.

UCD Agent Logon and Logoff

Agents (extensions) may dial a code, which temporarily takes them out of all UCD groups. Once the agent logs off, they will not receive any additional incoming UCD calls. This can be very helpful when an agent is out of the office or out to lunch. When the agent returns, they dial a code to log into all UCD groups. Once logged in, they start receiving UCD calls.

UCD Reroute

All UCD groups have the ability to reroute unanswered calls to a Menu, Voicemail, Phone or Virtual Extension. In addition, a voice mailbox can be set to be an announcement only so that it plays a message to the caller and then disconnects the call.

Virtual Extension (Phantom)

The **X-50** VoIP Telephone System has 40 special virtual mailbox or phantom extensions. They are used for personnel that do not require a physical telephone but need to be visible within the system. They can also be used as group mailboxes allowing multiple people to share the same mailbox.

Voice Mail

The system has an integrated Auto Attendant and voice mail system with 32 hours of message storage. Each authenticated extension, plus any virtual extension, has access to a password protected voice mailbox. For extensions that should or would not use a voice mailbox, it can be disabled. In addition, the administrator can program each voice mailbox to have e-mail delivery of a voice mail message. After a message is successfully sent, the mailbox can be programmed to save the message as new, save it as old or delete the message completely.

Wizard Setup

The **X-50** system, at factory default, starts with a step by step setup wizard. From the wizard screen, the administrator can load an existing configuration or select to use the step by step questions and answers. There are eight programming parameters that make up the setup wizard.

- WAN Settings
- LAN Settings
- Wireless Basic
- Internet or manual time setting
- Numbering plan
- IP Trunk
- Trunk DID Table (SIP Trunks required)
- Call Routing Table

Notes:

4 Telephone Feature Description Table

Telephone Feature Description Table

Although the **X-50** system uses standard SIP protocol it also has some special features that only work with the **X2020** SIP Telephone Endpoints. Several of these features can be programmed or changed using either the Telephone or System Graphical User Interface (GUI)

- If the feature is programmed using the System GUI - the column labeled GUI will have an "S"
- If the feature is programmed using the Telephone GUI - the column labeled GUI will have a "T"
- If the feature cannot be programmed using the GUI - the column labeled GUI will have a "N"

Feature	Programming Sequence	Page	GUI
Agent Log on/off - UCD Group	Log On *91 Log Off **91	page 53	N
Alphanumeric Display	Phone Specific	page 53	N
Automatic Hold	X2020 only	page 54	S
Busy Callback	Call ext + 6 Cancel *66	page 54	N
Call Forking (Requires SIP Trunk)	*26 + t + Ext t= 0=ICM 1=Outside 2=Both Ext = Extension Number Cancel **26	page 55	T
Call Forward - Direct	*21+t+D t= 0=ICM 1=Outside 2=Both D= EXT or Voicemail or UCD Cancel **21	page 55	T
Call Forward - Busy	*22 + t + D t= 0=ICM 1=Outside 2=Both D= EXT or VVA or UCD Cancel **22	page 55	T

Feature	Programming Sequence	Page	GUI
Call Forward - No Answer	*23 + t + D t= 0=ICM 1=Outside 2=Both D= EXT or Voicemail or UCD Cancel **23	page 55	T
Call Forward - DND	*24 + t + D t= 0=ICM 1=Outside 2=Both D= EXT or Voicemail or UCD Cancel **24	page 55	T
Call Forward - Follow Me - From the new extension....	*25 + t + Ext + * + pswd t= 0=ICM 1=Outside 2=Both Ext= The Extension Number pswd The voicemail password Default is 0000 Cancel **25 + Ext + * + pswd	page 55	N

Feature	Programming Sequence	Page	GUI
Call Forward Remote	*21 + t + * + pswd + * + O *22 + t + * + pswd + * + O *23 + t + * + pswd + * + O + * + T *24 + t + * + pswd + * + O *25 + t + * + pswd + * + O t= 0=ICM 1=Outside 2=Both pswd = VM Password O= Outside number T= Time to wait Cancel **2x x= 1~5	page 55	T
Call Hold	Hold Button	page 59	N
Call Log	X2020 only	page 59	T
Call Park/Call Park Answer	Defined by Numbering Plan (The default is 731, 732, 733 and 734)	page 60	T
Call Pickup	*53 + Extension	page 60	T
Call Waiting	*98 Cancel **98	page 60	T
Call Block		page 61	T

Feature	Programming Sequence	Page	GUI
Class of Service - Traveling	*55 + ext + pswd ext= extension pswd= extension password	page 62	N
Conference (3 way)	Press Hold while on a call Press the down navigation key Make second call Press the Conference button	page 61	N
Distinctive Ringing	Use Ring Type (Admin Menu or Web)	page 62	T
Do Not Disturb (DND)	*4 Cancel **4	page 63	T
Extension Feature Reset	*69 + Extension or Administrator Password	page 63	T
Feature Button Programming	*70 + BN + FT BN= Telephone - 01~04 Sidecar 05~28) FT= Feature Type: 00=Null 01=Extension (Virtual) Number 02=Trunk Number (PSTN or SIP Trunk) 03=Call Park Dial Code 04=Feature Key (Feature Access Code) 05=Others (such as outside number) 06=Do Not Disturb) 07=Live Record 08=Virtual Mailbox	page 64	T
Extension Feature Reset	*69 + ad-pswd ad-pswd= admin password	page 63	T

Feature	Programming Sequence	Page	GUI
Feature Button Reset	*68 + pswd pswd= extension password	page 66	S
LCD interactive	X2020 only	page 66	N
Multi-Line Appearance	See Feature Button Programming	page 67	T
Mute	Mute Button	page 67	N
On Hook dialing	X2020 only	page 68	N
Page Answer (Meet Me Page) - X2020 only	Press "Answer" button under LCD	page 68	N
Page Allow/Deny	*99 Page denied **99 Page Allowed	page 68	N
Phonebook	GUI Only	page 69	T
Phone Lock/Unlock	*97 + pswd **97 + pswd pswd= extension password	page 71	N
Plug & Play (PnP)	X2020 only	page 71	N
Reminder Tone (Stutter Dial Tone)	Whenever a feature is enabled	page 71	N
Service Mode (attendant only)	*790 - Toggle between each mode Go directly to a Mode *791 - Day Mode *792 - Night Mode *793 - Time Mode	page 72	N
Telephone Line Flash		page 72	N
Transfer Recall		page 73	N
Volume Control		page 73	T
Web management		page 73	Y

Some features require two buttons, one to activate and one to cancel a feature.

Agent Log On/Off - UCD Group

- *91 - Agent log On
- **91 - Agent Log Out

Description:

Any extension programmed into a UCD group is considered an "Agent". At times, an extension may want to stop their extension from ringing so they can simply "Log Out" of the UCD Group.

Operation:

From an Idle **X2020** Telephone Dial **91 to log out of a UCD group, dial *91 to log back into the UCD group.

Notes:

1. Only extension programmed as a member of one or more UCD Groups can use this feature.
2. When an agent logs out, they log out of all UCD groups.
3. When an agent logs in, they log out of all groups
4. There is no visual indication (lamp or LCD) when an agent is logged off.

Alphanumeric Backlit Display

Description

The **XBLUE X2020** telephone comes standard with a backlit graphic LCD display that supports 64 alphanumeric characters.

Operation:

N/A

Notes:

N/A

Automatic Hold

Description:

This feature helps simplify the call handling process by allowing the user to answer a call and then press a preprogrammed extension button without pressing the hold button first. The answered call will automatically be placed on hold. To pickup the held call the user will press the hold button or another extension can press the preprogrammed telephone line button.

Operation:

This is an automatic feature in the **H2020** telephone.

Notes:

1. This will work when the user is on a Telephone Line or Intercom call
2. Automatic Hold can be disabled by the administrator in the **H-50** system. It is found in the "Programmable Line Key" parameter in the "Voice" --> "Phone Section".

Busy Callback

Description:

The **H2020** supports busy callback to an extension. This allows the user to dial 6 when they call an extension and gets a busy signal. Once Busy Callback is activated, the called extension will ring calling parties extension when it becomes idle. The calling extension can also cancel the Callback by dialing *66.

Operation:

A confirmation tone is heard once the busy callback feature is enabled.

The User may dial *66 to cancel a busy callback.

Notes:

1. Busy callback will not work if the called extension has busy call forward enabled.

Call Forward - Forking

Description:

This feature will allow a transferred telephone line or intercom call to ring at two simultaneous destinations, such as an extension (LAN/WAN) or a cellular telephone. When one party answers the call the other ring telephone will stop ringing.



This feature requires SIP Trunks - It will not work with PSTN Lines.

Operation:

To activate:

- *26 + t + Extension Number
- * + 26 + t + * + (pswd) + * + Outside Number

- t= 0 for intercom
- 1 for outside line
- 2 for both intercom and outside line

To cancel

- **26

Notes:

1. This feature will not work when the extension is programmed as the attendant or alternate attendant.
2. This feature will not work for a call that rings to a UCD group.
3. Telephone line calls must be transferred to activate this feature.
4. This feature will only work with one or more SIP Trunks.

Call Forward

Description:

There are four different types of call forwarding; Always (Direct), Busy, No Answer, and DND each call can be forwarded to an internal extension, Voicemail, UCD or to an external telephone number such as a cellular telephone. This allows the user to customize how calls to their extension will be forwarded. In addition, intercom and telephone line calls can be programmed to go to the same or different locations.

Operation:

There are two programming procedures. One for internal and one for external. These can also be programmed using a standard Internet Web Browser.

Call Forward - Internal

Internal Procedure - * + CFW + t + DDD

- CFW =
 - 21 = Always (Direct) Forward
 - 22 = Busy Call Forward
 - 23 = No Answer Call Forward
 - * + CFW + t + DDD + T
 - 24 = Do Not Disturb (DND)

- t =
 - 0 for intercom
 - 1 for outside line
 - 2 for both intercom and outside line

- DDD =
 - Extension - Real or Virtual
 - Auto Attendant
 - UCD Group

- T = Wait Time (0 - 60 seconds)

Examples:

*21 2 450 - Direct Forward to VM, *22 2 124 - Busy call forward to extension 124

To Cancel the Forwarding any Forwarding Dial - ** + CFW

Cancel Example

** 21 - Cancel Direct Call Forward

Call Forward - Follow Me

Follow Me Forward allows the user to use a different telephone extension and still receive their calls. Go to the new location and enter the following information. Don't forget to dial the "*" before the password or the entry will not work.

Follow Me Forward - * 25 + t + EXT + * + pswd

- t =
 - 0 for intercom
 - 1 for outside line
 - 2 for both intercom and outside line
- EXT = The Extension Number
- pswd =
 - The extension password (Default 0000)

To Disable enter ** + 25 + Extension Number + * + Password

Call Forward - External

External Procedure - * + CFW + t + * + pswd + * + Outside Number

- CFW =
 - 21 = Always (Direct) Forward
 - 22 = Busy Call Forward
 - 23 = No Answer Call Forward
 - *23 + CFW + t+ * pswd + * + Outside Number + T
 - 24 = Do Not Disturb (DND)

- t =
 - 0 for intercom
 - 1 for outside line
 - 2 for both intercom and outside line

- pswd =
 - Extension Password (Default 0000)

- Outside Number =
 - Any 7 or 10 digit number such as a home or cellular telephone

- T = (No Answer time delay)
 - Waiting Time (0 - 60 seconds)

To Cancel the Forwarding any External Forwarding Dial - ** + CFW

Notes:

1. Follow me forward is an intercom function only.
2. Direct call forward overrides all other forwarding, followed by DND and then busy/no answer forwarding.

Call Hold

Description:

Both intercom and telephone line calls (PSTN or SIP Trunk) can be placed on hold. Once on hold the held party will receive Music on Hold (MOH).

Operation:

While on a call the user presses the hold button .

Use the flash key on an analog (Single Line) telephone to place a call on hold.

Notes:



1. When using an analog (Single Line) telephone without a “Flash” key may cause erratic operation.
2. Music on Hold is a file that is stored in the **X-50** System and not in the telephone. If using the **X2020** telephone on a different gateway, Music on Hold may not work the same way.

Call Log

Description:

The **X2020** stores a list of missed, received and dialed calls, which the user may use to make or return calls.

Operation:

Press the “Menu” softkey and then press the check button , Call Log will be highlighted. Press the Check button , and scroll down ▼ to select the desired call log. Select the desired number and press the check button  twice to recall or callback the selected number.

Notes:

1. The call log numbers will reference the extension's class of service, call restriction and call routing rules before the call is placed.
2. The systems local area code must be programmed into the Call Routing Tables in the **X-50** system.

Call Park

Description:

Call Park often referred to as “putting a call into orbit” allows extensions to place a call into a special holding area that can be retrieved by any other extension in the system by dialing the park answer call.

Operation:

While on a telephone line call, the extension pressed a preprogrammed call park button to park the call. Any other extension in the system can dial the park code or press their preprogrammed call park button to retrieve the call.

Notes:

1. Only extensions with a programmed Call Park button is allowed to park a call.
2. Any extension that dials the park code while a call is in the park location, is able to retrieve a call.
3. A Call placed into a park location will receive Music on Hold.

Call Pickup

Description:

This feature allows the user to pickup a call that is ringing at another extension.

Operation:

While a call is ringing at another extension, press the preprogrammed Call Pickup call or dial the call pickup code, *53 + extension number.

Notes:

1. Call pickup does not work with analog telephones

Call Waiting

Description:

The **H2020** SIP telephone can be programmed to receive special alert ring whenever a second call rings at the user's extension. If the user would not line to received the special ringing - just disable Call Waiting. If disabled, calls to the Intercom calls to the user's extension will receive a busy tone or follow the “Busy Forward” if programmed.

Operation:

To enable call waiting - allows a second call to ring at the user's extension - dial *98

To disable call waiting - does not allow a second call to ring at their extension - dial **98

Notes:

1. This feature is only available for the **H2020** SIP telephone.

Call Blocking

Description:

The **X2020** has the ability to block up to 10 different telephone numbers.

Operation:

Using a calls' inbound caller ID the **X2020** telephone allows the user to block up to 10 different telephone numbers, each can contain up to 31 digits. When using Caller Blocking Settings, it is important to use as many digits of the number to be blocked as possible. This will avoid inadvertently blocking large groups of numbers. For example, if the user only enters "913", then all calls with the area code 913 (Kansas) will be blocked.

- Enable Call Block: - Click on the Check Box to enable all 10 of the call Blocking Entries.
- Caller Blocking Entry x: (x = 0 - 9: - The user will enter the telephone numbers that they would like to block. Remember, to minimize errors the user should use as much of the telephone number as they can.

This parameter can be programmed using a standard Internet Web Browser.

Notes:

1. This feature is only available for the **X2020**.



Conference - 3 Way

Description:

The conference feature allows the user to connect two additional callers in a single conversation. There are two types of conference, supervised and unsupervised. A supervised conference is when the initiator (the person creating the conference) remains in the conference. An unsupervised conference is when the initiator (the person creating the conference) disconnects from the conference.

Operation:

Use the following steps to create a conference

- While on a call press the hold  button
- Press the down navigation  key. This will open a second communications path, allowing the user to place a second internal or external call.
- Dial the desired telephone number
- After the second call is answered and when the user is ready to establish the conference, press the conference  button, and all three parties will be joined in a single conversation.

Notes:

1. This feature is accessed through the menu on the LCD Display.
2. When using PSTN lines, the dB (Volume) level may be lower when in a conference.

Class of Service - Traveling

Description:

This feature allows the user to roam from one extension to another and retaining their dialing privileges, regardless of the telephone's programmed Class of Service.

Operation:

When making a call from a telephone with a more restrictive class of service, enter * 55 + the user's extension number + the user's voicemail password (Default is 0000) and then the user may place their call. This extension retains the new Class of Service for one minute after the call has been disconnected.

Notes:

Distinctive Ringing

Description:

At default all of the **X2020** extensions ring in the same way. However, each user may select from eleven (11) different ring tones making it easier to determine when their telephone is ringing. In addition, each telephone line (PSTN or SIP trunk) can be programmed with a distinctive Ring tone making it easier to determine which line is ringing.

Operation:

This can be programmed using the telephone menu or using a standard Internet Web Browser.

Notes:

1. In the event that both a telephone line and a telephone is set to have a distinctive ring, the telephone line ring assignment takes precedence.
2. Priority of distinctive ringing:
3. Caller ID Ring type is referenced first
4. Telephone line ringing is referenced second
5. Telephone extension is referenced third

Do Not Disturb (DND)

Description:

When Do Not Disturb (DND) is active all calls to the telephone is blocked. When DND call forward is set, calls will forward to the DND destination such as voice mail. If not, the call will receive a busy signal.

Operation:

From an idle extension dial * 4 to enable DND

From an idle extension dial **4 to disable DND

Notes:

1. DND forwarding overrides all other forwarding, when DND is enabled, except Direct Call Forward
2. This feature can be disabled by the system administrator
3. When DND is enabled, the user will receive stutter dial tone when they go off hook.
4. When DND is enabled a special ICON  will be displayed showing that the extension is in DND.
5. Other extensions will not receive an indication that an extension is in DND until they call the extension

Extension Feature Reset

Description:

This feature is a quick way to deactivate several features that have been changed from factory default.

Operation:

From the extension dial *69 + the extensions voicemail password or the administrator password

The following will be set back to factory default:

- Call Waiting
- Paging Accept
- All programmed buttons are returned to default
- Phone Lock is disabled
- All programmed call forwarding is removed
- DND is disabled
- The extension (Agent) is logged into all programmed groups
- Auto Answer is disabled
- All programmed Distribution List are deleted

Notes:

1. This is good when troubleshooting extension anomalies

Feature (Flexible) Button Programming

Description:

The four buttons on the **X2020** and any of the buttons on the Sidecar (DSS Console) can be reprogrammed to accommodate a telephone PSTN or SIP Trunk Line, a feature or another extension. At default, the four buttons on the telephone are set to the first four PSTN telephone lines (701, 702, 703, and 704) and all of the buttons on the Sidecar are set to extensions 101~124.

Operation:

These features can be programmed using these codes or using a standard Internet Web Browser.

- Dial *70 + BN + FT
- BN = the button to be programmed; 01 - 04 on the telephone and 05 through 28 on the DSS Console, going vertically down the left side, and then the right.
- FT = the numeric value for the next 6 feature types:
 - 00=Blank button
 - 01=Extension; can be a physical LAN telephone
 - 02=Trunk; can be either a PSTN or SIP Trunk or Trunk Group
 - 03=Call Park; enter the call park dial code
 - 04=Feature Key; enter the feature code such as *91 Agent log on
 - 05=Others; such as a WAN extension, a speed dial number or a specific outside telephone number
 - 06=Do Not Disturb; No need to enter *4 (Administrator can disable this feature)
 - 07=Live Record
 - 08=Virtual Mailbox (Virtual (Phantom) Extension - Group Mailbox)

Notes:

1. Most features can be programmed on a button
2. Some features require one button to enable and another to disable the feature

Examples:

Enter the following code to create a page button on button 4 - on the telephone:

TABLE 4.1 Dialing Codes

BN Program	BN Number	Others	Page Code
*70	04	05	400

Enter the following code to create a Call Park button on button 1 - on the telephone:

TABLE 4.2 Dialing Codes

BN Program	BN Number	Call Park	Park Location Code
*70	01	03	731

Enter the following code to create a SIP IP Trunk button (SIP Trunk 1 = 711) on button 17 - on the Sidecar - Upper Right - first button:

TABLE 4.3 Dialing Codes

BN Program	BN Number	Trunk	Page Code
*70	13	02	711

Enter the following code to create an Agent Log Off button on button 15 and an Agent Log On button on button 16 - on the Sidecar - Last two on the Lower Left buttons:

TABLE 4.4 Dialing Codes

BN Program	BN Number	Feature	Log on/off Code	Feature
*70	15	04	**91	Log Off
*70	16	04	*91	Log On

Enter the following code to create a Do Not Disturb button on button 28 - on the sidecar - Lower Right - last button:

TABLE 4.5 Dialing Codes

BN Program	BN Number	DND	No Code needed
*70	28	06	

Enter the following code to create a DND Call Forward button on button 4 - on the telephone - the forward destination is voicemail (450):

TABLE 4.6 Dialing Codes

BN Program	BN Number	Others	DND Forward Code	Type - Both	Destination Voicemail
*70	04	04	*24	2	450

Enter the following code to create a DND Call Forward button on button 4 - on the telephone - to an Outside Number such as a cellular telephone:

TABLE 4.7 Dialing Codes

BN Program	BN Number	Others	DND Forward Code	Type - Both	Outside Indicator	VM Password	Confirm Password	Outside Number
*70	04	04	*24	2	*	0000	*	5992583

The Operator (The extension that rings when 0 is dialed) can create a button to manually switch from Day to Night mode. Enter the following code to create a Service Mode button on button 5 of the Operator's Sidecar This will be the top button, on the left side:

TABLE 4.8 Dialing Codes

BN Program	BN Number	Feature Buttons	Feature Code
*70	05	04	*790

Feature Button Reset

Description:

The feature is used to bring the programmed buttons back to factory default. If the **X2020** is connected to the **X-50** system the telephone will reference the **X-50** for the current default button settings.

Operation:

Dial *68 + the extension (mailbox) password to default the programmable feature button

Notes:

Hold Reminder

Description:

Each time the programmable “Hold Reminder” timer is exceeded, a reminder tone will be heard at the extension that placed the call on hold.

Operation:

Each extension can enable or disable the Hold Reminder as well as adjust the length of the timer.

Notes:

1. These features can be programmed using the telephone or using a standard Internet Web Browser.

LCD & Interactive Buttons

Description:

The **X2020** has four interactive “Soft Buttons” that changes as the phone is being used. These soft buttons will assist the user with the operation and programming of their telephone.

Operation:

Notes:

Multi-Line Appearance

Description:

At default, all of the **X2020** telephones are programmed with the first four PSTN lines (701, 702, 703 and 704). All telephone lines can also be programmed on the Sidecar.

The button, once programmed, uses the LED to indicate the current state of the telephone line. For example, when the line is busy, the light will be lit solid.

TABLE 4.9 Telephone Line status

LED	Description
Dark	Idle
Fast Flash	Ringing
Slow Flash	Line is on hold
Wink Flash	Call is recalling
Lit Solid	Line is Busy

Operation:

When making an outside call, the user may press one of the programmed telephone line button and then dial the desired telephone number or just dial the telephone number and let the **X-50** system automatically route the call.

Notes:

Mute

Description:

Each **X2020** has a mute button that is used to temporarily disable the telephone's microphone.

Operation:

Press the Mute button to disable the telephone's microphone, which will light Red. Press the Mute button again to disable Mute and continue the conversation. When Mute is disabled, the LED will not be lit.

Notes:

1. The Mute button may not mute a headset

On-Hook Dialing

Description:

On hook dialing, also known as Hot Keypad, allows the user to dial a number without lifting the handset or pressing the speaker button.

Operation:

Simply dial an extension or outside telephone number without lifting the handset or pressing the speaker button.

The user may, lift the handset, press the check button  or wait 5 seconds (programmable) for the system to evaluate the dialed number and then process it according to any routing rules.

Notes:

Paging

Description:

There are two types of paging; All Call Paging and Group Paging. All Call Page, allows an extension to dial a single code and broadcast a message to all idle **X2020** telephone within the same subnet. There are three Group Paging groups, each can have up to 24 extensions. When the group number is dialed all idle extensions within the group and Subnet, will receive a broadcast message.

Operation:

Both All Call Page and Group Paging can be set to either LAN, WAN and both. When the All Call or Group Page code or button is pressed, all idle **X2020** telephones will receive the page. **X2020** telephones users can press the soft button under the word "Answer" to connect directly to the extension performing the page.

Notes:

1. With the paging parameter the "WAN" refers to any phone connected to the WAN port, but within the same subnet

Paging Allow/Deny

Description:

This feature allows the user to enter a code to allow or deny paging at their extension.

Operation:

To enable paging deny (thus block paging) dial *99

To disable paging deny (thus allowing paging) dial **99

Notes:

Phonebook

Description:

Each extension has a personal and public phonebook that contains the contact name, phone number, ringing tone, and group.

Operation:

Each telephone has a Private and Public Phonebook. The Private Phonebook is for the user's personal use, and the Public Phonebook is synchronize with a CSV file, which can be located in a centralized location. Currently, the Phonebook feature does not support Microsoft Excel's CSV files.

Private:

The Private Phonebook is for the user's personal use, and can be enter individually or they may use a CSV File to upload them all at once.

Private Phonebook Settings						
Phonebook Entry (1-4)	Dial	User Name	Phone Number	Ring Type	Group	Delete
1	<input type="button" value="Dial"/>	Anne Sweeney	1924020842	0	Family	<input type="checkbox"/>
2	<input type="button" value="Dial"/>	Alan Booker	769011	0	Friends	<input type="checkbox"/>
3	<input type="button" value="Dial"/>	Bob Smith	12122641501	0	Colleague	<input type="checkbox"/>
4	<input type="button" value="Dial"/>	Donald Kilroy	18752250474	0	VIP	<input type="checkbox"/>

New Phonebook Entry					
New:	User Name	Phone Number	Ring Type	Group	Add
	<input type="text"/>	<input type="text"/>	0	None	<input type="button" value="Add"/>

Enter the four parameters and then press the "Add" button, to add new entries.

- User Name: - Enter the user name that will be associated with this entry.
- Phone Number: - Enter the phone number (up to 64) digits.
- Ring Type: - There are eleven different ring tones that can be used to differentiate the entered telephone number when it calls into the system.
- Select the Group that will be associated with the entered telephone number. Select between Family, Friends, Colleague, VIP or None.

It is a good idea to create a back up of the configuration file once all of the numbers are entered. The user can create a back up by clicking on the "SW Upgrade" tab and then click on the "Backup" button. Be sure to locate the file where it is easy to locate should it be needed.

Click on the "Backup Button" and save it in a location that is easy to locate when needed.



Public

The Public phonebook gets linked to a CSV file in a centralised location, allowing an administrator to update all phones connected to the system with a single file. There are several ways to create a CSV file. One way is to use the backup created from the personal phonebook. Another way to create the file is using Windows Notepad. Once created save it with a name such as "Publicphonebook.csv, and place it in a location that is easily found.

The format of this file is very important:

```
Name,Number,Ring,Group,
Anne Sweeney,1924020842,0,family,
Alan Booker,769011,0,Friends,
Bob Smith,12122641501,0,Colleague,
Donald Kilroy,18752250474,0,VIP,
```

Once the file is ready to be uploaded, click on the "SW Upgrade" tab.

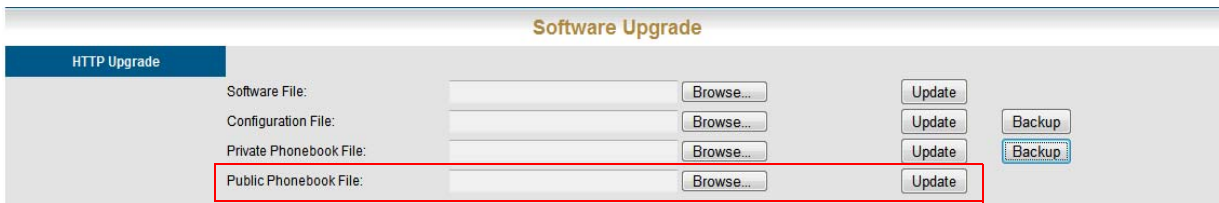

- Locate the "Public Phonebook File:" and click on the Browse... button
- Locate the saved file
- Click on the Update button

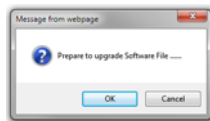

- Click on "OK" to complete the the upload or "Cancel" to stop the upload.
- Click on the Phonebook tab, and then the Public Page tab. If the file format is correct, the informaiotn will be visible. If the numbers are not visible recheck the file format.

Notes:

Phone Lock/Unlock

Description:

The phone Lock/Unlock feature allows the user to lock their extension to prevent someone from making unauthorized calls from their extension. The phone lock/unlock feature does not block intercom or emergency calls, it only blocks telephone line (PSTN or SIP Trunk) calls.

Operation:

- To lock the phone dial *97 + extension (mailbox) password
- To unlock the phone dial **97 + extension (mailbox) password

Notes:

1. Locked extensions can only make intercom or emergency calls

Plug and Play

Description:

When connecting an **X2020** to the **X-50** system over the LAN it will automatically authenticate and be assigned an extension number and activate the mailbox. An extension connecting over the WAN port will also automatically authenticate, be assigned an extension number, and activate the mailbox but requires some basic programming.

Operation:

Connect the **X2020** telephone to the LAN port, no other programming is required. When Connecting over the WAN port, there are four parameters that need to be programmed; the SIP Proxy Server, Outbound Proxy Server, Registrar Server, Registrar Outbound Server. This programming can be done using the telephone menu or using a standard Internet Web Browser.

Notes:

1. Although WAN extensions will automatically received an extension number it is a good idea to enter their extensions manually to make them more perminate. It has been found that after a power outage, for example, the extension numbers may change.

Reminder Tone

Description:

When the extension goes off hook, speaker or handset, stutter dial tone will be heard when DND, MWI or Call Forward is enabled.

Operation:

This is an automatic feature

Notes:

Service Mode

Description:

The Operator has the ability to change the mode of the system from day mode to night mode or timed mode. When the system is set to day mode, the Auto Attendant will only play the day greeting and extensions will use the day Class of Service for dialing privileges. When the system is in night mode, the Auto Attendant will only play the night greeting and extensions will use the night Class of Service for dialing privileges. When the system is in timed mode the system will automatically switch between day, lunch and night modes using the service mode settings in the **X-50** system.

Operation:

Only the attendant has the ability to swap between the service modes:

- Dial: *790 - displays the current mode
- Dial: *791 - changes the system into Day mode
- Dial: *792 - changes the system into Night mode
- Dial: *793 - changes the system into time mode to automatically change between modes.

Notes:

1. This feature only works with the attendant extension

Telephone Line Flash

Description:

The flash command is used to activate a telephone line feature, such as call waiting or three way calling.

Operation:

While on a telephone line call, **X2020** telephone users may press the software button under the word "Flash".

Notes:

1. When using an analog (Single Line) telephone without a "Flash" key may cause erratic operation.
2. Use *790 when programming a button to toggle between day and night modes.

Transfer

Description:

Calls can be transferred from an extension to another destination, such as another extension, voice mail, or an outside number. In addition, transfers can be blind, without announcing the call, supervised, listening for call supervision, or screened where the transferring extension can announce the call.

Operation:

- While on a telephone line call press the transfer button
- Press the preprogrammed DSS button or dial the desired destination
- Hang up to release the call, or remain on the line to announce the call

Notes:

1. If the receiving extension is forwarded, the transferred call will follow the forwarding
2. If the receiving extension is not forwarded, and goes unanswered, it will recall at the extension that transferred the call

Volume Control

Description:

The **X2020** system is equipped to adjust the volume levels of the following settings:

- Ringing (extension and telephone line)
- Handset
- speaker
- Headset

Operation:

Press the volume up to increase or down to decrease the volume of the currently used feature. For example, while the telephone is ringing use the volume button to increase or decrease the ringing volume.

Notes:

Web Management

Description:

The **X2020** can be programmed using the LCD menu or using a standard Internet Web Browser, such as Windows Internet Explorer.

Operation:

Enter the IP Address in the browser address bar to access the Web interface page for programming.

Notes:

Notes:

5 *Installation*

Installation Planning

This chapter will show how to prepare and install the **X-50** system and basic networking setup and protocol.

Basics

1. Never perform any wiring in a wet location, while standing in water or during a lightning storm.
2. The **X-50** should be installed in a well lit location with proper ventilation, having an optimum temperature range from 40° to 95° F and a relative humidity range of 20 to 80 percent.
3. The **X-50** should not be installed where it will be exposed to direct sunlight or heat.
4. Do not install the **X-50** close to or in a strong magnetic field, such as those generated by heavy motors, televisions, copy machines or some kitchen appliances. Ideally, the **X-50** should be installed in an electrically noise-free environment to avoid interference.
5. Be careful when connecting any type of antenna or power through a cable that will be connected directly or indirectly to the **X-50**.

Note:

The manufacturer Warranty does not cover damage caused by abuse, electrical or telephone line power surges or lightning damage.

Where to begin

The **X-50** can be mounted in one of three different ways, vertically, horizontally, or wall mounted. See “Wall Mount Template” for wall mounting in instructions

Vertically



Horizontally



For best results;

- If using PSTN telephone lines the **X-50** should be installed near where they enter the building, which is called the “RJ21X”.
- The **X-50** should be installed in a server room or anywhere that a computer might be placed. It should be placed on a clean hard surface or mounted on a wall.
- The **X-50** should be connected to all devices using Category 5, Category 5E or Category 6 cables.
- The **X-50** should be in a location that is easily accessible by anyone who may need to perform maintenance on the unit.
- The “TEL” port (analog telephone port) on the **X-50** may be connected directly to a standard corded, cordless telephone or FAX machine.
- The **X-50** should be placed on a line condition Uninterrupted Power Supply (UPS) system which will provide line conditioning and battery back up during a power outage. To minimize the number of UPS systems needed, power all telephone endpoints using Power of the Ethernet (PoE).

*Logical***1. Will this system be a standalone system or part of a voice network?**

This will help determine the numbering plan and the LAN/WAN requirements. If the **X-50** is going to be a standalone system, the default numbering plan should be fine. However, if the system is going to be connected to a voice network, the numbering plan may need to be modified to allow direct dialing to specific locations. See [“Numbering Plan” on page 91](#). In addition, a standalone system may not need to be connected to the Internet, so there is no need to set up the “WAN” port, and the system’s location is a lot more flexible.

2. Will this system be the “Master” system in a Voice Network?

If this system is part of a voice network, will it be the master system? If so, it will require a “Static IP Address”. If not, it can use a DHCP Address, because it will be programmed to synchronize with the master system.

3. Will this system have any remote workers?

A remote worker is someone who uses the telephone system’s resources but does not reside in the same building or physical area. Connecting remote workers requires a static Class A or B IP Address and the ISP’s DSL/Cable modem should be programmed as a bridge or concurrent bridge.

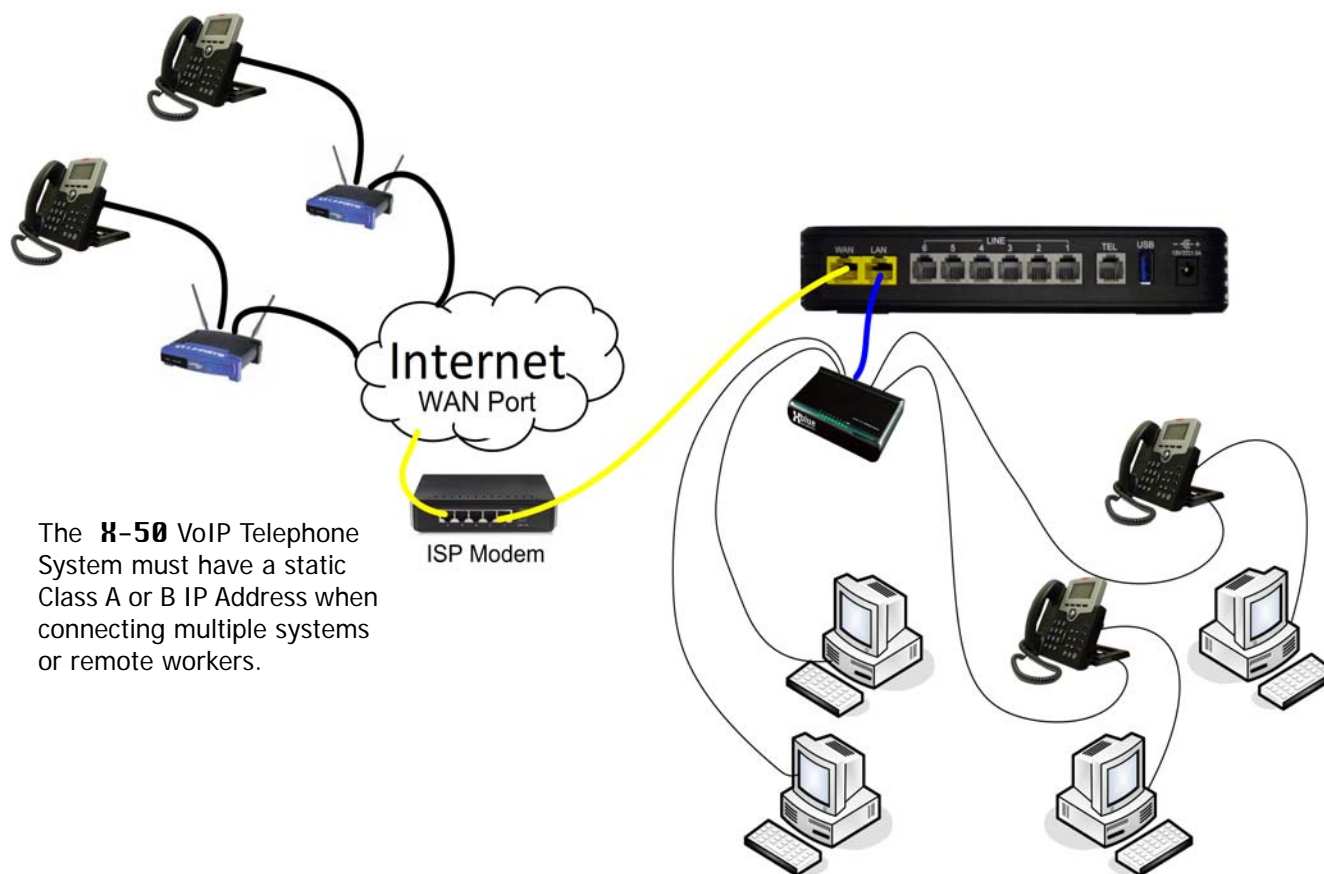

The **X-50** VoIP Telephone System must have a static Class A or B IP Address when connecting multiple systems or remote workers.

4. Will the system be connected to PSTN Lines?

This may determine where the system will be located. If PSTN lines are being used it is a good idea to locate the **X-50** VoIP Telephone System close to where they enter the building.

5. Will the system join an existing network or will it be on it's own network?

If joining an existing network, Connect the WAN port of the **X-50** to the current network. It will then act as both a WAN and a LAN. Also, if there is more than one wireless device make sure that they are not all using the same channel.

Joining an existing Local Area Network

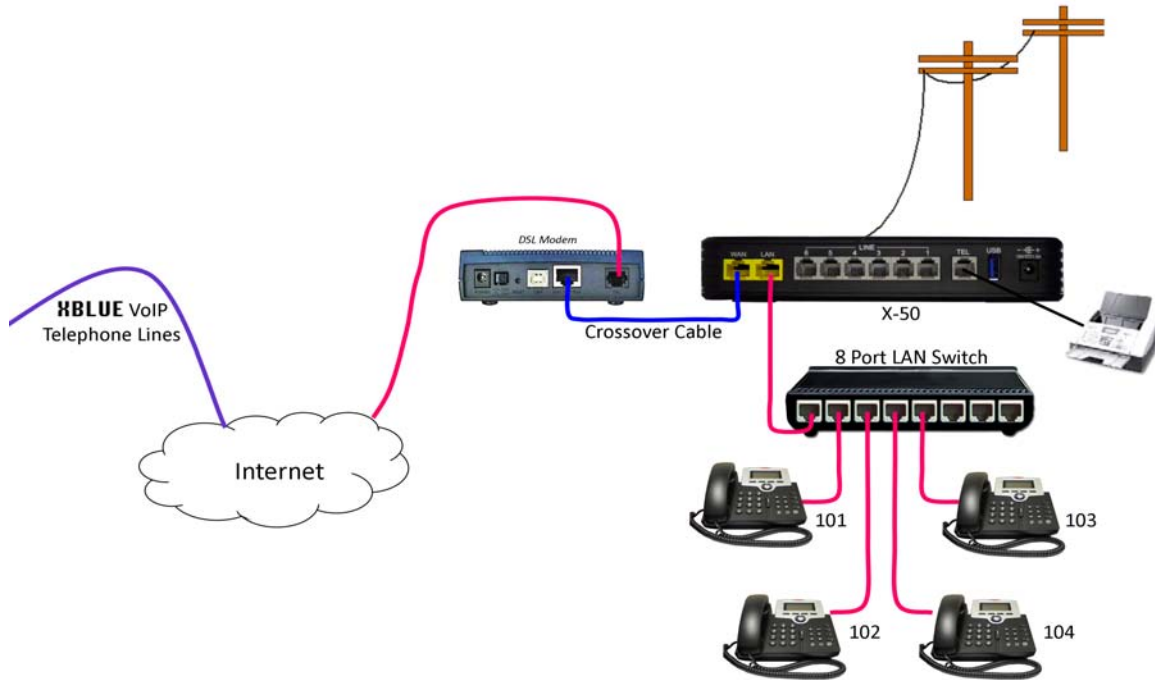

If the system is going to be a standalone system, with isolated cables for VoIP, there is no need to connect it to the Internet, except for remote programming.

A standalone Voice network.

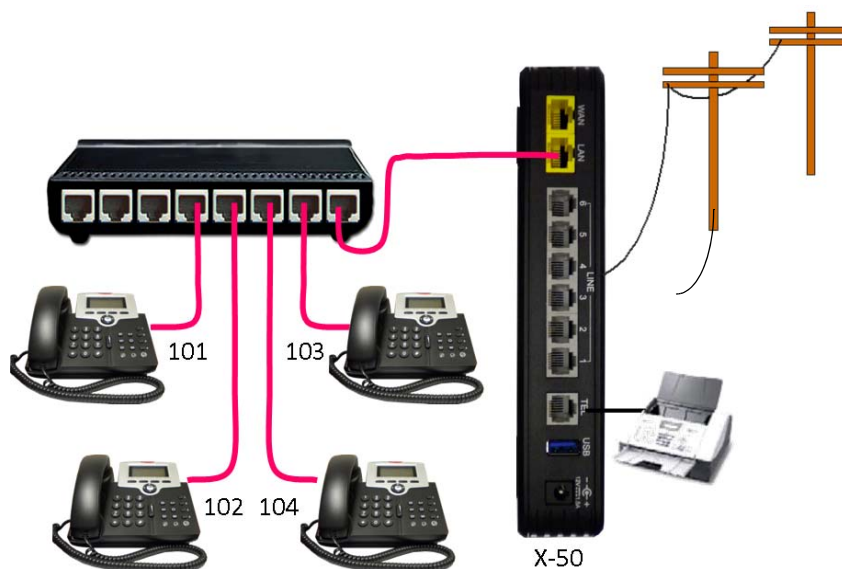

Physical

1. Locate where the PSTN telephone and DSL/Cable lines enter the building.

The **X-50** has six FXS ports, which supports standar Public Switched Telephone Network (PSTN) telephone lines. In addition, it has both a LAN and a WAN port, which may be connected to an existing network as well as a Wireless LAN. Therefore, the **X-50** will need to be located in an area that will allow it to be connected to both the PSTN telephone lines and any existing network switch, router or gateway.

When using PSTN lines, it is a good idea to install the **X-50** close to where the telephone lines enter the office or building. However, if only "SIP Trunks" are going to be used, which is not recommended because of power outages and emergencies, the system can be located near where the Internet Service Provider's (ISP) DSL/Cable modem enters the building.

2. Verify that all cables, between data devices, are Category 5, 5E or 6.

All devices connected to the **X-50** must use a Category 5, 5E or 6 high speed Ethernet cable. This will ensure the best data transfer rates. Failure to use the correct cable will cause spotty results in voice communication.

3. Cables between the FXS Port, labeled "TEL" (Analog Telephone Port) or PSTN telephone lines can be Category 3, 5, 5E or 6. It is acceptable to use Category 3 cabling when connecting the FXO (Telephone Lines) and the FXS (Single Line Telephone).

Installing the X-50 VoIP Telephone System

1. Remove all of the components from the box.
2. Wall Mount - locate the supplied wall template and secure it to the wall. Drill starter holes and place the supplied anchors into the holes. Position the supplied screws into the anchors and secure them. It will be necessary to back the screws out about 1/4 of an inch to securely hold the system on the wall.
3. Table or shelf Mount - There are two ways to mount the system on a table or shelf, vertical and horizontal, neither has an advantage over the other.

Vertical Installation - the system comes with a special weighted base stand designed to secure the **X-50** VoIP Telephone System in a vertical position.

Horizontal Installation - the system also comes equipped with "Rubber" feet at the bottom of the unit so that it can be placed on a table or shelf with a low profile. The Antenna, for the Wireless LAN, will bend at 90 degrees so that it can be tilted upward.

The **X-50** is designed to operate either vertically or horizontally.



Before Programming the X-50

Because the **X-50** is a complete Gateway and Router, including a DHCP server it is a good idea to do some basic programming before connecting it to an existing network. Connect a PC to the **X-50** LAN Port, using the supplied Patch Cable and then power up the **X-50** system. If the user's PC is set to DHCP, it will connect to the **X-50** and the two devices will become a network. The Gateway's default IP Address is 192.168.10.1.

6 Programming Wizard

Getting Started

The **X-50** is a fully functioning Voice over Internet Protocol (VoIP) Gateway and router, which is programmed using a standard Internet browser such as Microsoft's Internet Explorer®. Any computer with a Network Interface Card (NIC), connected to a TCP/IP network, can be used to program the **X-50** VoIP Telephone System.

Setup Wizard

Once the administrator logs in and authenticates the first time, the programming wizard will walk the administrator through the programming process. The next time the administrator logs into the **X-50**, after the programming wizard is completed, the administrator will be sent to the main programming landing page which shows the current status of the **X-50** VoIP Telephone System.

There are two ways to begin programming the **X-50** system; manually or restore from a backup.

If restoring a backup, Click the next button and then locate the backup file and click on the Update Settings button. The update will take about 2 minutes.

The system will reboot after uploading the configuraiton file.

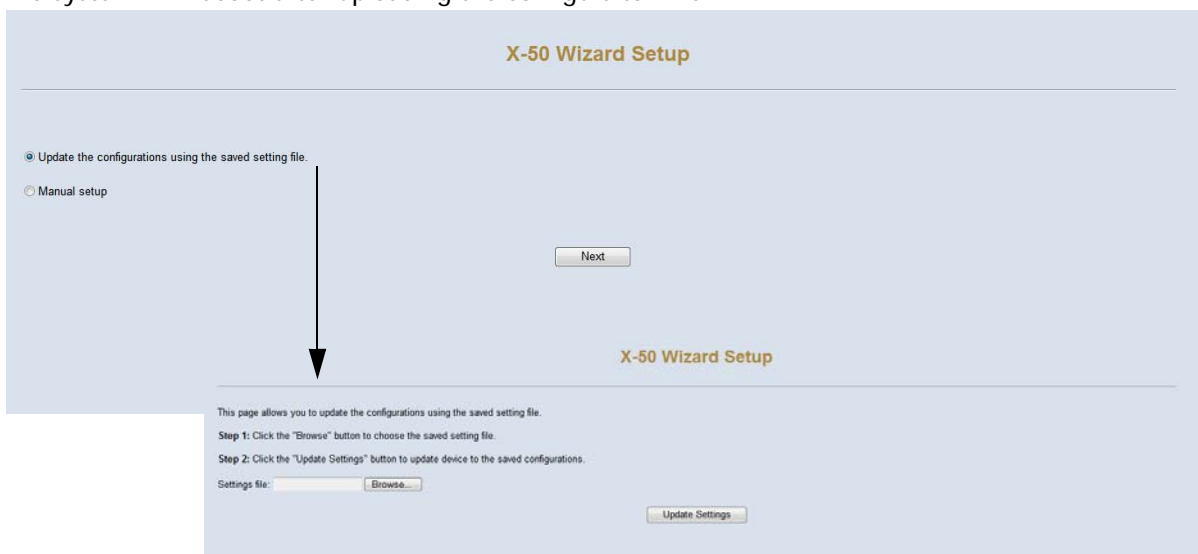

The Setup Wizard guides the administrator through the required setup parameters to make the **X-50** operational. The Setup Wizard must be completed at least once, before gaining access to the “Advanced Setup” programming area. If any of the parameters are unknown, just press “Next” and continue. All of these parameters can be adjusted later using the “Advanced Setup” area.

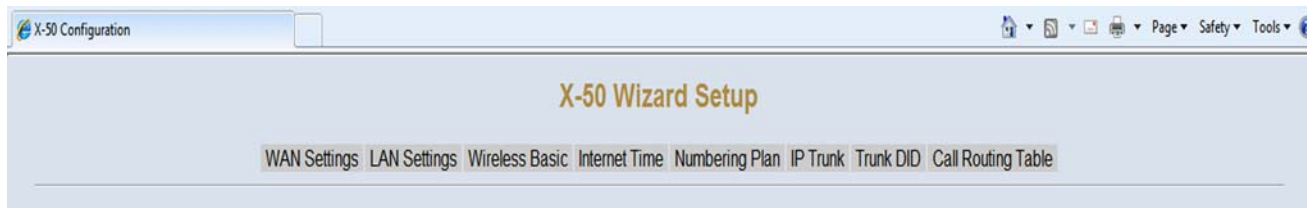

Setup Wizard Tabs

- WAN Settings (See “WAN Port Settings” on page 83.)
- LAN Settings (See “LAN Port Settings” on page 87.)
- Wireless Basic (See “Wireless Basics” on page 89.)
- Internet Time (See “Internet Time” on page 90.)
- Numbering Plan (See “Numbering Plan” on page 91.)
- IP Trunks (if needed) (See “SIP Trunks” on page 94.)
- DID Trunks (Requires IP TRunk) (See “SIP Trunks” on page 94.)
- Call Routing Table (See “Call Routing Table” on page 97.)



Before beginning the installation process it is a good idea to gather as much networking information as possible. This includes IP Addresses for the LAN, WAN, Default Gateway, Subnet, etc. It is also a good idea to make a note of all MAC Addresses for all wireless devices as well as system or voice network numbering plan, SIP trunk information and how dialed numbers will be routed.

WAN Port Settings

The WAN Settings Tab is automatically selected and the default page in the Setup Wizard. Unlike a LAN port, the WAN port can be used to redirect class A or B IP Addresses from an external location, such as the Internet, to a specific internal Port. This process is called Network Address Translation or NAT.

IP Settings (Default)

- At default, the “WAN Port Settings” are set to Automatic Configuration - DHCP. Dynamic Host Configuration Protocol (DHCP) allows the WAN port of the system to automatically receive an IP and Subnet Mask Addresses from the Internet Service Provider (ISP).
- The system can use either dynamic (automatically assigned) or Static DNS settings. Unless required by the ISP it is probably easier to leave this set to automatic.

WAN Services

- Enable Firewall - Although nothing is 100% safe against malicious network attacks, keeping the firewall enabled, should minimize the effectiveness of these attacks.

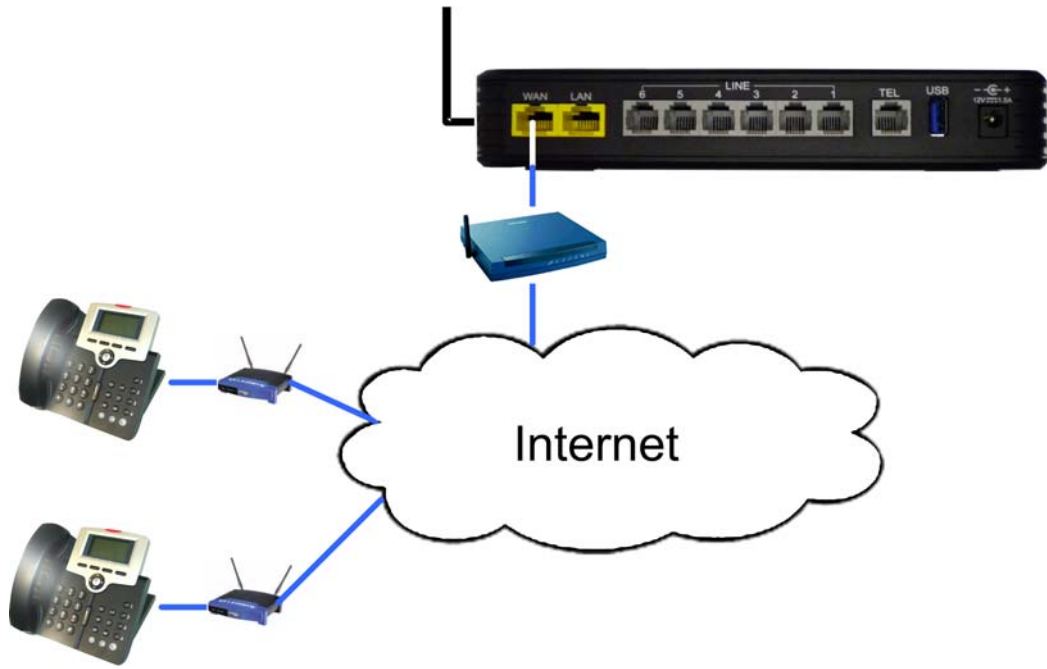

IP Settings (Static IP Address)

X-50 Wizard Setup

[WAN Settings](#)
[LAN Settings](#)
[Wireless Basic](#)
[Internet Time](#)
[Numbering Plan](#)
[IP Trunk](#)
[Trunk DID](#)
[Call Routing Table](#)

IP Settings

Enter information provided to you by your ISP to configure the WAN IP settings.

Static IP ▾

IP Address: 192.168.1.1

Subnet Mask: 255.255.255.0

Gateway: 192.168.1.254

Static DNS 1: 8.8.8.8

Static DNS 2: 4.4.4.4

WAN Services

Enable Firewall

Depending on the installation it may be possible to configure the WAN port to use a “Static IP Address”, which can be used by some ISP’s but generally is used when the system is not part of a voice network or supporting remote workers. For example, when using e-mail delivery or NAT for remote to programming. This parameter makes it easier for network administrators to enter a specific IP Address, which they often reserve for printers, servers, routers, and gateways.

- Internet IP Address - Enter the IP address that will be used to identify the **X-50** system.
- Subnet Mask - when using “Static IP Address” the Subnet Mask will have to be entered by the administrator. If there is a single Subnet, the entry will be 255.255.255.0.
- Gateway - The Default Gateway refers to the Gateway device that connects the Intranet (LAN) to the Internet. Basically, it is the window to the Internet.
- Static DNS 1 & 2 - The Domain Name System (DNS) the Internet’s phone book, and is used to translate IP Addresses to something that is easy to remember such as “xbluenetworks.com”. Some Internet Service Providers (ISP) require Static DNS when using static IP Addresses.

WAN Services

- Enable Firewall - Although nothing is 100% safe against malicious network attacks, keeping the firewall enabled should minimize the effectiveness of these attacks.

Point-to-Point Protocol over Ethernet (PPPOE)

X-50 Wizard Setup

WAN Settings | LAN Settings | Wireless Basic | Internet Time | Numbering Plan | IP Trunk | Trunk DID | Call Routing Table

IP Settings

Enter information provided to you by your ISP to configure the WAN IP settings.
PPP usually requires that you have a user name and password to establish your connection. In the boxes below, enter the user name and password that your ISP has provided to you.

PPPoE ▾

PPP Username:

PPP Password:

Authentication Method: AUTO ▾

Automatic Assign
 Static DNS

Primary DNS server:

Secondary DNS server:

WAN Services

Enable Firewall

Next Cancel

The WAN Port of the **X-50** can also be set to PPPoE. In this case, the Internet Service Provider (ISP) will supply the administrator with a User Name and Password (most likely it will be case sensitive), which is required when connecting the WAN port to the Internet. The ISP's modem/gateway must be set as a bridge, allowing the **X-50** system to authenticate directly with the ISP.

- Automatic (Auto) - This will automatically negotiate the correct authentication protocol.
- Password Authentication Protocol (PAP) - This will send the authentication un-encrypted.
- Challenge Handshake Authentication (CHAP) - This is more secure than the aforementioned PAP, and sends the authentication encrypted.
- Microsoft's version of CHAP that allows mutual authentication between peers, by piggybacking challenge and response packets on a successful packet.
- Static DNS 1 & 2 - The Domain Name System (DNS) the Internet's phone book, and is used to translate IP Addresses to something that is easy to remember such as "xbluenetworks.com". Some Internet Service Providers (ISP) require Static DNS when using static IP Addresses.

WAN Services

- Enable Firewall - Although nothing is 100% safe against malicious network attacks, keeping the firewall enabled, should minimize the effectiveness of these attacks.

LAN Port Settings

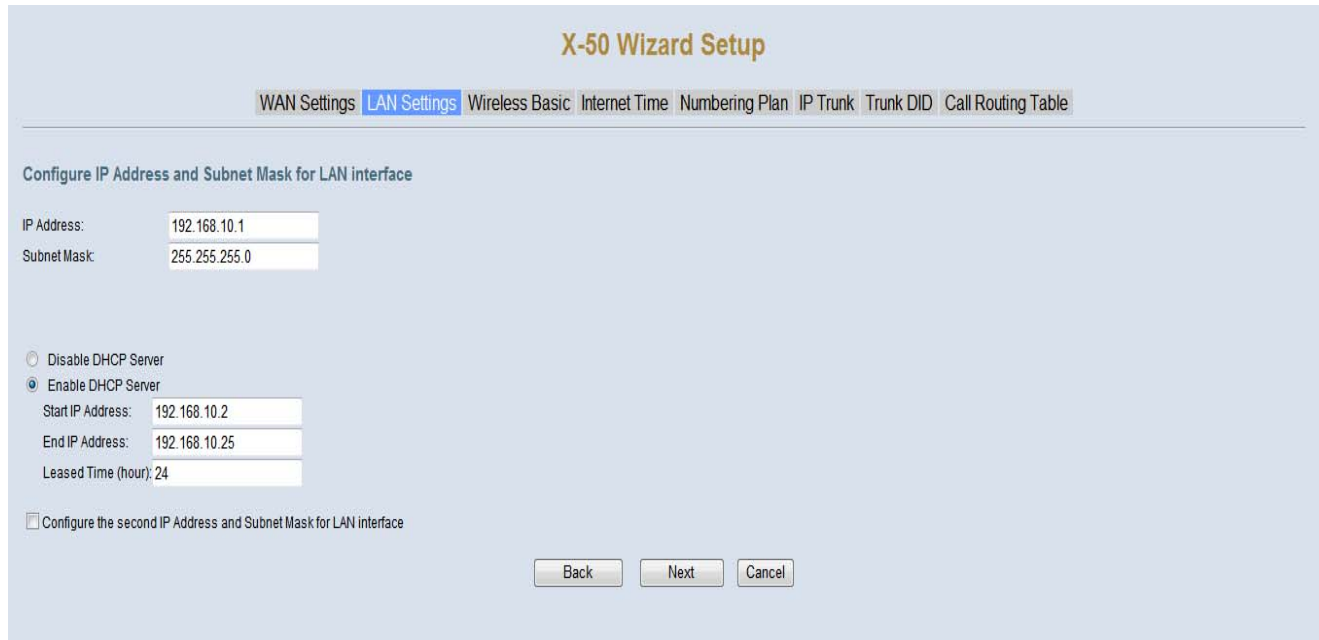

Once the WAN port settings are complete, press next to get to the Local Area Network (LAN) Port Settings page. At default the LAN IP Address is set to 192.168.10.1 and Dynamic Host Configuration Protocol (DHCP) server is enabled.



The **X-50** system is a gateway, which joins two or more different types of networks together, such as WAN, LAN and PSTN. If the **X-50** system is connected to the ISP through a bridge to allow for connecting to external devices. The LAN Address will be set to 192.168.10.1 and it is set to be the network's DHCP Server.

However, if the **X-50** is only using email delivery and remote programming then the WAN port can be set to join as a node or client on the existing Local Area Network.

When connecting the WAN port of the **X-50** to an existing LAN, the LAN port of the **X-50** must be given a different IP address such as (192.168.100.1). The LAN of the **X-50** is then considered "Down Stream" from the existing LAN.

When establishing any network numbering plan, do not use the IP address x.x.x.254 because this address is reserved for the system's DSP and will cause erratic operation.

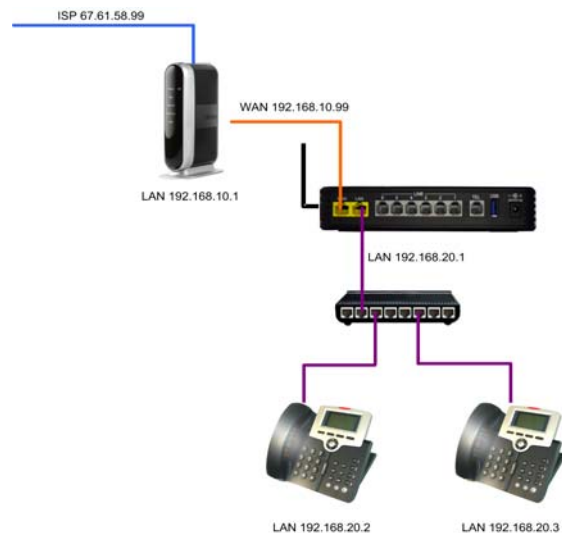

Configure IP Address and Subnet Mask for LAN Interface

- LAN IP Address - at default the LAN IP Address is set to 192.168.10.1, but can be customized to accommodate any valid IP Address. In addition, the LAN IP Address is considered the default gateway for any of the SIP telephone endpoints connected within the LAN. When establishing any network numbering plan, do not use the IP address x.x.x.254 because this address is reserved for the system's DSP and will cause erratic operation.
- Subnet Mask - when using the "Static IP Address" setting, the Subnet Mask will have to be Manually entered. If there is a single Subnet, the entry will be 255.255.255.0.
- Universal Plug and Play (UPnP) - When enabled, the **X-50** will recognize any device that is connected to the LAN port and begins broadcast UPnP protocol.
- Dynamic Host Configuration Protocol (DHCP) Server - When enabled the **X-50** can be used to automatically assign client devices an IP Address. In addition, the administrator can grant a specific range of valid IP Addresses. At default the DHCP is enabled and will allow from 192.168.10.2 to 192.168.10.25 but can be expanded to 192.168.10.253. When disabled, every device connected to the network will have to be manually configured with an IP Address, which is good for security but creates a lot of extra work for the administrator. When establishing any network numbering plan, do not use the IP address x.x.x.254 because this address is reserved for the system's DSP and will cause erratic operation.
- Leased Time - The amount of time that each dynamically assigned IP Address will be assigned to any one device before it is renewed. If the device is still connected and active the device will probably continue with the same IP Address. However, if the device has been removed and inactive for more than the lease time, it may be assigned a different IP Address the next time it is connected.

Wireless Basics

X-50 Wizard Setup

WAN Settings
LAN Settings
Wireless Basic
Internet Time
Numbering Plan
IP Trunk
Trunk DID
Call Routing Table

This page allows you to configure the basic features of the wireless LAN interface. You can enable or disable the wireless LAN interface, hide the network from active scans, set the wireless network name (also known as SSID) and restrict the channel set based on country requirements.

Wireless Basic

Configure the basic features of the wireless LAN interface.

Enable Wireless

Hide Access Point

SSID:

BSSID:

Country:

The **X-50** is equipped with a wireless router, which allows wireless devices to connect using 802.11b, 802.11g and 802.11n protocol speeds.

- **Enable Wireless** - The wireless router is enabled at default, and can be disabled by un-checking this parameter.
- **Hide Access Point** - Check this parameter to “hide” the **X-50** wireless signal. This stops the SSID from being broadcast, making it harder for unauthorized endpoints to access the Wireless Access Point (WAP). When SSID is disabled, the user must enter the specific IP Address of the **X-50** to connected wirelessly.
- **SSID - Service Set Identifier** - This is the name that will be broadcast to make it easier for authorized endpoints to connect to the **X-50** wirelessly.
- **BSSID - Basic Service Set Identifier** - uniquely identifies each Basic Service Set (BSS), which is the building block for all 802.11(x) devices. The BSSID is a locally administered MAC Address of the Wireless Access Point (WAP).
- The **Country** parameter determines the frequencies and restricts based on country requirements.

Internet Time

X-50 Wizard Setup

[WAN Settings](#) | [LAN Settings](#) | [Wireless Basic](#) | **[Internet Time](#)** | [Numbering Plan](#) | [IP Trunk](#) | [Trunk DID](#) | [Call Routing Table](#)

Time Settings

Configure the NTP time server so the unit will have correct system time.

Automatically synchronize with Internet time servers

First NTP time server:

Second NTP time server:

Third NTP time server:

Fourth NTP time server:

Fifth NTP time server:

Time zone offset:

Manual Date and Time Settings

| |

The **X-50** can be set to synchronize its date and time with specific sites found on the internet. This is referred to as “Network Time Protocol (NTP)”.

- The **X-50** allows for up to five different time server locations to be used to synchronize the time. Therefore, if one or more servers fail, the time will not be lost. It is a good idea to select at least one primary and one secondary time server, however, only the primary is required. Use the drop down menu, to select the desired timer server.
- Time Zone Offset - This is the amount of time added or deducted from Greenwich Mean Time (GMT)

If the system is not connected to the Internet, click on “Manual Date and Time Settings” to enter the time manually. Do not reset the system after the date and time is set manually, it may cause the system time to adjust erratically.

Manual Date and Time Settings

Date: / / MM/DD/YY

Time: : : HH:MM:SS

Numbering Plan

X-50 Wizard Setup

[WAN Settings](#) | [LAN Settings](#) | [Wireless Basic](#) | [Internet Time](#) | **Numbering Plan** | [IP Trunk](#) | [Trunk DID](#) | [Call Routing Table](#)

Numbering Plan

The device has a flexible numbering plan so that the system directory numbers can be customized to meet a wide range of applications. It's disallowed to conflicting among the directory numbers of the all system resources.

Start extension number:

End extension number:

Operator extension during day:

Operator extension during night:

Alternate Operator extension during day:

Alternate Operator extension during night:

FXS Phone Number:

Operator Code:

Extension Registration

No.	Phone Number	Password
1	<input type="text"/>	<input type="text"/>
2	<input type="text"/>	<input type="text"/>
3	<input type="text"/>	<input type="text"/>
4	<input type="text"/>	<input type="text"/>
5	<input type="text"/>	<input type="text"/>
20	<input type="text"/>	<input type="text"/>
21	<input type="text"/>	<input type="text"/>
22	<input type="text"/>	<input type="text"/>
23	<input type="text"/>	<input type="text"/>
24	<input type="text"/>	<input type="text"/>

The numbering plan establishes the “dial plan” that will be used for the **X-50** system. It defines the start extension number (101) and the ending extension number (125), as well as the day and night operator extension or extensions. In addition, the **X-50** includes one FXS (Single Line - analog - Telephone) which has a default number of 125 and the number to be dialed to ring the operator (0); all of which can be customized.

The SIP Authentication area is where the extension telephone numbers and passwords are established. These numbers are used by the SIP telephone endpoints to authenticate to the **X-50** system. It is important to keep in mind if this system is going to be part of a larger voice network, the whole network must have one unified numbering plan. For example, a system in Boston may have extensions numbered 1001 - 1025, in Chicago 1501 - 1525, Las Vegas 2001 - 2025 and in San Francisco 3001 - 3025, etc. This will allow an extension to dial 4 digits (3 digits number plans will also work) and speak to someone at a different location. For example, someone in Boston dials 2021 and speaks to an extension user in Las Vegas without using a telephone line. Tables [“Suggested 4-Digit Numbering Plan” on page 92](#) and [“Suggested 3-Digit Numbering Plan” on page 93](#) show some suggestions extension numbering plans.

Note:

When entering a new numbering plan do not use 311, 411 and 911 as extension numbers.

TABLE 6.1 Suggested 4-Digit Numbering Plan

Single System		Voice Network Numbering Plan									
Alone	PSWD	1	2	3	4	5	6	7	8	9	10
		Primary									
101	101101	1001	1501	2001	3001	4001	5001	6001	7001	8001	9001
102	102102	1002	1502	2002	3002	4002	5002	6002	7002	8002	9002
103	103103	1003	1503	2003	3003	4003	5003	6003	7003	8003	9003
104	104104	1004	1504	2004	3004	4004	5004	6004	7004	8004	9004
105	105105	1005	1505	2005	3005	4005	5005	6005	7005	8005	9005
106	106106	1006	1506	2006	3006	4006	5006	6006	7006	8006	9006
107	107107	1007	1507	2007	3007	4007	5007	6007	7007	8007	9007
108	108108	1008	1508	2008	3008	4008	5008	6008	7008	8008	9008
109	109109	1009	1509	2009	3009	4009	5009	6009	7009	8009	9009
110	110110	1010	1510	2010	3010	4010	5010	6010	7010	8010	9010
111	111111	1011	1511	2011	3011	4011	5011	6011	7011	8011	9011
112	112112	1012	1512	2012	3012	4012	5012	6012	7012	8012	9012
113	113113	1013	1513	2013	3013	4013	5013	6013	7013	8013	9013
114	114114	1014	1514	2014	3014	4014	5014	6014	7014	8014	9014
115	115115	1015	1515	2015	3015	4015	5015	6015	7015	8015	9015
116	116116	1016	1516	2016	3016	4016	5016	6016	7016	8016	9016
117	117117	1017	1517	2017	3017	4017	5017	6017	7017	8017	9017
118	118118	1018	1518	2018	3018	4018	5018	6018	7018	8018	9018
119	119119	1019	1519	2019	3019	4019	5019	6019	7019	8019	9019
120	120120	1020	1520	2020	3020	4020	5020	6020	7020	8020	9020
121	121121	1021	1521	2021	3021	4021	5021	6021	7021	8021	9021
122	122122	1022	1522	2022	3022	4022	5022	6022	7022	8022	9022
123	123123	1023	1523	2023	3023	4023	5023	6023	7023	8023	9023
124	124124	1024	1524	2024	3024	4024	5024	6024	7024	8024	9024
125	125125	1025	1525	2025	3025	4025	5025	6025	7025	8025	9025

TABLE 6.2 Suggested 3-Digit Numbering Plan

Single System		Voice Network Numbering Plan									
Alone	PSWD	1	2	3	4	5	6	7	8	9	10
		Primary									
101	101101	101	151	201	301	401	501	601	701	801	901
102	102102	102	152	202	302	402	502	602	702	802	902
103	103103	103	153	203	303	403	503	603	703	803	903
104	104104	104	154	204	304	404	504	604	704	804	904
105	105105	105	155	205	305	405	505	605	705	805	905
106	106106	106	156	206	306	406	506	606	706	806	906
107	107107	107	157	207	307	407	507	607	707	807	907
108	108108	108	158	208	308	408	508	608	708	808	908
109	109109	109	159	209	309	409	509	609	709	809	909
110	110110	110	160	210	310	410	510	610	710	810	910
111	111111	111	161	211	312	412	511	611	711	811	912
112	112112	112	162	212	313	413	512	612	712	812	913
113	113113	113	163	213	314	414	513	613	713	813	914
114	114114	114	164	214	315	415	514	614	714	814	915
115	115115	115	165	215	316	416	515	615	715	815	916
116	116116	116	166	216	317	417	516	616	716	816	917
117	117117	117	167	217	318	418	517	617	717	817	918
118	118118	118	168	218	319	419	518	618	718	818	919
119	119119	119	169	219	320	420	519	619	719	819	920
120	120120	120	170	220	321	421	520	620	720	820	921
121	121121	121	171	221	322	422	521	621	721	821	922
122	122122	122	172	222	323	423	522	622	722	822	923
123	123123	123	173	223	324	424	523	623	723	823	924
124	124124	124	174	224	325	425	524	624	724	824	925
125	125125	125	175	225	326	426	525	625	725	825	965

- Day and Night Operator - at default the Single Line (Analog) Telephone, extension 125, is programmed to be the day and night operator.
- Operator speed dial is the number that will be dialed to ring the operator. Generally this is set to zero (0).
- Phone Number & passwords to authenticate each SIP telephone endpoint. Although, remote workers will automatically authenticate it is a good idea to manually enter the extension number and password of all remote workers. Because the WAN port authenticates first, remote workers may change their extension number when the system is reset.

SIP Trunks

X-50 Wizard Setup

[WAN Settings](#) | [LAN Settings](#) | [Wireless Basic](#) | [Internet Time](#) | [Numbering Plan](#) | **IP Trunk** | [Trunk DID](#) | [Call Routing Table](#)

Up to 8 SIP Uplink Servers can be programmed on the unit. The information required to set up these connections should be obtained from the ITSP.

Subscriber Information

IP Trunk 1			
Phone Number	<input type="text"/>	Auth ID	<input type="text"/>
Auth Password	<input type="text"/>	SIP Proxy	port 5060
Outbound Proxy	port 5060	Register Server	port 5060
Outbound Registrar	Port 5060	Register Expires	180
Register Status	On	Outgoing Caller ID	<input type="text"/>
Support DID	No	Support E.164	No
IP Trunk 2			
Phone Number	<input type="text"/>	Auth ID	<input type="text"/>
Auth Password	<input type="text"/>	SIP Proxy	port 5060
Outbound Proxy	port 5060	Register Server	port 5060
Outbound Registrar	Port 5060	Register Expires	180
Register Status	On	Outgoing Caller ID	<input type="text"/>
Support DID	No	Support E.164	No
IP Trunk 7			
Phone Number	<input type="text"/>	Auth ID	<input type="text"/>
Auth Password	<input type="text"/>	SIP Proxy	port 5060
Outbound Proxy	port 5060	Register Server	port 5060
Outbound Registrar	Port 5060	Register Expires	180
Register Status	On	Outgoing Caller ID	<input type="text"/>
Support DID	No	Support E.164	No
IP Trunk 8			
Phone Number	<input type="text"/>	Auth ID	<input type="text"/>
Auth Password	<input type="text"/>	SIP Proxy	port 5060
Outbound Proxy	port 5060	Register Server	port 5060
Outbound Registrar	Port 5060	Register Expires	180
Register Status	On	Outgoing Caller ID	<input type="text"/>
Support DID	No	Support E.164	No

Local Port

Local SIP Port for IP Trunk:

Local RTP Port for IP Trunk:

The **X-50** comes equipped to support eight SIP IP Trunks and fifty Direct Inward Dial (DID) numbers. SIP Trunks are not physically connected, they authenticate over the Internet. Thus, the voice quality of these line are directly related to the ISP speed. There are several SIP IP Trunk providers on the market and the integration should be standardized. However, this may not always be the case, and although we do our best to integrate all SIP Trunks, there is no guarantee, written or implied, that every SIP IP Trunk provider will work with the **X-50**.

The settings will be provided by the SIP IP Trunk Provider; please contact the provider if any adjustments are needed to integrate their SIP Trunk.

- Phone number - The assigned phone number which will be provided by the SIP IP Trunk provider.
- User Name - The SIP IP Trunk provider will provide the user name. Depending on the provider, the user name may be an account number, telephone number or reference number.
- Auth ID - Authentication ID - The SIP IP Trunk provider will provide the Authentication ID. Depending on the provider, the Auth ID may be an account number, telephone number or reference number.
- Auth Password - Authentication Password - The SIP IP Trunk provider will provide the Authentication Password. Depending on the provider, the Auth Password may be an account number, telephone number or reference number.



A **Proxy Server** is a “Go Between” that makes request on behalf of other clients. Its primary roll is to route packets the fastest way possible and enforce routing policies, even if it has to rewrite specific parts of the request before forwarding the packet.

A **Register Server** sends a Registrar Server requests so that it will place vital information in a location for the Domain Server. Some SIP IP Trunk providers require that a Registrar Server be reference in order to keep the connection working correctly.

An **Outbound Proxy** is often used as a central location for security verification before connecting two devices. This is commonly used as an additional layer of security.

- SIP Proxy - The SIP IP Trunk Provider will provide the SIP Proxy. The SIP Proxy can be either a class A or B IP Address, or must likely will be a specific Uniform (Universal) Resource Locator (URL) Address.
- Port - 5060 is one of the “Well Known Ports” that is used for the transmission of both TCP or UDP SIP Packets. Some providers may require this to be changed, but most will not.
- Outbound Proxy - The SIP IP Trunk Provider will provide the Outbound Proxy. The Outbound Proxy's Address can be either a class A or B IP Address, or must likely will be a specific Uniform (Universal) Resource Locator (URL) Address.
- Port - 5060 is one of the “Well Known Ports” that is used for the transmission of both TCP or UDP SIP Packets. Some providers may require this to be changed, but most will not.
- Register Server - The SIP IP Trunk Provider will provide the Registrar Server. The Registrar Server's address can be either a class A or B IP Address, or must likely will be a specific Uniform (Universal) Resource Locator (URL) Address.
- Port - 5060 is one of the “Well Known Ports” that is used for the transmission of both TCP or UDP SIP Packets. Some providers may require this to be changed, but most will not.
- SIP Domain - The SIP IP Trunk Provider will provide the SIP Domain. The SIP Domain can be either a class A or B IP Address, or must likely will be a specific Uniform (Universal) Resource Locator (URL) Address.
- Register Expires - If “Register Status” is set to “On” this timer will be referenced and it is how often the **X-50** will send a signal to the Registrar Server in order to keep the information current. If there is no reply within the programmed time, at default 60 seconds, the connection is terminated.
- Register Status - When Set to “On” the Register Expires will be referenced, otherwise it will not be referenced. The SIP IP Trunk provider will provide the proper settings for this parameter.

- Support E.164 - This protocol was defined by ITU-T, to standardize international telecommunications numbering plan, used over the Public Switched Telephone Network (PSTN). For proper dialing formats, some SIP IP Trunk Providers may require this to be enabled. At default, it is disabled.

Direct Inward Dial (DID)

X-50 Wizard Setup

[WAN Settings](#) | [LAN Settings](#) | [Wireless Basic](#) | [Internet Time](#) | [Numbering Plan](#) | [IP Trunk](#) | **[Trunk DID](#)** | [Call Routing Table](#)

DID Table

No.	DID Number	Destination	Outgoing Call ID	Display Name	Trunk
1					Group 2 ▼
2					Group 2 ▼
3					Group 2 ▼
4					Group 2 ▼
5					Group 2 ▼
6					Group 2 ▼
7					Group 2 ▼
8					Group 2 ▼
9					Group 2 ▼
45					Group 2 ▼
46					Group 2 ▼
47					Group 2 ▼
48					Group 2 ▼
49					Group 2 ▼
50					Group 2 ▼

- DID Number - Enter the DID numbers that will be received from the SIP Trunks.
- Destination - Enter the destination of the receiving DID number, valid entries are a physical, virtual extension or a UCD group.
- Outgoing Caller ID - Enter the telephone number that the SIP Trunk will send when the entered DID extension makes an outgoing call.
- Display Name - Enter the name that the SIP Trunk will send when the entered DID extension makes an outgoing call.

Call Routing Table

X-50 Wizard Setup

[WAN Settings](#) | [LAN Settings](#) | [Wireless Basic](#) | [Internet Time](#) | [Numbering Plan](#) | [IP Trunk](#) | [Trunk DID](#) | [Call Routing Table](#)

Call Routing Table Configuration

The Call Routing Table automatically routes outgoing calls using the most appropriate route. The appropriate route is determined based on the number dialed. If necessary, the unit can automatically modify the dialed number by deleting and/or inserting digits.

No.	From	To	Min	Max	Del	Insert	Destination
1	0	#	1	99	0		Group 1
2			1	99	0		PSTN Line 1
3			1	99	0		PSTN Line 1
4			1	99	0		PSTN Line 1
5			1	99	0		PSTN Line 1
6			1	99	0		PSTN Line 1
7			1	99	0		PSTN Line 1
8			1	99	0		PSTN Line 1
9			1	99	0		PSTN Line 1
10			1	99	0		PSTN Line 1
35			1	99	0		PSTN Line 1
36			1	99	0		PSTN Line 1
37			1	99	0		PSTN Line 1
38			1	99	0		PSTN Line 1
39			1	99	0		PSTN Line 1
40			1	99	0		PSTN Line 1

Once programmed, the Call Routing Table will automatically route calls through the proper telephone line or group of lines (line group). Each entry may contain up to ten digits and has a "From" (start evaluation) and a "To" (end evaluation) digit or set of digits. In addition, dialed numbers can be automatically modified to ensure that they are sent through the most cost effective route. For example, if the main number of another system on the voice network is dialed, that number can be deleted, and a new number can be inserted. The Call Routing Tables are also used to direct three or four digit dialing between **X-50** VoIP Telephone Systems.



For proper operation of Call Log - Dialed, Missed, and Received Calls, the home area code, and automatic long distance insert, must be programmed into the Call Routing Table.

Enter the home area code, where the system is located, such as 913 in the "From" and "To", then the maximum and minimum digits dialed will be 10, in both, then enter 3 digits to be deleted by the system before the number is dialed. Do not enter any digits into the "Delete" parameter if all 10 digits should be dialed. Therefore, when a number in the entered area code is dialed, the area code if there is an entry in the delete parameter, in the example, 913, will be delete. The remaining 7 digits will be dialed.

The second entry will automatically enter a 1 for all other 10 digit numbers. Enter "From 2", "To 9", Min=10, Max=10, Insert=1, and "Group" default is 1. When any number that begins with 2 through 9, except 913, will receive a 1, when it is sent to the telephone line.

Kansas

No.	From	To	Min	Max	Del	Insert	Destination	IGW Group	Remove	Edit	Change Order
1	913	913	10	10	3		Group 1		<input type="checkbox"/>	Edit	Up Down
2	2	9	10	10	0	1	Group 1		<input type="checkbox"/>	Edit	Up Down
3	0	#	1	99	0		Group 1		<input type="checkbox"/>	Edit	Up Down

In Scottsdale Arizona, for example, any 10 digit number that is dialed with 480 as the first three digits, 480 will be deleted. Any 10 digit number that has 602 and 623 as an area code, all 10 digits will be dialed. All other 10 digit numbers regardless of area code will receive a 1 before sending the call to the telephone line.

Scottsdale, AZ

No.	From	To	Min	Max	Del	Insert	Destination	IGW Group	Remove	Edit	Change Order
1	480	480	10	10	3		Group 1		<input type="checkbox"/>	Edit	Up Down
2	602	602	10	10	0		Group 1		<input type="checkbox"/>	Edit	Up Down
3	623	623	10	10	0		Group 1		<input type="checkbox"/>	Edit	Up Down
4	2	9	10	10	0	1	Group 1		<input type="checkbox"/>	Edit	Up Down
5	0	#	1	99	0		Group 1		<input type="checkbox"/>	Edit	Up Down

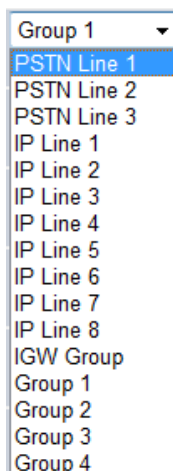

Calls can automatically be routed to a specific telephone (PSTN) or Group of lines, a specific SIP IP Trunk or group of SIP IP Trunks or to another **X-50**.

Using the routing table eliminates the need for users to remember, what can be, complex dialing plans.

- The “From” entry, works in conjunction with the “To” entry, and where the digit evaluation begins. This entry can contain up to ten digits. When a dialed number falls within the “From” and the “To” entries the call will be routed through the programmed destination.



The “To” entry must be a greater number than the “From” entry, or the rule will be invalid.

- The “To” entry, works in conjunction with the “From” entry, and where the digit evaluation ends. This entry can contain up to ten digits. When a dialed number falls within the “From” and the “To” entries the call will be routed through the programmed destination.
- The “Min” entry, works in conjunction with the “Max” entry, and determines the minimum number of digits required to be considered for evaluation.
- The “Max” entry, works in conjunction with the “Min” entry, and determines the maximum number of digits that will be evaluated. Any digits that exceeds this number will not be evaluated.
- The “del” (delete digits) column is the number of digits that will be deleted when the dialed digits match the “From” and the “To” entry.
- The maximum number of digits that can be inserted, from the insert column is ten.
- Calls can be routed to a specific telephone line, 1 through 6, a SIP IP Line, 1 through 8, between other **X-50** systems using the IGW group, or a group can be created using either telephone lines or SIP IP Trunk Lines, or a combination of both.

Complete the Setup Wizard by selecting the “Save & Reboot” to save the changes or “Exit & Reboot” to discard the changes. Select the “Back” button to modify any parameters that may need to be changed before completing the wizard.

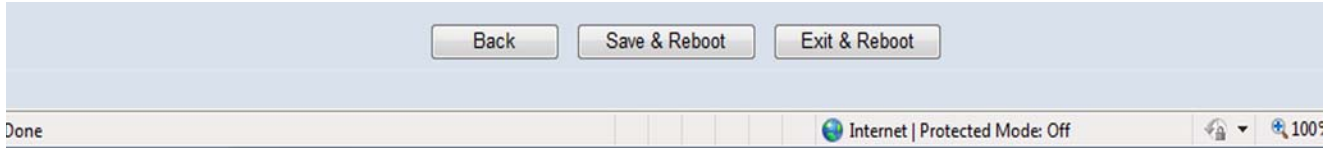

7 *Advanced Programming*

Advanced Programming

Using an Internet browser enter the **X-50** VoIP Telephone System's IP Address. The default LAN IP Address is set to 192.168.10.1.









This will bring up the Login window



The default login is: admin2583

The default Password is: 000000

There are eight major sections that make up the programming parameters of the **X-50** VoIP Telephone System. Two sections, "Device Info", which shows current network status of the gateway and "Diagnostics", which shows WAN/LAN, Wireless, Pinging the Default Gateway and the DNS station as well as the current status of the FXO - Telephone Lines, SIP IP Trunks, the Auto Attendant Ports, and the FXS - Single Line Telephone.

-  Device Info
-  Advanced Setup
-  Wireless
-  Voice
-  Management
-  Diagnostics
-  Logout

Device Information

- **Device Info**

- - Summary
- - Statistics
 - - LAN
 - - WAN
- - Route
- - ARP
- - DHCP

Device Information Introduction

The parameters contained within the Device Information section is for reference only, showing statistical information, about the hardware and software, of the **X-50** VoIP Telephone System.



The “Device Info” page is a quick way to determine the current status of the **X-50**, and a great troubleshooting tool. However, these pages are only for reference, nothing can be changed or programmed.

This page shows the software versions and the hardwares' physical addresses as well as the LAN and WAN port IP Addresses and the Date & time.

Device Information

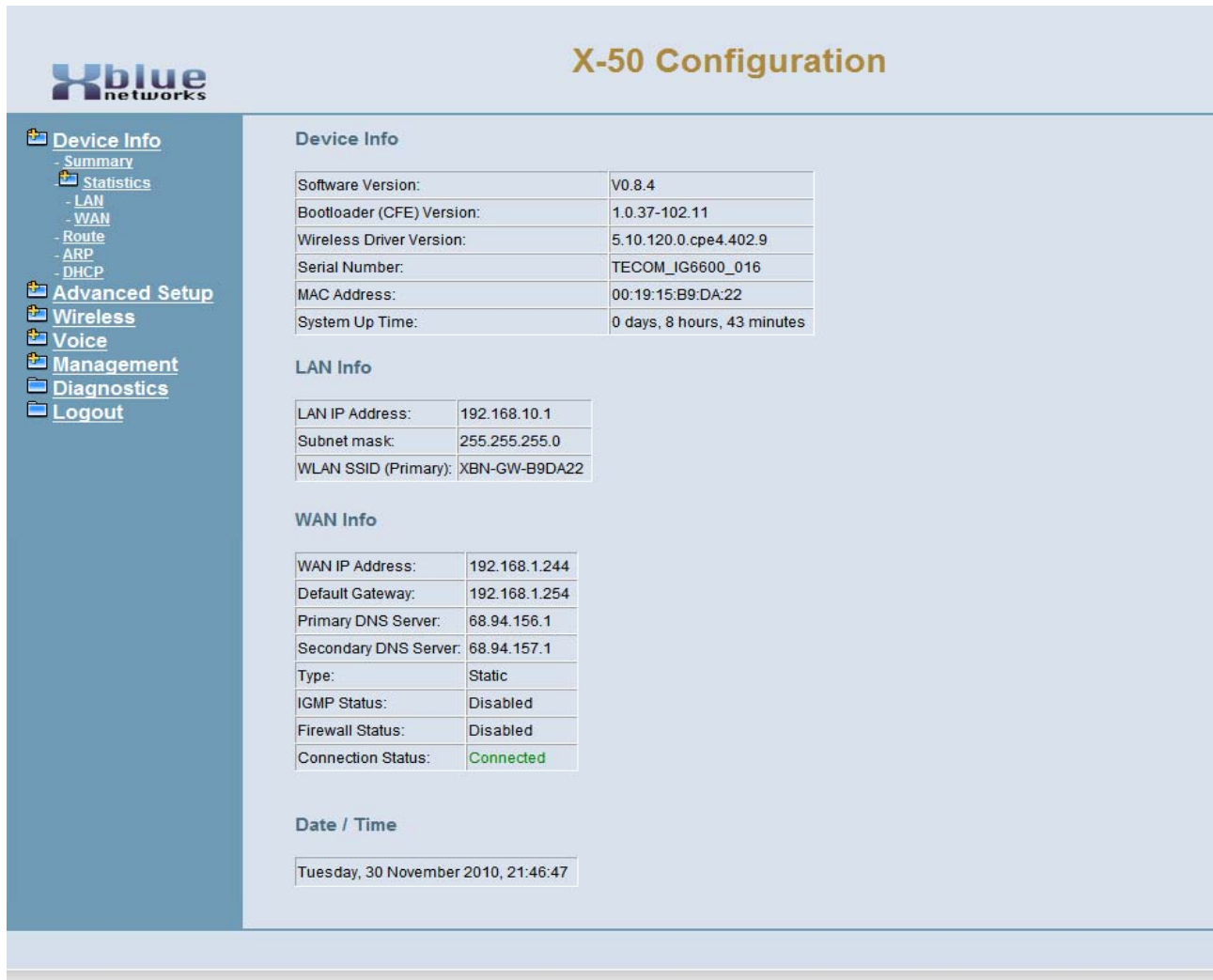

Xblue networks **X-50 Configuration**

Device Info

- Summary
- Statistics
- LAN
- WAN
- Route
- ARP
- DHCP

Advanced Setup

- Wireless
- Voice
- Management
- Diagnostics
- Logout

Software Version:	V0.8.4
Bootloader (CFE) Version:	1.0.37-102.11
Wireless Driver Version:	5.10.120.0.cpe4.402.9
Serial Number:	TECOM_IG6600_016
MAC Address:	00:19:15:B9:DA:22
System Up Time:	0 days, 8 hours, 43 minutes

LAN Info

LAN IP Address:	192.168.10.1
Subnet mask:	255.255.255.0
WLAN SSID (Primary):	XBN-GW-B9DA22

WAN Info

WAN IP Address:	192.168.1.244
Default Gateway:	192.168.1.254
Primary DNS Server:	68.94.156.1
Secondary DNS Server:	68.94.157.1
Type:	Static
IGMP Status:	Disabled
Firewall Status:	Disabled
Connection Status:	Connected

Date / Time

Tuesday, 30 November 2010, 21:46:47

The current settings for the LAN and WAN ports are found in the Statistics folder. These Pages show how many packets have been received and transmitted. This information is invaluable when troubleshooting.

LAN

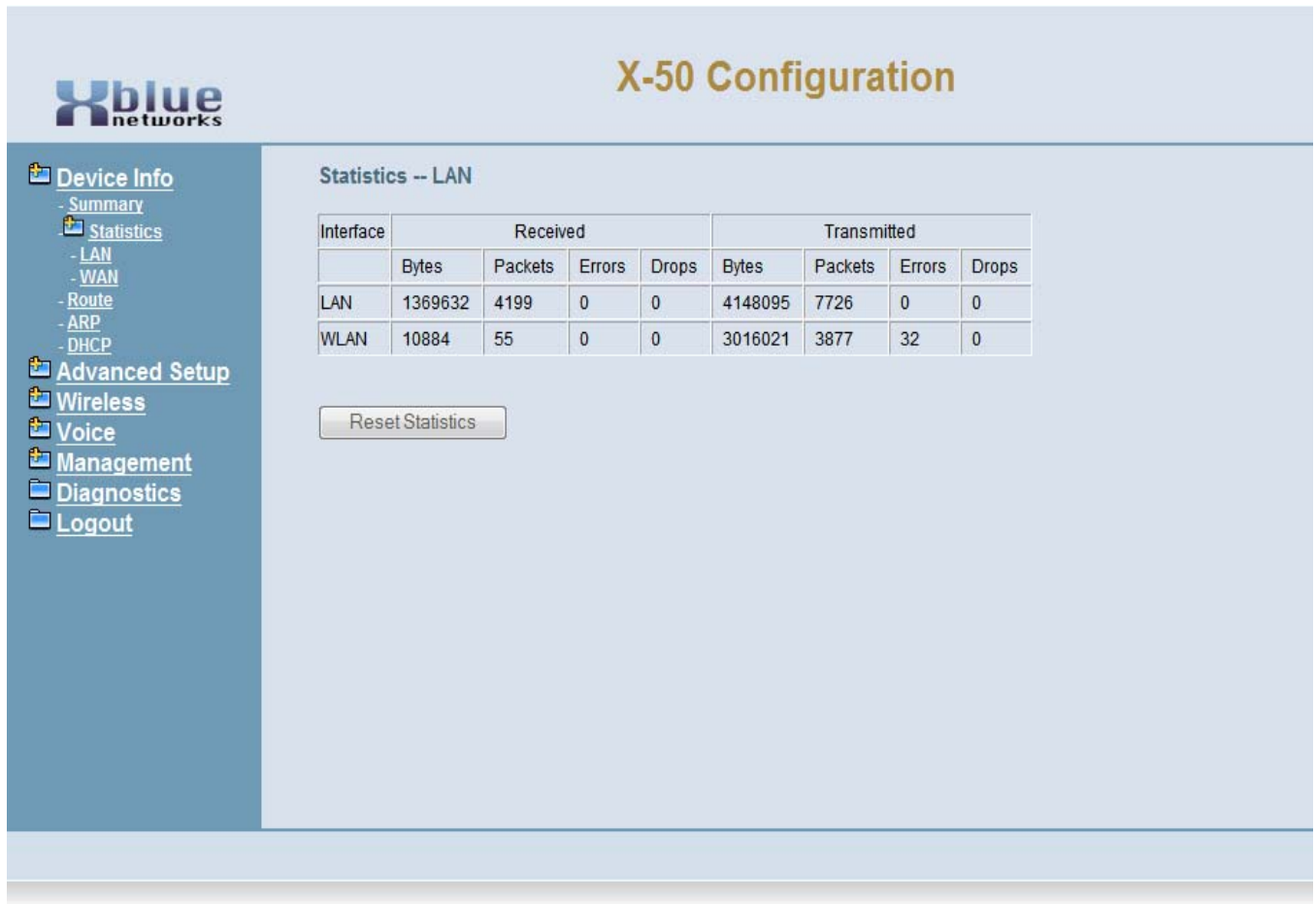

The screenshot displays the X-50 Configuration web interface. The top left features the Xblue Networks logo. The main title is "X-50 Configuration". On the left is a navigation menu with categories: Device Info (Summary, Statistics, LAN, WAN, Route, ARP, DHCP), Advanced Setup, Wireless, Voice, Management, Diagnostics, and Logout. The "Statistics -- LAN" section is active, showing a table of interface statistics and a "Reset Statistics" button.

Interface	Received				Transmitted			
	Bytes	Packets	Errors	Drops	Bytes	Packets	Errors	Drops
LAN	1369632	4199	0	0	4148095	7726	0	0
WLAN	10884	55	0	0	3016021	3877	32	0

Reset Statistics

WAN port statistics.

WAN

The screenshot shows the X-blue networks X-50 Configuration interface. On the left is a navigation menu with the following items: Device Info (Summary, Statistics, LAN, WAN, Route, ARP, DHCP), Advanced Setup, Wireless, Voice, Management, Diagnostics, and Logout. The main content area is titled "Statistics -- WAN" and contains a table with the following data:

Received				Transmitted			
Bytes	Packets	Errors	Drops	Bytes	Packets	Errors	Drops
3562719	38511	0	0	7672563	10613	0	0

Below the table is a "Reset Statistics" button.

The Route table shows the destination, Gateway and Subnet Mask IP Addresses as well as the Flag, metric and Interface.

The screenshot shows the Xblue Networks X-50 Configuration interface. On the left is a navigation menu with options: Device Info (Summary, Statistics, LAN, WAN, Route, ARP, DHCP), Advanced Setup, Wireless, Voice, Management, Diagnostics, and Logout. The main content area is titled 'X-50 Configuration' and 'Device Info -- Route'. It includes a legend for flags: U - up, ! - reject, G - gateway, H - host, R - reinstate, D - dynamic (redirect), M - modified (redirect). Below the legend is a table with the following data:

Destination	Gateway	Subnet Mask	Flags	Metric	Interface
192.168.1.0	0.0.0.0	255.255.255.0	U	0	WAN
192.168.1.0	192.168.1.254	255.255.255.0	UG	1	WAN
192.168.10.0	0.0.0.0	255.255.255.0	U	0	LAN
0.0.0.0	192.168.1.254	0.0.0.0	UG	0	WAN

Flags	Meaning
U	Up
!	Rejected
G	Gateway
H	Host
R	Reinstate
D	Dynamic Redirect
M	Modified (Redirect)

- Interface - Type of connection - LAN or WAN

The Address Resolution Protocol (ARP) table is where the **X-50** catalogs the IP address of a device with its physical Hardware (MAC) address. In addition, this page shows which device (LAN or WAN) is using the specific IP Address.

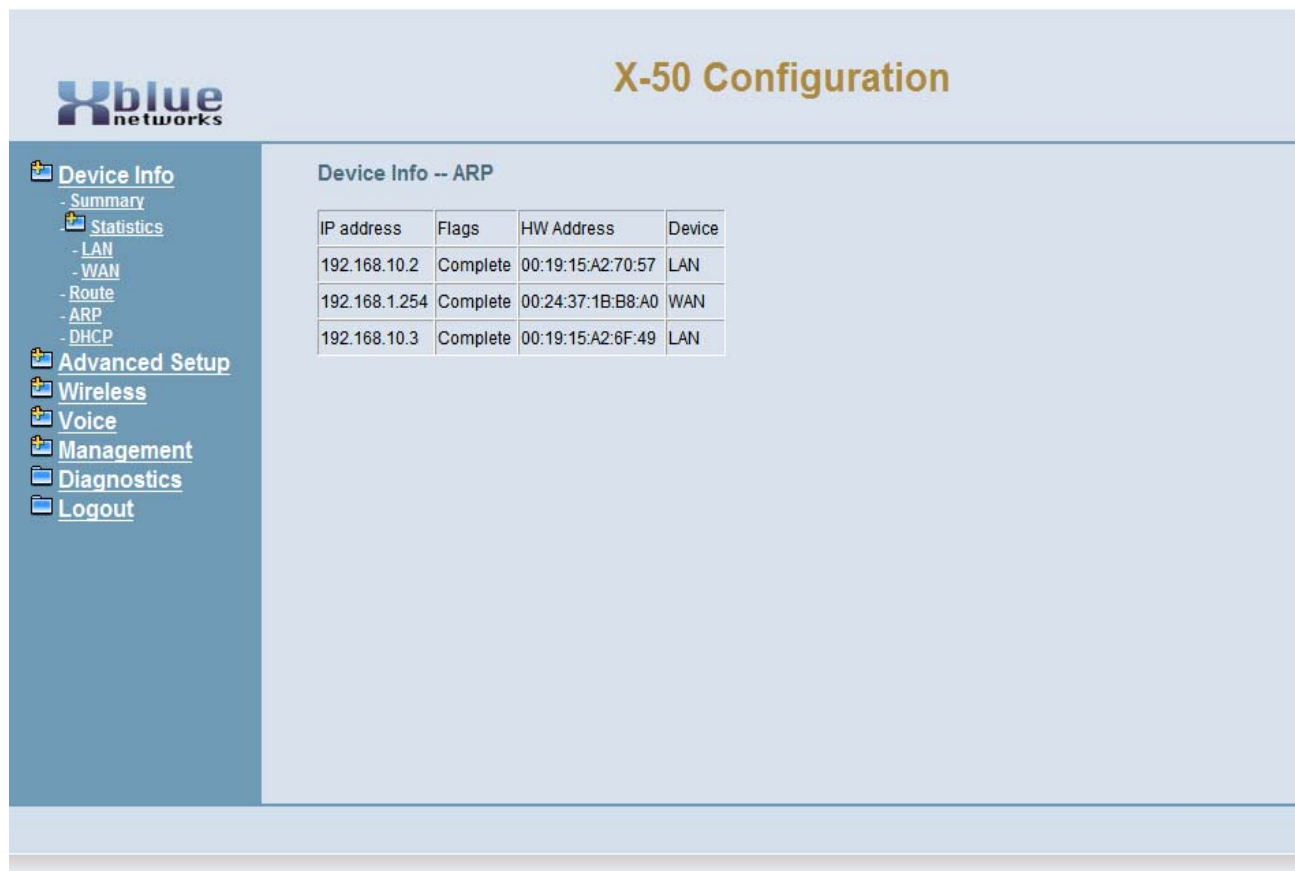

The screenshot displays the X-50 Configuration interface. On the left is a navigation menu with the following items: Device Info (Summary, Statistics, LAN, WAN, Route, ARP, DHCP), Advanced Setup, Wireless, Voice, Management, Diagnostics, and Logout. The main content area is titled "X-50 Configuration" and "Device Info -- ARP". It contains a table with the following data:

IP address	Flags	HW Address	Device
192.168.10.2	Complete	00:19:15:A2:70:57	LAN
192.168.1.254	Complete	00:24:37:1B:B8:A0	WAN
192.168.10.3	Complete	00:19:15:A2:6F:49	LAN

- IP Address - Shows the IP Address of the device connected to the **X-50** system.
- Flags - Identifies when the device is connecting and once it is connected.
- HW Address - Shows the MAC Address of the device connecting to the **X-50** system.
- Device - Shows if the device is connected using a LAN or a WAN port.

The Dynamic Host Configuration Protocol (DHCP) table shows how many devices are connected to the **X-50** VoIP Telephone System. In addition, it shows the MAC Address, IP Address, and the remaining length of the lease.

The screenshot displays the X-50 Configuration web interface. The top left features the Xblue Networks logo. The main title is "X-50 Configuration". A left-hand navigation menu includes sections for "Device Info" (with sub-items: Summary, Statistics, LAN, WAN, Route, ARP, DHCP), "Advanced Setup", "Wireless", "Voice", "Management", "Diagnostics", and "Logout". The main content area is titled "Device Info -- DHCP Leases" and contains a table with the following data:

Hostname	MAC Address	IP Address	Expires In
	00:19:15:a2:70:57	192.168.10.2	14 hours, 55 minutes, 4 seconds
	00:19:15:a2:6f:49	192.168.10.3	14 hours, 54 minutes, 54 seconds

- Host Name - The "name" of the device connected to the network.
- MAC Address - The physical address of the device connected to the network.
- IP Address - The IP address of the device connected to the network.
- Expires In - The length of time left on the current device's lease.

Advanced Setup - WAN

- Device Info
- **Advanced**
- - WAN
- - LAN
- - NAT
- - Parental Control
- - Quality of Service
- - Routing
- - Dynamic DNS

Advanced - WAN

Wide Area Network

At default, the WAN Port is set to Automatic Configuration - DHCP. Dynamic Host Control Protocol (DHCP) allows the WAN Port of the **X-50** to automatically receive an IP and Subnet Mask Address as well as locate and join the network's default gateway or router. However, this may have been changed during the Setup Wizard. At default, the WAN port can be set to Automatic Configuration - DHCP, but it could be set to Static IP or PPPoE.

The screenshot displays the 'X-50 Configuration' web interface. On the left is a navigation menu with categories like Device Info, Advanced Setup, Security, Parental Control, Quality of Service, Routing, Dynamic DNS, Upnp, File Server, Print Server, Wireless, Voice, Management, Diagnostics, and Logout. The 'Advanced Setup' category is expanded to show 'WAN' selected. The main content area is titled 'IP Settings' and contains the following information:

- IP Settings:** Configure the DHCP for WAN interface. "Save settings" button saves the WAN configuration data and make the new configuration effective. These settings as following will take effect after the unit reboot.
- Network Type:** Static
- IP address:** 192.168.1.24
- Subnet mask:** 255.255.255.0
- Primary DNS:** 68.94.15.1
- Secondary DNS:** 68.94.1.1
- Gateway:** 192.168.1.2
- Enable Firewall:** DISABLE
- DHCP:** A dropdown menu currently set to 'DHCP'.
- HostName:** XBN-50
- DNS Options:**
 - Automatic Assigned DNS
 - Static DNS
- DNS Servers:**
 - Primary DNS server: [Empty text box]
 - Secondary DNS server: [Empty text box]
- WAN Services:**
 - Enable Firewall:

At the bottom of the configuration area are two buttons: 'Save and Reboot' and 'Save Settings'.

IP Settings (Default)

- At default, the “WAN Port Settings” are set to Automatic Configuration - Dynamic Host Control Protocol (DHCP), which allows the WAN port of the system to automatically receive an IP and Subnet Mask Address as well as locate and join the network’s default gateway or router.
- The Host Name will be broadcast on the network and used by Dynamic Name Service (DNS).
- The system can use either dynamic (automatically assigned) or Static DNS settings. Unless required by the ISP, it is probably easier to leave this set to automatic.

WAN Services

- Enable Firewall - Although nothing is 100% safe against malicious network attacks, keeping the firewall enabled, will minimize the effectiveness of these attacks.

IP Settings (Static IP Address)

X-50 Configuration

IP Settings

Configure the IP Address and Subnet Mask for WAN interface. "Save settings" button saves the WAN configuration data and make the new configuration effective.
These settings as following will take effect after the unit reboot.

Network Type: Static

IP address: 192.168.1.24 Subnet mask: 255.255.255.0

Primary DNS: 68.94.15.1 Secondary DNS: 68.94.1.1

Gateway: 192.168.1.2 Enable Firewall: DISABLE

Static IP ▼

IP Address: 192.168.1.24

Subnet Mask: 255.255.255.0

Gateway: 192.168.1.2

Static DNS 1: 68.94.15.1

Static DNS 2: 68.94.1.1

WAN Services

Enable Firewall

Save and Reboot Save Settings

The WAN IP settings can be set to “Static IP Address”, which allows the administrator to enter a specific IP Address for the **X-50**. Network administrators often reserve specific IP Addresses for servers, routers, and gateways. In addition, when using a static IP address, it is easier to connect to the **X-50** for programming, especially when programming through Network Address Translation (NAT).

- Internet IP Address - enter the IP address that will be used to identify the **X-50**.

- Subnet Mask - when using the “Static IP Address” setting, the Subnet Mask will have to be manually entered. If there is a single Subnet, the entry will be 255.255.255.0. For more information about Subnet Masks refer to [“Subnet Mks” on page 249](#)
- Gateway - The default gateway refers to the Gateway device that connects the Intranet, to the Internet. Basically, it is the window to the Internet.
- Static DNS 1 & 2 - The Static DNS address maybe required by the Internet Service Provider (ISP). If not, the default gateway address can be used.

WAN Services

- Enable Firewall - Although nothing is 100% safe against malicious network attacks, keeping the firewall enabled, will minimize the effectiveness of these attacks.

Point-to-Point Protocol over Ethernet (PPPOE)

The screenshot displays the 'X-50 Configuration' web interface for Xblue Networks. The left sidebar contains a navigation menu with categories like Device Info, Advanced Setup, Security, Parental Control, Quality of Service, Routing, Dynamic DNS, Upnp, File Server, Print Server, Wireless, Voice, Management, Diagnostics, and Logout. The main content area is titled 'IP Settings' and includes a descriptive paragraph about PPP requirements. Below this, it shows network configuration details: Network Type (Static), IP address (192.168.1.244), Subnet mask (255.255.255.0), Primary DNS (68.94.156.1), Secondary DNS (68.94.157.1), Gateway (192.168.1.254), and Enable Firewall (DISABLE). A dropdown menu is set to 'PPPoE'. There are input fields for 'PPP Username' and 'PPP Password', and a dropdown for 'Authentication Method' set to 'AUTO'. Two radio buttons are present for 'Automatic Assigned DNS' (selected) and 'Static DNS'. At the bottom, there is a checkbox for 'Enable Security' and two buttons: 'Save and Reboot' and 'Save Settings'.

The WAN Port of the **X-50** can also be set to PPPoE. In this case, the Internet Service Provider (ISP) will supply the administrator with a specific User Name and Password (most likely it will be case sensitive), which is required when connect the WAN port to the Internet.

- Automatic (Auto) - This will automatically negotiate the correct authentication protocol.
- Password Authentication Protocol (PAP) - This will send the authentication un-encrypted.
- Challenge Handshake Authentication (CHAP) - This is more secure than the aforementioned PAP, and sends the authentication encrypted.
- Microsoft's version of CHAP that allows mutual authentication between peers, by piggybacking challenge and response packets on a successful packet.
- Static DNS 1 & 2 - The Static DNS address maybe required by the Internet Service Provider (ISP). If not, the default gateway address can be used.

WAN Services

- Enable Firewall - Although nothing is 100% safe against malicious network attacks, keeping the firewall enabled, will minimize the effectiveness of these attacks.

Local Area Network (LAN)

When the **X-50** comes on line the Local Area Network (LAN) IP Address will be set to "192.168.10.1" and the Subnet Mask will be set to "255.255.255.0". However, this may have been changed during the Setup Wizard.

Xblue networks **X-50 Configuration**

LAN Settings
 Configure the IP Address and Subnet Mask for LAN interface. "Save Settings" button saves the LAN configuration data to make the new configuration effective.
 These settings as following will take effect after the system reboot.

IP address:	192.168.10.1	Subnet mask:	255.255.255.0
Dsp IP address:	192.168.10.254	Enable DHCP Server:	ENABLE
Start IP Address:	192.168.10.2	End IP Address:	192.168.10.25
Leased Time:	24	Enable Secondary IP:	DISABLE
Secondary IP address:		Secondary Subnet mask:	

IP Address :

Subnet mask:

DSP IP Address:

Disable DHCP Server

Enable DHCP Server

Start IP Address:

End IP Address:

Leased Time (hour):

Static IP Lease List: (A maximum 32 entries can be configured)

MAC Address	IP Address	Remove

Configure the second IP Address and Subnet Mask for LAN interface



The **X-50** system is a gateway, which joins two or more different types of networks together, such as WAN, LAN and PSTN. If the **X-50** system is connected to the ISP through a bridge to allow for connecting to external devices. The LAN Address will be set to 192.168.10.1 and it is set to be the network's DHCP Server.

However, if the **X-50** is only using email delivery and remote programming then the WAN port can be set to join as a node or client on the existing Local Area Network.

When connecting the WAN port of the **X-50** to an existing LAN, the LAN port of the **X-50** must be given a different IP address such as (192.168.100.1). The LAN of the **X-50** is then considered "Down Stream" from the existing LAN.

When establishing any network numbering plan, do not use the IP address x.x.x.254 because this address is reserved for the system's DSP and will cause erratic operation.

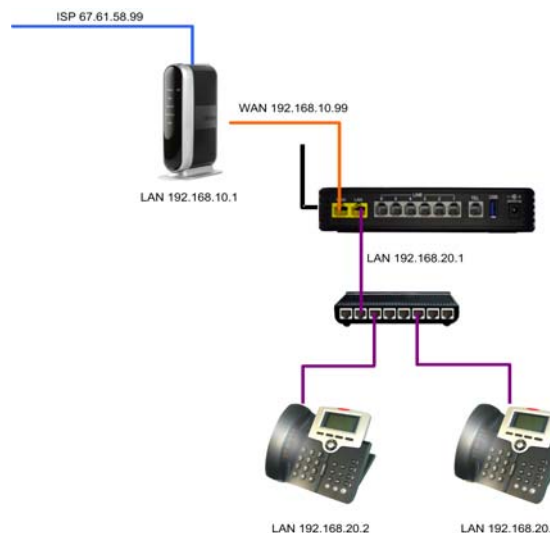

- LAN IP Address - at default the LAN IP Address is set to 192.168.10.1, but can be customized to accommodate any valid IP Address. In addition, it is considered the default gateway for any of the IP Telephone endpoints connected to the LAN ports.
- Subnet Mask - when using the "Static IP Address" setting, the Subnet Mask will have to be Manually entered. If there is a single Subnet, the entry will be 255.255.255.0. For more information about Subnet Masks refer to ["Subnet Maks" on page 249](#)
- DSP IP Address - The telephone system uses Digital Signal Processing to process standard telephony tones, which requires its own IP Address. Once assigned, no other device on the network can have the same IP Address, or the system will work erratically. The default IP Address is 192.168.10.254
- Universal Plug and Play (UPnP) - When enabled, the **X-50** will recognize any device that is connected to the LAN port and begins broadcast UPnP protocol.
- Dynamic Host Configuration Protocol (DHCP) - When enabled the **X-50** can be used to automatically assign client devices an IP Address. In addition, the administrator can grant a specific range of valid IP Addresses. At default the DHCP is enabled and will allow from 192.168.10.2 to 192.168.10.25. When disabled, every device connected to the network will have to be manually configured with an IP Address, which is good for security but creates a lot of extra work for the administrator.
- Leased Time - The amount of time that each dynamically assigned IP Address will be assigned to any one device before it is renewed. If the device is still connected and active, the device will probably continue with the same IP Address, otherwise it may be reassigned to another device.

Advanced - NAT

Network Address Translation (NAT)

- Device Info
- **Advanced**
- - WAN
- - LAN
- - **NAT**
- Virtual Servers Setup
- Port Triggering
- DMZ
- - Parental Control
- - Quality of Service
- - Routing
- - Dynamic DNS

NAT reconciles the internal class "C" IP Addresses with the published Class "A" or "B" Static IP Addresses. It is this protocol that makes it possible to share one published Internet address with multiple internal LAN devices. NAT settings should be used carefully, because it may open the network up to malicious network attacks.



Remote devices use NAT to gain access to internal devices. This protocol gives remote computers, like one at a home with an IP Address of 192.168.10.20, access to a device in the office with an IP address of 72.77.21.99. This gives remote locations the ability to access and program a specific device, such as the **X-50**, from a remote location.

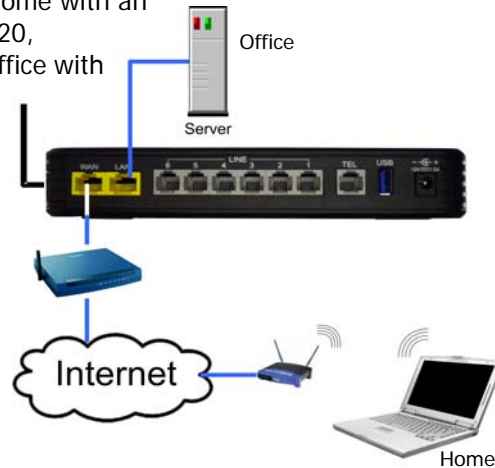

Virtual Servers Setup

The Virtual Server parameter directs incoming TCP, UDP or both TCP/UDP, traffic from the WAN side of the connection, to a specific IP address on the LAN side. This is one way of directing incoming IP address data directly to a specific LAN device. This parameter is useful for remote access for Peer to Peer communication and games. The entered server's IP address is normally the computer or device on the LAN network that is running a specific application or game. When the WAN IP Address is presented to the **X-50** system, the information is compared to this table and when a match is found, it will be redirected to entered internal IP address

Select Virtual Server Setup, and then select "Add" to add servers or "Remove" to remove servers from the current list.

X-50 Configuration

NAT -- Virtual Servers Setup

This page allows you to direct incoming traffic from WAN side (identified by Protocol and External port) to the Internal server with private IP address on the LAN side. The Internal port is required only if the external port needs to be converted to a different port number used by the server on the LAN side. A maximum 32 entries can be configured.

Server Name	External Port Start	External Port End	Protocol	Internal Port Start	Internal Port End	Server IP Address	Remove

A maximum of 32 entries can be configured.

X-50 Configuration

NAT -- Virtual Servers Setup

Select the service name, and enter the server IP address and click "Apply/Save" to forward IP packets for this service to the specified server.
NOTE: The "Internal Port End" cannot be modified directly. Normally, it is set to the same value as "External Port End". However, if you modify "Internal Port Start", then "Internal Port End" will be set to the same value as "Internal Port Start".
 Remaining number of entries that can be configured:32

Use Interface:

Service Name:
 Select a Service:
 Custom Service:

Server IP Address:

External Port Start	External Port End	Protocol	Internal Port Start	Internal Port End
3389	3389	TCP	3389	3389
3389	3389	UDP	3389	3389
		TCP		
		TCP		
		TCP		
		TCP		
		TCP		
		TCP		
		TCP		
		TCP		
		TCP		
		TCP		

- Use Interface -
- Service Name - The administrator may create their own or use one of the of the preprogrammed commonly used services.
- Custom Service - If used, this required field allows the administrator to enter a name to be used for the custom service.
- Server IP Address - Enter the IP address of the "Server" or device that will receive the incoming TCP/UDP traffic.
- External Port Start - Enter the start port of the service to be directed to the entered Server IP Address.
- External Port End - Enter the end port of the service to be directed to the entered Server IP Address. This may be the same as the start port number.
- Protocol - Select the protocol to be used TCP, UDP or Both.
- Internal Port Start - This port should match the external Port Start entry
- Internal Port End - This Port should match the External Port End entry

NAT - Port Triggering

Port Triggering, unlike Virtual Servers which redirects a specific IP Address to a specific location, Port Triggering opens a port in the firewall allowing any IP Address, with the correct port in the address header, access into the system.

When an incoming port falls between the port start and the port end settings, and the protocol matches the associated protocol, the entered port start and port end will be opened, and directed to the open protocol. The trigger port end, cannot exceed 400 ports more than the trigger port start.

Select Port Triggering Setup and then select "Add" to add ports or "Remove" to remove ports from the current list.

X-50 Configuration

NAT -- Port Triggering

Some applications require that specific ports in the Router's firewall be opened for access by the remote parties. Port Trigger dynamically opens up the 'Open Ports' in the firewall when an application on the LAN initiates a TCP/UDP connection to a remote party using the 'Triggering Ports'. The Router allows the remote party from the WAN side to establish new connections back to the application on the LAN side using the 'Open Ports'. A maximum 32 entries can be configured.

Application Name	Trigger				Open			Remove
	Protocol	Port Range		Protocol	Port Range			
		Start	End		Start	End		

NAT Port Triggering

- Use Interface -
- Select an application - The user may create their own or use one of the of the preprogrammed commonly used services.
- Custom application - If used, this required field allows the administrator to enter a name to be used for the custom application.
- Port Trigger Start - Enter the start port number that will be passed through the firewall.
- Port Trigger End - Enter the end port number, no more than 40 ports greater than the start port, that will be passed through the firewall.
- Trigger Protocol - Select the protocol to be used TCP, UDP or Both.
- Open Port Start - Enter the internal start port that will be opened in the firewall.
- Open Port End - Enter the internal end port that will be opened in the firewall.
- Open Protocol - Select the protocol, TCP, UDP or Both, that will be opened

DeMilitarized Zone (DMZ)

The DMZ is a special location within a network, which was designed to add an extra layer of security. Basically, information from the WAN (outside) is sent to a server with a firewall which evaluates the information if the information is valid it is then sent to another server with another firewall for further evaluation. Although these two servers are physically within a LAN, they are actually programmed to exist in front of the LAN to ensure no unwanted packets are transmitted into the LAN.

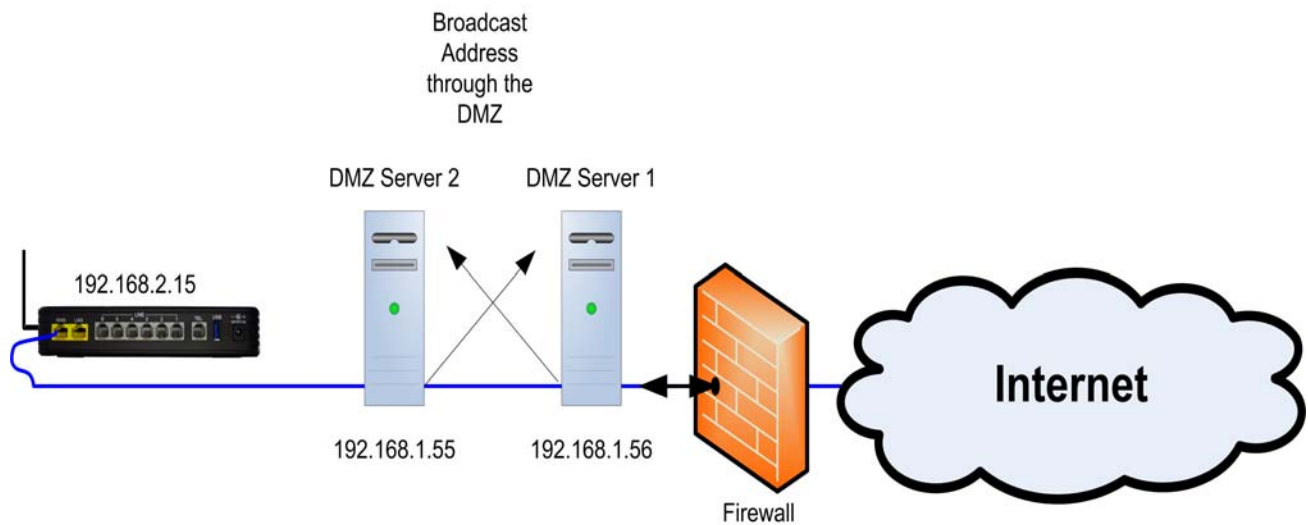

However, the most common use for the "DMZ" is to systemically place a server or gateway directly onto the Internet without requiring a class "A" or "B" address.

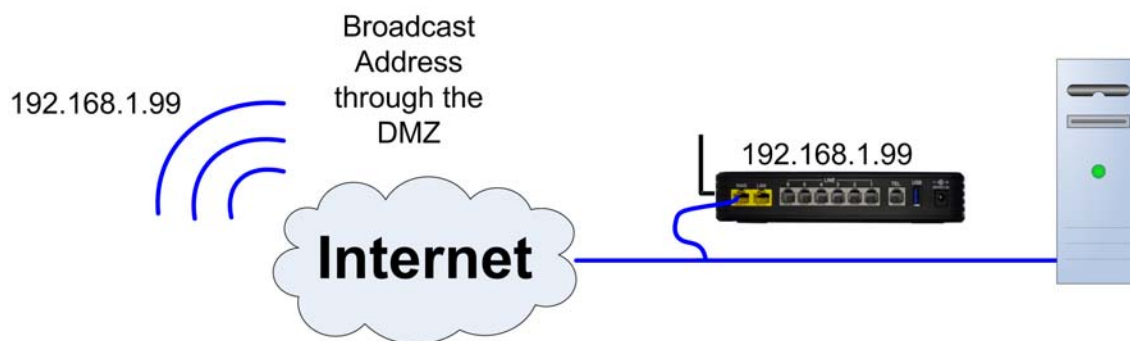

Placing a server or gateway may open the network to malicious network attacks.

Enter the IP Address of the device to be placed into the "DMZ".

The screenshot displays the X-50 Configuration web interface. On the left is a navigation menu with categories: Device Info, Advanced Setup (with sub-items: WAN, LAN, NAT, Virtual Servers, Port Triggering, DMZ Host), Security, Parental Control, Quality of Service, Routing (with sub-items: Dynamic DNS, Upnp, File Server, Print Server), Wireless, Voice, Management, Diagnostics, and Logout. The main content area is titled "X-50 Configuration" and "NAT -- DMZ Host". It contains the following text: "The unit will forward IP packets that do not belong to any of the applications configured in the Virtual Servers table from the WAN to the DMZ host computer..", "Enter the computer's IP address and click 'Apply' to activate the DMZ host..", and "Clear the IP address field and click 'Apply' to deactivate the DMZ host.". Below this text is a label "DMZ Host IP Address:" followed by an empty text input field and a "Save/Apply" button.

Security

Security, not to be confused with “Wireless Security” (for wireless security see [page 150](#)), is used to block incoming and outgoing IP Addresses as well as a “Parental Control” settings.

- Device Info
- **Advanced**
- - WAN
- - LAN
- - NAT
- - **Security**
- Outgoing IP Filtering
- Incoming IP Filtering
- Parental Control
- - Quality of Service
- - Routing
- - Dynamic DNS

Incoming and outgoing Filters are used to direct specific packets to the programmed location based on a set of parameters. This type of filtering is commonly used with games to facilitate the movement of IP packets.

Outgoing Filtering

Select Outgoing IP Filtering Setup, and then select “Add” to add IP Address or “Remove” to remove IP Addresses from the current list.

Xblue networks **X-50 Configuration**

Outgoing IP Filtering Setup

By default, all outgoing IP traffic from LAN is allowed, but some IP traffic can be **BLOCKED** by setting up filters..

Choose Add or Remove to configure outgoing IP filters..

Filter Name	Protocol	Source Address / Mask	Source Port	Dest. Address / Mask	Dest. Port	Remove
<input type="button" value="Add"/> <input type="button" value="Remove"/>						

X-50 Configuration

Add IP Filter -- Outgoing

The screen allows you to create a filter rule to identify outgoing IP traffic by specifying a new filter name and at least one condition below. All of the specified conditions in this filter rule must be satisfied for the rule to take effect. Click 'Apply/Save' to save and activate the filter.

Filter Name:

Protocol:

Source IP address:

Source subnet mask:

Source Port (port or port:port):

Destination IP address:

Destination Subnet Mask:

Destination Port (port or port:port):

The outgoing IP Filter is a set of parameters used to create a rule, which will block specific IP Addresses. All of the parameters must be true or the packet will continue unchanged.

- Filter Name - Each outgoing filter should have a unique name.
- Source Protocol - TCP, UDP, TCP/UDP or ICMP
- Source IP Address - the originating IP Address of packet to be evaluated
- Source Subnet Mask - the originating Subnet Mask of the packet to be evaluated.
- Source Port - the originating port of the packet to be evaluated
- Destination IP Address - the destination IP Address of the packet to be evaluated.
- Destination Subnet Mask - the destination Subnet Mask of the Packet to be evaluated
- Destination Port - the destination port of the packet to be evaluated

Each of these parameters are check, if one of the parameters does not match, the packet is released, otherwise the next parameter will be checked. The action will only take place if all of the parameters are found to be true.

Incoming Filtering

Select Incoming IP Filtering Setup, and then select "Add" to add IP Address or "Remove" to remove IP Addresses from the current list.

Xblue networks X-50 Configuration

Incoming IP Filtering Setup

When the firewall is enabled on a WAN or LAN interface, all incoming IP traffic is BLOCKED. However, some IP traffic can be **ACCEPTED** by setting up filters.

Choose Add or Remove to configure incoming IP filters..

Filter Name	Interfaces	Protocol	Source Address / Mask	Source Port	Dest. Address / Mask	Dest. Port	Remove
-------------	------------	----------	-----------------------	-------------	----------------------	------------	--------

Navigation Menu:

- Device Info
- Advanced Setup
 - WAN
 - LAN
- NAT
- Security
 - IP Filtering
 - Outgoing
 - Incoming
- Parental Control
- Quality of Service
- Routing
 - Dynamic DNS
 - Upnp
 - File Server
 - Print Server
- Wireless
- Voice
- Management
- Diagnostics
- Logout

X-50 Configuration

Add IP Filter -- Incoming

IP Incoming Filtering allows you to create a filter rule to identify incoming IP traffic by specifying a new filter name and at least one condition below. All of the specified conditions in this filter rule must be satisfied for the rule to take effect. Click 'Apply/Save' to save and activate the filter..

Filter Name:

Protocol:

Source IP address:

Source Subnet Mask:

Source Port (port or port:port):

Destination IP address:

Destination Subnet Mask:

Destination Port (port or port:port):

WAN Interfaces (Configured in Routing mode and with firewall enabled) and LAN Interfaces
Select one or more WAN/LAN interfaces displayed below to apply this rule.

LAN to WAN

LAN to LAN

The incoming IP Filter is a set of parameters used to create a rule, which will allow specific IP Addresses when the Firewall is enabled. All of the parameters must be true or the packet will be blocked.

- Filter Name - Each incoming filter should have a unique name.
- Source Protocol - TCP, UDP, TCP/UDP or ICMP
- Source IP Address - the originating IP Address of packet to be evaluated
- Source Subnet Mask - the originating Subnet Mask of the packet to be evaluated.
- Source Port - the originating port of the packet to be evaluated
- Destination IP Address - the destination IP Address of the packet to be evaluated.
- Destination Subnet Mask - the destination Subnet Mask of the Packet to be evaluated
- Destination Port - the destination port of the packet to be evaluated

Each of these parameters are check, if one of the parameters does not match, the packet is released, otherwise the next parameter will be checked. The action will only take place if all of the parameters are found to be true.

Parental Control

Also, known as Administration Control, this feature allows the administrator to identify specific devices to allow or deny access to the Internet. There are two areas of Parental Control, Time Restrictions, which limits the time of day and day of week that a device can access the Internet, and the other allows or denies specific Uniformed Resource Locator (URL) Addresses.

Access Time Restriction

Access Time Restriction

Select Parental Control, and then select "Add" to enter a Time Restriction rule for one a specific client device on the network.

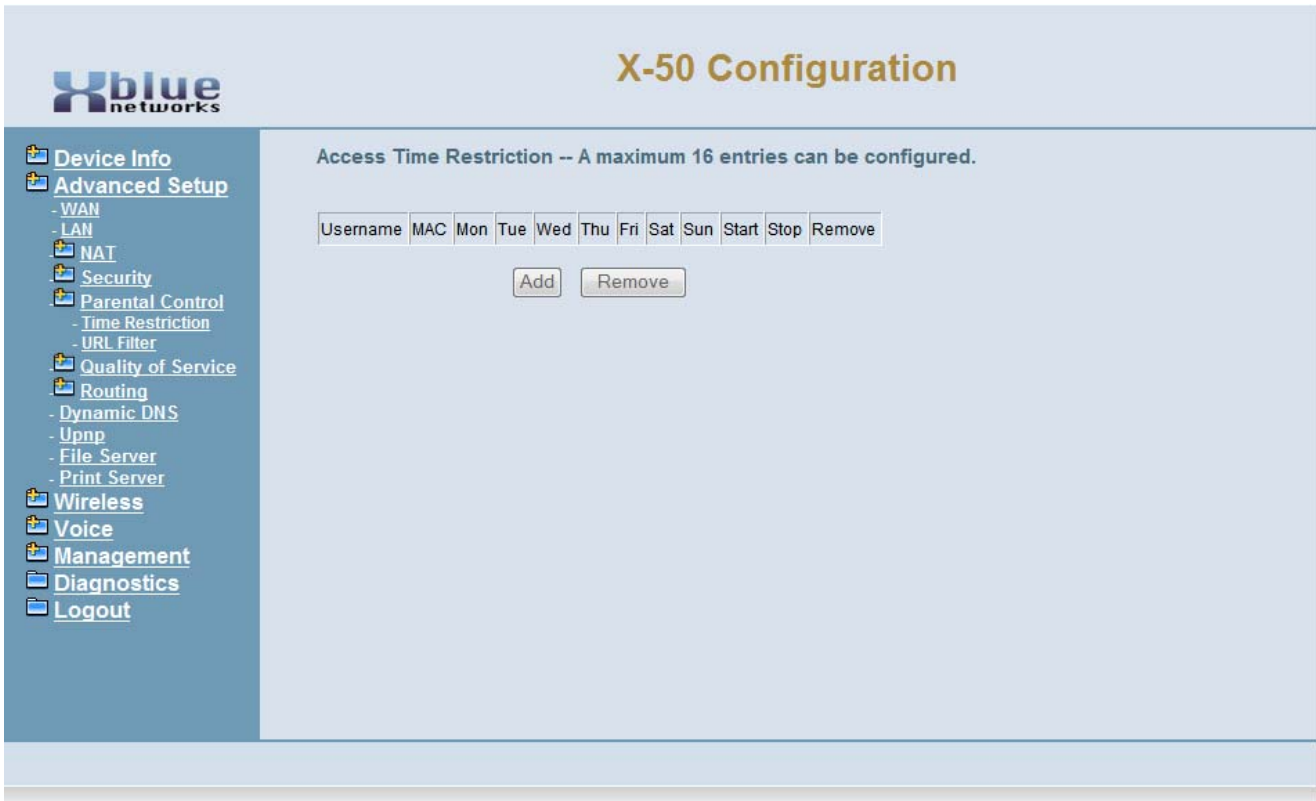

Before beginning to do any restriction programming it is a good idea to gather some information, such as the MAC Addresses of each device to be programmed and all URL's to be allowed or blocked.

Time Restriction

Xblue networks

X-50 Configuration

Access Time Restriction

This page adds time of day restriction to a special LAN device connected to the Router. The 'Browser's MAC Address' automatically displays the MAC address of the LAN device where the browser is running. To restrict other LAN device, click the "Other MAC Address" button and enter the MAC address of the other LAN device. To find out the MAC address of a Windows based PC, go to command window and type "ipconfig /all".

User Name

Browser's MAC Address

Other MAC Address

(xxxxxxxxxxxx)

Days of the week	Mon	Tue	Wed	Thu	Fri	Sat	Sun
Click to select	<input type="checkbox"/>	<input type="checkbox"/>	<input type="checkbox"/>	<input type="checkbox"/>	<input type="checkbox"/>	<input type="checkbox"/>	<input type="checkbox"/>

Start Blocking Time (hh:mm)

End Blocking Time (hh:mm)

- User Name - Enter the user's name or enter a unique name that will identify this control schedule.
- Browser's MAC Address - Enter the physical address of the device that will be using this control schedule.
- Click on "Other MAC Address" to enter the MAC Address of the user to be restricted. If programming from that client, just click on "Browser's MAC Address" and it will automatically be entered into the Text Box.
- Days of the Week - Select the days of the week that device will not be able to access the Internet. Not selecting a day, will essentially block the device for that 24 hour period.
- Start and End blocking time - Enter the time to start and end blocking the entered device. The Device will not have access to the Internet during the entered time.
- There can be a maximum of 16 Parental Controls established for each **X-50** System.

URL Filter

The URL filter allows the administrator to “exclude” or “include” specific Universal Resource Locator addresses. Unlike the “Time Restriction” entries, which affects only one member, the “URL Filter” affects all devices on the network. This allows the administrator to enter the name of a Website, such as AOL Instant Messaging, rather than the actual IP Address “xxx.xxx.xxx.xxx”.

Select Parental Control, URL Filtering and then select “Add” to enter a URL Filtering rule. Select whether to “Exclude” or “Include” entered URL Address

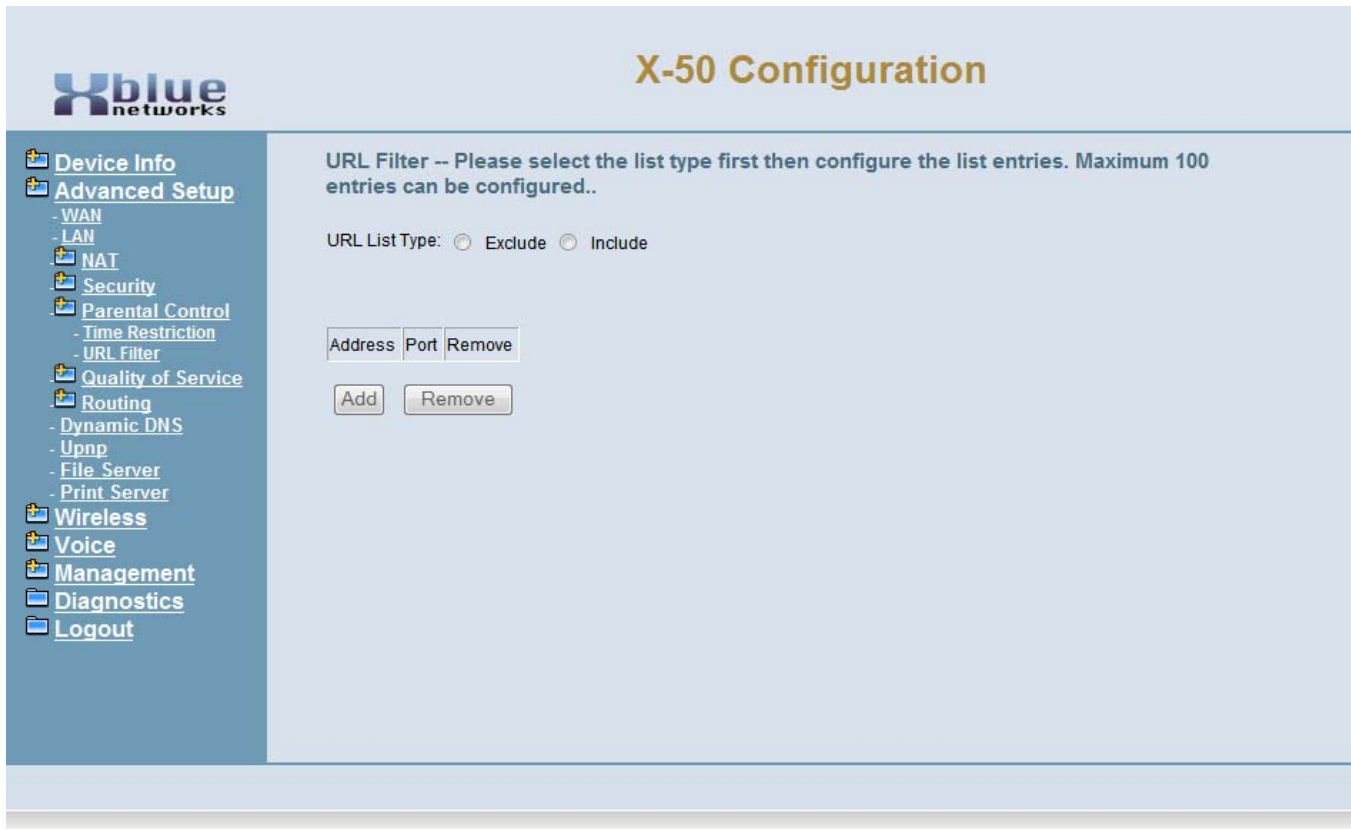

Security
7

The screenshot displays the X-50 Configuration web interface. On the left is a navigation menu with the following items: Device Info, Advanced Setup (with sub-items: WAN, LAN, NAT, Security, Parental Control (with sub-items: Time Restriction, URL Filter), Quality of Service, Routing, Dynamic DNS, Upnp, File Server, Print Server), Wireless, Voice, Management, Diagnostics, and Logout. The main content area is titled "X-50 Configuration" and "Parental Control -- URL Filter Add". It contains the instruction: "Enter the URL address and port number then click 'Apply/Save' to add the entry to the URL filter." Below this are two input fields: "URL Address:" and "Port Number:". The "Port Number" field has a note: "(Default 80 will be applied if leave blank.)". An "Apply/Save" button is located below the input fields.

- Enter the URL address to be Included or Excluded
- Enter the Port Number, if different from Port 80, to be Included or Excluded by this entry. The port may be one of the "Well Known Ports" or a specific port such as "AOL Instant Messaging Port 531".

Quality of Service (QoS)

- Device Info
- **Advanced**
- - WAN
- - LAN
- - NAT
- - Security
- - **Quality of Service**
- DSCP Marking
- Bandwidth Control
- - Routing
- - Dynamic DNS

Quality of Service is a generic term used to represent the ability to prioritize, and if needed change the header for, specific IP packets. QoS is often used to improve voice quality and data transfer rates. However, using QoS does not guarantee voice quality, the only way to guarantee voice quality is to have a data network connection that is large enough to handle both the data and voice traffic. Moreover, the **X-50** does not guarantee voice quality. Voice quality is a function of the network, network devices, data integrity and sufficient bandwidth to handle the networks' traffic. Therefore, XBLUE will do its best to help with voice quality but there is no guarantee, written or implied, that the quality of the voice network will be satisfactory, without changing network devices or upgrading available bandwidth.

DSCP (Differentiated Services Code Point)

The screenshot displays the X-50 Configuration web interface. The top left corner features the Xblue Networks logo. The main title is "X-50 Configuration". On the left side, there is a navigation menu with the following items: Device Info, Advanced Setup (expanded), WAN, LAN, NAT, Security, Parental Control, Quality of Service (expanded), DSCP Marking (selected), Bandwidth Control, Routing, Dynamic DNS, Upnp, File Server, Print Server, Wireless, Voice, Management, Diagnostics, and Logout. The main content area is titled "DSCP Marking" and contains the following text: "This feature attaches a DSCP value to IP packets sent to the WAN side. A DSCP value can be set for each type of packet (RTP, Signaling and Other)." Below this text is a checkbox labeled "Enable DSCP Mark" which is currently unchecked. At the bottom of the main content area is a "Save Settings" button.

Once enabled, press "Apply/Save" and the following window will open:

Click on "Add" create a new QoS rule.

Xblue networks

X-50 Configuration

DSCP Marking

This feature attaches a DSCP value to IP packets sent to the WAN side. A DSCP value can be set for each type of packet (RTP, Signaling and Other).

Enable DSCP Mark

Default DSCP Mark:

Signaling DSCP Mark:

RTP DSCP Mark:

Default DSCP Mark

DSCP - Differentiated Services Code Point - is a 6-bit field in the IP header, used for QoS Classification. If it is set to "No Change" or "Best Effort" then no QoS will take place.

- Default DSCP Mark - Using the drop down menu, select the protocol that will be identified for QoS processing.
- Signaling DSCP Mark - Using the drop down menu, select how the protocol will be modified for processing.
- RTP DSCP Mark - Using the drop down menu, select what order the packets will be processed.
- CS - Class Selector - Prior to the use of Assured Forwarding Classes, Class Selector was used. Class Selector, is not very flexible because it uses the Precedence field in the Type of Service to prioritize packets.
- Expedited Forwarding has the characteristics of low delay, low loss, and low jitter, making it suitable for Voice, Video and other real-time services. To avoid larger delays, it is important not to use Expedited Forwarding for more than 1/3 of the network traffic.

Bandwidth Control

Bandwidth Control is used to ensure that the highest priority IP packets are given priority over all other IP Packets. At default, the system automatically assigns voice packets the highest priority.

Select enable or disable of the Bandwidth Control, and then select “Save”.

The screenshot displays the X-50 Configuration web interface. On the left is a navigation menu with categories: Device Info, Advanced Setup (with sub-items: WAN, LAN, NAT, Security, Parental Control, Quality of Service (with sub-items: DSCP Marking, Bandwidth Control), Routing (with sub-items: Dynamic DNS, Upnp, File Server, Print Server), Wireless, Voice, Management, Diagnostics, and Logout), and Logout. The main content area is titled "X-50 Configuration" and "Bandwidth Control". It contains a descriptive paragraph: "When Bandwidth Control is enabled, IP packets forwarded from the LAN side to the WAN side are separated according to their traffic type. By setting an upper limit for bandwidth and assigning bandwidth to voice packets, those packets are given priority when forwarded. There are three types of traffic - RTP, Signaling and Other. It is possible to ensure quality by giving priority to RTP packets. When Bandwidth Control is disabled, the QoS feature is disabled." Below this text are three settings: "Bandwidth Policy" set to "Enable Bandwidth Control", "Upstream Bandwidth" set to "1M" kbit, and "Downstream Bandwidth" set to "1M" kbit. A "Save Settings" button is located at the bottom of the settings area.

- Bandwidth Control
- Enabled - Bandwidth control will prioritize IP Packets
- Disabled - IP Packets will not be analyzed or prioritized
- Upstream Bandwidth - This feature is used to determine the size of the upstream information
- Downstream Bandwidth - This feature is used to determine the size of the downstream information

Routing

- Device Info
- **Advanced**
- - LAN
- - WAN
- - NAT
- - Security
- - Quality of Service
- - **Routing**
- - Static Route
- RIP
- - Dynamic DNS

Static Routing

Static routing is used to establish IP Packet routing without requiring the devices to communicate with each other. This is considered a “no fault” network, because there is no way for the network to recover in the event of a failure.

Select Static Route, and then select “Add” to the static routing address, select “save” to activate the route.

The screenshot shows the Xblue X-50 Configuration web interface. The left sidebar contains a navigation menu with the following items: Device Info, Advanced Setup (with sub-items: WAN, LAN, NAT, Security, Parental Control, Quality of Service, Routing, Dynamic DNS, Upnp, File Server, Print Server), Wireless, Voice, Management, Diagnostics, and Logout. The main content area is titled "X-50 Configuration" and "Routing -- Static Route (A maximum 32 entries can be configured)". Below the title is a table with columns: Destination, Subnet Mask, Gateway, Interface, and Remove. Below the table are two buttons: "Add" and "Remove".

- Enter the Destination Network Address
- Enter the Subnet Mask of the Destination Network Address
- Enter the Gateway IP Address
- Select if the routing will be sent through the WAN/eth0 or the LAN/br0

Select Static Route, and then select "Add" to the static routing address, select "save" to active the route.

The screenshot shows the X-50 Configuration web interface. The title is "X-50 Configuration". The sidebar on the left contains the following menu items: Device Info, Advanced Setup (with sub-items: WAN, LAN), NAT, Security, Parental Control, Quality of Service, Routing (with sub-item: Static Route), Dynamic DNS, Upnp, File Server, Print Server, Wireless, Voice, Management, Diagnostics, and Logout. The main content area is titled "Routing -- Static Route Add". Below the title, there is a text instruction: "Enter the destination network address, subnet mask, gateway AND/OR available WAN interface then click 'Apply/Save' to add the entry to the routing table..". The form contains four input fields: "Destination Network Address:" (text box), "Subnet Mask:" (text box), "Use Interface:" (dropdown menu with "WAN" selected), and "Use Gateway IP Address:" (text box). An "Apply/Save" button is located at the bottom right of the form.

- Destination Network Address - Enter the Destination Network IP Address
- Subnet Mask - Enter the Destination Network Subnet Mask
- Use Interface - Select between WAN and LAN
- Use Gateway/IP Address - Enter the Gateway IP Address

Dynamic DNS

- Device Info
- Advanced
 - - WAN
 - - LAN
 - - NAT
 - - Security
 - - Quality of Service
 - - Routing
 - - **Dynamic DNS**

Unlike Standard Domain Name System (DNS), Dynamic DNS (DDNS) does not require a static Class "A" or "B" IP address. However, Dynamic DNS requires the device (server, gateway, router etc.) to run a special software application that continuously identifies the individual unit to the remote DNS Server, allowing the IP address to change without disrupting service.

The **X-50** has two Dynamic DNS software applications pre-loaded; DynDNS.org and TZO.

Select Dynamic DNS, and then select "Add" to enable Dynamic DNS. Press "Save" to retain the changes.

The screenshot shows the 'X-50 Configuration' page for Dynamic DNS. On the left is a navigation menu with categories like Device Info, Advanced Setup, Security, Parental Control, Quality of Service, Routing, Wireless, Voice, Management, Diagnostics, and Logout. The 'Dynamic DNS' option is highlighted under the 'Advanced Setup' category. The main content area is titled 'Dynamic DNS' and contains a descriptive paragraph: 'The Dynamic DNS service allows you to alias a dynamic IP address to a static hostname in any of the many domains, allowing the unit to be more easily accessed from various locations on the Internet..'. Below this is the instruction 'Choose Add or Remove to configure Dynamic DNS..' and a table with columns: Hostname, Username, Service, Interface, Update Cycle, and Remove. At the bottom of the table are two buttons: 'Add' and 'Remove'.

Hostname	Username	Service	Interface	Update Cycle	Remove
----------	----------	---------	-----------	--------------	--------

Dynamic DNS

7

Select Dynamic DNS, and then select “Add” to enable Dynamic DNS. Press “Save” to retain the changes.

X-50 Configuration

Add Dynamic DNS

This page allows you to add a Dynamic DNS address from DynDNS.org or TZO.

D-DNS provider:

Hostname:

Interface:

DynDNS Settings

Username:

Password:

Update Cycle:

- Select the DDNS Provider (DynDNS.org or TSO)
- Enter the name that will be associated to the Dynamic IP Address
- Select Between “WAN/eth0” and “LAN/bro0”
- DynDNS Settings - Enter the User Name and Password associated with the DNS account.

Universal Plug and Play (UPnP)

Universal Plug and Play is a set of protocols created specifically to allow devices on a peer to peer network, generally using either TCP port 5000 or UDP port 1900, to connect seamlessly and simplify their implementation.

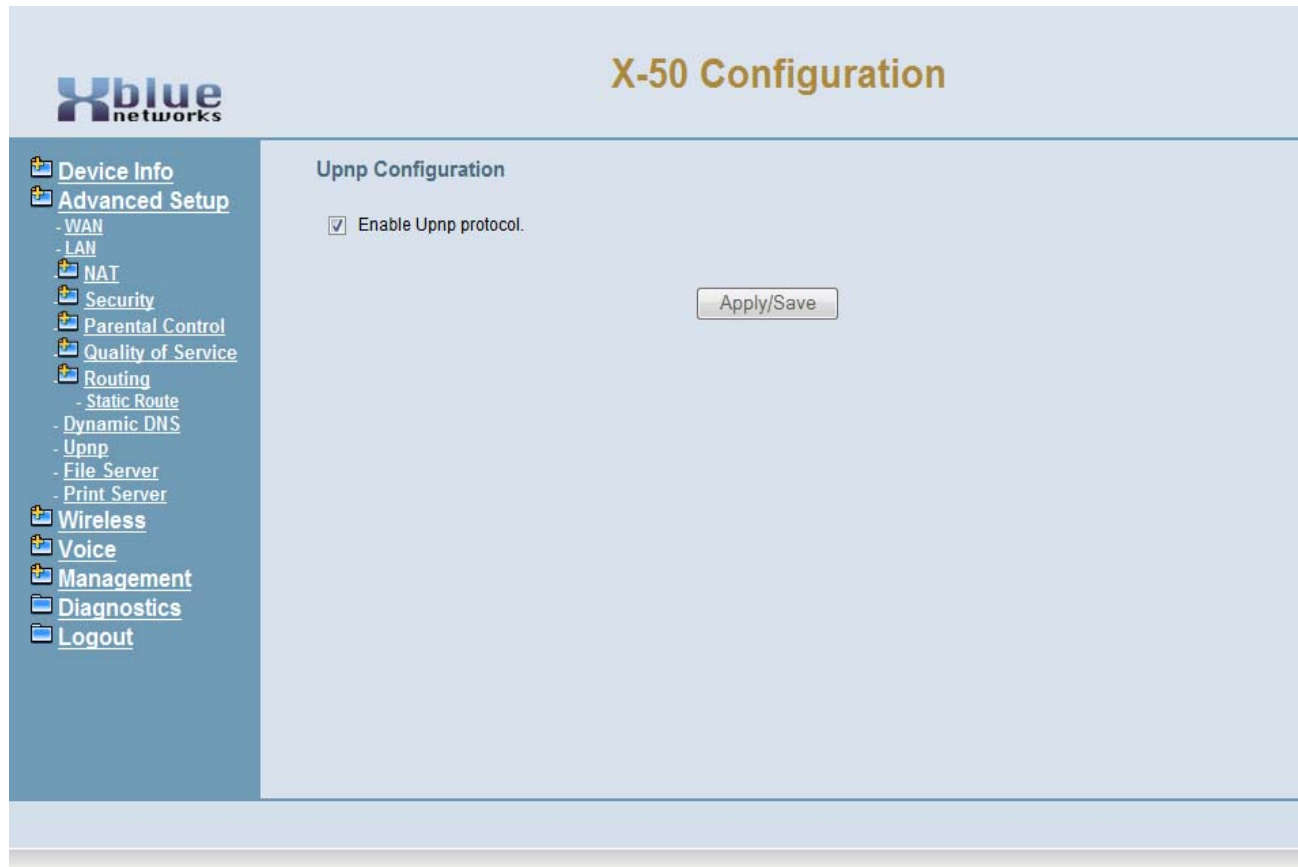

File Server

This future feature will allow the administrator share the contents of an external hard drive by connecting one to the USB port on the **X-50** system.

X-50 Configuration

File Server - Configuration

File Server provides file sharing service for various Microsoft Windows clients and can integrate with a Windows Server domain. Your USB mass storage can be accessed by Windows/Linux Network Neighborhood

Select the desired values and click "Apply/Save" to configure the Mass Storage options

Enable/Disable Mass Storage se.

Service Name:

Workgroup:

Read only access:

Enable/Disable account management.

User Name:

Password:

- Service Name - Enter the name that will be used when on the network to identify the storage area
- Workgroup - Enter the workgroup name. At default, the entered name is workgroup
- Read only access - When checked, anyone connected to the device will only be able to read the information.
- User Name - Enter the name that will be used to authenticate a user and give them access to the device.
- Password - Enter then password that will be used to authenticate a user and give them access to the device.

To locate the workgroup:

1. On a computer connected to the network, go to "Start" and locate "Control Panel"
2. In Control Panel click on the "System" icon
3. Click on the "Computer Name" tab (Windows 7 users will click on "Advanced System Settings") and then locate the "Computer Name" tab.
4. The workgroup name can be found in the middle of the "Computer Name" tab, next to "Workgroup:".

Note:

The File Server cannot be connected if Printer Server is connected.

Printer Server

The **X-50** system can work as a print server, which allows other members of the workgroup to share the printer connected to the USB port.

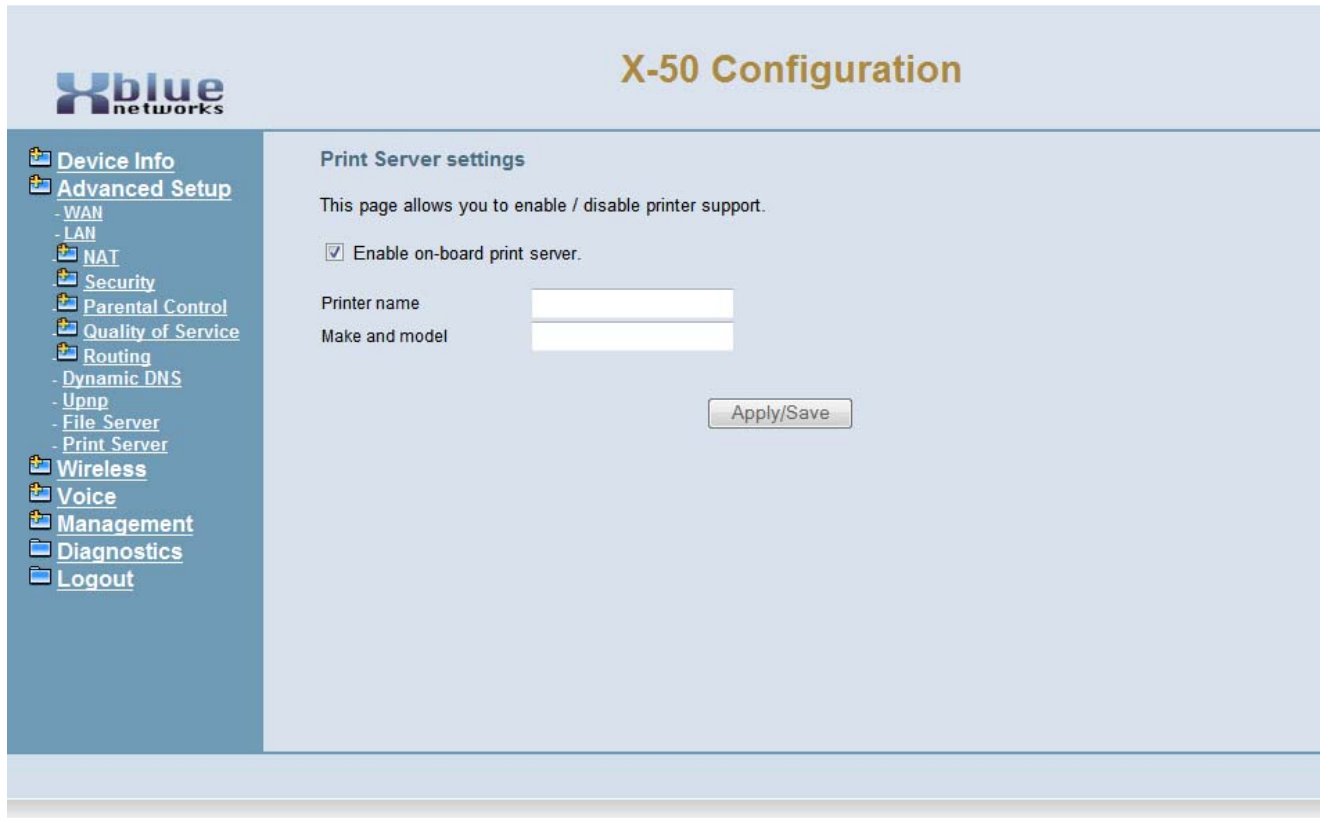

- Enter the name of the printer, such as CanonPrinter, that will be shared in the workgroup
- Enter the make and model number. i.e. Canon iR1024

Use the following steps to add the printer to clients on the network:

1. On a computer connected to the network, Click on "Start" and "Printer" (Windows7 - go to "Devices and Printers")
2. Click on "Add a Printer"
3. Click on "Add a network printer" and then press "Next"
4. Click on "Connect to a printer on the Internet or on a home or office network."
5. In the URL text window, enter "http://" plus the IP Address, "/printers/" plus the entered "printer name". For example, "http://192.168.10.1/printers/CanonPrinter" and then press next.
6. Select the printer manufacturer and then select the specific printer.
7. Click on Finish

8 *Wireless Programming*

Wireless Programming

Integrated in the **X-50** is an 802.11a, 802.11b, 802.11g and 802.11n wireless gateway. This gateway can be used by standard computing devices as well as 802.11 communications devices.

At default the wireless interface is enabled, but unsecured. It is very important that security is enabled prior to going on line and although nothing is 100% safe against malicious network attacks, enabling security will minimize the effectiveness of any attacks. In addition, wireless security will stop unintended client devices from joining the network.

- Device Info
- Advanced Setup
- **Wireless**
 - - Basic
 - - Security
 - - MAC Filter
 - - Wireless Bridge
 - - Advanced
 - - Station Info
- Voice
- Management
- Diagnostics
- Logout

During the Setup Wizard, some of the default wireless settings may have been changed. Therefore, this manual will show what the defaults are without any changes from the Setup Wizard.

Basic

- Device Info
- Advanced
- **Wireless**
 - - **Basic**
 - - Primary
 - - Additional
 - - Security
 - - MAC Filter
 - - Wireless Bridge
 - - Advanced
 - - Station Info
 - Power Saving

Being able to connect to a wireless gateway can be easy and convenient. And Wireless connections are now reaching speeds comparable to a wired connections. However, wireless gateways are easy to locate and join, with or without the administrator's permission, so please enable Wireless Security as soon as possible.

Primary Wireless Network Programming Parameters

Xblue networks **X-50 Configuration**

Wireless-primary Network

This page allows you to configure basic features of the wireless LAN interface. You can enable or disable the wireless LAN interface, hide the network from active scans, set the wireless network name (also known as SSID) and restrict the channel set based on country requirements. Click "Apply/Save" to configure the basic wireless options.

Enable Wireless
 Hide Access Point
 Clients Isolation
 Disable WMM Advertise
 Enable Wireless Multicast Forwarding (WMF)

SSID:
 BSSID:
 Country:
 Max Clients:

- Enable Wireless - At default the checkbox indicates that wireless is enabled - when enabled the wireless name (SSID) will be broadcast and visible to anyone that is looking for wireless gateways.
- Hide Access Point - It is possible to enable the wireless but not broadcast the name (SSID). Select the Checkbox to enable "Hide Access Point", i.e. make it invisible or undetectable.
- Clients Isolation - Prevents wireless clients from seeing one another even though they are on the same network. Select the Checkbox to enable "clients isolation", thus isolating the clients from each other.
- Disable WMM Advertise - Wi-Fi Multimedia is used as Quality of Service, controlling the throughput of audio, video and voice applications. At default, this is disabled.
- Enable Wireless Multicast Forwarding (WMF) - is a delivery protocol for information to a group of destinations. Although most applications use unicast (broadcasting to a single location), WMF is typically used in oneway streaming media. At default, this is disabled.
- SSID - Service Set Identifier is the name that identifies a particular wireless gateway or router. This name is broadcast and easily found by another wireless devices. For security, it is a good idea to change the default SSID name. It is a good idea to use a name that makes sense to the administrator, but not so specific as to give away where the device is located.
 - Do's and Don't's when naming SSID
 - Do not use the company name, address, phone number
 - Do not use a personal name
 - Do not use a birth date or other personal information
 - Do not use an antagonistic name such as "BigDog" or "NetworkGenius"
 - Do not make the name tantalizing, such as "SEXY-BOX" or "SECRET"
 - Do select a name that contains both letters and numbers
 - Do select a name that is easy to recognize but not memorize
 - Do consider changing the SSID every few months
- BSSID - Basic Service Set Identifier is set to the Media Access Control (MAC) address of the **X-50** gateway. This is a fixed parameter that cannot be modified.
- Country - Select the country that the **X-50** system will be installed. Based on the country select, the **X-50** will automatically set the wireless channel.
- Max Clients - Enter the maximum number (valid entries are 1 - 128) of client computers that will be supported by the wireless access point.
- Enable Wireless Guest Network - The Wireless Guest Network allows clients to join the wireless access point (**X-50** VoIP Telephone System) without getting access to the network or other network clients. This is similar to a "Hot Spot". Double Click on the Checkbox to enable the "Guest Network"
- Guest SSID - At default the Guest SSID is set to "Guest" but should be changed as indicated in the SSID.

Additional Networks

X-50 Configuration

Wireless--Additional Networks

This page allows you to configure additional Wireless Networks.

Enabled	SSID	Hidden	Isolate Clients	Disable WMM Advertise	Enable WMF	Max Clients	BSSID
<input type="checkbox"/>	w10_Guest1	<input type="checkbox"/>	<input type="checkbox"/>	<input type="checkbox"/>	<input type="checkbox"/>	16	N/A
<input type="checkbox"/>	w10_Guest2	<input type="checkbox"/>	<input type="checkbox"/>	<input type="checkbox"/>	<input type="checkbox"/>	16	N/A
<input type="checkbox"/>	w10_Guest3	<input type="checkbox"/>	<input type="checkbox"/>	<input type="checkbox"/>	<input type="checkbox"/>	16	N/A

Apply/Save

- Enable Wireless - At default the checkbox indicates that wireless is enabled - when enabled the wireless name (SSID) will be broadcast and visible to anyone that is looking for wireless gateways.
- SSID - Service Set Identifier is the name that identifies a particular wireless gateway or router. This name is broadcast and easily found by another wireless devices. For security, it is a good idea to change the default SSID name. It is a good idea to use a name that makes sense to the administrator, but not so specific as to give away where the device is located.
 - Do's and Don't's when naming SSID
 - Do not use the company name, address, phone number
 - Do not use a personal name
 - Do not use a birth date or other personal information
 - Do not use an antagonistic name such as "BigDog" or "NetworkGenius"
 - Do not make the name tantalizing, such as "SEXY-BOX" or "SECRET"
 - Do select a name that contains both letters and numbers
 - Do select a name that is easy to recognize but not memorize
 - Do consider changing the SSID every few months
- Hidden - Hide Access Point - It is possible to enable the wireless but not broadcast the name (SSID). Select the Checkbox to enable "Hide Access Point", i.e. make it invisible or undetectable.

- Isolation Clients - Prevents wireless clients from seeing one another even though they are on the same network. Select the Checkbox to enable "clients isolation", thus isolating the clients from each other.
- Disable WMM Advertise - Wi-Fi Multimedia is used as Quality of Service, controlling the throughput of audio, video and voice applications. At default, this is disabled.
- Enable Wireless Multicast Forwarding (WMF) - is a delivery protocol for information to a group of destinations. Although most applications use unicast (broadcasting to a single location), WMF is typically used in oneway streaming media. At default, this is disabled.
- Maximum Clients - Enter the number of clients that can access the selected wireless access point. a Maximum of 16 clients can be authenticated at one time.
- BSSID - Basic Service Set Identifier is set to the Media Access Control (MAC) address of the **X-50** gateway. This is a fixed parameter that cannot be modified.

Security

- Device Info
- Advanced
- **Wireless**
 - - Basic
 - - **Security**
 - - MAC Filter
 - - Wireless Bridge
 - - Advanced
 - Station Info

A wireless access point can be very convenient but also very dangerous because it opens the network to unauthorized user access. It cannot be stressed enough how important it is that every wireless access point must have some type of security enabled, even if the system is not broadcasting its SSID.

*At default, the **X-50** does not have any wireless security enabled.*

Note:

If the location is not using the wireless interface, be sure to disable it!



It is never a good idea to install a wireless device such as a router or gateway without some sort of encryption and or security. Failure to properly secure a device on a network may result in unauthorized entry into the wireless network. However, even the best encryption does not guarantee unauthorized access, but some encryption is better than no encryption.

The goal of any security is to deny access to unwanted intruders. The **X-50** has several different security protocols. Once the security protocol is selected it is very easy to connected authorized clients.

What does that say?



Like any lock and key system, the key must match the lock in order to gain access. Wireless security is no different. The selected encryption protocol will not allow wireless devices to join the network unless it has the correct key.

Keys are generated several different ways, one simple but effective way is using a shared key which takes a phrase, such as "ItIsWindyInChicago" and put it through a complex mathematical algorithm, which may vary in length from 64 to 128 bits and generates a key that may resemble "Ea1e3683Cd". Any device that broadcasts that key to the **X-50** will be granted access otherwise access is denied.

For more advanced network administrators the **X-50** comes with 9 different types of security protocols, and it has Wi-Fi Protected Setup (WPS), which is an easy and fast way to establish wireless security.

Xblue networks

X-50 Configuration

Wireless -- Security

Please select your Security Mode Manual WPS

Manual Setup AP

You can set the network authentication method, selecting data encryption, specify whether a network key is required to authenticate to this wireless network and specify the encryption strength. Click "Apply/Save" when done.

Network Authentication:

WEP Encryption:

Encryption Strength:

Current Network Key:

Network Ke 1:

Network Ke 2:

Network Ke 3:

Network Ke 4:

Enter 13 ASCII characters or 26 hexadecimal digits for 128-bit encryption keys
Enter 5 ASCII characters or 10 hexadecimal digits for 64-bit encryption keys

Network Authentication - Using the drop down menu select which security protocol will be used

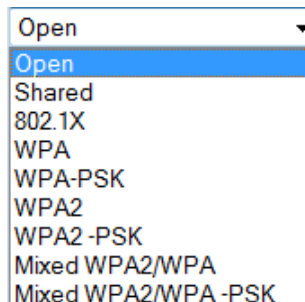

At default, Network Authentication is set to "Open" and WEP encryption is disabled, which allows anyone to join the network. Change WEP Encryption to enabled, and 4 network keys are displayed and become operational.

Open and Shared both use Wired Equivalent Privacy (WEP) encryption which allows the administrator to select between 4 different network keys. 802.1x and WPA require the administrator to set valid RADIUS parameters. WPA-PSK requires the administrator to create a valid WPA pre-shared Key. Use the following protocols to establish wireless security.

- **Open** – no encryption – not recommended without WEP enabled.
- **Shared** – each device on the wireless network must use the same WEP “Shared” authentication key. This should be considered rudimentary security.
- **802.1x** – is a Port based authentication based on Extensible Authentication Protocol, which generally requires a client application, which authenticates to a specified server (RADIUS) before being allowed to connect to the wireless access point.
- **WEP – Wired Equivalent Privacy** – One of the original wireless encryption protocols, which was thought to be secure. Today, with a minor investment, it can be cracked pretty quickly. This should be considered basic security.
- **WPA – Wi-Fi Protected Access** – an “intermediate measure” security protocol created by the Wi-Fi Alliance, which uses Temporal is found to be more secure than WEP.
- **TKIP – Temporal Key Integrity Protocol** – Was added to WPA and is backwards compatible with older WEP devices, but can be infiltrated with re-injection and spoofing.
- **PSK – Pre-Shared Key** (RFC 4785) – can be convenient when managing a closed network for easier authentication.
- **WPA2** – The second version of WPA, which is more secure, but does not always work with older wireless installations.
- **AES – Advanced Encryption Standard** – Block Cipher encryption which was adopted by the US Government, and now used world wide for security.
- **RADIUS – (RFC 2865) Remote Authentication Dial in User Service** – is a client/server protocol using centralized authentication, which requires a network server for all endpoints that connect to the network. This is done in the application layer, using UDP packets.
- **RADIUS Port** – The “Well Known Ports” for sending UDP packets are 1812 and 1645 depending on the network installation and the server.

Select WPS to quickly establish wireless security.

X-50 Configuration

Wireless -- Security

Please select your Security Mode Manual WPS

Keep existing Clients Yes No

Select WPS Method Push-Button PIN

Access Point Pin 76308574 [Help](#)

External Device Pin

Currently authorized Clients: 0

- Keep existing Clients - If there are any authorized clients connected to the wireless access point, they may be automatically granted access, by selecting "Yes". Select "No" to disconnect all current wireless devices.
- Access Point PIN - Personal Identification Number - The **X-50** system generates a PIN to be used to authenticate clients on the network.
- External Device PIN - The administrator enters a PIN to be used to authenticate clients on the network.

Select WPS Method Push-Button PIN

Attention:The button on the front of the Device is for the primary network only!
To add a client for a additional network, use this button.

Add a new client

Currently authorized Clients: 1

- Push Button - Select Push button to add clients by pressing "Add Enrolee".

One method of wireless security is "MAC Filtering". This requires the administrator to enter the Media Access Control (MAC) address of each client that has permission to join the wireless access point. If the MAC address is not entered, the client cannot join the network.

MAC Filtering

Select "Wireless MAC Filtering", and then select "Add" to add a MAC address or "Remove" to remove servers from the current list. Click on disable, allow, or deny and then click on add an entry.

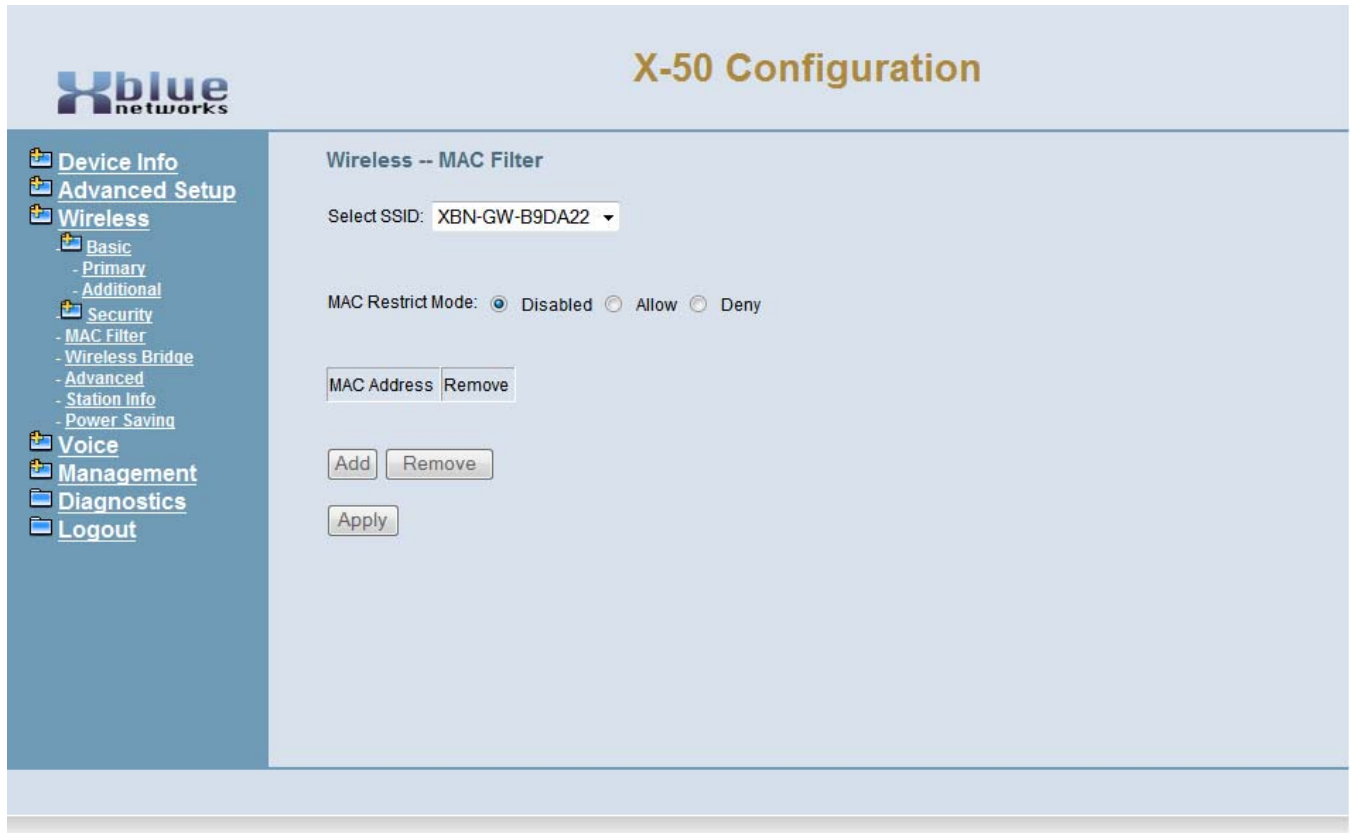

Select “Wireless MAC Filtering”, and then select “Add” to add a MAC address or “Remove” to remove servers from the current list.

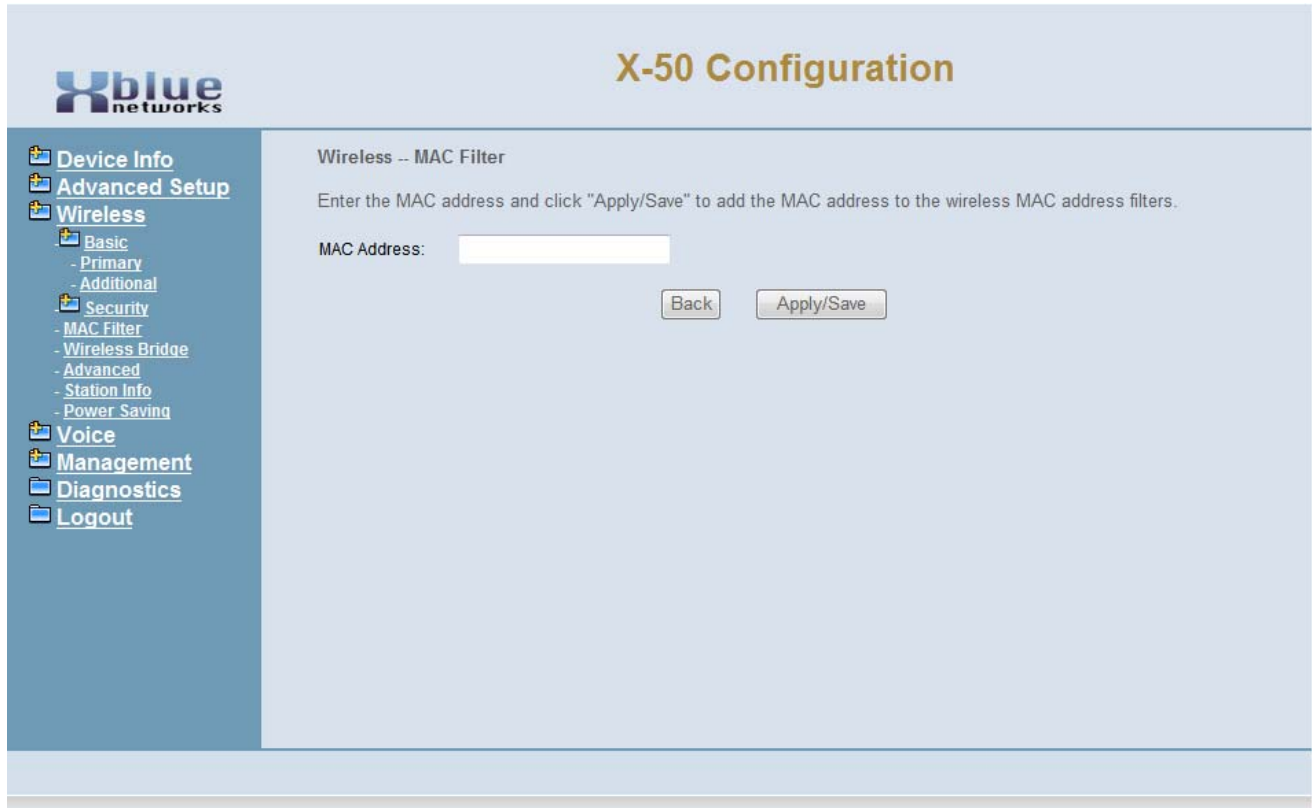

Locating a device's MAC Address:

Usually, the MAC Address can be found on a label, which is affixed to the outside of the device, and labeled “MAC Address” However, some times it is called something different such as physical, hardware or device address, but in all cases the MAC Address is 6 Octets, which is 12 numbers or characters, and should be written as xx:xx:xx:xx:xx:xx. In all cases, a label with the MAC Address must be on the Printed Circuit Board of the device connecting to the network.

A computer's MAC Address is easily found by going to the Command Prompt, “Start --> Accessories --> Run” type CMD, and press enter.

Type [ipconfig /all] and press enter. The MAC Address will probably be written as xx-xx-xx-xx-xx-xx.

- Enter the MAC Address for each client device and press save.

Wireless Bridge

The **X-50** can be set as an Access Point or a Wireless Bridge. A wireless access point allows other devices to access the wireless network. Whereas a Wireless Bridge, wirelessly bridges two sections of a network and also allows wired access to both sides of the connection.



What does that say?

A wireless bridge allows a network to be “extended” wirelessly, and converts the wireless signal to a wired one. In the example below, Lets say there is a wired network in the office area, and another one in the warehouse area, but there is no cable connecting them together. A wireless bridge, as seen below, can connect the two devices creating one network, that is bridged together.

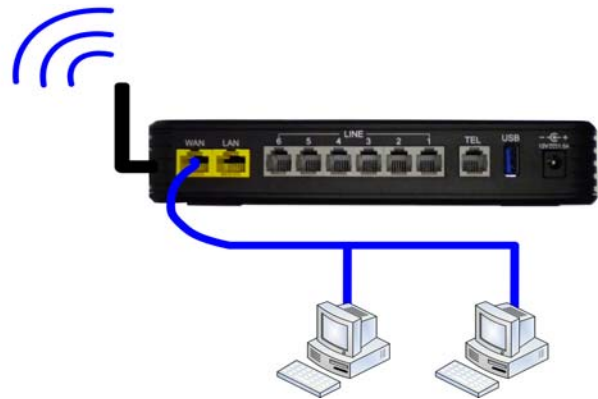
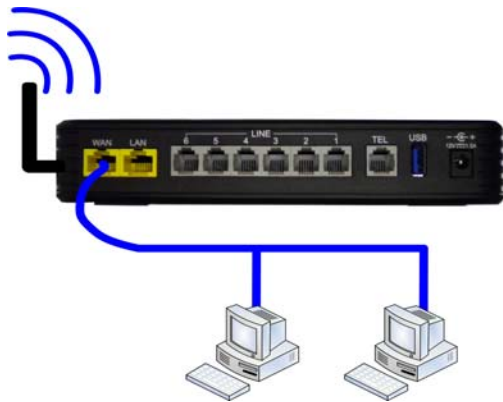

A wireless access point also extension a network, but client computers can only be connected wirelessly.

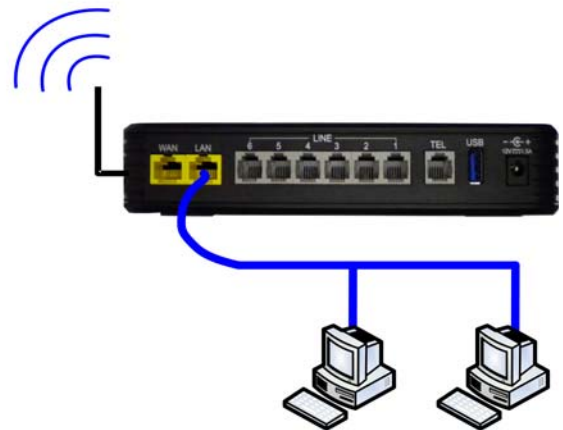
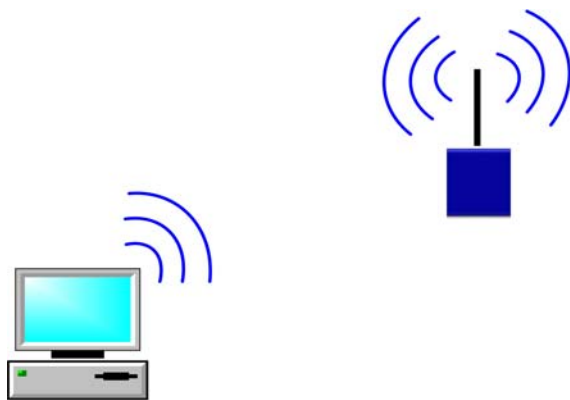

Select between “Wireless Access Point” and “Wireless Bridge”, and then select “Enable” and enter the SSID and MAC Address or Enable (Scan) and have the **X-50** locate the Wireless Device.

The screenshot shows the X-50 Configuration page for Wireless Bridge. The page title is "X-50 Configuration" and the sub-header is "Wireless -- Bridge". The left sidebar contains a navigation menu with the following items: Device Info, Advanced Setup, Wireless (selected), Basic, Primary, Additional, Security, MAC Filter, Wireless Bridge (selected), Advanced, Station Info, Power Saving, Voice, Management, Diagnostics, and Logout. The main content area contains the following text: "This page allows you to configure wireless bridge features of the wireless LAN interface. You can select Wireless Bridge (also known as Wireless Distribution System) to disable access point functionality. Selecting Access Point enables access point functionality. Wireless bridge functionality will still be available and wireless stations will be able to associate to the AP. Select Disabled in Bridge Restrict which disables wireless bridge restriction. Any wireless bridge will be granted access. Selecting Enabled or Enabled(Scan) enables wireless bridge restriction. Only those bridges selected in Remote Bridges will be granted access. Click "Refresh" to update the remote bridges. Wait for few seconds to update. Click "Apply" to configure the wireless bridge options." Below the text are the following form fields: AP Mode: Access Point (dropdown), Bridge Restrict: Enable (dropdown), and Remote Bridges MAC Address: two input fields. At the bottom of the form are two buttons: Refresh and Apply.

- If disabled, then no action is needed
- Select between Wireless Access Point and Wireless Bridge
- Select enabled and enter the SSID and MAC Address or select Enabled (Scan) to have the **X-50** locate the correct wireless device.

Advanced

- Device Info
- Advanced
- **Wireless**
 - - Basic
 - - Security
 - - MAC Filter
 - - Wireless Bridge
 - - **Advanced**
 - Station Info
 - Power Saving

Several of the advanced wireless parameters are programmed in this area.



X-50 Configuration

- Device Info
- Advanced Setup
- Wireless
 - Basic
 - Primary
 - Additional
- Security
 - MAC Filter
 - Wireless Bridge
 - Advanced
 - Station Info
 - Power Saving
- Voice
- Management
- Diagnostics
- Logout

Wireless -- Advanced

This page allows you to configure advanced features of the wireless LAN interface. You can select a particular channel on which to operate, force the transmission rate to a particular speed, set the fragmentation threshold, set the RTS threshold, set the wakeup interval for clients in power-save mode, set the beacon interval for the access point, set XPress mode and set whether short or long preambles are used. Click "Apply/Save" to configure the advanced wireless options.

Band:	2.4GHz	
Channel:	1	Current: 1
Auto Channel Timer(min)	0	
802.11n/EWC:	Auto	
Bandwidth:	20MHz in 2.4G Band and 40MHz in 5G Band	Current: 20MHz
Control Sideband:	Lower	Current: None
802.11n Rate:	Auto	
802.11n Protection:	Auto	
Support 802.11n Client Only:	Off	
54g™ Rate:	1 Mbps	
Multicast Rate:	Auto	
Basic Rate:	Default	
Fragmentation Threshold:	2346	
RTS Threshold:	2347	
DTIM Interval:	1	
Beacon Interval:	100	
Global Max Clients:	16	
XPress Technology:	Disabled	
Transmit Power:	100%	
WMM(Wi-Fi Multimedia):	Enabled	
WMM No Acknowledgement:	Disabled	
WMM APSD:	Enabled	

- Band - 2.4 GHz
 - Broadcast band based of the country selection
- Channel default 6 based on the country selection

- Channel is adjustable from “Auto” and 1 - 11
- Automatic Channel Timer (min) - Number of minutes between spectrum scans.
 - When “Channel” is set to Auto, the **X-50** searches for the best channel in the specified timeframe.
- 802.11n/EWC - This setting automatically uses 802.11n support or disables it.
 - Auto or Disable
- Bandwidth - The administrator can select to use both 20 and 40MHz or restrict it to 20MHz in 2.4G band and 40MHz in 5G band.
 - 20MHz or 40MHz or 20MHz in 2.4G Band and 40MHz in 5G band
- Control Sideband - If 40MHz is selected - The administrator must select between upper and lower sidband.
 - Upper or Lower
- 802.11n Rate - Select a specific data rate or select auto to allow the system to determine the best rate. This is only applicable when 802.11n/EWC is set to auto.
 - Auto, use 54g Rate, 6.5, 13, 19.5, 26, 39, 52, 58.5, 65, 78, 104, 117, and 130 Mbps.
- 802.11n protection - used to improve 802.11n performance in a mixed 802.11b and 802.11g protocols. Turn this feature off to maximize throughput, but disables all other protocols.
 - Auto or Off
- 802.11n Support Client Only - Select “Off” to allow other wireless devices 801.11b and 802.11g to connect to the system. Select “On” to allow only 802.11n clients to connect to the system.
 - Off or On
- 54g[®] Rate - Select the data transfer rate speed from 1 to 54Mbps. Auto, will allow the system to determine the best transfer rate.
 - Auto, 1 Mbps through 54 Mbps.
- Multicast Rate - Transmit rate
 - Auto (1, 2, 5.5, 11, 12, 18, 24, 36, 54 Mbps)
- Basic Rate - transmit rate - Select the basic rate that a client must support
 - Default (All, 1, 2, 5.5, 6, 11, 12, 24 Mbps)
- Fragmentation Threshold 2346
 - The **X-50** allows the administrator to set the maximum frame size the wireless device can send without fragmenting the frame. This setting is rarely changed. The default setting is the maximum frame size of 2346, which means that it will not fragment any frames that it sends to wireless clients. This setting is best for most environments.
- RTS Threshold 2347
 - RTS/CTS frames packet size threshold once exceeded RTS/CTS is sent.
- DTIM Interval - Delivery Traffic Indication Message - Informs the clients about the presence of buffered multicast/broadcast data on the access point.
 - The default value is 1 and it can be set from 1 to 255 ms.
- Beacon Interval - Beacon Frames are transmitted to periodically announce the presence of a wireless LAN.
 - The default value is 100 and it can be set from 1 to 65535.
- Global Max Clients - This is the maximum number of wireless clients for all established wireless networks.
- XPress[®] Technology
 - Enable this feature to improve wireless performance.
- Transmit Power 100% (20%, 40%, 60%, 80%)

- WMM (Wi-Fi Multimedia) - This feature improves the experience for audio, video and voice applications over the Wi-Fi network.
- WMM No Acknowledgement - When disabled, this feature sends wireless confirmaiton packets, however, when disabled it will not send the packets causing less wireless transmission.
- WMM APSD - (Automatic Power Save Delivery) allows SIP telephone endpoints to work in low power consumption mode.

Station Info

- Device Info
- Advanced
- **Wireless**
 - - Basic
 - - Security
 - - MAC Filter
 - - Wireless Bridge
 - - Advanced
 - **Station Info**

Station info is a reference only window that shows the authenticated wireless stations and their status. Use this window to ensure that unauthorized wireless devices are not connected to the wireless network.

The screenshot displays the X-50 Configuration web interface. The main heading is "X-50 Configuration". Below it, the sub-heading is "Wireless -- Authenticated Stations". A message states: "This page shows authenticated wireless stations and their status." Below this message is a table with the following columns: MAC, Associated, Authorized, SSID, and Interface. A "Refresh" button is located below the table. The left sidebar contains a navigation menu with the following items: Device Info, Advanced Setup, Wireless (with sub-items: Basic, Primary, Additional), Security (with sub-items: MAC Filter, Wireless Bridge, Advanced, Station Info, Power Saving), Voice, Management, Diagnostics, and Logout.

If Unauthorized wireless devices are seen, when reviewing this page, it is a good idea to change the security and reboot the **X-50** VoIP Telephone System which will remove the unauthorized devices.

Power Saving

Wireless Power Saving gives the administrator the ability to turn off the WLAN interface at a specific the preprogrammed time. The time must be entered in 24 hour format, where 07:00 is used for 7:00 am and 17:30 is used for 5:30 pm.

The screenshot shows the X-50 Configuration web interface. On the left is a navigation menu with categories: Device Info, Advanced Setup, Wireless (Basic, Security, Voice), Management, Diagnostics, and Logout. The main content area is titled "X-50 Configuration" and "Power Saving - Configuration". It contains a checkbox for "Turn off WLAN at a specific time of the day" which is checked. Below this, it asks to "Please enter the time in a 24 hour forma." and provides two input fields: "WLAN off at:" with the value "00:00" and "WLAN on at:" with the value "07:00". An "Apply/Save" button is located at the bottom right of the configuration area.

XBLUE Wireless Universal Adapter

Because there is not always an Ethernet port where you want to put a telephone, XBLUE suggests an XBLUE Wireless Universal Adapter. Just program the wireless adapter to connect to the **X-50**, and then connect the adapter to the network port of the **X2020**. The phone will authenticate to the **X-50** just like a wired telephone.

Getting Started

1. Make sure that the wireless on the **X-50** is on line and operational.
2. Connect the Ethernet cable from the Wireless adapter to the **X2020** telephone's network connection.
3. The integrated wireless adapter will automatically locate the **X-50**, and authenticate, and download the security password.



Note:

The quality of your wireless connection may affect the quality of the voice connection. There is no guarantee, written or implied, that the XBLUE Wireless adapter will work 100 percent of the time.

Notes:

9 *Voice*

Voice

Use “Voice” area of programming when establishing the system numbering plan, dial codes, service mode, answering position, call routing and restrictions and other telephone system parameters.

- Device Info
- Advanced Setup
- Wireless
- **Voice**
 - + Phone
 - + Trunk
 - + System
 - + Voicemail
 - - STUN
 - - Registered Phone
- Management
- Diagnostics
- Logout

Phone Extension

- Device Info
- Advanced Setup
- Wireless
- **Voice**
 - **+ Phone**
 - - Phone Extension
 - - Extension Linekey
 - + Trunk
 - + System
 - + Voicemail
 - - Registered Phone
 - - STUN
 - Management
 - Diagnostics
 - Logout

During the Setup Wizard, some of the default Voice settings may have been changed. Therefore, this manual will show what the defaults are without any changes from the Initial Setup Wizard.

The system is equipped to support up to 24 SIP telephone extensions and 1 FXS (Single Line or Analog Extension). Depending on the configuration and programming, the SIP Extensions can all be in the same location or spread out throughout the globe.



X-50 Configuration

- Device Info
- Advanced Setup
- Wireless
- Voice
 - Phone
 - Phone Extension
 - Programmable Linekey
- Trunk
- System
- Voicemail
- STUN
- Registered Phone
- Management
- Diagnostics
- Logout

SIP Authentication

This table allows you to configure the authentication for SIP client.
The current range of the extension numbers is from 101 to 125.
NOTE: If you remove a phone number from the table, its configuration file and the voice messages will be removed from the system.

No.	Phone Number	Password	Day COS	Night COS
1	101	••••••	0	0
2	102	••••••	0	0
3	103	••••••	0	0
4	104	••••••	0	0
5			0	0
6			0	0
7			0	0
8			0	0
9			0	0
20			0	0
21			0	0
22			0	0
23			0	0
24			0	0

FXS Phone Display Name Day COS Night COS

Registration Configuration

The settings allow you to change the parameters for SIP Registration.
NOTE: You need to reboot the system to make the changes to take effect.

Minimal Expire (10 - 3600)
SIP Port (1024 - 65535)

SIP Authentication

The information entered in this window becomes the authentication and extension number, and the password for each SIP extension. In addition, each extension is assigned a day and a night class of service, which controls the extension's dialing privileges. The Extension Number entered here must be within the numbering range as it is defined in the Numbering Plan See [page 187](#).

- Phone Number - Enter the phone number, generally 3 or 4 digits in length, that will be used by a SIP extension to authenticate on the **X-50** VoIP Telephone System. This number will also become the extension number for the entered extension. The extension number must be between the extension start and the extension end numbers as defined in the numbering plan [page 187](#).
- Password - Enter a password (up to 24 characters) that will be used to authenticate each SIP extension.
- Day Class of Service - Each extension is assigned a day class of service from 0 through 7 as defined in Call Restriction Table Configuration page found under the Trunk section of the Voice programming parameter.
- Night Class of Service - Each extension is assigned a night class of service from 0 through 7 as defined in Call Restriction Table Configuration page found under the Trunk section of the Voice programming parameter.
- FXS Phone -
 - FXS phone is the extension number of the Single Line Telephone Port in the **X-50** VoIP Telephone System. Although the extension number cannot be changed here, the extension's name and the day and night classes of service are defined here.
 - FXS Display Name - Enter the name to be displayed when this extension calls another extension within the system or voice network.
 - FXS Class of Service - Select the Day and Night Class of Service for this extension
- Registration Configuration - Allows the administrator the ability to change some specific SIP registration parameters.
 - - Minimal Expire - This is the minimal amount of time that an extension will remain registered before trying to reregister.
 - - SIP Port - This allows the administrator the ability to redefine the port that SIP extensions will use to communicate.

Extension Line Keys

X-50 Configuration

Extension Line Keys
This page allows you to configure the default settings for extension's line keys.

LineKey 1 Type	Trunk	Value	700
LineKey 2 Type	Trunk	Value	701
LineKey 3 Type	Trunk	Value	702
LineKey 4 Type	Trunk	Value	703
LineKey 5 Type	Extension	Value	101
LineKey 6 Type	Extension	Value	102
LineKey 7 Type	Extension	Value	103
LineKey 23 Type	Extension	Value	119
LineKey 24 Type	Extension	Value	120
LineKey 25 Type	Extension	Value	121
LineKey 26 Type	Extension	Value	122
LineKey 27 Type	Extension	Value	123
LineKey 28 Type	Extension	Value	124
Auto Hold	Disable		

Extension List

101	Configure
102	Configure
103	Configure
104	Configure
105	Configure

Save Settings Cancel Changes

The default programmable line keys on each **X2020** telephone can be defined here. Once the SIP telephone extension has been authenticated the default buttons will automatically be assigned to match these entries. However, each extension has the ability to redefine their line keys after they are operational.

Each Programmable Line Key can be a LAN or WAN SIP telephone - showing when it is off-hook or idle - a PSTN or SIP Trunk line - showing when it is busy or idle, Call Park - placing calls onto system (orbit) hold, a Feature key as defined in the Telephone Feature Code Section, a one touch Do Not Disturb (DND) button, a live record button - allowing users to record live conversations on the fly, or it could be programmed as "Others", which allows the administrator to program a virtual extension, UCD group, etc.

Features that can be assigned to a button

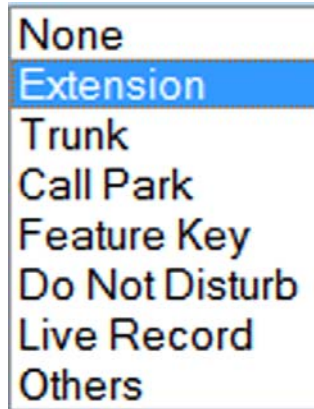

- Extension - Enter an extension number that is authenticated on the system to see when it is busy or idle.
- Trunk - Enter the trunk (PSTN or SIP Trunk Line) to see when it is busy or idle.
- Call Park - This will allow the user to press one button and place calls into Park Orbit.
- Feature Key - Select feature key and enter the feature code to activate a feature shown in the "Telephone Feature".
- Do not Disturb (DND) Select DND to allow the user to place their extension to press one button to place their extension into DND
- Live Record - Select Live Record to allow the user to record a live conversation with the press of a single button.
- Others - Select Others to enter other dial codes such as a UCD group, Page group, etc.

Trunk

- Device Info
- Advanced Setup
- Wireless
- **Voice**
 - + Phone
 - **+ Trunk**
 - - IP Trunk
 - - Trunk Group
 - - Answering Position
 - - Call Routing
 - - Call Restriction
 - - Emergency Numbers
 - + System
 - + Voicemail
 - - Registered Phone
 - - STUN
- Management
- Diagnostics
- Logout

A trunk also known as a Telephone or Central Office (CO) Line, provides access to the Public Switch Telephone Network (PSTN). The **X-50** offers two different types of Trunks; POTS and SIP. There are six (6) POTS (Plain Old Telephone Service) Trunks, which are analog lines that are usually connected to a traditional telephone line provider, such as a home telephone line.

There are also eight (8) SIP Trunks, which are telephone lines that are routed over the IP backbone, allowing remote access to the providers Land Telephone (Central Office) Lines. Using SIP trunks will require more bandwidth but may provide features that standard analog lines cannot provide, such as Direct Inward Dial (DID).



What does that say?

Plain Old Telephone Lines are Analog Telephone Trunks (POTS) - Each of these telephone Lines or trunk connects directly from the telephone line provider to the **X-50** system.



Unlike analog trunks, SIP trunks do not physically connect to the **X-50** VoIP Telephone System. Each SIP trunk is assigned a special authentication ID and Password, that systemically connects them from the SIP Telephone Line provider to the **X-50** VoIP Telephone System using the broadband (Internet) Connection. Once programmed, the **X-50** system and the SIP trunks remain "connected" and are accessed just like an analog trunk.

Because SIP Trunks are accessed through the broadband (Internet) connection it is important that there is enough bandwidth. Contact the ISP to ensure that the bandwidth is a is sufficient to handle the SIP Trunk Requirements. It is suggested that a minimum of 7meg up and 1 meg down, known as 7 x 1, should be enough.



SIP Trunks

The **X-50** comes equipped to support eight SIP IP Trunks and fifty Direct Inward Dial (DID) numbers. SIP Trunks are not physically connected, they authenticate over the Internet. Thus, the voice quality of these line are directly related to the ISP speed. There are several SIP IP Trunk providers on the market and the integration should be standardized. However, this may not always be the case, and although we do our best to integrate all SIP Trunks, there is no guarantee, written or implied, that every SIP IP Trunk provider will work with the **X-50**.



X-50 Configuration

- Device Info
- Advanced Setup
- Wireless
- Voice
 - Phone
 - IP Trunk
 - Trunk FQD
 - Trunk Group
 - Answering Position
 - Call Routing
 - Call Restriction
 - Emergency Numbers
- System
 - VoiceMail
 - STUN
 - Registered Phone
- Management
- Diagnostics
- Logout

Subscriber Information

This page allows you to configure the proxy and registration of IP Trunk. up to 8 lines of IP Trunk are supported.

IP Trunk 1

Phone Number	<input type="text"/>
Auth ID	<input type="text"/>
Auth Password	<input type="password"/>
SIP Proxy	<input type="text"/>
Port	5060
Outbound Proxy	<input type="text"/>
Port	5060
Register Server	<input type="text"/>
Port	5060
Outbound Registrar	<input type="text"/>
Port	5060
Register Expires	180
Outgoing Caller ID	<input type="text"/>
Registration	Yes
Support E.164	No
Support DID	No

IP Trunk 2

Phone Number	<input type="text"/>
Auth ID	<input type="text"/>
Auth Password	<input type="password"/>
SIP Proxy	<input type="text"/>
Port	5060
Outbound Proxy	<input type="text"/>
Port	5060
Register Server	<input type="text"/>
Port	5060
Outbound Registrar	<input type="text"/>
Port	5060
Register Expires	180
Outgoing Caller ID	<input type="text"/>
Registration	Yes
Support E.164	No
Support DID	No

IP Trunk 8

Phone Number	<input type="text"/>
Auth ID	<input type="text"/>
Auth Password	<input type="password"/>
SIP Proxy	<input type="text"/>
Port	5060
Outbound Proxy	<input type="text"/>
Port	5060
Register Server	<input type="text"/>
Port	5060
Outbound Registrar	<input type="text"/>
Port	5060
Register Expires	180
Outgoing Caller ID	<input type="text"/>
Registration	Yes
Support E.164	No
Support DID	No

Local SIP Port for IP Trunk: (1024 - 65535)

Local RTP Port for IP Trunk:

End Dial

Support End Dial on #

Interdigit Timeout

Interdigit Timeout sec

Pause Time

Pause Time sec

Session Timeout

Session Timeout min (0, 10-60)

RPort

Enable RPort

The settings will be provided by the SIP IP Trunk Provider; please contact them to check on any adjustments that may be needed.

- Phone number - The assigned phone number which will be provided by the SIP IP Trunk provider. Generally, this will resemble a standard telephone number, but in some cases there may be a series of numbers plus the actual telephone number.
- Auth ID - Authentication ID - The SIP IP Trunk provider will provide the Authentication ID. Depending on the provider, the Auth ID may be an account number, telephone number or reference number.
- Auth Password - Authentication Password - The SIP IP Trunk provider will provide the Authentication Password. Depending on the provider, the Auth Password may be an account number, telephone number or reference number.



A **Proxy Server** is a “go-between” that makes requests on behalf of other clients. Its primary roll is to route packets the fastest way possible and enforce routing policies, even if it has to rewrite specific parts of the request before forwarding the packet.

A **Register Server** sends a Registrar Server requests so that it will place vital information in a location for the Domain Server. Some SIP IP Trunk providers require that a Registrar Server be reference in order to keep the connection working correctly.

An **Outbound Proxy** is often used as a central location for security verification before connecting two devices. This is commonly used as an additional layer of security.

- SIP Proxy - The SIP IP Trunk Provider will provide the SIP Proxy. The SIP Proxy can be either a class A or B IP Address, or must likely will be a specific Uniform (Universal) Resource Locator (URL) Address.
- SIP Proxy Port - 5060 is one of the “Well Known Ports” that is used for the transmission of both TCP or UDP SIP Packets. Some providers may require this to be changed, but most will not.
- Outbound Proxy - The SIP IP Trunk Provider will provide the Outbound Proxy. The Outbound Proxy's Address can be either a class A or B IP Address, or must likely will be a specific Uniform (Universal) Resource Locator (URL) Address.
- Outbound Proxy Port - 5060 is one of the “Well Known Ports” that is used for the transmission of both TCP or UDP SIP Packets. Some providers may require this to be changed, but most will not.
- Register Server - The SIP IP Trunk Provider will provide the Registrar Server. The Registrar Server's address can be either a class A or B IP Address, or must likely will be a specific Uniform (Universal) Resource Locator (URL) Address.
- Register Proxy Port - 5060 is one of the “Well Known Ports” that is used for the transmission of both TCP or UDP SIP Packets. Some providers may require this to be changed, but most will not.
- Register Expires - If “Register Status” is set to “On” this timer will be referenced and it is how often the **X-50** will send a signal to the Registrar Server in order to keep the information current. If there is no reply within the programmed time, at default 60 seconds, the connection is terminated.
- Outgoing Caller ID - This is the caller ID that will be sent when making an outbound call on the programmed SIP trunk.
- Registration - If set to no, the IP trunk will not send register to the register proxy.

- Register Status - When Set to "On" the Register Expires will be referenced, otherwise it will not be referenced. The SIP IP Trunk provider will provide the proper settings for this parameter.
- Support E.164 - This protocol was defined by ITU-T, to standardize international telecommunications numbering plan, used over the Public Switched Telephone Network (PSTN). For proper dialing formats, some SIP IP Trunk Providers may require this to be enabled. At default, it is disabled.
- Support Direct Inward Dial (DID) - When set to "Yes" the IP Trunk can be used in DID operation. See Direct Inward Dial on [page 176](#)

Local Port

- Local SIP Port for IP Trunk - Enter the port supplied by the SIP trunk provider.
- Local RTP Port for IP Trunk - Enter the Real-Time Protocol supplied by the SIP trunk provider.
- Support End Dial on # - When set to "Yes" the call will be sent out immediately after pressing the # key.
- Interdigit Timeout - At the expiration of this timer the call will be sent, even if the user is not done dialing.
- Pause Time - This is the amount of time that will be placed into a dialed number when a "P" is entered into the number.
- Session Timeout - This is the amount of communications time for the IP trunk. An entry of Zero means that there is no restriction.
- RPort - When enabled, the client is behind Network Address Translation (NAT), the Rport will allow SIP proxy to append the public IP address the NAT port, and transfer the SIP message to the correct location.

Direct Inward Dial

One feature that some SIP Trunk providers offer is the ability to use Direct Inward Dial (DID) numbers. DID numbers are published direct telephone numbers that rings to a specific user's extension, bypassing the attendant and auto attendant. DID's were once saved for large companies who could buy hundreds of sequential telephone numbers, which were assigned to specific employees. SIP Trunk providers allow smaller companies to purchase a limited set of these numbers, such as ten DID's, 2200 to 2210. However, not all SIP trunk providers offer the DID feature so it is important to check before signing any contracts. SIP Trunks with DID assignments are not affected by the Answer Position (See [page 179](#)) assignments.

X-50 Configuration

DID Table

No.	DID Number	Destination	Outgoing Call ID	Display Name	Trunk
1					Group 2 ▾
2					Group 2 ▾
3					Group 2 ▾
4					Group 2 ▾
5					Group 2 ▾
45					Group 2 ▾
46					Group 2 ▾
47					Group 2 ▾
48					Group 2 ▾
49					Group 2 ▾
50					Group 2 ▾

Save Settings Cancel Changes

The function of this table is to enter the incoming 10 digit telephone number and assign it to a specific telephone extension.

- **DID Number** - This is the published, direct telephone number that will be dialed to reach the user.
- **Destination** - also known as the Extension Number - This is the extension number that will ring when the DID number is received into the system.
- **Outgoing Call ID** - This is the telephone that will be sent by the SIP provider when making a call from the programmed destination.
- **Display Name** - This is the name that will be displayed when the DID Trunk rings the Extension.
- **Trunk - Group** - Use the dropdown menu when assigning a DID Trunk to a Trunk Group. The SIP Trunk must be marked as "DID Yes".

Trunk Groups

The **X-50** VoIP Telephone System has four (4) Trunk Groups, each that support one or more trunks. Trunk Groups are used to group trunks that are used in similar ways, such as local and long distance trunks. At default, all of the “PSTN” Trunks are in group 1, and SIP Trunks are in group 2.



X-50 Configuration

- Device Info
- Advanced Setup
- Wireless
- Voice
 - Phone
 - Trunk
 - IP Trunk
 - Trunk DID
 - Trunk Group
 - Answering Position
 - Call Routing
 - Call Restriction
 - Emergency Numbers
 - System
 - Voicemail
 - STUN
 - Registered Phone
- Management
- Diagnostics
- Logout

Trunk Group & Label

Trunk Group assignment allows you to assign a physical Trunk to a virtual Trunk Group.

Trunk Line	Group Assign	Enable Label	Label Name	Ring Type
PSTN Line 1	Group 1	Disable		0
PSTN Line 2	Group 1	Disable		0
PSTN Line 3	Group 1	Disable		0
PSTN Line 4	Group 1	Disable		0
PSTN Line 5	Group 1	Disable		0
PSTN Line 6	Group 1	Disable		0
IP Line 1	Group 2	Disable		0
IP Line 2	Group 2	Disable		0
IP Line 3	Group 2	Disable		0
IP Line 4	Group 2	Disable		0
IP Line 5	Group 2	Disable		0
IP Line 6	Group 2	Disable		0
IP Line 7	Group 2	Disable		0
IP Line 8	Group 2	Disable		0

Trunk Group Priority

Trunk group Priority allows you to define the four trunk groups' call priority.

Group 1: Access Priority	IP First	Search Order	Increasing
Group 2: Access Priority	IP First	Search Order	Increasing
Group 3: Access Priority	IP First	Search Order	Increasing
Group 4: Access Priority	IP First	Search Order	Increasing

- Group Assign - Each trunk is a member of one of the four (4) trunk groups, which are grouped in terms of dialing or calling privilege, such as Local and long distance lines.

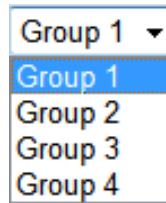

- Enable Label - Each trunk can be assigned a "Label Name", which is either displayed (Enabled) or not displayed (disabled). At default, all Label Name is disabled.

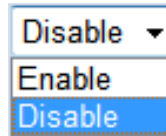

- Label Name - Each trunk within the group can be labeled, if enabled, when accessed.
- Ring Type - Each group can select one of 10 different ring types.

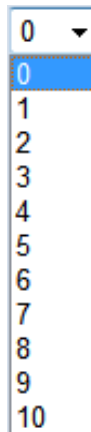

Trunk Group Priority

This feature allows the administrator to select the order that trunks will be accessed when making an outbound call.

- Access Priority - Select which type of trunk to be accessed first when making a call - IP Trunk first or PSTN first
- Search Order - Select which order, highest to lowest (decreasing) or lowest to highest (Increasing) the trunks will be accessed.

Answer Position

Answer position, also known as ring assignment, is where each trunk (PSTN and SIP) are programmed to ring during the Day and Night. The answer position can be set to an Extension, Auto Attendant, Operator or UCD Group. At default, all trunks are set to ring UCD group 430 (see Numbering Plan [page 187](#)) during the day, which rings all authenticated extensions and Auto Attendant at night.

Xblue networks X-50 Configuration

Answering Position

Answering Position allows you to configure an answering position for each Trunk line's incoming call including PSTN trunk and IP Trunk. You can choose Auto Attendant, Operator, UCD group or manually configure the target phone number on Day/Night basis.

Line Selection: PSTN Line 1

Day Answer Mode: UCD Group	Night Answer Mode: Auto Attendant
Day Number: 430	Night Number: 453

Buttons: Save Settings, Cancel Changes

- Line Selection - Select the trunk to be modified
- Select between the four (4) answering positions for day and for night

Day Answer Mode	<ul style="list-style-type: none"> Extension Auto Attendant Operator UCD Group
Night Answer Mode	<ul style="list-style-type: none"> Extension Auto Attendant Operator UCD Group

- - Extension - The extension setting can have one of the 25 extension (24 SIP and 1 SLT) set to ring when a call is placed into the system.
- - Auto Attendant - The **X-50** can be programmed to answer with an automated (receptionist) attendant, which can answer calls and allow them to dial their desired location. Each call is answered by a day or night outgoing message (OGM), which will play depending on the time of day and day of week.

- - Operator - In system programming, one extension can be programmed as the system operator. This is the extension that will ring when another extension dials zero "0".
- - UCD Group - Similar to hunt group, the UCD group can be programmed to ring all extensions at one time (All Ring), hunt for the extension that is onhook and idle the longest (Distributed), or hunt for the first extension that is idle within the group (Linear). When set to Linear, a no answer time, if enabled, will determine when to hunt to the next extension. See System - Numbering Plan (see [page 187](#)) to set up UCD Groups.

Call Routing Rules

Call Routing is used to automatically direct dialed numbers through a specific trunk, trunk group, or through another **X-50** system. The rule will only be followed if all aspects of the rule are “true”, otherwise it is ignored. Enter the information that will make up the rule and press “Add”.

Xblue networks **X-50 Configuration**

Call Routing Table Configuration

Call Routing allows you to configure the call routing table. Each item will be a routing rule for outgoing call. From/To define the number range, Min/Max define the match length, Del/Insert can change the target number, Destination to define the outbound call interface.

Add a new Call routing entry. A maximum 40 entries are allowed.

From:

To:

MinLength:

MaxLength:

Delete:

Insert:

Destination:

IGW Group:

No.	From	To	Min	Max	Del	Insert	Destination	IGW Group	Remove	Edit	Change Order
1	0	#	1	99	0		Group 1		<input type="checkbox"/>	<input type="button" value="Edit"/>	<input type="button" value="Up"/> <input type="button" value="Down"/>

- From - This is the lowest digit or digits that will be affected by this Call routing rule.
- To - This is the highest digit or digits that will be affected by this call routing rule.
- MinLength - the minimum number of digits to be used by this call routing rule.
- MAXLength - The maximum number of digits to be used by this routing rule.
- Delete - This is the number of digits that will be deleted when the rule is found to be true. For example, when rerouting a dialed number that was dialed for long distance to a local line, the first four (4) digits 1 + XXX should be deleted, so the number will be set to four (4).
- Insert - Enter the digits that should prefix, be dialed before the actual dialed digits. For example, in some cases, it is cheaper to pay long distance prices, rather than local long distance, so the call can be redirected over the long distance telephone lines by adding 1 + XXX.
- Destination - Select the line that will be used when the rule is found to be true. IGW is used when the system is part of an overall voice network.
- IGW Group - The IGW Group is activated when the destination is set to IGW Group. Use the drop down menu to select the system where callers should be sent when the entered digits are dialed.



For proper operation of Call Log - Dialed, Missed, and Received Calls, the home area code, and automatic long distance insert, must be programmed into the Call Routing Table.

Enter the home area code, where the system is located, such as 913 in the "From" and "To", then the maximum and minimum digits dialed will be 10, in both, then enter 3 digits to be deleted by the system before the number is dialed. Do not enter any digits into the "Delete" parameter if all 10 digits should be dialed. Therefore, when a number in the entered area code is dialed, the area code if there is an entry in the delete parameter, in the example, 913, will be delete. Tthe remaining 7 digits will be dialed.

The second entry will automatically enter a 1 for all other 10 digit numbers. Enter "From 2", "To 9", Min=10, Max=10, Insert=1, and "Group" default is 1. When any number that begins with 2 through 9, except 913, will receive a 1, when it is sent to the telephone line.

Kansas

No.	From	To	Min	Max	Del	Insert	Destination	IGW Group	Remove	Edit	Change Order
1	913	913	10	10	3		Group 1		<input type="checkbox"/>	Edit	Up Down
2	2	9	10	10	0	1	Group 1		<input type="checkbox"/>	Edit	Up Down
3	0	#	1	99	0		Group 1		<input type="checkbox"/>	Edit	Up Down

In Scottsdale Arizona, for example, any 10 digit number that is dialed with 480 as the first three digits, 480 will be deleted. Any 10 digit number that has 602 and 623 as an area code, all 10 digits will be dialed. All other 10 digit numbers regardless of area code will receive a 1 before sending the call to the telephone line.

Scottsdale, AZ

No.	From	To	Min	Max	Del	Insert	Destination	IGW Group	Remove	Edit	Change Order
1	480	480	10	10	3		Group 1		<input type="checkbox"/>	Edit	Up Down
2	602	602	10	10	0		Group 1		<input type="checkbox"/>	Edit	Up Down
3	623	623	10	10	0		Group 1		<input type="checkbox"/>	Edit	Up Down
4	2	9	10	10	0	1	Group 1		<input type="checkbox"/>	Edit	Up Down
5	0	#	1	99	0		Group 1		<input type="checkbox"/>	Edit	Up Down

Call Restriction Rules

The call restriction table allows the administrator to enter up to 13 digits that when dialed can be allowed or denied. The **X-50** system allows the administrator to select which tables' rules will be referenced first the allow or the deny table.

If the priority is set to "Denied" the system will use the following rule:

- If the dialed number matches an entry in the deny table, the call is denied. Otherwise, the call is sent to the allow table.
- If the dialed number matches an entry in the allow table, the call is allowed. Otherwise, the call is denied.

If the priority is set to "Allow" the system will use the following rule:

- If the dialed number matches an entry in the allow table, the call is allowed. Otherwise, the call is sent to the deny table.
- If the dialed number matches an entry in the deny table, the call is denied, otherwise the call is allowed.

If there are entries in only the allow table, calls will be processed using the following rule:

- Calls in the allow table will be allowed - all other calls will be denied.

If there are entries in only the deny table, calls will be processed using the following rule:

- Calls in the deny table will be denied - all other calls will be allowed.

Use the restriction rules to establish dialing privileges for the 7 classes of service.

X-50 Configuration

Call Restriction Table Configuration

Call Restriction allows you to configure the call restriction allowed table and denied table. A maximum 40 entries can be configured.

Add a new Call restriction entry. A maximum 40 entries are allowed.

From:

To:

Trunk Access:

COS:

Table Type:

Call Restriction Table -- Allowed

No.	From	To	Trunk Access	COS	Remove	Edit	Change Order
1	0	#	YN	7	<input type="checkbox"/>	<input type="button" value="Edit"/>	<input type="button" value="Up"/> <input type="button" value="Down"/>

Call Restriction Table -- Denied

No.	From	To	Trunk Access	COS	Remove	Edit	Change Order
-----	------	----	--------------	-----	--------	------	--------------

Priority:

- From - Enter up to 13 digits that will be used as the beginning of the evaluation number.
- To - Enter up to 13 digits that will be used as the ending of the evaluation number.
- Trunk Access (Yes/No) - This allows or deny's the call to have access to a Trunk, when the digits are dialed.
- COS - Class of Service - Select the Class of Service that will be applied to a call that matches the entry.

Routing Emergency Numbers

Xblue networks

X-50 Configuration

Emergency Numbers

This page allows you configure five emergency call numbers and lines with which emergency calls are sent out.

Number 1	911
Number 2	
Number 3	
Number 4	
Number 5	
Line Selection	PSTN First ▼

Save Settings Cancel Changes

- Each system can evaluate up to five different numbers. If a match is found, the call will be sent through the “Line Selection” parameter.
- Using the drop down menu, select which way the call should be directed when a match is found. Calls can be directed through the first PSTN line, First SIP Trunk or through an idle PSTN lines.

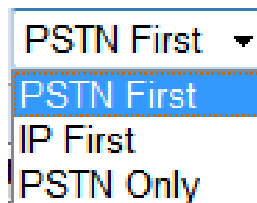

System

- Device Info
- Advanced Setup
- Wireless
- **Voice**
 - + Phone
 - + Trunk
 - + **System**
 - - **Numbering Plan**
 - - Service Mode
 - - Transmission
 - - IGW Group
 - - SMDR
 - - UCD Call Log
 - + Voicemail
 - - Registered Phone
- Management
- Diagnostics
- Logout

During the Setup Wizard, some of the default Numbering settings may have been changed. Therefore, this manual will show what the defaults are without any changes from the Setup Wizard.

Numbering Plan

X-50 Configuration

Numbering Plan

Numbering Plan allows you to configure the extension number range. You can define the special extension number or service number.

These settings will take effect after the system reboot.

Start Extension: 101 End Extension: 125 FXS Phone Number: 125

Start Extension	101	
End Extension	125	
FXS Phone Number	125	
Operator code	0	Configuration
Voicemail service number	453	
Start Virtual Extension Number	830	
Start PSTN Line number	700	
Start IP Trunk number	710	
Start Trunk Group number	80	
All Paging number	400	
All Paging Range	Both	
Start Paging Group number	401	Configuration
Start ICD Group number	430	Configuration
System Speed Dial	600	Configuration
Start Call Park number	731	

Save Settings Cancel Changes

- Start Extension - Enter the beginning extension number for the system.
- End Extension - Enter the ending extension number for the system. If the number does not fall between the start and end number, it is considered an invalid extension.
- FXS Phone Number - Enter the analog or single line number that will be dialed to ring the single telephone number. The number must be within the start and end extension numbers.
- Operator speed-dial number, at default is set to Zero (0) and can be directed to any extension within the numbering plan. At default the extension is set to 101 for both day and night, but can be changed by pressing the configuration button.

The operator extension can be set to any number within the numbering plan.

X-blue networks

X-50 Configuration

Operator Configuration

This page allows you to configure the operator-related settings

Operator day	<input type="text" value="101"/>
Operator night	<input type="text" value="101"/>
Alternate Operator day	<input type="text"/>
Alternate Operator night	<input type="text"/>
Reroute Time	<input type="text" value="0"/> (0, 15-180)

- The day and a night operator can be the same or different extension numbers. The entered extension number will be accessed when an extension dials zero (0).
- A day and a night alternate operator can also be assigned. They can be the same or different numbers. The Alternate operator will automatically begin ringing if the call goes unanswered by the operator extension.
- Reroute Time - is the amount of time that a call will ring at the operator extension before ringing the alternate extension. When set to unlimited, the call will not forward. The timer can be set from 15 to 180 seconds. If the alternate attendant does not answer the call, and this timer is greater than zero (0) the call will go to the operator mailbox.

Press "Save Settings" to save the programming and "Back" to return to the main Numbering Plan Programming page.

- Voicemail Service Number - Is the pilot number that will be dialed to ring one of the four voice mail ports.
- Start PSTN Line Number - The **X-50** has 6 PSTN lines, numbered 701, 701,702, 703, 704 and 705.
- Start IP Trunk Number - The **X-50** has 8 SIP Trunks, number 711, 712, 713, 714, 715, 716, 717 and 718.
- There are 4 trunk group numbers, 80, 81, 82 and 83, each can have one or more trunks, with a combination of PSTN and/or SIP Trunks.
- All Paging Group - Dial this code to page all extensions in the system.
- Range - LAN, WAN and/or Both (All extensions must be in the same subnet)

- Start Paging Group Number - The **X-50** has three paging groups, each with the ability to have up to 24 LAN, WAN or both extension types.

Enter up to 24 extensions in a group.

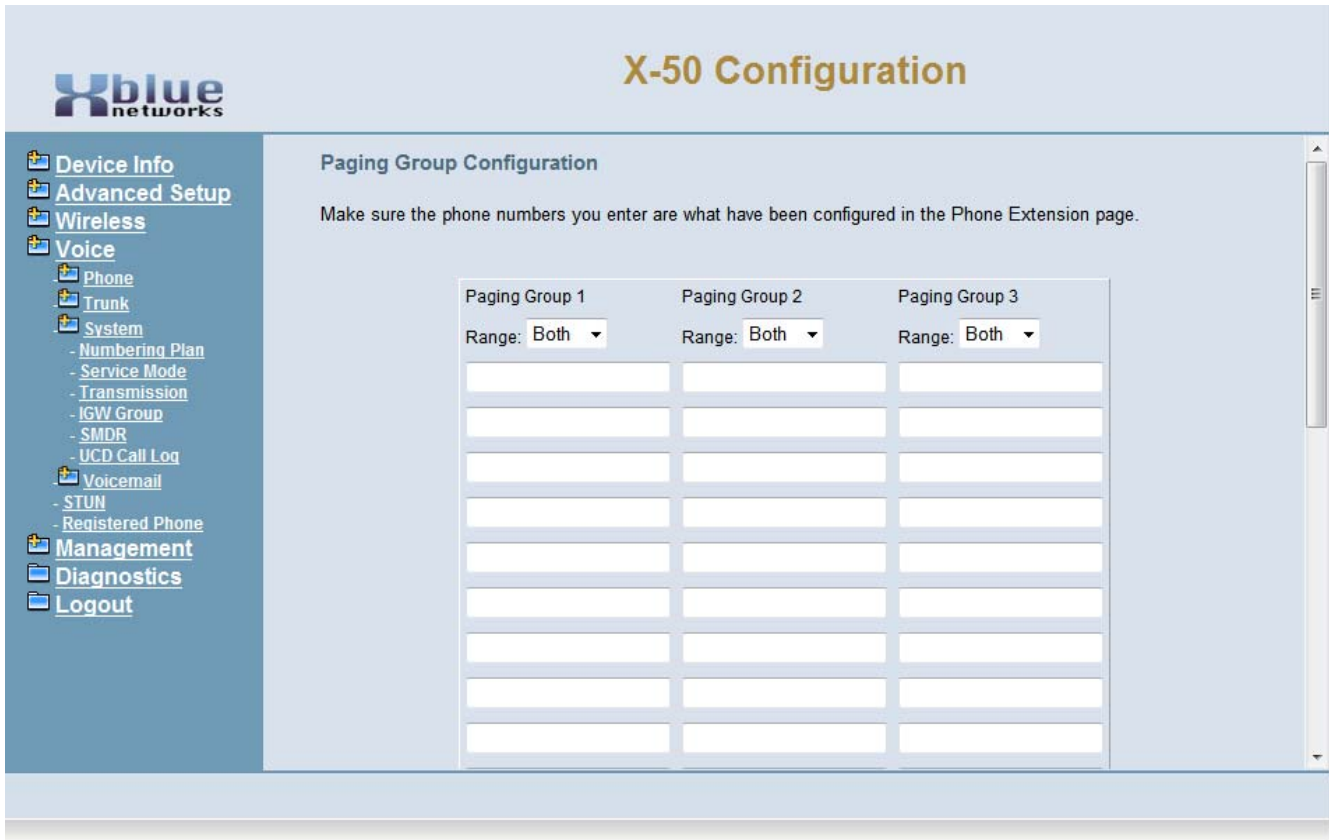

- Using the drop down menu, select LAN/WAN or Both (all extensions must be in the same subnet).
- Enter the up to 24 SIP telephone extension numbers -

Press “Save Settings” to save the programming and “Back” to return to the main Numbering Plan Programming page.

- UCD Group - Uniform Call Distribution Group also known as a Hunt or UCD group.



X-50 Configuration

- Device Info
- Advanced Setup
- Wireless
- Voice
 - Phone
 - Trunk
 - System
 - Numbering Plan
 - Service Mode
 - Transmission
 - IGW Group
 - SMDR
 - UCD Call Log
 - Voicemail
 - STUN
 - Registered Phone
- Management
- Diagnostics
- Logout

UCD Group Configuration

UCD Group Number	Ring Mode	No Answer Time	Timer Enable	Reroute Time	Reroute Destination Type	Destination	UCD Group Name
430	All Ring			20 seconds	AA Menu	453	
431	Linear	10 seconds	NO	20 seconds	AA Menu	453	
432	Distributed	10 seconds	NO	20 seconds	Voice Mail	453	
433	All Ring			20 seconds	AA Menu	453	

UCD Group 1 Extension	UCD Group 2 Extension	UCD Group 3 Extension	UCD Group 4 Extension
101	103	105	
102	104	106	

- The **X-50** has 4 UCD groups, each can be programmed as an All Ring (rings all extensions within the group), Linear (if a busy extension is found it will hunt to another group, but will not continue to hunt if the extension rings), or Distributed (rings the extension that is on-hook and idle the longest).
- No Answer Time - The no answer time becomes active when a group is defined as Linear or Distributive. The timer is adjustable between 10 and 120 seconds. This timer is not active when set to "All Ring".
- Timer Enable - The No Answer Timer (when set to either Linear or Distributive) the timer can be enabled or disabled.
- Reroute Time - At the expiration of the Reroute Time the call will be routed to the reroute destination. The timer is adjustable from 10 to 120 seconds.
- Reroute Destination - Calls can be rerouted to the main auto attendant, or to Voicemail.
- UCD Group Name - Each UCD group can be labeled with a different name.

- Speed Dial - The **X-50** has 100 system speed bins which can be accessed by all extensions within the system. Each programmed Speed Dial can be set to reference the extensions' class of service before dialing the number.

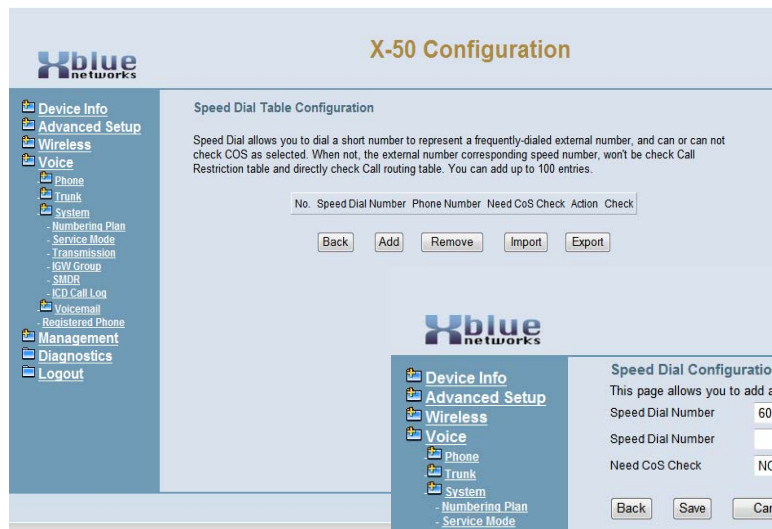

Press "Add" to add system (Global) speed dial numbers.

Press "Import" to import a list of up to 100 numbers from a "CSV" file.

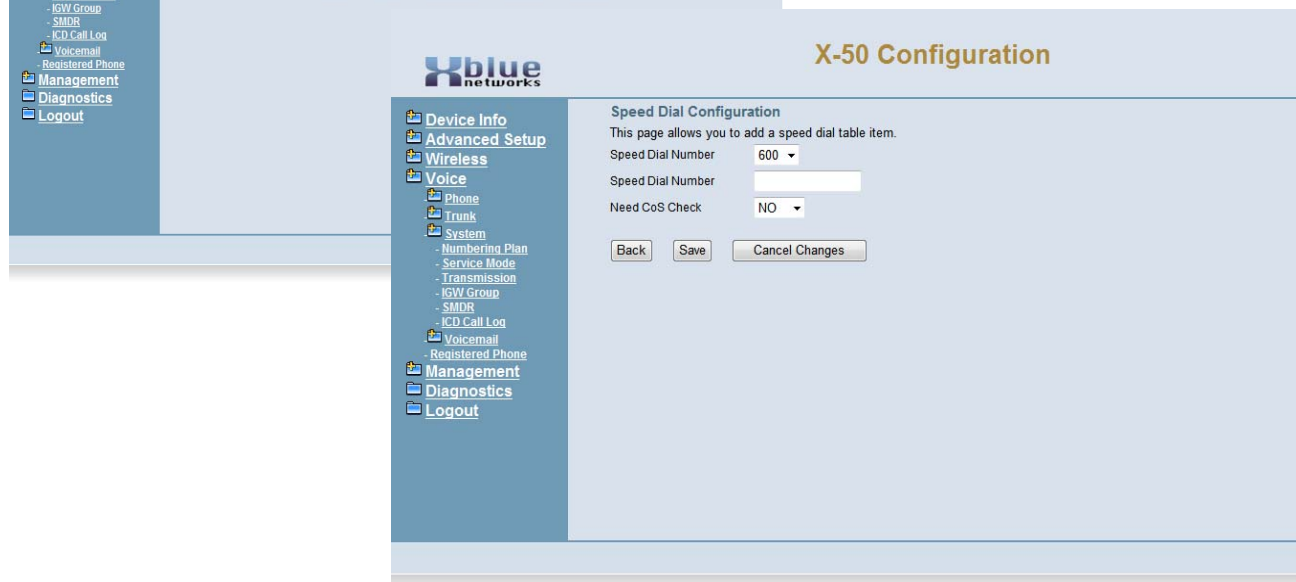

Press "Save Settings" to save the programming and "Back" to return to the main Numbering Plan Programming page.

- Start Call Park Number - The **X-50** system allows calls to be placed into a park or orbit location in the system allowing all extensions to have access to the call.

Service Mode

There are three service modes; Day (the system remains in day mode), Night (the system remains in night mode), or timed (the system automatically changes between day and night modes) based on the Service Mode Configuration. Enter the time in eight digit twenty-four hour format.

Week Day	Working Hours	Lunch Break
Sun	00000000	12001300
Mon	08001700	12001300
Tue	08001700	12001300
Wed	08001700	12001300
Thu	08001700	12001300
Fri	08001700	12001300
Sat	00000000	00000000

Buttons: Save Settings, Cancel Changes

- Define each day with a “Start” and an “End” time. A start time of 00:00 and an end time of 00:00 results in no change of status.
- The system can be placed into Day Mode

Service Mode Configuration

Service Mode configuration allows you to configure the day/night service mode. You can also customize the working time manually for each week day.

Time Day Night

Buttons: Save Settings, Cancel Changes

- The system can be placed into Night Mode

Service Mode Configuration

Service Mode configuration allows you to configure the day/night service mode. You can also customize the working time manually for each week day.

Time Day Night

Buttons: Save Settings, Cancel Changes

Transmission

The transmission area of programming is used to set the country that the unit will be installed and the signalling protocol that will be used. At default, the **X-50** is set to North America.



X-50 Configuration

- Device Info
- Advanced Setup
- Wireless
- Voice
- Phone
- Trunk
- System
 - Numbering Plan
 - Service Mode
 - Transmission
 - IGW Group
 - SMDR
 - UCD Call Log
- Voicemail
- STUN
- Registered Phone
- Management
- Diagnostics
- Logout

Audio

Country: NORTH AMERICA ▾

RTP Packet Size: 20 ▾ ms

Codec G.711 u-law: First ▾

Codec G.711 a-law: Second ▾

Codec G.726-40: Third ▾ Payload: 96

Codec G.726-32: Fourth ▾ Payload: 97

Codec G.726-24: Fifth ▾ Payload: 98

Codec G.726-16: Sixth ▾ Payload: 99

RFC2833 Payload: 101

DTMF Type: RFC2833 ▾

Hold Recall Time: 60 ▾ sec

FXS

Fax Support: G711_PASS ▾

Caller ID Method: FSK After Ring ▾

Interdigit Timeout: 5.0 ▾ sec

FXO

Call Abandon Time: 600 ▾ ms

Ring Recognition Time: 200 ▾ ms

Delay Ring Time: 3.0 ▾ sec

Dial Wait Time: 1 ▾ sec

Interdigit Timeout: 5.0 ▾ sec

Flash Time: 700 ▾ ms

Flash New Call: Disable ▾

FXO to FXO Call Duration: 5 ▾ min

DTMF Signal On Duration: 100 ▾ ms

DTMF Signal Off Duration: 100 ▾ ms

Pause Time: 1.5 ▾ sec

Ring Abandon Time: 6.0 ▾ sec

Release Guard Time: 1.0 ▾ sec

Audio

- Country - North America, UK, Japan, Sweden, Germany, France, Belgium, Finland, Italy, Netherlands, China, Spain
- RTP Packet Size - (Real-time Transport Protocol) defines a standardized packet format for delivering audio and video over IP networks. The default is set to 20, and is adjustable from 10 to 60 milliseconds.
- Codec settings - Set the order that each Codec will be used. When the system gets busier, it will automatically increase the compression, to decrease the traffic (voice over IP packets), to ensure that all of the calls can be completed with the best possible voice quality.

Codec	Priority	Payload	Compression
G.711 u-law	First		Low
G.711 a-law	Second		Low
G.726-40	Third	96	Low - Medium
G.726-32	Forth	97	Medium
G.726-24	Fifth	98	Medium High
G.726-16	Sixth	99	High
RFC 2833	G.729 audio data compression 10 ms duration		

- DTMF Type - Select between transmitting DTMF tone or SIP-INFO method. Generally, this will be set to DTMF Type.
- Hold Recall Time - The recall feature pertains to calls that are parked, on hold, or calls that have been transferred to another extension. Calls which go unanswered after the preprogrammed time are "Recalled" to the extension which initiated the park, hold or transfer. This timer is used to ensure that calls do not go unattended. At default, the timer is set to 60 seconds, and can be adjusted to 30, 60, 90, 120, 150, 180, 210, 240, 270, 300.

FXS (Single Line Telephone)

- FAX Support - (also known as Fax Detection) can be set to either G711_Pass (passes the signal directly through the system) or T38 allows fax transmission, in real time, over an IP Network.
- Caller ID Method - Caller ID, in the US, is a FSK signal that is passed between the first and second ring. However, the **X-50** has the ability to compensate for other types of Caller ID Protocol - FSK before ring, FSK after ring, DTMF before ring, DTMF after ring.
- Interdigit Timeout - At default the **X-50** is set to 5 seconds, and adjustable from 2 to 9 seconds.

FXO (Telephone (Trunk) Line)

- Call Abandon Time - This is the timer that the system uses to verify the At default the call abandon timer is set to 600 ms, and is adjustable from - Disabled, and 100 to 1000 ms. Changing this may cause erratic operation.
- Ring Recognition Time - This timer determines the minimum ring signal detection time for all analog telephone lines. Changing this may cause erratic operation.
- Delay Ring Time - This timer determines the amount of time that the system will wait before the system begins audibly ringing. Changing this may cause erratic operation.
- Dial Wait Time - This parameter is to compensate for older telephone line providers, which are slow to process the first digit dialed. Changing this parameter may cause erratic operation.
- Interdigit Timeout - This timer is the amount of time that will be allowed to pass between digits dialed.
- Flash Time - This timer determines the flash timing that will be sent to the telephone line provider when the user presses the hook-switch.
- Flash New Call - Enable/Disable - This allows the administrator to grant or deny system users the ability to flash the telephone line to "renew" dial tone and allow the caller to start dialing. Disabling this feature will disable call waiting.
- FXO to FXO Call Duration - This time establishes the amount of time two telephone lines can be conferenced together before the call is disconnected. The default is 5 minutes, and is adjustable from 1 to 15 minutes plus unlimited. Note: It is not advised or recommended to set this timer to "unlimited".
- DTMF Signal on Duration - This is the amount of time that the DTMF tone will audibly play.
- DTMF Signal off Duration - This is the amount of time that will pass between between audible tones.
- Pause Time - The pause timer, which appears as a "P" is the amount of time that will pass between dialing functions.
- Ring Abandon Time - This timer gives the system the ability to match a telephone line provider's disconnect timer.
- Release Guard Time - This timer is a noise sensitivity adjustment timer used to eliminate false disconnects. At default it is set to 1.0 and can be set from 1.0, 1.5, 2.0, 2.5, 3.0. Increase this timer to ignore noise on the telephone lines to avoid erroneous disconnects.

Internet Gateway Group - Voice Network

XBLUE networks

X-50 Configuration

IGW Group List

IGW Name	IP Address	SIP Port	COS	Valid	Action	Remove
						<input type="button" value="Remove"/>

IGW Group Configuration

IGW Name:

IGW Password:

Run Mode:

This parameter is used when connecting multiple systems creating to create a voice Network or Campus Environment. The **X-50** can be part of a 10 system voice network. One system is a "Master System" and requires a static IP Address the remaining 9 are "Slave" systems do not require static IP addresses.

- Gateway Name - Enter the name of the gateway.
- Enter the Gateway Password
- Select if the system will be a master or slave system.

Voice Network

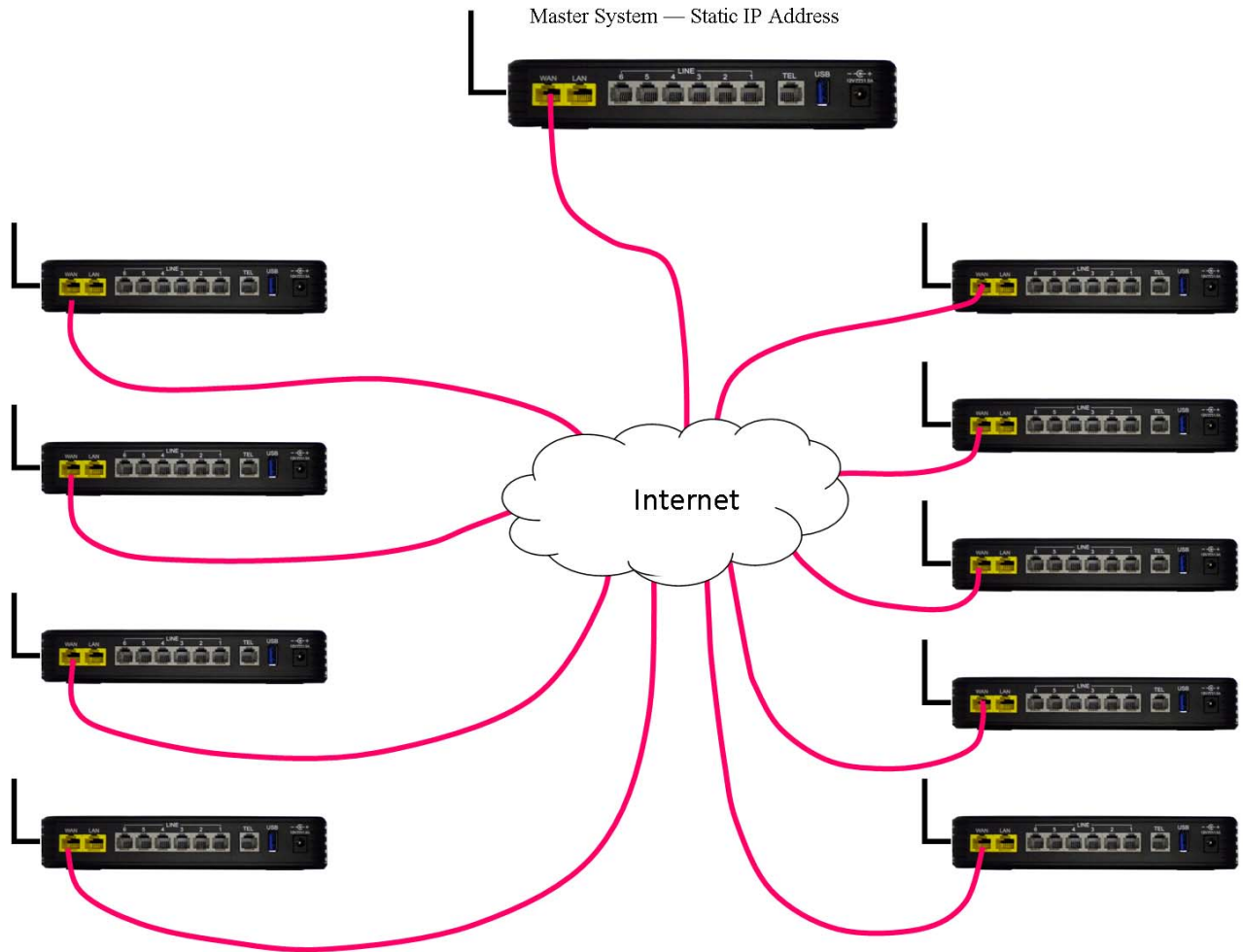

Station Message Detail Recording (SMDR)

The screenshot shows the X-50 Configuration web interface. At the top left is the 'blue networks' logo. The main title is 'X-50 Configuration'. On the left is a navigation menu with categories: Device Info, Advanced Setup, Wireless, Voice, Phone, Trunk, System (with sub-items: Numbering Plan, Service Mode, Transmission, IGW Group, SMDR, UCD Call Log), Voicemail (with sub-items: STUN, Registered Phone), Management, Diagnostics, and Logout. The main content area is titled 'SMDR' and contains the text: 'SMDR allows to view the SMDR record and configure the SMDR. Click View SMDR to view the SMDR record, and click Configure SMDR to configure the SMDR.' Below this text are two buttons: 'View SMDR' and 'Configure SMDR'.

The **X-50** system has the ability to record call statistics for incoming, outgoing, or both types of calls. Select View to review the list or configure, to configure how SMDR will be recorded in the system.

SMDR Configuration

The screenshot shows the 'X-50 Configuration' page for SMDR Configuration. The interface includes a navigation menu on the left with categories like Device Info, Advanced Setup, Wireless, Voice, and Management. The main content area is titled 'SMDR Configuration' and contains the following settings:

- SMDR Configuration**: The PSTN Outgoing Call Duration Start Time is used to estimate whether the PSTN outgoing call has connected, and if its duration is less than it, the call won't be recorded. If log mode is configured, the specified SMDR record will be sent to local or/and remote Syslog.
- PSTN Outgoing Call Duration Start Time:** 0 s
- Log Mode:** local
- Local Type:** both

At the bottom of the configuration area, there are three buttons: 'Back', 'Save Settings', and 'Cancel Changes'.

- Start Time - A New SMDR record will be created after a call has been active for the entered time.
- Log Mode - Select between, local, remote, both to create a new SMDR record or enter None to disable SMDR.

SMDR View

X-50 Configuration

SMDR Record

SMDR allows you to query the call record as you request.

Extension Type Trunk Month

Type	Ext.	Trunk	Outside	Date	Time	Duration
Incoming	AA2	pstn1	4313261324	12-11-2010	16:00:37	31
Incoming	AA4	pstn1	4139653704	12-10-2010	17:43:29	58
Incoming	AA4	pstn1	4579653713	12-10-2010	17:42:42	47
Incoming	101	pstn1	6038353209	12-10-2010	16:42:53	34
Incoming	101	pstn1	6913438460	12-10-2010	16:28:47	146
Incoming	103	pstn1	6029413460	12-10-2010	16:25:08	219
Incoming	101	pstn2	5139871909	12-10-2010	16:26:16	23
Incoming	101	pstn1	6093439460	12-10-2010	16:24:50	18
Incoming	101	pstn1	2498191913	12-10-2010	16:06:06	41
Incoming	104	pstn1	9198299219	12-10-2010	15:30:19	26
Incoming	101	pstn1	9938299213	12-10-2010	15:29:34	45
Outgoing	103	pstn4	12983193898	12-10-2010	15:06:23	816

- Extension - Select to report on all extensions or none of them.
- Type - Select to report on an Incoming or Outgoing call or Both.
- Trunk - Select to report on Just SIP Trunks, PSTN telephone lines or both
- Month - Report on all months (View only)

UCD Call Log

Uniform Call Distribution Group Report

The screenshot shows the X-50 Configuration web interface. On the left is a navigation menu with categories: Device Info, Advanced Setup, Wireless, Voice, Management, Diagnostics, and Logout. Under the Voice category, there are sub-items: Phone, Trunk, System, Numbering Plan, Service Mode, Transmission, IGW Group, SMDR, UCD Call Log, Voicemail, STUN, and Registered Phone. The main content area is titled "X-50 Configuration" and "Incoming Call Log for UCD". Below the title, it says "Incoming Call Log for UCD show the incoming missed call record for UCD group." There is a table header with columns: Caller ID Name, Caller ID Number, UCD Group, Date, and Time. The table body is currently empty.

UCD Call Log

9

The UCD Group, often called Unified Call Distribution or UCD, allows callers to ring into a group of "Agents", which can be internal or external (Remote Worker). This log shows any calls that were unanswered.

Voicemail

- Device Info
- Advanced Setup
- Wireless
- **Voice**
 - + Phone
 - + Trunk
 - + System
 - **+ Voicemail**
 - - General
 - - Extension
 - - Holiday
 - - Advanced
 - - Registered Phone
- Management
- Diagnostics
- Logout

The **X-50** system comes complete with an integrated Auto Attendant (Automated or Virtual Receptionist) and Voicemail system. The system can be programmed to answer with the Automated Attendant, bypassing the traditional attendant, allowing callers to dial digits and route their call to the appropriate destination. Each extension in the system can be assigned a mailbox so that they may receive private messages. In addition, the system can be programmed to E-mail a standard "WAV" file of the voicemail message.

Auto Attendant

Voicemail General Settings

The screenshot displays the 'X-50 Configuration' web interface for Xblue Networks. The left sidebar contains a navigation menu with categories: Device Info, Advanced Setup, Wireless, Voice (with sub-items: Phone, Trunk, System, Voicemail, General, Phone Extension, Virtual Extension, Update MOH File, Holiday, Advanced, STUN, Registered Phone), Management, Diagnostics, and Logout. The main content area is divided into two sections: 'Auto Attendant' and 'Voice Mail'.

Auto Attendant Settings:

- Admin Password: 6 digits (masked with dots)
- MAX Try Time: 3 (range 1-9)
- Action When Max Error Reached: Forward to Operator (dropdown)
- Prompt Language: Language 1 Only (dropdown)
- VAA Codec: PCMU (dropdown)
- RTP Packet Size: 20 ms (dropdown)
- DISA: Disable (dropdown)
- Dial by Name Code: 5
- Single Digit Table: Configuration (button)
- Greeting Mode: Working (dropdown)

Voice Mail Settings:

- Email Notify with Voice Files: Yes (dropdown)
- Days for Keeping Voice Mail: 30 (range 0-30)
- SMTP Support SSL: Yes (dropdown)
- SMTP Server: smtpout.secureserver.net
- SMTP Server Port: 465
- Sender Email Address: voicemail@xbluenetwor
- Sender User Name: voicemail@xbluenetwor
- Sender Password: (masked with dots)
- Max recording time: 5 min (dropdown)
- Silence detection for VM recording: Enable (dropdown)
- Voicemail Tag: (empty text field)
- Email Header: You have a new voicem
- Housekeeping Time: Configuration (button)

At the bottom of the configuration area, there are two buttons: 'Save Settings' and 'Cancel Changes'.

- Admin Password - At default, the **X-50** systems' password is 000000. Highlight the password and then enter a new 6 digit (000000 - 999999) password. This password will also be used when accessing the administrator mailbox to record system outgoing message (OGM).
- MAX Try Time - Enter the number of times between 1 and 9 that a caller can enter wrong information before being sent to the Action When Max Error Reached.
- Action When MAX Error Reached - There are two destinations; forward to operator or disconnect.
- Prompt Language - The system is equipped with two languages, english and Chinese.

- VVA Code - The default is set to PCMU, the United States uses the PCMU codec, other countries use PCMA codec.
- RTP Packet Size - At default this is set to 20 ms, and is adjustable from "Dynamic, 10 - 60", but should remain set to 20 unless otherwise instructed.
- DISA - Direct Inward System Access - this feature, when enabled, allows inbound callers to enter a code and gain access to system features such as outbound calling. Note: Enabling this feature may result in unexpected long distance charges, which are the sole responsibility of the owner/user of the equipment.
- Dial by Name Code - Enter the code that will be used by callers, when dialing a persons name, once they are answered by the automated attendant. Once this code is selected, it will automatically reserve the entered number on all 10 menus.

Single Digit Dialing Table

The **X-50** system is equipped with ten (10) Single Digit Dial Menus that allows the administrator to program menu trees which are a series of choices that a caller can dial to process their call more efficiently. For example, a main greeting may instruct the caller to dial 1 for sales, which accesses menu 2. Then the caller is instructed to dial 1 for Northeast Sales, 2 for Central Eastern Sales, Southeast Sales, etc.

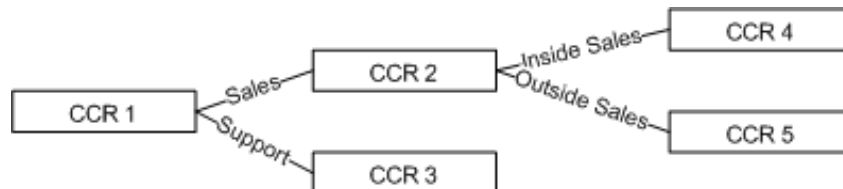
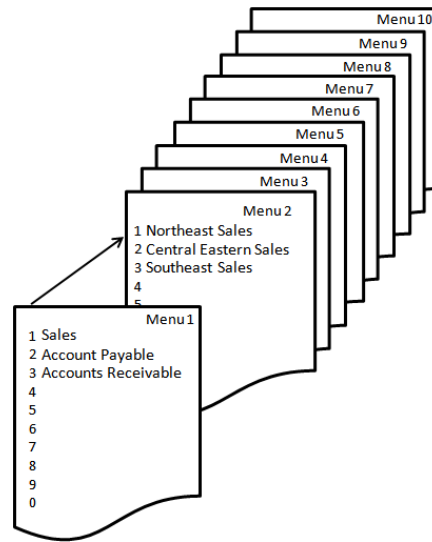

Click on the Single Digit Dialing table button to program the digits that callers will be instructed to dial.

- Using the dropdown box select the AA Menu to be programmed.
- Using the dropdown box select the destination for each number.
- Null - No action will be taken and the call will be prompted “You have pressed an invalid Digit”.
- UCD - Enter the UCD number, which at default is 430, 431, 432 or 433 that will ring when the digit is pressed.
- Extension - Enter the extension number that will ring when the digit is pressed.
- AA Menu - Enter the voicemail dial code, which at default is 450, plus the Menu number 0 - 9.

TABLE 9.1 Enter 45 + N

45 + N	Menu Number	45 + N	Menu Number
0	Menu 1	5	Menu 6
1	Menu 2	6	Menu 7
2	Menu 3	7	Menu 8
3	Menu 4	8	Menu 9
4	Menu 5	9	Menu 10

Press the “Back” button to return to the “General” voicemail programming menu

- Greeting Mode - The system can be manually placed into Temporary or Holiday mode, or remain in working mode to allow the clock to automatically switch between Day, Night and Holiday modes.

Voicemail

- E-mail Notify with Voice Files - Also known as "E-mail Delivery" or "Unified Messaging". When a new voicemail message is left in an extension with e-mail delivery set to "Yes" a standard "WAV" file will be created and e-mailed to the entered e-mail address. This requires access to the network and an e-mail server or e-mail address.
- Days for keeping Voice Mail - This is the maximum number of days that any voice mail message will be kept on the system. At default it is set to 30 so, on the 31st day, messages from the first day will be automatically deleted.
- SMTP Support SSL - When set to "Yes" the voice mail will be required to authenticate with the e-mail server before it can send an e-mail message.
- SMTP Server - Enter the SMTP server that will be accessed when sending a e-mail of a new voice message.



If the SMTP server is unknown, locate a computer on the network and open their e-mail client. If using Outlook or Outlook express go to "Tools" and select "Account Settings". Click on the e-mail address and locate "Outgoing e-mail Server" and make a note of the address.

Also, to locate the SMTP Server Port - click on "More Settings" and then click on the "Advanced" Tab, and locate the "Outgoing SMTP" Port and make a note of the port. This will be needed the next step.

- SMTP Server Port - Enter the SMTP port that will be used when accessing the SMTP server. Some common ports are 25, 80, 465 and 995.
- Sender E-mail Address - Enter the e-mail address that will be used when sending a new voice mail message. If possible, a new e-mail address, which resembles "voicemail@yourcompany.com" can be created making the sender's voice mailbox consistent.
- Sender User Name - This is the name that is used to authenticate the sender before being able to send an e-mail using the entered SMTP server. This entry may resemble the sender e-mail address.
- Sender Password - This is the password that is used to authenticate the sender before being able to send an e-mail using the entered SMTP server.
- Max Recording Time - This is the maximum recording time for a voice mail message. Once this timer is reached the caller will be disconnected and the message will be sent. At default this timer is set to 1 minutes and is adjustable from 1 to 30 minutes.
- Silence Detection for VM recording - This allows the system to monitor new voice mail messages for silence. Once the silence time is reached, the voicemail will prompt the caller to enter a DTMF Digit to continue. If no DTMF tone is entered, the call will be disconnected.
- Voicemail Tag - The tag is what is shown when an E-mail arrives at its destination.
- E-mail Header - The header is the information that is shown on the "Subject" line of the E-mail.

House Keeping

The screenshot shows the 'X-50 Configuration' web interface. On the left is a navigation menu with the following items: Device Info, Advanced Setup, Wireless, Voice (expanded), Phone, Trunk, System, Voicemail (with sub-items: General, Phone Extension, Virtual Extension, Update MOH File, Holiday, Advanced, STUN, Registered Phone), Management, Diagnostics, and Logout. The main content area is titled 'Housekeeping Time' and contains the following text: 'This page allows you to configure the housekeeping time setting.' Below this is a 'Date:' field with radio buttons for Sun (checked), Mon, Tue, Wed, Thu, Fri, and Sat. The 'Time:' field consists of two dropdown menus showing '01' and '00' followed by 'HH:MM'. At the bottom right of the configuration area are two buttons: 'Back' and 'Apply/Save'.

- Select the time of day and day of week that the system should do maintenance, deleting old messages and doublechecking message waiting indication, etc.

Phone Extension

Each SIP telephone connected to the system has a corresponding voice mailbox, which can be customized. Click on the “Configuration” button to configure the voice mailbox.

The screenshot displays the X-50 Configuration web interface. The top section, titled "X-50 Configuration", shows a table of phone extensions with columns for No., Ext., First Name, Last Name, and Operation. Below the table are "Configure" buttons for each extension. An arrow points from the "Configure" button for extension 125 to a detailed "Extension Configuration" page for that extension. This page includes fields for Voice Mail (set to "Enable"), Password (4 digits), E-mail Address (Drew@company.com), Prompt Language (Language 1 Only), Distribution Lists (Configuration), and Email Message (Save as New). Buttons for "Back", "Save Settings", and "Cancel Changes" are at the bottom.

No.	Ext.	First Name	Last Name	Operation
1	125			Configure
2	101	Drew	Donaldson	Configure
3	102	Wayne	Buck	Configure

Extension Configuration
 This page allows you to configure voice mail settings for each extension.
Ext. 125 Configuration

Voice Mail: (4 digits)
 Password: (4 digits)
 E-mail Address:
 Prompt Language:
 Distribution Lists:
 Email Message:

- Voicemail - Enable/Disable - Disable the voice mailbox for any extension that should not have a voice mailbox.
- Password (4 Digit) - At default the voice mailbox password is set to 0000, and can be change to any 4 digit (0000 - 9999) number.
- E-mail Address - Enter the E-mail address for the user of this extension. SMTP Settings in “General Settings” must be programmed, or this will not work.
- Prompt Language - Select the language prompts to be used with this user.

Distribution Lists

Each extension has the ability to create three private distribution list, each with up to 10 members. This will allow the extension user to send a single voicemail message to multiple extension users at one time.

Distribution Lists

X-50 Configuration

Distribution Lists--Ext. 125
This page allows you to configuration voice messages distribution destination.

Distribution List 1	Distribution List 2	Distribution List 3

Back Save Settings Cancel Changes

- Enter the desired extension number into one or more distribution lists.

Virtual Extension

The **X-50** system can have up to 50 virtual or phantom extensions, which are users that do not have a physical telephone, but want to have a mailbox on the system. Once a virtual number is assigned it can be used as an answer position, DID Routing position, and the callers will be sent directly to the mailbox. In addition, each virtual number can be programmed to receive an e-mail each time a new message is received.

Xblue networks X-50 Configuration

Virtual Extension

Virtual Extension configuration allows you to configure voice mail settings for each virtual extension.

No.	Ext.	First Name	Last Name	Operation
1	831	Ronny	Gordon	<input type="button" value="Configure"/>
2				

Xblue networks X-50 Configuration

Extension Configuration

This page allows you to configure voice mail settings for each extension.

Ext. 830 Configuration

Voice Mail:

Password: 4 digits

E-mail Address:

Prompt Language:

Distribution Lists:

Email Message:

Leaving Messages:

- Enter the virtual extension number - must be within the numbering plan - and press save.
- Once the virtual extension is saved, the "Configure" button will be visible.
- Click on "Configure" to program voice mail message enable, password, e-mail delivery, language, Distribution list, email message, and leaving messages.

Update MOH File

Click on Browse to select a different Music on Hold file to play to callers on hold.

The screenshot shows the 'X-50 Configuration' web interface. On the left is a navigation menu with categories: Device Info, Advanced Setup, Wireless, Voice (with sub-items: Phone, Trunk, System, Voicemail, General, Phone Extension, Virtual Extension, Update MOH File, Holiday, Advanced, STUN, Registered Phone), Management, Diagnostics, and Logout. The main content area is titled 'Update MOH File' and contains the following text: 'This page allows you to upload the Music On Hold (MOH) file.' followed by a note: 'NOTE: The device do not allow "stereo" MOH format, please upload a MOH file with "mono" format.' Below this are two steps: 'Step 1: Click the "Browse" button to choose the MOH file.' and 'Step 2: Click the "Upload File" button to upload this file.' At the bottom of the main area, there is a text input field labeled 'MOH File:' followed by a 'Browse...' button and an 'Upload File' button.

Holiday Settings

This allows the administrator to preprogram up to 20 different dates to play a special holiday greeting. The holiday greeting will only play when the date matches the entry, after that date, the appropriate Day or Night greeting will begin playing automatically.

Holiday Settings Schedule

Xblue networks X-50 Configuration

Holiday Settings
Holiday Settings allows you to configure the holiday or special off-duty days.

No.	Date(MMDD)	Holiday
1	0101	Off duty ▾
2	0102	Off duty ▾
3	0103	Off duty ▾
4		On duty ▾
5		On duty ▾
6		On duty ▾
7		On duty ▾
8		On duty ▾
9		On duty ▾
10		On duty ▾

<< < > >>

Save Settings Cancel Changes

- Enter the month (MM) and day (DD) for each holiday. Enter each day that is considered a holiday separately. If the holiday lasts for two or more days enter each day individually. For example, if January 1, 2 and 3 were all holidays, each day will be entered individually.
- On/Off duty - Select on duty if the system should process the entered date or off duty to ignore the entry.

Advanced

Opens the **X-50** FTP site to view the voicemail files

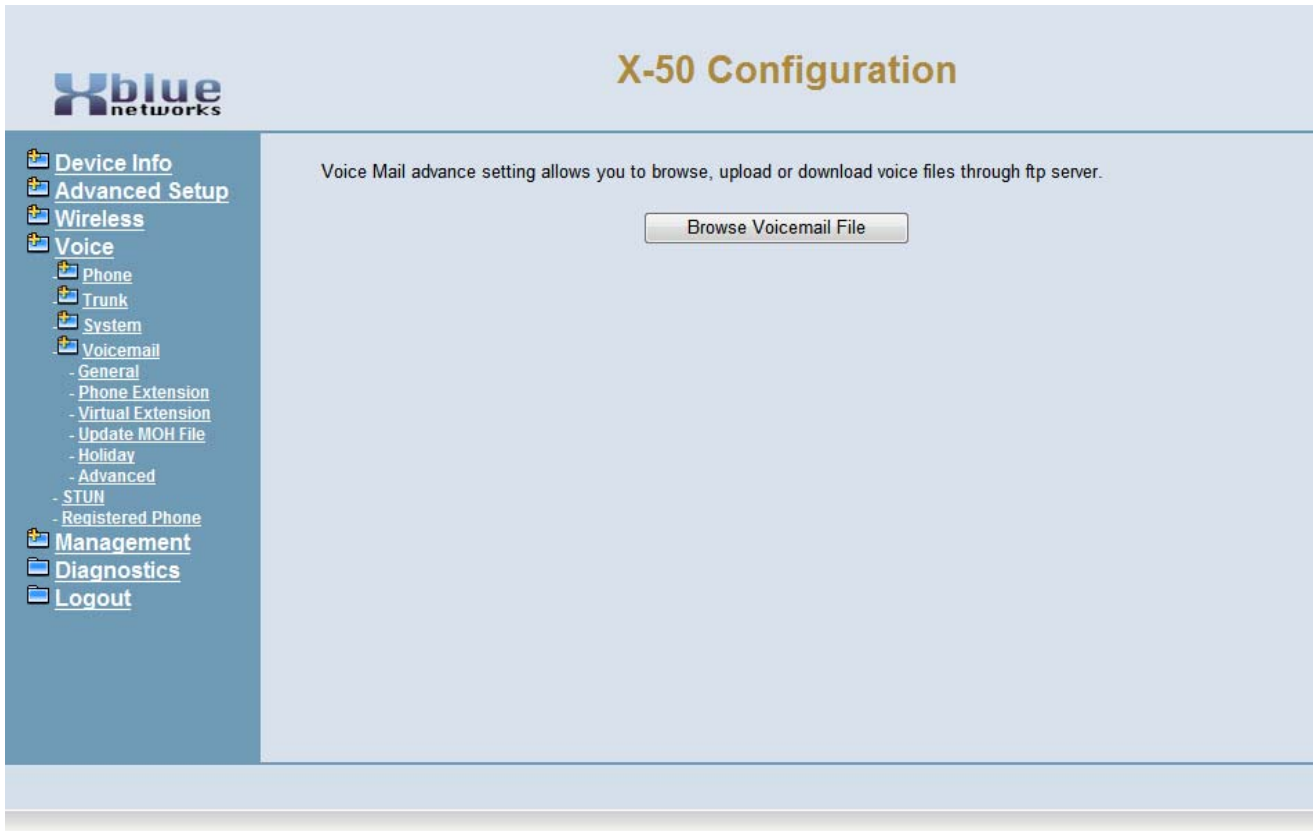

Xblue networks

X-50 Configuration

Voice Mail advance setting allows you to browse, upload or download voice files through ftp server.

[Browse Voicemail File](#)

Click on "Browse Voicemail File" to view the files.



WARNING - Any changes made in this page may result in erratic operation. DO NOT make changes unless instructed to do so by a qualified technical support representative.

STUN

Use STUN (Session Traversal Utilities for NAT) to support remote phones that are installed behind NAT or a firewall.

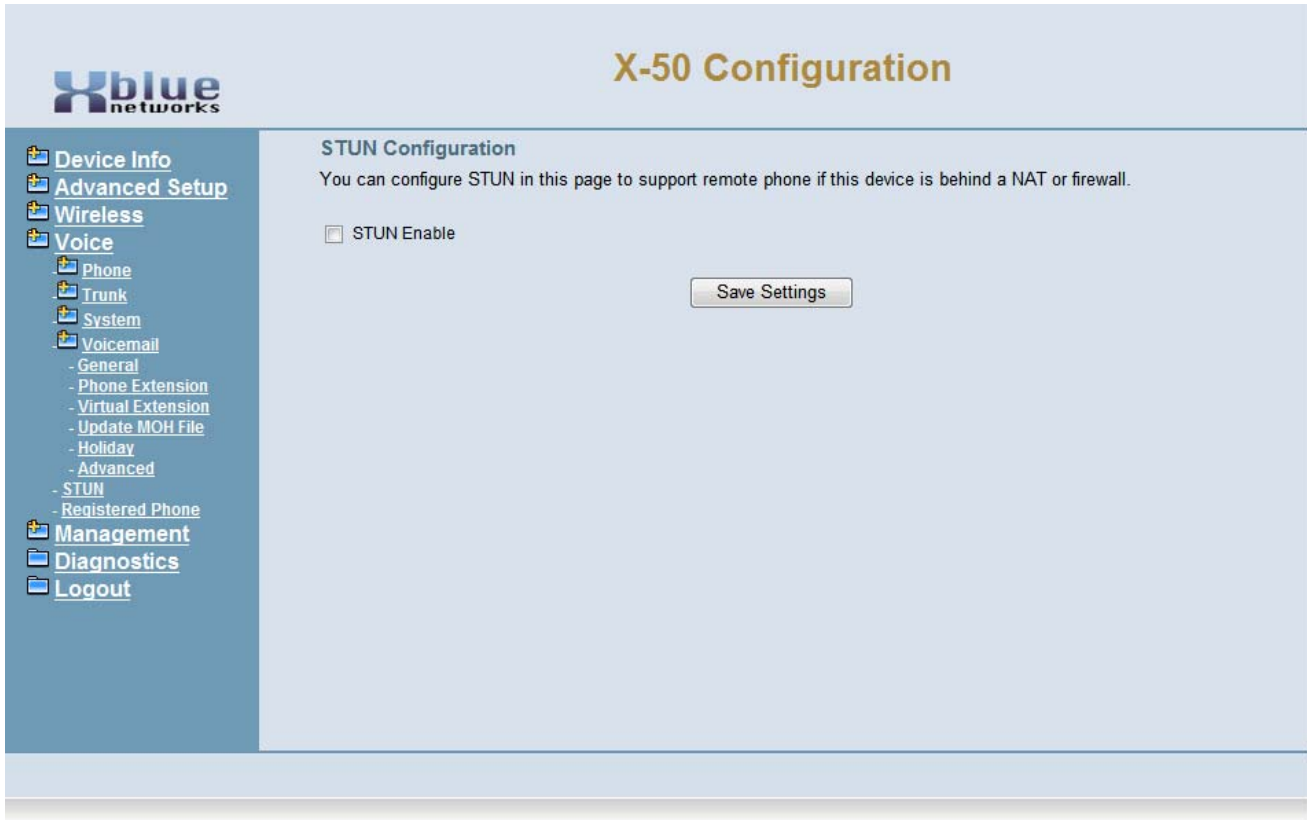

Registered Phones

Select registered phones to see which phones are currently connected to the system.

X-50 Configuration

Registered Phone

This page lists the information of registered phones, and provides the link to access the phone's web page.

Note: The "Link to Phone" may not work correctly with following cases:

- 1: The registered phone is a remote phone and is behind NAT.
- 2: The X-50 is behind NAT.

Phone	Model	Version	IP Address	From	Execution
101	X2020	V0.9.3.2	192.168.10.15	LAN	Link to Phone
102	X2020	V0.9.3.2	192.168.10.16	LAN	Link to Phone
103	X2020	V0.9.3.2	192.168.10.17	LAN	Link to Phone
104	X2020	V0.9.3.2	192.168.10.14	LAN	Link to Phone
105	X2020	V0.9.3.2	192.168.4.103	WAN	Link to Phone
106	X2020	V0.9.3.2	192.168.0.7	WAN	Link to Phone
107	IP2061	V0.9.3.2	192.168.1.103	WAN	Link to Phone

- Click on "Link to Phone" to make any adjustments to an individual telephone.

Note:

The "Link to Phone" feature was designed for connection within the same subnet and may not work when connecting through a firewall or NAT or WAN port.

Notes:

10 Management

Management

The Management Section of the system allows the administrator to perform special management functions.

- Device Info
- Advanced Setup
- Wireless
- Mobile Network
- Voice
- **Management**
 - + Settings
 - - System Log
 - - TR-069 Client
 - + Time Settings
 - + Access Control
 - - PTC
 - - Update Software
 - - Reboot
- Diagnostics
- Logout

Settings

- Device Info
- Advanced Setup
- Wireless
- Mobile Network
- Voice
- **Management**
 - + **Settings**
 - - **Backup**
 - - **Update**
 - - Restore Default
 - - System Log
 - - TR-069 Client
 - + Time Settings
 - + Access Control
 - - PTC
 - - Update Software
 - - Reboot
- Diagnostics
- Logout

Settings

The settings area allows the administrator to create a backup, update the system, and restore the system to factory default.

Backup

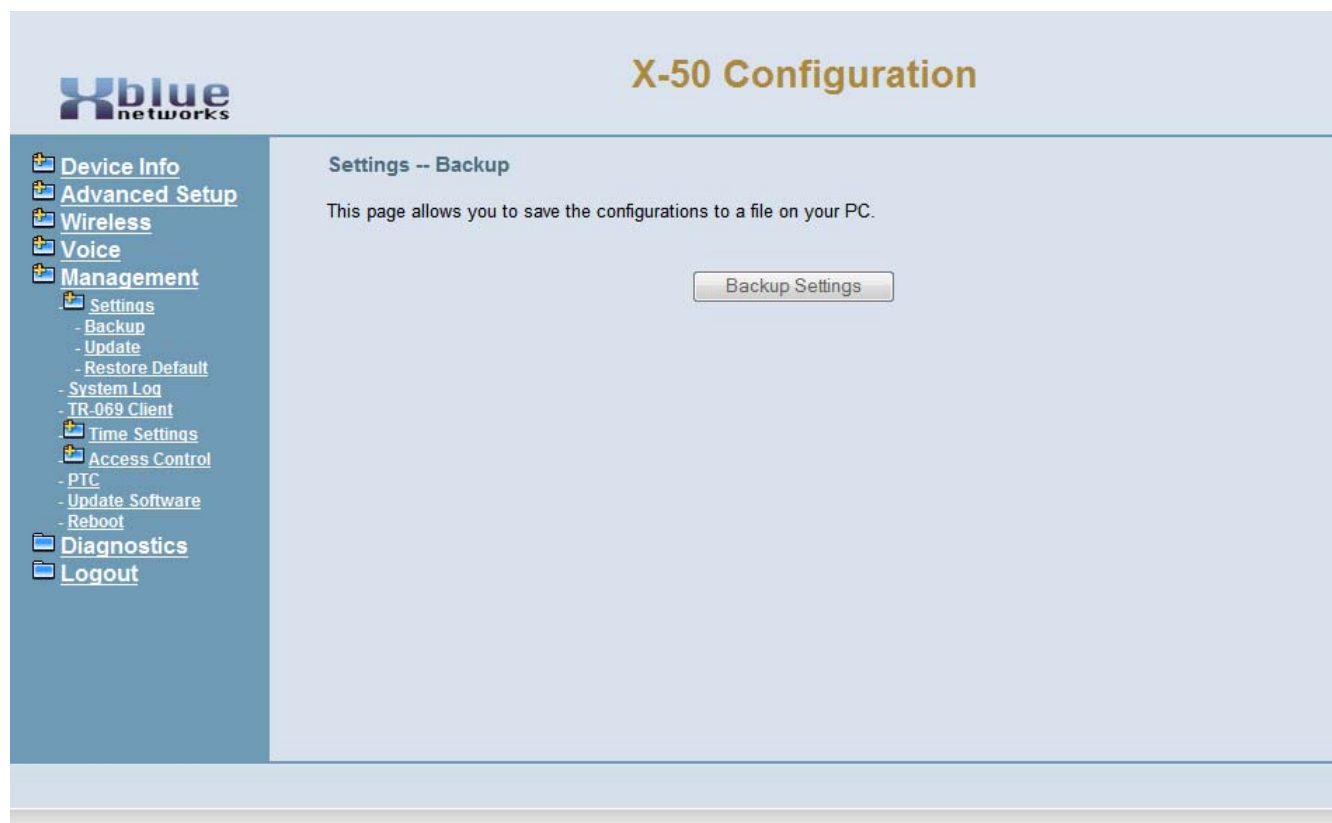

Click on the "Backup Settings" button to create a back up of the system.

Update

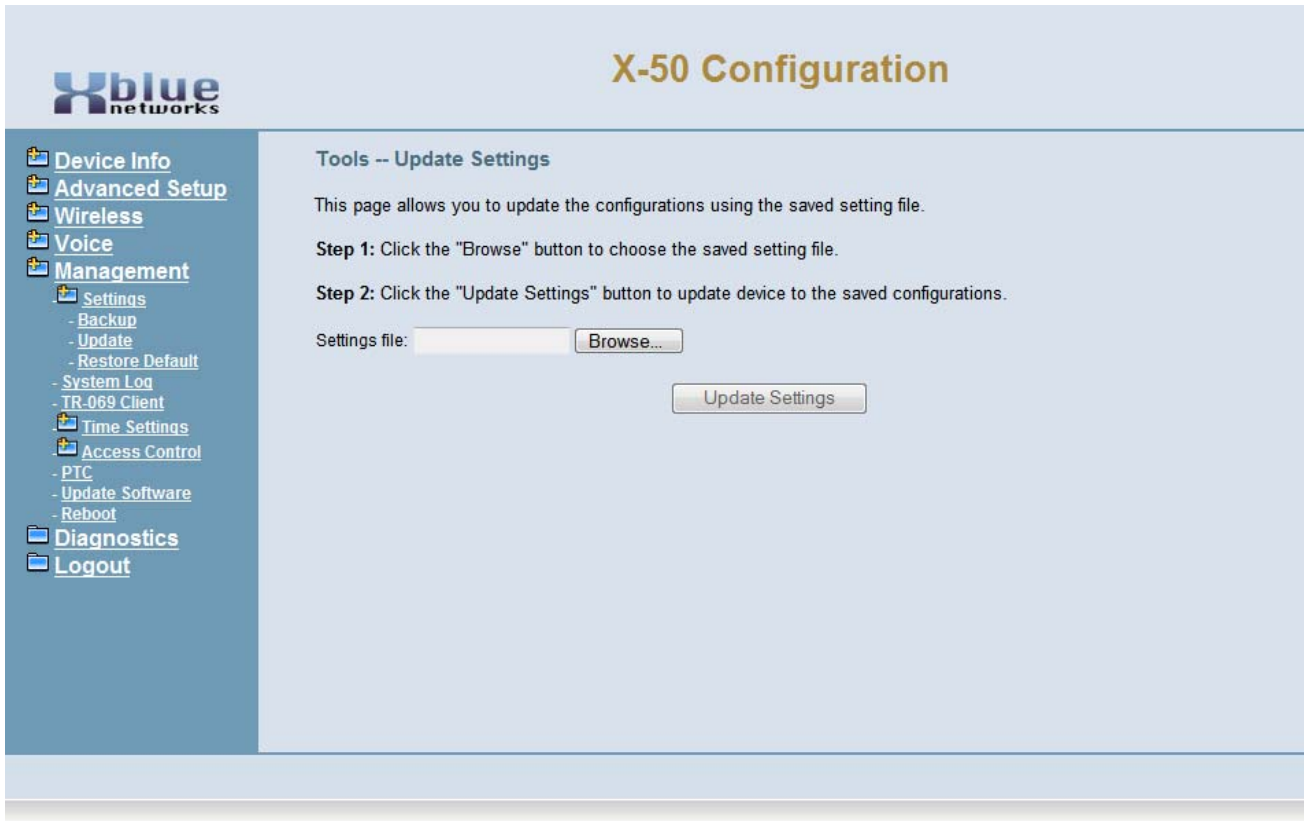

Update
10

Use Update to restore a previously back up.

- Click on the Browse button and select the file to be used
- Click on Update Settings

Note:

The system will reboot, which will take about 2 minutes after the backup is restored.

Restore Default

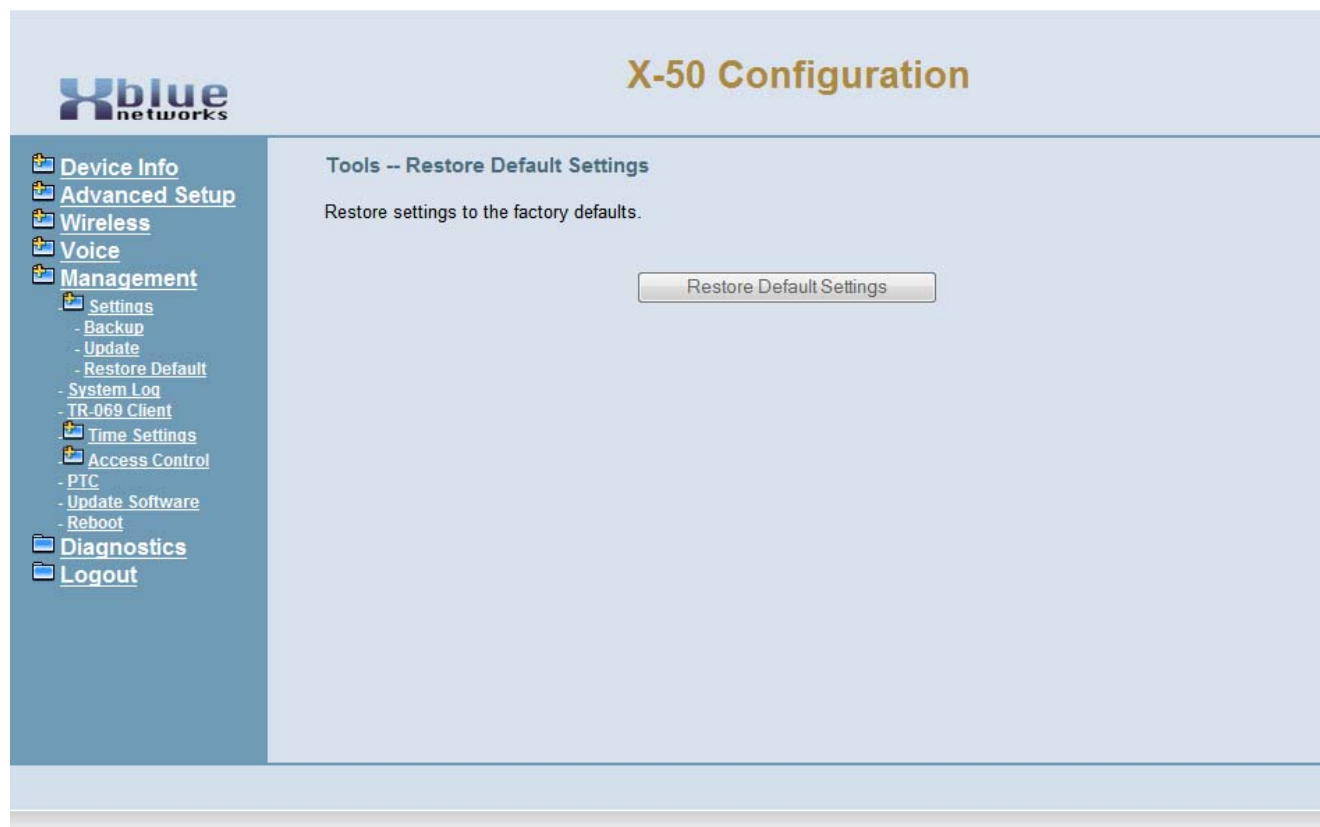

Use the "Restore Default Settings" to return the system back to factory default. All programmed parameters will be restored to the factory default settings and "Initial Startup Wizard" will be activated.

System Log

The system log is used to verify and diagnose network settings and errors. There are several different levels of system logs, from informational to critical.



Select "Configure System" log to select the level of logging required.

- Enable or Disable the Log
- Log Level - Select between Emergency, Alert, Critical, Error, Warning, Notice, Informational or Debugging. Each selection in the list, in decending order, adds more informaiton to the log. Select the level of information that is needed.

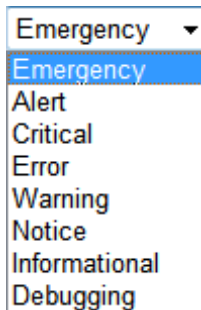

- Display Warning - Select between Emergency, Alert, Critical, Error, Warning, Notice, Informational or Debugging. Each selection in the list, in decending order, adds more informaiton to the log. Select the level of information that is needed.

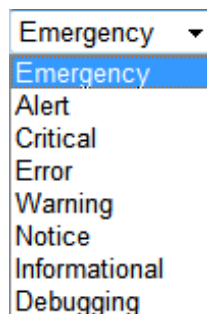

- Mode - Local or Remote - Local mode is used to debug the system that the administrator is currently logged into. Remote mode is used to debug any system within the voice network.

TR-069

TR-069 is the protocol for Wide Area Networks (WAN) Management which defines the auto configuration of a server.

The screenshot shows the 'X-50 Configuration' page for 'TR-069 client - Configuration'. The interface includes a navigation menu on the left with categories like Device Info, Advanced Setup, Wireless, Voice, and Management. The main content area is titled 'TR-069 client - Configuration' and contains the following configuration options:

- Inform:** Radio buttons for Disable and Enable.
- Inform Interval:** Text input field containing '300'.
- ACS URL:** Text input field.
- ACS User Name:** Text input field.
- ACS Password:** Text input field.
- Interface:** Dropdown menu set to 'WAN'.
- Display SOAP messages on serial console:** Radio buttons for Disable and Enable.
- Connection Request Authentication:** Checked checkbox .
- Connection Request User Name:** Text input field.
- Connection Request Password:** Text input field.
- Connection Request URL:** Text input field containing 'http://192.168.1.244:30005/'.

At the bottom of the configuration area are two buttons: 'Apply/Save' and 'GetRPCMethods'.

TR-069
10

- Device Info
- Advanced Setup
- Wireless
- Mobile Network
- Voice
- Management
 - + Settings
 - - Backup
 - - Update
 - - Restore Default
 - - System Log
 - - TR-069 Client
 - + **Time Settings**
 - - Internet Time
 - - Daylight Saving time
 - + Access Control
 - - PTC
 - - Update Software
 - - Reboot
- Diagnostics
- Logout

These settings may have been changed during the Setup Wizard

Time Settings

The **X-50** system has the ability to synchronize the date and time with up to five different time servers, and it can be set to use automatic daylight savings time rules.

Internet Time

- First (second, third, fourth, fifth) NTP time server. Only if the current server is unavailable will the next one be referenced.
- Time Zone Offset - Select the Time Zone where the system is installed.

Select Manual Date and Time Settings when not connected to a Network.

Manual Date and Time Settings

X-50 Configuration

Time Settings

This page allows you to configure the time synchronization method of the unit.

Automatically synchronize with Internet time servers.

Manual Date and Time Settings

Date: 12 / 11 / 2010 MM/DD/YY

Time: 08 : 00 : 10 PM HH:MM:SS

Apply/Save

Daylight Saving Time

The **X-50** system can be set to use automatic daylight savings or it can be set to manual.

The screenshot displays the 'X-50 Configuration' web interface. On the left is a navigation menu with the following items: Device Info, Advanced Setup, Wireless, Voice, Management (expanded), Settings, System Log, TR-069 Client, Time Settings (expanded), Internet Time, Daylight Saving Time (selected), Access Control, PTC, Update Software, Reboot, Diagnostics, and Logout. The main content area is titled 'Daylight Saving Time' and contains the text: 'This page allows you to configure the Daylight Saving Time (DST)'. Below this text is a dropdown menu labeled 'Default International DST Rule'. At the bottom of the configuration area are two buttons: 'Save Settings' and 'Cancel Changes'. The Xblue Networks logo is visible in the top left corner of the interface.

- Device Info
- Advanced Setup
- Wireless
- Mobile Network
- Voice
- Management
 - + Settings
 - - System Log
 - - TR-069 Client
 - + Time Settings
 - + **Access Control**
 - - PTC
 - - Update Software
 - - Reboot
- Diagnostics
- Logout

Access Control

Access control is used to control access to the gateway.

Web Port

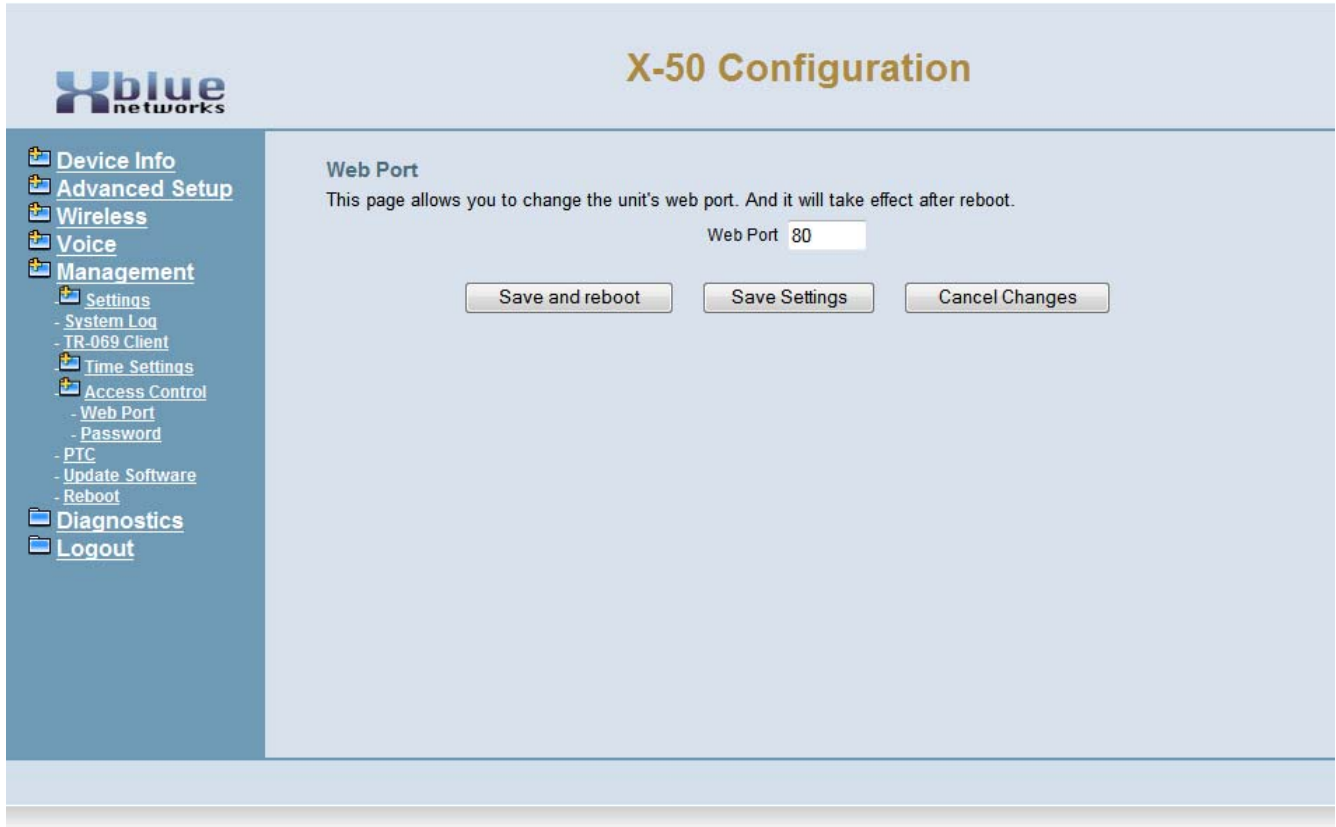

- Select the port to be used when accessing the Web Port. At default it is set to port 80.

Note:

Changing this port may affect the operation of the system

Passwords

The **X-50** has three different levels of passwords, Admin, Support and User.

Xblue networks **X-50 Configuration**

Access Control -- Passwords

Access to your DSL router is controlled through three user accounts: admin, support, and user. The user name "admin2583" has unrestricted access to change and view configuration of your device. The user name "support" is used to allow an ISP technician to access your device for maintenance and to run diagnostics. The user name "user" can access the device, view configuration settings and statistics, as well as, update the router's software. Use the fields below to enter up to 16 characters and click "Apply/Save" to change or create passwords. Note: Password cannot contain a space.

Username:

Old Password:

New Password:

Confirm Password:

TABLE 10.1 Passwords

User Name	Password	Interface	Access
admin2583	000000	LAN/WAN	Full - Admin Programming
user	user	WAN Only	Limited - System Admin
support	support	WAN Only	Full - Technical Support

PTC Configuration

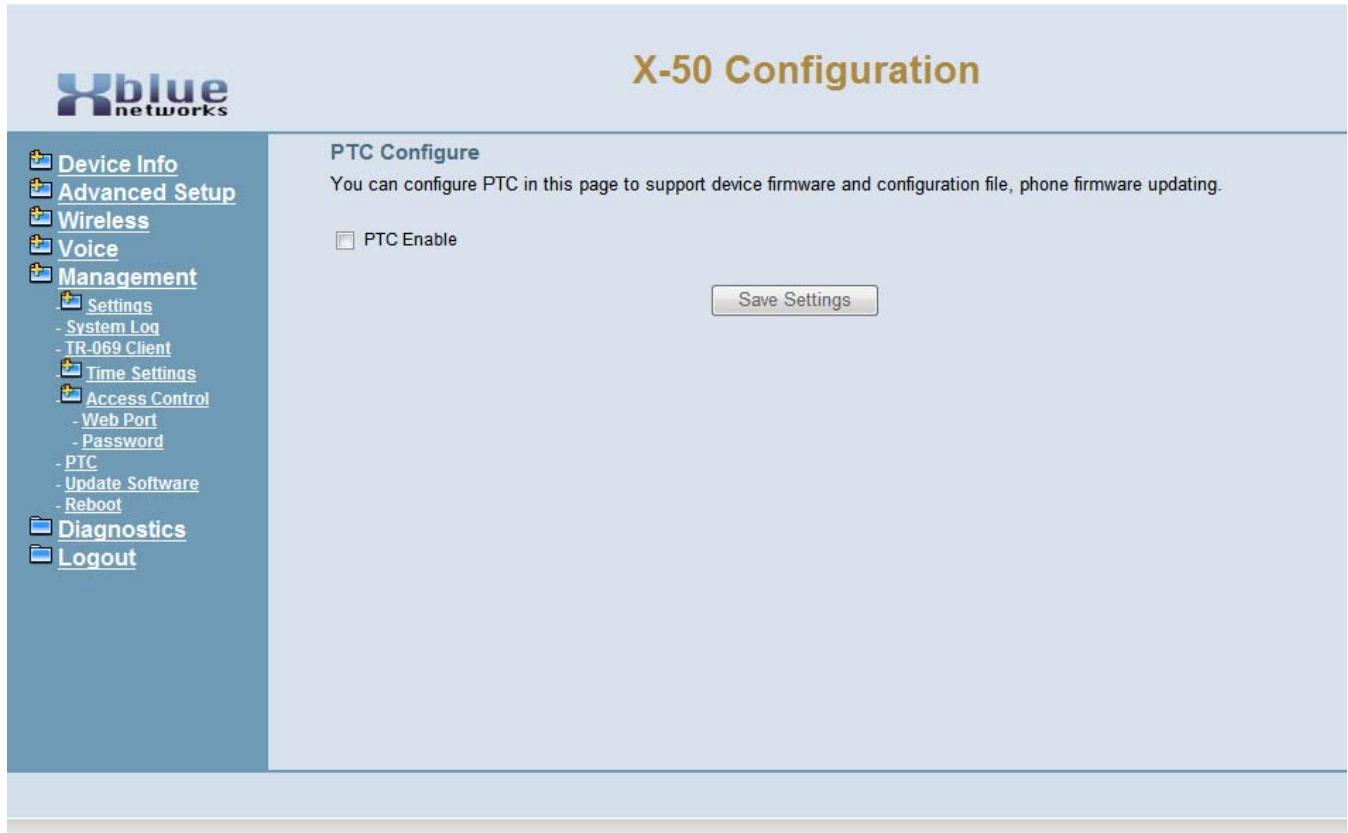

The screenshot shows the X-50 Configuration page for PTC. The page has a light blue header with the Xblue Networks logo on the left and the title "X-50 Configuration" on the right. A dark blue sidebar on the left contains a navigation menu with the following items: Device Info, Advanced Setup, Wireless, Voice, Management (selected), Settings, System Log, TR-069 Client, Time Settings, Access Control (with sub-items Web Port and Password), PTC (with sub-items Update Software and Reboot), Diagnostics, and Logout. The main content area is titled "PTC Configure" and contains the text: "You can configure PTC in this page to support device firmware and configuration file, phone firmware updating." Below this text is a checkbox labeled "PTC Enable" which is currently unchecked. A "Save Settings" button is located to the right of the checkbox.

Update Software

Select update software to update the software on the **X-50** VoIP Telephone System.

Note:

For best results the upgrade file must be stored on a local PC Hard drive. The upgrade procedure should only be done through the LAN port, Do no attempt this through the WAN port.

The screenshot displays the 'X-50 Configuration' web interface. On the left is a navigation menu with categories: Device Info, Advanced Setup, Wireless, Voice, Management (expanded), Diagnostics, and Logout. Under 'Management', sub-items include Settings, System Log, TR-069 Client, Time Settings, Access Control (with sub-items Web Port and Password), PTC, Update Software, and Reboot. The main content area is titled 'Management -- Update Software' and contains three steps: Step 1: Obtain an updated software image file from your system provider. Step 2: Click the "Browse" button to choose the software file. Step 3: Click the "Update Software" button to update the software. A note states: 'NOTE: The update process takes about 5 minutes to complete, and the unit will reboot.' Below the text is a 'Software File:' label followed by an empty text input field and a 'Browse...' button. At the bottom of the form is an 'Update Software' button.

Reboot

Use the Reboot page to reboot the gateway. Once the gateway begins, it will take about 2 minutes to complete the reboot process. If the software was upgraded, the reboot may take longer.

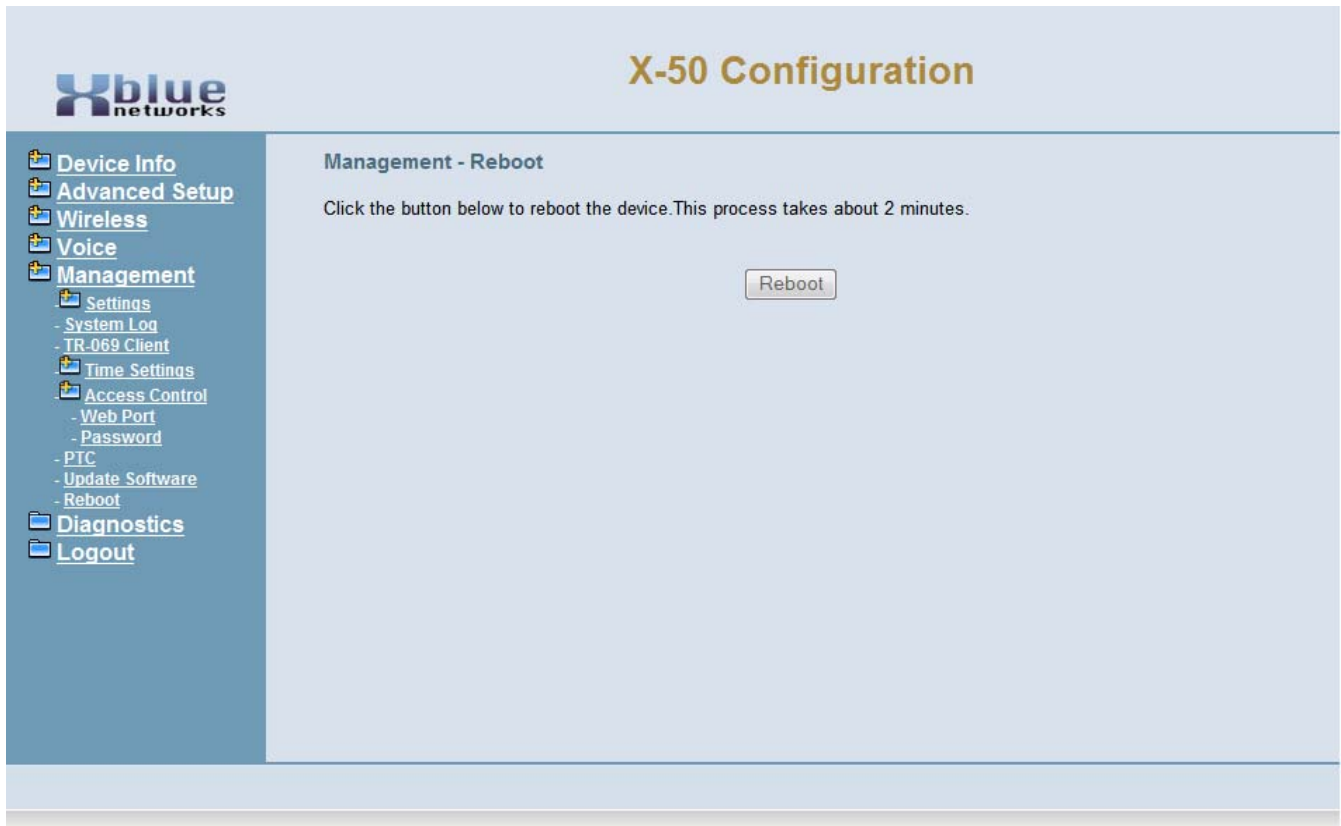

11 *Diagnostics*

System Diagnostics

The Diagnostics page gives a snapshot of what is going on in the system, which is divided into four sections; “Test your network Connection”, “Test the status of the PSTN Line”, “Test the status of IP Trunk Line”, “Test the status of Auto Attendant (AA) Line” and “Test the status of the FXS”.

- Device Info
- Advanced Setup
- Wireless
- Mobile Network
- Voice
- Diagnostics
- Logout

X-50 Configuration

Refresh Mode: automatically manually

Test your network connection

Test your WAN Connection: **PASS**
 Test your LAN Connection: **PASS**
 Test your Wireless Connection: **PASS**
 Ping default gateway: **PASS**
 Ping primary Domain Name Server: **PASS**

Test the status of PSTN Line

PSTN Line 1: **IDLE**
 PSTN Line 2: **IDLE**
 PSTN Line 3: **IDLE**
 PSTN Line 4: **IDLE**
 PSTN Line 5: **N/A**
 PSTN Line 6: **N/A**

Test the status of IP Trunk Line

IP Trunk Line 1: **N/A**
 IP Trunk Line 2: **N/A**
 IP Trunk Line 3: **N/A**
 IP Trunk Line 4: **N/A**
 IP Trunk Line 5: **N/A**
 IP Trunk Line 6: **N/A**
 IP Trunk Line 7: **N/A**
 IP Trunk Line 8: **N/A**

Test the status of AA Line

Auto Attendant Line 1: **IDLE**
 Auto Attendant Line 2: **IDLE**
 Auto Attendant Line 3: **IDLE**
 Auto Attendant Line 4: **IDLE**

Test the status of FXS

FXS Line 1: **IDLE**

The Diagnostic Page shows the status of the **X-50** system. “Pass” indicates that the system is connected and operating correctly. “Failed” indicates that the network is not connected.

PSTN Line, IP Trunk Line, Auto Attendant line, or FXS line will show when they are “Idle” or “Busy”. If needed, press the “Disconnect” button to release the line.

12 Voicemail

Getting to Know your Voice Mailbox

A complete Voicemail and Auto Attendant come standard with the **X-50** VoIP Telephone System. When the **X2020** telephone is connected to an **X-50** VoIP Telephone System, it can access voicemail by pressing the message button, which is the button with an envelope.



When a new message arrives, the light above the display will begin flashing and the display will show an envelope with the new message count.

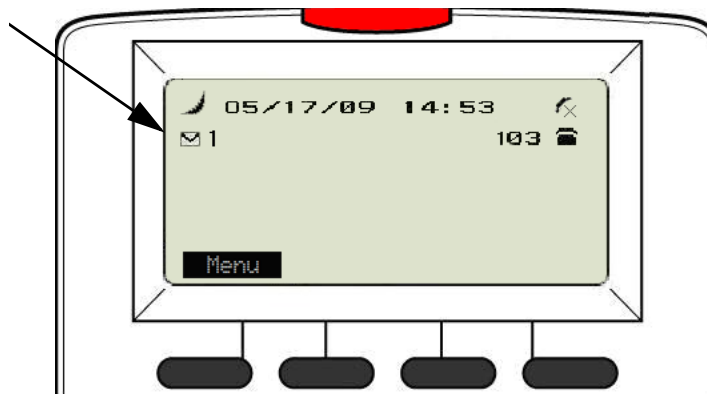

Setting up your Voice Mailbox

It is a good idea to customize your voice mailbox when you begin working with your new telephone system. To do this you will press your message button  and you will be prompted to enter your password. The default password is four zeros (0000).

The voicemail system will prompt you, but you may dial the digit you wish when it answers. Use the following steps to personalize your greeting and name.

- Dial 3
- Press 2 - to record a new greeting
- Record your personalized greeting and then press the # key. A common greeting will be "Hi, this is Jonathan I am either on my phone or away from my desk. Please leave a detailed message and I will return your call as soon as I can."
- The message is automatically saved.
- Press # to go back one level
- Press 5 to record your name - Say only your first and last name and then press the # key.
- Simply hang up the phone and your voicemail is setup and active.

It is also a good idea to change the mailbox password. At default, the password is four zeros (0000) and can be changed to any 4 digit sequence from 0000 - 9999.

- After recording your personal greeting and Name...
- Press 4 to change the mailbox password.
- Enter the new four digit password
- Press 1 to confirm the new telephone number

Using your Voice Mailbox

Press the message button and enter the default or new password...

- Press 1 - To listen to new voicemail messages
 - Press 1 - To listen to new messages
 - Press 1 - To Save new messages
 - Press 4 - To Delete the playing message
 - Press 2 - To Skip to the next message
 - Press 3 - To delete the playing message
 - Press 4 - To forward the message another mailbox
 - Press 5 - To listen to the previous Message
 - Press # - To go to the previous message
- Press 2 - Delete all Voice Mail Messages (New and Saved)
- Press 3 - Record your personal greeting
- Press 4 - Change your mailbox password
- Press 5 - Record your mailbox name
- Press 6 - Send a voicemail message to another extension

Remote Message Pickup

Messages, new and saved, may be picked up from a remote location. Call into the system and when the Auto Attendant answers....

- Press *
- Dial the mailbox number
- Enter your password

H-50 Voicemail User Flow Chart

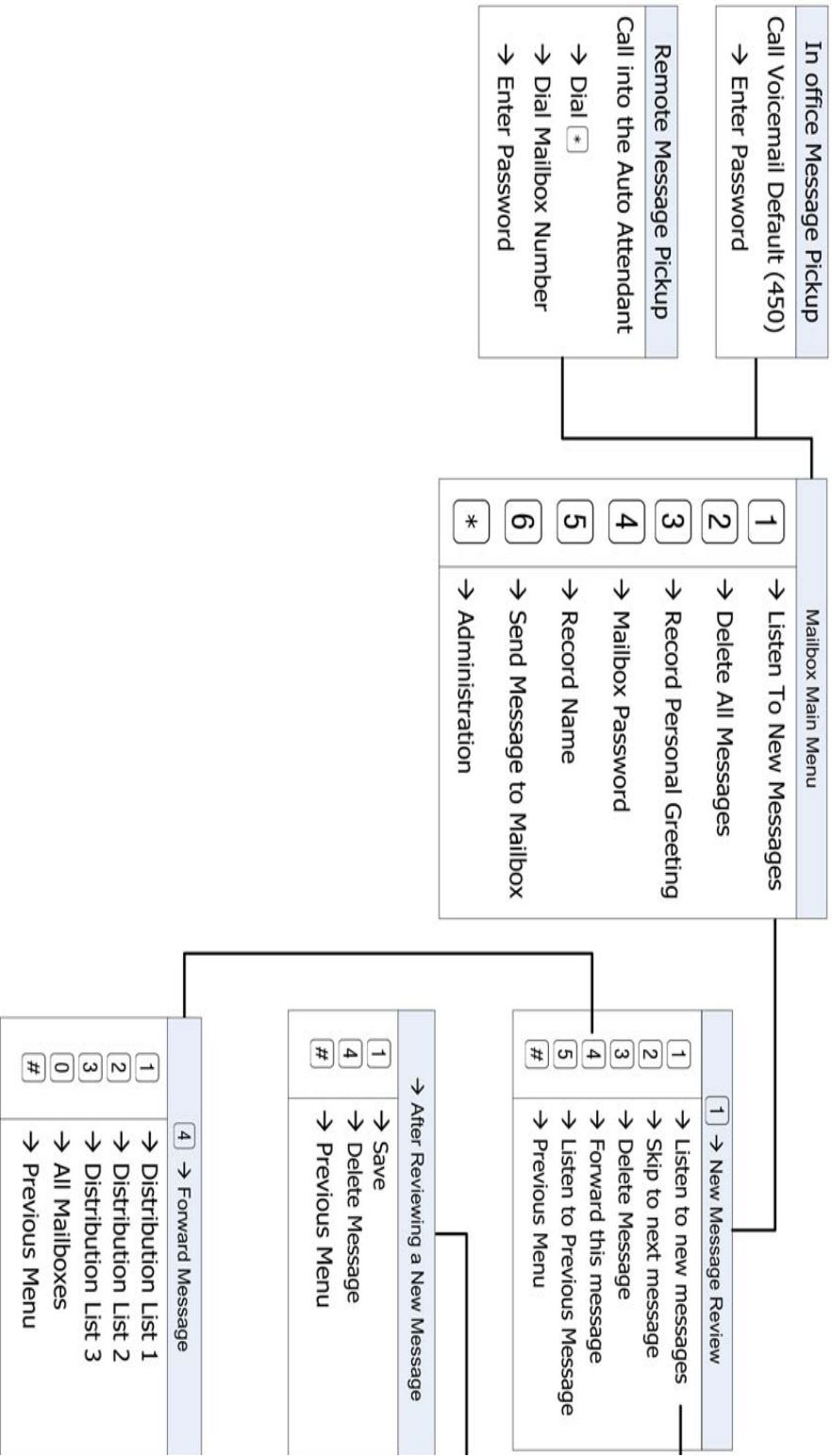

Voicemail Administration

Any mailbox can log into the administration mailbox to rerecord the main system greetings. The Automated (Receptionist) Attendant can answer with one of eleven (11) menus, each with with five different greetings, Day, Lunch, Night, Holiday and Temporary.

To log into the administration mailbox, first log into one of the existing mailboxes....

- Press *
- Enter the administration mailbox Password - The default is six zeros (000000)
- Dial Zero to change the greeting mode from Day to Night or Night to Day
- Dial 1 to record the English Greeting
- Enter the Greeting (Menu) ID number - 0, which is the default for all telephone lines, additional menu numbers are 1 through 10.
- Dial 1 to record the Day Greeting
- Dial 2 to record the Night Greeting
- Dial 3 to record the Break (Lunch) Greeting
- Dial 4 to record the Holiday Greeting
- Dial 5 to record the Temporary Greeting

In the Answer Position the auto attendant can be set with a "Menu Tree". A menu tree allows callers to route their call by dialing the digits associated with their choice. Each Menu can have its own personalized greeting, explaining what the caller should dial to find their desired person.

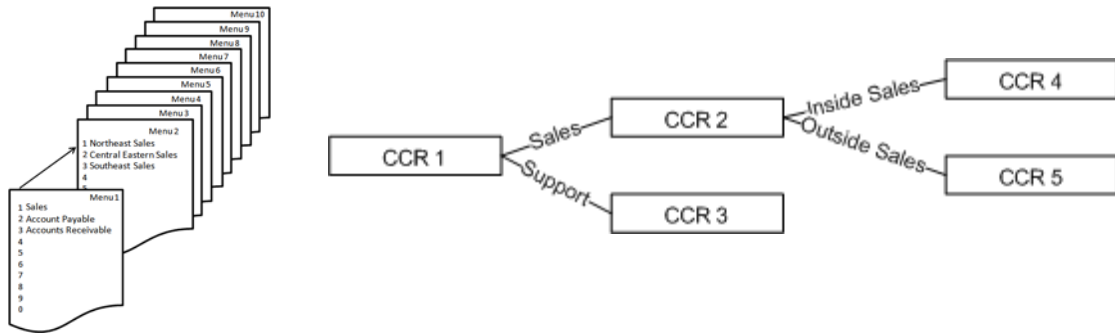

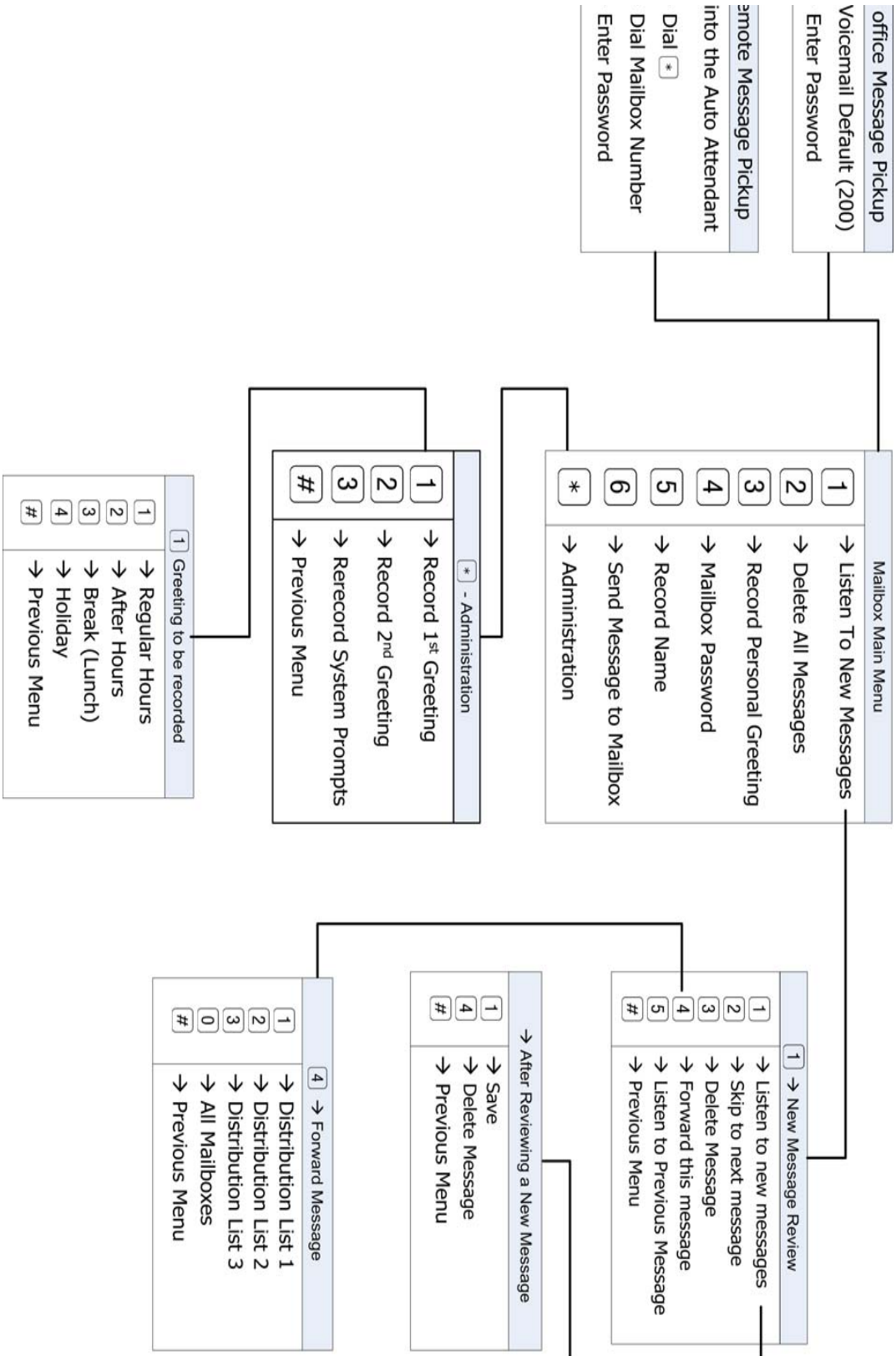

13 Glossary of Terms

Glossary

ARP – Address Resolution Protocol – allows devices to find a “host device” using the network layer (MAC Address). This allows SIP telephone endpoints to use non static IP Addresses when connecting to the system

ACLEP – Algebraic Code Excited Linear Predication – Reproduces voice transmissions using mathematical approximation that is determined 15ms prior to the next transmission, which itself is calculating at 10 frames per second. This approximation allows for greater voice compression and significantly better voice quality.

ATM – Asynchronous Transfer Mode – A packet switching transfer method designed to transport real time voice and video over a standard telephone line.

Bridge – A Cable or DSL modem/gateway is required to identify a specific location on their network. Some ISP units incorporate a router so that the user does not have to purchase another device, while others use a unit that has no routing capability, and requires the user to supply a router. When using remote workers or joining a voice network the ISP units must be set as a bridge, and the **X-50** system is used at the router.

BSS – Basic Service Set –.

BSSID – Basic Service Set Identifier (BSSID) –

CHAP – Challenge Handshake Authentication Protocol – similar to PAP but the ID and password is encrypted.

CO – Central Office – A legacy telephone company line.

Converged – A converged PBX is a system that can be used with both VoIP and PCM/TDM. The converged system uses the PCM/TDM internally, while a Media Gateway (see Gateway) is used to integrate the Voice over IP component.

Default Gateway – The default gateway, usually seen as an IP Address, is the location used for endpoints to access the Internet, sometimes called the “Doorway to the Internet”. If the default gateway is not entered or entered incorrectly, endpoints will have no access to the Internet.

Differentiated Services Code Point (DSCP) – The DSCP is part of the overall Quality of Service (QoS) strategy.

DMZ – In computer network security there is a special location commonly called the Demilitarized Zone but really stands for Data Management Zone, which can be a physical or logical subnetwork that is exposed to external services such as the Internet.

DNS – A Domain Name System is the “Phone Book” for the Internet. It translates “Human Relatable” names such as www.xbluenetworks.com into the numeric IP Address. The DNS can be a local or remote server, and it is a essential part of today’s Internet.

(DHCP) Dynamic Host Configuration Protocol – A dynamic IP address is assigned by a DHCP server, such as a router or network file server. Each time a network device is powered on it is “leased” (issued) an IP Address which has a scheduled expiration time. Once the lease expires the address may be released to the same device or another device.

FXO - Foreign Exchange Office - is where a standard telephone line is connected and requires telephone line signaling interface for standard analog telephone lines also known as “POTS”, Plain Old Telephone Service. When the telephone line is taken off hook, the FXO signals the telephone line provider by closing the “loop relay”, which signals the telephone line provider that it is off hook and should receive dial tone.

FXS - Foreign Exchange Station - is where a standard Analog or Single Line Telephone is connected to the system. The system provides talk battery, dial tone, generates ring voltage and generates DTMF Tones for the telephone line provider to process and make calls.

Gateway – A Gateway, sometimes called a Media Gateway, is the device that joins disparate networks; similar to a MUX, taking a T1 and converting it to a standard Loop-Start CO Line.

Gatekeeper – A Gatekeeper maintains a registry of remote devices. Each remote device must register and be authenticated to be granted access to the “Voice Network”. In addition, it provides address translation and provides other services such as bandwidth management and locating gateways.

H.323 – the originally created as a multi-media protocol, later to incorporate Voice over IP. It is the most mature and widely used protocol.

Intranet – An Intranet is a private computer network that an Internet Protocol backbone. This could be considered a private version of the Internet.

Internet – The Internet is a series of interconnected computers and computer networks that transmit and receives data using a packet switching protocol known as Internet Protocol. The Internet is generically known as the “World Wide Web”.

IGW – Internet Gateway – A gateway joins two or more disparate networks, such as an intranet (LAN) from the Internet (WAN), or when separating a normal LAN from wireless guests. Generally, a gateway will have at least one each WAN and LAN port.

IGMP – Internet Group Management Protocol – The protocol that manages multicast groups to more efficiently stream multicast groups, such as Video and Gaming.

IP Address – Internet Protocol Addresses – IP addresses are assigned two different ways, static or Dynamic.

Static - A static IP Address is used by any device that establishes infrastructure, such as a router, a severer, a printer, faxes etc. Internal or Intranet IP address are easy to establish and program. However, Internet static IP addresses are usually purchased at a premium but they are required when several endpoints are “pointed” to the same location such as a voice server.

Dynamic - A dynamic IP Address is used by any device that does not establish infrastructure, such as a client endpoint. A client endpoint (laptop for example) moves freely, so it is assigned a temporary IP Address from a device such as a server or router. These addresses are “leased” to the device for a period of time and are subject to change.

ISP – Internet Service Provider – An Internet Service Provider (ISP) is generally either a telephone or cable company which provides a high speed connection to the World Wide Web (www).

IETF – Internet Engineering Task Force – The task force wrote the specification SIP.

Jitter - defines the lack of synchronization caused by mechanical or electrical changes. The most common cause for jitter is lack of bandwidth.

LAN – Local Area Network – A LAN allows network devices to share and access files through a series of wires known as a “Network”. Generally, a LAN uses one DHCP Server, it is “small” in size (geographically) like a home or office, and it does not require any external IPS to transmission data between endpoints.

Latency - is an important indicator of the dynamic performance of a Virtual Acoustic Environment (VAE). In a VAE, the end-to-end latency refers to the time elapsed from the beginning of an event or action, such as a voice transmission, until the receiving party hears the signal. High latency causes poor reproduction of a voice transmission, whereas lower latency results in higher voice quality.

LDAP – Lightweight Directory Access Protocol – A directory is a set of objects with similar attributes organized in a logical and hierarchical manner. The most common example is the telephone directory, which consists of a series of names (either of persons or organizations) organized alphabetically, with each name having an address and phone number attached.

MAC – Media Access Control – The MAC address is a unique, level 2, identifier which is required on all devices that connect to a network. This address is usually assigned at the factory where the device is built. Unlike an IP or Subnet Mask address, the MAC address does not change, which is critically important when using Dynamic Host Configuration Protocol (DHCP). A MAC address consists of 6 octets in hexadecimal format and looks like xx:xx:xx:xx:xx:xx (00-01-43-65-a0-e4).

Menu Trees - A menu tree is a series of choices that a caller can dial to process their call more efficiently. For example, a main greeting may instruct the caller to dial 1 for sales, which accesses menu 2, which instructs the caller to dial 1 for Northeast Sales, 2 for Central Eastern Sales, Southeast Sales, etc.

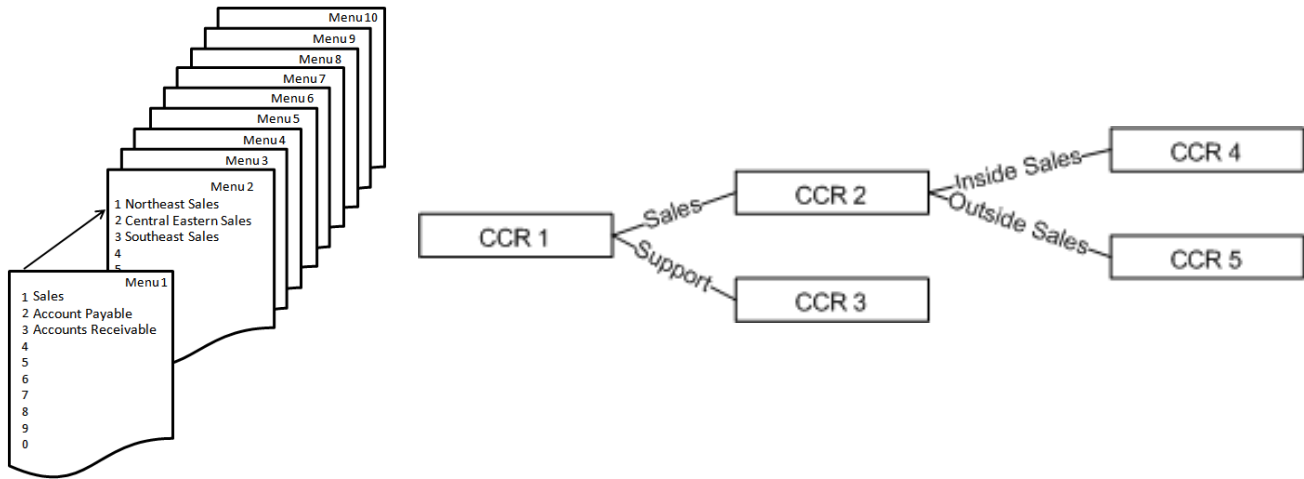

Enable Wireless Multicast Forwarding (WMF) - is a delivery protocol for information to a group of destinations. Although most applications use unicast (broadcasting to a single location), WMF is typically used in oneway streaming media. At default, this is disabled.

NAT – Network Address Translation – NAT reconciles the internal DHCP Addresses with the published Static IP Address. It is this protocol that makes it possible to share one published Internet address with multiple internal LAN devices.

NIC – Network Interface Card – Any device that connects to a network requires either a wired or wireless Network Interface Card. Each NIC has its own unique Media Access Control (MAC) address.

NPT – Network Time Protocol – A protocol that defines the ability to synchronize different computer systems over a packet switched network, using UDP packets via port 123 as the transport layer.

TABLE 13.1 Some Network Time Protocol

Network Time Protocol	
time-a.nist.gov 129.6.15.28 NIST, Gaithersburg, Maryland	time.nist.gov 192.43.244.18 NCAR, Boulder, Colorado
time-b.nist.gov 129.6.15.29 NIST, Gaithersburg, Maryland	nist1.dc.certifiedtime.com 216.200.93.8 Abovnet, North Virginia
time-a.timefreq.bldrdoc.gov 132.163.4.101 NIST, Boulder, Colorado	nist1.dc.certifiedtime.com 216.200.93.8 Abovnet, North Virginia
time-b.timefreq.bldrdoc.gov 132.163.4.102 NIST, Boulder, Colorado	nist1.dc.certifiedtime.com 216.200.93.8 Abovnet, North Virginia
time-c.timefreq.bldrdoc.gov 132.163.4.103 NIST, Boulder, Colorado	nist1.nyc.certifiedtime.com 208.184.49.129 Abovnet, New York City
utcnist.colorado.edu 128.138.140.44 University of Colorado, Boulder	nist1.sjc.certifiedtime.com 207.126.103.202 Abovnet, San Jose, California

P2P – Peer to Peer – All computers have the ability share information with each other without logging into a server. This protocol is very helpful with VoIP.

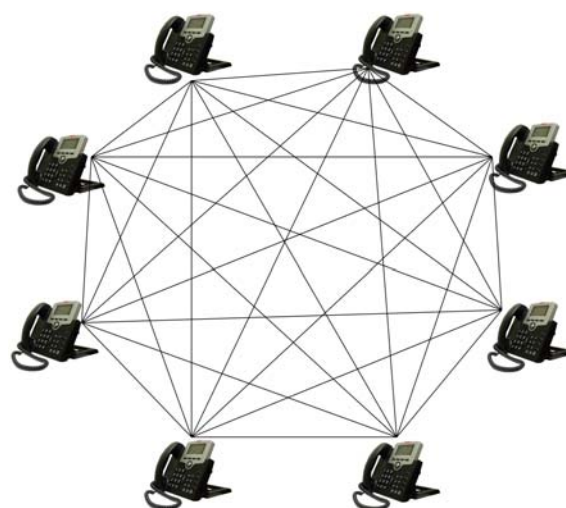
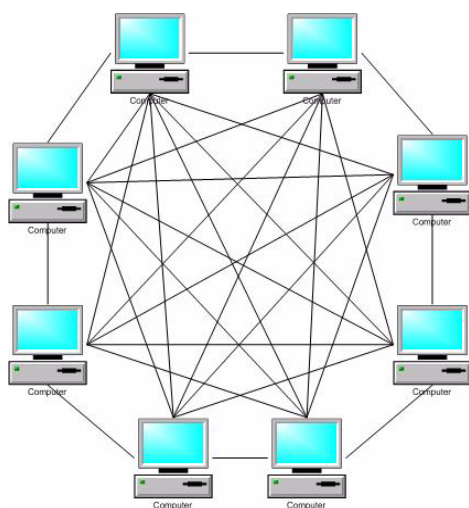

PPPoE – Point-to-Point Protocol over Ethernet – This transport protocol is used on telephone networks as “ATM”, where the DSL modem encapsulates PPP packets inside ATM cells and send them over a WAN Connection.

PAP – Password Authentication Protocol – This requires the requesting device to send an un-encrypted authentication, which must contain both the ID and password, to the local router when attempting to connect.

MSCHAPS – Microsoft Version Challenge Handshake Authentication Protocol – enables mutual authentication between peers by piggybacking a peer challenge and response packet for each successful packet.

Protocol – A clearly defined way of doing something.

PSTN – Public Service Telephone Network – Is the generic name given to the legacy telephone company lines.

QoS – Quality of Service – Although QoS is synonymous with packet prioritization; it really is the measurement of the voice or data transmission quality, from end to end. However, QoS can be improved by using packet prioritization, which allows voice to take precedents over data packets. This results in a better “connection” and communication between two end points.

Remote Worker – A remote worker is someone that will be using the telephone system’s resources but does not reside in the same physical area.

RJ21X – An RJ21X is the location, usually on a “Punchdown Block”, where the Telephone Company’s Telephone Lines enter into the building.

Router – A router is used to direct incoming and outgoing data packets. A router is often used to assign DHCP Addresses, basic Internet security and Network Address Translation (NAT).

Security – (See Wireless Security)

SIP – Session Initiated Protocol – This protocol was specifically developed for transmitting voice over the Internet, by communications professionals. SIP has very little “overhead” helping to eliminate jitter and latency. Although not yet realized, SIP was developed as an “universal standard”, and the goal is to make SIP phones as common as standard 2500 sets.

STUN – Session Traversal Utilities for NAT – STUN is a protocol that allows applications operating through a Network Address Translation (NAT) to discover the presence of a network address translator and to obtain the mapped IP address and port number that the NAT application (UDP) contains to remote hosts.

SMTP – Simple Mail Transport Protocol – is the standard used to transport outgoing electronic mail (E-mail) across IP Networks. Generally, SMTP uses Port 25, but most sophisticated gateways will allow the administrator to match the port with the provider.

Static IP Address – See IP address

SSID – Service Set Identifier – is the name that identifies a particular wireless LAN. This name is broadcast and can easily be found by another wireless device.

SSL – Secure Sockets Layer – is one of the cryptographic protocols (type of encryption) used to provide security over an IP network such as the Internet. Generally, SSL uses port 443.

Subnet Mask Address – The Subnet Mask Address is used to segment (divide) a network into multiple networks. Also, using a complex mathematical formula, the Subnet Mask Address is used to determine how many IP Addresses are available per Class.

Basically, the lower the number, the more IP Addresses are available. For example, if the Subnet Mask Address is 255.255.255.0, only the last number is 0, so the maximum number of IP addresses possible is 254 (both zero 0 and 255 are reserved). If the Subnet Mask Address is 255.255.0.0 then the possible number of IP addresses becomes 255^2 or 66,000. Finally if the Subnet Mask Address is 255.0.0.0 then the possibilities are 255^3 or 16.8 million addresses. The Subnet Mask Address consists of a group of 4 numbers (Octets), each ranging from 0~255, and is usually written as xxx.xxx.xxx.xxx.

Subnet Mask	Max Subnets	Client Devices
255.255.255.0	1	254
255.255.240.0	16	65,280
255.255.224.0	32	261,120
255.255.192.0	64	1,044,480
255.255.128.0	128	4,177,920
255.255.0.0	255	16,581,375

TDM – Time Division Multiplexing - The division of voice transmission, based on time.

URL– Uniform (Universal) Resource Locator - This is a subset, along with Uniform Resource Name, of Uniform Resource Identifier, which is used to retrieve websites using a name rather than an IP Address.

Vocoders – A voice encoder, known as a Vocoder, defines the voice compression and decompression that will be used for the voice transmission. Currently, all Voice over IP connections are full duplex, so every call opens bandwidth for “send, Receive, and Overhead (data signalling)”. Common Vocoders are G.711, G.728, G.729, G.723.1

VoIP – Voice over Internet Protocol – Voice over IP is a protocol that defines the transport of voice packets, using Internet Protocol, over a LAN, WAN or Internet.

VPN – A Virtual Private Network is a communications network “tunneled through” another network, creating a larger dedicated network. The “tunnel” is built using special security protocols, which are established and accepted by all parties. Once the “tunnel” is established the locations will continuously send a “keep alive” signal to keep the locations connected.

WAN – Wide Area Network – A WAN network devices to share and access files through a series of wires known as a “Network”. A WAN is used with multiple locations, and has no physical boundaries. It is actually possible to have a WAN that spans the globe.

Wireless Security –

- **Open** – no encryption – not recommended
- **Shared** – each device on the wireless network must use the same “Shared” authentication key. This should be considered rudimentary security.
- **802.1x** – is a Port based authentication which generally requires a client application, which authenticates to a specified server (RADIUS) before being allowed to connect to the wireless access point.
- **WEP – Wired Equivalent Privacy** – One of the original wireless encryption protocols, which was thought to be secure. Today, with a minor investment, it can be cracked pretty quickly. This should be considered basic security.
- **WPA – Wi-Fi Protected Access** – an “intermediate measure” security protocol created by the Wi-Fi Alliance, which is found to be more secure than WEP.
- **TKIP – Temporal Key Integrity Protocol** – Was added to WPA and is backwards compatible with older WEP devices, but can be infiltrated with re-injection and spoofing.
- **PSK – Pre-Shared Key** (RFC 4785) – can be convenient when managing a closed network for easier authentication.
- **WPA2** – The second version of WPA, which is more secure, but does not always work with older wireless installations.
- **AES – Advanced Encryption Standard** – Block Cipher encryption which was adopted by the US Government, and now used world wide for security.
- **RADIUS – (RFC 2865) Remote Authentication Dial in User Service** – is a client/server protocol using centralized authentication, which requires a network server for all endpoints that connect to the network. This is done in the application layer, using UDP packets.
- **RADIUS Port** – The “Well Known Ports” for sending UDP packets are 1812 and 1645 depending on the network installation and the server.

Well Known Ports - Personal Computers have approximately 64,000 “virtual” Ports, each can be used for specific tasks. For example, Port 80 is used to access the Internet, Port 25 is used for SMTP, etc. There are a group of these ports that are called “Commonly Open” or “Well Known Ports” and generally are between 0 and 1023. In table 9.2 there is a list of “Well Known Ports” and some Not so “Well Known Ports”.

TABLE 13.2 Well Known Ports

Port Number	Description
21	FTP
23	Telnet
25	SMTP
53	Domain Name Server (DNS)
80	HTTP - Commonly known as the Internet
110	POP3
119	Network News Transfer Protocol
125	NTP (Network Time Protocol)
143	IMAP
220	IMAP Version 3
389	LDAP
443	HTTPS
531	AOL Instant Messenger (Unofficial)
636	LDAPS
953	DNS
992	Telnet over TLS/SSL
993	IMAPS
995	POP3 over TLS/SSL
1194	Open VPN
3101	Blackberry Enterprise Server (Unofficial)
3389	Microsoft Remote Server (Remote Desk Top)
5060	SIP
5061	SIP over TLS
5500	VNC remote Desktop Protocol (Unofficial)
5631	PC Anywhere (data)
5632	PC Anywhere (Status)
5800	VNC over HTTP (Unofficial)
5900	Virtual Network Computing (VNC) - Apple Remote Desktop
5938	Team Viewer Remote Desktop (Unofficial)
6891 - 6900	Windows Live Messenger - File Transfer (Unofficial)
6901	Windows Live MEssenger - Voice (Unofficial)
8008	HTTP Alternate
23399	Skype (Unofficial)

Wi-Fi Multimedia - WMM is the standard which was created to define QOS with WiFi Networks and is used to improve audio, video and Voice applications transmitted over WiFi.

WWW – World Wide Web – The world wide web is the generic name for the Internet.

Numerics

802.11 89
 802.11a 24, 145
 802.11b 24, 89, 145
 802.11g 24, 89, 145
 802.11n 24, 89, 145
 802.11n/EWC 159

A

Access Control 230
 Web Port 230
 Access Point PIN 153
 ACLEP 243
 Action When MAX Error Reached 203
 Address Resolution Protocol 108, 243
 Admin Password 203
 Administration Control 128
 Advanced 102
 Advanced Network Address Translation (NAT) 116
 Advanced Programming 110
 AES 152, 250
 Agent Log On/Off
 UCD 53
 Agent Log on/off 48
 Algebraic Code Excited Linear Predication 243
 All Paging Group 188
 All Ring Group 180, 190
 Alphanumeric Display 48, 53
 Analog Telephone Trunks 172
 Answer Position 179
 All Ring Group 180
 Auto Attendant 179
 Extension 179
 ICD
 All Ring 180
 Linear 180
 ICD Group 180
 Line Selection 179
 Operator 180
 ARP 108, 243
 Assured Forwarding Classes 134
 Asynchronous Transfer Mode 243
 ATM 243, 247
 Auto Attendant 16, 202, 235, 237
 Email Header 206
 Voicemail Tag 206
 Auto Attendant Menu 205
 Automated Receptionist 202
 Automatic Authentication Protocol 113
 Automatic Channel Timer 159
 Automatic Configuration 110
 Automatic Daylight Savings 228
 Automatic Hold 48, 54
 Automatic Power Save Delivery 160

B

Backlit Display 53
 Backup 219
 Bandwidth 19, 159
 Bandwidth Control 135
 Basic Service Set 89, 243
 Basic Service Set Identifier 89, 147, 149, 243
 BSS 89, 243
 BSSID 89, 147, 149, 243
 Busy Callback 48, 54

C

Call Abandon Time 195
 Call Block 50
 Call Blocking 61
 Call Fork 55
 Call Forking 48
 Call Forward 55
 Busy 48
 Direct 48
 DND 49
 External 50
 Follow Me 49
 No Answer 49
 Remote 50
 Call Hold 50, 59
 Call Log 50, 59
 Call Park 50, 60
 Call Park Answer 50
 Call Park Number 191
 Call Pickup 50, 60
 Call Restriction Table 168
 Call Routing 181
 Delete 181
 Destination 181
 From 181
 Insert 181
 MAXLength 181
 MinLength 181
 To 181
 Call Routing Table 82, 97
 Delete Digits 99
 From 99
 Max 99
 Min 99
 To 99
 Call Waiting 50, 60
 Caller ID Method 194
 Callouts 13
 Campus 15
 Campus Environment 18, 25, 196
 Category 3 79
 Category 5 76, 79
 Category 5E 76, 79
 Category 6 76, 79
 Central Office 243

Challenge Handshake Authentication 86, 113, 243
 CHAP 86, 113, 243
 MSCHAP 86
 Cipher Encryption 152, 250
 Class of Service 184
 COS 167
 Day 168
 Night 168
 Traveling 31, 51, 62
 Class Selector 134
 Clients Isolation 147, 149
 CO Line 243
 Common Voicemail Greeting 238
 Conference - 3-Way 61
 Conference 3-Way 51
 Configure System 222
 Connecting Multiple Systems 196
 Converged 243

D

Data Management Zone 244
 Date & Time 104
 Day and Night
 Alternate Operator 188
 Operator 188
 Day Operator 91, 93
 Daylight Savings 228
 Days for keeping Voice Mail 206
 DDNS 139, 141
 Default Gateway 82, 85, 243
 Delay Ring Time 195
 Demilitarized Zone 121, 244
 Destination Network Address 137
 Gateway IP Address 137
 Subnet Mask 137
 Device 108
 Device Info 102
 DHCP 83, 87, 88, 109, 115, 244
 DHCP Address 248
 DHCP Server, 80
 Diagnostic
 Busy 236
 Disconnect 236
 Failed 236
 Idle 236
 Pass 236
 Diagnostics 102
 Diagnostics Pages 235
 Dial by Name Code 204
 Dial Plan 91
 Dial Wait Time 195
 DID 171, 176
 Destination 96
 DID Number 176
 Direct Inward Dial 82
 Display Name 176

Outgoing Caller ID 96, 176
 Ringing
 Destination Number 176
 Extension Number 176
 Trunk Group 176
 DID Number 96
 Differentiated Services Code Point 133
 Direct Inward Dial 171
 Direct Inward Dial (DID) 176
 Direct Inward System Access 204
 DISA 204
 Disable Voice Mailbox 208
 Disable WMM Advertise 147, 149
 Distinctive Ringing 51, 62
 Distributed Group 190
 DMZ 121, 244
 DND
 Display Name 96
 DNS 85, 86, 111, 244
 Do Not Disturb - DND 63
 Do Not Disturb (DND) 51
 Domain Name System 85, 86, 244
 Standard 139
 Domain Server 95, 174
 Down Stream 87, 115
 Downstream Bandwidth 135
 DSCP 133, 134
 DSL 247
 DSP IP Address 115
 DTMF Digit 206
 DTMF Signal off Duration 195
 DTMF Signal on Duration 195
 DTMF Type 194
 Dynamic DNS 139
 Dynamic Domain Name System 139
 Dynamic Host Configuration Protocol 83, 87, 88, 109, 110,
 115, 244
 Dynamic IP Address 141, 244, 245
 Dynamic Name Service 111
 DynDNS Settings 141
 DynDNS.org 141

E

E-mail Delivery 206
 E-mail Delivery of a Voice Message 202
 E-mail Notify with Voice Files 206
 Emergency Number Routing 185
 Enable Label 178
 Enable Wireless 89, 147, 148
 Enable Wireless Multicast Forwarding 147, 149
 Environmental 23
 Ethernet Cable 79
 Extensible Authentication Protocol 152
 Extension
 Extension Number 91
 Ringling 179

Voice Mailbox 208
Voicemail 208
Extension Feature Reset 51, 63
External Call Forward 50

F

Factory Default 219, 221
FAX
 Detection 194
 Support 194
Feature (Flexible) Button 64
Feature Button Programming 51
Feature Button Reset 52, 66
File Server 143
 Password 143
 User Name 143
Firewall 83, 85, 111, 119, 121, 127, 215
Flags 108
Flash New Call 195
Flash Time 195
Foreign Exchange Office 244
Foreign Exchange Station 244
FXO 13, 79, 244
FXO to FXO Call Duration 195
FXS 13, 79, 91
 (Extension) Phone Number 168
 Phone Number 187

G

G.711 249
G.723.1 249
G.728 249
G.729 249
Gatekeeper 244
Gateway 79, 80, 81, 107, 244
Gateway Name 196
Gateway Password 196
GMT 90
Greenwich Mean Time 90
Group Assign 178
Guest SSID 147

H

H.323 244
Hide Access Point 89, 147, 148
Hold Recall Time 194
Hold Reminder 66
Holiday 212
Holiday Schedule 212
Holiday Schedule Settings 212
Host Name 109
Hot Spot 147
House Keeping 207
Hunt Group 189

I

ICD Group
 Groups 190
 Name 190
IETF 245
IGMP 244
IGW 99, 181, 196, 244
IGW Group 181, 196
Incoming IP Filter 123, 127
 Destination IP Address 127
 Destination Port 127
 Destination Subnet Mask 127
 Filter Name 127
 ICMP 127
 IP Filtering 126
 Source Port 127
 Source Protocol 127
 Source Subnet Mask 127
 TCP 127
 TCP/UDP 127
 UDP 127
Initial Setup Wizard 221
Initialize System 219
Installation Basics 75
Interactive Buttons 66
Interdigit Timeout 175, 194, 195
Internet 172, 244
Internet Browser 81
Internet Engineering Task Force 245
Internet Gateway 244
Internet Gateway Group 196
Internet Gateway Router 16
Internet Group Management Protocol 244
Internet IP Address 85, 111
Internet Protocol Address 245
Internet Protocols 27
Internet Service Provider 17, 83, 85, 86, 113, 245
Internet Time 82, 90
Intranet 16, 244
IP Address 82, 83, 104, 108, 109, 114, 245, 249
 DHCP 19, 77
 Fixed 17, 18
 Static 17, 19, 77, 85
IP Backbone 171
IP Packet Routing 137
IP Packets 123, 135
 Analyzed 135
 Prioritized 135
IP PBX Configuration 24
IP Settings 85
IP Trunk Number 188
IP Trunks 82
ISP 79, 83, 85, 86, 87, 111, 113, 115, 245

J

Jitter 134, 245, 248

K

Keep Alive 249

L

Label Name 178
 LAN 13, 77, 79, 82, 87, 104, 105, 115, 245
 LAN IP Address 88, 115
 LAN Port Settings 87
 LAN Settings 82
 LAN/br0 137
 LAN/bro0 141
 Land Telephone 171
 Latency 245, 248
 LCD interactive 52
 LDAP 245
 Leased
 Expires In 109
 Leased Time 88, 115
 LED Function 21
 Lightweight Directory Access Protocol 245
 Line Select 179
 Linear Group 190
 Link to Phone 215
 Local Area Network 16, 24, 87, 114, 245
 Logout 102

M

MAC 245
 Brower's MAC Address 129
 MAC Address 82, 89, 108, 109, 129, 147, 149, 154, 245
 MAC Address Locating 155
 MAC Filtering 154
 MAC Address 154, 157
 HW Address 108
 Mailbox Password 238
 Management 102, 217
 Manual Date and Time Settings 90
 Max Recording Time 206
 MAX Try Time 203
 Maximum Configuration 20
 Media Access Control 147, 149, 154
 Meet Me Page 52
 Menu
 Single Digit Dialing 20
 Menu Tree Routing 25
 Menu Trees 204
 Message Button 238
 Microsoft Version Challenge Handshake Authentication Protocol 248
 Minimal Expire 168
 MSCHAPS 248
 Multi-Line Appearance 52, 67
 Music on Hold 211
 Mute 52, 67

N

NAT 83, 111, 116, 175, 214, 215, 246, 248
 Network Address Translation 17, 83, 111, 175, 246, 248
 Network Authentication 151
 Network Interface Card 81, 246
 Network Time Protocol 90, 247
 NIC 81, 246
 NIC Card 246
 Night Operator 91, 93
 No Answer Time 190
 No Fault Network 137
 NPT 247
 NTP 90
 Time Setting 226
 Numbering Plan 19, 77, 82, 91
 End Extension 187
 Stand Alone 92
 Start Extension 187
 UCD Groups 180
 Voice Network 92, 93

O

On Hook Dialing 52
 On-Hook Dialing 68
 Operator Speed-Dial Number 187
 Orbit Location 191
 Outbound Proxy 95, 174
 Outgoing Caller ID 174
 Outgoing IP Filter 125
 Destination IP Address 125
 Destination Port 125
 Destination Subnet Mask 125
 Filter Name 125
 ICMP 125
 Outgoing Filters 123
 Outgoing IP Filtering 124
 Source IP Address 125
 Source Port 125
 Source Protocol 125
 Source Subnet Mask 125
 TCP 125
 UDP 125

P

P2P 247
 Page Allow/Deny 52
 Page Answer 52
 Paging 68
 Paging Allow/Deny 68
 Paging Group 189
 PAP 86, 113, 247
 Parental Control 123, 128, 130
 Days of the Week 129
 MAC Addresses 128
 Maximum Controls 129

- Start and End Blocking Time 129
- Time Restriction 130
- Time Restrictions 128
- URL 128
- URL Filter 130
- User's Name 129
- Password 86
 - Admin 231
 - Support 231
 - User 231
- Password (Authenticate) 168
- Password Authentication Protocol 86, 113, 247
- Passwords
 - Levels 231
- Pause Time 175, 195
- Peer to Peer 117, 142, 247
- Personal Identification Number 153
- Personalize Your Greeting 238
- Phantom Extension 210
- Phantom Mailbox Extensions 20
- Phone (Extension) Number 168
- Phone Book 52, 69
- Phone Extension
 - Configuration 208
- Phone Lock/Unlock 52, 71
- Plain Old Telephone Service 171
- Plain Old Telephone Service (POTS)
 - Trunks 171
- Plug & Play (PnP) 52
- Plug and Play 71
- Point to Point Protocol over Ethernet 113, 247
- Port Triggering 119
- PPP 247
- PPPoE 86, 110, 113, 247
- Printer Server 144
- Programmable Feature Buttons 169
- Programmable Key
 - Call Park 169
 - Do Not Disturb 169
 - Live Record 169
 - Others 169
 - PSTN 169
 - SIP Telephone Extension 169
 - SIP Trunk 169
- Programmable Line Keys 169
- Prompt Language 203
- Protocol 248
- Proxy Server 95, 174
- PSK 152, 250
- PSTN 77, 87, 115, 171, 177, 248
 - Public Switched Telephone Network 79
- PSTN Line Number 188
- PSTN Lines 235
- PTC Configuration 232
- Public Service Telephone Network 248
- Public Switch Telephone Network 171, 248
- Public Switched Telephone Network

PSTN 79

Q

- QOS 248
- QoS 132, 134
- Quality of Service 132, 147, 248

R

- RADIUS 152, 250
- RADIUS Parameters 152
- Radius Port 152, 250
- Reboot System 234
- Record Greeting 238
- Record Your Name 238
- Register Server 95, 174
- Registered Phones 215
- Registrar Server 95, 174
- Registration 174
- Registration Configuration 168
- Release Guard Time 195
- Reminder Tone 52, 71
- Remote Authentication Dial in User Service 152, 250
- Remote Message Pickup 239
- Remote Worker 201
 - Session Timer 18
- Reroute Destination 190
- Reroute Time 188, 190
- Restore Default 221
- Restore Default Settings 221
- Restore System Backup 219
- Ring Abandon Time 195
- Ring Assignment 179
 - Day 179
 - Night 179
- Ring Recognition Time 195
- Ring Type 178
- RJ21X 76, 248
- Router 79, 248
- Routing Emergency Numbers 185
- RTP 134
- RTP Packet Size 204
- RTP Port 175

S

- Secure Sockets Layer 248
- Security (see Wireless Security) 248
- Sender E-mail Address 206
- Sender Password 206
- Sender User Name 206
- Service Mode 52, 72, 192
- Service Mode Configuration 192
- Service Name 143
- Service Set Identifier 89, 147, 148, 248
- Session Initiated Protocol 13, 248
- Session Timeout 175
- Session Timer 18

- Session Traversal Utilities 214
 - Session Traversal Utilities for NAT 248
 - Setup Wizard 82, 110, 114, 145, 186
 - Silence Detection 206
 - Simple Mail Transport Protocol 248
 - Single Digit Dial Menus 204
 - Single Digit Dialing 205
 - Auto Attendant 205
 - Extension 205
 - Greeting Mode 205
 - Null 205
 - UCD 205
 - Single Digit Dialing Table 204
 - Single Digit Table 204
 - Single Line Telephone 91
 - SIP 248
 - SIP Authentication 91
 - Trunk 171
 - SIP Extension Authentication 167
 - SIP IP Trunk Provider 95, 174
 - Authentication ID 95, 174
 - Authentication Password 95, 174
 - Outbound Proxy 95, 174
 - Phone Number 95, 174
 - Port - 5060 95, 174
 - Register Expires 95, 174
 - Register Server 95, 174
 - Register Status 95, 175
 - SIP Domain 95
 - SIP Proxy 95, 174
 - Support E.164 96, 175
 - User Name 95
 - SIP IP Trunks 79, 99
 - SIP Port 168, 175
 - SIP Telephone Endpoints 91
 - SIP Trunk 171
 - Direct Inward Dial (DID) 176
 - RPort 175
 - SIP Trunks 172
 - SMDR 198
 - SMDR Configuration 199
 - Log Mode 199
 - Start Time 199
 - SMDR Log 200
 - SMDR View
 - Extension 200
 - Month 200
 - Trunk 200
 - Type 200
 - SMTP 206, 248
 - SMTP Server 206
 - SMTP Server Port 206
 - SMTP Support SSL 206
 - Source IP Address 127
 - Speed Dial 191
 - SSID 89, 147, 148, 157, 248
 - SSL 248
 - Stand Alone Installation 14
 - Standalone 77
 - Static DNS 83, 111, 113
 - Static IP Address 85, 88, 110, 111, 115, 116, 245, 248
 - Static Route 138
 - Static Routing 137
 - Station Message Detail Recording 198
 - Statistics 105
 - WAN 106
 - STUN 214
 - Stutter Dial Tone 52
 - Subnet 16
 - Subnet Mask Address 83, 85, 88, 107, 112, 114, 115, 249
 - System Backup 219, 220
 - System Capacities 25
 - System Log 222
 - Display Warning 223
 - Enable 222
 - Log Level 222
 - Mode 223
 - System Specifications 23
- T
- TCP 117
 - TCP/IP 81
 - TCP/IP Backbone 16
 - TCP/UDP 117, 125
 - TDM 249
 - Telephone Line Access
 - Access Priority 178
 - Telephone Line Flash 52
 - The Host Name 111
 - Time Division Multiplexing 249
 - Time Settings 226
 - Internet Time 226
 - Time Zone Offset 226
 - Timer Enable 190
 - TKIP 152, 250
 - Tools
 - Update 220
 - TR-069 WAN Management 224
 - Transfer 73
 - Transfer Recall 52
 - Transmission 193
 - Audio 194
 - Codec Settings 194
 - Country 194
 - FXO 195
 - FXS 194
 - RTP Packet Size 194
 - Traveling Class of Service 31
 - Trunk
 - Central Office Line 171
 - Trunk Access 184
 - Trunk Group 188
 - DID 176

- Enable Label 178
- Group Assignment 178
- Label Name 178
- Ring Type 178
- Trunk Groups 177
- Trunk Priority
 - Search Order 178
- TSO 141
- Type of Service 134

U

- UCD
 - Agent Log On/Off 53
- UCD Group 189, 201
- UCD Log 201
- UDP 117, 152, 250
- Unified Call Distribution 201
- Unified Messaging 206
- Uniform Call Distribution 189, 201
- Uniform Resource Identifier 249
- Uniform Resource Name 249
- Uniformed Resoruce Locator 128
- Uninterrupted Power Supply 76
- Universal Plug and Play 88, 115, 142
- Universal Resource Locator 130
- Update
 - Restore System Backup 219
 - System Software 233
- Update Software 233
- UPnP 88, 115
- URL 128, 130, 249
- USB Port 144
- User Name 86
- Using Your Voice Mail 238

V

- Virtual Extension 210
- Virtual Extension Number 210
- Virtual Mailbox Extension 20
- Virtual Private Network 249
- Virtual Receptionist 202
- Virtual Server 117, 119
- Vocoder 249
- Voice 102
- Voice Mail 16
- Voice Mailbox 208
- Voice Network 15, 19, 77, 196, 197
 - Suggested Numbering Plan 92, 93
- Voice over Internet 13
- Voice over Internet Protocol 81
- Voice over IP 249
- Voicemail 237
 - Distribution Lists 209
 - Email Address 208
 - FTP view 213
 - Mailbox

- Disable 208
- Password 208
- Prompt Language 208
- Voicemail Extension 208
- Voicemail General Settings 203
- Voicemail Service Number 188
- Voicemail System 202
- VoIP 81, 249
- VoIP & Signalling Protocols 25
- Volume Control 52, 73
- VPN 249
 - Security Protocol 249
- VVA Code 204

W

- WAN 13, 77, 79, 82, 87, 104, 105, 115, 249
 - Statistics 106
 - TR-069 224
 - WAN Port 17, 83, 110, 111
 - WAN Port Settings 87
 - WAN Settings 82, 83
- WAN/eth0 137, 141
- WAP 89
- Web Management 52, 73
- Web Port 230
- Well Known Ports 152, 251
- WEP 151, 152, 250
- Wide Area Network 16, 24, 224, 249
- WiFi 24
 - Wi-Fi Alliance 152, 250
- Wi-Fi Multimedia 147
- Wi-Fi Protected Setup 151
- Wired Equivalent Privacy 152
- Wireless 102, 145
 - 802.11n protection 159
 - 802.11n Rate 159
 - 802.11n Support Client Only 159
 - Advanced 158
 - Band 158
 - Basic Rate 159
 - Beacon Interval 159
 - Channel 158
 - Control Sideband 159
 - DTIM Interval 159
 - Fragmentation Threshold 159
 - Guest Access 148
 - Guest Network 147
 - Max Clients 147
 - Maximum Clients 149
 - Multicast Rate 159
 - RTS Threshold 159
 - Security 150
 - Security Protocol 151
 - Station Info 161
 - Transmit Power 159
 - WPA-PSK 152
- Wireless Access Point 89, 154, 156, 157

Wireless Basic 82
Wireless Bridge 156, 157
Wireless Gateway 146
Wireless Interface 145
Wireless LAN 80, 89
Wireless MAC Filtering 154, 155
Wireless Power Saving 162
Wireless Security 146
 802.1x 152, 250
 Advanced Encryption Standard 152, 250
 AES 152, 250
 Open 152, 250
 Pre-Shared Key 152, 250
 PSK 152, 250
 RADIUS 152, 250
 RADIUS Port 152, 250
 Remote Authentication Dial In User Service 152, 250
 Security 123
 Shared 152, 250
 Temporal Key Integrity Protocol 152, 250
 TKIP 152, 250
 WEP 152, 250
 WiFi Equivalent Privacy 152, 250
 Wired Equivalent Privacy 152, 250
 Wireless Security 123
 WPA 152, 250
 WPA2 152, 250
WLAN 162
WMF 147, 149
WMM 147, 149, 160
Workgroup 143
World Wide Web 252
WPA 152, 250
WPA2 152, 250
WPS 151
www 252