

Vostro 3681

Service Manual

1



Notes, cautions, and warnings

 **NOTE:** A NOTE indicates important information that helps you make better use of your product.

 **CAUTION:** A CAUTION indicates either potential damage to hardware or loss of data and tells you how to avoid the problem.

 **WARNING:** A WARNING indicates a potential for property damage, personal injury, or death.

1 Working on your computer	5
Safety instructions	5
Before working inside your computer	5
Safety precautions	6
Electrostatic discharge—ESD protection	6
ESD field service kit	7
Transporting sensitive components	7
After working inside your computer	8
2 Technology and components	9
DDR4	9
USB features	10
HDMI 1.4b	12
3 Disassembly and reassembly	13
Recommended tools	13
Screw size list	13
System board layout	14
Side cover	14
Removing the side cover	14
Installing the side cover	16
Bezel	17
Removing the front bezel	17
Installing the front bezel	18
3.5 in. Hard disk drive	19
Removing the 3.5-inch hard drive	19
Installing the 3.5-inch hard drive	19
HDD/ODD Bracket	20
Removing the HDD/ODD bracket	20
Installing the HDD/ODD bracket	22
Optical drive	24
Removing the Optical Disk Drive	24
Installing the Optical Disk Drive	26
Memory module	27
Removing the memory modules	27
Installing the memory modules	28
Graphics card	29
Removing the graphics card	29
Installing the graphics card	30
Coin cell battery	31
Removing the coin-cell battery	31
Installing the coin-cell battery	31
M.2 2230 Solid state drive	32
Removing the 2230 solid-state drive	32

Installing the 2230 solid-state drive.....	33
M.2 2280 Solid state drive.....	34
Removing the 2280 solid-state drive.....	34
Installing the 2280 solid-state drive.....	35
WLAN Card.....	36
Removing the WLAN card.....	36
Installing the WLAN card.....	37
SD card.....	39
Removing the media card reader.....	39
Installing the media card reader.....	39
Power supply unit.....	40
Removing the power-supply unit.....	40
Installing the power-supply unit.....	42
Heatsink assembly.....	45
Removing the heatsink assembly.....	45
Installing the heatsink assembly.....	46
Processor.....	47
Removing the processor.....	47
Installing the processor.....	49
System board.....	50
Removing the system board.....	50
Installing the system board.....	53
4 Troubleshooting.....	57
Real-Time Clock (RTC Reset).....	57
System diagnostic lights.....	57
Diagnostic error messages.....	58
System error messages.....	61
Recovering the operating system.....	61
Flashing BIOS (USB key).....	62
Flashing the BIOS.....	62
WiFi power cycle.....	62
5 Getting help and contacting Dell.....	63

Working on your computer

Safety instructions

Prerequisites

Use the following safety guidelines to protect your computer from potential damage and to ensure your personal safety. Unless otherwise noted, each procedure included in this document assumes that the following conditions exist:

- You have read the safety information that shipped with your computer.
- A component can be replaced or, if purchased separately, installed by performing the removal procedure in reverse order.

About this task

 **NOTE:** Disconnect all power sources before opening the computer cover or panels. After you finish working inside the computer, replace all covers, panels, and screws before connecting to the power source.

 **WARNING:** Before working inside your computer, read the safety information that shipped with your computer. For additional safety best practices information, see the [Regulatory Compliance Homepage](#)

 **CAUTION:** Many repairs may only be done by a certified service technician. You should only perform troubleshooting and simple repairs as authorized in your product documentation, or as directed by the online or telephone service and support team. Damage due to servicing that is not authorized by Dell is not covered by your warranty. Read and follow the safety instructions that came with the product.

 **CAUTION:** To avoid electrostatic discharge, ground yourself by using a wrist grounding strap or by periodically touching an unpainted metal surface at the same time as touching a connector on the back of the computer.

 **CAUTION:** Handle components and cards with care. Do not touch the components or contacts on a card. Hold a card by its edges or by its metal mounting bracket. Hold a component such as a processor by its edges, not by its pins.

 **CAUTION:** When you disconnect a cable, pull on its connector or on its pull-tab, not on the cable itself. Some cables have connectors with locking tabs; if you are disconnecting this type of cable, press in on the locking tabs before you disconnect the cable. As you pull connectors apart, keep them evenly aligned to avoid bending any connector pins. Also, before you connect a cable, ensure that both connectors are correctly oriented and aligned.

 **NOTE:** The color of your computer and certain components may appear differently than shown in this document.

 **CAUTION:** System will shut down if side covers are removed while the system is running. The system will not power on if the side cover is removed.

Before working inside your computer

About this task

To avoid damaging your computer, perform the following steps before you begin working inside the computer.

Steps

1. Ensure that you follow the [Safety Instruction](#).
2. Ensure that your work surface is flat and clean to prevent the computer cover from being scratched.
3. Turn off your computer.
4. Disconnect all network cables from the computer.

 **CAUTION:** To disconnect a network cable, first unplug the cable from your computer and then unplug the cable from the network device.

5. Disconnect your computer and all attached devices from their electrical outlets.
6. Press and hold the power button while the computer is unplugged to ground the system board.

 **NOTE:** To avoid electrostatic discharge, ground yourself by using a wrist grounding strap or by periodically touching an unpainted metal surface at the same time as touching a connector on the back of the computer.

Safety precautions

The safety precautions chapter details the primary steps to be taken before performing any disassembly instructions.

Observe the following safety precautions before you perform any installation or break/fix procedures involving disassembly or reassembly:

- Turn off the system and all attached peripherals.
- Disconnect the system and all attached peripherals from AC power.
- Disconnect all network cables, telephone, and telecommunications lines from the system.
- Use an ESD field service kit when working inside any tablet/notebook/desktop to avoid electrostatic discharge (ESD) damage.
- After removing any system component, carefully place the removed component on an anti-static mat.
- Wear shoes with non-conductive rubber soles to reduce the chance of getting electrocuted.

Standby power

Dell products with standby power must be unplugged before you open the case. Systems that incorporate standby power are essentially powered while turned off. The internal power enables the system to be remotely turned on (wake on LAN) and suspended into a sleep mode and has other advanced power management features.

Unplugging, pressing and holding the power button for 15 seconds should discharge residual power in the system board.

Bonding

Bonding is a method for connecting two or more grounding conductors to the same electrical potential. This is done through the use of a field service electrostatic discharge (ESD) kit. When connecting a bonding wire, ensure that it is connected to bare metal and never to a painted or non-metal surface. The wrist strap should be secure and in full contact with your skin, and ensure that you remove all jewelry such as watches, bracelets, or rings prior to bonding yourself and the equipment.

Electrostatic discharge—ESD protection

ESD is a major concern when you handle electronic components, especially sensitive components such as expansion cards, processors, memory DIMMs, and system boards. Very slight charges can damage circuits in ways that may not be obvious, such as intermittent problems or a shortened product life span. As the industry pushes for lower power requirements and increased density, ESD protection is an increasing concern.

Due to the increased density of semiconductors used in recent Dell products, the sensitivity to static damage is now higher than in previous Dell products. For this reason, some previously approved methods of handling parts are no longer applicable.

Two recognized types of ESD damage are catastrophic and intermittent failures.

- **Catastrophic** – Catastrophic failures represent approximately 20 percent of ESD-related failures. The damage causes an immediate and complete loss of device functionality. An example of catastrophic failure is a memory DIMM that has received a static shock and immediately generates a "No POST/No Video" symptom with a beep code emitted for missing or nonfunctional memory.
- **Intermittent** – Intermittent failures represent approximately 80 percent of ESD-related failures. The high rate of intermittent failures means that most of the time when damage occurs, it is not immediately recognizable. The DIMM receives a static shock, but the tracing is merely weakened and does not immediately produce outward symptoms related to the damage. The weakened trace may take weeks or months to melt, and in the meantime may cause degradation of memory integrity, intermittent memory errors, etc.

The more difficult type of damage to recognize and troubleshoot is the intermittent (also called latent or "walking wounded") failure.

Perform the following steps to prevent ESD damage:

- Use a wired ESD wrist strap that is properly grounded. The use of wireless anti-static straps is no longer allowed; they do not provide adequate protection. Touching the chassis before handling parts does not ensure adequate ESD protection on parts with increased sensitivity to ESD damage.
- Handle all static-sensitive components in a static-safe area. If possible, use anti-static floor pads and workbench pads.

- When unpacking a static-sensitive component from its shipping carton, do not remove the component from the anti-static packing material until you are ready to install the component. Before unwrapping the anti-static packaging, ensure that you discharge static electricity from your body.
- Before transporting a static-sensitive component, place it in an anti-static container or packaging.

ESD field service kit

The unmonitored Field Service kit is the most commonly used service kit. Each Field Service kit includes three main components: anti-static mat, wrist strap, and bonding wire.

Components of an ESD field service kit

The components of an ESD field service kit are:

- **Anti-Static Mat** – The anti-static mat is dissipative and parts can be placed on it during service procedures. When using an anti-static mat, your wrist strap should be snug and the bonding wire should be connected to the mat and to any bare metal on the system being worked on. Once deployed properly, service parts can be removed from the ESD bag and placed directly on the mat. ESD-sensitive items are safe in your hand, on the ESD mat, in the system, or inside a bag.
- **Wrist Strap and Bonding Wire** – The wrist strap and bonding wire can be either directly connected between your wrist and bare metal on the hardware if the ESD mat is not required, or connected to the anti-static mat to protect hardware that is temporarily placed on the mat. The physical connection of the wrist strap and bonding wire between your skin, the ESD mat, and the hardware is known as bonding. Use only Field Service kits with a wrist strap, mat, and bonding wire. Never use wireless wrist straps. Always be aware that the internal wires of a wrist strap are prone to damage from normal wear and tear, and must be checked regularly with a wrist strap tester in order to avoid accidental ESD hardware damage. It is recommended to test the wrist strap and bonding wire at least once per week.
- **ESD Wrist Strap Tester** – The wires inside of an ESD strap are prone to damage over time. When using an unmonitored kit, it is a best practice to regularly test the strap prior to each service call, and at a minimum, test once per week. A wrist strap tester is the best method for doing this test. If you do not have your own wrist strap tester, check with your regional office to find out if they have one. To perform the test, plug the wrist-strap's bonding-wire into the tester while it is strapped to your wrist and push the button to test. A green LED is lit if the test is successful; a red LED is lit and an alarm sounds if the test fails.
- **Insulator Elements** – It is critical to keep ESD sensitive devices, such as plastic heat sink casings, away from internal parts that are insulators and often highly charged.
- **Working Environment** – Before deploying the ESD Field Service kit, assess the situation at the customer location. For example, deploying the kit for a server environment is different than for a desktop or portable environment. Servers are typically installed in a rack within a data center; desktops or portables are typically placed on office desks or cubicles. Always look for a large open flat work area that is free of clutter and large enough to deploy the ESD kit with additional space to accommodate the type of system that is being repaired. The workspace should also be free of insulators that can cause an ESD event. On the work area, insulators such as Styrofoam and other plastics should always be moved at least 12 inches or 30 centimeters away from sensitive parts before physically handling any hardware components.
- **ESD Packaging** – All ESD-sensitive devices must be shipped and received in static-safe packaging. Metal, static-shielded bags are preferred. However, you should always return the damaged part using the same ESD bag and packaging that the new part arrived in. The ESD bag should be folded over and taped shut and all the same foam packing material should be used in the original box that the new part arrived in. ESD-sensitive devices should be removed from packaging only at an ESD-protected work surface, and parts should never be placed on top of the ESD bag because only the inside of the bag is shielded. Always place parts in your hand, on the ESD mat, in the system, or inside an anti-static bag.
- **Transporting Sensitive Components** – When transporting ESD sensitive components such as replacement parts or parts to be returned to Dell, it is critical to place these parts in anti-static bags for safe transport.

ESD protection summary

It is recommended that all field service technicians use the traditional wired ESD grounding wrist strap and protective anti-static mat at all times when servicing Dell products. In addition, it is critical that technicians keep sensitive parts separate from all insulator parts while performing service and that they use anti-static bags for transporting sensitive components.

Transporting sensitive components

When transporting ESD sensitive components such as replacement parts or parts to be returned to Dell, it is critical to place these parts in anti-static bags for safe transport.

Lifting equipment

Adhere to the following guidelines when lifting heavy weight equipment:

 **CAUTION: Do not lift greater than 50 pounds. Always obtain additional resources or use a mechanical lifting device.**

1. Get a firm balanced footing. Keep your feet apart for a stable base, and point your toes out.
2. Tighten stomach muscles. Abdominal muscles support your spine when you lift, offsetting the force of the load.
3. Lift with your legs, not your back.
4. Keep the load close. The closer it is to your spine, the less force it exerts on your back.
5. Keep your back upright, whether lifting or setting down the load. Do not add the weight of your body to the load. Avoid twisting your body and back.
6. Follow the same techniques in reverse to set the load down.

After working inside your computer

About this task

After you complete any replacement procedure, ensure that you connect any external devices, cards, and cables before turning on your computer.

Steps

1. Connect any telephone or network cables to your computer.

 **CAUTION: To connect a network cable, first plug the cable into the network device and then plug it into the computer.**

2. Connect your computer and all attached devices to their electrical outlets.
3. Turn on your computer.
4. If required, verify that the computer works correctly by running **ePSA diagnostics**.

Technology and components

This chapter details the technology and components available in the system.

DDR4

DDR4 (double data rate fourth generation) memory is a higher-speed successor to the DDR2 and DDR3 technologies and allows up to 512 GB in capacity, compared to the DDR3's maximum of 128 GB per DIMM. DDR4 synchronous dynamic random-access memory is keyed differently from both SDRAM and DDR to prevent the user from installing the wrong type of memory into the system.

DDR4 needs 20 percent less or just 1.2 volts, compared to DDR3 which requires 1.5 volts of electrical power to operate. DDR4 also supports a new, deep power-down mode that allows the host device to go into standby without needing to refresh its memory. Deep power-down mode is expected to reduce standby power consumption by 40 to 50 percent.

DDR4 Details

There are subtle differences between DDR3 and DDR4 memory modules, as listed below.

Key notch difference

The key notch on a DDR4 module is in a different location from the key notch on a DDR3 module. Both notches are on the insertion edge but the notch location on the DDR4 is slightly different, to prevent the module from being installed into an incompatible board or platform.

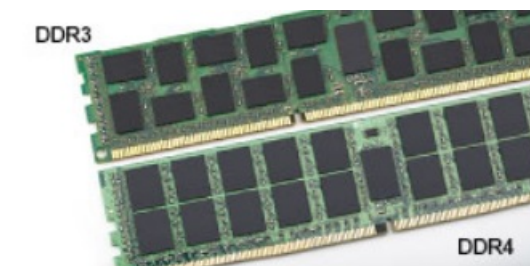

Figure 1. Notch difference

Increased thickness

DDR4 modules are slightly thicker than DDR3, to accommodate more signal layers.



Figure 2. Thickness difference

Curved edge

DDR4 modules feature a curved edge to help with insertion and alleviate stress on the PCB during memory installation.



Figure 3. Curved edge

Memory Errors

Memory errors on the system display 2,3 failure code. If all memory fails, the LCD does not turn on. Troubleshoot for possible memory failure by trying known good memory modules in the memory connectors on the bottom of the system or under the keyboard, as in some portable systems.

NOTE: The DDR4 memory is imbedded in board and not a replaceable DIMM as shown and referred.

USB features

Universal Serial Bus, or USB, was introduced in 1996. It dramatically simplified the connection between host computers and peripheral devices like mice, keyboards, external drives, and printers.

Table 1. USB evolution

Type	Data Transfer Rate	Category	Introduction Year
USB 2.0	480 Mbps	High Speed	2000
USB 3.2 Gen 1	5 Gbps	SuperSpeed	2010

USB 3.2 Gen 1 (SuperSpeed USB)

For years, the USB 2.0 has been firmly entrenched as the de facto interface standard in the PC world with about 6 billion devices sold, and yet the need for more speed grows by ever faster computing hardware and ever greater bandwidth demands. The USB 3.1 Gen 2 finally has the answer to the consumers' demands with a theoretically 10 times faster than its predecessor. In a nutshell, USB 3.2 Gen 1 features are as follows:

- Higher transfer rates (up to 5 Gbps)
- Increased maximum bus power and increased device current draw to better accommodate power-hungry devices
- New power management features
- Full-duplex data transfers and support for new transfer types
- Backward USB 2.0 compatibility
- New connectors and cable

The topics below cover some of the most commonly asked questions regarding USB 3.2 Gen 1.



Speed

Currently, there are 3 speed modes defined by the latest USB 3.2 Gen 1/USB 3.2 Gen 1 and USB 3.2 Gen 2x2 specification. They are Super-Speed, Hi-Speed and Full-Speed. The new SuperSpeed mode has a transfer rate of 4.8 Gbps. While the specification retains Hi-Speed, and Full-Speed USB mode, commonly known as USB 2.0 and 1.1 respectively, the slower modes still operate at 480 Mbps and 12 Mbps respectively and are kept to maintain backward compatibility.

USB 3.2 Gen 1 achieves the much higher performance by the technical changes below:

- An additional physical bus that is added in parallel with the existing USB 2.0 bus (refer to the picture below).
- USB 2.0 previously had four wires (power, ground, and a pair for differential data); USB 3.0/USB 3.1 Gen 1 adds four more for two pairs of differential signals (receive and transmit) for a combined total of eight connections in the connectors and cabling.
- USB 3.2 Gen 1 utilizes the bidirectional data interface, rather than USB 2.0's half-duplex arrangement. This gives a 10-fold increase in theoretical bandwidth.

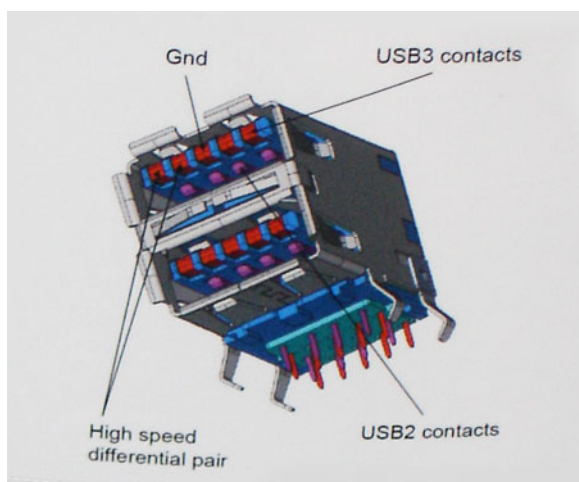

With today's ever increasing demands placed on data transfers with high-definition video content, terabyte storage devices, high megapixel count digital cameras etc., USB 2.0 may not be fast enough. Furthermore, no USB 2.0 connection could ever come close to the 480Mbps theoretical maximum throughput, making data transfer at around 320 Mbps (40 MB/s) — the actual real-world maximum. Similarly, USB 3.0/USB 3.1 Gen 1 connections will never achieve 4.8Gbps. We will likely see a real-world maximum rate of 400MB/s with overheads. At this speed, USB 3.0/USB 3.1 Gen 1 is a 10x improvement over USB 2.0.

Applications

USB 3.2 Gen 1 opens up the laneways and provides more headroom for devices to deliver a better overall experience. Where USB video was barely tolerable previously (both from a maximum resolution, latency, and video compression perspective), it's easy to imagine that with 5-10 times the bandwidth available, USB video solutions should work that much better. Single-link DVI requires almost 2 Gbps throughput. Where 480Mbps was limiting, 5Gbps is more than promising. With its promised 4.8Gbps speed, the standard will find its way into some products that previously weren't USB territory, like external RAID storage systems.

Listed below are some of the available SuperSpeed USB 3.2 Gen 1 products:

- External Desktop USB Hard Drives
- Portable USB Hard Drives
- USB Drive Docks & Adapters
- USB Flash Drives & Readers
- USB Solid-state Drives
- USB RAIDs
- Optical Media Drives
- Multimedia Devices
- Networking
- USB Adapter Cards & Hubs

Compatibility

The good news is that USB 3.2 Gen 1 has been carefully planned from the start to peacefully co-exist with USB 2.0. First of all, while USB 3.2 Gen 1 specifies new physical connections and thus new cables to take advantage of the higher speed capability of the new protocol, the connector itself remains the same rectangular shape with the four USB 2.0 contacts in the exact same location as before. Five new connections to carry receive and transmitted data independently are present on USB 3.2 Gen 1 cables and only come into contact when connected to a proper SuperSpeed USB connection.

HDMI 1.4b

This topic explains the HDMI 1.4b and its features along with the advantages.

HDMI (High-Definition Multimedia Interface) is an industry-supported, uncompressed, all-digital audio/video interface. HDMI provides an interface between any compatible digital audio/video source, such as a DVD player, or A/V receiver and a compatible digital audio and/or video monitor, such as a digital TV (DTV). The intended applications for HDMI TVs, and DVD players. The primary advantage is cable reduction and content protection provisions. HDMI supports standard, enhanced, or high-definition video, plus multichannel digital audio on a single cable.

HDMI 1.4b Features

- **HDMI Ethernet Channel** - Adds high-speed networking to an HDMI link, allowing users to take full advantage of their IP-enabled devices without a separate Ethernet cable
- **Audio Return Channel** - Allows an HDMI-connected TV with a built-in tuner to send audio data "upstream" to a surround audio system, eliminating the need for a separate audio cable
- **3D** - Defines input/output protocols for major 3D video formats, paving the way for true 3D gaming and 3D home theater applications
- **Content Type** - Real-time signaling of content types between display and source devices, enabling a TV to optimize picture settings based on content type
- **Additional Color Spaces** - Adds support for additional color models used in digital photography and computer graphics
- **4K Support** - Enables video resolutions far beyond 1080p, supporting next-generation displays that will rival the Digital Cinema systems used in many commercial movie theaters
- **HDMI Micro Connector** - A new, smaller connector for phones and other portable devices, supporting video resolutions up to 1080p
- **Automotive Connection System** - New cables and connectors for automotive video systems, designed to meet the unique demands of the motoring environment while delivering true HD quality

Advantages of HDMI

- Quality HDMI transfers uncompressed digital audio and video for the highest, crispest image quality.
- Low -cost HDMI provides the quality and functionality of a digital interface while also supporting uncompressed video formats in a simple, cost-effective manner
- Audio HDMI supports multiple audio formats from standard stereo to multichannel surround sound
- HDMI combines video and multichannel audio into a single cable, eliminating the cost, complexity, and confusion of multiple cables currently used in A/V systems
- HDMI supports communication between the video source (such as a DVD player) and the DTV, enabling new functionality

Disassembly and reassembly



Recommended tools

The procedures in this document require the following tools:

- Small flat blade screwdriver
- Phillips # 1 screwdriver
- Small plastic scribe
- Hex screwdriver

Screw size list

Table 2. Screw size list

Component	M2x3 	M2X4 	6-32X1/4" 
Hard drive			1
HDD/ODD bracket			1
Optical drive	1		
WLAN	1		
SSD card	1		
Power supply unit (PSU)			3
IO module			6
Internal antenna			
Card reader			2
System board		1	8
Front IO bracket			1

System board layout

This section illustrates the system board and calls out the ports and connectors.

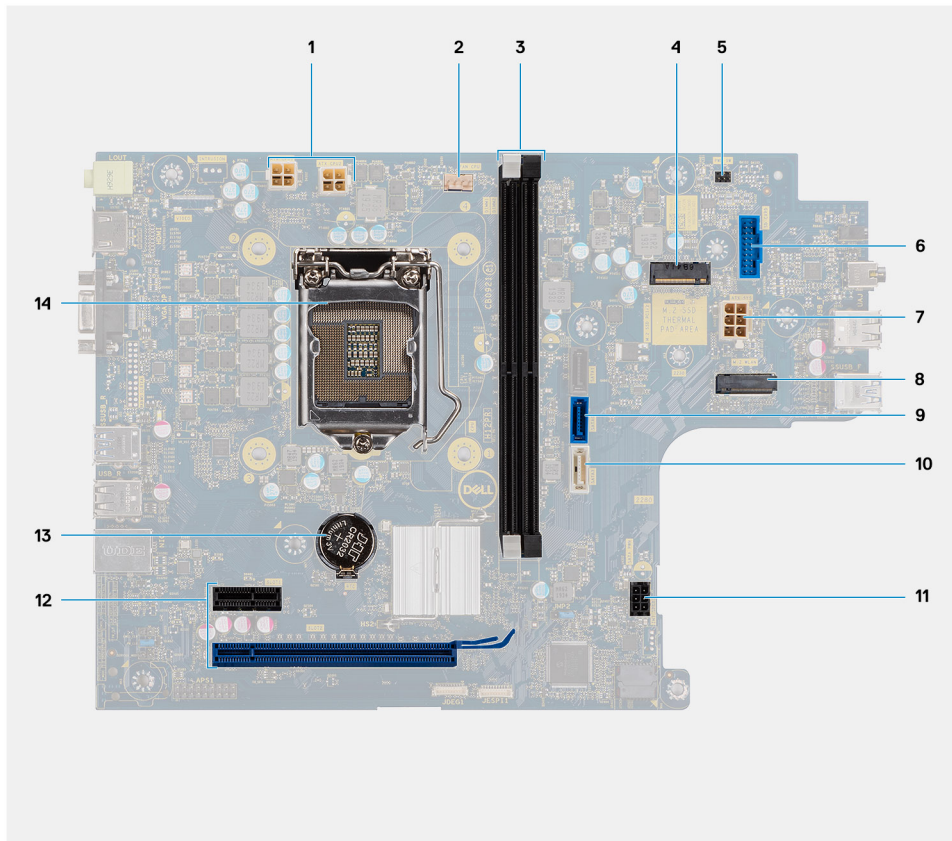

1. ATX Power connector (ATX_CPU1 and ATX_CPU2)
2. CPU fan connector (Fan_CPU)
3. Memory-module slots (DIMM1, DIMM2)
4. M.2 2230/2280 connector (for SSD)
5. Power switch connector (PWR_SW)
6. SD card reader connector
7. ATX Power connector(ATX_SYS)
8. M.2 2230 connector (for WLAN card)
9. SATA 3.0 data connector (SATA0)
10. SATA 3.0 data connector (SATA3)
11. SATA 3.0 power connector (SATA_PWR)
12. PCIe expansion slots (SLOT1: PCIe x1, SLOT2: PCIe x16)
13. Coin-cell battery
14. CPU socket

Side cover

Removing the side cover

Prerequisites

1. Follow the procedure in [Before working inside your computer](#).

About this task

The following images indicate the location of the side cover and provide a visual representation of the removal procedure:

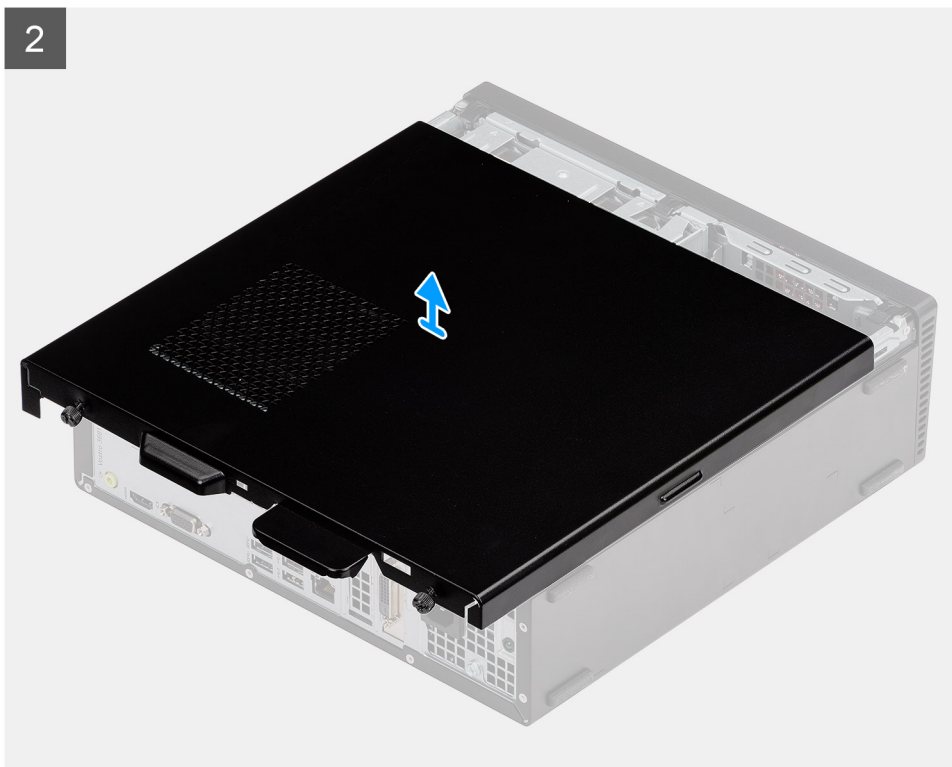

Steps

1. Loosen the two captive screws and slide the side cover to release it from the chassis.
2. Lift the side cover, off the chassis.

Installing the side cover

Prerequisites

If you are replacing a component, remove the existing component before performing the installation procedure:

About this task

The following images indicate the location of the side cover and provide a visual representation of the installation procedure:

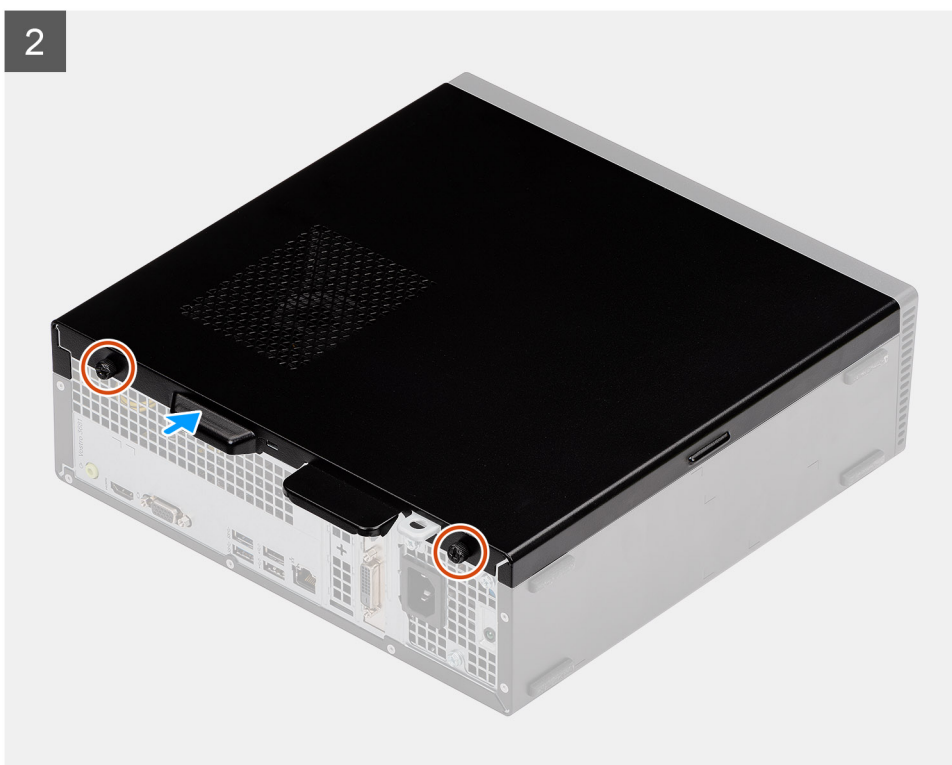
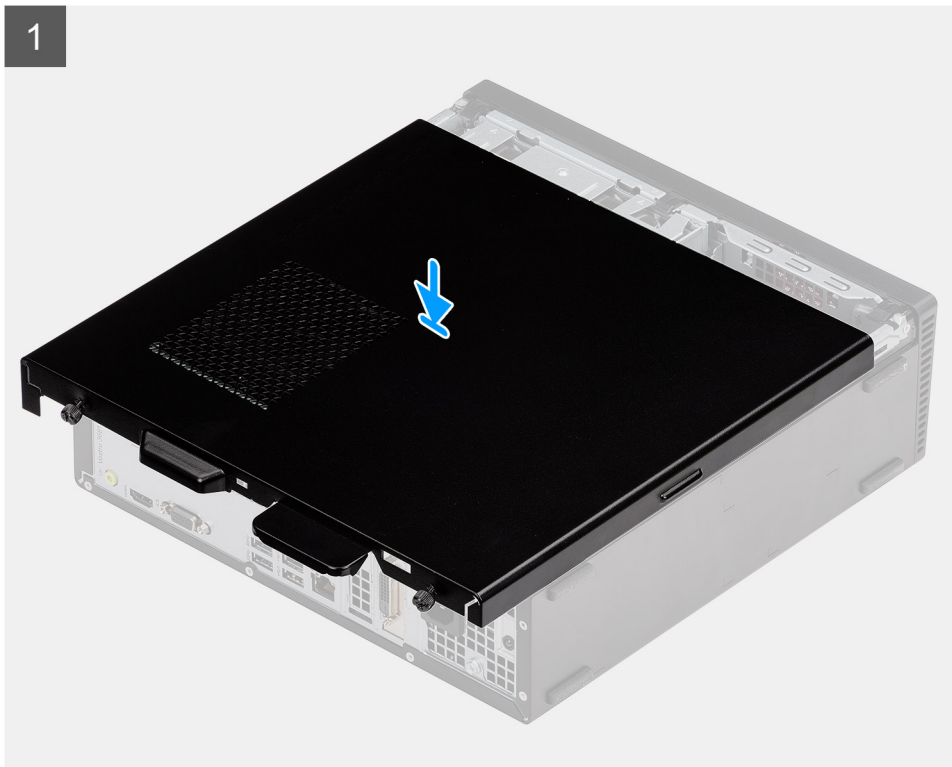

Steps

1. Align the tabs on the side cover with the slots and replace the side cover on the chassis.
2. Slide the side cover towards the front of the unit and tighten the two cap screws to secure the side cover to the chassis.

Next steps

1. Follow the procedure in [After working inside your computer](#).

Bezel

Removing the front bezel

Prerequisites

1. Follow the procedure in [Before working inside your computer](#).
2. Remove the [side cover](#).
3. Place the computer in an upright position.

About this task

The following images indicate the location of the front bezel and provide a visual representation of the removal procedure:

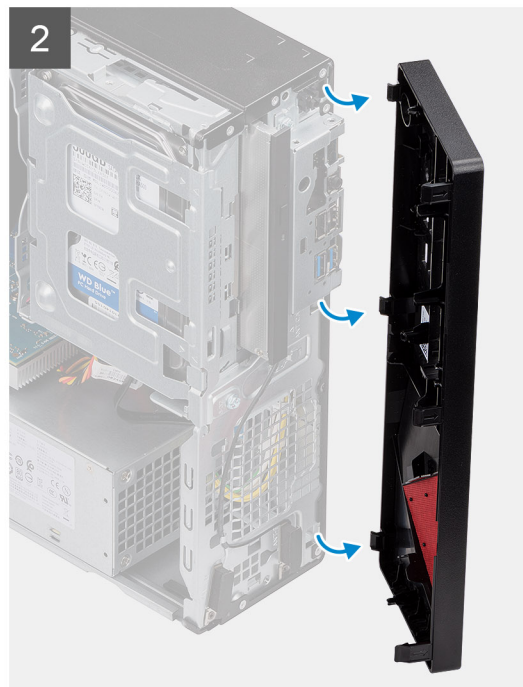
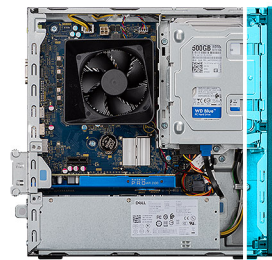

Steps

1. Gently pry and release the front bezel tabs sequentially from the top.
2. Rotate the front cover outward from the chassis.

Installing the front bezel

Prerequisites

If you are replacing a component, remove the existing component before performing the installation procedure.

- Place the computer in an upright position.

About this task

The following images indicate the location of the front bezel and provide a visual representation of the installation procedure:

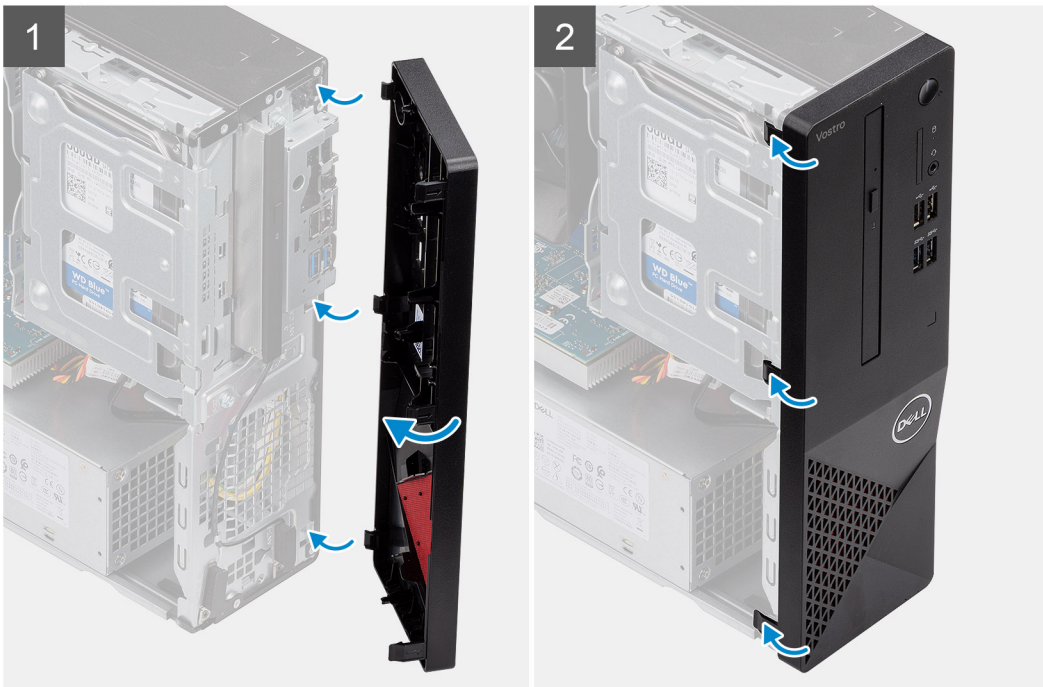
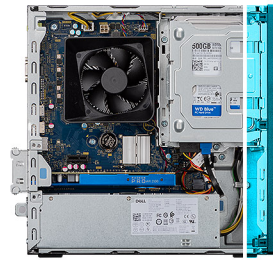

Steps

1. Align the tabs on the bezel with the slots on the chassis.
2. Rotate the front cover towards the chassis and snap it into place.

Next steps

1. Install the [side cover](#).
2. Follow the procedure in [After working inside your computer](#).

3.5 in. Hard disk drive

Removing the 3.5-inch hard drive

Prerequisites

1. Follow the procedure in [Before working inside your computer](#).
2. Remove the [side cover](#).

About this task

The following images indicate the location of the 3.5-inch hard drive and provides a visual representation of the removal procedure:

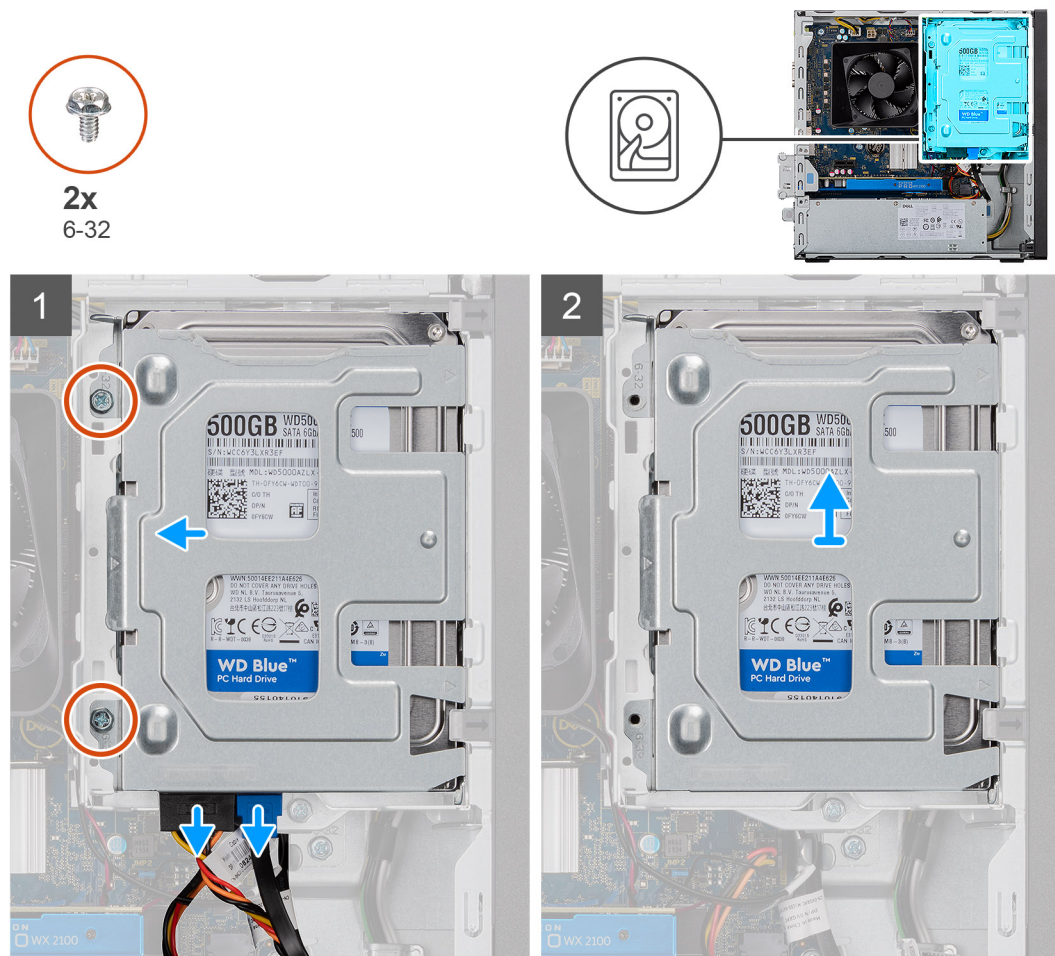

Steps

1. Disconnect the data and power SATA cables from the hard drive and remove the two #6-32 screws.
2. Lift and remove the 3.5 inch hard drive from the bracket.

Installing the 3.5-inch hard drive

Prerequisites

If you are replacing a component, remove the existing component before performing the installation procedure.

About this task

The following images indicate the location of the 3.5-inch hard drive and provides a visual representation of the installation procedure:

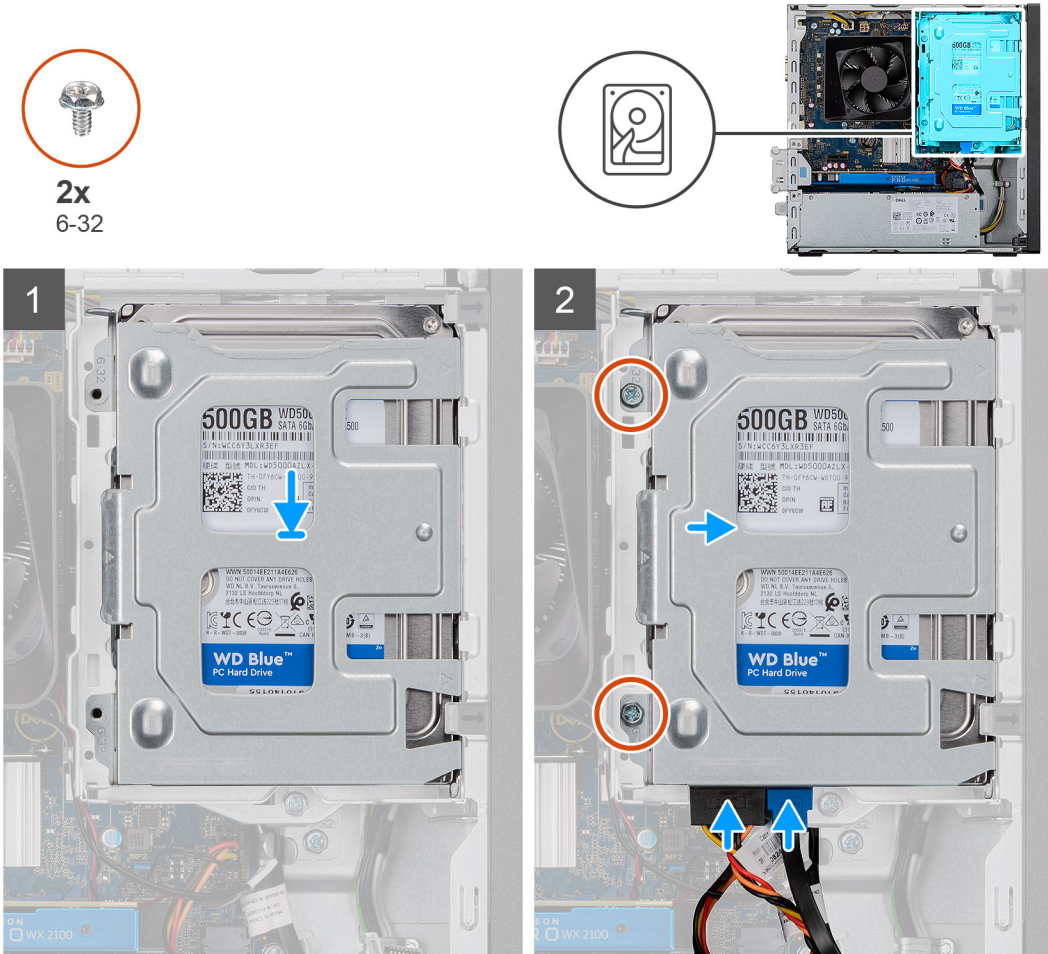

Steps

1. Place the hard drive into the hard-drive bracket and align the tabs on the bracket with the slots on the hard drive.
2. Secure the two #6-32 screws securing the 3.5 in. hard drive to the bracket.

Next steps

1. Install the [side cover](#).
2. Follow the procedure in [After working inside your computer](#).

HDD/ODD Bracket

Removing the HDD/ODD bracket

Prerequisites

1. Follow the procedure in [Before working inside your computer](#).
2. Remove the [side cover](#).
3. Remove the [3.5 in. HDD](#).

About this task

The following image indicates the location of the HDD/ODD bracket and provides a visual representation of the removal procedure.



1x
6-32

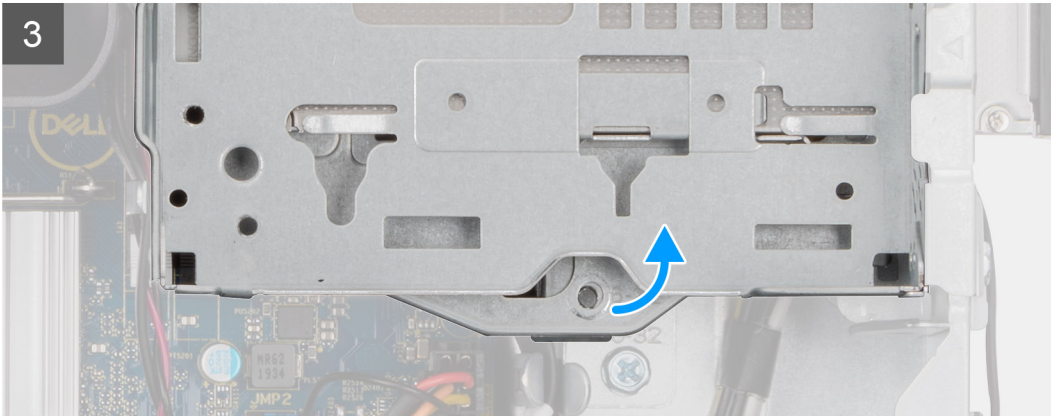
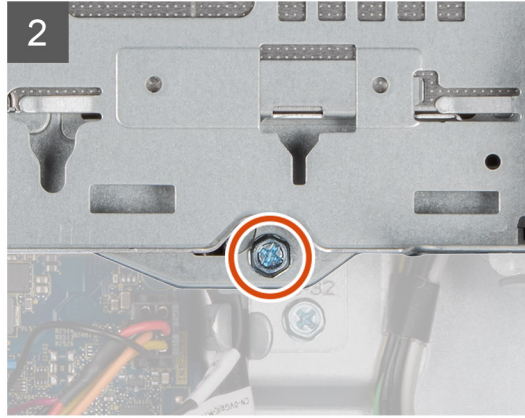

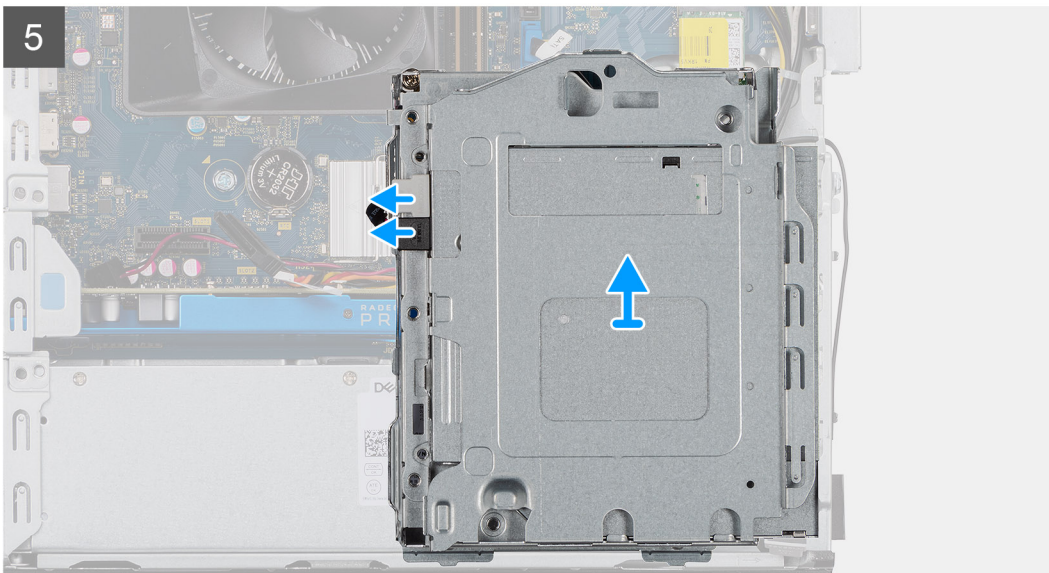
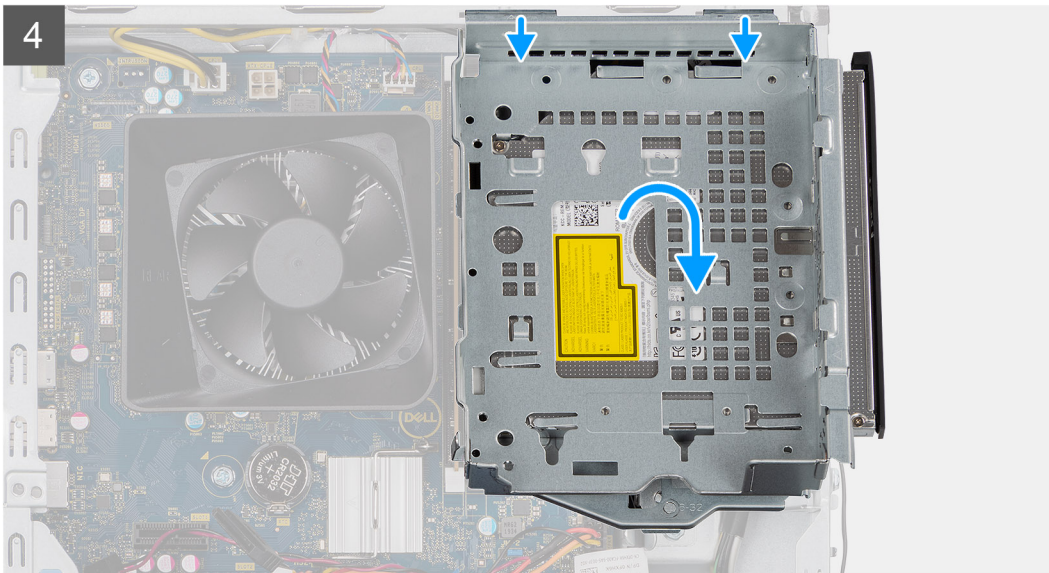

Steps

1. Release the ODD power and SATA cables from tabs on the side of the ODD bracket.
2. Remove the single #6-32 screw securing the ODD bracket to the chassis.
3. Lift the ODD bracket from the chassis.
4. Push the ODD to unlock it.
5. Disconnect the SATA power and data connectors from the ODD.
6. Lift and remove the ODD bracket from the chassis.

Installing the HDD/ODD bracket

Prerequisites

If you are replacing a component, remove the existing component before performing the installation procedure.

About this task

The following images indicate the location of the HDD/ODD bracket and provides a visual representation of the installation procedure:

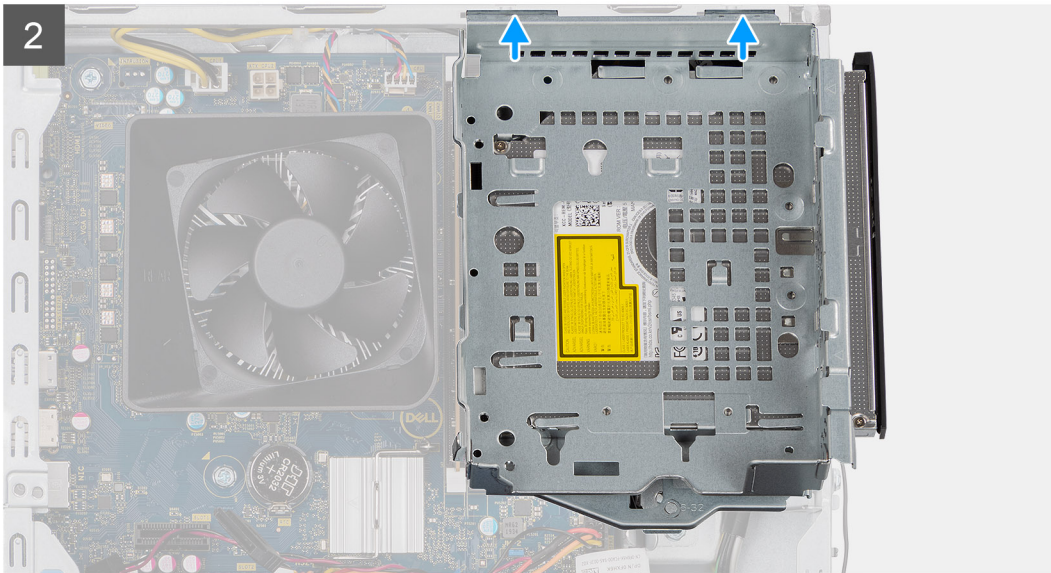
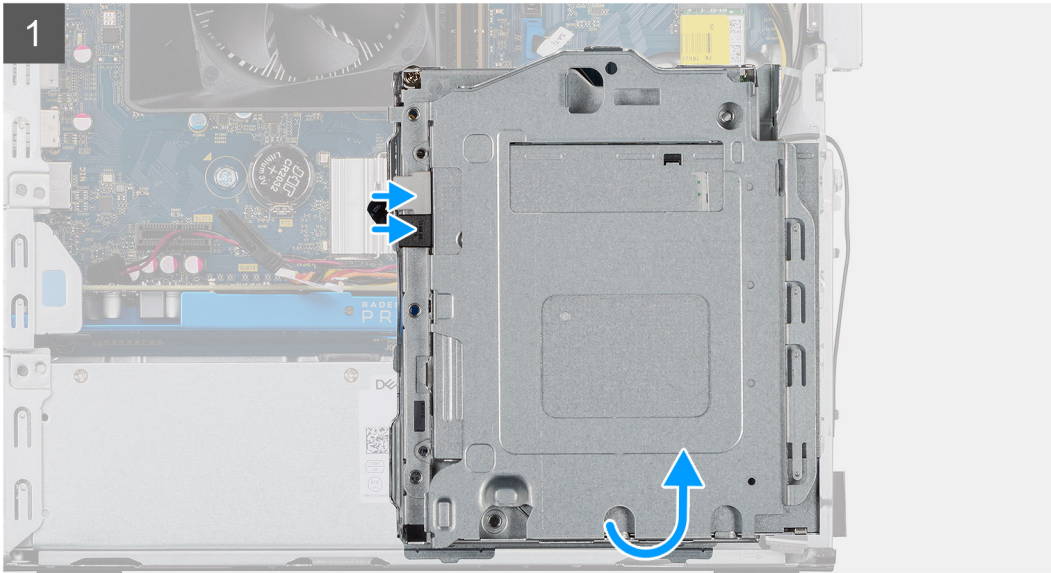



1x
6-32

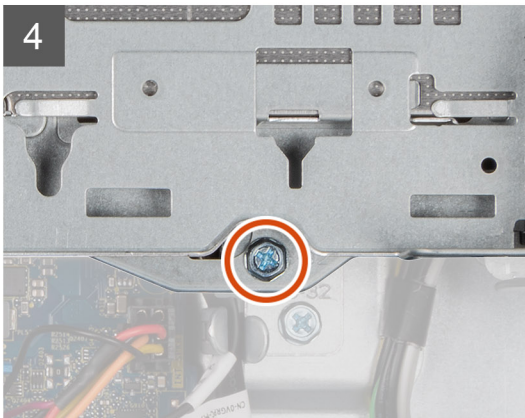

Steps

1. Align and place the ODD bracket on the system unit chassis and connect the ODD SATA and power connectors
2. Push the ODD bracket into the chassis.
3. Snap the ODD bracket aligning the holes on the ODD bracket with that on the chassis.
4. Replace the single #6-32 screw securing the ODD to the chassis.
5. Tuck the power SATA cables along the tabs of the ODD bracket.

Next steps

1. Install the [3.5 in. HDD](#).
2. Install the [side cover](#).
3. Follow the procedure in [After working inside your computer](#).

Optical drive

Removing the Optical Disk Drive

Prerequisites

1. Follow the procedure in [Before working inside your computer](#).

2. Remove the [side cover](#).
3. Remove the [3.5 in. HDD](#).
4. Remove the [HDD/ODD bracket](#).

About this task

The following images indicate the location of the ODD and provides a visual representation of the removal procedure.



1x
M2x3

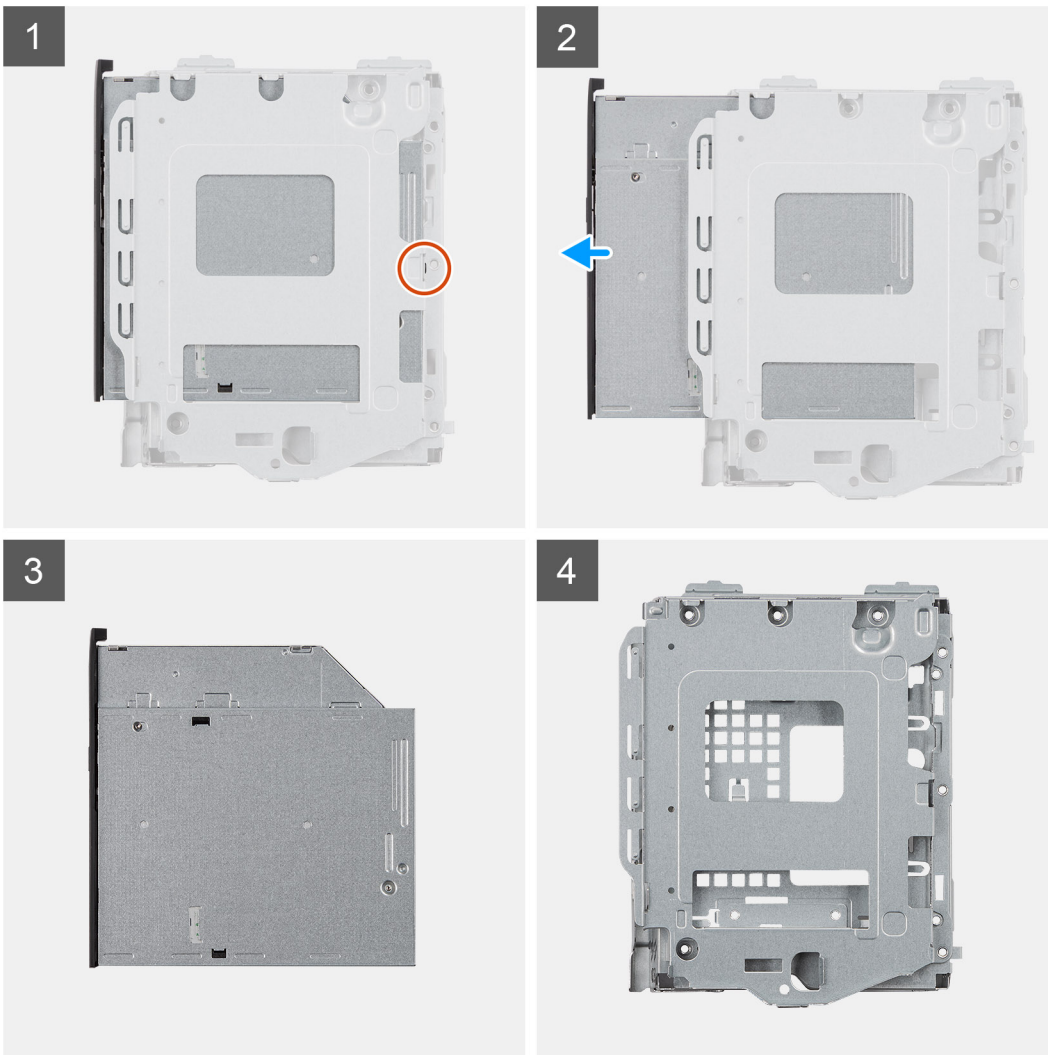

Steps

1. Remove the single M2x3 screw securing the optical drive to the bracket.
2. Remove the optical drive from the bracket.

Installing the Optical Disk Drive

Prerequisites

If you are replacing a component, remove the existing component before performing the installation procedure.

About this task

The following images indicate the location of the Optical Disk Drive and provide a visual representation of the installation procedure:



1x
M2x3

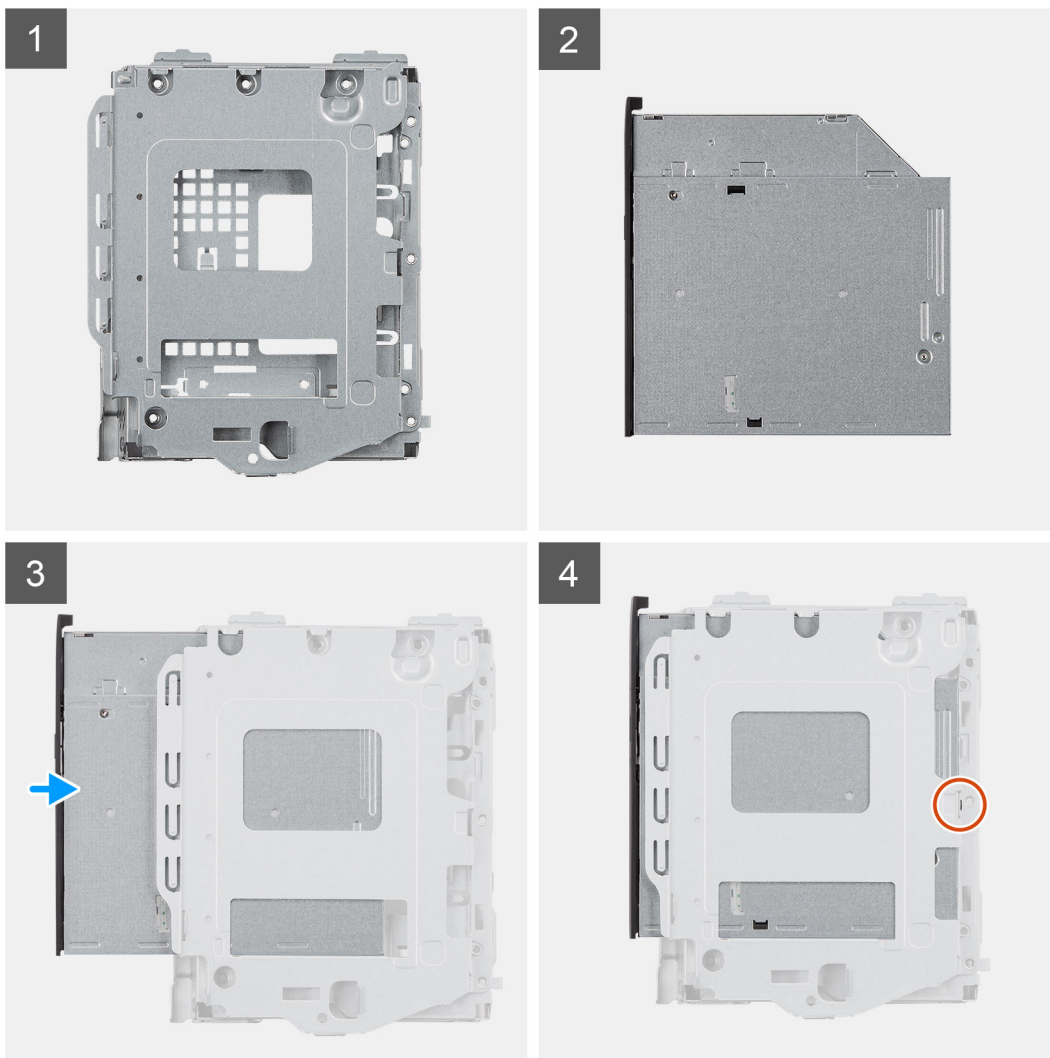

Steps

1. Insert the optical drive into the ODD bracket.
2. Replace the single M2x3 screw securing the optical drive to the bracket.

Next steps

1. Install the [HDD/ODD bracket](#).
2. Install the [3.5 in. HDD](#).
3. Install the [side cover](#).
4. Follow the procedure in [After working inside your computer](#).

Memory module

Removing the memory modules

Prerequisites

1. Follow the procedure in [Before working inside your computer](#).
2. Remove the [side cover](#).
3. Remove the [HDD/ODD bracket](#).

About this task

The following images indicate the location of the memory modules and provide a visual representation of the removal procedure:

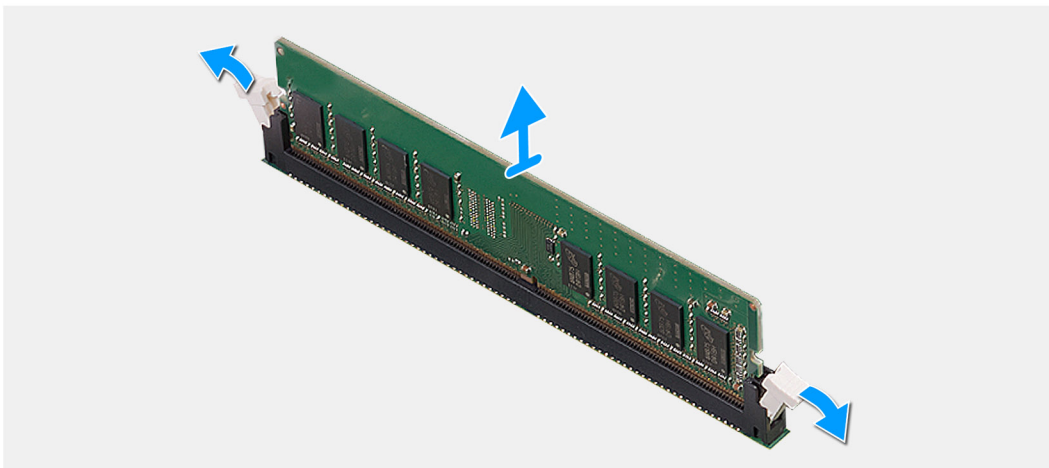
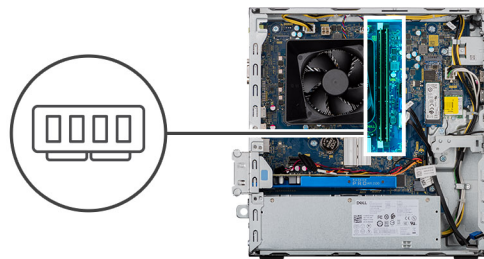

Steps

1. Lay the chassis on the right side.
2. Use your fingertips to carefully spread apart the securing-clips on each end of the memory-module slot.
3. Grasp the memory module near the securing clip, and then gently ease the memory module out of the memory-module slot.

i **NOTE:** Repeat step 2 to step 4 to remove any other memory modules installed in your computer.

i **NOTE:** Note the slot and the orientation of the memory module in order to replace it in the correct slot.

i **NOTE:** If the memory module is difficult to remove, gently ease the memory module back and forth to remove it from the slot.

CAUTION: To prevent damage to the memory module, hold the memory module by the edges. Do not touch the components on the memory module.

Installing the memory modules

Prerequisites

If you are replacing a component, remove the existing component before performing the installation procedure.

About this task

The following images indicate the location of the memory modules and provides a visual representation of the installation procedure.

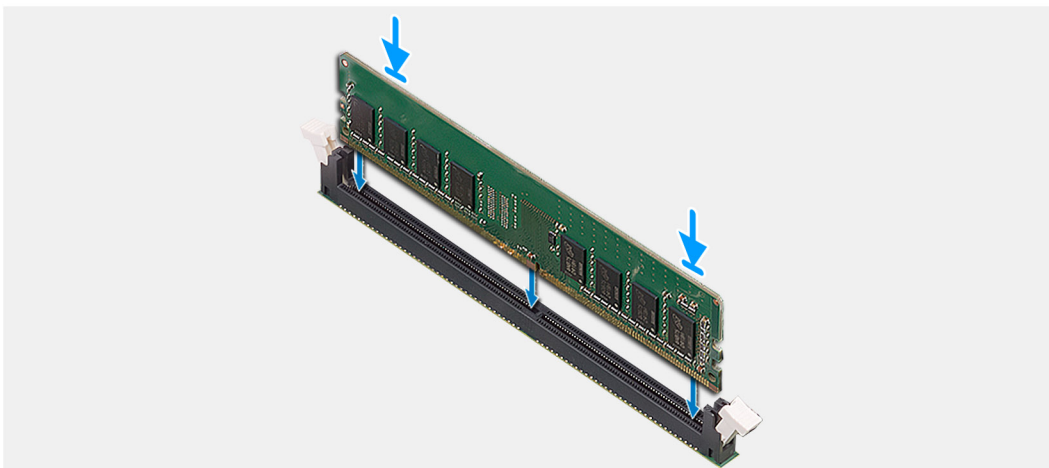
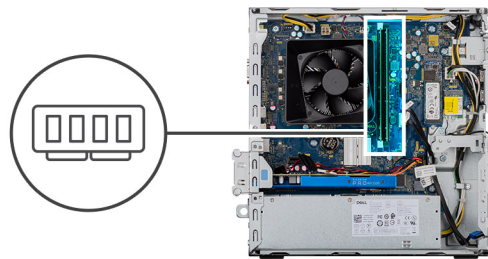

Steps

1. Align the notch on the memory module with the tab on the memory-module slot.
2. Insert the memory module into the memory-module connector until the memory module snaps into position and the securing clip locks in place.

- NOTE:** The securing clips return to the locked position. If you do not hear the click, remove the memory module and reinstall it.
- NOTE:** If the memory module is difficult to remove, gently ease the memory module back and forth to remove it from the slot.
- NOTE:** To prevent damage to the memory module, hold the memory module by the edges. Do not touch the components on the memory module.

Next steps

1. Install the [ODD bracket](#).
2. Install the [side cover](#).
3. Follow the procedure in [After working inside your computer](#).

Graphics card

Removing the graphics card

Prerequisites

1. Follow the procedure in [Before working inside your computer](#).
2. Remove the [side cover](#).

About this task

The following images indicate the location of the graphics card and provides a visual representation of the removal procedure.

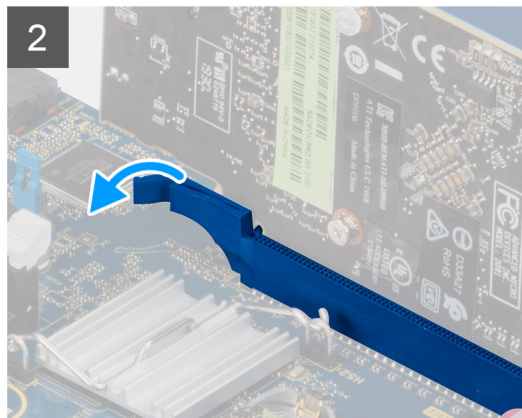
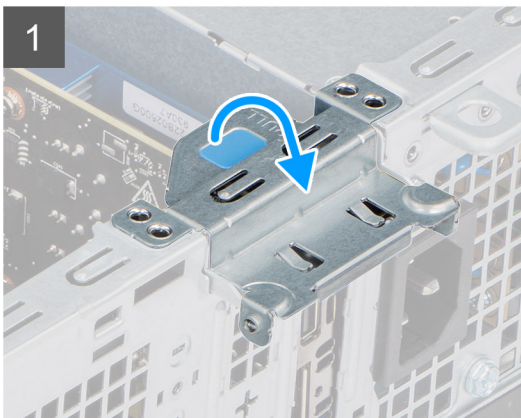
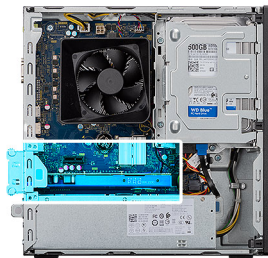

Steps

1. Lift the pull tab to open the PCIe door.
2. Push and hold the securing tab on the graphics-card slot and lift the graphics card from the graphics-card slot.
3. Lift and remove the graphics card from the system board.

Installing the graphics card

Prerequisites

If you are replacing a component, remove the existing component before performing the installation procedure.

About this task

The following images indicate the location of the graphics card and provides a visual representation of the installation procedure.

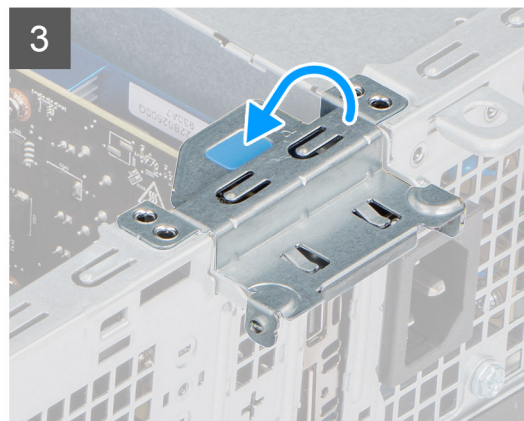
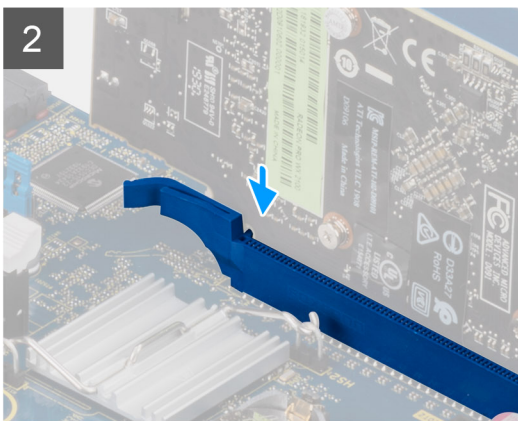
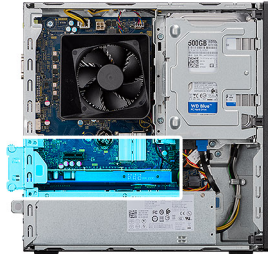

Steps

1. Align the graphics card with the PCI-Express card connector on the system board.
2. Using the alignment post, connect the card in the connector and press down firmly. Ensure that the card is firmly seated.
3. Lift the pull tab to close the PCIe door.

Next steps

1. Install the [side cover](#).
2. Follow the procedure in [After working inside your computer](#).

Coin cell battery

Removing the coin-cell battery

Prerequisites

1. Follow the procedure in [Before working inside your computer](#).
 **CAUTION:** Removing the coin-cell battery resets the BIOS setup program's settings to default. It is recommended that you note the BIOS setup program's settings before removing the coin-cell battery.
2. Remove the [side cover](#).

About this task

The following images indicate the location of the coin-cell battery and provides a visual representation of the removal procedure.

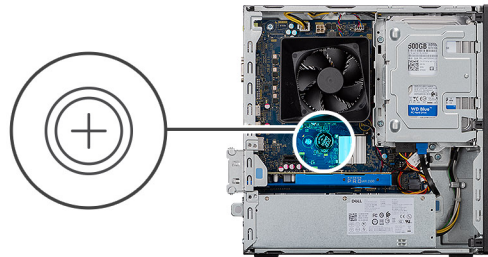

Steps

1. Lay the computer on the right side.
2. Push the coin-cell battery-release lever on the coin-cell battery socket to release the coin-cell battery out of the socket.
3. Remove the coin-cell battery.

Installing the coin-cell battery

Prerequisites

If you are replacing a component, remove the existing component before performing the installation procedure.

About this task

The following images indicate the location of the coin-cell battery and provides a visual representation of the installation procedure.

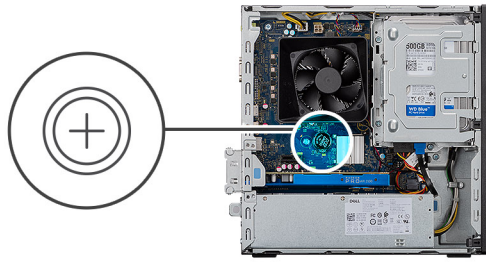

Insert the coin-cell battery into the socket with the positive side (+) labeled facing up and snap the battery in the socket.

Next steps

1. Install the [side cover](#).
2. Follow the procedure in [After working inside your computer](#).

M.2 2230 Solid state drive

Removing the 2230 solid-state drive

Prerequisites

1. Follow the procedure in [Before working inside your computer](#).
2. Remove the [side cover](#).
3. Remove the [HDD/ODD bracket](#).

About this task

The following images indicate the location of the 2230 solid-state drive and provides a visual representation of the removal procedure.



1x
M2x3

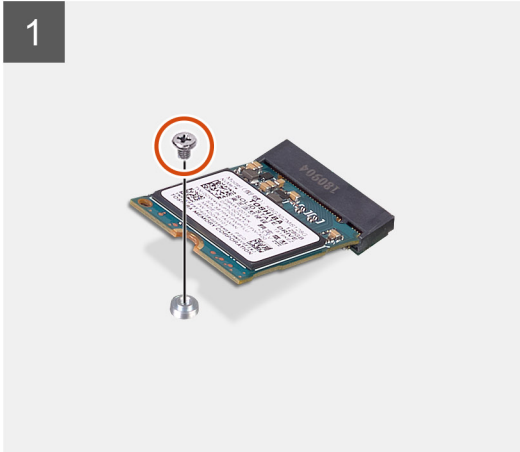
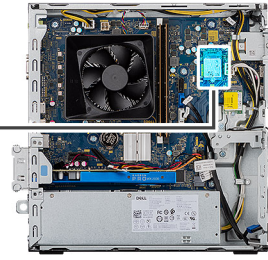

Steps

1. Remove the screw (M2x3) that secures the 2230 solid-state drive to the system board.
2. Slide and lift the solid-state drive from the M.2 card slot on the system board.

Installing the 2230 solid-state drive

Prerequisites

 **CAUTION:** Solid-state drives are fragile. Exercise care when handling the solid-state drive.

If you are replacing a component, remove the existing component before performing the installation procedure.

About this task

The following images indicate the location of the solid-state drive and provides a visual representation of the installation procedure.



1x
M2x3

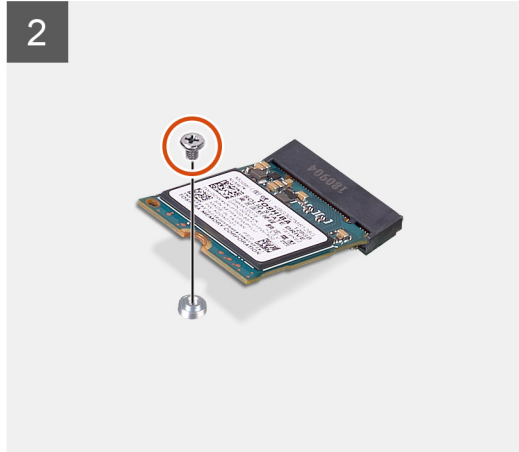
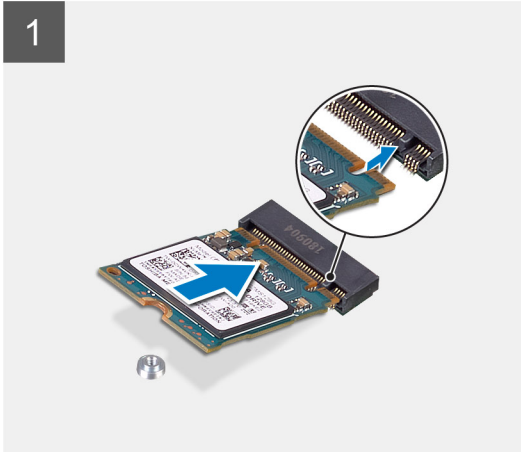
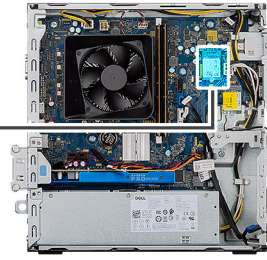

Steps

1. Locate the notch on the 2230 solid-state drive.
2. Align the notch on the 2230 solid-state drive with the tab on the M.2 card slot.
3. Slide the 2230 solid-state drive into the M.2 card slot on the system board.
4. Replace the screw (M2x3) that secures the 2230 solid-state drive to the system board.

Next steps

1. Install the [HDD/ODD bracket](#).
2. Install the [side cover](#).
3. Follow the procedure in [After working inside your computer](#).

M.2 2280 Solid state drive

Removing the 2280 solid-state drive

Prerequisites

1. Follow the procedure in [Before working inside your computer](#).
2. Remove the [side cover](#).
3. Remove the [HDD/ODD bracket](#).

About this task

The following images indicate the location of the 2280 solid-state drive and provide a visual representation of the removal procedure.



1x
M2x3

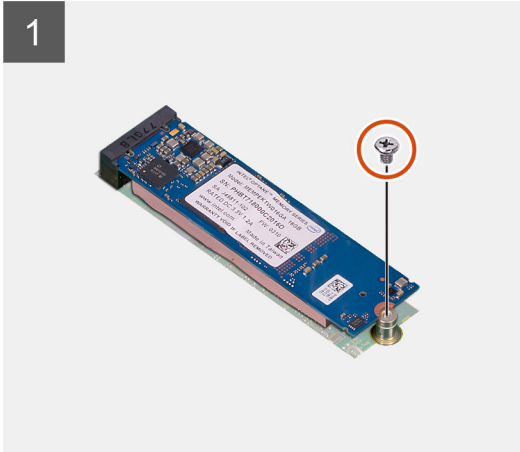
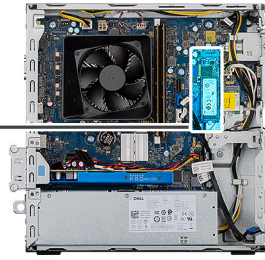

Image:

Steps

1. Remove the screw (M2x3) that secures the 2280 solid-state drive to the system board.
2. Slide and lift the solid-state drive from the M.2 card slot on the system board.

Installing the 2280 solid-state drive

Prerequisites

 **CAUTION: Solid-state drives are fragile. Exercise care when handling the solid-state drive.**

If you are replacing a component, remove the existing component before performing the installation procedure.

About this task

The following images indicate the location of the 2280 solid-state drive and provides a visual representation of the installation procedure.



1x
M2x3

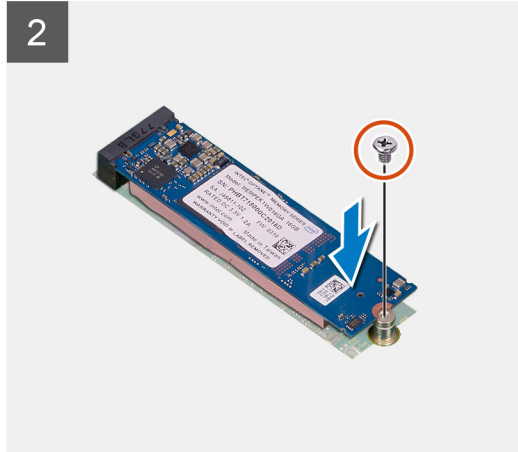
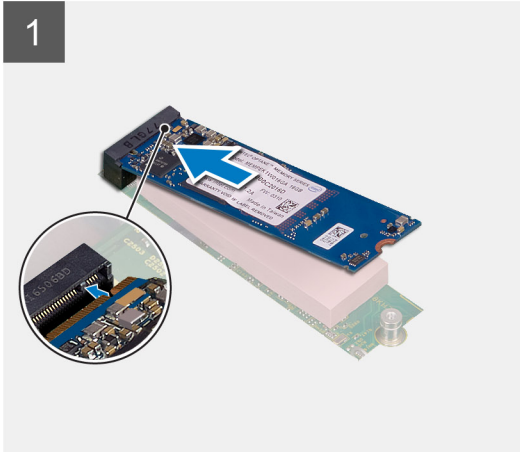
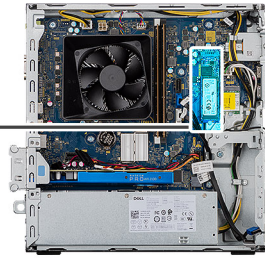

Steps

1. Locate the notch on the 2280 solid-state drive.
2. Align the notch on the 2280 solid-state drive with the tab on the M.2 card slot.
3. Slide the 2230 solid-state drive into the M.2 card slot on the system board.
4. Replace the screw (M2x3) that secures the 2230 solid-state drive to the system board.

Next steps

1. Install the [HDD/ODD bracket](#).
2. Install the [side cover](#).
3. Follow the procedure in [After working inside your computer](#).

WLAN Card

Removing the WLAN card

Prerequisites

1. Follow the procedure in [Before working inside your computer](#).
2. Remove the [side cover](#).
3. Remove the [ODD bracket](#).

About this task

The following images indicate the location of the wireless card and provides a visual representation of the removal procedure.



1x
M2x3

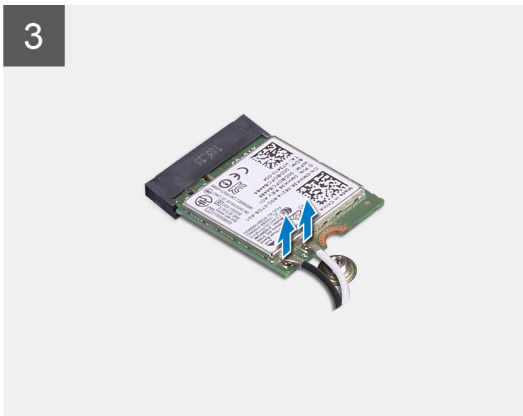
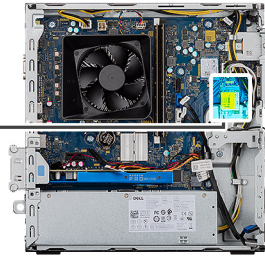

Steps

1. Remove the single (M2x3) screw that secures the wireless card to the system board.
2. Slide and lift the wireless-card bracket off the wireless card.
3. Disconnect the antenna cables from the wireless card.
4. Slide and remove the wireless card at an angle from the wireless-card slot.

Installing the WLAN card

Prerequisites

If you are replacing a component, remove the existing component before performing the installation procedure.

 **NOTE:** To avoid damage to the wireless card, do not place any cables under it.

About this task

The following images indicate the location of the wireless card and provide a visual representation of the installation procedure:



1x
M2x3

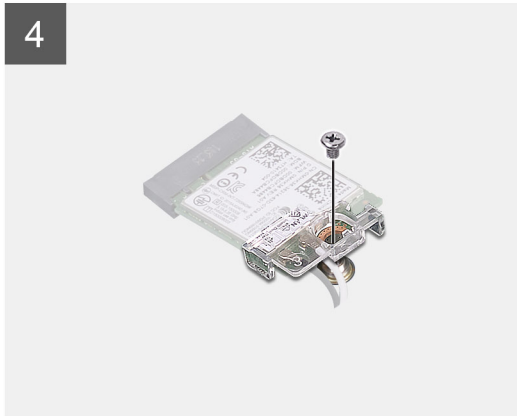
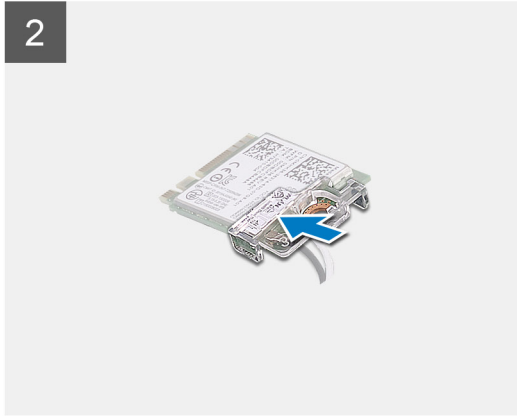
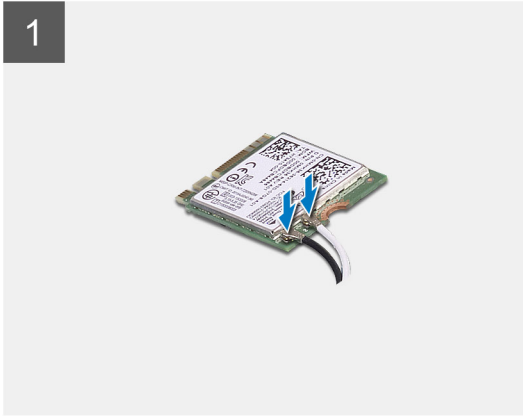
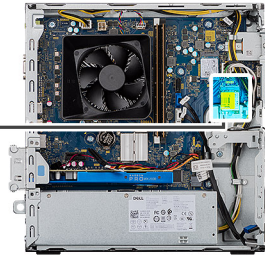

Steps

1. Connect the antenna cables to the WLAN card.
The following table provides the antenna-cable color scheme for the wireless card supported by your computer.

Table 3. Antenna-cable color scheme

Connectors on the wireless card	Antenna-cable color
Main (white triangle)	White
Auxiliary (black triangle)	Black

2. Slide and place the wireless card bracket on the antennae connectors on the WLAN card.
3. Align the notch on the wireless card with the tab on the wireless-card slot.
4. Slide the wireless card at an angle into the wireless-card slot of the system board.
5. Replace the single (M2x3) screw that secures the wireless card to the system board.

Next steps

1. Install the [ODD bracket](#)
2. Install the [side cover](#).
3. Follow the procedure in [After working inside your computer](#).

SD card

Removing the media card reader

Prerequisites

1. Follow the procedure in [Before working inside your computer](#).
2. Remove the [side cover](#).
3. Remove the [front bezel](#).
4. Remove the [HDD/ODD bracket](#).

About this task

The following images indicate the location of the front cover and provide a visual representation of the removal procedure.



2x
M6x32

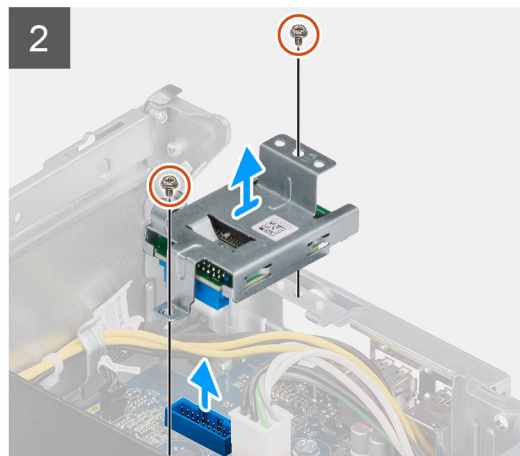
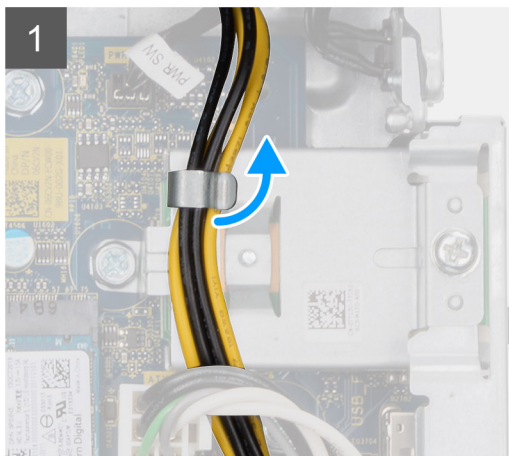
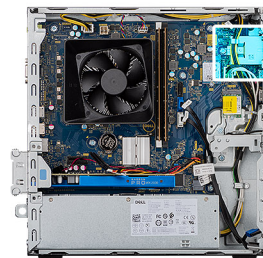

Steps

1. Unroute the PSU power cable from over the SD card reader.
2. Remove the two M3x5 screws securing the SD card reader to the chassis.
3. Lift and remove the SD card reader from the system board.

Installing the media card reader

Prerequisites

About this task

The following images indicate the location of the media card reader and provide a visual representation of the installation procedure.



2x
M6x32

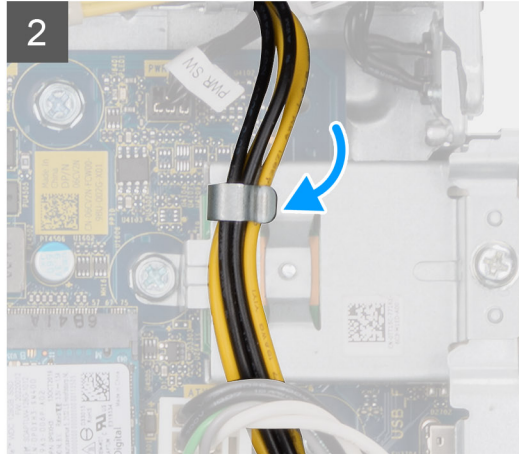
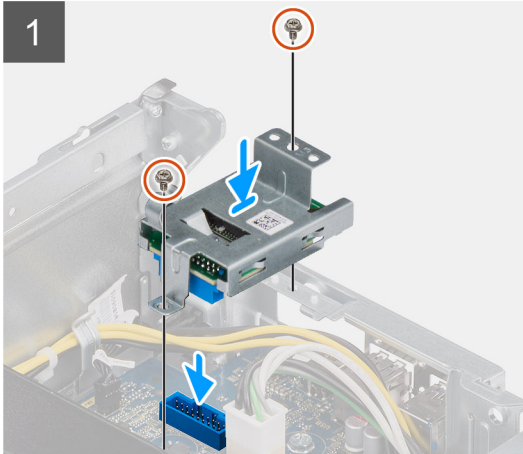
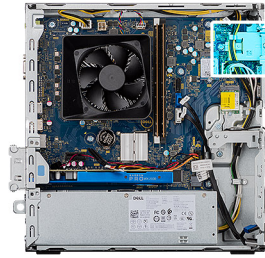

Steps

1. Place the SD card reader on the system board ensuring the SD card reader sits flush on the connector on the system board.
2. Replace the two M3x5 screws securing the SD card reader to the system board.
3. Route the PSU power cable from over the SD card reader.

Next steps

1. Install the [HDD/ODD Bracket](#).
2. Install the [front bezel](#).
3. Install the [side cover](#).
4. Follow the procedure in [After working inside your computer](#).

Power supply unit

Removing the power-supply unit

Prerequisites

1. Follow the procedure in [Before working inside your computer](#).
2. Remove the [side cover](#).
3. Remove the [front bezel](#).
4. Remove the [HDD/ODD bracket](#).

NOTE: Note the routing of all cables as you remove them so that you can route them correctly while you are replacing the power-supply unit.

About this task

The following images indicate the location of the power-supply unit and provides a visual representation of the removal procedure.



6x
6x32

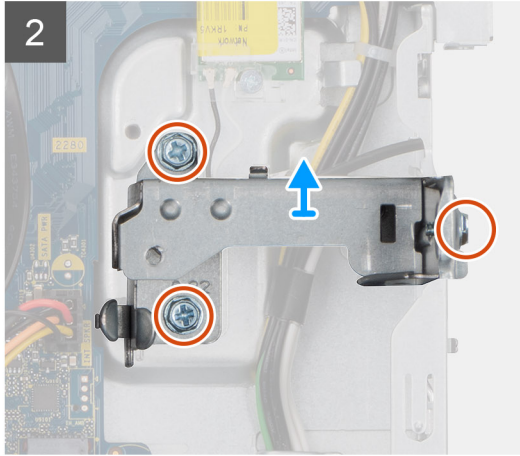
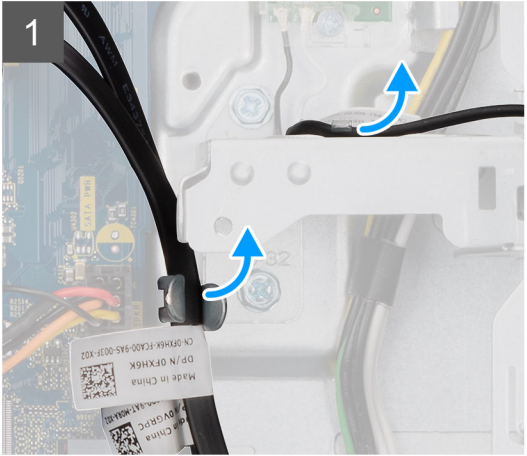

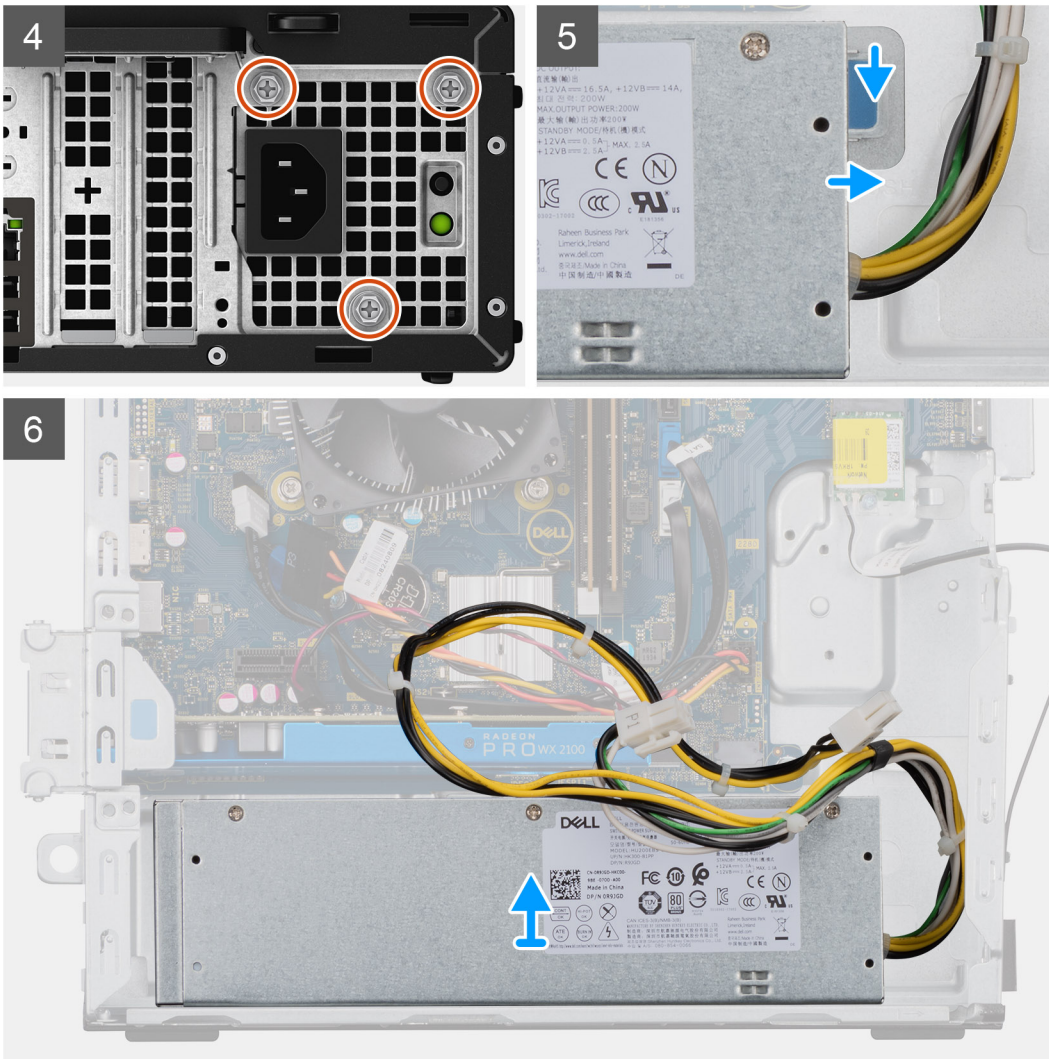

Steps

1. Lay the computer on the right side.
2. Disconnect the power cables from the system board and remove them from the routing guides on the chassis.
3. Remove the three (#6-32) screws that secure the power-supply unit to the chassis.
4. Press the securing clip and slide the power-supply unit away from the back of the chassis.
5. Lift the power-supply unit off the chassis.

Installing the power-supply unit

Prerequisites

If you are replacing a component, remove the existing component before performing the installation procedure.

⚠ WARNING: The cables and ports on the back of the power-supply unit are color-coded to indicate the different power wattage. Ensure that you plug in the cable to the correct port. Failure to do so may result in damaging the power-supply unit and/or system components.

About this task

The following images indicate the location of the power-supply unit and provides a visual representation of the installation procedure.

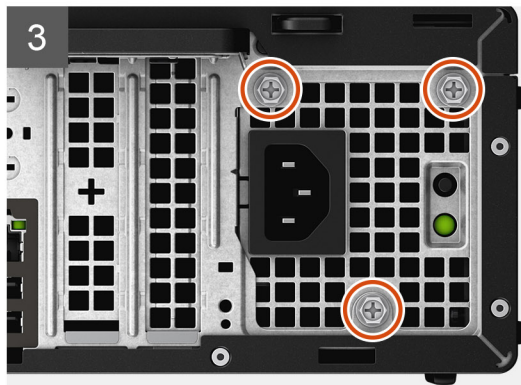
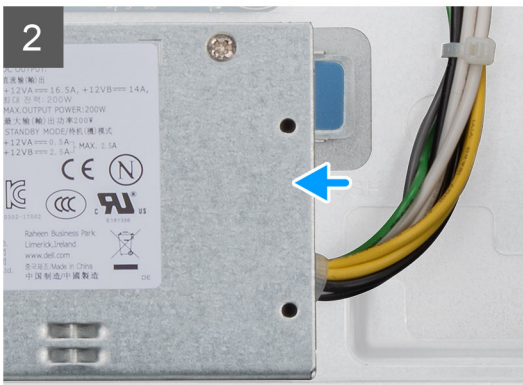

3



6x
6x32



5

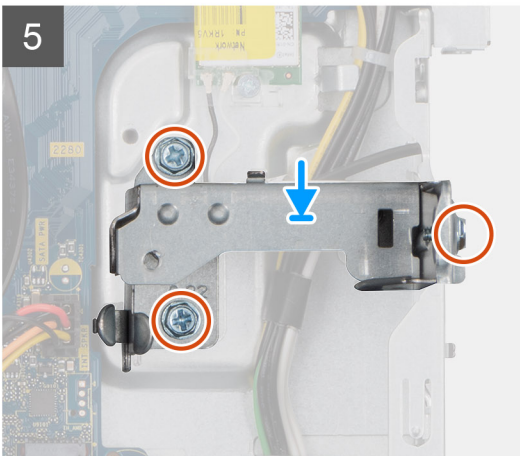

6

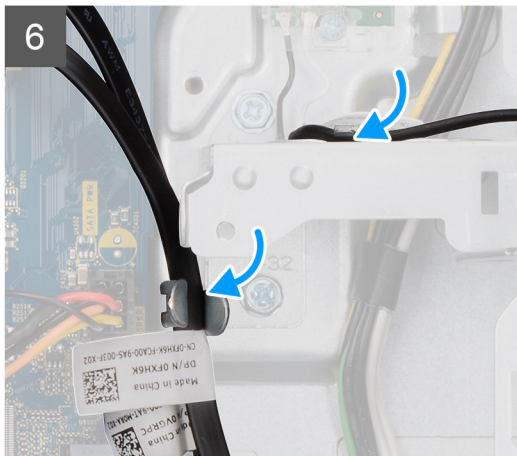

Steps

1. Slide the power-supply unit into the chassis until the securing tab snaps into position.
2. Replace the three screws (#6-32) that secure the power-supply unit to the chassis.
3. Route the power cable through the routing guides on the chassis and connect the power cables to their respective connectors on the system board.

Next steps

1. Install the [HDD/ODD Bracket](#).
2. Install the [front bezel](#).
3. Install the [side cover](#).
4. Follow the procedure in [After working inside your computer](#).

Heatsink assembly

Removing the heatsink assembly

Prerequisites

1. Follow the procedure in [Before working inside your computer](#).



WARNING: The heat sink may become hot during normal operation. Allow sufficient time for the heat sink to cool before you touch it.



CAUTION: For maximum cooling of the processor, do not touch the heat transfer areas on the heat sink. The oils in your skin can reduce the heat transfer capability of the thermal grease.

2. Remove the [side cover](#).

About this task

The following images indicate the location of the processor fan and 65 W heat-sink assembly and provide a visual representation of the removal procedure.

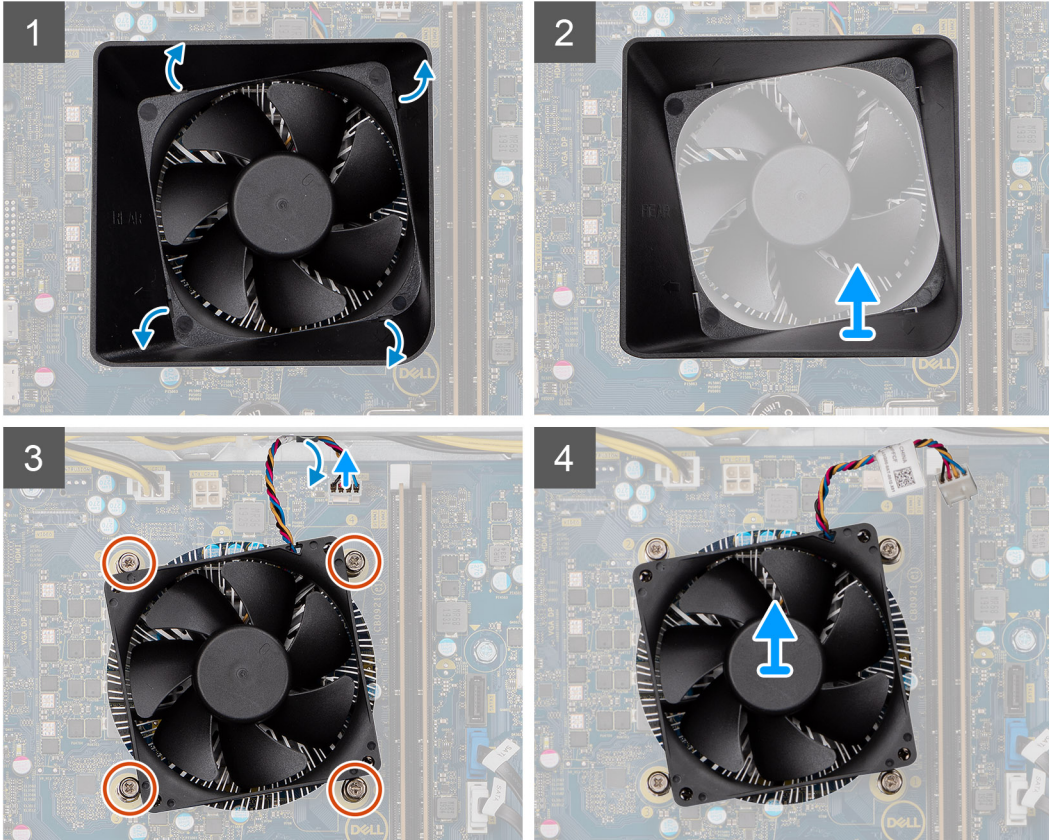
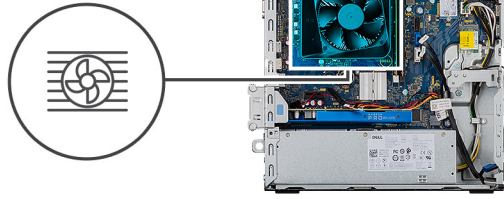

Steps

1. Insert a flat head screw driver along the four marked edges of the fan shroud and gently push towards the fan to disengage the fan shroud from the heatsink assembly.
2. Lift and remove the fan shroud from the system unit.
3. Disconnect the processor-fan cable from the system board.
4. Loosen the four captive screws in reverse sequential order (4->3->2->1) that secure the processor fan and heat-sink assembly to the system board.
5. Lift the processor fan and heat-sink assembly off the system board.

Installing the heatsink assembly

Prerequisites

If you are replacing a component, remove the existing component before performing the installation procedure.

CAUTION: If either the processor or the heat sink is replaced, use the thermal grease that is provided in the kit to ensure that thermal conductivity is achieved.

About this task

The following images indicate the location of the processor fan and 95 W heat-sink assembly and provide a visual representation of the installation procedure.

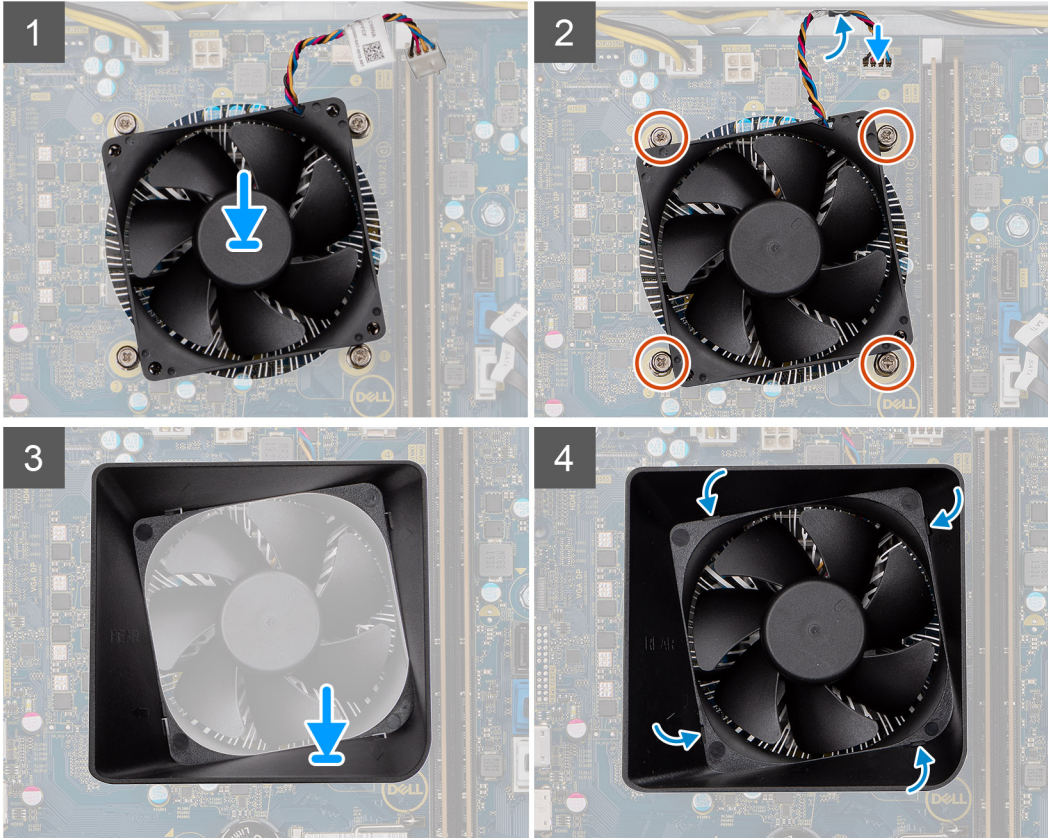
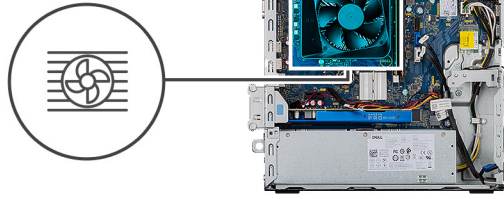

Steps

1. Align the screw holes on the processor fan and heat-sink assembly with the screw holes on the system board.
2. In the sequential order (1->2->3->4), tighten the captive screws that secure the processor fan and heat-sink assembly to the system board.
3. Connect the processor-fan cable to the system board.
4. Replace the fan shroud on the heat-sink assembly along the marked orientation and snap it into place.

Next steps

1. Install the [side cover](#).
2. Follow the procedure in [After working inside your computer](#).

Processor

Removing the processor

Prerequisites

1. Follow the procedure in [Before working inside your computer](#).
2. Remove the [side cover](#).

3. Remove the [heatsink assembly](#).

i **NOTE:** The processor might still be hot after the computer is shut down. Allow the processor to cool down before removing it.

About this task

The following images indicate the location of the processor and provides a visual representation of the removal procedure:

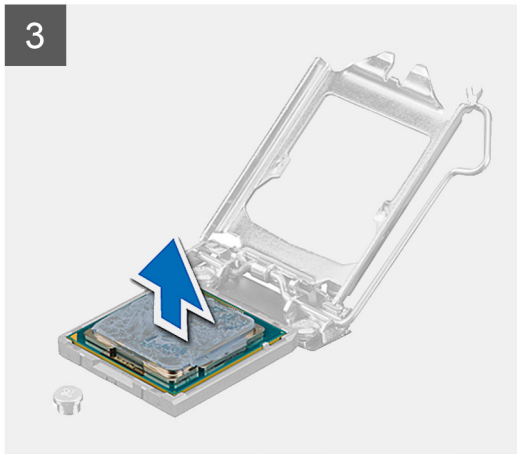
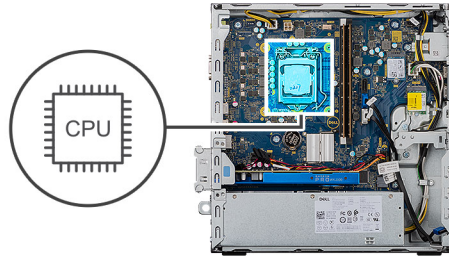

Steps

- 1. Press the release lever down and then push it away from the processor to release it from the securing tab.
- 2. Extend the release lever completely and open the processor cover.

⚠ CAUTION: When removing the processor, do not touch any of the pins inside the socket or allow any objects to fall on the pins in the socket.

- 3. Gently lift the processor from the processor socket.

Installing the processor

Prerequisites

If you are replacing a component, remove the existing component before performing the installation procedure.

About this task

The following images indicate the location of the processor and provides a visual representation of the installation procedure:

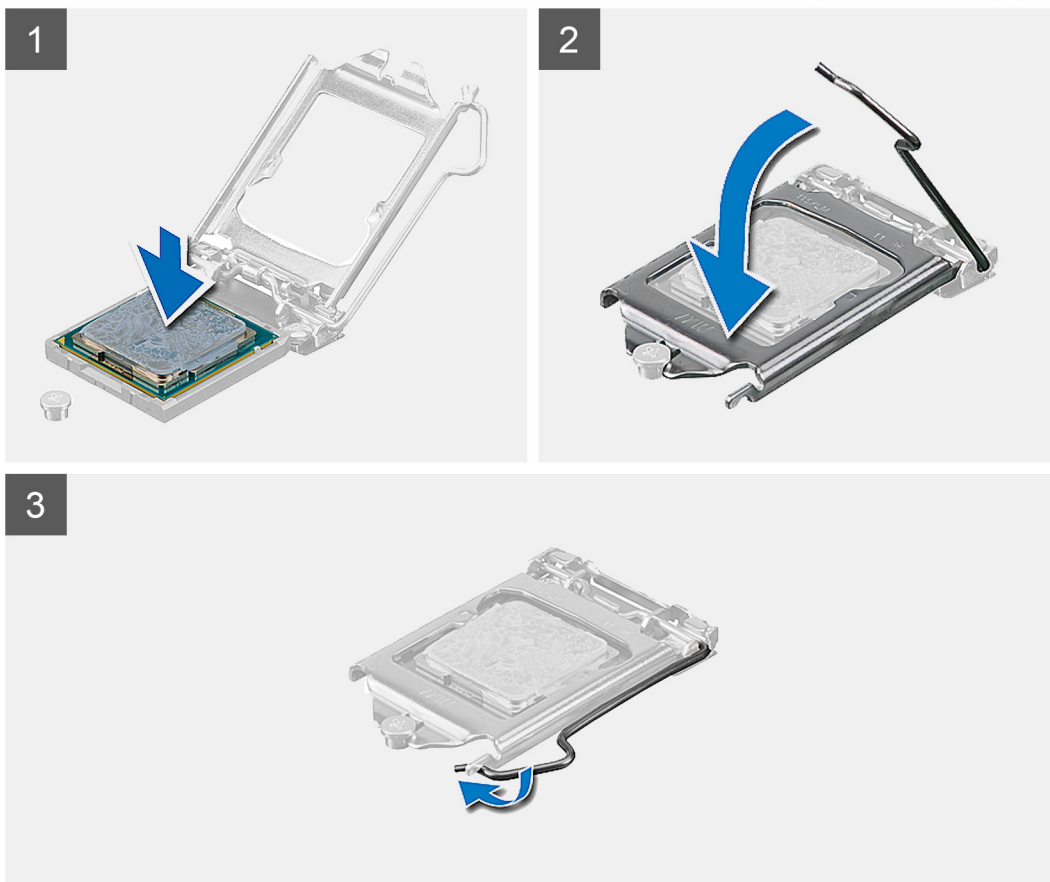
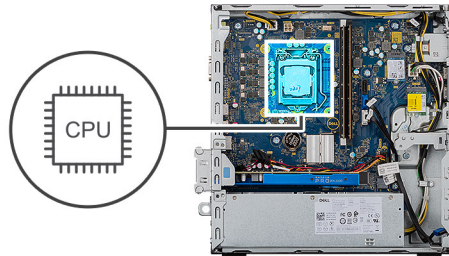

Steps

1. Ensure that the release lever on the processor socket is fully extended in the open position.

i **NOTE:** The pin-1 corner of the processor has a triangle that aligns with the triangle on the pin-1 corner on the processor socket. When the processor is properly seated, all four corners are aligned at the same height. If one or more corners of the processor are higher than the others, the processor is not seated properly.

2. Align the notches on the processor with the tabs on the processor socket and place the processor in the processor socket.

⚠ **CAUTION:** Ensure that the processor-cover notch is positioned underneath the alignment post.

3. When the processor is fully seated in the socket, pivot the release-lever down and place it under the tab on the processor cover.

Next steps

1. Install the [heatsink assembly](#).
2. Install the [side cover](#).
3. Follow the procedure in [After working inside your computer](#).

System board

Removing the system board

Prerequisites

1. Follow the procedure in [Before working inside your computer](#).

i **NOTE:** Your computer's Service Tag is stored in the system board. You must enter the Service Tag in the BIOS setup program after you replace the system board.

i **NOTE:** Replacing the system board removes any changes that you have made to the BIOS using the BIOS setup program. You must make the appropriate changes again after you replace the system board.

i **NOTE:** Before disconnecting the cables from the system board, note the location of the connectors so that you can reconnect the cables correctly after you replace the system board.

2. Remove the [side cover](#).
3. Remove the [front bezel](#).
4. Remove the [HDD/ODD bracket](#).
5. Remove the [optical disk drive](#).
6. Remove the [memory modules](#).
7. Remove the [graphics card](#).
8. Remove the [solid-state drive/Intel Optane memory module](#).
9. Remove the [wireless card](#).
10. Remove the [media card reader](#).
11. Remove the [processor fan and heat-sink assembly](#).
12. Remove the [processor](#).

About this task

The following images indicate the location of the system board and provides a visual representation of the removal procedure.

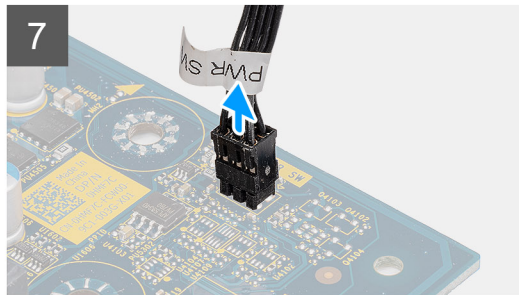
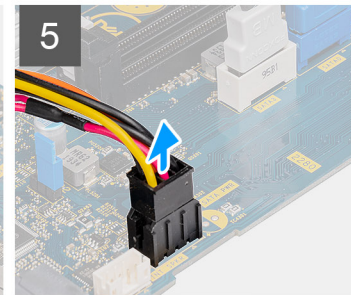
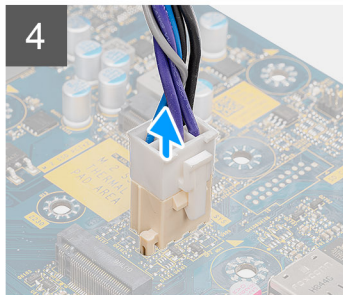
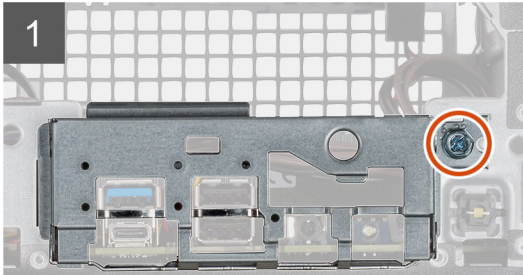
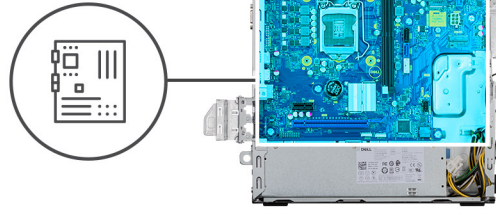
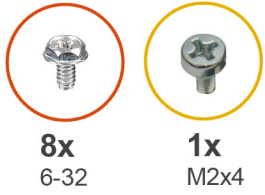



9



Steps

1. Lay the computer on the right side.
2. Remove the screw (#6-32) that secures the front I/O-bracket to the chassis and remove the front I/O-bracket.
3. Disconnect the 4-pin power supply ATEX connector from the system board.
4. Disconnect the 6-pin power supply ATEX connector from the system board.
5. Disconnect the front I/O cable connector from the system board.
6. Disconnect the SATA cables from the system board.
7. Disconnect the power switch cable from the system board.
8. Remove the eight (#6-32) screws that secure the system board to the chassis.
9. Remove the screw (M2x4) that secures the system board to the chassis.
10. Lift the system board at an angle and remove the system board off the chassis.

Installing the system board

Prerequisites

If you are replacing a component, remove the existing component before performing the installation procedure.

About this task

The following images indicate the location of the system board and provides a visual representation of the installation procedure:

1



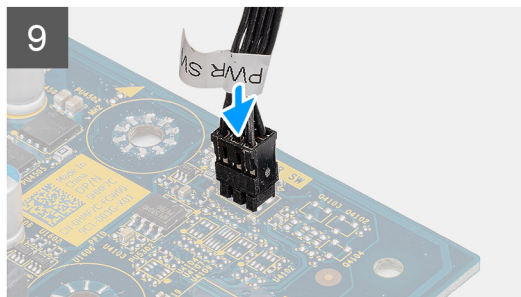
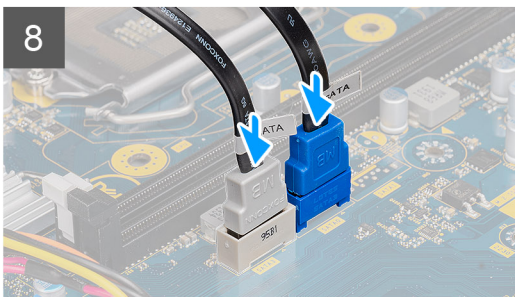
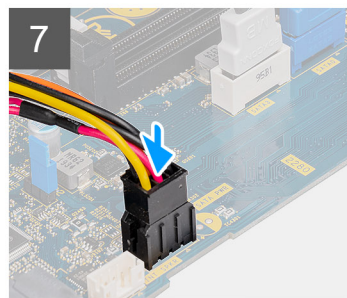
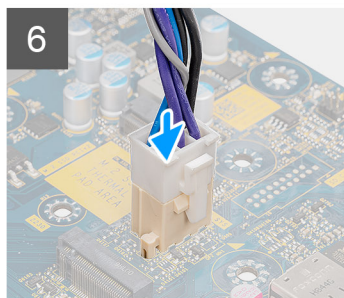
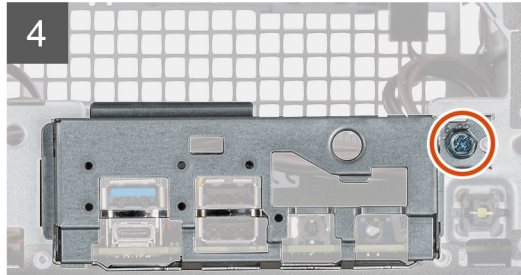
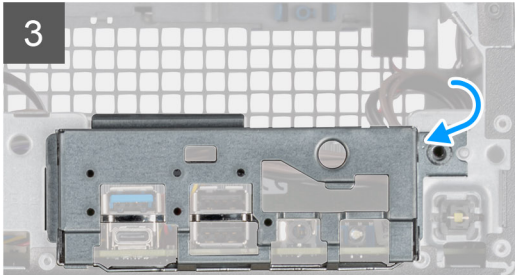
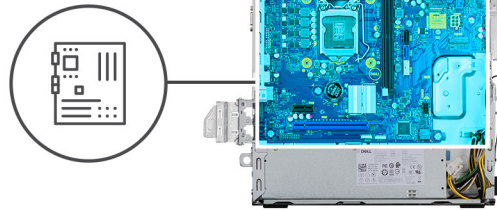
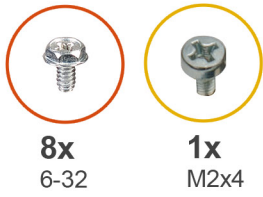



Steps

1. Slide the front I/O-ports on the system board into the front I/O-slots on the chassis and align the screw holes on the system board with the screw holes on the chassis.
2. Align the front I/O-bracket with the slots on the chassis.
3. Lay the system unit vertically and secure it using the eight #6-32 screws to the chassis.
4. Replace the screw (M2x4) that secures the system board to the chassis.
5. Connect the 4-pin power supply ATEX connector to the system board.
6. Connect the 6-pin power supply ATEX connector to the system board.
7. Connect the front I/O cable connector to the system board.
8. Connect the SATA cables to the system board.
9. Connect the power switch cable to the system board.

Next steps

1. Install the [processor](#).
2. Install the [heat sink](#).
3. Install the [media card reader](#)
4. Install the [WLAN card](#)
5. Install the [solid-state drive/Intel Optane memory module](#).
6. Install the [graphics card](#).
7. Install the [memory modules](#).

8. Install the [HDD/ODD Bracket](#).
 9. Install the [front bezel](#).
 10. Install the [side cover](#).
 11. Follow the procedure in [After working inside your computer](#).
-  **NOTE:** Your computer's Service Tag is stored in the system board. You must enter the Service Tag in the BIOS setup program after you replace the system board.
-  **NOTE:** Replacing the system board removes any changes that you have made to the BIOS using the BIOS setup program. You must make the appropriate changes again after you replace the system board.

Troubleshooting

Real-Time Clock (RTC Reset)

The Real Time Clock (RTC) reset function allows you or the service technician to recover Dell Inspiron, systems from No POST/No Power/No Boot situations. The legacy jumper enabled RTC reset has been retired on these models.

Start the RTC reset with the system powered off and connected to AC power. Press and hold the power button for thirty (30) seconds. The system RTC Reset occurs after you release the power button.

System diagnostic lights

Power-supply diagnostics light

Indicates the status of the power-supply in either of the two states:

- Off: No Power
- On: Power is supplied.

Power button light

Table 4. Power button LED status

Power button LED state	System state	Description
Off	<ul style="list-style-type: none"> • S4 • S5 	There is in Hibernate or Off state.
Solid White	S0	Working state
Solid Amber		Various sleep states or No POST
Blinking Amber/White		Failure to POST

This platform relies on the Power button LED light blinking in an amber/white pattern to determine a failure as listed in the following table:

NOTE:

The blinking patterns consists of two numbers (representing First Group: Amber blinks, Second Group: White blinks).

- **First Group: The Power button LED light blinks Amber, 1 to 9 times followed by a short pause with LED off for a couple of seconds.**
- **Second Group: The Power button LED light then blinks White, 1 to 9 times, followed by a longer pause before the next cycle starts again after a short interval.**

Example: No Memory detected (2,3). Power button LED blinks 2-times in Amber followed by a pause, and then blinks 3-times in White. The Power button LED will pause for few seconds before the next cycle repeats itself again.

Table 5. Diagnostics LED codes

Diagnostic light codes	Problem description
1,2	Unrecoverable SPI flash failure
2,1	CPU failure
2,2	System board failure, corrupt BIOS, ROM error
2,3	No memory/RAM detected

Table 5. Diagnostics LED codes(continued)

Diagnostic light codes	Problem description
2,4	Memory/RAM failure
2,5	Invalid Memory installed
2,6	System board error, chipset error, clock failure, gate A20 failure, super I/O failure, keyboard controller failure
3,1	CMOS battery failure
3,2	PCIe or video card/chip failure
3,3	Recovery Image not found
3,4	Recovery Image found but invalid
3,5	Power Rail Failure
3,6	Paid SPI volume error
3,7	Intel (ME) Management Engine error
4,2	CPU power cable connection issue

Diagnostic error messages

Table 6. Diagnostic error messages

Error messages	Description
AUXILIARY DEVICE FAILURE	The touchpad or external mouse may be faulty. For an external mouse, check the cable connection. Enable the Pointing Device option in the System Setup program.
BAD COMMAND OR FILE NAME	Ensure that you have spelled the command correctly, put spaces in the proper place, and used the correct path name.
CACHE DISABLED DUE TO FAILURE	The primary cache internal to the microprocessor has failed. Contact Dell
CD DRIVE CONTROLLER FAILURE	The optical drive does not respond to commands from the computer.
DATA ERROR	The hard drive cannot read the data.
DECREASING AVAILABLE MEMORY	One or more memory modules may be faulty or improperly seated. Reinstall the memory modules or, if necessary, replace them.
DISK C: FAILED INITIALIZATION	The hard drive failed initialization. Run the hard drive tests in Dell Diagnostics .
DRIVE NOT READY	The operation requires a hard drive in the bay before it can continue. Install a hard drive in the hard drive bay.
ERROR READING PCMCIA CARD	The computer cannot identify the ExpressCard. Reinsert the card or try another card.
EXTENDED MEMORY SIZE HAS CHANGED	The amount of memory recorded in non-volatile memory (NVRAM) does not match the memory module installed in the computer. Restart the computer. If the error appears again, Contact Dell
THE FILE BEING COPIED IS TOO LARGE FOR THE DESTINATION DRIVE	The file that you are trying to copy is too large to fit on the disk, or the disk is full. Try copying the file to a different disk or use a larger capacity disk.
A FILENAME CANNOT CONTAIN ANY OF THE FOLLOWING CHARACTERS: \ / : * ? " < > -	Do not use these characters in filenames.

Table 6. Diagnostic error messages(continued)

Error messages	Description
GATE A20 FAILURE	A memory module may be loose. Reinstall the memory module or, if necessary, replace it.
GENERAL FAILURE	The operating system is unable to carry out the command. The message is usually followed by specific information. For example, Printer out of paper. Take the appropriate action.
HARD-DISK DRIVE CONFIGURATION ERROR	The computer cannot identify the drive type. Shut down the computer, remove the hard drive, and boot the computer from an optical drive. Then, shut down the computer, reinstall the hard drive, and restart the computer. Run the Hard Disk Drive tests in Dell Diagnostics .
HARD-DISK DRIVE CONTROLLER FAILURE 0	The hard drive does not respond to commands from the computer. Shut down the computer, remove the hard drive, and boot the computer from an optical drive. Then, shut down the computer, reinstall the hard drive, and restart the computer. If the problem persists, try another drive. Run the Hard Disk Drive tests in Dell Diagnostics .
HARD-DISK DRIVE FAILURE	The hard drive does not respond to commands from the computer. Shut down the computer, remove the hard drive, and boot the computer from an optical drive. Then, shut down the computer, reinstall the hard drive, and restart the computer. If the problem persists, try another drive. Run the Hard Disk Drive tests in Dell Diagnostics .
HARD-DISK DRIVE READ FAILURE	The hard drive may be defective. Shut down the computer, remove the hard drive, and boot the computer from an optical. Then, shut down the computer, reinstall the hard drive, and restart the computer. If the problem persists, try another drive. Run the Hard Disk Drive tests in Dell Diagnostics .
INSERT BOOTABLE MEDIA	The operating system is trying to boot to non-bootable media, such as an optical drive. Insert bootable media.
INVALID CONFIGURATION INFORMATION-PLEASE RUN SYSTEM SETUP PROGRAM	The system configuration information does not match the hardware configuration. The message is most likely to occur after a memory module is installed. Correct the appropriate options in the system setup program.
KEYBOARD CLOCK LINE FAILURE	For external keyboards, check the cable connection. Run the Keyboard Controller test in Dell Diagnostics .
KEYBOARD CONTROLLER FAILURE	For external keyboards, check the cable connection. Restart the computer, and avoid touching the keyboard or the mouse during the boot routine. Run the Keyboard Controller test in Dell Diagnostics .
KEYBOARD DATA LINE FAILURE	For external keyboards, check the cable connection. Run the Keyboard Controller test in Dell Diagnostics .
KEYBOARD STUCK KEY FAILURE	For external keyboards or keypads, check the cable connection. Restart the computer, and avoid touching the keyboard or keys during the boot routine. Run the Stuck Key test in Dell Diagnostics .
LICENSED CONTENT IS NOT ACCESSIBLE IN MEDIADIRECT	Dell MediaDirect cannot verify the Digital Rights Management (DRM) restrictions on the file, so the file cannot be played.
MEMORY ADDRESS LINE FAILURE AT ADDRESS, READ VALUE EXPECTING VALUE	A memory module may be faulty or improperly seated. Reinstall the memory module or, if necessary, replace it.

Table 6. Diagnostic error messages(continued)

Error messages	Description
MEMORY ALLOCATION ERROR	The software you are attempting to run is conflicting with the operating system, another program, or a utility. Shut down the computer, wait for 30 seconds, and then restart it. Run the program again. If the error message still appears, see the software documentation.
MEMORY DOUBLE WORD LOGIC FAILURE AT ADDRESS, READ VALUE EXPECTING VALUE	A memory module may be faulty or improperly seated. Reinstall the memory module or, if necessary, replace it.
MEMORY ODD/EVEN LOGIC FAILURE AT ADDRESS, READ VALUE EXPECTING VALUE	A memory module may be faulty or improperly seated. Reinstall the memory module or, if necessary, replace it.
MEMORY WRITE/READ FAILURE AT ADDRESS, READ VALUE EXPECTING VALUE	A memory module may be faulty or improperly seated. Reinstall the memory module or, if necessary, replace it.
NO BOOT DEVICE AVAILABLE	The computer cannot find the hard drive. If the hard drive is your boot device, ensure that the drive is installed, properly seated, and partitioned as a boot device.
NO BOOT SECTOR ON HARD DRIVE	The operating system may be corrupted, Contact Dell.
NO TIMER TICK INTERRUPT	A chip on the system board may be malfunctioning. Run the System Set tests in Dell Diagnostics .
NOT ENOUGH MEMORY OR RESOURCES. EXIT SOME PROGRAMS AND TRY AGAIN	You have too many programs open. Close all windows and open the program that you want to use.
OPERATING SYSTEM NOT FOUND	Reinstall the operating system. If the problem persists, Contact Dell.
OPTIONAL ROM BAD CHECKSUM	The optional ROM has failed. Contact Dell.
SECTOR NOT FOUND	The operating system cannot locate a sector on the hard drive. You may have a defective sector or corrupted File Allocation Table (FAT) on the hard drive. Run the Windows error-checking utility to check the file structure on the hard drive. See Windows Help and Support for instructions (click Start > Help and Support). If a large number of sectors are defective, back up the data (if possible), and then format the hard drive.
SEEK ERROR	The operating system cannot find a specific track on the hard drive.
SHUTDOWN FAILURE	A chip on the system board may be malfunctioning. Run the System Set tests in Dell Diagnostics . If the message reappears, Contact Dell.
TIME-OF-DAY CLOCK LOST POWER	System configuration settings are corrupted. Connect your computer to an electrical outlet to charge the battery. If the problem persists, try to restore the data by entering the System Setup program, then immediately exit the program. If the message reappears, Contact Dell.
TIME-OF-DAY CLOCK STOPPED	The reserve battery that supports the system configuration settings may require recharging. Connect your computer to an electrical outlet to charge the battery. If the problem persists, Contact Dell.
TIME-OF-DAY NOT SET-PLEASE RUN THE SYSTEM SETUP PROGRAM	The time or date stored in the system setup program does not match the system clock. Correct the settings for the Date and Time options.
TIMER CHIP COUNTER 2 FAILED	A chip on the system board may be malfunctioning. Run the System Set tests in Dell Diagnostics .

Table 6. Diagnostic error messages(continued)

Error messages	Description
UNEXPECTED INTERRUPT IN PROTECTED MODE	The keyboard controller may be malfunctioning, or a memory module may be loose. Run the System Memory tests and the Keyboard Controller test in Dell Diagnostics or Contact Dell .
X:\ IS NOT ACCESSIBLE. THE DEVICE IS NOT READY	Insert a disk into the drive and try again.

System error messages

Table 7. System error messages

System message	Description
Alert! Previous attempts at booting this system have failed at checkpoint [nnnn]. For help in resolving this problem, please note this checkpoint and contact Dell Technical Support	The computer failed to complete the boot routine three consecutive times for the same error.
CMOS checksum error	RTC is reset, BIOS Setup default has been loaded.
CPU fan failure	CPU fan has failed.
System fan failure	System fan has failed.
Hard-disk drive failure	Possible hard disk drive failure during POST.
Keyboard failure	Keyboard failure or loose cable. If reseating the cable does not solve the problem, replace the keyboard.
No boot device available	No bootable partition on hard disk drive, the hard disk drive cable is loose, or no bootable device exists. <ul style="list-style-type: none"> If the hard drive is your boot device, ensure that the cables are connected and that the drive is installed properly and partitioned as a boot device. Enter system setup and ensure that the boot sequence information is correct.
No timer tick interrupt	A chip on the system board might be malfunctioning or motherboard failure.
NOTICE - Hard Drive SELF MONITORING SYSTEM has reported that a parameter has exceeded its normal operating range. Dell recommends that you back up your data regularly. A parameter out of range may or may not indicate a potential hard drive problem	S.M.A.R.T error, possible hard disk drive failure.

Recovering the operating system

When your computer is unable to boot to the operating system even after repeated attempts, it automatically starts Dell SupportAssist OS Recovery.

Dell SupportAssist OS Recovery is a standalone tool that is preinstalled in all Dell computers installed with Windows 10 operating system. It consists of tools to diagnose and troubleshoot issues that may occur before your computer boots to the operating system. It enables you to diagnose hardware issues, repair your computer, back up your files, or restore your computer to its factory state.

You can also download it from the Dell Support website to troubleshoot and fix your computer when it fails to boot into their primary operating system due to software or hardware failures.

For more information about the Dell SupportAssist OS Recovery, see *Dell SupportAssist OS Recovery User's Guide* at www.dell.com/support.

Flashing BIOS (USB key)

Steps

1. Follow the procedure from step 1 to step 7 in "Flashing the BIOS" to download the latest BIOS setup program file.
2. Create a bootable USB drive. For more information see the knowledge base article [SLN143196](https://www.dell.com/support/sln/143196) at www.dell.com/support.
3. Copy the BIOS setup program file to the bootable USB drive.
4. Connect the bootable USB drive to the computer that needs the BIOS update.
5. Restart the computer and press **F12** when the Dell logo is displayed on the screen.
6. Boot to the USB drive from the **One Time Boot Menu**.
7. Type the BIOS setup program filename and press **Enter**.
8. The **BIOS Update Utility** appears. Follow the instructions on the screen to complete the BIOS update.

Flashing the BIOS

About this task

You may need to flash (update) the BIOS when an update is available or when you replace the system board.

Follow these steps to flash the BIOS:

Steps

1. Turn on your computer.
2. Go to www.dell.com/support.
3. Click **Product support**, enter the Service Tag of your computer, and then click **Submit**.
 **NOTE: If you do not have the Service Tag, use the auto-detect feature or manually browse for your computer model.**
4. Click **Drivers & downloads > Find it myself**.
5. Select the operating system installed on your computer.
6. Scroll down the page and expand **BIOS**.
7. Click **Download** to download the latest version of the BIOS for your computer.
8. After the download is complete, navigate to the folder where you saved the BIOS update file.
9. Double-click the BIOS update file icon and follow the instructions on the screen.

WiFi power cycle

About this task

If your computer is unable to access the internet due to WiFi connectivity issues a WiFi power cycle procedure may be performed. The following procedure provides the instructions on how to conduct a WiFi power cycle:

 **NOTE: Some ISPs (Internet Service Providers) provide a modem/router combo device.**

Steps



1. Turn off your computer.
2. Turn off the modem.
3. Turn off the wireless router.
4. Wait for 30 seconds.
5. Turn on the wireless router.
6. Turn on the modem.
7. Turn on your computer.

Getting help and contacting Dell

Self-help resources



You can get information and help on Dell products and services using these self-help resources:

Table 8. Self-help resources

Self-help resources	Resource location
Information about Dell products and services	https://www.dell.com/
Dell Support	
Tips	
Contact Support	In Windows search, type <code>Contact Support</code> , and press Enter.
Online help for operating system	<ul style="list-style-type: none"> Windows: https://www.dell.com/support/windows Linux: https://www.dell.com/support/linux
Troubleshooting information, user manuals, set up instructions, product specifications, technical help blogs, drivers, software updates, and so on.	https://www.dell.com/support/home/
Dell knowledge base articles for various of system concerns:	<ol style="list-style-type: none"> Go to https://www.dell.com/support/home/?app=knowledgebase. Type the subject or keyword in the Search box. Click Search to retrieve the related articles.
Learn and get more information about your product: <ul style="list-style-type: none"> Product specifications Operating system Setting up and using your product Data backup Troubleshooting and diagnostics Factory and system restore BIOS information 	Dell provides several online and telephone-based support and service options. If you do not have an active Internet connection, you can find contact information about your purchase invoice, packing slip, bill, or Dell product catalog. <ul style="list-style-type: none"> Select Detect Product. Locate your product through the drop-down menu under View Products. Enter the Service Tag number or Product ID in the search bar. Once on product support page, scroll down to Manuals and Documents section to preview all the Manuals, documents, and other information for your product.

Contacting Dell

Dell provides several online and telephone-based support and service options. If you do not have an active Internet connection, you can find contact information about your purchase invoice, packing slip, bill, or Dell product catalog. Availability varies by country/region and product, and some services may not be available in your area. To contact Dell for sales, technical support, or customer service issues:

1. Go to <https://www.dell.com/support/>.
2. Select your country/region from the drop-down menu on the lower right corner of the page.
3. For **customized support**:
 - a. Enter your system Service Tag in the **Enter your Service Tag** field.
 - b. Click **submit**.
 - The support page that lists the various support categories is displayed.
4. For **general support**:
 - a. Select your product category.
 - b. Select your product segment.
 - c. Select your product.
 - The support page that lists the various support categories is displayed.
5. For contact details of Dell Global Technical Support, see <https://www.dell.com/contactdell>.
 -  **NOTE: The Contact Technical Support page is displayed with details to call, chat, or email the Dell Global Technical Support team.**
 -  **NOTE: Availability varies by country/region and product, and some services may not be available in your area.**