









**RIGIDBOT**

(Big Part #2117)

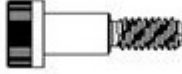
Link to Website videos: [www.Rigidbot.com](http://www.Rigidbot.com)

1:1 Scale Drawings of screws		
Part Number	Pictures	Quantity
1032		112
1033		65
1034		5
1035		7
1049		2
1107		4
1108		1
1109		2
1110		1

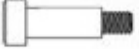
# Welcome!

Thank you for purchasing the RIGIDBOT! We have provided this instruction manual to help you with the assembly of your product so that you can create the things that change the world. As you go through this manual please follow each page carefully, following the assemblies and steps as they are shown. On the cover there is a link to the website that provides you with a video tutorial of the RIGIDBOT being assembled to help answer possible questions. On each page we have provided you with step by step picture explanations as well as the parts needed for that assembly. A 1:1 Scale Drawing of all of the screws provided is located on the previous page. This will help you with the assembly as well as a list of all of the parts found on pages 29-33. We hope you enjoy your journey assembling the RIGIDBOT and in this product. Thank You!

# Sub-Assembly 1

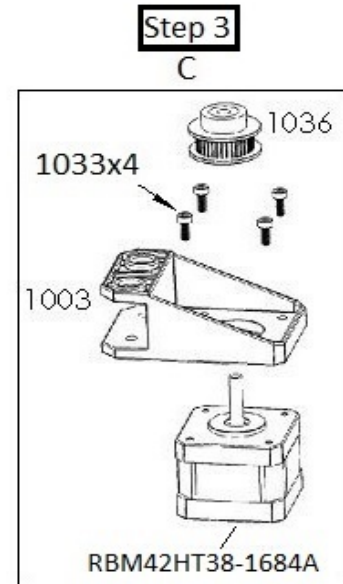
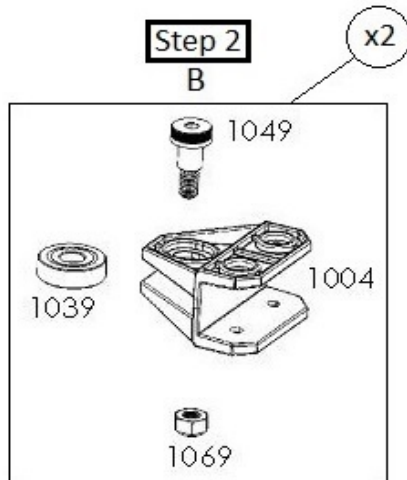
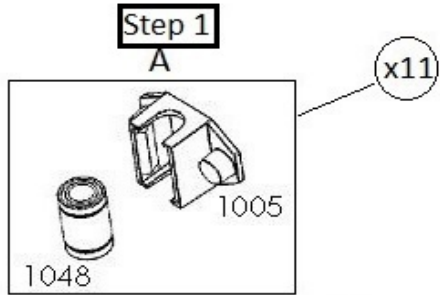



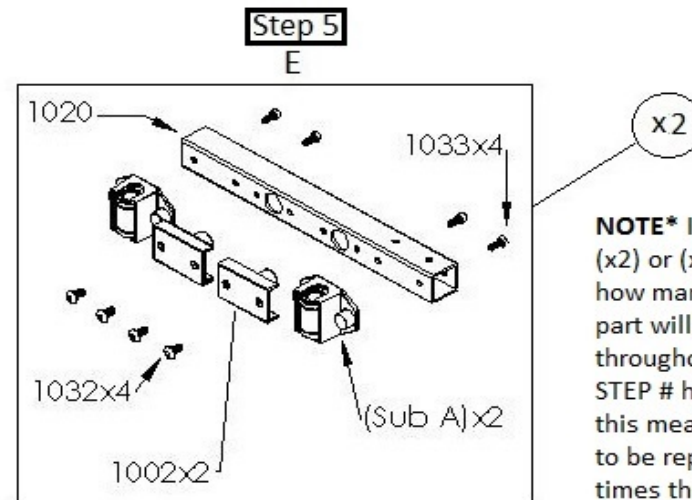
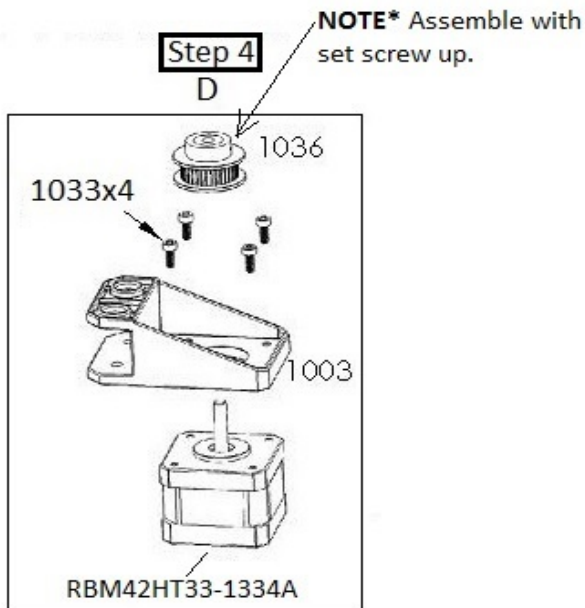







**NOTE\*** Make sure that you have the correct motor and part number in step 3 which is different than in Step 4





**NOTE\*** If a PART # has a (x2) or (x6) it is referring to how many of that same part will be used throughout that step. If a STEP # has a (x4) or (x6) this means that the step is to be repeated four or six times throughout the assembly.



## Sub Assembly 1 Parts/Instructions

Part Number	Description	Picture	Quantity
1005	Bearing Holder		11
1048	Rigid Rod Bearing		11
1049	10 mm Fastener		2
1039	Bearing for X/Y Belt		2
1069	Belt Tension Nut		2
1004	Belt Tensioner		2
1036	Pulley		2
1033	Allen - M3 x 8mm		16
1003	Motor Mount		2
RBM42HT38-1684A	Stepper Motor Big		1
RBM42HT33-1334A	Stepper Motor Small		1

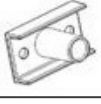
Follow the steps in numerical order as they are shown starting with step 1. In step 2 apply (part #1039) first and then insert (part #1049) through the bearing.

1032	Button Allen - M4 X 8mm		8
Sub A	Bearing/Holder		4
1020	SQ X-Axis Support		2
1002	Rod Connector		4

## Sub Assembly 2 Parts List

Part Number	Description	Picture	Quantity
1033	Allen - M3 x 8mm		33
1028	Head Plate		1
Sub A	Bearing/Holder		7
1006	Belt Connector		1
1003	Motor Mount		2
RBM42HT38-1684AL	Stepper Z Motor		2
RBM42HT38-1684A	Stepper Motor Big		2
2027	Build Plate Support		1
1008	Limit Switch Holder		3
1042	Limit Switch PCB		3

In step 7 if you purchased the upgraded z-rod follow the steps on the left. If not then follow the steps from the picture on the right. \*Make sure to correctly tighten part 1075 after it has been placed onto the motor and the rod (part #1076). Also pay attention to the way part #1003 is turned opposite of the upgraded z rod. On step 8 make sure that part number # 1042 is turned down correctly.

# Sub Assembly 2

Sub F **Step 6**

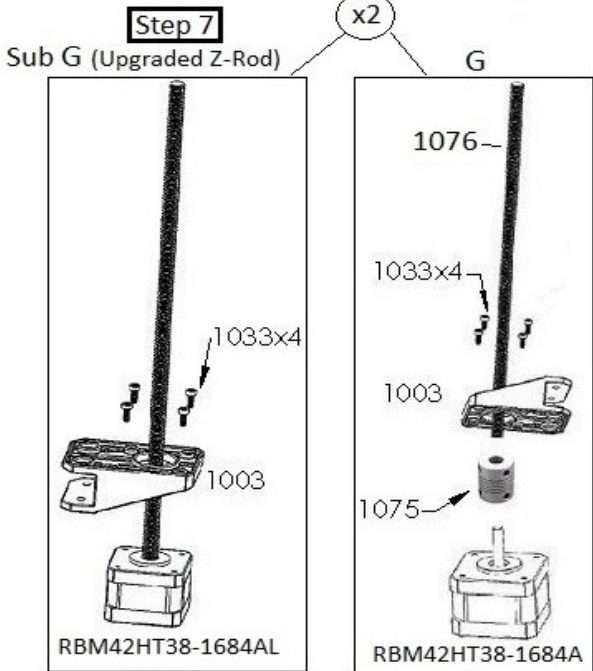
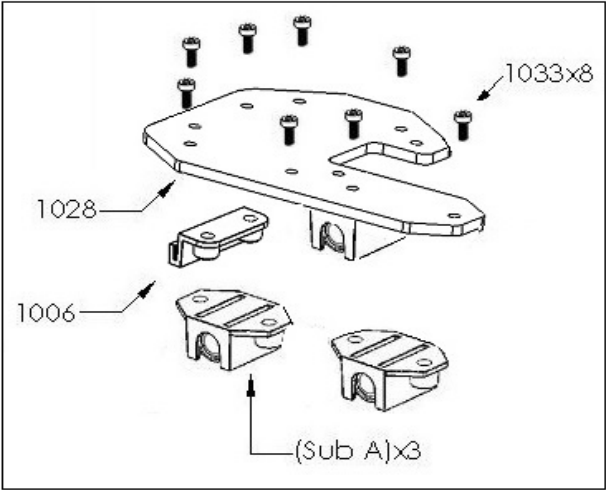

Sub H **Step 8**

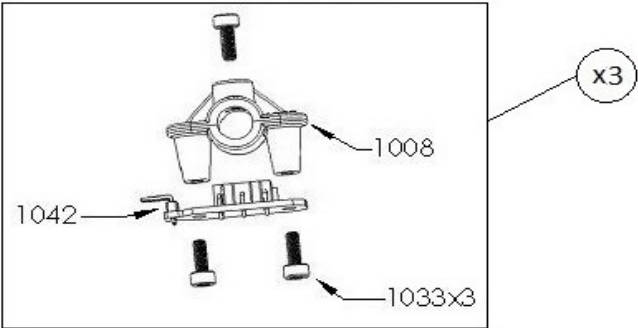

Sub I **Step 9**

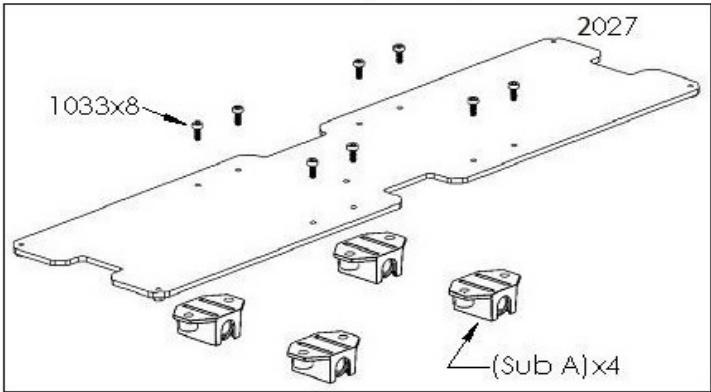



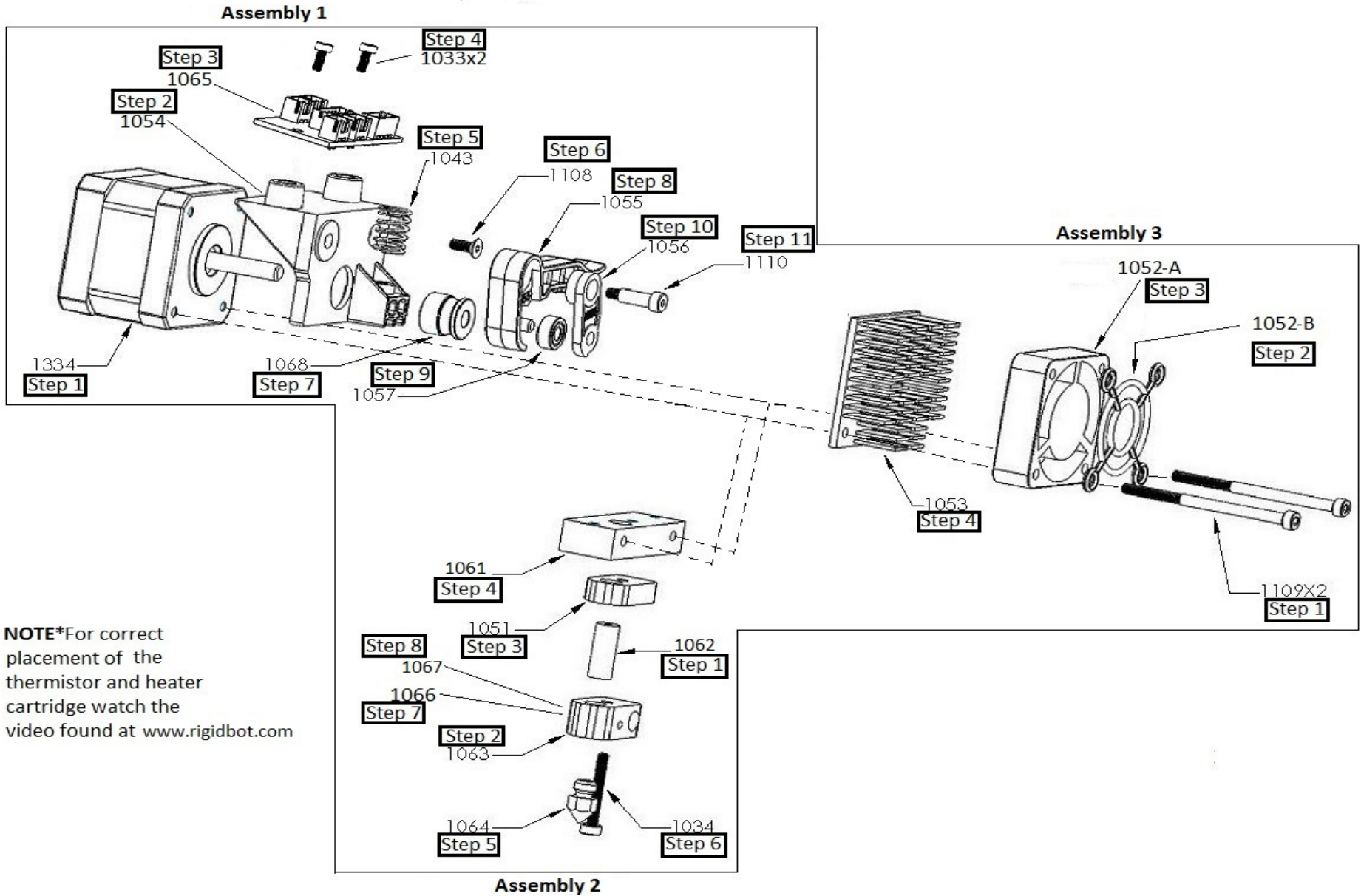

# Extruder Assembly













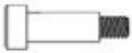
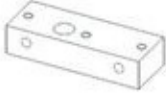



# Extruder Assembly Parts /Instructions

Part Number	Description	Picture	Quantity
RBM42HT33-1334A	Motor Small		1
1054	Head plastic top		1
1065	PCB		1
1033	PCB Screws		2
1043	Spring		1
1108	Head Cap Screw		1
1068	Drive Gear		1
1055	Head plastic arm		1
1057	Extruder bearing		1

First, assemble steps 1-11 in assembly 1. After assembly 1 has been completed follow steps 1-8 in assembly 2. When both assembly 1 and assembly 2 have been completed finish steps 1-4 in assembly 3. After Assembly 1-3 have been correctly put together place the two holes on Assembly 2 in line with Assembly 3 screws as shown in the picture and put screws through the holes tightening them to the motor. NOTE\* Tighten dc all the way but don't over tighten causing the fan to crack. Make sure the open end of the fan blade (part #1052-A) is facing the heat sink (part # 1053), if you have questions refer to the videos on the website.

Parts continued on next page

1056	Head plastic insert		1
1110	Shoulder Screw		1
1061	Mounting Block		1
1051	Head Peek		1
1062	Feeder Tube		1
1063	Heating Block		1
1064	Extruder Nozzle .4mm		1
1034	Allen - M3 x 22mm		1
1052 -A	Extruder Fan		1
1052 - B	Extruder Fan Metal		1

1053	Heat Sink		1
1067	Thermister		1
1066	Heater Cartridge		1
1109	12.9 Head cap screw		2

# Extruder Fully Assembled

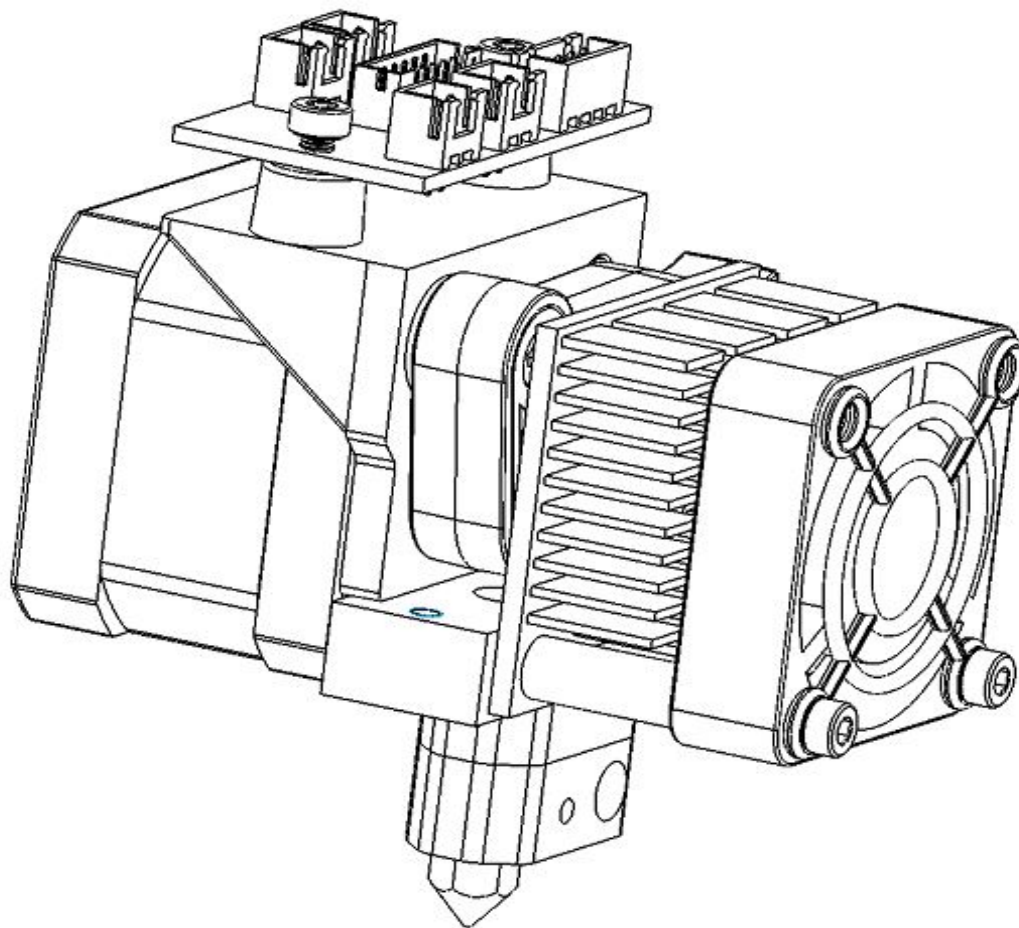

Note\* Thermistor, Heater Cartridge, Wiring connectors are not shown.



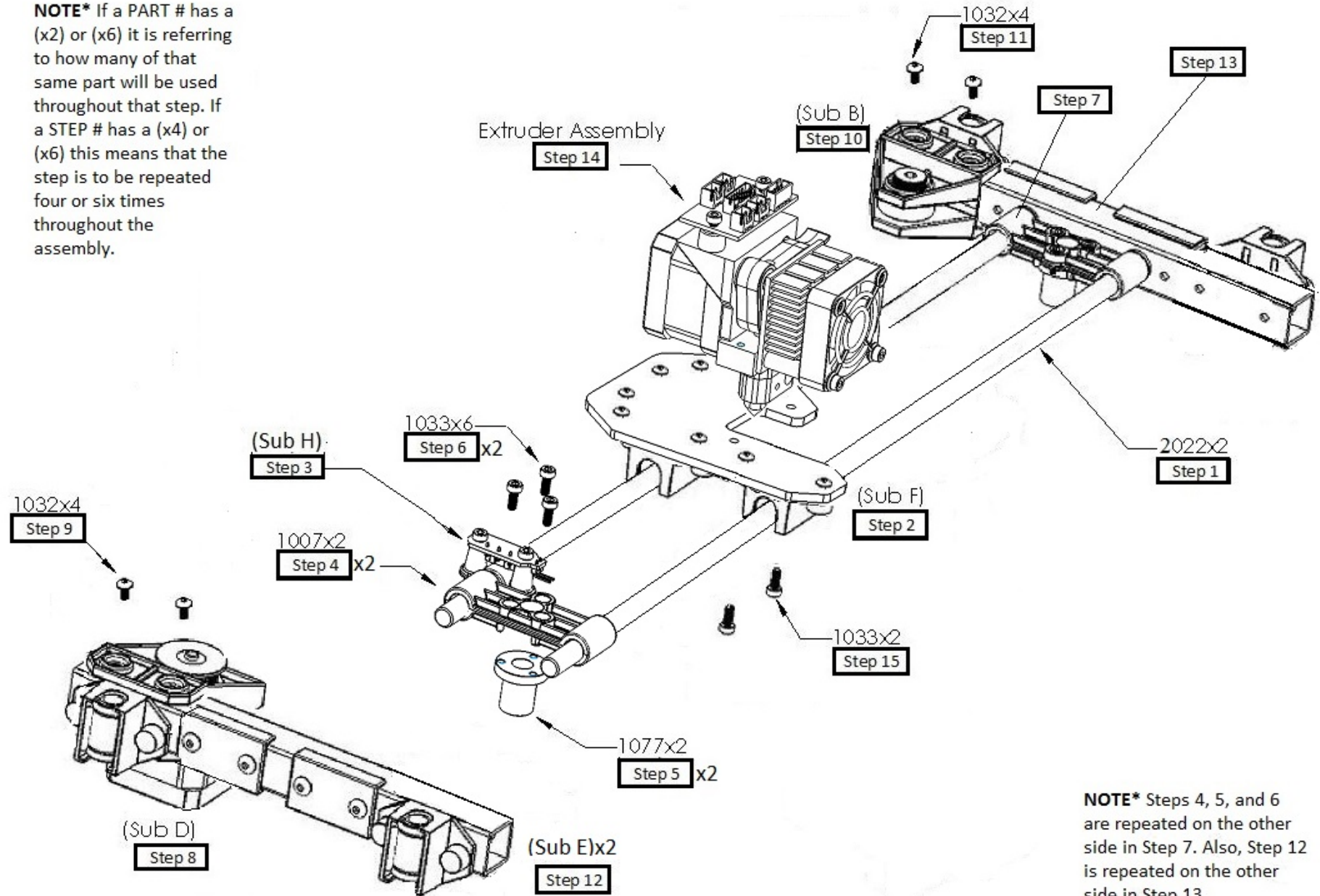

# Gantry Assembly

**NOTE\*** If a PART # has a (x2) or (x6) it is referring to how many of that same part will be used throughout that step. If a STEP # has a (x4) or (x6) this means that the step is to be repeated four or six times throughout the assembly.



**NOTE\*** Steps 4, 5, and 6 are repeated on the other side in Step 7. Also, Step 12 is repeated on the other side in Step 13.

# Gantry Assembly Parts/Instructions

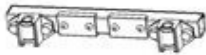

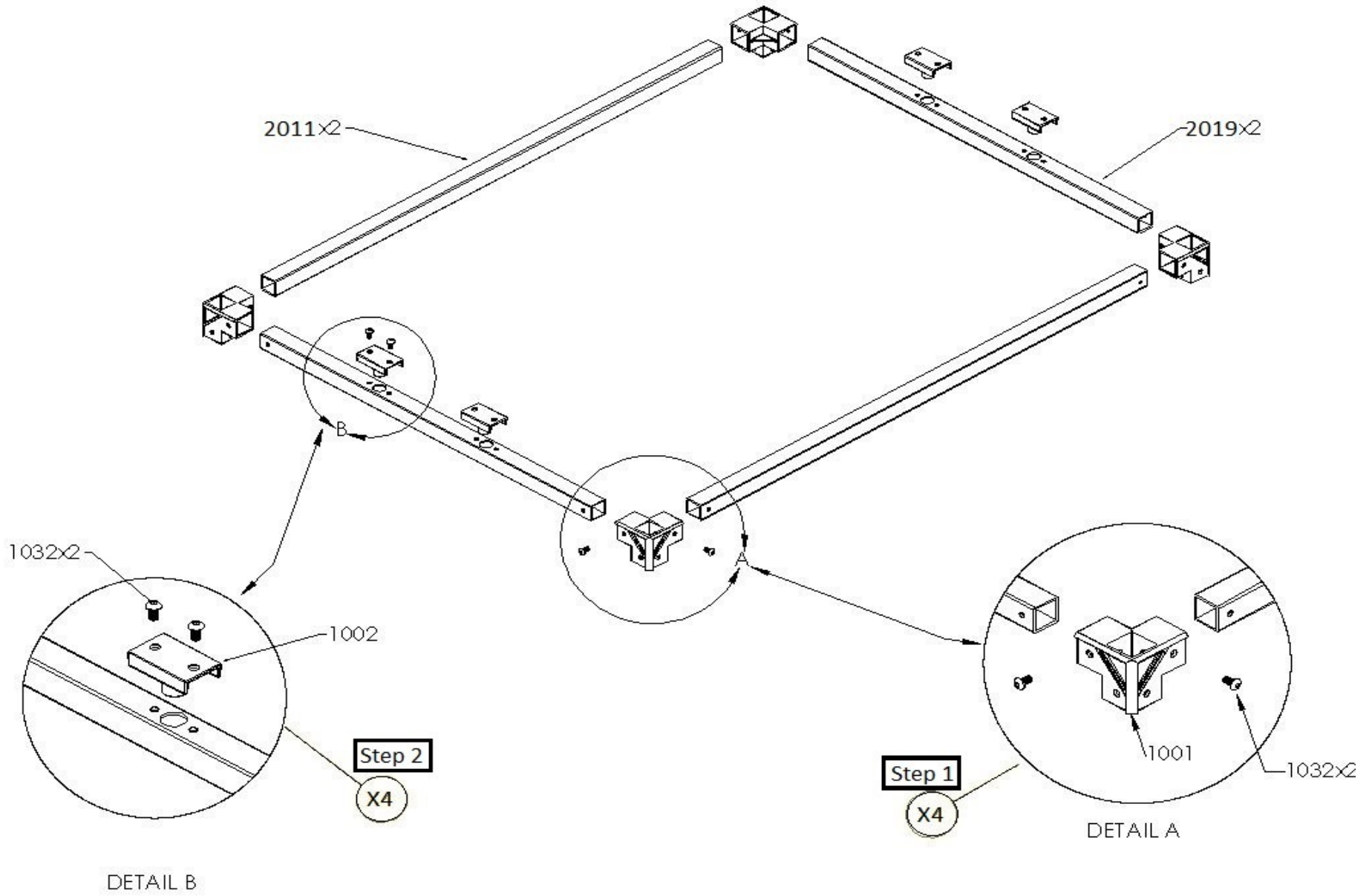

Part Number	Description	Picture	Quantity
2022	8 mm steel rod		2
Sub F	Extruder Mount		1
Sub H	Limit Switch		1
1007	Z-nut bracket		2
1077	Z-nut 8mm		2
1033	Allen - M3 x 8mm		8
Sub D	Motor/Mount		1
1032	Allen - M4 x 8mm		8
Sub B	Idler Bearing		1
Sub E	Z rod support		2
Extruder Assembly	Extruder		1

For the gantry assembly follow the steps in correct order. NOTE\* If a PART # has a (x2) or (x6) it is referring to how many of that same part will be used throughout that step. If a STEP # has a (x4) or (x6) this means that the step to be repeated four or six times throughout the assembly. There are four screws that are used on Sub D and Sub B totaling 8 screws with two on top and two on the bottom. Sub H and Sub F must be placed on the rods before parts 1007 and before Sub E are placed on the sides.

# Top Frame Assembly



# Top Frame Assembly Parts/Instructions

Part Number	Description	Picture	Quantity
2019	SQ- Top Short		2
2011	SQ- Bottom Front		2
1002	Rod Connector		4
1032	Button Allen - M4 X 8mm		16
1001	Knuckle		4





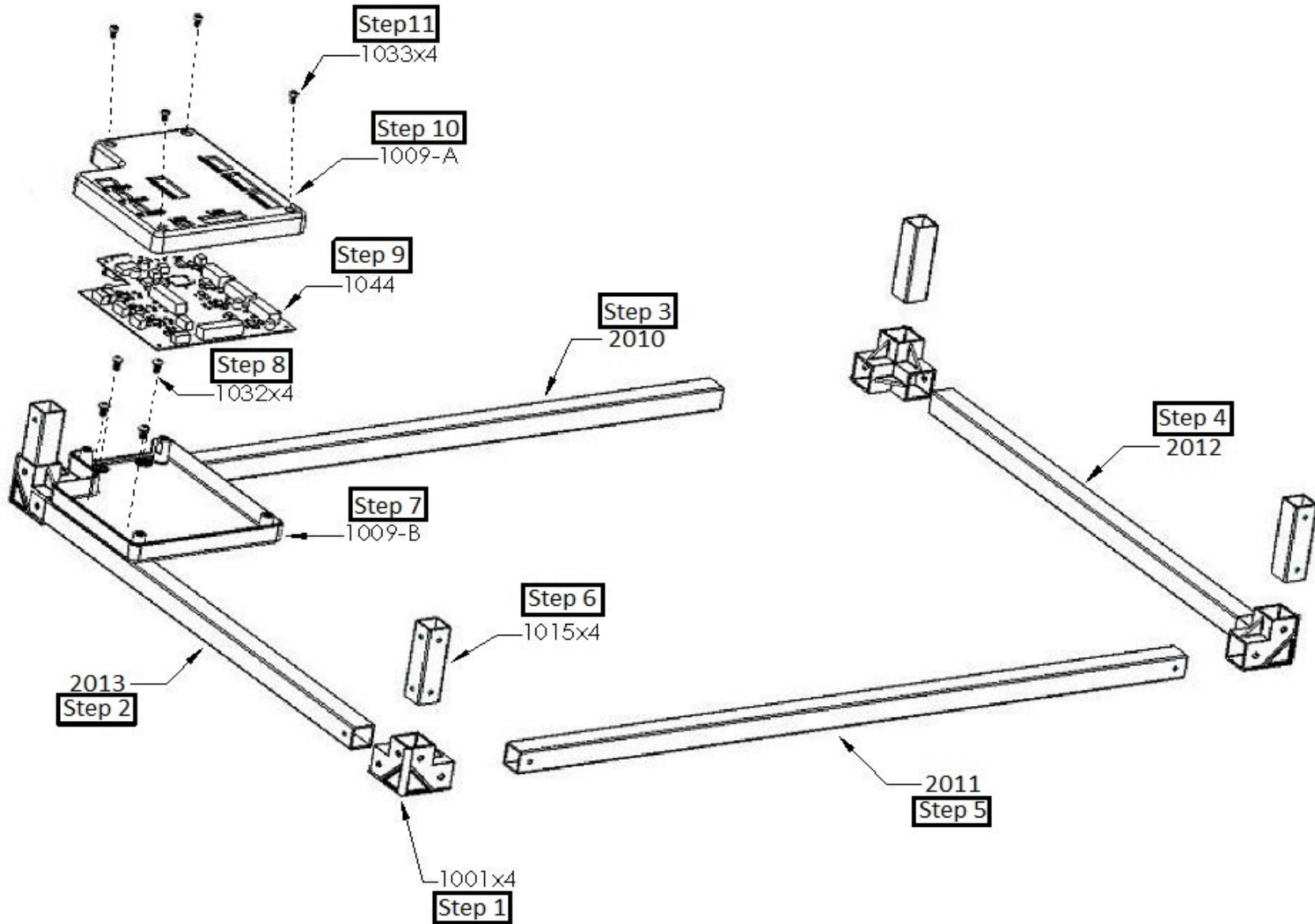





Follow the steps in order. NOTE\* If a PART # has a (x2) or (x6) it is referring to how many of that same part will be used throughout that step. If a STEP # has a (x4) or (x6) this means that the step is to be repeated four or six times throughout the assembly.

# Bottom Frame Assembly





# Bottom Frame Assembly Parts /Instructions

Part Number	Description	Picture	Quantity
1001	Knuckle		4
2013	Rigid SQ Bottom left		1
2010	Rigid SQ bottom back		1
2012	Rigid SQ bottom right		1
2011	Rigid SQ bottom front		1
1015	Rigid SQ short vertical		4
1009-B	Bottom enclosure		1
1032	Allen - M4 x 8mm		4
1044	Main board		1
1009-A	Top enclosure		1







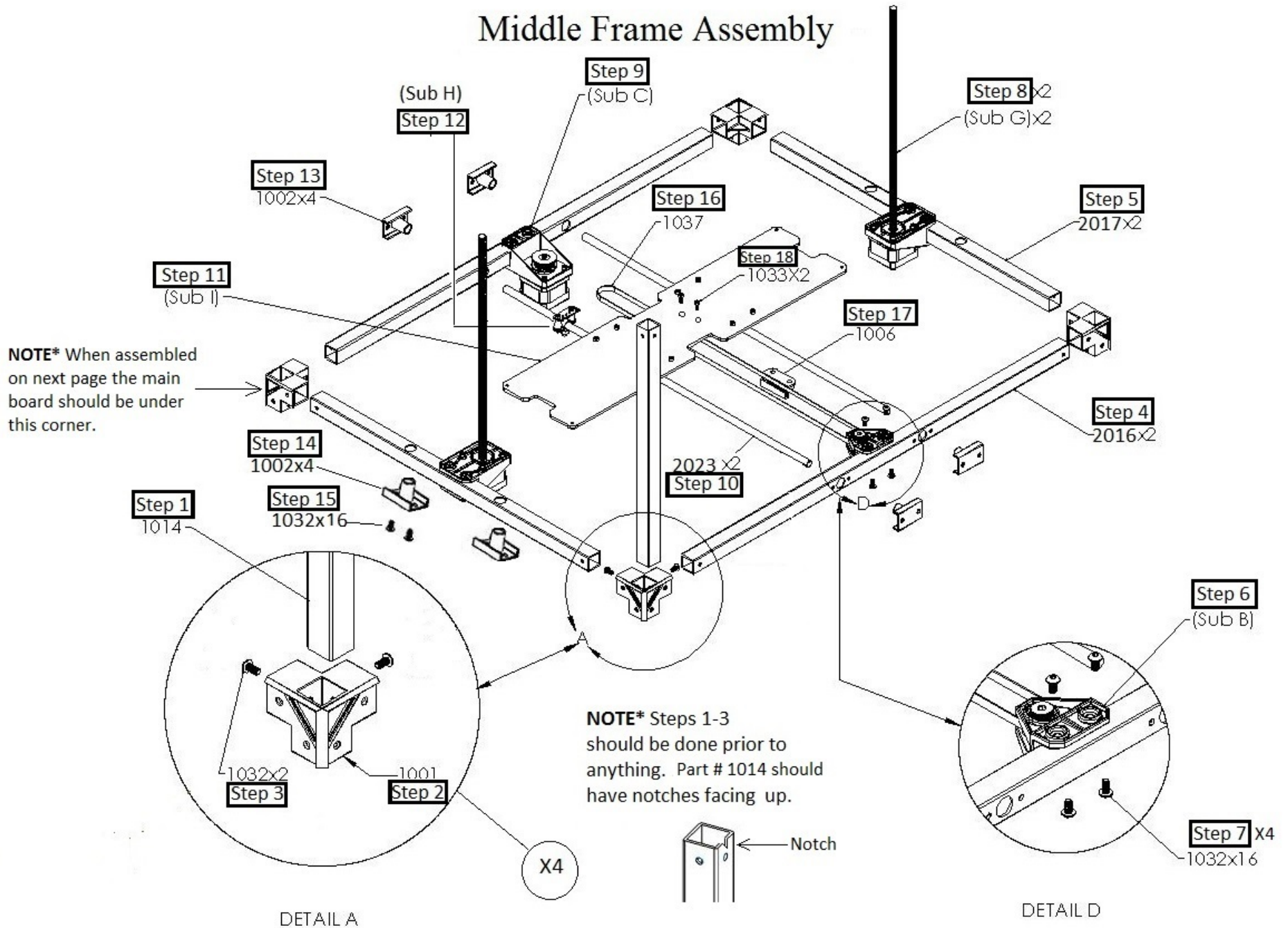



Follow the steps in order. NOTE\* Don't place any of the outside screws connecting the bars and part numbers 1001. These will be placed in a different step later on in the instruction manual.

1033	Allen - M3 x 8mm		4
------	------------------	---	---





# Middle Frame Assembly



# Middle Frame Assembly Parts /Instructions

Part Number	Description	Picture	Quantity
1014	Rigid SQ long vertical		4
1001	Rigid Knuckle		4
1032	Allen - M4 x 8mm		32
2016	Rigid SQ middle long		2
2017	Rigid SQ middle short		2
Sub G	Z Motor and Mount		2
Sub C	Motor and Mount		1
2023	8mm Steel Rod Y axis		2
Sub I	Build Plate Mount		1
Sub H	Limit Switch		1







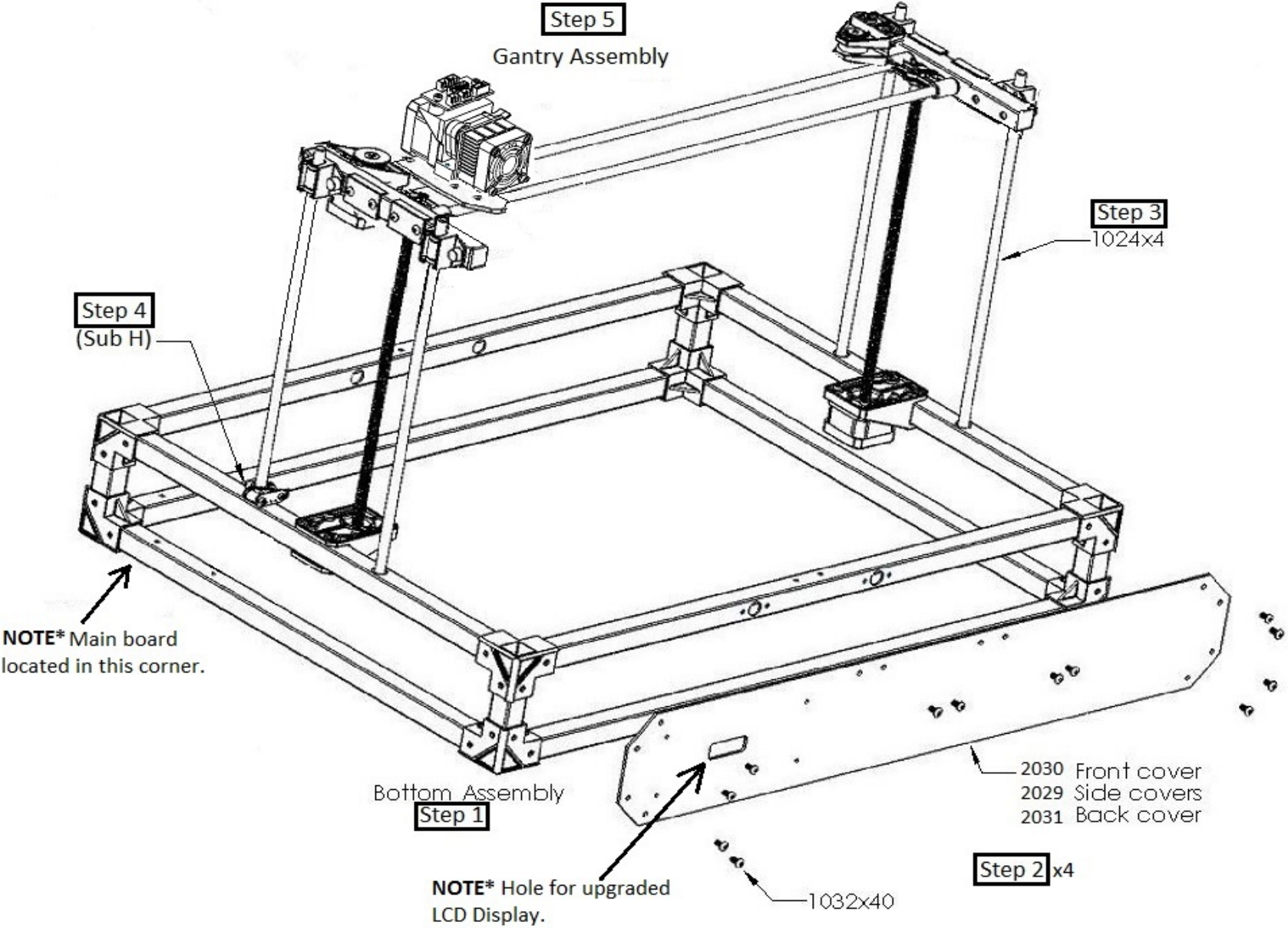

**IMPORTANT\*\*** Doing Steps 1-3 first is very important! In step 1 make sure the notch on the vertical bars (part #1014) are NOT going into the rigid knuckle (part #1001). Four of the (part #1032) screws are used for each Sub B, C and G assembly when connecting them to the frame.  
**NOTE\*** Step 18 two screws will go down and screw into step 17 (part #1006) and tight against the board. Note\* The Y-gantry belt should be cut and verified that it is tight fitting.

1002	Rod Connector		8
1037	X/Y Belt		1
1006	Belt Connector		1
1033	Allen - M3 x 8mm		2
Sub B	Idler Bearing		1

# Bottom/Middle/Gantry Assembly

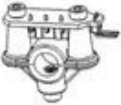

# Bottom/Middle/Gantry Parts/Instructions

Part Number	Description	Picture	Quantity
Bottom Assembly	Bottom		1
2030	Front Cover		1
2029	Side Covers		2
2031	Back Cover		1
1032	Allen - M4 x 8mm		
1024	8mm Steel Rod Z axis		4
Sub H	Limit Switch		1
Gantry Assembly	Gantry/Extruder		1





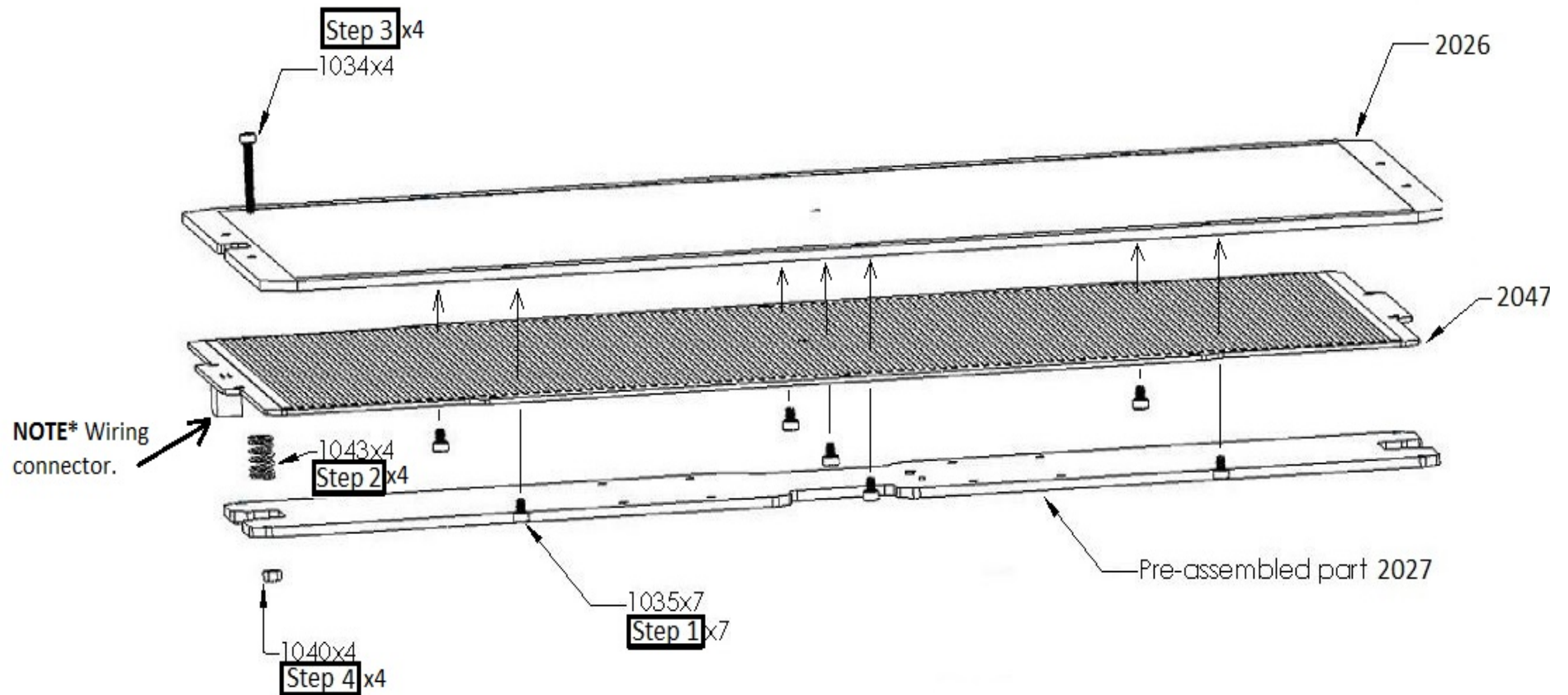

NOTE\* Some previously assembled parts are not shown. In step 2 install all four covers with screws (part #1032). The front cover hole that is shown in the picture is only used for the upgraded LCD Display and would only be used if it was purchased. Some grease may be needed with the z rods to help the motor do its job properly.

# Heated Bed Assembly



NOTE\* Don't tighten screw nut completely, allow looseness for leveling the bed later.

# Heated Bed Assembly Parts/Instructions

Part Number	Description	Picture	Quantity
2027	Build Plate Mount		1
1035	Allen - M3 x 4mm		7
2047	Heated Build PCB		1
2026	Build Plate		1
1034	Allen - M3 x 22mm		4
1043	Spring		4
1040	Heat Bed Nut		4

The wiring connector on part 2047 should be on the side closest to the main board and opposite of the belt connector. NOTE\* If a PART # has a (x2) or (x6) it is referring to how many of that same part will be used throughout that step. If a STEP # has a (x4) or (x6) this means that the step is to be repeated four or six times throughout the assembly.

# Completing Frame Assembly

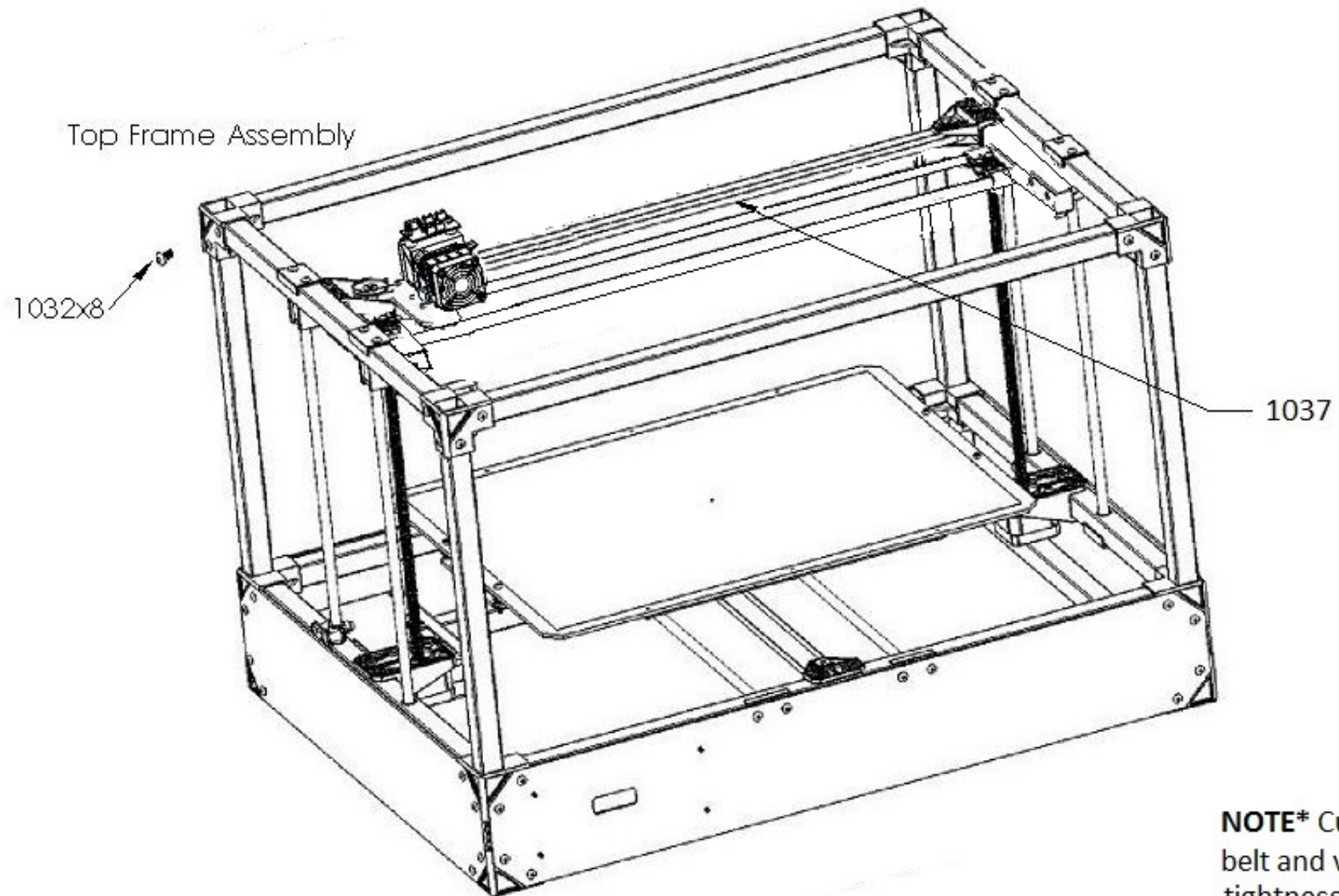



# Completed Assembly Parts /Instructions

Parts Number	Description	Picture	Quantity
Top Frame Assembly	Top Frame		1
1032	Allen - M4 x 8mm		8
1037	Belt		1







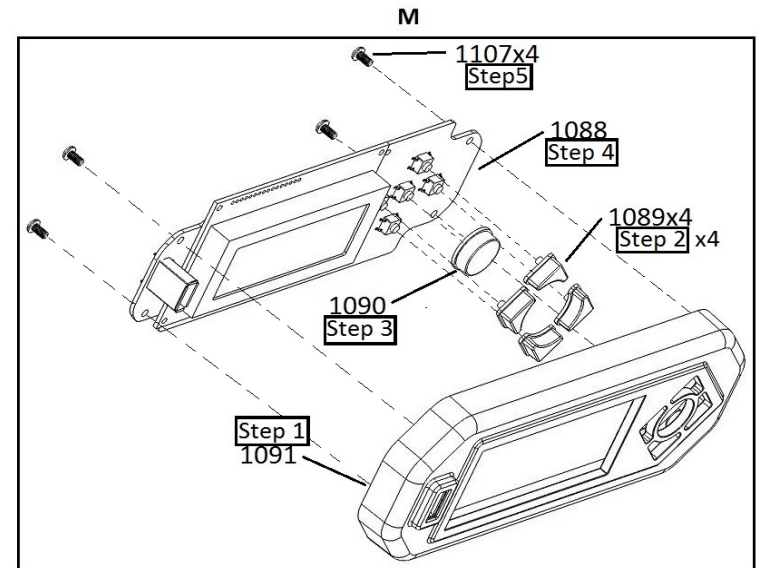
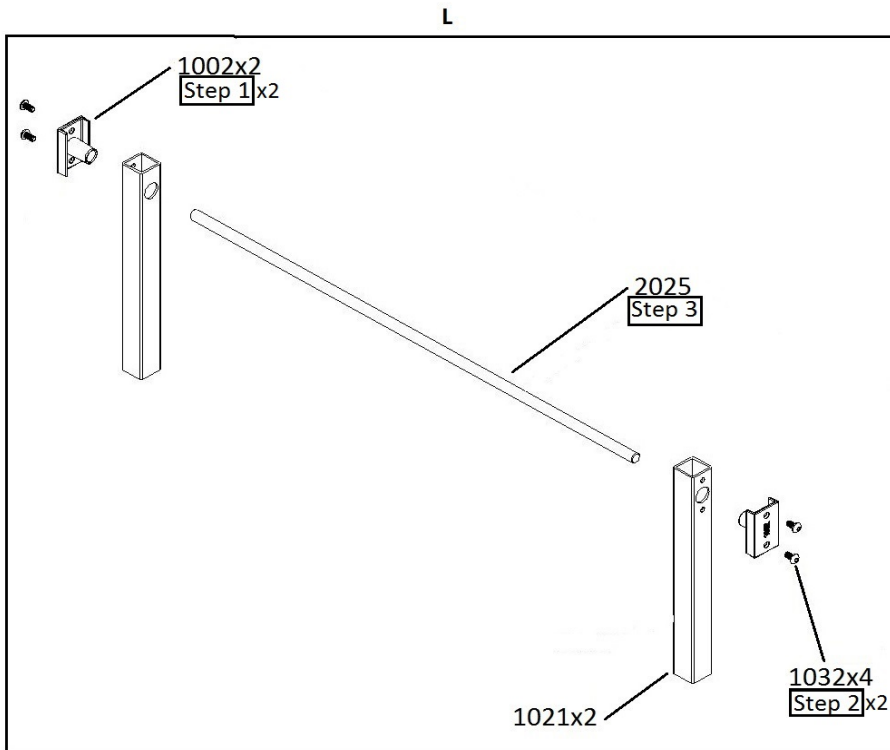
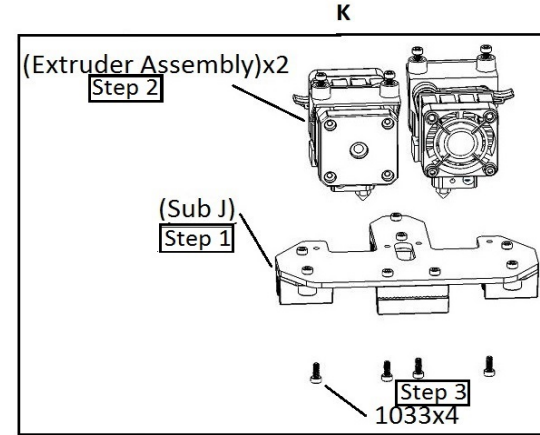
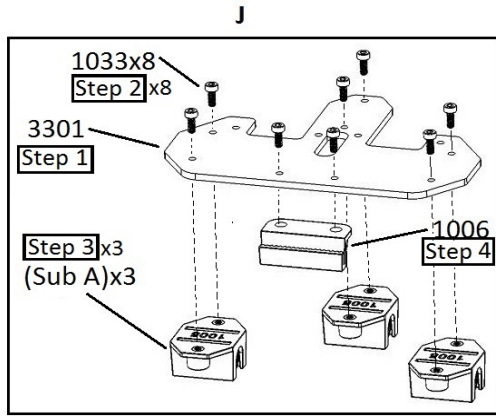



Add the top frame along with the belt and eight screws (part # 1032). Cut the belt and adjust it to fit tight. **IMPORTANT\*** After completely assembling the rigid bot, calibrate the z rods and level the printing bed so that the extruder nozzle is completely level on the printing bed. Refer to videos for accurate calibration and leveling.

# Add-On Assemblies





NOTE\* See videos for dual extruder assembly.



# Add-On Assembly Parts/Instructions

Part Number	Description	Picture	Quantity
1033	Allen - M3 x 8mm		12
Sub A	Bearing/Holder		3
1006	Belt Connector		1
3301	Dual Head Plate		1
Sub J	Build Plate mount		1
Extruder Assembly	Extruder		2
1002	Rod Connector		2
2025	Spooler Rack Bar		1
1021	Rigid SQ-Spooler rack		2
1032	Button Allen - M4 X 8mm		4

Follow these steps if any of the add ons were purchased. NOTE\* Some add ons have not yet been available for purchase. If the LCD upgrade was purchased follow the steps for M and place it in the hole on the front of the machine and simply add four (part #1032) screws on the back, then connect the wiring





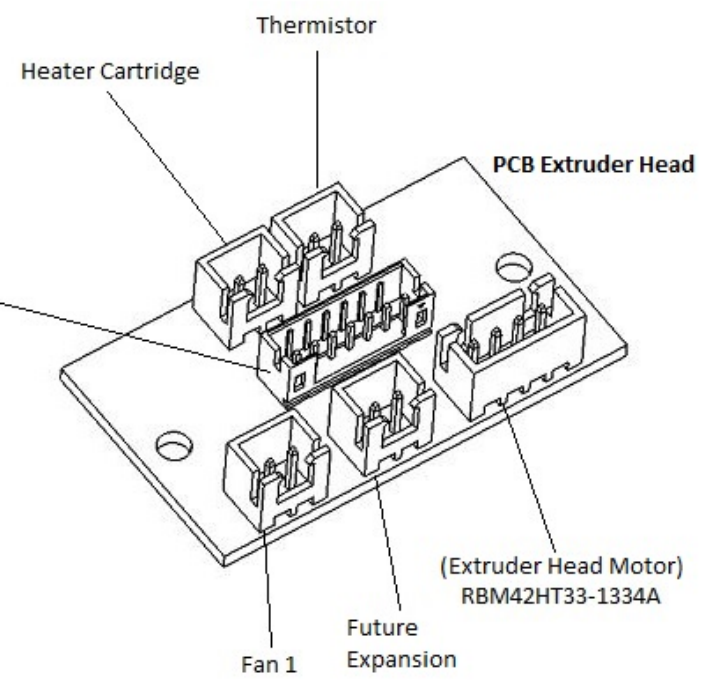
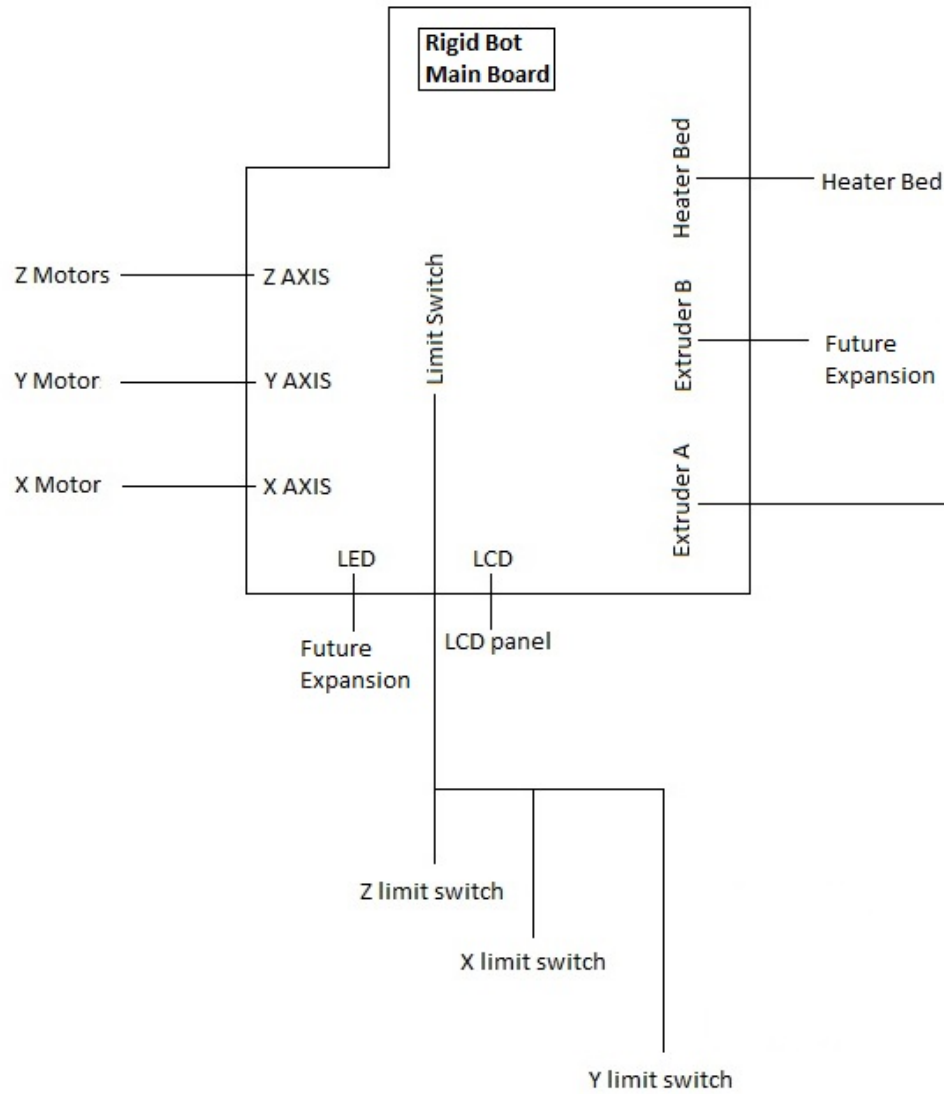



1107	Button Head Cap Screw		4
1088	LCD - Electronic PCB		1
1090	LCD - Center Button		1
1089	LCD - Arrow Button		4
1091	LCD - Plastic Enclosure		1







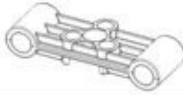



# Wiring/Cable Management













Note\* For correct wiring assembly watch video at [www.rigidbot.com](http://www.rigidbot.com)











# Parts List

Part Number	Description	Picture	Quantity
1001	Knuckle		12
1002	Rod Connector		16
1003	Motor Mount		4
1004	Belt Tensioner		2
1005	Bearing Holder		11
1006	Belt Connector		2
1007	Z-Nut Bracket		2
1008	Limit Switch Holder		3
1009 A	Top Enclosure		1









1009 B	Bottom Enclosure		1
2010	Rigid SQ- Bottom Back		1
2011	Rigid SQ- Bottom Front		1
2012	Rigid SQ- Bottom Right		1
2013	Rigid SQ- Bottom Left		1
1014	Rigid SQ- Long Vertical		4
1015	Rigid SQ- Short Vertical		4
2016	Rigid SQ- Middle Long		2
2017	Rigid SQ- Middle Short		2
2019	Rigid SQ- Top Short		2

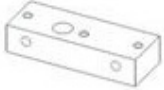









1020	Rigid SQ- X Axis Support		2
1021	Rigid SQ- Spooler Rack		2
2022	8mm Steel ROD X axis		2
2023	8mm Steel ROD Y axis		2
1024	8mm Steel ROD Z axis		4
2025	Spooler Rack Bar		1
2026	Build Plate		1
2027	Build Plate Support		1
1028	Head Plate		1
2029	Side cover Small		2

2030	Front cover Small		1
2031	Back cover Small		1
1032	Button Allen – M4 x 8mm		112
1033	Allen – M3 x 8mm		65
1034	Allen – M3 x 22mm		5
1035	Allen – M3 x 4mm		7
1036	Pulley		2
1037	Belt		2
1038	Pulley and Belt Pack		1
1039	Bearing 608 for X/Y Belt		2











1040	Heated Bed Nut – M3 Nut		4
1041	Cable Management		1
1042	Limit Switch PCB		3
1043	Rigid Spring		5
1044	Main Board		1
RBM42HT33-1334A	Motor Small		2
RBM42HT38-1684A	Motor Big		1
RBM42HT38-1684AL	Z Motor		2
2047	Heated Build PCB		1
1048	Rigid Rod Bearing		11

1049	Fastener – 10mm M6 thread		2
1050	Extruder Head Hardware (6 parts)		1
1051	Head Peek		1
1052 A	Extruder Fan		1
1052 B	Extruder Fan Metal		1
1053		1	
1054	Head – Plastic – Material Load Top		1
1055	Head – Plastic – Material Load ARM		1
1056	Head – Plastic – Material Load Insert		1
1057	Extruder Feed Ball Bearing		1

1058	Bearings		1
1061	Mounting Block		1
1062	Feeder Tube		1
1063	Heating Block		1
1064	Extruder Nozzle - .4mm		1
1065	Head PCB		1
1066	heater cartridge		1
1067	Thermistor		1
1068	Drive Gear		1
1069	Belt Tension Nut M6 1mm Pitch		2
1070	Rigid Logo Sticker		1

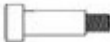
1071	Rigid Hot Sticker		1
1072	Rigid Safety Sticker		1
1075	Z - Coupler		2
1076	Z - 8mm rod		2
1077	Z - Nut - 8mm		2
1088	LCD - Electronic PCB		1
1089	LCD - Arrow Button		4
1090	LCD - Center Button		1
1091	LCD - Plastic Enclosure		1
1092	Power Supply		1
1093	Heated Base Plate Wiring		1



1097	Allen Wrench main		1
1104	LCD – Wiring		1
1105	Zip Tie Pack of 6		1
1106	Head Wiring		1
1107	Button Head Cap Screw		4
1108	Class 10.9 Socket Head Cap Screw		1
1109	Class 12.9 Socket Head Cap Screw		2
1110	Shoulder Screw		1
1111	2mm, 2inch long Hex L-Key		1
1112	1.5mm, 1 3/4inch long Hex L-Key		1
1113	Limit Switch Wiring		1