

# SLUSH PUPPIE



## SLUSH PUPPIE® MAKER INSTRUCTIONS FOR USE

Product Ref: 9041\_v11. Voltage: 220-240V 50/60Hz. Power: 20 Watts.

# CONTENTS

<b>Safety Information</b>	<b>2</b>
<b>Before You Begin</b>	<b>3</b>
– Remove Packaging	
– What's in the box	
– What you will need	
– Tips on using your SLUSH PUPPIE Maker	
<b>Assembly</b>	<b>4-5</b>
<b>Using the Machine</b>	<b>5-6</b>
– Making Slush Puppies	
– Dispensing Slush Puppies	
<b>Storage and Maintenance</b>	<b>7</b>
– Cleaning and Care	
– Storage	
– Servicing	
– Troubleshooting	
– Helpful Hints and Tips	
– Technical Specification	



**Watch a Video**  
For top tips and guidance on making perfect Slush Puppies a video can be found at: [slushpuppie.fizzcreations.com](http://slushpuppie.fizzcreations.com) or simply scan here.



## SAFETY INFORMATION

**PLEASE READ THESE INSTRUCTIONS CAREFULLY BEFORE ASSEMBLING AND USING YOUR SLUSH PUPPIE MAKER. WE RECOMMEND YOU KEEP THESE INSTRUCTIONS IN A SAFE PLACE FOR FUTURE REFERENCE.**

- ✗ Never use any attachments or tools not included with the SLUSH PUPPIE Maker. The use of these attachments may cause, fire, electric shock or injury.
- ✗ Never use the SLUSH PUPPIE Maker for anything other than its intended use. The appliance is for household use only. This appliance is used indoors only. This appliance is intended to be used in household and similar applications: staff kitchen areas in shops, offices and other working environments; farm houses; by clients in hotels, motels and other residential type environments; bed and breakfast type environments.
- ✗ Never allow children to use the SLUSH PUPPIE Maker, close supervision is necessary when this appliance is in use near children.
- ✗ Never let the power cord hang over the edge of the worktop, touch hot surfaces, become knotted, trapped or pinched.
- ✗ Never place on or near a heat source.
- ✗ Never leave the SLUSH PUPPIE Maker unattended during use.
- ✗ Never touch the exposed metal parts of the appliance during use as they will become very hot.
- ✗ Never operate the SLUSH PUPPIE Maker by means of an external timer or separate remote control system.
- ✗ Never immerse the power cord or plug into water or any other liquid. This is to protect against electric shock.
- ✓ Always ensure the SLUSH PUPPIE Maker is only used by a responsible adult.
- ✓ Always use the SLUSH PUPPIE Maker on a stable level surface.
- ✓ Always ensure that hands are dry before handling the plug or switching on the SLUSH PUPPIE Maker.
- ✓ Always unplug this unit when not in use and before cleaning.
- ✓ Always allow the SLUSH PUPPIE Maker to fully cool down before cleaning or storing.
- ✓ Always carry out regular checks on the SLUSH PUPPIE Maker and power cord.

In order to avoid hazard, should there be any sign of damage, do not attempt to use or repair. If the supply cord is damaged, it must be replaced by the manufacturer, its service agent or similarly qualified persons in order to avoid a hazard. The SLUSH PUPPIE Maker has no user serviceable parts.

This appliance can be used by children aged from 8 years and above and persons with reduced physical, sensory or mental capabilities or lack of experience and knowledge if they have been

given supervision or instruction concerning use of the appliance in a safe way and understand the hazards involved.

- Children shall not play with the appliance.
- Cleaning and user maintenance shall not be made by children unless they are older than 8 and supervised.
- Keep the appliance and its cord out of reach of children less than 8 years.

## Electrical Safety

**PLEASE READ THESE INSTRUCTIONS THOROUGHLY BEFORE USING THE SLUSH PUPPIE MAKER OR CONNECTING IT TO THE MAINS ELECTRICITY SUPPLY.**

- A 3 amp BS1362 ASTA approved fuse must be fitted.
- There are no user serviceable parts inside the SLUSH PUPPIE Maker. In order to avoid hazard always refer servicing to a qualified service personnel.
- Do not allow the SLUSH PUPPIE Maker to be exposed to rain or moisture during use or storage.
- Before switching on, make sure that the voltage of your electricity supply is the same as that indicated on the SLUSH PUPPIE Maker's rating plate. Connecting it to any other power source may cause damage.
- The mains lead of the SLUSH PUPPIE Maker is not replaceable by the user. If the mains lead is damaged, the entire SLUSH PUPPIE Maker should be replaced by a suitable qualified person in order to avoid hazard. In order to avoid hazard if the plug has to be changed because it is not suitable for your socket, or due to damage, it should be cut off and a replacement fitted by a qualified person.

# BEFORE YOU BEGIN

## Remove Packaging

Carefully remove all packaging material and promotional labels from the SLUSH PUPPIE Maker.

## What's in the box

In the box you will find...

### Canister Lid

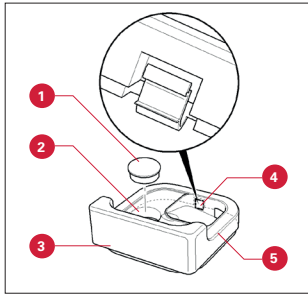

- 1 Ice/Salt Inlet Cap
- 2 Ice/Salt Inlet
- 3 Canister Lid
- 4 Locking Catch
- 5 Syrup Inlet

### Ice Canister

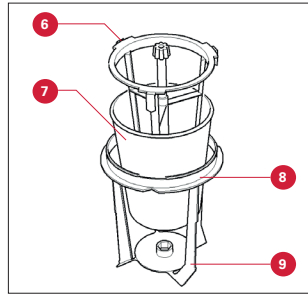

- 6 Ice Canister Cage with Ice Paddle Locking Clips
- 7 Ice Canister
- 8 Ice Paddle Assembly
- 9 Slush Puppie Blades

### Slush Puppie Container

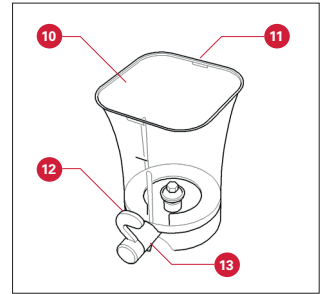

- 10 Slush Puppie Container
- 11 Locking Notch
- 12 Tap Handle
- 13 Tap

### Motor Base

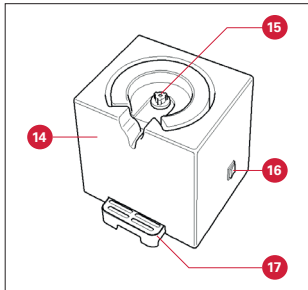

- 14 Motor Base
- 15 Drive Sprocket
- 16 Mix/Off/Dispense Switch
- 17 Drinks Tray

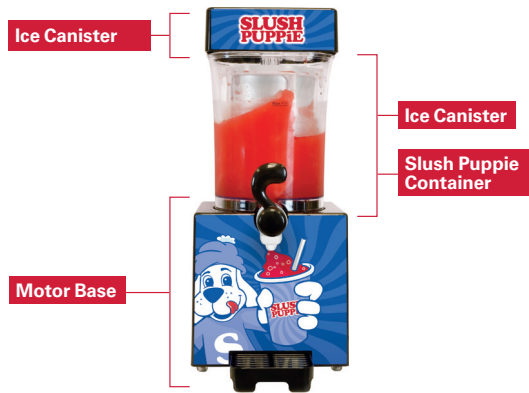

## What you will need...

Once you've chosen a flavour, make the Slush Puppie syrup mixture in a jug that will hold at least 1 litre of mixture. Carefully follow the instructions on the syrup bottle. **To make 1 litre of Slush Puppie, mix 835ml of water to 165ml syrup.** This is a guide and should your mixture not produce the desired slush, you can add more water or syrup as necessary. If the mixture is not freezing enough to produce slush, it is likely you will need more water. If the mixture is becoming too

solid it is likely you will need more syrup.

To make perfect Slush Puppies chill your mixture for a minimum of 2 hours but ideally overnight. If the mixture is too warm, chilling or freezing within the Ice Canister will not take place. **For faster Slush Puppies and the best results** we recommend freezing the Ice Canister for 1 hour before making Slush Puppies. Do not freeze the Ice Canister for longer than this as it will become too cold.

### Ice Cubes

Make sure you have enough ice cubes on hand to fill the Ice Canister.

### Water

At least 80ml of cold water.

### Salt

We recommend you have enough salt to fill 7 Ice/Salt Inlet Caps. This is equivalent to approximately 170g

**NOTE:** The salt will not be consumed; it is used to stop the ice mix from rapidly freezing.

### Cups

Use your own, or purchase the Slush Puppie Cups (9oz).



## TIP: Using Your SLUSH PUPPIE Maker

Your SLUSH PUPPIE Maker can make a maximum of 1 litre of Slush Puppie mix in one go.

**PLEASE NOTE** that the Slush Puppie mix will reduce in volume when the slush starts to form.

**DO NOT** exceed the maximum capacity of 1 litre of liquid in the Slush Puppie Container as indicated by the 'Max Fill' level on the front of the container. This will result in the liquid overflowing into the Ice Canister, mixing with the salt and ice.

# ASSEMBLY

It's almost time for some Slush Puppies.

First, let's get the SLUSH PUPPIE Maker ready for action...



**DO NOT** plug the power cord into the mains electrical supply until the SLUSH PUPPIE Maker is fully assembled. Before using for the first time, clean any removable parts with a soft sponge and washing up liquid. Thoroughly rinse with clean water and dry.

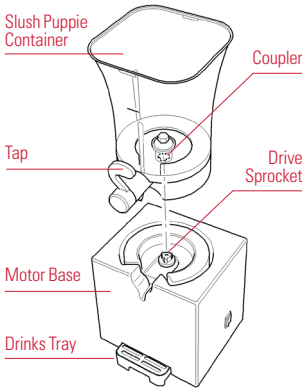

**1** Insert the Slush Puppie Container onto the Motor Base. Make sure the Coupler on the Slush Puppie Container is correctly aligned with the Drive Sprocket and slots firmly into position. The Tap should sit directly above the Drinks Tray.

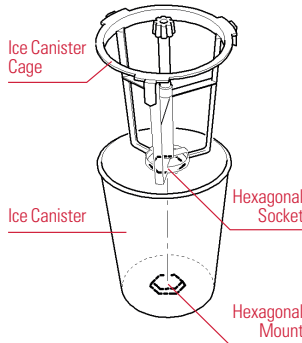

**2** Insert the Ice Canister Cage into the Ice Canister. Make sure the Hexagonal Socket on the Ice Canister Cage aligns with the Hexagonal Mount in the Ice Canister.

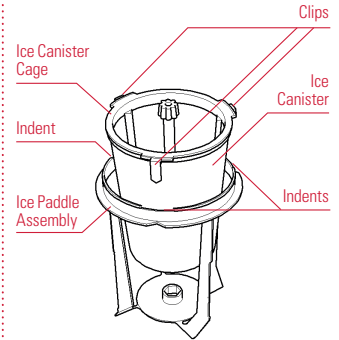

**3** Insert the Ice Canister complete with Ice Canister Cage into the Ice Paddle Assembly so that the Clips line up with the 3 Indents. Make sure the Ice Canister is correctly seated. Carefully push each Clip into place. A loud 'click' will indicate each Clip is securely in position.

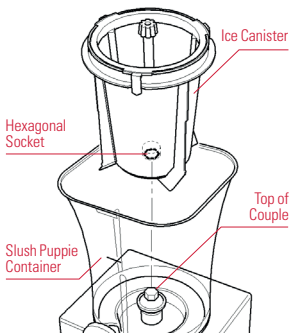

**4** Insert the assembled Ice Canister into the Slush Puppie Container. Make sure the Hexagonal Socket on the Ice Canister aligns with the top of the Coupler in the Slush Puppie Container and slots firmly into place.

**5** Fit the Canister Lid into place. Make sure the Slush Puppie logo is at the front and the text displaying FRONT on the Canister Lid is facing forwards. Push down on the front of the lid and then the rear. The Central Spindle of the Ice Paddle assembly should be firmly in place in the mount on the underside of the Canister Lid. Secure the Locking Catch onto the rear Locking Notch of the Slush Puppie Container.

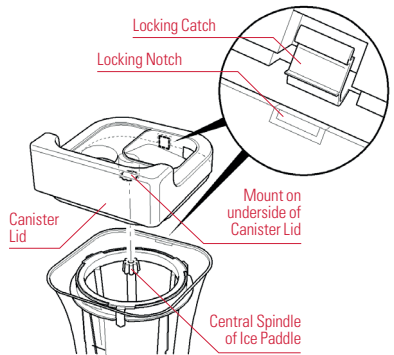

# ASSEMBLY

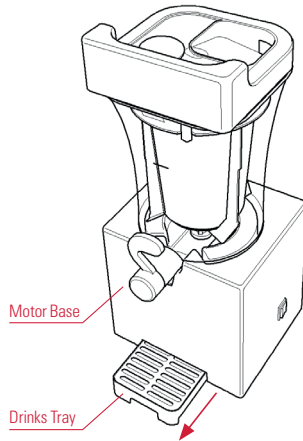
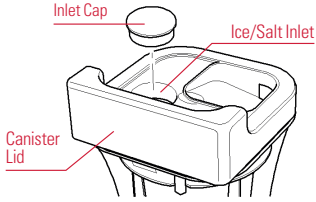

- 6 Push the Inlet Cap into position in the Ice/Salt Inlet.
- 7 Carefully pull the Drinks Tray out from the Motor Base until it is fully extended.

# USING THE MACHINE

**Making Slush Puppies**  
**Are you ready? Feeling thirsty?**  
**Let's make some Slush Puppies!**



### Watch a Video

For top tips and guidance on making perfect Slush Puppies a video can be found at: [slushpuppie.fizzcreations.com](http://slushpuppie.fizzcreations.com) or simply scan here.

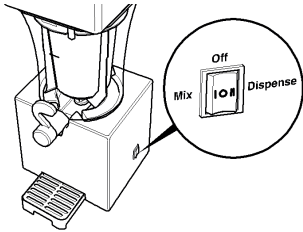

- 1 Plug the SLUSH PUPPIE Maker into an appropriate mains power supply and check that it is switched on at the socket.
- 2 Press the Mix/Off/Dispense switch to position I (Mix).

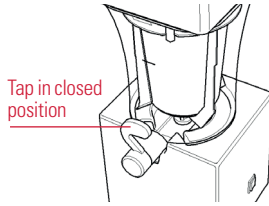

Tap in closed position

- 3 Ensure the Tap is in the closed position.



### IMPORTANT

It is very important that your SLUSH PUPPIE Maker is working before you add ice; otherwise the motor or blade could freeze.

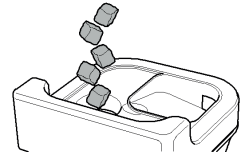

- 4 Remove the Inlet Cap and half fill the Ice Canister with ice through the Ice/Salt Inlet. This is indicated by the ICE and SALT marker on the Canister Lid.



- 5 Pour 2 inlet caps of salt into the Ice/Salt Inlet.



### IMPORTANT

Add salt to the Ice Canister only. The salt will not be consumed; it is used to stop the ice mix from rapidly freezing.

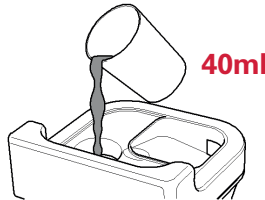

- 6 Pour 40ml of water into the Ice Canister through the Ice/Salt Inlet.

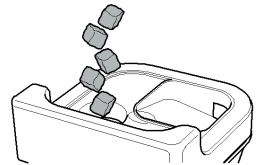

- 7 Fill the rest of the Ice Canister with ice cubes through the Ice/Salt Inlet. **Note:** The ice level should be at least 3cm below the rim of the Ice Canister.

# USING THE MACHINE



- 8** Pour a further 3 Inlet Caps of salt into the Ice Canister through the Ice/Salt Inlet.



### IMPORTANT

Add salt to the Ice Canister only. The salt will not be consumed; it is used to stop the ice mix from rapidly freezing.

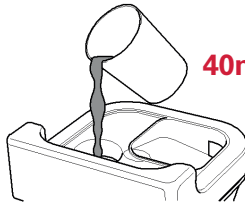

- 9** Pour a further 40ml of water into the central Ice Canister.

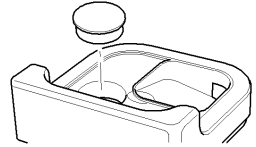

- 10** Re-fit the Inlet Cap into position on the lid.

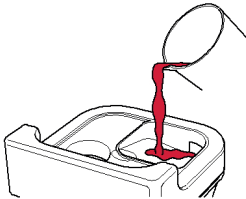

- 11** Slowly pour your Slush Puppy syrup mixture through the Syrup Inlet at the rear right of the Canister Lid. This is indicated by the BEVERAGES HIGH IN SUGAR CONTENT ONLY marker on the Canister Lid. Not suitable on carbonated beverages.



### IMPORTANT

**DO NOT** exceed the 1 litre limit as shown by the Max Fill line on the Slush Puppy Container.



### IMPORTANT

Add salt to the Ice Canister only. The salt will not be consumed; it is used to stop the ice mix from rapidly freezing.

- 12** Leave the SLUSH PUPPIE Maker running for approximately 15-25 minutes. Do not leave the SLUSH PUPPIE Maker unattended or exceed the running time (40 minutes). The amount of time until the desired consistency is reached will depend on the ambient temperature.

- 13** When the mixture level drops add more ice cubes to the Ice Canister to a level no higher than 3cm from the rim of the Ice Canister. Do not fill the ice to the top of the canister as this cools the Ice Canister too much; add a couple of ice cubes at a time and leave a minute or two before adding more ice cubes. Add 2 or 3 Inlet Caps of salt to the Ice Canister and the equivalent amount of water.

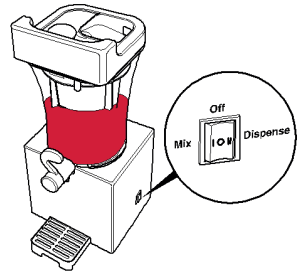

**Note:** If the Ice Canister jams, simply turn the machine off and wait for the ice to melt around the canister, enough to allow the blades to rotate again. Once this has melted enough, add ice again, slowly and regularly to cool the canister enough to make slush.

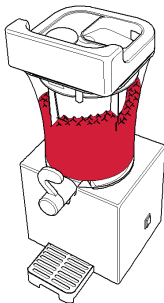

- 14** To create perfect Slush Puppies, wait until peaks form in the Slush Puppy mixture before dispensing.  
**Note:** After using the SLUSH PUPPIE Maker wait at least 15 minutes before using again. This will allow the motor to cool.

## Dispensing Slush Puppies

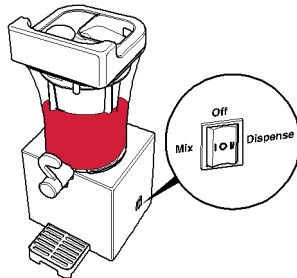

Tap in open position

- Press the Mix/Off/Dispense switch to Position II (dispense).
- Place a cup or glass onto the Drinks Tray and turn the Tap Handle clockwise so that it is in the open position. The mixture will start to pour.
- To stop dispensing, turn the Tap Handle anti-clockwise.
- When you have finished, press the Mix/Off/Dispense switch to Off (Position O).

# STORAGE AND MAINTENANCE

## Cleaning and Care

We recommend cleaning the Ice Canister straight after use. There is a large amount of salt used when making Slush Puppies. This salt is not consumed and prevents freezing.

If the salt is left in the Ice Canister for a long period of time it will corrode the metal. Please refer to the steps below:

### To clean your SLUSH PUPPIE Maker:

- 1 Unplug the SLUSH PUPPIE Maker from the mains electricity supply and allow it to cool completely.
- 2 Remove all detachable parts.  
**Note:** When removing the Canister Lid, press the Clip and the rear inwards to release the Canister Lid. Please take care when handling any sharp edges or parts during cleaning.
- 3 Clean the detachable, non-electronic parts in lukewarm water with some washing-up liquid and rinse them under a tap.
- 4 Clean the outer surface of the SLUSH PUPPIE Maker with a soft damp cloth.
- 5 After each use please clean the Ice Canister thoroughly. The Ice Canister is sturdy but the metal is purposely designed to be thin. Salt must not be left in or on the Ice Canister after use as it can cause corrosion. The ultra-thin Ice Canister allows the freezing cold temperatures to transfer to the outer wall, this design helps you to make perfect Slush Puppie.



### IMPORTANT

Before cleaning your SLUSH PUPPIE Maker, make sure the machine is turned off with the Mix/Off/Dispense switch set to Off (Position O).



### IMPORTANT

**DO NOT** immerse the Motor Base in water or any other liquids.



### IMPORTANT

**DO NOT** use coarse or abrasive cleaners or steel wool to clean the SLUSH PUPPIE Maker.



### IMPORTANT

Never spray or apply cleaning products directly onto the SLUSH PUPPIE Maker. If necessary, apply cleaner to a soft cloth instead.



### IMPORTANT

**DO NOT** use a dishwasher to clean your SLUSH PUPPIE Maker.

## Storage

### To safely store your SLUSH PUPPIE Maker:

- 1 Make sure the SLUSH PUPPIE Maker is turned off with the Mix/Off/Dispense switch set to Off (Position O).
- 2 Unplug the SLUSH PUPPIE Maker from the mains electricity supply.
- 3 Make sure the SLUSH PUPPIE Maker has completely cooled and is clean before storing.
- 4 Store the SLUSH PUPPIE Maker in its original packaging in a clean dry place. Do not allow the SLUSH PUPPIE Maker to be exposed to rain or moisture during use or storage.

## Servicing

If you drop or damage your SLUSH PUPPIE Maker do not use it until it has been examined by an authorised service centre or appliance technician. Servicing must only be carried out by qualified service personnel.

The SLUSH PUPPIE Maker is for household use only.

## Troubleshooting

If your SLUSH PUPPIE Maker is not working as expected you may find a simple solution listed below:

Whats is happening?	What it could be
The motor is not spinning	The blade may have become frozen. Turn the SLUSH PUPPIE Maker off, move the frozen blade and restart the machine.
The mixture is not freezing or chilling	The Ice Canister may not be cold enough. Add more ice and salt. The mixture added is too warm. We recommend chilling the syrup mixture for at least 2 hours, ideally overnight before use. For best results, freeze the Ice Canister for 1 hour before use.
If the SLUSH PUPPIE Maker is getting too cold too quickly	Too much ice is being used. When filling the Ice Canister leave a gap of 3cm from the top of the ice to the canister rim.
If the Canister Lid comes off	Too much ice is being used. When filling the Ice Canister leave a gap of 3cm from the top of the ice to the Ice Canister rim.
If your SLUSH PUPPIE Maker is not making slush	This could be due to salt falling into the wrong compartment. Make sure salt is only poured into the Ice/Salt Inlet indicated by the ICE AND SALT marker on the Ice Canister Lid.

## Helpful Hints and Tips

- Do not add thick liquids or solids to the Slush mix.
- Do not operate the SLUSH PUPPIE Maker for longer than required and do not use for longer than 40 minutes of continuous use.
- Consume Slush Puppies as soon as they have been served.
- Slush mixtures with higher sugar content will reach the desired consistency more quickly than mixtures with lower sugar content.
- When preparation begins always start with liquid mixtures and not frozen mixtures.
- Follow the instructions on the syrup bottle carefully. We recommend you use the SLUSH PUPPIE branded syrup.
- You can use any drink with a high sugar level in your SLUSH PUPPIE Maker such as fresh orange juice.
- If you are not using official SLUSH PUPPIE branded syrup please ensure your mixture has a high sugar content which helps with the reaction to create the slush. If the mixture is not freezing sufficiently to produce slush, there is too much sugar in the mixture and it will need to be diluted. If the mixture is becoming too solid, it is likely you will need more sugar in your mixture.

## Technical Specification

Voltage: 220–240 V 50/60 Hz  
Power: 20 Watts  
Capacity: 1 litre



## WARNING!

- This product is not a toy.
- WEEE products must be disposed of by handing it over at a designated collection point. For more information about where you can drop off your waste product for recycling please contact your local authority.

© 2020 SLUSH PUPPIE®. SLUSH PUPPIE® is a registered trademark of The ICEE Company, a Subsidiary of J&J Snack Foods Corp.



6 Commerce Way, Lancing, BN15 8TA, UK  
**Fizz Creations Europe LTD**  
Unit 3D North Point House,  
New Mallow Road, Cork, T23 AT2P, Ireland  
[www.fizzcreations.com](http://www.fizzcreations.com)  
© 2020 Fizz Creations Ltd. All rights reserved.