



ADMINISTRATION GUIDE

Linksys Voice System

SPA9000 IP Telephony System
SPA400 PSTN VoIP Gateway with Integrated Voice Mail Server
SPA9x2 IP Phones

Preface	vi
Document Audience	vi
Firmware	vii
Document Purpose and Contents	viii
Document Conventions	ix
Related Documentation	ix
Finding Information in PDF Files	xi
Finding Text in a PDF	xi
Finding Text in Multiple PDF Files	xi
Online Resources	xiii
Copyright and Trademarks	xiii
Technical Support	xiii
Chapter 1: Getting Started	13
Introduction to the Linksys Voice System	13
SPA9000 IP PBX	14
SPA400 SIP-PSTN Gateway and Voicemail Server	14
SPA900 Series IP Phones and Accessories	14
Deployment Scenarios	15
Deploying the LVS with PSTN Access and Local Voice Mail	16
Deploying the LVS with ITSP Service Only	17
Deploying the LVS with ITSP Service, PSTN Access and Local Voice Mail	18
ITSP Service, PSTN and ISDN Access and Local Voice Mail	19
Initial Installation, and Configuration	20
Chapter 2: Basic Administration of the SPA9000	21
Upgrading Firmware for the SPA9000	21
Connecting to the SPA9000 Administration Web Server	24
Saving or Discarding Changes SPA9000	24
Access Levels	25
Setting Passwords for User and Administrator Accounts	25
Configuring Basic Settings	26
Setting Up the WAN Connection for the SPA9000	26
Setting the Date and Time	27
Configuring Daylight Saving Time	27
SPA9000 Ethernet Port	28
LAN and Application Guidelines	28
Configuring Multicast Addressing and Group Paging	29
Collecting System Logs and Debug Information	31
Viewing Information about the SPA9000	33
Viewing Information about Client Stations	33
Using the Interactive Voice Response Unit	33
Using the IVR Menu	34
Entering a Password through the IVR	37
Chapter 3: Configuring the SPA9000 for ITSP Interoperability . .	39
About LVS and SIP	39
Network Address Translation (NAT) and Voice over IP (VoIP)	40
NAT Mapping with SIP-ALG Router	40
NAT Mapping with Session Border Controller	41

Configuring NAT Mapping with a Static IP Address	41
Configuring NAT Mapping with STUN	42
Firewalls and SIP	43
Configuring SIP Timer Values	44
Chapter 4: Configuring Phone Lines and Calling Routing Behavior	45
Configuring SPA9000 FXS Ports	45
Configuring Line Interfaces on the SPA9000	46
Configuring a Line Interface for ITSP Service	46
Configuring a Line Interface for a SPA400 (PSTN or Voice Mail)	48
Configuring Call Capacity for a Line Interface	51
Configuring Dial Plans	52
How the Dialed Digits are Processed	53
Digit Sequences	53
Digit Sequence Examples	55
Acceptance and Transmission the Dialed Digits	56
Editing the System Dial Plan	57
Entering a Phone Dial Plan	58
Entering the Line Interface Dial Plan	59
Setting the Timers for the Dial Plan	59
Managing the Line Selection for Outbound Calls	63
Line Availability	63
Configuring a Call Routing Rule	63
Entering a Call Routing Rule	65
Managing Caller ID Settings for Outgoing Calls	65
Managing Inbound Calls with the Contact List	66
Routing an Inbound Call to the Auto Attendant	66
Routing an Inbound Call to a Receptionist or Client Stations	66
Example Contact List Rules	66
Supporting Multiple DID Numbers Per Line Interface	68
An incoming call to the main number is answered by the Auto-Attendant, while calls to the other nine DID numbers are routed to dedicated private extensions.	69
Supporting Direct Inward Dialing to Phone Extensions	69
Entering a Contact List Rule	70
Call Forwarding Support on SPA9000	71
Call Transfer Support on SPA9000	72
Call Forward Bridge Mode	72
Call Transfer Bridge Mode	72
Managing Inbound Calls with Hunt Groups	73
Hunt Group that Rings All Stations Simultaneously	73
Hunt Group that Rings Stations Individually	75
Managing Inbound Calls with Shared Line Appearances	77
About Shared Line Appearances	77
Chapter 5: Administering the SPA400 and Voice Mail Service . . .	80
Connecting to the SPA400 Administration Web Server	80
Configuring the SPA400 Network Connection	81
Saving or Discarding Changes on the SPA400	82
Managing Access to the SPA400 Web-Based Configuration Utility	83
Upgrading the Firmware for the SPA400	84

Configuring a SPA400 to Interoperate with the SPA9000	85
Configuring a SPA400 for PSTN Access	87
Configuring a SPA400 for Voice Mail Service	87
Voice Mail Capacity	88
Configuring Local Voice Mail Service on a SPA400	88
Setting Up Voice Mail on Each Station	90
Enabling Remote Voice Mail Access (Optional)	93
Managing the Voice Mail Messages on the USB Key	94
Enabling Debugging on the SPA400	95
Chapter 6: Configuring Music on Hold	97
Using the Internal Music Source for Music On Hold	97
Using the Internal Music Source	97
Changing the Music File for the Internal Music Source	98
Restoring the Original Music File	98
Configuring a Streaming Audio Server	99
Using a Streaming Audio Server	99
Using the IVR with an SAS Line	100
Example SAS with MOH	100
Configuring the Streaming Audio Server	101
Chapter 7: Configuring the LVS Auto-Attendant	103
How the Auto Attendant Works	103
Working with the Auto Attendant Greetings	104
Using Pre-Recorded Prompts	104
Recording an Auto Attendant Prompt	105
Downloading Prompts	107
Writing an Auto Attendant Script	108
An Introduction to XML Scripting Grammar in AA Script Examples	109
Elements of XML Scripting Grammar	111
Auto Attendant XML Instructions Set	113
Entering an Auto Attendant Script	115
Configuring the DayTime, NightTime and Weekend/Holiday Auto Attendants	116
Configuring Dial Plans for the Auto Attendant	117
Chapter 8: Localization	118
Requirements for Localization	118
Localizing the SPA9000 Auto Attendant Prompts	118
Local Time Configuration	120
Configuring the SPA9000 and SPA9xx Call Progress Tones	120
Localizing the SPA400 Voice Mail Prompts	125
Localizing the SPA400 Call Disconnect Tones	126
Localizing the SPA400 Caller ID Method	128
Appendix A: Advanced Topics in LVS Administration	130
Technology Background	130
Session Initiation Protocol	130
SPA9000 Media Proxy	132
Using the SPA9000 with a Firewall or Router	133
SPA400 SIP-PSTN Gateway	133

SPA9000 Architecture	134
SIP-NAT Interoperation	135
Determining Whether the Router Uses Symmetric or Asymmetric NAT	136
Advanced Call Control and Routing	137
Configuring Vertical (Supplementary) Service Codes	137
Managing the Outbound Call Routing Groups	139
Configuring Outbound Call Codec Selection Codes	141
Advanced Topics for SPA400 Voice Mail Service	141
How Voicemail Works	142
Checking Voicemail from an External Number	142
Depositing Voicemail	143
Subscribing to Voicemail Notification	144
Remote Provisioning Features	145
Using Configuration Profiles	145
Client Auto-Configuration	146
Manual Client Configuration	147
Client Registration	149
Using the Upgrade URL	150
Using the Resync URL	151
Using the Reboot URL	151
Appendix B: SPA9000 Field Reference	152
Router Tab	152
Status page	152
Wan Setup page	153
Lan Setup page and Application page	156
Voice tab	156
Info page	156
System page	159
SIP Page	160
Provisioning page	176
Regional page	176
FXS 1/2 page	189
Line 1/2/3/4 page	196
Appendix C: SPA400 Field Reference	203
Setup	203
Basic Setup	203
SPA9000 Interface	204
Voice	205
Voicemail Server	208
Voicemail Users	209
Administration	209
Management	209
Factory Default	210
USB Setting	210
Firmware Upgrade	210
Reboot	210
Status	211
Gateway	211
Event Logs	212

Set Log Level	212
Tone	212
Appendix D: Warranty Information	214
Limited Warranty	214
Exclusions and Limitations	214
Obtaining Warranty Service	215
Technical Support	215
Appendix E: Regulatory Information	216
Federal Communications Commission Interference Statement	216
Industry Canada Statement	216
Règlement d'Industry Canada	216
EC Declaration of Conformity (Europe)	217
User Information for Consumer Products Covered by EU Directive 2002/96/EC on Waste Electric and Electronic Equipment (WEEE)	217
Appendix F: Safety Information	224
Meaning of the Warning Symbol	224
General Safety Information	224
Power Safety Information	225
Appendix G: Software License Agreement	227
Software in Linksys Products:	227
Software Licenses:	227
Schedule 1 Linksys Software License Agreement	227
Schedule 2	229
Schedule 3	234
Appendix H: Contacts	237
Appendix I: Acronyms	238
Appendix J: Glossary	241

Preface

The *Linksys Voice System Administration Guide* is intended to help VARs and Service Providers to manage and configure the Linksys Voice System (LVS). This preface provides helpful information about this guide and other resources that are available to you. Before you begin to use this guide, refer to the following topics:

- "Document Audience," on page vi
- "Document Purpose and Contents," on page viii
- "Document Conventions," on page ix
- "Related Documentation," on page ix
- "Finding Information in PDF Files," on page xi
- "Online Resources," on page xiii
- "Copyright and Trademarks," on page xiii

Document Audience

This document is written for the following audience:

- Service providers offering services using LVS products
- VARs and resellers who need LVS configuration references
- System administrators or anyone who performs LVS installation and administration

**Note**

This guide does not provide the configuration information required by specific service providers. Please consult with the service provider for specific service parameters.

Firmware

This guide supports the following firmware releases. The installed firmware must be at least the indicated in the table below.

Product	Firmware Version
SPA9000	5.1.9
SPA400	1.0.1.4
SPA922/SPA942	5.2.5
SPA962	5.2.8
SPA901	5.1.5
SPA921/SPA941	5.1.8

Document Purpose and Contents

This document provides information that an administrator needs to configure the Linksys Voice System, which typically consists of a SPA9000 IP PBX, one or more SPA900 Series IP phones, and the optional SPA400 PSTN gateway and voice mail server. This guide focuses primarily on the tasks that an administrator performs to configure a SPA9000 with the SPA9000 administration web server.

NOTE: This guide does not cover initial installation and configuration, SPA900 Series phone configuration, the Setup Wizard, or provisioning. See ["Related Documentation,"](#) on page ix.

The information in this guide is organized into the following chapters and appendices:

Chapter 1, "Getting Started."	This chapter introduces you to the Linksys Voice System (LVS) by describing the components and presenting several deployment scenarios.
Chapter 2, "Basic Administration of the SPA9000."	This chapter introduces you to basic administrative tasks using the SPA9000 administration web server and the Interactive Voice Response Unit.
Chapter 3, "Configuring the SPA9000 for ITSP Interoperability"	This chapter provides configuration details for the purpose of helping you to ensure that your infrastructure properly supports the LVS.
Chapter 4, "Configuring Phone Lines and Calling Routing Behavior"	This chapter describes many features that you can configure on the SPA9000 to ensure smooth handling of all inbound and outbound calls, and ease of use.
Chapter 5, "Administering the SPA400 and Voice Mail Service"	This chapter guides you through the process of configuring and managing the SPA400 for PSTN access and voice mail service.
Chapter 6, "Configuring Music on Hold"	This chapter explains how to configure Music on Hold using either a music file or streaming audio.
Chapter 7, "Configuring the LVS Auto-Attendant"	This chapter describes how to configure the LVS Auto Attendant using the IVR, and XML scripting.
Chapter 8, "Localization"	You can localize your LVS with the language files, tones, and ring patterns that are appropriate for your region.
Appendix A, "Advanced Topics in LVS Administration"	This appendix provides technical information that is useful to individuals who want a better understanding of how the LVS works.
Appendix B, "SPA9000 Field Reference"	This appendix describes the fields on each page of the SPA9000 administration web server.
Appendix C, "SPA400 Field Reference"	This appendix describes the fields on each page of the SPA400 administration web server.

Document Conventions

The following are the typographic conventions used in this document.

Typographic Element	Meaning
Boldface	May indicate either of the following: <ul style="list-style-type: none"> • A user interface element that you need to click, select, or otherwise act on • A literal value to be entered in a field.
<i>Italic</i>	May indicate either of the following: <ul style="list-style-type: none"> • A variable that should be replaced with a literal value. • The name of a page, section, or field in the user interface
Monospaced Font	Indicates code samples or system output.

Related Documentation

This *LVS Administration Guide* is part of a complete suite of documentation that is available to assist you in using and configuring Linksys devices. The following documents are of special interest to LVS administrators.



Note

These documents and more are available at Linksys.com.

Document Title	Description	Intended Audience
<i>Linksys Voice System Installation and Configuration Guide</i>	<ul style="list-style-type: none"> • Network design considerations and site preparation • Switch configuration • Initial installation and configuration of the LVS components • SPA9000, SPA400, SPA900 series IP phones 	VARs and Service Providers
<i>Linksys Phone Administration Guide</i>	<ul style="list-style-type: none"> • Configuration and management of IP phones • Deployment options with or without the SPA9000 IP PBX • SPA9x2 series IP phones 	VARs and Service Providers

Document Title	Description	Intended Audience
<i>Linksys SPA9x2 Phone User Guide</i>	<ul style="list-style-type: none"> • Phone setup • Phone features • SPA9x2 series IP phones 	VARS and phone end-users
<i>Linksys Analog Telephone Adapter Administration Guide</i>	<ul style="list-style-type: none"> • Administration and use of Linksys ATAs • PAP2T, SPA2102, SPA3102, SPA8000, AG310, RTP300, WRP400, and WRTP54G 	VARS, system administrators, and Service Providers
<i>Linksys Provisioning Guide</i>	<ul style="list-style-type: none"> • Provisioning LVS components 	Service Providers only
SPA9000 FAQs Specification, Troubleshooting, Configuration, and General Specifications	Answers to Frequently Asked Questions, within the Easy Answers Knowledge Base at www.linksys.com/kb	VARS and Service Providers

Finding Information in PDF Files

The PDF Find/Search tool lets you find information quickly and easily online. You can:

- Search an individual PDF.
- Search multiple PDFs at once (for example, all PDFs in a specific folder or disk drive).
- Perform advanced searches.

Finding Text in a PDF

1. Enter your search terms in the *Find* box on the toolbar.



Note

By default, the Find tool is available at the right end of the Acrobat toolbar. If the Find tool does not appear, choose **Edit > Find**.



2. Optionally, click the arrow next to the *Find* text box to refine your search by choosing special options such as *Whole words only*.
3. Press **Enter**. Acrobat displays the first instance of the search term. Press **Enter** again to continue to more instances of the term.

Finding Text in Multiple PDF Files

The *Search* window lets you search for terms in multiple PDF files that are stored on your PC or local network. The PDF files do not need to be open.

1. Start Acrobat Professional or Adobe Reader.
2. Choose **Edit > Search**, or click the arrow next to the *Find* box and then choose **Open Full Acrobat Search**.

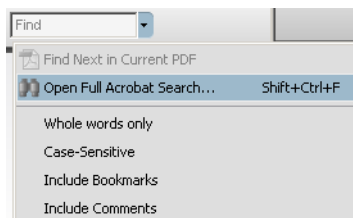

3. In the *Search* window, complete the following steps:
 - a. Enter the text that you want to find.
 - b. Choose **All PDF Documents in**.
 - c. From the drop-down box, choose **Browse for Location**. Then choose the location on your computer or local network, and click **OK**.

- d. If you want to specify additional search criteria, click **Use Advanced Search Options**, and choose the options you want.
- e. Click **Search**.

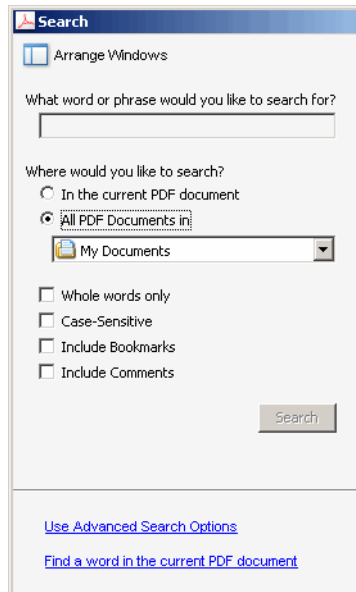

4. When the Results appear, click + to open a folder, and then click any link to open the file where the search terms appear.

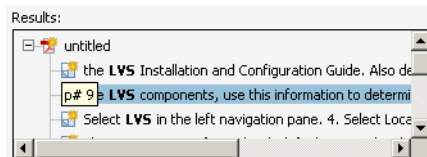
**Note**



For more information about the Find and Search functions, see the Adobe Acrobat online help.

Online Resources

Website addresses in this document are listed without **http://** in front of the address because most current web browsers do not require it. If you use an older web browser, you may have to add **http://** in front of the web address.

Resource	Link
Linksys	www.linksys.com
Linksys International	www.linksys.com/international
Glossary	www.linksys.com/glossary
Network Security	www.linksys.com/security

Copyright and Trademarks

 <p>LINKSYS® A Division of Cisco</p> <p> CISCO</p>	<p>Linksys is a registered trademark or trademark of Cisco Systems, Inc. and/or its affiliates in the U.S. and certain other countries. Copyright © 2008 Cisco Systems, Inc. All rights reserved. Other brands and product names are trademarks or registered trademarks of their respective holders.</p>
--	---

Technical Support

A list of technical support phone numbers and websites is available in [Appendix H, "Contacts."](#)

Getting Started

This chapter introduces you to the Linksys Voice System (LVS) by describing the components and presenting several deployment scenarios.

- "Introduction to the Linksys Voice System," on page 13
- "Deployment Scenarios," on page 15
- "Initial Installation, and Configuration," on page 20

Introduction to the Linksys Voice System

The LVS is an affordable and feature-rich voice over IP (VoIP) telephone system that is designed especially for small businesses. The LVS uses standard TCP/IP protocols and can provide global connectivity through any Internet Telephony Service Provider (ITSP) that supports Session Initiation Protocol (SIP).

At minimum, the LVS includes a SPA9000 IP PBX and one or more SPA900 series IP phones. These devices are connected through a switch to a local area network. With an Internet connection, the LVS can subscribe to ITSP services to take advantage of low calling rates. With the optional SPA400, the LVS can connect to the Public Switched Telephone Network (PSTN) to support legacy phone lines. [Figure 1-1](#) illustrates the LVS Solution in a typical deployment.

Figure 1-1 The Linksys Voice System (LVS) with the SPA9000 and SPA400

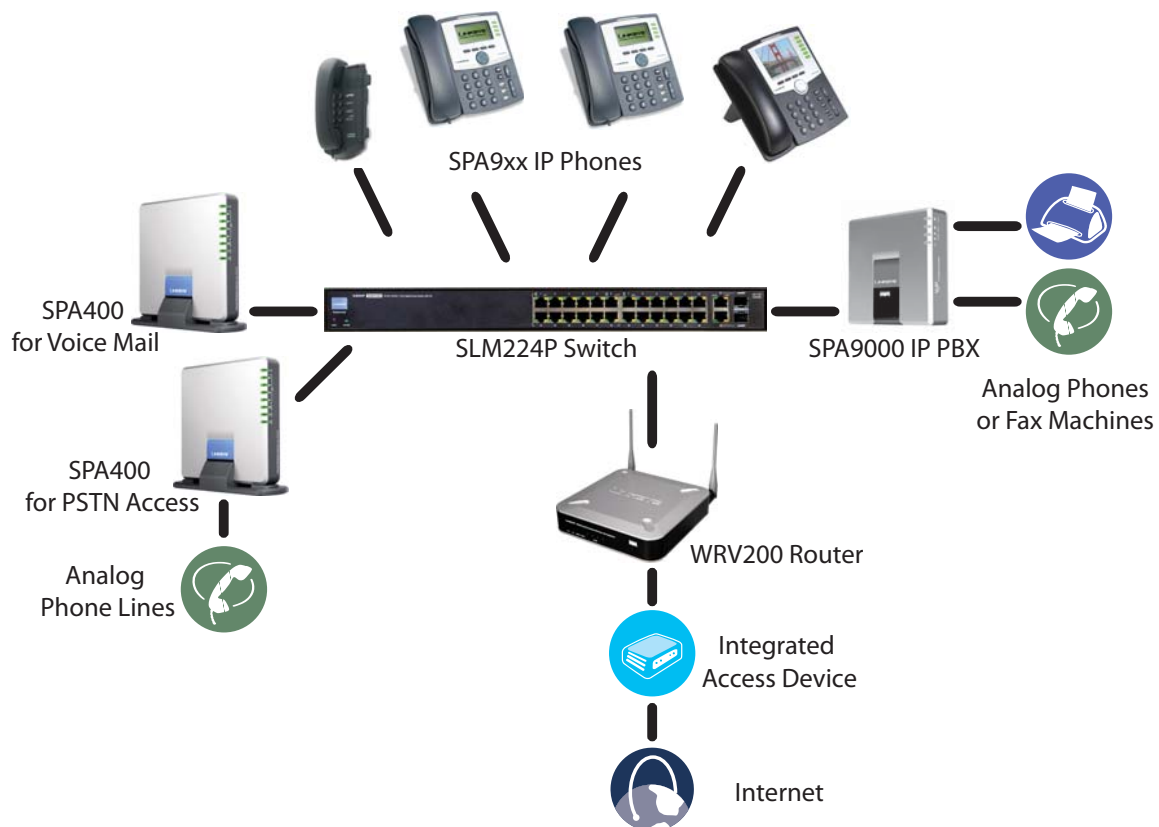

SPA9000 IP PBX

The SPA9000 is an IP PBX that supports up to 16 phones. It also has a built-in Analog Telephone Adapter (ATA) with two FXS ports for analog telephones, fax devices, or an external music source for the music on-hold service. Devices connected to the FXS ports are not included in the licence's device count.

The SPA9000 has four line interfaces, which can be configured in any combination for ITSP service, ISDN access, SPA400 PSTN access, or SPA400 voice mail service. A different ITSP account can be configured on each line interface. If a service provider supplies a group of sequential direct inward dial (DID) phone numbers (such as 408-555-0100 through 555-0145) the SPA9000 can support all of the assigned numbers on a single line interface.

The SPA9000 includes an Auto Attendant service that plays pre-recorded voice messages to offer the caller a menu of choices and to direct the call. When the Auto-Attendant is enabled, it parses and operates on user input (key presses that produce DTMF tones) following the rules specified in the Auto Attendant script on the SPA9000.

SPA400 SIP-PSTN Gateway and Voicemail Server

The SPA400 provides a SIP-PSTN gateway for voice connectivity between the PSTN and the local client stations that are connected to the SPA9000. It also includes an integrated voice mail application that supports up to 32 voice mail accounts with customized greetings, providing LVS users the ability to receive and playback voice mail messages.

Each SPA400 occupies one of the four line interfaces on the SPA9000. The SPA400 has four ports for that can be connected to PSTN or ISDN lines.





SPA900 Series IP Phones and Accessories

Linksys provides a variety of IP phones to meet the needs of small businesses. [Table 1-1](#) provides a comparison of the available models.

NOTE: This guide explains how to configure the SPA9000 and the SPA400 to support the calling features on the phones. For more information about the phones, see the *Linksys Phone Administration Guide* and the *Linksys SPA9x2 Phone User Guide*.

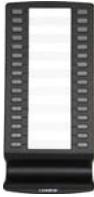
Table 1-1 Linksys SP900 Series IP Phones and Accessories

Product		RJ-45	Voice Lines	Additional Features/ Notes
SPA922*		2	1	One-line IP phone with Power over Ethernet (PoE) support

Product		RJ-45	Voice Lines	Additional Features/ Notes
SPA932		—	—	Attendant console (sidecar) for SPA962 with 32 buttons and LEDs for monitoring and call transfer
SPA942*		2	4	Four-line IP phone with Power over Ethernet (PoE) support
SPA962*		2	6	Six-line IP Phone with high-resolution color display and Power over Ethernet (PoE) support
POES5		1	N/A	Provides an 802.3af PoE port for connection back to a PoE switch for SPA9000, SPA400 and SPA9x1 phones
WBP54G		1	N/A	Converts your IP phone into a wireless device, so it can connect to your wireless network without an Ethernet cable

* **NOTE:** SPA922, SPA942, SPA962 do not include an external power adapter as they support Power over Ethernet (802.3af). If the phones are connected to a non-POE switch, the PA100 power adapter is required.

Deployment Scenarios

The LVS can meet the calling needs of many small businesses. Various deployment scenarios are possible. This section includes the following examples:

- ["Deploying the LVS with PSTN Access and Local Voice Mail," on page 16](#)
- ["Deploying the LVS with ITSP Service Only," on page 17](#)
- ["Deploying the LVS with ITSP Service, PSTN Access and Local Voice Mail," on page 18](#)

- ["ITSP Service, PSTN and ISDN Access and Local Voice Mail,"](#) on page 19

Deploying the LVS with PSTN Access and Local Voice Mail

In this scenario, the customer requires a robust phone system but is not using VoIP services. The LVS is deployed with a SPA9000 IP PBX, one SPA400 for PSTN access with four FXO ports, and another SPA400 for local voice mail service. Optionally, analog phones or fax machines (not illustrated) can be connected to the two phone ports on the SPA9000.

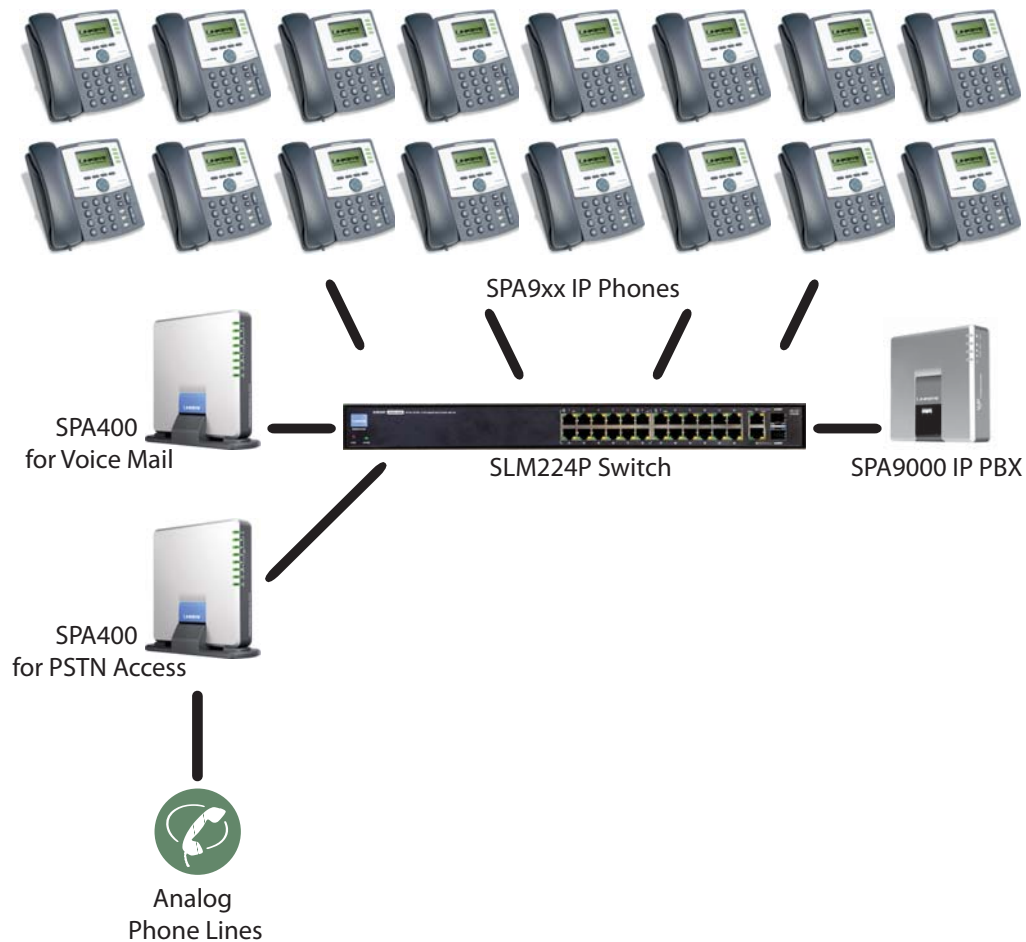

Deploying the LVS with ITSP Service Only

In this scenario, a customer has no legacy telephone numbers and does not require local voice mail (either needs no voice mail at all or has voice mail hosted by the ITSP). The LVS is deployed with the SPA9000 IP PBX, VoIP service, and four SPA9x2 series phones. Four phones are connected at this time, but the LVS can be expanded to include 16 SPA9xx IP phones. Optionally, analog phones or fax machines (not illustrated) can be connected to the two phone ports on the SPA9000.

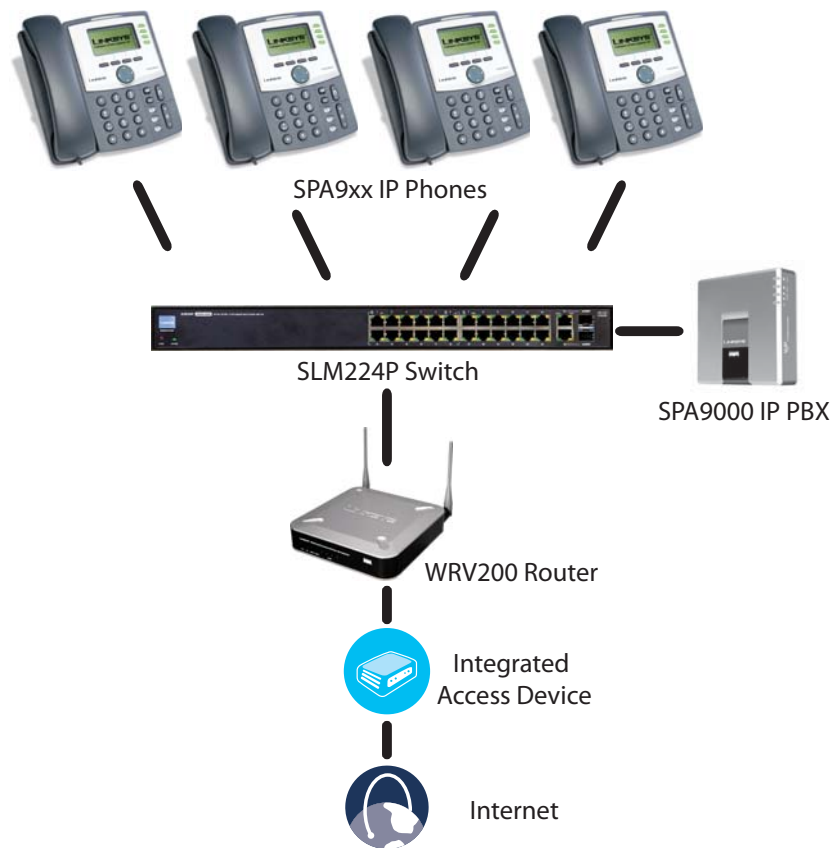

Deploying the LVS with ITSP Service, PSTN Access and Local Voice Mail

In this scenario, the customer wants to use ITSP service for reduced long distance fees but needs to support legacy local telephone numbers (for example, to receive calls over the original legacy telephone number, or to route local telephone calls). This customer also prefers local voice mail service. The LVS is deployed with the SPA9000 IP PBX, VoIP service, one SPA400 unit for voice mail service, another SPA400 units for PSTN access with four FXO ports, and up to 16 SPA900 series phones. Optionally, analog phones or fax machines (not illustrated) can be connected to the two phone ports on the SPA9000.

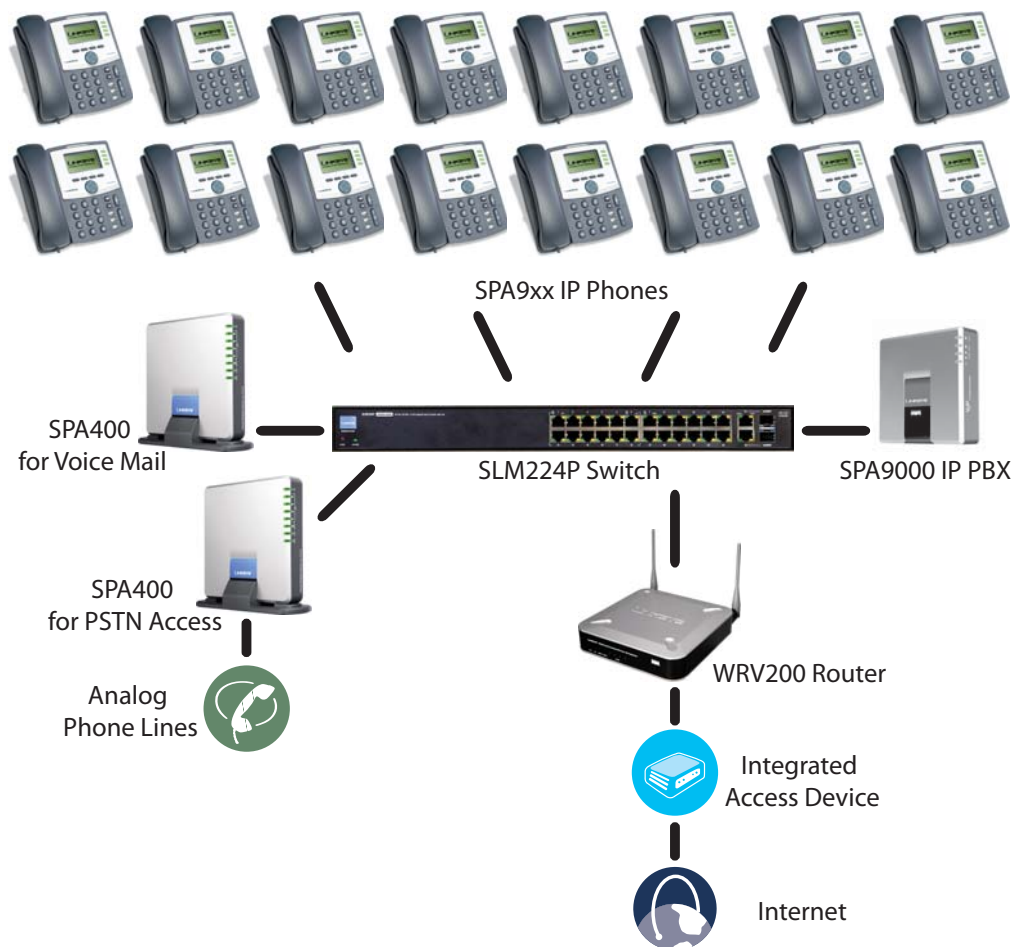

ITSP Service, PSTN and ISDN Access and Local Voice Mail

In this scenario, the customer takes full advantage of the LVS solution, with the SPA9000 IP PBX, VoIP service, one SPA400 unit for voice mail service, another SPA400 for PSTN access with four FXO ports, one ISDN Gateway for ISDN BRI access with four BRI ports, and up to 16 SPA9xx IP phones. Optionally, analog phones or fax machines (not illustrated) can be connected to the two phone ports on the SPA9000.

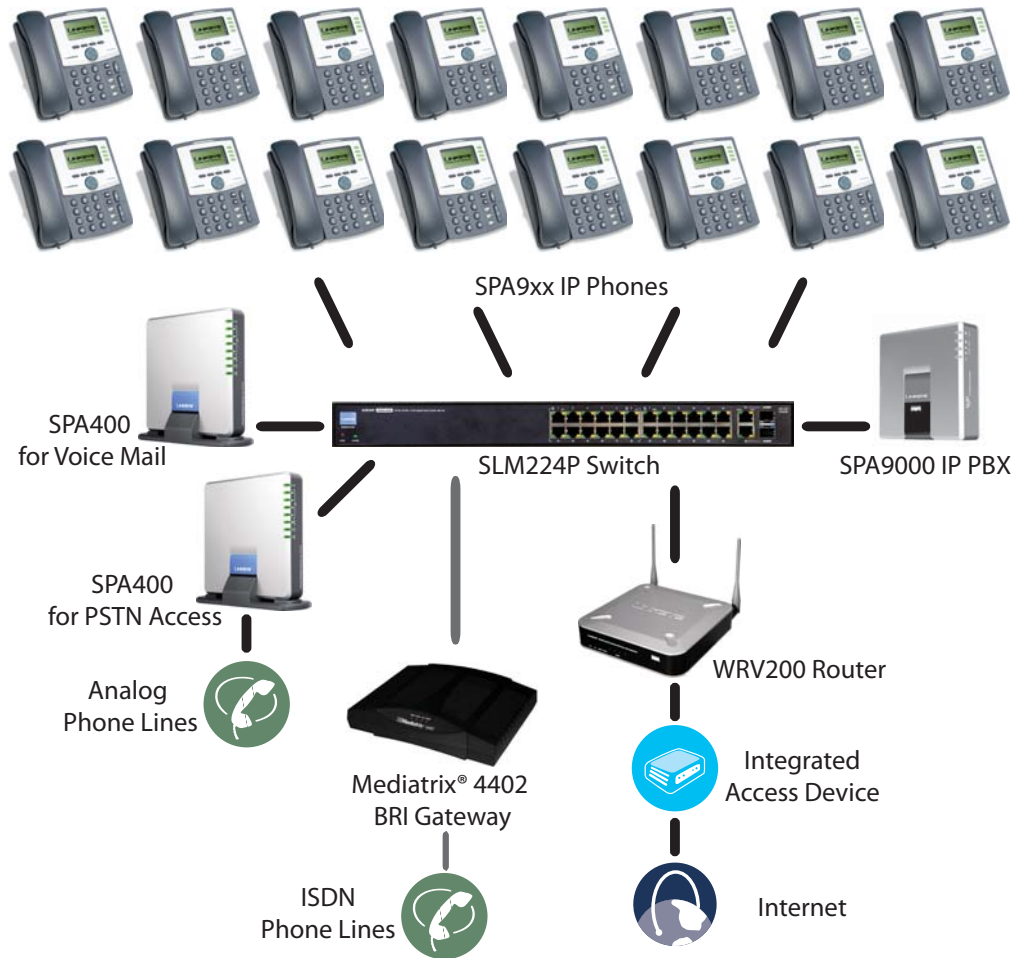

Initial Installation, and Configuration

Linksys strongly recommends that you use the *Linksys Voice System Installation and Configuration Guide* to design your system, to prepare the site, to connect and configure your equipment, and to set up the essential calling features. By following the instructions in the installation guide, you can get your system running in less time and with the settings that help to ensure strong performance.

After you complete the procedures in the installation guide, the users can make and receive calls. When the optional SPA400 is installed, the users also can record and retrieve voice mail messages. The SPA9000 has a fully functional Auto Attendant to greet callers, and a default dial plan that is suitable for most dialing scenarios. You can use this administration guide to refine the settings, to configure advanced features, and to manage the system.

NOTE: Because the *Linksys Voice System Installation and Configuration Guide* provides all of the procedures that you need for initial installation and configuration, those instructions are not duplicated in this administration guide.

Basic Administration of the SPA9000

This chapter introduces you to basic administrative tasks using the SPA9000 administration web server and the Interactive Voice Response Unit.

For Installation and Configuration of LVS in the most common deployment scenarios, refer to the *Linksys Voice System Installation and Configuration Guide*, which is available at Linksys.com.

See the following topics:

- "[Upgrading Firmware for the SPA9000](#)," on page 21
- "[Connecting to the SPA9000 Administration Web Server](#)," on page 24
- "[Saving or Discarding Changes SPA9000](#)," on page 24
- "[Access Levels](#)," on page 25
- "[Setting Passwords for User and Administrator Accounts](#)," on page 25
- "[Configuring Basic Settings](#)," on page 26
- "[Viewing Information about the SPA9000](#)," on page 33
- "[Viewing Information about Client Stations](#)," on page 33
- "[Using the Interactive Voice Response Unit](#)," on page 33

Upgrading Firmware for the SPA9000

As needed, you can download new firmware from Linksys.com and then install the firmware on the SPA9000.

1. Download the firmware from Linksys.com by completing the following steps:
 - a. Start a web browser and enter the following address: www.linksys.com.
 - b. On the menu at the top of the page, choose **Support > Technical Support**.
 - c. Click **Choose a Product**.
 - d. From the *Voice over IP (VoIP)* drop-down list, choose **IP PBX**.
 - e. On the *Choose the Device IP PBX* page, choose **SPA9000** from the drop-down list on the left side of the page.

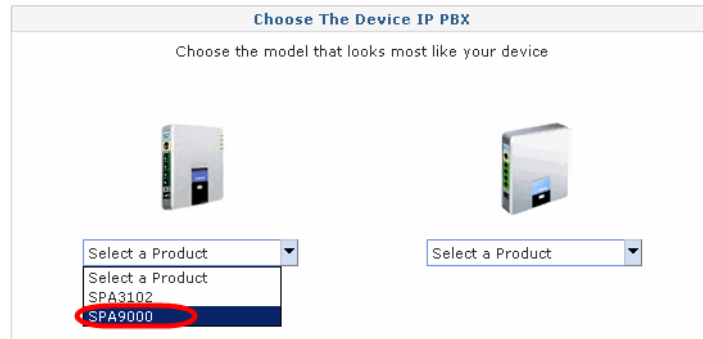

- f. On the *Technical Support* page, click the link in the *Downloads* section.



- g. On the *SPA9000 Downloads* page, choose the version from the *Please select a version* drop-down list.
- h. In the *Firmware* section, click the link for the version that you want to install, and then save the file on the administration computer.
2. Extract the Zip file, and then run the executable file to upgrade the firmware. When the *Firmware Upgrade Warning* window appears, click **Continue**.

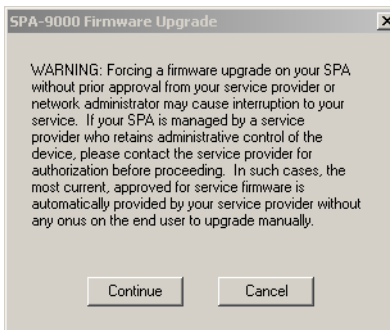

3. In the next window that appears, enter the IP address of the SPA9000, and then click **OK**.

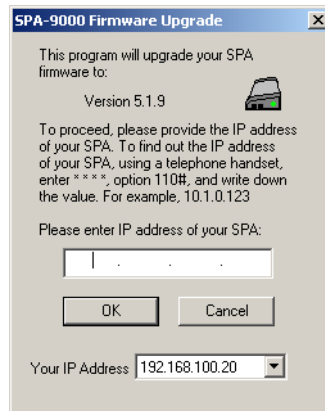

4. In the *Confirm Upgrade* window, verify that the correct device information and product number appear. Then click **Upgrade**.

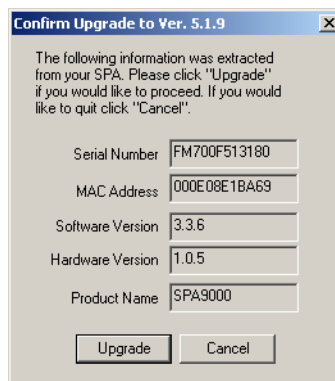

5. When the confirmation message appears, click **OK**.

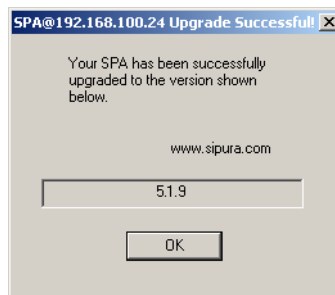

6. To verify the upgrade, complete the following steps:

- a. Connect to the SPA9000 administration web server, and choose Admin access with Advanced settings. (See ["Connecting to the SPA9000 Administration Web Server,"](#) on page 24).
- b. Review the *Router > Status* page. The *Software Version* field should show the firmware version that you installed.

NOTE: You may need to refresh your browser to display the updated page reflecting the new version number.

Connecting to the SPA9000 Administration Web Server

To connect to the SPA9000 administration web server, perform the following steps.

1. Start Internet Explorer on any computer that is connected to the same network as the SPA9000.

NOTE: You should have previously connected and configured the SPA9000 as described in the LVS Installation Guide.

2. Enter the IP address of the SPA9000.

NOTE: You can find the IP address of the SPA9000 by connecting an analog telephone to the Phone 1 or Phone 2 port on the SPA9000. Then lift the receiver of the phone and press **** on the keypad to access the IVR menu. Press **110#** to hear the IP address.

3. To view administrative features, click **Admin Login** and then click **Advanced**.

NOTE: By default, no password is required. For more information, see ["Setting Passwords for User and Administrator Accounts,"](#) on page 25.

ALTERNATIVELY: After starting Internet Explorer, enter: `<SPA9000_ipaddress>/admin/advanced`

Saving or Discarding Changes SPA9000

Changes can be saved or discarded at any time.

- Changes are submitted only when you click the **Submit All Changes** button at the bottom of a page. When changes are saved, the SPA9000 may reboot, depending on the type of changes.
- To discard unsubmitted changes, click the **Undo All Changes** button at the bottom of the page.
- Unsubmitted changes are retained when you move among the pages within the Voice module or the Router module. This feature allows you to make changes on various pages within a module before clicking **Submit All Changes**.
- Unsubmitted changes are discarded when you switch between the Router and Voice tabs, between the User and Administrator accounts, or between the Basic and Advanced views.

TIP: Before you make changes, it is recommended that you save a copy of your current working configuration:

1. In Internet Explorer, connect to the administration web server.
2. From the menu, choose **File > Save As**.
3. Save the configuration as Web Page Complete. You can use the saved file to review the saved settings in all pages of the administrative GUI.

NOTE: To save a Telephone Configuration, first enter the IP address for the configuration, and then follow the above procedure.

Access Levels

You can use the SPA9000 administration web server to configure and manage your system. Three levels of access are available:

- **User Level:** The User account only has the privilege to access part of the web profile parameters.
- **Administrator Level:** The Administrator account has the privilege to modify all the web profile parameters and can also modify the passwords of both Administrator and User account.
- **Advanced:** Administrators and Users can view advanced features by clicking the Advanced link in the top right corner or lower left corner of the menu bar.

By default, no passwords are assigned for either the Administrator account or the User account. If the password has been set for the Administrator account, the browser prompts for authentication.

You can switch from User access to Administrator access by clicking the **Admin Login** link. Likewise, you can switch from Administrator access to User access by clicking the **User Login** link. If a password is set, you will be prompted to enter the password after you click the link.

Setting Passwords for User and Administrator Accounts

The Administrator account name for the SPA9000 is **admin** (with a *lower-case a*) and the User account name is **user**. These account names cannot be changed.



Note

The system prompts for an Administrator account password only if a password has been set. By default, there is no password. You should set a password to protect your SPA9000 from unauthorized access.

1. Connect to the SPA9000 administration web server, and choose Admin access with Advanced settings. (See ["Connecting to the SPA9000 Administration Web Server,"](#) on page 24.)
2. Click **Voice tab > System**.
3. In the *System Configuration* section, enter the *Admin Password* and the *User Password*, as needed. Up to 39 characters are allowed for the passwords.
4. Click **Submit All Changes**.

Configuring Basic Settings

This section provides information about the following tasks:

- ["Setting Up the WAN Connection for the SPA9000,"](#) on page 26
- ["Setting the Date and Time,"](#) on page 27
- ["Configuring Daylight Saving Time,"](#) on page 27
- ["LAN and Application Guidelines,"](#) on page 28
- ["Configuring Multicast Addressing and Group Paging,"](#) on page 29
- ["Collecting System Logs and Debug Information,"](#) on page 31

Setting Up the WAN Connection for the SPA9000

The SPA9000 becomes a DHCP client of any server on the network. The recommended setting is to use a static IP address. This configuration provides ease of installation and prevents connectivity issues that would occur if the IP address of the SPA9000 changed.

1. Connect to the SPA9000 administration web server, and choose Admin access with Advanced settings. (See ["Connecting to the SPA9000 Administration Web Server,"](#) on page 24.)
2. Click **Router tab > Wan Setup**.
3. From the *Connection Type* drop-down list, choose **Static IP**.
4. In the *Static IP Settings* area, enter the Static IP of the SPA9000, as well as the *NetMask* and *Gateway* for your network.
5. In the *Optional Settings* area, enter the Primary DNS for your network.

NOTE: It is recommended to set an IP address that is outside the address range assigned by the DHCP server. For example, if the DHCP server assigns IP addresses in the range from 192.168.1.50 to 192.168.1.254, you should select a static IP address between 192.168.1.2 and 192.168.1.49.

6. Click **Submit All Changes**. The SPA9000 reboots.

Setting the Date and Time

The date and time appear on the phone display and are used to activate the daytime and nighttime Auto Attendant settings. Normally the date and time are set by the network, which has a connection to an NTP server. If needed, you can identify the NTP server on the *Voice > Wan Setup* page, *Optional Settings* section.

**Note**

Do not use the date/time settings on the *Voice > Regional* page to set your system time.

1. Connect to the SPA9000 administration web server, and choose Admin access with Advanced settings. (See ["Connecting to the SPA9000 Administration Web Server,"](#) on page 24).
2. Click **Router tab > Wan Setup**.
3. Scroll down to the *Optional settings* section.
4. Enter the fully qualified domain name of the NTP server that you want to use, such as time.nist.gov.
5. Click **Submit All Changes**.
6. Click **Voice tab > Regional**.
7. Scroll down to the *Miscellaneous* section.
8. From the *Time Zone* drop-down list, choose your local time zone.
9. Click **Submit All Changes**.
- 10.

Configuring Daylight Saving Time

You can enter a daylight saving time rule to ensure that the time is adjusted appropriately for your region.

Syntax and Examples

SYNTAX: start = <start-time>; end=<end-time>; save = <save-time>

EXAMPLE: start=3/9/7;end=11/2/7;save=1

In this example, Daylight Saving Time begins March 9, 2007, and ends Nov. 2, 2007. One hour is added to the time of day during this period.

- The <start-time> and <end-time> values specify the start and end dates and times of daylight saving time. Each value is in the following format: <month> /<day> /<weekday>[/HH:[mm[:ss]]]

- The <save-time> value is the number of hours, minutes, and/or seconds to add to the current time during daylight saving time. The <save-time> value can be preceded by a negative (-) sign if subtraction is desired instead of addition. The <save-time> value is in this format: [/[+|-]HH:[mm[:ss]]]
- The <month> value equals any value in the range 1-12 (January-December).
- The <day> value equals [+|-] any value in the range 1-31. If <day> is 1, it means the <weekday> on or before the end of the month (in other words the last occurrence of <weekday> in that month).
- The <weekday> value equals any value in the range 1-7 (Monday-Sunday). It can also equal 0. If the <weekday> value is 0, this means that the date to start or end daylight saving is exactly the date given. In that case, the <day> value must not be negative. If the <weekday> value is not 0 and the <day> value is positive, then daylight saving starts or ends on the <weekday> value on or after the date given. If the <weekday> value is not 0 and the <day> value is negative, then daylight saving starts or ends on the <weekday> value on or before the date given.
- The abbreviation HH stands for hours (0-23).
- The abbreviation mm stands for minutes (0-59).
- The abbreviation ss stands for seconds (0-59).

Entering the Daylight Saving Time Rule

1. Connect to the SPA9000 administration web server, and choose Admin access with Advanced settings. (See ["Connecting to the SPA9000 Administration Web Server,"](#) on page 24).
2. Click **Voice tab > Regional**.
3. Scroll down to the *Miscellaneous* section.
4. Enter the rule in the *Daylight Saving Time Rule* field.
5. Click **Submit All Changes**.

SPA9000 Ethernet Port

The SPA9000 Ethernet port is used to connect an administrative computer. Typically, this port is used only during initial installation and configuration. With WAN access enabled by default, you can manage your SPA9000 from any computer that is connected to the same subnetwork as the SPA9000. The default IP address for this port is 192.168.0.1.

LAN and Application Guidelines

Although the SPA9000 can provide router and Application services, it does not have sufficient power to provide both phone and routing/application services in a highly utilized environment. For this reason, Linksys recommends that the SPA9000 not be used as a router at any time. Instead, use the SPA9000 as an appliance by connecting its INTERNET port to a network switch and leaving the ETHERNET port disconnected.

It is recommended that you leave the LAN and Application settings at the default values.

Configuring Multicast Addressing and Group Paging

For initialization and system updates, the SPA9000 communicates with all the client stations at once by using IP multicast. This method also is used in the group paging application. For this reason, the SPA9000 and the SPA9xx IP phones must reside on a network where multicasting is allowed. Default addresses are provided, but you can change these addresses as needed.



Note

Make sure that the SPA9000 and the SPA900 Series phones use the same multicast address and port number. Also make sure that you enable spanning tree and port fast on your LAN switch, as described in the *LVS Installation and Configuration Guide*.

Setting the Multicast Address

For administration purposes, the SPA9000 can send the following reboot, restart, page, and ring messages to the group:

- Graceful reboot
 - Immediate reboot
 - Graceful restart
 - Immediate restart
 - Group page start
 - Group page end
 - Get ringing calls
1. Connect to the SPA9000 administration web server, and choose Admin access with Advanced settings. (See ["Connecting to the SPA9000 Administration Web Server,"](#) on page 24).
 2. Click **Voice tab > SIP**.
 3. Scroll down to the *PBX Parameters* section.
 4. Enter the correct multicast address in the *Multicast Address* field.

PBX Parameters			
Proxy Network Interface:	WAN	Proxy Listen Port:	6060
Multicast Address:	224.168.168.168:6061	Group Page Address:	224.168.168.168:3456
Max Expires:	60	Force Media Proxy:	yes
Proxy Debug Option:	none		
Call Routing Rule:	(<:L1>9xx. <:L2>8xx.)		
Call Park MOH Server:	imusic	Call Park DLG Refresh Intvl:	0
Default Group Line:	1,2,3,4	Group 1 User ID:	
Group 1 Line:		Group 2 User ID:	
Group 2 Line:		Group 3 User ID:	
Group 3 Line:		Group 4 User ID:	
Group 4 Line:			
Hunt Groups:	500:101,103,105,hunt=ra;10;1,cfwd=vm2100		
SIP DIDN Field:	TO UserID	SIP DIDN Param Name:	didn
Accept All MWI As Line:	Current	Phone DLG Refresh Intvl:	0

NOTE: The default value is 224.168.168.168:6061.

5. Click **Submit All Changes**.
6. Enter the same multicast address in the phone configurations:
 - a. Click the **PBX Status** link to view a list of all phones.
 - b. Find the phone that you want to configure, and then click the hyperlink in the *IP Address* column. The *Telephone Configuration* page appears in a separate browser window.
 - c. Click the **SIP** tab.
 - d. Scroll down to the *Linksys Key System Parameters* section.
 - e. Enter the IP address in the *Multicast Address* field.
 - f. Click **Submit All Changes**.
 - g. Click the **Back** button on the Internet Explorer toolbar to return to the list of phones.
 - h. Repeat these steps for each phone.

Setting the Group Page Address

In the group paging application, the originator sends RTP packets to an IP multicast address at which all the other client stations are listening. This address is chosen by the SPA9000 and is configured on the *Voice > SIP* page, *PBX Parameters* section, *Group Page Address* field.

The originator starts the group page by choosing **PageGroup** from the Corporate Directory on the phone, or by using a speed dial or personal directory entry. All client stations are alerted at once. If the client station is on a call when a group page starts, the call is automatically placed on hold. The speaker on each paged station is turned on automatically unless the handset or headset is being used. Group page is one-way only. The paged client stations can only listen to the call from the originator.

1. Connect to the SPA9000 administration web server, and choose Admin access with Advanced settings. (See ["Connecting to the SPA9000 Administration Web Server,"](#) on page 24).
2. Click **Voice tab > SIP**.
3. Scroll down to the *PBX Parameters* section.

4. Enter the correct multicast address in the *Group Page Address* field.

PBX Parameters			
Proxy Network Interface:	WAN	Proxy Listen Port:	6060
Multicast Address:	224.168.168.168:6061	Group Page Address:	224.168.168.168:3456
Max Expires:	60	Force Media Proxy:	yes
Proxy Debug Option:	none		
Call Routing Rule:	(<:L1>9xx. <:L2>8xx.)		
Call Park MOH Server:	imusic	Call Park DLG Refresh Intvl:	0
Default Group Line:	1,2,3,4	Group 1 User ID:	
Group 1 Line:		Group 2 User ID:	
Group 2 Line:		Group 3 User ID:	
Group 3 Line:		Group 4 User ID:	
Group 4 Line:			
Hunt Groups:	500:101,103,105,hunt=ra;10;1,cfwd=vm2100		
SIP DIDN Field:	TO UserID	SIP DIDN Param Name:	didn
Accept All MWI As Line:	Current	Phone DLG Refresh Intvl:	0

NOTE: The default value is 224.168.168.168:34567.

5. Click **Submit All Changes**.

Collecting System Logs and Debug Information

If you are working with an ITSP that needs more information to configure interoperability, you can collect system logs and debug information for the SPA9000. You can send these logs to the ITSP for their use.

Requirements:

- You need a PC that is on the same subnetwork as the SPA9000, to capture the log files. This PC needs to be running a syslog daemon. Enter the IP address of this PC on the *Voice > System* page, in the *Syslog Server* and *Debug Server* fields.
- If you are interested in working with these logs yourself, you will need to use an application that reads syslogs. Linksys partners can download a syslog server tool (slogsrv.exe) from the Linksys Partner Connection. (VARs, see *Product Utilities > Linksys Voice System > SPA Utilities > Syslog Server for SPA Devices*. SPs, see *Technical Tools > SPA Utilities > Syslog Server for SPA Devices*.)



Note

As a best practice, enable logging only when needed, and disable logging when you finish the investigation. Logging information can impact system performance.

1. Connect to the SPA9000 administration web server, and choose Admin access with Advanced settings. (See ["Connecting to the SPA9000 Administration Web Server,"](#) on page 24).
2. Click **Voice tab > System**.

3. In the *Miscellaneous Settings* section, enter the following settings:
 - **Syslog Server:** Enter the server IP address and port to collect basic information about system activity (no SIP messages).
 - **Debug Server:** Enter the server IP address and port to collect information about SIP messages.

NOTE: SIP logging is not enabled until you complete this procedure by enabling system logging on the line interface.

 - i. **Debug Level:** Choose 3 to enable debugging.
4. Click **Voice tab > Line N**, where *N* represents the line interface number of the line that you are investigating.
5. Scroll down to the *SIP Settings* section, and then choose a **SIP Debug Option**, based on the level of SIP information that you want to collect.

NOTE: Typically, your ITSP support personnel will tell you what type of information they need in the logs. The drop-down list includes three categories of options: *none*, *1-line*, and *full*.

- none: Disables SIP logging
- 1-line: Identifies the SIP message type but does not include the message body
Options within this category allow you to choose to exclude OPT, NTFY, and REG information to reduce the length of the logs.
- full: Includes the SIP message body
Options within this category allow you to choose to exclude OPT, NTFY, and REG information to reduce the length of the logs.

EXAMPLES:

- If you are troubleshooting a problem with line registration. Select **full**.
 - If you are troubleshooting a call problem. Select **full excl. OPT|NTFY|REG**.
6. Click **Submit All Changes**. The information is stored on the specified server and port, with a file name in the following format: *syslog,port.log*.
 7. **IMPORTANT:** When you finish collecting the information, disable the logging:
 - a. Click **Voice tab > Line**. Change **SIP Debug Option** to **none**.
 - b. Click **Voice tab > System**. In the *Miscellaneous Settings* section, change **Debug Level** to **0**.

Viewing Information about the SPA9000

The *Router Status* page provides information about software version, hardware version, MAC address, WAN connection type, IP address, and the packets that have been sent and received.

SPA9000 Router > Status

Router		Voice	
Status	Wan Setup	Lan Setup	Application
			PBX Status
			User Login basic advanced
Product Information			
Product Name:	SPA9000	Serial Number:	FM700F513180
Software Version:	5.1.9	Hardware Version:	1.0.5
MAC Address:	000E08E1BA69	Client Certificate:	Installed
Customization:	Open	Licenses:	K0
System Status			
Current Time:	3/26/2008 05:53:59	Elapsed Time:	1 day and 00:37:20
Wan Connection Type:	Static IP	Current IP:	192.168.0.109
Host Name:	SipuraSPA	Domain:	
Current Netmask:	255.255.255.0	Current Gateway:	192.168.0.1
Primary DNS:	192.168.0.1		
Secondary DNS:			
LAN IP Address:	192.168.1.1	Broadcast Pkts Sent:	0
Broadcast Bytes Sent:	0	Broadcast Pkts Recv:	25633
Broadcast Bytes Recv:	8006598	Broadcast Pkts Dropped:	0
Broadcast Bytes Dropped:	0		
Undo All Changes		Submit All Changes	

Viewing Information about Client Stations

The *PBX Status* page provides information about the client stations (IP phones), with hyperlinks to station configuration pages.

1. Connect to the SPA9000 administration web server, and choose Admin access with Advanced settings. (See "[Connecting to the SPA9000 Administration Web Server](#)," on page 24).
2. To view the status information for the client stations, click the **PBX Status** link in the top right corner or lower left corner of the page. The list of client stations appears.

SPA9000 > PBX Status

Registration	Station	User ID	IP Address	Reg Expires(s)	User-Agent
<input type="checkbox"/>	Sales1	100	192.168.1.137	71	Linksys/SPA942-5.2.8
<input type="checkbox"/>	Sales2	101	192.168.1.134	75	Linksys/SPA942-5.2.8
<input type="checkbox"/>	Accounting	103	192.168.1.107	72	Linksys/SPA942-5.2.8
<input type="checkbox"/>	CustomerSupport	105	192.168.1.105	72	Linksys/SPA942-5.2.8

3. To view the *Telephone Configuration* page for any station, click the hyperlink in the *IP Address* column. For information about the telephone configurations, see the *Linksys Phone Administration Guide*.

Using the Interactive Voice Response Unit

In addition to the administration web server, the SPA9000 is equipped with an Interactive Voice Response unit (IVR) that allows you to perform certain administrative tasks by using an analog phone that is connected to the SPA9000.

- ["Using the IVR Menu," on page 34](#)
- ["Entering a Password through the IVR," on page 37](#)

Using the IVR Menu

To use the IVR menu, complete the following steps.

1. Connect an analog telephone to the Phone 1 or Phone 2 port of the SPA9000.
2. Press **** (quickly press the star key four times).
3. Wait until you hear "Linksys configuration menu."
4. Refer to [Table 2-1](#) to identify the option required.
5. Enter the required option followed by the # (pound) key.

NOTE:

- To enter a period, use the star key (*).
- When entering a value, such as an IP address, to exit without entering any changes, press the * (star) key twice within half a second. Otherwise, the * is treated as a decimal point.
- After entering a value, such as an IP address, press the # (pound) key to indicate you have finished your selection.
- To save a new setting, press **1**. To review a new setting, press **2**. To re-enter a setting, press **3**. To cancel your entry and return to the main menu, press * (star).

For example, to enter the IP address *191.168.1.105* by keypad, press the following keys: **191*168*1*105**. Press the # (pound) key to indicate that you have finished entering the IP address. Then press **1** to save the IP address, or press the * (star) key to cancel your entry and return to the main menu.

- If the menu is inactive for more than one minute, the SPA9000 times out. You need to re-enter the menu by pressing ****.
6. To exit the menu, hang up the telephone.

The settings that you have saved take effect after you hang up the telephone. The SPA9000 may reboot at this time.

Table 2-1 IVR Options

IVR Action	IVR Menu Choice	Parameter(s)	Notes
Enter IVR Menu	* * * *	None	Ignore SIT or other tones until you hear, "Linksys configuration menu. Please enter option followed by the pound key or hang-up to exit."
Exit IVR Menu	3948	None	
Check DHCP	100	None	The IVR spells "S,T,A,T,I,C" if the setting is for a static IP address or "D,H,C,P" for a DHCP IP address.
Enable/Disable DHCP	101	Enter 0 to enable Enter 1 to disable	Requires password
Check WAN IP Address	110	None	IVR announces the current IP address of the WAN port.
Set Static IP Address	111	Enter IP address using numbers on the telephone key pad. Use the * (star) key when entering a decimal point.	DHCP must be "Disabled," otherwise you hear, "Invalid Option," if you try to set this value. Hang up the phone after setting the IP address. The SPA9000 reboots and the new address takes effect. Do not attempt to use IVR option 110 immediately after changing the IP address. The old IP address is reported until the SPA9000 reboots. Requires password
Check Network Mask	120	None	IVR announces the current network mask of SPA.
Set Network Mask	121	Enter value using numbers on the telephone key pad. Use the * (star) key when entering a decimal point.	DHCP must be "Disabled," otherwise you hear, "Invalid Option," if you try to set this value. Requires password
Check Static Gateway IP Address	130	None	IVR announces the current gateway IP address of SPA.

Table 2-1 IVR Options (Continued)

Set Static Gateway IP Address	131	Enter IP address using numbers on the telephone key pad. Use the * (star) key when entering a decimal point.	DHCP must be "Disable," otherwise you hear, "Invalid Option," if you try to set this value. Requires password
Check MAC Address	140	None	IVR announces the MAC address of SPA in hex string format.
Check Firmware Version	150	None	IVR announces the version of the firmware running on the SPA.
Check Primary DNS Server Setting	160	None	IVR announces the current setting in the <Primary DNS> parameter.
Set Primary DNS Server	161	Enter IP address using numbers on the telephone key pad. Use the * (star) key when entering a decimal point.	Requires password
Check administration web server port	170	None	IVR announces the port that the web server is listening on. (Default is 80)
Check LAN IP Address	210	None	IVR announces the current IP address of the LAN port.
Check PBX multicast address	180	None	IVR announces the current value.
Set PBX multicast address	181	Enter IP address and port. Use * key for entering a dot. For example, 224.168.168.169:8089 is 224*168*168*169*8089.	Enter a * between the IP address and the Port fields. Requires Password
Enable/Disable administration web server	7932	Enter 1 to enable Enter 0 to disable	Requires password
Manual Reboot of Unit	732668	None	After you hear "Option Successful," hang up. Unit reboots automatically.

Table 2-1 IVR Options (Continued)

User Factory Reset of Unit WARNING: ALL "User-Changeable" NON-DEFAULT SETTINGS WILL BE LOST! This might include network and service provider data.	877778	Enter 1 to confirm Enter *(star) to cancel operation	SPA prompts for confirmation. After confirming, you hear "Option Successful." Hang up. Unit reboots and all "User Changeable" configuration parameters are reset to factory default values.
Factory Reset of Unit WARNING: ALL NON-DEFAULT SETTINGS WILL BE LOST! This includes network and service provider data.	73738	Enter 1 to confirm Enter * (star) to cancel operation	SPA prompts for confirmation. After confirming, you hear "Option Successful." Hang up. Unit reboots and all configuration parameters are reset to factory default values.

**Note**

The items marked with "Requires Password" only require a password if the Administrator password is set.

Entering a Password through the IVR

To input the password using the phone keypad, the following translation conventions apply:

- To input: A, B, C, a, b, c—press **"2"**
- To input: D, E, F, d, e, f—press **"3"**
- To input: G, H, I, g, h, i—press **"4"**
- To input: J, K, L, j, k, l—press **"5"**
- To input: M, N, O, m, n, o—press **"6"**
- To input: P, Q, R, S, p, q, r, s—press **"7"**

- To input: T, U, V, t, u, v—press “**8**”
- To input: W, X, Y, Z, w, x, y, z—press “**9**”
- To input all other characters in the Administrator account password, press “**0**”



Note

This translation convention only applies to the password input.

For example, to input password **test#@1234** by phone keypad, you need to press the following sequence of digits: **8378001234**.

1. After entering a value, press the # (pound) key to indicate end of input.
 - To save value, press **1**.
 - To review the value, press **2**.
 - To re-enter the value, press **3**.
 - To cancel the value entry and return to the main configuration menu, press * (star).

NOTES:

- The final # key is not included in the password value.
 - Saved settings take effect when the telephone is hung-up, and if necessary, the SPA9000 automatically reboots.
2. After one minute of inactivity, the unit times out. The user needs to re-enter the configuration menu from the beginning by pressing * * * *.

Configuring the SPA9000 for ITSP Interoperability

This chapter provides configuration details for the purpose of helping you to ensure that your infrastructure properly supports the LVS.

- ["About LVS and SIP," on page 39](#)
- ["Network Address Translation \(NAT\) and Voice over IP \(VoIP\)," on page 40](#)
- ["Firewalls and SIP," on page 43](#)
- ["Configuring SIP Timer Values," on page 44](#)

About LVS and SIP

The LVS is implemented using open standards, such as Session Initiation Protocol (SIP), to help ensure interoperation with all ITSPs that support SIP. This section provides information about the SIP requests and the settings that you may need to adjust on your network or your SPA9000 to help ensure interoperability.

The VoIP telephone service is coordinated by SIP requests and responses, whether the calls are internal or external. [Figure 3-1](#) illustrates the SIP requests and responses between client stations in the LVS. The SPA9000 acts as a SIP proxy and establishes a session. After the session is established, Real Time Protocol (RTP) traffic flows directly between the two client stations.

Figure 3-1 SIP Requests and Responses for Internal Calls

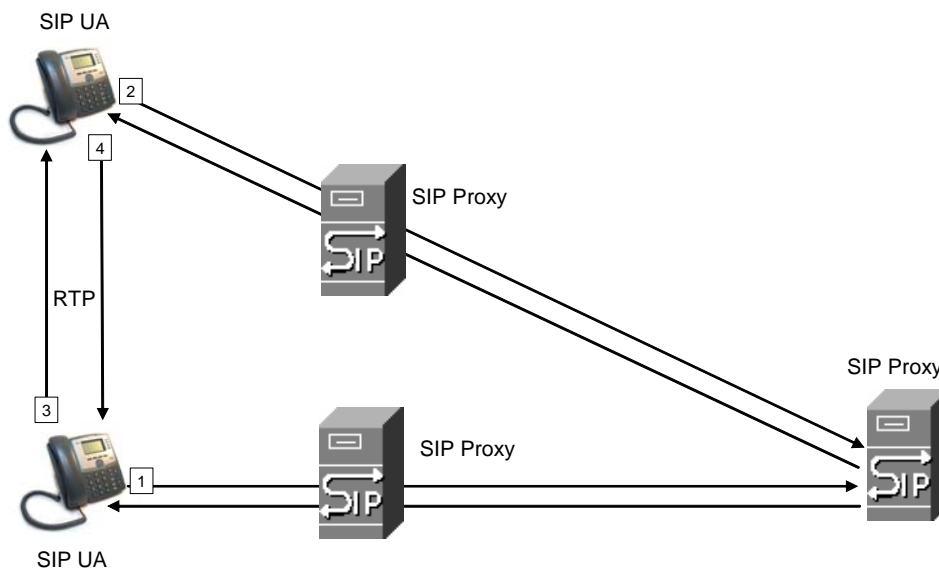

Likewise, SIP requests and responses are exchanged to support outbound and inbound calls that are handled through the ITSP service. In [Figure 3-2](#), UserA and UserB are client stations that are registered to the SPA9000. When UserA calls UserC, the SPA9000 directs the request to the SIP proxy at the ITSP, which is then responsible for routing the request to UserC. After the session is established, RTP is anchored by the SPA9000.

Figure 3-2 SPA9000 as a SIP Proxy for Internet Calls

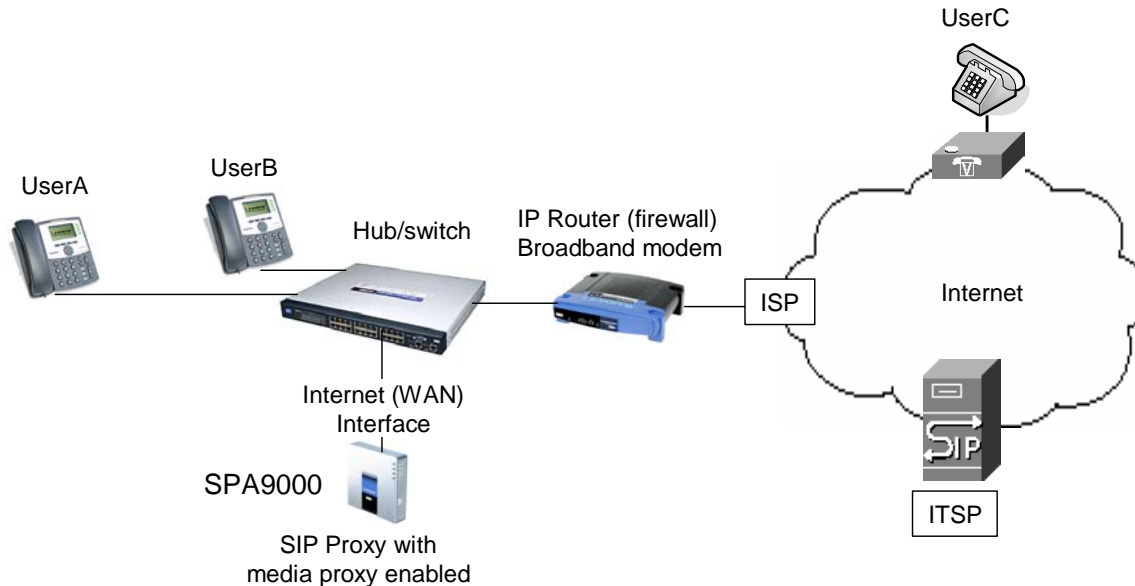

Network Address Translation (NAT) and Voice over IP (VoIP)

NAT is a function that allows multiple devices to share the same public, routable, IP address to establish connections over the Internet. NAT is present in many broadband access devices to translate public and private IP addresses. To enable VoIP to co-exist with NAT, some form of NAT traversal is required.

Some ITSPs provide NAT traversal, but some do not. If your ITSP does not provide NAT traversal, you have several options.

- ["NAT Mapping with SIP-ALG Router," on page 40](#)
- ["NAT Mapping with Session Border Controller," on page 41](#)
- ["Configuring NAT Mapping with a Static IP Address," on page 41](#)
- ["Configuring NAT Mapping with STUN," on page 42](#)

NAT Mapping with SIP-ALG Router

You can achieve NAT mapping by using a router that has a SIP ALG (Application Layer Gateway). The Linksys WRV200 router is recommended for this purpose, although any router with a SIP-ALG can be used. By using a SIP-ALG router, you have more choices in selecting an ITSP.

NAT Mapping with Session Border Controller

It is strongly recommended that you choose an ITSP that supports NAT mapping through a Session Border Controller (see [Figure 3-3](#)). With NAT mapping provided by the ITSP, you have more choices in selecting a router.

Figure 3-3 NAT Support with Session Border Controller Provided by ITSP

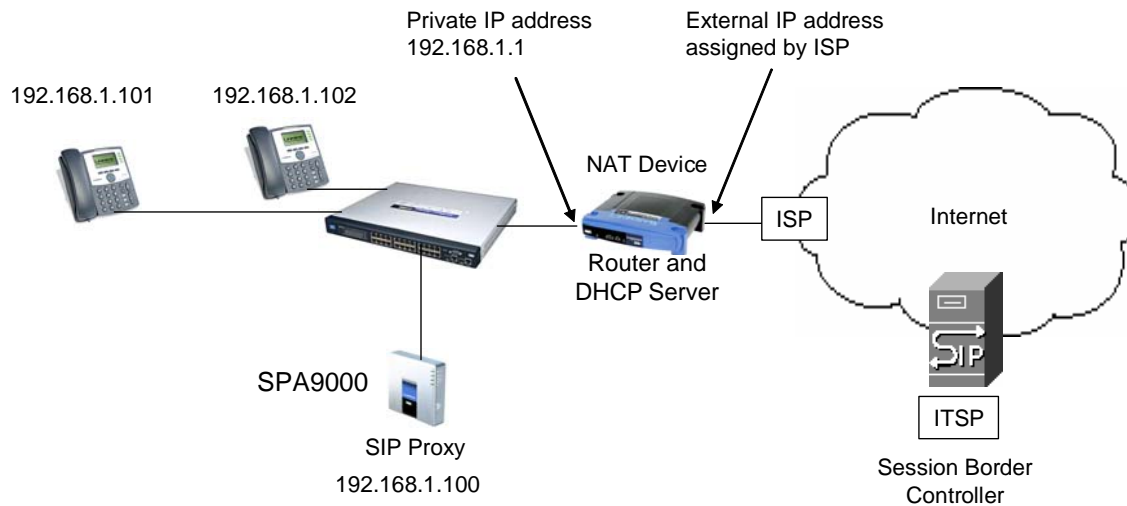

Configuring NAT Mapping with a Static IP Address

Configuring NAT mapping in the SPA9000 is recommended only if the ITSP network does not provide a Session Border Controller functionality. In this case, and if the external (public) IP address is static, then it is recommended to perform a static (permanent) mapping on SPA9000. This setting is also recommended if NAT mechanism used in the router is symmetric.



Note

The LAN switch needs to be configured to enable Spanning Tree Protocol and Port Fast on the ports to which the SPA9000 and the SPA9xx phones are connected.

1. Connect to the SPA9000 administration web server, and choose Admin access with Advanced settings. (See ["Connecting to the SPA9000 Administration Web Server,"](#) on page 24.)
2. Click **Voice tab > SIP**.
3. Scroll down to the *NAT Support Parameters* section, and then enter the following settings to support static mapping to your public IP address:
 - **Handle VIA received, Insert VIA received, Substitute VIA Addr:** yes
 - **Handle VIA rport, Insert VIA rport, Send Resp To Src Port:** yes
 - **EXT IP:** Enter the public IP address for your router.

SPA9000 Voice > SIP: NAT Support Parameters

NAT Support Parameters			
Handle VIA received:	yes	Handle VIA rport:	yes
Insert VIA received:	yes	Insert VIA rport:	yes
Substitute VIA Addr:	yes	Send Resp To Src Port:	yes
STUN Enable:	no	STUN Test Enable:	no
STUN Server:		EXT IP:	xxx.xxx.xxx.xxx
EXT RTP Port Min:		NAT Keep Alive Intvl:	15

4. Click **Voice tab > Line N**, where N is the number of the line interface for the ITSP service that you need to configure.
5. Scroll down to the *NAT Settings* section.
 - **NAT Mapping Enable:** Choose **YES**.
 - **NAT Keep Alive Enable:** Choose **YES** (optional).

NOTE: Your ITSP may require the SPA9000 to send NAT keep alive messages to keep the NAT ports open permanently. For more information, see [Appendix A, "Advanced Topics in LVS Administration," "SIP-NAT Interoperation"](#) section on page 135.

6. Click **Submit All Changes**.

NOTE: You also need to configure the firewall settings on your router to allow SIP traffic. See ["Firewalls and SIP,"](#) on page 43.

Configuring NAT Mapping with STUN

Configuring NAT mapping in the SPA9000 is recommended only if the ITSP network does not provide a Session Border Controller functionality. In this case, and if the external (Public) IP address is assigned dynamically by the network (and the router uses asymmetric NAT mechanism), it is possible to use STUN as a mechanism to discover the NAT mapping in SPA9000. This is considered a practice of last resort and should be used only if the other methods are unavailable.



Note

STUN is a viable option only if your router uses asymmetric NAT. See [Appendix A, "Advanced Topics in LVS Administration," "Determining Whether the Router Uses Symmetric or Asymmetric NAT"](#) section on page 136.

1. Connect to the SPA9000 administration web server, and choose Admin access with Advanced settings. (See ["Connecting to the SPA9000 Administration Web Server,"](#) on page 24.)
2. Click **Voice tab > SIP**.

3. Scroll down to the *NAT Support Parameters* section, and then enter the following settings to enable and support the STUN server settings:
 - **Handle VIA received, Insert VIA received, Substitute VIA Addr:** yes
 - **Handle VIA rport, Insert VIA rport, Send Resp To Src Port:** yes
 - **STUN Enable:** Choose **yes**.
 - **STUN Server:** Enter the IP address for your STUN server.
4. Click **Voice tab > Line N**, where N is the number of the line interface for the ITSP service that you need to configure.
5. Scroll down to the *NAT Settings* section.
 - **NAT Mapping Enable:** Choose **YES**.
 - **NAT Keep Alive Enable:** Choose **YES** (optional).
6. Click **Submit All Changes**.

NOTE: Your ITSP may require the SPA9000 to send NAT keep alive messages to keep the NAT ports open permanently. For more information, see [Appendix A, "Advanced Topics in LVS Administration," "SIP-NAT Interoperation" section on page 135](#).

NOTE: You also need to configure the firewall settings on your router to allow SIP traffic. See ["Firewalls and SIP," on page 43](#).

Firewalls and SIP

To enable SIP requests and responses to be exchanged with the SIP proxy at the ITSP, you must ensure that your firewall allows both SIP and RTP unimpeded access to the Internet.

- Make sure that the following ports are not blocked:
 - SIP ports—UDP port 5060 through 5063, which are used for the SPA9000 line interfaces
 - RTP ports—16384 to 16482
- Also disable SPI (Stateful Packet Inspection) if this function exists on your firewall.

Configuring SIP Timer Values

The SPA9000 is configured with default timer values that should be adequate in most circumstances. However, you can adjust the SIP timer values as needed to ensure interoperability with your ISTP. For example, if SIP requests are returned with an “invalid certificate” message, you may need to enter a longer SIP T1 retry value.

To view the default settings or to make changes, open the *Voice > SIP* page, and scroll down to the *SIP Timer Values* section. For field descriptions, see [“SIP Timer Values \(sec\) section,”](#) on [page 161](#).

Configuring Phone Lines and Calling Routing Behavior

This chapter describes many features that you can configure on the SPA9000 to ensure smooth handling of all inbound and outbound calls, and ease of use.

- ["Configuring SPA9000 FXS Ports," on page 45](#)
- ["Configuring Line Interfaces on the SPA9000," on page 46](#)
- ["Configuring Dial Plans," on page 52](#)
- ["Managing the Line Selection for Outbound Calls," on page 63](#)
- ["Managing Caller ID Settings for Outgoing Calls," on page 65](#)
- ["Managing Inbound Calls with the Contact List," on page 66](#)
- ["Managing Inbound Calls with Hunt Groups," on page 73](#)
- ["Managing Inbound Calls with Shared Line Appearances," on page 77](#)

Configuring SPA9000 FXS Ports

The SPA9000 FXS ports can be used to connect analog phones and fax machines to the LVS. A port also can be configured for a Streaming Audio Server for Music On Hold. See [Chapter 6, "Configuring Music on Hold."](#)

**Note**

A fax machine can be connected to the Phone port of the SPA9000. Fax support through an ITSP line requires a T.38 fax machine on both ends and the availability of T.38 FAX relay through the ITSP. T.38 support is dependent on fax machine and network / transport resilience. Linksys makes no guarantee with the use of this product regarding fax transmission services

1. Connect to the SPA9000 administration web server, and choose Admin access with Advanced settings. (See ["Connecting to the SPA9000 Administration Web Server," on page 24.](#))
2. Click **Voice tab > FXS N**, where N is the port number.
3. Scroll down to the *Subscriber Information* section, and then enter the following settings:
 - **Display Name:** Enter an extension number of name for the FXS 1 port, such as Receptionist Area Fax Machine. You can use this extension number to add the analog phone to the contact list, hunt groups, and shared line appearances.
 - **User ID:** Enter a three- to four-digit extension number that is not is use by other extension.

- If the device is a fax machine, disable echo cancelling. On the *FXS N* page, *Audio Configuration* section, set the *FAX Disable ECAN* field to **yes**. Also make sure that the *Preferred Codec* is set to **G.711u** (default setting).
4. Enter the *Dial Plan* settings, as needed. See "[Configuring Dial Plans](#)," on page 52.
 5. Click **Submit All Changes**.

Configuring Line Interfaces on the SPA9000

You can configure the following types of services on the SPA9000 line interfaces:

- **ITSP service:** Up to 16 DID numbers can be supported on each line interface. You can configure different ITSP accounts on different line interfaces.
- **PSTN service:** You can configure a line interface to register the SPA9000 with a SPA400 to support PSTN lines.
- **SPA400 voice mail service:** You can configure a line interface to register the SPA9000 with a SPA400 to support voice mail server. This SPA400 should have no more than two PSTN lines connected. If more than two PSTN lines and voice mail are required, you should reserve one SPA400 exclusively for voice mail. Exceeding these guidelines will affect the quality of voice mail playback and command recognition.
- **ISDN services:** You can configure a line interface to register the SPA9000 with a Mediatrix® 4400 ISDN BRI Digital gateway. For more information, refer to the *SPA9000/Mediatrix® 440X ISDN Gateway Configuration Guide*, available at www.linksys-itsp.com (for Europe, Middle East and Africa Service Providers) and www.linksys-voip.eu (for Europe, Middle East and Africa Value Added Resellers).

This section includes the following topics:

- "[Configuring a Line Interface for ITSP Service](#)," on page 46
- "[Configuring a Line Interface for a SPA400 \(PSTN or Voice Mail\)](#)," on page 48
- "[Configuring Call Capacity for a Line Interface](#)," on page 51

Configuring a Line Interface for ITSP Service

1. Connect to the SPA9000 administration web server, and choose Admin access with Advanced settings. (See "[Connecting to the SPA9000 Administration Web Server](#)," on page 24.)
2. Click **Voice tab > Line N**, where *N* represents the line interface number.
3. From the *Line Enable* drop-down list, choose **yes**.
4. Enter the account information for your ITSP account:

User ID: The account number or logon name for your ITSP account (often the same as the phone number)

Password: The password for your ITSP account

Proxy: The proxy server for your ITSP account

SPA9000 Voice > Line

The screenshot shows the configuration page for a line on a SPA9000 device. The page is titled 'SPA9000 Voice > Line'. The configuration is organized into several sections:

- Line Enable:** A dropdown menu set to 'yes'.
- Network Settings:** Includes fields for SIP ToS/DiffServ Value (0x68), RTP ToS/DiffServ Value (0xb8), SIP CoS Value (3), and RTP CoS Value (6).
- SIP Settings:** Includes fields for SIP Transport (UDP), SIP Port (5060), SIP 100REL Enable (no), Auth Resync-Reboot (yes), SIP Proxy-Require (empty), SIP Remote-Party-ID (yes), SIP GUID (no), SIP Debug Option (none), Restrict Source IP (no), Referor Bye Delay (4), Refer Target Bye Delay (0), Refer-To Target Contact (no), and Auth INVITE (no).
- Subscriber Information:** Includes fields for Display Name, Password (circled in red), User ID (circled in red), Auth ID, Use Auth ID (no), Contact List (aa), Call Capacity (unlimited), and C fwd No Ans Delay (20).
- Dial Plan:** Includes a field for Dial Plan with the value (<9:>xx.).
- NAT Settings:** Includes fields for NAT Mapping Enable (no), NAT Keep Alive Enable (no), NAT Keep Alive Msg (\$NOTIFY), and NAT Keep Alive Dest (\$PROXY).
- Proxy and Registration:** Includes fields for Proxy (circled in red) and Outbound Proxy (empty).

NOTES:

- **SIP Port:** You can keep the default value. Each line must have a unique SIP port (5060 for Line 1, 5061 for Line 2, 5062 for Line 3, 5064 for Line 4).
 - **Contact List:** The default value is *aa*, for the Auto Attendant. As a general practice, you should leave the default value until after you confirm that the line is registered. Then you can configure the contact list. For more information, see ["Managing Inbound Calls with the Contact List,"](#) on page 66.
 - Depending on your ITSP network configuration requirements, you may need to set additional parameters such as Outbound Proxy. Service Provider will indicate the setting of any additional parameter for each ITSP line.
5. Click the **Submit All Changes** button. The SPA9000 device reboots.
 6. To verify the registration state, perform the following tasks:
 - After the devices reboot, Click **Voice tab > Info**. Scroll down to the *Line Status* section for the line that you configured (*Line 1 Status ... Line 4 Status*). Verify that the line is registered. If the line is not registered, you may need to refresh the browser several times because it can take a few seconds for the registration to succeed.

SPA9000 Voice > Info > Line Status

Line 1 Status	
Registration State:	Registered
Next Registration In:	253 s
Mapped SIP Port:	

- Use an external phone to place an inbound call to the telephone number that was assigned by your ITSP. Assuming that you have left the default settings in place, the Auto Attendant answers the call. You can then dial an extension number to verify that the call rings to the station.



Note

The LVS can be configured to support multiple DID's per Line Interface. For more information, "[Supporting Direct Inward Dialing to Phone Extensions](#)," on page 69.

Configuring a Line Interface for a SPA400 (PSTN or Voice Mail)

You can configure a line interface to register the SPA9000 to a SPA400 for PSTN access or voice mail service. To enable the interoperability of the SPA9000 and the SPA400, you need to enter corresponding information on the *SPA9000 Voice > Line* page and on the *SPA400 Setup > SPA9000 Interface* page. For voice mail service, also configure the *SPA400 Setup > Voicemail Server* page.

NOTE:

- The SPA9000 registers to the SPA400. Therefore, the SPA400 must be available when the SPA9000 attempts to register to it.
- Before you begin this procedure, connect the SPA400 as described in either the *SPA400 Quick Install Guide* or the *LVS Installation and Configuration Guide*.
- Determine the DHCP-obtained IP address of the SPA400 by reviewing the DHCP client list on the router.



Note

Important: For optimum Voice Mail performance, a SPA400 should be dedicated to the Voice Mail application when either of the following conditions is met:

1) More than 2 FXO connections are required

—OR—

2) More than 2 users commonly access voice mail at the same time.

1. Connect to the SPA9000 administration web server, and choose Admin access with Advanced settings. (See "[Connecting to the SPA9000 Administration Web Server](#)," on page 24.)
2. Click **Voice tab > Line N**, where *N* represents the line interface number.
3. From the *Line Enable* drop-down list, choose **yes**.
4. Enter the following information:

- **User ID:** Enter a user ID, such as 9000.
This entry must exactly match the user ID on the *SPA400 Setup > SPA9000 Interface* page, *User ID* field. For more information, see ["Configuring a SPA400 to Interoperate with the SPA9000,"](#) on page 85.
- **Proxy:** Enter the IP address of the SPA400.
- **Register Expires: 60**
This setting ensures that the SPA9000 and SPA400 are resynchronized every 60 seconds. This setting ensures that any changes in settings are synchronized on both devices.

SPA9000 Voice > Line: Subscriber Information, Proxy and Registration

SIP Settings			
SIP Transport:	UDP	SIP Port:	5061
SIP 100REL Enable:	no	Auth Resync-Reboot:	yes
SIP Proxy-Require:		SIP Remote-Party-ID:	yes
SIP GUID:	no	SIP Debug Option:	none
Restrict Source IP:	no	Referor Bye Delay:	4
Refer Target Bye Delay:	0	Referee Bye Delay:	0
Refer-To Target Contact:	no	Auth INVITE:	no
Subscriber Information			
Display Name:		User ID:	9000
Password:		Use Auth ID:	no
Auth ID:		Call Capacity:	unlimited
Contact List:	aa		
Cfwd No Ans Delay:	20		
Dial Plan			
Dial Plan:	(<9:>xx.)		
NAT Settings			
NAT Mapping Enable:	no	NAT Keep Alive Enable:	no
NAT Keep Alive Msg:	\$NOTIFY	NAT Keep Alive Dest:	\$PROXY
EXT SIP Port:			
Proxy and Registration			
Proxy:	192.168.40.110		
Outbound Proxy:			
Use Outbound Proxy:	no	Use OB Proxy In Dialog:	yes
Register:	yes	Make Call Without Reg:	no
Register Expires:	60	Ans Call Without Reg:	no
Use DNS SRV:	no	DNS SRV Auto Prefix:	no

5. Also in the *Proxy and Registration* section, enter the following settings to ensure that calls can be transferred and forwarded to the voice mail server:
 - Set *VMSP Bridge* to **all** (required if this line is being used for SPA400 voice mail service).
 - Set *XFER Bridge Mode* to **all**.
 - Set *CFWD Bridge Mode* to **all**.

NOTES:

- **SIP Port:** You can keep the default value. Each line must have a unique SIP port (5060 for Line 1, 5061 for Line 2, 5062 for Line 3, 5064 for Line 4).
- **Contact List:** The default value is *aa*, for the Auto Attendant. As a general practice, you should leave the default value until after you confirm that the line is registered in the *Voice > Info* page, *Line Status* section, *Registration State* field. Then you can configure the

contact list. For more information, see ["Managing Inbound Calls with the Contact List,"](#) on page 66.

6. Proceed as needed:

- If you are using this SPA400 for voice mail service, continue to [Step 7](#).
- If you are using this SPA400 for PSTN access only, click **Submit All Changes** to finish this procedure. You will need to configure the SPA400. For more information, see ["Configuring a SPA400 to Interoperate with the SPA9000,"](#) on page 85 and ["Configuring a SPA400 for PSTN Access,"](#) on page 87.

7. Enter the following settings for the SPA400 voice mail service:

- **Mailbox Deposit URL: 900@<IP address of SPA400> : 5090**
The SPA9000 uses this address to deposit voice mail on the voice mail server.
- **Mailbox Manage URL: 800@<IP address of SPA400> : 5090**
The SPA9000 uses this address to access voice mail on the voice mail server.
- **Mailbox Subscribe URL: 8888@<IP address of SPA400> : 5090**
The SPA9000 uses this address to subscribe to voice mail service on the voice mail server.
- **Mailbox Subscribe Expires: 30**
This setting ensures that the SPA9000 and the SPA400 voice mail server are resynchronized every 30 seconds, and prevents problems when you make changes in the settings.

SPA9000 Voice > Line

Proxy and Registration	
Proxy:	192.168.0.110
Outbound Proxy:	
Use Outbound Proxy:	no
Register:	yes
Register Expires:	30
Use DNS SRV:	no
Proxy Fallback Intvl:	3600
Mailbox Status:	
Mailbox Deposit URL:	900@192.168.0.110:50
Mailbox Manage URL:	800@192.168.0.110:50
CFWD Bridge Mode:	none
Use OB Proxy In Dialog:	yes
Make Call Without Reg:	no
Ans Call Without Reg:	no
DNS SRV Auto Prefix:	no
Proxy Redundancy Method:	Normal
Mailbox Subscribe URL:	8888@192.168.0.110:50
Mailbox Subscribe Expires:	30
VMSP Bridge:	None
XFER Bridge Mode:	none

8. Click the **Submit All Changes** button. The SPA9000 device reboots.



Note

You need to configure the SPA400 with the corresponding settings. See ["Configuring Local Voice Mail Service on a SPA400,"](#) on page 88.

Configuring Call Capacity for a Line Interface

Each line interface has a limited number of simultaneous calls that are allowed, based on the Call Capacity parameter. When the maximum call capacity is reached, the SPA9000 does not allocate any more calls to that line interface.

This section includes the following topics:

- ["Bandwidth Requirements and Call Capacity," on page 51](#)
- ["Setting the Call Capacity Parameter," on page 52](#)

Bandwidth Requirements and Call Capacity

The available connection bandwidth determines the maximum number of simultaneous calls that the system can support with the appropriate audio quality. Before installing and configuring the LVS components, use this information to determine the maximum number of simultaneous VoIP connections that the system can support. For asymmetric connections, such as ADSL, the maximum number of calls is determined by the upstream bandwidth. In general it is a good practice to use no more than 75% of the total available bandwidth for calls. This provides space for data traffic and helps ensure good voice quality.

[Table 4-1](#) provides the approximate bandwidth budget for different codecs.

Table 4-1 Bandwidth Budget

Codec	Approximate bandwidth budget (kbps)				
	Each side of conversation	2 calls	4 calls	6 calls	8 calls
G.711	110	220	440	660	880
G.726-40	87	174	348	522	696
G.726-32	79	158	316	474	632
G.726-24	71	142	284	426	568
G.726-16	63	126	252	378	504
G.729	55	110	220	330	440

Setting the Call Capacity Parameter

You can set the maximum total number of incoming and outgoing calls on each line interface. The default value is unlimited. You can set a value from 1 to 15, or leave the setting as unlimited.

NOTE: The SPA9000 does not distinguish between incoming and outgoing calls for call capacity.

1. Connect to the SPA9000 administration web server, and choose Admin access with Advanced settings. (See ["Connecting to the SPA9000 Administration Web Server,"](#) on page 24.)
2. Click **Voice tab > Line N**, where *N* represents the line interface number.
3. Scroll down to the *Subscriber Information* section.
4. From the *Call Capacity* drop-down list, choose the maximum number of calls to allow.

SPA9000 Voice > Line: Subscriber Information

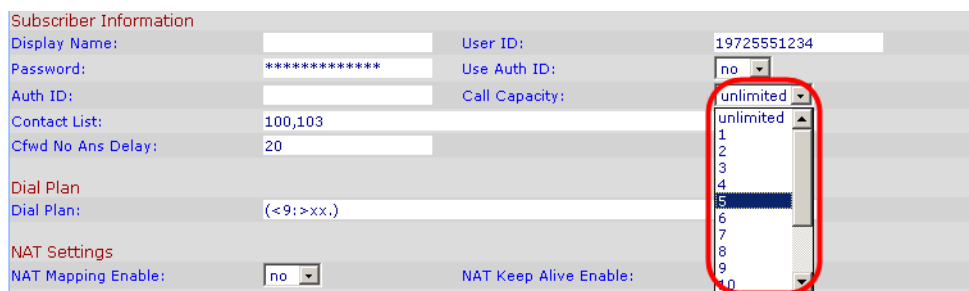

The screenshot shows the 'Subscriber Information' section of the SPA9000 administration web interface. The 'Call Capacity' dropdown menu is open, showing a list of options: unlimited, 1, 2, 3, 4, 5, 6, 7, 8, 9, and 10. The number 5 is highlighted in blue. A red circle is drawn around the dropdown menu.

Subscriber Information			
Display Name:	<input type="text"/>	User ID:	19725551234
Password:	*****	Use Auth ID:	no
Auth ID:	<input type="text"/>	Call Capacity:	unlimited
Contact List:	100,103		
Cfwd No Ans Delay:	20		
Dial Plan			
Dial Plan:	(<9:>x.x.)		
NAT Settings			
NAT Mapping Enable:	no	NAT Keep Alive Enable:	

5. Click **Submit All Changes**.

Configuring Dial Plans

Dial plans determine how the digits are interpreted and transmitted. They also determine whether the dialed number is accepted or rejected. You can use a dial plan to facilitate dialing or to block certain types of calls such as long distance or international.

This section includes information that you need to understand dial plans, as well as procedures for configuring your own dial plans. This section includes the following topics:

- ["How the Dialed Digits are Processed,"](#) on page 53
- ["Digit Sequences,"](#) on page 53
- ["Digit Sequence Examples,"](#) on page 55
- ["Acceptance and Transmission the Dialed Digits,"](#) on page 56
- ["Editing the System Dial Plan,"](#) on page 57
- ["Entering a Phone Dial Plan,"](#) on page 58
- ["Setting the Timers for the Dial Plan,"](#) on page 59

How the Dialed Digits are Processed

When a user lifts a handset or presses a speaker button, the following sequence of events begins:

1. The phone begins collecting the dialed digits. The inter-digit timer starts tracking the time that elapses between digits. For more information, see ["Setting the Timers for the Dial Plan," on page 59.](#)
2. If the inter-digit timer value is reached, or if another terminating event occurs, the phone compares the dialed digits with the PHONE (SYSTEM) dial plan (on the *SPA9xx Telephone Configuration > Ext N page, Dial Plan* section). For more information, see ["Acceptance and Transmission the Dialed Digits," on page 56,](#) ["Editing the System Dial Plan," on page 57,](#) and ["Entering a Phone Dial Plan," on page 58.](#)

NOTE: If a call is placed from a phone that is connected to a SPA9000 FXS port, the FXS port dial plan applies. See ["Configuring a Line Interface for a SPA400 \(PSTN or Voice Mail\)," on page 48.](#)

3. If the phone dial plan allows the call to process, the dialed numbers are sent to the SPA9000.
4. The SPA9000 compares the dialed digits to the CALL ROUTING RULE (on the *SPA9000 Voice > SIP page, PBX Parameters* section). For more information, see ["Configuring a Call Routing Rule," on page 63.](#)
5. If the call routing rule allows the call to process, then the SPA9000 compares the dialed digits to the LINE INTERFACE dial plan (on the *SPA9000 Voice > Line N page, Dial Plan* section). For more information, see ["Entering the Line Interface Dial Plan," on page 59.](#)
6. The SPA9000 uses the information in the line dial plan to manipulate the number (for example, to remove steering digits) and then transmits the number.

Digit Sequences

A dial plan contains a series of digit sequences, separated by the | character. The entire collection of sequences is enclosed within parentheses. Each digit sequence within the dial plan consists of a series of elements, which are individually matched to the keys that the user presses. The sequence can include the elements that are listed in [Table 4-2.](#)



Note

White space is ignored, but may be used for readability.

Table 4-2 Digit Sequences and Functions

Digit Sequence	Function
0 1 2 3 4 5 6 7 8 9 0 * #	Enter any of these characters to represent a key that the user must press on the phone keypad.
x	Enter x to represent any character on the phone keypad.

Digit Sequence	Function
[sequence]	<p>Enter characters within square brackets to create a list of accepted key presses. The user can press any one of the keys in the list.</p> <ul style="list-style-type: none"> Numeric range For example, you would enter [2-9] to allow the user to press any one digit from 2 through 9. Numeric range with other characters For example, you would enter [35-8*] to allow the user to press 3, 5, 6, 7, 8, or *.
. (period)	<p>Enter a period for element repetition. The dial plan accepts 0 or more entries of the digit. For example, 01. allows users to enter 0, 01, 011, 0111, and so on.</p>
<dialled:substituted>	<p>Use this format to indicate that certain dialed digits are replaced by other characters when the sequence is transmitted. The dialed digits can be zero or more characters.</p> <p>EXAMPLE 1: <8:1650>xxxxxxx</p> <p>When the user presses 8 followed by a seven-digit number, the system automatically replaces the dialed 8 with 1650. If the user dials 85550112, the system transmits 16505550112.</p> <p>EXAMPLE 2: <:1>xxxxxxxxxx</p> <p>In this example, no digits are replaced. When the user enters a 10-digit string of numbers, the number 1 is added at the beginning of the sequence. If the user dials 9725550112, the system transmits 19725550112</p>
, (comma)	<p>Enter a comma between digits to play an “outside line” dial tone after a user-entered sequence.</p> <p>EXAMPLE: 9,1xxxxxxxxxx</p> <p>An “outside line” dial tone is sounded after the user presses 9, and the tone continues until the user presses 1.</p>
! (exclamation point)	<p>Enter an exclamation point to prohibit a dial sequence pattern.</p> <p>EXAMPLE: 1900xxxxxxxx!</p> <p>The system rejects any 11-digit sequence that begins with 1900.</p>
*xx	<p>Enter an asterisk to allow the user to enter a 2-digit star code.</p>
S0	<p>Enter S0 to reduce the timer to 0 so that the dialed digits are evaluated after 0 seconds.</p> <p>For more information about modifying the timers for the evaluation of dialed digits, see “Setting the Timers for the Dial Plan,” on page 59.</p>

Digit Sequence Examples

The following examples show digit sequences that you can enter in a dial plan.

In a complete dial plan entry, sequences are separated by a pipe character (|), and the entire set of sequences is enclosed within parentheses.

EXAMPLE: ([1-8]xx | 9, xxxxxxx | 9, <:1>[2-9]xxxxxxxx | 8, <:1212>xxxxxxx | 9, 1 [2-9]xxxxxxxx | 9, 1 900 xxxxxxx ! | 9, 011xxxxxx. | 0 | [49]11)

- Extensions on your system

EXAMPLE: ([1-8]xx | 9, xxxxxxx | 9, <:1>[2-9]xxxxxxxx | 8, <:1212>xxxxxxx | 9, 1 [2-9]xxxxxxxx | 9, 1 900 xxxxxxx ! | 9, 011xxxxxx. | 0 | [49]11)

[1-8]xx Allows a user dial any three-digit number that starts with the digits 1 through 8. If your system uses four-digit extensions, you would instead enter the following string:
[1-8]xxx

- Local dialing with seven-digit number

EXAMPLE: ([1-8]xx | **9, xxxxxxx** | 9, <:1>[2-9]xxxxxxxx | 8, <:1212>xxxxxxx | 9, 1 [2-9]xxxxxxxx | 9, 1 900 xxxxxxx ! | 9, 011xxxxxx. | 0 | [49]111)

9, xxxxxxx After a user presses 9, an external dial tone sounds. The user can enter any seven-digit number, as in a local call.

- Local dialing with 3-digit area code and a 7-digit local number

EXAMPLE: ([1-8]xx | 9, xxxxxxx | **9, <:1>[2-9]xxxxxxxx** | 8, <:1212>xxxxxxx | 9, 1 [2-9]xxxxxxxx | 9, 1 900 xxxxxxx ! | 9, 011xxxxxx. | 0 | [49]11)

9, <:1>[2-9]xxxxxxxx This example is useful where a local area code is required. After a user presses 9, an external dial tone sounds. The user must enter a 10-digit number that begins with a digit 2 through 9. The system automatically inserts the 1 prefix before transmitting the number to the carrier.

- Local dialing with an automatically inserted 3-digit area code

EXAMPLE: ([1-8]xx | 9, xxxxxxx | 9, <:1>[2-9]xxxxxxxx | **8, <:1212>xxxxxxx** | 9, 1 [2-9]xxxxxxxx | 9, 1 900 xxxxxxx ! | 9, 011xxxxxx. | 0 | [49]11)

8, <:1212>xxxxxxx This example is useful where a local area code is required by the carrier but the majority of calls go to one area code. After the user presses 8, an external dial tone sounds. The user can enter any seven-digit number. The system automatically inserts the 1 prefix and the 212 area code before transmitting the number to the carrier.

- U.S. long distance dialing

EXAMPLE: ([1-8]xx | 9, xxxxxxx | 9, <:1>[2-9]xxxxxxxx | 8, <:1212>xxxxxxx | **9, 1 [2-9]xxxxxxxx** | 9, 1 900 xxxxxxx ! | 9, 011xxxxxx. | 0 | [49]11)

9, 1 [2-9]xxxxxxxx After the user presses 9, an external dial tone sounds. The user can enter any 11-digit number that starts with 1 and is followed by a digit 2 through 9.

- Blocked number

EXAMPLE: ([1-8]xx | 9, xxxxxxx | 9, <:1>[2-9]xxxxxxxx | 8, <:1212>xxxxxxx | 9, 1 [2-9]xxxxxxxx | **9, 1 900 xxxxxxx !** | 9, 011xxxxxx. | 0 | [49]11)

9, 1 900 xxxxxxx ! This digit sequence is useful if you want to prevent users from dialing numbers that are associated with high tolls or inappropriate content, such as 1-900 numbers in the U.S.. After the user press 9, an external dial tone sounds. If the user enters an 11-digit number that starts with the digits 1900, the call is rejected.

- U.S. international dialing

EXAMPLE: ([1-8]xx | 9, xxxxxxx | 9, <:1>[2-9]xxxxxxxx | 8, <:1212>xxxxxxx | 9, 1 [2-9]xxxxxxxx | 9, 1 900 xxxxxxx ! | **9, 011xxxxxx.** | 0 | [49]11)

9, 011xxxxxx. After the user presses 9, an external dial tone sounds. The user can enter any number that starts with 011, as in an international call from the U.S.

- Informational numbers

EXAMPLE: ([1-8]xx | 9, xxxxxxx | 9, <:1>[2-9]xxxxxxxx | 8, <:1212>xxxxxxx | 9, 1 [2-9]xxxxxxxx | 9, 1 900 xxxxxxx ! | 9, 011xxxxxx. | **0 | [49]11**)

0 | [49]11 This example includes two digit sequences, separated by the pipe character. The first sequence allows a user to dial 0 for an operator. The second sequence allows the user to enter 411 for local information or 911 for emergency services.

Acceptance and Transmission the Dialed Digits

When a user dials a series of digits, each sequence in the dial plan is tested as a possible match. The matching sequences form a set of candidate digit sequences. As more digits are entered by the user, the set of candidates diminishes until only one or none are valid. When a terminating event occurs, the SPA9000 either accepts the user-dialed sequence and initiates a call, or else rejects the sequence as invalid. The user hears the reorder (fast busy) tone if the dialed sequence is invalid.

The following explains how terminating events are processed.

Terminating Event	Processing
The dialed digits do not match any sequence in the dial plan.	The number is rejected.
The dialed digits exactly match one sequence in the dial plan.	<ul style="list-style-type: none"> If the sequence is allowed by the dial plan, the number is accepted and is transmitted according to the dial plan. If the sequence is blocked by the dial plan, the number is rejected.

Terminating Event	Processing
A timeout occurs.	<p>The number is rejected if the dialed digits are not matched to a digit sequence in the dial plan within the time specified by the applicable interdigit timer.</p> <ul style="list-style-type: none"> The Interdigit Long Timer applies when the dialed digits do not match any digit sequence in the dial plan. The default value is 10 seconds. The Interdigit Short Timer applies when the dialed digits match one or more candidate sequences in the dial plan. The default value is 3 seconds. <p>For more information, see "Setting the Timers for the Dial Plan," on page 59.</p>
The user presses the # key or the dial softkey on the phone display.	<ul style="list-style-type: none"> If the sequence is complete and is allowed by the dial plan, the number is accepted and is transmitted according to the dial plan. If the sequence is incomplete or is blocked by the dial plan, the number is rejected.

Editing the System Dial Plan

Follow this procedure to edit the system dial plan, which will be auto-provisioned to the first extension of each phone.

1. Connect to the SPA9000 administration web server, and choose Admin access with Advanced settings. (See ["Connecting to the SPA9000 Administration Web Server,"](#) on page 24.)
2. Click **Voice tab > SIP**.
3. Scroll down to the *PBX Phone Parameters* section.

SPA9000 Voice > SIP: PBX Phone Parameters

The screenshot shows the 'PBX Phone Parameters' configuration page. The 'Phone Dial Plan' field is circled in red and contains the text: `(9,[3469]11S0|9,<:1408>[2-9]xxxxxx|9,<:1>[2-9]xxxxxxxxxS0|9,1[2-9]x`. Other fields include 'Next Auto User ID' (106), 'Phone Upgrade Rule', 'Phone Config XML', 'Use LVS_PROXY' (no), and 'CTI Enable' (yes).

4. Enter the digit sequences in the *Dial Plan* field. For more information and examples, see ["Digit Sequences and Functions,"](#) on page 53.

**Note**

Separate each digit sequence with a pipe character, and enclose the entire set of digit sequences within parentheses. Refer to the following example:

```
(9,8<:1408>[2-9]xxxxxx | 9,8,1[2-9]xxxxxxxxx | 9,8,011xx. | 9,8,xx.[1-8]xx)
```

5. Click **Submit All Changes**. The phones reboot.
6. Verify that you can successfully complete a call using each digit sequence that you entered in the dial plan.

**Note**

If you hear a reorder (fast busy) tone, you need to review your entries and modify the dial plan appropriately. See ["Digit Sequences," on page 53.](#)

Entering a Phone Dial Plan

The phone dial plan is automatically updated when the system phone dial plan is modified. There are special cases where it is required to enter the phone dial plan directly on the phone. Follow the procedure below to enter a dial plan for a particular extension on a client station in the following cases:

- The phone is outside the SPA9000 multicast domain (e.g. when the phone is connected to the SPA9000 via a VPN connection).
 - For additional extensions on an existing phone (the system wide phone dial plan is propagated only to extension 1 of all phones).
1. Connect to the SPA9000 administration web server, and choose Admin access with Advanced settings. (See ["Connecting to the SPA9000 Administration Web Server," on page 24.](#))
 2. Click the **PBX Status** link near the top right corner or lower left corner of the page, to view the list of client stations.
 3. Click the hyperlink in the *IP Address* column for the first phone that you want to configure. The telephone configuration page appears in a separate browser window.
 4. Click the **Ext 1** tab, or the tab for the extension that you want to configure.
 5. Scroll down to the *Dial Plan* section.
 6. Enter the digit sequences in the *Dial Plan* field.

NOTE:

- The default (US-based) system-wide dial plan appears automatically in the field. You can delete digit sequences, add digit sequences, or replace the entire dial plan with a new

dial plan. For more information and examples, see ["Digit Sequences and Functions," on page 53.](#)

- Separate each digit sequence with a pipe character, and enclose the entire set of digit sequences within parentheses. Refer to the following example:
(9,8<:1408>[2-9]xxxxxx | 9,8,1[2-9]xxxxxxxxxx | 9,8,011xx. | 9,8,xx.[1-8]xx)
7. Click **Submit All Changes**. The phone reboots.
 8. If you need to configure a dial plan for any other extensions on the phone (depending on the model), click the appropriate *Extension* tab, enter the dial plan, and submit the changes.
 9. Click the browser's **Back** button to return to the list of phones.
 10. Repeat this procedure for each client station that needs a unique dial plan.
 11. Verify that you can successfully complete a call using each digit sequence that you entered in the dial plan.



Note

If you hear a reorder (fast busy) tone, you need to review your entries and modify the dial plan appropriately. See ["Digit Sequences," on page 53.](#)

Entering the Line Interface Dial Plan

This dial plan is used to strip steering digits from a dialed number before it is transmitted out to the carrier.

1. Connect to the SPA9000 administration web server, and choose Admin access with Advanced settings. (See ["Connecting to the SPA9000 Administration Web Server," on page 24.](#))
2. Click **Voice tab > Line N**, where *N* represents the line interface number.
3. Scroll down to the *Dial Plan* section.
4. Enter the digit sequences in the *Dial Plan* field.
5. Click **Submit All Changes**.

Setting the Timers for the Dial Plan

The system uses dial plan timers to determine when a user's entry (or a null entry) is evaluated. You can modify the timers for an entire dial plan or for individual sequences within a dial plan.

There are three types of control timers:

- ["Dial Plan Timer \(Off-Hook Timer\)," on page 60](#)
- ["Interdigit Long Timer \(Incomplete Entry Timer\)," on page 61](#)
- ["Interdigit Short Timer \(Complete Entry Timer\)," on page 61](#)

Dial Plan Timer (Off-Hook Timer)

You can think of the Dial Plan Timer as “the off-hook timer.” This timer starts counting when the phone goes off hook. If no digits are dialed within the specified number of seconds, the timer expires and the null entry is evaluated. Unless you have a special dial plan string to allow a null entry, the call is rejected. The default value is 5.

Syntax for the Dial Plan Timer

SYNTAX: (P<n> | dial plan)

- **s:** The number of seconds; if no number is entered after P, the default timer of 5 seconds applies.
- **n:** (optional): The number to transmit automatically when the timer expires; you can enter an extension number or a DID number. No wildcard characters are allowed because the number will be transmitted as shown. If you omit the number substitution, <n>, then the user hears a reorder (fast busy) tone after the specified number of seconds.

Examples for the Dial Plan Timer

- Allow more time for users to start dialing after taking a phone off hook.

EXAMPLE: (P9 | (9,8<:1408>[2-9]xxxxxx | 9,8,1[2-9]xxxxxxxx | 9,8,011xx. | 9,8,xx.[1-8]xx)

P9 After taking a phone off hook, a user has 9 seconds to begin dialing. If no digits are pressed within 9 seconds, the user hears a reorder (fast busy) tone. By setting a longer timer, you allow more time for users to enter the digits.

- Create a hotline for all sequences on the System Dial Plan

EXAMPLE: (P9<:23> | (9,8<:1408>[2-9]xxxxxx | 9,8,1[2-9]xxxxxxxx | 9,8,011xx. | 9,8,xx.[1-8]xx)

P9<:23> After taking the phone off hook, a user has 9 seconds to begin dialing. If no digits are pressed within 9 seconds, the call is transmitted automatically to extension 23.

- Create a hotline on a line button for an extension

EXAMPLE: (P0 <:1000>)

With the timer set to 0 seconds, the call is transmitted automatically to the specified extension when the phone goes off hook. Enter this sequence in the Phone Dial Plan for Ext 2 or higher on a client station.

Setting the Dial Plan Timer for the System Dial Plan

Follow the procedure [“Editing the System Dial Plan,”](#) on page 57.

Interdigit Long Timer (Incomplete Entry Timer)

You can think of this timer as the “incomplete entry” timer. This timer measures the interval between dialed digits. It applies as long as the dialed digits do not match any digit sequences in the dial plan. Unless the user enters another digit within the specified number of seconds, the entry is evaluated as incomplete, and the call is rejected. The default value is 10 seconds.

**Note**

This section explains how to edit a timer as part of a dial plan. Alternatively, you can modify the Control Timer that controls the default interdigit timers for all calls. See [“Editing the Control Timers for the Default Interdigit Values,”](#) on page 62.

Syntax for the Interdigit Long Timer

SYNTAX: L:s, (dial plan)

- **s:** The number of seconds; if no number is entered after L:, the default timer of 5 seconds applies.
- Note that the timer sequence appears to the left of the initial parenthesis for the dial plan.

Example for the Interdigit Long Timer

EXAMPLE: L:15, (9,8<:1408>[2-9]xxxxxx | 9,8,1[2-9]xxxxxxxxxx | 9,8,011xx. | 9,8,xx.|[1-8]xx)

L:15, This dial plan allows the user to pause for up to 15 seconds between digits before the Interdigit Long Timer expires. This setting is especially helpful to users such as sales people, who are reading the numbers from business cards and other printed materials while dialing.

Setting the Interdigit Long Timer for the System Dial Plan

Follow the procedure [“Editing the System Dial Plan,”](#) on page 57.

Interdigit Short Timer (Complete Entry Timer)

You can think of this timer as the “complete entry” timer. This timer measures the interval between dialed digits. It applies when the dialed digits match at least one digit sequence in the dial plan. Unless the user enters another digit within the specified number of seconds, the entry is evaluated. If it is valid, the call proceeds. If it is invalid, the call is rejected. The default value is 3 seconds.

**Note**

This section explains how to edit a timer as part of a dial plan. Alternatively, you can modify the Control Timer that controls the default interdigit timers for all calls. See [“Editing the Control Timers for the Default Interdigit Values,”](#) on page 62.

Syntax for the Interdigit Short Timer

- **SYNTAX 1:** *S:s*, (*dial plan*)

Use this syntax to apply the new setting to the entire dial plan within the parentheses.

- **SYNTAX 2:** *sequence Ss*

Use this syntax to apply the new setting to a particular dialing sequence.

- **s:** The number of seconds; if no number is entered after *S*, the default timer of 5 seconds applies.

Examples for the Interdigit Short Timer

- Set the timer for the entire dial plan.

EXAMPLE: **S:6**, (9,8<:1408>[2-9]xxxxxx | 9,8,1[2-9]xxxxxxxx | 9,8,011xx. | 9,8,xx.|[1-8]xx)

S:6, While entering a number with the phone off hook, a user can pause for up to 15 seconds between digits before the Interdigit Short Timer expires. This setting is especially helpful to users such as sales people, who are reading the numbers from business cards and other printed materials while dialing.

- Set an instant timer for a particular sequence within the dial plan.

EXAMPLE: (9,8<:1408>[2-9]xxxxxx | **9,8,1[2-9]xxxxxxxxS0** | 9,8,011xx. | 9,8,xx.|[1-8]xx)

9,8,1[2-9]xxxxxxxxS0 With the timer set to 0, the call is transmitted automatically when the user dials the final digit in the sequence.

Setting the Interdigit Long Timer for the System Dial Plan

Follow the procedure ["Editing the System Dial Plan,"](#) on page 57.

Setting the Interdigit Long Timer for the Phone Dial Plan

Follow the procedure ["Entering a Phone Dial Plan,"](#) on page 58.

Editing the Control Timers for the Default Interdigit Values**Note**

Use the following procedure to edit the default timer settings for all calls. If you need to edit a timer setting only for a particular digit sequence or type of call, you can edit the dial plan. See [Table 4-2, 'Digit Sequences and Functions,'](#) on page 53.

1. Connect to the SPA9000 administration web server, and choose Admin access with Advanced settings. (See ["Connecting to the SPA9000 Administration Web Server,"](#) on page 24.)
2. Click **Voice tab > Regional**.
3. Scroll down to the *Control Timer Values* section.

4. Enter the desired values in the *Interdigit Long Timer* field and the *Interdigit Short Timer* field. Refer to the definitions at the beginning of this section.

SPA9000 Voice > Regional: Control Timer Values

Control Timer Values (sec)			
Hook Flash Timer Min:	.1	Hook Flash Timer Max:	.9
Callee On Hook Delay:	0	Reorder Delay:	5
Call Back Expires:	1800	Call Back Retry Intvl:	30
Call Back Delay:	.5	VMWI Refresh Intvl:	0
Interdigit Long Timer:	10	Interdigit Short Timer:	3
CPC Delay:	2	CPC Duration:	0

Managing the Line Selection for Outbound Calls

When a user places an outbound call, the SPA9000 chooses a line based on the group membership of the station and the Call Routing Rule for the line interface. You can configure the settings to route calls through particular lines, based on factors such as the dialed number, the destination, or the corporate identity that you want to represent.

This section includes the following topics:

- ["Line Availability," on page 63](#)
- ["Configuring a Call Routing Rule," on page 63](#)
- ["Entering a Call Routing Rule," on page 65](#)

Line Availability

The SPA9000 considers a line to be available for an outgoing call if the following conditions are met:

- The line is enabled in the configuration and is functioning. See ["Configuring Line Interfaces on the SPA9000," on page 46](#).
- The line is authorized by the *Call Routing Rule* for the dialed number. See ["Configuring a Call Routing Rule," on page 63](#).
- The line has capacity to take more calls. See ["Configuring Call Capacity for a Line Interface," on page 51](#).
- The Dial Plan for this line allows the dialed number. See ["Configuring Dial Plans," on page 52](#).

Configuring a Call Routing Rule

A Call Routing Rule is a special dial plan that specifies the lines that can be used to transmit a dialed number. The same number pattern can apply to more than one line.

SYNTAX: (<:L_{w,x,y,z}>number-pattern | <:L_{w,x,y,z}>number-pattern | <:L_{w,x,y,z}>number-pattern | <:L_{w,x,y,z}>number-pattern)

- **L:** A signifier for "Line"

- **w, x, y, z:** The number of the line interface (L1 for Line 1, L2 for Line 2, and so on)
- **number-pattern:** The dialed sequence that can use the specified lines
- **Other elements:**
 - Enclose the entire call routing rule in parentheses.
 - Use a comma to separate each digit sequence within a number-pattern.
 - Use a pipe character (|) to separate each call routing rule.

**Note**

The Call Routing rules use the same digit sequences as the Dial Plan rules. See [Table 4-2, 'Digit Sequences and Functions,' on page 53.](#)

- Any line interface can be used for allowed digit sequences

EXAMPLE: (<:L1,2,3,4>9xx.)

Any line interface can be used for any dialed sequence that begins with 9 and includes at least two additional numbers. The SPA9000 chooses an available line from the list, proceeding in the listed order. See [Table 4-2, 'Digit Sequences and Functions,' on page 63.](#)

- Different line interfaces for U.S., international, and 1-800 numbers

EXAMPLE: (<:L1,2>9xx. | <:L3>011852xx. | <:L4>1800xxxxxxx)

This example has three parts:

- <:L1,2>9xx. Line 1 and Line 2 can be used if the sequence starts with 9 and includes at least two additional digits.
 - <:L3>011852xx. Line 3 can be used if the sequence starts with 011852 and includes at least two additional digits.
 - <:L4>1800xxxxxxx Line 4 can be used if the sequence starts with 1800 and includes at least seven additional digits.
- Separate lines for long distance and local calling

EXAMPLE: (<:L1>9xx. | <:L2>8xx.)

Line 1 is used for any dialed sequence that starts with 9. Line 2 is used for any dialed sequence that starts with 8. This call routing rule is effective if users understand that 9 is the steering digit for long distance (with Line 1 configured for the ITSP and its inexpensive long distance service) and that 8 is the steering digit for local calls (with Line 2 configured for a SPA400 that has local phone lines connected).

- Wildcard characters

EXAMPLE: (<:L1>51*,577?)

In this example, Line 1 can be used when either of the following number patterns is dialed:

- The user dials a number that starts with 51, followed by any other characters.
- The user dials any four-digit number starting with 577.

Entering a Call Routing Rule

1. Connect to the SPA9000 administration web server, and choose Admin access with Advanced settings. (See ["Connecting to the SPA9000 Administration Web Server,"](#) on page 24.)
2. Click **Voice tab > SIP**.
3. Scroll down to the *PBX Parameters* section.
4. In the *Call Routing Rule* field, enter the rule that you want to apply
5. Click **Submit All Changes**.
6. To verify your progress, place a call to a phone that has caller ID, and confirm that the expected number appears.

Managing Caller ID Settings for Outgoing Calls

By default, outgoing calls through an ITSP line are identified by the User ID (usually the phone number) and Display Name of the selected line interface. Alternatively, you can map a DID number to a phone extension so that all outbound calls from that extension will identify the caller by the DID number and the assigned phone display name. (See ["Supporting Multiple DID Numbers Per Line Interface,"](#) on page 68.)



Note

Caller ID for a PSTN line is controlled by the phone company. Caller ID through an ITSP line should work as described, but if not, contact your ITSP to see what is allowed for caller ID configuration.

1. Connect to the SPA9000 administration web server, and choose Admin access with Advanced settings. (See ["Connecting to the SPA9000 Administration Web Server,"](#) on page 24.)
2. Click **Voice > Line N**, where *N* represents the line interface number.
3. Scroll down to the *Subscriber Information* section.
4. Enter the desired display name for Caller ID in the *Display Name* field.
5. Click **Submit All Changes**.

Managing Inbound Calls with the Contact List

You can use the Contact List to route inbound calls to the Auto Attendant, to a receptionist, to a client station, to a group of stations, or to a combination of these.

- ["Routing an Inbound Call to the Auto Attendant," on page 66](#)
- ["Routing an Inbound Call to a Receptionist or Client Stations," on page 66](#)
- ["Example Contact List Rules," on page 66](#)
- ["Entering a Contact List Rule," on page 70](#)

Routing an Inbound Call to the Auto Attendant

By default, all inbound calls are routed to the Auto Attendant (**aa**). This automated system answers inbound calls by playing pre-recorded voice message that asks the caller to enter the desired extension. If you want only the Auto Attendant to receive a call, keep the default setting, *aa*, in the *Contact List* field on the *Voice > Line N* page, *Subscriber Information* section, for each line interface. For more information, see [Chapter 7, "Configuring the LVS Auto-Attendant."](#)

Routing an Inbound Call to a Receptionist or Client Stations

You can route an inbound call to a receptionist or to client stations by using a Contact List. You specify the Contact List for each line interface (Line 1, Line 2, Line 3, Line 4). For example, if Line 1 is configured for an ITSP account, and a call is placed to a Direct Inward Dialing (DID) number for that account, then the call is routed to the Contact List that is specified on the Line 1 configuration page. Likewise, if Line 2 is configured for a SPA400 that has PSTN lines attached, and a call is placed to the associated PSTN phone number, then the call is routed as specified in the *Voice > Line* page, *Subscriber Information* section, *Contact List* field.

Example Contact List Rules

The following examples show rules that you can enter to route incoming calls.

**Note**

The SPA9000 alerts all registered clients stations if * is used in the Contact List (*SPA9000 Voice > Line N* page > *Subscriber Information* section).

- Routing calls to a receptionist

EXAMPLE: 100

An incoming call to any DID number on this line interface causes station 100 to ring. The receptionist answers the call. If the call is not answered, it automatically goes to the voice mailbox for station 100, assuming that voice mail is configured.

- Routing calls simultaneously to two or more stations

EXAMPLE: 100, 104

An incoming call to any DID number on this line interface causes station 100 and station 104 to ring. Either station can answer the call.

NOTE: The list of extension numbers may include * to represent multiple wildcard characters or ? to represent a single wildcard character. For example, 10? represents all stations numbered 100 through 109.

- Special routing for different DID numbers

EXAMPLE: 9725550155:100|9725550156:101, 102

An incoming call to 972-555-0155 causes station 100 to ring. An incoming call to 972-555-0156 causes station 101 and station 102 to ring simultaneously.



Note

In this example, the rules are separated by a pipe character (|) to indicate an “or” condition.

- Routing calls to a station and forwarding unanswered calls to voice mail

EXAMPLE 1: 5300, cfwd=vm25300

An incoming call through this line interface causes station 5300 to ring. If there is no answer, the call is forwarded to the voice mail server on line interface 2, mailbox number 5300. The time interval is determined by the value *Cfwd No Ans Delay* field, which is located below the *Contact List* field on the *Voice > Line* page. The default value is 20 seconds.

EXAMPLE 2: 4085550122:5001|4085550123:5000,cfwd=aa

An incoming call to 408-555-0122 causes station 5001 to ring. An incoming call to 408-555-0123 causes station 5000 to ring. If station 5000 does not answer its call, the call is forwarded to the Auto Attendant. The time interval is determined by the value *Cfwd No Ans Delay* field, which is located below the *Contact List* field. The default value is 20 seconds.

- Routing a call by ringing stations randomly

EXAMPLE: 530?,hunt=ra;10;2,cfwd=vm25404

An incoming call through this line interface causes one station in the group 5300 through 5309 to ring. The station is chosen randomly (ra). After 10 seconds, if the call is unanswered, then another station is chosen randomly from the remaining stations. The system cycles through the list two times. If the call is unanswered, it is forwarded to the voice mail server on line interface 2, mailbox 5404.

SYNTAX: hunt=algo;interval;max, cfwd=target

- **algo:** The order to ring the stations

restart (re)—Always start from beginning of the list

next (ne)—Start from the next on the list to the last station that rings

random (ra)—Order is randomized for each call

- **interval:** The number of seconds to ring each station
- **max:** The total time in seconds or the total number of cycles to elapse before the call is rejected or forwarded to the target. If max is less than interval, it is interpreted as the number of cycles. If max is 0, hunting goes on indefinitely until the caller hangs up or some one answers the call.

NOTE: You also can create a hunt group that acts as a separate extension within the system. For more information, see [“Managing Inbound Calls with Hunt Groups,” on page 73.](#)

Supporting Multiple DID Numbers Per Line Interface

An ITSP can provide a block of DID numbers, for example with a main number of 4085553000, and additional DID numbers from 4085553001–4084443009. The ITSP can identify the local client stations to which an external incoming call should be routed. Linksys recommends including this information in the TO header of the incoming INVITE while the request-URI is addressed to the line interface user-id. In the INVITE, the ITSP indicates the DID number in the TO header user-id field.

EXAMPLE SIP Header 1:

```
INVITE sip:4089993000@itsp1.com SIP/2.0
```

```
To: <sip:4089993003@itsp1.com>
```

Alternatively, the DID number can be indicated as a parameter in the TO header with a configurable parameter name, such as **didn**.

EXAMPLE SIP Header 2:

```
INVITE sip:4089993000@itsp1.com SIP/2.0
```

```
To: <sip:4089993000@itsp1.com>;didn=4089993003
```

You can identify the field to use for the DID number and the parameter name on the *Voice > SIP* page, *PBX Parameters* section, *SIP DIDN* and *SIP DIDN Param Name* fields. For the first example above, these two fields are ignored; for the second example, *SIP DIDN* is set to **TO Param** and *SIP DIDN Param Name* is set to **didn**.

The Contact List is used to route the calls to a client station based on DID numbers that are embedded in the INVITE message.

EXAMPLE Contact List Rule:

```
4089993000:aa|4089993001:3001|4089993002:3002|...|4089993009:3009
```

An incoming call to the main number is answered by the Auto-Attendant, while calls to the other nine DID numbers are routed to dedicated private extensions.

Supporting Direct Inward Dialing to Phone Extensions

Direct Inward Dialing allows the external users to dial directly any phone extension in the LVS system, without passing through the Auto Attendant or the receptionist.

Before proceeding with the configuration you need to have the full correspondence between the external (DID) number and the extension number. [Table 4-3](#) provides an example.

Table 4-3 DID-to-Extension Mapping Example

DID number	Extension number	User
408-555-5550	aa	Auto Attendant
408-555-5551	101	User 1
408-555-5552	102	User 2
408-555-5553	103	User 3
408-555-5554	104	User 4
408-555-5650	500	Support (hunt) group

NOTE:

- Direct Inward Dialing requires network support for SIP trunking DID.
- It is important that the DID number format match exactly the format of the number signaled in the SIP trunk.
- Please check with your Service Provider to confirm the availability of this feature and the correct DID number format, before proceeding with this configuration.

SYNTAX:

```
<DIDn1>:+<Extn1>|<DIDn2>:+<Extn2>|<DIDn3>:+<Extn3>|<DIDn4>:+<Extn4>|<DIDn5>:
+<Extn5>|<DIDn6>:+<Extn6>|<DIDn7>:+<Extn7>|<DIDn8>:+<Extn8>|<DIDn9>:+<Extn9>|
<DIDn10>:+<Extn10>|<DIDn11>:+<Extn11>|<DIDn12>:+<Extn12>|<DIDn13>:+<Extn13>|
<DIDn14>:+<Extn14>|<DIDn15>:+<Extn15>|<DIDn16>:+<Extn16>|<default_route>
```

EXAMPLE:

```
4085555550:aa|4085555551:+101|4085555552:+102|4085555553:+103|4085555554:+104|4085555650:+500|
```

- Enter a plus (+) or a minus (-) before the extension number to achieve the desired results for caller ID and call routing:
 - + <Extn1> The extension will be alerted when there is an incoming call to the DID number, and the DID number will be used as the local user-ID in outbound SIP requests, along with the display-name of the extension.

- - <Extn1> The extension will not be alerted when there is an incoming call to the DID number. However, the DID number will be used as the local user-ID in outbound SIP requests, along with the display-name of the extension. DIDn#: DID number, matching the format of the number signaled in the SIP trunk
- Extn#: Target extension number or **a** for Auto Attendant
- Default route: The default route (extension, hunt group or Auto Attendant) to be used in case the incoming target number does not match any of the DID numbers in the contact list with the format described in the sections above.
- Call forwarding: Optionally, add call forward information to the Contact List to specify how unanswered calls are handled.

NOTE: It is useful to add call forward information to ensure that calls are answered when the designated phone is unstaffed, as may be the case during lunch time or after hours. In this case, if the call is not answered within a specified time, the call is routed to another phone or to the Auto Attendant.

SYNTAX:

<DIDn1>:+<Extn1>,cfwd=<target>|<DIDn2>:+<Extn2>,cfwd=<target>|<DIDn3>:+<Extn3>,cfwd=<target>

EXAMPLE:

4085555550:aa|4085555551:+101,cfwd=aa|4085555552:+102|4085555553:+103|4085555554:+104|4085555650:+500|

Entering a Contact List Rule



Note

The maximum length of the <Contact List> parameter is 383 characters.

1. Connect to the SPA9000 administration web server, and choose Admin access with Advanced settings. (See ["Connecting to the SPA9000 Administration Web Server,"](#) on page 24.)
2. Click **Voice tab > Line N**, where *N* represents the line interface number.
3. Scroll down to the *Subscriber Information* section.

SPA9000 Voice > Line: Subscriber Information

Subscriber Information			
Display Name:	14088501231	User ID:	14088501231
Password:		Use Auth ID:	no
Auth ID:		Call Capacity:	
Contact List:	aa		
Cfwd No Ans Delay:	20		

4. Enter the desired rules in the *Contact List* field. For more information, see ["Example Contact List Rules,"](#) on page 66 and ["Entering a Contact List Rule,"](#) on page 70.

5. If you included a call forward rule, modify the *Cfwd No Ans Delay* parameter to specify the number of seconds that elapse before a call is considered to be unanswered.
6. Click **Submit All Changes**. The SPA9000 reboots.
7. To verify your progress, make an inbound call and verify that the call is handled as you intended.

Call Forwarding Support on SPA9000

SPA9000 supports the call forward scenarios listed in the following table.

Called Party	Caller	Forward Target	Remarks
Client station	Client station	Client station	Proxy only; no direct involvement
Client station	Client station	External	Very similar to calling external number
Client station	External	Client station	ACKs the 302 from called party. Then INVITEs the target. NOTE: If the original INVITE is forked to more than one client station, call forward is not performed.
Client station	External	External	ACKs the 302 from called party. Sends 200 to caller, then blind REFERS caller to target. NOTE: If the original INVITE is forked to more than one client station, call forward is not performed
External	Client station	External	ACKs the 302 from called party, then INVITEs the target

SPA9000 supports call forward by client station:

- unconditionally
- when busy
- on no answer



Note

When an incoming call from the ITSP is forked to multiple client stations, the SPA9000 does not honor the 3xx response returned by any of the client stations. If you wish the call to be forwarded to voicemail or another client station when it is not picked up, you can specify the optional `"cfwd=target"` syntax in the Contact List.

Call Transfer Support on SPA9000

- ["Call Forward Bridge Mode," on page 72](#)
- ["Call Transfer Bridge Mode," on page 72](#)

Call Forward Bridge Mode

The normal way of performing the call forwarding operation is for the SPA9000 to send a (blind) SIP REFER to the calling device to let it contact the target number directly. It then drops out of the call completely. This requires the calling device to understand the SIP signaling involved and the operation permitted by the underlying service provider. The SPA400 cannot handle this operation.

With bridging, the SPA9000 maintains two separate call legs throughout the call: one with the caller and one with the call forward target. The two call peers connect only with the SPA9000, while the SPA9000 acts as a proxy for the RTP packets exchanged between the two parties.

On the *Voice > Line N* page, *Proxy and Registration* section, the *CWFD Bridge Mode* field has two possible values:

- none—Do not bridge forwarded calls (use the normal REFER method)
- all—Bridge all forwarded calls

Call Transfer Bridge Mode

The normal way of performing this operation is for the SPA9000 to send a SIP REFER method to the calling device to let it contact the transfer target directly. The SPA9000 then drops out of the call completely. This requires the calling device (the transferee) and the target device to understand the SIP signaling involved and the operation permitted by the underlying service providers. Note that the call legs with transferee and the transfer target might be with different ITSP. The SPA400, for instance, cannot handle this operation.

With bridging, the SPA9000 maintains two separate call legs throughout the call: one with the transferred call and one with the transfer target. The two call peers connect only with the SPA9000, while the SPA9000 acts as a proxy for the RTP packets exchanged between the two parties.

On the *Voice > Line N* page, *Proxy and Registration* section, the *XFER Bridge Mode* field has three possible values:

- none —Do not bridge call transfer (use the normal REFER method)
- all —Bridge all call transfer
- all except same line—Bridge call transfer only if it is between two different line interfaces

Managing Inbound Calls with Hunt Groups

A Hunt Group is a group of client stations that are treated as one extension for the purpose of managing inbound calls. The client stations in the hunt group can be alerted simultaneously or sequentially. The first client station to pick up the call establishes a private connection to the caller.

You can configure two types of Hunt Groups:

- ["Hunt Group that Rings All Stations Simultaneously," on page 73](#)
- ["Hunt Group that Rings Stations Individually," on page 75](#)

**Note**

Compare a Shared Line Appearance to a Hunt Group. A Hunt Group may ring several stations simultaneously, but only one station can answer and manage the call. A Shared Line Appearance also rings multiple lines simultaneously but allows multiple stations to share and manage the call. For more information, see ["Managing Inbound Calls with Shared Line Appearances," on page 77](#).

Hunt Group that Rings All Stations Simultaneously

You can create a hunt group that simultaneously rings all stations in the group. Optionally, you can assign a name to the group or use wildcard characters to create the list of stations in the group.

Syntax for a "Ring All Stations" Hunt Group Rule

The basic syntax for this type of group is shown below. Optionally, you can assign a name to the group.

SYNTAX: ext-in:name=groupname,hunt-list

- **ext-in (required):** The extension number that users dial to contact this group
- **name (optional):** The name of the group, which appears in the Corporate Directory on the phones
- **hunt-list (required):** The station numbers that participate in this group, separated by commas

NOTE: To create multiple groups, separate the hunt group rules by typing the pipe character: |

Examples of "Ring All Stations" Hunt Group Rules

- Contacting a group of stations simultaneously

EXAMPLE: 500:101,102,103

This hunt group is assigned a number (500:). The group includes three stations (101,102,103). A call to extension 500 rings all three stations simultaneously.

- Creating a named hunt group

EXAMPLE: 500:name=TechSupport,101,102,103

This hunt group is assigned a number (500:) and a name (name=TechSupport). The group includes three stations (101,102,103). A call to extension 500 rings all three stations simultaneously.

- Wildcards in Hunt List

EXAMPLE 1: 500:10?

In this example, the ? symbol is a wildcard character that represent any single digit. A call to extension 500 simultaneously rings all stations 100 through 109.

EXAMPLE 2: 500:1*

In this example, the * symbol is a wildcard character that represents any number of digits. A call to extension 500 simultaneously rings all stations that begins with the number 1.

EXAMPLE: 500:name=TechSupport,1*

In this example, the group has a name, Tech Support. The * symbol is a wildcard character that represents any number of digits. A call to extension 500 simultaneously rings all stations that begins with the number 1.

- Creating multiple hunt groups

EXAMPLE: 500:name=TechSupport,101,102,103|600:name=AccountSupport,2*|

Two hunt groups are created and are assigned names. A call to extension 500 simultaneously rings stations 101, 102, and 103. A call to extension 600 simultaneously rings all stations that begin with the number 2.

Creating a Hunt Group to Ring All Stations

1. Connect to the SPA9000 administration web server, and choose Admin access with Advanced settings. (See ["Connecting to the SPA9000 Administration Web Server,"](#) on page 24.)
2. Click **Voice tab > SIP**.
3. Scroll down to the *PBX Parameters* section.
4. In the *Hunt Groups* field, type your hunt group rule. See ["Syntax for a "Ring All Stations" Hunt Group Rule" on page_61](#) and ["Examples of "Ring All Stations" Hunt Group Rules" on page_61](#).
5. Click **Submit All Changes**. The phones reboot.
6. To verify the settings, place a call to the new group line. Verify that all of the listed extensions ring simultaneously.

Hunt Group that Rings Stations Individually

You can create a hunt group that rings the stations individually, in sequential order or random order. You need to set the ring interval and the maximum number of cycles or seconds to occur before a call is transferred to voice mail.

Syntax for a “Ring Individual Stations” Hunt Group Rule

The syntax for a “ring individual stations” hunt group rule is shown below. Optionally, you can assign a name to the group.

SYNTAX: ext-in:name=groupname,hunt-list,type=algo;ring-interval;max,cfwd=ext-fwd

- **ext-in** (required): The extension number that users dial to contact this group
- **name** (optional): The name of the group, which appears in the Corporate Directory on the phones
- **hunt-list** (required): The station numbers that participate in this group, separated by commas
- **type** (required to ring individual stations): The type of routing among the stations in the group
 - **re** (sequentially from the beginning): Every incoming call is routed to the first station in the list. If the call is unanswered, it cycles through the stations in the listed order. The syntax is `hunt=re`.
 - **ne** (sequentially from the next station): An incoming call is routed by determining which station most recently answered a call for this group. The new call is routed to the station that is next in the list. If the call is unanswered, it cycles through the stations in the listed order. The syntax is `hunt=ne`.
 - **ra** (random): An incoming call is routed randomly to any listed station. If the call is unanswered, it cycles through the stations in random order. The syntax is `hunt=ra`.
- **ring-interval** (required to ring individual stations): The number of seconds that elapse before an unanswered call is routed to another station in the group
- **max** (required to ring individual stations): Either the maximum number of cycles or the total number of seconds that elapse before an unanswered call is forwarded to the `cfwd` destination. If the `max` value is less than the ring interval, it is interpreted as the number of cycles. If the `max` value is greater than the ring interval, it is interpreted as the total number of seconds.
- **cfwd** (required to ring individual stations): The Call Forward destination for an unanswered call. The destination can be another station, a voice mailbox, or the Auto Attendant.

NOTE: Wildcard characters can be used in the hunt list. Multiple groups can be entered, using the pipe character as a separator.

Examples of “Ring Individual Stations” Hunt Group Rules

- “From the Beginning” Order with Forwarding to the Auto Attendant

```
300:name=TechSupport,101,102,100,hunt=re;20;2,cfwd=aa
```

This hunt group is assigned an extension number (300:) and a name (name=TechSupport,). The group includes three stations (101,102,100,). Calls are routed sequentially from the beginning of the list (hunt=re;). Every new call is routed to station 101. If the call is unanswered, it cycles to station 102 and then to station 100. Each phone rings for 20 seconds (20;). After 2 cycles elapse, an unanswered call is forwarded to the Auto Attendant (, cfwd=aa).

- Random Order with Forwarding to a Voice Mailbox

```
400:name=Sales,101,102,103,hunt=ra;30;1,cfwd=vm2100
```

This hunt group is assigned an extension number (400:) and a name (name=Sales,). The group includes three stations (101,102,103,). Calls are routed in random order (hunt=ra;). A new call is routed to a randomly chosen station. If the call is unanswered, it cycles through the stations in random order. Each phone rings for 30 seconds (30;). After 1 cycle is completed, an unanswered call is forwarded to the voice mail for station 100, where Line 2 is configured for the voice mail service (1,cfwd=vm2100).

- “Next Station” Order with Forwarding to a Station

```
500:name=Scheduling,102,103,101,hunt=ne;45;240,cfwd=100
```

This hunt group is assigned an extension number (500:) and a name (name=Scheduling,). The group includes three stations (102,103,101,). Calls are routed in “next station” order (hunt=ne;). Suppose that station 103 answered the most recent call. A new call is routed to the next station in the list, which is station 101. If the call is unanswered, then it cycles to station 102, and so on. Each phone rings for 45 seconds (45;). After a total of 240 seconds has elapsed, the call is forwarded to station 100 (240,cfwd=100).

- Multiple Lines with Wildcard Characters

```
400:name=CustomerService,10?,hunt=re;20;2,cfwd=aa|500:name=Sales,20?,hunt=ra;30;1,cfwd=vm100|600:name=TechSupport,300,301,302,hunt=ne;45;3,cfwd=100|
```

Three hunt groups are created. A call to extension 400 rings stations 100 to 109 in “from the beginning order.” A call to extension 500 rings stations 200 to 209 in random order. A call to extension 600 rings the listed stations in “next station” order.

Creating a Hunt Group to Ring Individual Stations

1. Connect to the SPA9000 administration web server, and choose Admin access with Advanced settings. (See [“Connecting to the SPA9000 Administration Web Server,” on page 24.](#))
2. Click **Voice tab > SIP**.
3. Scroll down to the *PBX Parameters* section.

4. In the *Hunt Groups* field, enter the hunt group rule. See [“Syntax for a “Ring Individual Stations” Hunt Group Rule” on page_62](#) and [“Examples of “Ring Individual Stations” Hunt Group Rules” on page_63](#).
5. Click **Submit All Changes**. The SPA9000 and the phones reboot.
6. To verify the settings, place a call to the extension that you created. Verify that member stations ring in the desired order, with the desired ring interval, maximum cycles, and call forwarding.

Managing Inbound Calls with Shared Line Appearances

A shared line appearance (SLA) allows multiple stations to share an extension number and to manage a call as a group.

About Shared Line Appearances

An incoming call to an SLA causes all stations to ring simultaneously. The phones display the line status, such as idle, ringing, or busy.

NOTE:

- If a shared line is being used by one of the stations in the group, no one can use the corresponding line key until the line is released. A message appears on the phone display to indicate that a shared call is active.
- All stations with a line key for the SLA can monitor the status based on the appearance of the line key button:
 - Green: The SLA is available.
 - Flashing Red Quickly: A call is ringing the SLA and has not been answered.
 - Flashing Red Intermittently: A call is active at another station.
 - Flashing Red Slowly: A call is on hold.
 - Solid Red: A call is active on this station.
- All stations with a display can monitor the status of any SLA that is configured. The icon next to the line key will change to show ringing, off-hook, or busy "<-->" until the phone is back on-hook.
- Comparing the SLA to a Hunt Group, both may ring several stations simultaneously. However, only one station in a Hunt Group can answer and manage the call. For more information, see [“Managing Inbound Calls with Hunt Groups,” on page 73](#).

1. Connect to the SPA9000 administration web server, and choose Admin access with Advanced settings. (See ["Connecting to the SPA9000 Administration Web Server,"](#) on page 24.)
2. Choose the client station that you want to configure:
 - a. Click the **PBX Status** link near the top right corner or lower left corner of the page to view the list of client stations.
 - b. Click the hyperlink in the *IP Address* column for the first phone that you want to configure. The telephone configuration page appears in a separate browser window.
3. Configure the shared extension on the selected station:
 - a. Click the tab for the extension that you want to configure (*Ext 1 ... Ext n*, depending on the phone model).

NOTE: As a general practice, Linksys recommends that you always reserve Extension 1 on the client station as the primary and private extension of the designated user.
 - b. Scroll down to the *Share Line Appearance* section, and then enter the following settings:
 - **Share Ext:** Choose **shared**.
 - **Shared User ID:** Enter a user ID number for this SLA. After the line key is configured, this ID will appear on the phone display and in the Corporate Directory.

SPA9xx Telephone Configuration > Ext: Shared Line Appearance

Share Line Appearance	
Share Ext:	shared
Shared User ID:	200
Subscription Expires:	3600

- c. Scroll down to the *Subscriber Information* section, and then enter a User ID and Display Name for this shared extension.

SPA9xx Telephone Configuration > Ext: Subscriber Information

Subscriber Information	
Display Name:	
User ID:	100
Password:	
Use Auth ID:	no
Auth ID:	
Mini Certificate:	
S RTP Private Key:	

- d. Scroll down the *Proxy and Registration* section, and enter the same *Proxy* value as on the primary extension for this station.

SPA9xx Telephone Configuration > Ext: Proxy and Registration

Proxy and Registration	
Proxy:	192.168.0.109:6060
Use Outbound Proxy:	no
Outbound Proxy:	
Use OB Proxy In Dialog:	yes
Register:	yes
Make Call Without Reg:	no
Register Expires:	3600
Ans Call Without Reg:	no
Use DNS SRV:	no
DNS SRV Auto Prefix:	no
Proxy Fallback Intvl:	3600
Proxy Redundancy Method:	Normal

4. Configure a line key button for the shared extension:
 - a. Click the **Phone** tab.
 - b. Scroll down to the *Line Key* area for the line key button that you want to configure (*Line 1 ... Line n*, depending on the phone model).
 - c. Enter the following settings to correspond with the entries that you made on the Extension tab:
 - **Extension:** From the drop-down list, choose the number corresponding to the *Ext N* tab that you configured for this SLA. For example, if you configured the SLA on the *Ext 2* page, then choose 2 from the *Extension* drop-down list.
 - **Shared Call Appearance:** From the drop-down list, choose shared.
 - **Short Name:** Type the extension number that you entered as the *Shared User ID* for the extension. This extension number will appear on the phone display and in the Corporate Directory.

SPA9xx Telephone Configuration: Ext: Line Key

Line Key 2			
Extension:	<input type="text" value="2"/>	Short Name:	<input type="text" value="200"/>
Share Call Appearance:	<input type="text" value="shared"/>		

NOTE: You can configure additional line keys for the same SLA.

5. Click **Submit All Changes**.
6. Repeat this procedure for each phone that you want to configure with the SLA.

Administering the SPA400 and Voice Mail Service

This chapter guides you through the process of configuring and managing the SPA400 for PSTN access and voice mail service.

The SPA400 provides a SIP-PSTN gateway for voice connectivity between the PSTN and the local client stations that are connected to the SPA9000. It also includes an integrated voice mail application that supports up to 32 voice mail accounts with customized greetings, providing LVS users the ability to receive and playback voice mail messages.

- ["Connecting to the SPA400 Administration Web Server," on page 80](#)
- ["Configuring the SPA400 Network Connection," on page 81](#)
- ["Managing Access to the SPA400 Web-Based Configuration Utility," on page 83](#)
- ["Upgrading the Firmware for the SPA400," on page 84](#)
- ["Configuring a SPA400 to Interoperate with the SPA9000," on page 85](#)
- ["Configuring a SPA400 for Voice Mail Service," on page 87](#)
- ["Managing the Voice Mail Messages on the USB Key," on page 94](#)
- ["Enabling Debugging on the SPA400," on page 95](#)

SEE ALSO: [Appendix C, "SPA400 Field Reference"](#)

Connecting to the SPA400 Administration Web Server

You can manage a SPA400 by using the web-based configuration utility.

**Note**

If you have not already done so, connect the SPA400 to the same switch as the SPA9000 and the SPA900 series IP phones. For more information, see the *SPA400 Quick Install Guide*.

1. Start Internet Explorer, and enter the IP address of the SPA400 that you want to configure.

NOTE: Use Internet Explorer. By default, the SPA400 is configured to obtain an IP Address via DHCP. You can check the obtained IP address on the router DHCP server's client list.

2. When the password prompt appears, enter the default user name, **Admin**, with no password. Then click **OK**.

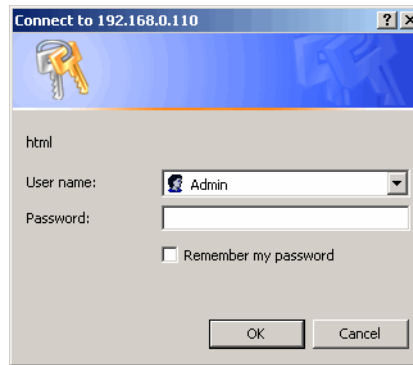

NOTE: The user name must be entered exactly as shown: **Admin**. By default, no password is required, but a password can be set on the *Administration > Management* page. See ["Managing Access to the SPA400 Web-Based Configuration Utility,"](#) on page 83.

Configuring the SPA400 Network Connection

The SPA400 becomes a DHCP client of any server on the network. The recommended setting is to use a static IP address. This configuration provides ease of installation and prevents connectivity issues that would occur if the IP address of the SPA400 changed.

1. Start Internet Explorer, and enter the IP address of the SPA400.

NOTE: By default, the SPA400 is configured to obtain an IP Address via DHCP. You can check the obtained IP address on the router DHCP server's client list.

2. When the password prompt appears, enter the default user name, **Admin**, with no password. Then click **OK**.

NOTE: The user name must be entered exactly as shown: **Admin**. For information about managing system access, refer to the *LVS Administration Guide*.

3. Click **Setup tab > Basic Setup**.

4. Enter the following settings:

Network Setup section:

- **Fixed IP address:** Click the radio button, and then enter a valid IP address.

NOTE: To avoid addressing conflicts, enter an IP address that is outside the range of addresses that are automatically assigned by your DHCP server.

- **IP Subnet Mask:** Enter the subnet mask for the subnetwork that the SPA400 is on.
- **Gateway IP Address:** Enter the IP address of the router for this subnetwork.

Domain Name Server (DNS) Address section:

- **Primary DNS:** Enter the IP address of the primary DNS server.

- **Secondary DNS:** Enter the IP address of the secondary DNS server.

NTP section:

- **NTP:** Enter a fully qualified name of a Network Time Protocol server, such as time.nist.gov.
 - **Time Zone:** Select the time zone for your region.
5. Click Save Settings. The SPA400 will reboot. To reconnect to the web administration server, enter the new IP address for the SPA400 in the browser Address bar.

Saving or Discarding Changes on the SPA400

Changes can be saved or discarded at any time.

- Changes are submitted only when you click the **Save Settings** button at the bottom of a page.
- To discard unsubmitted changes, click the **Cancel Changes** button at the bottom of the page.
- Unsubmitted changes are not retained when you move among the pages.
- After you submit changes in the SIP or Voice mail accounts settings, reboot the SPA400.



TIP: Before you make changes, save a copy of your current working configuration:

1. In Internet Explorer, connect to the administration web server.
2. Navigate to the page that has the settings that you want to save.
3. From the menu, choose **File > Save As**.
4. Save the configuration as Web Page Complete. The currently displayed page is saved. You can use the saved file to review the settings as needed.
5. Repeat these steps for each page, as needed.

Managing Access to the SPA400 Web-Based Configuration Utility

One log on can be established for access to the SPA400 web-based configuration utility. The default username of Admin can be changed, and a password can be entered.

1. Connect to the SPA400 administration web server. (See ["Connecting to the SPA400 Administration Web Server,"](#) on page 80.)
2. Click **Administration tab > Management**.

SPA400 Administration > Management

The screenshot shows the SPA400 Administration web interface. At the top, there is a navigation bar with tabs for Administration, Setup, Administration, Status, and Event Logs. Below this, there is a sub-menu with options: Management (highlighted with a red circle), Factory Default, USB Setting, Firmware Upgrade, and Reboot. The main content area is titled "Gateway Access" and "Local Access". It contains three input fields: "Gateway Username:" with the value "Admin", "Gateway Password:", and "Re-enter to Confirm:". At the bottom right, there are two buttons: "Save Settings" and "Cancel Changes".

3. Proceed as needed:
 - **Gateway Username:** Type the desired username in this field, up to 32 characters.
 - **Gateway Password:** Type the password.
 - **Retype to Confirm:** Type the password again. Both entries must match exactly.
4. Click **Save Settings**.
5. To restart the SPA400, complete the following steps:
 - a. Click **Administration tab > Reboot**.
 - b. Click the **Restart System** button.
 - c. When the confirmation message appears, click **OK**. The SPA400 reboots.
 - d. When the *Reboot OK. Go to Setup page?* message appears, click **OK** and wait for 60 seconds (the time required for the SPA9000 to re-register with SPA400).

Upgrading the Firmware for the SPA400

As needed, you can download new firmware from Linksys.com and then install the firmware on the SPA400.

1. Connect to the SPA400 administration web server. (See "[Connecting to the SPA400 Administration Web Server](#)," on page 80.)
2. Click **Administration tab > Firmware Upgrade**.
3. Click **Browse**.

SPA400 Administration > Firmware Upgrade

The upgrade firmware file needs to be downloaded and stored on your PC

File Path:

4. Find the binary (.bin file) that you extracted to your Desktop, and click **Open**. The selected file appears in the *File Path* field on the *Firmware Upgrade* page.

The upgrade firmware file needs to be downloaded and stored on your PC

File Path: C:\Documents and Settings\lbeason\Desktop\spa400-01-0

5. Click **Upgrade**.
6. When the confirmation message appears, click **OK**.



7. When the *Setup* page reappears, verify that the *Firmware Version* number matches the firmware version that you installed. You have successfully upgraded the firmware.

SPA400 Main Page: Firmware Version



NOTE: You may need to refresh your browser to display the updated banner reflecting the new version number.

Configuring a SPA400 to Interoperate with the SPA9000

A SPA400 must be configured to register the SPA9000. To enable the interoperation of the two devices, you need to enter corresponding information on the *SPA9000 Voice > Line* page and on the *SPA400 Setup > SPA9000 Interface* page. For voice mail service, additional entries are needed on the *SPA400 Setup > Voicemail Server* page.

NOTES:

- Complete this procedure for each SPA400, whether it is used as a PSTN gateway or as a voice mail server.
 - You also must configure a SPA9000 line interface for this device. See ["Configuring a Line Interface for a SPA400 \(PSTN or Voice Mail\)," on page 48.](#)
 - If you install multiple SPA400 units, keep track of the MAC addresses to ensure that you know which device you are configuring. In the administration web server, you can see the MAC address by clicking the Status tab.
1. Connect to the SPA400 administration web server. (See ["Connecting to the SPA400 Administration Web Server," on page 80.](#))
 2. When the password prompt appears, enter the user name and password. Then click **OK**.
NOTE: For more information about the administrator account, see ["Managing Access to the SPA400 Web-Based Configuration Utility," on page 83.](#)
 3. Click **Setup tab > SPA9000 Interface**.
 4. Enter the following settings:
 - **User ID: 9000**
This is the user ID that the SPA9000 will use to register with the SPA400. Any ID can be used, but must match exactly the User ID that you entered on the corresponding *SPA9000 Voice > Line* page.
 - **SPA9000 Address:** Select the **Discover Automatically** radio button (required for SPA9000 operation).
This setting enables the SPA400 to learn the IP address and the UDP port of the SPA9000 from the SIP Registration packets sent by SPA9000.
 - **Call Signalling Packets:** 68
 - **RTP Packets:** b8

NOTES:

- Leave the *Signalling Port* at the default value of **5060**. This port is the source port that is used to originate signaling between the SPA400 and the SPA9000.

- Leave the *RTP Port* at the default value of 10000. This port is the base UDP port for the block of UDP ports that the SPA400 uses to send and receive RTP and RTCP packets.
 - Leave the *Session Timer* fields at the default values: Enabled with 0 seconds in both Refresh Time fields.
5. Click **Save Settings** at the bottom of the page.
 6. Click **Setup tab > Voice**.
 7. Enter the following settings:
 - **Preferred Codec:** Select **G.711u**.
 - **Packetization:** Choose **30ms** from the *Packetization* drop-down list for G.711U.
 - **VAD:** Choose **OFF** from the *VAD* drop-down list for G.711U.

SPA400 Setup > Voice

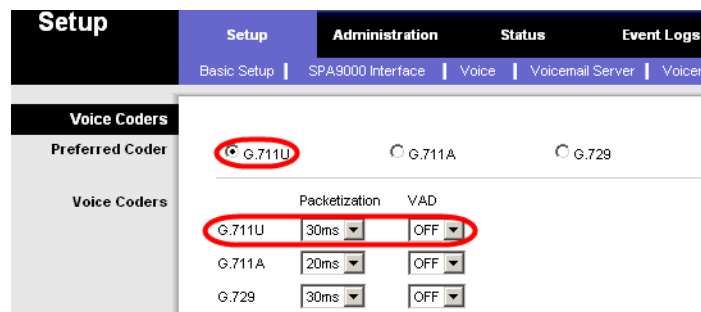

8. Click **Save Settings** at the bottom of the page.
9. To restart the SPA400, complete the following steps:
 - a. Click **Administration tab > Reboot**.
 - b. Click the **Restart System** button.
 - c. When the confirmation message appears, click **OK**. The SPA400 reboots.
 - d. When the *Reboot OK. Go to Setup page?* message appears, click **OK**.
10. If you are using this SPA400 as a PSTN gateway, connect the RJ11 cables from the SPA400 to the wall outlet for PSTN access.
11. To verify your progress, perform the following tasks:
 - Click the **Status** tab, and confirm that the SIP registration status is Registered.
 - If you connected PSTN lines to the ports on the SPA400, confirm that you can place an external call to the phone number that is associated with the PSTN line. The call is directed according to the Contact List. Also, in the SPA400 web configuration page, click the **Status** tab, and then verify that a voltage value appears in the *Battery Level* section.

SPA400 Administration > Status: Battery Level

Battery Level	Line 1:	-49 V
	Line 2:	0 V
	Line 3:	0 V
	Line 4:	0 V

NOTE: If the battery level is 0 V on a line that you have connected to the PSTN, troubleshoot the phone wiring.

- Connect to the SPA9000 administration web server, and choose Admin access with Advanced settings. Click **Voice tab > Info**. Scroll down to the *Line 2 Status* section, and verify that the *Registration Status* is *Registered*.

12. Click **Save Settings**.



Note

If you are using this SPA400 for voice mail service, continue to ["Configuring a SPA400 for Voice Mail Service,"](#) on page 87.

Configuring a SPA400 for PSTN Access

Typically, there is no need to change the default settings on the *Voice* page. Make changes only if a problem is suspected and only after consulting with a service technician from your telephone service provider. It is essential that the settings on your system are compatible with those of the Central Office.

Configuring a SPA400 for Voice Mail Service

The SPA400 includes a USB adapter with an integrated voice mail application for the users and extensions that are configured on the SPA9000. The integrated voice mail application server supports 32 configurable voice mail accounts. Although a SPA9000 can be configured with up to four SPA400 devices, only one SPA400 can be configured with the voice mail server.



Note

Important: For optimum voice mail performance, a SPA400 should be dedicated to the voice mail application when either of the following conditions is met:

1) More than 2 FXO connections are required

—OR—

2) More than 2 users commonly access voice mail at the same time.



Note

Before you begin any of the procedures in this section, configure a SPA9000 line interface for this device. See ["Configuring a Line Interface for a SPA400 \(PSTN or Voice Mail\),"](#) on page 48.

This section includes the following topics:

- ["Voice Mail Capacity,"](#) on page 88

- ["Configuring Local Voice Mail Service on a SPA400,"](#) on page 88
- ["Setting Up Voice Mail on Each Station,"](#) on page 90
- ["Enabling Remote Voice Mail Access \(Optional\),"](#) on page 93

Voice Mail Capacity

The provided 128-Mb USB drive can store more than 3.8 hours of messages (approximately 230 60-second messages). For example, with 10 voice mail users, each user can store up to 23 60-second messages. When disk capacity is reached, inbound voice mail deposit attempts are disconnected. If additional voice mail storage is required, please contact Linksys for recommended high-capacity USB drives.

Configuring Local Voice Mail Service on a SPA400

You need to configure the voice mail server and set up the voice mail boxes for the users.

NOTE: The settings on this page correspond to the settings on the *SPA9000 Voice > Line* page. See ["Configuring a Line Interface for a SPA400 \(PSTN or Voice Mail\),"](#) on page 48.

1. Connect to the SPA400 administration web server. (See ["Connecting to the SPA400 Administration Web Server,"](#) on page 80.)
2. Click **Setup tab > Voicemail Server**.
3. Enter the following information:
 - **Server Port: 5090**
The voice mail server uses this UDP port to listen for signalling between the SPA400 and the SPA9000. This port must be different from the port number that you entered on the SPA9000 Interface page.
 - **SPA9000 subscriber ID: 8888**
The SPA9000 uses the subscriber ID to subscribe to the SPA400 Voice mail Server for obtaining notification.
 - **Mailbox deposit number: 900**
The SPA9000 uses the deposit number to deposit voice mail on the voice mail server.
 - **Mailbox manage number: 800**
The SPA9000 uses the deposit number to access voice mail on the voice mail server.

SPA400 Setup > Voicemail Server: Voicemail Setting

Voicemail Setting	
Server Port:	5090
SPA9000 subscriber ID:	8888
Mailbox deposit number:	900
Mailbox manage number:	800
AA Language:	English
Maximum length of a voicemail message:	60 seconds

NOTE: These settings correspond to the settings on the SPA9000 Voice > Line page.

SPA400 > Setup > Voicemail Server	SPA9000 > Voice > Line N
Server Port: 5090	Proxy and Registration
SPA9000 subscriber ID: 8888	Proxy: 192.168.0.110
Mailbox deposit number: 900	Outbound Proxy:
Mailbox manage number: 800	Use Outbound Proxy: no
AA Language: English	Register: yes
Maximum length of a voicemail message: 60 seconds	Register Expires: 30
	Use DNS SRV: no
	Proxy Fallback Intvl: 3600
	Mailbox Status: 103:0/0,102:3/0,100:0
	Mailbox Deposit URL: 900@192.168.0.110:50
	Mailbox Manage URL: 800@192.168.0.110:50
	Mailbox Subscribe URL: 8888@192.168.0.110:50
	Mailbox Subscribe Expires: 30
	CFWD Bridge Mode: all
	XFER Bridge Mode: all

4. Click **Save Settings**.
5. Configure the voice mail users (required):
 - a. Click the **Voicemail Users** tab.
 - b. Enable the voice mail accounts and enter the user's extensions and passwords:
 - **Enable:** Select the check box to enable the voice mail account.
 - **User ID:** Enter the user's extension number.
 - **Password:** Enter a password for this user. Users can change their own passwords after logging on with the assigned password.

SPA400 Setup > Voicemail Users

<input checked="" type="checkbox"/> Enable User 1	User ID: 100	Password: ●●●
<input checked="" type="checkbox"/> Enable User 2	User ID: 101	Password: ●●●
<input checked="" type="checkbox"/> Enable User 3	User ID: 102	Password: ●●●

NOTE: Later you configure each client station for voice mail access to the mail boxes that you create on this page.

6. Click **Save Settings** at the bottom of the page.

7. Restart the SPA400 by completing the following steps:
 - a. Click **Administration tab > Reboot**.
 - b. Click the **Restart System** button.
 - c. When the confirmation message appears, click **OK**. The SPA400 reboots.
 - d. When the *Reboot OK. Go to Setup page?* message appears, click **OK**.
8. To verify your progress, click the **Status** tab, and verify the following settings:
 - **USB status:** Mount
 - **Voice mail status:** OK
 - **SPA9000 Registration status:** Registered

SPA400 Status

Gateway Information	
Firmware Version:	1.0.0.9
MAC Address:	00:18:39:23:C5:9C
Current Time:	Wed Jan 2 10:59:38 2008
Internet Connection	
IP Address:	192.168.0.110
IP Subnet Mask:	255.255.255.0
Gateway IP Address:	192.168.0.1
Primacy DNS:	192.168.0.1
Secondary DNS:	
SPA400 Status	
USB status:	Mount
Voice mail status:	OK
USB capacity status:	used 1952 kb, remaining 123720 kb
SIP registration status:	Registered

NOTE: If the SPA registration status is not Registered, trying powering off the SPA9000 and powering it on again.

9. Continue to the next procedure, "[Setting Up Voice Mail on Each Station](#)," on page 90.

Setting Up Voice Mail on Each Station

You need to set up each station that needs to have a voice mailbox. Perform this procedure after you have configured both the SPA400 and the SPA9000.

1. Connect to the SPA9000 administration web server. (See "[Connecting to the SPA9000 Administration Web Server](#)," on page 24.)
2. Click the **PBX Status** link near the top right corner or lower left corner of the page. The screen lists each phone by Station Name and Extension number.

SPA9000 PBX Status

Registration	Station	User ID	IP Address	Reg Expires(s)	User-Agent
<input type="checkbox"/>	000e08df14c5	100	192.168.1.137	76	Linksys/SPA942-5.2.8
<input type="checkbox"/>	000e08df14cd	101	192.168.1.134	76	Linksys/SPA942-5.2.8
<input type="checkbox"/>	000e08dc3ff5	102	192.168.1.105	57	Linksys/SPA942-5.2.8
<input type="checkbox"/>	000e08dc3e8f	103	192.168.1.107	78	Linksys/SPA942-5.2.8
<input type="checkbox"/>	000e08df4e9a	104	192.168.1.101	89	Linksys/SPA942-5.2.8

3. Find the phone that you want to configure, and then click the hyperlink in the *IP Address* column. The *Telephone Configuration* page appears in a separate browser window.

SPA9xx Telephone Configuration > Info

LINKSYS
A Division of Cisco Systems, Inc.

Linksys Telephone Configuration

Info System SIP Provisioning Regional Phone Ext 1 Ext 2 Ext 3 Ext 4 User

User Login basic advanced
Personal Directory Call History

System Information

DHCP:	DHCP	Current IP:	192.168.0.137
Host Name:	SipuraSPA	Domain:	
Current Netmask:	255.255.255.0	Current Gateway:	192.168.0.1
Primary DNS:	192.168.0.1		
Secondary DNS:			

Product Information

Product Name:	SPA-942	Serial Number:	4LO00G807383
---------------	---------	----------------	--------------

4. To assign a station name, complete the following steps:
 - a. Click the **Phone** tab.
 - b. In the *General* section, type a name in the *Station Name* field.

SPA9xx Telephone Configuration > Phone: General

General

Station Name: Accounting Voice Mail Number: vmm

Text Logo:

BMP Picture Download URL:

Select Logo: Default Select Background Picture: None

Screen Saver Enable: no Screen Saver Wait: 300

Screen Saver Icon: Background Picture

NOTE: This setting assists you in managing the phones. The station name appears on the phone display, in the Corporate Directory, and in features such as Group Call Pickup, that list the participating phones in a menu.

5. To assign a voice mail box to the primary extension, complete the following steps:

- a. Click the **Ext 1** tab.
- b. Scroll down to *Call Feature Settings*.
- c. Enter the *Mailbox ID* in the following format:

<lineN><mailbox>

Example: 2105

- lineN: The SPA9000 line (1, 2, 3, or 4) that is configured with the voice mail settings
In the example, 2 is the number of the SPA9000 line interface that is configured for the SPA400 voice mail server.
- mailbox: The voice mailbox number for this station, as configured on the SPA400 *Voice Mail Users* page.
In the example, voice mailbox 105 is assigned to the station.

NOTE: The mailbox value corresponds to a User ID on the SPA400 voice mail server.

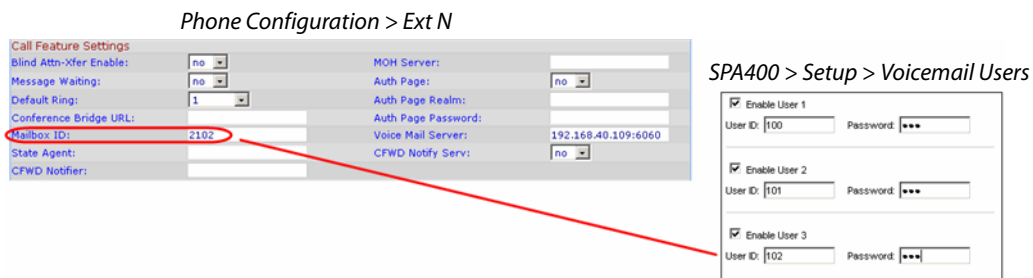

6. Click **Submit All Changes**. The phone reboots.
7. Close the browser window for this station.
8. Return to the browser window that shows the list of stations, and then repeat this procedure for each station that you need to configure.

NOTE: When you finish configuring stations, you can click the **Back** button on the browser toolbar to return to the main web configuration page.

9. To verify your progress, perform the following tasks:

- **Station Name:** Verify that the station name appears on the phone display and in the list of stations on the PBX Status page.
- **Mailbox Status:** Connect to the SPA9000 administration web server, and choose Admin access with Advanced settings. Click **Voice tab > Line 2**. In the *Proxy and Registration* section, check the *Mailbox Status* field. You should see a listing for each extension that you configured with voice mail. Refer to the following example.

SPA9000 Voice > Line: Proxy and Registration

Proxy and Registration			
Proxy:	192.168.0.110		
Outbound Proxy:			
Use Outbound Proxy:	no	Use OB Proxy In Dialog:	yes
Register:	yes	Make Call Without Reg:	no
Register Expires:	30	Ans Call Without Reg:	no
Use DNS SRV:	no	DNS SRV Auto Prefix:	no
Proxy Fallback Intvl:	3600	Proxy Redundancy Method:	Normal
Mailbox Status:	103:0/0,102:0/0,SPA9	Mailbox Subscribe URL:	8888@192.168.0.110:5
Mailbox Deposit URL:	900@192.168.0.110:50	Mailbox Subscribe Expires:	30
Mailbox Manage URL:	800@192.168.0.110:50	VMSP Bridge:	None

- **Voice Mail:** Press the **Message** button. You hear one of the following responses:
 - “Password”: If you are prompted for a password, the station is configured properly. You can enter the password and manage the mailbox.
 - “Mailbox number”: If you are prompted for the mailbox number, a mailbox is not assigned to this station. Review the settings on the SPA400 Voice mail User page (see [“Configuring the Voice Mail Server and Voice Mail Users on the SPA400” on page_53](#)) and the Phone configuration page (see [“Setting Up Each Station” on page_55](#)).
 - Busy Tone: A busy tone indicates a problem with the configuration. Verify that the USB drive is properly inserted into the SPA400, and review the various entries that you made in the configuration.

Enabling Remote Voice Mail Access (Optional)

You can configure the SPA9000 to allow the users to check their voice mail when they are out of the office.



Note

If your users will call into your voice mail system through an ITSP line, your ITSP must support out-of-band DTMF (IE RFC2833).

1. Connect to the SPA9000 administration web server. (See [“Connecting to the SPA9000 Administration Web Server,” on page 24.](#))
2. Click **Voice tab > SIP**.
3. Scroll down to the *Auto Attendant Parameters* section.
4. Edit the *AA Dial Plan 1* string to include a code for the voice mail server, as described below.
 - **SYNTAX:** (10x|xxx.|<dialcode:vmmN>)
 - **EXAMPLE:** (10x|xxx.|<8:vmm2>)
 - dialcode: The digit that users dial, when prompted by the Auto Attendant, to access voice mail remotely.

NOTE: The Contact List for this line must be configured for the Auto Attendant to answer.

- MailboxManageNumber: The Mailbox Manage Number that was entered on the SPA400 Voice mail Settings page. If you followed the instructions in the procedure ["Configuring the SPA400" on page_48](#), you set 800 as the Mailbox Manage Number.
 - vmmN: Replace N with the number of the SPA9000 line interface (Line 1 ... Line 4) that is configured for the SPA400 voice mail server.
5. Copy and paste the same string into the **AA Dial Plan 2** field, for the purpose of allowing remote access of voice mail at all times of day. For more information about AA Dial Plans, refer to ["Configuring Dial Plans for the Auto Attendant," on page 117](#).
 6. Click **Voice tab > Line N**, where N is the number of the line interface for this SPA400 unit.
 7. Make sure that the *VMSP Bridge*, *XFER Bridge Mode*, and *CFWD Bridge Mode* fields are set to **all**.
 8. Click **Submit All Changes**. The SPA9000 and the phones reboot.
 9. To verify your progress, perform the following tasks:
 - a. Dial into the site from an external number.
 - b. When the Auto Attendant prompts you for an extension, press 8.
 - c. When the Voice Mail Server prompts for a mailbox number, enter the mailbox number.
 - d. When prompted for a password, enter the password.

Managing the Voice Mail Messages on the USB Key

To delete unneeded voice mail messages on the USB key, refer to the procedure below.

1. Connect to the SPA400 administration web server. (See ["Connecting to the SPA400 Administration Web Server," on page 80](#).)
2. Click **Administration tab > USB Setting**.

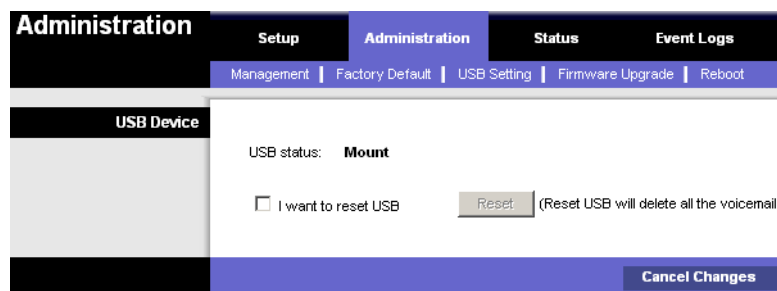

3. Check the *I want to reset USB* check box.
4. Click **Reset**.

**Note**

All the voicemail of all users will be deleted. The deleted voicemail messages are not recoverable.

- When the confirmation message appears, click **OK** to continue or click **Cancel** to end the operation without deleting the messages.

Enabling Debugging on the SPA400

If you are investigating issues, you can collect system logs and debug information for the SPA400.

Requirements:

- You need a PC that is on the same subnetwork as the SPA9000, to capture the log files. This PC needs to be running a syslog daemon. Enter the IP address of this PC on the *Voice > System* page, in the *Syslog Server* and *Debug Server* fields.
- If you are interested in working with these logs yourself, you will need to use an application that reads syslogs. Linksys partners can download a syslog server tool (slogsrv.exe) from the Linksys Partner Connection. (VARs, see Product Utilities > Linksys Voice System > SPA Utilities > Syslog Server for SPA Devices. SPs, see Technical Tools > SPA Utilities > Syslog Server for SPA Devices.)

**Note**

As a best practice, enable logging only when needed, and disable logging when you finish the investigation. Logging information can impact system performance.

- Connect to the SPA400 administration web server. (See ["Connecting to the SPA400 Administration Web Server,"](#) on page 80.)
- Click **Event Logs tab**.
- Use the drop-down lists to choose the types of information that you want to collect.

Event Log Level	
Telephony:	All Information
SIP:	Error
DSP:	All Information
Dial plan:	Error
Voice mail:	Error
Others:	Error

- Click **Save Settings**.
- Click **Setup tab > Basic Setup**.

6. In the *Syslog Settings* section, enter the IP address of the *Syslog Server*, which normally is a PC on the same network as the SPA400.

The screenshot shows the SPA400 web interface with the following sections and values:

- Setup** (Main menu)
- Administration** (Sub-menu)
- Basic Setup** | SPA9000 Interface | Voice | Voicemail Server | Voicemail Users
- Network Setup**
 - Dynamic IP Address: (DHCP Client)
 - Fixed IP Address: 192 . 168 . 1 . 113
 - IP Subnet Mask: 255 . 255 . 255 . 0
 - Gateway IP Address: 192 . 168 . 1 . 1
- Domain Name Server (DNS) Address**
 - Primary DNS: 192 . 168 . 1 . 1
 - Secondary DNS:
- NTP**
 - NTP Server 1: time.nist.gov
 - Time Zone: (GMT-08:00) Pacific Time (USA & Canada)
- Syslog Settings**
 - Syslog Server: 192.168.1.132:1400 (highlighted with a red circle)
- Save Settings** | **Cancel Changes**

7. Start a command prompt on the PC, and run the system logging software.
8. Run the scenario that causes the problem and when done, press **CTRL+C** in the command window to stop the logs.
9. When you are finished collecting logs, return to the *Event Logs* page and reset the logs to **Off**.

Configuring Music on Hold

This chapter explains how to configure Music on Hold using either a music file or streaming audio.

This chapter includes the following topics:

- ["Using the Internal Music Source for Music On Hold," on page 97](#)
- ["Configuring a Streaming Audio Server," on page 99](#)

Using the Internal Music Source for Music On Hold

The SPA9000 has an internal music source with the user ID **imusic** that plays an internally stored music file repeatedly. The SPA9000 ships with a default music file (*Romance de Amor*). You can override this file by downloading a new file into the unit by using TFTP.

Refer to the following topics:

- ["Using the Internal Music Source," on page 97](#)
- ["Changing the Music File for the Internal Music Source," on page 98](#)
- ["Restoring the Original Music File," on page 98](#)

Using the Internal Music Source

The SPA9000 has an internal music source that plays an internally stored music file repeatedly. The SPA9000 ships with a default music file (*Romance de Amor*).

1. Use the phone menu to find the IP address of the phone:
 - a. Press the **Setup** button on the phone keypad.
 - b. Press **9 - Network**, and then scroll down to **2- Current IP Address**.
2. Start Internet Explorer, and then enter the IP address of the telephone. The Telephone Configuration page appears in a separate browser window.
3. Click **Admin Login**, and then click **Advanced**.
4. Click the **Ext 1** tab.
5. Scroll down to the *Call Feature Settings* section.
6. Enter the following value in the *MOH Server* field: **imusic**
7. Click **Submit All Changes**.
8. To verify, place a test call to the extension. When the call is answered and put on hold, the caller should hear the default music file (*Romance de Amor*).

Changing the Music File for the Internal Music Source

The following resources are required to change the music file for the internal music source:

- TFTP server software
 - The IP address of the administration computer that is connected to the SPA9000
 - A music source in G.711u format, sampled at 8000 samples/sec with no file header, up to 65.5 seconds in length, with no header information
1. Before you begin, make sure that you have TFTP server software running on your computer.
 2. Connect to the SPA9000 administration web server, and choose Admin access with Advanced settings. (See ["Connecting to the SPA9000 Administration Web Server,"](#) on page 24).
 3. Click **Voice tab > SIP**.
 4. Scroll down to the *Internal Music Source Parameters* section.
 5. Enter the following URL in the Internal Music URL field:
`tftp://server_IPaddress:port/path`
 - server_IPaddress: The local IP address of the computer you are using as the TFTP server
 - port: The port number used by the TFTP server (default **69**)
 - path: The location and name of a music file in the correct format
 - For example, if the computer local IP address is 192.168.0.5, the directory is named *musicdir*, and the converted music file is named *jazzmusic.dat*, then you would enter the following URL: `tftp://192.168.0.5:69/musicdir/jazzmusic.dat`
 6. Click **Submit All Changes**. The SPA9000 reboots. Then the SPA9000 downloads the file and stores it in flash memory.

Restoring the Original Music File

If you want to restore the original default music file for the internal music source, you can download the file from Linksys.com.

1. On Linksys.com, choose **Support > Technical Support**.
2. Click **Choose A Product**.
3. Choose **IP PBX** from the *Voice over IP* drop-down list.
4. Under *Downloads*, choose the **Click Here** link.
5. Choose the correct version in the drop-down list.
6. Under *Others*, click the **Default Music File** link.

7. Unzip this file and save it to an accessible directory on your TFTP server. Then repeat this procedure and enter the correct server IP address, port, and the path to the unzipped file.

Configuring a Streaming Audio Server

This section describes how to use and configure a streaming audio server (SAS). It includes the following topics:

- ["Using a Streaming Audio Server," on page 99](#)
- ["Using the IVR with an SAS Line," on page 100](#)
- ["Example SAS with MOH," on page 100](#)
- ["Configuring the Streaming Audio Server," on page 101](#)

Using a Streaming Audio Server

On a connected call, the SPA9000 may place the remote party on hold by performing a hook-flash to initiate a three-way call or by swapping two calls during call-waiting. If the remote client indicates that it can still receive audio while the call is holding, the SPA9000 can be configured to contact an auto-answering streaming audio server (SAS) to stream audio to the holding party. When used this way, the SAS is referred to as an MOH Server.

The SAS feature lets you use attach an audio source to one of the SPA9000 FXS ports (Phone 1 or Phone 2 on the PAP2T) and use it as a streaming audio source device. If the SPA9000 has multiple FXS ports, either or both of the associated lines (Line 1 and Line 2 on the PAP2T) can be configured as an SAS server.

When the line is called and the FXS port is off hook, the SPA9000 answers the call automatically and streams audio to the calling party.

If the FXS port is on-hook when the incoming call arrives, the SPA9000 replies with a SIP 503 response code to indicate "Service Not Available." If an incoming call is auto-answered, but later the FXS port changes to on-hook, the SPA does not terminate the call but continues to stream silence packets to the caller. If an incoming call arrives when the SAS line has reached full capacity, the SPA replies with a SIP 486 response code to indicate "Busy Here."

The SAS line can be setup to refresh each streaming audio session periodically using a SIP re-INVITE message, which detects if the connection to the caller is down. If the caller does not respond to the refresh message, the SAS line terminates the call so that the streaming resource can be used for other callers.

Each SAS server can maintain up to five simultaneous calls. If the second line on the SPA9000 is disabled, then the SAS line can maintain up to 10 simultaneous calls. Further incoming calls receive a busy signal (SIP 486 Response).

The streaming audio source must be off-hook for the streaming to occur. Otherwise incoming calls get a error response (SIP 503 Response). The SAS line does not ring for incoming calls even if the attached equipment is on-hook.

If no calls are in session, battery is removed from tip-and-ring of the FXS port. Some audio source devices have an LED to indicate the battery status. This can be used as a visual indication as to whether audio streaming is in progress.

Set up the Proxy and Subscriber Information for the SAS Line as you normally would with a regular user account.

Call Forwarding, Call Screening, Call Blocking, DND, and Caller-ID Delivery features are not available on an SAS line.

Using the IVR with an SAS Line

The IVR can still be used on an SAS line, but the user needs to follow the following steps:

1. Power off the SPA9000.
2. Connect a phone to the port and make sure the phone is on-hook.
3. Power on the SPA9000.
4. Pick up handset and press * * * * to invoke IVR in the usual way.

If the SPA9000 boots and finds that the SAS line is on-hook, it does not remove battery from the line so that IVR may be used. But if the SPA9000 boots up and finds that the SAS line is off-hook, it removes battery from the line because no audio session is in progress.

Example SAS with MOH

Figure 6-1 MOH Application with a SPA9000 Line Configured as an SAS

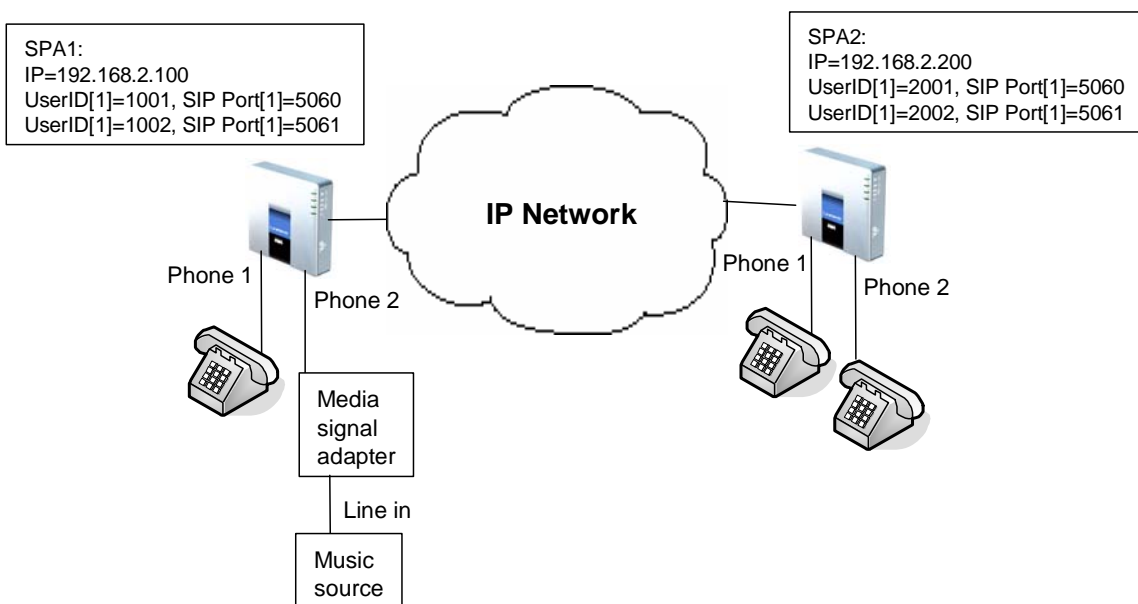

In this example, the SAS Line is registered with the SPA9000 as the other subscribers.

On SPA1:

SAS Enable[1] = no
MOH Server [1] = 1002
SAS Enable[2] = yes

On SPA2:

SAS Enable[1] = no
MOH Server [1] = 1002
SAS Enable[2] = no
MOH Server [2] = 1002

Configuring the Streaming Audio Server

The following provides step-by-step procedures for implementing a SAS with an external music source.

1. Connect an RJ-11 adapter between the music source (a CD player or iPod, for example) and an FXS port on the SPA9000 (Phone 1 or Phone 2).
2. Connect to the SPA9000 administration web server, and choose Admin access with Advanced settings. (See ["Connecting to the SPA9000 Administration Web Server,"](#) on page 24).
3. Configure the FXS port:
 - a. Click **Voice tab > FXS N**, where *N* represents the SPA9000 phone port number where you connected the RJ-11 adapter.
 - b. Enter the following settings:
 - **Display Name:** Enter an extension number of name for the FXS 1 port, such as Receptionist Area Fax Machine.
 - **User ID:** Enter a three- to four-digit extension number that is not is use by other extension.
 - c. Scroll down to the *Streaming Audio Server (SAS)* section.
 - d. From the **SAS Enable** drop-down list, choose **yes**.

Voice > FXS N > Streaming Audio Server

Streaming Audio Server (SAS)

SAS Enable: SAS DLG Refresh Intvl:

SAS Inbound RTP Sink:

4. Click **Submit All Changes**.

5. Configure each phone to use this audio source as the MOH server:
 - a. Click the **PBX Status** link to view the list of phones.
 - b. In the list, find the phone that you want to configure, and then click the hyperlink in the *IP Address* column. The Telephone Configuration page appears in a separate window.
 - c. Click the **Ext 1** tab.
 - d. Scroll down to the *Call Feature Settings* section.
 - e. In the *MOH Server* field, enter the extension number that you assigned to the FXS port for the streaming audio server.
 - f. Click **Submit All Changes**.
 - g. Close the window for the Telephone Configuration page.
 - h. Repeat this step to configure each phone, as needed.

Configuring the LVS Auto-Attendant

This chapter describes how to configure the LVS Auto Attendant using the IVR, and XML scripting.

This chapter contains the following sections:

- ["How the Auto Attendant Works," on page 103](#)
- ["Working with the Auto Attendant Greetings," on page 104](#)
- ["Writing an Auto Attendant Script," on page 108](#)
- ["Configuring the DayTime, NightTime and Weekend/Holiday Auto Attendants," on page 116](#)
- ["Configuring Dial Plans for the Auto Attendant," on page 117](#)

How the Auto Attendant Works

The Auto Attendant (**aa**) is an internal service within the SPA9000. This service answers calls and plays pre-recorded voice messages that offer a menu of choices. The Auto Attendant parses the user input (key presses or DTMF tones), based on the Auto Attendant Dial Plan. Finally, the Auto Attendant routes the call to the selected extension.

The Auto Attendant can handle up to ten incoming calls simultaneously. It can accommodate two categories of callers:

- Callers who do not call you regularly or are not accustomed to using Auto-Attendants. The Auto Attendant plays a greeting and provides menus to help callers reach the desired extension.
- Callers who call you regularly and want to move through the system quickly. The Auto Attendant allows experienced users to input their responses at any time.

The Auto Attendant relies upon the following components:

- **Contact List.** When a call comes in, the SPA9000 directs the call according to the entries in the Contact List for the line interface. By default, the Auto Attendant is the only client on this list, so the Auto Attendant picks up every call. Alternatively, you can enter a list of client stations to alert, with the Auto Attendant picking up a call only if a number (or group) of clients did not pick up the call first. This parameter is configured on the *Voice > Line N page, Subscriber Information* section, *Contact List* field. For more information, see ["Managing Inbound Calls with the Contact List," on page 66.](#)
- **Recorded Prompts.** The Auto Attendant plays prompts to assist the users. The system includes a set of pre-recorded prompts, and you can record your own custom prompts. For more information, see ["Working with the Auto Attendant Greetings," on page 104.](#)
- **AA Script.** This XML script determines which prompt is used to greet callers and which prompts are played in response to valid or invalid user inputs. You can enter up to three scripts. One script is active at any time. These scripts are configured on the *Voice > SIP*

page, *Auto Attendant Parameters* section, *AA Script 1 - 3* fields. For more information, see ["Writing an Auto Attendant Script,"](#) on page 108.

- **DayTime, NightTime, and Weekend/Holiday AA.** You can activate different AA scripts for different times of day. By default, the DayTime AA settings are activated and use AA Script 1. As needed, you can activate the NightTime AA and the Weekend/Holiday AA, with your selection of a script (AA Script 1, 2, or 3). You also need to define the start and end time for daytime, nighttime, and weekend/holiday. For more information, see ["Configuring the DayTime, NightTime and Weekend/Holiday Auto Attendants,"](#) on page 116.
- **AA Dial Plan.** The Auto Attendant parses the user input according to the dial plan that is identified in the AA script. You can create up to two dial plans. These dial plans are configured on the *Voice > SIP* page, *Auto Attendant Parameters* section, *AA Dial Plan 1 - 2* fields. See ["Configuring Dial Plans for the Auto Attendant,"](#) on page 117.

Working with the Auto Attendant Greetings

This section provided information about adding, and editing the Auto Attendant greetings. See the following topics:

- ["Using Pre-Recorded Prompts,"](#) on page 104
- ["Recording an Auto Attendant Prompt,"](#) on page 105
- ["Downloading Prompts,"](#) on page 107

Using Pre-Recorded Prompts

You can save up to ten Auto Attendant prompts. Four pre-recorded prompts are provided, as listed in [Table 7-1](#).

Table 7-1 Prompts

Prompts ID	Default Audio Content
Prompt1	"If you know your party's extension, you may enter it now."
Prompt2	"Your call has been forwarded."
Prompt3	"Not a valid extension, please try again."
Prompt4	"Goodbye."



Note

These prompts are available in languages other than English. See ["Localizing the SPA9000 Auto Attendant Prompts,"](#) on page 118.

You can replace the pre-recorded prompts with your own recordings, and you can add up to six additional recordings. For example, you may want to change the default prompt, Prompt 1, to greet callers with your company name. You may want to record a different prompt for nighttime or holiday hours. You can make these recordings by using the IVR. The recordings are encoded with G.711U and saved in flash.

Recording an Auto Attendant Prompt

Follow this procedure to overwrite an existing recording or to add a new recording.



Note

Customized prompts are erased when a factory reset is performed on the SPA9000.

1. Connect an analog phone to the Phone 1 or Phone 2 port of the SPA9000.
2. Press the star key (*) four times: *****

The IVR plays the following prompt: *Linksys configuration menu. Please enter the option followed by the # (pound) key or hang up to exit.*

3. Press **72255#** to access the Auto Attendant message settings.

The IVR plays the following prompt: *Please enter the message number followed by the # (pound) key.*

4. Enter the number of the message (1 through 10) that you wish to record, review, or delete. The IVR plays the following prompt: *Enter 1 to record. Enter 2 to review. Enter 3 to delete. Enter * to exit.*

5. Press **1** to record a new message.

NOTE: The IVR checks the available buffer size. If there is no more buffer capability, IVR plays the *Option Failed* message and returns to the previous menu.

If the buffer space is sufficient, the IVR plays the following prompt: *You may record your message after the tone. When finished, press #.*

6. After the tone, record the new message and then press #.

The IVR plays the following prompt: *To save, enter 1. To review, enter 2. To re-record, enter 3. To exit, enter *.*

7. Press **1** to save the new recorded message.

The IVR plays the following prompt: *One moment, please.*

8. Wait for several seconds while the save is completed.

Example Prompts

In this example, the business will have different Auto Attendant Scripts for different times of day.

Prompt ID	Message
Prompt1	"If you know your party's extension, you may enter it now."
Prompt2	"Your call has been forwarded."
Prompt3	"Not a valid extension, please try again."
Prompt4	"Goodbye."
Prompt5	"Welcome to All Seasons Travel."
Prompt6	"Thank you for calling All Seasons Travel. Presently we are closed."
Prompt7	"We are open Monday through Friday 9 AM to 6 PM, and we are closed on Saturdays and Sundays. Our address is 101 Main Street, Anytown, Anystate, USA."
Prompt8	"If you know your party's three-digit extension, you may enter it now."
Prompt9	"To reach our receptionist, press 0 at any time. For our company location, press 1. For travel support, press 2. For sales, press 3. Otherwise, please stay on the line for our receptionist."
Prompt10	"Welcome to the All Seasons Travel support line. If this is regarding our Holiday Getaway Special, please press 1; otherwise, please stay on the line for one of our travel associates. Or press * to go back."

For examples of AA scripts that use custom prompts, see ["An Introduction to XML Scripting Grammar in AA Script Examples,"](#) on page 109.

Using the IVR Prompts to Change Recordings

The IVR prompts guides you through the process of recording, erasing, and changing greetings. Refer to [Figure 7-1](#).

Figure 7-1 IVR Prompt Menu Call Flow

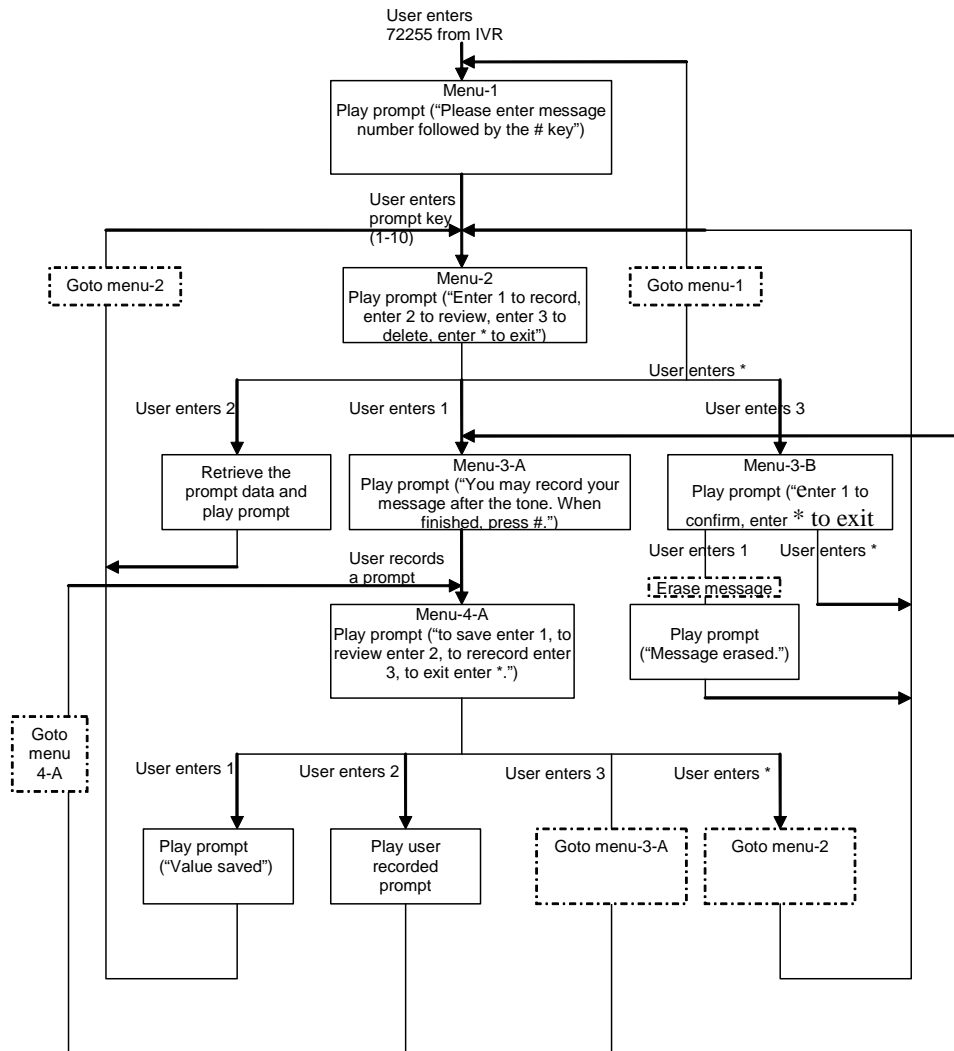

Downloading Prompts

You can download customized prompt files from a TFTP/HTTP/HTTPS server. These files must be encoded in G.711u, size less than 60 seconds, with the header removed. The total prompt file size cannot be larger than 94.5 seconds.

The prompt is downloaded at the device boot up time. If the prompt has already been downloaded from the given URL, the download is not performed. If the prompt file name is **none**, the corresponding prompt currently saved in the flash is erased. The default value is blank.

1. Connect to the SPA9000 administration web server, and choose Admin access with Advanced settings. (See ["Connecting to the SPA9000 Administration Web Server,"](#) on page 24).
2. Click **Voice tab > SIP**.
3. Scroll down to the *Auto Attendant Parameters* section.
4. In the *AA Prompts URL Script* field, enter the location and the file name for the prompts files, in the following format:

SYNTAX:

```
serv=scheme://server_addr[:port]/root_path;p1={prompt1 file path name};[p2={prompt2 file path name};][p3={prompt3 file path name};][p4={prompt4 file path name};][p5={prompt5 file path name};][p6={prompt6 file path name};][p7={prompt7 file path name};][p8={prompt8 file path name};][p9={prompt9 file path name};][p10={prompt10 file path name};]
```

- scheme = tftp|http|https
- default port is 69 for tftp, 80 for http, and 443 for https
- root_path can be empty
- [] denotes optional item
- none: The prompt will be erased.

EXAMPLE:

```
serv=tftp://192.168.2.150/root/test;p1=menu.wav;p2=transfer.wav;p3=nomatch.wav;p4=none;
```

In this example, Prompt 1 is downloaded from `tftp://192.168.2.150/root/test/menu.wav`, Prompt 2 from `tftp://192.168.2.150/root/test/transfer.wav`, and Prompt 3 from `tftp://192.168.2.150/root/test/nomatch.wav`. Prompt 4 is erased.

5. Click **Submit All Changes**.

Writing an Auto Attendant Script

The SPA9000 AA allows users to define the AA instructions using XML script. This section includes the following topics:

- ["An Introduction to XML Scripting Grammar in AA Script Examples,"](#) on page 109
- ["Elements of XML Scripting Grammar,"](#) on page 111
- ["Auto Attendant XML Instructions Set,"](#) on page 113
- ["Entering an Auto Attendant Script,"](#) on page 115

An Introduction to XML Scripting Grammar in AA Script Examples

The SPA9000 lets you use XML scripting grammar to define the Auto Attendant instructions. You can study the example scripts to learn about the scripting grammar. You also may find it helpful to use these scripts as the basis for your own custom scripts.

SEE ALSO: ["Elements of XML Scripting Grammar," on page 111](#)

Example 1: Routing Calls to Any Extension Number (Default AA Script 1)

In this example, the business is using the default AA Script 1, which prompts the caller to enter any extension number. Each part of the script is described in the following table.

Script Elements	Purpose
<aa>	This script is for the AA.
<form id="dir" type="menu">	This form is given the name "dir" for directory, and it is a menu type of form, which accepts DTMF inputs.
<audio src="prompt1" bargein="T"/>	The Auto Attendant plays Prompt 1, using the default recording: <i>If you know your party's extension, you may enter it now.</i> Callers are allowed to begin dialing (bargein) at any time.
<noinput timeout="10" repeat="T"/>	If there is no input after 10 seconds, the Auto Attendant repeats the menu prompt.
<dialplan src="dp1"/>	AA Dial Plan 1 is used to evaluate the inputs.
<nomatch repeat="F"> <audio src="prompt3" bargein="T"/> </nomatch>	If the dialed digits do not match the dial plan, the Auto Attendant plays Prompt3: <i>Not a valid extension, please try again.</i>
<match> <default> <audio src="prompt2"/> <xfer name="ext" target="\$input"/> </default> </match>	If the dialed digits match the dial plan, the Auto Attendant plays Prompt 2 (<i>Your call has been forwarded.</i>) The call is transferred to the extension number that the user entered.
</form>	The form is ended.
</aa>	The script is ended.

Example 2: Routing Calls with a Departmental Sub-Menu

In this example, the business wants to expedite the handling of sales calls. A custom prompt is used to give special instructions about calls for the sales department. A sub-menu for the sales group is provided to direct calls to the correct person within that department.

Script Elements	Purpose
<aa>	This script is for the AA.
<form id="DIR" type="menu">	This form is given the name "DIR" for Directory. It is a menu type of form, which accepts DTMF inputs.
<audio src="prompt1" bargein="T"/>	The Auto Attendant plays custom Prompt1. <i>Welcome to ABC company. For Sales, enter 1. If you know your party's extension, you may enter it now.</i> Callers are allowed to begin dialing (bargein) at any time.
<dialplan src="dp1"/>	Dial plan 1 is used to evaluate the inputs within this form.
<noinput timeout="10" repeat="T"/>	If there is no input after 10 seconds, the Auto Attendant repeats the menu prompt.
<nomatch> <audio src="prompt3" bargein="T"/> </nomatch>	If the user input does not match the specified dial plan, the Auto Attendant plays Prompt3: <i>Not a valid extension, please try again.</i>
<match> <case input="1"> <goto next="SALES"/> </case> <default> <audio src="prompt2"/> <xfer name="ext" target="\$input"/> </default> </match>	If the user input matches the dial plan, the response depends upon the user entry: <ul style="list-style-type: none"> If the user pressed 1, the Auto Attendant processes the input by using the Sales sub-menu (below in this script). If the user pressed any keys other than 1, the Auto Attendant plays Prompt 2 (<i>Your call has been transferred.</i>) The call is transferred to the extension number that the user entered.
</form>	The "DIR" form is closed.
<form id="SALES" type="menu">	This part of the script contains the "SALES" sub-form.
<audio src="prompt5"/>	The Auto Attendant plays custom Prompt 5: <i>Press 1 for price info, press 2 for return, press 0 for sales representative, press * to exit.</i>

Script Elements	Purpose
<code><dialplan src="dp2"/></code>	AA Dial Plan 2 is used to evaluate the inputs within this form.
<code><noinput timeout="10" repeat="T"/></code>	If there is no input after 10 seconds, the Auto Attendant repeats the menu prompt.
<pre> <nomatch> <audio src="prompt3" bargein="T"/> </nomatch> </pre>	If the user input does not match the specified dial plan, the Auto Attendant plays Prompt3: <i>Not a valid extension, please try again.</i>
<pre> <match> <case input="*"> <audio src="prompt4"/> <exit/> </case> <default> <audio src="prompt2"/> <xfer name="ext" target="\$input"/> </default> </match> </pre>	<p>If the user input matches the dial plan, the response depends upon the user entry:</p> <ul style="list-style-type: none"> • If the user presses *, the Auto Attendant plays Prompt 4: <i>Good-bye.</i> • If the user presses any digits other than *, the Auto Attendant plays Prompt 2 (<i>Your call has been transferred.</i>) The call is transferred to the extension number that the user entered.
<code></form></code>	The form is ended.
<code></aa></code>	The script is ended.

Elements of XML Scripting Grammar

This section includes the following topics:

- ["Audio Instruction," on page 111](#)
- ["Action Instruction," on page 112](#)
- ["Noinput Instruction," on page 112](#)
- ["Nomatch Instruction," on page 113](#)
- ["Menu Matched Instruction for Touch Tone \(DMTP\) Input," on page 113](#)

Audio Instruction

The following is an example of the **audio** instruction:

```
<audio src="prompt1" bargein="T"/>
```

The Auto Attendant plays the audio file that is specified in the `src` attribute. When playing the audio, the Auto Attendant allows the caller to interrupt the current prompt by pressing digits when the `bargein` attribute is set to **T**. The Auto Attendant ignores any digits from the caller if `bargein` is set to **F**. The default value of the `bargein` attribute is **T**.



TIP: Generally, enter an audio instruction as the first element in the script. In a <form> dialog, if <audio> dialog is not been defined, the Auto Attendant does not play a prompt. If it is defined, the Auto Attendant first plays the specified prompt, then executes the action instruction that is described in the next section.

Action Instruction

The actions include:

- **goto**—The Auto Attendant proceeds to the next dialog in the script. All dialogs are identified by the attribute “id”. The value in the id attribute must be unique. Otherwise, the Auto Attendant selects the last valid dialog as the transfer target dialog.

EXAMPLE: <goto link= “dir_dlg”>

- **xfer**—The Auto Attendant blind transfers the caller to the target.

EXAMPLE: <xfer name= “Technical Support” target= “5000”/>

The name attribute is optional. The target attribute must be a valid target phone number.

- **exit** —When this action is reached, the Auto Attendant is stopped, and the call ends.

EXAMPLE: </exit>

NOTE: In one dialog, only one action can be defined. After the **xfer** or **exit** action is performed, the Auto Attendant ends automatically.

Noinput Instruction

The <noinput> dialog can only be used in the menu dialog and is optional. When it is specified, Auto Attendant executes the audio and action instructions if the user does not input any digits with the value of the <timeout> parameter, in seconds.

If the **repeat** attribute is set to **T**, the Auto Attendant plays the menu prompt after playing the prompt specified in the <noinput> dialog and ignores the action instruction. If the value is **F**, the Auto Attendant executes the **action** instruction. The default value of the **repeat** attribute is **F**.

Either the **audio** or the **action** instruction can be empty. If both are empty, the Auto Attendant does nothing and waits for user input.

Nomatch Instruction

The <nomatch> dialog can be used only in a menu dialog and is optional. This dialog is activated when DMTF digits do not match the dial plan. When the **nomatch** condition is met, Auto Attendant executes the **audio** and **action** instructions in the <nomatch> dialog. If the **repeat** attribute is set to **T**, the Auto Attendant plays the menu prompt after playing the no input prompt and ignores the **action** instruction. If the **repeat** attribute is set to **F**, the Auto Attendant executes the **action** instruction. The default value of the **repeat** attribute is **F**.

Either the **audio** or **action** instruction can be empty. If both are empty, the Auto Attendant does nothing and ignores all buffered digits.

Menu Matched Instruction for Touch Tone (DMTP) Input

The <match> dialog can be used only in the menu dialog and it is a mandatory field. When the DTMF digits match the dialplan, the <match> dialog is activated. The Auto Attendant compares each <case> dialog and executes the corresponding audio/action instructions. If the Auto Attendant cannot find a match in any <case> dialogs, it performs the <default> dialog audio/action instruction if <default> is defined; otherwise, the Auto Attendant ends.

You can specify exact numbers, (for example 1, 23, 1234 and so on), in the **input** attribute of the <case> dialog, or you can use the dial pattern (for example, "50xx", "408xxx5061", "xx."). The user can also combine several dial patterns together and use "|" to separate them (for example, "50xx|408xxx5061|1234").

The user can use the variable "\$input" in the target attribute of the **xfer** action. The value of this variable means that the input value that is already passed by the dialplan. The Auto Attendant does no translation, but directly transfers the call to the target.

EXAMPLE

```
<default>
  <audio src="prompt2"/>
  <xfer name="ext" target="$input"/>
</default>
```

Outband DTMF (INFO/AVT) is recognized by Auto Attendant. To enable the recognition of inband DTMF, go to the *Voice > SIP* page, *Auto Attendant Parameters* section, and set *AA Decode Inband DTMF* to *yes*.

Auto Attendant XML Instructions Set

The complete set of XML instructions for Auto Attendant Scripts are described in the following table:

Instruction	Description	Syntax and Example(s)
dialplan	This determines the dialplan id of the current menu <form>. The Auto Attendant processes the user input according to the dial plan and then is dispatched to the match, nomatch, or noinput instruction.	<pre><dialplan src = "dp1"/> "dp1" matches the AA Dial Plan 1 parameter found on the Voice - SIP screen of the administration web server. "dp2" matches the AA Dial Plan 2 parameter found on the Voice - SIP screen of the administration web server.</pre>
noinput	When specified, the Auto Attendant executes the specified audio and action instructions if the user does not input any digits in <timeout> seconds. If the repeat attribute is set to "T", then the Auto Attendant plays the menu prompt after playing the prompt specified in the <noinput> audio instruction and ignore the action instruction; otherwise, the Auto Attendant executes the action instruction. By default, "repeat" is "F".	<pre><noinput timeout="5" repeat="T"> <!--audio instruction (optional) --> <!--action instruction (optional) --> </noinput></pre>
nomatch	When specified, the nomatch instruction runs when the user input digits do not match anything in the dial plan. The Auto Attendant executes the specified audio and action instructions. If the repeat attribute is set to "T", the Auto Attendant plays the menu prompt after playing the no input prompt and ignore the action instruction; otherwise, the Auto Attendant executes the action instruction. By default, "repeat" is "F".	<pre><nomatch repeat="F"> <!--audio instruction (optional) --> <!--action instruction (optional) --> </nomatch></pre>
match	Upon a match between the user input and the dial plan, the Auto Attendant transfers to the corresponding <case> and execute the corresponding audio and/or action instructions. If the Auto Attendant cannot find a match in any of the <case> statements, it performs the <default> case.	<pre><match > <case input= "x"/> <!--audio instruction (optional) --> <!--action instruction (optional) --> </case> <case input= "#"/> <!--audio instruction (optional) --> <!--action instruction (optional) --> </case> <default> <!--audio instruction (optional) --> <!--action instruction (optional) --> </default> </match></pre>

Instruction	Description	Syntax and Example(s)
goto	The Auto Attendant transfers the caller from one <form> to the other <form>. All <form>s are identified by the attribute "id". The value in the id attribute must be unique; otherwise, the Auto Attendant selects the last valid <form> as the transfer-to target.	<pre><goto link= "daytime"></pre> <p>"daytime" is the id of a <form> entry. Example: <form id="daytime" type="menu"></p>
xfer	The Auto Attendant performs a blind transfer of the caller to the target, and then it ends processing "target = \$input" is equivalent to the input value already passed by the dialplan. There is no significance to the name attribute.	<pre><xfer name= "Technical Support" target= "5000"/></pre>
exit	When this action is reached, the Auto Attendant stops, and the call ends	<pre><exit></pre>
audio	The Auto Attendant plays the audio specified in the "src" attribute. This attribute must be prompt<n>, with <n> being a number in the range 1–10. When playing the audio, the Auto Attendant allows the caller to interrupt the current prompt by pressing digits if the bargein attribute is set to "T". The Auto Attendant ignores any digits from the caller if the bargein attribute is set to "F" (the default value).	<pre><audio src= "prompt1" bargein= "T"/></pre>

Entering an Auto Attendant Script



TIP: To get started, you may want to copy the default script from the *Voice > SIP* page, *Auto Attendant Parameters* section, *AA Script 1* field. You can paste it into any word processing application, where you can see the entire script more easily. Make your changes, remove any formatting such as line breaks, and paste the final string into the appropriate AA Script field.

1. Connect to the SPA9000 administration web server, and choose Admin access with Advanced settings. (See ["Connecting to the SPA9000 Administration Web Server,"](#) on page 24).
2. Click **Voice tab > SIP**.
3. Scroll down to the *Auto Attendant Parameters* section.
4. Enter your script in the appropriate field: *AA Script 1 - 3*. For more information, see ["Writing an Auto Attendant Script,"](#) on page 108.
5. Click **Submit All Changes**.

Configuring the DayTime, NightTime and Weekend/Holiday Auto Attendants

You can customize the Auto Attendant with prompts and actions that are appropriate for different times of day and for the days when the business is closed.

NOTE: By default, the DayTime Auto Attendant is activated, using AA Script 1, an answer delay of 0 seconds, and no start or end time.

1. Connect to the SPA9000 administration web server, and choose Admin access with Advanced settings. (See ["Connecting to the SPA9000 Administration Web Server,"](#) on page 24).
2. Click **Voice tab > SIP**.
3. Scroll down to the *Auto Attendant Parameters* section.
4. Proceed as needed:
 - To set up the DayTime Auto Attendant:
 - *DayTime AA*: Choose **yes** from the drop-down list.
 - *DayTime AA Script*: Choose **1, 2, or 3** from the drop-down list.
 - *DayTime*: Enter the start and end times in 24-hour format
SYNTAX: start=hh:mm:ss;end=hh:mm:ss
EXAMPLE: start=08:30:00;end=18:00:00
 In this example, the business hours begin at 8:30 a.m. and end at 6:00 p.m.
 - NOTE:** When you enter the *DayTime* setting, you are in effect also setting the nighttime hours. There is no separate field for NightTime start and end times.
 - *DayTime Answer Delay*: Enter the number of seconds that the Auto Attendant waits before answering a call. This setting is useful when the Auto Attendant is used as a backup tool for a live answerer. For example, assume that the Contact List includes both the receptionist and the Auto Attendant. You might set the Answer Delay to 12 seconds. If the receptionist does not answer within that time, then the Auto Attendant answers the call.
 - To set up the NightTime Auto Attendant:
 - *NightTime AA*: Choose **yes** from the drop-down list.
 - *NightTime AA Script*: Choose **1, 2, or 3** from the drop-down list.
 - *DayTime*: Define the daytime hours, which also defines the nighttime hours. Enter the start and end times in 24-hour format
SYNTAX: start=hh:mm:ss;end=hh:mm:ss
EXAMPLE: start=08:30:00;end=18:00:00
 In this example, the daytime hours begin at 8:30:00 a.m. and end at 6:00:00 p.m.
 Nighttime hours begin at 6:00:01 p.m. and end at 8:29:59 a.m.

- *NightTime Answer Delay*: Enter the number of seconds that the Auto Attendant waits before answering a call. Typically the nighttime delay is set to 0 because no one is on site to answer calls.
- To set up the Weekend/Holiday Auto Attendant:
 - *Weekend/Holiday AA*: Choose **yes** from the drop-down list.
 - *Weekend/Holiday AA Script*: Choose **1**, **2**, or **3** from the drop-down list.
 - *Weekends/Holidays*: Define the weekend and holidays, using the following syntax:
[wk=n1[,ni];][hd=mm/dd/yyyy|mm/dd/yyyy-mm/dd/yyyy[,mm/dd/yyyy|mm/dd/yyyy-mm/dd/yyyy];]
 - * For weekends, the syntax is wk=n1[,ni]. In place of n1, specify first day of the weekend (1 for Monday, 2 for Tuesday, and so on). If the weekend lasts more than one day, specify the final day of the weekend in place of n1. Separate the values with a comma.
 - * For holidays, specify each date in mm/dd or mm/dd/yyyy format (the year is optional). Separate the dates with a comma, or indicate a range of dates with a dash.

EXAMPLE: wk=6,7;hd=1/1,2/21/2006,5/30/2006,12/19/2006-12/30/2006
In this example, the weekend is defined as Saturday and Sunday. The holidays are Jan. 1 indefinitely; Feb. 21, 2006; May 30, 2006; and Dec. 19-30, 2006.
 - *Weekend/Holiday Answer Delay*: Enter the number of seconds that the Auto Attendant waits before answering a call. Typically the weekend delay is set to 0 because no one is on site to answer calls.

5. Click **Submit All Changes**.

Configuring Dial Plans for the Auto Attendant

Each Auto Attendant script refers to an Auto Attendant Dial Plan to determine how to process the DTMF digits that are entered by the caller. You can define two dial plans on the Voice > SIP page, Auto Attendant Parameters section, *AA Dial Plan 1* and *AA Dial Plan 2* fields.

EXAMPLE 1, Default AA Dial Plan 1: (10x|xxx.)

EXAMPLE 2: (<x:500x>|408555xxxx|xxxxx)", "(<1:1002>|<2:21111>|<3:3333>|xxxxx)

In this example, when the user inputs DTMF digits, AA parses them using the dial plan first, then the parsing result is directed to the AA script menu instruction.

Localization

You can localize your LVS with the language files, tones, and ring patterns that are appropriate for your region.

- ["Requirements for Localization," on page 118](#)
- ["Localizing the SPA9000 Auto Attendant Prompts," on page 118](#)
- ["Local Time Configuration," on page 120](#)
- ["Configuring the SPA9000 and SPA9xx Call Progress Tones," on page 120](#)
- ["Localizing the SPA400 Voice Mail Prompts," on page 125](#)
- ["Localizing the SPA400 Call Disconnect Tones," on page 126](#)
- ["Localizing the SPA400 Caller ID Method," on page 128](#)

**Note**

For instructions about localizing the phone display, see the *Linksys Phone Administration Guide*, which is available at www.linksys.com.

Requirements for Localization

You need TFTP server software to localize the SPA9000.

Localizing the SPA9000 Auto Attendant Prompts

The default Auto Attendant prompts are in English. You can localize your system by downloading and installing the appropriate language files for your region. Store these prompts on a TFTP/HTTP/HTTPS server, and the SPA9000 will download the files at the device boot up time.

The set of files includes the following types of prompts:

- Prompt 1: Greets the caller and prompts for an extension number
- Prompt 2: Notifies the caller that the call is being forwarded
- Prompt 3: Notifies the caller of an invalid extension
- Prompt 4: Good-bye
- Prompt 5: Greets the caller with specific prompts for General Information, Sales, and Support.
- Prompt 6: Notifies the caller that the office is currently closed and prompts for an extension number.

**Note**

The Auto Attendant prompt files must be encoded in G.711u and must have a total file size (message and header) of 94.5 seconds or less.

1. Download the prompts:
 - a. Start Internet Explorer, enter the address of the EMEA Portal (www.linksys-voip.eu or www.linksys-itsp.com), and log on.
 - b. In the left navigation pane, select the following links: **FW & Tools > LVS > Localization > SPA9000 Auto Attendant prompts**.
 - c. Select the **download** link for the language that you want. Repeat as needed for up to nine languages.

NOTE: North American partners can find localization files in the Utilities area of the Linksys Partner Connection.

2. Store the downloaded files on a TFTP/HTTP/HTTPS server.
3. Configure the SPA9000 to download the files from the server:
 - a. Connect to the SPA9000 administration web server, and choose Admin access with Advanced settings. (See "[Connecting to the SPA9000 Administration Web Server](#)," on page 24).
 - b. Click **Voice tab** > the **SIP** tab.
 - c. Scroll down to the *Auto Attendant Parameters* area of the page.
 - d. In the *AA Prompts URL* field, enter the script for the server, path, and prompt file names.

SYNTAX:

```
serv=scheme://server_addr[:port]/root_path;[p1={prompt1 file path name};][p2={prompt2 file path name};][p3={prompt3 file path name};][p4={prompt4 file path name};][p5={prompt5 file path name};][p6={prompt6 file path name};][p7={prompt7 file path name};][p8={prompt8 file path name};][p9={prompt9 file path name};][p10={prompt10 file path name};]
```

EXAMPLE:

```
serv=tftp://192.168.2.150/root/test;p1=fr_1.wav;p2=fr_2.wav;p3=fr_3.wav;p4=none;
```

NOTE:

- **scheme:** Enter one of the following values: tftp, http, or https.
- **port:** The default ports are 69 for tftp, 80 for http, and 443 for https.
- **root_path** can be empty.
- **[]** denotes an optional item.
- If the prompt file name is **none**, the corresponding prompt currently saved in the flash is erased.

4. Click **Submit All Changes**.

The prompts are downloaded when the SPA9000 boots up. If a prompt has already been downloaded from the given URL, the download is not performed.

5. To verify that the prompts are localized, make a call to the Auto Attendant. From an internal phone, you can press the **Setup** button, then press **1 - Directory**, then **2 - Corporate Directory**, and then scroll down to find and select the number for the Auto Attendant.

Local Time Configuration

You will need to localize the date, time, and daylight saving time rule. See ["Setting the Date and Time," on page 27](#) and ["Configuring Daylight Saving Time," on page 27](#). Use the following table to find the correct Daylight Saving Time Rules for EMEA and Australia.

Country	Daylight Saving Time Rule	Time Zone
Australia (ACST)	start=4/1/7/3;end=10/1/7/2;save=-1	GMT+10:30
Australia (AEST)	start=4/1/7/3;end=10/1/7/2;save=-1	GMT+11
Australia (AWST)	start=3/-1/7/3;end=10/-1/7/2;save=-1	GMT+09:00
France	start=3/-1/7/2;end=10/-1/7/2;save=1	GMT+1
Germany	start=3/-1/7/2;end=10/-1/7/2;save=1	GMT+1
Spain	start=3/-1/7/2;end=10/-1/7/2;save=1	GMT+1
UK/Ireland	start=3/-1/7/2;end=10/-1/7/2;save=1	GMT

Configuring the SPA9000 and SPA9xx Call Progress Tones

Call progress tones, such as dial tone and reorder, indicate the call progress to the users. You can configure your SPA9000 and your SPA9xx phones to use the appropriate call progress tones for your region.

1. Localize the tones for the SPA9000:
 - a. Start Internet Explorer, and then enter the IP address of the SPA9000. Click **Admin Login** and then click **Advanced**. Connect to the SPA9000 administration web server, and choose Admin access with Advanced settings. (See ["Connecting to the SPA9000 Administration Web Server," on page 24](#)).
 - b. Click **Voice tab > Regional**.
 - c. In the *Call Progress Tones* section, enter the values from Table 3-1 into the corresponding fields.
 - d. Click **Submit All Changes**.
2. Localize the tones for the phones:

- a. Click the **PBX Status** link.
- b. Find the phone that you want to configure, and then click the hyperlink in the *IP Address* column.
- c. Click **Regional**.
- d. In the *Call Progress Tones* section, enter the values from [Table 8-1](#) into the corresponding fields.
- e. Click **Submit All Changes**.
- f. Repeat this step as needed for each phone.

Table 8-1 SPA9000 Call Progress Tones by Country

Australia	
Dial Tone	400@-19,425@-19;10(*0/1+2)
Outside Dial Tone	420@-16;10(*0/1)
Prompt Tone	520@-19,620@-19;10(*0/1+ 2)
Reorder Tone	425@-19;*(2.5/5)
Off Hook Warning Tone	480@-10,620@0;10(.125/.125/1+2)
Ring Back Tone	400@-19,425@-19;*(.4/.2/1+2,.4/2/1+2)
Busy Tone	425@-16;10(.375/.375/1)
Call Waiting Tone	400@-20;30(0.1/2/1)
Confirm Tone	600@-16;1(.25/.25/1)
Denmark	
Dial Tone	425@-10;*(*/0/1)
Outside Dial Tone	425@-16;10(*0/1)
Prompt Tone	425@-19,620@-19;*(*/0/1+2)
Reorder Tone	425@-10;*(0.25/0.25/1)
Off Hook Warning Tone	425@-10;*(.2/.2/1,.2/.6/1)
Ring Back Tone	425@-10;*(1/4/1)
Busy Tone	425@-10;10(0.25/0.25/1)
Call Waiting Tone	425@-20;30(0.2/0.2/1,0.2/3.6/1,0.2/0.2/1,0.2/0/1)
Confirm Tone	425@-16;1(.25/.25/1)

France	
Dial Tone	440@-10;*(*/0/1)
Outside Dial Tone	440@-16;10(*0/1)
Prompt Tone	440@-19,620@-19;*(*/0/1+2)
Reorder Tone	440@-10;*(.5/.5/1)
Off Hook Warning Tone	425@-10;*(.2/.2/1,.2/.6/1)
Ring Back Tone	440@-10;*(1.5/3.5/1)
Busy Tone	440@-10;10(.5/.5/1)
Call Waiting Tone	440@-20;30(.175/.175/1,.175/3.5/1)
Confirm Tone	440@-16;1(.25/.25/1)
Germany	
Dial Tone	425@-10;10(*0/1)
Outside Dial Tone	425@-13,400@-13;10(*0/1+2)
Prompt Tone	440@-19,620@-19;30(*0/1+2)
Reorder Tone	440@-10;*(.5/.5/1)
Off Hook Warning Tone	425@-10;*(.2/.2/1,.2/.6/1)
Ring Back Tone	440@-10;10(1.5/3.5/1)
Busy Tone	425@-10;10(0.48/0.48/1)
Call Waiting Tone	425@-20;30(0.2/0.2/1,0.2/5/1)
Confirm Tone	440@-16;1(.25/.25/1)
Ireland	
Dial Tone	400@-10;*(*/0/1)
Outside Dial Tone	425@-16;10(*0/1)
Prompt Tone	425@-19,620@-19;*(*/0/1+2)
Reorder Tone	425@-10;*(0.25/0.25/1)
Off Hook Warning Tone	425@-10;*(.2/.2/1,.2/.6/1)
Ring Back Tone	425@-10;(0.4/0.2/1,0.4/2/1)
Busy Tone	425@-10;10(0.5/0.5/1)
Call Waiting Tone	425@-20;30(0.18/0.2/1,0.2/4.5/1)
Confirm Tone	425@-16;1(.25/.25/1)

Italy	
Dial Tone	425@-10;*(0.2/0.2/1,0.6/1/1)
Outside Dial Tone	425@-16;10(0.2/0.2/1,0.6/1/1)
Prompt Tone	425@-19,620@-19;*(*/0/1+2)
Reorder Tone	425@-10;*(0.2/0.2/1)
Off Hook Warning Tone	425@-10;*(.2/.2/1,.2/.6/1)
Ring Back Tone	425@-10;*(1/4/1)
Busy Tone	425@-10;10(0.5/0.5/1)
Call Waiting Tone	425@-20;30(0.4/0.1/1,0.25/0.1/1,0.15/14/1)
Confirm Tone	425@-16;1(.25/.25/1)
Netherlands	
Dial Tone	425@-10;*(*/0/1)
Outside Dial Tone	425@-16;10(*0/1)
Prompt Tone	425@-19,620@-19;*(*/0/1+2)
Reorder Tone	425@-10;*(0.25/0.25/1)
Off Hook Warning Tone	425@-10;*(.2/.2/1,.2/.6/1)
Ring Back Tone	425@-10;*(1/4/1)
Busy Tone	425@-10;10(.5/.5/1)
Call Waiting Tone	425@-20;30(0.5/9.5/1)
Confirm Tone	425@-16;1(.25/.25/1)
Norway	
Dial Tone	425@-10;*(*/0/1)
Outside Dial Tone	425@-16;10(*0/1)
Prompt Tone	425@-19,620@-19;*(*/0/1+2)
Reorder Tone	425@-10;*(0.2/0.2/1)
Off Hook Warning Tone	1400@-10;*(0.4/15/1)
Ring Back Tone	425@-10;(1/4/1)
Busy Tone	425@-10;10(.5/.5/1)
Call Waiting Tone	425@-20;30(0.2/0.6/1,0.2/10/1)
Confirm Tone	1400@-16;1(20/0/1)

Portugal	
Dial Tone	425@-10;*(*/0/1)
Outside Dial Tone	425@-16;10(*0/1)
Prompt Tone	425@-19,620@-19;*(*/0/1+2)
Reorder Tone	425@-10;*(.2/.2/1,.2/.2/1,.2/.6/1)
Off Hook Warning Tone	425@-10;*(.2/.2/1,.2/.6/1)
Ring Back Tone	425@-10;*(1/5/1)
Busy Tone	425@-10;10(.5/.5/1)
Call Waiting Tone	425@-20;30(0.2/0.2/1,0.2/5/1)
Confirm Tone	425@-16;1(.25/.25/1)
Spain	
Dial Tone	425@-10;*(*/0/1)
Outside Dial Tone	425@-16;10(*0/1)
Prompt Tone	425@-19,620@-19;*(*/0/1+2)
Reorder Tone	425@-10;*(.2/.2/1,.2/.2/1,.2/.6/1)
Off Hook Warning Tone	425@-10;*(.2/.2/1,.2/.6/1)
Ring Back Tone	425@-10;*(1.5/3/1)
Busy Tone	425@-10;10(.2/.2/1)
Call Waiting Tone	425@-20;30(.175/.175/1,.175/3.5/1)
Confirm Tone	425@-16;1(.25/.25/1)
Sweden	
Dial Tone	425@-10;*(*/0/1)
Outside Dial Tone	425@-16;10(*0/1)
Prompt Tone	425@-19,620@-19;*(*/0/1+2)
Reorder Tone	425@-10;*(0.25/0.75/1)
Off Hook Warning Tone	425@-10;*(.2/.2/1,.2/.6/1)
Ring Back Tone	425@-10;*(1/5/1)
Busy Tone	425@-10;10(0.25/0.25/1)
Call Waiting Tone	425@-20;30(0.5/9.5/1)
Confirm Tone	425@-16;1(.25/.25/1)

UK	
Dial Tone	350@-10;440@-10;*(*/0/1+2)
Outside Dial Tone	425@-16;10(*/0/1)
Prompt Tone	400@-19,620@-19;*(*/0/1+2)
Reorder Tone	400@-10;*(0.4/0.35/1,0.225/0.525/1)
Off Hook Warning Tone	425@-10;*(.2/.2/1,.2/.6/1)
Ring Back Tone	400@-10;(0.4/0.2/1,0.4/2/1)
Busy Tone	400@-10;10(0.375/0.375/1)
Call Waiting Tone	400@-20;30(0.1/2/1)
Confirm Tone	400@-16;1(20/0/1)

Localizing the SPA400 Voice Mail Prompts

By default, the voice mail system is configured for the English language. You can localize the system by downloading and installing the appropriate language files for your region.

1. Download the files:
 - a. Start Internet Explorer, enter the address of the EMEA Portal (www.linksys-voip.eu or www.linksys-itsp.com), and log on.
 - b. In the left navigation pane, select the following links: **FW & Tools > LVS > Localization > SPA400 Voice mail prompts**.
 - c. Select the **download** link for the language that you want.

NOTE: For SPA400 Firmware versions above 1.0.1.3, download the PCM format of the files.

- d. Save the sounds.zip file.

NOTE: North American partners can find localization files in the Utilities area of the Linksys Partner Connection.

2. Extract the files:
 - a. Use WinZip to open the sounds.zip file.
 - b. Click **Extract** on WinZip toolbar.
 - c. Select the Desktop or other temporary destination, select the **Use folder names** check box, and then click **Extract**.

A progress bar appears as the files are extracted. The Sounds folder appears in the selected location.

3. Move the files to the SPA400 USB drive to replace the existing voice prompts:
 - a. Power off the SPA400 by removing the power cord, and then remove the USB drive.
 - b. Insert the SPA400 USB drive into a USB port on the PC where you extracted the files.
 - c. When the *USB Disk* window appears, click **Open folder to view files using Windows Explorer**, and then click **OK**. The USB drive contains the *spa400vm* folder.

NOTE: If the *USB Disk* window does not appear, use Windows Explorer to navigate to the USB disk drive (usually Drive E).
 - d. Open *spa400vm\var\lib*. The window displays the *lib* contents, including the *sounds* folder.
 - e. If desired, make a backup copy of the existing *sounds* folder.

NOTE: You are not overwriting any user message files in this procedure. However, it is a good practice to make a backup copy of your files before doing any upgrades.
 - f. Move the new *sounds* folder into *spa400vm\var\lib* on the USB drive. When the *Confirm Folder Replace* window appears, click **Yes to All**.
 - g. Remove the USB drive from the PC and insert it into the SPA400.
 - h. Power on the SPA400.
4. Place a test call to the voice mail system to confirm that the new language prompts are used.

Localizing the SPA400 Call Disconnect Tones

One important aspect of VoIP-PSTN integration is the Call Disconnect operation. This operation allows the gateway to detect that the call has been terminated on the other end, so the local line hangs up automatically. Detecting the tone cadence of the Call Disconnect signal is a trigger for closing the loop.

Each country has its own Call Disconnect Signal tone which needs to be configured on the SPA400 *Tone* page.



Note

This feature is available in SPA400 firmware version 1.0.1.4.

1. Start Internet Explorer, enter the IP address of the SPA400, and log on.
2. Click the **Tone** tab.

Call process tone configuration

Tone on fraction : %

High cutoff frequency : Hz

Low cutoff frequency : Hz

Call process tone detection

Tone Setting

	First Tone		2nd (optional)		3rd (optional)		4th (optional)	
	On (ms)	Off (ms)	On (ms)	Off (ms)	On (ms)	Off (ms)	On (ms)	Off (ms)
Detection time	<input type="text" value="500"/>	<input type="text" value="500"/>	<input type="text"/>	<input type="text"/>	<input type="text"/>	<input type="text"/>	<input type="text"/>	<input type="text"/>

Repeat count :

Save Settings
Cancel Changes

3. Enter the appropriate settings for your country, as listed in [Table 8-2, 'Call Processing Tones,' on page 127.](#)

Table 8-2 Call Processing Tones

Country	First Tone		2nd (optional)		3rd (optional)		4th (optional)		Repeat Count
	On (ms)	Off (ms)	On (ms)	Off (ms)	On (ms)	Off (ms)	On (ms)	Off (ms)	
Australia	375	375	375	375					5
Denmark	450	450	250	250					1
France	500	500							1
Germany	250	250							1
Ireland	500	500							1
Italy	200	200							1
Netherlands	180	330	180	330					2
Norway	200	200							1
Portugal	200	200							1
Spain	200	200	200	200	200	600			2
Sweden	250	750							1
UK	400	350	225	525					2

4. Click **Save Settings**.

5. On the menu, click **Setup > Voice**.
6. Scroll down to the *Tear Down FXO port when silence period detected for* field, and enter: 0
Refer to the following illustration.

Tear down FXO port when silence detected for : sec
(0 ~ 3600, 0 means Turn Off)

Save Settings **Cancel Changes**

7. Click **Save Settings**.
8. To restart the SPA400, complete the following steps:
 - a. Click **Administration > Reboot**.
 - b. Click the **Restart System** button.
 - c. When the confirmation message appears, click **OK**. The SPA400 reboots.
 - d. When the *Reboot OK. Go to Setup page?* message appears, click **OK**.

Localizing the SPA400 Caller ID Method

You need to identify the caller ID method to use in your country.



Note This feature is available in SPA400 firmware version 1.0.1.4.

1. Click **Setup tab > Voice**.
2. Scroll down to the *Line Settings* section.
3. From the *Caller Id and CP Tone Method* drop-down list, choose your region.

Caller Id & CP Tone Method

- North American (default)
- Japanese
- European(FSK)
- Chinese
- UK BT
- UK CCA
- Canadian
- Australian
- Singapore
- DTMF(Finland, Sweden)
- DTMF(Denmark)

NOTE: In the United Kingdom, choose UK BT or UK CCA. In the rest of Europe, choose European (FSK).

4. Click **Save Settings**.
5. To restart the SPA400, complete the following steps:
 - a. Click **Administration > Reboot**.
 - b. Click the **Restart** button.

- c. When the confirmation message appears, click **OK**. The SPA400 reboots.
 - d. When the *Reboot OK* message appears, click **OK**.
6. To verify your progress, make a call from outside to any of the PSTN lines connected to the SPA400 (make sure that CID is enable in your PSTN line). In the ringing SPA phone display you should now be able to see the number from the calling number.

Advanced Topics in LVS Administration

This appendix provides technical information that is useful to individuals who want a better understanding of how the LVS works.

- ["Technology Background," on page 130](#)
- ["SPA9000 Architecture," on page 134](#)
- ["SIP-NAT Interoperation," on page 135](#)
- ["Advanced Call Control and Routing," on page 137](#)
- ["Configuring Vertical \(Supplementary\) Service Codes," on page 137](#)
- ["Advanced Topics for SPA400 Voice Mail Service," on page 141](#)
- ["Remote Provisioning Features," on page 145](#)

Technology Background

This section provides background information about the technology and protocols used by the SPA9000 system. It includes the following topics:

- ["Session Initiation Protocol," on page 130](#)
- ["SPA9000 Media Proxy," on page 132](#)
- ["Using the SPA9000 with a Firewall or Router," on page 133](#)
- ["SPA400 SIP-PSTN Gateway," on page 133](#)

Session Initiation Protocol

The LVS is implemented using open standards, such as Session Initiation Protocol (SIP), allowing interoperation with all ITSPs supporting SIP. [Figure A-1](#) illustrates a SIP request for connection to another subscriber in the network. In the SIP protocol, the requestor of the session is called the user agent server (UAS), while the receiver of the request is called the user agent client (UAC).

Figure A-1 SIP Requests and Responses

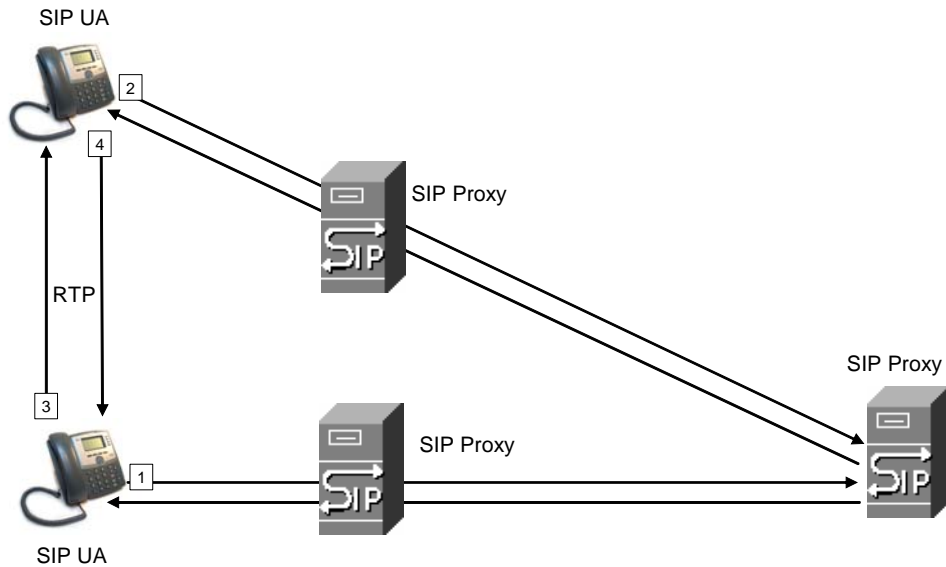
**Note**

In this manual, the term client station is used to describe any SIP UA (including IP phones) that registers with the SPA9000.

In a SIP VoIP network, when the SIP proxy receives a request from a client station (UAS) for a connection and it does not know the location of the UAC, it forwards the message to another SIP proxy in the network. Once the UAC is located and the response is routed back to the UAS, a direct peer-to-peer session is established between the two UAs. The actual voice traffic is transmitted between UAs over dynamically assigned ports using the Real-time Protocol (RTP).

In [Figure A-2](#), UserA and UserB are client stations (UAs) that register over the local area network to which the SPA9000 PBX is connected. When UserA calls UserB, the SPA9000 acts as a SIP proxy and establishes a session between the two UAs. After the session is established, RTP traffic flows directly between the two client stations.

Figure A-2 SPA9000 as a SIP Proxy

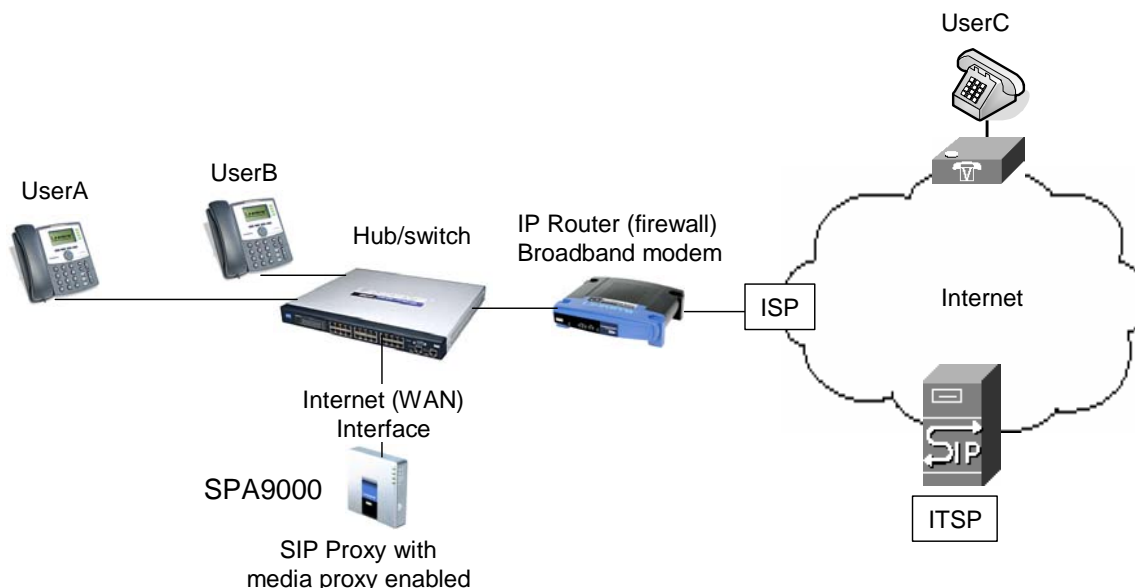

When a user picks up the handset in an LVS system, the SPA9000 collects DTMF digits from a touchtone analog telephone or the locally connected SPA900 Series IP phones. Unless the call is for a local client station, the SPA9000 system sends the full number in a SIP INVITE message to another SIP proxy server for further call processing.

To minimize dialing delay, a dial plan is maintained that is matched against the cumulative number entered by the user. Invalid phone numbers that are not compatible with the dial plan are detected and the user is alerted using a configurable tone (reorder) or announcement.

Figure A-2 also illustrates connectivity between the SPA9000 and the ITSP over the Internet. When UserA calls UserC, the SPA9000 directs the request to the SIP proxy at the ITSP, which is then responsible for routing the request to UserC. Even after the SIP session is established, the SPA9000 continues to direct RTP packets between UserA and the ITSP.

SPA9000 Media Proxy

To address this possible security issue, the SPA9000 can also function as a media (RTP) proxy. This option forces RTP traffic destined for the Internet (or IP WAN) to be directed to the SPA9000, which then directs it to the remote UA. This configuration may simplify firewall configuration because the client stations do not require direct access to the Internet through the firewall.

To enable the media proxy, go to the *Voice > SIP* page, *PBX Parameters* section, and set the *Force Media Proxy* parameter to **True**. With the media proxy enabled, when UserA calls User C, the SPA9000 still acts as the SIP proxy and forwards the request to the SIP server on the ITSP. However, even after the SIP session is established, the SPA9000 continues to direct RTP packets between UserA and the ITSP.

Local traffic is not affected by this configuration. When UserA initiates a call to UserB, RTP traffic still flows directly between the two UAs. The media proxy only affects RTP traffic to a UA connected through the ITSP.

Using the SPA9000 with a Firewall or Router

When using the SPA9000 behind a firewall or router, make sure that the following ports are not blocked:

SIP ports—By default, UDP ports 5060 through 5063

RTP ports—16384 to 16482

Also disable SPI if this function exists on your firewall.

SPA400 SIP-PSTN Gateway

When a local user on the SPA9000 network initiates a call to a PSTN subscriber, the SPA400 acts as the SIP-PSTN gateway, which converts the SIP and RTP media packets into the appropriate signal for transmission to the PSTN switch. For example, if UserA calls UserD, the SIP request is routed by the SIP proxy in the SPA9000 to the SPA400 (see [Figure A-3](#)).

Figure A-3 The SPA400 as a SIP-PSTN Gateway

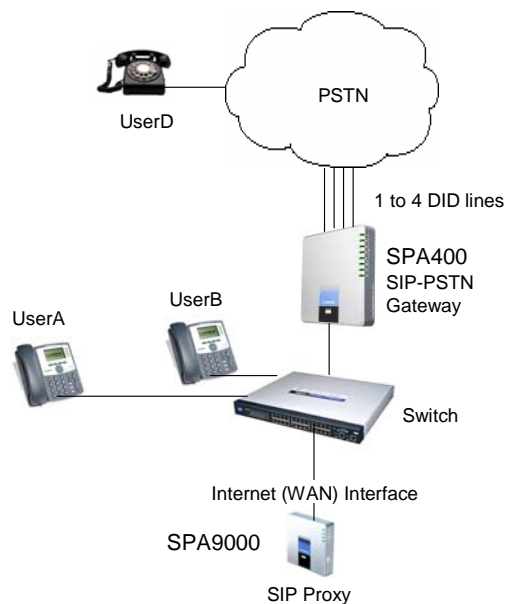

The SPA400 then converts the SIP and RTP packets it receives from UserA and the signals it receives from the PSTN switch.

SPA9000 Architecture

This section describes the basic architecture, function, and configuration options for the SPA9000.

Figure A-4 SPA9000 Architecture

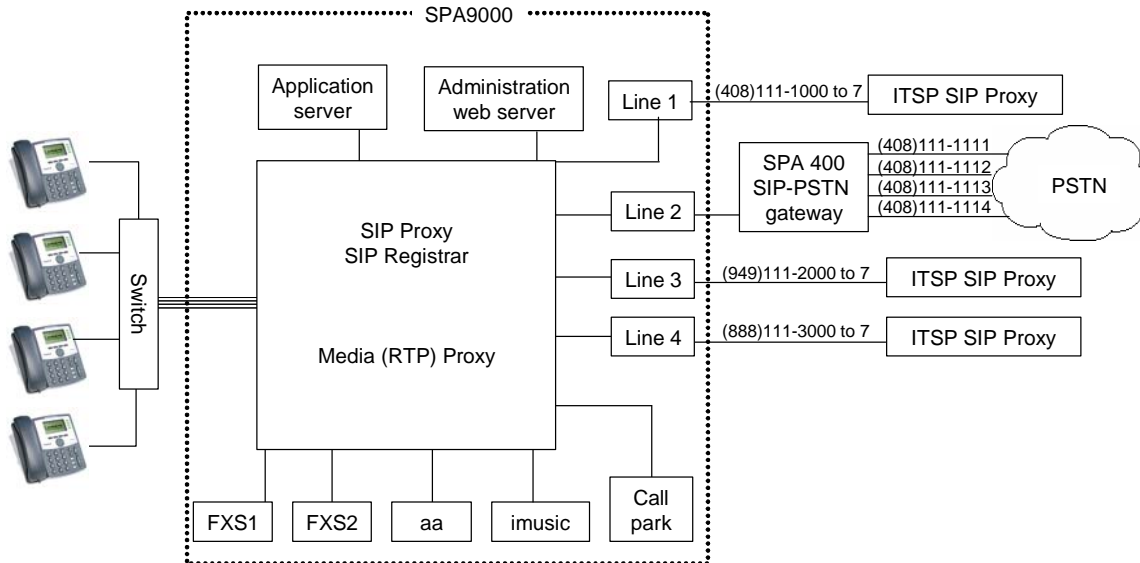

As shown in [Figure A-4](#), the SPA 9000 provides four logical line interfaces, referred to as Line 1, 2, 3, and 4. Each line can be configured with the same or a different ITSP. Each SPA400 also occupies one line interface. The SPA9000 has five internal clients that register implicitly with the internal SIP proxy:

- FXS1 (fxs1)
- FXS2 (fxs2)
- Call Park (callpark)
- Auto-Attendant (aa)
- Internal Music Server (imusic)

FXS1 and FXS2 correspond to the two physical FXS ports. The FXS ports can only register with the local SIP proxy. The Call Park is used to maintain calls that are parked, and AA is a scriptable auto-attendant application.

Table A-1 Architectural Components

Architectural Component	Function
SIP proxy and Registrar server	Accepts registration from client stations and proxies SIP messages.
Media proxy server	Proxies RTP packets between client stations and proxies SIP messages.
Configuration server	Serves configuration files to client stations and auto configures un-provisioned client stations.
Application server	Supports advanced features such as call park/pickup, directory, directed call pickup and group paging, hunt groups, and shared line appearances.
Internal music source	Streams audio files to client stations (both on-net and off-net). The FXS1 and FXS2 can optionally be connected to an external music source to act as a streaming audio server (SAS). When working in this mode, each FXS port can handle up to 10 concurrent calls.
Administration web server	Allows configuration and monitoring of the SPA9000.
ATA with 2 FXS ports	Each FXS port can be connected to analog phones, fax machine, or an external music source. Each port can support up to two calls simultaneously. The FXS ports can only register to the internal proxy server.
Call park	The call park is used to maintain calls that are parked and can handle up to 10 calls simultaneously
Auto-Attendant	AA is a scriptable auto-attendant application that can handle up to 10 calls simultaneously

SIP-NAT Interoperation

If the SPA9000 is behind the NAT device, the private IP address of the SPA9000 is not usable for communications with the SIP entities outside the private network.



Note

If the ITSP offers an outbound NAT-Aware proxy, this discovers the public IP address from the remote endpoint and eliminates the need to modify the SIP message from the UAC.

The SPA9000 system must substitute the private IP address information with the proper external IP address/port in the mapping chosen by the underlying NAT to communicate with a

particular public peer address/port. For this, the SPA9000 system needs to perform the following tasks:

- Discover the NAT mappings used to communicate with the peer.

This can be done with the help of an external device, such as a STUN server. A STUN server responds to a special NAT-Mapping-Discovery request by sending back a message to the source IP address/port of the request, where the message contains the source IP address/port of the original request. The SPA9000 system can send this request when it first attempts to communicate with a SIP entity over the Internet. It then stores the mapping discovery results returned by the server.

- Communicate the NAT mapping information to the external SIP entities.

If the entity is a SIP Registrar, the information should be carried in the Contact header that overwrites the private address/port information. If the entity is another SIP UA when establishing a call, the information should be carried in the Contact header as well as in the SDP embedded in SIP message bodies. The VIA header in outbound SIP requests might also need to be substituted with the public address if the UAS relies on it to route back responses.

- Extend the discovered NAT mappings by sending keep-alive packets.

Because the mapping is alive only for a short period, the SPA9000 system continues to send periodic keep-alive packets through the mapping to extend its validity as necessary.

Determining Whether the Router Uses Symmetric or Asymmetric NAT

STUN does not work on routers with symmetric NAT. With symmetric NAT, IP addresses are mapped from one internal IP address and port to one external, routable destination IP address and port. If another packet is sent from the same source IP address and port to a different destination, then a different IP address and port number combination is used. This method is restrictive because an external host can send a packet to a particular port on the internal host *only if* the internal host first sent a packet from that port to the external host.



Note

This procedure assumes that a syslog server is configured and is ready to receive syslog messages. For more information about logging, see ["Collecting System Logs and Debug Information,"](#) on page 31.

1. Make sure you do not have firewall running on your PC that could block the syslog port (port 514 by default).
2. Connect to the SPA9000 administration web server, and choose Admin access with Advanced settings. (See ["Connecting to the SPA9000 Administration Web Server,"](#) on page 24).
3. To enable debugging on the SPA9000, complete the following tasks:
 - a. Click **Voice tab > System**.

- b. In the *Debug Server* field, enter the IP address of your syslog server.

NOTE: This address and port number must be reachable from the SPA9000.
- c. From the *Debug level* drop-down list, choose **3**.
4. To collect information about the type of NAT your router is using, complete the following tasks:
 - a. Click **Voice tab > SIP**.
 - b. Scroll down to the *NAT Support Parameters* section.
 - c. From the *STUN Test Enable* field, choose **yes**.
5. To enable SIP signalling, complete the following task:
 - a. Click **Voice tab > Line N**, where *N* represents the line interface number.
 - b. In the *SIP Settings* section, choose **full** from the *SIP Debug Option* field.
6. Click **Submit All Changes**.
7. View the syslog messages to determine whether your network uses symmetric NAT. Look for a warning header in the REGISTER messages, such as Warning: 399 spa "Full Cone NAT Detected."

Advanced Call Control and Routing

- ["Configuring Vertical \(Supplementary\) Service Codes," on page 137](#)
- ["Managing the Outbound Call Routing Groups," on page 139](#)
- ["Configuring Outbound Call Codec Selection Codes," on page 141](#)

Configuring Vertical (Supplementary) Service Codes

Users can enter vertical (supplementary) service codes, also known as star (*) codes, to activate special calling features, such as *69 for call return. The LVS is pre-configured with default star codes, but you can customize them for your site. The codes are automatically appended to the dial plan.

1. Connect to the SPA9000 administration web server, and choose Admin access with Advanced settings. (See ["Connecting to the SPA9000 Administration Web Server," on page 24](#)).
2. Click **Voice tab > Regional**.
3. Scroll down to the *Vertical Service Activation Codes* area or the *Vertical Service Announcement Codes* section.

SPA9000 Voice > Regional: Vertical Service Activation Codes, Announcement Codes

Vertical Service Activation Codes			
Call Return Code:	*69	Call Redial Code:	*07
Blind Transfer Code:	*98	Call Back Act Code:	*66
Call Back Deact Code:	*86	Call Back Busy Act Code:	*05
Cfwd All Act Code:	*72	Cfwd All Deact Code:	*73
Cfwd Busy Act Code:	*90	Cfwd Busy Deact Code:	*91
Cfwd No Ans Act Code:	*92	Cfwd No Ans Deact Code:	*93
Cfwd Last Act Code:	*63	Cfwd Last Deact Code:	*83
Block Last Act Code:	*60	Block Last Deact Code:	*80
Accept Last Act Code:	*64	Accept Last Deact Code:	*84
CW Act Code:	*56	CW Deact Code:	*57
CW Per Call Act Code:	*71	CW Per Call Deact Code:	*70
Block CID Act Code:	*67	Block CID Deact Code:	*68
Block CID Per Call Act Code:	*81	Block CID Per Call Deact Code:	*82
Block ANC Act Code:	*77	Block ANC Deact Code:	*87
DND Act Code:	*78	DND Deact Code:	*79
CID Act Code:	*65	CID Deact Code:	*85
CWCID Act Code:	*25	CWCID Deact Code:	*45
Dist Ring Act Code:	*26	Dist Ring Deact Code:	*46
Speed Dial Act Code:	*74	Secure All Call Act Code:	*16
Secure No Call Act Code:	*17	Secure One Call Act Code:	*18
Secure One Call Deact Code:	*19	Conference Act Code:	
Attn-Xfer Act Code:		Modem Line Toggle Code:	*99
FAX Line Toggle Code:	#99	Media Loopback Code:	*03
Referral Services Codes:			
Feature Dial Services Codes:			
Vertical Service Announcement Codes			
Service Annc Base Number:			
Service Annc Extension Codes:			

- Edit the codes, as needed.
- If desired, enter referral services and feature call services codes. For more information, see [Appendix B, "SPA9000 Field Reference," "Regional page" section on page 176.](#)

**Note**

The * codes should not conflict with any of the other vertical service codes internally processed by the SPA9000. You can empty the corresponding *code that you do not want to SPA9000 to process.

- Click **Submit All Changes**. For more information about each field, see ["Vertical Service Activation Codes section," on page 181.](#)

Managing the Outbound Call Routing Groups

Every station belongs to an outbound call routing group. You can leave all stations in the default group, or you can assign selected stations to groups for the purpose of routing their outbound calls to preferred lines.

A company has three sales teams (New York, Los Angeles, and London) that work in an office in New York City. Calls from the New York sales team need to go out through the local PSTN lines. Calls from the Los Angeles team need to go out through an ITSP account with a Los Angeles DID number. Likewise, calls from the London sales team need to go out through an ITSP account with a London DID number. During peak call periods, if a preferred line is unavailable, calls can be routed through the general use ITSP account.

The LVS administrator creates three call routing groups and assigns client stations to them. For each group, the administrator also defines the preferred line interfaces, in order.

Call Routing Group Membership

Every station belongs to one or more of the following call routing groups:

- **Default Group:** The Default Group includes any station that is not assigned to another group.

USE CASE EXAMPLE: Non-sales personnel remain in this group.

- **Group 1 -4:** Groups 1-4 include the stations that are identified in the *Group 1 User ID...* *Group 4 User ID* fields. If the user ID matches more than one group, then the smallest group number is assumed. You can add a station to a group by entering the user ID, or you can add a range of stations by entering numbers and wildcard characters.

USE CASE EXAMPLE: The administrator enters the station user IDs for each group in the following fields:

- **Group 1 User ID:** 11?
This group includes stations 110 through 119, which are used by the New York team.
- **Group 2 User ID:** 101, 102, 103
This group includes stations 101, 102, and 103, which are used by the Los Angeles team.
- **Group 3 User ID:** 203, 204, 209
This group includes stations 203, 204, and 209, which are used by the London team.

Call Routing Group Line Preference

After you create a group, you must enter a list of lines, in the preferred order. When a group member places a call, the SPA9000 chooses the first line in the list. If it is unavailable, the SPA9000 chooses the next line, and so on, until an available line is found. To enter the lines, type the line numbers in the desired order, separated by commas.



Note

The field cannot be left blank.

USE CASE EXAMPLE: The administrator enters the line preferences for each group in the following fields:

- **Group 1 Line:** 2,1
Outbound calls from Group 1 (New York) go out through Line 2 (SPA400 connected to PSTN lines). If that line interface is not available, calls can go out through Line 1 (general use ITSP account).
- **Group 2 Line:** 3,1
Outbound calls from Group 2 (Los Angeles) go out through Line 3 (ITSP account with a Los Angeles DID number). If that line interface is not available, calls can go out through Line 1 (general use ITSP account).
- **Group 3 Line:** 4,1
Outbound calls from Group 3 (London) go out through Line 4 (ITSP account with a London DID number). If that line interface is not available, calls can go out through Line 1 (general use ITSP account).

Creating or Modifying an Outbound Call Routing Group

1. Connect to the SPA9000 administration web server, and choose Admin access with Advanced settings. (See ["Connecting to the SPA9000 Administration Web Server," on page 24](#)).
2. Click **Voice tab > SIP**.
3. Scroll down to the *PBX Parameters* section.
4. In the *Group 1 User ID* field, or other desired Group User ID field, enter the user IDs for the stations that you want to include. For more information, see ["Call Routing Group Membership," on page 139](#).
5. In the *Group 1 Line* field, or other desired Group Line field, enter the line interfaces in the order of preference. For more information, see ["Call Routing Group Line Preference," on page 140](#).

NOTE: As you make your entries, read the field labels to distinguish between the fields for *Group 1 User ID ... Group 4 User ID* and *Group 1 Line ... Group 4 Line*.

6. Click **Submit All Changes**.
7. To verify your progress, place a call to a phone that has caller ID, and confirm that the expected number appears.

Configuring Outbound Call Codec Selection Codes

A user can enter a code selection code before dialing a number, to choose the preferred codec for the associated call. The LVS is pre-configured with default codec selection codes, but you can customize them for your site. The codes are automatically appended to the dial plan.

To select a specific codec per call, the phone user enters the code before entering the telephone number.

1. Connect to the SPA9000 administration web server, and choose Admin access with Advanced settings. (See ["Connecting to the SPA9000 Administration Web Server,"](#) on page 24).
2. Click **Voice tab > Regional**.
3. Scroll down to the *Outbound Call Codec Selection Codes* section.

SPA9000 Voice > Regional: Outbound Call Codec Selection Codes

Outbound Call Codec Selection Codes			
Prefer G711u Code:	*017110	Force G711u Code:	*027110
Prefer G711a Code:	*017111	Force G711a Code:	*027111
Prefer G723 Code:	*01723	Force G723 Code:	*02723
Prefer G726r16 Code:	*0172616	Force G726r16 Code:	*0272616
Prefer G726r24 Code:	*0172624	Force G726r24 Code:	*0272624
Prefer G726r32 Code:	*0172632	Force G726r32 Code:	*0272632
Prefer G726r40 Code:	*0172640	Force G726r40 Code:	*0272640
Prefer G729a Code:	*01729	Force G729a Code:	*02729

4. Edit the codes, as needed.
5. Click **Submit All Changes**.

Advanced Topics for SPA400 Voice Mail Service

On the SPA9000, accessing a voicemail server to check or deposit voicemail is similar to calling an external number, or being call forwarded to an external number. Each line interface can use a different voicemail server.

There are three groups of voicemail operations:

- Depositing voicemail
- Managing voicemail from a client station or from an external number
- Subscription to voicemail notification and receiving voicemail notification

SPA9000 assumes that a voicemail account can include more than one mailbox ID (MBID). The voicemail account is defined with a user-ID, which can be the same as the line interface user-ID.

Three parameters must be configured on the SPA9000 for each line to support these operations: <Mailbox Deposit URL>, <Mailbox Manager URL>, and <Mailbox Subscribe URL>.

**Note**

The mailbox ID should be set to the extension number.

Voicemail service may be offered by a service provider different from the ITSP. For example, you can configure Line 1, 2, and 3 with accounts on an ITSP, but configure Line 4 an account with a different Internet voicemail service provider (IVMSP). The SPA9000 can be configured to bridge calls between the ITSP and the IVMSP when necessary (when depositing or checking voicemail by an external caller) using the <VMSP Bridge> parameter on each line interface.

How Voicemail Works

When a user checks voicemail from a client station, the SPA9000 sends an INVITE on its behalf to the configured <Mailbox Manage URL>. For example:

```
INVITE sip:mailbox-manage-url SIP/2.0
Via: SIP/2.0/UDP 192.168.2.205:5060;branch=z9hG4bK-171eb6b5
From: <sip:37683102@sip.myitisp.com>;tag=300704dd2590d20bo2;ref=5031;mbid=53371
To: <sip:mailbox-manage-url>
Call-ID: 58a2b2c5-66e2bd43@192.168.2.205
CSeq: 101 INVITE
Max-Forwards: 70
Contact: <sip:37683102@192.168.2.205:5060>
```

Here the client station is at extension 5031 and the mailbox ID is 53371. The voicemail server should then prompt the caller to enter a PIN and access the voicemail features for the given mailbox.

A user should also be able to call an external number explicitly from anywhere to retrieve voice mail messages. When the voicemail server receives such a call, it should prompt the caller to enter the mailbox ID and then the PIN number. If the user-ID of the voicemail account cannot be uniquely identified from the mailbox ID or from the called number, the server must first prompt the user to enter the user-ID before proceeding.

**Note**

If an EXT-To-DID mapping exists for the calling extension on the line interface, the user-ID and display name fields of the FROM header are replaced by the mapped DID number and the display name assigned to the phone, respectively. In this case, a DIVERSION header similar to the REFERRED-BY header is also included.

Checking Voicemail from an External Number

The Internet voicemail service provider (IVMSP) may have an external number for their subscribers to call to check/manage their mailboxes. If this is not available, you may do one of the following:

- Assign a DID number (from the ITSP).

- Create a virtual extension for this purpose.

For method (a), specify a rule in the <Contact List> for the dedicated DID number. For the DID number 18005551000, this would look like the following example:

```
...|...|18005551000:vmm3|...
```

The syntax vmm<n> tells the SPA9000 to forward calls dialed to 18005551000 to the voicemail management URL on Line <n>. Because no particular mailbox is specified in this example, the caller is prompted to enter the voicemail number after the voicemail server answers. You may also specify a particular mailbox ID with this syntax (for example, vm31234).

Method (b) is used in conjunction with the Auto-Attendant. For example, you can define a single-digit extension 7 to map to the voicemail management URL on Line 4, by adding a rule to <AA Dial Plan 1> or <AA Dial Plan 2> depending on which one you are using. The rule would look like the following:

```
<7:vmm4>
```

Again, you may also specify a particular mailbox in this syntax. For information about configuring the Auto-Attendant, refer to [Chapter 5, "Configuring the LVS Auto-Attendant."](#)

Depositing Voicemail

An external caller can be triggered to deposit voicemail into a mailbox by sending it a REFER request during a call with <Mailbox Deposit URL> indicated in the REFER-TO header and the mailbox ID in the REFERRED-BY header. The caller device then sends INVITE to the <Mailbox Deposit URL> as shown in the example below:

```
INVITE sip:mailbox-deposit-url SIP/2.0
Via: SIP/2.0/UDP 24.35.36.111;branch=z9hG4bK-29752ae9
From: "External Caller" <sip:9991234@sip.myitisp.com>;tag=b99e21414928473o2
To: <sip:mailbox-deposit-url>
Call-ID: 69e9e3d9-cfcbe2bb@24.35.36.111
CSeq: 101 INVITE
Contact: <sip:9991234@24.35.36.111>
Referred-By: <sip:37683101@sip.myitisp.com>;ref=5041;mbid=7675
```

In the last example, the caller is directed to deposit voicemail in the mailbox ID 7675 on the voicemail account 37683101. It further indicates that the directing station is at the internal extension 5041. Note that it is assumed that the caller device (or the ITSP) is faithfully relayed over the REFERRED-BY header.



Note The mailbox ID must be set to the extension number.

The INVITE sent for an internal caller to deposit voicemail is similar, except that the FROM header also includes a reference parameter, as shown in the following example:

```
INVITE sip:mailbox-deposit-url SIP/2.0
Via: SIP/2.0/UDP 172.12.244.56;branch=z9hG4bK-29752ae9
```

```

From: Line 1 <sip:37683101@sip.myitsp.com>;tag=b99e21414928473o2;ref=5031
To: <sip:mailbox-deposit-url>
Call-ID: 69e9e3d9-cfcbe2bb@172.12.244.56
CSeq: 101 INVITE
Max-Forwards: 70
Contact: <sip:37683101@172.12.244.56>
Referred-By: <sip:37683101@sip.myitsp.com>;mbid=7675

```

In the above example, the station wanting to deposit voicemail is at extension 5031; the mailbox ID is 7675 on the account 37683101 (for the station at extension 5041). Note that the referrer is the same as the caller in the last INVITE. In other words, this INVITE is self-triggered by the SPA9000.

If an EXT-To-DID mapping exists for the calling extension on the line interface, the user-ID and display name fields of the FROM header is replaced by, respectively, the mapped DID number and the display name assigned to the phone. Furthermore, if an EXT-To-DID mapping exists for the called phone, the user-ID field of the REFERRED-BY header is also replaced by the mapped DID number for the called extension.

Note

For information about how to add an EXT-to-DID mapping, see the <Contact List> parameter in [Appendix B, "SPA9000 Field Reference."](#)

Subscribing to Voicemail Notification

The SPA9000 sends a one-time SUBSCRIBE for the message-summary event package for each line with a valid <Mailbox Subscribe URL>. The SUBSCRIBE implies subscription for the status of all the mailboxes associated with the voicemail account used-ID; it does not include any mailbox ID in the request. Following is an example:

```

SUBSCRIBE sip:mailbox-subscribe-url SIP/2.0
Via: SIP/2.0/UDP 172.16.22.23:5062;branch=z9hG4bK-44f9d0f0
From: Line 3 <sip:14089991003@sip.myitsp.com>;tag=ac6013983cce7526
To: <sip:mailbox-subscribe-url>
Call-ID: ace86200-bbe839de@172.16.22.23
CSeq: 63017
SUBSCRIBE Max-Forwards: 70
Contact: <sip:14089991003@172.16.22.23:5062>
Expires: 30
Event: message-summary
User-Agent: Sipura/SPA9000-3.2.2
Content-Length: 0

```

The voicemail server is expected to send a NOTIFY immediately upon receiving this SUBSCRIBE message for each mailbox on this account. The Request-URI of the NOTIFY should reference the CONTACT header of the corresponding SUBSCRIBE, but the user-ID in the To header should be the mailbox ID. The following example shows a NOTIFY for the mailbox ID 5031 on the account 14089991003:

NOTIFY sip:14089991003@172.16.22.23:5062 SIP/2.0
 Via: SIP/2.0/UDP 178.178.221.230;branch=z9hG4bK-44f9d0f0
 From: <sip:voicemail@sip.myitsp.com>;tag=ab789
 To: <sip:5031@172.16.22.23:5062>;tag=ac6013983cce7526
 Call-ID: ace86200-bbe839de@178.178.221.230
 CSeq: 537
 NOTIFY Expires: 30
 Event: message-summary User-Agent: ITSP/Voicemail-Server
 Content-Length: 0
 Messages-Waiting: yes
 Voice-Message: 2/8 (0/2)

**Note**

Note that SPA9000 does not require the NOTIFY to be sent within the same subscription dialog. That is, it accepts the NOTIFY even without a TO-tag or a matching Call-ID as the original SUBSCRIBE.

Remote Provisioning Features

The SPA9000 provides for secure provisioning and remote upgrade. Provisioning is achieved through configuration profiles that are transferred to the device via TFTP, HTTP, or HTTPS.

Using Configuration Profiles

The SPA9000 accepts configuration profiles in XML format, or alternatively in a proprietary binary format, which is generated by a profile compiler tool available from Linksys. The SPA9000 supports up to 256-bit symmetric key encryption of profiles. For the initial transfer of the profile encryption key (initial provisioning stage), the SPA9000 can receive a profile from an encrypted channel (HTTPS with client authentication), or it can resync to a binary profile generated by the Linksys-supplied profile compiler. In the latter case, the profile compiler can encrypt the profile specifically for the target SPA9000, without requiring an explicit key exchange.

The XML file consists of a series of elements (one per configuration parameter), encapsulated within the element tags <flat-profile> ... </flat-profile>. The encapsulated elements specify values for individual parameters.

Refer to the following example of a valid XML profile:

```

<flat-profile>
  <Admin_Passwd>some secret</Admin_Passwd>
  <Upgrade_Enable>Yes</Upgrade_Enable>
</flat-profile>
  
```

Binary format profiles contain SPA9000 parameter values and user access permissions for the parameters. By convention, the profile uses the extension .cfg (for example, spa2000.cfg). The Linksys Profile Compiler (SPC) tool compiles a plain-text file containing parameter-value pairs into a properly formatted and encrypted .cfg file. The SPC tool is available from Linksys for the Win32 environment and Linux-i386-elf environment. Requests for SPC tools compiled on other

platforms are evaluated on a case-by-case basis. Please contact your Linksys sales representative for further information about obtaining the SPC tool.

The syntax of the plain-text file accepted by the profile compiler is a series of parameter-value pairs, with the value in double quotes. Each parameter-value pair is followed by a semicolon. Here is an example of a valid text source profile for input to the SPC tool:

```
Admin_Passwd "some secret";  
Upgrade_Enable "Yes";
```

Refer to the *LVS SPA Provisioning Guide* for further details.

The names of parameters in XML profiles can generally be inferred from the SPA9000 configuration Web pages, by substituting underscores (`_`) for spaces and other control characters. Further, to distinguish between Lines 1, 2, 3, and 4, corresponding parameter names are augmented by the strings `_1_`, `_2_`, `_3_`, and `_4_`. For example, Line 1 Proxy is named `Proxy_1_` in XML profiles.

Parameters in the case of source text files for the SPC tool are similarly named, except that to differentiate Line 1, 2, 3, and 4, the appended strings (`[1]`, `[2]`, `[3]`, or `[4]`) are used. For example, the Line 1 Proxy is named `Proxy[1]` in source text profiles for input to the SPC.

Client Auto-Configuration

An unprovisioned client station in the factory default state can be automatically provisioned by the SPA9000 by following the flow chart shown in [Figure A-5](#).

When the SPA9000 receives a request for `/cfg/init_$MA.xml`, it automatically assigns the next available user ID (extension number) to this client station. The next user ID to be assigned to a new client station is configured using The `<Next Auto User ID>` parameter and is automatically incremented each time a new number is assigned. Before assigning a new user ID, the SPA9000 also checks whether there is any registered client station using that ID and keeps increasing the ID until an unused value is found.

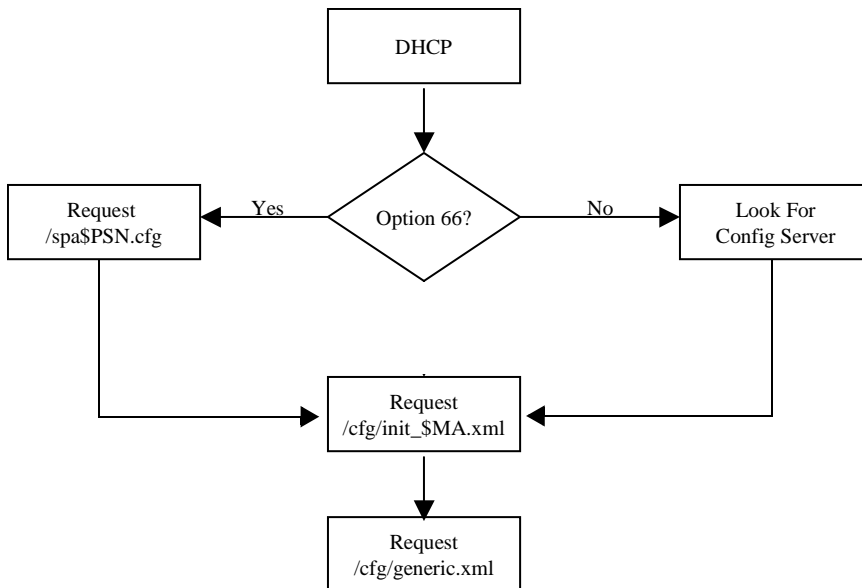
Figure A-5 Unprovisioned Client Station Acquiring a Configuration Profile

To add a new IP phone to the SPA9000, connect the IP phone to the QoS switch to which the SPA9000 is connected and power on the unit.

To add a previously-used IP phone to the SPA9000, perform the following steps:

1. Upgrade the IP phone with SPA9000-compatible firmware.
2. Factory reset the unit.
3. Power cycle the unit.
4. Connect the unit to the switch.

The SPA9000 provisions only the necessary parameters to the client stations. It assumes the rest of the parameters have appropriate values, which are either the default values or manually configured values. For example, the SPA9000 provisions only Extension 1 on the client stations. Access the administration web server using the Administrator account to manually configure other extensions on specific client stations.

Manual Client Configuration

The client stations can also be manually configured with the contents of the profile served by the SPA9000.

The following XML file is served by the SPA9000 when a client station requests `/spa$PSN.cfg`

```

<flat-profile>
<Resync_Periodic>1</Resync_Periodic>
<Profile_Rule>tftp://spa-9000-ip-address:69/cfg/init_$MA.xml</Profile_Rule>
</flat-profile>
  
```

The following XML file is served by the SPA9000 when client station requests `/cfg/init_$MA.xml`:

```

<flat-profile>
<User_ID_1_>next-available-user-id</User_ID_1_>
<Extension_1_>1</Extension_1_>
  
```

```

<Short_Name_1_>next-available-user-id</Short_Name_1_>
<Extension_2_>1</Extension_2_>
<Short_Name_2_>next-available-user-id</Short_Name_2_>
<Extension_3_>1</Extension_3_>
<Short_Name_3_>next-available-user-id</Short_Name_3_>
<Extension_4_>1</Extension_4_>
<Short_Name_4_>next-available-user-id</Short_Name_4_>
<Station_Name>client-station-mac-address</Station Name>
<Resync_Periodic>1</Resync_Periodic>
<Resync_Error_Retry_Delay>10</Resync_Error_Retry_Delay>
<Profile_Rule>ftp://spa-9000-ip-address:69/cfg/generic.xml</Profile_Rule>
<Linksys_Key_System>1</Linksys_Key_System>
</flat-profile>

```

The following XML file is served by the SPA9000 when a client station requests /cfg/generic.xml:

```

<flat-profile>
<Resync_Periodic>0</Resync_Periodic>
<Resync_Error_Retry_Delay>3600</Resync_Error_Retry_Delay>
<Admin_Passwd>spa-9000-admin-passwd</Admin_Passwd>
<Password_1_>phone-ext-password</Password_1_>
<Proxy_1_>spa-9000-ip-address:proxy-listen-port</Proxy_1_>
<Voice_Mail_Server_1_>spa-9000-ip-address:proxy-listen-port </Voice_Mail_Server_1_>
<Voice_Mail_Number>vmm</Voice_Mail_Number>
<Cfwd_Busy_Dest>vm</Cfwd_Busy_Dest>
<Cfwd_No_Ans_Dest>vm</Cfwd_No_Ans_Dest>
<Multicast_Address>spa-9000-multicast-address</Multicast_Address>
<Upgrade_Rule>phone-upgrade-rule</Upgrade_Rule>
<Dial_Plan>phone-dial-plan</Dial_Plan>
<Linksys_Key_System>1</Linksys_Key_System>
<Remote_Party_ID_1_>1</Remote_Party_ID_1_>
<Time_Zone>time-zone</Time_Zone>
<Daylight_Saving_Time_Rule>daylight-saving-time</Daylight_Saving_Time_Rule>
</flat-profile>

```

Table A-2 lists the variables used in these XML files.

Table A-2 Variables Used in XML Configuration Files

Variable	Description
spa-9000-ip-address	IP address of the SPA9000 SIP Proxy.
proxy-listen-port	Port at which the SPA9000 SIP Proxy is listening. This value is configured in <Proxy Listen Port>.
client-station-mac-address	This is the MAC address of the client station who is requesting the profile /cfg/init_\$(MA).xml (in other words, the \$(MA) portion of the requested filename).
next-available-user-id	The current value of <Next Auto User ID>.
Phone-upgrade-rule	Upgrade rule to be used by the client stations. This value is configured in <Phone Upgrade Rule>.
Phone-dial-plan	Dial plan to be used by the client stations. This value is configured in <Phone Dial Plan>.

Table A-2 Variables Used in XML Configuration Files

Variable	Description
time-zone	<Time Zone> value that is configured on the SPA9000.
daylight-saving-time	<Daylight Saving Time Rule> value that is configured on the SPA9000.
phone-ext-password	<Phone Ext Password> value configured on the SPA9000.
spa-9000-admin-passwd	<Admin Passwd> value configured on the SPA9000.
spa-9000-multicast-address	<Multicast Address> value configured on the SPA9000.

Client stations download spa\$PSN.cfg and init_\$MA.xml only once for initial configuration. However, they download generic.xml on every reboot. Therefore, parameters manually configured on the client station that overlap with the contents of generic.xml are overwritten with the SPA9000-supplied values. The list of parameters included in generic.xml are thus purposely kept to a very small set.

Client Registration

All client stations served by the SPA9000 must register to the SPA9000, which does not allow a station to make calls unless it is registered. If the client station is configured with Station Name, it should include a P-STATION-NAME header in the REGISTER request. Following is an example where User-A has been assigned a primary extension of 5031.

```
REGISTER sip:192.168.0.1:6060 SIP/2.0
Via: SIP/2.0/UDP 192.168.0.4:5060;branch=z9hG4bK-8865c41e
From: "User-A" <sip:5031@192.168.0.1:6060>;tag=a76a3e1dfc6045cdo0
To: "User-A" <sip:5031@192.168.0.1:6060>
Call-ID: 52dab65d-21d02a8d@192.168.0.4
CSeq: 1 REGISTER
Max-Forwards: 70
Contact: "User-A" <sip:5031@192.168.0.4:5060>;expires=3600
User-Agent: Sipura/SPA841-3.1.4(a0714sec)
P-Station-Name: User-A
Content-Length: 0
Allow: ACK, BYE, CANCEL, INFO, INVITE, NOTIFY, OPTIONS, REFER, SUBSCRIBE
Allow-Events: dialog
```

In this example, User-A shares a line appearance with User-B, whose primary extension is 5041. Extension 2 on the User-A station must then be set up the same way as Extension 1 (User-A primary extension), but with the <Shared User ID> parameter set to 5041. The User-A station then performs a third-party registration for Extension 2, as shown below. Note that the TO header <user-id> parameter is the User-B primary extension.

```
REGISTER sip:192.168.0.1:6060 SIP/2.0
Via: SIP/2.0/UDP 192.168.0.4:5061;branch=z9hG4bK-25c8108c
From: "User-A" <sip:5031@192.168.0.1:6060>;tag=3c43d094a9424bo1
To: "User-A" <sip:5041@192.168.0.1:6060>
Call-ID: 26c913d8-485f71e3@192.168.0.4
CSeq: 1 REGISTER
Max-Forwards: 70
Contact: "User-A" <sip:5041@192.168.0.4:5061>;expires=3600
User-Agent: Sipura/SPA841-3.1.4(a0714sec)
```

P-Station-Name: 000e08daf417
 Content-Length: 0
 Allow: ACK, BYE, CANCEL, INFO, INVITE, NOTIFY, OPTIONS, REFER, SUBSCRIBE
 Allow-Events: dialog

The 200 reply sent by the SPA9000 to the client station REGISTER request includes a DATE header that the client station can use to synchronize with its local real-time clock. The time served in the DATE header is the local time (as opposed to GMT). There is thus no need to configure an NTP server or a time zone on the client stations. This assumes that the SPA9000 can maintain the real-time clock based on an NTP server or a DATE header supplied by the ITSP. Following is an example of a 200 response to REGISTER (note that there is no weekday in the DATE header):

```
SIP/2.0 200 OK
To: "User-A" <sip:5031@192.168.0.1:6060>;tag=41a7-0
From: "User-A" <sip:5031@192.168.0.1:6060>;tag=8d0bd416dc8a7ec2o0
Call-ID: 9a12cb26-8d9172f2@192.168.0.4
CSeq: 1 REGISTER
Via: SIP/2.0/UDP 192.168.0.4:5060;branch=z9hG4bK-e62fe987
Contact: sip:5031@192.168.0.4:5060;expires=3600
Content-Length: 0
Date: Mon, 18 Jul 2005 14:39:40 PST
```

Using the Upgrade URL

Remote firmware upgrade is achieved via TFTP or HTTP (firmware upgrades using HTTPS are not supported). Remote upgrades are controlled by configuring the desired firmware image URL into the SPA9000 via a remote profile resync.



Note To use this feature, the *Upgrade Enable* field on the *Voice > Provisioning* page must be set to **Yes**.

SYNTAX:

`http://spa-ip-addr/admin/upgrade?[protocol://][server-name[:port]][/firmware-pathname]`

EXAMPLE: `http://192.168.2.217/admin/upgrade?tftp://192.168.2.251/spaconf.cfg`

Both HTTP and TFTP are supported for the upgrade operation.

- If no protocol is specified, TFTP is assumed. If **no server-name** is specified, the host that requests the URL is used as *server-name*.
- If no port specified, the default port of the protocol is used. (69 for TFTP or 80 for HTTP)
- The *firmware-pathname* is typically the file name of the binary located in a directory on the TFTP or HTTP server. If no *firmware-pathname* is specified, `/spa.bin` is assumed, as in the following example: `http://192.168.2.217/admin/upgrade?tftp://192.168.2.251/spa.bin`

Using the Resync URL

The SPA9000 can be configured to automatically resynchronize its internal configuration state to a remote profile periodically and on power up. The automatic resyncs are controlled by configuring the desired profile URL into the device.

**Note**

The SPA resynchronizes only when it is idle.

SYNTAX:

`http://spa-ip-addr/admin/resync?[[protocol://]][server-name[:port]]/profile-pathname]`

EXAMPLE: `http://192.168.2.217/admin/resync?tftp://192.168.2.251/spaconf.cfg`

- If no parameter follows **/resync?**, the Profile Rule setting from the Provisioning page is used.
- If no protocol is specified, TFTP is assumed. If no server-name is specified, the host that requests the URL is used as *server-name*.
- If no port is specified, the default port is used (69 for TFTP, 80 for HTTP, and 443 for HTTPS).
- The profile-path is the path to the new profile with which to resync.

Using the Reboot URL

You can use the Reboot URL to reboot the SPA9000.

**Note**

The SPA9000 reboots only when it is idle.

SYNTAX: `http://spa-ip-addr/admin/reboot`

EXAMPLE: `http://192.168.2.217/admin/reboot`

SPA9000 Field Reference

This appendix describes the fields on each page of the SPA9000 administration web server.

After you connect to the SPA9000, you can use the following tabs to open the modules of the application:

- ["Router Tab," on page 152](#)
- ["Voice tab," on page 156](#)

Router Tab

After you click the *Router* tab, you can choose the following pages:

- ["Status page," on page 152](#)
- ["Wan Setup page," on page 153](#)
- ["Lan Setup page and Application page," on page 156](#)

Router tab >

Status page

You can use the *Status* page to view information about the SPA9000. The *Status* page has the following sections:

- ["Product Information section," on page 152](#)
- ["System Status section," on page 153](#)

Router tab > *Status page* >

Product Information section

Product Name	Model number of the SPA9000
Serial Number	Serial number of the SPA9000
Software Version	Version number of the SPA9000 software
Hardware Version	Version number of the SPA9000 hardware
MAC Address	MAC address of the SPA9000
Client Certificate	Status of the client certificate, which authenticates the SPA9000 for use in the ITSP network
Customization	For an remote configuration (RC) unit, this field indicates whether the unit has been customized or not. Pending indicates a new RC unit that is ready for provisioning. If the unit has already retrieved its customized profile, this field displays the name of the company that provisioned the unit.

Licenses	When populated with the value K0, indicates that the SPA9000 is licensed for up to 16 users; if this field is blank, install firmware version 5.2.5 or higher.
----------	--

Router tab > Status page >
System Status section

Current Time	Current date and time of the system; for example, 10/3/2003 16:43:00
Elapsed Time	Total time elapsed since the last reboot of the system; for example, 25 days and 18:12:36
Wan Connection Type	The connection type: DHCP or Static IP
Current IP	The current IP address assigned to the SPA9000
Host Name	The current host name assigned to the SPA9000
Domain	The network domain name of the SPA9000
Current Netmask	The network mask assigned to the SPA9000
Current Gateway	The default router assigned to the SPA9000
Primary DNS	The primary DNS server assigned to the SPA9000
Secondary DNS	The secondary DNS server assigned to the SPA9000
LAN IP Address	The LAN IP address of the SPA9000. SPA9000 NOTE: Do not deploy the SPA9000 as a router.
Broadcast Pkts Sent	Total number of broadcast packets sent
Broadcast Bytes Sent	Total number of broadcast bytes sent
Broadcast Pkts Recv	Total number of broadcast bytes received
Broadcast Bytes Recv	Total number of broadcast bytes received and processed
Broadcast Pkts Dropped	Total number of broadcast packets received but not processed
Broadcast Bytes Dropped	Total number of broadcast bytes received but not processed

Router tab >
Wan Setup page

You can use the *Wan Setup* page to enter the WAN connection settings. This page includes the following sections:

- ["Internet Connection Settings section," on page 154](#)
- ["Static IP Settings section," on page 154](#)
- ["PPPoE Settings section," on page 154](#)
- ["Optional Settings section," on page 154](#)
- ["MAC Clone Settings section," on page 155](#)
- ["Remote Management section," on page 155](#)
- ["QoS Settings section," on page 155](#)

- ["VLAN Settings section," on page 155](#)

Router tab > Wan Setup page >

Internet Connection Settings section

Connection Type	IP address assignment scheme, static or DHCP.
-----------------	---

Router tab > Wan Setup page >

Static IP Settings section

Static IP	Static IP address of SPA9000, which takes effect if DHCP is disabled. Default: 0.0.0.0
NetMask	The NetMask used by SPA9000 when DHCP is disabled. Default: 255.255.255.0
Gateway	The default gateway used by SPA9000 when DHCP is disabled. Default: 0.0.0.0

Router tab > Wan Setup page >

PPPoE Settings section

PPPoE Login Name	The account name assigned by the ISP for connecting on a Point-to-Point Protocol over Ethernet (PPPoE) link.
PPPoE Login Password	The password assigned by the ISP for connecting on a Point-to-Point Protocol over Ethernet (PPPoE) link.
PPPoE Service Name	The service name assigned by the ISP for connecting on a Point-to-Point Protocol over Ethernet (PPPoE) link.

Router tab > Wan Setup page >

Optional Settings section

HostName	The host name of the SPA9000
Domain	The network domain of the SPA9000.
Primary DNS	The DNS server that is used by the SPA9000 NOTE: When DHCP is enabled, you can enter the IP address of a DNS server in addition to DHCP-supplied DNS servers. When DHCP is disabled, enter the primary DNS server. Default: 0.0.0.0
Secondary DNS	The DNS server that is used by the SPA9000 NOTE: When DHCP is enabled, you can enter the IP address of a DNS server in addition to DHCP-supplied DNS servers. When DHCP is disabled, enter the primary DNS server. Default: 0.0.0.0
DNS Server Order	The method for selecting the DNS server: Manual, Manual/DHCP, and DHCP/Manual

DNS Query Mode	The mode of DNS query: parallel or sequential NOTE: With parallel DNS query mode, the SPA9000 sends the same DNS lookup request to all the DNS servers at the same time, and the first incoming reply is accepted by the SPA9000. Default: parallel
Primary NTP Server	The IP address or name of the primary NTP server
Secondary NTP Server	The IP address or name of the secondary NTP server
DHCP IP Revalidate Timer:	

Router tab > Wan Setup page >

MAC Clone Settings section

Enable MAC Clone Service	Enable if you need to assign a different MAC address to the SPA9000 via the Cloned MAC Address field.
Cloned MAC Address	The MAC address that you need the SPA9000 to assume

Router tab > Wan Setup page >

Remote Management section

Enable WAN Web Server	Allows (yes) or prevents (no) access to the administration web server from a computer that is not directly connected to the SPA9000. Default: yes
WAN Web Server Port	The port that is used for WAN access to the SPA9000 Default: 80

Router tab > Wan Setup page >

QoS Settings section

QoS Policy	The queueing discipline, set to none or token bucket filter (TBF). TBF limits the rate of transmission to not attempt to exceed the Maximum Uplink Speed.
QoS QDisc	Allow QoS Queuing. Options are None or TBF (token bucket filter). Information can be found at about TBF at: http://lartc.org/howto/lartc.qdisc.classless.html
Maximum Uplink Speed	Define this value to allow the token bucket filter queueing discipline to manage traffic flow to ensure high quality voice audio.

Router tab > Wan Setup page >

VLAN Settings section

Enable VLAN	Enable voice data to be tagged with the defined VLAN ID. NOTE: Choose yes if your SPA9000 is connected to a switch that uses VLAN tagging.
-------------	---

VLAN ID	The VLAN tag for the VLAN to which the SPA9000 is assigned
---------	--

Router tab >

Lan Setup page and Application page



Note

Linksys Engineering and Quality Assurance strongly advise against using the SPA9000 as a router. For this reason, the *Lan Setup* and *Application* tabs should not be modified from the default, unused state. The SPA9000 must only be connected to a switch via the SPA9000 INTERNET RJ45 connector. Do not connect any cable to the SPA9000 ETHERNET port, or you may experience degraded audio performance.

Voice tab

After you click the Voice tab, you can use the following pages:

- ["Info page," on page 156](#)
- ["Voice tab >," on page 159](#)
- ["SIP Page," on page 160](#)
- ["Regional page," on page 176](#)
- ["FXS 1/2 page," on page 189](#)
- ["Line 1/2/3/4 page," on page 196](#)

Voice tab >

Info page

You can use the *Info* page to view information about the FXS devices and the line interfaces. This page includes the following sections:

- ["Product Information section," on page 152](#)
- ["System Status section," on page 157](#)
- ["FXS 1/2 Status section," on page 157](#)
- ["Line 1/2/3/4 Status section," on page 158](#)
- ["Auto Attendant Prompt Status section," on page 158](#)
- ["Internal Music Status section," on page 159](#)

Voice tab > Info page >

Product Information section

Product Name	The model number of the SPA9000
Serial Number	The serial number of the SPA9000
Software Version	The version number of the SPA9000 software
Hardware Version	The version number of the SPA9000 hardware
MAC Address	The MAC address of the SPA9000
Client Certificate	The status of the client certificate, which authenticates the SPA9000 for use in the ITSP network
Customization	For an remote configuration (RC) unit, this field indicates whether the unit has been customized or not. Pending indicates a new RC unit that is ready for provisioning. If the unit has already retrieved its customized profile, this field displays the name of the company that provisioned the unit.
Licenses	When populated with the value K0, indicates that the SPA9000 is licensed for up to 16 users; if this field is blank, install firmware version 5.2.5 or higher.

Voice tab > Info page >

System Status section

Current Time	The current date and time of the system; for example, 10/3/2003 16:43:00
Elapsed Time	The total time elapsed since the last reboot of the system; for example, 25 days and 18:12:36

Voice tab > Info page >

FXS 1/2 Status section

Hook State	The readiness of the device that is connected to the corresponding Phone port on the SPA9000 <ul style="list-style-type: none"> • On: Ready for use • Off: In use
Message Waiting	Indicates whether the station assigned to the FXS port has new voicemail waiting: Yes or No
Call Back Active	Indicates whether a call back request is in progress: Yes or No
Last Called Number	Last number called
Last Caller Number	Number of the last caller if available from caller ID, example 4085551212
Call 1/2 State	Status of the call; Ringing, Idle, or Connected
Call 1/2 Tone	Type of tone used by the call, for example Ring Back 2 for inbound call or None for outbound call
Call 1/2 Encoder	Codec used for encoding
Call 1/2 Decoder	Codec used for decoding

Call 1/2 FAX	Status of the fax pass-through mode; set to No if this line is used for voice calls
Call 1/2 Type	Direction of the call: Inbound or Outbound
Call 1/2 Remote Hold	Indicates whether or not the far end has placed the call on hold: Yes or No
Call 1/2 Callback	Indicates whether the call was triggered by a call back request
Call 1/2 Peer Name	Name of the peer, internal station name if local phone, or name acquired from caller-ID
Call 1/2 Peer Phone	Phone number of the other phone involved in the call, either the extension if a local phone, or the number acquired from caller-ID
Call 1/2 Duration	Duration of the call
Call 1/2 Packets Sent	Number of packets sent
Call 1/2 Packets Recv	Number of packets received
Call 1/2 Bytes Sent	Number of bytes sent
Call 1/2 Bytes Recv	Number of bytes received
Call 1/2 Decode Latency	Number of milliseconds for decoder latency
Call 1/2 Jitter	Number of milliseconds for receiver jitter
Call 1/2 Round Trip Delay	Number of milliseconds for delay
Call 1/2 Packets Lost	Number of packets lost
Call 1/2 Packet Error	Number of invalid packets received

Voice tab > Info page >

Line 1/2/3/4 Status section

)

Registration State	The status of the registration on the line interface: Registered or Not Registered
Last Registration At	Last date and time the line was registered: mm/dd/yyyy hh:mm:ss
Next Registration In	Number of seconds before the next registration renewal; example 2672s
Message Waiting	Indicates whether you have new voicemail waiting: Yes or No
Mapped SIP	Port number of the SIP port mapped by NAT

Voice tab > Info page >

Auto Attendant Prompt Status section

Field	Description
Prompt 1	The duration of the prompt in milliseconds
Prompt 2	The duration of the prompt in milliseconds
Prompt 3	The duration of the prompt in milliseconds
Prompt 4	The duration of the prompt in milliseconds
Prompt 5	The duration of the prompt in milliseconds
Prompt 6	The duration of the prompt in milliseconds
Prompt 7	The duration of the prompt in milliseconds

Prompt 8	The duration of the prompt in milliseconds
Prompt 9	The duration of the prompt in milliseconds
Prompt 10	The duration of the prompt in milliseconds
Space Remaining	Number of milliseconds available
Current AA	Auto-attendant in use; example: Daytime

Voice tab > Info page >

Internal Music Status section

Installed Music Path	The pathname for the music source used for the music-on-hold feature; example: Factory Default
----------------------	--

Voice tab >

System page

You can use the *System* page to set up restricted access domains, manage web access to the SPA9000, set the logon passwords, and manage system log settings and debugging. This page includes the following sections:

- ["System Configuration section," on page 159](#)
- ["Miscellaneous Settings section," on page 159](#)

Voice tab > System page >

System Configuration section

Restricted Access Domains	Define up to five IP addresses or fully qualified domain names to identify the domains in which the SPA9000 is allowed to operate.
Enable Web Admin Access	Allows (yes) or prevents (no) local access to the administration web server
Admin Passwd	Password for the administrator. Up to 39 characters are allowed for the passwords. All characters are legal. Default: no password
User Password	Password for the user. Up to 39 characters are allowed for the passwords. All characters are legal. Default: no password

Voice tab > System page >

Miscellaneous Settings section

Syslog Server	The IP address of the syslog server to which the SPA9000 sends syslog messages. Leave blank if you do not want to receive syslog messages.
Debug Server	The IP address of the debug server, which logs debug information. The level of detailed output depends on the Debug Level parameter setting.

Debug Level	The level of debug information that is generated, from 0 to 3. 0 is a minimal level of debugging information that is acceptable for most purposes. Levels 1 to 3 are typically used only by Linksys personnel. NOTE: Default: 0
-------------	--

Voice tab >

SIP Page

You can use the *SIP* page to enter many settings that are important for the proper functioning of SIP on your SPA9000. This page includes the following sections:

- ["SIP Parameters section," on page 160](#)
- ["SIP Timer Values \(sec\) section," on page 161](#)
- ["Response Status Code Handling section," on page 163](#)
- ["RTP Parameters section," on page 163](#)
- ["SDP Payload Types section," on page 165](#)
- ["NAT Support Parameters section," on page 166](#)
- ["PBX Parameters section," on page 167](#)
- ["Internal Music Source Parameters section," on page 170](#)
- ["Auto Attendant Parameters section," on page 171](#)
- ["PBX Phone Parameters section," on page 174](#)

Voice tab > SIP page

SIP Parameters section

Max Forward	SIP Max Forward value, which can range from 1 to 255. Default: 70
Max Redirection	Number of times an invite can be redirected to avoid an infinite loop. Default: 5
Max Auth	Maximum number of times (from 0 to 255) a request may be challenged. Default: 2
SIP User Agent Name	User-Agent header used in outbound requests. If empty, the header is not included. Macro expansion of \$A to \$D corresponding to GPP_A to GPP_D allowed. Default: \$VERSION
SIP Server Name	Server header used in responses to inbound responses. Default: \$VERSION

SIP Reg User Agent Name	User-Agent name to be used in a REGISTER request. If this value is not specified, the <SIP User Agent Name> is also used for the REGISTER request. Default: blank
SIP Accept Language	Accept-Language header used. There is no default (this indicates SPA9000 does not include this header). If empty, the header is not included.
DTMF Relay MIME Type	MIME Type used in a SIP INFO message to signal a DTMF event. Default: application/dtmf-relay
Hook Flash MIME Type	MIME Type used in a SIP INFO message to signal a hook flash event. Default: application/hook-flash
Remove Last Reg	Lets you remove the last registration before registering a new one if the value is different. Select yes or no from the drop-down menu. Default: no
Use Compact Header	Lets you use compact SIP headers in outbound SIP messages. Select yes or no from the drop-down menu. If set to yes, the SPA9000 uses compact SIP headers in outbound SIP messages. If set to no, the SPA9000 uses normal SIP headers. If inbound SIP requests contain compact headers, SPA9000 reuses the same compact headers when generating the response regardless the settings of the <Use Compact Header> parameter. If inbound SIP requests contain normal headers, SPA9000 substitutes those headers with compact headers (if defined by RFC 261) if <Use Compact Header> parameter is set to yes. Default: no
Escape Display Name	Select yes if you want the SPA9000 to enclose the string (configured in the Display Name) in a pair of double quotes for outbound SIP messages. Any occurrences of or \ in the string is escaped with \ and \\ inside the pair of double quotes. Otherwise, select no. Default: no
RFC 2543 Call Hold	If set to yes, unit will include c=0.0.0.0 syntax in SDP when sending a SIP re-INVITE to the peer to hold the call. If set to no, unit will not include the c=0.0.0.0 syntax in the SDP. The unit will always include a=sendonly syntax in the SDP in either case. Default: yes
Mark All AVT Packets	If set to yes, all AVT tone packets (encoded for redundancy) have the marker bit set. If set to no, only the first packet has the marker bit set for each DTMF event. Default: yes
SIP TCP Port Min	The lowest TCP port number that can be used for SIP sessions. Default: 5060
SIP TCP Port Max	The highest TCP port number that can be used for SIP sessions. Default: 5080

Voice tab > SIP page

SIP Timer Values (sec) section

SIP T1	RFC 3261 T1 value (RTT estimate), which can range from 0 to 64 seconds. Default: .5
--------	---

SIP T2	RFC 3261 T2 value (maximum retransmit interval for non-INVITE requests and INVITE responses), which can range from 0 to 64 seconds. Default: 4
SIP T4	RFC 3261 T4 value (maximum duration a message remains in the network), which can range from 0 to 64 seconds. Default: 5
SIP Timer B	RFC 3261 INVITE transaction time-out value, which can range from 0 to 64 seconds. Default: 32
SIP Timer F	RFC 3261 Non-INVITE transaction time-out value, which can range from 0 to 64 seconds. Default: 32
SIP Timer H	RFC 3261 time-out value for ACK receipt, which can range from 0 to 64 seconds. Default: 32
SIP Timer D	RFC 3261 wait time for response retransmits, which can range from 0 to 64 seconds. Default: 32
SIP Timer J	RFC 3261 wait time for Non-INVITE response hang-around time, which can range from 0 to 64 seconds. Default: 32
INVITE Expires	INVITE request Expires header value. If you enter 0, the Expires header is not included in the request. Range: 0–(2 ³¹ –1). Default: 240
ReINVITE Expires	ReINVITE request Expires header value. If you enter 0, the Expires header is not included in the request. Range: 0–(2 ³¹ –1). Default: 30
Reg Min Expires	Minimum registration expiration time allowed from the proxy in the Expires header or as a Contact header parameter. If the proxy returns a value less than this setting, the minimum value is used. Default: 1
Reg Max Expires	Maximum registration expiration time allowed from the proxy in the Min-Expires header. If the value is larger than this setting, the maximum value is used. Default: 7200
Reg Retry Intvl	Interval to wait before the SPA9000 retries registration after failing during the last registration. Default: 30
Reg Retry Long Intvl	When registration fails with a SIP response code that does not match <Retry Reg RSC>, the SPA9000 waits for the specified length of time before retrying. If this interval is 0, the SPA9000 stops trying. This value should be much larger than the Reg Retry Intvl value, which should not be 0. Default: 1200
Reg Retry Random Delay	Random delay range (in seconds) to add to <Register Retry Intvl> when retrying REGISTER after a failure. Default: 0 (disabled)

Reg Retry Long Random Delay	Random delay range (in seconds) to add to <Register Retry Long Intvl> when retrying REGISTER after a failure. Default: 0 (disabled)
Reg Retry Intvl Cap	The maximum value to cap the exponential back-off retry delay (which starts at <Register Retry Intvl> and doubles on every REGISTER retry after a failure). In other words, the retry interval is always at <Register Retry Intvl> seconds after a failure. If this feature is enabled, <Reg Retry Random Delay> is added on top of the exponential back-off adjusted delay value. Default: 0 (disables the exponential back-off feature)

Voice tab > SIP page

Response Status Code Handling section

The RSC handling defines the behavior of the user audio tones played under specific conditions signaled by the network, such as congestion, queuing, etc. The default settings (blank) are adequate in most circumstances.

NOTE: These settings need to be compatible with the ITSP network settings. The ITSP you use will inform you about any specific setting you need to modify on these areas. These parameters have impact on the signaling and audio reliability.

SIT1 RSC	SIP response status code for the appropriate Special Information Tone (SIT). For example, if you set the SIT1 RSC to 404, when the user makes a call and a failure code of 404 is returned, the SIT1 tone is played. Reorder or Busy Tone is played by default for all unsuccessful response status code for SIT 1 RSC through SIT 4 RSC.
SIT2 RSC	SIP response status code to INVITE on which to play the SIT2 Tone.
SIT3 RSC	SIP response status code to INVITE on which to play the SIT3 Tone.
SIT4 RSC	SIP response status code to INVITE on which to play the SIT4 Tone.
Try Backup RSC	SIP response code that retries a backup server for the current request.
Retry Reg RSC	Interval to wait before the SPA9000 retries registration after failing during the last registration.

Voice tab > SIP page

RTP Parameters section

The RTP parameters define the specification of the RTP audio packets. The most important parameter is the RTP Packet size (time) which defines the interval of transmission of the RTP packets. It is extremely important that time interval matches the ITSP settings. Its default value is 0.030 (30 milliseconds).

NOTE: These settings need to be compatible with the ITSP network settings. The ITSP you use will inform you about any specific setting you need to modify on these areas. These parameters have impact on the signaling and audio reliability.

RTP Port Min	Minimum port number for RTP transmission and reception. <RTP Port Min> and <RTP Port Max> should define a range that contains at least 4 even number ports, such as 100 – 106. Default: 16384
RTP Port Max	Maximum port number for RTP transmission and reception. Default: 16482
RTP Packet Size	Packet size in seconds, which can range from 0.01 to 0.16. Valid values must be a multiple of 0.01 seconds. Default: 0.030
Max RTP ICMP Err	Number of successive ICMP errors allowed when transmitting RTP packets to the peer before the SPA9000 terminates the call. If value is set to 0, the SPA9000 ignores the limit on ICMP errors. Default: 0
RTCP Tx Interval	Interval for sending out RTCP sender reports on an active connection. It can range from 0 to 255 seconds. During an active connection, the SPA9000 can be programmed to send out compound RTCP packet on the connection. Each compound RTP packet except the last one contains a SR (Sender Report) and a SDES.(Source Description). The last RTCP packet contains an additional BYE packet. Each SR except the last one contains exactly 1 RR (Receiver Report); the last SR carries no RR. The SDES contains CNAME, NAME, and TOOL identifiers. The CNAME is set to <User ID>@<Proxy>, NAME is set to <Display Name> (or Anonymous if user blocks caller ID), and TOOL is set to the Vendor/Hardware-platform-software-version (such as Linksys/SPA9000-1.0.31(b)). The NTP timestamp used in the SR is a snapshot of the SPA9000's local time, not the time reported by an NTP server. If the SPA9000 receives a RR from the peer, it attempts to compute the round trip delay and show it as the <Call Round Trip Delay> value (ms) in the Info section of SPA9000 web page. Default: 0
No UDP Checksum	Select yes if you want the SPA9000 to calculate the UDP header checksum for SIP messages. Otherwise, select no. Default: no
Stats In BYE	Determines whether the SPA9000 includes the P-RTP-Stat header or response to a BYE message. The header contains the RTP statistics of the current call. Select yes or no from the drop-down menu. The format of the P-RTP-Stat header is: P-RTP-State: PS=<packets sent>,OS=<octets sent>,PR=<packets received>,OR=<octets received>,PL=<packets lost>,JI=<jitter in ms>,LA=<delay in ms>,DU=<call duration in s>,EN=<encoder>,DE=<decoder>. Default: no

Voice tab > SIP page

SDP Payload Types section

The SDP Payload types defines the naming/numbering conventions for the audio codecs used by the SPA9000 when communicating with the ITSP network. Naming should match the ITSP names used. The default values are adequate in most circumstances.

NOTE: These settings need to be compatible with the ITSP network settings. The ITSP you use will inform you about any specific setting you need to modify on these areas. These parameters have impact on the signaling and audio reliability.

- *Dynamic Payloads:* The configured dynamic payloads are used for outbound calls only where the SPA9000 presents the SDP offer. For inbound calls with a SDP offer, the SPA9000 follows the caller dynamic payload type assignments.
- *Codec Names:* The SPA9000 uses the configured codec names in its outbound SDP. The SPA9000 ignores the codec names in incoming SDP for standard payload types (0 – 95). For dynamic payload types, the SPA9000 identifies the codec by the configured codec names. Comparison is case-insensitive.

NSE Dynamic Payload	NSE dynamic payload type. The valid range is 96-127. Default: 100
AVT Dynamic Payload	AVT dynamic payload type. The valid range is 96-127. Default: 101
INFOREQ Dynamic Payload	INFOREQ dynamic payload type. Default: blank
G726r16 Dynamic Payload	G.726-16 dynamic payload type. The valid range is 96-127. Default: 98
G726r24 Dynamic Payload	G.726-24 dynamic payload type. The valid range is 96-127. Default: 97
G726r32 Dynamic Payload	G726r32 dynamic payload type. Default: 2
G726r40 Dynamic Payload	G.726-40 dynamic payload type. The valid range is 96-127. Default: 96
G729b Dynamic Payload	G.729b dynamic payload type. The valid range is 96-127. Default: 99
NSE Codec Name	NSE codec name used in SDP. Default: NSE
AVT Codec Name	AVT codec name used in SDP. Default: telephone-event
G711u Codec Name	G.711u codec name used in SDP. Default: PCMU
G711a Codec Name	G.711a codec name used in SDP. Default: PCMA

G726r16 Codec Name	G.726-16 codec name used in SDP. Default: G.726-16
G726r24 Codec Name	G.726-24 codec name used in SDP. Default: G.726-24
G726r32 Codec Name	G.726-32 codec name used in SDP. Default: G.726-32
G726r40 Codec Name	G.726-40 codec name used in SDP. Default: G.726-40
G729a Codec Name	G.729a codec name used in SDP. Default: G.729a
G729b Codec Name	G.729b codec name used in SDP. Default: G.729ab
G723 Codec Name	G.723 codec name used in SDP. Default: G.723
EncapRTP Codec Name	EncapRTP codec name used in SDP. Default: encaprtpt

Voice tab > SIP page

NAT Support Parameters section

Handle VIA received	If you select yes, the SPA9000 processes the received parameter in the VIA header (this value is inserted by the server in a response to any one of its requests). If you select no, the parameter is ignored. Select yes or no from the drop-down menu. Default: no
Handle VIA rport	If you select yes, the SPA9000 processes the rport parameter in the VIA header (this value is inserted by the server in a response to any one of its requests). If you select no, the parameter is ignored. Select yes or no from the drop-down menu. Default: no
Insert VIA received	Inserts the received parameter into the VIA header of SIP responses if the received-from IP and VIA sent-by IP values differ. Select yes or no from the drop-down menu. Default: no
Insert VIA rport	Inserts the rport parameter into the VIA header of SIP responses if the received-from IP and VIA sent-by IP values differ. Select yes or no from the drop-down menu. Default: no
Substitute VIA Addr	Lets you use NAT-mapped IP-address port values in the VIA header. Select yes or no from the drop-down menu. Default: no
Send Resp To Src Port	Sends responses to the request source port instead of the VIA sent-by port. Select yes or no from the drop-down menu. Default: no

STUN Enable	Enables the use of STUN to discover NAT mapping. Select yes or no from the drop-down menu. Default: no
STUN Test Enable	If the STUN Enable feature is enabled and a valid STUN server is available, the SPA9000 can perform a NAT-type discovery operation when it powers on. It contacts the configured STUN server, and the result of the discovery is reported in a Warning header in all subsequent REGISTER requests. If the SPA9000 detects asymmetric NAT or asymmetric firewall, NAT mapping is disabled. Default: no
STUN Server	IP address or fully-qualified domain name of the STUN server to contact for NAT mapping discovery. Default: blank
EXT IP	External IP address to substitute for the actual IP address of the SPA9000 in all outgoing SIP messages. If 0.0.0.0 is specified, or the field is left blank, no IP address substitution is performed. NOTE: You must also configure port forwarding for SIP [5060-5063] and RTP [16384-16482] when using the EXT IP field, or phone users may experience one-way audio because the RTP stream will not find its way between the two phones. If this parameter is specified, the SPA9000 assumes this IP address when generating SIP messages and SDP (if NAT Mapping is enabled for that line). However, the results of STUN and VIA received parameter processing, if available, supersede this statically configured value. Default: blank
EXT RTP Port Min	External port mapping number of the RTP Port Min. number. If this value is not zero, the RTP port number in all outgoing SIP messages is substituted for the corresponding port value in the external RTP port range. Default: blank
NAT Keep Alive Intvl	Interval between NAT-mapping keep alive messages. Default: 15

Voice tab > SIP page

PBX Parameters section

Field	Description
Proxy Network Interface	This setting tells the SPA9000 how the client stations are connected. Choices: {LAN, WAN}. The SPA9000 communicates with client stations via the selected interface only. Default: WAN NOTE: For optimum voice performance, Linksys Engineering and Quality Assurance recommend that only WAN is used.
Proxy Listen Port	Port at which the SPA9000 listens for client messages at the selected network interface. The proxy also sends SIP messages from this port. Default: 6060

Multicast Address	IP address (and port number) where the SPA9000 sends control messages to all the client stations at once. This must be a multicast address and must contain a port number. Default: 224.168.168.168:6061 .
Group Page Address	IP address (and port number) where the SPA9000 tells the client stations to send and receive group page RTP packets. This must be a multicast address and must contain a port number. Default: 224.168.168.168:34567 .
Max Expires	Sets the maximum allowed Registration expires value in seconds for client stations. Linksys recommends using a relatively small value, such as 60 or 120. Default: 60
Force Media Proxy	Forces external client stations to use the SPA9000 Media Proxy when exchanging RTP traffic with external peers. Linksys recommends using a relatively small value, such as 60 or 120. Default: no
Proxy Debug Option	Controls what SIP messages to log that are received at or sent from the Proxy listen port. Choices are as follows: { none—No logging. 1-line—Logs the start-line only for all messages, 1-line excl. OPT—Same as 1-line but excludes OPTIONS request/response. 1-line excl. NTFY—Same as 1-line but excludes NOTIFY request/response. 1-line excl. REG—Same as 1-line but excludes REGISTER request/response. 1-line excl. OPT NTFY REG—Same as 1-line but excludes OPTIONS, NOTIFY, and REGISTER request/response. full—Logs all SIP messages in verbose mode. full excl. OPT—Same as full but excludes OPTIONS request/response. full excl. NTFY—Same as full but excludes NOTIFY request/response. full excl. REG—Same as full but excludes REGISTER request/response. full excl. OPT NTFY REG—Same as full but excludes OPTIONS, NOTIFY, and REGISTER request/response. Default: None

Call Routing Rule	<p>Special dial plan that determines which line interfaces can be used for an external outbound call request from client station based solely on the target public number. The dial plan is in the <i>(rule rule ... rule)</i> format where:</p> <p><i>rule</i> = <:Ln[,n[,n[,n]]]><i>pattern</i> <i>n</i> = 1, 2, 3, or 4, <i>pattern</i> = any digit pattern (see <Dial Plan> on how to choose a digit pattern).</p> <p>If the target number matches the pattern of a rule, the Line indices in the rule's prefix are the line interfaces that can be used to make that call. Matches are performed from left to right, so make sure the most specific rules are placed first. For example:</p> <p>Default: (<:L1,2,3,4>9xx.)</p> <p>The default call routing rule specifies that any of the four line interfaces can be used for any target number starting with 9 followed by at least 2 more numbers.</p>
Call Park MOH Server	<p>The MOH Server to be used to handle a parked call. For example: mohs@192.168.1.1:5082.</p> <p>If this parameter is not specified, the internal parking lot is used to host the parked call, in which case the parked caller hears the internal music file.</p> <p>Default: imusic</p>
Call Park DLG Refresh Intvl	<p>The interval in seconds between refreshing a call park session.</p> <p>Default: 0 (disables session refreshes)</p>
Default Group Line	<p>Same as <Group 1/2/3/4 Line>, but applies to the default group.</p> <p>Default: 1,2,3,4</p>
Group 1/2/3/4 User ID	<p>Comma-separated list of User ID patterns. A client station whose User ID matches any of the give patterns is considered to belong to that group. If the User ID matches more than one group, the smallest group number is assumed. If the User ID does not match any group, the client station is considered to belong to the default group (also known as Group 0). Each User ID pattern allows * and ? wildcards as well as %xx escaped characters.</p> <p>Default: blank (includes all client stations)</p>
Group 1/2/3/4 Line	<p>Ordered comma-separated list of line interfaces. The SPA9000 attempts to make external calls for group members in the order in which the lines are listed.</p> <p>Example: 1,3</p> <p>When a group member places an outbound call, the SPA9000 attempts to use Line 1 first. If Line 1 is not available, the SPA9000 attempts to use Line 3.</p> <p>By default, this field is blank, meaning that no line can be seized.</p>
Hunt Groups	<p>Defines one or more hunt groups that can be called directly by any client station like a regular extension. The syntax is the same as <Contact List>. Each defined group extension and name also appears in the corporate directory. This parameter is parsed twice by the SPA9000 such that a group member of one group can also be the extension of another group (that is, one level of recursion allowed).</p> <p>Default: blank</p>

SIP DIDN Field	Determines which field is used to indicate the DID number for an incoming INVITE to a line interface. The choices are: TO UserID—The user-id field of the TO header TO Param—A parameter in the TO header with the name specified in <SIP DIDN Param Name>, such as didn=1234 Default: TOUserID
SIP DIDN Param Name	Parameter name to indicate the DID number in an incoming INVITE message. Default: didn
Accept All MWI as Line	Choose the line. Choices are 1, 2, 3, 4, or Current. Default: Current
Phone DLG Refresh Intvl	Default: 0

Voice tab > SIP page

Internal Music Source Parameters section

Internal Music URL	URL from which to download a music file to be used by the parking lot. The format is: [tftp://]server-ip-addr[:port]/path TFTP is the only protocol supported for music download. Default port is 69. Changing the value of this parameter from the web interface triggers a graceful reboot of the SPA9000. If a valid entry is specified, the SPA9000 attempts to download the file on bootup and store the samples in flash memory. The SPA9000 remembers the link where the stored file is downloaded and does not try to download again on the next reboot. The music samples are encoded in G711u format at 8000 samples/second. The file should not contain any extra header information. Maximum length of the file is 65.536 seconds (524288 bytes). Default: blank
--------------------	--

Internal Music Script	<p>Script that tells the SPA9000 how to play the downloaded music file, in the format [section[,section[...]]], where:</p> <p><i>section</i> = [[<i>n</i>](<i>start/end[/pause]</i>)]<i>[pause2]</i></p> <p><i>n</i> = number of times to repeat the section before moving to the next section. Default: 1</p> <p><i>start/end</i> = starting and 1+ending sample for this section; note that samples are numbered from 0 to total-length - 1. You may enter -1 or a very large number if the end of the file is intended as the ending sample. Default start is 0, and default end is end of the file.</p> <p><i>pause</i> = number of samples to pause after the ending sample is played. Default: 0</p> <p><i>pause2</i> = additional number of samples to pause after the entire <i>n</i> repetitions of the section are played. Default: 0</p> <p>A maximum of 16 sections can be specified. Samples should be encoded in G711u format at 8000 samples/second. When all sections are played, the SPA9000 replays from the first section again.</p> <p>Examples: 40000 (plays the entire file, pauses for 5s, then repeats) 2(0/32000),3(32000/100000/4000)2000,(100000/-1)80000</p>
Internal Music Refresh Intvl	<p>The interval in seconds between refreshing an internal music session. Default: 0 (disables session refreshes)</p>
Internal Music LBR Codec	<p>Selects one low bit-rate codec as an alternative to G711u and G711a for playing internal music. Choices are {none, G729a, G726-16, G726-24, G726-32, G726-40}.</p> <p>Default: none</p>
Internal Music Preferred Codec	<p>Selects which codec is the preferred choice to play internal music. Choices are {G711u, G711a, Low Bit Rate}. Low Bit Rate refers to the selected <Internal Music LBR Codec>. If <Internal Music LBR Codec> is none, G711u is the preferred codec also.</p> <p>Default: G711u</p>
Internal Music Use Pref Codec Only	<p>Forces the internal music player to use the preferred codec only. Default: no</p>

Voice tab > SIP page

Auto Attendant Parameters section

AA Dial Plan 1	<p>Dial Plan 1 to be used in an AA script. Example: <dialplan src=dp1/>.</p> <p>Default: (10x xxx.)</p>
AA Dial Plan 2	<p>Dial Plan 2 to be used in an AA script. Example: <dialplan src=dp2/>.</p> <p>Default: (<:10>x xxx.)</p>

AA script 1/2/3	<p>AA script. See Chapter 4, Configuring the LVS Auto-Attendant, for the complete syntax.</p> <p>Default:</p> <pre><aa><form id="dir" type="menu"> <audio src="prompt1" bargein="T"/> <noinput timeout="10" repeat="T"/> <nomatch repeat="F"> <audio src="prompt3" bargein="T"/> </nomatch> <dialplan src="dp1"/> <match> <default> <audio src="prompt2"/> <xfer name="ext" target="\$input"/> </default></match> </form></aa></pre>
Daytime AA	<p>To enable the daytime Auto-Attendant, select yes. Otherwise, select no.</p> <p>Default: yes</p>
Day Time	<p>Daytime hours for the daytime Auto-Attendant in 24-hour format. Enter the start and end times in this format:</p> <p>start=hh:mm:ss;end=hh:mm:ss (hh for hours, mm for minutes, and ss for seconds).</p> <p>For example, start=9:0:0;end=17:0:0 means that the start time is 9 AM and the end time is 5 PM. The other hours (5 PM to 9 AM) are considered nighttime hours.</p> <p>If you do not enter start and end times, the whole day (24 hours) is considered as daytime, so the nighttime Auto-Attendant is not used, even if it is enabled.</p>
DayTime AA Script	<p>Specifies which AA script (1, 2, or 3) is used for the AA treatment when operating in daytime mode.</p> <p>Default: 1</p>
DayTime Answer Delay	<p>Number of seconds before the AA answers when operating in the daytime mode.</p> <p>Default: 12</p>
Nighttime AA	<p>To enable the nighttime Auto-Attendant, select yes. Otherwise, select no.</p> <p>Default: no</p>
NightTime AA Script	<p>Specifies which AA script (1, 2, or 3) is used for the AA treatment when operating in daytime mode.</p> <p>Default: 1</p>
NightTime Answer Delay	<p>Number of seconds before the AA answers when operating in the nighttime mode.</p> <p>Default: 0</p>
Weekend/Holiday AA	<p>To enable this Auto-Attendant, select yes. Otherwise, select no.</p> <p>Default: no</p>
Weekend/Holiday AA Script	<p>Specifies which AA script (1, 2, or 3) is used for the AA treatment when operating in daytime mode.</p> <p>Default: 1</p>

Weekends/Holidays	<p>When the weekend/holiday Auto-Attendant is enabled, you can use this setting to specify the weekends and holidays. Up to four weekend days can be defined. Use this format:</p> <p>[wk=n1[,ni];][hd=mm/dd/yyyy]mm/dd/yyyy-mm/dd/yyyy[,mm/dd/yyyy]mm/dd/yyyy-mm/dd/yyyy;]</p> <p>(wk for weekend, which can be 1 for Monday to 7 for Sunday)</p> <p>(hd for holiday, which does not have to include the year)</p> <p>For example, wk=6,7;hd=1/1,2/21/2006,5/30/2006,12/19/2006-12/30/2006 means that Saturdays and Sundays are the weekends. Holidays are January 1-2, 2006; May 30, 2006; and December 19-30, 2006.</p>
Weekend/Holiday Answer Delay	<p>Number of seconds before the AA answers when operating in the weekend/holiday mode.</p> <p>Default: 0</p>
AA LBR Codec	<p>Selects one low bit rate codec as an alternative to G711u and G711a for playing AA prompts. Choices are {none, G729a, G726-16, G726-24, G726-32, G726-40}.</p> <p>Default: None</p>
AA Preferred Codec	<p>Selects which codec is the preferred choice to play AA prompts. Choices are {G711u, G711a, Low Bit Rate}. Low Bit Rate refers to the selected <AA LBR Codec>. If <AA LBR Codec> is none, G711u is the preferred codec also.</p> <p>Default: G711u</p>
AA User Pref Codec Only	<p>Forces the AA to use the preferred codec only.</p> <p>Default: no</p>
AA Decode Inband DTMF	<p>If set to yes the AA tries to decode the incoming audio and check for DTMF digits if the payload type is G711u or G711a.</p> <p>Note that the inband DTMF signal coming from the IP network is not as reliable. This method will consume some resources on the CPU for each call to the AA. The recommended method is to use out-of-band DTMF signaling, such as RFC2833 (aka AVT) or SIP INFO.</p> <p>Default: no</p>

AA Prompts URL Script	<p>Instructs the SPA9000 to erase or download user-recorded prompt files from a TFTP/HTTP/HTTPS server. These files must be encoded in G711u, size less than 60 seconds, with the header removed.</p> <p>The sum of the prompt files cannot be longer than 94.5 seconds. The prompt is downloaded when the device boots. If the prompt has already been downloaded from the given URL, the download does not occur. If prompt file name is none, the corresponding prompt currently saved in the flash is erased.</p> <p>Default: blank</p> <p>The following is the format of the prompt file:</p> <pre>serv=scheme://server_addr[:port]/root_path;[p1={prompt1 file path name};][p2={prompt2 file path name};][p3={prompt3 file path name};][p4={prompt4 file path name};][p5={prompt5 file path name};][p6={prompt6 file path name};][p7={prompt7 file path name};][p8={prompt8 file path name};][p9={prompt9 file path name};][p10={prompt10 file path name};]</pre> <p>Where:</p> <p>scheme = tftp http https default port is 69 for tftp, 80 for http, and 443 for https root_path can be empty [] denotes optional item</p> <p>For example:</p> <pre>serv=tftp://192.168.2.150/root/test/ ;p1=menu.wav;p2=transfer.wav;p3=nomatch.wav;p4=none;</pre> <p>The following shows the source for each prompt in this example:</p> <pre>prompt 1: tftp://192.168.2.150/root/test/menu.wav prompt 2: tftp://192.168.2.150/root/test/transfer.wav prompt 3: tftp://192.168.2.150/root/test/nomatch.wav prompt 4 is erased</pre>
-----------------------	---

Voice tab > SIP page

PBX Phone Parameters section

Next Auto User ID	<p>User-id assigned to the next (unprovisioned) client station that requests initial profile from the SPA9000 internal configuration server. The parameter is automatically incremented once a new user-id is assigned.</p> <p>Default: 5000</p>
Phone Ext Password	<p>A REGISTRATION password to apply on Ext 1 of all the client stations. If password is not specified, all stations are allowed to register without being challenged by the SPA9000.</p> <p>Default: blank</p>

Phone Upgrade Rule	<p>Upgrade rule for all the client stations. For example: tftp://192.168.2.207/\$PN.bin</p> <p>Note that the \$PN macro is expanded to the product name of the client requesting the firmware. This allows upgrading phone clients with different firmware using a single rule.</p> <p>Default: blank</p>
Phone Dial Plan	<p>Dial plan for the client stations.</p> <p>Default: (*xx [3469]11 0 00 [2-9]xxxxxx 1xxx[2-9]xxxxxxS0 xxxxxxxxxxxxx.)</p> <p>This dial plan tells the phone to do the following:</p> <ul style="list-style-type: none"> • *xx: Allows any 3-character entry, with any character in the first position • 3469]11: Allows 311, 411, 611, and 911 • 0: Allows 0 • 00: Allows 00 • [2-9]xxxxxx: Allows any 7-digit telephone number, as in a local call without an area code • 1xxx[2-9]xxxxxxS0: Allows any 10-digit telephone number starting with 1, as in a long distance call; with the S0 entry, the dialed digits are evaluated after 0 seconds • xxxxxxxxxxxxx.: Allows any entry of 12 or more digits
Phone Config XML	<p>XML configuration to be served to the phones when they request the init_\$MA.xml file from the SPA9000 during their first-time initialization (either a brand-new phone or after a factory reset). If this parameter is empty, the SPA9000 serves the normal auto-generated startup XML configuration file to the phone instead.</p> <p>The purpose of this parameter is to facilitate ITSP provisioning of new phones remotely. ITSP can simply include a default phone profile rule parameter in this parameter so that the phone can obtain it from the SPA9000 on initial power-up. For example:</p> <pre><Profile_Rule>https://www.itsp.com/init/spa\$MA.cfg</Profile_Rule></pre> <p>Do not include <flat-profile>...</flat-profile>. The SPA9000 automatically adds them when serving the configuration file to the phones.</p> <p>Default: blank</p>
Use LVS_PROXY	<p>If this option is yes, the SPA9000 uses the hostname LVS_PROXY instead of its IP address in the Profile_Rule parameter that is served to the phones when they request init_\$MA.xml during first-time initialization (when <Phone Config XML> is not specified). On reboot, the phones resolve the LVS_PROXY by querying the LAN via multicast. The SPA9000 replies to the query with its actual IP address. This allows the SPA9000 to use a dynamically-assigned IP address that is not fixed.</p> <p>Make sure that the phones have a compatible firmware that understands that LVS_PROXY is a special hostname. For SPA-941/942/921/922/901, use 4.1.12 or later; for SPA-841, use 3.1.6(KS) or later.</p>
CTI Enable	<p>Enables or disables the Computer Telephone Interface feature provided by some servers.</p> <p>NOTE: If you have a SPA962 with a SPA932 console, enable CTI to support busy lamp field (B LF).</p>

Voice tab >

Provisioning page

This page is available for service provider use only. Information is available in the *Linksys Provisioning Guide*, which is available only to service providers who are registered with Linksys.

Voice tab >

Regional page

You can use the *Regional* page to customize the tones and ring patterns, vertical service activation codes (star codes) and announcement codes, codec selection codes, and other regional settings such as time zone. This page includes the following sections:

- ["Call Progress Tones section," on page 176](#)
- ["Distinctive Ring Patterns section," on page 178](#)
- ["Distinctive Call Waiting Tone Patterns section," on page 178](#)
- ["Distinctive Ring/CWT Pattern Names section," on page 179](#)
- ["Ring and Call Waiting Tone Spec section," on page 180](#)
- ["Control Timer Values \(sec\) section," on page 180](#)
- ["Vertical Service Activation Codes section," on page 181](#)
- ["Vertical Service Announcement Codes section," on page 185](#)
- ["Outbound Call Codec Selection Codes section," on page 186](#)
- ["Miscellaneous section," on page 187](#)

Voice tab > Regional page

Call Progress Tones section

Field	Description
Dial Tone	Prompts the user to enter a phone number. Reorder Tone is played automatically when <Dial Tone> or any of its alternatives times out. Default: 350@-19,440@-19;10(*0/1+2)
Second Dial Tone	Alternative to the Dial Tone when the user dials a three-way call. Default: 420@-19,520@-19;10(*0/1+2)
Outside Dial Tone	Alternative to the Dial Tone. It prompts the user to enter an external phone number, as opposed to an internal extension. It is triggered by a (comma) character encountered in the dial plan. Default: 420@-16;10(*0/1)

Prompt Tone	Prompts the user to enter a call forwarding phone number. Default: 520@-19,620@-19;10(*0/1+2)
Busy Tone	Played when a 486 RSC is received for an outbound call. Default: 480@-19,620@-19;10(.5/.5/1+2)
Reorder Tone	Played when an outbound call has failed or after the far end hangs up during an established call. Reorder Tone is played automatically when <Dial Tone> or any of its alternatives times out. Default: 480@-19,620@-19;10(.25/.25/1+2)
Off Hook Warning Tone	Played when the caller has not properly placed the handset on the cradle. Off Hook Warning Tone is played when Reorder Tone times out. Default: 480@10,620@0;10(.125/.125/1+2)
Ring Back Tone	Played during an outbound call when the far end is ringing. Default: 440@-19,480@-19;*(2/4/1+2)
Confirm Tone	Brief tone to notify the user that the last input value has been accepted. Default: 600@-16; 1(.25/.25/1)
SIT1 Tone	Alternative to the Reorder Tone played when an error occurs as a caller makes an outbound call. The RSC to trigger this tone is configurable on the SIP screen. Default: 985@-16,1428@-16,1777@-16;20(.380/0/1,.380/0/2,.380/0/3,0/4/0)
SIT2 Tone	Alternative to the Reorder Tone played when an error occurs as a caller makes an outbound call. The response status code (RSC) to trigger this tone is configurable on the SIP screen. Default: 914@-16,1371@-16,1777@-16;20(.274/0/1,.274/0/2,.380/0/3,0/4/0)
SIT3 Tone	Alternative to the Reorder Tone played when an error occurs as a caller makes an outbound call. The RSC to trigger this tone is configurable on the SIP screen. Default: 914@-16,1371@-16,1777@-16;20(.380/0/1,.380/0/2,.380/0/3,0/4/0)
SIT4 Tone	This an alternative to the Reorder Tone played when an error occurs as a caller makes an outbound call. The RSC to trigger this tone is configurable on the SIP screen. Default: 985@-16,1371@-16,1777@-16;20(.380/0/1,.274/0/2,.380/0/3,0/4/0)
MWI Dial Tone	Played instead of the Dial Tone when there are unheard messages in the caller's mailbox. Default: 350@-19,440@-19;2(.1/.1/1+2);10(*0/1+2)
Cfwd Dial Tone	Played when all calls are forwarded. Default: 350@-19,440@-19;2(.2/.2/1+2);10(*0/1+2)
Holding Tone	Informs the local caller that the far end has placed the call on hold. Default: 600@-19*(.1/.1/1,.1/.1/1,.1/9.5/1)
Conference Tone	Played to all parties when a three-way conference call is in progress. Default: 350@-19;20(.1/.1/1,.1/9.7/1)

Secure Call Indication Tone	Played when a call has been successfully switched to secure mode. It should be played only for a short while (less than 30 seconds) and at a reduced level (less than -19 dBm) so it does not interfere with the conversation. Default: 397@-19,507@-19;15(0/2/0,,2/.1/1,.1/2.1/2)
Feature Invocation Tone	Played when a feature is implemented. Default: 350@-16;*(.1/.1/1)

Voice tab > Regional page

Distinctive Ring Patterns section

Ring1 Cadence	Cadence script for distinctive ring 1. Default: 60(2/4)
Ring2 Cadence	Cadence script for distinctive ring 2. Default: 60(.8/.4,.8/4)
Ring3 Cadence	Cadence script for distinctive ring 3. Default: 60(.4/.2,.4/.2,.8/4)
Ring4 Cadence	Cadence script for distinctive ring 4. Default: 60(.3/.2,1/.2,.3/4)
Ring5 Cadence	Cadence script for distinctive ring 5. Default: 1(.5/.5)
Ring6 Cadence	Cadence script for distinctive ring 6. Default: 60(.2/.4,.2/.4,.2/4)
Ring7 Cadence	Cadence script for distinctive ring 7. Default: 60(.4/.2,.4/.2,.4/4)
Ring8 Cadence	Cadence script for distinctive ring 8. Default: 60(0.25/9.75)
Ring9 Cadence	Cadence script for distinctive ring 9. Default: 60(.4/.2,.4/2)

Voice tab > Regional page

Distinctive Call Waiting Tone Patterns section

CWT1 Cadence	Cadence script for distinctive CWT 1. Default: 30(.3/9.7)
CWT2 Cadence	Cadence script for distinctive CWT 2. Default: 30(.1/.1, .1/9.7)
CWT3 Cadence	Cadence script for distinctive CWT 3. Default: 30(.1/.1, .1/.1, .1/9.7)
CWT4 Cadence	Cadence script for distinctive CWT 4. Default: 30(.1/.1, .3/.1, .1/9.3)

CWT5 Cadence	Cadence script for distinctive CWT 5. Default: 1(.5/.5)
CWT6 Cadence	Cadence script for distinctive CWT 6. Default: 30(.1/.1,.3/.2,.3/9.1)
CWT7 Cadence	Cadence script for distinctive CWT 7. Default: 30(.3/.1,.3/.1,.1/9.1)
CWT8 Cadence	Cadence script for distinctive CWT 8. Default: 2.3(.3/2)
CWT9 Cadence	Cadence script for distinctive CWT 9. Default: 30(.3/9.7)

Voice tab > Regional page

Distinctive Ring/CWT Pattern Names section

Ring1 Name	Name in an INVITE's Alert-Info Header to pick distinctive ring/CWT 1 for the inbound call. Default: Bellcore-r1
Ring2 Name	Name in an INVITE's Alert-Info Header to pick distinctive ring/CWT 2 for the inbound call. Default: Bellcore-r2
Ring3 Name	Name in an INVITE's Alert-Info Header to pick distinctive ring/CWT 3 for the inbound call. Default: Bellcore-r3
Ring4 Name	Name in an INVITE's Alert-Info Header to pick distinctive ring/CWT 4 for the inbound call. Default: Bellcore-r4
Ring5 Name	Name in an INVITE's Alert-Info Header to pick distinctive ring/CWT 5 for the inbound call. Default: Bellcore-r5
Ring6 Name	Name in an INVITE's Alert-Info Header to pick distinctive ring/CWT 6 for the inbound call. Default: Bellcore-r6
Ring7 Name	Name in an INVITE's Alert-Info Header to pick distinctive ring/CWT 7 for the inbound call. Default: Bellcore-r7
Ring8 Name	Name in an INVITE's Alert-Info Header to pick distinctive ring/CWT 8 for the inbound call. Default: Bellcore-r8
Ring9 Name	Name in an INVITE's Alert-Info Header to pick distinctive ring/CWT 9 for the inbound call. Default: Bellcore-r9

Voice tab > Regional page

Ring and Call Waiting Tone Spec section

Field	Description
Ring Waveform	Waveform for the ringing signal: Sinusoid or Trapezoid. Default: Trapezoid
Ring Frequency	Frequency of the ringing signal. Valid values are 10–100 (Hz). Default: 0
Ring Voltage	Ringing voltage. 60–90 (V). Default: 85
CWT Frequency	Frequency script of the call waiting tone. All distinctive CWTs are based on this tone. Default: 440@-10

Voice tab > Regional page

Control Timer Values (sec) section

Hook Flash Timer Min	Minimum on-hook time before off-hook qualifies as hook-flash. Less than this the on-hook event is ignored. Range: 0.1–0.4 seconds. Default: .1
Hook Flash Timer Max	Maximum on-hook time before off-hook qualifies as hook-flash. More than this the on-hook event is treated as on-hook (no hook-flash event). Range: 0.4–1.6 seconds. Default: .9
Callee On Hook Delay	Phone must be on-hook for at this time in sec before the SPA9000 tears down the current inbound call. It does not apply to outbound calls. Range: 0–255 seconds. Default: 0
Reorder Delay	Delay after far end hangs up before reorder tone is played. 0 = plays immediately, inf = never plays. Range: 0–255 seconds. Default: 5
Call Back Expires	Expiration time in seconds of a call back activation. Range: 0–65535 seconds. Default: 1800
Call Back Retry Intvl	Call back retry interval in seconds. Range: 0–255 seconds. Default: 30
Call Back Delay	Delay after receiving the first SIP 18x response before declaring the remote end is ringing. If a busy response is received during this time, the SPA9000 still considers the call as failed and keeps on retrying. Default: .5
VMWI Refresh Intvl	Interval between VMWI refresh to the CPE. Default: 0

Interdigit Long Timer	Long timeout between entering digits when dialing. The interdigit timer values are used as defaults when dialing. The Interdigit_Long_Timer is used after any one digit, if all valid matching sequences in the dial plan are incomplete as dialed. Range: 0–64 seconds. Default: 10
Interdigit Short Timer	Short timeout between entering digits when dialing. The Interdigit_Short_Timer is used after any one digit, if at least one matching sequence is complete as dialed, but more dialed digits would match other as yet incomplete sequences. Range: 0–64 seconds. Default: 3
CPC Delay	Delay in seconds after caller hangs up when the SPA9000 starts removing the tip-and-ring voltage to the attached equipment of the called party. Range: 0–255 seconds. SPA9000 has had polarity reversal feature since release 1.0 which can be applied to both the caller and the callee end. This feature is generally used for answer supervision on the caller side to signal to the attached equipment when the call has been connected (remote end has answered) or disconnected (remote end has hung up). This feature should be disabled for the called party (in other words, by using the same polarity for connected and idle state) and the CPC feature should be used instead. Without CPC enabled, reorder tone is played after a configurable delay. If CPC is enabled, dial tone is played when tip-to-ring voltage is restored. Resolution is 1 second. Default: 2
CPC Duration	Duration in seconds for which the tip-to-ring voltage is removed after the caller hangs up. After that, tip-to-ring voltage is restored and dial tone applies if the attached equipment is still off-hook. CPC is disabled if this value is set to 0. Range: 0 to 1.000 second. Resolution is 0.001 second. Default: 0 (CPC disabled)

Voice tab > Regional page

Vertical Service Activation Codes section



Note

Vertical Service Activation Codes are automatically appended to the dial-plan. There is no need to include them in dial-plan, although no harm is done if they are included.

Call Return Code	This code calls the last caller. Default: *69
Call Redial Code	Redials the last number called. Default: *07
Blind Transfer Code	Begins a blind transfer of the current call to the extension specified after the activation code. Default: *98
Call Back Act Code	Starts a callback when the last outbound call is not busy. Default: *66

Call Back Deact Code	Cancels a callback. Default: *86
Call Back Busy Act Code	Starts a callback when the last outbound call is busy. Default: *05
Cfwd All Act Code	Forwards all calls to the extension specified after the activation code. Default: *72
Cfwd All Deact Code	Cancels call forwarding of all calls. Default: *73
Cfwd Busy Act Code	Forwards busy calls to the extension specified after the activation code. Default: *90
Cfwd Busy Deact Code	Cancels call forwarding of busy calls. Default: *91
Cfwd No Ans Act Code	Forwards no-answer calls to the extension specified after the activation code. Default: *92
Cfwd No Ans Deact Code	Cancels call forwarding of no-answer calls. Default: *93
Cfwd Last Act Code	Forwards the last inbound or outbound calls to the extension specified after the activation code. Default: *63
Cfwd Last Deact Code	Cancels call forwarding of the last inbound or outbound calls. Default: *83
Block Last Act Code	Blocks the last inbound call. Default: *60
Block Last Deact Code	Cancels blocking of the last inbound call. Default: *80
Accept Last Act Code	Accepts the last outbound call. It lets the call ring through when do not disturb or call forwarding of all calls are enabled. Default: *64
Accept Last Deact Code	Cancels the code to accept the last outbound call. Default: *84
CW Act Code	Enables call waiting on all calls. Default: *56
CW Deact Code	Disables call waiting on all calls. Default: *57
CW Per Call Act Code	Enables call waiting for the next call. Default: *71
CW Per Call Deact Code	Disables call waiting for the next call. Default: *70
Block CID Act Code	Blocks caller ID on all outbound calls. Default: *67
Block CID Deact Code	Removes caller ID blocking on all outbound calls. Default: *68

Block CID Per Call Act Code	Blocks caller ID on the next outbound call. Default: *81
Block CID Per Call Deact Code	Removes caller ID blocking on the next inbound call. Default: *82
Block ANC Act Code	Blocks all anonymous calls. Default: *77
Block ANC Deact Code	Removes blocking of all anonymous calls. Default: *87
DND Act Code	Enables the do not disturb feature. Default: *78
DND Deact Code	Disables the do not disturb feature. Default: *79
CID Act Code	Enables caller ID generation. Default: *65
CID Deact Code	Disables caller ID generation. Default: *85
CWCID Act Code	Enables call waiting, caller ID generation. Default: *25
CWCID Deact Code	Disables call waiting, caller ID generation. Default: *45
Dist Ring Act Code	Enables the distinctive ringing feature. Default: *26
Dist Ring Deact Code	Disables the distinctive ringing feature. Default: *46
Speed Dial Act Code	Assigns a speed dial number. Default: *74
Secure All Call Act Code	Makes all outbound calls secure. Default: *16
Secure No Call Act Code	Makes all outbound calls not secure. Default: *17
Secure One Call Act Code	Makes the next outbound call secure. (It is redundant if all outbound calls are secure by default.) Default: *18
Secure One Call Deact Code	Makes the next outbound call not secure. (It is redundant if all outbound calls are not secure by default.) Default: *19
Conference Act Code	If this code is specified, the user must enter it before dialing the third party for a conference call. Enter the code for a conference call.
Attn-Xfer Act Code	If the code is specified, the user must enter it before dialing the third party for a call transfer. Enter the code for a call transfer.
Modem Line Toggle Code	Toggles the line to a modem. Default: *99 . Modem pass-through mode can be triggered only by pre-dialing this code.

FAX Line Toggle Code	Toggles the line to a fax machine. Default: #99
Referral Services Codes	<p>These codes tell the SPA9000 what to do when the user places the current call on hold by hook flash and is listening to the second dial tone.</p> <p>One or more *codes can be configured into this parameter, such as *98, or *97 *98 *123, etc. Max length is 79 chars. Each *code (and the following valid target number according to current dial plan) entered on the second dial-tone triggers the SPA9000 to perform a blind transfer to a target number that is prepended by the service *code.</p> <p>For example, after the user dials *98, the SPA9000 plays a special dial tone called the Prompt Tone while waiting for the user to enter a target number (which is checked according to dial plan as in normal dialing). When a complete number is entered, the SPA9000 sends a blind REFER to the holding party with the Refer-To target equals to *98<target_number>. This feature allows the SPA9000 to hand off a call to an application server to perform further processing, such as call park.</p> <p>The *codes should not conflict with any of the other vertical service codes internally processed by the SPA9000. You can empty the corresponding *code that you do not want to SPA9000 to process.</p> <p>Default: blank</p>

Feature Dial Services Codes	<p>These codes tell the Linksys ATA what to do when the user is listening to the first or second dial tone.</p> <p>One or more *code can be configured into this parameter, such as *72, or *72 *74 *67 *82, etc. Max total length is 79 chars. This parameter applies when the user has a dial tone (first or second dial tone). Enter *code (and the following target number according to current dial plan) entered at the dial tone triggers the Linksys ATA to call the target number prepended by the *code. For example, after user dials *72, the Linksys ATA plays a prompt tone awaiting the user to enter a valid target number. When a complete number is entered, the Linksys ATA sends a INVITE to *72<target_number> as in a normal call. This feature allows the proxy to process features like call forward (*72) or BLock Caller ID (*67).</p> <p>The *codes should not conflict with any of the other vertical service codes internally processed by the Linksys ATA. You can empty the corresponding *code that you do not want to Linksys ATA to process.</p> <p>You can add a parameter to each *code in Features Dial Services Codes to indicate what tone to play after the *code is entered, such as *72'c' *67'p'. Below are a list of allowed tone parameters (note the use of back quotes surrounding the parameter w/o spaces)</p> <ul style="list-style-type: none"> • 'c' = <Cfwd Dial Tone> • 'd' = <Dial Tone> • 'm' = <MWI Dial Tone> • 'o' = <Outside Dial Tone> • 'p' = <Prompt Dial Tone> • 's' = <Second Dial Tone> • 'x' = No tones are place, x is any digit not used above <p>If no tone parameter is specified, the Linksys ATA plays Prompt tone by default.</p> <p>If the *code is not to be followed by a phone number, such as *73 to cancel call forwarding, do not include it in this parameter. In that case, simple add that *code in the dial plan and the Linksys ATA send INVITE *73@..... as usual when user dials *73.</p>
Media Loopback Code	Default: *03

Voice tab > Regional page

Vertical Service Announcement Codes section

Service Annc Base Number	Base number for service announcements.
Service Annc Extension Codes	Extension codes for service announcements.

Voice tab > Regional page

Outbound Call Codec Selection Codes section**Note**

These codes automatically appended to the dial-plan. So no need to include them in dial-plan (although no harm to do so either).

Prefer G711u Code	Makes this codec the preferred codec for the associated call. Default: *017110.
Force G711u Code	Makes this codec the only codec that can be used for the associated call. Default: *027110.
Prefer G711a Code	Makes this codec the preferred codec for the associated call. Default: *017111
Force G711a Code	Makes this codec the only codec that can be used for the associated call. Default: *027111.
Prefer G723 Code	Makes this codec the preferred codec for the associated call. Default: *01723.
Force G723 Code	Makes this codec the only codec that can be used for the associated call. Default: *02723.
Prefer G726r16 Code	Makes this codec the preferred codec for the associated call. Default: *0172616.
Force G726r16 Code	Makes this codec the only codec that can be used for the associated call. Default: *0272616.
Prefer G726r24 Code	Makes this codec the preferred codec for the associated call. Default: *0172624.
Force G726r24 Code	Makes this codec the only codec that can be used for the associated call. Default: *0272624.
Prefer G726r32 Code	Makes this codec the preferred codec for the associated call. Default: *0172632.
Force G726r32 Code	Makes this codec the only codec that can be used for the associated call. Default: *0272632.
Prefer G726r40 Code	Makes this codec the preferred codec for the associated call. Default: *0172640.
Force G726r40 Code	Makes this codec the only codec that can be used for the associated call. Default: *0272640.
Prefer G729a Code	Makes this codec the preferred codec for the associated call. Default: *01729.
Force G729a Code	Makes this codec the only codec that can be used for the associated call. Default: *02729.

Voice tab > Regional page
Miscellaneous section

Set Local Date (mm/dd)	Sets the local date (mm stands for months and dd stands for days). The year is optional and uses two or four digits. Default: blank
Set Local Time (HH/mm)	Sets the local time (hh stands for hours and mm stands for minutes). Seconds are optional. Default: blank
Time Zone	Selects the number of hours to add to GMT to generate the local time for caller ID generation. Choices are GMT-12:00, GMT-11:00, ..., GMT, GMT+01:00, GMT+02:00, ..., GMT+13:00. Default: GMT-08:00
FXS Port Impedance	Sets the electrical impedance of the FXS port. Choices are 600, 900, 600+2.16uF, 900+2.16uF, 270+750 150nF, 220+850 120nF, 220+820 115nF , or 200+600 100nF. Default: 600
Daylight Saving Time Rule	<p>Enter the rule for calculating daylight saving time; it should include the start, end, and save values. This rule is comprised of three fields. Each field is separated by ; (a semicolon) as shown below. Optional values inside [] (the brackets) are assumed to be 0 if they are not specified. Midnight is represented by 0:0:0 of the given date.</p> <p>SYNTAX: start = <start-time>; end=<end-time>; save = <save-time></p> <p>The <start-time> and <end-time> values specify the start and end dates and times of daylight saving time. Each value is in this format: <month>/<day> / <weekday>[/HH:[mm:ss]]</p> <p>The <save-time> value is the number of hours, minutes, and/or seconds to add to the current time during daylight saving time. The <save-time> value can be preceded by a negative (-) sign if subtraction is desired instead of addition. The <save-time> value is in this format: [/[+ -]HH:[mm:ss]]</p> <p>The <month> value equals any value in the range 1-12 (January-December).</p> <p>The <day> value equals [+ -] any value in the range 1-31.</p> <p>If <day> is 1, it means the <weekday> on or before the end of the month (in other words the last occurrence of < weekday> in that month).</p> <p>The <weekday> value equals any value in the range 1-7 (Monday-Sunday). It can also equal 0. If the <weekday> value is 0, this means that the date to start or end daylight saving is exactly the date given. In that case, the <day> value must not be negative. If the <weekday> value is not 0 and the <day> value is positive, then daylight saving starts or ends on the <weekday> value on or after the date given. If the <weekday> value is not 0 and the <day> value is negative, then daylight saving starts or ends on the <weekday> value on or before the date given.</p> <p>The abbreviation HH stands for hours (0-23). The abbreviation mm stands for minutes (0-59). The abbreviation ss stands for seconds (0-59).</p> <p>The default Daylight Saving Time Rule is start=4/1/7;end=10/-1/7;save=1.</p>

FXS Port Input Gain	Input gain in dB, up to three decimal places. The range is 6.000 to -12.000. Default: -3 .
FXS Port Output Gain	Output gain in dB, up to three decimal places. The range is 6.000 to -12.000. The Call Progress Tones and DTMF playback level are not affected by the <FXS Port Output Gain>. Default: -3
DTMF Playback Level	Local DTMF playback level in dBm, up to one decimal place. Default: -16.0
DTMF Playback Length	Local DTMF playback duration in milliseconds. Default: .1
Detect ABCD	To enable local detection of DTMF ABCD, select yes. Otherwise, select no. Setting has no effect if DTMF Tx Method is INFO; ABCD is always sent OOB regardless in this setting. Default: yes
Playback ABCD	To enable local playback of OOB DTMF ABCD, select yes. Otherwise, select no. Default: yes
Caller ID Method	The following choices are available: Bellcore (N.Amer,China)—CID, CIDCW, and VMWI. FSK sent after first ring (same as ETSI FSK sent after first ring) (no polarity reversal or DTAS). DTMF (Finland, Sweden)—CID only. DTMF sent after polarity reversal (and no DTAS) and before first ring. DTMF (Denmark)—CID only. DTMF sent after polarity reversal (and no DTAS) and before first ring. ETSI DTMF—CID only. DTMF sent after DTAS (and no polarity reversal) and before first ring. ETSI DTMF With PR—CID only. DTMF sent after polarity reversal and DTAS and before first ring. ETSI DTMF After Ring—CID only. DTMF sent after first ring (no polarity reversal or DTAS). ETSI FSK—CID, CIDCW, and VMWI. FSK sent after DTAS (but no polarity reversal) and before first ring. Waits for ACK from CPE after DTAS for CIDCW. ETSI FSK With PR (UK)—CID, CIDCW, and VMWI. FSK is sent after polarity reversal and DTAS and before first ring. Waits for ACK from CPE after DTAS for CIDCW. Polarity reversal is applied only if equipment is on hook. Default: Bellcore(N.Amer, China)
Caller ID FSK Standard	The SPA9000 supports bell 202 and v.23 standards for caller ID generation. Select the FSK standard you want to use, bell 202 or v.23 . Default: bell 202
Feature Invocation Method	Select the method you want to use, Default or Sweden default . Default: Default
More Echo Suppression	Enable or disable more echo suppression. Default: no

Voice tab >

FXS 1/2 page

You can use the *FXS 1* page and the *FXS 2* page to configure the settings for the FXS devices that are connected to the Phone 1 and Phone 2 ports of the SPA9000.

- ["Line Enable section," on page 189](#)
- ["Network Settings section," on page 189](#)
- ["SIP Settings section," on page 190](#)
- ["Subscriber Information section," on page 191](#)
- ["Dial Plan section," on page 191](#)
- ["Mailbox Status section," on page 191](#)
- ["Streaming Audio Server \(SAS\) section," on page 192](#)
- ["Call Feature Settings section," on page 192](#)
- ["Audio Configuration section," on page 193](#)
- ["FXS Port Polarity Configuration section," on page 196](#)

Voice tab > FXS 1/2 page

Line Enable section

Line Enable	Enables this line for service (yes) or removes this line from service (no) Default: yes
-------------	---

Voice tab > FXS 1/2 page

Network Settings section

SIP ToS/DiffServ Value	TOS/DiffServ field value in UDP IP packets carrying a SIP message. Default: 0x68
SIP CoS Value [0-7]	CoS value for SIP messages. Default: 3
RTP ToS/DiffServ Value	ToS/DiffServ field value in UDP IP packets carrying RTP data. Default: 0xb8
RTP CoS Value [0-7]	CoS value for RTP data. Default: 6

Network Jitter Level	Determines how jitter buffer size is adjusted by the SPA9000. Jitter buffer size is adjusted dynamically. The minimum jitter buffer size is 30 milliseconds or (10 milliseconds + current RTP frame size), whichever is larger, for all jitter level settings. However, the starting jitter buffer size value is larger for higher jitter levels. This setting controls the rate at which the jitter buffer size is adjusted to reach the minimum. Select the appropriate setting: low, medium, high, very high, or extremely high. Default: high
Jitter Buffer Adjustment	Controls how the jitter buffer should be adjusted. Select the appropriate setting: up and down, up only, down only, or disable. Default: up and down

Voice tab > FXS 1/2 page

SIP Settings section

SIP Port	Port number of the SIP message listening and transmission port. Default: 5080
SIP Remote-Party-ID	To use the Remote-Party-ID header instead of the From header, select yes. Otherwise, select no. Default: yes
SIP Debug Option	SIP messages are received at or sent from the proxy listen port. This feature controls which SIP messages to log. The choices are as follows: none—No logging. 1-line—Logs the start-line only for all messages. 1-line excl. OPT—Logs the start-line only for all messages except OPTIONS requests/responses. 1-line excl. NTFY—Logs the start-line only for all messages except NOTIFY requests/responses. 1-line excl. REG—Logs the start-line only for all messages except REGISTER requests/responses. 1-line excl. OPT NTFY REG—Logs the start-line only for all messages except OPTIONS, NOTIFY, and REGISTER requests/responses. full—Logs all SIP messages in verbose mode. full excl. OPT—Logs all SIP messages in full text except OPTIONS requests/responses. full excl. NTFY—Logs all SIP messages in full text except NOTIFY requests/responses. full excl. REG—Logs all SIP messages in full text except REGISTER requests/responses. full excl. OPT NTFY REG—Logs all SIP messages in full text except for OPTIONS, NOTIFY, and REGISTER requests/responses. Default: none

Restrict Source IP	<p>If line interfaces use the same SIP Port value and the Restrict Source IP feature is enabled, the proxy IP address for Lines 1 and 2 is treated as an acceptable IP address for both lines. To enable the Restrict Source IP feature, select yes. Otherwise, select no.</p> <p>A source IP address is untrusted if it does not match any of the IP addresses resolved from the configured Proxy or Outbound Proxy if Use Outbound Proxy is set to yes.</p> <p>Default: no</p>
Referor Bye Delay	<p>Controls when the SPA9000 sends BYE to terminate stale call legs after completion of call transfers. Multiple delay settings (Referor, Refer Target, Referee, and Refer-To Target) are configured on this screen. For the Referor Bye Delay, enter the appropriate period of time in seconds.</p> <p>Default: 4</p>
Refer Target Bye Delay	<p>For the Refer Target Bye Delay, enter the appropriate period of time in seconds.</p> <p>Default: 0</p>
Referee Bye Delay	<p>For the Referee Bye Delay, enter the appropriate period of time in seconds.</p> <p>Default: 0</p>
Refer-To Target Contact	<p>To contact the refer-to target, select yes. Otherwise, select no.</p> <p>Default: no</p>
Sticky 183	<p>If this feature is enabled, the IP telephony ignores further 180 SIP responses after receiving the first 183 SIP response for an outbound INVITE. To enable this feature, select yes. Otherwise, select no.</p> <p>Default: no</p>

Voice tab > FXS 1/2 page

Subscriber Information section

Display Name	Display name for caller ID.
User ID	Extension number for this line.

Voice tab > FXS 1/2 page

Dial Plan section

Dial Plan	Dial plan script for this line.
-----------	---------------------------------

Voice tab > FXS 1/2 page

Mailbox Status section

Message Waiting	Indicates whether you have new voicemail waiting.
-----------------	---

Voice tab > FXS 1/2 page

Streaming Audio Server (SAS) section

SAS Enable	To enable the use of the line as a streaming audio source, select yes. Otherwise, select no. If enabled, the line cannot be used for outgoing calls. Instead, it auto-answers incoming calls and streams audio RTP packets to the caller. Default: no
SAS DLG Refresh Intvl	If this value is not zero, it is the interval at which the streaming audio server sends out session refresh (SIP re-INVITE) messages to determine whether the connection to the caller is still active. If the caller does not respond to the refresh message, the SPA9000 ends this call with a SIP BYE message. The range is 0 to 255 seconds (0 means that the session refresh is disabled). Default: 30
SAS Inbound RTP Sink	This setting works around devices that do not play inbound RTP if the streaming audio server line declares itself as a send-only device and tells the client not to stream out audio. Enter a Fully Qualified Domain Name (FQDN) or IP address of an RTP sink; this value is used by the SPA9000's streaming audio server line in the SDP of its 200 response to an inbound INVITE message from a client. The purpose of this parameter is to work around devices that do not play inbound RTP if the SAS line declares itself as a "sendonly" device and tells the client not to stream out audio. This parameter is a FQDN or IP address of a RTP sink to be used by the SPA SAS line in the SDP of its 200 response to inbound INVITE from a client. It will appear in the c = line and the port number and, if specified, in the m = line of the SDP. If this value is not specified or equal to 0, then c = 0.0.0.0 and a=sendonly is used in the SDP to tell the SAS client to not to send any RTP to this SAS line. If a non-zero value is specified, then a=sendrecv and the SAS client will stream audio to the given address. Special case: If the value is \$IP, then the SAS line's own IP address is used in the c = line and a=sendrecv. In that case the SAS client will stream RTP packets to the SAS line. Default: blank

Voice tab > FXS 1/2 page

Call Feature Settings section

Blind Attn-Xfer Enable	Enables the SPA9000 to perform an attended transfer operation by ending the current call leg and performing a blind transfer of the other call leg. If this feature is disabled, the SPA9000 performs an attended transfer operation by referring the other call leg to the current call leg while maintaining both call legs. To use this feature, select yes. Otherwise, select no. Default: no
MOH Server	User ID or URL of the auto-answering streaming audio server. When only a user ID is specified, the current or outbound proxy is contacted. Music-on-hold is disabled if the MOH Server is not specified.
Xfer When Hangup Conf	Makes the SPA9000 perform a transfer when a conference call has ended. Select yes or no from the drop-down menu. Default: Yes

Conference Bridge URL	This feature supports external conference bridging for n-way conference calls (n > 2), instead of mixing audio locally. To use this feature, set this parameter to that of the server's name; for example, <i>conf@myserver.com:12345</i> or <i>conf</i> (which uses the Proxy value as the domain). Default: blank
Conference Bridge Ports	Maximum number of conference call participants. The range is 3 to 10. Default: 3
Enable IP Dialing	To use IP dialing, select yes. Otherwise, select no. Default: no
Emergency Number	Comma-separated list of emergency number patterns. If an outbound call matches one of the patterns, the SPA9000 disables call waiting, hook flash event handling, and fax tone detection. Operation is restored to normal when the phone is on-hook again. If you leave this field blank, the SPA9000 has no emergency number.
Mailbox ID	Enter the ID number of the mailbox for this line.

Voice tab > FXS 1/2 page

Audio Configuration section



Note

A codec resource is considered as allocated if it has been included in the SDP codec list of an active call, even though it eventually may not be the one chosen for the connection. So, if the G.729a codec is enabled and included in the codec list, that resource is tied up until the end of the call whether or not the call actually uses G.729a. If the G.729a resource is already allocated and since only one G.729a resource is allowed per device, no other low-bit-rate codec may be allocated for subsequent calls; the only choices are G.711a and G.711u. On the other hand, two G.723.1/G.726 resources are available per device. Therefore it is important to disable the use of G.729a in order to guarantee the support of two simultaneous G.723/G.726 codecs.

Preferred Codec	Preferred codec for all calls. (The actual codec used in a call still depends on the outcome of the codec negotiation protocol.) Select one of the following: G711u , G711a , G726-16 , G726-24 , G726-32 , G726-40 , G729a , or G723 Default: G711u
Second Preferred Codec, Third Preferred Codec	Other codecs to be preferred if the preferred codec is not available due to the codec negotiation protocol. Default: Unspecified
Use Pref Codec Only	If set to yes, the call can be completed only with the preferred codec. Default: no
Silence Supp Enable	To enable silence suppression so that silent audio frames are not transmitted, select yes. Otherwise, select no. Default: no

Use Pref Codec Only	To use only the preferred codec for all calls, select yes. (The call fails if the far end does not support this codec.) Otherwise, select no. Default: no
Silence Threshold	Select the appropriate setting for the threshold: high, medium, or low. Default: medium
G729a Enable	To enable the use of the G729a codec at 8 kbps, select yes. Otherwise, select no. Default: yes
Echo Canc Enable	To enable the use of the echo canceller, select yes. Otherwise, select no. Default: yes
G723 Enable	To enable the use of the G723a codec at 6.3 kbps, select yes. Otherwise, select no. Default: yes
Echo Canc Adapt Enable	To enable the echo canceller to adapt, select yes. Otherwise, select no. Default: yes
G726-16 Enable	To enable the use of the G726 codec at 16 kbps, select yes. Otherwise, select no. Default: yes
Echo Supp Enable	To enable the use of the echo suppressor, select yes. Otherwise, select no. Default: yes
G726-24 Enable	To enable the use of the G726 codec at 24 kbps, select yes. Otherwise, select no. Default: yes
FAX CED Detect Enable	To enable detection of the fax Caller-Entered Digits (CED) tone, select yes. Otherwise, select no. Default: yes
G726-32 Enable	To enable the use of the G726 codec at 32 kbps, select yes. Otherwise, select no. Default: yes
FAX CNG Detect Enable	To enable detection of the fax Calling Tone (CNG), select yes. Otherwise, select no. Default: yes
G726-40 Enable	To enable the use of the G726 codec at 40 kbps, select yes. Otherwise, select no. Default: yes
FAX Passthru Codec	Select the codec for fax passthrough, G711u or G711a. Default: G711u
DTMF Process INFO	To use the DTMF process info feature, select yes. Otherwise, select no. Default: yes
FAX Codec Symmetric	To force the SPA9000 to use a symmetric codec during fax passthrough, select yes. Otherwise, select no. Default: yes
DTMF Process AVT	To use the DTMF process AVT feature, select yes. Otherwise, select no. Default: yes

FAX Passthru Method	Select the fax passthrough method: None, NSE, or ReINVITE. Default: NSE
DTMF Tx Method	Select the method to transmit DTMF signals to the far end: InBand, AVT, INFO, Auto, InBand+INFO, or AVT+INFO. InBand sends DTMF using the audio path. AVT sends DTMF as AVT events. INFO uses the SIP INFO method. Auto uses InBand or AVT based on the outcome of codec negotiation. Default: Auto
DTMF Detection Mode	Determines where to use Normal or Strict DTMF detection Strict mode reduces the likelihood of false DTMF detection but requires an extra hold time after detection. Also the DTMF level is raised. Under strict mode, the minimum duration threshold is 60 and 90 ms for AVT and SIP-INFO respectively. The level threshold is -20 dBm. Default: Strict
FAX Process NSE	To use the fax process NSE feature, select yes. Otherwise, select no. Default: yes
Hook Flash Tx Method	Select the method for signaling hook flash events: None, AVT, or INFO . None does not signal hook flash events. AVT uses RFC2833 AVT (event = 16). INFO uses SIP INFO with the single line signal=hf in the message body. The MIME type for this message body is taken from the Hook Flash MIME Type setting. Default: None
FAX Disable ECAN	If enabled, this feature automatically disables the echo canceller when a fax tone is detected. To use this feature, select yes. Otherwise, select no. Default: no
Release Unused Codec	This feature allows the release of codecs not used after codec negotiation on the first call, so that other codecs can be used for the second line. To use this feature, select yes. Otherwise, select no. Default: yes
FAX Enable T38	To enable the use of the ITU-T T.38 standard for faxing, select yes. Otherwise, select no. Default: yes
FAX Tone Detect Mode	This parameter has three possible values: caller or callee - SPA will detect FAX tone whether it is callee or caller caller only - SPA will detect FAX tone only if it is the caller callee only - SPA will detect FAX tone only if it is the callee Default: caller or callee
FAX T38 Redundancy	The redundancy factor for the T.38 Fax Relay from 0 (none) to 4 Default: 1
FAX Tone Detect Mode:	The method of fax tone detection: caller and callee, caller only, or callee only Default: caller or callee NOTE: This setting allows a fax tone to be detected from either side of the call.

Voice tab > FXS 1/2 page

FXS Port Polarity Configuration section

Idle Polarity	Polarity before a call is connected: Forward or Reverse . Default: Forward
Caller Conn Polarity	Polarity after an outbound call is connected: Forward or Reverse . Default: Forward
Callee Conn Polarity	Polarity after an inbound call is connected: Forward or Reverse . Default: Forward

Voice tab >

Line 1/2/3/4 page

You can use the *Line 1 - Line 4* pages to configure the line interfaces on your SPA9000. The line interface page includes the following sections:

- ["Line Enable section," on page 196](#)
- ["Network Settings section," on page 196](#)
- ["SIP Settings section," on page 197](#)
- ["Subscriber Information section," on page 199](#)
- ["Dial Plan section," on page 199](#)
- ["NAT Settings section," on page 199](#)
- ["Proxy and Registration section," on page 200](#)

Voice tab > Line page

Line Enable section

Line Enable	To enable this line for service, select yes. Otherwise, select no. Default: yes
-------------	---

Voice tab > Line page

Network Settings section

SIP ToS/DiffServ Value	TOS/DiffServ field value in UDP IP packets carrying a SIP message. Default: 0x68
SIP CoS Value [0-7]	CoS value for SIP messages. Default: 3

RTP ToS/DiffServ Value	ToS/DiffServ field value in UDP IP packets carrying RTP data. Default: 0xb8
RTP CoS Value [0-7]	CoS value for RTP data. Default: 6

Voice tab > Line page

SIP Settings section

SIP Transport	Options: UDP, TCP, or TLS Default: UDP
SIP Port	Port number of the SIP message listening and transmission port. Default: 5060
SIP 100REL Enable	To enable the support of 100REL SIP extension for reliable transmission of provisional responses (18x) and use of PRACK requests, select yes. Otherwise, select no. Default: no
Auth Resync-Reboot	If this feature is enabled, the SPA9000 authenticates the sender when it receives the NOTIFY resync reboot (RFC 2617) message. To use this feature, select yes. Otherwise, select no. Default: yes
SIP Proxy-Require	The SIP proxy can support a specific extension or behavior when it detects this header from the user agent. If this field is configured and the proxy does not support it, it responds with the message, unsupported. Enter the appropriate header in the field provided. Default: blank
SIP Remote-Party-ID	To use the Remote-Party-ID header instead of the From header, select yes. Otherwise, select no. Default: yes
SIP GUID	The Global Unique ID is generated for each line for each device. When it is enabled, the SPA9000 adds a GUID header in the SIP request. The GUID is generated the first time the unit boots up and stays with the unit through rebooting and even factory reset. This feature was requested by Bell Canada (Nortel) to limit the registration of SIP accounts. Default: no

SIP Debug Option	<p>SIP messages are received at or sent from the proxy listen port. This feature controls which SIP messages to log. Choices are as follows:</p> <p>none—No logging.</p> <p>1-line—Logs the start-line only for all messages.</p> <p>1-line excl. OPT—Logs the start-line only for all messages except OPTIONS requests/responses.</p> <p>1-line excl. NTFY—Logs the start-line only for all messages except NOTIFY requests/responses.</p> <p>1-line excl. REG—Logs the start-line only for all messages except REGISTER requests/responses.</p> <p>1-line excl. OPT NTFY REG—Logs the start-line only for all messages except OPTIONS, NOTIFY, and REGISTER requests/responses.</p> <p>full—Logs all SIP messages in verbose mode.</p> <p>full excl. OPT—Logs all SIP messages in full text except OPTIONS requests/responses.</p> <p>full excl. NTFY—Logs all SIP messages in full text except NOTIFY requests/responses.</p> <p>full excl. REG—Logs all SIP messages in full text except REGISTER requests/responses.</p> <p>full excl. OPT NTFY REG—Logs all SIP messages in full text except for OPTIONS, NOTIFY, and REGISTER requests/responses.</p> <p>Default: None</p>
Restrict Source IP	<p>If line interfaces use the same SIP Port value and the Restrict Source IP feature is enabled, the proxy IP address for Lines 1 and 2 is treated as an acceptable IP address for both lines. To enable the Restrict Source IP feature, select yes. Otherwise, select no. A source IP address is untrusted if it does not match any of the IP addresses resolved from the configured <Proxy> (or <Outbound Proxy> if <Use Outbound Proxy> is yes).</p> <p>Default: no</p>
Referor Bye Delay	<p>Controls when the SPA9000 sends BYE to terminate stale call legs upon completion of call transfers. Multiple delay settings (Referor, Refer Target, Referee, and Refer-To Target) are configured on this screen. For the Referor Bye Delay, enter the appropriate period of time in seconds.</p> <p>Default: 4</p>
Refer Target Bye Delay	<p>For the Refer Target Bye Delay, enter the appropriate period of time in seconds.</p> <p>Default: 0</p>
Referee Bye Delay	<p>For the Referee Bye Delay, enter the appropriate period of time in seconds.</p> <p>Default: 0</p>
Refer-To Target Contact	<p>To contact the refer-to target, select yes. Otherwise, select no.</p> <p>Default: no</p>
Auth INVITE	<p>When enabled, authorization is required for initial incoming INVITE requests from the SIP proxy.</p>

Voice tab > Line page

Subscriber Information section

Display Name	Display name for caller ID.
User ID	User ID assigned by the ITSP, often the same as the DID.
Password	Password for this User ID.
Use Auth ID	To use the authentication ID and password for SIP authentication, select yes. Otherwise, select no to use the user ID and password. Default: no
Auth ID	Authentication ID for SIP authentication.
Call Capacity	Maximum number of calls allowed on this line interface. You can set a value from 1 to 15, or leave the setting as unlimited. Note that the SPA9000 does not distinguish between incoming and outgoing calls when talking about call capacity. Note: unlimited = 16. Default: unlimited
Contact List	List of client stations that the SPA9000 alerts when there is an incoming call to the line interface from the ITSP.
Cfwd No Ans Delay	Delay, in seconds, before the call forwarding of no-answer calls feature is triggered. Default: 20

Voice tab > Line page

Dial Plan section

Dial Plan	Dial plan script for this line. Default: (xx.) The Dial Plan strips off the steering digit prior to sending the dialed number to the ITSP.
-----------	--

Voice tab > Line page

NAT Settings section

NAT Mapping Enable	To use externally mapped IP addresses and SIP/RTP ports in SIP messages, select yes. Otherwise, select no. Default: no
NAT Keep Alive Enable	To send the configured NAT keep alive message periodically, select yes. Otherwise, select no. Default: no
NAT Keep Alive Msg	Enter the keep alive message that should be sent periodically to maintain the current NAT mapping. If the value is \$NOTIFY, a NOTIFY message is sent. If the value is \$REGISTER, a REGISTER message without contact is sent. Default: \$NOTIFY

NAT Keep Alive Dest	Destination that should receive NAT keep alive messages. If the value is \$PROXY, the messages are sent to the current or outbound proxy. Default: \$PROXY
EXT SIP Port	Enter the port number of the external port to substitute for the actual SIP port of the SPA9000 in all outgoing SIP messages. Default: blank

Voice tab > Line page

Proxy and Registration section

Proxy	SIP proxy server for all outbound requests. Default: blank
Outbound Proxy	SIP Outbound Proxy Server where all outbound requests are sent as the first hop.
Use Outbound Proxy	Enable the use of <Outbound Proxy>. If set to no, <Outbound Proxy> and <Use OB Proxy in Dialog> is ignored. Default: no
Use OB Proxy In Dialog	Whether to force SIP requests to be sent to the outbound proxy within a dialog. Ignored if <Use Outbound Proxy> is no or <Outbound Proxy> is empty. Default: yes
Register	Enable periodic registration with the <Proxy>. This parameter is ignored if <Proxy> is not specified. Default: yes
Make Call Without Reg	Allow making outbound calls without successful (dynamic) registration by the unit. If No, dial tone will not play unless registration is successful. Default: no
Register Expires	Allow answering inbound calls without successful (dynamic) registration by the unit. If proxy responded to REGISTER with a smaller Expires value, the SPA9000 will renew registration based on this smaller value instead of the configured value. If registration failed with an Expires too brief error response, the SPA9000 will retry with the value given in the Min-Expires header in the error response. Default: 3600 Recommended: 60
Ans Call Without Reg	Expires value in sec in a REGISTER request. SPA9000 will periodically renew registration shortly before the current registration expired. This parameter is ignored if <Register> is no. Values are yes or no.
Use DNS SRV	Whether to use DNS SRV lookup for Proxy and Outbound Proxy. Default: no
DNS SRV Auto Prefix	If enabled, the SPA9000 will automatically prepend the Proxy or Outbound Proxy name with _sip._udp when performing a DNS SRV lookup on that name. Default: no

Proxy Fallback Intvl	<p>This parameter sets the delay (sec) after which the SPA9000 will retry from the highest priority proxy (or outbound proxy) servers after it has failed over to a lower priority server. This parameter is useful only if the primary and backup proxy server list is provided to the SPA9000 via DNS SRV record lookup on the server name. (Using multiple DNS A record per server name does not allow the notion of priority and so all hosts are considered at the same priority and the SPA9000 will not attempt to fall back after a fail over).</p> <p>Default: 3600</p>
Proxy Redundancy Method	<p>SPA9000 will make an internal list of proxies returned in DNS SRV records. In normal mode, this list will contain proxies ranked by weight and priority.</p> <p>If based on SRV, the port is configured, the SPA9000 does normal first and also inspects the port number based on 1st proxy's port in the list.</p> <p>Default: Normal</p>
Mailbox Status	<p>The status of the connection to the voice mail server</p> <p>Mailbox status for all the mailboxes associated with this line interface. The status is automatically updated when the SPA9000 receives voicemail status notification from the ITSP.</p> <p>Format: [<i>mbs</i>[,<i>mbs</i>[,<i>mbs</i>[...]]]] where:</p> <p><i>mbs</i> = <i>mbid</i>:<i>new</i>/<i>old</i></p> <p><i>mbid</i> = mailbox ID, such as 12345</p> <p><i>new</i> = number of new messages in mailbox: 0,1,2,...</p> <p><i>old</i> = number of old messages in mailbox: 0, 1, 2, ...</p>
Mailbox Subscribe URL	<p>Note: This parameter allows \$USER and \$PROXY macros, such as \$USER@\$PROXY</p>
Mailbox Deposit URL	<p>This parameter allows \$USER, \$PROXY, and \$MBID macros, such as \$USER@\$PROXY, or \$MBID@\$PROXY.</p> <p>Default: blank</p>
Mailbox Subscribe Expires	<p>Identifies when the mailbox subscription expires.</p> <p>Recommended: 30</p>
Mailbox Manage URL	<p>This parameter allows \$USER, \$PROXY, and \$MBID macros, such as \$USER@\$PROXY, or \$MBID@\$PROXY.</p> <p>Default: blank</p>

VMSP Bridge	<p>Applies only if this line interface offers voice mail services. It specifies whether the SPA9000 should bridge the call from an external caller on the same or a different line interface. The choices are:</p> <p>None—Do not bridge external calls from any line interfaces</p> <p>All—Bridge external calls from any line interfaces except from the same line</p> <p>All+Self—Bridge external calls from any line interfaces including the same line</p> <p>Notes:</p> <p>If the external call is also on this line interface, the SPA9000 does not attempt to bridge the call even if the value is All.</p> <p>If <PBX Network Interface> is WAN, <Force Media Proxy> must be yes for VMSP Bridging to function properly.</p> <p>Default: None</p>
CFWD Bridge Mode	<p>Instructs the SPA9000 how to handle call forwarding of an external caller to another external number by a client station.</p> <p>The normal way of performing this operation is for the SPA9000 to send a (blind) SIP REFER to the calling device to let it contact the target number directly. It then drops out of the call completely. This requires the calling device to understand the SIP signaling involved and the operation permitted by the underlying service provider. The SPA400, for instance, cannot handle this operation.</p> <p>With bridging, the SPA9000 maintains two separate call legs throughout the call: one with the caller and one with the call forward target. The two call peers connect only with the SPA9000, while the SPA9000 acts as a proxy for the RTP packets exchanged between the two parties.</p> <p>This parameter has two possible values:</p> <p>None—Do not bridge forwarded calls (use the normal REFER method)</p> <p>All—Bridge all forwarded calls</p> <p>Default: None</p>
XFER Bridge Mode	<p>Instructs the SPA9000 how to handle call transferring of an external caller to another external number by a client station.</p> <p>The normal way of performing this operation is for the SPA9000 to send a SIP REFER method to the calling device to let it contact the transfer target directly. The SPA9000 then drops out of the call completely. This requires the calling device (the transferee) and the target device to understand the SIP signaling involved and the operation permitted by the underlying service providers. Note that the call legs with transferee and the transfer target might be with different ITSP. The SPA400, for instance, cannot handle this operation.</p> <p>With bridging, the SPA9000 maintains two separate call legs throughout the call: one with the transferred call and one with the transfer target. The two call peers connect only with the SPA9000, while the SPA9000 acts as a proxy for the RTP packets exchanged between the two parties.</p> <p>This parameter has three possible values:</p> <p>none —Do not bridge call transfer (use the normal REFER method)</p> <p>all —Bridge all call transfer</p> <p>all except same line—Bridge call transfer only if it is between 2 different Line interfaces</p>

SPA400 Field Reference

This appendix describes the fields on each page of the SPA400 administration web server.

- ["Setup," on page 203](#)
- ["Administration," on page 209](#)
- ["Status," on page 211](#)
- ["Event Logs," on page 212](#)

Setup

This section describes the fields on the following pages within the Setup module:

- ["Basic Setup," on page 203](#)
- ["SPA9000 Interface," on page 204](#)
- ["Voice," on page 205](#)
- ["Voicemail Server," on page 208](#)
- ["Voicemail Users," on page 209](#)

Setup tab

Basic Setup

Network Setup	
Dynamic IP Address (DHCP Client)	Select this button to obtain an IP address through DHCP. Fixed IP address is the recommended setting. Default setting: Dynamic IP Address
Fixed IP Address	Select this button to assign a static IP address to the SPA400. This is the recommended configuration.
IP Subnet Mask	Subnet mask
Gateway IP Address	IP address of the Gateway/Router
Domain Name Server (DNS) Address	
Primary DNS	IP address of the primary domain name server
Secondary DNS	IP address of the secondary domain name server

NTP	
NTP Server 1	IP address or FQDN of a NTP server
Time Zone	Select the time zone
Syslog Server	The IP address of the syslog server to which the SPA9000 sends syslog messages. Leave blank if you do not want to receive syslog messages.

Setup tab

SPA9000 Interface

SPA9000 User ID	
User ID	The User ID of the SPA9000 This value must be identical to the User ID that is entered on the SPA9000 line interface page for this SPA400 device.
SPA 9000 Address	
Discover Automatically	Select this radio button if you want the SPA400 to learn the SPA9000 IP address and port number from the SIP registration packet. (Recommended)
Static Address	Select this radio button to enter the IP address of SPA9000. Specify the IP Address and Port in the provided fields.
IP Address	IP address of the SPA9000
Port	UDP port number that the SPA9000 uses to register to the SPA400 Default: 5060
Port ID	
Port ID 1	A unique ID for the Line 1 port, too allow the SPA9000 to identify incoming calls from the PSTN Default: FXO_Port_ID_1
Port ID 2	A unique ID for the Line 2 port, too allow the SPA9000 to identify incoming calls from the PSTN Default: FXO_Port_ID_2
Port ID 3	A unique ID for the Line 3 port, too allow the SPA9000 to identify incoming calls from the PSTN Default: FXO_Port_ID_3
Port ID 4	A unique ID for the Line 4 port, too allow the SPA9000 to identify incoming calls from the PSTN Default: FXO_Port_ID_4

Signaling	
Signaling Port	The UDP port that the SPA400 uses to listen for incoming call setup requests Default: 5060
RTP	
RTP Port	The base UDP port for the block of UDP ports that that the SPA400 uses to send and receive RTP and RTCP packets Default: 10000
IP Tos/DiffServ	
Call Signaling Packets	TOS field in IP header for outgoing SIP packets Default: 68
RTP Packets	TOS field in IP header for outgoing RTP/RTCP packets Default: b8
Session	
Enable Session Timer	Enables the SPA400 to encode the Timer header in all INVITE requests for ringing timeout (checked by default)
Desired Refresh Time	Desired session timer in seconds (0 by default)
Minimum Refresh Time	Minimum value of the session timer in seconds (0 by default)

Setup tab

Voice

NOTE: The default settings should be sufficient in most use cases. These settings should be adjusted only after consultation with a service technician for the telephone company. It is essential that these settings are compatible with those of the Central Office.

Voice Codecs	
Preferred Codecs	
Preferred Codec	The preferred voice codec that SPA400 uses to negotiate with remote VoIP devices to determine the voice codec for a call: G.711U, G.711A, or G.729
Voice Codecs	
Packetization	The packetization time in milliseconds for each codec: G.711U, G.711A, G.729
VAD	Voice Activity Detection (OFF or ON) Default: OFF

Voice Setting	
Calling Timers	
Wait-for-Answer time	The time in seconds that the SPA400 waits for the called party to answer the call before terminating the call automatically The maximum value is 100 seconds. Default: 180
Call Limit	The maximum time that a call can continue before it is terminated automatically Default: 65535
Dialing Parameters	
Tone out on	The duration in milliseconds of each tone in a DTMF sequence Default: 200
Tone out off	The number of milliseconds that elapses between successive digits in a DTMF sequence Default: 200
DTMF power	The power level in 0.1 dBm of the DTMF tones Default: -130
Answer after	The number of rings that occur before the SPA400 answers an incoming call The maximum value is 2 rings. Default: 2
Dial out wait	The number of milliseconds that elapse after the SPA400 seizes a telephony port and before the SPA400 sends DTMF digits Default: 400
Dial out battery threshold	The minimum voltage level that the SPA400 must detect on a telephony port before seizing a telephony port for an outbound call Default: 20
Line Settings	
Transmit Gain	The gain level that the SPA400 may use to increase or attenuate the power level before transmitting to the telephony port NOTE: Change this setting if remote call participants have trouble hearing the LVS users. Make changes in increments of 3 dB; changes of less than 3 dB will not have a perceptible impact. Default: 0
Receive Gain	The gain level that the SPA400 may use to increase or attenuate the power level before receiving on the telephony port NOTE: The default Receive Gain settings should be satisfactory in most use cases. Unnecessary changes in Receive Gain can cause problems with echo. Default: 0

Impedance	The impedance of the lines that are connected to SPA400's telephony ports Default: 600 Ohms
Tip/Ring voltage	The tip-to-ring voltage reserved for voice transmission Default: 3.5 Volts
Operational loop current Min	The minimum loop current that maintains an off-hook state. If the loop current drops below this value, the phone enters on hook state. Default: 10 mA
On-Hook speed	The time that the loop current drops to 0mA when the phone enters the on-hook state. Default: Less than 0.5ms
Ring frequency Min	The minimum frequency of a valid ring Default: 10
Ring frequency Max	The maximum frequency of a valid ring Default: 100
Ring Validation Time	The minimum duration of a valid ring Default: 256ms
Ring Indication Delay	The delay in reporting the ring after it presents on the PSTN line Default: 512ms
Ring Timeout	The delay on reporting that the ring stopped after it no longer presents on the PSTN line Default: 640ms
Ring Threshold	The minimum voltage(rms value) of a valid ring Default: 13.5-16.5vrms
Ringer Impedance	Default: High
DC current Limiting	Default: Enable
Caller Id & CP Tone Method	The regional settings for Caller ID and call progress tones Default: North American
Battery reversal as disconnect signal	Can be chosen as a method for signalling the end of a call Default: unselected
Loop period shut-down as disconnect signal	Can be chosen as a method for signalling the end of a call Default: selected
Minimum period for disconnect signal	The minimum duration that the loop current is cut off to signal the end of the call; used with the loop period shut-down method Default: 750

Tear down FXO port when silence detected for	The duration of silence that causes the FXO port to disconnect the call Default: 300
--	--

Setup tab

Voicemail Server

Voicemail Settings	
Server Port	The UDP port this is open to receive packets NOTE: This port number must be different from the signaling port on the SPA9000 line interface. This port appears in the various mailbox URL fields on the SPA9000 line interface page. Default: 5090
SPA9000 subscriber ID	The ID that the SPA9000 uses to subscribe to the SPA400 voice mail server to obtain notifications NOTE: This value appears in the <i>Proxy and Registration: Mailbox Subscribe URL</i> field on the SPA9000 line interface page. Example <ul style="list-style-type: none"> • SPA9000 subscriber ID: 8888 • Mailbox Subscribe URL: 8888@192.168.0.110:5090 Default: 8888
Mailbox deposit number	The phone number that the SPA9000 uses to deposit voice mail NOTE: This value appears in the <i>Proxy and Registration: Mailbox Deposit URL</i> field on the SPA9000 line interface page. Example <ul style="list-style-type: none"> • Mailbox deposit number: 900 • Mailbox Deposit URL: 900@192.168.0.110:5090 Default: 900
Mailbox manage number	The phone number that the SPA9000 uses to access voice mail NOTE: This value appears in the <i>Proxy and Registration: Mailbox Manage URL</i> field on the SPA9000 line interface page. Example <ul style="list-style-type: none"> • Mailbox manage number: 800 • Mailbox Manage URL: 800@192.168.0.110:5090 Default: 800
AA Language	The language that is used by the voice mail Auto Attendant: English, German, Spanish, French, Dutch, Portuguese, Czech Default: English
Maximum length of a voicemail message	The maximum number of seconds that can elapse before a voice mail message is ended automatically Default: 60

Setup tab

Voicemail Users

User Setting	
Enable User <i>N</i>	Enables the mailbox Notes: Each mailbox can be assigned to a client station that is managed by the SPA9000. Before a station can deposit and access voicemail, the mail box ID must be configured through the <i>Ext N</i> page.
User ID	The mailbox ID
Password	The password for the mailbox

Administration

This section describes the fields on the following pages within the Administration module:

- ["Management," on page 209](#)
- ["Factory Default," on page 210](#)
- ["USB Setting," on page 210](#)
- ["Firmware Upgrade," on page 210](#)
- ["Reboot," on page 210](#)

Administration tab

Management

Gateway Access	
Local Access	
Gateway Username	The user name that is entered to log on to the SPA400 web configuration utility (default = Admin)
Gateway Password	The password that is entered to log on to the SPA400 web configuraton utility (default = <i>blank</i>)
Re-enter to Confirm	If you entered a new password, retype it in this field.

Administration tab

Factory Default

Restore Factory Defaults	Erases the current settings and resets the SPA400 to the original factory default settings
---------------------------------	--

Administration tab

USB Setting

USB Device	
USB status	The status of the USB storage device: mount (file system mounted and available) or unmount
I want to reset USB (check box) Reset (button)	Erases the voice mail messages that are stored on the USB

Administration tab

Firmware Upgrade

Firmware Upgrade	
File Path	The file path to the firmware file that you want to install, as selected by using the Browse button
Browse	Allows you to select a firmware file on your PC, and populates the <i>File Path</i> field
Upgrade	Starts the Firmware upgrade, using the file that is specified in the <i>File Path</i> field

Administration tab

Reboot

Restart System	Restarts the SPA400 NOTE: All SPA400 connections will be broken.
-----------------------	--

Status

Status tab

Gateway



Note

This page is read only. No changes can be made.

Gateway Information	
Firmware Version	The firmware version that is installed on this device
Build Date	The date when the firmware was last updated
MAC Address	The MAC address of this device
Current Time	The current date and time
System Up Time	The length of time that the system has been operating, in days, hours, and minutes
Internet Connection	
IP Address	The IP address of this device
IP Subnet Mask	The subnet mask for this subnet
Gateway IP Address	The IP address of the gateway device
Primary DNS	The primary DNS server
Secondary DNS	The secondary DNS server
SPA400 Status	
USB status	The status of the USB storage device: mount (file system mounted and available) or unmount
Voice mail status	The status of the voice mail service; OK indicates that voice mail service is enabled
USB capacity status	The amount of storage space that is currently in use, and the amount that is remaining, example: Used 5712KB, remaining 119960KB
SIP registration status	The status of the SIP registration; Registered indicates that the SPA9000 is registered to the SPA400

FXO Line status	
Hook Status	
Line status (1-4)	The status of each line port: <ul style="list-style-type: none"> • On-Hook indicates that the FXO port is not in use. • Off-Hook indicates that a call is in progress.
Battery Level	
Line (1-4)	The currently voltage on the line port, if the port is connected to a PSTN line; for example, a connected line could show -51 V

Event Logs

This section describes the fields on the SetLog Level page.

Event Logs tab

Set Log Level

SPA400 logs significant events onto its internal buffer. For each log type, you can choose to include Fatal Errors, Errors, Events, or All Information. Another option is OFF, meaning that no information is collected for the selected log type.

Event Log Level	
Telephony	Log level for telephony events
SIP	Log level for SIP events
DSP	Log level for DSP events
Dial plan	Log level for dial plan events
Voice mail	Log level for voice mail events
Others	Log level for all other events

Tone

Call process tone configuration	
Tone on fraction	The duty cycle of the CP tone to be detected
High cutoff frequency	The highest frequency of a valid CP tone
Low cutoff frequency	The lowest frequency of a valid CP tone

Call process tone detection	
Tone Setting	
Detection time	The cadence of the CP tone to be detected; if the tone's cadence matches the time length as in the edit boxes, it is considered a valid CP tone
Repeat	
Repeat count	The number of times that the cadence needs to repeat to be considered as a valid CP tone.

Warranty Information

Limited Warranty

Linksys warrants this Linksys hardware product against defects in materials and workmanship under normal use for the Warranty Period, which begins on the date of purchase by the original end-user purchaser and lasts for the period specified for this product at www.linksys.com/warranty. The internet URL address and the web pages referred to herein may be updated by Linksys from time to time; the version in effect at the date of purchase shall apply.

This limited warranty is non-transferable and extends only to the original end-user purchaser. Your exclusive remedy and Linksys's entire liability under this limited warranty will be for Linksys, at its option, to (a) repair the product with new or refurbished parts, (b) replace the product with a reasonably available equivalent new or refurbished Linksys product, or (c) refund the purchase price of the product less any rebates. Any repaired or replacement products will be warranted for the remainder of the original Warranty Period or thirty (30) days, whichever is longer. All products and parts that are replaced become the property of Linksys.

Exclusions and Limitations

This limited warranty does not apply if: (a) the product assembly seal has been removed or damaged, (b) the product has been altered or modified, except by Linksys, (c) the product damage was caused by use with non-Linksys products, (d) the product has not been installed, operated, repaired, or maintained in accordance with instructions supplied by Linksys, (e) the product has been subjected to abnormal physical or electrical stress, misuse, negligence, or accident, (f) the serial number on the Product has been altered, defaced, or removed, or (g) the product is supplied or licensed for beta, evaluation, testing or demonstration purposes for which Linksys does not charge a purchase price or license fee.

ALL SOFTWARE PROVIDED BY LINKSYS WITH THE PRODUCT, WHETHER FACTORY LOADED ON THE PRODUCT OR CONTAINED ON MEDIA ACCOMPANYING THE PRODUCT, IS PROVIDED AS IS WITHOUT WARRANTY OF ANY KIND. Without limiting the foregoing, Linksys does not warrant that the operation of the product or software will be uninterrupted or error free. Also, due to the continual development of new techniques for intruding upon and attacking networks, Linksys does not warrant that the product, software or any equipment, system or network on which the product or software is used will be free of vulnerability to intrusion or attack. The product may include or be bundled with third party software or service offerings. This limited warranty shall not apply to such third party software or service offerings. This limited warranty does not guarantee any continued availability of a third party's service for which this product's use or operation may require.

TO THE EXTENT NOT PROHIBITED BY LAW, ALL IMPLIED WARRANTIES AND CONDITIONS OF MERCHANTABILITY, SATISFACTORY QUALITY OR FITNESS FOR A PARTICULAR PURPOSE ARE LIMITED TO THE DURATION OF THE WARRANTY PERIOD. ALL OTHER EXPRESS OR IMPLIED CONDITIONS, REPRESENTATIONS AND WARRANTIES, INCLUDING, BUT NOT LIMITED TO, ANY IMPLIED WARRANTY OF NON-INFRINGEMENT, ARE DISCLAIMED. Some jurisdictions do not allow limitations on how long an implied warranty lasts, so the above limitation may not apply to you. This limited warranty gives you specific legal rights, and you may also have other rights which vary by jurisdiction.

TO THE EXTENT NOT PROHIBITED BY LAW, IN NO EVENT WILL LINKSYS BE LIABLE FOR ANY LOST DATA, REVENUE OR PROFIT, OR FOR SPECIAL, INDIRECT, CONSEQUENTIAL, INCIDENTAL OR PUNITIVE DAMAGES, REGARDLESS OF THE THEORY OF LIABILITY (INCLUDING NEGLIGENCE), ARISING OUT OF OR RELATED TO THE USE OF OR INABILITY TO USE THE PRODUCT (INCLUDING ANY SOFTWARE), EVEN IF LINKSYS HAS BEEN ADVISED OF THE POSSIBILITY OF SUCH DAMAGES. IN NO EVENT WILL LINKSYS' LIABILITY EXCEED THE AMOUNT PAID BY YOU FOR THE PRODUCT. The foregoing limitations will apply even if any warranty or remedy provided under this limited warranty fails of its essential purpose. Some jurisdictions do not allow the exclusion or limitation of incidental or consequential damages, so the above limitation or exclusion may not apply to you.

Obtaining Warranty Service

If you have a question about your product or experience a problem with it, please go to www.linksys.com/support where you will find a variety of online support tools and information to assist you with your product. If the product proves defective during the Warranty Period, contact the Value Added Reseller (VAR) from whom you purchased the product or Linksys Technical Support for instructions on how to obtain warranty service. The telephone number for Linksys Technical Support in your area can be found in the product User Guide and at www.linksys.com. Have your product serial number and proof of purchase on hand when calling. A DATED PROOF OF ORIGINAL PURCHASE IS REQUIRED TO PROCESS WARRANTY CLAIMS. If you are requested to return your product, you will be given a Return Materials Authorization (RMA) number. You are responsible for properly packaging and shipping your product to Linksys at your cost and risk. You must include the RMA number and a copy of your dated proof of original purchase when returning your product. Products received without a RMA number and dated proof of original purchase will be rejected. Do not include any other items with the product you are returning to Linksys. Defective product covered by this limited warranty will be repaired or replaced and returned to you without charge. Customers outside of the United States of America and Canada are responsible for all shipping and handling charges, custom duties, VAT and other associated taxes and charges. Repairs or replacements not covered under this limited warranty will be subject to charge at Linksys' then-current rates.

Technical Support

This limited warranty is neither a service nor a support contract. Information about Linksys' current technical support offerings and policies (including any fees for support services) can be found at: www.linksys.com/support. This limited warranty is governed by the laws of the jurisdiction in which the Product was purchased by you. Please direct all inquiries to: Linksys, P.O. Box 18558, Irvine, CA 92623

Regulatory Information

This appendix includes the following regulatory statements:

- [“Federal Communications Commission Interference Statement,” on page 216](#)
- [“Industry Canada Statement,” on page 216](#)
- [“Règlement d’Industry Canada,” on page 216](#)
- [“EC Declaration of Conformity \(Europe\),” on page 217](#)
- [“User Information for Consumer Products Covered by EU Directive 2002/96/EC on Waste Electric and Electronic Equipment \(WEEE\),” on page 217](#)

Federal Communications Commission Interference Statement

This product has been tested and complies with the specifications for a Class B digital device, pursuant to Part 15 of the FCC Rules. These limits are designed to provide reasonable protection against harmful interference in a residential installation. This equipment generates, uses, and can radiate radio frequency energy and, if not installed and used according to the instructions, may cause harmful interference to radio communications. However, there is no guarantee that interference will not occur in a particular installation. If this equipment does cause harmful interference to radio or television reception, which is found by turning the equipment off and on, the user is encouraged to try to correct the interference by one or more of the following measures:

- Reorient or relocate the receiving antenna
- Increase the separation between the equipment or devices
- Connect the equipment to an outlet other than the receiver’s
- Consult a dealer or an experienced radio/TV technician for assistance

Industry Canada Statement

This device complies with Industry Canada ICES-003 rule.

Operation is subject to the following two conditions:

This device may not cause interference and

This device must accept any interference, including interference that may cause undesired operation of the device.

Règlement d’Industry Canada

Cet appareil est conforme à la norme NMB003 d’Industrie Canada.

Le fonctionnement est soumis aux conditions suivantes :

- Ce périphérique ne doit pas causer d'interférences;
- Ce périphérique doit accepter toutes les interférences reçues, y compris celles qui risquent d'entraîner un fonctionnement indésirable..

EC Declaration of Conformity (Europe)

In compliance with the EMC Directive 89/336/EEC, Low Voltage Directive 73/23/EEC, and Amendment Directive 93/68/EEC, this product meets the requirements of the following standards:

- EN55022 Emission
- EN55024 Immunity

The following acknowledgements pertain to this software license.

User Information for Consumer Products Covered by EU Directive 2002/96/EC on Waste Electric and Electronic Equipment (WEEE)

This document contains important information for users with regards to the proper disposal and recycling of Linksys products. Consumers are required to comply with this notice for all electronic products bearing the following symbol:



English - Environmental Information for Customers in the European Union

European Directive 2002/96/EC requires that the equipment bearing this symbol on the product and/or its packaging must not be disposed of with unsorted municipal waste. The symbol indicates that this product should be disposed of separately from regular household waste streams. It is your responsibility to dispose of this and other electric and electronic equipment via designated collection facilities appointed by the government or local authorities. Correct disposal and recycling will help prevent potential negative consequences to the environment and human health. For more detailed information about the disposal of your old equipment, please contact your local authorities, waste disposal service, or the shop where you purchased the product.

Български (Bulgarian) - Информация относно опазването на околната среда за потребители в Европейския съюз

Европейска директива 2002/96/ЕС изисква уредите, носещи този символ върху изделието и/или опаковката му, да не се изхвърлят с несортирани битови отпадъци. Символът обозначава, че изделието трябва да се изхвърля отделно от сметосъбирането на обикновените битови отпадъци. Ваша е отговорността този и другите електрически и електронни уреди да се изхвърлят в предварително определени от държавните или общински органи специализирани пунктове за събиране. Правилното изхвърляне и рециклиране ще спомогнат да се предотвратят евентуални вредни за околната среда и здравето на населението последствия. За по-подробна информация относно изхвърлянето на вашите стари уреди се обърнете към местните власти, службите за сметосъбиране или магазина, от който сте закупили уреда.

Ceština (Czech) - Informace o ochranì životního prostředí pro zákazníky v zemích Evropské unie

Evropská směrnice 2002/96/ES zakazuje, aby zařízení označené tímto symbolem na produktu anebo na obalu bylo likvidováno s netříděným komunálním odpadem. Tento symbol udává, že daný produkt musí být likvidován odděleně od běžného komunálního odpadu. Odpovídáte za likvidaci tohoto produktu a dalších elektrických a elektronických zařízení prostřednictvím určených sbírných míst stanovených vládou nebo místními úřady. Správná likvidace a recyklace pomáhá předcházet potenciálním negativním dopadům na životní prostředí a lidské zdraví. Podrobnější informace o likvidaci starého vybavení si získáte od místních úřadů, podniku zabývajícího se likvidací komunálních odpadů nebo obchodu, kde jste produkt zakoupili.

Dansk (Danish) - Miljøinformation for kunder i EU

EU-direktiv 2002/96/EF kræver, at udstyr der bærer dette symbol på produktet og/eller emballagen ikke må bortskaffes som usorteret kommunalt affald. Symbolet betyder, at dette produkt skal bortskaffes adskilt fra det almindelige husholdningsaffald. Det er dit ansvar at bortskaffe dette og andet elektrisk og elektronisk udstyr via bestemte indsamlingssteder udpeget af staten eller de lokale myndigheder. Korrekt bortskaffelse og genvinding vil hjælpe med til at undgå mulige skader for miljøet og menneskers sundhed. Kontakt venligst de lokale myndigheder, renovationstjenesten eller den butik, hvor du har købt produktet, angående mere detaljeret information om bortskaffelse af dit gamle udstyr.

Deutsch (German) - Umweltinformation für Kunden innerhalb der Europäischen Union

Die Europäische Richtlinie 2002/96/EC verlangt, dass technische Ausrüstung, die direkt am Gerät und/oder an der Verpackung mit diesem Symbol versehen ist, nicht zusammen mit unsortiertem Gemeindeabfall entsorgt werden darf. Das Symbol weist darauf hin, dass das Produkt von regulärem Haushaltmüll getrennt entsorgt werden sollte. Es liegt in Ihrer Verantwortung, dieses Gerät und andere elektrische und elektronische Geräte über die dafür zuständigen und von der Regierung oder örtlichen Behörden dazu bestimmten Sammelstellen zu entsorgen. Ordnungsgemäßes Entsorgen und Recyceln trägt dazu bei, potentielle negative Folgen für Umwelt und die menschliche Gesundheit zu vermeiden. Wenn Sie weitere Informationen zur Entsorgung Ihrer Altgeräte benötigen, wenden Sie sich bitte an die örtlichen Behörden oder städtischen Entsorgungsdienste oder an den Händler, bei dem Sie das Produkt erworben haben.

Eesti (Estonian) - Keskkonnaalane informatsioon Euroopa Liidus asuvatele klientidele

Euroopa Liidu direktiivi 2002/96/EÜ nõuete kohaselt on seadmeid, millel on tootel või pakendil käesolev sümbol, keelatud kõrvaldada koos sorteerimata olmejäätmetega. See sümbol näitab, et toode tuleks kõrvaldada eraldi tavalistest olmejäätmevoogudest. Olete kohustatud kõrvaldama käesoleva ja ka muud elektri- ja elektroonikaseadmed riigi või kohalike ametiasutuste poolt ette nähtud kogumispunktide kaudu. Seadmete korrektne kõrvaldamine ja ringlussevõtt aitab vältida võimalikke negatiivseid tagajärgi keskkonnale ning inimeste tervisele. Vanade seadmete kõrvaldamise kohta täpsema informatsiooni saamiseks võtke palun ühendust kohalike ametiasutustega, jäätmekäitlusfirmaga või kauplusega, kust te toote ostsite.

Español (Spanish) - Información medioambiental para clientes de la Unión Europea

La Directiva 2002/96/CE de la UE exige que los equipos que lleven este símbolo en el propio aparato y/o en su embalaje no deben eliminarse junto con otros residuos urbanos no seleccionados. El símbolo indica que el producto en cuestión debe separarse de los residuos domésticos convencionales con vistas a su eliminación. Es responsabilidad suya desechar este y cualesquiera otros aparatos eléctricos y electrónicos a través de los puntos de recogida que ponen a su disposición el gobierno y las autoridades locales. Al desechar y reciclar correctamente estos aparatos estará contribuyendo a evitar posibles consecuencias negativas para el medio ambiente y la salud de las personas. Si desea obtener información más detallada sobre la eliminación segura de su aparato usado, consulte a las autoridades locales, al servicio de recogida y eliminación de residuos de su zona o pregunte en la tienda donde adquirió el producto.

Ελληνικά (Greek) - Στοιχεία περιβαλλοντικής προστασίας για πελάτες εντός της Ευρωπαϊκής Ένωσης

Η Κοινοτική Οδηγία 2002/96/EC απαιτεί ότι ο εξοπλισμός ο οποίος φέρει αυτό το σύμβολο στο προϊόν και/ή στη συσκευασία του δεν πρέπει να απορρίπτεται μαζί με τα μικτά κοινοτικά απορρίμματα. Το σύμβολο υποδεικνύει ότι αυτό το προϊόν θα πρέπει να απορρίπτεται ξεχωριστά από τα συνήθη οικιακά απορρίμματα. Είστε υπεύθυνος για την απόρριψη του παρόντος και άλλου ηλεκτρικού και ηλεκτρονικού εξοπλισμού μέσω των καθορισμένων εγκαταστάσεων συγκέντρωσης απορριμμάτων οι οποίες παρέχονται από το κράτος ή τις αρμόδιες τοπικές αρχές. Η σωστή απόρριψη και ανακύκλωση συμβάλλει στην πρόληψη πιθανών αρνητικών συνεπειών για το περιβάλλον και την υγεία. Για περισσότερες πληροφορίες σχετικά με την απόρριψη του παλιού σας εξοπλισμού, παρακαλώ επικοινωνήστε με τις τοπικές αρχές, τις υπηρεσίες απόρριψης ή το κατάστημα από το οποίο αγοράσατε το προϊόν.

Français (French) - Informations environnementales pour les clients de l'Union européenne

La directive européenne 2002/96/CE exige que l'équipement sur lequel est apposé ce symbole sur le produit et/ou son emballage ne soit pas jeté avec les autres ordures ménagères. Ce symbole indique que le produit doit être éliminé dans un circuit distinct de celui pour les déchets des ménages. Il est de votre responsabilité de jeter ce matériel ainsi que tout autre matériel électrique ou électronique par les moyens de collecte indiqués par le gouvernement et les pouvoirs publics des collectivités territoriales. L'élimination et le recyclage en bonne et due forme ont pour but de lutter contre l'impact néfaste potentiel de ce type de produits sur l'environnement et la santé publique. Pour plus d'informations sur le mode d'élimination de

votre ancien équipement, veuillez prendre contact avec les pouvoirs publics locaux, le service de traitement des déchets, ou l'endroit où vous avez acheté le produit.

Italiano (Italian) - Informazioni relative all'ambiente per i clienti residenti nell'Unione Europea

La direttiva europea 2002/96/EC richiede che le apparecchiature contrassegnate con questo simbolo sul prodotto e/o sull'imballaggio non siano smaltite insieme ai rifiuti urbani non differenziati. Il simbolo indica che questo prodotto non deve essere smaltito insieme ai normali rifiuti domestici. È responsabilità del proprietario smaltire sia questi prodotti sia le altre apparecchiature elettriche ed elettroniche mediante le specifiche strutture di raccolta indicate dal governo o dagli enti pubblici locali. Il corretto smaltimento ed il riciclaggio aiuteranno a prevenire conseguenze potenzialmente negative per l'ambiente e per la salute dell'essere umano. Per ricevere informazioni più dettagliate circa lo smaltimento delle vecchie apparecchiature in Vostro possesso, Vi invitiamo a contattare gli enti pubblici di competenza, il servizio di smaltimento rifiuti o il negozio nel quale avete acquistato il prodotto.

Latviešu valoda (Latvian) - Ekoloģiska informācija klientiem Eiropas Savienības jurisdikcijā

Direktīvā 2002/96/EK ir prasība, ka aprīkojumu, kam pievienota zīme uz paša izstrādājuma vai uz tā iesaiņojuma, nedrīkst izmest nešķīrotā veidā kopā ar komunālajiem atkritumiem (tiem, ko rada vietēji iedzīvotāji un uzņēmumi). Šī zīme nozīmē to, ka šī ierīce ir jāizmet atkritumos tā, lai tā nenonāktu kopā ar parastiem mājsaimniecības atkritumiem. Jūsu pienākums ir šo un citas elektriskas un elektroniskas ierīces izmest atkritumos, izmantojot īpašus atkritumu savākšanas veidus un līdzekļus, ko nodrošina valsts un pašvaldību iestādes. Ja izmešana atkritumos un pārstrāde tiek veikta pareizi, tad mazinās iespējamais kaitējums dabai un cilvēku veselībai. Sīkākas ziņas par novecojuša aprīkojuma izmešanu atkritumos jūs varat saņemt vietējā pašvaldībā, atkritumu savākšanas dienestā, kā arī veikalā, kur iegādājāties šo izstrādājumu.

Lietuvškai (Lithuanian) - Aplinkosaugos informacija, skirta Europos Sąjungos vartotojams

Europos direktyva 2002/96/EC numato, kad įrangos, kuri ir kurios pakuotė yra pažymėta šiuo simboliu (įveskite simbolį), negalima šalinti kartu su nerūšiuotomis komunalinėmis atliekomis. Šis simbolis rodo, kad gaminį reikia šalinti atskirai nuo bendro buitinių atliekų srauto. Jūs privalote užtikrinti, kad ši ir kita elektros ar elektroninė įranga būtų šalinama per tam tikras nacionalinės ar vietinės valdžios nustatytas atliekų rinkimo sistemas. Tinkamai šalinant ir perdurbant atliekas, bus išvengta galimos žalos aplinkai ir žmonių sveikatai. Daugiau informacijos apie jūsų senos įrangos šalinimą gali pateikti vietinės valdžios institucijos, atliekų šalinimo tarnybos arba parduotuvės, kuriose įsigijote tą gaminį.

Malti (Maltese) - Informazzjoni Ambjentali ghal Kliġenti fl-Unjoni Ewropea

Id-Direttiva Ewropea 2002/96/KE titlob li t-tagħmir li jkun fih is-simbolu fuq il-prodott u/jew fuq l-ippakkjar ma jistax jintrema ma' skart municipali li ma giex isseparat. Is-simbolu jindika li dan il-prodott għandu jintrema separatament minn ma' l-iskart domestiku regolari. Hija responsabbiltà tiegħek li tarmi dan it-tagħmir u kull tagħmir iehor ta' l-elettriku u elettroniku permezz ta' facilitajiet ta' għbir appuntati apposta mill-gvern jew mill-awtoritajiet lokali. Ir-rimi b'mod korrett u r-riciklagg jghin jipprevjeni konsegwenzi negattivi potenzjali għall-ambjent u għas-saħha tal-bniedem. Għal aktar informazzjoni dettaljata dwar ir-rimi tat-tagħmir antik tiegħek, jekk jogħgbok ikkuntattja lill-awtoritajiet lokali tiegħek, is-servizzi għar-rimi ta' l-iskart, jew il-hanut minn fejn xtrajt il-prodott.

Magyar (Hungarian) - Környezetvédelmi információ az európai uniós vásárlók számára

A 2002/96/EC számú európai uniós irányelv megkívánja, hogy azokat a termékeket, amelyeken, és/vagy amelyek csomagolásán az alábbi címke megjelenik, tilos a többi szelektálatlan lakossági hulladékkal együtt kidobni. A címke azt jelöli, hogy az adott termék kidobásakor a szokványos háztartási hulladékelszállítási rendszerektől elkülönített eljárást kell alkalmazni. Az Ön felelőssége, hogy ezt, és más elektromos és elektronikus berendezéseit a kormányzati vagy a helyi hatóságok által kijelölt gyűjtőrendszeren keresztül számolja fel. A megfelelő hulladékfeldolgozás segít a környezetre és az emberi egészségre potenciálisan ártalmas negatív hatások megelőzésében. Ha elavult berendezéseinek felszámolásához további részletes információra van szüksége, kérjük, lépjen kapcsolatba a helyi hatóságokkal, a hulladékfeldolgozási szolgálattal, vagy azzal üzlettel, ahol a terméket vásárolta.

Nederlands (Dutch) - Milieu-informatie voor klanten in de Europese Unie

De Europese Richtlijn 2002/96/EC schrijft voor dat apparatuur die is voorzien van dit symbool op het product of de verpakking, niet mag worden ingezameld met niet-gescheiden huishoudelijk afval. Dit symbool geeft aan dat het product apart moet worden ingezameld. U bent zelf verantwoordelijk voor de vernietiging van deze en andere elektrische en elektronische apparatuur via de daarvoor door de landelijke of plaatselijke overheid aangewezen inzamelingskanalen. De juiste vernietiging en recycling van deze apparatuur voorkomt mogelijke negatieve gevolgen voor het milieu en de gezondheid. Voor meer informatie over het vernietigen van uw oude apparatuur neemt u contact op met de plaatselijke autoriteiten of afvalverwerkingsdienst, of met de winkel waar u het product hebt aangeschaft.

Norsk (Norwegian) - Miljøinformasjon for kunder i EU

EU-direktiv 2002/96/EF krever at utstyr med følgende symbol avbildet på produktet og/eller pakningen, ikke må kastes sammen med usortert avfall. Symbolet indikerer at dette produktet skal håndteres atskilt fra ordinær avfallsinnsamling for husholdningsavfall. Det er ditt ansvar å kvitte deg med dette produktet og annet elektrisk og elektronisk avfall via egne innsamlingsordninger slik myndighetene eller kommunene bestemmer. Korrekt avfallshåndtering og gjenvinning vil være med på å forhindre mulige negative konsekvenser for miljø og helse. For nærmere informasjon om håndtering av det kasserte utstyret ditt, kan du ta kontakt med kommunen, en innsamlingsstasjon for avfall eller butikken der du kjøpte produktet.

Polski (Polish) - Informacja dla klientów w Unii Europejskiej o przepisach dotyczących ochrony środowiska

Dyrektywa Europejska 2002/96/EC wymaga, aby sprzęt oznaczony symbolem znajdującym się na produkcie i/lub jego opakowaniu nie był wyrzucany razem z innymi niesortowanymi odpadami komunalnymi. Symbol ten wskazuje, że produkt nie powinien być usuwany razem ze zwykłymi odpadami z gospodarstw domowych. Na Państwu spoczywa obowiązek wyrzucania tego i innych urządzeń elektrycznych oraz elektronicznych w punktach odbioru wyznaczonych przez władze krajowe lub lokalne. Pozbywanie się sprzętu we właściwy sposób i jego recykling pomogą zapobiec potencjalnie negatywnym konsekwencjom dla środowiska i zdrowia ludzkiego. W celu uzyskania szczegółowych informacji o usuwaniu starego sprzętu, prosimy zwrócić się do lokalnych władz, służb oczyszczania miasta lub sklepu, w którym produkt został nabyty.

Português (Portuguese) - Informação ambiental para clientes da União Europeia

A Directiva Europeia 2002/96/CE exige que o equipamento que exhibe este símbolo no produto e/ou na sua embalagem não seja eliminado junto com os resíduos municipais não separados. O

símbolo indica que este produto deve ser eliminado separadamente dos resíduos domésticos regulares. É da sua responsabilidade eliminar este e qualquer outro equipamento eléctrico e electrónico através das instalações de recolha designadas pelas autoridades governamentais ou locais. A eliminação e reciclagem correctas ajudarão a prevenir as consequências negativas para o ambiente e para a saúde humana. Para obter informações mais detalhadas sobre a forma de eliminar o seu equipamento antigo, contacte as autoridades locais, os serviços de eliminação de resíduos ou o estabelecimento comercial onde adquiriu o produto.

Română (Romanian) - Informații de mediu pentru clienții din Uniunea Europeană

Directiva europeană 2002/96/CE impune ca echipamentele care prezintă acest simbol pe produs și/sau pe ambalajul acestuia să nu fie casate împreună cu gunoiul menajer municipal. Simbolul indică faptul că acest produs trebuie să fie casat separat de gunoiul menajer obișnuit. Este responsabilitatea dvs. să cașati acest produs și alte echipamente electrice și electronice prin intermediul unităților de colectare special desemnate de guvern sau de autoritățile locale. Casarea și reciclarea corecte vor ajuta la prevenirea potențialelor consecințe negative asupra sănătății mediului și a oamenilor. Pentru mai multe informații detaliate cu privire la casarea acestui echipament vechi, contactați autoritățile locale, serviciul de salubritate sau magazinul de la care ați achiziționat produsul.

Slovenčina (Slovak) - Informácie o ochrane životného prostredia pre zákazníkov v Európskej únii

Podľa európskej smernice 2002/96/ES zariadenie s týmto symbolom na produkte a/alebo jeho balení nesmie byť likvidované spolu s netriedeným komunálnym odpadom. Symbol znamená, že produkt by sa mal likvidovať oddelene od bežného odpadu z domácností. Je vašou povinnosťou likvidovať toto i ostatné elektrické a elektronické zariadenia prostredníctvom špecializovaných zberných zariadení určených vládou alebo miestnymi orgánmi. Správna likvidácia a recyklácia pomôže zabrániť prípadným negatívnym dopadom na životné prostredie a zdravie ľudí. Ak máte záujem o podrobnejšie informácie o likvidácii starého zariadenia, obráťte sa, prosím, na miestne orgány, organizácie zaoberajúce sa likvidáciou odpadov alebo obchod, v ktorom ste si produkt zakúpili.

Slovenščina (Slovene) - Okoljske informacije za stranke v Evropski uniji

Evropska direktiva 2002/96/EC prepoveduje odlaganje opreme, označene s tem simbolom – na izdelku in/ali na embalaži – med običajne, nerazvrščene odpadke. Ta simbol opozarja, da je treba izdelek odvreči ločeno od preostalih gospodinjskih odpadkov. Vaša odgovornost je, da to in preostalo električno in elektronsko opremo odnesete na posebna zbirališča, ki jih določijo države ustanove ali lokalna uprava. S pravilnim odlaganjem in recikliranjem boste preprečili morebitne škodljive vplive na okolje in zdravje ljudi. Če želite izvedeti več o odlaganju stare opreme, se obrnite na lokalno upravo, odpad ali trgovino, kjer ste izdelek kupili.

Suomi (Finnish) - Ympäristöä koskevia tietoja EU-alueen asiakkaille

EU-direktiivi 2002/96/EY edellyttää, että jos laitteistossa on tämä symboli itse tuotteessa ja/tai sen pakkauksessa, laitteistoa ei saa hävittää lajittelemattoman yhdyskuntajätteen mukana. Symboli merkitsee sitä, että tämä tuote on hävitettävä erillään tavallisesta kotitalousjätteestä. Sinun vastuullasi on hävittää tämä elektroniikkatuote ja muut vastaavat elektroniikkatuotteet viemällä tuote tai tuotteet viranomaisten määräämään keräyspisteeseen. Laitteiston oikea hävittäminen estää mahdolliset kielteiset vaikutukset ympäristöön ja ihmisten terveyteen. Lisätietoja vanhan laitteiston oikeasta hävitystavasta saa paikallisilta viranomaisilta, jätteenhävityspalvelusta tai siitä myymälästä, josta ostit tuotteen.

Svenska (Swedish) - Miljöinformation för kunder i Europeiska unionen

Det europeiska direktivet 2002/96/EC kräver att utrustning med denna symbol på produkten och/eller förpackningen inte får kastas med osorterat kommunalt avfall. Symbolen visar att denna produkt bör kastas efter att den avskiljts från vanligt hushållsavfall. Det faller på ditt ansvar att kasta denna och annan elektrisk och elektronisk utrustning på fastställda insamlingsplatser utsedda av regeringen eller lokala myndigheter. Korrekt kassering och återvinning skyddar mot eventuella negativa konsekvenser för miljön och personhälsa. För mer detaljerad information om kassering av din gamla utrustning kontaktar du dina lokala myndigheter, avfallshanteringen eller butiken där du köpte produkten.

Safety Information

Meaning of the Warning Symbol



IMPORTANT SAFETY INSTRUCTIONS

This warning symbol means danger. This symbol is used to indicate a situation that could cause bodily injury. Before you work on any equipment, be aware of the hazards involved with electrical circuitry and be familiar with standard practices for preventing accidents.

General Safety Information



WARNING: Work During Lightning Activity

Do not work on the system or connect or disconnect cables during periods of lightning



WARNING: Installation Instructions

Read the installation instructions before connecting the system to the power source



WARNING: SELV Circuit

To avoid electric shock, do not connect safety extra-low voltage (SELV) circuits to telephone-network voltage (TNV) circuits. LAN ports contain SELV circuits, and WAN ports contain TNV circuits. Some LAN and WAN ports both use RJ-45 connectors. Use caution when connecting cables.



WARNING: Equipment Installation

Only trained and qualified personnel should be allowed to install, replace, or service this equipment.

**WARNING: Local National Electrical Codes**

Installation of the equipment must comply with local and national electrical codes.

**WARNING: Product Disposal**

Ultimate disposal of this product should be handled according to all national laws and regulations.

Power Safety Information

**WARNING: TN Power**

The device is designed to work with TN power systems.

**WARNING: Warning Ground Conductor Warning**

Never defeat the ground conductor or operate the equipment in the absence of a suitably installed ground conductor. Contact the appropriate electrical inspection authority or an electrician if you are uncertain that suitable grounding is available.

**WARNING: Power Supply Installation Warning**

The power supply must be placed indoors.

**WARNING: Circuit Breaker**

This product relies on the building's installation for short-circuit (overcurrent) protection. Ensure that the protective device is rated not greater than: 120 VAC, 15A U.S. (240 VAC, 10A international)



WARNING: Warning Main Disconnecting Device

The plug-socket combination must be accessible at all times, because it serves as the main disconnecting device.

Software License Agreement

Software in Linksys Products:

This product from Cisco-Linksys LLC or from one of its affiliates Cisco Systems-Linksys (Asia) Pte Ltd. or Cisco-Linksys K.K. ("Linksys") contains software (including firmware) originating from Linksys and its suppliers and may also contain software from the open source community. Any software originating from Linksys and its suppliers is licensed under the Linksys Software License Agreement contained at Schedule 1 below. You may also be prompted to review and accept that Linksys Software License Agreement upon installation of the software.

Any software from the open source community is licensed under the specific license terms applicable to that software made available by Linksys at www.linksys.com/gpl or as provided for in Schedules 2 and 3 below.

Where such specific license terms entitle you to the source code of such software, that source code is upon request available at cost from Linksys for at least three years from the purchase date of this product and may also be available for download from www.linksys.com/gpl. For detailed license terms and additional information on open source software in Linksys products please look at the Linksys public web site at: www.linksys.com/gpl/ or Schedule 2 below as applicable.

BY DOWNLOADING OR INSTALLING THE SOFTWARE, OR USING THE PRODUCT CONTAINING THE SOFTWARE, YOU ARE CONSENTING TO BE BOUND BY THE SOFTWARE LICENSE AGREEMENTS BELOW. IF YOU DO NOT AGREE TO ALL OF THESE TERMS, THEN YOU MAY NOT DOWNLOAD, INSTALL OR USE THE SOFTWARE. YOU MAY RETURN UNUSED SOFTWARE (OR, IF THE SOFTWARE IS SUPPLIED AS PART OF ANOTHER PRODUCT, THE UNUSED PRODUCT) FOR A FULL REFUND UP TO 30 DAYS AFTER ORIGINAL PURCHASE, SUBJECT TO THE RETURN PROCESS AND POLICIES OF THE PARTY FROM WHICH YOU PURCHASED SUCH PRODUCT OR SOFTWARE.

Software Licenses:

The software Licenses applicable to software from Linksys are made available at the Linksys public web site at: www.linksys.com and www.linksys.com/gpl/ respectively. For your convenience of reference, a copy of the Linksys Software License Agreement and the main open source code licenses used by Linksys in its products are contained in the Schedules below.

Schedule 1 Linksys Software License Agreement

THIS LICENSE AGREEMENT IS BETWEEN YOU AND CISCO-LINKSYS LLC OR ONE OF ITS AFFILIATES CISCO SYSTEMS-LINKSYS (ASIA) PTE LTD. OR CISCO-LINKSYS K.K. ("LINKSYS") LICENSING THE SOFTWARE INSTEAD OF CISCO-LINKSYS LLC. BY DOWNLOADING OR INSTALLING THE SOFTWARE, OR USING THE PRODUCT CONTAINING THE SOFTWARE, YOU ARE CONSENTING TO BE BOUND BY THIS AGREEMENT. IF YOU DO NOT AGREE TO ALL OF THESE TERMS, THEN YOU MAY NOT DOWNLOAD, INSTALL OR USE THE SOFTWARE. YOU MAY RETURN UNUSED SOFTWARE (OR, IF THE SOFTWARE IS SUPPLIED AS PART OF ANOTHER PRODUCT, THE UNUSED PRODUCT) FOR A FULL REFUND UP TO 30 DAYS AFTER ORIGINAL PURCHASE, SUBJECT TO THE RETURN PROCESS AND POLICIES OF THE PARTY FROM WHICH YOU PURCHASED SUCH PRODUCT OR SOFTWARE.

License. Subject to the terms and conditions of this Agreement, Linksys grants the original end user purchaser of the Linksys product containing the Software ("You") a nonexclusive license to use the Software solely as embedded in or (where authorized in the applicable documentation) for communication with such product. This license may not be sublicensed, and is not transferable except to a person or entity to which you transfer ownership of the complete Linksys product containing the Software, provided you permanently transfer all rights under this Agreement and do not retain any full or partial copies of the Software, and the recipient agrees to the terms of this Agreement.

"Software" includes, and this Agreement will apply to (a) the software of Linksys or its suppliers provided in or with the applicable Linksys product, and (b) any upgrades, updates, bug fixes or modified versions ("Upgrades") or backup copies of the Software supplied to You by Linksys or an authorized reseller, provided you already hold a valid license to the original software and have paid any applicable fee for the Upgrade.

Protection of Information. The Software and documentation contain trade secrets and/or copyrighted materials of Linksys or its suppliers. You will not copy or modify the Software or decompile, decrypt, reverse engineer or disassemble the Software (except to the extent expressly permitted by law notwithstanding this provision), and You will not disclose or make available such trade secrets or copyrighted material in any form to any third party. Title to and ownership of the Software and documentation and any portion thereof, will remain solely with Linksys or its suppliers.

Collection and Processing of Information. You agree that Linksys and/or its affiliates may, from time to time, collect and process information about your Linksys product and/or the Software and/or your use of either in order (i) to enable Linksys to offer you Upgrades; (ii) to ensure that your Linksys product and/or the Software is being used in accordance with the terms of this Agreement; (iii) to provide improvements to the way Linksys delivers technology to you and to other Linksys customers; (iv) to enable Linksys to comply with the terms of any agreements it has with any third parties regarding your Linksys product and/or Software and/or (v) to enable Linksys to comply with all applicable laws and/or regulations, or the requirements of any regulatory authority or government agency. Linksys and/or its affiliates may collect and process this information provided that it does not identify you personally. Your use of your Linksys product and/or the Software constitutes this consent by you to Linksys and/or its affiliates' collection and use of such information and, for EEA customers, to the transfer of such information to a location outside the EEA.

Software Upgrades etc. If the Software enables you to receive Upgrades, you may elect at any time to receive these Upgrades either automatically or manually. If you elect to receive Upgrades manually or you otherwise elect not to receive or be notified of any Upgrades, you may expose your Linksys product and/or the Software to serious security threats and/or some features within your Linksys product and/or Software may become inaccessible. There may be circumstances where we apply an Upgrade automatically in order to comply with changes in legislation, legal or regulatory requirements or as a result of requirements to comply with the terms of any agreements Linksys has with any third parties regarding your Linksys product and/or the Software. You will always be notified of any Upgrades being delivered to you. The terms of this license will apply to any such Upgrade unless the Upgrade in question is accompanied by a separate license, in which event the terms of that license will apply.

Open Source Software. The GPL or other open source code incorporated into the Software and the open source license for such source code are available for free download at <http://www.linksys.com/gpl>. If You would like a copy of the GPL or other open source code in this

Software on a CD, Linksys will mail to You a CD with such code for \$9.99 plus the cost of shipping, upon request.

Term and Termination. You may terminate this License at any time by destroying all copies of the Software and documentation. Your rights under this License will terminate immediately without notice from Linksys if You fail to comply with any provision of this Agreement.

Limited Warranty. The warranty terms and period specified in the applicable Linksys Product User Guide shall also apply to the Software.

Disclaimer of Liabilities. IN NO EVENT WILL LINKSYS OR ITS SUPPLIERS BE LIABLE FOR ANY LOST DATA, REVENUE OR PROFIT, OR FOR SPECIAL, INDIRECT, CONSEQUENTIAL, INCIDENTAL OR PUNITIVE DAMAGES, REGARDLESS OF CAUSE (INCLUDING NEGLIGENCE), ARISING OUT OF OR RELATED TO THE USE OF OR INABILITY TO USE THE SOFTWARE, EVEN IF LINKSYS HAS BEEN ADVISED OF THE POSSIBILITY OF SUCH DAMAGES. IN NO EVENT WILL LINKSYS' LIABILITY EXCEED THE AMOUNT PAID BY YOU FOR THE PRODUCT. The foregoing limitations will apply even if any warranty or remedy under this Agreement fails of its essential purpose. Some jurisdictions do not allow the exclusion or limitation of incidental or consequential damages, so the above limitation or exclusion may not apply to You.

Export. Software, including technical data, may be subject to U.S. export control laws and regulations and/or export or import regulations in other countries. You agree to comply strictly with all such laws and regulations.

U.S. Government Users. The Software and documentation qualify as "commercial items" as defined at 48 C.F.R. 2.101 and 48 C.F.R. 12.212. All Government users acquire the Software and documentation with only those rights herein that apply to non-governmental customers.

General Terms. This Agreement will be governed by and construed in accordance with the laws of the State of California, without reference to conflict of laws principles. The United Nations Convention on Contracts for the International Sale of Goods will not apply. If any portion of this Agreement is found to be void or unenforceable, the remaining provisions will remain in full force and effect. This Agreement constitutes the entire agreement between the parties with respect to the Software and supersedes any conflicting or additional terms contained in any purchase order or elsewhere.

END OF SCHEDULE 1

Schedule 2

If this Linksys product contains open source software licensed under Version 2 of the "GNU General Public License" then the license terms below in this Schedule 2 will apply to that open source software. The license terms below in this Schedule 2 are from the public web site at <http://www.gnu.org/copyleft/gpl.html>

GNU GENERAL PUBLIC LICENSE

Version 2, June 1991

Copyright (C) 1989, 1991 Free Software Foundation, Inc.

51 Franklin Street, Fifth Floor, Boston, MA 02110-1301, USA

Everyone is permitted to copy and distribute verbatim copies of this license document, but changing it is not allowed.

Preamble

The licenses for most software are designed to take away your freedom to share and change it. By contrast, the GNU General Public License is intended to guarantee your freedom to share and change free software--to make sure the software is free for all its users. This General Public License applies to most of the Free Software Foundation's software and to any other program whose authors commit to using it. (Some other Free Software Foundation software is covered by the GNU Lesser General Public License instead.) You can apply it to your programs, too.

When we speak of free software, we are referring to freedom, not price. Our General Public Licenses are designed to make sure that you have the freedom to distribute copies of free software (and charge for this service if you wish), that you receive source code or can get it if you want it, that you can change the software or use pieces of it in new free programs; and that you know you can do these things.

To protect your rights, we need to make restrictions that forbid anyone to deny you these rights or to ask you to surrender the rights. These restrictions translate to certain responsibilities for you if you distribute copies of the software, or if you modify it.

For example, if you distribute copies of such a program, whether gratis or for a fee, you must give the recipients all the rights that you have. You must make sure that they, too, receive or can get the source code. And you must show them these terms so they know their rights.

We protect your rights with two steps: (1) copyright the software, and (2) offer you this license which gives you legal permission to copy, distribute and/or modify the software.

Also, for each author's protection and ours, we want to make certain that everyone understands that there is no warranty for this free software. If the software is modified by someone else and passed on, we want its recipients to know that what they have is not the original, so that any problems introduced by others will not reflect on the original authors' reputations.

Finally, any free program is threatened constantly by software patents. We wish to avoid the danger that redistributors of a free program will individually obtain patent licenses, in effect making the program proprietary. To prevent this, we have made it clear that any patent must be licensed for everyone's free use or not licensed at all.

The precise terms and conditions for copying, distribution and modification follow.

TERMS AND CONDITIONS FOR COPYING, DISTRIBUTION AND MODIFICATION

0. This License applies to any program or other work which contains a notice placed by the copyright holder saying it may be distributed under the terms of this General Public License. The "Program", below, refers to any such program or work, and a "work based on the Program" means either the Program or any derivative work under copyright law: that is to say, a work containing the Program or a portion of it, either verbatim or with modifications and/or translated into another language. (Hereinafter, translation is included without limitation in the term "modification".) Each licensee is addressed as "you".

Activities other than copying, distribution and modification are not covered by this License; they are outside its scope. The act of running the Program is not restricted, and the output from the Program is covered only if its contents constitute a work based on the Program (independent of having been made by running the Program). Whether that is true depends on what the Program does.

1. You may copy and distribute verbatim copies of the Program's source code as you receive it, in any medium, provided that you conspicuously and appropriately publish on each copy an appropriate copyright notice and disclaimer of warranty; keep intact all the notices that refer to this License and to the absence of any warranty; and give any other recipients of the Program a copy of this License along with the Program.

You may charge a fee for the physical act of transferring a copy, and you may at your option offer warranty protection in exchange for a fee.

2. You may modify your copy or copies of the Program or any portion of it, thus forming a work based on the Program, and copy and distribute such modifications or work under the terms of Section 1 above, provided that you also meet all of these conditions:

- a) You must cause the modified files to carry prominent notices stating that you changed the files and the date of any change.
- b) You must cause any work that you distribute or publish, that in whole or in part contains or is derived from the Program or any part thereof, to be licensed as a whole at no charge to all third parties under the terms of this License.
- c) If the modified program normally reads commands interactively when run, you must cause it, when started running for such interactive use in the most ordinary way, to print or display an announcement including an appropriate copyright notice and a notice that there is no warranty (or else, saying that you provide a warranty) and that users may redistribute the program under these conditions, and telling the user how to view a copy of this License. (Exception: if the Program itself is interactive but does not normally print such an announcement, your work based on the Program is not required to print an announcement.)

These requirements apply to the modified work as a whole. If identifiable sections of that work are not derived from the Program, and can be reasonably considered independent and separate works in themselves, then this License, and its terms, do not apply to those sections when you distribute them as separate works. But when you distribute the same sections as part of a whole which is a work based on the Program, the distribution of the whole must be on the terms of this License, whose permissions for other licensees extend to the entire whole, and thus to each and every part regardless of who wrote it.

Thus, it is not the intent of this section to claim rights or contest your rights to work written entirely by you; rather, the intent is to exercise the right to control the distribution of derivative or collective works based on the Program.

In addition, mere aggregation of another work not based on the Program with the Program (or with a work based on the Program) on a volume of a storage or distribution medium does not bring the other work under the scope of this License.

3. You may copy and distribute the Program (or a work based on it, under Section 2) in object code or executable form under the terms of Sections 1 and 2 above provided that you also do one of the following:

- a) Accompany it with the complete corresponding machine-readable source code, which must be distributed under the terms of Sections 1 and 2 above on a medium customarily used for software interchange; or,
- b) Accompany it with a written offer, valid for at least three years, to give any third party, for a charge no more than your cost of physically performing source distribution, a complete machine-readable copy of the corresponding source code, to be distributed under the terms of Sections 1 and 2 above on a medium customarily used for software interchange; or,
- c) Accompany it with the information you received as to the offer to distribute corresponding source code. (This alternative is allowed only for noncommercial distribution and only if you received the program in object code or executable form with such an offer, in accord with Subsection b above.)

The source code for a work means the preferred form of the work for making modifications to it. For an executable work, complete source code means all the source code for all modules it contains, plus any associated interface definition files, plus the scripts used to control compilation and installation of the executable. However, as a special exception, the source code distributed need not include anything that is normally distributed (in either source or binary form) with the major components (compiler, kernel, and so on) of the operating system on which the executable runs, unless that component itself accompanies the executable.

If distribution of executable or object code is made by offering access to copy from a designated place, then offering equivalent access to copy the source code from the same place counts as distribution of the source code, even though third parties are not compelled to copy the source along with the object code.

4. You may not copy, modify, sublicense, or distribute the Program except as expressly provided under this License. Any attempt otherwise to copy, modify, sublicense or distribute the Program is void, and will automatically terminate your rights under this License. However, parties who have received copies, or rights, from you under this License will not have their licenses terminated so long as such parties remain in full compliance.

5. You are not required to accept this License, since you have not signed it. However, nothing else grants you permission to modify or distribute the Program or its derivative works. These actions are prohibited by law if you do not accept this License. Therefore, by modifying or distributing the Program (or any work based on the Program), you indicate your acceptance of this License to do so, and all its terms and conditions for copying, distributing or modifying the Program or works based on it.

6. Each time you redistribute the Program (or any work based on the Program), the recipient automatically receives a license from the original licensor to copy, distribute or modify the Program subject to these terms and conditions. You may not impose any further restrictions on the recipients' exercise of the rights granted herein. You are not responsible for enforcing compliance by third parties to this License.

7. If, as a consequence of a court judgment or allegation of patent infringement or for any other reason (not limited to patent issues), conditions are imposed on you (whether by court order, agreement or otherwise) that contradict the conditions of this License, they do not excuse you from the conditions of this License. If you cannot distribute so as to satisfy simultaneously your obligations under this License and any other pertinent obligations, then as a consequence you may not distribute the Program at all. For example, if a patent license would not permit royalty-free redistribution of the Program by all those who receive copies directly or indirectly through you, then the only way you could satisfy both it and this License would be to refrain entirely from distribution of the Program.

If any portion of this section is held invalid or unenforceable under any particular circumstance, the balance of the section is intended to apply and the section as a whole is intended to apply in other circumstances.

It is not the purpose of this section to induce you to infringe any patents or other property right claims or to contest validity of any such claims; this section has the sole purpose of protecting the integrity of the free software distribution system, which is implemented by public license practices. Many people have made generous contributions to the wide range of software distributed through that system in reliance on consistent application of that system; it is up to the author/donor to decide if he or she is willing to distribute software through any other system and a licensee cannot impose that choice.

This section is intended to make thoroughly clear what is believed to be a consequence of the rest of this License.

8. If the distribution and/or use of the Program is restricted in certain countries either by patents or by copyrighted interfaces, the original copyright holder who places the Program under this License may add an explicit geographical distribution limitation excluding those countries, so that distribution is permitted only in or among countries not thus excluded. In such case, this License incorporates the limitation as if written in the body of this License.

9. The Free Software Foundation may publish revised and/or new versions of the General Public License from time to time. Such new versions will be similar in spirit to the present version, but may differ in detail to address new problems or concerns.

Each version is given a distinguishing version number. If the Program specifies a version number of this License which applies to it and "any later version", you have the option of following the terms and conditions either of that version or of any later version published by the Free Software Foundation. If the Program does not specify a version number of this License, you may choose any version ever published by the Free Software Foundation.

10. If you wish to incorporate parts of the Program into other free programs whose distribution conditions are different, write to the author to ask for permission. For software which is copyrighted by the Free Software Foundation, write to the Free Software Foundation; we sometimes make exceptions for this. Our decision will be guided by the two goals of preserving the free status of all derivatives of our free software and of promoting the sharing and reuse of software generally.

NO WARRANTY

11. BECAUSE THE PROGRAM IS LICENSED FREE OF CHARGE, THERE IS NO WARRANTY FOR THE PROGRAM, TO THE EXTENT PERMITTED BY APPLICABLE LAW. EXCEPT WHEN OTHERWISE

STATED IN WRITING THE COPYRIGHT HOLDERS AND/OR OTHER PARTIES PROVIDE THE PROGRAM "AS IS" WITHOUT WARRANTY OF ANY KIND, EITHER EXPRESSED OR IMPLIED, INCLUDING, BUT NOT LIMITED TO, THE IMPLIED WARRANTIES OF MERCHANTABILITY AND FITNESS FOR A PARTICULAR PURPOSE. THE ENTIRE RISK AS TO THE QUALITY AND PERFORMANCE OF THE PROGRAM IS WITH YOU. SHOULD THE PROGRAM PROVE DEFECTIVE, YOU ASSUME THE COST OF ALL NECESSARY SERVICING, REPAIR OR CORRECTION.

12. IN NO EVENT UNLESS REQUIRED BY APPLICABLE LAW OR AGREED TO IN WRITING WILL ANY COPYRIGHT HOLDER, OR ANY OTHER PARTY WHO MAY MODIFY AND/OR REDISTRIBUTE THE PROGRAM AS PERMITTED ABOVE, BE LIABLE TO YOU FOR DAMAGES, INCLUDING ANY GENERAL, SPECIAL, INCIDENTAL OR CONSEQUENTIAL DAMAGES ARISING OUT OF THE USE OR INABILITY TO USE THE PROGRAM (INCLUDING BUT NOT LIMITED TO LOSS OF DATA OR DATA BEING RENDERED INACCURATE OR LOSSES SUSTAINED BY YOU OR THIRD PARTIES OR A FAILURE OF THE PROGRAM TO OPERATE WITH ANY OTHER PROGRAMS), EVEN IF SUCH HOLDER OR OTHER PARTY HAS BEEN ADVISED OF THE POSSIBILITY OF SUCH DAMAGES.

END OF TERMS AND CONDITIONS

END OF SCHEDULE 2

Schedule 3

If this Linksys product contains open source software licensed under the OpenSSL license then the license terms below in this Schedule 3 will apply to that open source software. The license terms below in this Schedule 3 are from the public web site at <http://www.openssl.org/source/license.html>

The OpenSSL toolkit stays under a dual license, i.e. both the conditions of the OpenSSL License and the original SSLeay license apply to the toolkit. See below for the actual license texts. Actually both licenses are BSD-style Open Source licenses. In case of any license issues related to OpenSSL please contact openssl-core@openssl.org.

OpenSSL License

```
-----
/*
=====
===
```

Copyright (c) 1998-2007 The OpenSSL Project. All rights reserved.

Redistribution and use in source and binary forms, with or without modification, are permitted provided that the following conditions are met:

1. Redistributions of source code must retain the above copyright notice, this list of conditions and the following disclaimer.
2. Redistributions in binary form must reproduce the above copyright notice, this list of conditions and the following disclaimer in the documentation and/or other materials provided with the distribution.

3. All advertising materials mentioning features or use of this software must display the following acknowledgment: "This product includes software developed by the OpenSSL Project for use in the OpenSSL Toolkit. (<http://www.openssl.org/>)"
4. The names "OpenSSL Toolkit" and "OpenSSL Project" must not be used to endorse or promote products derived from this software without prior written permission. For written permission, please contact openssl-core@openssl.org.
5. Products derived from this software may not be called "OpenSSL" nor may "OpenSSL" appear in their names without prior written permission of the OpenSSL Project.
6. Redistributions of any form whatsoever must retain the following acknowledgment: "This product includes software developed by the OpenSSL Project for use in the OpenSSL Toolkit (<http://www.openssl.org/>)"

THIS SOFTWARE IS PROVIDED BY THE OpenSSL PROJECT ``AS IS'' AND ANY EXPRESSED OR IMPLIED WARRANTIES, INCLUDING, BUT NOT LIMITED TO, THE IMPLIED WARRANTIES OF MERCHANTABILITY AND FITNESS FOR A PARTICULAR PURPOSE ARE DISCLAIMED. IN NO EVENT SHALL THE OpenSSL PROJECT OR ITS CONTRIBUTORS BE LIABLE FOR ANY DIRECT, INDIRECT, INCIDENTAL, SPECIAL, EXEMPLARY, OR CONSEQUENTIAL DAMAGES (INCLUDING, BUT NOT LIMITED TO, PROCUREMENT OF SUBSTITUTE GOODS OR SERVICES; LOSS OF USE, DATA, OR PROFITS; OR BUSINESS INTERRUPTION) HOWEVER CAUSED AND ON ANY THEORY OF LIABILITY, WHETHER IN CONTRACT, STRICT LIABILITY, OR TORT (INCLUDING NEGLIGENCE OR OTHERWISE) ARISING IN ANY WAY OUT OF THE USE OF THIS SOFTWARE, EVEN IF ADVISED OF THE POSSIBILITY OF SUCH DAMAGE.

=====
 This product includes cryptographic software written by Eric Young (ey@cryptsoft.com). This product includes software written by Tim Hudson (tjh@cryptsoft.com).

Original SSLeay License

Copyright (C) 1995-1998 Eric Young (ey@cryptsoft.com)

All rights reserved.

This package is an SSL implementation written by Eric Young (ey@cryptsoft.com).

The implementation was written so as to conform with Netscapes SSL.

This library is free for commercial and non-commercial use as long as the following conditions are aheared to. The following conditions apply to all code found in this distribution, be it the RC4, RSA, lhash, DES, etc., code; not just the SSL code. The SSL documentation included with this distribution is covered by the same copyright terms except that the holder is Tim Hudson (tjh@cryptsoft.com).

Copyright remains Eric Young's, and as such any Copyright notices in the code are not to be removed.

If this package is used in a product, Eric Young should be given attribution as the author of the parts of the library used. This can be in the form of a textual message at program startup or in documentation (online or textual) provided with the package.

Redistribution and use in source and binary forms, with or without modification, are permitted provided that the following conditions are met:

1. Redistributions of source code must retain the copyright notice, this list of conditions and the following disclaimer.
2. Redistributions in binary form must reproduce the above copyright notice, this list of conditions and the following disclaimer in the documentation and/or other materials provided with the distribution.
3. All advertising materials mentioning features or use of this software must display the following acknowledgement:

"This product includes cryptographic software written by Eric Young (eay@cryptsoft.com)"

The word 'cryptographic' can be left out if the routines from the library being used are not cryptographic related :-).

4. If you include any Windows specific code (or a derivative thereof) from the apps directory (application code) you must include an acknowledgement: "This product includes software written by Tim Hudson (tjh@cryptsoft.com)"

THIS SOFTWARE IS PROVIDED BY ERIC YOUNG ``AS IS'' AND ANY EXPRESS OR IMPLIED WARRANTIES, INCLUDING, BUT NOT LIMITED TO, THE IMPLIED WARRANTIES OF MERCHANTABILITY AND FITNESS FOR A PARTICULAR PURPOSE ARE DISCLAIMED. IN NO EVENT SHALL THE AUTHOR OR CONTRIBUTORS BE LIABLE FOR ANY DIRECT, INDIRECT, INCIDENTAL, SPECIAL, EXEMPLARY, OR CONSEQUENTIAL DAMAGES (INCLUDING, BUT NOT LIMITED TO, PROCUREMENT OF SUBSTITUTE GOODS OR SERVICES; LOSS OF USE, DATA, OR PROFITS; OR BUSINESS INTERRUPTION) HOWEVER CAUSED AND ON ANY THEORY OF LIABILITY, WHETHER IN CONTRACT, STRICT LIABILITY, OR TORT (INCLUDING NEGLIGENCE OR OTHERWISE) ARISING IN ANY WAY OUT OF THE USE OF THIS SOFTWARE, EVEN IF ADVISED OF THE POSSIBILITY OF SUCH DAMAGE.

The licence and distribution terms for any publically available version or derivative of this code cannot be changed. i.e. this code cannot simply be copied and put under another distribution licence [including the GNU Public Licence.]

END OF SCHEDULE 3

Contacts

For additional information or troubleshooting help, refer to the User Guide on the CD-ROM. Additional support is also available by phone or online.

US/Canada Contacts

24-Hour Technical Support

US/Canada: 866-606-1866

Mexico: 800-314-0939

RMA (Return Merchandise Authorization)

<http://www.linksys.com/warranty>

Website

<http://www.linksys.com>

FTP Site

<ftp://ftp.linksys.com>

Support

<http://www.linksys.com/support>

Sales Information

800-546-5797 (800-LINKSYS)

Global Contacts

Website

<http://www.linksys.com/international>

Product Registration

<http://www.linksys.com/registration>

Acronyms

This appendix defines acronyms that are commonly used in Linksys documentation.

A/D	Analog To Digital Converter
ANC	Anonymous Call
B2BUA	Back to Back User Agent
Bool	Boolean Values. Specified as "yes" and "no", or "1" and "0" in the profile
CA	Certificate Authority
CAS	CPE Alert Signal
CDR	Call Detail Record
CID	Caller ID
CIDCW	Call Waiting Caller ID
CNG	Comfort Noise Generation
CPC	Calling Party Control
CPE	Customer Premises Equipment
CWCID	Call Waiting Caller ID
CWT	Call Waiting Tone
D/A	Digital to Analog Converter
dB	decibel
dBm	dB with respect to 1 milliwatt
DHCP	Dynamic Host Configuration Protocol
DNS	Domain Name Server
DRAM	Dynamic Random Access Memory
DSL	Digital Subscriber Loop
DSP	Digital Signal Processor
DTAS	Data Terminal Alert Signal (same as CAS)
DTMF	Dual Tone Multiple Frequency
FQDN	Fully Qualified Domain Name
FSK	Frequency Shift Keying
FXS	Foreign eXchange Station
GW	Gateway
ITU	International Telecommunication Union
HTML	Hypertext Markup Language
HTTP	Hypertext Transfer Protocol
HTTPS	HTTP over SSL
ICMP	Internet Control Message Protocol
IGMP	Internet Group Management Protocol
ILEC	Incumbent Local Exchange Carrier
IP	Internet Protocol
ISP	Internet Service Provider
ITSP	IP Telephony Service Provider

IVR	Interactive Voice Response
LAN	Local Area Network
LBR	Low Bit Rate
LBRC	Low Bit Rate Codec
MC	Mini-Certificate
MGCP	Media Gateway Control Protocol
MOH	Music On Hold
MOS	Mean Opinion Score (1-5, the higher the better)
ms	Millisecond
MSA	Music Source Adaptor
MWI	Message Waiting Indication
OSI	Open Switching Interval
PCB	Printed Circuit Board
PR	Polarity Reversal
PS	Provisioning Server
PSQM	Perceptual Speech Quality Measurement (1-5, the lower the better)
PSTN	Public Switched Telephone Network
NAT	Network Address Translation
OOB	Out-of-band
REQT	(SIP) Request Message
RESP	(SIP) Response Message
RSC	(SIP) Response Status Code, such as 404, 302, 600
RTP	Real Time Protocol
RTT	Round Trip Time
SAS	Streaming Audio Server
SDP	Session Description Protocol
SDRAM	Synchronous DRAM
sec	seconds
SIP	Session Initiation Protocol
SLA	Shared line appearance
SLIC	Subscriber Line Interface Circuit
SP	Service Provider
SPA	Linksys Phone Adaptor
SSL	Secure Socket Layer
TFTP	Trivial File Transfer Protocol
TCP	Transmission Control Protocol
UA	User Agent
uC	Micro-controller
UDP	User Datagram Protocol
URL	Uniform Resource Locator
VM	Voicemail
VMWI	Visual Message Waiting Indication/Indicator

VQ	Voice Quality
WAN	Wide Area Network
XML	Extensible Markup Language

Glossary

ACD (Automatic Call Distribution)—A switching system designed to allocate incoming calls to certain positions or agents in the order received and to hold calls not ready to be handled (often with a recorded announcement).

Area code—A 3-digit code used in North America to identify a specific geographic telephone location. The first digit can be any number between 2 and 9. The second and third digits can be any number.

Billing increment—The division by which the call is rounded. In the field it is common to see full-minute billing on the local invoice while 6-second rounding is the choice of most long-distance providers that bill their customers directly.

Blocked calls—Caused by an insufficient network facility that does not have enough lines to allow calls to reach a given destination. May also pertain to a call from an originating number that is blocked by the receiving telephone number.

Bundled service—Offering various services as a complete package.

Call completion—The point at which a dialed number is answered.

Call termination—The point at which a call is disconnected.

CDR (Call Detail Records)—A software program attached to a VoIP/telephone system that records information about the telephone number's activity.

Carrier's carrier—Companies that build fiber optic and microwave networks primarily selling to resellers and carriers. Their main focus is on the wholesale and not the retail market.

Casual access—When customers choose not to use their primary carriers to process the long-distance call being made. The customer dials the carrier's 101XXXX number.

CO (Central Office)—Switching center for the local exchange carrier.

Centrex—This service is offered by the LEC to the end user. The feature-rich Centrex line offers the same features and benefits as a PBX to a customer without the capital investment or maintenance charges. The LEC charges a monthly fee to the customer, who must agree to sign a term agreement.

Circuits—The communication path(s) that carry calls between two points on a network.

Customer Premise Equipment—The only part of the telecommunications system that the customer comes into direct contact with. Example of such pieces of equipment are telephones, key systems, PBXs, voice-mail systems, and call accounting systems as well as wiring telephone jacks. The standard for this equipment is set by the FCC, and the equipment is supplied by an interconnect company.

Dedicated access—Customers have direct access to the long-distance provider via a special circuit (T1 or private lines). The circuit is hardwired from the customer site to the POP and does not pass through the LEC switch. The dial tone is provided from the long-distance carrier.

Dedicated Access Line (DAL)—Provided by the local exchange carrier. An access line from the customer's telephone equipment directly to the long-distance company's switch or POP.

Demarcation point—This is where the LEC ownership and responsibility (wiring, equipment) ends and the customer's responsibilities begin.

Direct Inward Dialing (DID)—Allows an incoming call to bypass the attendant and ring directly to an extension. Available on most PBX systems and a feature of Centrex service.

Dual Tone Multifrequency (DTMF)—Better known as the push button keypad. DTMF replaces dial pulses with electronically produced tones for network signaling.

Enhanced service—Services that are provided in addition to basic long distance and accessed by way of a touchtone phone through a series of menus.

Exchange code (NXX)—The first three digits of a phone number.

Flat-rate pricing—The customer is charged one rate (sometimes two rates, one for peak and one for off-peak) rather than a mileage-sensitive program rate.

IXC (Interexchange Carrier)—A long-distance provider that maintains its own switching equipment.

IVR (Interactive Voice Response)—Provides a mechanism for information to be stored and retrieved using voice and a touchtone telephone.

Local loop—The local telephone company provides the transmission facility from the customer to the telephone company's office, which is engineered to carry voice and/or data.

North American Numbering Plan (NANP)—How telephone numbers are identified in North America. The telephone number can be identified based on their three separate components: (NPA), (NXX), and (XXXX).

PIN (Personal Identification Code)—A customer calling/billing code for prepaid and pay-as-you-go calling cards.

Private Branch Exchange—Advanced phone system commonly used by the medium to larger customer. It allows the customer to perform a variety of in-house routing (inside calling). The dial tone that is heard when the customer picks up the phone is an internal dial tone.

SS7 (SPA9000 Signaling Number 7)—Technology used by large carriers to increase the reliability and speed of transmission between switches.

Switch (switching)—Equipment that connects and routes calls and provides other interim functions such as least cost routing, IVR, and voicemail. It performs the "traffic cop" function of telecommunications via automated management decisions.

Touchtone (DTMF)—The tone recognized by a push button (touchtone) telephone.

Unified messaging— Platform that lets users send, receive, and manage all e-mail, voice, and fax messages from any telephone, PC, or information device.

Voicemail—A system that allows storage and retrieval of voice messages through voice-mail boxes.

