



OUTDOORS RV

OWNER MANUAL

541-624-5500
62582 Pierce Rd.
La Grande, OR 97850



Revised 8/6/2018

Table of Contents

INTRODUCTION	1	ELECTRICAL SYSTEMS	62
Owner Manual & Info Packet	1	120 Volt AC System	62
Reporting Safety Defects	1	12 Volt DC System	66
Safety Information	2	The RV Battery	68
WARRANTY	3	Solar	70
Outdoors RV 1-2-3 Warranty	3	Bulbs and Fuses	71
Warranty Exclusions	3	PROPANE SYSTEM	72
Owner Responsibility	4	Propane Safety	72
Dealer Responsibility	4	System Components	74
Outdoors RV Responsibility	4	Filling Propane Tanks	77
Warranty Disclaimers	4	Propane System Checks	78
In Matters Of Dispute	4	Propane Leak Detector	78
Component Product Registration ...	5	Lighting Propane Appliances	80
How to Obtain Warranty Service ...	5	APPLIANCES AND EQUIPMENT	81
Pre-Delivery Inspection	6	Furnace	82
Owner Registration	6	Water Heater	82
Getting to Know Your RV	6	Water Pump	83
Making an Appointment	6	Refrigerator	83
Inspecting Repairs	7	Range/Oven/Cooktop	83
ON THE ROAD	8	Range Hood	83
Guidelines for Equipment Selection ..	8	Microwave/Convection Oven	83
Operator Licensing Requirements ..	10	Fireplace	84
Hitching Up	10	Air Conditioner	84
Braking System	13	Thermostat	85
Loading Your RV	15	TV/Stereo Antenna	85
Hitch Receivers	17	TV/Satellite Connections	85
Distributing your Load	17	Televisions	87
Safe Driving Guidelines	22	Awning	87
Tire Safety and Information	25	Slide-Out Topper	88
Wheel Lug Nut Torquing	31	Power Roof Vents	88
Pre-Departure Checklist	33	Manual Roof Vent	88
LIVING WITH YOUR RV	35	Rear Monitor Camera	88
Fire Safety	35	Heated Holding Tanks	88
Effects of Long-Term Occupancy ..	37	Monitor Panel	89
Leveling and Stabilization.....	43	Propane Leak Detector	89
Window Coverings	45	Carbon Monoxide Detector	89
Dinette Conversion	46	Smoke Detector	91
Sofa Conversion	47	Wireless Function Controller	91
Storage Compartments	48	Spare Tire Carriers	91
Entry Doors, Screens and Locks ...	49	Slideout Room	92
PLUMBING SYSTEMS	50	Toy-Lock	95
Fresh (Potable) Water System	50	Battery Tray	95
Sanitizing Fresh Water System	56	Tongue Jack	96
Waste Water System	56	Manual Stabilizer Jacks	96
Plumbing Systems Awareness	60	Electric Stabilizer Jacks	96
		Automatic Leveling System	96
		Flow-Longer LP Gas Line Kit	96
		LP Generator	97

Table of Contents

STORAGE & WINTERIZATION 97
Storage Checklist 97
Winterization 98
Reactivating RV After Storage 100

MAINTENANCE 101
Exterior 102
Interior 108
Maintenance Schedule 110
Maintenance & Repair Log 111

THE RV TOOL BOX 112

OWNER NOTES 113

RAMP MODEL FEATURES
See Addendum (if applicable)

Introduction

Outdoors RV Manufacturing appreciates and welcomes you as a customer. We want your RV purchase and camping experience to be most enjoyable for many years to come! We have provided this Owner Manual so that you and your family will be able to make the most out of your camping experience.

Your new RV has been constructed to conform with or exceed Federal and State safety regulations. Quality assurance methods and/or functions meet or exceed standards prescribed by ANSI/NFPA 1192 and/or CSA Z240 as approved by the agency having jurisdiction in the United States or Canada.

We thank you for your purchase!

Outdoors RV Manufacturing

P.O. Box 1047
62585 Pierce Road
La Grande, OR 97850
Phone: 541-962-1866
Fax: 541-962-1894 (Parts & Service)



Website: <http://outdoorsrvmfg.com/>

Facebook: <https://www.facebook.com/outdoorsrvmfg/>

OWNER MANUAL AND INFORMATION PACKET

To help you get started please make time to read and review this Owner Manual. This information will help provide you with many of the functions and required maintenance procedures necessary on your RV. Your RV will require regular care and maintenance in order to deliver maximum value and performance. Your dealership will provide you basic operating and maintenance instructions. However, be sure to read all instructional materials and equipment manuals located in your Owner Information Packet included with your new RV. Many of these manuals are also available as free downloads at each product manufacturers website in the event that something may be missing from your packet. You may also visit our website for a free download of this manual.

Some components in this manual or packet may be components of a differing product line or are optional equipment in which case will be noted as 'If Equipped'. Product specifications, design and equipment may change without notice due to continuous product improvement by Outdoors RV. It is possible that recent product changes may not be included in this manual. Product information included in this Owner Manual were as accurate as possible at the time of publication and may or may not be specific in their depiction of actual equipment, fabrics, interior, or exterior decor or design options as installed on or in your RV. This manual is subject to change without notice.

REPORTING SAFETY DEFECTS

If you believe that your vehicle has a defect which could cause a crash or could cause injury or death, you should immediately inform the National Highway Traffic Safety Administration (NHTSA) in addition to notifying Outdoors RV Manufacturing. If NHTSA receives similar complaints, it may open an investigation, and if it finds that a safety defect exists in a group of vehicles, it may order a recall and remedy campaign. However, NHTSA cannot become involved in individual problems between you, your dealer, or Outdoors RV Manufacturing.

Introduction

To contact NHTSA, you may call the Vehicle Safety Hotline toll-free at 1-888-327-4236 (TTY: 1-800-424-9153); go to <http://nhtsa.safercar.gov>; or write to: Administrator, NHTSA, 1200 New Jersey Avenue SE, Washington, DC 20590. You can also obtain other information about motor vehicle safety from <http://www.safercar.gov>.

SAFETY INFORMATION

Shown below are various hazard warnings you will find throughout this manual. They are used to alert you to potentially dangerous or hazardous situations. When you see these symbols, please read them carefully, and follow their instructions to help prevent damage to your recreational vehicle and for your personal safety as well as others nearby.

⚠ DANGER

- *DANGER* indicates an immediately hazardous situation that, if not avoided, **will result in death or serious injury**.

⚠ WARNING

- *WARNING* indicates a potentially hazardous situation that, if not avoided, **could result in death or serious injury**.

⚠ CAUTION

- *CAUTION* indicates a potentially hazardous situation that, if not avoided, **may result in minor or moderate injury**.

NOTICE

- *NOTICE* is used to address particularly important information that is not necessarily injury related and may include situations involving property damage or issues which may void warranty.

OUTDOORS RV 1-2-3 WARRANTY

1 Year - Limited Bumper to Bumper Warranty - Transferable

Outdoors RV Manufacturing warrants for a period of one (1) year from the date of purchase that the RV manufactured and assembled by Outdoors RV Manufacturing shall be free from defects in materials and workmanship supplied and attributable to Outdoors RV except as specifically excluded below. If a defect occurs within the first year please contact an Outdoors RV Mfg. authorized dealer and schedule an appointment for an inspection of the defect.

Outdoors RV Mfg., at its sole discretion, reserves the right to substitute parts or components of substantially equal quality, touch-up cosmetic flaws, make design and or manufacturing improvements as the remedy under this Limited Warranty. All owners (original or subsequent) must be properly registered with Outdoors RV Manufacturing to be considered for eligibility.

This Limited Warranty may be transferred during the one (1) year term by the original owner to a subsequent purchaser. The limited one (1) year warranty, however, shall in no way be extended beyond the one (1) year from the original date of purchase by reason of the transfer from the original consumer purchaser to any subsequent purchaser(s). The subsequent purchaser(s) also has an obligation to notify Outdoors RV Mfg. immediately upon the transfer of the warranty and to provide proof of purchase within the one (1) year.

2 Year - Limited Structural Fiberglass Wall Warranty - Non Transferable

A customer must have followed the maintenance section of the owners manual and provide documentation of exterior roof, window, door, luggage doors, and moldings seal maintenance along with proper fiberglass care maintenance to an Outdoors RV Mfg. authorized dealer in order to be considered for the fiberglass wall warranty. The best method for proper documentation is to have your local authorized Outdoors RV dealer perform the inspection and work for you. If a structural fiberglass defect occurs after the first year and within the second year please contact the Outdoors RV Service Department in La Grande, OR to schedule an appointment at the factory for an inspection of the defect. You will be responsible for transporting the RV to and from the factory in La Grande, OR. If correct maintenance was performed and documented properly and the defect is valid, Outdoors RV Mfg. will authorize the repair at the factory in La Grande, OR at no expense to the customer (Travel costs not included).

3 Year - Limited Custom Built Chassis Warranty - Non Transferable

A customer must have followed the maintenance section of this owners manual and provide documentation from an Outdoors RV Mfg. authorized dealer of the following: Inspection of the chassis hardware (regularly tighten as necessary) along with maintenance records of proper care of the trailer A-frame, bumper and overall chassis in regards to cleaning, and touch-up paint, to be considered for the chassis warranty. If a chassis defect occurs after the first year and within the third year please contact the Outdoors RV Service Department in La Grande, OR to schedule an appointment at the factory for an inspection of the defect. You will be responsible for transporting the RV to and from the factory in La Grande, OR. The best method for proper documentation is to have your authorized Outdoors RV Mfg. dealer perform the inspection and work for you. If correct maintenance was performed and documented properly and the defect is valid, Outdoors RV Mfg. will authorize the repair at the factory in La Grande, OR at no expense to the customer (Travel costs not included).

WARRANTY EXCLUSIONS

This Limited Warranty and the obligations stated herein shall not apply to:

1. RVs used for business, rental, commercial, or disaster relief purposes other than recreational travel and family camping.
2. RVs which are not originally sold through an authorized Outdoors RV Mfg. dealer (i.e. sold through auction, repossession, and salvage or otherwise 'distressed' condition).
3. Equipment, products, components, appliances, or accessories not manufactured or installed by Outdoors RV Mfg. whether or not warranted, including but not limited to, tires, batteries, and other installed equipment or accessories.
4. Damage or loss caused in whole or part by misuse, abuse, neglect, theft, vandalism, RV modification, improper customer or dealer installation, incorrect line voltage, unauthorized repair or failure to follow instructions supplied with the recreational vehicle.
5. Damage or loss caused in whole or in part by any unauthorized attachments, modifications or alterations to the structure, body, pin-box, or frame of the recreational vehicle including but not limited to trailer hitches for towing, or platforms for supporting cargo.
6. Any upholstery damage including, but not limited to tears, punctures, or misuse.
7. Any fading or discoloring of fabrics, carpet, or flooring roll goods.
8. Routine maintenance including, without limitation, caulking, re-caulking, and waxing of the body of the recreational vehicle, tightening screws, brake adjustments, latches, locks, changing fuses, or light bulbs, and maintaining the air conditioning and heating systems.
9. Damage or loss caused in whole or in part by exposure to natural atmospheric elements, corrosive chemicals, ash, or fumes generated or released by vehicles, collision, road hazards, rock chips, condensation, or any other source.
10. Damage or loss caused in whole or in part by overloading or the improper balancing of the load.
11. Damage or loss to the recreational vehicle caused in whole or in part by the tow vehicle selected by the owner to pull the recreational vehicle including but not limited to the improper selection or installation of the towing hitch on the tow vehicle.
12. Damage or loss caused in whole or in part by the willful or negligent acts of the driver of the vehicle pulling the recreational vehicle, an accident involving the recreational vehicle caused by the condition of any road surface over which the recreational vehicle is pulled, or striking over a curb or any other object.
13. Any injury, loss, or damage due to mold or fungi.
14. Any incidental and consequential damages including but not limited to transportation, fuel, food, lodging, telephone calls, towing charges, bus and taxi fares, or car rentals, on-site service calls, as well as commercial use and loss of use.
15. Any RV licensed, registered, or primarily used outside of the United States or Canada.
16. Damage to electronics due to voltage issues.
17. Damage or loss caused in whole or in part by the owners operation, use, or misuse of the tow vehicle.
18. Wheel alignment.
19. Any and all damage or loss to the owners tow vehicle.

OWNER RESPONSIBILITY

1. Perform proper care and maintenance as outlined by this manual and corresponding component warranty information including taking whatever preventable measures necessary to maintain the exterior sealants of the unit and to prevent foreseeable secondary moisture or water damage to the unit from rain, plumbing leaks, condensation, and other natural accumulation of water in the unit. Examples of secondary damage include, but are not limited to, stained upholstery, carpeting or drapes, mold formation and growth, furniture, cabinetry or floor deterioration, etc. Minor adjustments (such as adjustments to interior or exterior doors, cabinet latches, etc.) will be performed by the selling dealer during the first 90 days after delivery. Thereafter, such adjustments are the responsibility of the owner as normal maintenance.
2. Written notice of defects must be provided to the selling dealer or manufacturer within 30 days of discovery by owner but no later than 10 days after the warranty expiration of the warranty period.
3. Returning your RV to an authorized dealer for any repairs or service that is required.
4. Reviewing the information contained within this manual and all supplied component information.

DEALER RESPONSIBILITY

1. By agreement with the manufacturer, the dealer is obligated to maintain the RV prior to retail sale, to perform a detailed pre-delivery inspection and to repair or replace any parts necessary to correct defects in material or workmanship.
2. Explain and review the Limited Warranty provisions to the customer.
3. Assist the customer with all necessary registrations and warranty cards for your new RV.
4. Instruct the customer on how to obtain service and warranty on separately warranted components, whether in or out of warranty.
5. Service Outdoors RV products the dealer currently stocks.
6. Fill out and submit warranty registrations within 7 days from the date of delivery.

OUTDOORS RV RESPONSIBILITY

The distinction between 'defects' and 'damage' as used in this Limited Warranty is that a 'defect' item is covered under warranty and a 'damage' item is not. We have no control over 'damage' items caused by such things as collision, misuse, and lack of maintenance which occurs after the recreational vehicle is delivered to the owner. Therefore 'damage' for any reason which occurs after the recreational vehicle is delivered is not covered under warranty. Maintenance services are also excluded from warranty as it is the retail owner responsibility to maintain the recreational vehicle.

Outdoors RV does not take any responsibility, to any owner, beyond the original cost of the recreational vehicle to Outdoors RV or for any undertaking, representation, or warranty made by any dealer beyond the expressed herein.

WARRANTY DISCLAIMERS

The limited warranty provided by Outdoors RV Manufacturing in lieu of all other warranties, express or implied, including any implied warranty of merchantability or fitness for any particular purpose, and in lieu of all other obligations or liabilities on the part of Outdoors RV Mfg. Implied warranties, including the implied warranty of merchantability or fitness for a particular purpose, if any, given by law, shall be limited to and not extend beyond the duration of the written warranty periods set forth herein. No person has the authority to enlarge, amend, or modify this Limited Warranty.

Outdoors RV will not be responsible or liable for loss of use of the recreational vehicle, on site service calls or service charges, loss of time, inconvenience, expenses for gasoline, towing charges or transportation costs, loss of use, rental of substitute equipment, telephone, travel, lodging, damage or loss of personal property, loss of revenues or other commercial loss, or any other kind of nature resulting from any defect in the recreational vehicle.

In regards to the use and operation of Outdoors RV recreational vehicles, Outdoors RV customers and owners of Outdoors RV recreational vehicles are solely responsible for the selection and proper use of tow vehicles. All customers should consult with your motor vehicle manufacturer or dealer concerning the purchase and use of suitable tow vehicles for Outdoors RV recreational vehicles. Outdoors RV further disclaims any liability with respect to damages which may be incurred by a customer or owner of Outdoors RV recreational vehicles as a result of the operation, uses or misuses of a tow vehicle.

Any action to enforce this Limited Warranty or any implied warranty shall not be brought more than one (1) year after the expiration of the terms of this Limited Warranty.

Some states do not allow the exclusion or limitation of incidental or consequential damages so the above limitation or exclusion may or may not apply. Further some states do not allow a reduction in the statute of limitations so the above reduction may not apply.

IN MATTERS OF DISPUTE

CHOICE OF LAW: The laws and jurisdiction of the state of Oregon shall govern any and all matters of dispute between you and Outdoors RV Manufacturing. Any dispute or action you bring to enforce warranty rights against Outdoors RV Manufacturing must be brought in the County of Union, in the State of Oregon. The parties irrevocably consent to jurisdiction in such courts.

Warranty

WARNING

- *Failure to follow proper procedures or install correct equipment can result in property damage, injury, and or death. The instructions included in this manual are intended as a guide, and in no respect extend the responsibilities to Outdoors RV Manufacturing beyond the standard written warranty as presented in this manual.*

Proper maintenance will help avoid situations where this Limited Warranty will not cover items due to neglect. As the owner of a new RV, you are responsible for regular care and proper maintenance. Service should be performed in accordance with this manual, as well as corresponding manufacturers warranty on components included in your unit.

The owner is responsible to return the RV to an authorized dealer for any repairs and service that may be required. Your Outdoors RV dealer is responsible for proper service before delivery and will have continued interest in your satisfaction. We recommend that warranty and maintenance services be performed by your Outdoors RV Dealer.

COMPONENT PRODUCT REGISTRATION

Your owner information packet contains individual product warranty registrations and should be completed and mailed promptly. Your dealership will provide you with any assistance you may need to complete the registration forms. These forms may be available as free downloads via each product manufacturers website in the event that something may be missing from your packet.

HOW TO OBTAIN WARRANTY SERVICE

To obtain warranty service the retail owner must deliver the recreational vehicle to an authorized Outdoors RV dealer with proof of purchase and freight pre-paid, (if having transported), within a reasonable time after the discovery of the defect within the warranty period. Outdoors RV does not cover any transportation cost incurred to transport the recreational vehicle to the dealer or to the manufacturing plant. All towing and or transportation costs are the owner responsibility. Upon requesting service you will be asked for:

1. Your name
2. Date of purchase
3. Outdoors RV Vehicle Identification Number (VIN)
4. Provide explanation and list of required repairs.

Service must be obtained from Outdoors RV authorized dealers. If you cannot locate an authorized Outdoors RV dealer please contact **Outdoors RV Service Department at 541-962-1866** for assistance. Do not pay for any services or use non-authorized dealers without obtaining **Prior Authorization** from Outdoors RV Manufacturing. Your incurred costs may not be completely covered by Outdoors RV Manufacturing.

Warranty

Appliance and Component Warranty Service/Administration

Appliance and component manufacturers may or may not provide their own warranties. These warranties are separate from the Outdoors RV Limited Warranty and constitute the only warranty for these specific appliances and components. The terms, conditions, and warranty periods of these items may vary from the Outdoors RV Limited Warranty. All warranty claims for appliances and component manufacturers providing warranties will be administered through the Outdoors RV dealer network. Outdoors RV dealers will work with each individual appliance and component manufacturer. If the Outdoors RV dealer and/or the retail owner need assistance they should contact the Outdoors RV Service Department. Outdoors RV will directly contact the appliance and/or component manufacturer. After the one year warranty period, all appliance and component warranty must be directed to the respective appliance component manufacturers providing warranties. All warranty claims for these components will be administered by the appliance and/or component manufacturer. In no way shall the Outdoors RV Manufacturing Limited Warranty be modified or amended.

PRE-DELIVERY INSPECTION

Your Outdoors RV dealer is required to review the limited warranty and inspect the unit along with you. The dealer has been provided with a pre-delivery checklist. Review this checklist with the dealer. You should not sign this checklist until the review is complete and any questions about anything you do not understand have been answered.

OWNER REGISTRATION

The owner registration form is completed at the dealership at the time of delivery. The new owner signs the form and the dealer will forward the completed registration form to Outdoors RV within seven (7) days. Be sure this form has been completed and signed prior to leaving the dealership.

GETTING TO KNOW YOUR RV

Outdoors RV recommends a 'Trial' campout before heading out on your first real campout. Plan a short trip near your home for the night or in your driveway and really use your RV as if you were actually camping. By 'trial' camping for several days and using all components, appliances, etc. in your RV you will have the opportunity to use and become familiar with the systems within your RV and find out what items are needed and not needed while camping. If any questions, difficulties or problems occur during your trial campout, contact your dealer to discuss or arrange for a visit, with your RV, to resolve any issues before the actual first campout. Getting to know your RV before the first adventure can save a lot of frustration and leave more time for fun.

MAKING AN APPOINTMENT

Call ahead

Contact your dealer to schedule an appointment preferably by phone or in person. If you are requesting repairs to be made at a dealership other than where you purchased your RV the dealership service manager may ask for your 'Date of Purchase' and 'Vehicle Identification Number' (VIN). This VIN number is found in various locations including the Manufacturer Certification Label located on the driver side at the front of the RV. Also you will find it located on the yellow Cargo Carrying Capacity Label inside the main entry door jamb.

Warranty

Example of Manufacturer Certification Label located at driver side front of RV.

MANUFACTURED BY / FABRIQUE PAR:		DATE	
GVWR / PNBV	KG (LB)		
GAWR (EACH AXLE) / PNBE (CHAQUE ESSIEU)	KG (LB)	TIRES / PNEU	
RIMS / JANTE			
COLD INFL. PRESS. / PRESS. DE GONFL. A FROID	KPA (PSI / LPC)	<input type="checkbox"/> SINGLE <input type="checkbox"/> DUAL
THIS VEHICLE CONFORMS TO ALL APPLICABLE U.S. FEDERAL MOTOR VEHICLE SAFETY STANDARDS IN EFFECT ON THE DATE OF MANUFACTURE SHOWN ABOVE.			
THIS VEHICLE CONFORMS TO ALL APPLICABLE STANDARDS PRESCRIBED UNDER THE CANADIAN MOTOR VEHICLE SAFETY REGULATIONS IN EFFECT ON THE DATE OF MANUFACTURE. - CE VEHICULE EST CONFORME A TOUTES LES NORMES QUI LUI SONT APPLICABLES EN VERTU DU REGLEMENT SUR LA SECURITE DES VEHICULES AUTOMOBILES DU CANADA EN VIGUEUR A LA DATE DE SA FABRICATION.			
V.I.N. / N.I.V.:	TYPE / TYPE: TRAILER TRA / REM		FD-306 REV A

Example of Cargo Carrying Capacity label located in door jamb of main entry.

RECREATION VEHICLE TRAILER CARGO CARRYING CAPACITY
VIN:
THE WEIGHT OF CARGO SHOULD NEVER EXCEED
454 kgs or 1000 lbs
CAUTION:
A full load of water equals 294 kg or 649 lbs of cargo @ 1 kg/L (8.3 lbs/gal)

Provide the dealer with a repair list

Have a repair list available including any known parts that are required to perform the repair(s). Your repair(s) may require special parts that the dealer may need to order. Please explain what you would like to be repaired or adjusted so that the service manager can discuss available appointment dates with you.

INSPECTING REPAIRS

Outdoors RV and your dealer want you to be satisfied with any repair. Have the dealer service personnel review with you the repair that was performed. Thoroughly inspect the repair(s). Once satisfied, sign the warranty repair work order. Your dealer should provide you with a copy of the work order for your records.

On the Road

GUIDELINES FOR EQUIPMENT SELECTION AND PREPARATION

Your towing equipment, its adjustments, and how you load the RV will have a great effect on towing stability and handling. The following rules will help you select and adjust your equipment in a manner that will help produce acceptable towing characteristics. Also you will want to check specific requirements in the states and provinces where you will be traveling.

Before discussing equipment selection, we will explain some common weight terminology with their abbreviations. You will occasionally see these abbreviations used throughout this manual.

CCC (Cargo Carrying Capacity) is the available weight capacity for cargo, not including fresh water and LP gas however dealer added options may reduce this by the Load Carrying Capacity Reduction.

GAWR (Gross Axle Weight Rating) is the maximum permissible loaded weight a specific axle is designed to carry.

GCWR (Gross Combination Weight Rating) is the value specified by the tow vehicle manufacturer as the maximum allowable loaded weight of the tow vehicle with its towed trailer or towed vehicle.

GVWR (Gross Vehicle Weight Rating) is the maximum permissible weight of the fully loaded RV. GVWR includes all weight at the RV axles and tongue or fifth wheel pin. The GVWR is equal to or greater than the sum of the Unloaded Vehicle Weight plus the Cargo Carrying Capacity.

LCCR (Load Carrying Capacity Reduction) is the amount the Cargo Carrying Capacity is reduced due to vehicle weight added by the dealer (dealer added options and accessories) between vehicle certification and the first retail sale.

UVW (Unloaded Vehicle Weight) is the weight of the vehicle as built at the factory.

Use a tow vehicle with the appropriate axle capacity (GAWR) for your RV, and which has the appropriate equipment such as heavy duty radiator, transmission, final drive gearing, suspension, wheels and tires. The tow vehicle must be rated by its manufacturer both to the gross weight (GCWR) and to carry the tongue weight of your fully loaded RV. Please check with your tow vehicle manufacturer for your towing specifications. Weigh your loaded RV and tow vehicle according to the instructions found in this chapter on '*Loading Your RV*' and '*Determining and Distributing Your RV Load*'. Improper loading can lead to possible tire, axle, and frame damage, and can lead to loss of towing stability and control resulting in a vehicle crash.

⚠ WARNING

- *Improper loading can lead to possible tire, axle, and frame damage, and can lead to loss of towing stability and control resulting in a vehicle crash.*

On the Road

Consult with your RV dealer or tow vehicle dealer and towing equipment supplier to determine the correct type of hitch assembly, hitch ball, brake controller, and other equipment you should use for towing and leveling your RV.

Towing equipment to consider may include a weight distributing system, and a sway control system. A weight distributing hitch system will redistribute a percentage of the loaded tongue weight of your RV allowing the combination of tow vehicle and RV to sit level and will improve safe drivability. The weight of your loaded RV in comparison to the towing capacity of your tow vehicle should be evaluated during this consultation.

Installation of tow equipment must be performed by a competent installer. Make sure the installation follows the tow vehicle and tow equipment manufacturers' instructions.

Conventional Travel Trailer: Use a weight distribution hitch rated to pull not less than the RV GVWR and spring bars rated appropriately for your loaded tongue weights. The hitch must be equipped with a 2 5/16" diameter ball as close as practical to the rear bumper to minimize rear overhang. Under no circumstances add any hitch extenders to the rear of your tow vehicle.

Fifth Wheel Travel Trailer: Use a hitch and receiver assembly sized for the 2" SAE king pin and rated to pull not less than the GVWR of the fifth wheel travel trailer. The receiver should be attached to the truck chassis. No weight distribution or sway control devices are needed with a fifth wheel hitch.

NOTICE

- *Fifth wheel hitch extenders also called gooseneck tongue adapters are not to be used with Outdoors RV fifth wheel travel trailers. Use of a hitch extending device may cause structural damage to the chassis pin-box assembly. Damage caused by the use of a hitch extending device is not covered under Outdoors RV Warranty Policy.*

Use a brake controller that automatically applies the brakes in proportion to the tow vehicle brake and that also has a hand control for applying the travel trailer brakes only. See the '**Braking Systems**' section in this chapter for additional information.

Maintain proper tire pressure as listed on the 'Tire and Loading Information' label located at the driver side front corner of your RV. When checking tire pressure, ensure that all tires are at the same pressure. For additional tire information refer to the section in this chapter titled '**Tire Information and Safety**'.

Use properly installed side mirrors adjusted to provide a clear view of the area at both sides of and behind the RV. Locate them as close as possible to the driver to provide the maximum field of view. If you are towing an RV that is wider than your tow vehicle, you will need extended side mirrors to see rear and side approaching traffic. Many newer truck manufacturers install side mirrors that rotate or extend to provide additional viewing angles for towing. Your factory side mirrors may be adequate if they are of this design.

On the Road

OPERATOR LICENSING REQUIREMENTS

States, Canadian provinces and municipalities may require special permits and licenses based on the size and weight of your RV especially if it is over eight feet wide.

Some states or Canadian provinces may require additional equipment for the tow vehicle such as side and rear view mirrors. Inquire at your local motor vehicle administration to find out what requirements affect you. If you plan to travel in another state or Canadian province don't forget to check its requirements also. For example surge brakes may not be legal in some jurisdictions. In addition to licenses and permits there may be weight, height, and width limits for using certain roads, bridges, and tunnels. Also be aware of restrictions regarding the transport of propane and other volatile gases or fuels in tunnels. And don't forget to contact your insurance company to make sure you have the proper coverage.

HITCHING UP

The hitch, spring bars, sway control, safety chains, and breakaway switch are all important safety devices that protect your investment as well as other people's lives and property. As an RV owner it is your responsibility to be familiar with these devices and their proper use. Make sure you read and understand the instructions furnished by the manufacturers of each of these devices. Hitching up your RV will become routine with experience. Make it a habit to examine all hitch components before hitching your RV. Always inspect the condition of wiring and connectors for damage and function. Test breakaway switch to verify that the RV brakes do indeed lock up in the event of a disconnected hitch while traveling. Remember that the breakaway switch emergency braking feature requires a fully charged battery on the RV. This important safety item is required in most states.

Check for cracked or bent hitch components, cracked welds, and deformed or stripped bolts. Be sure the hitch ball is tight and well lubricated. Check the tongue for cracks especially at the front cross member. Be sure the coupler locking device works freely. Inspect the safety chains. If you have a fifth wheel model check all truck mounted hitch components. Be sure the king pin locking device works properly. Inspect the pin-box and king pin assembly. Periodically check pin-box mounting bolt torque. Be sure that all moving parts of the hitch are well lubricated. If you find defects in any hitch component correct it before towing the RV.

Before attempting to hitch up your RV read the instructions provided by the hitch manufacturer. The following instructions are usable in most cases. If the instructions provided with your hitch are different than the instructions below, follow the hitch manufacturer's instruction. Hitching up should be a two person job. One person should drive the truck and the second person should act as the spotter to assist the driver when maneuvering the truck into position. The RV should be on flat ground when stored. When hitching up it is recommended that a set of tire chocks be used on at least one tire (One chock in front of the tire and one behind the tire). This will help reduce any unintentional movement of the RV.

CAUTION

- *It is highly recommended that tire chocks be placed in front and rear of at least one tire to help prevent any unintentional movement.*

WARNING

- *After every trip all hitching components on both the tow vehicle as well as the RV should be inspected for wear or damage. If any excessive wear or cracking is observed, have the trailer inspected by a qualified professional and if necessary replace the affected parts before any unnecessary travel.*

Conventional Travel Trailer:

1. Operate tongue jack to provide adequate clearance between coupler and hitch ball on tow vehicle.
2. Locate spotter in a safe position that is clear from between the tow vehicle and the RV tongue yet visible to both you and the coupler so that you will be able to see spotter directions for guiding hitch ball under coupler socket as you back up.
3. Back the tow vehicle slowly until the hitch ball is directly under the coupler ball socket.
4. Put the tow vehicle transmission in park and set the parking brake.
5. Be sure the tongue coupler latch is fully open. Lower the tongue until the ball is firmly seated in the socket. Close the coupler latch and secure it with a locking pin, bolt, or padlock. It may be necessary to rock the RV or tow vehicle slightly to get the coupler latch to close completely. Raise the jack leg until jack foot pad is off the ground.
6. Step back and check that the RV is level from front to rear. Do not permit the front of the RV to be lower or higher than the rear as it may create unsafe handling characteristics as well as a hitch connection or rear bumper that may drag while maneuvering uneven terrain. Adjust hitch ball height if necessary to achieve a level stance of the RV.
7. If using a weight distributing hitch follow hitch manufacturer operating instructions.
8. Remove foot pad (if removable) and retaining pin and store for unhitching. Continue raising tongue jack until it is fully retracted.
9. If using a sway control device follow device manufacturer operating instructions.
10. Adjust safety chain length by moving quick connect end link to an appropriate link along the chain so that each chain is the same length and as short as possible but still allows full turning angles without becoming tight. Chains should be crossed over each other and short enough to cradle the coupler off the ground if the tongue ever accidentally becomes uncoupled. Attach each chain hook to the chain connection loops provided on your hitch. **WARNING - Never attach safety chains to the hitch ball or to any removable part of the hitch.**
11. Connect the breakaway switch lanyard loop using a quick connect coupler or carabineer at the hitch safety chain loop. Be sure that the length of the lanyard is adjusted so the switch cannot be activated during a full 'jackknife' turn. **WARNING - Do not connect the breakaway switch lanyard to the hitch ball, safety chains, or to any removable part of the hitch.**
12. Plug the 12 volt electrical cord (7-pin) into the mating tow vehicle socket.
13. Run an operational check of stop lights, turn indicators, running lights, back-up lights (if equipped), and electric brakes before driving away. See '*Braking System*' in this chapter and '*Electrical System*' chapter for more details about the electrical systems.
14. Remove tire chocks.
15. Reverse the procedure for unhitching.

WARNING

- *Do not connect the breakaway switch lanyard to the hitch ball or to any removable part of the hitch. Remember that the breakaway switches' emergency braking feature requires a fully charged battery on the RV.*
- *Never attach safety chains to the hitch ball or to any removable part of the hitch.*

Fifth Wheel Travel Trailer:

Always ensure that the RV is stable before attempting to hitch up. Both the truck and RV should be on near level ground. Connecting the receiver and pin-box will be much easier if both height and side-to-side level is closely matched.

1. Slowly back the truck toward the pin-box until the king pin and coupler are in close proximity then stop with the engine running, transmission in park, and the parking brake set.
2. Raise or lower the front of the fifth wheel using the landing gear so that the king pin height closely matches that of the hitch plate assembly in the truck.
3. Open the coupler locking device so that the pin can engage the hitch plate jaws.
4. Lower the truck tailgate.
5. Continue backing and engage the king pin and coupler completely.
6. Place the truck transmission in park and set the parking brake.
7. Ensure that the coupler latch is locked in place and secure it with a locking pin, bolt, or padlock. It may be necessary to rock the RV or tow vehicle slightly to get the coupler latch to close completely
8. Plug in the 12 volt electrical cord (7-pin) to the mating receptacle in the truck bed.
9. Raise the fifth wheel landing gear to its fully retracted position.
10. Connect the breakaway switch lanyard loop using a quick connect coupler or carabineer at a fixed location on the truck such as hitch mounting rails. Be sure that the length of the lanyard is adjusted so the switch cannot be activated during a full 'jackknife' turn. **WARNING - Do not connect the breakaway switch lanyard to the king pin, pin-box, or to any removable part of the hitch.**
11. Close truck tailgate.
12. If this is your first hitching up, make sure that the height of the pin-box and truck hitch have been adjusted so that the loaded RV is level when attached to the truck and ready to travel.
13. Remove tire chocks.
14. Run an operational check of stop lights, turn indicators, running lights, back-up lights (if equipped), and electric brakes before driving away. See '*Braking System*' in this chapter and '*Electrical System*' chapter for more details about the electrical systems.
15. Reverse the procedure for unhitching.

NOTICE

- *Periodically check pin-box attachment bolt torque with a torque wrench. Torque to 135 ft/lbs. (5/8-11 Grade 5 bolts).*
- *Damage may occur to your truck and/or RV if you fail to lower the truck tailgate prior to hitching or fail to raise the tailgate afterwards.*

WARNING

- *Do not connect the breakaway switch lanyard to the king pin, pin box, or to any removable part of the hitch. Remember that the breakaway switches emergency braking feature requires a fully charged battery on the RV.*

BRAKING SYSTEM

The electric brakes on your RV are similar to the drum brakes on many cars and trucks. The basic difference between them is that your RV brakes are operated by 12 volt DC power from the tow vehicle rather than by hydraulic action. The brakes have been factory calibrated for smooth, positive response. During break-in they may squeak. This is normal and should cease after a few miles of wear. The brake system on your RV consists of several major components all of which must function properly for safe braking.

Brake System Components

- **Tow Vehicle Battery** - The tow vehicle battery is the primary power source for the RV braking system.
- **RV Battery** - The RV battery provides power to activate the brakes in the event that the RV unintentionally becomes disconnected from the tow vehicle while traveling. This is accomplished via the breakaway switch.
- **RV Brakes** - Your RV brakes are actuated by 12 volt power from the tow vehicle brake controller. The greater the braking effort from the brake controller, the greater the breaking force applied to the RV brakes. The RV brakes are also actuated by the breakaway switch in case the tow vehicle and trailer become uncoupled. To ensure brakes are in good working order, brake shoes, and drums should be checked for wear annually. The RV brakes are self-adjusting, eliminating the need to adjust as a maintenance item.
- **Breakaway Switch** - The breakaway switch is located on the RV tongue or pin-box. This important safety item is required in most states. It has a steel cable (lanyard) which will reach to the frame of the tow vehicle. This device is one of the most vital components on your RVs braking system. It automatically applies the RV brakes if the tow vehicle and RV become uncoupled while in motion. The breakaway switch operates when a pull pin linked by the cable to the tow vehicle is separated from the switch. When the switch closes, power for brake application is transferred from the onboard RV battery. The steel lanyard must be anchored to the tow vehicle when the RV is hitched up. Secure this cable loop to the permanent frame of the tow vehicle or a part of the hitch that is not removable. Do not fasten the breakaway switch lanyard to the hitch ball, hitch pin, or any other removable part of the hitch.

Test the breakaway switch operation before each trip as follows:

1. Hitch the RV to the tow vehicle.
2. Pull out the breakaway switch actuating pin.
3. Test brakes by ensuring that they prevent the hitched RV and tow vehicle from rolling when the tow vehicle is placed in 'Drive'. The breakaway switch is functioning properly if the RV brakes are activated.

On the Road

4. If the brakes are not activated, check that the RV battery is connected and fully charged, and the RV brakes are properly adjusted.
5. Obtain service repair if the RV brakes do not operate after making these checks.
6. Reinsert the breakaway switch activating pin immediately after testing. If the pin is left out for an extended period of time your batteries will quickly become drained.

WARNING

- *Remember that the breakaway switches emergency braking feature requires a fully charged battery on the RV.*
- *Do not use the breakaway switch as a parking brake. Do not leave the actuating pin out of the breakaway switch for more than a few minutes or the battery will be drained which will not provide emergency braking when needed.*
- *Do not tow your RV with a malfunctioning breakaway switch or a dead or missing battery.*
- *Check your breakaway system periodically to ensure that wiring and connections are secure. A short or an open circuit can result in a no-brake condition.*

NOTICE

- *Disconnect 12 volt power cord before testing breakaway switch. Failure to do so will result in severe damage to electronic brake control.*

- **Brake controller** - The tow vehicle brake controller is not supplied with your RV. The RV electric brakes are automatically applied by the brake controller which is mounted within easy reach of the driver. This controller is connected to the tow vehicles brake system and is actuated whenever the tow vehicles brakes are applied. It may also be used to manually apply the RV brakes to control sway. See section on '*Safe Driving Guidelines*' in this chapter for additional info on brake controller usage. The controller should be adjustable for the amount of force applied to the RV brakes when you apply pressure to the tow vehicle brake pedal. In time you will learn to adjust the amount of safe braking force dependant upon road conditions and the load you are pulling. During ice, snow and rain conditions, as well as lighter towing loads you will not want as much braking force to the RV as you would with dry road conditions and heavier loads. Consult your controller instructions or a professional installer for further information and wiring instructions.

⚠ WARNING

- *Do not install a non-self resetting fuse in the circuit between the tow vehicle battery and the brake controller. A blown fuse would cause the controller to cease operation of both automatic and manual braking causing loss of trailer braking with possibly no advance warning.*

- **7 - Way Cable Connection** - The 7-pin cable connection at the front of the RV transfers electrical power from the tow vehicles battery to the RV brakes, exterior lighting system, and RV battery. See diagram in '*Electrical System*' chapter for specific wiring connections.
- **Grounding** - The electrical circuit that operates your RV brakes can be reliably completed only by proper grounding back to the tow vehicle. A poor ground circuit from the brakes to the tow vehicle battery can hurt braking performance as much as a poor primary circuit from the battery to the brakes. Do not rely on the hitch ball/coupler or fifth wheel hitch mechanism for a good ground.

Braking Tips

- Before moving your RV, inspect all external braking system components. Inspect all wiring connections. Test the breakaway switch as outlined previously.
- Never use the RV brakes alone (manually) for extended periods. They are designed to stop the RV not the tow vehicle. This action places excessive loads on the brakes causing overheating, fading, and premature wear.
- Never use the tow vehicle brakes alone. The added weight of the RV will more than double the load on the tow vehicle brakes causing overheating, fading, and premature wear. Driving control can also be affected due to the force of the RV pushing against the tow vehicle. On slippery road surfaces this can result in jackknifing.
- Always use the automatic brake controller. The brake controller, when properly adjusted, will apply just the right amount of braking force to the RV for your towing conditions.
- Down hill grades and curves require reduced speeds. A down hill grade will also require using lower gearing of the tow vehicle transmission to keep the brakes from overheating.
- Rain or slippery conditions require reduced speeds. Whenever in doubt, reduce your vehicle speed to ensure predictable, safe operation.

LOADING YOUR RV

The RV chassis and its components are designed to carry a certain maximum load. This load consists of the empty RV itself plus weight added in the form of water, food, clothing, and anything else that may be stored in or attached to the RV. The maximum load for which the RV is designed is called the Gross Vehicle Weight Rating (GVWR) and is the total loaded weight over the axles combined with the weight over the tongue or fifth wheel king pin. Another critical weight factor is the Gross Axle Weight Rating (GAWR). This is the maximum weight a specific axle is designed to carry. This represents the empty axle weight plus the maximum added load over the axle area. On RVs with two axles, the GAWR is based on a combined rating of both axles.

On the Road

The total of all axle loads plus the tongue or king pin weight must not exceed the GVWR. The tires equipped on your RV are designed to carry the loads specified. Tires need to be of sufficient capacity to carry the load. Always maintain required tire pressure by checking frequently. Never replace or mix tires with a lower capacity specification. In addition to knowing the overall weight that can be safely loaded in or attached to the RV you must know how to distribute this weight so that correct amounts of weight are placed on the axles and tongue.

Proper weight distribution is required for towing stability and will assure that the RV is not rear, front, or side heavy. A light tongue/pin weight or heavy weights placed at the rear of the RV may cause sway. On the other hand, too much weight on the tongue/pin can overload the tow vehicle and cause poor tow vehicle braking, poor steering, poor cornering, and can damage the RV chassis.

⚠ WARNING

- *Before towing your RV consult this Owner Manual for proper cargo loading, weighing procedures, and terminology definitions. Do not exceed the GVWR and GAWR. Do not exceed the tow vehicle GVWR, GAWR, GCWR or hitch rating. Failure to move cargo to keep within the weight limits can result in damage and/or loss of stability when towing resulting in serious injury or death. Please follow all recommendations in this Owner Manual when loading and towing your RV.*
- *Please check with your tow vehicle manufacturer for your towing specifications.*
- *Do not exceed the specified tongue weight or spring bar rating. Damage to the RV chassis and poor handling and braking may result.*

Steps for Determining Correct Load Limit

1. Locate the statement "The weight of cargo should never exceed XXX kg or XXX lbs." on your vehicles Cargo Carrying Capacity label. (Yellow label at door jamb of main entry).
2. This figure is the available amount of cargo and luggage load capacity.
3. Determine the combined weight of luggage and cargo being loaded on the vehicle. That weight may not safely exceed the available cargo and luggage load capacity listed on this label.

This is the remaining available cargo capacity after the RV has been loaded with water and LP gas. Water and propane weights are already adjusted into this Cargo Carrying Capacity so that you do not have the additional calculations to perform in determining your correct load limit.

On the Road

HITCH RECEIVERS

If your RV is factory equipped with a hitch receiver attached to the rear, whether it is a cargo carrying hitch or an actual tow rated hitch, you will need to account for any loading that you may add as cargo weight. There are two factory installed hitch types offered as follows:

1. A 2" ***Cargo Carrying Only*** receiver which is designed for bike racks, cargo racks, and many different accessory attachments. This receiver has a ***Maximum Load Rating of 250 LBS.*** and should never be used to tow anything behind your RV.
2. A 2" ***Tow Rated (mid-profile fifth-wheel models only)*** receiver which is designed for towing small boats, four-wheelers, motorcycles, and light weight trailers as well as bike and cargo racks. A wiring harness connection has been provided for connecting tail lights however it intentionally does not include circuits for braking, back-up lighting, or charge line. This receiver has a ***Maximum Load Rating of 300 LBS. Tongue Weight and 3000 LBS. Maximum Trailer Weight (300/3000 LBS).*** If equipped with the tow rated receiver, never use a hitch bar longer than 10" (254 mm). The maximum length of the hitch bar is measured from the center of the fastening pin to the center of the ball. Do not use weight distribution bars or equipment with this receiver on the second trailer. Check the state or province where your tow vehicle and RV are registered as well as any state or province where travel is planned in the U.S. and/or Canada for braking requirements and towing regulations.

WARNING

- ***If you do not have a Outdoors RV factory installed hitch receiver, towing items behind your RV or overloading the rear may void warranty and may result in damage to the tow vehicle and/or RV or add-on items, towing difficulties, property damage and/or personal injury.***
- ***The Tow Rated receiver (if equipped) on your RV is a weight carrying hitch only. Do not use weight distribution bars or equipment when towing. Use of this equipment with the hitch receiver may void warranty and may cause damage that could lead to adverse towing and handling, loss of control, or an accident resulting in death or serious injury.***

DISTRIBUTING YOUR LOAD

Using the information located on the Manufacturer Certification Label located at the driver side front of your RV, you must compare the GVWR with the actual loaded weight of your RV. If the loaded weight of your RV exceeds the GVWR, your RV is overloaded, and as such, you will need to remove items to bring the weight below the GVWR. Follow the method outlined here to determine the weight distribution of your RV. When weighing your RV or tow vehicle always use a platform scale such as those used by trucking companies or highway weigh scales. The weigh station attendant can guide you through the correct positioning of the RV and tow vehicle onto the scales.

On the Road

1. **Weigh the RV by itself.** After driving the tow vehicle and RV onto the scale disconnect the RV from the tow vehicle and move the tow vehicle off the scale. The measured weight of the loaded RV must not exceed its GVWR. If the GVWR is exceeded, cargo or equipment items must be removed.
2. **Find the tongue weight.** When the total RV weight is under the rated GVWR, you next determine the king pin or tongue/coupler weight. Re-hitch the tow vehicle to the RV. Move the RV forward until the tow vehicle is off the scales. Ensure the system is level. You do not need to unhitch the tow vehicle for this weight. Record this weight and subtract it from the total weight (GVWR) previously noted. This weight difference is the approximate pin or tongue weight.
3. **Calculate the percentage of tongue weight.** Divide the loaded pin or tongue weight by the total loaded RV weight. Multiply this by 100. This result is the percentage of the total weight the pin or tongue is carrying. You need to know this to properly load your RV. If the tongue weight exceeds the proper range for your tow vehicle, shift some of the load rearward to arrive at the proper balance. If the tongue weight is below the proper range move some of the load forward. If you have to shift the load to get the proper pin or tongue weight, check to be sure that you do not exceed the weight rating of the axles, tires, pin, tongue, or hitch.

WARNING

- *Weight distributing hitches will change the weight balance of the RV and tow vehicle axles. If equipped, it is recommended that the RV and tow vehicle be re-weighed to ensure that all weight ratings are not exceeded.*

With the RV attached to the tow vehicle each wheel position should be weighed separately to be sure individual axles and tires are not overloaded. If an overload condition exists on any axle or wheel position, RV cargo loading must be redistributed or removed.

If an overload situation is not corrected, tire or mechanical failures may occur. The individual wheel positions (particularly the rear positions) on the towing vehicle should also be weighed for possible overloading while the RV remains attached.

The following procedures are to be performed after establishing the above recommended hitch/axle loading and with the RV and tow vehicle loaded with all supplies, passengers, and equipment.

To obtain individual tow vehicle axle weights, Gross weights and Gross Combined Vehicle Weights (GVWR):

1. Drive onto scale. Take a reading with the tow vehicle front half approximately half way onto the scale. This reading must not exceed the tow vehicles front GAWR.
2. The second reading will be with the tow vehicle fully onto the scale but with the RV axles off scale. This reading must not exceed the tow vehicle GVWR.
3. Subtract the first reading from the second reading. The difference is the amount of weight on the tow vehicles rear axle. This result must not exceed the tow vehicles rear GAWR.

On the Road

To obtain tow vehicle individual wheel position weights:

1. Place the right front tire of the tow vehicle on the scale with RV off scale and take a weight reading. Subtract this from the weight of the front axle to get the left front tire weight.
2. Place both right side tires on the scale with RV off scale and take a weight reading.
3. Subtract the weight of the right front tire from the weight of the right side of the tow vehicle to find the weight on the right rear tire.
4. Subtract the weight of the right rear tire from the weight of the rear axle to get the weight of the left rear tire.
5. Compare the weight on each tire to the tire load rating on its sidewall. The weights on the tires must not exceed the tire rating.

To obtain RV individual axle weights:

1. Place all of the RV axles on the scale with tow vehicle off the scale and record the weight.
2. Pull the RV forward until the rear most axle is on the scale and the forward axle is off the scale. Record the weight of the rear axle.
3. The difference between these two weights is the weight on the front axle.
4. Compare the weight of each axle to the GAWR. The weight on either axle must not exceed its individual rating.

To obtain RV individual wheel position weights:

1. Place the right side tires of the RV on the scale with tow vehicle off the scale and record the weight.
2. Pull forward until only the RV right rear tire is on the scale and take a weight reading.
3. Subtract the weight of the right rear tire from the weight of both right side tires to find the right front tire weight.
4. Subtract the weight of the right front tire from the front axle weight to find the left front tire weight.
5. Compare the weight on each tire to the tire load rating on its sidewall. The weights on the tires must not exceed the tire load rating.

⚠ WARNING

- *Do not exceed the rated load of the tow vehicle, the RV, or the rated capacity of any axle or tire.*
- *Please check with your tow vehicle manufacturer for your towing specifications.*

NOTICE

- *Periodically re-weigh your RV and tow vehicle. Different traveling configurations may change your load and weight distribution. If other equipment or options such as leveling jacks, awnings, roof storage pods, etc, are installed after the RV leaves the factory, the weight of these items must be subtracted from the load and CCC.*

CAUTION

- *Tire load ratings are dependent on the tire inflation pressures. Please refer to the Tire and Loading Information label on your RV for specific tire pressures. Under inflated tires can be damaged and result in loss of inflation pressures.*
- *Remember that your tow vehicle is an integral part of your total towing combination. Weigh and load it with the same considerations as your RV. Gross weight and axle weight ratings will be found on labels on the drivers' door pillar or inside the glove compartment door. Consult your tow vehicle owner manual or towing guide for more information. If you do not have a towing guide, you can request one from your tow vehicle manufacturer.*
- *Please check with your tow vehicle manufacturer for your towing specifications.*
- *Your RV contains a label listing the Cargo Carrying Capacity (CCC). Please note that the stated CCC may be limited by the tow rating of your tow vehicle. Ask your tow vehicle manufacturer for more information about tow ratings.*

How Overloading Affects Your Tires

The results of overloading can have serious consequences in terms of passenger safety. Too much weight for your vehicles suspension system can cause spring, shock absorber or brake failure, handling or steering problems, irregular tire wear, tire failure, or other damage. In cases of serious overloading, brakes can fail completely, particularly on steep hills. The load a tire will carry safely is a combination of the size of the tire, its load range, and corresponding inflation pressure. Excessive load and/or under inflation can cause tire overloading. As a result, abnormal tire flexing occurs, which can generate an excessive amount of heat within the tire. Excessive heat may exceed the tires capabilities, which may lead to tire failure. It is the air pressure which enables a tire to support the load, so proper inflation is critical. Never exceed the tire limitation for load or air pressure. If you discover that your tires cannot support the actual weights, you must lighten the load.

Installing tires with a higher carrying capacity only solves the problem of tire overload. It has no effect on the over-loading of other components (i.e., wheels, axles, shocks, or bearings). Wheels may not be capable of withstanding the higher pressures necessary to support the load.

If you decide to install a tire size other than that originally provided on your RV, care must be taken to ensure adequate load carrying capacity and compatibility between tire and wheel size.

WARNING

- *There is a danger of serious injury or death if a tire of one bead diameter is installed on a wheel of a different diameter. Always replace a tire with another tire of exactly the same size.*

On the Road

Loading Tips

After you have determined how much weight you can carry and have selected those items to make up that weight, make a list, and keep it for future reference. Load your RV so that you get proper weight distribution on the axles and tires. Make a loading diagram representing your properly loaded RV. It will help you locate where specific items are stored and will help speed the loading process. Secure and brace items so they won't move during travel. Do not load heavy items near either end of the RV or on the rear bumper. Adjust cargo to keep the side to side tire load as equal as possible. Keep in mind that towing with full holding tanks after a trip can radically change the handling characteristics versus what it was prior to the trip.

During the design and development of your RV, the number and size of storage compartments and the liquid tank capacities are maximized for value and conveniences. If the RV operator fills all liquid tanks to capacity, and fills all storage compartments and cupboards to maximum volume with heavy items, the RV could potentially be overloaded. The operator is responsible for analyzing the conditions under which the RV will be used for each trip.

Thoughtful consideration of the weight placed in the RV can yield important benefits:

- Maximum flexibility in use of the available storage space provided in the RV.
- Improved tow vehicle and RV handling characteristics.
- Better tow vehicle fuel mileage.
- Reduced tire wear.

⚠ WARNING

- *Exceeding the GAWR or GVWR of your tow vehicle or RV can cause undesirable handling characteristics and may create a safety hazard. Do not install any type of weight carrying rack, frame, or hitch to the rear bumper, A-frame assembly, chassis, or body component of the RV unless specified by Outdoors RV. Add-ons such as these may void your warranty on structural components.*
- *Do not store or carry propane containers, gasoline, or other flammable liquids inside your RV.*
- *Move cargo to maintain proper balance. Do not exceed GVWR (total weight rating) or GAWRs (axle weight ratings) of the trailer or tow vehicle.*
- *Please check with your tow vehicle manufacturer for your towing specifications.*

NOTICE

- *Use extra care in packing and storing dishes, utensils, canned foods, and liquids in rear kitchen models as this is an area that is easily overloaded.*

On the Road

SAFE DRIVING GUIDELINES

Outdoors RV does not recommend transporting passengers in your RV while traveling.

Your tow vehicle will have very different handling and stopping characteristics when it is towing an RV. The following guidelines will help you develop needed driving skills for safe towing.

- **Know the height of your RV.** This is very important as there are many low-clearance overpasses that your RV may not completely clear. Hitting a bridge overpass could potentially cause an extreme amount of damage to your RV. Have a friend help you measure the overall height at the air conditioner or highest point to the ground. This should be done with the RV unloaded; tires aired up properly, and hitched up. Make note of this to keep handy in the tow vehicle in the event you encounter a low overpass.
- **Travel very slowly** if you are new to towing, or if you have a new RV or tow vehicle, until you have learned the handling and stopping characteristics of the tow vehicle and RV combination. Practice turning, stopping, and backing in a secluded place away from traffic.
- **Do not permit a driver who is inexperienced at towing to operate your tow vehicle and RV combination without your direct supervision.** Remember it's slow speed for beginners.
- **Tow at moderate speeds** allowing for adverse highway and wind conditions. Even under the best of conditions, do not exceed posted speed limits for vehicles towing trailers. As speed increases, trailer sway stability, stopping ability, and the ability to make emergency maneuvers are greatly reduced.
- **Reduce speed before starting down hills,** even short ones, and avoid heavy tow vehicle braking on downgrades. RV towing stability is reduced when traveling downhill, and is further reduced by tow vehicle braking.
- **Slow down before entering turns** and avoid heavy braking in turns. RV stability is reduced in turns, and the weight of the RV tends to push the back of the tow vehicle outwards in turns, which can cause loss of control and jackknifing.
- **If it is windy or passing vehicles are affecting handling, slow down** until full, comfortable control can be maintained. RV sway can be started by crosswinds and winds from passing vehicles, especially trucks and busses passing from the rear. Reduced speed improves RV stability and handling.
- **Do not use cruise control while towing.** These devices can interfere with your ability to slow down in an emergency.
- **Avoid quick steering movements** that can start the RV swaying.
- **Close, lock and dead bolt entry doors** and secure all windows and slide-outs before traveling.
- **Plan your trip and map out the roads you plan to use.** Find out any hill grades in the areas you will be traveling. Some mountain passes have extreme change in elevation and curves you may prefer to avoid.
- **Rain or snow/ice conditions require extreme caution when towing.** Vehicle speed should be reduced and in some cases, towing should be avoided.
- **Maintain at least twice the normal stopping distance while towing your RV.** The increased weight of the combination of vehicle requires greater stopping distances.

On the Road

- **Use lower gears on long grades.** Downshift on uphill grades to avoid overheating or undue engine loads. Downshift on downhill grades to allow engine braking to assist in controlling vehicle speed. Avoid continuous or frequent brake application. The weight of the combination of vehicles can cause brakes to overheat and fade.
- **Allow ample time for passing.** Your acceleration will be much slower and your combination of vehicles is much longer than the tow vehicle alone.

Once you become accustomed to the feel of your tow vehicle/RV combination, you will find that it becomes very second nature. Become familiar with the position of the RV in traffic, and be cautious when maneuvering to allow for its length and width. Always allow extra room to corner and to change lanes. Learn to use the side mirrors to view the road behind and to the sides, check them often.

When traveling off the highway in the country or mountains you must be careful of overhanging tree limbs and other overhead or side obstacles. Light branches will brush aside, but heavier branches and limbs may cause damage to the roof or sidewall of your RV. Consider your roof height, vents, jacks, antennas, air conditioner, and other equipment attached to the roof or side of your tow vehicle and RV when you are calculating clearance.

Avoid parking too close to the curb as signs, telephone poles, and other obstructions can cause interferences. Watch for overhead and side clearance at drive-in restaurants and gas stations or other drive-thru areas so you do not damage the side or roof of your RV. Watch for sharply crowned roads which can tip your RV into obstructions when parking close to a curb or roadside.

If Your RV is Swaying

1. Steer as little as possible while maintaining control of the vehicle. Because of your natural reaction time lag, quick steering movements to counter trailer sway can actually cause increased sway and loss of control. Try to hold the wheel as straight as possible until stability is regained.
2. Slow down but avoid strong tow vehicle braking. Reduce speed gradually whenever possible. Use the hand control to gradually apply the trailer brakes; this will help keep the vehicles aligned. Tow vehicle braking reduces trailer stability, and sliding tow vehicle tires causes loss of control and jackknifing.
3. If a reduction in trailer stability has occurred, slow down immediately and stop as soon as possible. Check tire pressures, sway control adjustment (if equipped), and hitch spring bar adjustment (if equipped), cargo weight distribution, and look for any signs of mechanical failure. Until the problem has been identified and corrected, travel at reduced speeds that permit full control.

Backing Up

Place your hand at the bottom of the steering wheel. The back of the RV will move in the same direction that your hand moves. The rear of the tow vehicle will go the opposite way you want the RV to turn. Be careful as the RV/tow vehicle angle gets large, the hitch and/or tow vehicle and RV may be damaged by jackknifing.

You will need a much greater turning radius than the tow vehicle itself requires. When backing, be sure to watch not only the rear, but also both sides of the tow vehicle.

On the Road

Before backing up, you should designate a person to 'spot' you to ensure that you will not bump the RV into anything out of your field of view. In time, and with a little practice, you will be able to back your RV with little effort. Always be aware that you have poor visibility to the rear. Always have your spotter standing safely outside at the rear of the RV to guide you in safe backing. Use both rear view mirrors when backing. If you are in doubt, stop, place the vehicle in park, shut the engine off, engage the parking brake, and go look for yourself at the RV to ensure it is going where you intend it to go.

⚠ WARNING

- *Ensure that small children are not present anywhere near your RV when backing up.*

Parking

When parking parallel to a curb, be sure to allow for poles or other obstructions beyond the curb as the front and rear portions of the RV swing wider than the tow vehicle's body. Always shift the transmission to PARK with automatic transmissions, or low or reverse for manual transmissions, and set the parking brake.

Parking on a Grade

Try to avoid parking your hitched RV/tow vehicle on a hill or grade. However, if you must park on a grade, follow these steps:

1. Apply and hold the tow vehicle brakes.
2. Have someone place wheel chocks under the RV wheels.
3. When the wheel chocks are in place and the assistant is clear, release the tow vehicle brakes until the chocks absorb the load.
4. Apply the tow vehicle parking brake.
5. Shift the transmission to PARK, with an automatic transmission or low or reverse for manual transmissions.

If the vehicle you are parking on a grade is equipped with an automatic transmission, do not shift into PARK until the RV wheels are chocked and the tow vehicle parking brake is set. If you do, the weight of the vehicle and RV may put so much strain on the transmission that it may be hard to shift out of PARK.

When starting after being parked on a grade:

1. Apply and hold the tow vehicle brakes.
2. Start engine in PARK for automatic transmissions or NEUTRAL with parking brake set for manual transmissions.
3. Shift into gear and release the tow vehicle parking brake.
4. Release the tow vehicle brakes and move the RV until the chocks are free.
5. Apply and hold the tow vehicle brakes and have an assistant remove the chocks.

On the Road

TIRE SAFETY AND INFORMATION

Your RV is equipped with quality tires made by a major tire manufacturer. Under normal circumstances and with proper maintenance, you should receive thousands of miles of trouble free service. For safety, RV stability, and maximum tire life, proper vehicle speeds and inflation pressures must be maintained. Tread depth and wear must also be monitored. Refer to the tire manufacturers' information provided in your owner information packet for information on maintenance and tire care. Always consult with your tire supplier when replacing tires to ensure that you are installing the correct size and load range based on the requirements of your RV.

Tire Labeling

Federal law requires tire manufacturers to place standardized information on the sidewall of all tires. This identifies and describes the fundamental characteristics of the tire and also provides a tire identification number for safety standard certification and in case of a recall.

The following diagram will help you locate the specific information for your tires. The info in this diagram may not be representative of your particular RV tire.



In this example we will use **ST225/75R15** for the sake of photo reference. Your tires may be similarly identified with a **LT235/85R16**.

- **ST** - 'Special Trailer' - indicates the tire is designed specifically for trailer use only.
- **LT** - 'Light Truck' - indicates the tire is designed for light truck or trailer use.
- **225** - This three digit number provides the section width in millimeters of the tire from sidewall edge to sidewall edge. In general, the larger the number, the wider the tire is.
- **75** - This two digit number, known as the aspect ratio, gives the tires ratio of height to width. Typically a tire with a larger number will have a taller section height however this is not a direct indicator to a tires overall height.
- **R** - Indicates that the tire has radial ply cord construction as opposed to bias ply cord construction.
- **15** - This two digit number indicates the wheel diameter in inches that the tire is designed for. If you change your wheel size you will have to purchase new tires to match the new wheel diameter.

On the Road

- **117/112** - This is the 'Load Index' rating. A numerical code associated with the maximum load a tire can carry at the speed indicated by its speed symbol (rating) under specified service conditions. In this instance **117=2833lbs**. You will not need to be concerned with the 112 as it refers to loading in a dual wheel configuration.
- **N** - This is the tires 'Speed Rating'. An indexed alphabetical code that refers to the maximum speed that a tire is rated by the tire manufacturer. In this instance **N=87mph**.
- **Load Range 'E'** - An alphabetic code that designates for a specific tire size the maximum load a tire can carry at a defined inflation pressure.

Additional information you may find on your tires:

- **US DOT** - Tire Identification Number (TIN) - This begins with the letters **DOT** and indicates that the tire meets federal standards. The next two numbers or letters are the plant code where it was manufactured, and the last four numbers represent the week and year the tire was made. For example, the numbers 3197 means the 31st week of 1997. The other numbers are marketing codes used at the manufacturers' discretion. This information is used to contact consumers if a tire defect requires a recall.
- **Tire Ply Composition & Materials** - The number of plies indicates the number of layers of rubber coated fabric in the tire. In general, the greater the number of plies, the more weight a tire can support. Tire manufacturers also must indicate the materials in the tire, which may include steel, nylon, polyester, and others.
- **Treadwear, Traction, & Temperature Grades** - These numbers are a numeric index guide to help the consumer make an informed decision in choosing replacement tires. These ratings are not typically found on trailer service type tires and will not be explained in detail here.
- **Load Limit & Maximum Cold Inflation** - This is the designated maximum load limit that the tire was designed to carry measured in lbs. & kg, based on a maximum cold air pressure measured in psi and kPa. The listed pressure is the maximum air pressure that should ever be put in the tire under normal driving conditions.

Additionally you will find on **(LT)** & **(ST)** tires a **(Max. Load Single)** and **(Max. Load Dual)** weight/pressure rating listed. The **(Max. Load Dual)** is used when running four wheels/tires per axle in a 'dually' configuration such as that seen on a semi-truck. The **Max. Load Dual** application does not apply to your RV.

Tire Pressure and Load Limits

Tire inflation pressure is the level of air in the tire that provides it with load-carrying capacity listed on the tire sidewall and affects the overall performance of the vehicle. The tire inflation pressure is a number that indicates the amount of air pressure measured in pounds per square inch (psi) or kilo Pascal (kPa - metric) in which a tire requires to be properly inflated. RV manufacturers determine this number based on the vehicles designed load limit, that is, the greatest amount of weight a vehicle can safely carry for the vehicles tire rating. The proper tire pressure for your RV is referred to as the 'Recommended Cold Inflation Pressure' (As you will read below, it is difficult to obtain the recommended tire pressure if your tires are not cold). Because tires are designed to be used on more than one type of vehicle, tire manufacturers list the 'maximum permissible inflation pressure' on the tire sidewall. This number is the greatest amount of air pressure that should ever be put in the tire under normal driving conditions.

On the Road

Checking Tire Pressure

It is important to check your RVs tire pressure at least once a month for the following reasons:

- Most tires may naturally lose air over time.
- Tires can lose air suddenly if you drive over a pothole or other object or if you strike the curb when parking.
- With radial tires, it may not be possible to determine under-inflation by visual inspection.

For convenience, purchase a tire pressure gauge to keep in your tow vehicle or RV. Gauges can be purchased at tire dealerships, auto supply stores, and other retail outlets.

The recommended tire inflation pressure that RV manufacturers provide reflects the proper psi when a tire is cold. The term cold does not relate to the outside temperature. Rather, a cold tire is one that has not been driven on for at least three hours. When you drive, your tires get warmer, causing the air pressure within them to increase. Therefore, to get an accurate tire pressure reading, you must measure tire pressure when the tires are cold or compensate for the extra pressure in warm tires.

Steps for Maintaining Proper Tire Pressure

1. Locate the recommended tire pressure on the RVs 'Tire and Loading Information' label located at the exterior driver side front corner of the sidewall. (See inserted label art for identification).
2. Record the tire pressure of all tires.
3. If the tire pressure is too high in any of the tires, slowly release air by gently pressing on the tire valve stem center core with the edge of your tire gauge until you get to the correct pressure.
4. If the tire pressure is too low, slowly add air, re-checking until you reach the proper pressure.
5. Check all the tires to make sure they have the same pressure.
6. Replace all valve stem caps.

If you have been towing your RV and think you may have an under-inflated tire, fill it to the recommended cold inflation pressure indicated on your RV Tire and Loading Information label. While your tire may still be slightly under-inflated (after cooling down) due to the extra pounds or pressure in the warm tire, it is safer to tow with air pressure that is slightly lower than the RV manufacturers recommended cold inflation pressure than to tow with a significantly under-inflated tire. Since this is a temporary fix, don't forget to recheck and adjust the tires pressure when you can obtain a cold reading. If you have operated your RV with a severely under inflated tire, promptly have it removed from the wheel for a complete internal inspection to be sure it is not damaged. Tires driven even for short distances while under inflated may be damaged beyond repair. Tires should be inspected regularly for excessive wear or irregular tread wear, bulges, aging, cracking, cuts or other damages. Remove any nail, stones, glass, etc., embedded in the tread to prevent damage. Even minor damage can lead to tire failure.

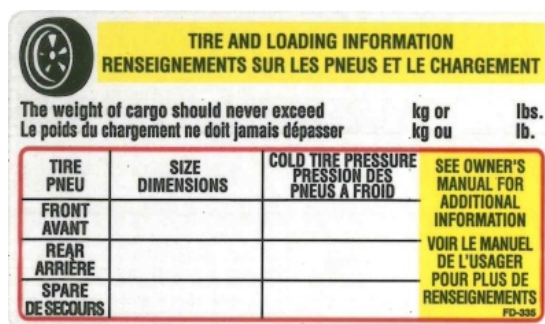

This is an example of the 'Tire and Loading Information' label which you will find located at the exterior driver side front corner of the sidewall. You will notice data on this label that includes the installed and recommended tire size, maximum cold air pressure, and maximum cargo weight. Note that air pressures and cargo weights are listed in both US and METRIC standard measurements.

⚠️ WARNING

- *Check tire pressures before traveling. Always check pressures when tires are cold. Do not exceed maximum recommended pressure.*
- *Keep tires properly inflated. A tire that is run long distances or at high speeds while seriously under inflated will overheat to the point where the tire may lose air suddenly and/or catch fire, possibly resulting in damage to the vehicle and its contents and/or personal injury.*
- *All your tires should be the same type, size, and construction. Do not mix bias-ply and radial-ply tires.*

Tire Size

To maintain tire safety, purchase new tires that are the same size as the RV's original tire size or another size recommended by the manufacturer. Refer to the 'Tire and Loading Information' label or the sidewall of the tire you are replacing to find the correct size. If you have any doubt about the correct size to choose, consult with your tire dealer or Outdoors RV Mfg.

Tire Tread







The tire tread provides the gripping action and traction that prevents your RV from slipping or sliding, especially when the road is wet or icy. In general, tires are not safe and should be replaced when the tread is worn down to 1/16 of an inch. Tires have built in tread wear indicators that let you know when its time to replace your tires. These indicators are raised sections spaced intermittently in the bottom of the tread grooves (See picture insert). When they appear 'flush' to the surface of the tread, it is time to replace your tires. Another common method for checking tread depth is to place a penny in the tread with Lincoln's head upside down and facing you. If you can see the top of Lincoln's head it is time for new tires.



The tire at the left provides a visual reference of a 'wear indicator' bar as circled in red. You will find several of these in various locations around the tire. When the tire tread is 'even' with or 'flush' to the wear indicator bar it is time to replace that tire. As a safety practice when purchasing new tires you should always replace them as a complete set.

Tire tread wear should be checked frequently. Once a wear pattern becomes firmly established in a tire it is difficult to stop, even if the underlying cause is corrected. The following chart will help you diagnose any uneven tire wear that you may notice. If you discover abnormal wear patterns other than 'Center Wear' or 'Edge Wear', which are due to improper inflation, contact your RV dealership or Outdoors RV Service Department to discuss possible available options to correct.

Tire Wear Diagnostics Chart

	<p>A TIRE WORN ON THE OUTSIDE EDGES, LIKE THIS, HAS BEEN RUN UNDERINFLATED.</p>		<p>A BAD TOE ADJUSTMENT CAN ALSO CAUSE "FEATHERING" OF A TIRE, WHICH YOU HAVE TO FEEL TO DETECT, SINCE THE TIRE MAY LOOK PERFECTLY GOOD, AS THIS ONE DOES.</p>
	<p>AND A TIRE WITH JUST THE CENTER WORN DOWN, LIKE THIS, HAS BEEN OVERINFLATED.</p>		<p>BALD SPOTS OR SCALLOPED EFFECTS ARE USUALLY CAUSED BY UNBALANCED WHEELS, TIRE DEFECTS, OR WORN SUSPENSION COMPONENTS.</p>
	<p>WHEN A TIRE IS WORN ON ONLY ONE SIDE, LIKE THIS ONE, IT'S A PRETTY GOOD INDICATION OF A CAMBER OR TOE PROBLEM.</p>		

Changing a Flat Tire

If you have a flat tire, Outdoors RV Mfg. recommends you call for road service. We do not suggest that you change a flat tire yourself. Changing a flat tire can be a potentially hazardous. Road service providers will have the necessary tools to change your tire quickly and safely. If you must change a flat tire yourself, the following guidelines will help you complete the job safely.

NOTICE

- *Outdoors RV Mfg. does not supply a jack, lug wrench, or any of the required socket wrench tools used in changing a tire including tools required for removing the spare tire from its bumper mount tire carrier (if equipped). You are responsible for supplying the appropriately sized sockets or 4-way wrench and jacking equipment. Prior to any trip, be sure to determine the proper size drive sockets required for the wheel lug nuts as well as the nut securing the spare tire to the bumper mount tire carrier bracket (if equipped). Add these to your RV toolbox. You should also consider including a torque wrench in your RV tool box.*

On the Road

1. Be sure the tow vehicle and RV are completely out of any traffic lane, and on solid ground or paved surface. **Do not attempt to change a flat tire on soft or uneven surface. Turn on the tow vehicle emergency flashers and set up flares or warning lights and/or signs.**
2. Place wheel chocks in front and behind a tire diagonally opposite the flat to keep the RV from rolling. If connected to the tow vehicle, place transmission in PARK, set the parking brake and loosen the hitch bars if equipped. Stop the tow vehicle engine. (For manual transmissions, shift to reverse, stop engine, and set parking brake).
3. Lower the spare tire to the ground and roll it near the flat tire. With the spare tire ready to install, you can more quickly get the tire changed to minimize the time the RV is jacked up.
4. Place an appropriately sized (for the axle weight of your RV) bottle jack directly under the chassis frame rail **ONLY** nearest the flat tire. **Never jack up or place jack stands on the axle tube or on the equalizers. Do not jack at any other point. Serious chassis damage can occur if other jacking points are used. Do not use a bumper jack.**
5. Raise the jack enough to take some of the load off, but not enough to raise the tire you are changing.
6. Loosen the wheel nuts on the flat tire but do not remove them at this time.
7. Using the bottle jack, raise the RV just high enough to remove the flat tire. Remove the wheel nuts and remove the wheel and tire.
8. Place the spare tire on the axle and secure it with the wheel nuts. Start all nuts by hand to prevent cross-threading. Tighten all nuts snugly in the sequence for your wheels shown in the illustration on the following page for your wheel type.
9. Lower the RV until the tire begins to make contact with the ground. Stop lowering at this point.
10. Tighten the wheel nuts in the sequence shown in the illustration on the following page for your wheel type (5, 6 or 8-lug) in three stages up to the final torque value as listed for your wheel.
11. Lower the RV completely, remove and stow jack, tools and flat tire.

⚠ WARNING

- ***Never go underneath any jacked-up RV unless it is properly supported on jack stands which have been rated for the load. Improperly supported vehicles can fall unexpectedly and cause serious injury or death.***

NOTICE

- ***Do not lift or support the RV on any part of the axle or suspension system. Damage to these components may occur. Always lift under the chassis frame as near to the axles as possible.***

Tire Repair

The proper repair of a punctured tire requires a plug for the hole and a patch for the area inside the tire that surrounds the puncture hole. Punctures through the tread can be repaired if they are not too large, but punctures to the sidewall should not be repaired. A tire must be removed from the wheel to be properly inspected before being plugged and patched. Tire repairs should only be performed by a professional tire shop with the proper equipment.

On the Road

Wheel Nut Torque Sequence

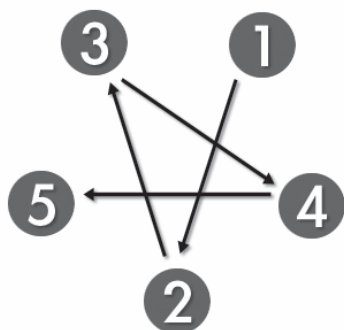

**15" x 5-Lug
Torque to 120 ft/lbs.**

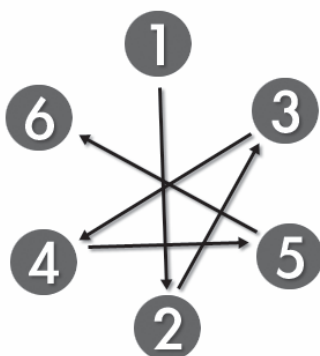

**15" x 6-Lug / 16" x 6-Lug
Torque to 120 ft/lbs.**

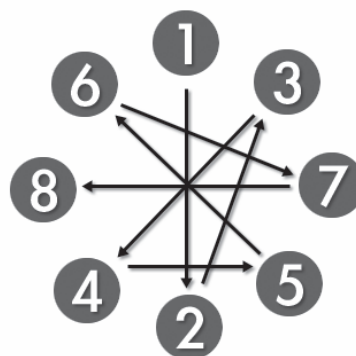

**16" x 8-Lug
Torque to 130 ft/lbs.**

WHEEL LUG NUT TORQUING

Do not exceed the listed torque values for your wheel.

Proper wheel lug nut torque is very important to safe and dependable trailering. The wheel and axle systems used in RVs are similar in many ways to those used on pick-up trucks. But they differ in several important ways. These differences require special attention to the wheel lug nut torque, both while the RV is new, and throughout the RVs lifetime. RV wheels may carry higher loads per wheel than passenger car or truck wheels. Furthermore, wheels on tandem axle RVs do not steer, and are subjected to high 'side load' stress as you go around corners, especially slow, tight turns. This tends to flex the wheel and suspension components and may gradually loosen the wheel lug nuts.

It is critical that the wheels be properly re-torqued during the first 10, 25, and 50 miles of road operation, or after any service or maintenance that requires the removal of a wheel. Although the wheels have been properly torqued before leaving the manufacturing plant, settling and wearing in of components during the first few miles of operation may cause some loosening of the wheel lug nuts.

Purchase a quality torque wrench and add this to your RV tool box. Read its directions carefully and learn to use it properly.

Before each trip and any time a wheel is removed or replaced for service, be sure to tighten the lug nuts, following the appropriate torquing sequence for your wheels as shown in the diagrams above. If the wheel was removed or replaced, check the torque again after 10, 25, and 50 miles. If you notice a wheel wobbling or hear a rattling sound coming from a wheel, especially at low speeds, a wheel lug nut may have come loose. This is usually caused by improper tightening or by faulty or damaged lug stud threads. If you have reason to believe a lug nut has come loose, stop the vehicle at the side of the road as soon as safely possible. Re-torque all lug nuts to the specified value. If lug stud threads are damaged or faulty, get professional service help. Do not tow the RV with missing lug nuts or faulty lug studs

⚠️ WARNING

- *If not properly tightened, loose lug nuts can damage the stud and/or wheels. If driven in this condition for any extended period severe wheel damage could occur affecting the handling of your RV.*
- *Use a torque wrench to tighten lug nuts. Tightening by hand or with an impact wrench is not recommended. Proper torque of lug nuts can only be achieved by using a torque wrench and a socket the correct size for the lug nut. Do not use a flexible extension, a four-way wrench, or any other type of wrench for final tightening that does not measure the actual force applied to the lug nut.*
- *Under or over torque of wheel lug nuts can cause the wheel to separate from the axle creating an unsafe situation.*
- *Never apply paint or lubricants to the lug nuts, stud, or mating surface of the wheel or hubs on your axle.*
- *It is the consumers' responsibility to follow these important safety instructions. Following these safety instructions will help ensure wheel lug nut torque is properly maintained on your RV.*

Tire Safety Tips

Preventing Tire Damage

- Slow down if you have to go over a pothole or other object in the road.
- Do not run over curbs or other foreign objects in the roadway, and try not to strike the curb when parking.

Tire Safety Checklist

- Check tire pressure regularly (at least once a month), including the spare.
- Inspect the tires for uneven wear patterns on the tread, cracks, foreign objects, or other signs of wear or trauma.
- Remove bits of glass, rocks and foreign objects wedged in the tread.
- Make sure your wheel valve stems have caps.
- Check tire pressure before going on a long trip.
- Do not overload your RV. Check the 'Tire and Loading Information' label for the maximum recommended load for your RV.

Additional Tire Tips

- You may increase the overall life of your tires by having a tire shop balance your wheel/tire assemblies. Your wheels and tires are not balanced from the factory.
- Rotating your tires may also increase their life span in the same way that you would do this for your tow vehicle or car.

Additional information can be found in a brochure titled 'Tire Safety - Everything Rides On It', published by The National Highway Traffic Safety Administration (NHTSA). It can be obtained free of charge on the NHTSA website located here...

https://one.nhtsa.gov/cars/rules/tiresafety/ridesonit/tires_index.html

On the Road

PRE-DEPARTURE CHECKLIST

1. Load your RV (If departing from home) - Remember to load your RV keeping in mind loading methods discussed in sections '*Loading Your RV*' and '*Distributing Your Load*'.

- Pre-chill refrigerator/freezer.
- Fill fresh water tank (If staying without a city water connection).
- Fill propane bottles.
- Replace any consumable items.
- Clothing.
- Non-refrigerated foods.
- Refrigerated foods.

2. Do a walk-thru inside your RV checking these things:

- All cabinet doors and drawers closed tightly (Tug on them to verify).
- All interior sliding door travel straps or latches are in place (If equipped).
- Lower and secure all night shades and metal galley blinds.
- Raise all roll shades (If equipped).
- Close and latch all windows and roof vents.
- Secure fold-down beds/lounges and collapsible tables (If equipped).
- Secure all loose items: bunk ladders, freestanding furniture, small appliances, food and housekeeping items, TVs and entertainment equipment, etc.
- Retract and lock TV swinging arms (If equipped).
- Move chairs or other furniture and equipment away from the walls.
- Retract satellite dish (If equipped).
- Turn off all interior/exterior lighting.
- Turn off all appliance switches and controls including water pump.
- Close all faucets.
- Position any furniture to prevent damage from retracting slide-out rooms. Retract all slide-out rooms.

On the Road

3. Do a walk-around the exterior checking these things:

- Retract all awnings (As equipped).
- Disconnect all electric, water and waste connections (If connected). Stow all cables and hoses.
- Verify exterior shower knobs are turned to the 'off' position.
- Close all propane gas cylinder valves.
- Turn off all exterior lighting.
- Close and lock all outside compartment doors.
- Clear all obstacles under and around the RV.
- Check above roof for low hanging branches.
- Retract stabilizer jacks, and remove and stow all portable jacks and blocks.
- Check tire pressures.
- Check wheel nut torque.
- Retract entry steps.
- Close and lock entry door(s) deadbolt.

4. Before driving away check these things:

- Tow vehicle mirrors adjusted properly.
- 7-Way (12 volt) power cord securely connected.
- Brake controller registers connected trailer and is functioning.
- Coupler/pin latch locked in place with safety clip or padlock.
- Safety chains crossed and attached to hitch loops.
- Break-a-way switch lanyard secured to non-removable location on hitch.
- All trailer exterior marker and tail lights functioning properly.
- Trailer wheels chocks removed and stowed.
- Trailer brakes pass function test.

Living With Your RV

FIRE SAFETY

The potential hazards of fire exist in all areas of life, and a recreational life-style is no exception. Your RV is a complex assembly made up of many materials, some of them flammable. But like most hazards, the possibility of fire can be minimized, if not totally eliminated by recognizing the danger and practicing common sense, safety, and maintenance habits.

Fire Extinguisher

A fire extinguisher is included with your RV which is located next to the main entry door near the floor. It is rated for Class B (gasoline, grease, and flammable liquids) and Class C (electrical) fires. Know where your fire extinguisher is located and how and when to use it. Read its instructions on the label and follow its recommended maintenance and testing. Fire extinguishers of this size are most effective when used immediately on small fires. They only contain a limited amount of chemical and therefore must be used properly so that the chemical is not wasted. **This fire extinguisher is non-refillable. After use discharge completely and discard. Any use requires discarding.**

Egress (Exit) Windows

'Egress' or 'Emergency Exit' windows are labeled with the word **EXIT** in bold red lettering to help identify which windows open large enough to escape through in the event of fire or emergency. Additionally all egress windows can be distinguished by red operational handles or levers. Dependant upon the window type, an egress window's opening may be a large section or the entire window. Review the location and operational instructions posted on the window with all occupants of your RV. Operate all egress windows occasionally to ensure that not only do they function properly but to train yourself to use them efficiently in the event of an emergency. Below are examples of two types of egress windows, one with side levers, and one with a single lever in the center. Both types must have the screen removed prior to exiting through the window. The screens have a red tab (as seen in example below) that must be pulled up and inward to remove.



Living With Your RV

WARNING

- *DO NOT BLOCK or cover emergency egress exit windows. Exit windows must remain accessible at all times. Be sure all occupants know which windows are emergency exit windows and understand how to use them.*

Smoke Detector

A smoke detector is included in your RV. It is typically located on the ceiling in the living room area. Read the smoke detector literature provided in your owner information packet and follow all maintenance recommendations suggested. Your smoke detector is powered by a 9 volt battery. Purchase an extra battery as a spare to keep in your RV.

WARNING

- *Test smoke alarm operation after vehicle has been in storage, before each trip, and at least once per week during use. Failure to do so can result in death or serious injury.*
- *SMOKE ALARMS HAVE A LIMITED LIFE. The unit should be replaced immediately if it is not operating properly. You should always replace a smoke alarm after 10 years from the date of purchase. Write the purchase date on the space provided on back of unit.*

Fire Safety Precautions

In addition to instructing occupants on what to do in case of fire, also consider these safety suggestions:

- Hold fire drills periodically. Practice operating the emergency exit windows.
- If you experience a fire while traveling, maintain control of the vehicle until you can safely stop. Evacuate the tow vehicle as quickly and safely as possible.
- Consider the cause and severity of the fire and risk involved before trying to put it out. If the fire is major or it is fuel-fed, stand clear of the vehicle and wait for the fire department or other emergency assistance.
- If your RV is damaged by fire, do not move, or use it until it has been thoroughly inspected and repaired by your dealership or Outdoors RV service facility. This may also include your insurance adjuster.
- Never leave unattended food cooking on the stove or in the oven.
- Never smoke in bed or leave cigars/cigarettes unattended.
- Keep candles or any open flames away from curtains, fabrics, walls, and ceiling.
- Do not store combustibles inside your RV (gasoline, charcoal lighter fluid, etc.)
- If your RV has a fabric room divider curtain near cooking appliances, ensure that the curtain is secured with its retaining strap so that it cannot become accidentally placed near any open flame such as the kitchen cook top.
- Portable fuel burning equipment, including wood and charcoal grills and stoves **must not** be used inside your RV. The use of this equipment inside the RV could cause fire and/or asphyxiation.

⚠ WARNING

- *Do not place propane cylinders inside the vehicle. Propane cylinders are equipped with safety devices that relieve excessive pressure by discharging propane to the atmosphere. Propane gas is highly flammable and can lead to a fire or explosion and result in death or serious injury.*
- *Urethane foam is flammable! Do not expose urethane foams to open flames or any other direct or indirect high temperature sources of ignition such as burning operations, welding, burning cigarettes, space heater, or unprotected electric light bulbs. Once ignited urethane foams will burn rapidly, releasing great heat and consuming oxygen very quickly. In an enclosed space the resulting deficiency of oxygen will present a danger of suffocation to the occupants. Hazardous gases released by the burning foam can be incapacitating or fatal to human beings in sufficient quantities.*
- *Explosive fuel clouds maybe present at fuel filling stations. Before refueling, (gasoline, diesel fuel or propane) be sure to turn off all pilot flames and appliances in your RV. Turning off the propane at the tank is insufficient. Pilot-less appliances may still spark or pilot flames may not extinguish immediately.*
- *Portable fuel burning equipment, including wood and charcoal grills and stoves shall not be used inside this Recreational Vehicle. The use of this equipment inside this Recreational Vehicle may cause fires or asphyxiation.*

EFFECTS OF LONG-TERM OCCUPANCY

Condensation

Outdoors RV Manufacturing has designed your travel trailer for recreational use and short-term occupancy. It is not designed or intended to be used as a permanent residence. If you occupy your RV for extended periods of time, be prepared to deal with condensation and humid conditions that may be encountered. The relatively small space and tight, compact construction of modern recreational vehicles means that normal living activities of even a few occupants will lead to rapid moisture saturation of the air contained in your RV especially in cold weather.

NOTICE

- *Your RV is not designed to be used as permanent housing. Use of this product for long term or permanent occupancy may lead to premature deterioration of structure, interior finishes, fabrics, carpeting, and drapes. Damage or deterioration as a result of long term occupancy may not be considered normal, and may under the terms of the warranty constitute misuse, abuse, or neglect, and may therefore reduce your warranty protection.*

Living With Your RV

Condensation occurs naturally, just as moisture collects on the outside of a glass of cold water. During humid weather, moisture can condense on the inside surfaces of the RV during cold weather when relative humidity of the interior air is high. This condition is increased because the insulated walls of a recreational vehicle are much thinner than the walls of your house. Estimates indicate that a family of four vaporizes up to three gallons of water daily through breathing, cooking, bathing, and washing.

Unless the water vapor is carried outside by ventilation or condensed by a dehumidifier, it will condense on the inside of the windows and walls as moisture or in cold weather as frost or ice. It may also condense out of sight within the walls or ceiling where it will manifest as warped or stained panels.

In extreme conditions it may appear as though the walls, windows, or roof vents are leaking. Appearance of these conditions may indicate a serious condensation problem. When you recognize the signs of excessive moisture and condensation in the RV, action should be taken to minimize their effects.

Here are a few frequently asked questions about condensation and some answers that will help you understand more about your RV and how to keep it comfortable.

Q. - In cold weather my windows and walls look like they're sweating. Is that condensation?

A. - Yes. Your windows are a good way to know if the humidity in your RV is too high. All air contains water vapor. When air is warm it can hold much more water vapor than when it is cold. When the air cools, the water vapor condenses back to liquid. Since your windows are usually cooler than the air, the water collects on the surface of the glass.

Q. - Where does all the water come from?

A. - Moisture in the air comes from many sources. Some of the most common are:

Cooking - Meals prepared for a family of four can add up to a gallon of water per day into the air from cooking.

Bathing - An average shower can put between 1/4 - 1/2 pound of water into the air.

Dishwashing - Washing the dishes for a typical days meals can add up to one pound of water into the air.

Floor Mopping - When an 8' x 10' kitchen floor is mopped and rinsed, almost 2 1/2 pounds of water can be released into the air.

Clothes Drying - After 10 pounds of clothes have been washed and spin-dried in a washer, they still contain about 10 pounds of water. If these clothes are dried inside, that water is released into the air.

Propane Appliances - When propane is burned, carbon dioxide, nitrogen, and water are given off into the air. For every 100 cubic feet of propane burned, nearly 88 pounds of water is released into the air.

Living With Your RV

Humidifiers - Humidifiers are designed to put moisture into dry air, up to two pounds per hour. So in a 24 hour period, an uncontrolled humidifier can put almost 50 pounds of water into the air.

House Plants - Plants give off almost as much water as you put on them.

People and Animals - A large source of water in the RV is the inhabitants themselves. A family of four can put up to 12 pounds of water into the air per day through breathing and perspiration.

As you can see, just the normal course of living adds a great deal of water into the air.

Q. - What will all this water do to my RV?

A - The least it will do is fog your windows. If it is really cold outside, frost or even ice could form on the inside of the glass.

Excessive moisture in the air could show up as water running down or dripping off the walls, ceilings, or fixtures. It may look like your roof or windows are leaking. This water may stain woodwork, carpeting, ceiling panels, or even furniture.

Most of the damage is caused by water you can't even see. Water will penetrate almost any material except glass and metals. Water vapor in the air always wants to move toward dry air. Scientists call this 'Vapor Pressure' action. It will go through walls, floor covering, plywood, paint, just about anything. The water that gets trapped in these materials can cause warping, mildew, paint failure, and rotting. The damage caused by excessive humidity can be invisible, and worse, expensive to fix. ***Please remember that this damage is not covered under the warranty.***

Q. - What can I do to reduce or eliminate condensation problems in my RV?

A - The two most important things are to reduce moisture released into the air and increase ventilation.

The Following Tips Will Assist with Minimizing Condensation

- Provide ventilation to allow excess moisture to escape to the outside when bathing, washing dishes, hair-drying, laundering, and using appliances and non-vented gas burners.
- Always use the range hood fan and roof vents when cooking and boiling water. Allow them to run for a period of time afterwards.
- Minimize excessive boiling or use of hot water.
- Keep the bath door closed with the power roof vent open and turned on when bathing/showering. Allow it to run for a period of time afterwards.
- Do not hang wet clothes in the RV to dry.
- Remove water or snow from shoes before entering to avoid bringing that moisture inside.
- If you operate or use vaporizing inhalers or similar devices, always provide adequate ventilation.
- Ventilate with outside air. Partially open one or more roof vents and/or windows to provide circulation of outside air into the interior. While this ventilation will increase furnace heating load, it will greatly reduce or eliminate condensation. Even when it is raining or snowing, outside air will be far dryer than interior air and will effectively reduce condensation.
- Do not tape windows or doors closed. This will prevent any air movement and will make the condensation problem worse.

Living With Your RV

- Use a fan to keep airflow circulating inside the RV so condensation and mildew cannot form in dead air spaces.
- Ventilate closets and cabinets. During use in cold weather, leave cabinet and closet doors partially open to warm and ventilate the interiors of storage spaces against exterior walls. The airflow will warm the exterior wall surface and reduce condensation, and prevent possible ice formation. Avoid crowding closets, pantries, and wardrobe space. Over crowded spaces restrict airflow.
- Open window coverings and windows as often as possible.
- In hot weather start the air conditioner early as it removes excess humidity from the air while lowering the temperature.
- Keep the temperature as reasonably cool during cold weather as possible. The warmer the vehicle the more cold exterior temperatures and warm interior temperature will collide on wall surfaces creating condensation.
- The natural tendency would be to close the RV tightly during cold weather. This will actually compound the problem. Simply put, you must remove some of the warm air and allow some cool air to get inside so the furnace will not recycle the humid interior air.

⚠ WARNING

- *Never use open flame gas or kerosene burning heaters indoors. These devices release water into the air, and the exhaust gases contain poisonous substances.*

NOTICE

- *Do not heat the interior of your RV with the range or oven. Open flames add moisture to the interior air. Do not use an air humidifier inside the RV. Water put into the air by the humidifier will increase condensation.*

Mold

Mold is a fungus that occurs naturally in the environment and serves necessary functions including aiding in the decomposition of plant and other organic material. Mold spreads by means of microscopic spores borne on the wind and is found everywhere life can be supported. Mold has existed for millions of years, and humans have coexisted despite their exposure to mold and mold spores.

If the proper conditions are present, mold can and will grow in your RV. Most people are familiar with mold growth on their bread and cheese or in the bathroom shower. In order to grow, mold requires a food source. These food sources might be supplied by items found in the RV such as fabric, carpet, wallpaper, or building materials (i.e. wood and insulation). Also most mold growth requires a temperate climate. The best growth occurs at temperatures between 40 degrees F and 100 degrees F. Most importantly, mold growth requires moisture, and moisture is the only growth factor that can be controlled.

Mold growth in the RV can stem from a variety of sources such as spills, leaks, overflows, condensation, damp or standing water, and human activity such as showering or cooking. By minimizing condensation as discussed in the previous section you will be reducing the potential for mold growth.

Living With Your RV

The Following Tips Will Assist with Minimizing Mold Growth

- Before bringing items into the RV check for signs of mold. Potted plants (root and soil), furnishings, or stored clothing, and bedding materials may also contain mold spores.
- Regular vacuuming and cleaning will help reduce levels of settled mold spores. Additionally, detergent solutions and most tile cleaners are effective in controlling mold growth on surfaces.
- Keep the humidity levels below 40% following recommendations in the '*Condensation*' section.
- Promptly clean up spills, condensation, and other sources of moisture. Thoroughly dry any wet surfaces or material. Do not let water pool or stand in or under your RV.
- Inspect for leaks on a regular basis. Look for discolorations or wet spots. Repair any leaks promptly.
- Pay close attention to any musty odors you may notice especially after coming into the RV after it has been closed up for a period of time. If you do notice any musty pungent odors, this is a good indication that you may have water intrusion into the structure of your RV with a mold growth started. This should be inspected as soon as possible.

For more information about mold and what you can do to reduce moisture and mold growth in your RV, please refer to the following websites and their literature:

U.S. Environmental Protection Agency - A Brief Guide to Mold, Moisture, and Your Home

<https://www.epa.gov/sites/production/files/2016-10/documents/moldguide12.pdf>

U.S. Environmental Protection Agency - Mold Remediation in Schools and Commercial Buildings

<https://www.epa.gov/sites/production/files/2014-08/documents/moldremediation.pdf>

Formaldehyde

All materials used in the making of all Outdoors RV products are CARB (California Air Resources Board) compliant for formaldehyde.

Formaldehyde is an important chemical used widely by industry to manufacture building materials and numerous household products including some paints, coatings, and cosmetics. It is also a by-product of combustion and certain other natural processes. It is used to add permanent-press qualities to clothing and draperies, as a component of glues and adhesives, and as a preservative in some products.

Formaldehyde is also found in tobacco smoke, household products, and the use of un-vented, fuel-burning appliances. Thus, it may be present in substantial concentrations both indoors and outdoors.

As is standard in the industry, your Outdoors RV recreational vehicle incorporates wood products that were manufactured using formaldehyde. Formaldehyde has an important role in the adhesives used to bind together the components of certain wood products such as particleboard used as shelving and in cabinetry and furniture; plywood paneling used for decorative wall covering and medium density fiberboard (MDF) used in miscellaneous other components. The wood products in your RV are designed to emit formaldehyde at lower than maximum levels allowable under standards issued by Recreational Vehicle Industry Association, and should not produce symptoms such as irritation of the eyes and throat in most people.

Studies have shown that while almost all of the formaldehyde used in the materials in your RV is consumed during the manufacturing process, a small amount remains. This left-over formaldehyde dissipates over time, typically ranging over several months. The rate at which products like pressed wood or textiles release formaldehyde can change.

Living With Your RV

Formaldehyde emissions will generally decrease as products age. When products are new, higher ambient temperatures or humidity can cause increased release of formaldehyde from these products.

Health Effects of Formaldehyde

Formaldehyde is a colorless, pungent smelling gas that can cause watery eyes, burning sensations in the eyes and throat, nausea, wheezing and coughing, fatigue, skin rash, and difficulty breathing in some people, and severe allergic reactions. High concentrations may trigger attacks in people with asthma. It has been shown to cause cancer in animals and may cause cancer in humans.

In almost all cases, the human body is naturally equipped to handle formaldehyde without harm. If formaldehyde is absorbed into the body, naturally occurring enzymes in the blood stream convert it into a non-toxic substance that is eventually expelled as a bodily waste.

A very small percentage of the population, however, is more sensitive to formaldehyde. For these people, coming in contact with formaldehyde can cause watery or itchy eyes, runny or bleeding nose, or sore throat. In most cases, these symptoms disappear with fresh air ventilation.

If you think you might have sensitivity to formaldehyde, or if you have any questions or concerns about the health effects of formaldehyde, please consult your doctor or local health professionals.

How to Reduce Exposure

To reduce or lessen your exposure to chemicals from off-gassing, you must ventilate your RV. Open windows, doors, and roof vents frequently after purchase and whenever the temperature and/or humidity are high. Operate vent fans, roof air conditioner and the furnace. Use a fan to force the stale air out and bring fresh air in.

- Use air conditioning and dehumidifiers to maintain moderate temperature and reduce humidity levels. Use the recommendations in this chapter on controlling moisture and humidity.
- Increase ventilation, particularly during the first few months after purchasing your RV.
- Do not smoke inside your RV. In addition to causing damage to your RV, tobacco smoke releases formaldehyde and other toxic chemicals.
- If you do use dehumidifiers to control humidity, be sure to drain and clean any water collection trays frequently so that they do not become a breeding ground for microorganisms.

For more information about formaldehyde and what you can do to minimize exposure in your RV, please refer to the following website and their literature:

U.S. Consumer Product Safety Commission

<https://www.cpsc.gov/PageFiles/121919/An-Update-On-Formaldehyde-725.pdf>

⚠️ WARNING

- ***IRRITANT - This product contains a urea-formaldehyde resin and may release formaldehyde vapors in low concentrations. Formaldehyde can be irritating to the eyes and upper respiratory system of especially susceptible persons such as those with allergies or respiratory ailments. Use with adequate ventilation. If symptoms develop, consult your physician.***

Living With Your RV

LEVELING AND STABILIZATION

Leveling of your RV at the campsite is important. A level RV is not only necessary for comfort but your refrigerator must be reasonably level in order to operate properly (See your refrigerator user guide for specific details regarding level conditions). Your RV must be leveled before lowering the stabilizer jacks. This can be accomplished by purchasing specially designed leveling blocks or wedges. Additionally you may choose to include a small level in your RV tool box.

Alternatively you can make your own leveling blocks using 2x6 or 2x8 lumber to assemble a ramp similar to the one shown in the picture to the right.



Do not use leveling blocks that are too narrow for the width of the tire. This is extremely unsafe and can potentially damage your tires.



Stabilization is recommended to keep your RV from bouncing and rocking while people are moving about inside the unhitched RV. Stabilizer jacks are intended to stabilize the body of both conventional and fifth-wheel RV. While a conventional RV's hitch weight is supported by the tongue jack, fifth-wheel models may benefit by adding a king-pin stabilizer jack that stabilizes the hitch area. This is not included with fifth-wheel models from the factory but can be purchased separately from your dealership. **Factory installed stabilizer jacks are not intended to lift or level the RV or support its entire weight. They are designed only to minimize the bouncing, rocking feeling you get when moving around inside an un-stabilized RV.**

Included with your RV is a crank handle for operating manual stabilizer jacks and optionally installed electric stabilizer jacks. If you have electric stabilizer jacks, in the event of power or motor failure you will still be able to raise and lower them. This crank handle is typically located in your front exterior storage compartment hanging on the wall. Fifth wheel models may have an optionally installed 4 or 6-Point Leveling System that automates the leveling process. See '*4 or 6-Point Leveling System*' in the '*Appliances and Equipment*' chapter for functionality.

Living With Your RV

If your RV is equipped with electric stabilizer jacks, you will find the control switches in the forward passenger side storage compartment on the front wall. Conventional travel trailers will have these switches located behind a sliding security panel in that same forward compartment. Before traveling, be sure to slide this panel closed to prevent any potential cargo shift from activating the jacks while moving down the road. On fifth-wheel models you will find the front landing gear switch located on the exterior at the driver side toward the front. If your fifth-wheel is equipped with the optionally installed 4 or 6-Point leveling system you will find its control panel in the driver side storage compartment on the front wall. If your RV is equipped with the wireless function controller you will be able to control electric stabilizer jacks and fifth-wheel landing gear remotely. Please refer to the specific literature provided in your owner information packet for detailed operating and maintenance instructions.

Stabilizing Procedure

1. If the site is not an asphalt pad, concrete slab or other prepared surface, be sure it is as level as possible. Be sure the ground surface is not soft and will support the feet of the stabilizing jacks adjusted to a snug, tight fit. It may be necessary to put blocks under each jacks foot pad.
2. If the site is not level, determine the final parking location for your RV and just prior to pulling completely into that spot, locate your leveling blocks just ahead of the RV front tires. Pull your RV up onto the leveling blocks until the RV is reasonably leveled from side to side. Set the tow vehicle in park and apply the parking brake. Block the RV tires so that it cannot roll.
3. For conventional travel trailers: With foot pad attached to the tongue jack, lower the tongue jack until you are able to uncouple the tow vehicle. Leave the safety chains (when possible) and breakaway switch temporarily connected. Level the RV from front to rear.
4. For fifth-wheel travel trailers (no 4 or 6-point leveling system): Lower the 'quick-drop' landing gear by releasing the snap pins and letting the inner leg tube and foot pad contact the ground. Raise the leg tube up just enough to re-insert the snap pin into the nearest hole available with the leg as close to the ground as possible. The position of each 'quick-drop' leg will depend upon how level your site is. It is not necessary that the legs be extended to the same length. Extend the landing gear legs to a point that the tow vehicle can be uncoupled. It may be necessary to put a larger block of wood under the foot pads to prevent the leg from sinking into soft ground. Level the RV from front to rear.
5. Check that all doors and windows operate freely and do not bind.
6. After your RV is leveled you will lower the stabilizer jacks. You may need to put a larger block of wood under any jack that is above soft ground to prevent the jack from sinking in allowing the RV to become unstable. Lower the jacks until they contact the ground or block with a snug, tight amount of pressure. Attempt to apply the same amount of pressure equally around the RV so that it does not come out of level. **Do not attempt to raise or level the RV with the stabilizer jacks as this will void warranty and damage the jack.**
7. For conventional travel trailers you may now remove the safety chains and breakaway switch without the risk of the RV rolling.
8. Before resuming travel, be sure all stabilizer jacks are fully retracted or removed if additional jack stands are used.

Living With Your RV

If your RV is equipped with slide-out room(s), complete the leveling and stabilization procedure before extending the rooms.

⚠ WARNING

- *Do not attempt to use the stabilizer jacks to level the RV, lift the weight of the RV, raise the tires off the ground, change a flat tire, or otherwise place all of the weight of the RV on the stabilizer jacks. Stabilizer jacks are not designed to carry this amount of weight and if used in this manner may collapse causing an unsafe situation that could result in death or serious injury.*

NOTICE

- *Do not attempt to use the stabilizer jacks to level the RV, lift the weight of the RV, raise the tires off the ground, change a flat tire, or otherwise place all of the weight of the RV on the stabilizer jacks. Stabilizer jacks are not designed to carry this amount of weight and if used in this manner may damage the jack and/or cause damage to the chassis frame or entry door jambs. Any damage caused by misuse of the stabilizer jacks in this manner will not be covered under warranty.*
- *If after-market stabilizer stands are used they must be placed only under the chassis frame rail. Do not place these stands in any other location as damage may occur which will not be covered under warranty.*

WINDOW COVERINGS

Night Shades (If equipped)

Night shades are a fabric accordion style shade that can be raised and lowered as desired. With both hands firmly grasp the knobs on the lower bar and raise or lower to the desired height. The shade will stay in position on its own.

Slow-Rise Roll Shades (If equipped)

Slow-Rise roll shades operate much like a typical roll shade however when releasing them to the full up position you may let go of the shade and it will slowly raise and stop at its upper limit. To raise the shade to a desired height, pull down on the bar until spring tension has been released then allow the shade to rise to the desired height, stop the shade at the desired height and release. To lower the shade, gently pull downward to the desired height. These blinds are adjustable for speed and upper stop height. An adjuster wheel at the left end of the shade roll will increase or decrease the speed of rise. The adjuster wheel on the right of the roll will increase or decrease the height in which the blind will stop at.

Living With Your RV

Metal Blinds

To lower the blind pull down on the cord slightly, and move it about 45 degrees to either the left or right to release, then lower the blind to the desired height. When at the desired height, move the cord back to the vertical position and the blind will stop.

To raise the blind first release the lower bar from the travel retainer clips, then pull straight down on the cord to the desired height and release.

To adjust the viewing angle on metal blinds rotate the rod either direction.

Remember to re-attach the lower bar to the travel retainer clips prior to traveling as damage will eventually occur to the blind and possibly other wall and trim finishes. This type of damage is not covered under warranty.

DINETTE CONVERSION - (Wrap-Around Style)

Dinette shown in 'Dining Arrangement'



1. Lift table from pedestal legs.
2. Store legs below.
3. Insert table into recess.



4. Arrange cushions as shown.
5. Reverse procedure to restore dinette.

- For additional space the rear backrest may be removed and stored.



Living With Your RV

DINETTE CONVERSION - (Mountain Style)

Dinette shown in 'Dining Arrangement'



1. Lift table from pedestal legs.
2. Store legs below.
3. Insert table into recess.



4. Arrange cushions as shown.
5. Reverse procedure to restore dinette.



SOFA CONVERSION

Jack-Knife Style

You will recognize the Jack-Knife sofa as not having arms at either end. To convert the Jack-Knife sofa into a sleeping space, lift up on the seat frame and pull toward you. Lower the seat frame to the base. To put back into the sofa position lift up slightly on seat frame and push away from you until backrest settles into upright position then release seat frame onto support base. It can be helpful to pull the backrest toward you while pushing the seat frame away from you.

Tri-Fold Style

You will recognize the Tri-Fold sofa as having arms at both ends. To convert the 'Tri-Fold' sofa into a bed, remove the backrest cushions, lift up on seat frame, and pull toward you until the seat unfolds with the mid-section mattress pad. Before setting on the floor you must unfold the legs under the seat frame. Then fold down the backrest frame to complete the bed conversion. You may put the backrest cushions back into place to provide a padded headboard effect. Reverse procedure to put back into sofa position.

Living With Your RV

Wall-Hugger Recliners

The wall hugger recliners may need to be pulled away from the wall slightly to avoid rubbing. You will find the reclining levers just between the seat cushions and arm rest on either side. Additionally the center armrest opens up to provide storage for remotes, etc.

STORAGE COMPARTMENTS

Exterior

All of the exterior storage compartments have locking latches except for the Propane tank compartment on fifth-wheel models. Fire prevention safety regulations require that the Propane tank compartment be unlocked at all times.

Please note: Your RV could be overloaded or put out of balance if not properly loaded. Refer to the **Loading Your RV'** section of this manual, and follow the loading and weighing instructions provided.

When storing equipment and supplies:

- Always keep tools and equipment stored in areas where they will not shift while traveling.
- Whenever possible, place heavy objects in storage compartments which are low and in the best location for weight distribution. Pack objects carefully in the storage compartments to minimize shifting. If necessary, use straps to prevent movement.
- Be sure liquid containers are capped and cannot tip or spill.
- Exterior storage compartments may not be watertight in all conditions. Carry any articles which could be damaged by water on the interior of the RV.

Interior

Interior storage compartments must be properly loaded to minimize doors and drawers coming open while traveling. Items will shift and can cause damage if allowed to fall out of cabinets. Doors and drawers have latches that will retain in the closed position under normal circumstances, however if drawers are overloaded they may slide open while turning corners. Additionally, traveling along rough country back roads may cause doors and drawers to open as well.

Many pantry cabinets serve dual purpose and include shelving that can be removed to convert to a wardrobe to hang clothing.

Bunk Area Storage (If Equipped)

Bunk model RVs include storage space at the lower bunk area accessible from the exterior of the RV. This storage may be utilized to store bulkier cargo such as bicycles and lawn chairs, etc. To maximize this storage space, first open the exterior compartment door. Then raise the lower bunk pad and platform. Latch the platform into place (if equipped). ***Do not store flammable liquids or hazardous chemicals inside the RV or any of its exterior storage compartments. Toxic fumes from these liquids or chemicals may enter the interior of your RV.***

Attaching Accessories To Walls Or Cabinets

We do not recommend drilling, screwing or riveting any wall hanging fasteners to your RV. There is a likelihood of damaging wires, or water lines contained within walls. Be advised that the use of 'sticky-back' adhesives fasteners, tapes, or glues may damage the panel surface beyond repair. Any damage to your RV due to the fastening of items to the RV will not be covered under warranty.

⚠ WARNING

- *Do not store flammable, volatile or hazardous chemicals inside your RV exterior storage compartments. Toxic fumes from these liquids or chemicals may enter the interior of your RV.*
- *Do not place propane cylinders inside the vehicle. Propane cylinders are equipped with safety devices that relieve excessive pressure by discharging propane into the atmosphere. Propane gas is highly flammable. Can lead to a fire or explosion and result in death or serious injury.*
- *Move cargo to maintain proper balance. Do not exceed GVWR (total weight rating) or GAWRs (axle weight ratings) of the trailer or tow vehicle.*

ENTRY DOORS, SCREENS AND LOCKS

Entry door locks and deadbolts are keyed alike. If your RV has two entry doors, there will be a separate set of keys for each door. Your entry keys will be numbered. Be sure to record these numbers and keep in a safe location. This number can also be located inside the lock-set when disassembled. In the event that keys get lost they can be replaced without having to replace the entire lock-set.

Some models are equipped with a 'Friction-Hinge' entry door which will allow the door to stay open without additional latching in moderately breezy wind conditions or if the RV is slightly out of level. This door operation will feel as if it is binding or needs lubrication when opening or closing, however, rest-assure that is by design. Keep in mind that this feature may be overcome by strong winds and could possibly swing open or closed unintentionally.

Other models do not include the 'Friction-Hinge' entry door feature and must be latched in the fully open position to prevent winds from swinging the door.

NOTE: It is always a good idea to lock the entry door deadbolt(s) before traveling. This will reduce the possibility of the door(s) opening on the road.

Dust Seepage

Travel over unpaved, dusty roads typically generates a large amount of dust which has a way of entering the RV through small cracks and gaps at entry doors. This problem may be reduced by slightly opening a roof vent. Road vibrations and bumps may cause the entry door to become out of adjustment over time. It may occasionally be necessary to adjust the door striker plate to maintain a tighter seal.

Plumbing Systems

Your RV plumbing consists of two primary systems: Fresh (potable) Water and Waste Water. Each system has its own holding tank(s) including a fresh water holding tank for clean potable water while camping away from city and park water connections and black and gray waste holding tanks for containing body waste and drainage from sinks and bath shower. Black and gray waste holding tanks are independent of each other and are not interconnected other than sharing the primary drain outlet.

Typically rear kitchen model RVs have (2) gray holding tanks, one for the kitchen sink and one for bath (shower and sink).

Many of the RV plumbing system components are identical to modern residential plumbing components and function in the same way.

FRESH (POTABLE) WATER SYSTEM

Fresh water is supplied to the RV system by two alternate sources.

- 1) The External Fresh Water connection (city or RV park water).
- 2) The self-contained On-Board Water Tank.

~ Prior to using the Fresh Water System it is recommended that the entire water system be sanitized, drained and flushed. See 'Sanitizing the Fresh Water System' in this chapter for details.

External Fresh Water Connection

It is highly recommended to purchase a 'Drinking Water Safe' RV specific fresh water hose as well as an in-line water filter and in-line pressure regulator for this water supply. To use the external water system, first connect the water hose to the potable water source, then to the hose connection on the driver side or rear of your RV. Fifth wheel models may be located inside the water center compartment on the driver side. Be sure to run the water for a few seconds to clear the hose from any debris before connecting to the RV. The water pump design is such that it will prevent water from this connection entering the on-board water tank.

The RV water pump should be turned off while the RV is connected to city or park campground water source. Since the city or park water source provides its own pressure, the water pump is not needed.

NOTICE

- ***IMPORTANT: EXCESSIVE WATER PRESSURE. Some city or campground water systems may operate at pressures that can damage the water system in your RV or cause water pump failure. If pressure at your site is over 70 PSI, you must use a pressure regulator. The recommended pressure range is 35 PSI to 45 PSI. Your RV supply dealer can advise you on the best choice regarding water pressure regulators.***

Plumbing Systems

On-Board Water Tank

The On-Board water tank fill location is typically located on the driver side of your RV, labeled 'WARNING - Potable Water Only'. Fifth wheel models may be located inside the water center compartment on the driver side.

1. Open the hatch door and remove the fill cap. Avoid allowing any debris to fall into the fill opening.
2. Insert your 'Drinking Water Safe' water hose from the water source. ***Do not use an oversize hose that seals off the opening of the fill spout.*** A smaller diameter hose allows for venting air space in the fill opening with the hose inserted and will fill more quickly and reduce the chance of pressurizing the tank. A pressurized tank can potentially damage fitting connections and even floor and cabinet structures. ***The water tank must be allowed to vent adequately as it is being filled.***
3. Turn on water at the source. Do not attempt to fill the water tank too quickly. Allow air to escape as water goes into the tank. ***Do not leave the RV unattended while filling.***
4. Occasionally check water level on the monitor panel inside your RV. When the monitor indicates that the tank is full, immediately shut off the water, remove hose, and close cap and door on water fill inlet.
5. The water pump must be powered on to use the on-board water tank system.

Whenever possible, fill the water tank when you arrive at or near your campsite. This will make towing and handling much more controllable and enjoyable.

NOTICE

- ***Never allow the water tank to be filled unattended. Never over-fill the water tank or allow it to become pressurized. Damage to tank, fittings, and floor or cabinet structures may occur. Damage caused by over filling or improper filling of the fresh water tank is considered misuse and is not covered by Outdoors RV Mfg Warranty.***

⚠ WARNING

- ***USE POTABLE WATER ONLY IN THE FRESH WATER SYSTEM. Sanitize, flush and drain before using. Failure to comply could result in death or serious injury.***
- ***Do not use the same hose for filling the potable water tank or for connection to the city water inlet that you would use for cleaning waste holding tanks. The use of a different hose will ensure that you will not contaminate your fresh water supply.***

Plumbing Systems

Draining the On-Board Water Tank

The on-board fresh water tank has a drain valve handle similar to that of your waste water drain system however, is identified by having a white handle. This valve handle will be located on the driver side of your RV along the lower edge of the chassis frame. Pull the valve handle out to drain and push in to close the valve.

Avoid leaving water in the tank when the RV is not in use. Turn the water pump off before draining the water tank.

Water Line Low Point Drains

Each water line (Hot and Cold) has its own drain valve for winterization and sanitation. Some RV models will have two drain valves per water line based on floor plan design. Drain valve locations are on the interior of your RV typically behind an access panel on the floor identified with the label shown in the picture below. Some models will be located in the lavy cabinet. Others may be located in galley, or entertainment cabinets behind an access. Fifth wheel models will be located inside the exterior water center compartment. If you have trouble locating these valves you can start by looking underneath for the small white tubes coming thru the floor along the edge at the exterior. This is the drain outlet location. The valves will be directly above these outlet tubes. Your dealership will also be able to help you locate these valves.



Shown at the left is an example of the water line drains found on fifth wheel models located inside the exterior water center compartment on the driver side. Valve handles rotate 90 degrees clockwise to close and counter-clockwise to drain. Your valve handles may not be oriented as shown however still function as outlined.

Shown at the right is an example of a drain valve access panel in a conventional RV. Removing the panel gains you access to the valves. Valve operation is the same as that of fifth-wheel models.



Plumbing Systems

To drain the water lines;

1. Turn off water pump.
2. Open all hot and cold low point drains.
3. Turn on all faucets.

For more complete direction on water system draining, refer to the '*Winterization*' section in the '*Storage and Winterization*' chapter.

Water Pump

The On-Board Fresh Water System requires a 12 volt water pump for operation. The water pump provides water pressure at each fixture while dry-camping without a pressurized city/park water connection. It is also used during the winterization procedure for pumping RV anti-freeze into the water lines to prevent freeze-up. This procedure is outlined in detail in the '*Winterization*' section in the '*Storage and Winterization*' chapter.

The water pump is self-priming and operates automatically when its switch is in the on position and a faucet has been opened. When the water pump senses a pressure drop in the system it will begin to pump water to maintain that pressure. Each first use after water lines have been drained, the water pump will run continuously for a minute or so until the water lines are primed and fully pressurized. Additionally when a faucet is opened it may sputter for a few seconds until all air is purged from the water line and faucet.

The power switch for your water pump will be located on the systems monitor/control panel typically found in a galley overhead cabinet. The water pump is typically located inside the base of the galley cabinet behind a drawer or access panel.

Shown at the right is an example of a water pump. On the right side you will see the filter screen identified. The pump assembly is typically located beneath a drawer in a galley cabinet. It may also be accessible from a removable panel on the side of the cabinet. On fifth wheel models the water pump is typically located behind the rear bulkhead in the pass-thru storage compartment, accessed from a service door.

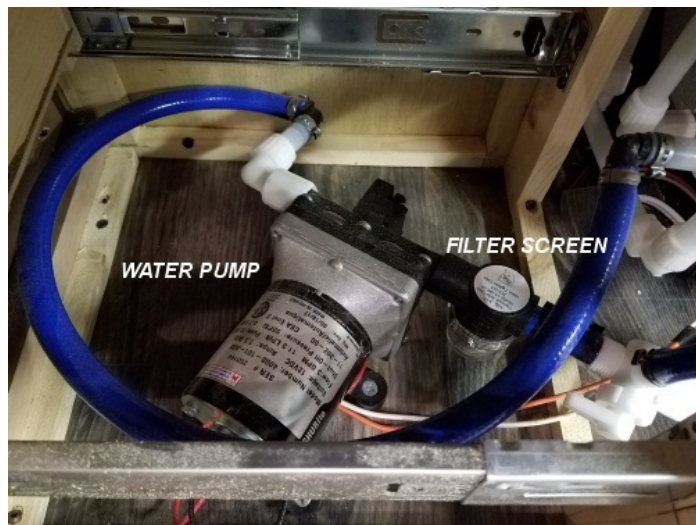

Plumbing Systems

Water Pump Screen

Your water pump includes a serviceable filter screen that can be removed and flushed out if it becomes clogged with debris. **Note: This is merely a particle filter screen and does not provide water purification.**

The filter screen housing is located on the inlet side of the water pump and is made of clear plastic so that you may perform a visual check of its condition without disassembly. It is recommended to inspect the filter screen after running the first full tank of water. Clean and inspect monthly thereafter.

To remove filter screen for cleaning;

It is recommended that this procedure be performed at a time when the fresh water tank and water lines have been drained to minimize water spillage onto the floor.

1. Turn off water pump.
2. Place a shallow drip pan or rag under the filter housing.
3. Unscrew the clear inspection housing cover and remove filter screen.
4. Flush out debris from filter screen and clear housing cover.
5. Reverse procedure to install.
6. Operate water pump to verify that there are no water leaks.

Additional information regarding water pump operation and maintenance can be found in your owner information packet provided with your RV.

NOTICE

- *Turn water pump or master 12V disconnect switch off before traveling. Road vibration could cause a faucet to open. If the water pump is on, your fresh water supply could be pumped into the waste holding tanks.*

Showers and Faucets

Interior and exterior showers and faucets operate much like that of the type in your home. Keep in mind that if you are dry camping with no city or park water connection you must have the water pump switched on. For hot water at showers and faucets, the water heater will require sufficient time to heat the water. For your safety, the interior and exterior shower faucets are equipped with a vacuum breaker device. This device is designed to prevent backflow of potentially contaminated water into the fresh water system. When the faucet is in the OFF position after use, water will drain from the shower head and hose. This is not a defect or leak, but indicates that the faucet is working properly.

Water Heater

Your RV is equipped with either a 6 or 10 gallon water heater depending on model and available space. Specific details are outlined in the '*Appliances and Equipment*' chapter of this manual.

Plumbing Systems

Water Heater By-Pass

The water heater by-pass allows for winterization of the water system without filling the water heater tank full of anti-freeze. The by-pass valve is located on the back of the water heater (see illustrations below). Most water heater by-pass valves are accessible behind a removable cabinet panel or cabinet drawer. The easiest way to find the by-pass valve is to locate the water heater on the exterior of the RV then go into the RV and look at the cabinetry in that general location for a removable access panel or bank of drawers that can be removed. Fifth wheel models are remotely located away from the water heater in the exterior water center compartment on the driver side of your RV. Identified in **RED** lettering its instructions are self-explanatory. Your RV dealer can assist you in finding and operating this feature if necessary.

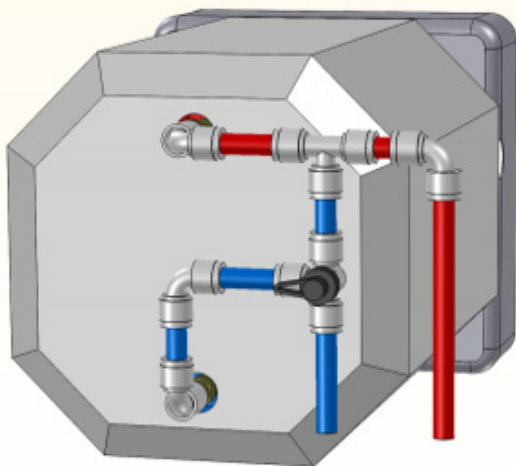

This view illustrates the by-pass valve oriented in the '*normal flow*' position. To 'by-pass', turn counter-clockwise 90 degrees.

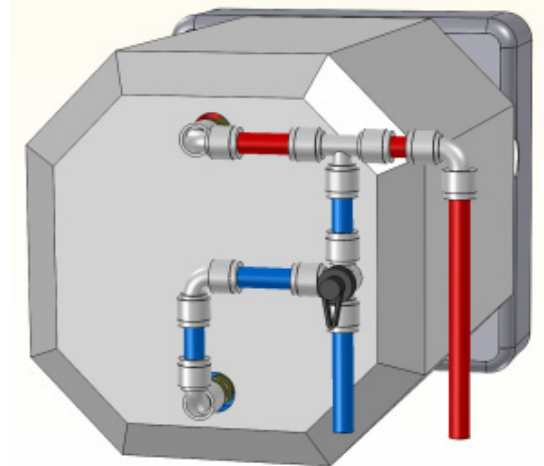

This view illustrates the by-pass valve oriented in the '*by-pass mode*' position. To switch to 'normal', turn clockwise 90 degrees.

While the by-pass valve is oriented in the '*normal flow*' position, water will travel into the valve assembly and be redirected into the bottom of the water heater. With the water heater turned on, water will then become heated inside its tank, then travel out the top of the water heater into the hot water lines as demand requires.

With the valve oriented in the '*by-pass mode*' position, water will flow through the by-pass valve and back in to the hot water lines thus 'by-passing' the water heater tank. In this mode during the winterization operation, anti-freeze is not allowed into the water heater tank.

Valve handles rotate 90 degrees clockwise to close and counter-clockwise to drain. Your valve handles may not be oriented as shown however still function as outlined.

The water heater has a one-way check valve at the upper connection that prevents 'by-passed' water from entering into the top of the water heater and therefore forces it into the hot water line.

Plumbing Systems

NOTICE

- *Do not turn on the water heater with the by-pass valve in 'by-pass mode' without water in the water heater tank. Damage to the water heater and heating element may occur if the water heater is turned on without water in its tank. This type of damage is not covered under warranty.*

SANITIZING THE FRESH WATER SYSTEM

To ensure complete disinfection of the potable water system, it is recommended that the following procedures be followed on a new system, one that has not been used for a period of time, or one that could have become contaminated. This procedure is also recommended before long periods of storage such as over winter.

To sanitize your fresh water system, follow this procedure:

1. Drain water lines, fresh water tank and water heater. Close all valves and replace water heater anode/drain plug when complete. Set water heater by-pass valve to the '*normal flow*' position to allow sanitization of the hot water tank and by-pass valve assembly. If you have installed a water filtration system, its filter can be removed at this time.
2. Prepare a chlorine solution using 1 gal. (3.8 L) of water and 1/4 cup (60 ml) household bleach (sodium hypochlorite solution). With tank empty, pour chlorine solution into the tank. Use 1 gal (3.8 L) solution for each 15 gal. (57 L) of tank capacity. This procedure will result in a residual chlorine concentration of 50 ppm in the water system. If a shorter time period is desired, create a solution of 100 ppm by using 1/2 cup of household bleach with 1 gal. of water.
3. Complete filling the tank with potable water. Turn on water pump. Open each faucet and run water until a distinct odor of chlorine can be detected in the water discharged. Do not forget the hot water taps, showers, and toilet.
4. Allow the system to stand for at least 4 hours when disinfecting with 50 ppm residual chlorine. If a shorter time period is desired, a 100 ppm chlorine concentration should be permitted to stand in the system for at least 1 hour.
5. Drain the entire system including hot water heater tank, fresh water tank, and water lines. Close all drain valves and replace anode/drain plug in water heater.
6. Flush the system with fresh water as described in step #3 (omitting the chlorine solution). Repeat as necessary until the smell of chlorine is gone. If you have installed a water filtration system, its filter can be replaced at this time.
7. When flushing is complete, close all drain valves, replace anode/drain plug in water heater and don't forget to drain gray and black holding tanks if you used them to contain the flushing water. The system is now ready for use.

WASTE WATER SYSTEM

The waste water system in your RV is essentially two separate systems. A gray water system that consists of the drain lines and holding tank for waste water from the sinks and shower or tub and a black water system which includes the drain line and holding tank for toilet waste.

Plumbing Systems

The drain plumbing system is very similar to that used in your home. The sinks and showers or tubs have water traps and are vented to the exterior to minimize waste gases from backing up into the RV.

The components are made of ABS plastics the same as plumbing parts found in modern homes, and are just as durable and resistant to most chemicals and cleaners used in the household.

Each system is self-contained and allows for disposal of waste water at designated dump stations at your convenience. A flexible sewer hose is required to connect the holding tank outlet to the inlet of an approved waste water dump station or sewer system. This hose can typically be purchased at your local department store or RV dealership. A storage location is provided for the sewer hose in the rear bumper by removing the rubber cap at either end.

If you encounter a clogged sink, shower or tub drain, you will be able to disassemble the water trap (sometimes called P-trap) in the same way that you would at home. Some models have a clean-out access fitting for using a plumber snake tool. These fittings are generally located behind drawers at galley cabinets.

Toilet

Your RV is equipped with a marine-type toilet. It is different than your toilet at home in that it does not have a water tank attached to the back of it to flush waste out through the pipes. Your RV toilet dumps waste directly into the black holding tank with very minimal pipe connecting between the two. By this design the RV toilet requires very little water to flush and relies on gravity to do the dirty work.

This toilet operates by use of a foot pedal that is pressed downward to control function. The pedal has two positions. To add water to bowl, press down half way. To flush, press all the way down. It is recommended to keep a small amount of water in the bowl at all times except when traveling. You may find that you will require more water in the bowl when flushing solids. Hold the flush pedal down long enough to release the contents of the bowl, but not longer than necessary as this will result in excessive water usage.

Unnecessary, frequent flushing of the toilet will quickly deplete your fresh water supply and fill your holding tank faster. If the black water tank becomes full, you will no longer be able to flush the toilet until the black tank can be drained. Remember to occasionally monitor tank levels.

Holding Tanks

Your RV will have a minimum of two holding tanks, a **Black** tank for the toilet and a **Gray** tank for the sinks and shower or tub. Typically rear kitchen model RVs will have an additional gray tank for the kitchen sink. Due to the distance of separation between kitchen and bathroom on rear kitchen model RVs the drain lines cannot share the same gray tank and must be plumbed to each respective tank. Unfortunately this means that the additional gray galley tank must be drained separately from the primary waste outlet location.

The primary holding tanks are generally located beneath the bathroom with drain valve handles and drain outlet(s) located on the driver side. On rear kitchen model RVs the additional gray tank is generally located close to the kitchen area. Mid-profile fifth-wheel drain handles are located in the front storage compartment. The black tank drain valve is identified with a black pull handle and the gray tank drain valve is identified with a gray colored pull handle.

Plumbing Systems

The two or three tanks are not interconnected in any way other than the final drain connection and can be drained individually through a common outlet.

In order to help prevent hard deposits from building up within the black tank and help to reduce unwanted odors, it is recommended to always keep a small amount of water in the black tank. Generally just enough to cover the bottom will do. This is easily done by filling the toilet bowl and dumping a few times.

When using your RV drainage system and holding tanks it is recommended that the black holding tank valve is kept closed until the tank is at least 3/4 full. If the black holding tank is allowed to constantly drain with the valve open you may create a residue build up that will become difficult to flush out later. Additionally, waste will build up along the internal edges of the drain valve potentially creating a situation where the valve may not fully close which in-turn will cause a sewer leakage problem that may not be resolved without disassembling the entire valve assembly. During self-containment use, the drain valves and outlet should be securely closed and capped to prevent leakage of waste materials onto the ground.

Do not put these items in toilet or drains:

- Facial tissues, paper towels, sanitary products (including those labeled flushable), wrappers, gum, cigarettes.
- Detergents or bleach.
- Automotive antifreeze, ammonia, alcohols, or acetones.
- Grease from cooking, table scraps or other solids that may cause clogging.

Quick tips to keep your waste tanks flowing freely:

- Keep black tank valve closed until tanks are at least 3/4 full before dumping.
- Be sure to keep enough water in the black tank to cover the bottom to reduce sticking of waste.
- Use only RV specific toilet paper which is designed to decompose much faster than household toilet papers.
- Use only cleaners and deodorizing chemicals approved for use in RV holding tanks. These chemicals are designed to aid in breaking down solid wastes and make the system much more pleasant to use and clean.
- Do not use harsh household drain cleaners.

Should you ever have a build up of solids, your RV is equipped with a Black Tank Flush System which will likely clear this up. See section in this chapter titled '***Black Tank Flush System***' for direction. If the problem continues, it may be necessary to purchase a waste water digester from your local RV dealer which can be added to the tank to help break down solids. Depending on the severity of the situation, it may be necessary to repeat these procedures.

Draining Holding Tanks

Prior to draining your waste holding tanks it is recommended that you wear protective equipment such as safety glasses or goggles, rubber gloves, and or face shield to prevent potential splashing of waste water onto your mouth, nose and eyes.

Plumbing Systems

IMPORTANT:

- *Do not pull the holding tank drain valves open while the protective cap is attached to the drain outlet.*
- *Do not attempt to drain both waste holding tanks at the same time.*
- *Always drain the waste holding tanks into an acceptable sewer inlet or dump station.*

1. Remove sewer outlet cap by twisting cap counter-clockwise.
2. Locate and attach your sewer hose to the holding tank drain outlet by aligning outlet pins to hose connector fitting and twisting clock-wise until secure.
3. Insert other end of the sewer hose into the sewer or dump station inlet, pushing it securely into place. In some cases, adapters or elbows may be necessary or required at the dump station end of the hose. Arrange the sewer hose so that it slopes evenly toward the dump station inlet.
4. Drain the black tank first. Before doing so, open the toilet ball valve with the foot pedal and check to see that the tank is at least 3/4 full. You will gain additional flushing action by filling the tank to at least 3/4 full with fresh water.
5. Firmly grasp the drain valve handle of the black tank (identified with a black handle) and pull the valve fully open with a quick, steady pull.
6. Allow enough time for the tank to drain completely. Rinse and flush the tank through the toilet. If additional flushing is necessary, this process can be repeated. Additionally you may use the 'Black Tank Flush System' at this time. See section in this chapter titled '**Black Tank Flush System**' for direction. When tank is empty and satisfactorily clean, push the handle in to fully close the valve.
7. Drain the gray tank by pulling the gray colored handle. The gray tank is drained last to aid in flushing the outlet and sewer hose. The gray water knife valve may be left open in a semi-permanent hookup while connected to a RV park sewer connection.
8. Ensure that drain valves are closed. Remove the sewer hose from the RV drain outlet fitting and cap the outlet.
9. Rinse out the sewer hose with fresh water and remove from the dump station connection. Sewer hose may be stowed in bumper.
10. Replace sewer or dump station cap.

Blank Tank Flush System (San-T-Flush)

The black waste holding tank is equipped with a rinsing spray head that will aid in the removal of sewage residue from the interior of the tank. This system uses a garden hose connection located along the driver side or rear exterior wall of your RV. It appears similar to the city water inlet however will be identified with the 'SAN-T-FLUSH' labeling. **DO NOT** mistake this connection for the *city water inlet*.

See additional literature in your owner information packet supplied with your RV.

WARNING

- *Holding tanks are enclosed sewer systems and as such, must be drained into an approved dump station. Both black and gray water holding tanks must be drained and thoroughly rinsed regularly to prevent accumulation of harmful or toxic materials.*

Plumbing Systems

NOTICE

- *Sewer drain cap must always be securely in place while the vehicle is in motion. Local or state regulations may prohibit highway travel unless the holding tank outlet is securely capped.*
- *Do not leave the RV unattended during the tank flushing process. Make sure the black tank termination valve is open and your sewer hose connected to an approved dump station. Overfilling the black water tank will result in water overflowing into the interior of your RV from the toilet and the resulting damage will not be covered under warranty.*

CAUTION

- *DO NOT connect city water pressure to black tank flush system unless drain valves are open. May result in an unsanitary condition leading to illness or personal injury.*

Odor Control

The secret to good air quality in and around your RV lies in finding an effective holding tank chemical and applying the proper amount based on use and ambient temperature. It is important to note some brands work more effectively than others. If you are experiencing unpleasant odors from your holding tanks, try switching brands or adjusting usage before considering it a plumbing problem. Follow the chemical manufacturer instructions for proper use.

The gray tank(s) can produce offending odors as well as the black tank and occasionally the rocking, bouncing movement of the RV while driving may empty a drain trap of its water and allow odors to enter the RV.

PLUMBING SYSTEMS AWARENESS

Plumbing system problems are typically of two categories: Inherent and neglect. Inherent problems are generally the result of road vibrations and campground water pressure variations. Neglect problems usually arise due to improper winterization, clogged filter screens, and not performing regular maintenance checks. Most plumbing system problems can be avoided by conscientious maintenance.

Vibration, flexing and twisting while traveling can work pipe fittings loose. Check all plumbing for leaks at least once a year. If the water pump runs when all faucets and drain valves are closed, you should suspect a water leak. Leaks occur most often around threaded fittings. If necessary, clean and/or tighten the fittings. Do not over tighten threaded fittings. Most only require little more than hand tightening.

The use of a wrench on plumbing fixture water connections must be performed delicately as over tightening may damage rubber seals, which in turn may create a leak. Fittings with rubber seals require only a slight additional turn beyond hand-tightened. If you have a leak at a fixture, first attempt to hand tighten the fitting. If that fails you may try a slight amount of tightening with a wrench, no more than 1/2 turn past hand-tightened. If a leak persists at the fitting, disconnect it completely and check for mineral deposits or foreign matter at the seating surfaces. Clean the surfaces. Replace the seal if necessary and tighten the fitting no more than 1/2 turn past hand-tightened.

Plumbing Systems

Most hose and tubing connections at fittings use a specialized clamp. In an emergency you may be able to tighten up a fitting connection leak with a standard automotive worm gear hose clamp however you will want to have it repaired with the proper clamp by your dealership at your earliest convenience.

Spare water line fitting seals and a few hose clamps would be a great addition to your RV tool box.

Drain trap slip-fittings, drain outlet knife valves, and the drain outlet cap seal are also areas that need to be checked occasionally for leakage as well.

Leaks caused by freeze damage can usually be prevented by proper winterization of the systems. See the *'Storage and Winterization'* chapter for proper winterization procedures. Freeze damage can be extensive and may include a burst water tank, split water piping, damaged water pump, toilet, or water heater.

Some models require the use of a 'waterless' drain trap due to space limitations. In the event that a drain line equipped with a waterless trap becomes clogged you must remove this trap prior to using any mechanical drain-cleaning device. The internal components of the waterless trap can be easily damaged and will no longer function properly if a drain clean-out snake tool is used. Pictured below you will see the differences between the two drain trap designs used.



A typical 'P' trap.



A 'Waterless' trap.

Electrical Systems

To provide you with the safest possible product the electrical systems in your RV have been designed using materials and assembly methods that meet or exceed all applicable codes, regulations, and standards in effect at the time that it was manufactured.

There are two basic electrical systems in your RV: **120 Volt AC, and 12 Volt DC**. Each of these has their own sub-systems as explained in the following sections.

120 VOLT AC SYSTEM

The 120 volt AC system provides electricity for appliances such as the air conditioner, microwave, refrigerator, water heater, fireplace (if equipped) and the power converter as well as all 120 volt wall outlets. For this system to function you must be plugged into 'shore power' at an appropriate electrical outlet designed for your connection. Additionally if you have a generator of adequate size, you will be able to power these appliances through the 120 volt system as well. Your RV is equipped with either a 30 Amp or 50 Amp Power Distribution Center and AC power cord. This system does not rely on RV batteries to function.

30 Amp Power Service

30 amp service is the most common found in the RV industry and used widely in most campgrounds. With this service you will be able to run all 120 volt appliances, however if your RV is equipped with a fireplace and microwave they will be wall switched on the same circuit to alternate use between the two due to the amount of power that those two appliances require. Wall switching hi-power demand appliances on a shared circuit is a common method used to comply with electrical codes when the Power Distribution Center does not have enough 'code allowed' breaker switches. With 30 amp service you will have one Ground Fault Circuit Interrupter sharing between the bath, kitchen, and patio protected outlets all on one circuit. Additionally your AC power cord will be '3-wire' which will only allow for connecting to the proper 30 amp service. Below you will see pictures identifying a 30 amp power distribution panel and its power cord connection. Refer to the AC power cord connection label for proper power supply to the RV.

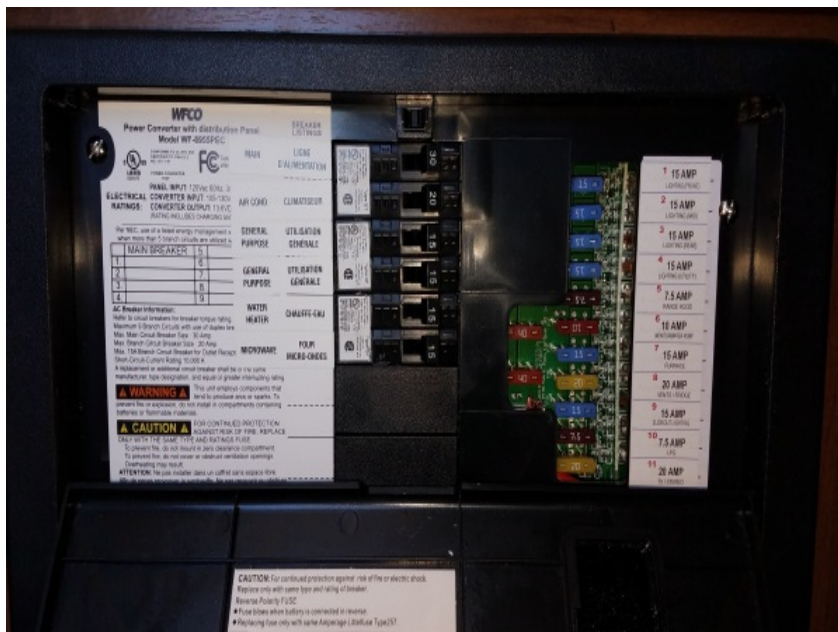

Electrical Systems

50 Amp Power Service

50 amp service provides for more electrical capacity and usage at one time than that of 30 amp service. With this service you will be able to run all 120 volt appliances simultaneously without switching the microwave and fireplace (if equipped). 50 amp service will also allow for a second air conditioner to be installed in the bedroom and run at the same time as the primary air conditioner in the living room. You will have two dedicated GFCI protected outlet circuits, one for bath and the other for kitchen thus allowing for use of higher-demand countertop appliances without tripping circuit breakers. Additionally your AC power cord will be '4-wire' which will only allow for connecting to the proper 50 amp service. Below you will see pictures identifying a 50 amp power distribution panel and its power cord connection. Refer to the AC power cord connection label for proper power supply to the RV.

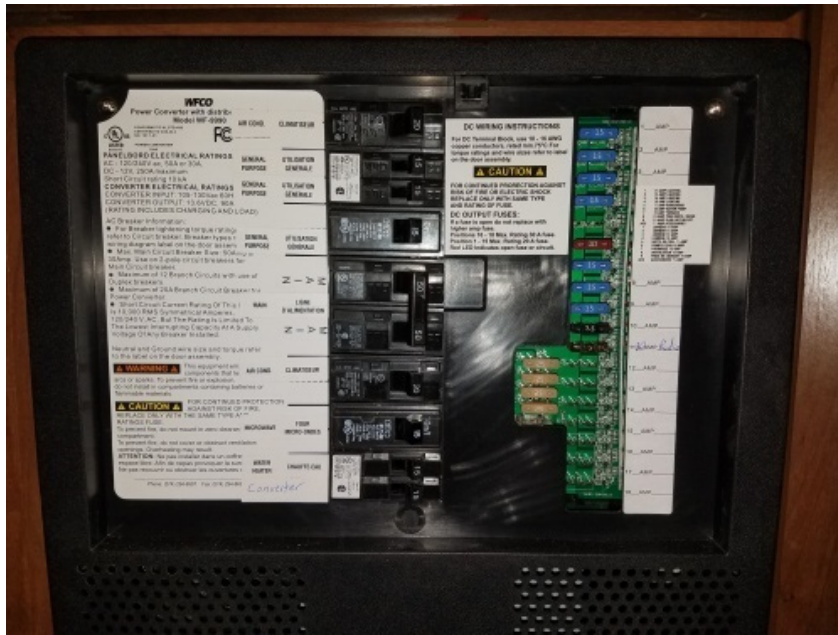

The power system in your RV is only as good as the power supply feeding it. If the campground has only 30 amp service available, an RV with a 50 amp panel will only be able to use up to 30 amps of power. Some campgrounds have only 15 amp service available which is not adequate to properly run an air conditioner or certain other appliances.

Power Distribution Center

The power distribution center in your RV is a self-contained unit which includes the AC breaker switches on the left side, DC fuses on the right side and the power converter in the lower half. The AC breakers function the same as those at home and will 'trip' if there is an overloaded or shorted circuit. When your RV is connected to an AC power source using the 30 or 50 amp power cord, the power converter will automatically convert 120 volt power into 12 volts to supply all low voltage circuits. The power converter also provides three-stage charging modes to help maintain battery state of charge.

The converter will supply a small current to the battery even when it is fully charged. To prevent excess battery acid loss, check the battery levels every 30 days while the converter is connected to 120 volt AC power. Always refill batteries with distilled water. See '**Battery Charging**' in this chapter.

Electrical Systems

The 12 volt DC circuits are protected by an ATC Type 257 fuse. If you are experiencing continuously blown fuses, do not attempt to 'fix' the problem by installing a larger amperage fuse. Continuously blowing fuses indicates that there is a shorted or grounded hot wire or overloaded circuit and must be immediately corrected. Keep a few spare fuses of each size in your RV tool box for emergency only.

The 120 volt circuits are protected by a common type circuit breaker and can be replaced if one becomes damaged or non-functioning. If you are experiencing continuously tripped breakers, do not attempt to 'fix' the problem by installing a larger amperage breaker. Continuously tripping breakers indicates that there is an over-loaded circuit, or shorted or grounded hot wire and must be immediately corrected. Overloaded circuits can occur in the RV the same as at home whereas if you operate too many high demand appliances on the same circuit at the same time you may overload it causing a breaker to trip.

Please refer to the Operator Manual included in your owner information packet provided with your RV for additional information.

⚠ WARNING

- ***Do not install fuses or circuit breakers with amperage ratings greater than that specified on the device or circuit label. This could potentially overheat the wiring and start a fire.***

AC Power Cord

Sometimes referred to as the 'shore power' cord, your RV is equipped with a heavy duty detachable power cord to connect to an external 30 or 50 amp (depending on model) rated AC power service. The cord and plug are a molded, weatherproof assembly. The cord provides a correct ground connection to the site service. Do not alter or cut the cord in any way. Do not remove the ground pin from the plug, or defeat the grounding circuit in the RV. Never plug the AC power cord into an ungrounded receptacle.

Before connecting to the electrical supply, check its supply rating. Be sure it matches the rating label at the AC power cord inlet on your RV unless you intend to use a power cord adapter.

The detachable power cord connects to the RV power inlet with a twist-lock connector and locking ring. When connecting the cord to your RV, be sure to align the pins correctly before twisting the connector in place. The locking ring provides additional strain relief and a weather resistant seal.

Making the Connection

1. Be sure the site power source breakers are OFF.
2. If the site power source breakers are not accessible, turn OFF the main breakers inside the RV.
3. Insert the female plug end of the RV cord into the power inlet on your RV (usually located on the drivers' side or at the rear). Hand tighten locking ring.
4. Insert the male cord end into the site power source receptacle. Push the plug straight into the receptacle until it seats completely.
5. Turn ON site power source breakers.
6. Turn ON RV main breakers.
7. Reverse procedure for disconnecting power cord.
8. Stow power cord before leaving.

Electrical Systems

Adapters and Extension Cords

In certain circumstances electrical adapters can be used to make the shore line power connection when necessary, however when using adapters your available AC power for the entire RV is reduced to the rating of the adapter. For example an RV wired with 50 amp service panel will be reduced to 30 amp service. An RV wired with a 30 amp service panel will be reduced to 20 or 15 amp service depending upon what adapter you have chosen for the supply connection. Some adapters can be found at many department stores however your RV dealership will be the best source for your needs. This is another great idea for your RV toolbox.

If it is necessary to use an extension cord to reach an available power supply, the correct size (wire gauge and length) extension cord must be used. The longer the extension length becomes the larger the wire gauge must be. Alternatively you may be able to purchase pre-made power cords in longer lengths with the proper plug ends for your RV.

It is not recommended to combine adapters and extension cords or multiple extension cords. Do not remove the ground pin from any cord or adapter, or defeat the grounding circuit in the RV or at the power source. Never use a two-conductor extension cord, or any cord that does not assure correct and adequate ground continuity.

⚠ WARNING

- *The use of incorrect size or length extension cords, adapters, and/or reducers may increase the risk of fire, personal injury or property damage and in doing so will not be covered under warranty.*

Ground Fault Circuit Interrupter (GFCI)

A Ground Fault Circuit Interrupter (GFCI), also called Ground Fault Interrupter (GFI) is a device that shuts off an electric power circuit when it detects that current is flowing along an unintended path, such as through water or a person. It is used to reduce the risk of electric shock. The GFCI device does not prevent electric shock, nor does it protect a person who comes in contact with both 'hot' and 'neutral' sides of the circuit. It does not protect against electrical overloads.

Your RV will be equipped with 1 or 2 GFCI outlets depending on whether you have 30 or 50 amp service. 30 amp service models will have 1 located in the bathroom. It protects outlets in the bath, kitchen and at the patio outlet all on one circuit. 50 amp service models will have 2 GFCI outlets on individual circuits. One is located in the bath which protects the bath outlet and may include the exterior patio outlet and the other is located in the kitchen to protect kitchen outlets and may also include the exterior patio outlet. Both of these arrangements may have additionally protected GFCI outlets.

Test the GFCI function each month while operating on AC power.

To test the GFCI:

1. Press the TEST button on the GFCI outlet. The RESET button should pop out indicating that the protected circuit has been disconnected.
2. If the RESET button does not pop out when the TEST button is pressed, ground fault protection on the protected circuit has been lost. Do not use the outlet or other outlets on the same circuit. Have the electrical system checked by your dealer or a qualified electrician. Do not use the system until the problem has been corrected.

Electrical Systems

3. Press the RESET button to reset the GFCI and restore power to the protected circuit. If the RESET button does not stay to the 'in' position you may have a shorted circuit. Do not use the outlet or other outlets on the same circuit. Have the electrical system checked by your dealer or a qualified electrician. Do not use the system until the problem has been corrected.

Note:

If any of the kitchen, bath or exterior patio outlets do not work, check the GFCI device for a tripped RESET button. Reset if necessary. If the GFCI continues to trip, have the RV electrical system checked at an authorized Outdoors RV dealer or by a qualified electrician. The GFCI may have reached the end of its life expectancy.

12 VOLT DC SYSTEM

Marker / Tail / Turn / Brake / Back-up Lighting

The marker and rear tail lighting system is independent of the Interior/Exterior 12 Volt DC System and is controlled primarily by the tow vehicle via the 7-Way cable at the front of your RV.

7-Way Cable Connection

Most new tow vehicles come equipped (or optioned in) with towing in mind and will already have the 7-way connection installed near the hitch location on your vehicle. In the event that your tow vehicle is not equipped with this connection we provide diagrams below of how this connection should be made.

Exterior 12 volt functions on this connection include: marker lights, tail/turn/brake and back-up lights (if equipped) as well as the RV brakes, battery charge line (12 volt power), and grounding between the tow vehicle and RV. These circuits are typically protected by fusing on the tow vehicle fuse panel.

Additionally the 12 volt power and RV brake lines are fused where the 7-way cord enters the RV.



Electrical Systems

Wire Color & Gauge	Molded Trailer/Sealed Car Connector Terminal	Thermo-Plastic/Metal Connector Terminal
White / 10 gauge	Common Ground	#1 Common Ground
Blue / 12 gauge	Electric Brake	#2 Electric Brake
Green / 14 gauge	Tail & License	#3 Tail & License
Black / 10 gauge	Battery Charge	#4 Battery Charge
Red / 14 gauge	Left Stop & Turn	#5 Left Stop & Turn
Brown / 14 gauge	Right Stop & Turn	#6 Right Stop & Turn
Yellow / 14 gauge	Center Auxiliary	#7 Center Auxiliary

Certain model RVs may be equipped with reverse back-up lighting which will connect to the Center Auxiliary #7 connection with a 14 gauge yellow wire. Disregard this connection if your RV is not equipped with back-up lights. Be certain that your installation includes a charge line from the tow vehicle alternator or battery with a battery isolator solenoid using a minimum 10 AWG stranded copper wire (rated appropriately for under-hood temperatures) to the Battery Charge #4 connection. Install a 30 amp fuse on this charge line near the tow vehicle power source. This circuit will help to maintain the RV battery charge and by utilizing the battery isolator you will not run the risk of any RV appliances or equipment draining power from the tow vehicle battery while it is not running. If your tow vehicle is already equipped with the proper 7-way electrical connection you may not need to wire a charge line circuit however it would be a good idea to verify that this circuit is providing power from the tow vehicle.

Interior/Exterior 12 Volt DC System

12 volt lighting, appliances and equipped items are powered and fused through the Power Distribution Center independently of the Marker and Tail Lighting System. These items may include, and are not limited to, interior lights, exterior utility lights, range hood, monitor panel, LPG detector, water pump, furnace, refrigerator, vents, entertainment equipment, awning, USB charging ports, etc. These items can function either from the RV batteries alone or through the Power Distribution Center when the RV is plugged into 'shore power'.

Please refer to section '**Power Distribution Center**' and the Distribution Center Operator Manual included in your owner information packet provided with your RV for additional information.

Other high power demand 12 volt equipment may include items such as stabilizer jacks, landing gear, water tank heater, slide-out control, and wireless remote, etc. These items are typically fused separately from the Power Distribution Center at an access panel location just rear of the RV batteries under the floor for conventional travel trailers and for fifth-wheel models you will find this fusing located behind an access panel just inside the passenger side exterior storage compartment.

These fuses are a 'Type-2' re-settable breaker fuse and typically do not need to be replaced if tripped. For these fuses to be reset you must disconnect the batteries from the RV. Find and fix the cause of the breaker tripping before reconnecting the RV batteries.

WARNING

- *Do not install fuses or breakers with amperage ratings greater than that specified on the device or circuit label. This could potentially overheat the wiring and start a fire.*

Electrical Systems

Battery Disconnect Switch

The battery disconnect switch allows for 12 volt power to be disconnected from the RV batteries. This switch is located inside the exterior storage compartment on the passenger side behind an access panel in the front wall (See picture below for identification). Fifth-wheel models will be located just inside the passenger side exterior storage compartment on the forward wall.

The battery disconnect switch is typically used when your RV is put into either long term or short term storage. Its purpose is to prevent the RV batteries from draining due to any 12 volt appliance or equipment that requires a constant draw of power. It is recommended to turn the disconnect switch 'Off' for any time that 12 volt power is not needed at the RV including during travel. Disconnecting 12 volt power to your RV with the battery disconnect switch does not disable solar charging functions or marker/tail light operations as wired from the factory.

Pictured at the right is the battery disconnect switch shown in the 'On' position. In the on position battery power will be supplied to the 12 volt circuits of your RV. Your switch may be either red or black. There is no functional difference between the two colors.



THE RV BATTERY

The RV batteries are the heart of the 12 volt system. When your RV is not connected to shore power, or if the generator (if equipped) is not running, most power needs are supplied by the batteries. If battery voltages are low, many problems can occur. It is very important to maintain the batteries in a full state of charge and to monitor their status regularly. The power converter charging and solar systems will help you maintain your battery voltage capacity however when the RV is not connected to shore power or a running generator, you must be energy efficient. Turn off any 12 volt lighting, appliances or equipment not currently being used. Learn to conserve your battery power.

Low battery charge or bad batteries are a common cause of poor performance of slide-out rooms, appliances and other components connected to the 12 volt system. Under low voltage, fuse and circuit breakers can blow without a short circuit condition. The refrigerator control system requires at least 10.5 volts and will shut down even with propane supplied, potentially ruining food in the refrigerator. Low voltage can also cause the furnace fan to run too slowly to operate an internal switch controlling the furnace gas valve which will shut the furnace down. Avoid running the batteries down completely. The breakaway switch emergency braking system relies on 12 volt power from your RV battery bank to function properly.

Electrical Systems

Battery Selection and Installation

Your RV has been designed to install up to two 12 volt Group 27 batteries (without box) or two 6 volt GC2 batteries in the standard battery rack and up to four 6 volt GC2 batteries if your RV is equipped with the expanded capacity battery tray. Or if you own a fifth-wheel model your battery rack will hold up to four 12 volt Group 24 batteries or up to four 6 volt GC2 batteries. When selecting a 12 volt battery always choose a RV/Marine grade deep-cycle battery. Your RV dealership or battery supplier can help you with your choice of battery and the pro's and con's of each installation.

It is critical that your RV batteries are connected properly. Whether you have chosen multiple 6 volt batteries or multiple 12 volt batteries they must be wired correctly or you may cause damage to the batteries or internal wiring and fusing in your RV. Consult with your RV dealership or battery supplier for proper wiring procedure.

Many RV'ers that 'dry camp' without shore power have had great success using multiple 6 volt batteries rather than the typical 12 volt battery set-up. Multiple 6 volt batteries in conjunction with two or three larger solar panels will generally provide a greater power reserve that is only limited by the amount of direct sunlight available to recharge your batteries. Depending on your camping power consumption you may find that this will satisfy your 12 volt power needs.

It is recommended that your batteries be secured in a battery box specifically designed for housing batteries using an appropriate hold-down strap around the support frame of the RV. Check occasionally to ensure that the straps have not worked loose.

Battery Charging and Maintenance

Under normal circumstances your RV batteries will maintain their charge by a combination of sources including the tow vehicle charge line while on the road, while your RV is plugged into shore power and with the solar panel(s) (if equipped). On those occasions when the battery needs to be charged from a different source, please consult with your battery supplier for specific charging requirements for your batteries.

⚠ WARNING

- *Disconnect the 120 volt electrical cord and both cables from the RV battery before working on either electrical system.*
- *Remove rings, metal watchbands, and other metal jewelry before working around the battery. Use caution when using metal tools. If tools contact the battery terminals or metal connected to them a short circuit could occur which could cause personal injury or fire.*
- *Do not allow battery acid to contact skin, eyes, fabrics, or painted surfaces. The sulfuric acid in the battery could cause serious personal injury or property damage. Wear eye protection when working with batteries.*
- *Never expose the battery to open flame or electric spark. Chemical action in the battery generates hydrogen gas which is flammable and explosive.*

Electrical Systems

Battery Monitor

The battery charge level can be checked on the monitor panel.

1. Unplug the AC power cord to turn the power converter off.
2. Turn on a light or two to load the batteries slightly.
3. Press the 'Batt' switch on the monitor panel to activate the reading.
4. Read battery condition on the display.

Battery charge status will read L (Low 6 - 11.6 volts), F (Fair 11.6 - 12.1 volts), G (Good 12.1 - 12.7 volts), and C (Charge = 12.7 volts or greater).

SOLAR

Outdoors RV travel trailers and fifth wheels are equipped with different levels of solar capabilities. All models include an exterior solar jack installed at the passenger side toward the front of the RV. Its design is such that you may purchase a portable solar panel kit that may sit on the ground or table and plug into the exterior jack. A portable solar panel system has its benefits in that you may be able to follow the sun for maximum charging as opposed to roof-top panels that may become shaded throughout the day. Portable panel units can be used in conjunction with roof-top installed panels for additional battery charging. If you choose to add a portable solar panel to your charging system it is advised to purchase a system that comes complete with a charge controller so that charging of the batteries can be monitored and controlled.

All models come installed with a roof-top junction box which allows the consumer to add solar panels at a later time. Your RV is pre-wired at this junction box for future roof-top panel installations. With this junction box you may connect up to a total of three 170 watt panels (or equivalent total of 510 watts) by simply plugging them in. If you choose to add roof-top panels to this junction box you will need to install an appropriately rated charge controller to regulate battery charging if not already equipped. The charge controller is wired in-line with the pre-wiring installed from the factory. Most models provide for the charge controller to be installed in the bedroom front overhead cabinet and are labeled accordingly. Pre-wire connections for the controller are located behind an access panel inside this front cabinet. Refer to your charge controller installation instructions for specific wiring connections or contact your RV dealership for more information.

Your RV may be optionally equipped with up to two large solar panels and a charge controller. This configuration allows you to add one additional panel rated up to 170 watts to the roof-top, if space is available, and plug in a portable unit at the exterior jack at the passenger side.

All solar system electrical connections are wired directly to your RV batteries. This provides for battery charging while your RV is in storage with the 12 volt power supply shut off at the battery disconnect.

Solar panel maintenance is very minimal and really only requires keeping the panels clean to provide optimal charging.

Electrical Systems

BULBS AND FUSES

When replacing light bulbs be sure to replace with the same wattage and base type as originally equipped. Most typical bulbs have identifying numbers on them which you will need when shopping for replacements. Many interior and exterior LED lights on your RV are non-serviceable. LED lights are more durable and last many, many years in comparison to a typical incandescent bulb however in the event that an LED light does burn out, the entire light fixture must be replaced. Please contact your dealership or Outdoors RV for replacement.

The fuses in your RV power center are an automotive ATC type and can be found at any auto parts store as well as most department stores. Blown fuses should always be replaced with the same size and rating that was originally equipped. If you are unsure of the correct fuse size you will find that each 12 volt circuit in the power panel is labeled with the correct fuse rating for each circuit.

It is recommended to keep a few replacement bulbs and fuses in your RV tool box.

⚠ WARNING

- *Do not install 12 volt fuses or breakers with amperage ratings greater than that specified on the device or circuit label. This could potentially overheat the wiring and start a fire.*

Propane System

Propane, also known as Liquid Petroleum Gas (LPG) is a clean burning dependable fuel for operating all gas appliances when utilized properly. Propane is supplied from the LP tanks on the tongue of your RV to operate your range, oven, furnace, and LP Gas generator (if equipped) and is an alternate energy source for your refrigerator and water heater. The propane system components consist of two tanks with shut-off valves, a regulator with auto-switchover, gas manifold and supply lines, and finally the appliances. Propane is stored in the LP tanks as a liquid under high pressure and vaporizes into gas form under the control of the pressure regulator. Consumption of propane gas depends upon the frequency and duration of use of the propane appliances. The furnace, oven, and generator (if equipped) typically have the highest consumption rates. During colder temperatures propane consumption will likely increase due to increased use of the furnace and water heater. It is advisable to check the LP tanks often and always keep one tank full.

PROPANE SAFETY

With proper handling precautions, propane is safe and provides modern convenience wherever you travel however propane gas is highly flammable and is contained under high pressure. Improper use may cause fire and/or explosions. Safety must be observed at all times when using the propane gas system.

Propane gas is colorless and odorless in its natural state. An odorant, similar to rotten egg smell has been added for consumer safety purposes to help detect leaks and provide warning. A small amount of people cannot smell this odor. If you are one of those people you must take extra care whenever you use your RV. Keep the LP tank valves closed and turn off all appliances if the RV is not being used. If a sulfur or 'rotten egg' smell is detected in or around the RV or if the LP gas detector beeps perform the following steps immediately:



IF YOU SMELL PROPANE

- 1. Extinguish any open flames and all smoking materials.***
- 2. Shut off the propane supply at the container valve(s) or propane supply connection.***
- 3. Do not touch electrical switches.***
- 4. Open doors and other ventilating openings.***
- 5. Leave the area until the odor clears.***
- 6. Have the propane system checked and leakage source corrected before using again.***

Ignition of flammable vapors could lead to a fire or explosion and result in death or serious injury.

Propane System

Because of the potentially dangerous nature of propane gas the following warnings and advisories are provided to ensure your safety. Please read and understand the importance of each.

⚠ WARNING

- *Propane cylinders are equipped with safety devices that relieve excessive pressure by discharging propane to the atmosphere.*
- *Propane gas is highly flammable.*
- *Propane regulators must always be installed with the regulator vent facing downward and that regulators that are not in compartments have been equipped with a protective cover. Owner must make sure that the regulator vent faces downward and that the cover is kept in place to minimize vent blockage that could result in excessive propane pressure causing fire or explosion.*
- *Portable fuel-burning equipment, including wood and charcoal grills and stoves, shall not be used inside the recreational vehicle because the use of such equipment inside the recreational vehicle can cause fires or asphyxiation.*
- *Do not bring or store propane cylinders, gasoline, or other flammable liquids inside the vehicle because a fire or explosion can result.*
- *This propane piping system is designed for use with propane only.*
- *Do not connect natural gas to this system.*
- *Securely cap inlet with the service valve closed when not connected for use.*
- *After turning on propane, except for normal cylinder replacement, test propane piping and connections to appliances for leakage with soapy water or bubble solution.*
- *Do not use products that contain ammonia or chlorine to test for leaks.*
- *Can lead to a fire or explosion and result in death or serious injury.*
- *Keep propane cylinder tanks away from heat sources.*
- *Regularly inspect high pressure LP gas hoses for signs of cracks or abrasion. Replace them before they become old enough to develop leaks.*
- *Never use a cylinder if it shows signs of dents, gouges, bulges, fire damage, corrosion, leakage, excessive rust or other forms of external damage.*
- *Do not store LP tanks or use gasoline or other flammable vapors and liquids in the vicinity of any appliances inside or outside of the RV.*

Propane System

Propane System Advisory

- Never check for leaks with an open flame. Use an approved leak detection solution or a non-ammoniated, non-chlorinated soap solution only.
- Always be careful when drilling holes or fastening objects to the trailer. The propane supply lines could become punctured by a nail or screw.
- Do not restrict access to propane containers. In an emergency, the container service valve must be easily identified and accessible. The container compartment door must not have a locking device and the propane label should be visible.
- Do not use any propane container other than the one furnished with your RV without being sure that all connecting components are compatible.
- Turn off propane tank valves before entering a propane bulk plant or motor fuel station. Turn off all pilot lights and appliances individually before refueling of motor fuel tanks and/or propane containers. When not individually turned off, automatic ignition appliances may continue to spark when propane is turned off at the container.
- Do not use a wrench or pliers to close the cylinder shut-off valve. This valve is designed to be closed by hand. If a tool is required, the valve needs repaired or replaced.
- Be sure the cylinders are securely fastened in their rack whenever they are mounted on the RV.
- If you do not have the special tools and training necessary, do not attempt to repair propane system components.
- DO NOT modify or alter the propane plumbing system.
- If any appliance or piping has been serviced, ensure that a system leak check has been performed by a trained technician. This should be verified before taking delivery of the RV.

SYSTEM COMPONENTS

LP Tanks

Also known as cylinders or bottles, modern LP tanks contain an Overfill Protection Device (OPD) that prevents them from being filled past 80% of total capacity. This is a safety device that allows for vapor expansion inside the tank without over pressurization. As a safety precaution, do not attempt to retrofit your LP gas system with an older non-OPD tank. **Do not use tools to tighten the LP tank shut-off valve.**

Hoses and Fittings

The LP gas hoses and fittings on your RV are essentially maintenance free however as precaution it is advisable to inspect the rubber hoses at the LP tanks and from the regulator to the manifold for deterioration or cracking whenever they are being disconnected and connected for filling. If you replace any hoses, be sure that the replacements are the same size, and properly rated and approved for RV use or contact your dealership for the correct part.

The green quick-disconnect fitting at each LP tank will be the one you will be operating most of the time. This fitting is designed to be hand-tightened and loosened without the use of tools. To tighten, turn clockwise. To loosen, turn counter-clockwise. This fitting has an internal O-ring seal and does not require the use of any pipe sealants or thread tapes. If it ever leaks or cannot be hand tightened without excessive force, the complete hose assembly must be replaced and its connections properly leak tested. **Do not use tools to tighten the green quick-disconnect tank fitting.**

Propane System

Propane Regulator with Automatic Changeover

The regulator and auto-changeover (see picture below) is a unitized device located between the LP tanks that control the flow of LP gas to the appliances. The auto-changeover will allow a continuous uninterrupted flow of LP gas to the system. When the first tank is empty the auto-switchover will automatically switch to the second tank without service interruption. The regulator receives hi-pressure LP gas from the tanks and reduces it to a low pressure to be safely used with the RV appliances.

Automatic Changeover Operation

For operation of the LP system you will want to ensure that all appliances and pilot lights are off. With both LP tanks filled and green quick-disconnect fittings hand tightened take notice of which direction the tank indicator knob is pointing to. The tank that the indicator knob is pointing to will be the 'service' tank and the other will be the 'reserve' tank. Fully open both LP tank valves. The indicator knob will then become green meaning that the tank it is pointing to is fully pressurized or full. At this time you may turn on any appliance gas valves and/or pilot lights and use as needed. When the service tank becomes empty the auto-switchover will direct gas flow from the service tank to the reserve tank and the indicator will turn from green to red. At this time you may refill the now empty tank before the reserve tank becomes empty thus providing continuous service without interruption. When refilling the empty tank, turn its supply valve fully closed then rotate the indicator knob to the reserve tank which will now become the service tank. The indicator will change from red back to green. Disconnect, fill, and reconnect the tank, open its valve and your auto-switchover is now ready to switch back to the original tank when the now service tank becomes empty.

At the right you will see the regulator/auto-switchover assembly installed between the LP tanks. Note that the indicator knob, with its pointer to the left, indicates that the tank on the left is the service tank. The green indicator shows you that it is fully pressurized.



This system requires very little maintenance. The regulator however does have a vent at the backside located under a white plastic cover. This vent must always face downward and be kept clear of obstructions such as spider webs, etc. Periodically remove the cover to inspect that the vent is clear. Remove any obstructions and reattach cover. Cover must remain on at all other times. Do not attempt to relocate or mount the regulator differently than as it was assembled from the factory.

Do not attempt to adjust or repair the regulator. It is pre-set at the factory to certain specifications and should only be adjusted by a qualified propane service technician. To avoid potential problems have your LP gas system checked at least once a year by an authorized service center.

Propane System

Regulator Freeze-Up

Freezing and frosting of the propane regulator is quite common in extremely cold climates and usually nothing to be concerned about provided everything is in working order and operating as it should. While this 'freezing' of the regulator may be a symptom of an actual problem, it usually is a sign that outside humidity is at a level capable of producing condensation. Occasionally however moisture can get into the system and freeze up causing a blockage inside the passage of the regulator. Much of this moisture intrusion is beyond your control and is introduced at bulk propane facilities. You can minimize potential moisture intrusion by keeping the service valve on the LP tank closed and capped when not in use.

Other Cold Weather Considerations

As outside temperatures drop, the BTU value of LP gas becomes less. The colder liquid LP gas in the tanks requires heat from surrounding air to vaporize. This lowering of BTU value can significantly affect the performance of the system. To help reduce this effect, keep your LP tanks as full as possible during colder temperatures.

Propane Gas Supply Lines

The propane gas system supply lines consist of the primary gas manifold, which is an iron steel pipe secured to the bottom of the chassis, and secondary lines consisting of copper tubing which transition from the supply manifold to each appliance with brass flare fittings making the connections. If repairs are needed to these lines or any component of the propane system, **DO NOT** attempt to repair yourself. Immediately follow the steps outlined in the **DANGER** warning '**IF YOU SMELL PROPANE**' in this chapter. Contact your RV dealership or a qualified propane service technician for proper repairs.

Although the propane gas system in your RV has been thoroughly tested for leaks at the factory, the gas system should be inspected and checked for leaks by an RV dealer or qualified propane service technician at least once a year.

BBQ Bib

Exterior kitchen model travel trailers are equipped with two BBQ bibs located directly below the exterior kitchen area stemming from the LP gas manifold. This bib provides a connection to use a portable BBQ in addition to the exterior cook top. To utilize this feature you will need a low-pressure propane BBQ that will function properly on the tank regulated RV gas system. Otherwise your BBQ may have to be modified by removing its regulator and adapting its gas inlet with the proper fittings to connect to the factory installed bib. Consult with your RV dealership for helpful tips on this.

Shown at the right you will see two BBQ bibs located off of the LP gas manifold. One is for the cook top at the exterior kitchen and the other is available for your supplied BBQ. As you can see these bibs have a shut-off valve. The bibs shown have their valves in the 'flow' position. To disable flow turn valve handle 90 degrees. Propane does not begin to flow unless the hose connection is plugged into the bib.



Propane System

⚠️ WARNING

- *When using this outdoor cooking area, the vehicle must be level and stabilized.*
- *Do not violate manufacturers' instructions on required clearances for cooking appliances during use.*
- *Do not store cooking appliances until cool to the touch.*
- *Can lead to a fire and explosion and result in death or serious injury.*

FILLING PROPANE TANKS

Prior to filling your LP tanks, please read and observe the following safety precautions:

⚠️ DANGER

- *All pilot lights, appliances, and their igniters (see operating instructions) shall be turned off before refueling of motor fuel tanks and/or propane containers.*
- *Can cause ignition of flammable vapors, which can lead to a fire or explosion and result in death or serious injury.*

⚠️ WARNING

- *Your RV has been equipped with propane containers that feature an Overfill Protection Device (OPD). NFPA 58 (Propane Code) states that these portable cylinders shall not be filled without this device.*
- *Do not under any circumstances use an older non-OPD cylinder. Inadvertently overfilling of the pre-OPD cylinders can result in uncontrolled propane flow that in unvented surroundings can cause fire and/or explosion.*
- *When refilling an empty cylinder, position the tank selector knob toward the full cylinder. Failure to do so will result in propane escaping out of the high pressure hose through the excess flow check valve.*
- *Do not fill propane container(s) to more than 80 percent of capacity.*
- *A properly filled container contains approximately 80 percent of its volume as liquid propane.*
- *Overfilling propane container(s) can result in uncontrolled propane flow, which could lead to a fire or explosion and result in death or serious injury.*
- *Failure to comply could result in a fire or personal injury.*

All new containers (and in some cases used containers) may contain moisture, air or other contaminants, and it is essential that these be removed before filling the container and placing it into service. Air in a container carries moisture, which can cause service problems and potential freeze-ups as discussed earlier.

Propane System

It is recommended that your new LP tanks be purged at their first filling. If a container is suspected of being depressurized or open to the atmosphere for a period of time it should be re-purged as if it were a new container. Your LP filling station should be versed at this procedure.

To fill the LP tanks they must be removed from the RV and taken to a propane supplier or filling station. Only qualified persons should fill your LP tanks. Do not attempt to fill them yourself.

1. Remove the propane tank cover.
2. Close the supply valve on the empty tank. Switch the tank selector knob on the auto-switchover to the full tank.
3. Disconnect the green quick-disconnect fitting from the tank service valve. Turn counter-clockwise to loosen. No tools should be required for this operation.
4. Be sure the plastic protective cap is clean and install it over the tank valve outlet. This will help protect the valve fitting threads and will prevent contamination or debris from entering the valve during transportation to a propane service facility.
5. Loosen the wing nut on the threaded rod. It should be loosened just enough to allow the hold down bracket to clear the empty tank.
6. Remove the empty tank and have it filled. **(Do not move the RV with the empty tank removed and the hold down bracket loose).**
7. Reverse the procedure to replace tank.

⚠ WARNING

- *Never check for leaks with an open flame.*
- *Do not check copper and brass plumbing lines and fittings for leaks using ammoniated or chlorinated household type detergents. These chemicals can cause cracks to form on copper and brass.*
- *If the leak cannot be located, take your RV to a propane service representative.*

PROPANE SYSTEM CHECKS

- Do a visual check of all exposed hoses, piping and fittings after you have arrived at a destination and before you use the propane system.
- Keep the tank valve closed and all gas appliances turned off if the RV is not in use.
- Always have the system checked by a professional any time you detect a garlic/rotten egg like odor or hear a sustained 'hiss' when you turn on the propane supply valves or the LP leak detector alarm sounds.

PROPANE LEAK DETECTOR

A permanently installed propane leak detector alarm is included with your RV. It is located low to the ground and typically mounted to kitchen or surrounding cabinets. The device contains an alarm that will sound alerting you to the presence of low levels of potentially dangerous propane gas that may have accumulated. It also requires frequent testing to ensure proper function. Please refer to the complete operating instruction manual provided with your owner information packet.

Propane System

DANGER

IF THE ALARM SOUNDS...

1. *Extinguish any open flames and all smoking materials.*
2. *Shut off the propane supply at the container valve(s) or propane supply connection.*
3. *Do not touch electrical switches.*
4. *Open doors and other ventilating openings.*
5. *Leave the area until the odor clears.*
6. *Have the propane system checked and leakage source corrected before using again.*

Ignition of flammable vapors could lead to a fire or explosion and result in death or serious injury.

WARNING

- *Activation of this device indicates the presence of LP gas, which can cause an explosion and/or fire. This normally indicates a leak in the LP gas piping or an LP gas appliance.*
- *Test Detector operation after vehicle has been in storage, before each trip, and at least once per month during use.*
- *This detector will only indicate the presence of LP gas at the sensor. LP gas may be present in other areas.*
- *The detector is not suitable as a smoke or fire detector.*
- *The detector is powered by a 12 volt source. Any interruption in power will render this alarm inoperative. Always ensure power is supplied especially when appliances are in use.*
- *This device detects the presence of LP gas. IT DOES NOT DISCONNECT THE GAS SUPPLY.*

NOTICE

- *The Propane Leak Detector Alarm draws enough current to discharge your batteries. Remember to turn the battery disconnect switch to the 'off' position or disconnect the batteries during storage.*
- *DO NOT attempt to repair the detector. If it fails to work properly as outlined in its operation manual replace the entire unit.*
- *The alarm may sound at times when no LP gas is present due to household product use such as aerosol hairspray, certain cleaners, adhesives, alcohol, etc.*

Propane System

LIGHTING PROPANE APPLIANCES

Detailed operating instruction manuals for propane appliances are included in your owner information packet. Please read these manuals for specific operating instructions. **Always follow the appliance manufacturer's lighting, operating and maintenance instructions.**

Air trapped in the propane lines may delay the initial lighting of any appliance. It could take several seconds or minutes for the propane to reach the appliance. This situation may potentially occur at anytime the LP tanks are removed for refilling.

To purge trapped air from the propane system;

1. Verify that the valves on your LP tanks are fully open with the tank selector knob pointing to a tank containing propane (identified by the green indicator).
2. Light a stovetop burner first.
3. When the stovetop burner flame burns steadily, your gas lines are now purged of any trapped air.
4. Turn off the stovetop burner.
5. Light any appliance as required.

The first time the furnace or oven is operated paints and oils used in manufacture may generate some smoke and fumes. If this occurs, open doors and windows to air out the RV. These materials should burn off after the first 15 to 20 minutes of appliance operation. During this 'burn-off' period your LP gas detector, smoke and CO detectors may alarm. You can temporarily remove the batteries from smoke and CO detectors to avoid this annoyance however do not attempt to disable the LP gas detector at any time.

Appliances and Equipment

NOTE: In this chapter we rely on the component manufacturer manuals that have been supplied with your RV in the owner information packet. We will only provide summary information for each component. For detailed information, please read and understand each component's operation manual and literature. In the event that your appliance operation manual is missing, you may download it from the manufacturers' website or contact Outdoors RV or your RV dealership.

~ Please read and understand the following safety warnings prior to operating any LP gas cooking appliance.

⚠ DANGER

- *Do not use gas cooking appliances for comfort heating.*
- *Can lead to carbon monoxide poisoning, which can lead to death or serious injury.*

⚠ WARNING

- *Never attempt to repair or alter a gas or electric appliance or component. Always consult an authorized and qualified service agency or technician.*

⚠ WARNING

- *Gas cooking appliances need fresh air for safe operation.*
Before operating:
- *Open vents or windows slightly or turn on exhaust fan prior to using cooking appliance.*
- *Gas flames consume oxygen, which should be replaced to ensure proper combustion.*
- *Improper use can result in death or serious injury.*
- *Do not operate this appliance unless the privacy curtain (if equipped) is secured away from the appliance or removed.*
- *Can cause a fire which could result in death or serious injury.*

⚠ WARNING

WHAT TO DO IF YOU SMELL GAS

- *Do not try to light any appliance. Extinguish any open flame including cigarettes.*
- *Evacuate all persons from the vehicle.*
- *Do not start the vehicles engine or electric generator (if equipped).*
- *Do not touch any electrical switch (including lights) or use any phone or radio in the vehicle.*
- *Shut off the gas supply at the gas container (bottle) or source.*
- *Immediately call your gas supplier from a neighbors phone. Follow your gas suppliers instructions.*
- *If you cannot reach your gas supplier, call the fire department.*
- *Do not turn on the gas supply until the gas leak(s) have been repaired.*

Appliances and Equipment

FURNACE

The furnace installed in your RV is an LP gas appliance. Carefully read the manufacturer's user manual for complete operational and safety instructions provided in your owner information packet prior to using the furnace.

The furnace utilizes a sealed combustion system, which means the combustion chamber is completely sealed from the inner atmosphere of your RV. Combustion air is drawn in from the outside and combustion by-products are expelled outside through an exhaust vent.

New furnaces sometimes emit smoke and an odor during the first 5-10 minutes of initial use due to paint and oils burning off the heating chamber. Do not mistake this for a malfunctioning furnace. Opening the windows and doors prior to first use will help reduce smoke and odors.

Before operating the furnace check the location of the exhaust vent on the exterior of the RV to be sure it will not be blocked by the opening of any door or exterior items such as a bush, tree or patio furniture. Exhaust heat can be hot and can potentially cause damage or start a fire to items sitting against the exhaust vent outlet.

If this appliance fails to light after refilling the LP tanks or opening the LP gas system you may have trapped air in the propane lines. Refer to the section '***Lighting Propane Appliances***' in the '***Propane System***' chapter for lighting procedure.

WATER HEATER

Your water heater is a combination LP gas/120V electric appliance that can be operated in either mode depending on your camping environment. It is protected at the power distribution center by a 15 amp resettable household type breaker. Carefully read the manufacturer's user manual for complete operational and safety instructions provided in your owner information packet prior to using your water heater.

Hot water heaters require very little care. However, the most common cause of problem with the water heater is turning it on before its tank is filled with water. Even running it for a brief period of time without water will damage the electric heating element.

Prior to operating your water heater for the first time, be sure there is water in its tank. The water heater by-pass must be in normal flow mode to allow water into the tank. Next connect the RV to a water source or if using the on-board water system ensure that the water pump is turned on. Open a hot water faucet until water is flowing with no air in the line. When water is flowing from the faucet, the water heater tank is full and is now safe to turn on.

If this appliance fails to light after refilling the LP tanks or opening the LP gas system you may have trapped air in the propane lines. Refer to the section '***Lighting Propane Appliances***' in the '***Propane System***' chapter for lighting procedure.

Refer to chapter '***Storage & Winterization***' for proper freeze protection procedures through winter months and when not in use for periods of time.

Appliances and Equipment

WATER PUMP

Carefully read the manufacturer's literature for complete operational instructions provided in your owner information packet prior to using your water pump. Refer to section '***Water Pump***' in the '***Plumbing Systems***' chapter of this manual for basic operation.

REFRIGERATOR

Your refrigerator is a 2-way combination LP gas/120V electric appliance that can be operated in either mode depending on your camping environment. Carefully read the manufacturer's manual for complete operational and safety instructions provided in your owner information packet prior to using your refrigerator.

If this appliance fails to light after refilling the LP tanks or opening the LP gas system you may have trapped air in the propane lines. Refer to the section '***Lighting Propane Appliances***' in the '***Propane System***' chapter for lighting procedure.

RANGE / OVEN / COOKTOP

This cooking appliance installed in your RV operates solely on LP gas. Carefully read the manufacturer's user manual for complete operational and safety instructions provided in your owner information packet prior to using.

RANGE HOOD

The range hood operates on 12V power and should be used for ventilating when cooking, especially when boiling water or cooking that gives off high moisture content. Prior to operating, verify that the exterior vent flap is unlatched and opens freely.

Periodically clean any cooking grease and splatters from the fan screen and underneath the range hood to reduce the risk of fire hazard and flame spread. Do not use harsh chemical cleaners or abrasives. Warm soapy water is recommended.

MICROWAVE / CONVECTION OVEN

Your microwave or convection oven (if equipped) is powered by 120V through the power distribution center. It is fused by a 15 amp re-settable household type breaker. Carefully read the manufacturer's user manual for complete operational and safety instructions provided in your owner information packet prior to using.

Never operate the microwave oven while it is empty or with any metallic object inside. This may cause unwarrantable damage to the appliance.

If your RV is equipped with an electric fireplace and 30 amp service, the microwave and fireplace will be switched so that only one or the other appliance can be operated at one time. You will generally find this switch located on the wall near the living room TV. To use the microwave the switch must be in the 'Microwave' position.

Appliances and Equipment

FIREPLACE (If Equipped)

Your fireplace (if equipped) is powered by 120V through the power distribution center. It is fused by a 15 amp re-settable household type breaker. Carefully read the manufacturer's user manual for complete operational and safety instructions provided in your owner information packet prior to using.

If your RV is equipped with an electric fireplace and 30 amp service, the microwave and fireplace will be switched so that only one or the other appliance can be operated at one time. You will generally find this switch located on the wall near the living room TV. To use the fireplace the switch must be in the 'Fireplace' position.

⚠ WARNING

- *This heater is hot when in use. To avoid burns, do not let bare skin touch the hot surfaces. The trim around the heater outlet becomes hot during operation.*
- *High temperatures may be generated under certain abnormal conditions. Do not partially or fully cover or obstruct the front of this heater.*

AIR CONDITIONER

Your air conditioner is powered by 120V through the power distribution center. It is fused by a 20 amp re-settable household type breaker. Carefully read the manufacturer's user manual for complete operational and safety instructions provided in your owner information packet prior to using.

As a general rule, your air conditioner will cool down the room air by about 15-20 degrees, depending on the outside temperature and humidity conditions.

To maintain peak operation of your A/C, periodically clean the foam filters located just inside the access covers of the return air grille. They can be soaked in mild soap and water, gently rinse clean. Do not use harsh chemicals or cleaners.

You can effectively increase your A/Cs efficiency by following a few simple steps whenever possible:

- Park in shaded areas.
- Keep blinds and shades pulled down.
- Keep windows and doors shut and minimize their usage.
- Operating on High Fan/Cooling mode will provide the maximum efficiency in high humidity or high temperatures.
- Use awnings to block direct sunlight exposure on the RV.
- Avoid using heat producing appliances.
- Give the A/C a 'head start' by turning the A/C on earlier in the morning.

If your RV has 50 amp electrical service the bedroom roof vent is pre-wired inside the ceiling for an A/C. Your dealership can provide this installation for you.

Appliances and Equipment

THERMOSTAT

The thermostat in your RV controls functions of both the furnace and air conditioner. Carefully read the manufacturer's literature for complete operating instructions provided in your owner information packet prior to using.

TV / STEREO ANTENNA

The TV antenna on your RV is a combined unit that provides signal for both the TV and stereo. To maximize the antenna signal to your TV you must switch 'on' the power button on the wall plate behind your TV. The red LED will be lit when functioning. See '*Figure 1 - Living Room Configuration*' diagram on the following page.

Carefully read the manufacturer's literature for complete operating instructions provided in your owner information packet prior to using.

TV / SATELLITE CONNECTIONS

Your RV is wired to provide you with TV and/or satellite broadcasting in both the living room and bedroom (satellite connectivity in bedroom not available on all models). You can receive VHF/UHF, AM/FM and satellite signal with the installed wiring and connections.

Carefully read the manufacturer's literature for complete operating instructions provided in your owner information packet prior to using.

Your viewing options include signal from the roof top TV antenna, signal from campground coax cable, or signal from your purchased satellite dish and receiver.

There are a few combinations of signal viewing options available to you based on the wiring as installed.

They are as follows:

- You can view **cable** coax signal at both living room and bedroom TV location simultaneously. However you cannot view cable coax signal at the same time as over-the-air antenna signal.
- You can view over-the-air VHF/UHF **antenna** signal at both living room and bedroom TV locations simultaneously. However you cannot view antenna signal at the same time as cable coax signal.
- You can view **satellite** signal (via your purchased satellite dish and receiver) to either the living room or bedroom (if equipped) locations or both simultaneously, however both locations simultaneously will be required to view the same programming.
- You can view satellite signal in one room and cable or antenna signal in the other simultaneously if you are properly equipped with satellite dish and receiver.

Your choice of viewing may require additional coax jumper cables to connect from TV and satellite receiver to appropriate wall jack connections as well as for diverting satellite signal from the living room location to the bedroom location.

Appliances and Equipment

The following diagrams identify the necessary connections for each viewing option.

This connection provides the satellite signal from the exterior 'DSS' connection and will connect to your receiver box. You may also 'jumper' this connection to the bedroom location.

This connection is for a cable or antenna signal. For a cable signal the switch at the right will be in the 'off' position. For an antenna signal the switch must be in the 'on' position with the red light lit up.



This connection is used to rout a satellite signal from the 'Satellite' connection on the wall plate at the left into the bedroom or aux TV 'DSS' location. This will require a short coax jumper lead connecting the two terminals. (Not all models are equipped with this feature).

FIGURE 1
LIVING ROOM CONFIGURATION

These wall plates are typically located behind or above your living room TV.

This outlet provides a power source for a 12V TV or can be used to charge cell phones or power other accessories.

This connection is for a cable or antenna signal. For a cable signal the switch at the wall plate in the living room will be in the 'off' position. For an antenna signal the switch must be in the 'on' position with the red light lit.

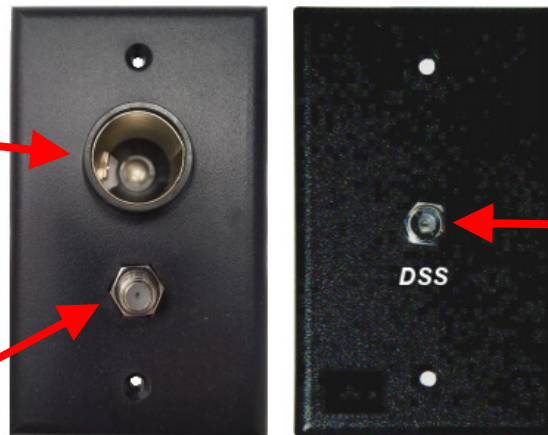

This connection provides satellite signal when 'jumpered' from the 'DSS' connection to the 'Satellite' connection at the living room location. (Not all models are equipped with this feature).

FIGURE 2
BEDROOM OR AUX TV LOCATION CONFIGURATION

These wall plates are typically located in the wall or ceiling near your bedroom or auxiliary TV location. Not available on all models.

Appliances and Equipment

This connection provides satellite signal to the wall plate located at the living room location identified as 'satellite' in FIGURE 1. (This is where you will connect your purchased satellite dish).



This connection provides cable signal to the wall plates at the living room and bedroom locations identified as 'TV 1' in FIGURE 1. (This is where you will connect the campground TV coax).

FIGURE 3
EXTERIOR CONNECTIONS
(These connections are typically located on the driver side or rear of your RV)

TELEVISIONS

Outdoors RV equips travel trailers with many different sizes and brands of television sets including 120V and 12V powered with internal DVD players. Please refer to the manufacturers manuals included in your owner information packet for specific care and operating instructions.

AWNING (with LED light feature)

Your awning is 12V powered and switched at either the monitor panel or adjacent to the primary entry door to provide operational viewing. Additionally if your RV is equipped with the wireless remote function controller you may operate your awning from outside or inside the RV. When rain is expected, it is recommended that you tilt the awning away from the entry door so that water can properly run off and away. In the event that you have power failure to the awning, it may be retracted manually. Carefully read the manufacturer's literature for complete operating instructions provided in your owner information packet prior to using.

Your awning includes LED strip lighting in place of a conventional patio light. This feature is typically switched near the primary entry door next to other entry light switches.

NOTICE

- *If heavy wind or rain is in the forecast, or whenever you leave your RV for a period of time, it is best to retract the awning. Damage to the awning or RV due to weather is not covered under the Outdoors RV warranty or the awning manufacturer warranty.*

WARNING

- *Do not attempt to repair or modify the awning. The awning roller tube is under extreme spring tension and if handled incorrectly could cause serious bodily injury. Repairs should only be performed by an authorized dealer or qualified technician.*

Appliances and Equipment

SLIDE-OUT TOPPER

Your RV may be optionally equipped with slide-out room topper(s). Functioning similar to that of an electric awning, their operation is fully automatic while the slide-out room is extended or retracted. Before retracting the slide-out room, verify that no branches or debris have come between the topper and the roof of the slide-out room. Damage may occur if debris is allowed to be rolled up into the topper awning. Carefully read the manufacturer's literature for complete operating instructions provided in your owner information packet prior to using.

POWER ROOF VENTS

Three variations of 12V power roof vents are installed in Outdoors RV travel trailers. Your model may not include all variations. Currently offered are the Maxx-fan with remote (reversible fan), Maxx-fan with wall switch (non-reversible fan), and the standard exhaust only fan. When operating any power roof vent in exhaust mode you will find that it will function more efficiently if you slightly open a window or two to allow a more circulating airflow. Open the roof vents when showering, bathing, washing dishes, cooking on the stovetop, or anytime hot water is used. Opening these vents will allow moisture to escape. Ventilation is extremely important in reducing the formation of condensation. Carefully read the manufacturer's literature provided in your owner information packet for complete operating instructions prior to using.

MANUAL ROOF VENT

Your RV may be equipped with manually opening roof vent(s). Open the roof vents when showering, bathing, washing dishes, cooking on the stovetop, or anytime hot water is used. Opening these vents will allow moisture to escape. Ventilation is extremely important in reducing the formation of condensation and mildew. Remember to close these vents before traveling as they may get damaged by excessive wind force at freeway speeds.

REAR MONITOR CAMERA

The optionally installed rear monitor camera provides additional safety measures while backing and parking your RV. Its operation requires that your tow vehicle and RV have their parking lights turned on. Carefully read the manufacturer's literature provided in your owner information packet for complete operating instructions prior to using. (Not available on all models).

HEATED HOLDING TANKS

Your RV includes heated holding tanks. Your gray and black waste holding tanks are fully enclosed insulated and duct heated whenever your furnace is operating.

The fresh water holding tank is also fully enclosed and insulated as well, however not all models are heated in the same way. Your RV may include an optionally installed 12V heat pad attached to the bottom of the fresh water tank. This heat pad will be in addition to ducted heat provided by the furnace while it is operating. The power switch for this heat pad will be located near or on the systems monitor panel. You will recognize it as being red and will illuminate when turned on.

Appliances and Equipment

To operate the fresh water tank heat pad;

1. When the outside temperature is near freezing, simply switch 'on' the holding tanks heater.
2. There must be liquid in the holding tank when the heater pad is turned on.
3. The tank heater immediately starts to protect your holding tank from freezing up.
4. The built-in sensor in the heat pad will turn on heating when temperatures are at 44° F or below. When the water within the tank is heated and rises to 64° F, the tank heater will automatically power cycle 'off' and deactivate.
5. Switch or power 'off' when outside temperatures are above freezing, or when tanks are empty.
6. Failure to follow these operating instructions could result in voiding your warranty.

MONITOR PANEL

Multiple styles of monitor panels are installed in Outdoors RV products. Some include very basic functionality while others include additional equipment switching. They will all include holding tank full capacities (fresh water, gray and black waste) and battery charge status.

To check tank levels or battery charge value, press and hold the appropriate button for the system you wish to check. The panel indicator LEDs will light up to current levels.

Water and holding tanks monitor will read E (Empty), 1/3, 2/3, or F (Full). Keep in mind that you may for example have a holding tank that reads 2/3 however it may be nearly to the Full (F) mark and not yet indicate so.

Refer to the '***Battery Monitor***' section in the '***Electrical Systems***' chapter for specific procedure on displaying correct battery charge value.

Erroneous Readings

The monitor panel displays readings from sensors located along the inner sides of the holding tanks.

These sensors can potentially send false readings under the following conditions:

- Water with low mineral content. Minerals in water help conduct the electrical signal to the monitor panel.
- Contamination. Residue remaining on the inside of the gray and black tanks after dumping (caused by normal use or putting grease, oils, etc. in the tanks).
- Low battery voltage.
- Loose wiring connections or bad grounding.

PROPANE LEAK DETECTOR

See '***Propane System***' chapter for information and warnings regarding this device. Carefully read the manufacturer's literature provided in your owner information packet for complete operating instructions prior to using.

CARBON MONOXIDE DETECTOR (Battery and Hard-Wired)

Your RV is equipped with a carbon monoxide detector that detects the presence of deadly carbon monoxide gas.

Appliances and Equipment

Carefully read the manufacturer's literature provided in your owner information packet for complete operating instructions prior to using. Please read and understand the following safety warnings before using your RV.

CAUTION

- *This CO alarm will only indicate the presence of carbon monoxide gas at the sensor. Carbon monoxide gas may be present in other areas.*

WARNING

- ***THIS IS NOT A SMOKE ALARM.** This CO alarm is designed to detect carbon monoxide from ANY source of combustion. It is NOT designed to detect smoke, fire or any other gas.*
- *The silence feature is for your convenience only and will not correct a CO problem. Always check your RV for a potential problem after any alarm. Failure to do so can result in injury or death.*
- *Battery operated CO alarms do not operate without working batteries. Removing the batteries, or failure to replace them at the end of their service life, removes your protection.*
- *Hard-Wired CO alarms do not operate if its circuits fusing is removed or blown. Ensure that the CO alarm is functioning while your RV is in use.*
- *Actuation of your CO alarm indicates the presence of carbon monoxide (CO) which can kill you. In other words, when your CO alarm sounds, you must not ignore it.*
- *Do not attempt to repair the CO alarm. If it becomes damaged or inoperable it must be replaced immediately.*

Test the CO alarm once a week. If the CO alarm ever fails to test correctly, have it replaced immediately! If the CO alarm is not working properly it cannot alert you to a problem.

This CO alarm will eventually reach its end of life. See operating literature included with your owner information packet for specific details regarding CO alarm end of life.

If the alarm sounds:

1. Immediately move to fresh air, outdoors, or by an open door or window. Do a head count to check that all persons are accounted for. Do not re-enter the RV or move away from the open door or window until the emergency services responder has arrived, the RV has been aired out, and your CO alarm remains in its normal condition.
2. Call your emergency services, fire department, or 911.

Appliances and Equipment

Some symptoms of CO poisoning;

Mild Exposure:

Headaches, running nose, sore eyes, often described as 'flu'-like symptoms.

Medium Exposure:

Dizziness, drowsiness, vomiting.

Extreme Exposure:

Unconsciousness, brain damage, death.

~ Check with a medical professional if you are experiencing any of these symptoms.

For your safety and to keep your carbon monoxide alarm in good working order, follow the tips below.

- Verify the alarm, lights and battery operation by pushing the 'Test' button weekly.
- Vacuum the CO alarm cover with a soft brush attachment once a month to remove accumulated dust.
- Instruct children to never play with the CO alarm. Warn children of the danger of carbon monoxide poisoning.
- Never use detergents or solvents to clean the carbon monoxide alarm.
- Avoid spraying paint, hair spray, air fresheners, or other aerosols near the CO alarm.
- Do not paint the CO alarm. Paint will seal the vents and interfere with the sensors ability to detect CO.
- Test the alarm operation after your RV has been in storage, before each trip and at least once a week during your camping season.

SMOKE DETECTOR

Refer to chapter '*Living With Your RV*' for reference.

WIRELESS FUNCTION CONTROLLER

Your RV may be equipped with a multi-function wireless controller. This feature allows for the remote operation of many of the main components in your RV such as slide-out rooms, awning, power stabilizer jacks, exterior lighting, etc. Carefully read the manufacturer's literature provided in your owner information packet for complete operating instructions prior to using.

NOTICE

- ***When using the wireless remote for awning patio lighting the manual wall switch must be left in the 'on' position for the remote to operate the light properly. If the wall switch is left 'off', the remote will appear to not function properly.***

SPARE TIRE CARRIERS

Folding Bumper Mount

Conventional A-frame models are equipped with a folding bumper mount spare tire carrier. By removing the locking pin the carrier may be lowered to allow access to any service compartment that may be behind. Outdoors RV does not provide a specific wrench or socket for removing your spare tire from its carrier.

Appliances and Equipment

We advise you to purchase a wrench with an appropriately sized socket for spare tire removal prior to hitting the road. Add this socket and/or wrench to your RV tool box.

Chassis Under-Mount

Fifth-wheel and ramp model RVs incorporate a spare tire mount located under the chassis just behind the axles. Your fifth-wheel or ramp model RV is provided with a special wrench, typically located in the front pass-thru storage compartment, for operating this tire carrier. You will find a hole in the side of the skirt metal, usually on the passenger side behind the axles, used for access to the carrier drive mechanism. This mechanism operates by rotating counter-clockwise to lower and clockwise to raise much the same as the spare tire carrier on a pick-up truck. If you will not be returning the spare or flat tire to the carrier, remember to raise the mechanism cable so that it does not get hung up on something while traveling.

SLIDE-OUT ROOM

Outdoors RV utilizes two different style slide-out mechanisms (not all models have slide-out rooms). One style is a 'Ram' system and consists of two ram mechanisms that are driven by a single 12V motor with drive shafts on each side. This system is located within the chassis structure. The other is an 'In-Wall' system that is mounted in the sidewall of the RV and is operated by two 12V motors at each upper corner of the wall opening. Carefully read the manufacturer's literature provided in your owner information packet for complete operating instructions prior to using.

⚠ WARNING

- ***Stand clear of the slide-out rooms' path and verify that there are no interior or exterior obstructions before extending or retracting the slide-out. The underside of the slide-out has hard, sharp edges protruding. Do not allow children under any slide-out rooms at any time. Keep all people, pets and objects away from the slide-out room and mechanism during operation. The mechanism may catch loose clothing or pinch or crush appendages. Failure to follow these warnings could result in serious injury or death.***

Before operating the slide-out room, level and stabilize your RV. If the RV is not level, the slide-out room and/or mechanism may become damaged over time. Stabilizer jacks help keep the RV square so that the slide-out room extends, retracts and seals correctly. Be sure stabilizer jacks are placed on a solid ground surface. Piers or supports are not necessary under the slide-out room when extended.

The slide-out mechanisms may occasionally make some amount of noise during operation. Some amount of noise is normal especially during the break-in period while components are seating properly. These noises will decrease after a period of time. Note that there will always be some noticeable noises when operating the slide-out.

When the slide-out room is extended, outside elements such as rain, snow, ice, dirt and other debris may cling to the outside surfaces of the slide-out room and mechanism. When the slide-out room is retracted, whatever is on the exterior will be brought inside the RV. Before retracting the slide-out room, check the outside surfaces. Wipe them dry or clean as much as possible. If the slide-out is extended for a long period, be sure to check for insect nests, etc before retracting.

Appliances and Equipment

Check for standing water or ice on the roof (if not equipped with slide topper). Remember that the slide-out seals are not designed to remove all of the water or debris that may accumulate on the exterior surfaces. You must wipe off as much as possible before retracting the slide-out room.

Slide-out Room Helpful Tips

- The RV must have fully charged batteries especially when you are not plugged into shore power.
- Turn off all unnecessary lights and 12 volt components prior to extending or retracting.
- The RV must be level with stabilizer jacks extended.
- Make sure the slide-out room has clearance, inside and outside to extend or retract.
- Make sure water and debris are removed from the exterior and roof before retracting.
- Avoid injury by keeping all body parts out of the way of the slide-out room.
- Make sure all other people are clear of the slide-out room before extending or retracting.
- DO NOT ride in the slide-out when extending or retracting.
- DO NOT step on the slide-out floor, or use the dinette or sofa of the slide-out when the room is retracted. The slide-out floor is not supported while in the retracted position and stepping on it may cause structural damage.
- When storing your RV slide-out rooms should be retracted.

In the event that your slide-out system (if equipped) fails to function due to a loss of power or component failure you do have a mechanical override option available to bring the slide room in for travel. This applies to both style mechanisms. Carefully read the manufacturer's literature provided in your owner information packet for complete operating instructions prior to using.

Ram Slide System Override

To manually override the ram system you will first need to locate its access panel underneath the RV near either the front or the rear ram on the slide-out room side of the RV.

1. You will need a 3/4" socket and ratchet wrench preferably 1/2" drive with a long handle or you may use a wrench. These items would be handy to keep in your RV toolbox.
2. Remove the access panel.
3. Disconnect the motor wires at the connectors (see figure 1).
4. With your thumb, depress the locking brake lever spring on the right hand side of the motor cover. Then rotate the override lever counter-clockwise with your index finger to disengage the motor brake (see figure 2).
5. Check for any obstacles that might be in the path of the slide-out room.
6. Push the room in until it is snugged up. This may require assistance.
7. Locate the manual override drive adapter on the output shaft of the gearbox (see figures 1&2). This is where you will operate the override with the 3/4" socket wrench.
8. Using your 3/4" socket and ratchet crank the room in completely so that the seals compress as they would normally.
9. Engage the brake lever by rotating clockwise as viewed from the end of the motor.
10. Check to make sure that you have a good seal.
11. Reconnect the motor electrical connections.
12. Take your RV to an authorized dealer for service.

Appliances and Equipment

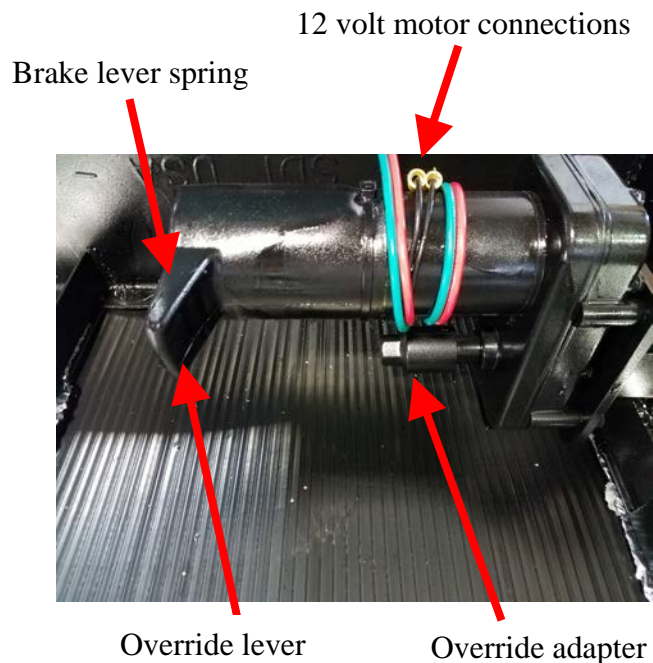

FIGURE 1



FIGURE 2

In-Wall System Override

The Schwintek In-Wall slide system can be manually overridden in two different methods depending on the malfunction. The **Electronic Override Method** can be used if there is an electrical component failure where the RV still has power but the electrical signal is not getting from the in/out switch through the controller to the motors. The **Motor Disengagement Method** is used if there is complete power failure and can also be used rather than the electronic override method however is a more complex operation. Carefully read the manufacturer's literature provided in your owner information packet for complete operating instructions prior to using.

Electronic Override Method

1. Locate the controller box (See Figure 3 below for identification).
2. Refer to the instructions on the controller label; Press the mode button on the controller six times and hold on the seventh for five seconds to enter electronic manual override mode.
3. Use the extend/retract switch to move both motors in or out.
NOTE: Over-current and short circuit detection are still enabled. Electronic manual override provides 12V directly to both motors.
4. To exit the mode, push and hold the mode button until the LEDs begin to blink simultaneously. Exiting the override mode resets the motor positions (you will have to resync motors. See procedure below).
NOTE: During this override procedure the motors are not synchronized. Visually watch the room: if one side is moving significantly slower than the other (or not at all) then immediately stop and use the **Motor Disengagement Method** outlined below.

Appliances and Equipment

Motor Disengagement Method

1. Remove motor retention screws. These screws will be found underneath the exterior seal located near the top of each vertical column on the outside of the RV.
2. Locate motor. At the top of each column you will see the motor through a slot on the inside of the RV.
3. Pull motor up until disengaged (roughly 1/2"). A flat-head screwdriver can be used to gently lift the motor up if necessary.
4. Reinstall motor retention screw to hold motor up out of gear engagement.
5. Push slide-room in until seated.
6. Lower each motor reengaging into drive position and reinstall retention screw.

Re-Synchronizing Motors

1. Fully extend the slide room using the switch. Keep the switch engaged until the motors shut down by themselves.
2. Retract the room 1-2 inches.
3. Repeat steps 1 and 2 until both motors shut down at the same time. In many cases, two or three repetitions are necessary to re-sync the system.
4. Fully extend the slide-out and keep the switch engaged until the motors shut down by themselves. Fully retract the slide-out, again keeping the switch engaged until the motors shut down on their own. If both motors shut down at the same time at full extension and full retraction, the room is properly synchronized. If they do not shut down at the same time, repeat the process until they do.

Pictured at the right, the Schwintek 'In-Wall' system controller is typically located in the closest adjacent cabinetry on either side of the slide-out room. It is usually behind an access panel or under a drawer. Location varies from model to model.



FIGURE 3

Visit www.lci1.com/support for additional information.

TOYLOCK

Your RV may be optionally equipped with a retractable locking cable system on the passenger side near the front, attached to the chassis frame. Use this to lock up items at night or while away from camp. Unlock padlock with supplied key, pull cable out of housing, thread cable end through items to be secured, reinsert cable end into retainer plate, attach and lock padlock.

BATTERY TRAY

Your RV may be optionally equipped with a battery tray designed specifically to hold four 6-volt batteries in a weatherproof container. The container is not included with your RV and must be purchased separately. The battery tray was designed to specifically to contain the 'Century Plastics Battery Box', Part # GC2-4 which can be purchased online or through your RV dealership.

Appliances and Equipment

TONGUE JACK

Your RV is equipped with an electric jack with a built-in hitch light feature. Refer to '***Leveling and Stabilization***' in the '***Living With Your RV***' chapter for basic operation. Additional product literature can be found in your owner information packet.

MANUAL STABILIZER JACKS

Your RV may be equipped with manual stabilizer jacks. These jacks come with a specific wrench used to raise and lower. This wrench is typically located in the front exterior storage compartment. Refer to '***Leveling and Stabilization***' in the '***Living With Your RV***' chapter for basic operation.

ELECTRIC STABILIZER JACKS

Your RV may be equipped with electric stabilizer jacks. The control switch(s) are located in the front exterior storage compartment on the passenger side of the RV. The jacks are operated front and rear independently of each other as well as remotely if equipped. Refer to '***Leveling and Stabilization***' in the '***Living With Your RV***' chapter for basic operation. Additional product literature can be found in your owner information packet.

AUTOMATIC LEVELING SYSTEM (Fifth-Wheel Models If equipped)

Your RV may be equipped with the automatic leveling jack system which provides the ability to automate the leveling process for you. The control panel for this system is located inside the front exterior storage compartment on the driver side of your fifth-wheel RV. This feature can be programmed to remember your hitch height so that when you are ready to leave your campsite your hitch hook-up process is simplified. Additional product literature can be found in your owner information packet.

⚠ WARNING

- ***Failure to act in accordance with the following may result in death or serious personal injury. The use of the Ground Control 3.0 leveling system to support the trailer for any reason other than which it is intended is prohibited by Lippert's limited warranty. The Lippert leveling system is designed as a "leveling" system only and should not be used to provide service for any reason under the trailer such as changing tires or servicing the leveling system. Any attempts to change tires or perform other service while trailer is supported by the Ground Control 3.0 leveling system could result in damage to the 5th wheel and/or cause death or serious injury.***

FLOW-LONGER LP-GAS LINE TAP KIT

Your RV includes a LP gas line kit that provides a non-regulated connection on one LP tank. With this kit you may connect portable LP gas appliances that are fueled by disposable gas cylinders. Keep in mind that because the connection for this kit is attached to only one LP tank that you must have the LP tank selector knob pointing to the tank that has this kits outlet fitting attached to. Read the product literature included in your owner information packet and all of its safety information prior to using.

Appliances and Equipment

LP GENERATOR

Your RV may include a 3.6 KW (3600 watts) generator intended for use when camping 'off-grid' or remote areas where no 120 volt service is available. See operating manual included in your owner information packet for specific operation and maintenance.

Storage and Winterization

STORAGE CHECKLISTS

The following checklists will help you perform the steps necessary to prepare your RV for the storage conditions you may anticipate. These checklists do not include every detail required and are not listed in any particular order. Additionally you may want to expand on them to suit your needs. See pertaining chapters in this manual for specific details. Also you may contact your dealer for additional suggestions suitable to your climate and storage conditions, particularly climates of extreme hot and cold.

Short-Term Storage (Less than 60 days)

1. Wash the RV exterior and underside including the chassis frame. Hose off accumulations of mud and road salts.
2. Thoroughly clean the interior of the RV, including carpets, counter tops, lavy, tub and shower, and galley.
3. Inflate tires to maximum rated cold pressure.
4. Park the RV as level as possible front to rear and side to side. Block tires at front and rear.
5. Check battery charge state. Recharge as necessary.
6. Disconnect battery cables. Clean terminals, top and sides of batteries and battery boxes. Reinstall cables. Apply a battery terminal spray to cable connections to prevent excess corrosion.
7. Drain and flush black and gray holding tanks.
8. Drain the fresh water system and holding tank.
9. Close and cap all holding tank drains, city water inlet, tank flush inlet, and fresh water fill spout.
10. Winterize if seasonally appropriate.
11. Remove all perishables from refrigerator and galley cabinets. Block refrigerator/freezer doors open to reduce odor build-up. An open box or tray of baking soda in the refrigerator will help to absorb odors.
12. Turn off all LP appliance pilot lights and gas valves.
13. Turn off propane valves at both tanks.
14. Open closet doors, drawers and cabinets so air can circulate.
15. In warm or hot climates, slightly open roof vents to provide air circulation and ventilation. In cold or wet climates, close and cover all vents to prevent entry of snow or rain.
16. Close and lock all windows.
17. Cover exterior appliance vents (water heater, furnace, range hood, refrigerator) to prevent insects from getting in. Be sure to remove all covering material before using appliances or vents.
18. Close curtains, blinds and shades to prevent sun fading of fabrics.
19. Switch on solar charging if batteries are to be left in RV.
20. Switch off all lighting, appliances and electrical equipment.
21. Switch battery disconnect to the 'OFF' position. Solar charging will continue with battery disconnect switch in the off position.
22. Disconnect and store the AC power cord.
23. Cover tires to minimize exposure to the elements.
24. Prepare generator for storage (if equipped). Refer to manufacturer literature supplied in your owner information packet.

Storage and Winterization

Long-Term Storage (Over 60 days)

1. Perform all steps as required for short-term storage.
2. Operate air conditioner to lubricate compressor seals.
3. Remove and clean or replace (if damaged) air conditioner filter. Cover the air conditioner exterior shroud to prevent insect nest build-up.
4. To help preserve the tires, park each tire on a piece of plywood about 12 inches square.
5. Cover the windows on the inside with foil, cardboard, paper, or equivalent, to reduce color fading of blinds and interior fabrics.
6. Remove the batteries in battery operated devices.
7. Check tire inflation every 30 days. Maintain maximum rated cold inflation pressure.
8. Check the sealant around all roof, floor and body seams and windows. Reseal if necessary.
9. Lubricate all locks and hinges.
10. If your RV is equipped with a gasoline generator it is advised that any fuel in the gas tank either be drained, used up, or add a quality fuel stabilizer additive to maintain fuel quality and reduce potential contamination of destabilized fuel.
11. Remove high grass or weed growth if the RV is parked on dirt. Caution should always be taken to prevent rodent intrusion when parked in remote areas. The RV should be checked periodically for any signs of pest intrusion.

NOTICE

- *While measures are taken at the factory to prevent areas of potential rodent or pest intrusion, any damage to the interior or exterior of your RV due to rodent or pest caused intrusion is not covered under warranty. Extra measures must be taken to prevent rodent intrusion.*
- *In the event of inclement weather conditions such as hail, hurricane, lightning, etc. you must take extra precautions to protect your RV investment. Damage resulting from this type of inclement weather is not covered under warranty.*

WINTERIZATION

Thoughtful planning and preparation for the winter season can help eliminate equipment failures and breakdowns, and can extend the life of your RV and its systems. Your dealer can advise you concerning specific winterization procedures and products for your climate area or the areas in which you will be storing your RV. Winterization may not be entirely necessary dependant upon your climate conditions.

Your dealer may also provide winterization service for all appliance and systems in the RV. The following checklist is provided if you prefer to perform winterization yourself.

1. Service and winterize the generator (if equipped) as outlined in the generator operating manual included in your owner information packet.
2. Winterize all appliances as outlined in the appliances operating manual.
3. Remove snow accumulations as often as possible.

Storage and Winterization

Water System Winterizing

Read this section completely before performing water system winterization.

NOTICE

- *Draining the water system alone may not provide adequate cold weather protection. If your RV is to be unheated during below freezing temperatures, you must perform the following winterization procedures. You may choose to consult your dealer for additional winterizing procedures for your specific climate. Your dealer can winterize your RV for you or can supply you with special antifreeze which is safe and approved for use in RV water systems. Follow the instructions furnished with the antifreeze. Damage to the water and drain systems due to improper winterization are not covered under warranty.*

WARNING

- *DO NOT use automotive or windshield washer antifreeze in the RV water system. These solutions may be harmful or fatal if swallowed.*

1. If you have equipped your RV with a water filtration system, remove the filter cartridge before beginning.
2. Shut off power and gas supply to water heater.
3. Drain the fresh water tank by opening the water tank drain valve. Close valve when empty.
4. Turn water pump on.
5. Open a cold water faucet farthest away from the water pump. When the flow of water stops, turn the water pump off.
6. Open all water faucets including shower, tub, kitchen, lavy, and exterior shower.
7. Drain shower heads by hanging them below diverter faucets.
8. Open water line hot and cold drain valves. Leave valves open. Refer to '*Water Line Low Point Drains*' section in the '*Plumbing Systems*' chapter for more information.
9. Drain water heater by removing anode/drain located near the bottom of the heater on the exterior and open the safety valve near the top. Refer to manufacturer literature provided in your owner information packet for specific details.
10. Flush toilet until water stops flowing.
11. Be sure all water from all plumbing fixtures has been drained.
12. When each faucet and drain line has drained, close all faucets, water line drain valves and fresh water tank drain valve. Install water heater drain plug and close the safety valve.
13. Drain and flush waste water system following the procedure outlined in '*Plumbing Systems*' chapter.
14. Use compressed air (30 psi max.) to blow out the black tank flush system. If using compressed air be sure that the black tank drain valve is open and uncapped. Alternatively you may pump antifreeze into the inlet with a hand pump available from your RV dealer.
15. Close holding tank drain valves and secure outlet cap.
16. Locate water heater by-pass valve and turn to 'By-Pass' mode. Refer to '*Water Heater By-Pass*' section in the '*Plumbing Systems*' chapter for more information.

Storage and Winterization

17. Locate water pump winterization pick-up tube and valve located next to water pump. Refer to '**Water Pump**' section in the '**Plumbing Systems**' chapter for more information.
18. Remove threaded plug from end of pick-up tube.
19. Place end of pick-up tube in a container of approved non-toxic RV antifreeze and open pick-up tube valve.
20. Turn water pump on. Pick-up tube should begin drawing antifreeze from the container.
21. Open each faucet, hot and cold individually beginning at the farthest point first. When antifreeze appears, allow a minimum of approximately 1 cup to flow steadily through the faucet and into the drain. This will winterize the drain traps at the same time. Close faucets.
22. Repeat at the next faucet moving toward the water pump. Remember to also open shower diverters allowing antifreeze through the diverter and shower heads.
23. Flush the toilet until antifreeze flows continuously. Release flush mechanism.
24. Install threaded plug to winterization pick-up tube.
25. Turn water pump off and open one faucet (hot and cold) to relieve pressure then close.

REACTIVATING YOUR RV AFTER STORAGE

If your RV was properly and carefully prepared for storage, taking it out of storage will not be difficult. The following procedure assumes that the RV was stored using the '**Winterization**' process outlined in the previous section. If you did not, and freeze damage or other deterioration has occurred, please contact any authorized Outdoors RV dealer for advice.

1. Thoroughly inspect the outside of the RV. Look for animal nests around wheel wells and any other 'nook and cranny' areas.
2. Remove all appliance vents, ceiling vent and air conditioner coverings. Be sure all furnace, water heater, and refrigerator openings are clear and free of debris or insect nests, webs, etc.
3. Open all doors and compartments. Check for animal or insect intrusion, water damage, or other deterioration.
4. Check battery charge levels. Refill electrolyte and recharge as necessary. Reinstall batteries if removed. Be sure cable ends and terminals are clean and free of corrosion.
5. Check tire pressures. Inflate to specified cold pressure.
6. Remove coverings from inside windows.
7. Drain, flush and sanitize the fresh water system as outlined in the '**Plumbing Systems**' chapter.
Note: DO NOT attempt to turn on the water heater without fresh water in the water heater tank.
8. Replace water filtration cartridge if equipped.
9. Turn water heater by-pass valve to 'Normal Flow' mode.
10. Operate all faucets and fixtures in the fresh water system. Check for leaks at all accessible water line fittings. Repair if necessary.
11. Operate all 12 volt lighting, equipment and accessories to verify function.
12. Install new batteries in battery operated devices such as smoke alarm, c/o alarm, etc.
13. Test carbon monoxide, propane, and smoke detector alarms. Immediately replace any that are defective.
14. Check monitor panel operation.
15. Operate vents and fans, including the range hood fan to verify function.

Storage and Winterization

16. Inspect the AC power cord, converter, and all outlets especially exterior patio and refrigerator outlets.
17. Inspect any exposed wiring underneath including slide-out room power cords (if equipped) for potential rodent damage. Have repaired as necessary.
18. Prepare the generator for operation if equipped. Refer to manufacturer literature supplied in your owner information packet.
19. Operate 120 volt appliances and air conditioner. Be sure to uncover exterior shroud if covered during storage operation.
20. Inspect the propane system. If any component of the propane system shows sign of wear, damage, or compromise have it immediately checked by a qualified propane technician before opening propane tank valves.
21. Check propane system for leaks as outlined in the '***Propane System***' chapter. If any propane leakage is discovered, immediately shut off propane tank valves. Follow all safety recommendation as outlined in the '***Propane System***' chapter. Contact your dealer or qualified propane service technician for repairs.
22. Verify operation of each propane appliance.
23. Check the sealant around all roof, floor and body seams and windows. Reseal if necessary.
24. Lubricate all exterior locks, hinges and latches as necessary.
25. Wash and wax exterior. Inspect the body for scratches or other damage. Touch up or repair as necessary. Flush the underside thoroughly.

Your RV should now be ready for a new camping adventure season. If you choose, your dealer can double check your preparation and repair any problems or make necessary adjustments.

Maintenance

Your RV has been designed to provide you with many years of use with a minimum amount of maintenance. This chapter will familiarize you with the areas of your RV that require scheduled care. Time spent taking care of your RV on a regular basis will pay for itself in extended service and will help protect your investment.

This chapter is intended to provide the owner and operator with a general overview of service and maintenance information for your RV. Detailed service and maintenance information for individual components may be found in the owner information packet included with your RV. Refer to the maintenance schedule at the end of this chapter for frequency of service.

EXTERIOR

Rubber Roof Care and Cleaning

Proper care and maintenance of your EPDM rubber roof is important for trouble-free performance. Normal maintenance is simple, easy and requires no special material. Refer to the rubber roof care and maintenance literature included in your owner information packet.

Fiberglass Siding

See additional literature included in your owner information packet for specific care and maintenance of your fiberglass siding.

Fiberglass Cap

Weathering starts immediately and can be influenced by the care your exterior fiberglass components receive. These components need to be washed, waxed, and taken care of like a car. The following care and maintenance recommendations will help you maintain the gel coat finish on your new RV. Following these instructions will help preserve the glossy finish and color of its surfaces as well as maintaining your RV's value.

- Wash monthly or more frequently as needed. Use automotive car wash soap; avoid strong alkaline cleaners or abrasives. Dish soaps have degreaser ingredients that may remove wax finishes.
- Wax fiberglass body components with a good grade paste wax formulated especially for gel coat surfaces. Waxing frequency depends on the level of exposure of the gel coated part. Water will bead on a freshly waxed, gel coated surface. When water no longer beads, waxing is needed. Once or twice per year is generally sufficient.
- Protect your RV with an appropriate breathable RV cover or shelter from sunlight when not in use.

For areas that have weathered and chalked:

- Wash the gel coated surface.
- Try a little wax in one area to see if this is sufficient to restore luster. If not, use a fine glaze or rubbing compound, followed by wax.

Cleaners

Polyester gel coats are very resistant to water and other chemicals, but there are a number of overly harsh cleaners that are available on the market that should be avoided. Avoid any strong alkaline (such as tri-sodium phosphate) or highly acidic cleaners. Avoid bleach and ammonia.

Maintenance

These materials, if left in contact with polyester, may attack or change the color. Any cleaner that is used should be in contact with the polyester the minimum amount of time required to do the job. All cleaners are meant to attack dirt and remove it. The longer they remain in contact past the recommended time frame, the more they can potentially attack the finish.

It is best to use mild automotive car wash soaps, which will work for a majority of stains and dirt accumulations. If you are unsure about using a cleaner, do the following things;

1. Read the label and follow the manufacture's instructions. Only use cleaners that are specifically recommended for fiberglass as detailed on the label of the cleaning product. Use of cleaners not designed for gel coated surfaces could be damaging. Cleaners specifically formulated for use on wood or teak normally are not appropriate for fiberglass.
2. For stubborn stains that cannot be removed with mild soap and water you may try mineral spirits. Be sure to rinse the fiberglass surface with clean water after using mineral spirits or any other chemical cleaner or the surface will become dull.
3. Run a test spot. Try it in an inconspicuous area. If it discolors or dulls this area, do not use it.

Waxes

There are a number of waxes on the market. Use one specifically designed for fiberglass. Apply a thin coat of wax. Do not leave a large residue because excess wax can yellow, causing a streaking pattern later.

General instructions on waxes:

- Read the directions on the can.
- Do not use in direct sunlight.
- Use clean cloths.
- Work a small area (about 3 feet by 3 feet) at a time.

Normally, the harder the consistency is of the wax, the higher the wax content will be. Softer waxes have a higher proportion of silicones and solvents in them. If a power buffer is used, use a low RPM with light pressure. Keep it moving at all times to prevent heat build-up. Waxes formulated specifically for gel coat fiberglass surfaces are handled by many boat dealers, shower stall dealers and automotive retail stores.

General Cleaning Tips

- Always wash your RV from top to bottom followed by thorough rinsing. The roof should be washed first to avoid potential streaking onto the exterior walls. Wash roof according to manufacturers' procedure.
- Strong solvents or cleaner concentrations can cause damage to painted surfaces.
- Abrasive materials such as steel wool, and abrasive brushes will harm finishes.
- Avoid temperature extremes. Heat accelerates chemical reactions and may evaporate water from solutions. Extremely low temperature may give poor cleaning results. Cleaning under adverse conditions may result in streaking or staining. Ideally cleaning should be done in shade at moderate temperatures.
- Do not substitute a heavy duty cleaner for recommended cleaners.
- Never use paint removers, aggressive alkaline, acid or abrasive cleaners.
- Follow manufacturers' recommendations for mixing and diluting cleaners. Always conduct a surface test to insure cleaning solution will not attack the gel coated surface.
- Never mix cleaners.

Maintenance

NOTICE

- *Physical damage to fiberglass should be addressed immediately to avoid moisture entering through breaks and causing problems with interior walls and components. Cover breaks in the fiberglass with plastic, sealing the edges with tape until proper repairs can be made.*

Exterior Graphic Care

The pressure sensitive graphics installed on the exterior surface of your RV require very little maintenance and should be treated similarly to a painted surface. The following are some guidelines to help you keep your exterior graphics looking new.

- Wash your graphics with any mild car wash soap solution, be sure to rinse thoroughly.
- High pressure sprayers are not recommended when washing your RV and may cause the edges of graphics to lift and peel away from the wall surface. We highly recommend the graphic material be hand washed, as you risk the graphic material lifting and/or peeling when using a high pressure washer. Graphics and decals that are damaged from high pressure washing are not covered under warranty.
- Do not use solvents such as acetone, methyl ethyl ketone, toluene, paint thinner, or lacquer thinner on your graphics.
- Test any cleaning solution on a small section of the graphic before using on a larger area.
- Do not paint over graphics with clear or any other type of paint.
- Do not let gasoline or other fuels splash onto or remain on any graphics or decals for any length of time. If a spill occurs, wipe off and rinse with water immediately.
- Do not apply wax over graphics or decals. Wax that has dried between stripes can be removed by softening it with rubbing (isopropyl) alcohol and cotton swabs. Be sure to rinse the area after cleaning.
- Be careful when storing your RV. The graphic materials should be protected from prolonged exposure to direct sunlight and heat.

Slide-Out Room Adjustment

If the slide-out system begins to make noises or operated erratically the mechanism may need adjustment. Your dealer or service center may charge you to perform these services if your RV is no longer covered under warranty. Regular maintenance and replacement of seals as soon as required will extend the life and usefulness of the slide-out system. If deteriorated seals are used past their useful life, rain, snow, and ice can penetrate inside the walls, floor, or roof and cause extensive damage that can be very expensive to repair. These repairs will not be covered under warranty if seals and adjustments are not maintained.

Closely inspect the slide-out operation and seals following the maintenance schedule and again before winter and again in the spring. Over time, the seals may stiffen, become brittle and crack. The time it takes for this to happen may vary depending on weather conditions and exposure to the sun. Seals that are protected from sunlight are hidden from view. They will last longer than the outer perimeter seals, but may still need replacing. If you see any evidence of water or wind leakage, have the slide-out seals checked. Replacement of these seals should be done by your dealer or authorized RV service center. It may be necessary to partially disassemble the slide-out and your dealer or service center has the special tools and experience to do this correctly.

Maintenance

Windows, Doors, Vents and Locks

Keep all moving parts, hinges, and latches adjusted and maintained. Pay particular attention to emergency egress window latching. It is critical that emergency egress windows function freely in the event of an emergency. Lubricate with light oil at least once a year. Check all component attachment screws occasionally to ensure that none have backed off. Tighten as necessary being careful not to over-tighten as plastic parts may crack and screws may strip out.

Window frames have weep holes along their bottom edges and must be kept clear of debris and dirt. Condensation on the inside of a window must have a place to drain to the outside of the RV. If these weep holes become blocked you may experience water overflowing the window track and onto the wall and floor under high humidity conditions. Window screens may be removed and gently washed with mild soap and water. Rinse thoroughly. Window tracks must be kept clean for windows to slide freely and may be vacuumed with a small attachment. Additionally a small amount of silicone spray in the tracks will typically free up most stubborn sliding window panes.

Lubricate locksets in doors and exterior storage compartments at least annually with powdered graphite. If the RV is frequently exposed to salt air, lubrication may become necessary more often.

Roof vent mechanisms should also be lubricated using a graphite powder. These can be accessed either from the roof (with the vent lid open) or from the inside with the screen removed.

Sealant Renewal of Exterior Components

This section outlines the procedures you must follow to maintain the weatherproof integrity of your RV. Leak damage caused by failure to inspect and maintain the roof, vents, TV/Radio antenna and molding seals may affect your warranty coverage.

The adhesives and sealants used in the construction of your RV were developed to remain waterproof under sustained effects of weather and vibration. However, even the finest materials will eventually dry out and lose their effectiveness. If your sealants are intact with no voids or cracking or peeling, resealing is not required.

Your dealer can perform the resealing inspection and work for you if you choose. Your dealer also has current information on sealants used in your RV, and can recommend the appropriate sealants for you if you prefer to do the work yourself. Always use sealants recommended by your dealer or Outdoors RV. Remember that any work performed by your dealer creates documentation that may be required for potential warranty work in the future.

Resealing Exterior Components

Inspect the sealants around all exterior components, doors, windows, corner moldings, etc. at least every three months. If any visible shrinkage, cracking or peeling, or any voids or missing sealant is evident these areas must be resealed immediately.

Remove any loose or peeling sealants. Wipe clean all areas to be resealed with an isopropyl alcohol using a clean dry rag. Allow to dry before applying new sealant.

Maintenance

Resealing Roof Components

Inspect roof vents, roof top moldings, and all other roof component seals. Refer to roof sealant literature included in your owner information packet for specific instructions on maintaining your roof sealants. Also check the air conditioner rubber seal between the roof and air conditioner to verify that it is still slightly compressed with no signs of cracking or gapping.

WARNING

- *Rubber roof membrane can become very slippery when wet. Thoroughly dry any wet areas you may need to access prior to performing any maintenance of the roof.*

Chassis Frame

There is very little that can go wrong with the RV chassis. Periodically inspect all attached hardware and tighten as required.

It is common for the chassis frame and components to eventually corrode and it is normal. When and how much depends on the environment the RV has been subjected to, how frequently the RV is subjected to harsh environments, and the frequency and completeness of maintenance performed. The more exposure to snow, rain, road salt, road chemicals, salt water, etc, the more accelerated and more severe the corrosion will be. Diligence on the part of the owner when the RV is subjected to these elements can significantly reduce the severity and how quickly this occurs.

When your RV is exposed to known corrosives (road salt, road chemicals, salt water, etc) take the time to wash and rinse off the frame, frame components, and axles as soon as possible after reaching your destination especially during winter months. Taking these precautionary steps will greatly reduce the extent and slow corrosive action significantly. Inspect the frame components periodically. If a spot of rust is developing or the frame was nicked or scratched by road debris, sand or wire brush the affected area and touch it up with rustproof enamel primer and paint.

Tire and Wheels

To obtain maximum tire life, inspect tires for wear and damage before the start of each trip and after you return. Refer to the *'Tire Safety and Information'* section in the *'On the Road'* chapter of this manual. Look for abnormal tread wear patterns. Inspect tire sidewalls for signs of visible cracking. If in doubt as to the tires condition, have a professional inspect them for you. This is especially important if the tires are several years old and have accumulated many miles. Replace the tires if you see cuts, bulges, peeling tread, sidewall cracking or other signs of damage. Remove stones and other objects stuck in the tread.

Wheels should be inspected for cracking or any major road damage around its inner and outer rim. Also check for cracking extending from lug nut holes and out-of-round or 'egged out' lug nut holes. A wheel should be replaced if any amount of cracking is identified. Have a professional take a look at them if there is any question. Remember to re-torque lug nuts before each trip and any time a wheel is removed from the RV.

Brakes and Wheel Bearings

Please refer to the manufacturer literature provided in your owner information packet for complete and detailed information on brake and wheel bearing maintenance.

Maintenance

All Outdoor RV products are equipped with self-adjusting, electric drum brakes. No parking brake is provided with this system.

All axles are equipped with E-Z Lube hub covers allowing for simplified maintenance between bearing inspection periods.

Your dealer can perform brake and wheel bearing inspections and maintenance for you if you prefer.

A-Frame Hitch Coupler

The standard coupler used on conventional A-frame tongue travel trailers is a non-adjustable type that requires minimal maintenance. You will want to make sure that it operates freely without binding. Occasionally apply a dry graphite lubricant to the latch moving parts. Ensure that it latches completely every time.

A-Frame Tongue Jack

Visually inspect tongue jack at each use. If it begins making any unusual noises, be sure to have it inspected by your dealer. Power and manual A-frame jacks will require occasional lubrication. See literature supplied in your owner packet for additional information.

Fifth Wheel Pin-Box

Your fifth wheel pin-box does require regular inspection and occasional maintenance. Please refer to the manufacturer literature provided in your owner information packet for complete and detailed information on pin-box inspection and maintenance.

Note: Do not attempt to install a gooseneck extension coupler. Doing so will void particular warranty coverage.

Water and Holding Tank Maintenance

Refer to the '*On-Board Water Tank*' and '*Holding Tanks*' sections in '*Plumbing Systems*' chapter for maintenance and care. Drain valve rods may require occasional lubrication where they enter the valve housing. Use light weight lubrication such as silicone or WD40 spray. This will require lowering a section of the LamiPlast plastic chassis enclosure for access.

Battery Maintenance and Care

Refer to '*The RV Battery*' section in '*Electrical Systems*' chapter for maintenance and care.

Appliance Maintenance

Please refer to each appliance manufacturers' manual supplied in your owner information packet for specific maintenance and care.

Electrical Connections

Electrical connections are easily overlooked when considering maintenance items however they must be constantly monitored as well. Corroded electrical terminals, contacts, and connectors may eventually cause electrical component failure. Any exterior electrical connections that are exposed to road and weather moisture or dirt and/or mud such as battery terminals, brake wire connectors, break-a-way safety switch, 7-way cord, AC shore power cord, and replaceable light bulb sockets, all must be inspected regularly. Any corrosion should be gently removed.

Maintenance

Contacts and terminals can be wire brushed or 'refreshed' with fine sandpaper. Battery terminals, after cleaning, can be sprayed with a corrosion preventative coating to reduce future build-up.

The breakaway switch has an o-ring seal preventing dirt and moisture from entering the contact area. If when inspecting its operation you discover moisture, dirt, or particles inside behind the seal it is recommended that the switch be replaced.

INTERIOR

Fabrics

Interior appointments such as draperies or curtains, bedspreads, mattress covers, pillows, dinette cushion and backrest covers are manufactured from high quality materials and may need to be dry cleaned or spot cleaned only. Refer to any attached labels for specific cleaning requirements. Frequent vacuuming will keep them free of dust and dirt. The affected area should be blotted, not rubbed, to prevent the stain from working deeper into the fabric. When spot cleaning, **DO NOT** use any chemicals or cleaners that are not designed specifically for cleaning fabrics. Always test fabric cleaners in an inconspicuous area to verify that they will not stain or fade the material prior to using on the spot to be cleaned.

Solid Surface Countertops

Your solid surface countertops are made of a very durable, environmentally friendly material that will withstand the test of time. Despite the material's hi-strength and durability you will want to take care of it to prolong its luster for the life of your RV. Refer to additional literature included in your owner information packet for specific care and maintenance.

Laminate Countertops

Some countertops in your RV are made of high-pressure laminates similar to what may be in your home, and are highly resistant to normal spills and scuffs. Soap and lukewarm water or a mild, non-abrasive cleaner are recommended. Avoid use of abrasive pads and scouring pads, which can dull the surface and make it more stain-prone. Always use a chopping block or cutting board when using knives. Pots and pans straight from the burner or oven should be placed on lined hot pads and not directly on the counter surface.

Shower Walls, Pans, Bath Tubs and Sinks (ABS Plastic)

Refer to additional literature included in your owner information packet for specific care and maintenance.

Shower Walls, Pans and Bath Tubs (Fiberglass)

Polyester gel coats are very resistant to water and other chemicals, but there are a number of overly harsh cleaners that are available on the market that should be avoided. Avoid any strong alkaline (such as tri-sodium phosphate) or highly acidic cleaners. Avoid bleach and ammonia. These materials, if left in contact with polyester, may attack or change the color.

Any cleaner that is used should be in contact with the polyester the minimum amount of time required to do the job. All cleaners are meant to attack dirt and remove it. The longer they remain in contact past the recommended time frame, the more they can potentially attack the finish.

It is best to use mild detergents such as hand dishwashing soap, which will work for a majority of stains and dirt accumulations. If you are unsure about using a cleaner, do the following things;

Maintenance

1. Read the label and follow the manufacture's instructions. Only use cleaners that are specifically recommended for fiberglass as detailed on the label of the cleaning product. Use of cleaners not designed for gel coated surfaces could be damaging. Cleaners specifically formulated for use on wood or teak normally are not appropriate for fiberglass.
2. For stubborn stains that cannot be removed with mild soap and water you may try mineral spirits. Be sure to rinse the fiberglass surface with clean water after using mineral spirits or any other chemical cleaner or the surface will become dull.
3. Run a test spot. Try it in an inconspicuous area. If it discolors or dulls this area, do not use it.

Blinds and Shades

Blinds and shades should be vacuumed regularly with a soft brush attachment. Use of a soft cloth and mild cleaner on metal blinds will help keep them looking new. For fabric shades, upholstery cleaners are not recommended. Instead, spot clean when necessary, using a mild soap and water solution on affected area.

Cabinet Doors and Drawers

Your cabinet door and drawer fronts should be cared for similar to fine furniture. Use a quality furniture polish to help maintain the luster of the wood as well as keeping the wood from drying out. Many accidental scratches can be hidden satisfactorily with a good quality furniture scratch cover-up.

Carpeting

Vacuum regularly to remove abrasive grit and dirt. Water based spills and spots should be removed immediately with a damp cloth. Grease or oil based stains and spots should be spot cleaned with a good quality spot cleaner made for this purpose. If complete shampooing is desired, it can be performed with home or rental equipment however it is best to be done by a competent professional carpet cleaner. Never soak or water-log your carpeting.

Vinyl Flooring

Vinyl flooring can be mopped using any readily available vinyl floor cleaning agent. Do not use any chemical or cleaner that is not specifically for vinyl flooring. Other chemicals or cleaners may strip the finish coating or create stains. Waxing is not needed.

Faucets and Fixtures

To protect the finishes on your kitchen and bath faucets and fixtures, use only a damp cloth or sponge. Do not use abrasive cleaners or materials as they can damage the finish.

Toilet

Use non-abrasive cleaners with a non-abrasive bowl brush, sponge or soft cloth. Do not use scouring powders, acids or concentrated cleaners which can damage surfaces, plastic parts and rubber seals.

Failure to do so can void your warranty.

Ceiling, Wall and Cabinet Panels

Clean only with a mild detergent in warm water, using a damp cloth to clean the panel. Never use strong chemicals or excessive water/moisture, as either can damage the panels. Aggressive scrubbing will damage the texture and finish.

MAINTENANCE SCHEDULE

Maintenance Item	Pre-Trip	After Use	Weekly	Every Month	Every 3 Months	Every 6 Months	Each Year	At Specified Mileage or Interval
Inspect Safety Chains	X			X				
Inspect 7-Way Cord Connection (Truck and Trailer)	X			X				
Inspect AC Power Cord	X			X				
Inspect Hitch Components (Truck)	X			X				
Inspect Chassis For Rust and Damage - Paint Touch-Up						(8)		
Check Pin Box Assembly Bolt Torques							(6)	
Inspect Pin Box King Pin For Excessive Wear							(10)	
Test Breakaway Switch Function	(10)			(10)				(3)
Axle Components, Brakes, Wheel Bearings								(5)(7)
Check Tires For Wear and Damage	(10)			(10)				
Check Wheel Lug Nut Torque	(10)			(10)				(10)
Inspect and Lubricate Stabilizer Jacks						(8)	X	
Lubricate Power Tongue Jack							(9)	
Inspect Fifth-Wheel Landing Gear Operation	X						(8)	X
Lubricate Entry Step Hinge Points						(8)	X	
Check Exterior Lighting Operation (Marker & Tail)	X			X			X	
Inspect Propane System Components	X			X			X	
Perform Propane System Pressure Check						(7)(8)		(7)
Inspect and Clean Battery, Cables, and Terminals						(10)		
Check Battery Charge	(10)			(10)				
Check Battery Electrolyte (If Lead Acid Filled)				X				
Lubricate Coupler and Latch							(8)(10)	
Wash Exterior Including Roof						X		
Wax Exterior							(8)	X
Check Slide-Out Room Function and Sealing	X			X				
Lubricate and Adjust Exterior Locks, Hinges, and Roof							(8)	X
Adjust and Lubricate Window Latches & Mechanisms							(8)	X
Check and Reseal All Exterior Sealants As Required				(8)(9)	X			
Inspect and Clean Appliance Vents (Water Heater, Furnace, etc.)			(9)				(9)	
Perform Fire Extinguisher Pressure Test			(9)					
Inspect and Test LP Detector			(9)					(1)
Inspect and Test CO Detector			(4)					(1)
Inspect and Test Smoke Alarm			(4)					(2)
Inspect and Test GFCI Receptacles				(9)(10)				(1)
Service Appliances and Equipment: Refrigerator, A/C, Generator, Furnace, Water Heater, etc.							(9)	(9)
Inspect and Clean Water Pump Filter Screen						(8)(10)		(10)
Inspect All Water/Drain Plumbing Fittings for Leakage							(8)	X
Sanitize Fresh Water Tank								(10)
Flush Black and Gray Holding Tanks		(10)						
Generator								(9)

- (1) Replace at 'Malfunction' or 'End or Life' indicator. See component literature for specific information.
- (2) Replace every 10 years.
- (3) Replace every 3-5 years.
- (4) Replace battery at 'Low Battery Warning' signal.
- (5) Refer to Dexter Axle Maintenance Schedule for all axle components.
- (6) Refer to MOR/ryde literature for specific bolt torques.
- (7) May require special equipment and/or qualified personnel.
- (8) May require more frequently based on environmental conditions, snow, dust, rain, severe climate and/or extreme use.
- (9) Refer to component literature for specific instructions.
- (10) Refer to according section in this owners manual for procedure.

The RV Tool Box

The following is a list of commonly carried items you may choose to include in your RV tool box. This list is primarily intended for the first time RV'er.

- Water pressure regulator for city water inlet.
- Inline water filter. Attach inline with pressure regulator on your water supply hose.
- 90 Degree elbow fitting. Use at city water inlet to prevent hose from kinking under weight.
- Torque wrench with appropriate sockets to fit your wheel lug nuts.
- 4-way lug wrench.
- Socket set with 3/4" socket to fit torque wrench. For manual operation of slide-out ram (if equipped).
- Tire chocks to prevent rolling.
- Leveling blocks. Use under tires to provide leveling.
- Stabilizer jack blocks. Use to prevent jack foot from sinking into soft ground and will help to increase stabilization.
- Sewer drain hose and all appropriate connections.
- Garden hose specific for cleaning and flushing holding tanks.
- Garden hose (drinking water safe) specific for city water and filling fresh water tank only.
- Spare fuses and bulbs specific to your lighting.
- Spare water line fitting seals and garden hose washers with screens.
- Holding tank water treatment chemicals.
- Various hand tools such as wrenches, screwdrivers, pliers, hacksaw, hammer, wire cutters, etc.
- Heavy duty bottle jack for changing flat tires. Ensure that you get one that exceeds the loaded capacity of your RV at the axle area. You may also want to include a piece of 3/4-1" plywood or block large enough to prevent jack from sinking into soft ground.
- 12-16" or larger level for checking level of your RV at the campsite.
- Tire pressure gauge.
- Folding tree saw. For those overgrown branches that have encroached upon your campsite since last year.
- Flash-light with spare batteries.
- Pocket knife or utility knife.
- Electrical tape and heavy duty duct tape.
- Zip ties, assorted sizes.
- Leather work gloves and safety glasses.
- Bungee cords.
- Hitch coupler lock.
- Additional fire extinguisher.
- Spray lubricant/grease.
- Scissors.
- Hose clamps of various sizes.
- Twist-lock and crimp style electrical connectors.
- Small shovel.
- Multi-test meter
- Road flares or safety cones.

