

Aurora R5

Service Manual

Computer Model: Alienware Aurora R5
Regulatory Model: D23M
Regulatory Type: D23M001



Notes, cautions, and warnings



NOTE: A NOTE indicates important information that helps you make better use of your computer.



CAUTION: A CAUTION indicates either potential damage to hardware or loss of data and tells you how to avoid the problem.



WARNING: A WARNING indicates a potential for property damage, personal injury, or death.

© 2016 Dell Inc. All rights reserved. This product is protected by U.S. and international copyright and intellectual property laws. Dell and the Dell logo are trademarks of Dell Inc. in the United States and/or other jurisdictions. All other marks and names mentioned herein may be trademarks of their respective companies.

2016 - 07

Rev. A00

Contents

Before working inside your computer.....	12
Before you begin	12
Safety instructions.....	12
Recommended tools.....	13
Screw list.....	14
After working inside your computer.....	15
Technical overview.....	16
Inside view of your computer.....	16
System-board components.....	17
Removing the stability foot.....	19
Procedure.....	19
Replacing the stability foot.....	21
Procedure.....	21
Removing the left-side cover.....	22
Procedure.....	22
Replacing the left-side cover.....	24
Procedure.....	24
Removing the right-side cover.....	25
Procedure.....	26
Replacing the right-side cover.....	28
Procedure.....	28

Removing the top-cover assembly.....	29
Prerequisites.....	29
Procedure.....	29
Replacing the top-cover assembly.....	32
Procedure.....	32
Post-requisites.....	32
Removing the bottom cover.....	33
Prerequisites.....	33
Procedure.....	33
Replacing the bottom cover.....	35
Procedure.....	35
Post-requisites.....	35
Removing the 3.5-inch hard drive.....	36
Prerequisites.....	36
Procedure.....	36
Replacing the 3.5-inch hard drive.....	40
Procedure.....	40
Post-requisites.....	40
Removing the 2.5-inch hard drives.....	41
Prerequisites.....	41
Procedure.....	41
Replacing the 2.5-inch hard drives.....	45
Procedure.....	45
Post-requisites.....	45

Removing the power-supply unit.....	46
Prerequisites.....	46
Procedure.....	46
Replacing the power-supply unit.....	53
Procedure.....	53
Post-requisites.....	53
Removing the processor-cooling assembly.....	54
Prerequisites.....	54
Procedure.....	55
Replacing the processor-cooling assembly.....	57
Procedure.....	57
Post-requisites.....	57
Removing the coin-cell battery.....	58
Prerequisites.....	58
Procedure.....	58
Replacing the coin-cell battery.....	60
Procedure.....	60
Post-requisites.....	60
Removing the memory modules.....	61
Prerequisites.....	61
Procedure.....	61
Replacing the memory modules.....	63
Procedure.....	63
Post-requisites.....	65

Removing the solid-state drive.....	66
Prerequisites.....	66
Procedure.....	66
Replacing the solid-state drive.....	68
Procedure.....	68
Post-requisites.....	69
Removing the graphics card.....	70
Prerequisites.....	70
Procedure.....	71
Replacing the graphics card.....	73
Procedure.....	73
Post-requisites.....	73
Removing the processor fan and heat-sink assembly.....	74
Prerequisites.....	74
Procedure.....	74
Replacing the processor fan and heat-sink assembly.....	76
Procedure.....	76
Post-requisites.....	76
Removing the processor.....	77
Prerequisites.....	77
Procedure.....	77
Replacing the processor.....	78
Procedure.....	78
Post-requisites.....	79

Removing the wireless card.....	80
Prerequisites.....	80
Procedure.....	80
Replacing the wireless card.....	82
Procedure.....	82
Post-requisites.....	83
Removing the antenna.....	84
Prerequisites.....	84
Procedure.....	84
Replacing the antenna.....	87
Procedure.....	87
Post-requisites.....	87
Removing the front-chassis fan.....	88
Prerequisites.....	88
Procedure.....	88
Replacing the front-chassis fan.....	91
Procedure.....	91
Post-requisites.....	91
Removing the top-chassis fan.....	92
Prerequisites.....	92
Procedure.....	92
Replacing the top-chassis fan.....	95
Procedure.....	95
Post-requisites.....	95

Removing the optical drive.....	96
Prerequisites.....	96
Procedure.....	96
Replacing the optical drive.....	100
Procedure.....	100
Post-requisites.....	100
Removing the front bezel	101
Prerequisites.....	101
Procedure.....	101
Replacing the front bezel.....	104
Procedure.....	104
Post-requisites.....	104
Removing the power-button board.....	105
Prerequisites.....	105
Procedure.....	105
Replacing the power-button board.....	107
Procedure.....	107
Post-requisites.....	107
Removing the rear trim cover.....	108
Prerequisites.....	108
Procedure.....	108
Replacing the rear trim cover.....	110
Procedure.....	110
Post-requisites.....	110

Removing the system board.....	111
Prerequisites.....	111
Procedure.....	112
Replacing the system board.....	115
Procedure.....	115
Post-requisites.....	115
Entering the Service Tag in the BIOS setup program.....	116
BIOS setup program.....	117
Overview.....	117
Entering BIOS setup program.....	117
System setup options.....	117
Clearing forgotten passwords.....	122
Prerequisites.....	122
Procedure.....	123
Post-requisites.....	124
Clearing CMOS Settings.....	125
Prerequisites.....	125
Procedure.....	125
Post-requisites.....	126
Flashing the BIOS.....	127
Technology and components.....	128
Audio.....	128
Downloading the audio driver.....	128
Identifying the audio controller.....	128
Changing the audio settings.....	129
Graphics.....	129
Downloading the graphics driver.....	130
Identifying the display adapter.....	130
Changing the screen resolution.....	130

Rotating the display.....	131
USB.....	133
Downloading the USB 2.0 and USB 3.0 driver.....	133
Identifying the USB drivers.....	133
Enabling or disabling the USB in BIOS setup program.....	134
Fixing a no-boot issue caused by USB emulation.....	134
Wi-Fi.....	134
Turning on or off Wi-Fi.....	135
Downloading the Wi-Fi driver.....	135
Identifying the Wireless drivers.....	135
Configuring the Wi-Fi.....	136
Bluetooth.....	136
Turning on or off Bluetooth.....	136
Pairing the Bluetooth-enabled devices.....	136
Removing the Bluetooth device.....	137
Transferring files between devices using Bluetooth.....	138
Hard drive.....	139
Identifying the hard drive.....	139
Identifying the hard drive in BIOS setup program.....	139
Chipset.....	139
Downloading the chipset driver.....	139
Identifying the chipset.....	140
Memory.....	141
Checking the system memory in Windows.....	142
Checking the system memory in BIOS setup program.....	142
Testing memory using ePSA.....	142
Processors.....	142
Identifying the processors in Windows.....	142
Checking the processor usage in the task manager.....	143
Operating System.....	144
Service Tag location.....	144
Device driver.....	144
Intel Chipset Software Installation Utility.....	144
Video drivers.....	145

Intel Serial IO driver.....	146
Intel Trusted Execution Engine Interface.....	147
Intel Wireless-AC 8260 Wi-Fi and Bluetooth drivers.....	148
BIOS overview.....	149
Boot menu.....	149
Boot menu enhancements.....	149
Timing key sequences.....	149

System diagnostic lights..... 150

Getting help and contacting Alienware..... 151

Self-help resources.....	151
Contacting Alienware.....	151

Before working inside your computer

 **NOTE:** The images in this document may differ from your computer depending on the configuration you ordered.

Before you begin

- 1 Save and close all open files and exit all open applications.
- 2 Shut down your computer.

Windows 10: Click or tap **Start** →  **Power** → **Shut down**.

 **NOTE:** If you are using a different operating system, see the documentation of your operating system for shut-down instructions.

- 3 Disconnect your computer and all attached devices from their electrical outlets.
- 4 Disconnect all cables such as telephone cables, network cables, and so on, from your computer.
- 5 Disconnect all attached devices and peripherals, such as keyboard, mouse, monitor, and so on, from your computer.
- 6 Remove any media card and optical disc from your computer, if applicable.
- 7 After the computer is unplugged, press and hold the power button for 5 seconds to ground the system board.

Safety instructions

Use the following safety guidelines to protect your computer from potential damage and ensure your personal safety.

 **WARNING:** Before working inside your computer, read the safety information that shipped with your computer. For more safety best practices, see the Regulatory Compliance home page at www.dell.com/regulatory_compliance.

 **WARNING:** Disconnect all power sources before opening the computer cover or panels. After you finish working inside the computer, replace all covers, panels, and screws before connecting to the electrical outlet.

 **CAUTION:** To avoid damaging the computer, ensure that the work surface is flat and clean.

 **CAUTION:** To avoid damaging the components and cards, handle them by their edges, and avoid touching pins and contacts.

 **CAUTION:** You should only perform troubleshooting and repairs as authorized or directed by the Dell technical assistance team. Damage due to servicing that is not authorized by Dell is not covered by your warranty. See the safety instructions that shipped with the product or at www.dell.com/regulatory_compliance.

 **CAUTION:** Before touching anything inside your computer, ground yourself by touching an unpainted metal surface, such as the metal at the back of the computer. While you work, periodically touch an unpainted metal surface to dissipate static electricity, which could harm internal components.

 **CAUTION:** When you disconnect a cable, pull on its connector or on its pull tab, not on the cable itself. Some cables have connectors with locking tabs or thumb-screws that you must disengage before disconnecting the cable. When disconnecting cables, keep them evenly aligned to avoid bending any connector pins. When connecting cables, ensure that the ports and connectors are correctly oriented and aligned.

 **CAUTION:** Press and eject any installed card from the media-card reader.

Recommended tools

The procedures in this document may require the following tools:

- Philips screwdriver
- Flat-head screwdriver

- Plastic scribe

Screw list

The following table provides the list of screws that are used for securing different components to Alienware Aurora R5.

Component	Secured to	Screw type	Quantity
3.5-inch hard-drive cage	Chassis	#6-32 X 1/4"	2
2.5-inch hard-drive cage	Chassis	#6-32 X 1/4"	4
Power-supply unit hinge	Chassis	#6-32 X 1/4"	6
		#6-32 X 1/4" BLK	3
Power-supply unit	Power-supply unit hinge	#6-32 X 1/4"	4
Power-supply unit bracket		#6-32 X 1/4"	2
Optical-drive assembly	Chassis	#6-32 X 1/4"	2
System board	Chassis	#6-32 X 1/4"	8
Top cover	Chassis	#6-32 X 1/4"	2
Top I/O assembly	Chassis	#6-32 X 1/4" BLK	4
Processor-cooling assembly bracket	Chassis	#6-32 X 1/4" BLK	2
Processor-cooling assembly radiator	Processor-cooling assembly bracket	#6-32 X 1/4" BLK	4
Top-chassis fan assembly	Chassis	#6-32 X 1/4"	1
Top-chassis fan bracket	Chassis	#6-32 X 1/4" BLK	1
Antenna assembly	Chassis	#6-32 X 1/4"	2
Power-button board	Top cover	M3 X 4	2
Rubber foot	Bottom cover	M3 X 4	4
M.2 SSD card	System board	Standoff M2	1
		M2 X 2.5	1
Optical-drive bracket	Optical drive	M2 X 2.5	1
WLAN bracket	System board	M2 X 2.5	1

After working inside your computer



CAUTION: Leaving stray or loose screws inside your computer may severely damage your computer.

- 1** Replace all screws and ensure that no stray screws remain inside your computer.
- 2** Connect any external devices, peripherals, or cables you removed before working on your computer.
- 3** Replace any media cards, discs, or any other parts that you removed before working on your computer.
- 4** Connect your computer and all attached devices to their electrical outlets.
- 5** Turn on your computer.

Technical overview

 **WARNING:** Before working inside your computer, read the safety information that shipped with your computer and follow the steps in [Before working inside your computer](#). After working inside your computer, follow the instructions in [After working inside your computer](#). For more safety best practices, see the Regulatory Compliance home page at www.dell.com/regulatory_compliance.

Inside view of your computer

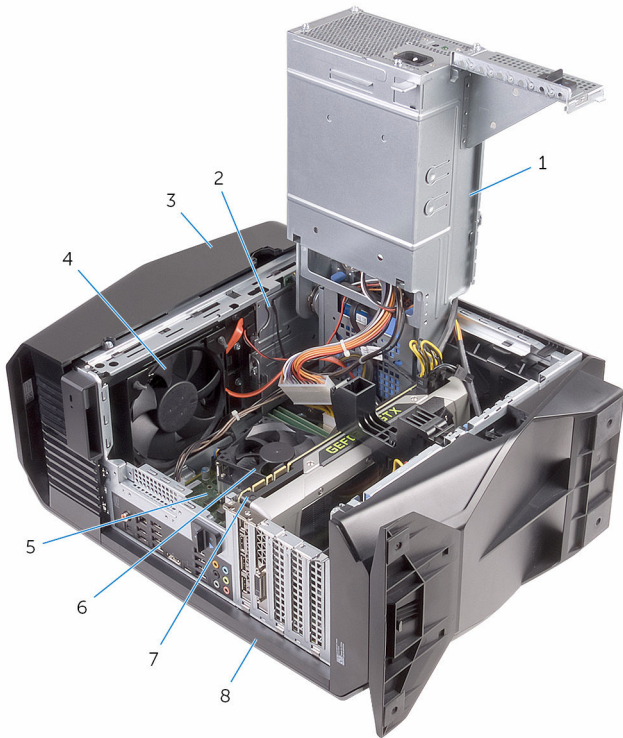

1 power-supply unit

2 optical-drive assembly

- 3 top cover
- 5 system board
- 7 graphics card
- 4 top-chassis fan
- 6 processor fan and heat-sink assembly
- 8 right-side cover

System-board components

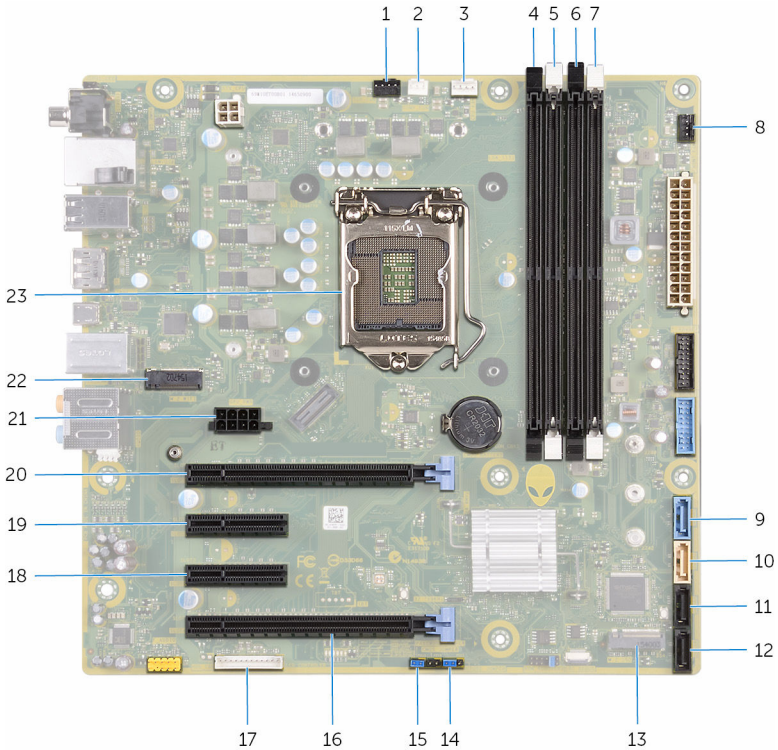

- 1 top-chassis fan (TOP_FAN)
- 2 processor-cooling assembly pump-fan connector (PUMP_FAN)
- 3 processor-fan connector (CPU_FAN)
- 4 memory-module slot 1 (XMM1)
- 5 memory-module slot 2 (XMM2)
- 6 memory-module slot 3 (XMM3)

7	memory-module slot 4 (XMM4)	8	front-chassis fan connector (FRONT_FAN)
9	SATA 6 Gbps drive connector (SATA1)	10	SATA 6 Gbps drive connector (SATA2)
11	SATA 6 Gbps drive connector (SATA3)	12	SATA 6 Gbps drive connector (SATA4)
13	solid-state drive slot (M.2 SSD)	14	CMOS reset jumper (CMOS JUMPER)
15	Password reset jumper (PASSWORD JUMPER)	16	PCI-Express x16 slot (SLOT4)
17	LED controller connector (LED_CONTROLLER)	18	PCI-Express x4 slot (SLOT3)
19	PCI-Express x4 slot (SLOT2)	20	PCI-Express x16 slot (SLOT1)
21	graphics-card power connector (GPU_POWER)	22	wireless-card slot (M.2 WIFI)
23	processor socket (CPU1)		

Removing the stability foot



WARNING: Before working inside your computer, read the safety information that shipped with your computer and follow the steps in [Before working inside your computer](#). After working inside your computer, follow the instructions in [After working inside your computer](#). For more safety best practices, see the Regulatory Compliance home page at www.dell.com/regulatory_compliance.

Procedure

- 1 Place the computer on a clean and flat surface with the bottom cover facing up.
- 2 Pull the securing tab to release the stability foot from the slots on the bottom cover.

3 Lift the stability foot off the bottom cover.

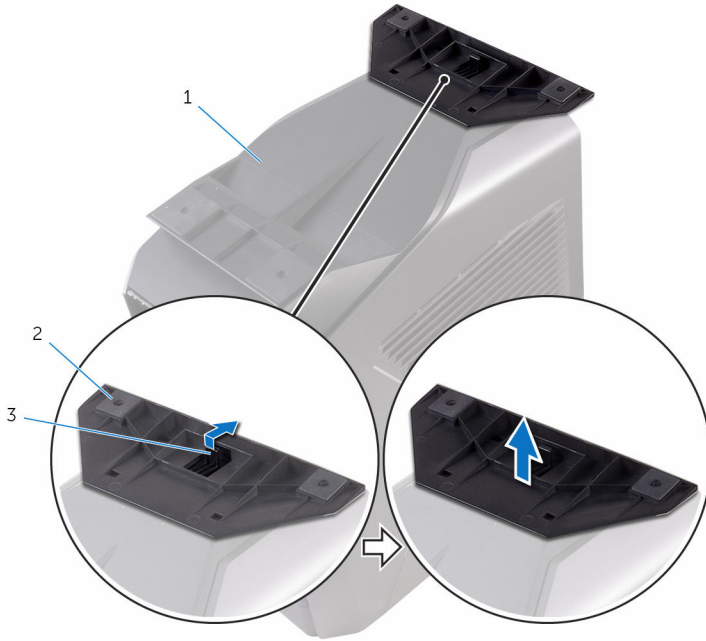

1 bottom cover
3 securing tab

2 stability foot

4 Lay the computer on its side.

Replacing the stability foot



WARNING: Before working inside your computer, read the safety information that shipped with your computer and follow the steps in [Before working inside your computer](#). After working inside your computer, follow the instructions in [After working inside your computer](#). For more safety best practices, see the Regulatory Compliance home page at www.dell.com/regulatory_compliance.

Procedure

- 1 Place the computer on a clean and flat surface with the bottom cover facing up.
- 2 Align the tabs on the stability foot with the slots on the bottom cover and snap the stability foot to lock it in place.
- 3 Turn the computer over and place it in upright position.

Removing the left-side cover



WARNING: Before working inside your computer, read the safety information that shipped with your computer and follow the steps in [Before working inside your computer](#). After working inside your computer, follow the instructions in [After working inside your computer](#). For more safety best practices, see the Regulatory Compliance home page at www.dell.com/regulatory_compliance.

Procedure



NOTE: Ensure that you remove the security cable and security screw from the security-cable slot (if applicable).

- 1 Pull the side-panel release latch.

2 Release the left-side cover away from the chassis and then lift it from the computer.



- 1 side-panel release latch
- 2 top cover
- 3 left-side cover

Replacing the left-side cover



WARNING: Before working inside your computer, read the safety information that shipped with your computer and follow the steps in [Before working inside your computer](#). After working inside your computer, follow the instructions in [After working inside your computer](#). For more safety best practices, see the Regulatory Compliance home page at www.dell.com/regulatory_compliance.

Procedure

Align the tabs on the left-side cover with the slots on the chassis and snap the left-side cover to lock it in place.

Removing the right-side cover



WARNING: Before working inside your computer, read the safety information that shipped with your computer and follow the steps in [Before working inside your computer](#). After working inside your computer, follow the instructions in [After working inside your computer](#). For more safety best practices, see the Regulatory Compliance home page at www.dell.com/regulatory_compliance.

Procedure

- 1 Carefully pry around the edges of the right-side cover from the chassis.

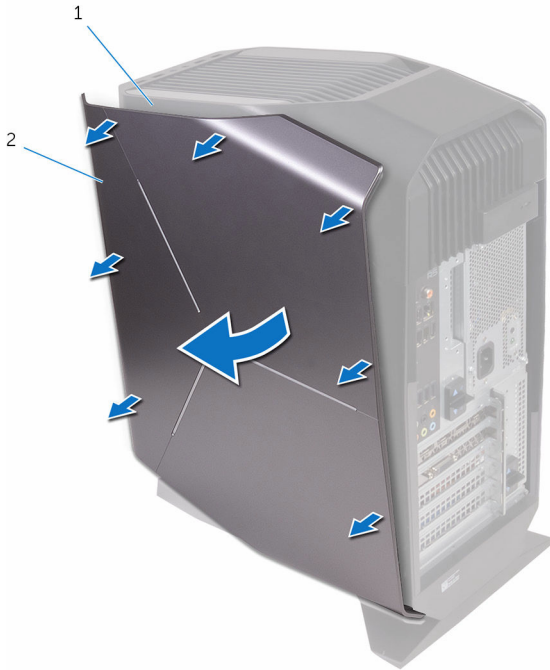

1 chassis

2 right-side cover

- 2 Disconnect the lighting cable from the right-side cover.

3 Lift the right-side cover off the chassis.

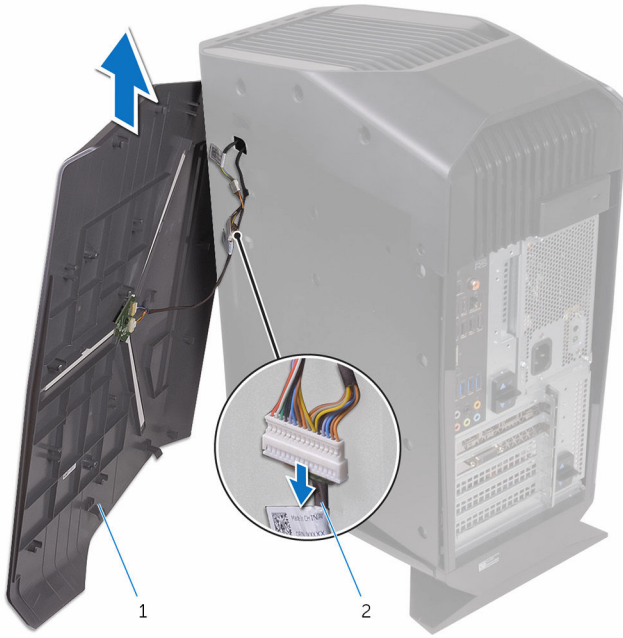

1 right-side cover

2 lighting cable

Replacing the right-side cover



WARNING: Before working inside your computer, read the safety information that shipped with your computer and follow the steps in [Before working inside your computer](#). After working inside your computer, follow the instructions in [After working inside your computer](#). For more safety best practices, see the Regulatory Compliance home page at www.dell.com/regulatory_compliance.

Procedure

- 1 Connect the lighting cable to the right-side cover.
- 2 Align the tabs on the right-side cover with the slots on the chassis and snap the right-side cover to lock it in place.

Removing the top-cover assembly



WARNING: Before working inside your computer, read the safety information that shipped with your computer and follow the steps in [Before working inside your computer](#). After working inside your computer, follow the instructions in [After working inside your computer](#). For more safety best practices, see the Regulatory Compliance home page at www.dell.com/regulatory_compliance.

Prerequisites

- 1 Remove the [left-side cover](#).
- 2 Remove the [right-side cover](#).

Procedure

- 1 Remove the screws that secure the top cover to the chassis.
- 2 Disconnect the lighting cable from the top cover.

3 Slide the lighting cable through the slot on the chassis.

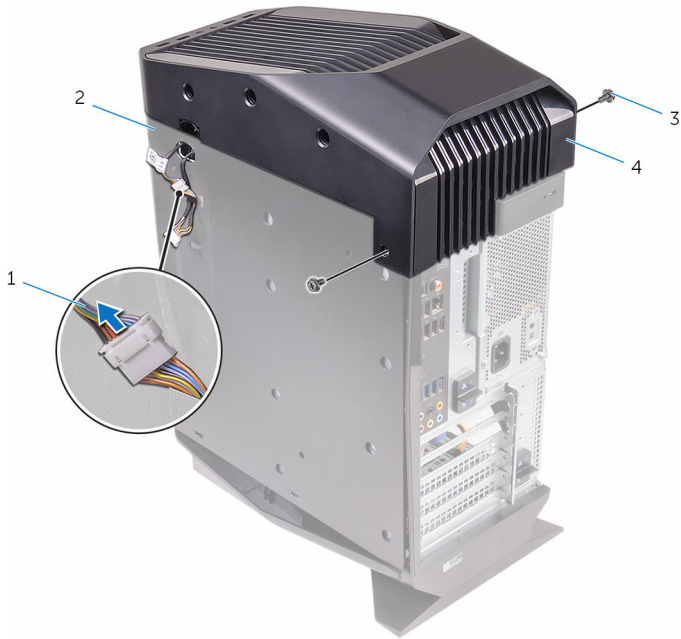

1 lighting cable

2 chassis

3 screws (2)

4 top cover

4 Starting from the rear, release the tabs on the top cover from the slots on the chassis.

5 Lift the top cover off the chassis.

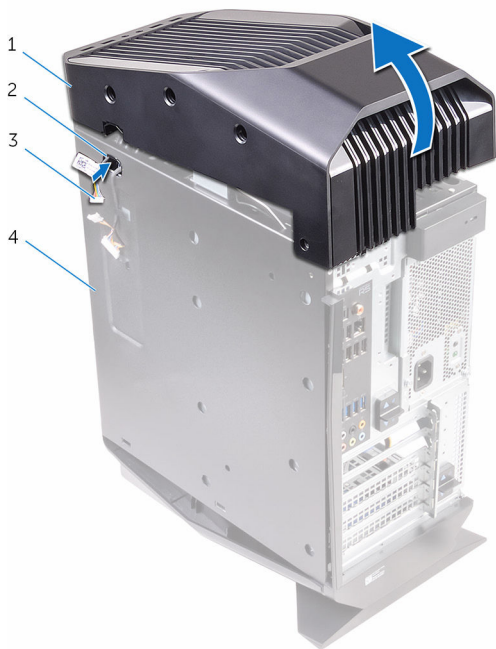

1 top cover

2 slot

3 lighting cable

4 chassis

Replacing the top-cover assembly

 **WARNING:** Before working inside your computer, read the safety information that shipped with your computer and follow the steps in [Before working inside your computer](#). After working inside your computer, follow the instructions in [After working inside your computer](#). For more safety best practices, see the Regulatory Compliance home page at www.dell.com/regulatory_compliance.

Procedure

- 1 Slide the lighting cable through the slot on the chassis.
- 2 Align the tabs on the top cover with the slots on the chassis and snap the top cover into place.
- 3 Connect the lighting cable to the top cover.
- 4 Replace the screws that secure the top cover to the chassis.

Post-requisites

- 1 Replace the [right-side cover](#).
- 2 Replace the [left-side cover](#).

Removing the bottom cover



WARNING: Before working inside your computer, read the safety information that shipped with your computer and follow the steps in [Before working inside your computer](#). After working inside your computer, follow the instructions in [After working inside your computer](#). For more safety best practices, see the Regulatory Compliance home page at www.dell.com/regulatory_compliance.

Prerequisites

Remove the [left-side cover](#).

Procedure

- 1 Place the computer on a clean and flat surface with the bottom cover facing up.
- 2 Press the securing tabs to release the bottom cover from the slots on the chassis.

3 Lift the bottom cover from the chassis.



1 bottom cover

2 chassis

3 securing tabs (4)

4 Tilt the computer back to the upright position.

Replacing the bottom cover



WARNING: Before working inside your computer, read the safety information that shipped with your computer and follow the steps in [Before working inside your computer](#). After working inside your computer, follow the instructions in [After working inside your computer](#). For more safety best practices, see the Regulatory Compliance home page at www.dell.com/regulatory_compliance.

Procedure

- 1 Tilt the computer towards the front until the base is facing up.
- 2 Align the tabs on the bottom cover with the slots on the chassis and snap the bottom cover to lock it in place.
- 3 Turn the computer over and place it in upright position.

Post-requisites

Replace the [left-side cover](#).

Removing the 3.5-inch hard drive



WARNING: Before working inside your computer, read the safety information that shipped with your computer and follow the steps in [Before working inside your computer](#). After working inside your computer, follow the instructions in [After working inside your computer](#). For more safety best practices, see the Regulatory Compliance home page at www.dell.com/regulatory_compliance.

Prerequisites

Remove the [left-side cover](#).

Procedure

- 1 Disconnect the data and power cables from the hard drive.

- 2** Press the release tabs on the hard-drive assembly and slide the hard-drive assembly out of the hard-drive cage.

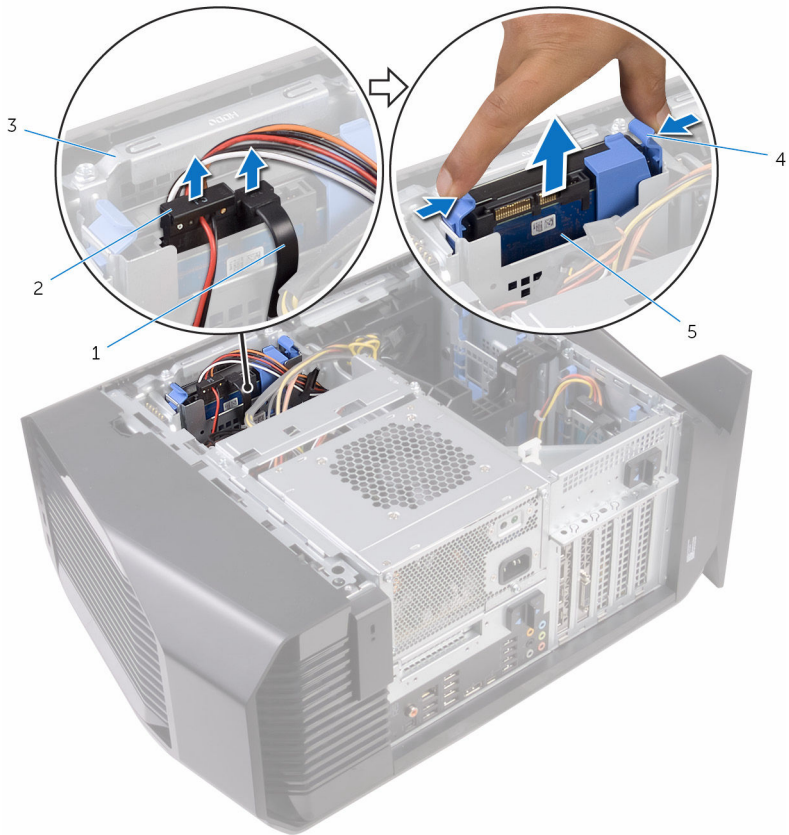

- | | | | |
|---|---------------------|---|--------------|
| 1 | data cable | 2 | power cable |
| 3 | hard-drive cage | 4 | release tabs |
| 5 | hard-drive assembly | | |

- 3** Pry the hard-drive bracket to release the tabs on the bracket from the slots on the hard drive.

- Lift the hard drive off the hard-drive bracket.

 **NOTE:** Note the orientation of the hard drive so that you can replace it correctly.

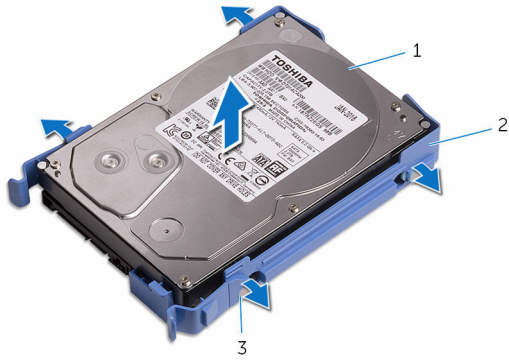

- | | | | |
|---|------------|---|--------------------|
| 1 | hard drive | 2 | hard-drive bracket |
| 3 | tabs (4) | | |

- Remove the screws that secure the hard-drive cage to the chassis.

6 Slide and lift the hard-drive cage off the chassis.

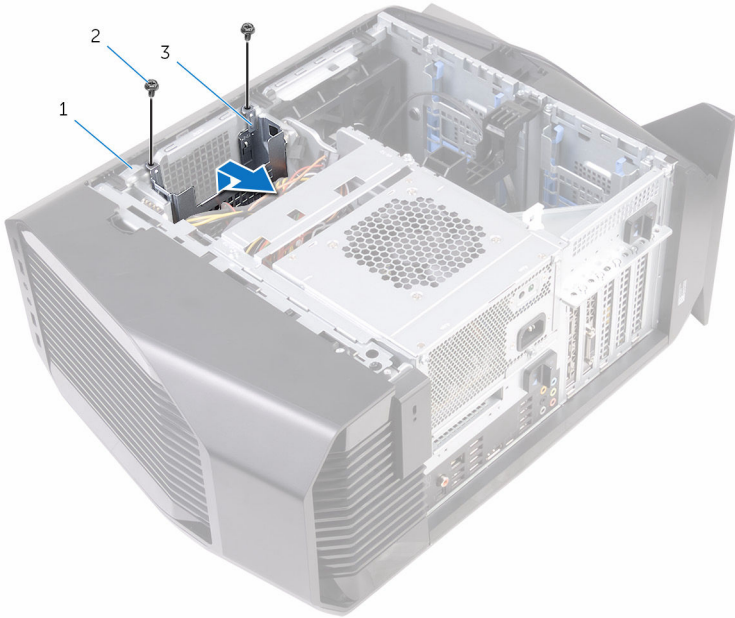

- 1 chassis
- 3 hard-drive cage

- 2 screws (2)

Replacing the 3.5-inch hard drive

 **WARNING:** Before working inside your computer, read the safety information that shipped with your computer and follow the steps in [Before working inside your computer](#). After working inside your computer, follow the instructions in [After working inside your computer](#). For more safety best practices, see the Regulatory Compliance home page at www.dell.com/regulatory_compliance.

Procedure

- 1 Align the tabs on the hard-drive cage with the slots on the chassis and slide the hard-drive cage into the chassis.
- 2 Replace the screws that secure the hard-drive cage to the chassis.
- 3 Place the hard drive into the hard-drive bracket and align the tabs on the bracket with the slots on the hard drive.
- 4 Snap the hard-drive bracket into the hard drive.
- 5 Slide the hard-drive assembly into the hard-drive cage until it snaps into place.
- 6 Connect the data and power cables to the hard drive.

Post-requisites

Replace the [left-side cover](#).

Removing the 2.5-inch hard drives



WARNING: Before working inside your computer, read the safety information that shipped with your computer and follow the steps in [Before working inside your computer](#). After working inside your computer, follow the instructions in [After working inside your computer](#). For more safety best practices, see the Regulatory Compliance home page at www.dell.com/regulatory_compliance.

Prerequisites

Remove the [left-side cover](#).

Procedure

- 1 Disconnect the data and power cables from the hard drive.

- 2** Press the release tabs on the hard-drive assembly and slide the hard-drive assembly out of the hard-drive cage.

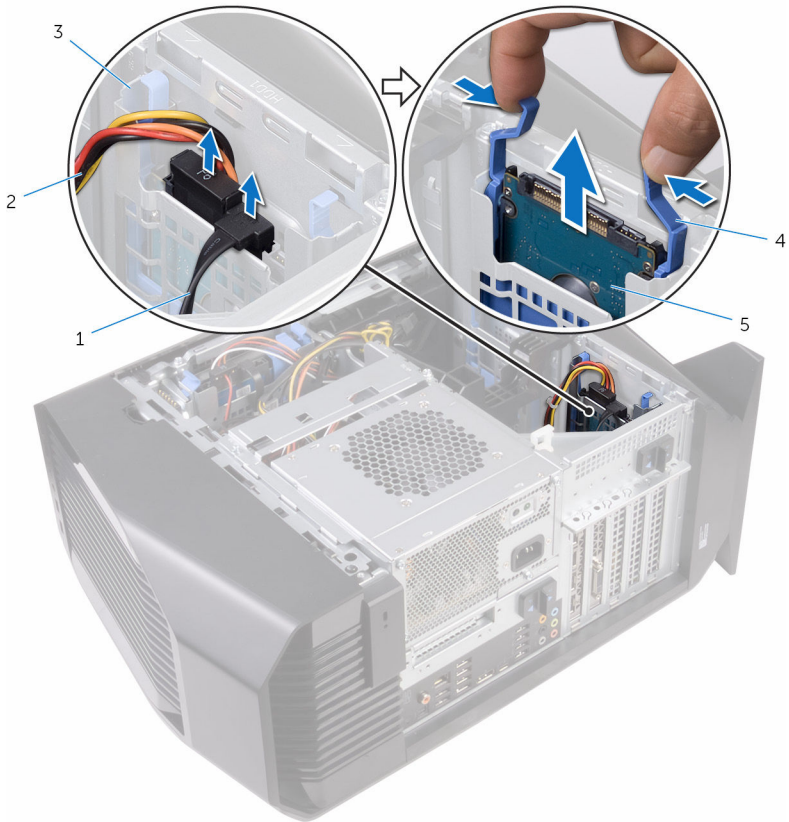

- | | | | |
|---|---------------------|---|--------------|
| 1 | data cable | 2 | power cable |
| 3 | hard-drive cage | 4 | release tabs |
| 5 | hard-drive assembly | | |

- 3** Pry the hard-drive bracket to release the tabs on the bracket from the slots on the hard drive.

- Lift the hard drive off the hard-drive bracket.

 **NOTE:** Note the orientation of the hard drive so that you can replace it correctly.

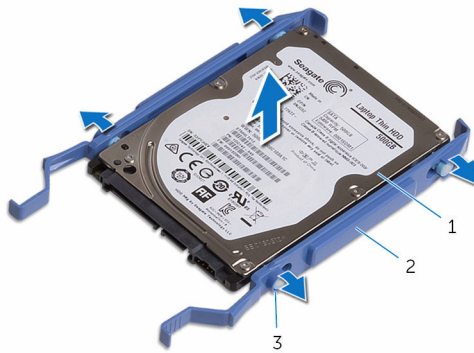

1 hard drive

2 hard-drive bracket

3 tabs (4)

- Remove the screws that secure the hard-drive cage to the chassis.

6 Slide and lift the hard-drive cage off the chassis.

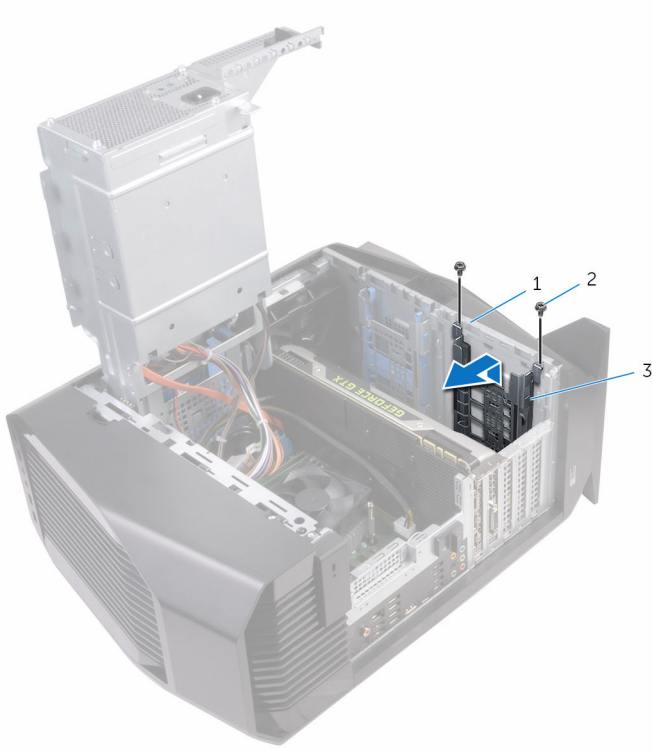

1 chassis

2 screws (2)

3 hard-drive cage

Replacing the 2.5-inch hard drives



WARNING: Before working inside your computer, read the safety information that shipped with your computer and follow the steps in [Before working inside your computer](#). After working inside your computer, follow the instructions in [After working inside your computer](#). For more safety best practices, see the Regulatory Compliance home page at www.dell.com/regulatory_compliance.

Procedure

- 1 Align the tabs on the hard-drive cage with the slots on the chassis and slide the hard-drive cage into the chassis.
- 2 Replace the screws that secure the hard-drive cage to the chassis.
- 3 Place the hard drive into the hard-drive bracket and align the tabs on the bracket with the slots on the hard drive.
- 4 Snap the hard-drive bracket into the hard drive.
- 5 Slide the hard-drive assembly into the hard-drive cage until it snaps into place.
- 6 Connect the data cable and power cable to the hard drive.

Post-requisites

Replace the [left-side cover](#).

Removing the power-supply unit



WARNING: Before working inside your computer, read the safety information that shipped with your computer and follow the steps in [Before working inside your computer](#). After working inside your computer, follow the instructions in [After working inside your computer](#). For more safety best practices, see the Regulatory Compliance home page at www.dell.com/regulatory_compliance.

Prerequisites

Remove the [left-side cover](#).

Procedure



NOTE: Note the routing of all cables as you remove them so that you can reroute them correctly after you replace the power supply.

- 1 Lay the computer on the right side.

- 2 Slide the power supply unit release latches towards the top of the computer.

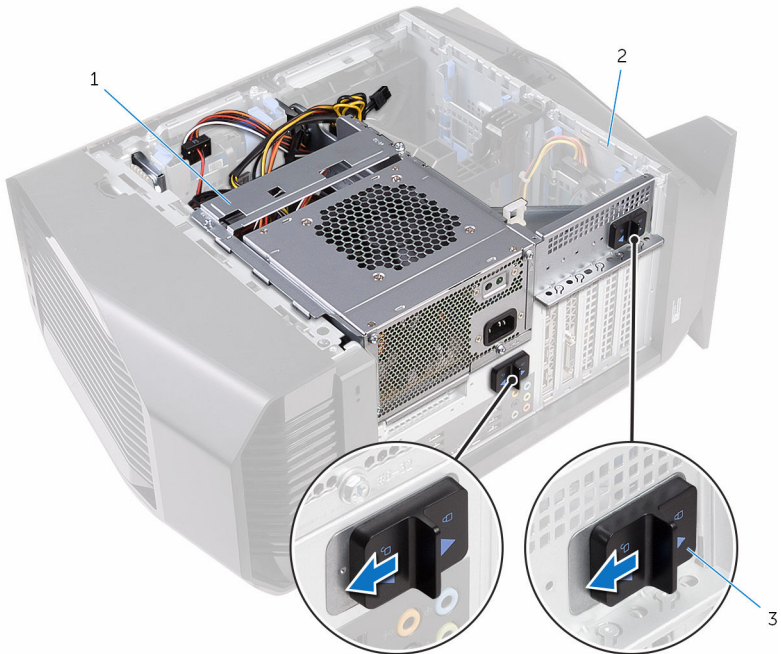

- 1 power-supply unit
3 power supply unit release latches (2)

2 chassis

- 3** Lift the power-supply unit while pressing and holding the graphics-card bracket.

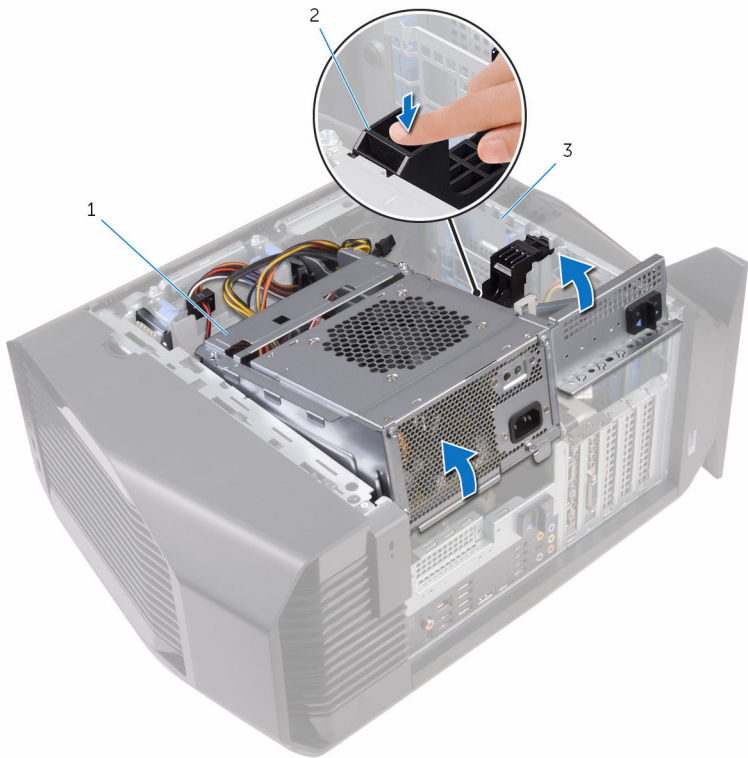

1 power-supply unit
3 chassis

2 graphics-card bracket

- 4 Rotate the power-supply unit away from the chassis.

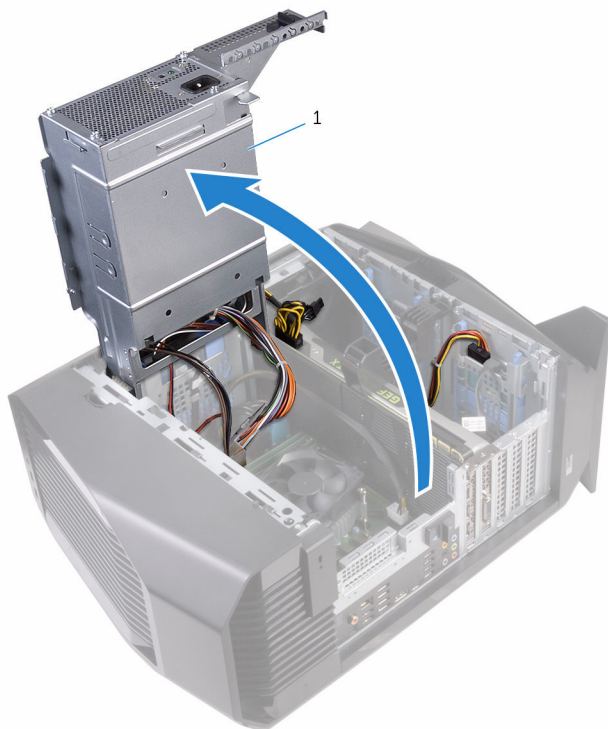

1 power-supply unit

- 5 Press the releasing clip on the power-cable connectors and disconnect the power cables from the graphics card.
- 6 Disconnect the power cables from the optical drive and hard drives.

- 7** Disconnect the processor-power cable and system-board power cable from the system board.

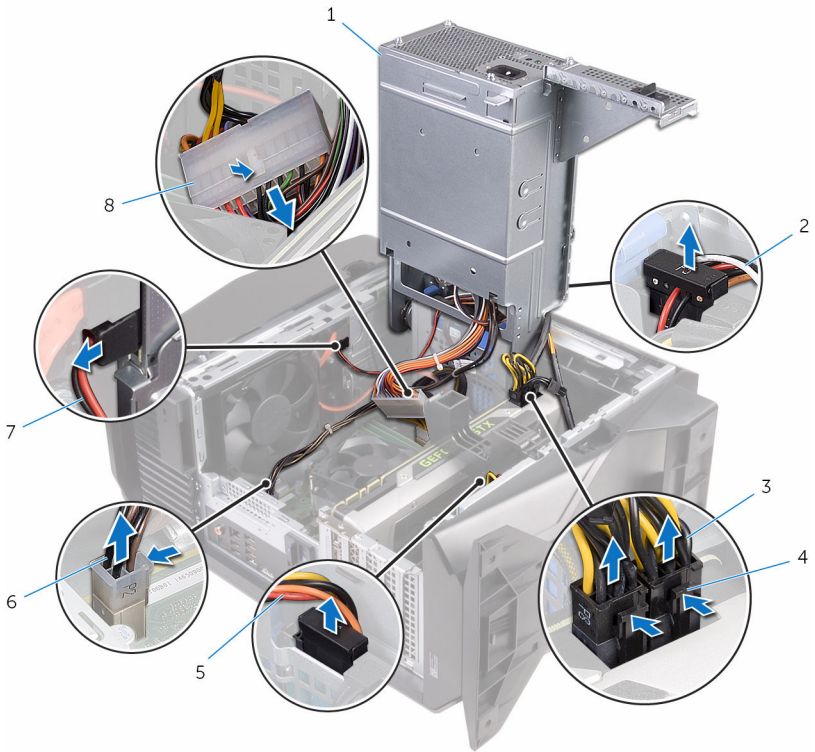

- | | | | |
|---|--------------------------------|---|--------------------------|
| 1 | power-supply unit | 2 | hard-drive power cable |
| 3 | graphics-card power cables (2) | 4 | releasing clips (2) |
| 5 | hard-drive power cable | 6 | processor-power cable |
| 7 | optical-drive power cable | 8 | system-board power cable |

- 8** Rotate the power-supply unit towards the chassis until the unit snaps into place.
- 9** Remove the screws that secure the power-supply unit bracket to the power-supply unit.

10 Lift the power-supply unit bracket off the power-supply unit.

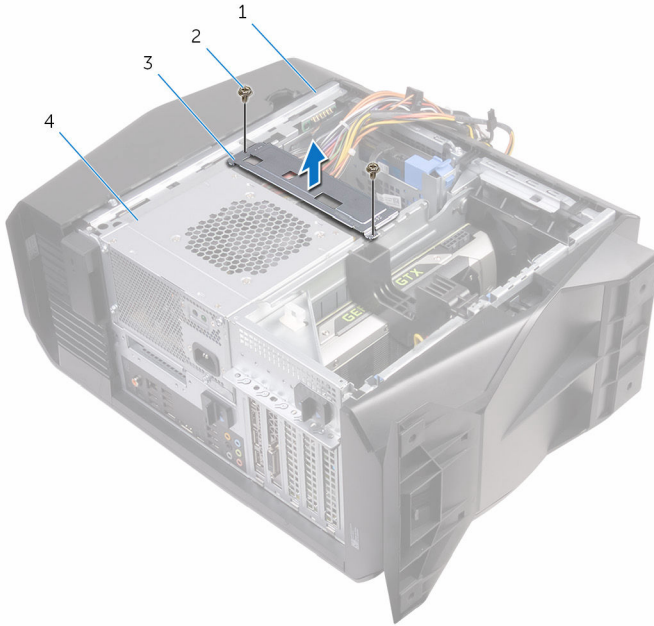

1 chassis

2 screws (2)

3 power-supply unit bracket

4 power-supply unit

11 Remove the screws that secure the power-supply unit to the chassis.

12 Lift the power-supply unit, along with the cables, off the chassis.

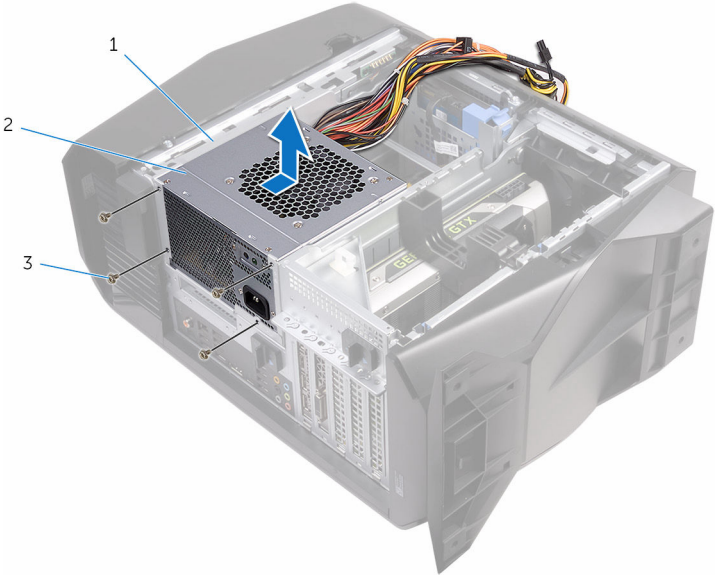

- 1 chassis
- 3 screws (4)

- 2 power-supply unit

Replacing the power-supply unit



WARNING: Before working inside your computer, read the safety information that shipped with your computer and follow the steps in [Before working inside your computer](#). After working inside your computer, follow the instructions in [After working inside your computer](#). For more safety best practices, see the Regulatory Compliance home page at www.dell.com/regulatory_compliance.

Procedure

- 1 Place the power supply on the chassis.
- 2 Align the screw holes on the power-supply unit with the screw holes on the chassis.
- 3 Replace the screws that secure the power-supply unit to the chassis.
- 4 Align the screw holes on the power-supply unit bracket with the screw holes on the power-supply unit.
- 5 Replace the screws that secure the power-supply unit bracket to the power-supply unit.
- 6 Slide the power supply unit release latches towards the top of the computer.
- 7 Lift and rotate the power-supply unit away from the chassis while pressing and holding the graphics-card bracket.
- 8 Connect the power cables to the graphics card, hard drives, and optical drive.
- 9 Connect the processor-power cable and system-board power cable to the system board.
- 10 Rotate the power-supply unit towards the chassis until the unit snaps into place.
- 11 Slide the power supply unit release latches towards the bottom of the computer.

Post-requisites

Replace the [left-side cover](#).

Removing the processor-cooling assembly



WARNING: Before working inside your computer, read the safety information that shipped with your computer and follow the steps in [Before working inside your computer](#). After working inside your computer, follow the instructions in [After working inside your computer](#). For more safety best practices, see the Regulatory Compliance home page at www.dell.com/regulatory_compliance.

Prerequisites

- 1 Remove the [left-side cover](#).
- 2 Remove the [right-side cover](#).
- 3 Remove the [top cover](#).

Procedure

- 1 Remove the screws that secure the radiator and fan assembly to the radiator and fan cage.

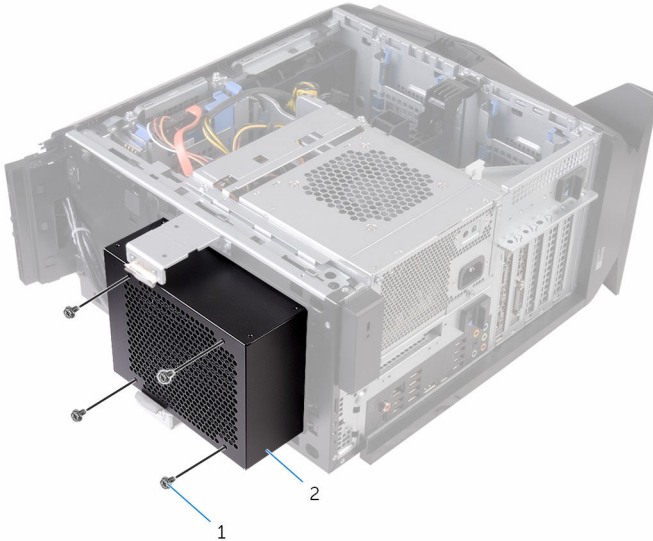

1 screws (4)

2 radiator and fan cage

- 2 Follow the procedure from step 1 to step 4 in "[Removing the power-supply unit](#)".
- 3 Disconnect the processor-cooling assembly cables from the system board.
- 4 In sequential order (as indicated on the processor cooler), loosen the captive screws that secure the processor cooler to the system board.

- 5 Lift the processor-cooling assembly along with the cables off the computer.

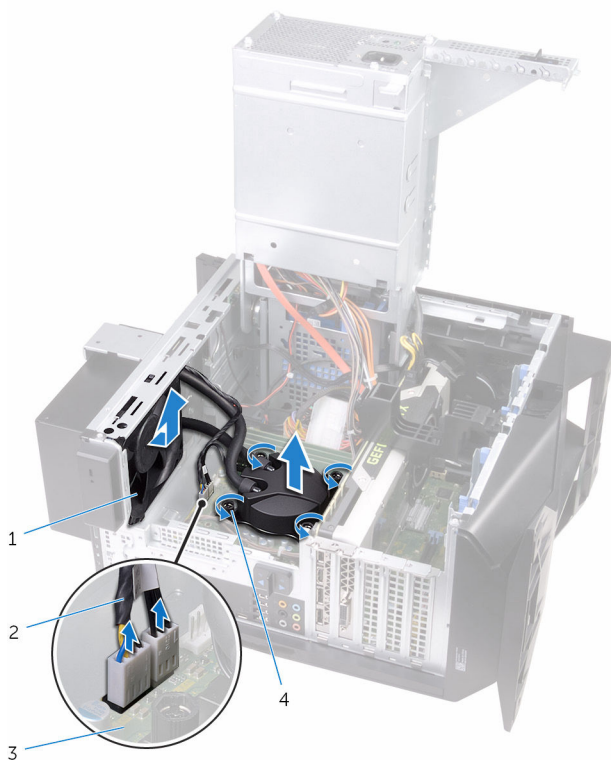

1 processor-cooling assembly

2 processor-cooling assembly cables

3 system board

4 captive screws (4)

Replacing the processor-cooling assembly



WARNING: Before working inside your computer, read the safety information that shipped with your computer and follow the steps in [Before working inside your computer](#). After working inside your computer, follow the instructions in [After working inside your computer](#). For more safety best practices, see the Regulatory Compliance home page at www.dell.com/regulatory_compliance.

Procedure

- 1 Slide the radiator and fan assembly into the radiator and fan cage.
- 2 Align the screw holes on the radiator and fan assembly with the screw holes on the radiator and fan cage.
- 3 Replace the screws that secure the radiator and fan assembly to the radiator and fan cage.
- 4 Align the screw holes on the processor cooler with the screw holes on the system board.
- 5 In sequential order (indicated on the processor cooler), tighten the captive screws that secure the processor cooler to the system board.
- 6 Connect the processor-cooling assembly cables to the system board.
- 7 Follow the procedure from step 10 to step 11 in "[Replacing the power-supply unit](#)".
- 8 Replace the screws that secure the radiator and fan assembly to the chassis.

Post-requisites

- 1 Replace the [top cover](#).
- 2 Replace the [right-side cover](#).
- 3 Replace the [left-side cover](#).

Removing the coin-cell battery

 **WARNING:** Before working inside your computer, read the safety information that shipped with your computer and follow the steps in [Before working inside your computer](#). After working inside your computer, follow the instructions in [After working inside your computer](#). For more safety best practices, see the Regulatory Compliance home page at www.dell.com/regulatory_compliance.

 **CAUTION:** Removing the coin-cell battery resets the BIOS setup program's settings to default. It is recommended that you note the BIOS setup program's settings before removing the coin-cell battery.

Prerequisites

- 1 Remove the [left-side cover](#).
- 2 Follow the procedure from step 1 to step 4 in "[Removing the power-supply unit](#)".

Procedure

- 1 Using a plastic scribe, press the battery-release lever away from the coin-cell battery until the coin-cell battery pops up.

2 Lift the coin-cell battery out of its socket.

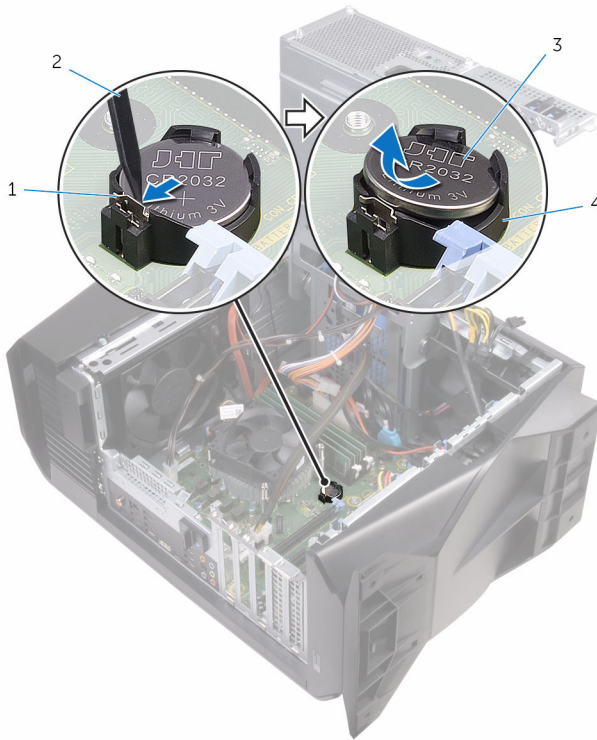

1 battery-release lever

2 plastic scribe

3 coin-cell battery

4 coin-cell battery socket

Replacing the coin-cell battery



WARNING: Before working inside your computer, read the safety information that shipped with your computer and follow the steps in [Before working inside your computer](#). After working inside your computer, follow the instructions in [After working inside your computer](#). For more safety best practices, see the Regulatory Compliance home page at www.dell.com/regulatory_compliance.

Procedure

Insert a new coin-cell battery (CR2032) into the battery socket with the positive side facing up, and snap the battery into place.

Post-requisites

- 1 Follow the procedure from step 10 to step 11 in "[Replacing the power-supply unit](#)".
- 2 Replace the [left-side cover](#).

Removing the memory modules



WARNING: Before working inside your computer, read the safety information that shipped with your computer and follow the steps in [Before working inside your computer](#). After working inside your computer, follow the instructions in [After working inside your computer](#). For more safety best practices, see the Regulatory Compliance home page at www.dell.com/regulatory_compliance.

Prerequisites

- 1 Remove the [left-side cover](#).
- 2 Follow the procedure from step 1 to step 4 in "[Removing the power-supply unit](#)".

Procedure

- 1 Locate the memory-module slots on the system board. For more information, see "[System-board components](#)".
- 2 Push the securing clips away from the memory module.

- 3** Grasp the memory module near the securing clip, and then gently ease the memory module out of the memory-module slot.

 **NOTE:** Repeat step 2 to step 3 to remove any other memory modules installed in your computer.

 **CAUTION:** To prevent damage to the memory module, hold the memory module by the edges. Do not touch the components on the memory module.

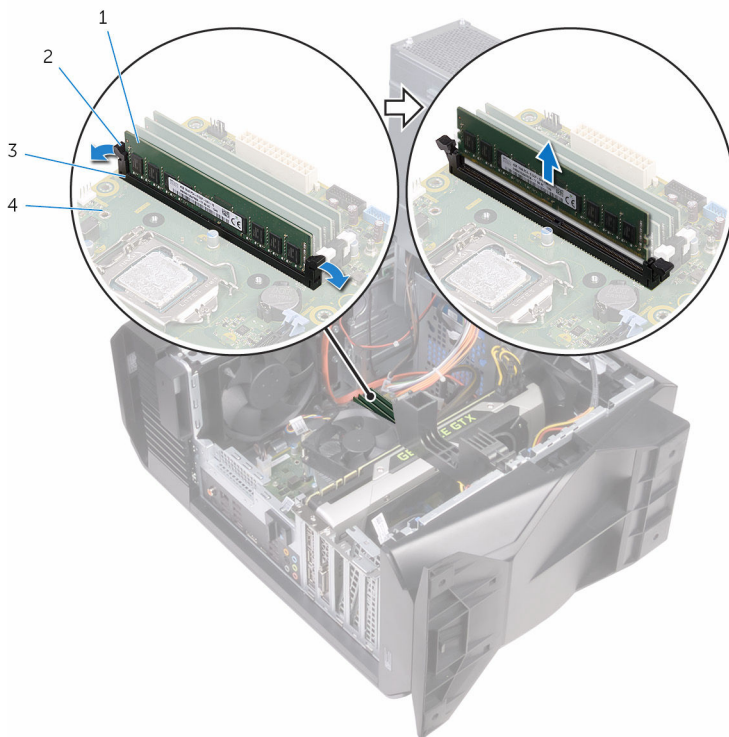

- | | | | |
|---|--------------------|---|--------------------|
| 1 | memory module | 2 | securing clips (2) |
| 3 | memory-module slot | 4 | system board |

Replacing the memory modules



WARNING: Before working inside your computer, read the safety information that shipped with your computer and follow the steps in [Before working inside your computer](#). After working inside your computer, follow the instructions in [After working inside your computer](#). For more safety best practices, see the Regulatory Compliance home page at www.dell.com/regulatory_compliance.

Procedure

- 1 Ensure that the securing clips are extended away from the memory-module slot.
- 2 Align the notch on the memory module with the tab on the memory-module slot.

- 3** Insert the memory module into the memory-module slot and press the memory module down until it snaps into position and the securing clips lock in place.

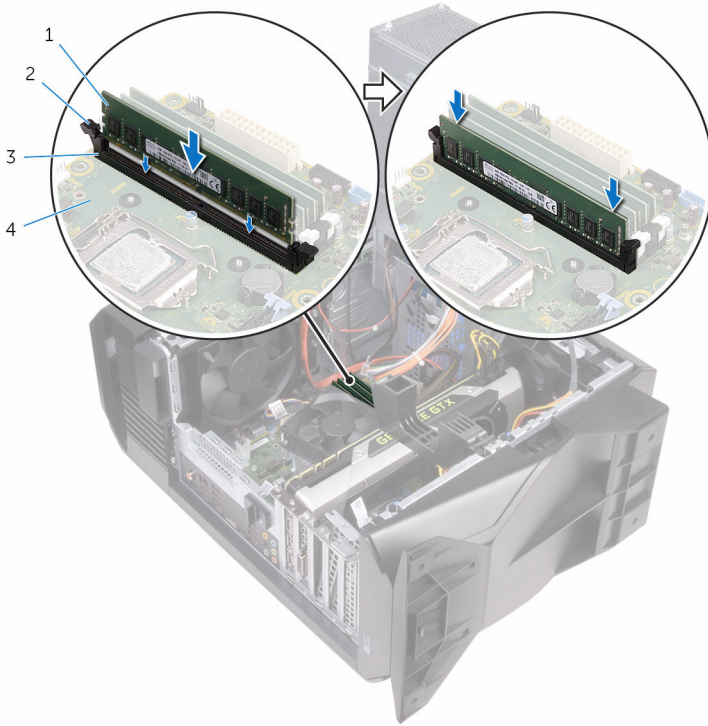

- | | | | |
|---|--------------------|---|--------------------|
| 1 | memory module | 2 | securing clips (2) |
| 3 | memory-module slot | 4 | system board |

NOTE: Use slots XMM1 and XMM2 if you need to use two memory modules. For more information, see [System-board components](#).



The following table lists the available memory configuration matrix:

Configuration	Slot			
	XMM1	XMM2	XMM3	XMM4
8 GB	4 GB	4 GB		
16 GB	8 GB	8 GB		
24 GB	4 GB	4 GB	8 GB	8 GB
32 GB	8 GB	8 GB	8 GB	8 GB
64 GB	16 GB	16 GB	16 GB	16 GB

Post-requisites

- 1 Follow the procedure from step 10 to step 11 in "[Replacing the power-supply unit](#)".
- 2 Replace the [left-side cover](#).

Removing the solid-state drive

-  **WARNING:** Before working inside your computer, read the safety information that shipped with your computer and follow the steps in [Before working inside your computer](#). After working inside your computer, follow the instructions in [After working inside your computer](#). For more safety best practices, see the Regulatory Compliance home page at www.dell.com/regulatory_compliance.
-  **CAUTION:** Solid-state drives are fragile. Exercise care when handling the solid-state drive.
-  **CAUTION:** To avoid data loss, do not remove the solid-state drive while the computer is in sleep or on state.

Prerequisites

- 1 Remove the [left-side cover](#).
- 2 Follow the procedure from step 1 to step 4 in "[Removing the power-supply unit](#)".

Procedure

- 1 Locate the solid-state drive slot on the system board. For more information, see "[System-board components](#)".
- 2 Remove the screw that secures the solid-state drive to the system board.

3 Slide and lift the solid-state drive off the system board.

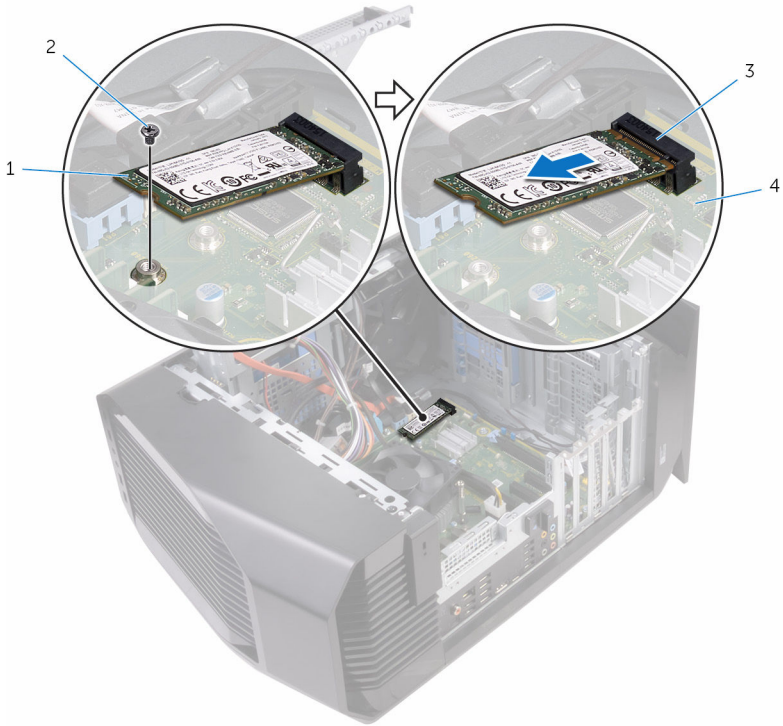

- 1 solid-state drive
- 3 solid-state drive slot

- 2 screw
- 4 system board

Replacing the solid-state drive

 **WARNING:** Before working inside your computer, read the safety information that shipped with your computer and follow the steps in [Before working inside your computer](#). After working inside your computer, follow the instructions in [After working inside your computer](#). For more safety best practices, see the Regulatory Compliance home page at www.dell.com/regulatory_compliance.

 **CAUTION:** Solid-state drives are fragile. Exercise care when handling the solid-state drive.

Procedure

- 1 Align the notch on the solid-state drive with the tab on the solid-state drive slot.
- 2 Insert the solid-state drive at a 45-degree angle into the system board.

- 3** Press the other end of the solid-state drive down and replace the screw that secure the solid-state drive to the system board.

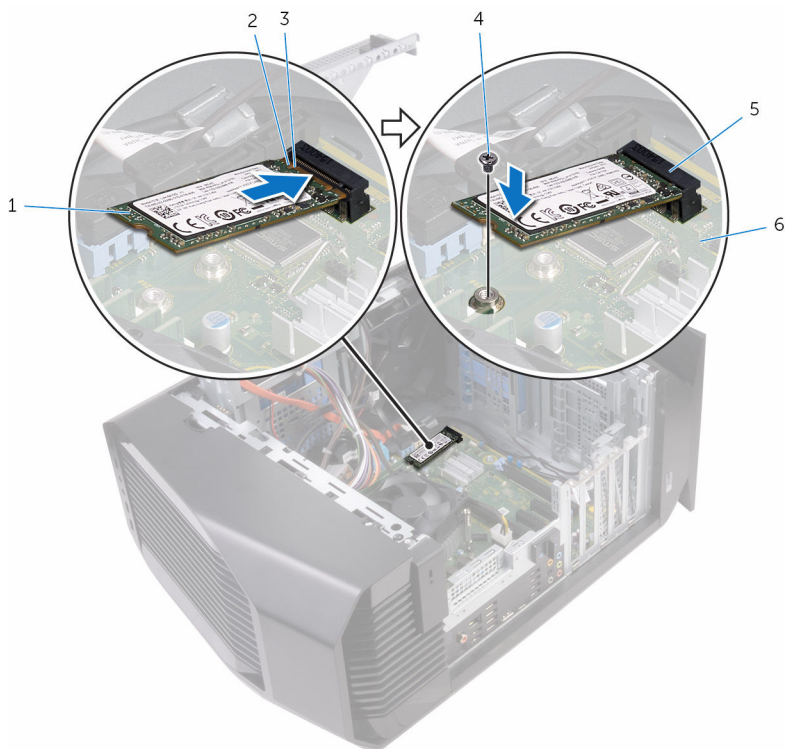

- 1 solid-state drive
3 tab
5 solid-state drive slot

- 2 notch
4 screw
6 system board

Post-requisites

- 1 Follow the procedure from step 10 to step 11 in "[Replacing the power-supply unit](#)".
- 2 Replace the [left-side cover](#).

Removing the graphics card



WARNING: Before working inside your computer, read the safety information that shipped with your computer and follow the steps in [Before working inside your computer](#). After working inside your computer, follow the instructions in [After working inside your computer](#). For more safety best practices, see the Regulatory Compliance home page at www.dell.com/regulatory_compliance.

Prerequisites

- 1 Remove the [left-side cover](#).
- 2 Follow the procedure from step 1 to step 4 in "[Removing the power-supply unit](#)".

Procedure

- 1 Lift to release the graphics-card bracket from the chassis.

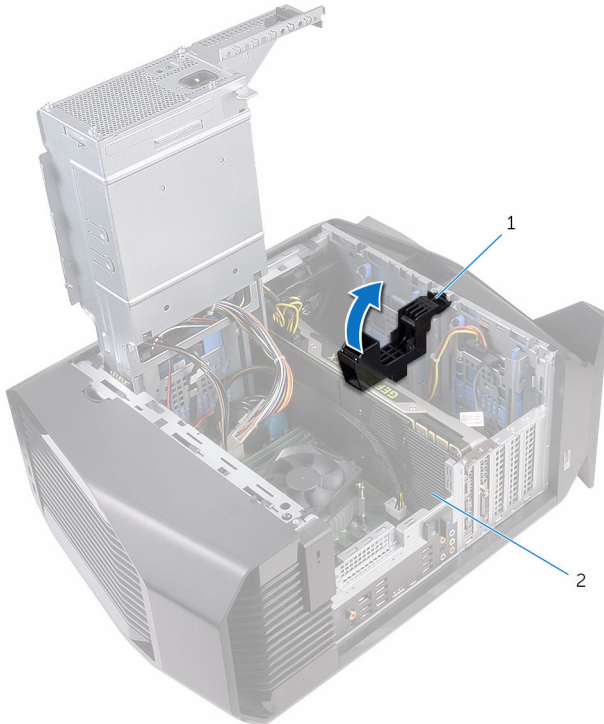

1 graphics-card bracket

2 graphics card

- 2 Press the releasing clip on the power-cable connectors and disconnect the power cables from the graphics card.

- 3** Push the securing tab on the PCIe slot away from the graphics card, grasp the card by its top corner, and ease it out of the slot.

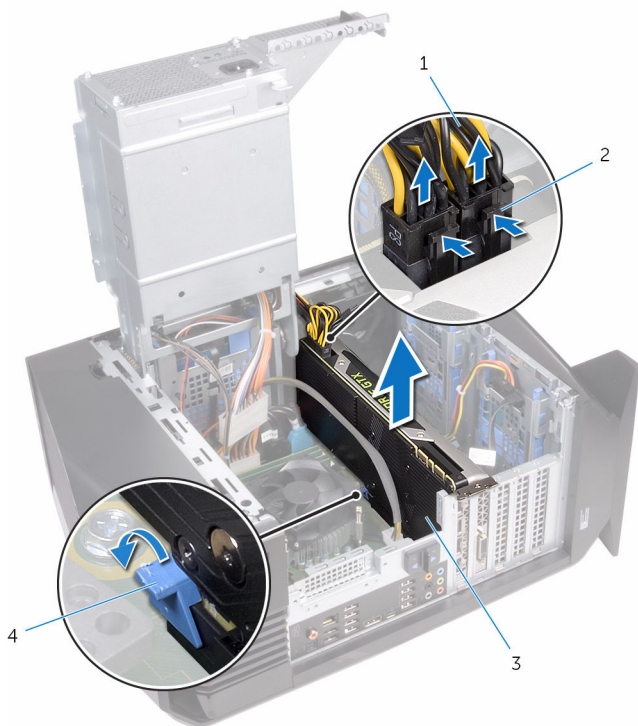

1 power cables

2 releasing clips (2)

3 graphics card

4 securing tab

Replacing the graphics card



WARNING: Before working inside your computer, read the safety information that shipped with your computer and follow the steps in [Before working inside your computer](#). After working inside your computer, follow the instructions in [After working inside your computer](#). For more safety best practices, see the Regulatory Compliance home page at www.dell.com/regulatory_compliance.

Procedure

- 1 Align the graphics card with the slot on the system board.
- 2 Place the card into the slot and press down firmly until the graphics card snaps into place.
- 3 Connect the power cables to the graphics card.
- 4 Slide the tab on the graphics-card bracket into the slot on the chassis and snap it into place.

Post-requisites

- 1 Follow the procedure from step 10 to step 11 in "[Replacing the power-supply unit](#)".
- 2 Replace the [left-side cover](#).

Removing the processor fan and heat-sink assembly

 **WARNING:** Before working inside your computer, read the safety information that shipped with your computer and follow the steps in [Before working inside your computer](#). After working inside your computer, follow the instructions in [After working inside your computer](#). For more safety best practices, see the Regulatory Compliance home page at www.dell.com/regulatory_compliance.

 **WARNING:** The heat sink may become hot during normal operation. Allow sufficient time for the heat sink to cool before you touch it.

 **CAUTION:** For maximum cooling of the processor, do not touch the heat transfer areas on the heat sink. The oils in your skin can reduce the heat transfer capability of the thermal grease.

Prerequisites

- 1 Remove the [left-side cover](#).
- 2 Follow the procedure from step 1 to step 4 in "[Removing the power-supply unit](#)".

Procedure

- 1 Disconnect the processor-fan cable from the system board.
- 2 Loosen the captive screws that secure the processor fan and heat-sink assembly to the system board.

- 3** Lift the processor fan and heat-sink assembly off the system board.

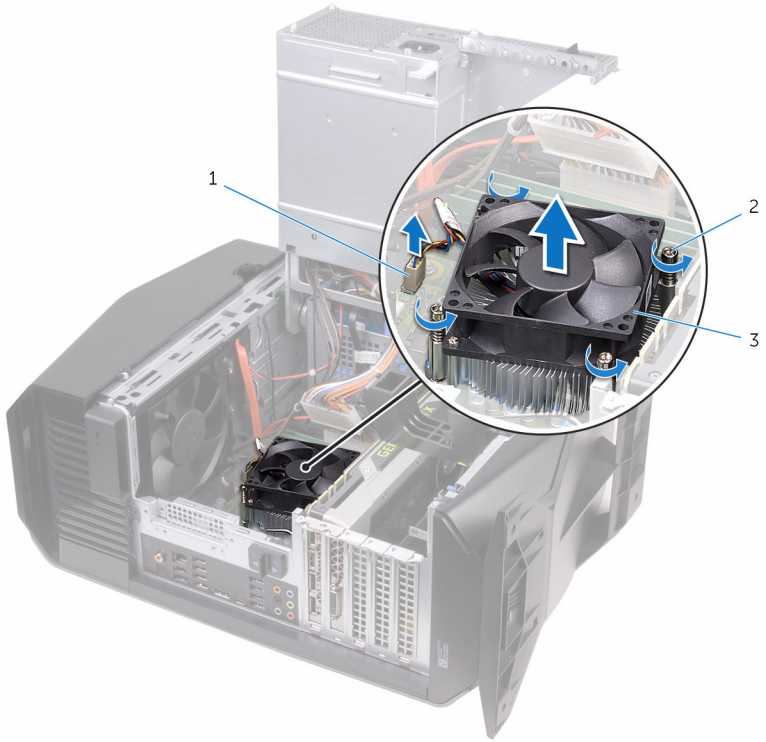

- | | | | |
|---|--------------------------------------|---|--------------------|
| 1 | processor-fan cable | 2 | captive screws (4) |
| 3 | processor fan and heat-sink assembly | | |

Replacing the processor fan and heat-sink assembly

 **WARNING:** Before working inside your computer, read the safety information that shipped with your computer and follow the steps in [Before working inside your computer](#). After working inside your computer, follow the instructions in [After working inside your computer](#). For more safety best practices, see the Regulatory Compliance home page at www.dell.com/regulatory_compliance.

Procedure

 **NOTE:** The original thermal grease can be reused if the original processor and heat-sink assembly are reinstalled together.

 **CAUTION:** If either the processor or the heat-sink assembly is replaced, use the thermal grease provided in the kit to ensure that thermal conductivity is achieved.

- 1 Place the processor fan and heat-sink assembly on the processor.
- 2 Align the captive screws on the processor fan heat-sink assembly with the screw holes on the system board.
- 3 Tighten the captive screws that secure the processor fan and heat-sink assembly to the system board.
- 4 Connect the processor-fan cable to the system board.

Post-requisites

- 1 Follow the procedure from step 10 to step 11 in "[Replacing the power-supply unit](#)".
- 2 Replace the [left-side cover](#).

Removing the processor

⚠ WARNING: Before working inside your computer, read the safety information that shipped with your computer and follow the steps in [Before working inside your computer](#). After working inside your computer, follow the instructions in [After working inside your computer](#). For more safety best practices, see the Regulatory Compliance home page at www.dell.com/regulatory_compliance.

Prerequisites

- 1 Remove the [left-side cover](#).
- 2 Follow the procedure from step 1 to step 4 in "[Removing the power-supply unit](#)".
- 3 Remove the [processor fan and heat-sink assembly](#) or [processor-cooling assembly](#) (as applicable).

Procedure

- 1 Press the release lever down and then push it away from the processor to release it from the tab.
- 2 Extend the release lever completely and open the processor cover.
- 3 Lift the processor off the processor socket.

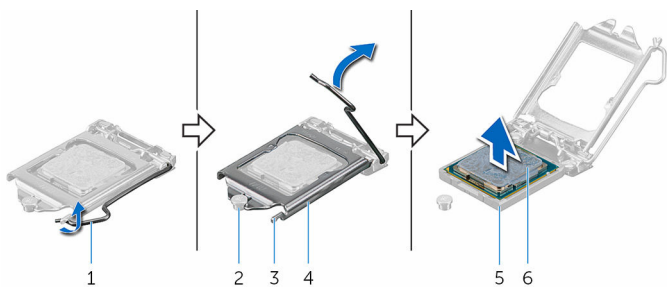

1 release lever

3 tab

5 processor socket

2 alignment post

4 processor cover

6 processor

Replacing the processor

 **WARNING:** Before working inside your computer, read the safety information that shipped with your computer and follow the steps in [Before working inside your computer](#). After working inside your computer, follow the instructions in [After working inside your computer](#). For more safety best practices, see the Regulatory Compliance home page at www.dell.com/regulatory_compliance.

 **CAUTION:** If either the processor or the heat sink is replaced, use the thermal grease provided in the kit to ensure that thermal conductivity is achieved.

 **NOTE:** A new processor ships with a thermal pad in the package. In some cases, the processor may ship with the thermal pad attached to it.

Procedure

- 1 Ensure that the release lever on the processor socket is fully extended and the processor cover is fully open.

 **CAUTION:** Position the processor correctly in the processor socket to avoid permanent damage to the processor.

- 2 Align the pin-1 corner on the processor with the pin-1 corner on the processor socket, and then place the processor in the processor socket.

 **CAUTION:** Ensure that the processor-cover notch is positioned underneath the alignment post.

- 3 When the processor is fully seated in the socket, close the processor cover.

- 4** Pivot the release lever down and place it under the tab on the processor cover.

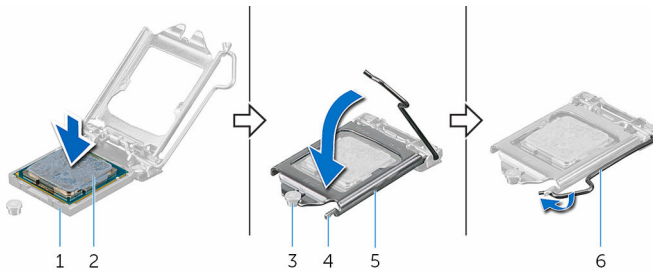

1 processor socket

3 alignment post

5 processor cover

2 processor

4 tab

6 release lever

Post-requisites

- 1 Replace the [processor fan and heat-sink assembly](#) or [processor-cooling assembly](#) (as applicable).
- 2 Follow the procedure from step 10 to step 11 in "[Replacing the power-supply unit](#)".
- 3 Replace the [left-side cover](#).

Removing the wireless card



WARNING: Before working inside your computer, read the safety information that shipped with your computer and follow the steps in [Before working inside your computer](#). After working inside your computer, follow the instructions in [After working inside your computer](#). For more safety best practices, see the Regulatory Compliance home page at www.dell.com/regulatory_compliance.

Prerequisites

- 1 Remove the [left-side cover](#).
- 2 Follow the procedure from step 1 to step 4 in "[Removing the power-supply unit](#)".

Procedure

- 1 Remove the screw that secures the wireless card to the system board.
- 2 Lift the wireless-card bracket off the wireless card.
- 3 Disconnect the antenna cables from the wireless card.

4 Slide and remove the wireless card from the wireless-card slot.

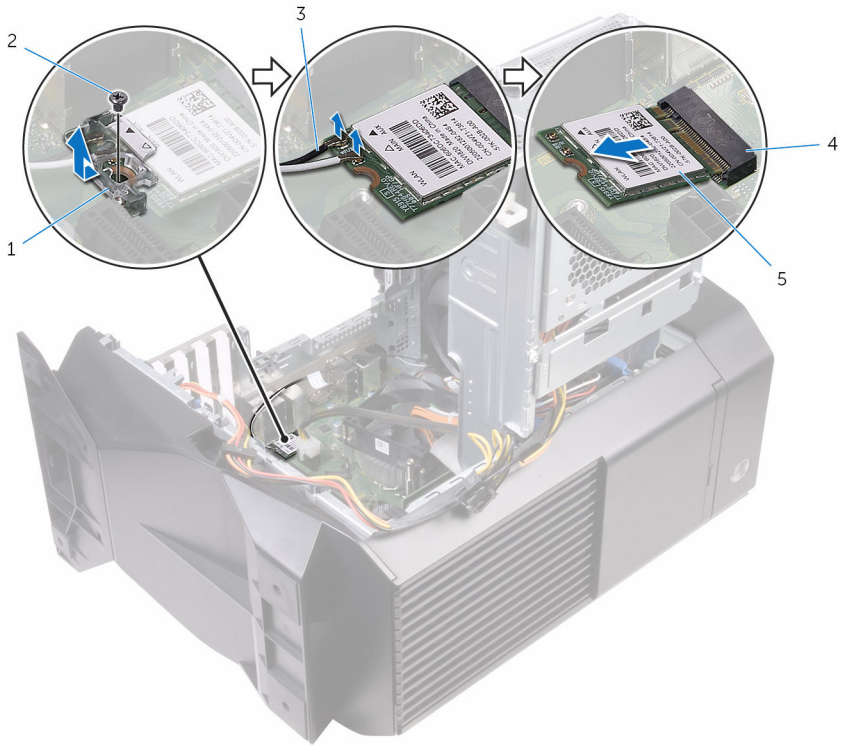

1 wireless-card bracket

2 screw

3 antenna cables

4 wireless-card slot

5 wireless card

Replacing the wireless card



WARNING: Before working inside your computer, read the safety information that shipped with your computer and follow the steps in [Before working inside your computer](#). After working inside your computer, follow the instructions in [After working inside your computer](#). For more safety best practices, see the Regulatory Compliance home page at www.dell.com/regulatory_compliance.

Procedure

- 1 Align the notch on the wireless card with the tab on the wireless-card slot.
- 2 Slide the wireless card at an angle into the wireless-card slot.
- 3 Connect the antenna cables to the wireless card.
- 4 Place the wireless-card bracket on the wireless card.

- 5 Replace the screw that secures the wireless card to the system board.

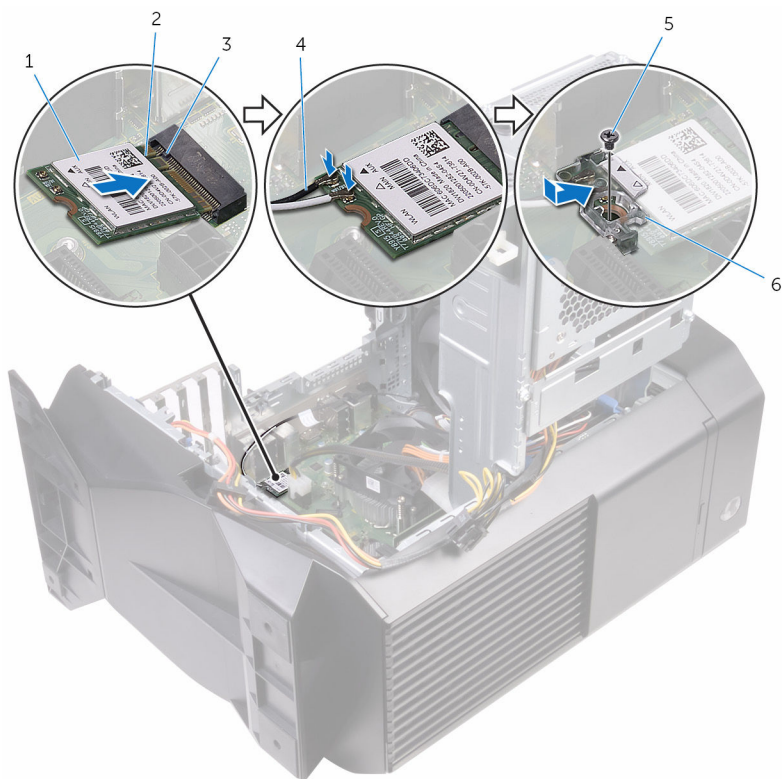

1 wireless card

2 notch

3 tab

4 antenna cables

5 screw

6 wireless-card bracket

Post-requisites

- 1 Follow the procedure from step 10 to step 11 in "[Replacing the power-supply unit](#)".
- 2 Replace the [left-side cover](#).

Removing the antenna



WARNING: Before working inside your computer, read the safety information that shipped with your computer and follow the steps in [Before working inside your computer](#). After working inside your computer, follow the instructions in [After working inside your computer](#). For more safety best practices, see the Regulatory Compliance home page at www.dell.com/regulatory_compliance.

Prerequisites

- 1 Remove the [left-side cover](#).
- 2 Remove the [right-side cover](#).
- 3 Remove the [top cover](#).

Procedure

- 1 Disconnect the antenna cables from the wireless card.
- 2 Note the antenna-cable routing and remove the antenna cables from the routing guides inside the chassis.

- 3** Push down the antenna cables towards the top of the computer through the cable-routing slot on the chassis.

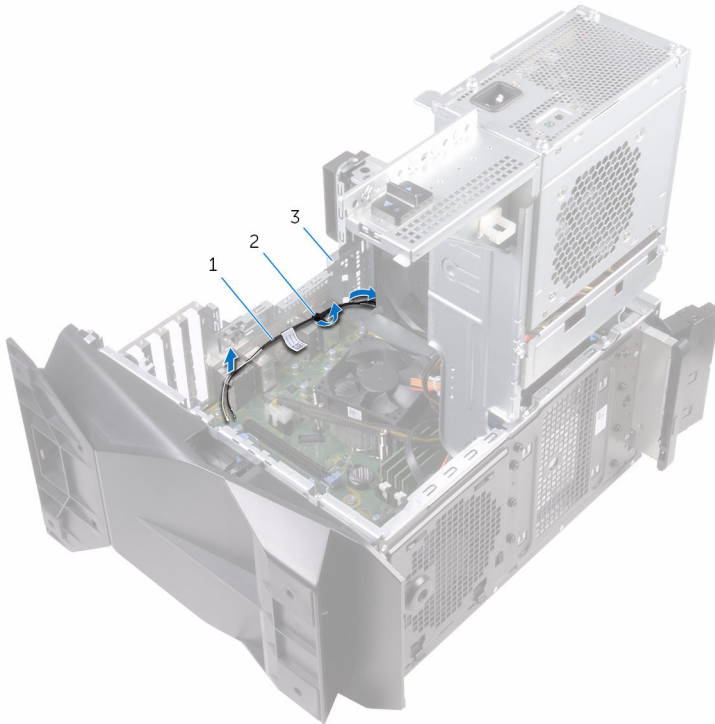

1 antenna cables

2 routing guides

3 chassis

- 4** Remove the antenna cables from the routing guides on the chassis.

5 Pry the antenna off the chassis.



1 antenna

2 antenna cables

3 routing guides

Replacing the antenna



WARNING: Before working inside your computer, read the safety information that shipped with your computer and follow the steps in [Before working inside your computer](#). After working inside your computer, follow the instructions in [After working inside your computer](#). For more safety best practices, see the Regulatory Compliance home page at www.dell.com/regulatory_compliance.

Procedure

- 1 Adhere the antenna to the chassis.
- 2 Route the antenna cables through the routing guides on the chassis and slide the cables through the cable-routing slot on the chassis.
- 3 Route the antenna cables through the routing guides inside the chassis.
- 4 Connect the antenna cables to the wireless card.

Post-requisites

- 1 Replace the [top cover](#).
- 2 Replace the [right-side cover](#).
- 3 Replace the [left-side cover](#).

Removing the front-chassis fan



WARNING: Before working inside your computer, read the safety information that shipped with your computer and follow the steps in [Before working inside your computer](#). After working inside your computer, follow the instructions in [After working inside your computer](#). For more safety best practices, see the Regulatory Compliance home page at www.dell.com/regulatory_compliance.

Prerequisites

- 1 Remove the [left-side cover](#).
- 2 Follow the procedure from step 1 to step 4 in "[Removing the power-supply unit](#)".
- 3 Remove the [graphics card](#).

Procedure

- 1 Disconnect the front-chassis fan cable from the system board.
- 2 Push the tab to release the front-chassis fan from the chassis.

3 Slide and lift the chassis fan off the chassis.

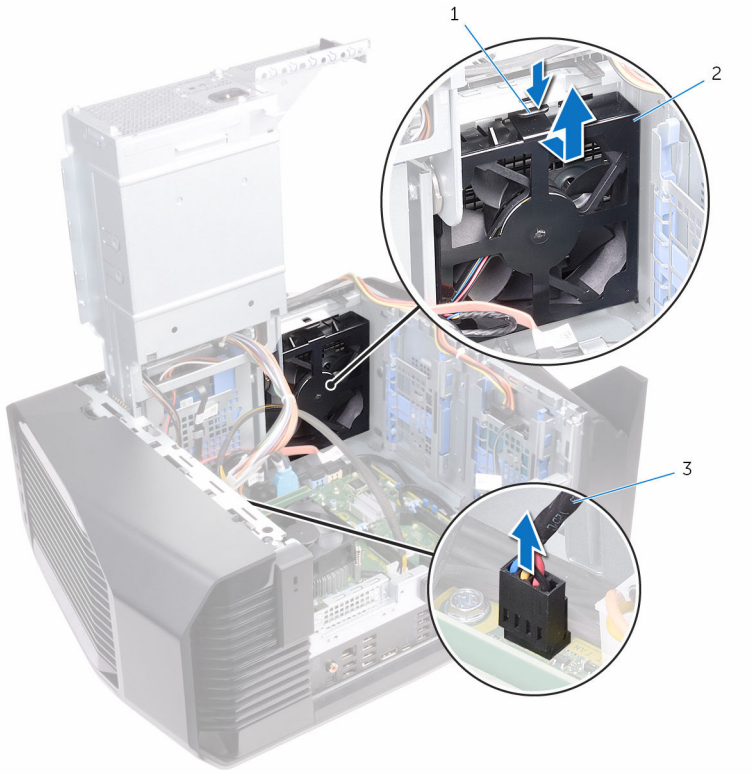

1 tab

2 front-chassis fan

3 front-chassis fan cable

- 4** Spread apart the tabs on the front-chassis fan bracket and lift the front-chassis fan along with its cable off the bracket.

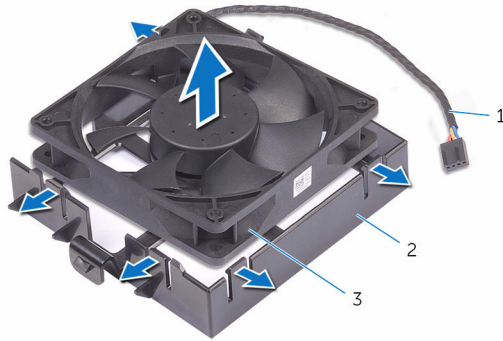

- 1 front-chassis fan cable
3 front-chassis fan

- 2 front-chassis fan bracket

Replacing the front-chassis fan



WARNING: Before working inside your computer, read the safety information that shipped with your computer and follow the steps in [Before working inside your computer](#). After working inside your computer, follow the instructions in [After working inside your computer](#). For more safety best practices, see the Regulatory Compliance home page at www.dell.com/regulatory_compliance.

Procedure

- 1 Align the tabs on the front-chassis fan bracket with the front-chassis fan and press down on the fan until it snaps into position.
- 2 Align the tabs on the front-chassis fan with the slots on the chassis and slide the fan until it snaps into position.
- 3 Connect the front-chassis fan cable to the system board.

Post-requisites

- 1 Replace the [graphics card](#).
- 2 Follow the procedure from step 10 to step 11 in "[Replacing the power-supply unit](#)".
- 3 Replace the [left-side cover](#).

Removing the top-chassis fan



WARNING: Before working inside your computer, read the safety information that shipped with your computer and follow the steps in [Before working inside your computer](#). After working inside your computer, follow the instructions in [After working inside your computer](#). For more safety best practices, see the Regulatory Compliance home page at www.dell.com/regulatory_compliance.

Prerequisites

- 1 Remove the [left-side cover](#).
- 2 Follow the procedure from step 1 to step 4 in "[Removing the power-supply unit](#)".

Procedure

- 1 Remove the screw that secures the top-chassis fan to the chassis.
- 2 Disconnect the top-chassis fan cable from the system board.

- 3** Remove the top-chassis fan from the chassis.

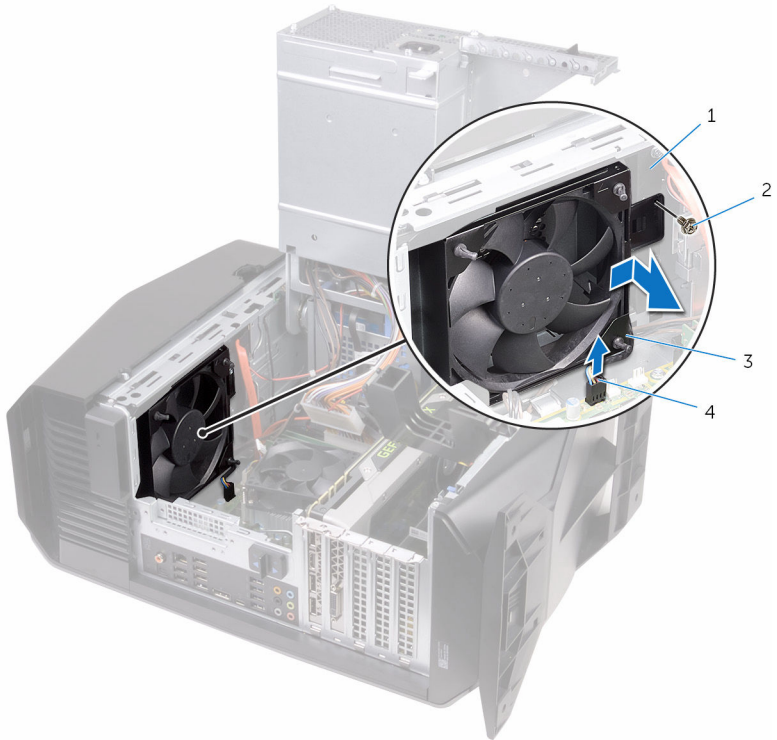

- | | | | |
|---|-----------------|---|-----------------------|
| 1 | chassis | 2 | screw |
| 3 | top-chassis fan | 4 | top-chassis fan cable |

- 4** Remove the top-chassis fan cable from the routing guide on the top-chassis fan bracket.
- 5** Push the rubber grommets through the holes at each corner of the fan to release top-chassis fan from the bracket.

6 Lift the top-chassis fan off the top-chassis fan bracket.

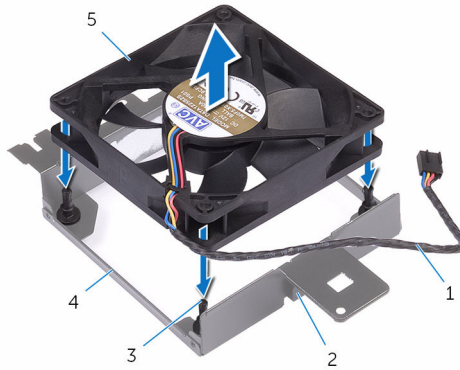

1 top-chassis fan cable

2 routing guide

3 rubber grommets (4)

4 top-chassis fan bracket

5 top-chassis fan

Replacing the top-chassis fan



WARNING: Before working inside your computer, read the safety information that shipped with your computer and follow the steps in [Before working inside your computer](#). After working inside your computer, follow the instructions in [After working inside your computer](#). For more safety best practices, see the Regulatory Compliance home page at www.dell.com/regulatory_compliance.

Procedure

- 1 Align the holes on the top-chassis fan with the holes on the top-chassis fan bracket.
- 2 Insert the ends of the rubber grommets through the holes at each corner of the fan.
- 3 Align the grommets in the fan with the holes at each corner of the top-chassis fan bracket and pull through until they snap into place.
- 4 Route the top-chassis fan cable through the routing guide on the bracket.
- 5 Align the tabs on the top-chassis fan with the slots on the chassis and slide the fan until it snaps into position.
- 6 Replace the screw that secures the top-chassis fan to the chassis.
- 7 Connect the top-chassis fan cable to the system board.

Post-requisites

- 1 Follow the procedure from step 10 to step 11 in "[Replacing the power-supply unit](#)".
- 2 Replace the [left-side cover](#).

Removing the optical drive



WARNING: Before working inside your computer, read the safety information that shipped with your computer and follow the steps in [Before working inside your computer](#). After working inside your computer, follow the instructions in [After working inside your computer](#). For more safety best practices, see the Regulatory Compliance home page at www.dell.com/regulatory_compliance.

Prerequisites

- 1 Remove the [left-side cover](#).
- 2 Follow the procedure from step 1 to step 4 in "[Removing the power-supply unit](#)".

Procedure

- 1 Disconnect the power and data cable from the optical-drive assembly.

- 2** Pull the securing tab to release the optical-drive assembly from the chassis.

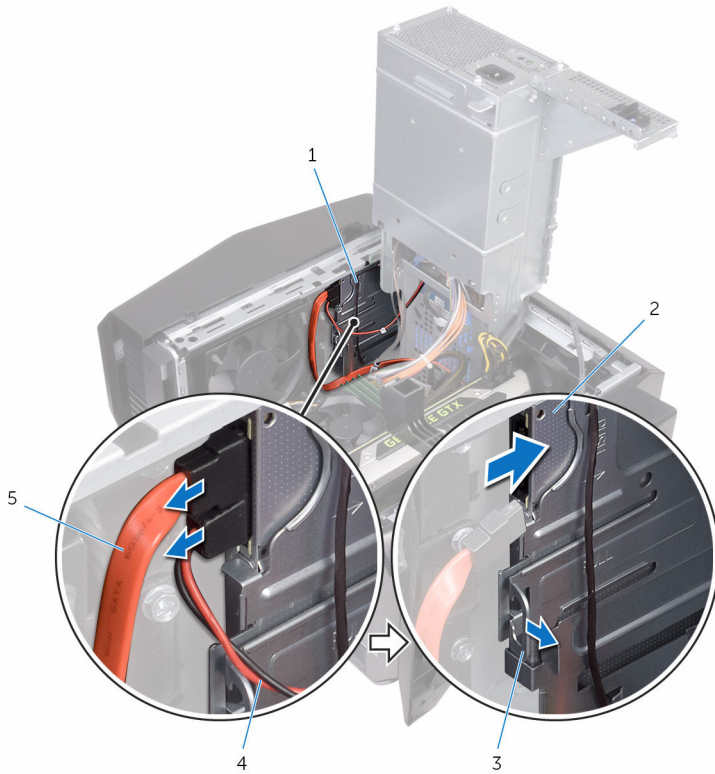

- 1 optical-drive assembly
- 3 securing tab
- 5 data cable

- 2 optical drive
- 4 power cable

- 3** Push to slide the optical-drive assembly out through the front of the computer.

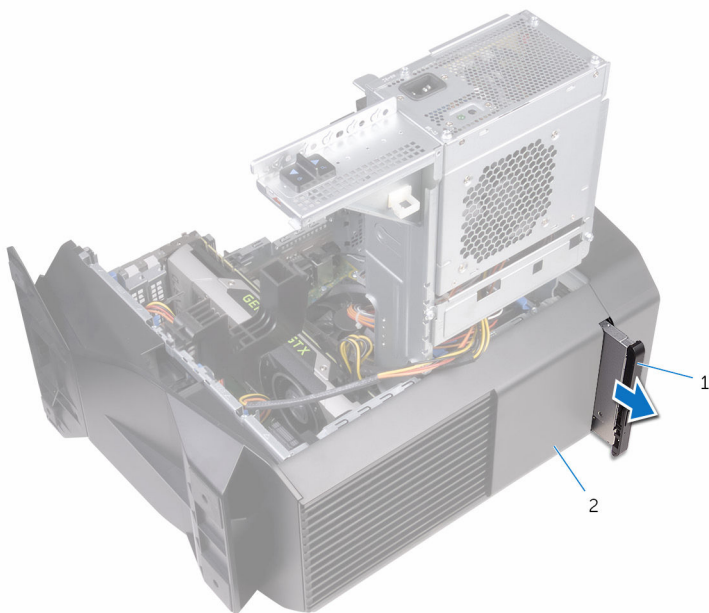

- 1 optical-drive assembly 2 chassis

- 4** Remove the screw that secures the optical-drive bracket to the optical drive.

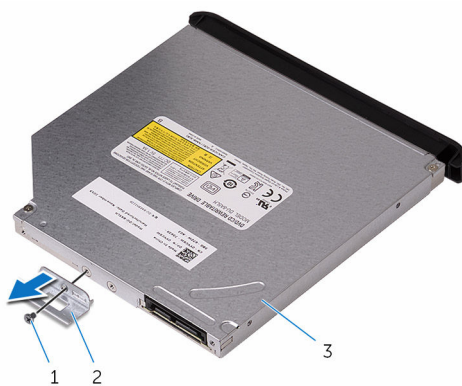

- 1 screw 2 optical-drive bracket
3 optical drive

- 5 Gently pull and disconnect the optical-drive bezel from the optical drive.

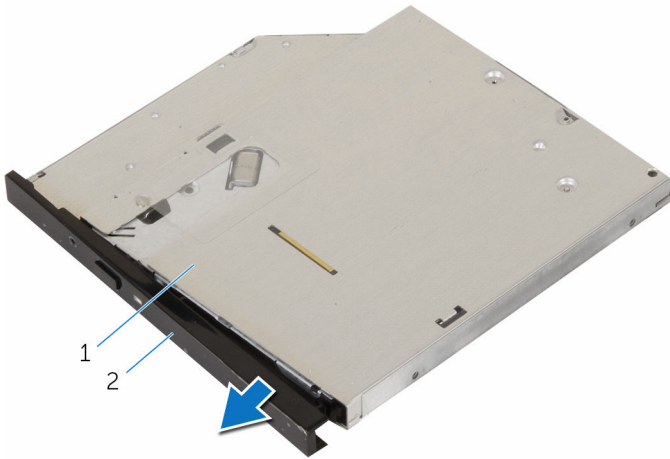

1 optical-drive bezel

2 optical drive

Replacing the optical drive



WARNING: Before working inside your computer, read the safety information that shipped with your computer and follow the steps in [Before working inside your computer](#). After working inside your computer, follow the instructions in [After working inside your computer](#). For more safety best practices, see the Regulatory Compliance home page at www.dell.com/regulatory_compliance.

Procedure

- 1 Align and snap the optical-drive bezel to the optical drive.
- 2 Align the screw hole on the optical-drive bracket with the screw hole on the optical drive.
- 3 Replace the screw that secures the optical-drive bracket to the optical drive.
- 4 Lift the securing tab and slide the optical-drive assembly through the front of the computer until the securing tab snaps into place.
- 5 Connect the data and power cables to the optical drive.

Post-requisites

- 1 Follow the procedure from step 10 to step 11 in "[Replacing the power-supply unit](#)".
- 2 Replace the [left-side cover](#).

Removing the front bezel



WARNING: Before working inside your computer, read the safety information that shipped with your computer and follow the steps in [Before working inside your computer](#). After working inside your computer, follow the instructions in [After working inside your computer](#). For more safety best practices, see the Regulatory Compliance home page at www.dell.com/regulatory_compliance.

Prerequisites

- 1 Remove the [left-side cover](#).
- 2 Remove the [right-side cover](#).
- 3 Follow the procedure from step 1 to step 3 in "[Removing the optical drive](#)".
- 4 Remove the [top cover](#).

Procedure

- 1 Place the computer in an upright position.

2 Grasp and release the front bezel tabs sequentially from the top, by moving them outward from the front panel.

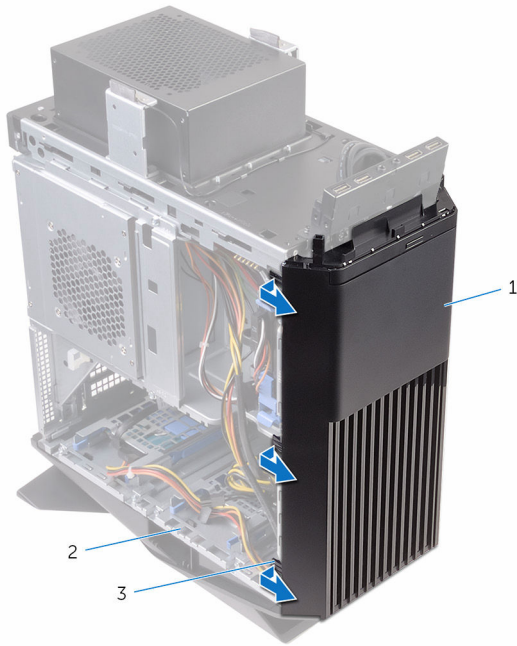

1 front bezel

2 chassis

3 tabs

- 3** Rotate and pull the front bezel away from the front of the computer to release the tabs on the front bezel from the slots on the front panel.

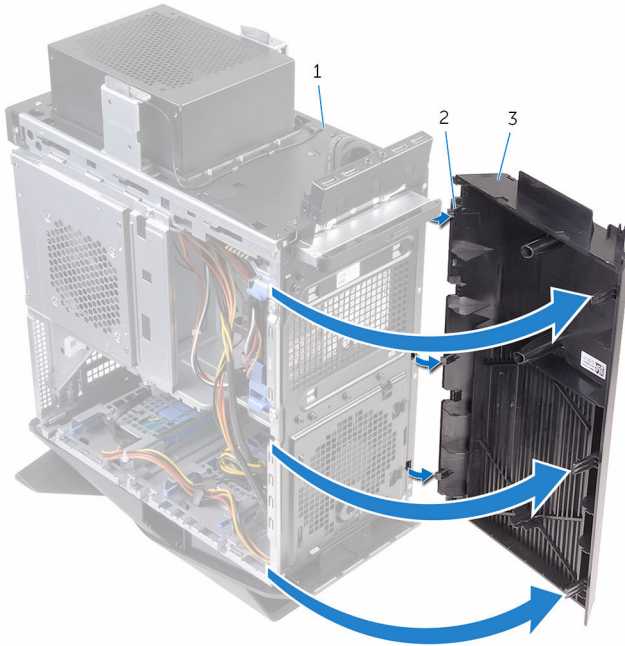

- 1 chassis
3 front bezel

- 2 tabs

Replacing the front bezel



WARNING: Before working inside your computer, read the safety information that shipped with your computer and follow the steps in [Before working inside your computer](#). After working inside your computer, follow the instructions in [After working inside your computer](#). For more safety best practices, see the Regulatory Compliance home page at www.dell.com/regulatory_compliance.

Procedure

- 1 Align and insert the front bezel tabs into the front panel slots.
- 2 Rotate the front bezel towards the computer until the front bezel tabs snap into place.

Post-requisites

- 1 Replace the [top cover](#).
- 2 Follow the procedure from step 4 to step 5 in "[Replacing the optical drive](#)".
- 3 Replace the [right-side cover](#).
- 4 Replace the [left-side cover](#).

Removing the power-button board



WARNING: Before working inside your computer, read the safety information that shipped with your computer and follow the steps in [Before working inside your computer](#). After working inside your computer, follow the instructions in [After working inside your computer](#). For more safety best practices, see the Regulatory Compliance home page at www.dell.com/regulatory_compliance.

Prerequisites

- 1 Remove the [left-side cover](#).
- 2 Remove the [right-side cover](#).
- 3 Remove the [top cover](#).

Procedure

- 1 Note the power-button module cable routing and remove the cable from the routing guides on the top cover.
- 2 Remove the screws that secure the power-button module to the top cover.

3 Lift the power-button module off the top cover.

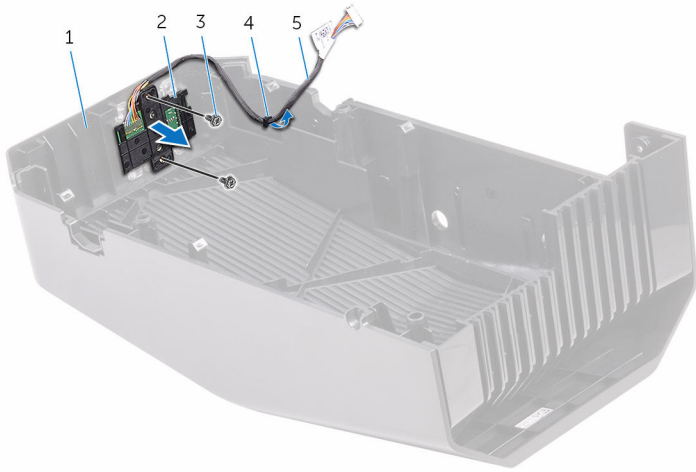

- | | | | |
|---|---------------------------|---|---------------------|
| 1 | top cover | 2 | power-button module |
| 3 | screws (2) | 4 | routing guide |
| 5 | power-button module cable | | |

4 Release the power-button board from under the tabs on the power-button board bracket.

5 Lift the power-button board along with the cable off the power-button board bracket.

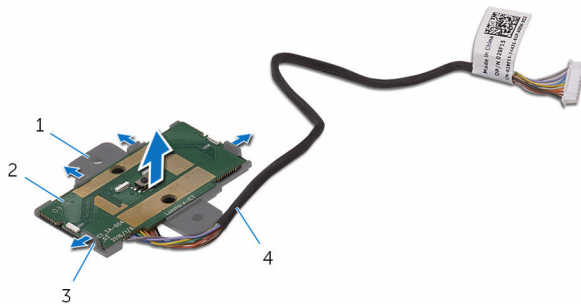

- | | | | |
|---|----------------------------|---|---------------------------|
| 1 | power-button board bracket | 2 | power-button board |
| 3 | tabs (4) | 4 | power-button module cable |

Replacing the power-button board



WARNING: Before working inside your computer, read the safety information that shipped with your computer and follow the steps in [Before working inside your computer](#). After working inside your computer, follow the instructions in [After working inside your computer](#). For more safety best practices, see the Regulatory Compliance home page at www.dell.com/regulatory_compliance.

Procedure

- 1 Align and slide the power-button board on the power-button board bracket and snap it into place.
- 2 Align the screw holes on the power-button module with the screw holes on the top cover.
- 3 Replace the screws that secure the power-button module to the top cover.
- 4 Route the power-button module cable through the routing guide on the top cover.

Post-requisites

- 1 Replace the [top cover](#).
- 2 Replace the [right-side cover](#).
- 3 Replace the [left-side cover](#).

Removing the rear trim cover



WARNING: Before working inside your computer, read the safety information that shipped with your computer and follow the steps in [Before working inside your computer](#). After working inside your computer, follow the instructions in [After working inside your computer](#). For more safety best practices, see the Regulatory Compliance home page at www.dell.com/regulatory_compliance.

Prerequisites

- 1 Remove the [left-side cover](#).
- 2 Remove the [right-side cover](#).
- 3 Remove the [top cover](#).

Procedure

- 1 Place the computer in an upright position.

2 Using the tab, slide and remove the rear trim cover from the chassis.



1 chassis

2 rear trim cover

Replacing the rear trim cover



WARNING: Before working inside your computer, read the safety information that shipped with your computer and follow the steps in [Before working inside your computer](#). After working inside your computer, follow the instructions in [After working inside your computer](#). For more safety best practices, see the Regulatory Compliance home page at www.dell.com/regulatory_compliance.

Procedure

Align the tabs on the rear trim cover with the slots on the chassis and snap the cover to lock it in place.

Post-requisites

- 1 Replace the [top cover](#).
- 2 Replace the [right-side cover](#).
- 3 Replace the [left-side cover](#).

Removing the system board

 **WARNING:** Before working inside your computer, read the safety information that shipped with your computer and follow the steps in [Before working inside your computer](#). After working inside your computer, follow the instructions in [After working inside your computer](#). For more safety best practices, see the Regulatory Compliance home page at www.dell.com/regulatory_compliance.

 **NOTE:** Your computer's Service Tag is stored in the system board. You must enter the Service Tag in the BIOS setup program after you replace the system board.

 **NOTE:** Replacing the system board removes any changes you have made to the BIOS using the BIOS setup program. You must make the appropriate changes again after you replace the system board.

 **NOTE:** Before disconnecting the cables from the system board, note the location of the connectors so that you can reconnect the cables correctly after you replace the system board.

Prerequisites

- 1 Remove the [left-side cover](#).
- 2 Follow the procedure from step 1 to step 4 in "[Removing the power-supply unit](#)".
- 3 Remove the [memory modules](#).
- 4 Remove the [solid-state drive](#).
- 5 Remove the [wireless card](#).
- 6 Remove the [processor fan and heat-sink assembly](#).
- 7 Remove the [graphics card](#).
- 8 Remove the [processor](#).

Procedure



NOTE: Note the routing of all cables as you remove them so that you can reroute them correctly after you replace the system board. For information on system board connectors, see "[System-board components](#)".

1 Disconnect all the cables connected to the system-board assembly.

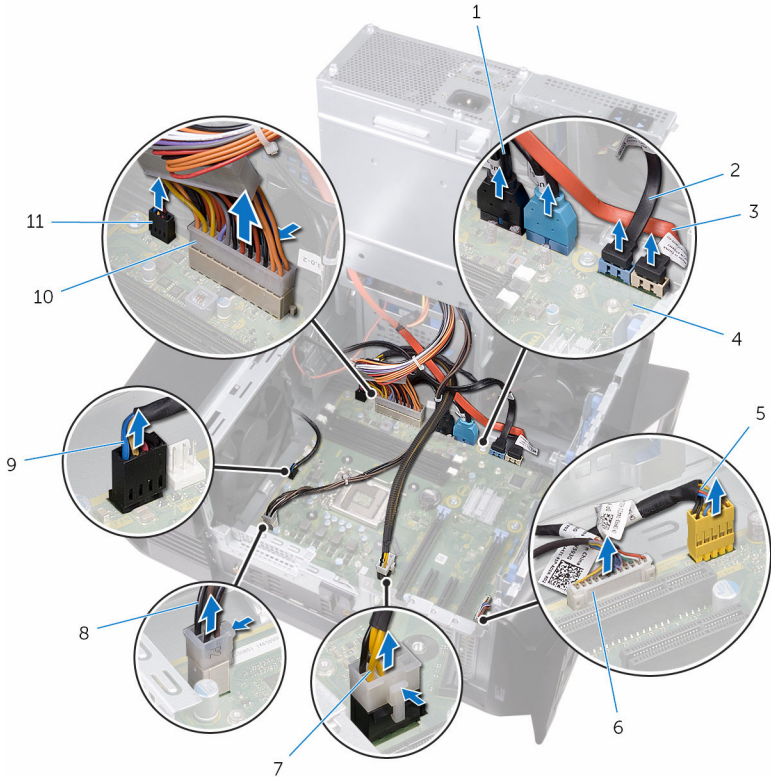

- | | | | |
|----|---------------------------------------|----|---------------------------------------|
| 1 | Top panel USB cables (SSUSB) | 2 | SATA 6 Gbps drive cable (SATA1) |
| 3 | SATA 6 Gbps drive cable (SATA2) | 4 | system board |
| 5 | front-panel audio cable (F_AUDIO) | 6 | LED controller cable (LED_CONTROLLER) |
| 7 | graphics-card power cable (GPU_POWER) | 8 | processor power cable (ATX_CPU) |
| 9 | top-chassis fan cable (TOP_FAN) | 10 | system-board power cable |
| 11 | front-chassis fan cable (FRONT_FAN) | | |

2 Remove the screws that secure the system-board assembly to the chassis.

3 Lift the system-board assembly out of the chassis.





1 chassis
3 screws (8)

2 system board

Replacing the system board

 **WARNING:** Before working inside your computer, read the safety information that shipped with your computer and follow the steps in [Before working inside your computer](#). After working inside your computer, follow the instructions in [After working inside your computer](#). For more safety best practices, see the Regulatory Compliance home page at www.dell.com/regulatory_compliance.

 **NOTE:** Your computer's Service Tag is stored in the system board. You must enter the Service Tag in the BIOS setup program after you replace the system board.

 **NOTE:** Replacing the system board removes any changes you have made to the BIOS using the BIOS setup program. You must make the appropriate changes again after you replace the system board.

Procedure

- 1 Align the system-board assembly with the slots on the chassis and place the system-board assembly in position.
- 2 Slide the system-board assembly to engage the latches that secure it to the chassis.
- 3 Replace the screws that secure the system-board assembly to the chassis.
- 4 Route and connect the cables that you disconnected from the system-board assembly.

Post-requisites

- 1 Replace the [processor](#).
- 2 Replace the [graphics card](#).
- 3 Replace the [processor fan and heat-sink assembly](#).
- 4 Replace the [wireless card](#).
- 5 Replace the [solid-state drive](#).
- 6 Replace the [memory modules](#).
- 7 Follow the procedure from step 10 to step 11 in "[Replacing the power-supply unit](#)".
- 8 Replace the [left-side cover](#).

Entering the Service Tag in the BIOS setup program

- 1 Turn on or restart your computer.
- 2 Press F2 when the AlienHead logo is displayed to enter the BIOS setup program.
- 3 Navigate to the **Main** tab and enter the Service Tag in the **Service Tag Input** field.

BIOS setup program

Overview

 **CAUTION:** Unless you are an expert computer user, do not change the settings in the BIOS setup program. Certain changes can make your computer work incorrectly.

 **NOTE:** Before you change BIOS setup program, it is recommended that you write down the BIOS setup program screen information for future reference.

Use BIOS setup program to:

- Get information about the hardware installed in your computer, such as the amount of RAM, the size of the hard drive, and so on.
- Change the system configuration information.
- Set or change a user-selectable option, such as the user password, type of hard drive installed, enabling or disabling base devices, and so on.

Entering BIOS setup program

- 1 Turn on (or restart) your computer.
- 2 During POST, when the AlienHead logo is displayed, watch for the F2 prompt to appear, and then press F2 immediately.

 **NOTE:** The F2 prompt indicates that the keyboard is initialized. This prompt can appear very quickly, so you must watch for it, and then press F2. If you press F2 before the F2 prompt, this keystroke is lost. If you wait too long and the operating system logo appears, continue to wait until you see the desktop. Then, turn off your computer and try again.

System setup options

 **NOTE:** Depending on your computer and its installed devices, the items listed in this section may or may not appear.

Main

System Date	Displays the current date in mm/dd/yyyy format.
System Time	Displays the current time in hh:mm:ss format.

BIOS Information

BIOS Version	Displays the BIOS version number.
--------------	-----------------------------------

Product Information

Product Name	Displays the product name. Default: Alienware Aurora R5.
Service Tag	Displays the service tag of your computer.
Asset Tag	Displays the asset tag of your computer.

Memory Information

System Memory	Displays the total computer memory installed.
Memory Speed	Displays the memory speed.

CPU Information

CPU Type	Displays the processor type
CPU Speed	Displays the speed of the processor.
CPU ID	Displays the processor identification code.
Cache L1	Displays the processor L1 cache size.
Cache L2	Displays the processor L2 cache size.
Cache L3	Displays the processor L3 cache size.

Advanced

Advanced BIOS Features

Intel SpeedStep	Allows you to enable or disable Intel Speedstep Technology. Default: Enabled.
	 NOTE: If enabled, the processor clock speed and core voltage are adjusted dynamically based on the processor load.
Virtualization	Allows you to enable or disable Intel Virtualization Technology feature for the processor.
VT for Direct I/O	Allows you to enable or disable Intel Virtualization Technology feature for the Direct I/O.
SATA Operation	Allows you to configure the operating mode of the integrated SATA hard drive controller.
Intel Ready Mode Technology	Allows you to enable or disable the Intel Ready Mode Technology.
Intel Software Guard Extensions	Allows you to enable or disable Intel Software Guard Extensions.
BIOS Recovery from Hard Drive	Allows you to enable or disable BIOS Recovery from hard drive.

USB Configuration

Front USB Ports	Allows you to enable or disable the front USB ports.
Rear USB Ports	Allows you to enable or disable the rear USB ports.

Power Options

Numlock Key	Allows you to set the status of the Num Lock key during boot to On or Off.
Wake Up by Integrated LAN	Allow the computer to be powered on by special LAN signals.
AC Recovery	Sets what action the computer takes when power is restored.

Advanced

Deep Sleep Control	Allows you to define the controls when Deep Sleep is enabled.
USB Wake Support (S3)	Allows you to enable the USB devices to wake the system from Standby.
USB PowerShare (S4/S5)	Allows you to charge external devices.
USB PowerShare Wake Support (S4/S5)	Allows you to enable front the USB devices to wake the system from S4/S5.
Auto Power On	
Auto Power On Mode	Allows you to set the computer to turn on automatically every day or on a preselected date. This option can be configured only if the Auto Power On mode is set to Enabled Everyday or Selected Day.
Auto Power On Date	Allows you to set the date on which the computer must turn on automatically. This option can be configured only if the Auto Power On mode is set to Enabled 1 to 31.
Auto Power On Time	Allows you to set the time at which the computer must turn on automatically. This option can be configured only if the Auto Power On mode is set to Enabled hh:mm:ss.

Performance Options

Overclocking Feature	
Core Over Clocking Level	Allows you enable or disable the OC level1/level2 setting and adjust the processor flex ratio and voltage in the Customization mode.
Computrace	Allows you to enable or disable the Computrace service using the Absolute software.
Core Ratio Limit Override	Allows you to set the core ratio limit.
Single Core	Allows you to select single core or multiple cores.

Advanced

Core Voltage Mode	Allows you to select between adaptive and override voltage modes.
Core Voltage Offset	Allows you to set the override value of core voltage.
Long Duration PWR Limit	Allows you to set the turbo mode power limit.
Short Duration PWR Limit Options	Allows you to set the turbo mode power limit.
XMP Memory	Allows you to set the XMP memory.

Security

Admin Password Status	Displays whether the admin password is set.
System Password Status	Displays whether the system password is set.
HDD Password Status	Displays if the hard drive password is set.
Admin Password	Displays the admin password.
System Password	Displays the system password.
HDD Password	Displays the hard drive password.
Firmware TPM	Displays the firmware TPM.

Boot

Boot List Option	Displays the available boot devices.
File Browser Add Boot Option	Allows you to set the boot path in the boot option list.
File Browser Del Boot Option	Allows you to delete the boot path in the boot option list.
Secure Boot Control	Allows you to enable or disable the secure boot control.
Load Legacy OPROM	Allows you to enable or disable the Legacy Option ROM.
Boot Option Priorities	Displays the available boot devices.

Boot

Boot Option #1	Displays the first boot device. Default: UEFI: Windows Boot Manager.
Boot Option #2	Displays the second boot device. Default: Onboard NIC Device.
Boot Option #3	Displays the third boot device. Default: Onboard NIC Device.

Save & Exit

Save Changes and Reset	Allows you to exit system setup and save your changes.
Discard Changes and Reset	Allows you to exit system setup and load previous values for all system setup options.
Restore Defaults	Allows you to load default values for all system setup options.
Discard Changes	Allows you to exit your changes.
Save Changes	Allows you to save your changes.

Clearing forgotten passwords



WARNING: Before working inside your computer, read the safety information that shipped with your computer and follow the steps in [Before working inside your computer](#). After working inside your computer, follow the instructions in [After working inside your computer](#). For more safety best practices, see the Regulatory Compliance home page at www.dell.com/regulatory_compliance.

Prerequisites

- 1 Remove the [left-side cover](#).
- 2 Follow the procedure from step 1 to step 4 in "[Removing the power-supply unit](#)".

Procedure

- 1** Locate the password jumper (P215) on the system board.
For information on the location of the Password jumper, see [System-board components](#).
- 2** Remove the jumper plug from pins 215.
- 3** Follow the procedure from step 8 to step 9 in "[Replacing the power-supply unit](#)".
- 4** Replace the [left-side cover](#).
- 5** Turn on your computer and wait until the operating system is completely loaded.
- 6** Shut down your computer.
- 7** Remove the [left-side cover](#).
- 8** Follow the procedure from step 1 to step 3 in "[Removing the power-supply unit](#)".

- 9 Replace the jumper plug on pins 215.

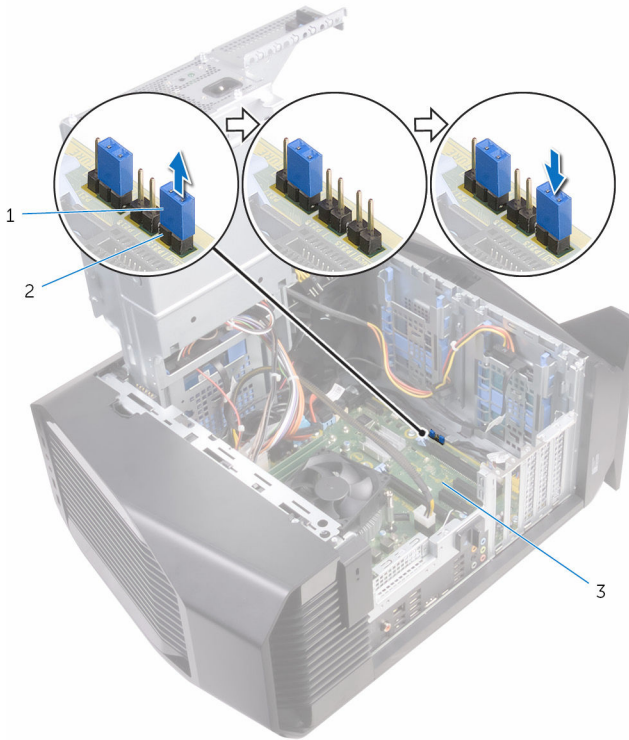

1 jumper plug

2 P215

Post-requisites

- 1 Follow the procedure from step 10 to step 11 in "[Replacing the power-supply unit](#)".
- 2 Replace the [left-side cover](#).

Clearing CMOS Settings



WARNING: Before working inside your computer, read the safety information that shipped with your computer and follow the steps in [Before working inside your computer](#). After working inside your computer, follow the instructions in [After working inside your computer](#). For more safety best practices, see the Regulatory Compliance home page at www.dell.com/regulatory_compliance.

Prerequisites

- 1 Remove the [left-side cover](#).
- 2 Follow the procedure from step 1 to step 4 in "[Removing the power-supply unit](#)".

Procedure

- 1 Locate the CMOS jumper (P217) on the system board.
For information on the location of the CMOS jumper, see "[System-board components](#)".
- 2 Disconnect the system-board power cable from the system board.
- 3 Remove the jumper plug from pins 217 and replace it on pins 216 (P216).
- 4 Wait for 5 seconds.
- 5 Remove the jumper plug from pins 216 and replace it on pins 217.

6 Connect the system-board power cable to the system board.

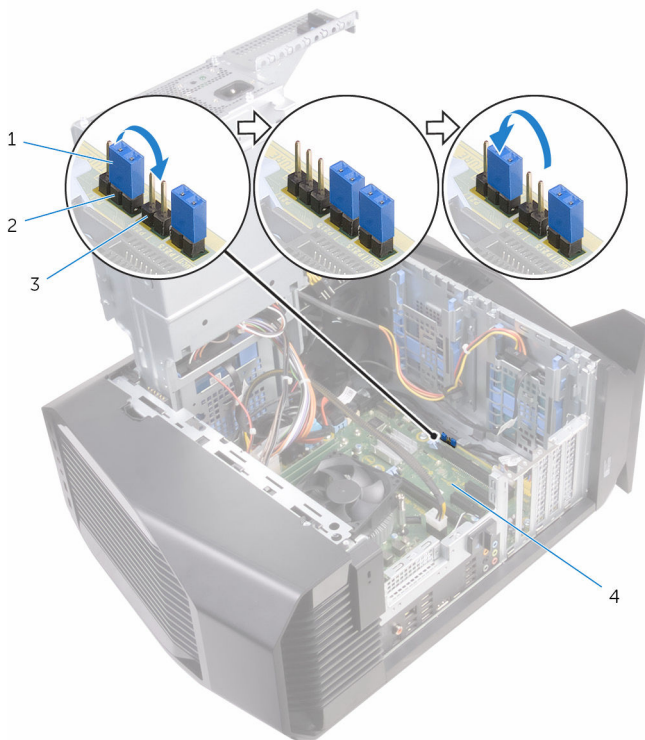

- 1 jumper plug
- 3 P216

- 2 P217
- 4 system board

Post-requisites

- 1 Follow the procedure from step 10 to step 11 in "[Replacing the power-supply unit](#)".
- 2 Replace the [left-side cover](#).

Flashing the BIOS

You may need to flash (update) the BIOS when an update is available or when you replace the system board. To flash the BIOS:

- 1 Turn on your computer.
- 2 Go to www.dell.com/support.
- 3 Click or tap **Product support**, enter the Service Tag of your computer, and then click or tap **Submit**.
 -  **NOTE:** If you do not have the Service Tag, use the auto-detect feature or manually browse for your computer model.
- 4 Click or tap **Drivers & downloads** → **Find it myself**.
- 5 Select the operating system installed on your computer.
- 6 Scroll down the page and expand **BIOS**.
- 7 Click or tap **Download** to download the latest version of the BIOS for your computer.
- 8 After the download is complete, navigate to the folder where you saved the BIOS update file.
- 9 Double-click or double-tap the BIOS update file icon and follow the instructions on the screen.

Technology and components

Audio

Alienware Aurora R5 is shipped with Realtek ALC3861 for optical S/PDIF output.



NOTE: The audio drivers are already installed when you receive your computer.

Downloading the audio driver

- 1 Turn on your computer.
- 2 Go to www.dell.com/support.
- 3 Click **Product support**, enter the Service Tag of your computer and then click **Submit**.



NOTE: If you do not have the Service Tag, use the auto-detect feature or manually browse for your computer model.

- 4 Click **Drivers & downloads** → **Find it myself**.
- 5 Scroll down the page and expand **Audio**.
- 6 Click **Download** to download the audio driver for your computer.
- 7 After the download is complete, navigate to the folder where you saved the audio driver file.
- 8 Double-click the audio driver file icon and follow the instructions on the screen to install the driver.

Identifying the audio controller

- 1 On the taskbar, click the search box, and then type `Device Manager`.
- 2 Click **Device Manager**.
The **Device Manager** window is displayed.

- Expand **Sound, video and game controllers** to view the audio controller.

Before installation	After installation
<ul style="list-style-type: none"> ▼ DESKTOP-JT89R5J <ul style="list-style-type: none"> > Audio inputs and outputs > Bluetooth > Computer > Disk drives > Display adapters > DVD/CD-ROM drives > Firmware > Human Interface Devices > IDE ATA/ATAPI controllers > Keyboards > Mice and other pointing devices > Monitors > Network adapters ▼ Other devices <ul style="list-style-type: none"> Audio Device on High Definition Audio Bus Ports (COM & LPT) Print queues Processors Security devices Software devices ▼ Sound, video and game controllers <ul style="list-style-type: none"> Intel(R) Display Audio NVIDIA High Definition Audio Storage controllers System devices Universal Serial Bus controllers 	<ul style="list-style-type: none"> ▼ Sound, video and game controllers <ul style="list-style-type: none"> Intel(R) Display Audio NVIDIA High Definition Audio Realtek High Definition Audio

Changing the audio settings

- On the taskbar, click the search box, and then type **Dell Audio**.
- Click **Dell Audio** and change the audio settings as required.

Graphics

Alienware Aurora R5 is shipped with the following graphics options:

Controller	Memory
Intel HD Graphics 530	Shared system memory
<ul style="list-style-type: none"> • AMD or NVIDIA • Supports Dual AMD or NVIDIA (SLI) 	Up to 6 GB

Downloading the graphics driver

- 1 Turn on your computer.
- 2 Go to www.dell.com/support.
- 3 Click **Product support** enter the Service Tag of your computer, and then click **Submit**.



NOTE: If you do not have the Service Tag, use the auto-detect feature or manually browse for your computer model.

- 4 Click **Drivers & downloads** → **Find it myself**.
- 5 Scroll down the page and expand **Video**.
- 6 Click **Download** to download the graphics driver for your computer.
- 7 After the download is complete, navigate to the folder where you saved the graphics driver file.
- 8 Double-click the graphics driver file icon and follow the instructions on the screen.

Identifying the display adapter

- 1 On the taskbar, click the search box, and then type `Device Manager`.
- 2 Click **Device Manager**.
The **Device Manager** window is displayed.
- 3 Expand **Display adapters**.

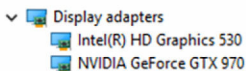

Changing the screen resolution

- 1 Right-click on your desktop and select **Display settings**.
- 2 Click **Advanced display settings**.
- 3 Select the appropriate resolution from the drop-down list.

4 Click **Apply**.

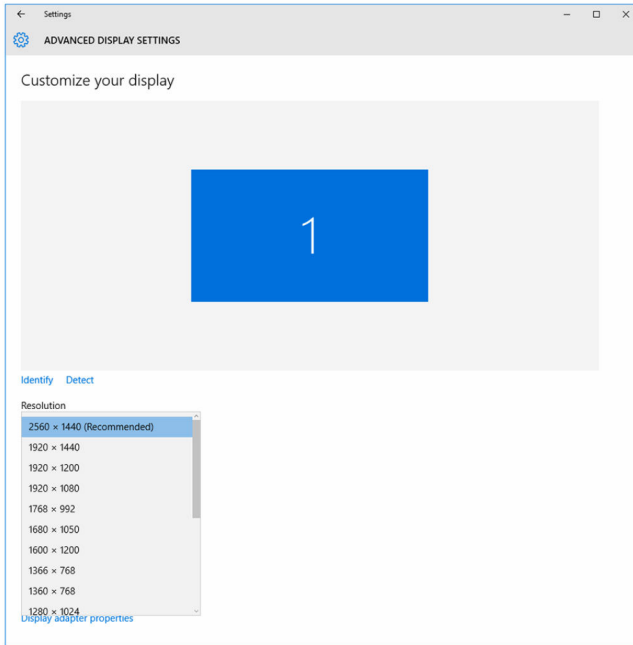

Rotating the display

- 1 Right-click on your desktop.

- 2 Select **Graphics Options** → **Rotation** and select from the listed options.

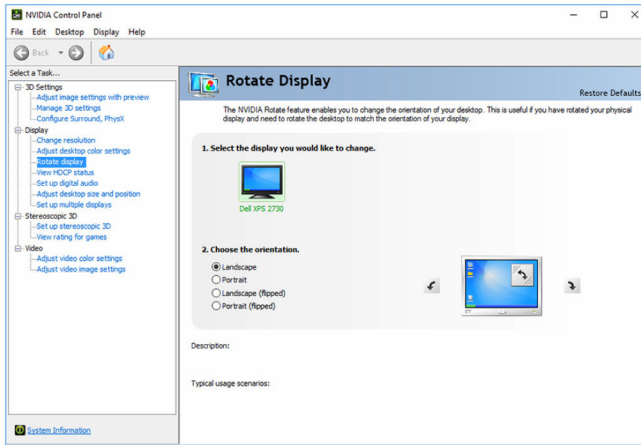

The display can be also rotated by selecting **Rotate Display** under the **Display** menu in the **NVIDIA Control Panel**.

For computers shipped with the AMD video card, the display can be rotated by selecting the required rotation on **Rotate Desktop** tab in the **AMD Catalyst Control Center**.

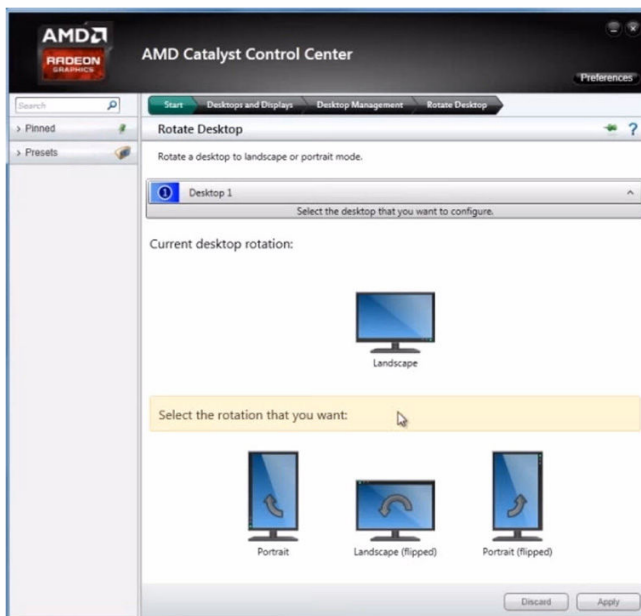

USB

The following table shows the USB ports available in Alienware Aurora R5.

Ports	Location
USB 3.0	Two on the front side
USB 3.0 with PowerShare	Two on the front side
USB 2.0	Six on the back panel
USB 3.1 Type-C	One on the back panel
USB 3.1	One on the back panel
USB 3.0	Three on the back panel

 **NOTE:** USB 3.0 needs the driver to be installed before it can detect any USB devices.

Downloading the USB 2.0 and USB 3.0 driver

- 1 Turn on your computer.
- 2 Go to www.dell.com/support.
- 3 Click **Product support** enter the Service Tag of your computer, and then click **Submit**.

 **NOTE:** If you do not have the Service Tag, use the auto-detect feature or manually browse for your computer model.

- 4 Click **Drivers & downloads** → **Find it myself**.
- 5 Scroll down the page and expand **Chipset**.
- 6 Click **Download** to download the USB 2.0 or USB 3.0 driver for your computer.
- 7 After the download is complete, navigate to the folder where you saved the USB 2.0 or USB 3.0 driver file.
- 8 Double-click the driver file icon and follow the instructions on screen.

Identifying the USB drivers

- 1 On the taskbar, click the search box, and then type `Device Manager`.
- 2 Click **Device Manager**.
The **Device Manager** window is displayed.

3 Expand **System devices**.



Enabling or disabling the USB in BIOS setup program

- 1 Turn on or restart your computer.
- 2 Press F2 when the AlienHead logo is displayed on the screen to enter the BIOS setup program.
The BIOS setup program is displayed.
- 3 On the **Advanced** tab, select **USB Configuration**.
- 4 Select the **Front USB Ports** or **Rear USB Ports** options to enable or disable the ports respectively.
- 5 Save the BIOS setup program settings and exit.

Fixing a no-boot issue caused by USB emulation

Sometimes the computer does not boot to the operating system when USB devices are connected to the computer during startup. This behavior occurs because the computer is looking for bootable files in the USB devices. Follow these steps to fix the no-boot issue:

- 1 Turn on or restart your computer.
- 2 Press F2 when the AlienHead logo is displayed on the screen to enter the BIOS setup program.
The BIOS setup program is displayed.
- 3 On the **Advanced** tab, select **USB Configuration**.
- 4 Select the **USB Boot Support** to disable it.
- 5 Save the settings and exit.

Wi-Fi

Alienware Aurora R5 is shipped with Wi-Fi 802.11b/g/n or Wi-Fi 802.11ac.

Turning on or off Wi-Fi

 **NOTE:** There is no physical switch to enable or disable Wi-Fi. It has to be done through computer settings.

- 1 Swipe-in from the right edge of the display, or click the **Action Center** icon on the taskbar to access the Action Center.
- 2 Click **Wi-Fi** to turn Wi-Fi on or off.

Downloading the Wi-Fi driver

- 1 Turn on your computer.
- 2 Go to www.dell.com/support.
- 3 Click **Product support** enter the Service Tag of your computer, and then click **Submit**.

 **NOTE:** If you do not have the Service Tag, use the auto-detect feature or manually browse for your computer model.

- 4 Click **Drivers & downloads** → **Find it myself**.
- 5 Scroll down the page and expand **Network**.
- 6 Click **Download** to download the Wi-Fi driver for your computer.
- 7 After the download is complete, navigate to the folder where you saved the Wi-Fi driver file.
- 8 Double-click the driver file icon and follow the on-screen instructions to install the driver.

Identifying the Wireless drivers

- 1 On the taskbar, click the search box, and then type `Device Manager`.
- 2 Click **Device Manager**.
The **Device Manager** window is displayed.
- 3 Expand **System devices**.



Configuring the Wi-Fi

- 1 Turn on Wi-Fi. For more information, see [Turning Wi-Fi on or off](#).
- 2 Swipe-in from the right edge of the display, or click the Action Center icon on the taskbar to access the Action Center.
- 3 Click **Wi-Fi**, and then click **Go to settings**.
A list of available networks is displayed.
- 4 Select your network and click **Connect**.

 **NOTE:** Type the network security key, if prompted.

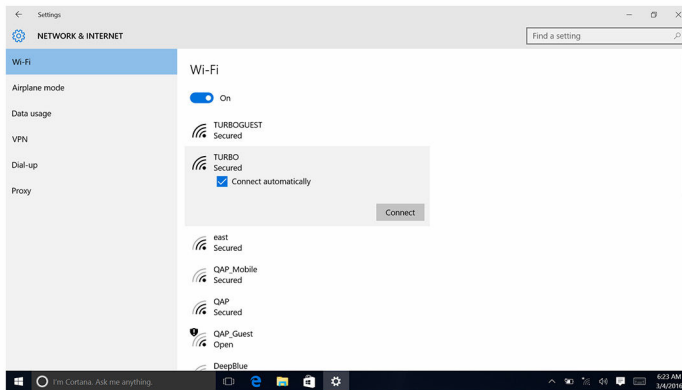

Bluetooth

Alienware Aurora R5 is shipped with Bluetooth 4.1/Bluetooth 4.2.

Turning on or off Bluetooth

 **NOTE:** There is no physical switch to enable or disable Bluetooth. It has to be done through the computer settings.

- 1 Swipe-in from the right edge of the display, or click the **Action Center** icon on the taskbar to access the Action Center.
- 2 Click **Bluetooth** to turn Bluetooth on or off.

Pairing the Bluetooth-enabled devices

- 1 Turn on Bluetooth. For more information, see [Turning on or off Bluetooth](#).

- 2 Swipe-in from the right edge of the display, or click the **Action Center** icon on the taskbar to access the Action Center.
- 3 Click **Bluetooth**, and then click **Go to settings**.
- 4 Select the required Bluetooth device for pairing.
- 5 Click **Pair** to pair the bluetooth devices.

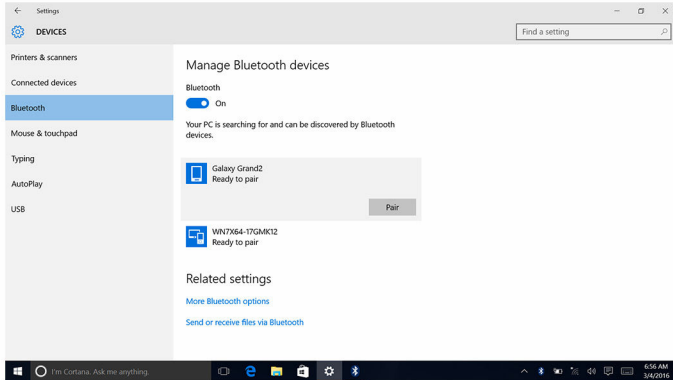

- 6 Click **Yes** to confirm the passcodes on both the devices.

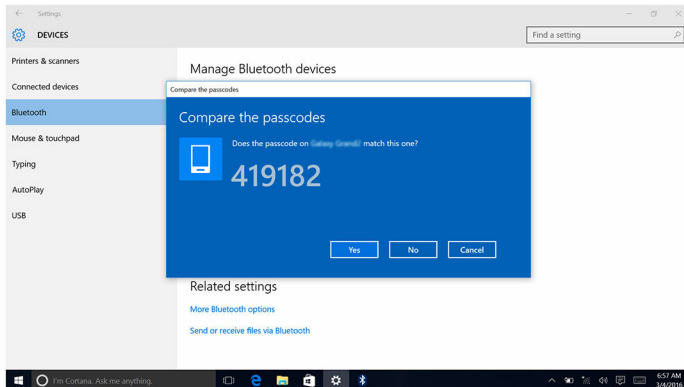

Removing the Bluetooth device

- 1 Swipe-in from the right edge of the display, or click the **Action Center** icon on the taskbar to access the Action Center.
- 2 Click **Bluetooth**, and then click **Go to settings**.

- 3 Click the device you want to remove, and then click **Remove device**.

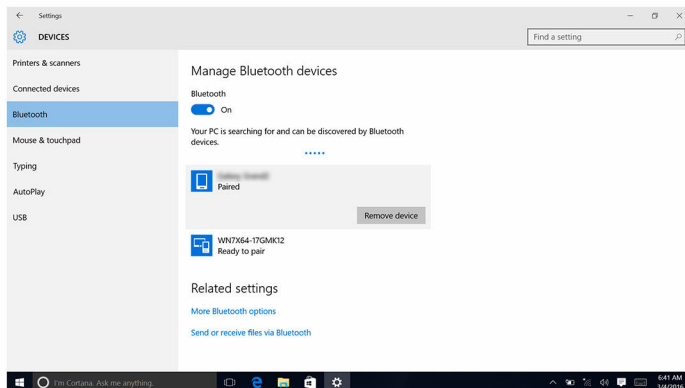

Transferring files between devices using Bluetooth

- 1 Swipe-in from the right edge of the display, or click the **Action Center** icon on the taskbar to access the Action Center.
- 2 Click **Bluetooth**, and then click **Go to settings**.
- 3 Select your Bluetooth device.
- 4 Click **Send or receive files via Bluetooth**.
- 5 In the **Bluetooth File Transfer** window, click **Send files**, and then select the file you want to transfer.

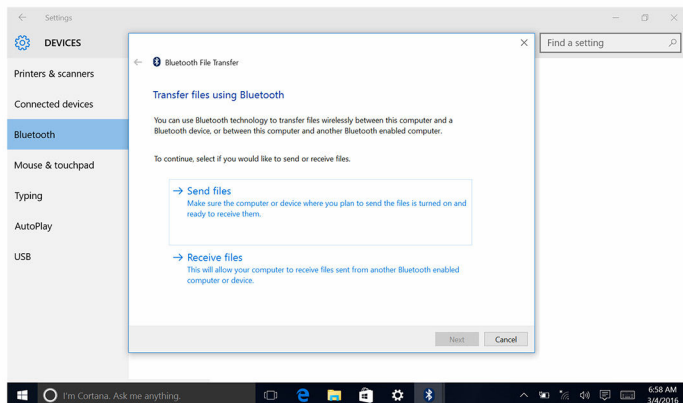

Hard drive

The following table shows the hard-drive options available in Alienware Aurora R5.

Options	Dimensions
SSD	One M.2 drive
SATA	<ul style="list-style-type: none">One 3.5-inch drive bayTwo 2.5-inch drive bays

Identifying the hard drive

- 1 On the taskbar, click the search box, and then type `Device Manager`.
- 2 Click **Device Manager**.
The **Device Manager** window is displayed.
- 3 Expand **Disk drives**.

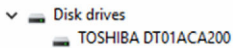

Identifying the hard drive in BIOS setup program

- 1 Turn on or restart your computer.
- 2 Press F2 when the AlienHead logo is displayed on the screen to enter the BIOS setup program.
A list of hard drives is displayed on the **Main** tab. For more information, see [System setup options](#).

Chipset

Alienware Aurora R5 is shipped with the Intel Z170 chipset.

Downloading the chipset driver

- 1 Turn on your computer.
- 2 Go to www.dell.com/support.

- 3 Click **Product support**, enter the Service Tag of your computer, and then click **Submit**.



NOTE: If you do not have the Service Tag, use the auto-detect feature or manually browse for your computer model.

- 4 Click **Drivers & downloads** → **Find it myself**.
- 5 Scroll down the page and expand **Chipset**.
- 6 Click **Download** to download the chipset driver for your computer.
- 7 After the download is complete, navigate to the folder where you saved the chipset driver file.
- 8 Double-click the chipset driver file icon and follow the instructions on the screen.

Identifying the chipset

- 1 On the taskbar, click the search box, and then type `Device Manager`.
- 2 Click **Device Manager**.
The **Device Manager** window is displayed.

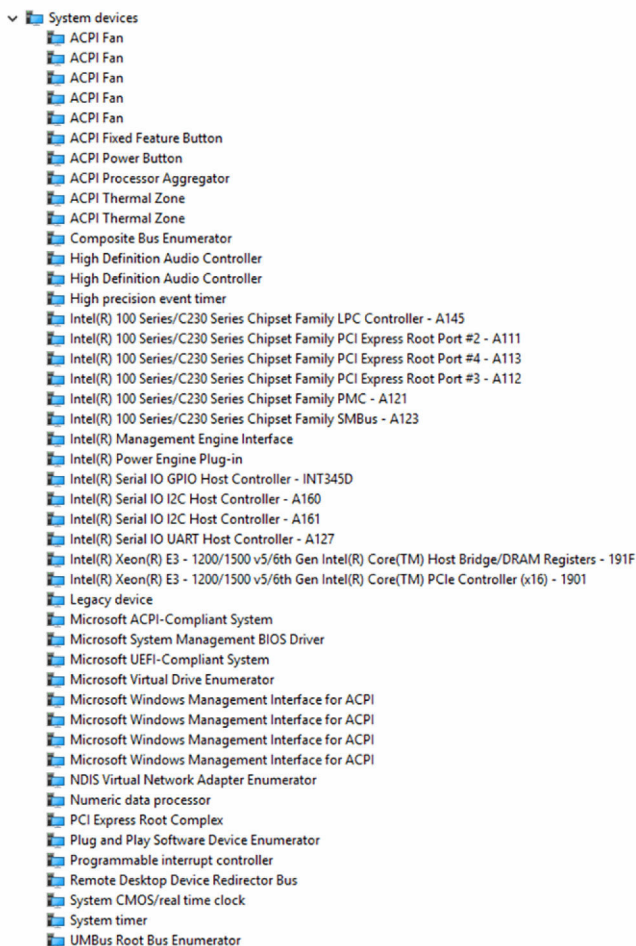

3 Expand System devices.



Memory

Alienware Aurora R5 has four DIMM (RAM) slots, which are accessible by removing the left-side cover and rotating the power-supply unit. Your computer supports 4 GB, 8 GB, 16 GB, 32 GB, and 64 GB DDR4 memory of up to 2133 MHz and up to 2400 MHz with XMP (optional).

Checking the system memory in Windows

- 1 Click **Start** .
- 2 Select **Settings** .
- 3 Click **System** → **About**.

Checking the system memory in BIOS setup program

- 1 Turn on or restart your computer.
- 2 Press F2 when the AlienHead logo is displayed on the screen to enter the BIOS setup program.
On the **Main** tab, the memory information is displayed. For more information, see [System setup options](#).

Testing memory using ePSA

- 1 Turn on or restart your computer.
- 2 Press F12 after the AlienHead logo is displayed on the screen to access the boot menu.
- 3 Use the arrow keys to highlight the **Diagnostics** menu option and press **Enter**.
- 4 Follow the instructions on the screen to complete the ePSA Pre-boot System Assessment (PSA).



NOTE: If the operating system logo appears, wait until you see the desktop. Turn off your computer and try again.

Processors

Alienware Aurora R5 is shipped with the following processor options:

- 6th Generation Intel Core i3
- 6th Generation Intel Core i5/i5k
- 6th Generation Intel Core i7/i7k

Identifying the processors in Windows

- 1 On the taskbar, click the search box, and then type `Device Manager`.

2 Click **Device Manager**.

The **Device Manager** window is displayed.

3 Expand **Processors** .

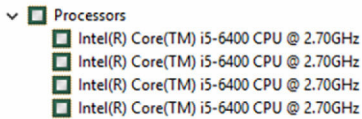

Checking the processor usage in the task manager

1 Right-click on the taskbar.

2 Click **Task Manager**.

The **Task Manager** window is displayed.

3 Click **Performance** tab to display the processor performance details.

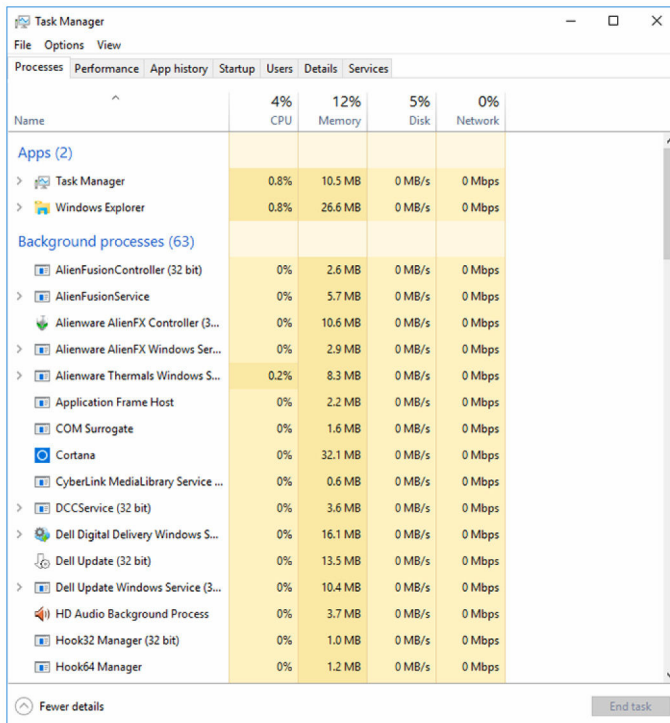

Operating System

Alienware Aurora R5 is shipped with the Windows 10 factory installation.

Service Tag location

The service tag is a unique alphanumeric identifier that allows Dell service technicians to identify the hardware components in your computer and access warranty information.

The Service Tag label is located at the rear of your computer towards the base.

Device driver

A device driver or software driver is a computer program allowing higher-level computer programs to interact with a hardware device. For Alienware Aurora R5, all driver installation for their devices is similar except that some systems may have more devices than others.

Intel Chipset Software Installation Utility

In the Device Manager, check if the chipset driver is installed.

Install the Intel chipset updates from www.dell.com/support.

- System devices
 - ACPI Fan
 - ACPI Fan
 - ACPI Fan
 - ACPI Fan
 - ACPI Fan
 - ACPI Fixed Feature Button
 - ACPI Power Button
 - ACPI Processor Aggregator
 - ACPI Thermal Zone
 - ACPI Thermal Zone
 - Composite Bus Enumerator
 - High Definition Audio Controller
 - High Definition Audio Controller
 - High precision event timer
 - Intel(R) 100 Series/C230 Series Chipset Family LPC Controller - A145
 - Intel(R) 100 Series/C230 Series Chipset Family PCI Express Root Port #2 - A111
 - Intel(R) 100 Series/C230 Series Chipset Family PCI Express Root Port #4 - A113
 - Intel(R) 100 Series/C230 Series Chipset Family PCI Express Root Port #3 - A112
 - Intel(R) 100 Series/C230 Series Chipset Family PMC - A121
 - Intel(R) 100 Series/C230 Series Chipset Family SMBus - A123
 - Intel(R) Management Engine Interface
 - Intel(R) Power Engine Plug-in
 - Intel(R) Serial IO GPIO Host Controller - INT345D
 - Intel(R) Serial IO I2C Host Controller - A160
 - Intel(R) Serial IO I2C Host Controller - A161
 - Intel(R) Serial IO UART Host Controller - A127
 - Intel(R) Xeon(R) E3 - 1200/1500 v5/6th Gen Intel(R) Core(TM) Host Bridge/DRAM Registers - 191F
 - Intel(R) Xeon(R) E3 - 1200/1500 v5/6th Gen Intel(R) Core(TM) PCIe Controller (x16) - 1901
 - Legacy device
 - Microsoft ACPI-Compliant System
 - Microsoft System Management BIOS Driver
 - Microsoft UEFI-Compliant System
 - Microsoft Virtual Drive Enumerator
 - Microsoft Windows Management Interface for ACPI
 - Microsoft Windows Management Interface for ACPI
 - Microsoft Windows Management Interface for ACPI
 - Microsoft Windows Management Interface for ACPI
 - NDIS Virtual Network Adapter Enumerator
 - Numeric data processor
 - PCI Express Root Complex
 - Plug and Play Software Device Enumerator
 - Programmable interrupt controller
 - Remote Desktop Device Redirector Bus
 - System CMOS/real time clock
 - System timer
 - UMBus Root Bus Enumerator

Video drivers

In the Device Manager, check if the video driver is installed.







Install the video driver update from www.dell.com/support.



- Display adapters
 - Intel(R) HD Graphics 530
 - NVIDIA GeForce GTX 970

Intel Serial IO driver

In the Device Manager, check if the Intel Serial IO driver is installed.

Install the driver updates from www.dell.com/support.

- ▼  Human Interface Devices
 -  HID-compliant consumer control device
 -  HID-compliant consumer control device
 -  HID-compliant system controller
 -  USB Input Device
 -  USB Input Device
 -  USB Input Device

- ▼  Mice and other pointing devices
 -  HID-compliant mouse

- System devices
 - ACPI Fan
 - ACPI Fan
 - ACPI Fan
 - ACPI Fan
 - ACPI Fan
 - ACPI Fixed Feature Button
 - ACPI Power Button
 - ACPI Processor Aggregator
 - ACPI Thermal Zone
 - ACPI Thermal Zone
 - Composite Bus Enumerator
 - High Definition Audio Controller
 - High Definition Audio Controller
 - High precision event timer
 - Intel(R) 100 Series/C230 Series Chipset Family LPC Controller - A145
 - Intel(R) 100 Series/C230 Series Chipset Family PCI Express Root Port #2 - A111
 - Intel(R) 100 Series/C230 Series Chipset Family PCI Express Root Port #4 - A113
 - Intel(R) 100 Series/C230 Series Chipset Family PCI Express Root Port #3 - A112
 - Intel(R) 100 Series/C230 Series Chipset Family PMC - A121
 - Intel(R) 100 Series/C230 Series Chipset Family SMBus - A123
 - Intel(R) Management Engine Interface
 - Intel(R) Power Engine Plug-in
 - Intel(R) Serial IO GPIO Host Controller - INT345D
 - Intel(R) Serial IO I2C Host Controller - A160
 - Intel(R) Serial IO I2C Host Controller - A161
 - Intel(R) Serial IO UART Host Controller - A127
 - Intel(R) Xeon(R) E3 - 1200/1500 v5/6th Gen Intel(R) Core(TM) Host Bridge/DRAM Registers - 191F
 - Intel(R) Xeon(R) E3 - 1200/1500 v5/6th Gen Intel(R) Core(TM) PCIe Controller (x16) - 1901
 - Legacy device
 - Microsoft ACPI-Compliant System
 - Microsoft System Management BIOS Driver
 - Microsoft UEFI-Compliant System
 - Microsoft Virtual Drive Enumerator
 - Microsoft Windows Management Interface for ACPI
 - Microsoft Windows Management Interface for ACPI
 - Microsoft Windows Management Interface for ACPI
 - Microsoft Windows Management Interface for ACPI
 - NDIS Virtual Network Adapter Enumerator
 - Numeric data processor
 - PCI Express Root Complex
 - Plug and Play Software Device Enumerator
 - Programmable interrupt controller
 - Remote Desktop Device Redirector Bus
 - System CMOS/real time clock
 - System timer
 - UMBus Root Bus Enumerator

Intel Trusted Execution Engine Interface

In the Device Manager, check if the Intel Trusted Execution Engine Interface driver is installed.

Install the driver update from www.dell.com/support.

- System devices
 - ACPI Fan
 - ACPI Fan
 - ACPI Fan
 - ACPI Fan
 - ACPI Fan
 - ACPI Fixed Feature Button
 - ACPI Power Button
 - ACPI Processor Aggregator
 - ACPI Thermal Zone
 - ACPI Thermal Zone
 - Composite Bus Enumerator
 - High Definition Audio Controller
 - High Definition Audio Controller
 - High precision event timer
 - Intel(R) 100 Series/C230 Series Chipset Family LPC Controller - A145
 - Intel(R) 100 Series/C230 Series Chipset Family PCI Express Root Port #2 - A111
 - Intel(R) 100 Series/C230 Series Chipset Family PCI Express Root Port #4 - A113
 - Intel(R) 100 Series/C230 Series Chipset Family PCI Express Root Port #3 - A112
 - Intel(R) 100 Series/C230 Series Chipset Family PMC - A121
 - Intel(R) 100 Series/C230 Series Chipset Family SMBus - A123
 - Intel(R) Management Engine Interface
 - Intel(R) Power Engine Plug-in
 - Intel(R) Serial IO GPIO Host Controller - INT345D
 - Intel(R) Serial IO I2C Host Controller - A160
 - Intel(R) Serial IO I2C Host Controller - A161
 - Intel(R) Serial IO UART Host Controller - A127
 - Intel(R) Xeon(R) E3 - 1200/1500 v5/6th Gen Intel(R) Core(TM) Host Bridge/DRAM Registers - 191F
 - Intel(R) Xeon(R) E3 - 1200/1500 v5/6th Gen Intel(R) Core(TM) PCIe Controller (x16) - 1901
 - Legacy device
 - Microsoft ACPI-Compliant System
 - Microsoft System Management BIOS Driver
 - Microsoft UEFI-Compliant System
 - Microsoft Virtual Drive Enumerator
 - Microsoft Windows Management Interface for ACPI
 - Microsoft Windows Management Interface for ACPI
 - Microsoft Windows Management Interface for ACPI
 - Microsoft Windows Management Interface for ACPI
 - NDIS Virtual Network Adapter Enumerator
 - Numeric data processor
 - PCI Express Root Complex
 - Plug and Play Software Device Enumerator
 - Programmable interrupt controller
 - Remote Desktop Device Redirector Bus
 - System CMOS/real time clock
 - System timer
 - UMBus Root Bus Enumerator

Intel Wireless-AC 8260 Wi-Fi and Bluetooth drivers

In the Device Manager, check if the network card driver is installed.

Install the driver updates from www.dell.com/support.

- Network adapters
 - Bluetooth Device (Personal Area Network)
 - Bluetooth Device (RFCOMM Protocol TDI)
 - Dell Wireless 1820 802.11ac
 - Killer e2400 Gigabit Ethernet Controller

In the Device Manager, check if the Bluetooth driver is installed.

Install the driver updates from www.dell.com/support.



BIOS overview

The BIOS manages data flow between the computer's operating system and attached devices such as hard disk, video adapter, keyboard, mouse, and printer.

Boot menu

The Alienware Area-51 R2 includes a one-time boot menu. By using this feature, you can change the sequence of devices that your computer attempts to boot from, for example, CD-ROM, hard drive, or network.

Boot menu enhancements

The boot menu enhancements are as follows:

- **Easier Access** — Press F12 to access the boot selection menu.
- **User Prompting** — The user is prompted to use the keystroke on the BIOS screen.
- **Diagnostics Options** — The boot menu includes the ePSA diagnostic options.

Timing key sequences

The keyboard is not the first device initialized by Setup. As a result, if you press a keystroke too early, the keyboard is locked out. In such case, a keyboard error message is displayed on the screen, and you cannot restart your computer with the Ctrl+Alt+Del key combination.

To prevent the keyboard from locking, wait until the keyboard is initialized completely. The keyboard is initialized if one of the following occurs:

- The keyboard lights flash.
- The F2=Setup prompt appears at the top-right corner of the screen during boot.

System diagnostic lights

The computer POST (Power On Self Test) ensures that it meets the basic computer requirements and the hardware is working appropriately before the boot process begins. If the computer passes the POST, the computer continues to start in a normal mode. However, if the computer fails the POST, the computer emits a series of LED codes in amber color during the start-up.

The following table shows different light patterns, what they indicate, and the suggested solutions.

Number of Power LED flashes	Problem description	Suggested solution
1	System board: BIOS and ROM failure	Flash latest BIOS version. If problem persists, replace the system board.
2	No memory or RAM detected	Confirm that the memory module is installed properly. If problem persists, replace the memory module.
3	System board or chipset error	Replace the system board.
4	Memory or RAM failure	Replace the memory module.
5	CMOS battery failure	Replace the CMOS battery.
6	Video card or chip failure	Replace the video card.
7	CPU failure	Replace the system board.
3,6	BIOS recovery image not found	Reimage the system BIOS.
3,7	BIOS recovery image found but invalid	Reimage the system BIOS.

Getting help and contacting Alienware

Self-help resources

You can get information and help on Alienware products and services using these online self-help resources:



Information about Alienware products and services www.alienware.com

Troubleshooting information, user manuals, setup instructions, product specifications, technical help blogs, drivers, software updates, and so on www.alienware.com/gamingservices

Videos providing step-by-step instructions to service your computer www.youtube.com/alienwareservices

Contacting Alienware

To contact Alienware for sales, technical support, or customer service issues, see www.alienware.com.

-  **NOTE:** Availability varies by country and product, and some services may not be available in your country.
-  **NOTE:** If you do not have an active internet connection, you can find contact information on your purchase invoice, packing slip, bill, or Dell product catalog.