

Systems

**IBM 3101 Display Terminal
Description**



Systems

**IBM 3101 Display Terminal
Description**



Federal Communications Commission (FCC) Statement

For IBM 3101 Display Terminal Models 10, 12, and 13

Warning: This equipment generates, uses, and can radiate radio frequency energy, and if not installed and used in accordance with the instruction manual, may cause interference to radio communications. As temporarily permitted by regulation, it has not been tested for compliance with the limits for Class A computing devices pursuant to Subpart J of Part 15 of FCC Rules, which are designed to provide reasonable protection against such interference. Operation of this equipment in a residential area is likely to cause interference, in which case, the user, at his own expense, will be required to take whatever measures may be required to correct the interference.

For IBM 3101 Display Terminal Models 20, 22, and 23

Warning: This equipment generates, uses, and can radiate radio frequency energy and, if not installed and used in accordance with the instructions manual, may cause interference to radio communications. It has been tested and found to comply with the limits for a Class A computing device pursuant to Subpart J of Part 15 of FCC Rules, which are designed to provide reasonable protection against such interference when operated in a commercial environment. Operation of this equipment in a residential area is likely to cause interference, in which case the user, at his own expense, will be required to take whatever measures may be required to correct the interference.

The above FCC statements apply only to those machines used in U.S.

Third Edition (April 1982)

This is a major revision of GA18-2033-1, which is now obsolete. This edition incorporates changes to the organization of the document, as well as technical changes, and should be read in its entirety.

Changes are made periodically to the information herein; any such changes will be reported in subsequent revisions or Technical Newsletters.

It is possible that this material may contain reference to, or information about, IBM products (machines and programs), programming, or services that are not announced in your country. Such references or information must not be construed to mean that IBM intends to announce such IBM products, programming, or services in your country.

Publications are not stocked at the address given below; requests for IBM publications should be made to your IBM representative or to the IBM branch office serving your locality.

A form for readers' comments is provided at the back of this publication; if the form has been removed, address comments to IBM Corporation, Department 812J, 1133 Westchester Avenue, White Plains, New York, 10604, U. S. A. IBM may use or distribute any of the information you supply in any way it believes appropriate without incurring any obligation whatever. You may, of course, continue to use the information you supply.

Preface

This publication describes the IBM 3101 Display Terminal and is intended as a reference for the following customer personnel, as well as IBM marketing representatives, system engineers, Technical Support Center personnel, and marketing and support services personnel of IBM Authorized Distributors:

- System analysts who are responsible for designing and coordinating the total system of which the 3101 will be a part
- System programmers who generate and update the host operating system and the programming associated with it
- Site planners who prepare the site for the setup of 3101s
- Persons who are responsible for setting up and relocating the 3101s

The reader is assumed to have a basic understanding of display systems and of their relationship to a central processor.

This publication consists of five chapters:

- Chapter 1, "Introduction," gives a general description of the IBM 3101 Display Terminal.
- Chapter 2, "Functional Description," is a detailed explanation of how the 3101 operates.
- Chapter 3, "Operator Controls and Indicators," explains the operation of setup switches, keyboard keys, and other operator controls and indicators.

- Chapter 4, "Programming Considerations," contains programming information and information about IBM programming support.
- Chapter 5, "Planning and Site Preparation," explains what must be done to prepare for the physical installation of the 3101.

The publication also has the following appendixes:

- Appendix A, "Summary of Communication Operations"
- Appendix B, "Character Set Information"
- Appendix C, "Messages in Operator Information Area"
- Appendix D, "Power Plug Requirements"
- Appendix E, "Physical Planning Template"
- Appendix F, "Code Translation Table"
- Appendix G, "Summary of 3101 Functions"
- Appendix H, "3101 Modem Cable Connection Instructions"
- Appendix I, "Summary of Cursor Movement"

The reader will also find the following publications helpful:

- *IBM 3101 Setup Instructions*, GA18-2034
- *IBM 3101 Operator Reference Information*, GA18-2035
- *IBM 3101 Customer Problem Analysis and Resolution Guide*, GA18-2036
- *An Introduction to the IBM 3101 Display Terminal*, GA18-2051

Contents

Chapter 1. Introduction	1-1
1.1 Logic Element	1-1
1.2 Video Element	1-1
1.3 Keyboard Element	1-1
1.4 Models	1-1
1.5 Special Design Considerations	1-2
1.6 Attachment	1-2
1.6.1 Direct Attachment	1-3
1.6.2 Remote Attachment	1-3
1.7 Maintenance	1-3
Chapter 2. Functional Description	2-1
2.1 Modes	2-1
2.1.1 Data Transfer Modes	2-1
2.1.2 Telecommunication Modes	2-2
2.1.3 Operational Modes	2-2
2.1.3.1 Normal Mode	2-2
2.1.3.2 Transparent Mode	2-3
2.1.3.3 Program Mode	2-3
2.2 Display	2-4
2.2.1 Display Fields	2-5
2.2.2 Display Attributes	2-5
2.2.3 Display Screen Buffer Address and Cursor Address	2-6
2.3 Data Stream	2-7
2.3.1 Data Stream Format	2-8
2.3.2 Data Stream to Printer	2-11
2.4 Data Flow	2-13
2.5 Telecommunication Operations, States, and Facilities	2-14
2.5.1 Telecommunication Operating States	2-14
2.5.1.1 Duplex Operating State—Character Mode	2-14
2.5.1.2 Half-Duplex Operating State—Character Mode	2-15
2.5.1.3 Half-Duplex Operating State—Block Mode	2-16
2.5.2 Telecommunication Facilities	2-17
2.5.2.1 Duplex Telecommunication Facility	2-17
2.5.2.2 Half-Duplex Telecommunication Facility without Reverse Channel	2-17
2.5.2.3 Half-Duplex Telecommunication Facility with Reverse Channel	2-18
2.6 Modems	2-19
2.7 Commands	2-19
2.8 Auxiliary Device Operations	2-26
2.8.1 Monitor-Print Operation	2-26
2.8.2 Buffer-Print Operation	2-26
2.9 System and Status Messages	2-27
2.9.1 Normal-Mode Messages	2-27
2.9.1.1 Mode Field Messages	2-27
2.9.1.2 Sub-Mode Field Messages	2-27
2.9.1.3 Lock Field Messages	2-27
2.9.1.4 Insert Field Message	2-30
2.9.1.5 Shift Field Message	2-30
2.9.1.6 Send/Receive Field Messages	2-30
2.9.1.7 Miscellaneous Status Field Messages	2-31
2.9.2 Test-Mode Messages	2-31
2.9.2.1 Mode Field Message	2-31
2.9.2.2 Machine Status Field Messages	2-31
2.9.2.3 Action Field Message	2-31
Chapter 3. Operator Controls and Indicators	3-1
3.1 Logic Element	3-1
3.1.1 Power Switch	3-2
3.1.2 Power-On Light	3-2
3.1.3 NORMAL/TEST Switch	3-2
3.1.4 Light 1	3-2
3.1.5 Light 2	3-2
3.1.6 Audible Alarm Volume Control	3-2
3.2 Video Element - Brightness and Contrast Control Knobs	3-3
3.3 Keyboard Element	3-3
3.3.1 Setup Switches	3-3
3.3.1.1 BLOCK/CHAR Switch	3-5
3.3.1.2 HDX/FDX Switch	3-5
3.3.1.3 Interface Switch (232C or V.24/V.28, CL, 422, or V.11)	3-5
3.3.1.4 PRTS/CRTS Switch	3-6
3.3.1.5 REVERSE CH Switch	3-6
3.3.1.6 Turnaround Character Switches	3-6
3.3.1.7 DUAL/MONO Switch	3-6
3.3.1.8 STOP 1/STOP 2 Switch	3-7
3.3.1.9 Parity Bit Selection Switches	3-7
3.3.1.10 Send Line Option Switch	3-7
3.3.1.11 NULL SUPP Switch	3-8
3.3.1.12 Time-Fill Switches	3-9
3.3.1.13 AUTO NL Switch	3-9
3.3.1.14 AUTO LF Switch	3-9
3.3.1.15 CR/CR•LF Switch	3-9
3.3.1.16 SCROLL Switch	3-9
3.3.1.17 REVERSE VIDEO Switch	3-10
3.3.1.18 Blink Cursor Switch	3-10
3.3.1.19 Line Speed Switches for Telecommunication Interface	3-10
3.3.1.20 Line Speed Switches for Auxiliary Interface	3-10
3.3.2 Keyboard Key Functions	3-11
3.3.2.1 ATTR Key	3-12
3.3.2.2 PRGM MODE Key	3-14
3.3.2.3 ESC Key	3-14
3.3.2.4 PRINT MSG Key	3-15
3.3.2.5 PRINT LINE Key	3-15
3.3.2.6 PRINT Key	3-15
3.3.2.7 AUX Key	3-15
3.3.2.8 ERASE EOL/EOF Key	3-16
3.3.2.9 ERASE INPUT Key	3-16
3.3.2.10 ERASE EOS Key	3-16
3.3.2.11 CLEAR Key	3-16
3.3.2.12 SEND MSG Key	3-16
3.3.2.13 SEND LINE Key	3-17
3.3.2.14 Click Key	3-17
3.3.2.15 LOCAL Key	3-17
3.3.2.16 Tab Key	3-18
3.3.2.17 Shift Lock Key	3-18
3.3.2.18 Shift Key	3-18
3.3.2.19 RESET Key	3-19
3.3.2.20 CANCEL Key	3-19
3.3.2.21 Backspace Key	3-19
3.3.2.22 Back-Tab Key	3-20
3.3.2.23 New Line Key	3-20
3.3.2.24 ALT Key	3-21
3.3.2.25 SEND Key	3-24
3.3.2.26 DEL Key	3-24
3.3.2.27 BREAK Key	3-25
3.3.2.28 Home Key	3-25
3.3.2.29 INS CHAR Key	3-25
3.3.2.30 INS LINE Key	3-26
3.3.2.31 DEL CHAR Key	3-26
3.3.2.32 DEL LINE Key	3-26
3.3.2.33 Move-Cursor Keys	3-27

3.3.2.34	Program Function Keys	3-27	5.2.1.2	Electrostatic Discharge Considerations	5-14
3.3.2.35	Inoperative Keys	3-27	5.2.1.3	Electromagnetic Interference	5-15
3.3.2.36	Dead Keys	3-28	5.2.2	Viewing Distance	5-15
Chapter 4. Programming Considerations		4-1	5.2.3	Ambient Lighting	5-15
4.1	IBM Host Systems	4-1	5.2.4	Cable Requirements and Installation	5-16
4.1.1	Levels of IBM Host Programming Support	4-1	5.2.4.1	3101 Cables	5-16
4.1.1.1	CPT-TWX 33/35 Type Terminal Support - Character Mode	4-2	5.2.4.2	Connector and Cable Specifications	5-18
4.1.1.2	Editing Function Support - Block Mode	4-2	5.2.5	Product and Environmental Safety	5-18
4.1.1.3	3101 Function Support - Character and Block Modes	4-3	5.2.5.1	Branch Circuits and Grounding	5-19
4.1.2	Line Speeds and Telecommunication Facilities Supported	4-3	5.2.5.2	Lightning Protection	5-19
4.1.3	Scope of Support and Operating Environment Restrictions	4-4	Appendix A. Summary of Send and Receive Operations		A-1
4.1.3.1	3704/3705 System Support	4-4	Appendix B. Character Set Information		B-1
4.1.3.2	System/370 Support	4-5	B.1	U.S. ASCII Character Set	B-2
4.1.3.3	4300 Support	4-8	B.2	Character Sets for Canada	B-3
4.1.3.4	8100 Support	4-9	B.3	Character Set for Japan	B-5
4.1.3.5	Series/1 Support	4-9	B.4	Character Set for France	B-7
4.2	General Programming Considerations	4-11	B.5	Character Set for Germany	B-8
4.2.1	ENQ Character	4-11	B.6	Character Set for Italy	B-9
4.2.2	Generating ASCII or ISO Code Control Characters	4-11	B.7	Character Set for the U.K.	B-10
4.2.3	Logical Keyboard Lock	4-11	Appendix C. Messages in Operator Information Area		C-1
4.2.4	Invalid Parameters for ESC Sequence	4-12	Appendix D. Power Plug Requirements		D-1
4.2.5	Timing Considerations for ESC Sequence	4-12	Appendix E. Physical Planning Template		E-1
4.2.6	Read Command Considerations	4-12	Appendix F. Code Translation Table		F-1
4.2.6.1	Duplex Telecommunication Facility	4-12	Appendix G. Summary of 3101 Functions		G-1
4.2.6.2	Half-Duplex Telecommunication Facility	4-13	Appendix H. 3101 Modem Cable Connection Instructions		H-1
Chapter 5. Planning and Site Preparation		5-1	Appendix I. Summary of Cursor Movement		I-1
5.1	Planning	5-1	Abbreviations		Abbrev-1
5.1.1	Telecommunication Service Preparation	5-2	Glossary		Gloss-1
5.1.1.1	Modem Cables	5-4	Index		Index-1
5.1.1.2	Telecommunication Interface Considerations	5-5			
5.1.1.3	Telecommunication Facilities	5-7			
5.1.2	Programming Support Preparation	5-8			
5.1.3	Setup Switch Setting Preparation	5-8			
5.2	Site Preparation	5-11			
5.2.1	Floor Plan	5-14			
5.2.1.1	Operator Workspace Considerations	5-14			

Figures

- 1-1. Examples of the IBM 3101 in a System Configuration 1-4
- 2-1. Mode Transition in Character Mode 2-1
- 2-2. Mode Transition in Block Mode 2-2
- 2-3. Relationship of Buffer Location and Display Surface Character Position 2-4
- 2-4. Examples of Formatted Displays 2-5
- 2-5. Attribute Character Bit Assignment in Display Buffer 2-6
- 2-6. Example of Data Stream to the Host 2-9
- 2-7. Example of Data Stream from the Host 2-10
- 2-8. IBM 3101 Data Flow 2-13
- 2-9. Duplex Operation State in Character Mode 2-14
- 2-10. Half-Duplex Operating State—Character Mode 2-15
- 2-11. Half-Duplex Operating State in Block Mode (Model 2X) 2-16
- 2-12. Command Descriptions 2-20
- 2-13. Display Screen Buffer and Cursor Address Codes 2-24
- 2-14. Set-Control Command Control-Byte Graphic Representation 2-25
- 2-15. Priorities of Lock Indications in Operator Information Area 2-28
- 3-1. Locations of Controls and Indicators 3-1
- 3-2. IBM 3101 Setup Switch Layout 3-4
- 3-3. IBM 3101 Keyboard Layout (U.S.) 3-12
- 3-4. Definition of Attribute Characters 3-14
- 3-5. Control Characters and Their Functions 3-22
- 4-1. Summary of Functions Supported by IBM Programming Support Levels 4-2
- 4-2. System/370 Support 4-5
- 5-1. Planning Checklist 5-1
- 5-2. IBM 3101 Telecommunication and Auxiliary Interface Diagram 5-3
- 5-3. Special Wiring for 113A-Type Modem 5-4
- 5-4. Current-Loop Wiring 5-5
- 5-5. Wiring Examples for Direct Connection to Host (EIA) 5-7
- 5-6. 3101 Setup Switches 5-9
- 5-7. 3101 Setup-Switch Checklists 5-10
- 5-8. IBM 3101 Dimensions 5-12
- 5-9. IBM 3101 Cabling 5-16
- 5-10. Connector and Cable Specifications 5-18
- A-1. Send Operation A-1
- A-2. Receive Operation A-4
- A-3. Character Conversion in Send-Print Data Stream A-5
- B-1. U.S. ASCII Character Set (87 Keys) B-2
- B-2. Bilingual English/Canadian French Character Set and Keyboard B-3
- B-3. Japanese Katakana Character Set and Keyboard B-5
- B-4. French Character Set and Keyboard B-7
- B-5. German Character Set and Keyboard B-8
- B-6. Italian Character Set and Keyboard B-9
- B-7. U.K. English Character Set and Keyboard B-10
- D-1. Plug with Side Earthing (Ground) Pin-16-A Max, 250 V D-1
- D-2. Plug with Earthing (Ground) Pin-10-A Max, 250 V D-1
- D-3. Plug with Earthing (Ground) Pin-15-A Max, 125 V D-1
- D-4. Plug with Contact Tube and Side Earthing (Ground) Pin-16-A Max, 250 V D-1
- D-5. Plug with Earthing (Ground) Pin-13-A Max, 250 V D-2
- D-6. Plug with Earthing (Ground) Pin-15-A Max, 250 V D-2
- D-7. Plug with Earthing (Ground) Pin-10-A Max, 250 V D-2
- D-8. Plug with Earthing (Ground) Pin-16-A Max, 250 V D-2
- D-9. Plug with Earthing (Ground) Pin-10-A Max, 250 V D-2
- D-10. Locking Plug with Earthing (Ground) Pin-10-A Max, 125 V D-2

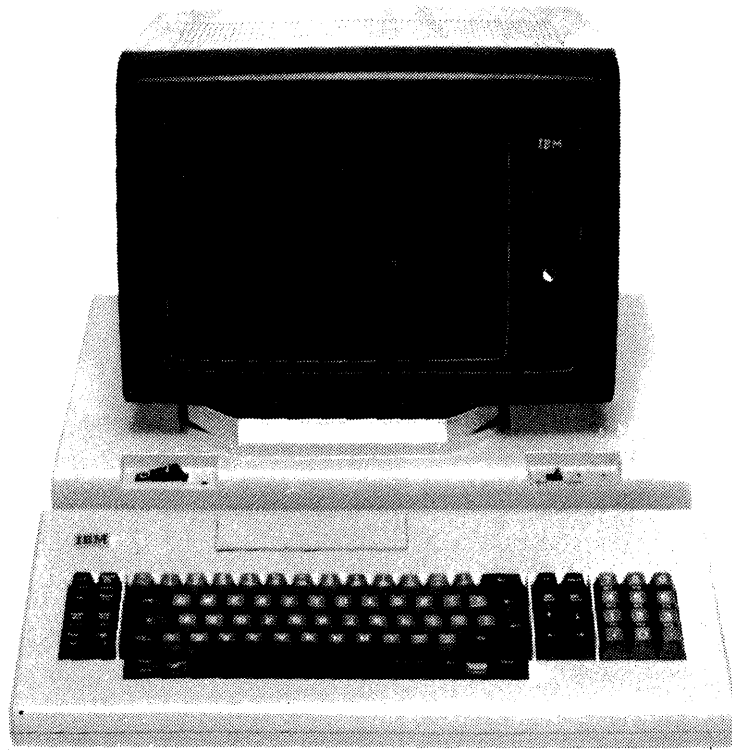

Frontispiece. IBM 3101 Display Terminal

Chapter 1. Introduction

The IBM 3101 Display Terminal is a modularly designed product consisting of three work-station elements: the logic element, the video element, and the keyboard element. It communicates with an IBM or non-IBM system/processor (hereafter called the *host*), using start-stop line control and the line transmission code of the American National Standard Code for Information Interchange (ASCII) or the International Organization for Standardization 7-bit extended code (ISO 646). The line speed for telecommunications with the host varies from 110 to 9600 bits per second (bps): 110, 150, 200, 300, 600, or 1200 bps for telecommunications through modems, and 110, 150, 200, 300, 600, 1200, 1800, 2400, 4800, or 9600 bps for direct connection. In addition, an output device, such as a printer or recorder, can be connected to the 3101.

The modular design of the 3101 enables the user to set it up and, later, to relocate or remove it, without the help of IBM service representatives.

The 3101 can also be used as a CPT-TWX 33/35 type terminal.

1.1 Logic Element

The logic element consists of a power supply, a logic card, fuses to protect the circuits from overload, and cable connectors for the video element, the keyboard element, an output device (auxiliary interface), and for a telecommunication interface.

1.2 Video Element

The video element has a 30-centimeter (12-inch), diagonal, monochrome, cathode ray tube (CRT), on which up to 24 lines of 80 characters each (1920 characters) can be displayed. A 25th line is used for operator information.

This element connects to the logic element by cable.

1.3 Keyboard Element

The keyboard element connects to the logic element by cable. The keyboard has 87 keys (or 88, for Japanese Katakana), including a clustered 12-key keypad, and can generate all 128 ASCII or ISO character codes.

Also on the keyboard element are setup switches with which the user selects required functions.

1.4 Models

The 3101 is available in six models: Models 10, 12, 13, 20, 22, and 23.

Models 10, 12, and 13 (hereafter collectively referred to as *Model 1X*) transfer data in *character mode*, which means that each character entered at the keyboard is immediately transferred to the host.

Models 20, 22, and 23 (hereafter collectively referred to as *Model 2X*) have all the functions that Model 1X has, but can also transfer data in *block mode*, which means the characters entered at the keyboard are stored in a buffer, where they can be edited by the operator, and are transferred to the host in a block. Model 2X also has field-control functions and can perform a buffer-print operation. Chapter 2 has more details.

1.5 Special Design Considerations

The following considerations have been incorporated in the design of the 3101:

- A 25th line displays messages and status information.
- The operator can select automatic scrolling, reverse-video image, and a blinking cursor.
- The 3101 can be placed in a local mode, where there is no host-system intervention. This mode is used for operator training, format creation, or display-data editing without disturbing the host.
- The logic of the 3101 has a self-diagnostic test that effectively checks the functions of the work-station elements.
- The keyboard has keyboard separator bars to help prevent accidental striking of control/function keys.
- The keyboard layout is familiar to typists, data-entry operators, and system operators, thus contributing to operator efficiency.
- The operator can tilt the video element vertically 10 or 15 degrees and can turn it up to 12.5 degrees in either direction.
- Because the keyboard connects to the logic element by cable, the keyboard can be moved, with limitations, for added operator comfort.
- A screen filter is provided to enhance display contrast.

1.6 Attachment

The 3101 can be attached to the host either directly by cable or through the Post Telephone and Telegraph Administration (PTT) or communication common carriers (or equivalent customer facilities). Figure 1-1 shows examples of the 3101 in various system configurations.

Host systems to which the 3101 can be attached are:

- IBM System/370 Models 115, 125, 135, 138, 145, 155II, 148, 158, 165, 168, and 195
- IBM 3031, 3032, 3033, or 3081 Processors

Note: Attachment to the IBM System/370, IBM 303X or IBM 3081 Processors is through an IBM 3704 Communications Controller, a 3705 Communications Controller, or a 2701 Data Adapter Unit.

- IBM 4300 Processors
- IBM 8100 Information System
- IBM Series/1
- Non-IBM Processor (mainframe)
- Non-IBM Minicomputer

1.6.1 Direct Attachment

The 3101 attaches to the host by a cable and one of the following interfaces:

- EIA RS-232C or CCITT V.24/V.28
- EIA RS-422 or CCITT V.11
- Current Loop (20 mA)

The actual length of the cable used is dependent on line speed, cable quality, the electrical environment of the installation, and the telecommunication interface.

1.6.2 Remote Attachment

Remote attachment is through a modem for the EIA RS-232C or CCITT V.24/V.28 interface, over a communication common carrier or equivalent telecommunication facility. With an attachment of this kind, the 3101 and its host can be separated by a long distance.

The modem used must be asynchronous, which is generally available for line speeds up to 1200 bps.

Note: IBM does not endorse connecting one 3101 to another without an intervening host, nor has IBM tested this type of connection. The 3101 is designed to be used with a host capable of reading data from and writing data to the terminal and processing the controls for transfer of that data. However, the user may wish to connect two 3101s directly. Such connections should be carefully planned, as certain functions of the 3101 may not be usable. A direct connection between two 3101 terminals should be attempted only after careful study of the 3101 functions and after consideration of all aspects of the application desired.

1.7 Maintenance

The 3101 is easy to maintain because of the work-station element concept, the offline self-diagnostic test, and the problem analysis and resolution procedures. If a problem occurs during the operation of the 3101, the operator follows the problem analysis and resolution procedures in the *IBM 3101 Customer Problem Analysis and Resolution Guide*, GA18-2036. If the test is successful, the problem can be assumed to be external to the 3101. However, if the cause of a problem is isolated to a work-station element, the failing element can be exchanged without the help of an IBM representative. The failing unit is then sent to an IBM Repair Center, where it is repaired and returned to the user.

In the U.S., if the customer has selected the On-Site Machine Element Replacement Service, the customer calls the IBM customer service coordinator. An IBM representative will bring the element specified by the customer to the customer's site, and install and test the replacement element. The failing element becomes the property of IBM.

Note: On-site assistance in the performance of customer problem analysis and resolution (CPAR) and the replacement of a failing element with a customer-supplied spare is available on a billable-hourly (per-call) basis.

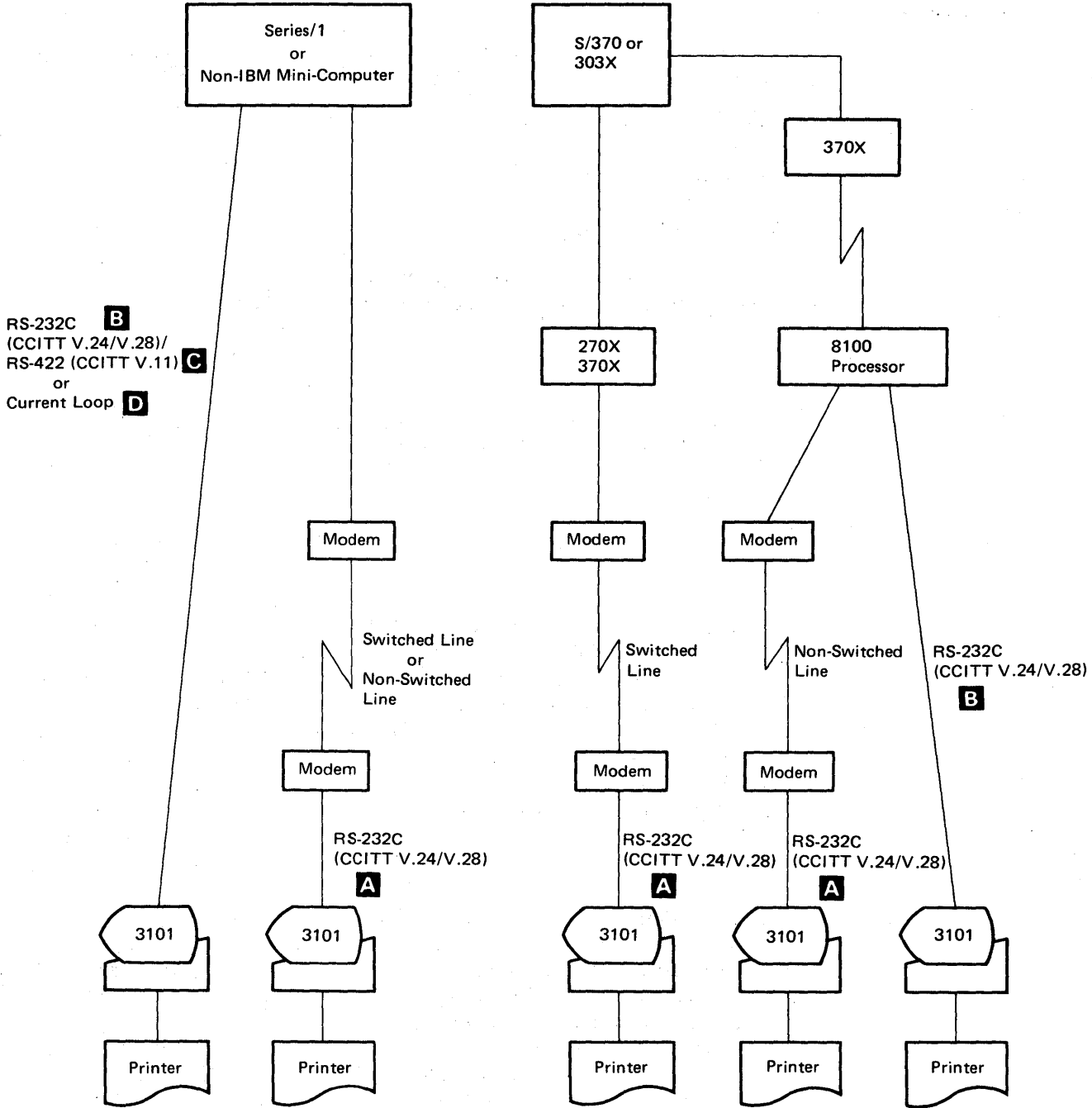

	Line speed	Models
A	110 – 1200 bps	10, 12, 13, 20, 22, 23
B	110 – 9600	10, 12, 13, 20, 22, 23
C	110 – 9600	13 or 23
D	110 – 9600	12 or 22

Note: For cable specifications of each telecommunication interface, see Figure 5-10.

Figure 1-1. Examples of the IBM 3101 in a System Configuration

Chapter 2. Functional Description

The main functions of the 3101 Display Terminal are to transfer data to the host and to display data transferred from the host. The 3101 can also transfer data to an attached output device. This chapter describes how the 3101 operates.

Appendix G summarizes the functions available for each 3101 model.

2.1 Modes

The 3101 has data transfer modes (character and block), telecommunication modes (communication and local), and operational modes (normal, transparent, and program).

2.1.1 Data Transfer Modes

The two data transfer modes are character and block. The mode is selected with the BLOCK/CHAR setup switch, which is described in Chapter 3. The 3101 Model 1X operates in character mode only; Model 2X operates in either mode.

In character mode, the 3101 transfers data to the host character-by-character. In block mode, characters entered at the keyboard are stored in the buffer and are not transferred to the host until the operator presses a Send key, or until the host issues a Read Buffer command.

Figures 2-1 and 2-2 show the transitions among telecommunication modes and operational modes, both in character and block mode. Keyboard key functions are described in Chapter 3.

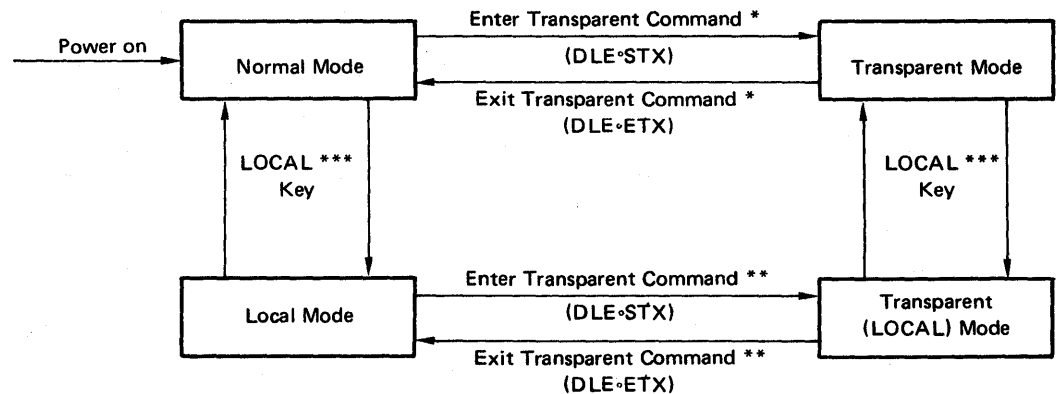

Note: * By the host or the operator (See Section 2.1.3.2)
** By the operator only
*** Function of local key is described in Chapter 3

Figure 2-1. Mode Transition in Character Mode

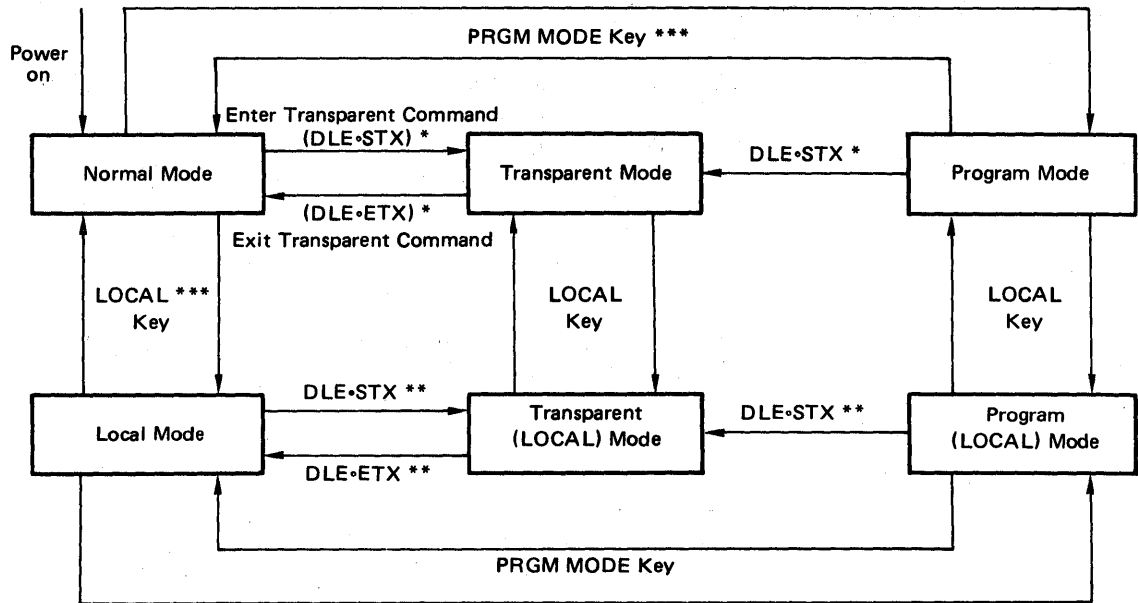

Note: * By the host or the operator (See Section 2.1.3.2)
 ** By the operator only
 *** Functions of these keys are described in Chapter 3

Figure 2-2. Mode Transition in Block Mode

2.1.2 Telecommunication Modes

The telecommunication modes are communication and local. The 3101 enters the communication mode after the Power (I/O) switch is turned on. In this mode, the 3101 can transfer data to the host or receive a data stream from the host.

In local mode (entered by pressing the LOCAL key), the 3101 does not communicate with the host (except to automatically respond to the Read Status command from the host), but all keyboard and display functions are active. The local mode can be used to train operators, create formats, or edit displayed data, without disturbing the host.

The host can prevent the 3101 from entering the local mode by issuing a Set Control command. It also can read 3101 status by issuing a Read Status command, even when the 3101 is in local mode.

2.1.3 Operational Modes

Each telecommunication mode has three operational modes: normal, transparent, and program.

2.1.3.1 Normal Mode

The 3101 enters the normal mode after the Power switch is set to on. In the normal mode, 96 ASCII graphic characters, including a DEL character, entered from the 3101 keyboard or received from the host can be displayed. Characters entered from the keyboard also can be transferred to the host.

2.1.3.2 Transparent Mode

The 3101 enters the transparent mode when the Enter Transparent Mode command (DLE•STX sequence) is received from the keyboard or host (Figure 3-5 shows this sequence). The message, (XPARENT), is displayed in line 25 (the Operator Information Area). The 3101 leaves the transparent mode and returns to the normal mode when it receives the Exit Transparent Mode command (DLE•ETX sequence, which also is described in Figure 3-5).

In transparent mode, the 3101 stores and displays all 128 ASCII or ISO code characters (159 for Bilingual English/Canadian French and 191 for Japanese Katakana) received from the host or entered from the keyboard. Characters entered from the keyboard are also transferred to the host in character mode. However, the ASCII or ISO code control characters shown in Figure 3-5 (for example, BS, HT, LF, and CR) and the control sequences (for example, the ESC and DLE•EOT sequence), except DLE•ETX, do not perform their functions. Function keys that do not generate ASCII or ISO code characters, such as Shift, Shift Lock, ALT, LOCAL, Click, and RESET, perform their defined functions.

The transparent mode can be used to facilitate debugging of the application program or to solve a problem related to telecommunications.

The host may send a Set Control command instructing the 3101 to ignore an Enter Transparent Mode command (DLE•STX sequence) entered from the keyboard.

In the transparent mode, the automatic-new-line function (described under “AUTO NL Switch” in Chapter 3) is automatically activated. An attribute character controls its own field but is not displayed, and PRGM MODE and ATTR key functions are inhibited. (Attribute characters are described later.)

If PF keys are pressed in the transparent mode, the ESC sequences generated by the keys are transferred to the host, but the ESC sequences and turnaround character are not displayed.

To end transparent mode operations, the Exit Transparent Mode command (DLE • ETX sequence) is used.

Note: Because DLE is a transparent-mode control character, it is not displayed. The DLE character is displayed only if the operator presses the DLE key twice or if the host sends two successive DLE characters to the 3101.

2.1.3.3 Program Mode

The 3101 enters the program mode when the PRGM MODE key on the keyboard is pressed in block mode. In program mode, the operator can locally edit the formatted screen, including attribute characters. See “PRGM MODE Key” and “ATTR Key” in Chapter 3 for more details.

The host may send a Set Control command instructing the 3101 to ignore the PRGM MODE key.

2.2 Display

The 3101 has a 1920-character display buffer, and the characters in the buffer are displayed on the display surface in 24 lines of 80 characters. Displayed data is stored in coded form in the display buffer, which has as many locations as there are character positions on the display surface. The data can be loaded from the host by the application program, or from a 3101 keyboard.

Display data stored in the buffer is presented to the operator on the display surface as alphanumeric characters and symbols. A fixed relationship exists between the address of a character in the buffer and the location of that character on the display surface. Figure 2-3 shows the concept of the buffered display.

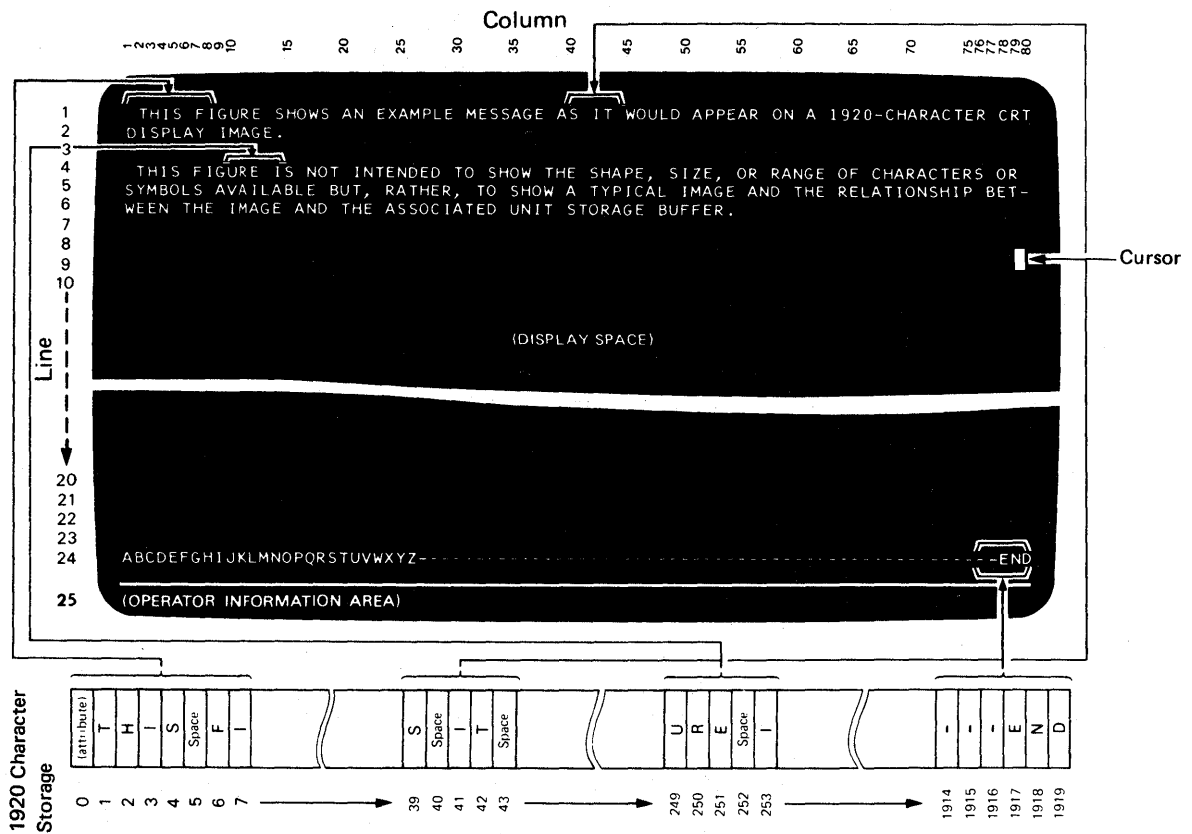

Figure 2-3. Relationship of Buffer Location and Display Surface Character Position

Display images can be formatted or unformatted. A formatted display is one that has separate fields defined by the host program or by the operator. The first character position in each field has an attribute character that defines the characteristics of the field. See "Display Fields" later in this chapter for a description of the attribute character.

Note: In a formatted display, if there is no attribute character in the first character position of the top row of the display surface (home position), a default attribute (Normal Displayed, Unprotected, and Field Not Modified) is assumed.

An unformatted display is one that has no defined fields. An operator can enter data into any position in the display space.

2.2.1 Display Fields

The application program can organize the display space into display fields. Each field has a field attribute character that defines the start of the field; the character occupies a character location in the buffer. A field does not wrap from the last character position of the last line (column 80 of line 24) to the first character location of the first line.

Display fields simplify operations for both the operator and programmers. Headings for each display field can be displayed to prompt the operator for data that should be entered, and the program can identify fields with entered data without reading the entire display buffer.

Figure 2-4 shows the versatility of formatted displays. In this example, the solid characters represent the displayed form of characters stored in the buffer, the dotted squares represent locations in the buffer where attribute characters are stored, and the dotted characters represent the display data that the program has defined as nondisplayable; that is, not to be displayed to the operator. In all presentations, attribute characters stored in the display buffer are not displayed; data characters may or may not be displayed, depending on program definition.

```
□NAME :□JOHN B DOE
□SALARY □12523
□JOB TITLE :□WRITER
□PHONE # :□123-7628
```

Figure 2-4. Examples of Formatted Displays

To define the start of a field, the application program may issue a Set Buffer Address (SBA) command, which is generated by the ESC•X command, and a Start Field command (ESC•3) to the display.

2.2.2 Field Attributes

The field-attribute character occupies the first character position of each display field in a formatted display; the corresponding character position on the display surface is always blank. Figure 2-5 shows the bit definition for the attribute character.

Attribute characters are treated as characters that are protected from operator intervention; that is, they cannot be replaced by alphanumeric characters entered from the keyboard (except in program mode). However, the modified data tag (MDT) bit (bit 1) of the attribute character can be changed by the operator or application program, as shown in Figure 2-5. In addition, attribute characters are not protected from being overwritten by any graphic data from the host.

Field attribute characters also define the following field characteristics for all character locations in the field:

- Character display (normal, highlighted, blinking, or nondisplay)
- Protected (from modification by the display operator) or unprotected (available for the operator to modify or enter data). The unprotected definition classifies a field as an input field.
- Tab stop positions (first character position of unprotected fields).

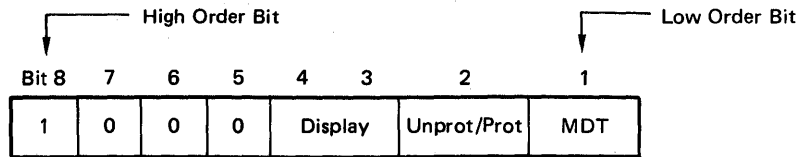

Bit Position	Meaning	Description
Bits 8 through 5	1000 - Indicates Attribute Character	Defines the start of the field. Other bit combinations do not indicate an attribute character.
Bits 4 and 3	00 - Normal Displayed 01 - Highlighted 10 - Blinking 11 - Nondisplay	All data in the field is displayed with normal intensity. All data in the field is highlighted. All data in the field blinks. No data in the field is displayed.
Bit 2	0 - Unprotected 1 - Protected	The field is unprotected (available for the operator to modify or enter data). The unprotected definition classifies a field as an input field. The field is protected from modification by the display operator.
Bit 1	1 - Field Modified 0 - Field not Modified	When the operator or host modifies this field, the Modified Data Tag (MDT) bit is set to 1. The MDT bit can also be set in the data stream by the application program. When the data is transferred to the host, the MDT bit is set to 0.

Figure 2-5. Attribute Character Bit Assignment in Display Buffer

2.2.3 Display Screen Buffer Address and Cursor Address

The cursor address allows a character entered from the keyboard or received from the host to be stored at the cursor position on the display. After the 3101 is powered on, the display is controlled by cursor address until the Set Buffer Address (SBA) command is received from the host. The host can send a character and display it without changing the cursor position, if the display is controlled by buffer address. The received character is stored at the specified buffer address. The buffer address increases its value by 1 upon receipt of each character. The cursor address is not used and does not change until the Cursor Move command is received. For example, when the 3101 receives the Clear All (ESC•L) command from the host after the SBA command is received, the entire display space is cleared, and the buffer address is reset to zero. The cursor address remains unchanged.

The Cursor Move (Up, Down, Right, Left, Home) command, Set Cursor Address command, or Insert Cursor command, followed by a received character from the host, enables the 3101 to store the received character at the location specified by the cursor address. The cursor address increases its value by 1 upon receipt of each character. When scrolling up creates a new line during a receive operation, the buffer addresses for moved-up data are changed, but the cursor address remains unchanged. To locate a desired cursor address or buffer address, a programmer must specify the row and column numbers on the display surface. Each number is given by a specific ASCII or ISO code character, as shown in Figure 2-13.

2.3 Data Stream

The 3101 data stream consists of data characters and control characters. Data characters are the ASCII (or ISO) graphic codes that represent messages or text, or the ASCII control characters. The control characters can be used to format the message or text, or to define functions to be performed. (See "Commands" later in this chapter.)

The ASCII code consists of 7 bits, and the 3101 always uses the eighth bit as a parity bit. The parity bit is ODD, EVEN, SPACE, or MARK, as determined by setup switch. (See "Parity Bit Selection Switches" in Chapter 3.)

Each character in the data stream has the following data-bit format:

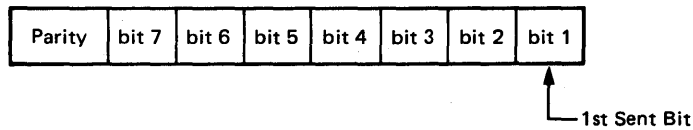

The ASCII code (or ISO code) used by the 3101 is defined in ANSI X3.4-1977 (ISO 646).

Start-stop line protocol requires the following transmission-bit format for communicating with the host:

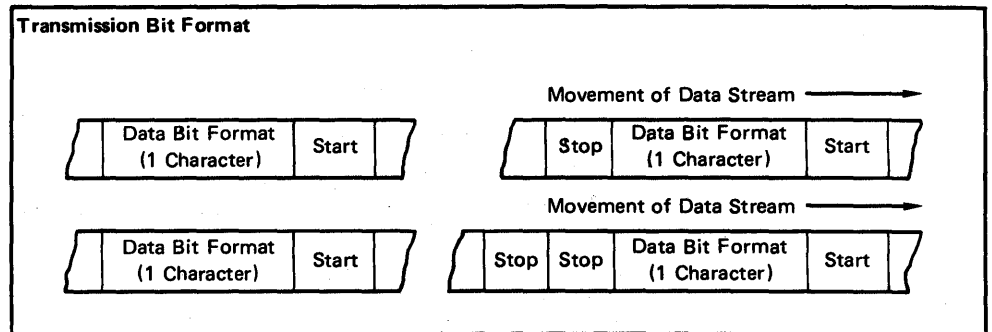

The 3101 transfers data to the host in bit-serial format. Each character has a start bit, eight data bits, and one or two stop bits that are determined by setup switch. (See "STOP 1/STOP 2 Switch" in Chapter 3.) When the 3101 receives a start bit in bit-serial format from the host, it samples the data bits until the stop bit (or bits) is received.

2.3.1 Data Stream Format

In character mode, the start bit does not always immediately follow the stop bit of the previously sent character. During this idle time between the stop bit and the start bit, the telecommunication line is held at mark-signal level.

In block mode, the data entered and stored in the screen buffer is transferred to the host in continuous form when a Send key (SEND, SEND MSG, or SEND LINE) is pressed, or the Read Buffer command is received. The start bit immediately follows the stop bit of the transferred character.

In a send operation, the format of the data stream is determined by the format of the display image (formatted or unformatted), which is described later in this chapter.

The type of data transferred is determined by the Set Control command from the host, which has a parameter that specifies one of the following three operations:

- Send All Data: All data of the display surface, a message, or a line is sent to the host as follows:

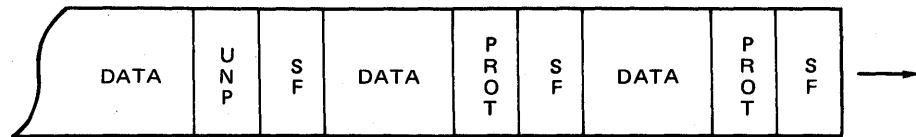

SF : Start Field (ESC·3) followed by an attribute character
 PROT: Protected (Field Attribute)
 UNP : Unprotected (Field Attribute)

If the display image is unformatted, Send All Data is always assumed.

When the 3101 is in the program or transparent mode, Send All Data is automatically specified, regardless of the field attribute character.

- Send Unprotected Data Only: All unprotected data of the display surface, a message, or a line is sent to the host as follows:

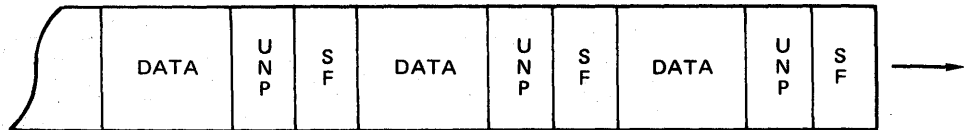

- Send Modified Data Only: All modified data of the display surface, a message, or a line is sent to the host as follows:

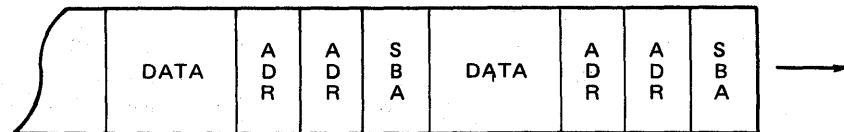

SBA : Set Buffer Address command (ESC·X) followed by 2 characters (address)
 ADR: Display Buffer Address (row and column; see Figure 2-13.)

To indicate an attribute character in the data stream during a Send All Data or a Send Unprotected Data operation, the 3101 inserts the Start Field command immediately before the attribute character.

When Send Modified Data is in effect, the MDT bit of the attribute character in each modified field is reset upon data transfer to the host. If the send operation is canceled, the MDT bits are reset up to the field where the Set Buffer Address (SBA) is sent. (For SBA, see "Commands" later in this chapter.)

When no data is to be sent in the formatted mode (for Send All Data or Send Unprotected Data), pressing a Send key or receiving a Read Buffer command from the host, causes the 3101 to send:

SF•attribute character•turnaround character

For Send Modified Data, the 3101 sends:

SBA•address•address•turnaround character

When no data to be sent is found in unformatted mode, only a turnaround character (EOT, CR, DC3, or ETX) is sent to the host.

Note: The turnaround character DC3 may also be called XOFF.

Figure 2-6 shows an example of the data stream to the host, and Figure 2-7 shows an example of the data stream from the host.

Note: The program may put back suppressed nulls to determine the correct field lengths of the original data stream.

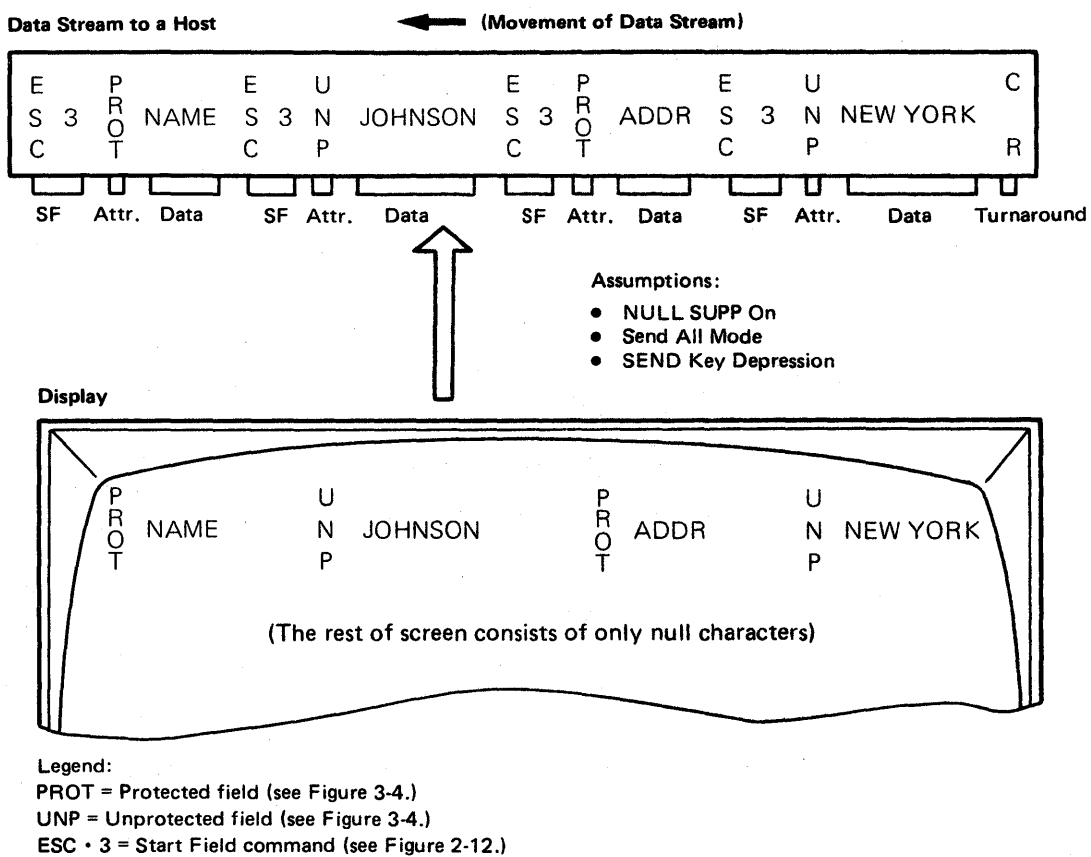

Figure 2-6. Example of Data Stream to the Host

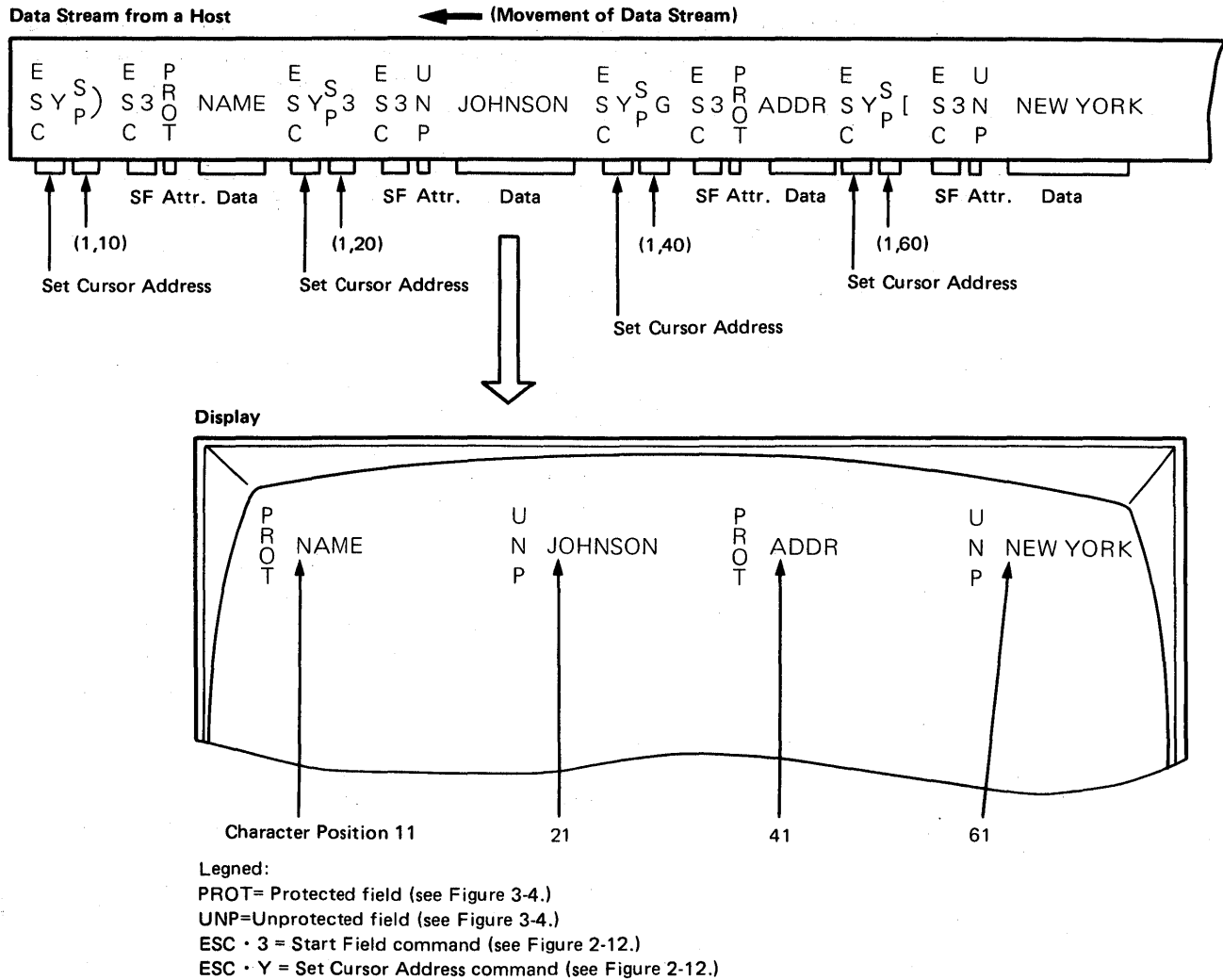

Figure 2-7. Example of Data Stream from the Host

Notes:

1. Error Symbol (\$) Conversion and Send Mark (␣) Treatment

In the normal operating mode, an error symbol stored in the buffer is converted to a space character when transferred to the host. A send mark stored in the buffer is treated as a null character when the 3101 generates a data stream to the host.

The treatment of an error symbol and the send mark in the *print* data stream is the same as in the data stream to the host. For details, see Figure A-3.

2. Cursor Address and Tab Stops

The data stream to the host does not have the cursor address and tab stop position when a Send key is pressed or when the Read Buffer command (ESC•8) is received.

3. Special Handling of Katakana Characters

The 3101 with Katakana keyboard is designed to support both English codes and Japanese Katakana codes. Shift-In (SI) and Shift-Out (SO) codes of ASCII are used to change the character set. SO changes the character set from English to Katakana, and SI changes it from Katakana to English.

The code points are assigned in accordance with the JIS 7-bit code structure (JIS Standard C-6220).

Special consideration is required for the Katakana character set when Katakana data is transferred from the host to the 3101. When the data from the host has consecutive Katakana characters, an SO must be placed just before the first Katakana character to enter the Shift-Out state, and an SI must be placed just after the last Katakana character to leave the Shift-Out state. In other words, the Katakana characters should always be sandwiched with SO and SI codes, such as SO アイウエオ SI.

If the 3101 receives an undefined code point from the host, the substitute character '?' will be displayed, and the code actually received will be stored in the buffer.

4. Special Handling of Canadian French

The same control codes--Shift Out (SO) and Shift In (SI)--as those used for Japanese Katakana, are used to create and transfer special composite characters (see "Dead Keys" in Chapter 3) and Bilingual Canadian French-unique characters (see Figure B-2).

In transparent mode, an attribute character may be identified to the SO or SI control code assigned to the actual shift-change characters.

When a formatted display image that has these control codes is sent to the host in transparent mode, the control codes may appear in the data stream to the host. For example, in transparent mode, a non-display protected attribute with the MDT bit on is sent as the ASCII control character, SO (hex 0E). Host application programmers should consider these conditions when the SO and SI control codes are to be used.

2.3.2 Data Stream to Printer

The data stream for the buffer-print operation is almost the same as the one described previously for the send operation, but some characters are handled differently:

In the normal mode, null characters, a send mark, attribute characters, error symbols, and nondisplayable field characters are converted to space characters.

In the program mode, a null character, a send mark, and an error symbol are converted to a space character. Figure A-3 in Appendix A summarizes character conversion for the print data stream.

In both formatted and unformatted modes, trailing nulls and null characters that are followed by End-of-Line (EOL) are suppressed when the NULL SUPP switch is set to On.

In a buffer-print operation, the CR•LF character and DEL are also automatically generated at the end of each line. The setting of the Time Fill setup switch determines the number of DEL characters.

The End-of-Line or turnaround character sequence is as follows:

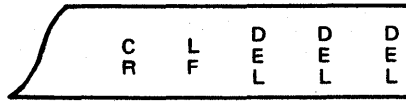

Number of DELs is switch-selectable
(Time Fill setup switch)

CR and LF are cursor control characters that are necessary for the print data stream.

Note: If the host transfers data to the 3101 while the 3101 is transferring data to the printer, the 3101 will process the data from the host, and the data displayed will be different from the data being printed. Therefore, host application programs should cause a Read Status command (ESC•6) to be sent to the 3101 before data is transferred to ensure that data is not being printed. If the 3101 responds with a Printer Busy status, the host should hold its data until the 3101 is ready to receive.

2.4 Data Flow

Figure 2-8 shows the data flow among 3101 units.

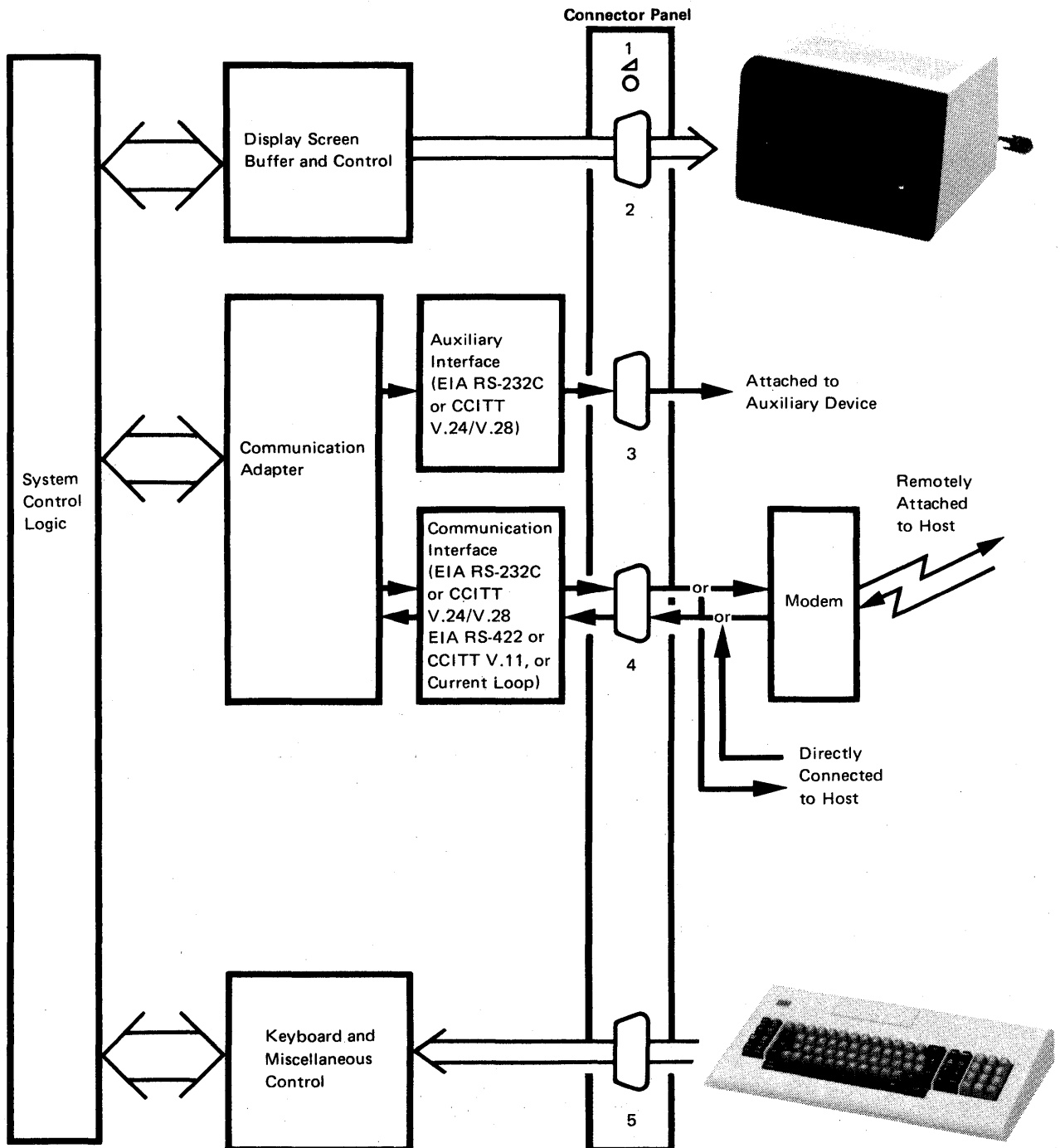

Figure 2-8. IBM 3101 Data Flow

2.5 Telecommunication Operations, States, and Facilities

There are two telecommunication operations--duplex and half duplex. The operator can select either operation with the HDX/FDX setup switch. The duplex operation requires the duplex telecommunication facility, but for the half-duplex operation, either the duplex or half-duplex telecommunication facility can be used. The 3101 communicates with the host over the telecommunication facility.

2.5.1 Telecommunication Operating States

The telecommunication operating states can be selected with the HDX/FDX and BLOCK/CHAR setup switches. They are:

- Duplex operating state--Character mode
- Half-duplex operating state--Character mode
- Half-duplex operating state--Block mode

2.5.1.1 Duplex Operating State--Character Mode

If the HDX/FDX setup switch is set to FDX (duplex), the 3101 enters the duplex operating state, and simultaneous two-way communications between the 3101 and host is possible--one way for transferring data and the other for receiving data. Characters entered at the keyboard are transferred directly to the host; they are not displayed unless a host application program echoes the characters back to the 3101. Figure 2-9 shows the data flow in the duplex operating state, by models.

This operating state requires a duplex telecommunication facility.

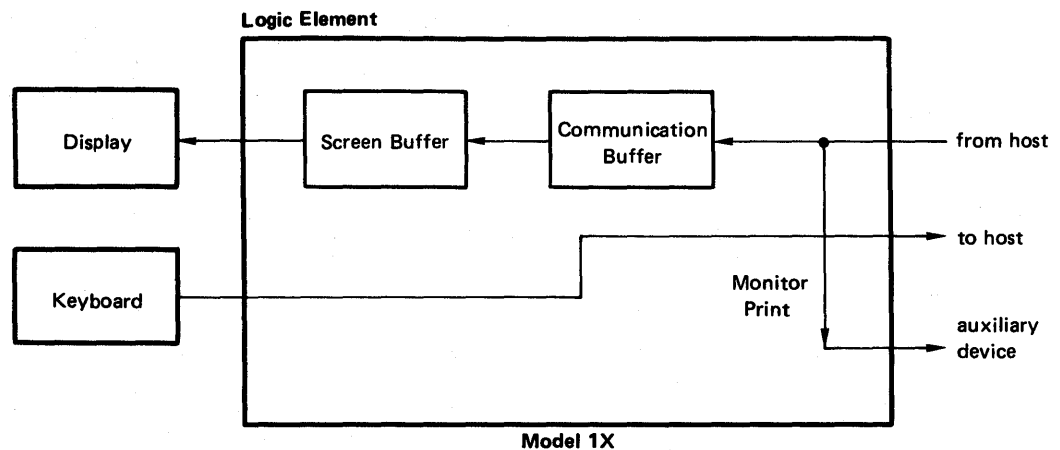

Figure 2-9 (Part 1 of 2). Duplex Operating State in Character Mode

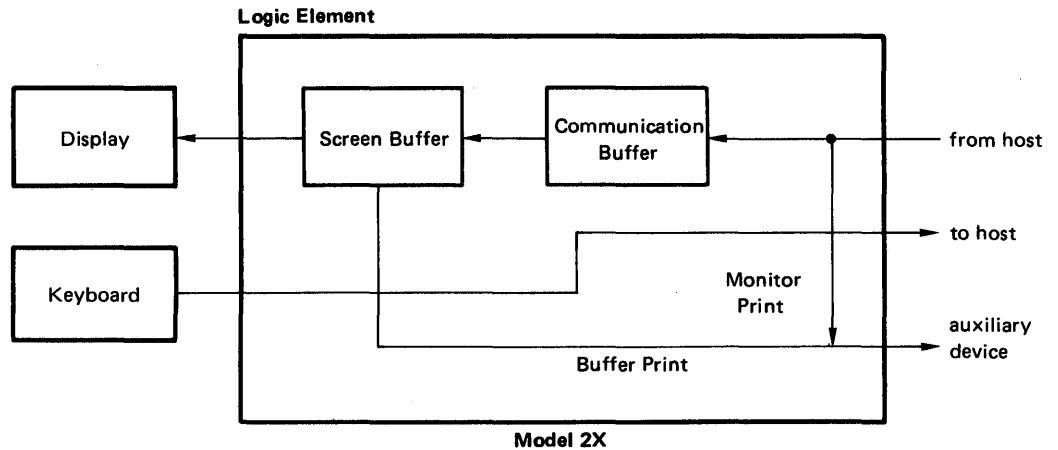

Figure 2-9 (Part 2 of 2). Duplex Operating State in Character Mode

2.5.1.2 Half-Duplex Operating State--Character Mode

In a half-duplex operating state (HDX/FDX switch set to HDX), keyed-in characters immediately appear on the display surface and are transferred to the host. In this operating state, the 3101 does not expect the characters to be echoed back. One of the following telecommunication facilities is required:

- Duplex
- Half-duplex with reverse channel¹
- Half-duplex without reverse channel¹

When the 3101 is switched on, the 3101 enters the normal state and waits either for the operator to press a key or for data from the host. If the operator presses a key first, the 3101 enters the transmit state. If the 3101 receives data from the host before the operator presses a key, the 3101 enters the receive state.

Figure 2-10 shows the data flow in the half-duplex operating state--character mode, by models.

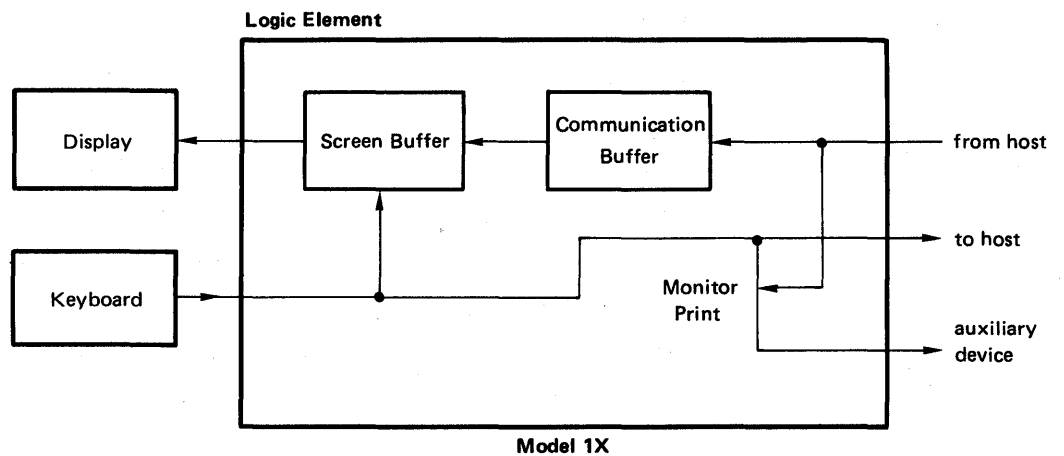

Figure 2-10 (Part 1 of 2). Half-Duplex Operating State-Character Mode

¹Reverse Channel Support: In conjunction with AT&T 202-type modems, a means of simultaneous telecommunications between the terminal and host over the half-duplex telecommunication facility is provided. The reverse channel is generally used only for sending a control signal.

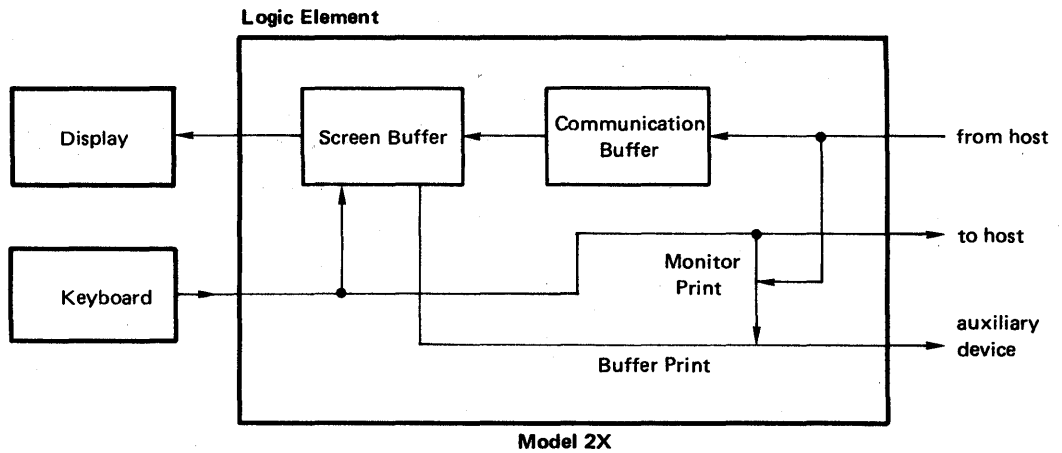

Figure 2-10 (Part 2 of 2). Half-Duplex Operating State-Character Mode

2.5.1.3 Half-Duplex Operating State--Block Mode

In block mode, the operating state is always half-duplex (HDX/FDX switch set to HDX only). In this state, the 3101 communicates with the host over the same telecommunication facilities as in character mode. When the 3101 is switched on, it enters the normal state and waits for the operator to press a send key or for data from the host. If the operator presses a send key first, the 3101 enters the transmit-pending state and starts transferring a block of data after a send key is pressed. If the 3101 receives data from the host first, it continues to receive the data until a turnaround character is received from the host. The 3101 then returns to the normal state.

Figure 2-11 shows the data flow in the half-duplex operating state--block mode.

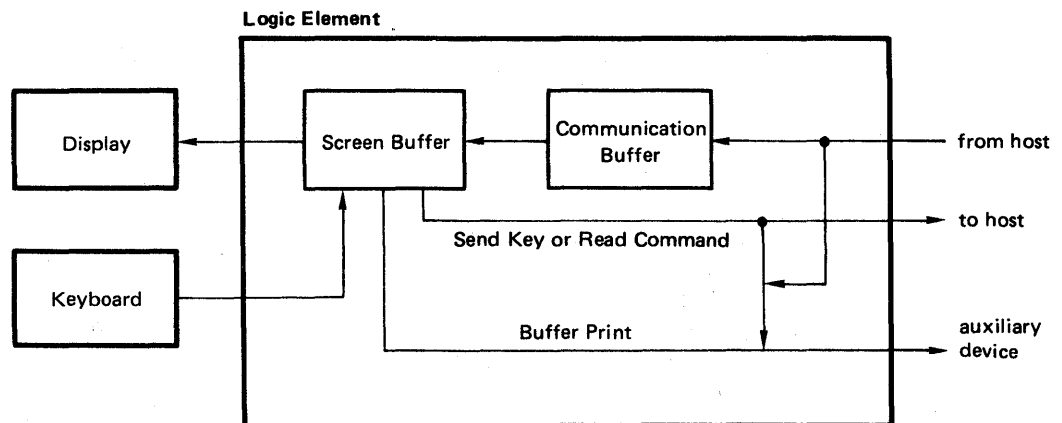

Figure 2-11. Half-Duplex Operating State in Block Mode (Model 2X)

2.5.2 Telecommunication Facilities

This section describes the processing of EIA RS-232C interface signals for each telecommunication facility. The following table shows the relationship between the operating states and telecommunication facilities.

Telecommunication Facility		Operating State		
		HDX-CHAR	FDX-CHAR	HDX-BLOCK
Duplex		X	X	X
Half-Duplex	with Reverse Channel	X	Not applicable	X
	without Reverse Channel	X	Not applicable	X

X: applicable

2.5.2.1 Duplex Telecommunication Facility

After power is applied, the 3101 automatically turns on the Data-Terminal-Ready (DTR) and the Request-to-Send (RTS) signals and waits for both the Data-Set-Ready (DSR) and Clear-to-Send (CTS) signals.

Note: The CTS signal may also be called Ready-for-Sending (RFS), and hereafter is referred to as CTS(RFS).

When these signals are detected, the 3101 enters the normal state (keyboard unlocked) and can start transferring data to the host.

If the CTS(RFS) signal is not detected, "LINE CHECK 1" appears in the Operator Information Area. If the DSR signal is not detected, "LINE CHECK 2" appears in the Operator Information Area. If both signals come on, the line connection between the 3101 and host is established, and the 3101 can start transferring data to the host.

During transmission to the host, the 3101 continually verifies that both the DSR and the CTS(RFS) signals stay on. If the DSR signal turns off, "LINE CHECK 2" immediately appears in the Operator Information Area. If the CTS signal stays off for more than 160 milliseconds, "LINE CHECK 1" appears in the Operator Information Area.

2.5.2.2 Half-Duplex Telecommunication Facility without Reverse Channel

After power is applied, the 3101 automatically turns on the DTR signal and waits for the DSR signal. If the DSR signal is not detected, "LINE CHECK 2" appears in the Operator Information Area. If the DSR signal is detected, the 3101 enters the normal state and waits either for the operator to press any key in character mode or a send key in block mode, or for the data-carrier-detected (CD) signal, which means the host has a message to send.

Note: The CD signal may also be called received-line-signal detector (RLSD) and hereafter is referred as CD(RLSD).

④ If the 3101 receives the CD(RLSD) signal before the operator presses a key, the 3101 enters the receive state. The keyboard locks, and the 3101 starts receiving the message. At the end of the message, the CD(RLSD) signal turns off, and the 3101 returns to the normal state.

If the operator presses a key in character mode or a send key in block mode before the CD(RLSD) signal is received, the 3101 issues the request-to-send (RTS) signal and enters the transmit-pending state, where it waits for the clear-to-send (CTS) signal to turn on. The 3101 enters the transmit state after receipt of the CTS, and starts transferring data.

When the 3101 sends a turnaround character at the end of the message, it turns off the RTS signal, and the CTS(RFS) signal from the modem or host goes off. Then the 3101 returns to the normal state.

If the CTS(RFS) signal is not detected within 320 milliseconds for U.S. units (U.S., A/FE, E/ME/A countries), or within 1.5 seconds for A/FE and E/ME/A type units, CTS time out occurs, and "LINE CHECK 1" appears in the Operator Information Area.

During the data transfer operation, if the CTS (RFS) signal stays off for more than 160 milliseconds, "LINE CHECK 1" appears, and the 3101 turns off the RTS signal.

2.5.2.3 Half-Duplex Telecommunication Facility with Reverse Channel

After power is applied, the 3101 automatically turns on the DTR signal and waits for the DSR signal. If the DSR signal is not detected, "LINE CHECK 2" appears in the Operator Information Area. If the DSR signal is detected, the 3101 enters the normal state and waits either for the CD(RLSD) signal or for the operator to press any key in character mode or a send key in block mode.

If the CD(RLSD) signal comes on first, the 3101 enters the receive state and immediately turns on the Secondary Transmitted Data (STD) signal. Then the 3101 locks the keyboard and starts receiving the messages from the host. If the CD(RLSD) signal goes off while the 3101 is in the receive state, and remains off for more than 160 milliseconds, the 3101 turns off the STD signal and returns to the normal state.

If the operator presses a key in character mode or a send key in block mode first, the 3101 issues the RTS signal and goes to the transmit-pending state, where it waits for both the CTS(RFS) and the Secondary Received Data (SRD) signals to turn on. If the signals come on, the 3101 then enters the transmit state, and the message is transferred to the host. When the 3101 sends a turnaround character at the end of the message, the 3101 turns off the RTS signal, and the CTS(RFS) signal from the modem or host goes off.

If a CTS(RFS) time out (320 milliseconds for U.S. units for U.S., A/FE, E/ME/A countries, and 1.5 seconds for A/FE and E/ME/A type units) occurs, the 3101 returns to the normal state, and "LINE CHECK 1" appears in the Operator Information Area. If an SRD time out (320 milliseconds) occurs, "SYSTEM NOT READY" appears in the Operator Information Area. When the transfer is complete, the line turnaround character is sent to the host, and the 3101 returns to the normal state.

If either the CTS(RFS) or SRD signal goes off in the transmit state, data transfer immediately ends and "LINE CHECK 1" appears. If the signal remains off for more than 160 milliseconds, the 3101 turns off the RTS signal and returns to the normal state.

2.6 Modems

As stated in Chapter 1, the 3101 can be remotely attached to the host through an external interface and a modem. The modem used depends on the telecommunication facility supported.

The following modems (or their equivalents) can be attached:

- 103A-Type
CCITT V.21
IBM 3976 Models 1 and 2

These are required for a duplex operation with a duplex telecommunication facility, and support both Originate and Answer features.

- 113A-Type Modem (U.S. and Canada only)

This modem is the same as the 103A-type, except it supports only the Originate feature (not Answer). Special wiring in the modem cable is required. (See Chapter 5.)

- 202-Type Modem (U.S. and Canada only)

This modem is used with the half-duplex telecommunication facility, with or without reverse channel. In reverse-channel operation, the 202-type modem can operate two data-transfer channels: a main EIA RS-232C channel for transferring or receiving data in one direction at a time, and a reverse channel for sending signals that control the direction of the main channel data.

- CCITT V.23-Type Modem (countries other than U.S. and Canada)

This modem is used with both half-duplex and duplex telecommunication facilities. With a duplex telecommunication facility, the modem can operate at line speeds of up to 1200 bps.

2.7 Commands

A command consists of the ASCII or ISO code escape character (ESC) and a graphic character. Commands can originate either at the host or at the keyboard. To issue a command from the keyboard, the operator presses the ESC key (see Chapter 3) and a graphic character. Figure 2-12 lists the escape sequences (ESC key and the graphic character key), the resulting commands, and the functions performed.

A command is not stored in the display buffer, nor does it move the cursor, unless it is a cursor-positioning command. If an invalid command is received, the 3101 sets the command-error bit, which is stored as status information in the system control logic until the host sends a Read Status command.

Escape Sequence	Command	Function
ESC·0	Set Tab	Sets tab stop at the cursor position or specified buffer address.
ESC·1	Clear Tab	Clears tab stop at the cursor position or specified buffer address.
ESC·2	Back Tab	(In block mode only). Moves cursor (or buffer address) one tab position to the left for an unformatted display, or to the first data character of an unprotected field for a formatted display.
ESC·3	Start Field	(Host only in block mode). Defines the start of a field, and is followed by a field attribute character, which is placed at the cursor position or specified buffer address. The format of this command is: ESC·3·x (x is a field attribute character.) See Figure 3-4 for parameters of the Start Field Command.
ESC·5	Read Cursor Address	(Host only). 3101 sends current cursor position in the following format: Byte 0 1 2 3 4 ESC Y x(row) y(column) EOT/ETX/CR/XOFF (Turnaround Character) See Figure 2-13 for x(row) and y(column).
ESC·6	Read Status	(Host only). 3101 sends following data stream: Byte 0 1 2 3 4 ESC 6 Status 0 Status 1 EOT/ETX/CR/XOFF (Turnaround Character) Status 0 (Byte 2): ASCII Bit 7: Inverse of bit 6 6: Communication buffer overrun ¹ 5: Line parity error detected ¹ 4: Command error detected ¹ 3: (Reserved) 2: Keyboard locked ² 1: Printer busy ³ (Model 2X) Status 1 (Byte 3): ASCII Bit 7: Inverse of bit 6 6: Block mode ³ (Model 2X) 5: HDX operation ³ 4: (Reserved) 3: (Reserved) 2: Program mode ³ (Model 2X) 1: Local mode ³

¹ Set when error is detected; reset when status bytes are sent to host.

² Turned on when LOCK— indication appears in line 25; turned off when RESET key is pressed.

³ Indicates current operating status.

Figure 2-12 (Part 1 of 4). Command Descriptions

Escape Sequence	Command	Function
ESC·7	Read Setup Switch	<p>(Host only). 3101 sends status of setup switches in following format:</p> <pre> Byte 0 1 2 3 4 ESC 7 CSU0 CSU1 EOT/ETX/CR/XOFF (Turnaround character) </pre> <p>CSU 0 (Byte 2): ASCII Bit 7: Inverse of bit 6 6: Block mode (Model 2X) 5: HDX operation 4: Permanent RTS 3: Reverse channel 2 and 1: Turnaround character 00 = ETX (End of Text) 01 = CR (Carriage Return) 10 = EOT (End of Transmission) 11 = XOFF (Transmission Off)</p> <p>CSU 1 (Byte 3): ASCII Bit 7: Inverse of bit 6 6: Dual case 5: Null suppression on (Model 2X) 4: Automatic new-line on 3: Automatic line-feed on 2: CR/CR·LF selection 1: Scrolling on</p>
ESC·8	Read Buffer	<p>(Host only in block mode). 3101 transfers contents of display buffer. The amount and type of data sent depend on the Set Control command (ESC·9).</p>
ESC·9	Set Control	<p>(Host only). Controls the functions listed below, and is sent in the following format:</p> <pre> Byte 0 1 2 ESC 9 x (Control byte) </pre> <p>Control byte (Byte 2): ASCII Bit 7: Inverse of bit 6 6 and 5: Specified data to be sent (Model 2X): 00 = All data 01 = Unprotected data 10 = Unprotected data 11 = Modified data 4: Prohibit from entering local mode 3: Prohibit from entering operator-initiated transparent mode 2: Prohibit from entering program mode (block mode only) 1: Disable Print keys (Model 2X)</p> <p>Note: After power is turned on, bits 1 through 6 are set to all 0's. See Figure 2-14 for graphic representing a control byte.</p>
ESC·A	Cursor Up	Moves cursor up one line.
ESC·B	Cursor Down	Moves cursor down one line.
ESC·C	Cursor Right	Moves cursor one character position to right.
ESC·D	Cursor Left	Moves cursor one character position to left.

Figure 2-12 (Part 2 of 4). Command Descriptions

Escape Sequence	Command	Function
ESC·E	Write Send Mark	(Model 2X). Places a send mark at the cursor position or the specified buffer address. The location previously occupied by the send mark is replaced with a null.
ESC·H	Cursor Home	Moves cursor to position 1, line 1.
ESC·I	Erase EOF/EOL	Clears all data (all unprotected data for Model 2X) from cursor position (or buffer address) to end of field or line whichever comes first. Note: For Model 2X, when the cursor (or buffer address) is at an attribute character position, or within a protected field, the command will be rejected. The command-error-detected bit of the status byte is set to 1.
ESC·J	Erase EOS	Clears all data (all unprotected data for Model 2X) from cursor (or buffer address) to the end of the display.
ESC·K	Erase Input	Clears all data (all unprotected data for Model 2X), except tab stops, from display.
ESC·L	Clear All	Clears entire display buffer (except Operator Information Area) to nulls. All tab stops and attribute characters (Model 2X) are also cleared.
ESC·N	Insert Line	(In block mode only). Inserts a line of nulls at the line identified by the cursor or buffer address. If the line is formatted, the field must have at least one line of nulls. If no lines of nulls are in the field, the command is rejected and the command-error-detected bit of the status byte is set to 1. See the INS LINE key in Chapter 3 for more details.
ESC·O	Delete Line	(In block mode only). Deletes the line identified by the cursor (or buffer address). If the current line has an attribute character or protected field character, the command is rejected, and the command-error-detected bit of the status byte is set to 1. See the DEL LINE key in Chapter 3 for more details.
ESC·P	Insert Character	(In block mode only). Enables character to be inserted at cursor location (or buffer address). An attempt to insert a character in a field without a null, in a protected field, or at an attribute character position results in a command rejection. The command-error-detected bit of the status byte is set to 1. When the host application is to insert any Canadian-French accented character, the following command sequence should be used: SO·ESC·P·X·SI └─ Shifted-out graphic code point Japanese-Katakana-unique character should be used in the same manner as that of Canadian-French accented character. See the INS CHAR key in Chapter 3 for more details.
ESC·Q	Delete Character	(In block mode only). Deletes the character at the cursor position. The command is rejected if the cursor (or buffer address) is at an attribute character or in a protected field. See the DEL key in Chapter 3 for more details.
ESC·S	Cancel	(Model 2X and host only). Ends data transfer to the host or printer that was initiated by a Send or Print key, or by a Read Buffer or Print command.

Figure 2-12 (Part 3 of 4). Command Descriptions

Escape Sequence	Command	Function
ESC·U	Print Line	(Model 2X only). Starts the print-line operation. See the PRINT LINE key in Chapter 3 for more details.
ESC·V	Print Message	(Model 2X only). Starts the print-message operation. See the PRINT MSG key in Chapter 3 for more details.
ESC·W	Print Page	(Model 2X only). Starts the print-page operation. See the PRINT PAGE key in Chapter 3 for more details.
ESC·X	Set Buffer Address	(Host only). Moves buffer address to any position on display surface without changing the cursor address. The two characters for buffer addressing follow this sequence. See Figure 2-13 for parameters of this ESC sequence. The format of this command is: ESC X x(row) y(column) See "Display Screen Buffer Address and Cursor Address" in Chapter 2 for more details.
ESC·Y	Set Cursor Address	(Host only). Moves cursor to any position on the display surface. The characters for cursor addressing follow this sequence. See Figure 2-13 for parameters of this ESC sequence. The format of this command is: ESC Y x(row) y(column)
ESC·Z	Insert Cursor	(Host only). Sets cursor address to the current buffer address.
ESC·:	Lock Keyboard	(Host only). Locks keyboard. Can be unlocked only by the Unlock keyboard command (ESC·;)
ESC·;	Unlock Keyboard	(Host only). Unlocks keyboard if previously locked by the host.

Figure 2-12 (Part 4 of 4). Command Descriptions

Row (x)			Column (y)					
Row	ASCII Hex	Graphic	Column	ASCII Hex	Graphic	Column	ASCII Hex	Graphic
1	20	Space	1	20	Space	41	48	H
2	21	!	2	21	!	42	49	I
3	22	" (double quotation)	3	22	" (double quotation)	43	4A	J
4	23	#*	4	23	#*	44	4B	K
5	24	\$	5	24	\$	45	4C	L
6	25	%	6	25	%	46	4D	M
7	26	&	7	26	&	47	4E	N
8	27	' (apostrophe)	8	27	' (apostrophe)	48	4F	O
9	28	(9	28	(49	50	P
10	29)	10	29)	50	51	Q
11	2A	*	11	2A	*	51	52	R
12	2B	+	12	2B	+	52	53	S
13	2C	, (comma)	13	2C	, (comma)	53	54	T
14	2D	- (dash)	14	2D	- (dash)	54	55	U
15	2E	. (period)	15	2E	. (period)	55	56	V
16	2F	/	16	2F	/	56	57	W
17	30	0	17	30	0	57	58	X
18	31	1	18	31	1	58	59	Y
19	32	2	19	32	2	59	5A	Z
20	33	3	20	33	3	60	5B	[*
21	34	4	21	34	4	61	5C	*
22	35	5	22	35	5	62	5D]*
23	36	6	23	36	6	63	5E	^*
24	37	7	24	37	7	64	5F	_(under score)
			25	38	8	65	60	,* (left single quotation)
			26	39	9	66	61	a
			27	3A	:	67	62	b
			28	3B	:	68	63	c
			29	3C	<	69	64	d
			30	3D	=	70	65	e
			31	3E	>	71	66	f
			32	3F	?	72	67	g
			33	40	@*	73	68	h
			34	41	A	74	69	i
			35	42	B	75	6A	j
			36	43	C	76	6B	k
			37	44	D	77	6C	l
			38	45	E	78	6D	m
			39	46	F	79	6E	n
			40	47	G	80	6F	o

* Graphic symbol varies among countries. See the following table.

Language	Graphic Symbol Key						
U.S. English	#	@	[\]	^	, (left single quotation)
Canadian French	#	@	[\]	^	,
Katakana	#	@	[¥]	^	,
French	£	\$	°	ç	§	^	µ
German	#	§	Ä	Ö	Ü	^	,
Italian	£	\$	°	ç	é	^	ù
English	£	\$	[\]	†	,

Figure 2-13. Display Screen Buffer and Cursor Address Codes

ASCII Bits	ASCII Hex Code	Graphic (x)	ASCII Bits	ASCII Hex Code	Graphic (x)	ASCII Bits	ASCII Hex Code	Graphic (x)	ASCII Bits	ASCII Hex Code	Graphic (x)
7654321			7654321			7654321			7654321		
0100000	20	SP	0110000	30	0	1000000	40	@*	1010000	50	P
0100001	21	!	0110001	31	1	1000001	41	A	1010001	51	Q
0100010	22	"	0110010	32	2	1000010	42	B	1010010	52	R
0100011	23	#*	0110011	33	3	1000011	43	C	1010011	53	S
0100100	24	\$	0110100	34	4	1000100	44	D	1010100	54	T
0100101	25	%	0110101	35	5	1000101	45	E	1010101	55	U
0100110	26	&	0110110	36	6	1000110	46	F	1010110	56	V
0100111	27	'	0110111	37	7	1000111	47	G	1010111	57	W
0101000	28	(0111000	38	8	1001000	48	H	1011000	58	X
0101001	29)	0111001	39	9	1001001	49	I	1011001	59	Y
0101010	2A	*	0111010	3A	:	1001010	4A	J	1011010	5A	Z
0101011	2B	+	0111011	3B	;	1001011	4B	K	1011011	5B	[*
0101100	2C	,	0111100	3C	<	1001100	4C	L	1011100	5C	*
0101101	2D	-	0111101	3D	=	1001101	4D	M	1011101	5D]*
0101110	2E	.	0111110	3E	>	1001110	4E	N	1011110	5E	^*
0101111	2F	/	0111111	3F	?	1001111	4F	O	1011111	5F	-

* Graphic symbol varies among countries. See Note of Figure 2-13.

Notes:

1. Position 7 = inverse of bit 6
2. Meaning of the ASCII bits of ESC-9 sequence

ASCII Bit	Meaning of Bit
Bit 7	Inverse of bit 6
6 – 5	00 = All data 10 = Unprotected data 01 = Unprotected data 11 = Modified data
4	Prohibit from entering local mode
3	Prohibit from entering operator-initiated transparent mode
2	Prohibit from entering program mode (block mode only)
1	Disable print keys (Model 2X)

Figure 2-14. Set-Control Command Control-Byte Graphic Representation

2.8 Auxiliary Device Operations

An auxiliary device, such as a recorder or printer, can be attached to the 3101 through the auxiliary interface (EIA RS-232C). The printer attached to the 3101 can be used for a monitor-print or buffer-print operation.

2.8.1 Monitor-Print Operation

As shown in Figure 2-8, data flow is normally through the telecommunication interface. When the operator presses the AUX key (described in Chapter 3), data through the telecommunication interface also flows through the auxiliary interface to the attached auxiliary device, and is printed or recorded.

In a half-duplex operation, the auxiliary device receives data from both the transmit and receive data lines of the telecommunication interface. In a duplex operation, the attached device receives data from the receive data line only.

Note: Pressing the AUX key causes the Received-Line-Signal Detector (RLSD) or Data-Carrier Detected (CD) line of the auxiliary interface to be turned on. Pressing this key again causes the line to be turned off.

2.8.2 Buffer-Print Operation

With the Model 2X, the contents of the display buffer can be sent to an attached printer through the auxiliary interface. This is accomplished when one of the Print keys described in Chapter 3 is pressed, or when an appropriate command is received from the host. The amount of data printed can be a single line, the entire contents of the buffer, or a designated portion of the buffer, depending on which Print key is pressed or which command is received from the host.

The Cancel key or the Cancel command immediately ends the transfer of a data stream to the printer.

Attribute characters and nondisplayed field characters are converted to space characters.

During the buffer-print operation, the keyboard is locked, but the host can send data to the 3101. If this happens, data currently displayed may differ from the data that is currently being printed.

If the 3101 receives the Cancel or Read Status command from the host, or the operator presses the Cancel key while the 3101 is transferring data to the attached auxiliary device, the 3101 responds to the command.

If the contents of the display buffer must be printed during a monitor-print operation, pressing one of the Print keys immediately interrupts the monitor printing and starts the buffer-print operation. The monitor-print operation resumes when the buffer-print operation is complete.

In transparent mode, a Print command (ESC•U, ESC•V, or ESC•W) sent by the host does not start the buffer-print operation.

2.9 System and Status Messages

Messages about the status of the 3101 and system appear in the Operator Information Area, which is at the bottom of the display image (outside the data area). These messages can be classified as *normal mode* and *test mode* messages.

2.9.1 Normal-Mode Messages

In normal operations, the Operator Information Area has the following fields:

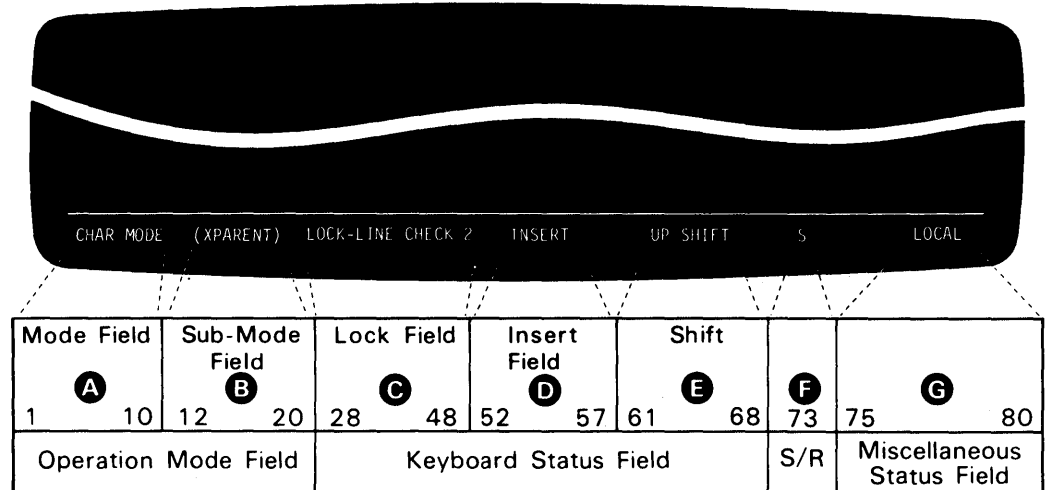

The messages that appear in these fields follow. For messages in languages other than English, refer to Appendix C.

2.9.1.1 Mode Field Messages

The messages that appear in this field **A** depend on the setting of the BLOCK/CHAR setup switch, which is described in Chapter 3. When the switch is set to BLOCK, *BLOCK MODE* appears; when set to CHAR, *CHAR MODE* appears.

For Model 1X, *CHAR MODE* appears regardless of the switch setting.

2.9.1.2 Sub-Mode Field Messages

When the 3101 enters the transparent mode, *(XPARENT)* appears here **B**. When the PRGM MODE key is pressed, *(PROGRAM)* appears. After the ATTR key is pressed, *(IN ATTR)* appears.

2.9.1.3 Lock Field Messages

When an internal 3101 condition prevents the recognition of a key that has been pressed, the keyboard will lock, and *LOCK-*, followed by a reason indication, will appear in the Lock field **C**. The following reason indications are displayed according to priorities. Figure 2-15 shows the priority of the indications and summarizes the reasons for their appearance.

Reason of Condition	Priority of Display	Notes	Cause when realtime indication displayed without LOCK
LINE CHECK 2	1 (High)	1, 2, 3	Data-Set-Ready (DSR) off
LINE CHECK 1	2	1, 2, 4	Clear-to-Send (CTS) off (or RFS off)
SYSTEM NOT READY	3	1, 2, 4	Secondary Received Data (SRD) off
RE-KEY	4		
SYSTEM COMMAND	5	1, 2, 3	Keyboard Lock command received
PRINTING**	6	1, 2, 3	Transmitting data stream to a printer
SENDING*	7	1, 2, 3	Transmitting data stream to a host
DISABLED KEY	8		
MODE/SETUP CHECK	8		
FORMAT CHECK*	8		
INVALID SEQUENCE***	8 (Low)		

* Block mode only
** Model 2X (character and block modes) only
*** Bilingual English/Canadian French

Notes:

- This condition is displayed immediately (on a realtime basis), whenever the condition occurs, if:
 - No reason indication is displayed (as a result, the realtime indication is displayed without LOCK-), or
 - A lower-priority reason without LOCK- is displayed.
 - A lower-priority reason with LOCK- is already displayed (as a result, the realtime indication is displayed with LOCK-).
- This condition is stacked if a higher-priority reason is already displayed; pressing RESET causes the realtime indication to be displayed if the realtime condition is not removed.
- This condition is displayed as long as it lasts if no key is pressed after RESET is pressed; the indication disappears when the condition is removed.
- To clear the indication even if LOCK- is not displayed, press the RESET key. LOCK- appears in the Operator Information Area when a key is pressed if the condition is not removed; the keyboard is locked.

Figure 2-15. Priorities of Lock Indications in Operator Information Area

The LOCK- and reason indications are as follows:

LOCK-LINE CHECK 2: Appears when any key, except Shift, Shift Lock, RESET, Click, ALT, and LOCAL is pressed while the Data-Set-Ready (DSR) signal is off. With the Model 2X, this message also appears when a data transfer started by any Send key is unsuccessful because of a DSR signal failure.

LOCK-LINE CHECK 1: Appears in character mode when any ASCII or ISO code character key is pressed while the Clear-to-Send (CTS) or Ready-for-Sending (RFS) signal is off.

Appears in block mode if the CTS(RFS) signal drops during data transfer. Also appears when a message transmission initiated by a send key failed because of the CTS time out.

LOCK-SYSTEM NOT READY: Appears if a key that causes data transfer is pressed when the host is not ready to communicate. This occurs when:

- Secondary Received Data (SRD) time out occurs after the operator presses a key in character mode, or any Send key in block mode.

- An ASCII or ISO-code character key is pressed when the 3101 receives data from the host while in character mode with a half-duplex operation.
- Data transfer started by any Send key is unsuccessful because of an SRD signal failure.

LOCK-RE-KEY: Indicates that some entered data was lost because of a keyboard buffer overrun. For detailed information about keyboard buffer overrun, see “Read Status Command” in Figure 2-12.

LOCK-SYSTEM COMMAND: Appears when any key, except Shift, Shift Lock, ALT, AUX, RESET, Click, and BREAK is pressed while the keyboard is disabled because of a Keyboard Lock command from the host.

LOCK-PRINTING: Indicates the keyboard is locked because data is being sent to the printer. This indication appears when any key except Shift, Shift Lock, Click, RESET, ALT, BREAK, and CANCEL key is pressed during a print operation.

LOCK-SENDING: Indicates that data is being transferred to the host. This indication appears when any key except Shift, Shift Lock, ALT, AUX, RESET, Click, and CANCEL key is pressed in the transmit-pending or transmit state while the 3101 is in block transmission.

LOCK-DISABLED KEY: Indicates the operator pressed the LOCAL or PRGM MODE key, or entered the DLE•STX (ALT plus P keys and ALT plus B keys) control characters, after they were disabled by the Set Control command (ESC•9). Pressing a Print key or a Send key while the 3101 is inhibited from entering data by a logical keyboard lock condition also causes this message to appear.

LOCK-MODE/SETUP CHECK: Appears when a keystroke is invalid because of the current operating mode or a setup switch condition.

For Model 1X, the indication appears when the operator presses the BREAK key in a half-duplex telecommunication facility without reverse channel, or the AUX or BREAK key while in local mode. If MONO is selected, this indication appears when the operator presses any of the five national character keys.

For Model 2X, the indication appears when:

- Any Send key is pressed in character mode or local mode.
- The DEL key is pressed in block mode, and the 3101 is not in transparent mode.
- The Back Tab, INS CHAR, INS LINE, DEL CHAR, or DEL LINE key is pressed in character mode.
- The ATTR key is pressed in any mode except program.
- The PRGM MODE key is pressed in transparent mode or character mode.
- An invalid control character is entered in block mode, and not in transparent mode, except the STX, ETX, EOT, and DLE characters.

- A block-mode-only ESC sequence is entered in character mode.
- The ESC key is pressed and is followed by an invalid graphic character key while the 3101 is in block mode.
- Any of five national character keys is pressed in mono case.
- The AUX or BREAK key is pressed in local mode.

LOCK-FORMAT CHECK: Appears when the operator performs one of the following invalid key actions:

- Presses the following while the cursor is in a protected field or at an attribute character position:
 - Graphic character key
 - ERASE EOL/EOF key
 - DEL CHAR key
 - INS/DEL LINE key (The message also appears if these are pressed while the cursor is on a line that includes a protected field or an attribute character.)
- Presses the INS LINE key when the field does not have at least one line of null characters.
- Presses any graphic character key while the 3101 is in the insert status and there is not at least one null character in the field (or to the end of the display image for an unformatted display).
- Presses an invalid combination of the ATTR key and a graphic key.
- Presses the SEND MSG or PRINT MSG key when the cursor is in a protected field or at an attribute character position.

LOCK-INVALID SEQUENCE: (Bilingual English/Canadian French keyboard) This message appears when the operator tries to enter an invalid character after pressing one of the five special accent mark keys (; , ^ , " , '). These keys are called *dead keys*. The message also appears when the 3101 receives data or a command that moves the cursor during a dead-key sequence.

2.9.1.4 Insert Field Message

INSERT appears here **D** when the INS CHAR key is pressed in block mode.

2.9.1.5 Shift Field Message

UP SHIFT appears in this field **E** when the keyboard is in an up-shift status.

2.9.1.6 Send/Receive Field Messages

In the S/R field **F**, S appears when the 3101 is transferring data with the setup switches set to the HDX and CRTS positions in character mode. The operator must press the turnaround character key to leave this state. It disappears when the 3101 sends a turnaround character.

R appears when the 3101 is receiving data with the setup switches set to the HDX and CRTS positions in character mode. It disappears when the 3101 receives the turnaround character.

Note: If *R* appears during local mode operation, it means the host is going to send data to the 3101.

2.9.1.7 Miscellaneous Status Field Messages

If the LOCAL key is pressed, *LOCAL* appears in this field **G**. When the AUX key is pressed, *AUX ON* appears.

Note: If a buffer-print operation is started by any Print key, the *AUX ON* indication disappears until the data transfer to the printer is complete or is canceled.

When the LOCAL key is pressed, the reason indication disappears. When the key is pressed again, the indication reappears if the 3101 still has the same condition.

2.9.2 Test-Mode Messages

When the 3101 is powered on, or the NORMAL/TEST switch is turned to TEST, a resident diagnostic test--the Basic Assurance Test (BAT)--automatically runs. If the test detects a hardware problem, one of the following error messages is displayed in the machine status field.

Mode Field	Machine Status Field	Action Field
A	B	C
1 14	15 62	63 80

Following are the messages that appear in these fields.

2.9.2.1 Mode Field Message

TEST MODE appears only when the NORMAL/TEST switch is set to TEST.

2.9.2.2 Machine Status Field Messages

MACHINE CHECK - LOGIC.: Appears when the problem is with the logic element.

MACHINE CHECK - LOGIC OR KEYBOARD.: Appears if either the logic element or the keyboard element has a problem.

MACHINE CHECK - KEYBOARD.: Appears when the keyboard element has a problem.

2.9.2.3 Action Field Message

SEE PROBLEM GUIDE is displayed and refers the operator to the *Customer Problem Analysis and Resolution Guide*, GA18-2036.

Chapter 3. Operator Controls and Indicators

Each work-station element has controls and/or indicators that enable the operator to turn power on and off, adjust the display image, adjust the volume of the audible alarm, invoke internal tests, and communicate with the host and an attached auxiliary device. This chapter describes the 3101 controls and indicators, the locations of which are shown in Figure 3-1.

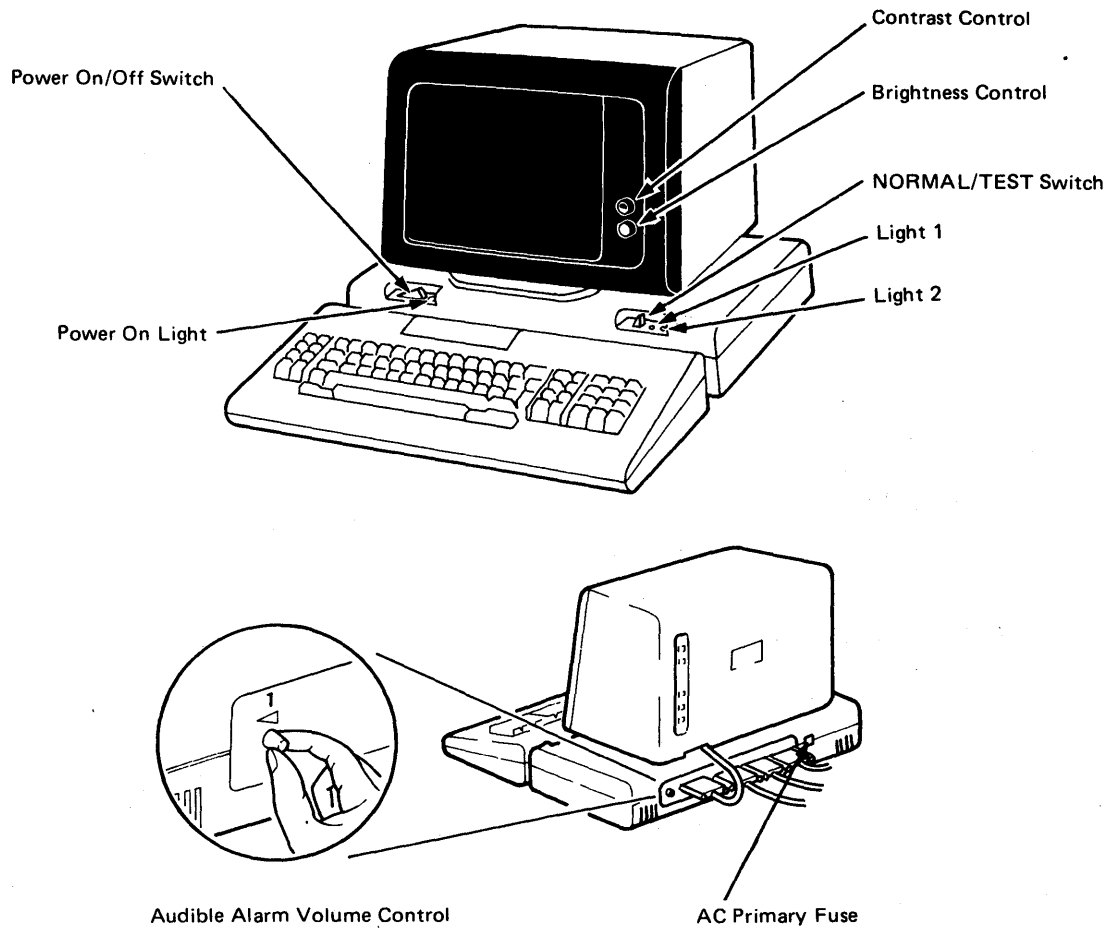

Figure 3-1. Locations of Controls and Indicators

3.1 Logic Element

The logic element has the following controls and indicators:

- Power switch
- Power-On light
- NORMAL/TEST switch
- Light 1

- Light 2
- Audible alarm volume control

A description of each control and indicator follows:

3.1.1 Power Switch

The Power (I/O) switch applies and removes ac power.

When the switch is set to on (I), the basic assurance test (BAT) checks the functions of the work-station elements and, if no problem is found, starts a power-on-reset (POR) sequence. When the POR sequence successfully completes, CHAR MODE (character mode) or BLOCK MODE appears in the Operator Information Area. If the BAT detects a problem, a MACHINE CHECK- message appears in the Operator Information Area. (For more information about MACHINE CHECK-, see "Test Mode Messages" in Chapter 2 and the *IBM 3101 Operator Reference Information*, GA18-2035).

An ac primary fuse at the rear of the logic element protects against overcurrent. If the fuse has to be changed, it must be replaced with one of the same amperage rating.

3.1.2 Power-On Light

This indicator lights when 3101 power is on.

3.1.3 NORMAL/TEST Switch

When the NORMAL/TEST switch is set to TEST, the BAT starts and checks the operation of the 3101. All characters are displayed, as are the setup switch settings, and the keyboard operation can be checked. This switch is used for problem analysis and resolution (CPAR). For more information, see the *IBM 3101 Customer Problem Analysis and Resolution Guide*, GA18-2036.

3.1.4 Light 1

Light 1 blinks when the video element is functioning correctly with the NORMAL/TEST switch set to TEST. When the switch is set to NORMAL, the light is off.

3.1.5 Light 2

When on, Light 2 indicates the presence of the data-set-ready signal for the EIA RS-232C or CCITT V.24/V.28 interface. For the EIA RS-422 or CCITT V.11 interface and the 20-mA current loop interface, the light means the 3101 is detecting the mark signal.

3.1.6 Audible Alarm Volume Control

The audible alarm volume control, which is at the rear of the logic element, enables the operator to adjust the sound level of the alarm. The loudest setting (H) is designed to satisfy the requirements of a typically noisy computer or office environment.

The audible alarm sounds when:

- The BEL character is entered from the keyboard or received from the host.
- An inoperative (unlabeled) key is pressed.
- A Model-2X key (ATTR, PRGM MODE, Back-Tab, INS CHAR, INS LINE, DEL CHAR, DEL LINE, PRINT, PRINT MSG, PRINT LINE, SEND, SEND MSG, SEND LINE, or CANCEL) is pressed on the Model-1X keyboard.
- The NORMAL/TEST switch is changed to the TEST position.
- The operator enters a data character in column 72 of any line, or at the end of a line (column 80), when AUTO NL is off.
- The operator enters a data character in the eighth position before the end of the display surface, or at the end of the display surface, when SCROLL is off.
- The logical keyboard-lock condition occurs.

(See “Logical Keyboard Lock” in Chapter 4 for more details.)

3.2 Video Element - Brightness and Contrast Control Knobs

The brightness control adjusts the brightness of the characters on the display surface. The contrast control adjusts the contrast between the characters and the background of the display image. On the Model 2X, the contrast control also adjusts the contrast between normal-display characters (normal field) and highlighted characters (highlighted field) for data-field control.

3.3 Keyboard Element

This section describes the setup switches and the functions of the keyboard keys.

3.3.1 Setup Switches

The setup switches enable the user to select functions. They are in an operator-accessible location on the keyboard element and are arranged in four groups (groups 1 through 4) with eight switches in each group. Figure 3-2 shows the layout of the setup switches.

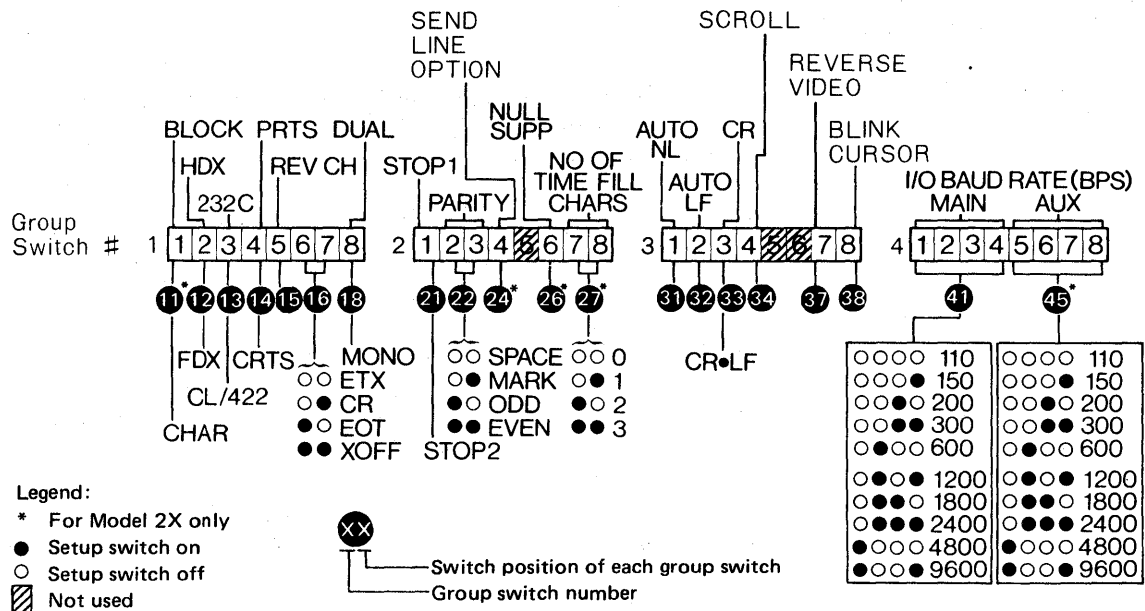

- Switch 12 — Transmission is HDX when in block mode, regardless of this switch setting.
- Switch 14 — Used with EIA RS-232C or CCITT V.24/V.28 operation.
- Switch 15 — Used with EIA RS-232C operation only.
- Switch 33 — CR can be selected regardless of switch 16 (CR) setting.

Notes:

1. Switches 1 through 5 of switch group 1 are effective only when the power switch is turned on or when the NORMAL/TEST switch is changed from TEST to NORMAL. Changing the settings of these setup switches during normal operation may cause unpredictable results.
2. Some setup switches have a higher priority than others. When a high-priority switch is set, it affects the functions of other setup switches, regardless of their physical settings. For example, when HDX/FDX 12 is set to FDX, PRTS/CRTS 14 and REV CH 15 are functionally forced to PRTS and REV CH Off, even if they are physically set to CRTS and REV CH On, respectively. The following chart shows high-priority switches.

	High ←	Priority	→	Low		
	11	12	13	14	15	31
1	BLOCK	HDX				On
2		FDX		PRTS	Off	
3			CL/422	PRTS	Off	
4				PRTS	Off	

The circled setting (for example, FDX) shows the physical setting; a non-circled setting means it is forced by a circled setting.

Figure 3-2. IBM 3101 Setup Switch Layout

3.3.1.1 BLOCK/CHAR Switch

The BLOCK/CHAR switch ⑪ selects the data transfer mode--block or character. The switch is effective only on the Model 2X, because character mode is always used on Model 1X, regardless of the setting of the switch.

In block mode, HDX ⑫ and AUTO NL on ⑬ are forced, regardless of their switch settings.

3.3.1.2 HDX/FDX Switch

This switch ⑫ selects either the half-duplex (HDX) or duplex (FDX) telecommunication operation. When the data-transfer mode is character, the telecommunication operation can be either half-duplex or duplex. In block data-transfer mode, the telecommunication operation is half-duplex.

Each telecommunication operation requires the following telecommunication facilities:

- For duplex operation, the duplex telecommunication facility
- For half-duplex operation, one of the following facilities can be used:
 - Duplex telecommunication facility
 - Half-duplex telecommunication facility with reverse channel
 - Half-duplex telecommunication facility without reverse channel

With the HDX/FDX switch in the FDX position, and the duplex telecommunication facility provided, a duplex operation is enabled. Characters entered from the keyboard in character mode are displayed only if they are echoed back from the host, generally by a program.

When this switch is set to FDX in character mode, PRTS ⑭ and REVERSE CH Off ⑮ are functionally forced, even if CRTS and REVERSE CH On are physically selected.

With the HDX/FDX switch in the HDX position, a half-duplex operation is enabled. The characters entered from the keyboard in character mode are displayed and transferred to the host.

3.3.1.3 Interface Switch (232C or V.24/V.28, CL, 422, or V.11)

This switch ⑬ selects either an EIA RS-232C or a CCITT V.24/V.28 interface (all models), an EIA RS-422 or CCITT V.11 interface (Models 13 and 23), or a 20-mA current loop interface (Models 12 and 22). The selection of other than the EIA RS-232C or CCITT V.24/V.28 should be based on the type of interface provided or available.

In the 232C or V.24/V.28 position, the EIA RS-232 or CCITT V.24/V.28 is selected as the interface. In the CL/RS-422 or V.11 position, the 20-mA current loop, EIA RS-422, or CCITT V.11 interface is selected.

If the CL/422 or V.11 position is selected, PRTS ⑭ and REVERSE CH Off ⑮ are forced.

3.3.1.4 PRTS/CRTS Switch

The Permanent Request-to-Send/Controlled Request-to-Send (PRTS/CRTS) switch 14 is used for EIA RS-232C or CCITT V.24/V.28 operation only, and the switch setting depends on the type of telecommunication facility required.

With a duplex telecommunication facility, and the 3101 in duplex telecommunication operation, the request-to-send signal must stay on; therefore, the switch must be set to PRTS. Under the same facility, when the 3101 is in the half-duplex telecommunication operation, the setup switch can be set to either PRTS or CRTS, depending on host support. The modem used with this switch is a 103A or CCITT V.21 type. If this switch is set to PRTS, REVERSE CH Off 15 is assumed.

With a half-duplex telecommunication facility, the request-to-send signal must be controlled; therefore, the switch must be set to CRTS. The modem used with this switch is a 202 or CCITT V.23 type. When the interface selection switch 13 is set to the CL/422 or V.11 position, the PRTS/CRTS switch setting is ignored.

3.3.1.5 REVERSE CH Switch

This switch 15 is used with the EIA RS-232C or CCITT V.24/V.28 interface only. Setting this switch to REV CH On activates a half-duplex telecommunication facility with a reverse channel. The switch should be off if a half-duplex telecommunication facility without reverse channel is used. The switch setting depends on the type of telecommunication facility required.

When PRTS 14 is selected, the REVERSE CH switch setting is ignored.

3.3.1.6 Turnaround Character Switches

The combined setting of two switches 16 and 17 determines what character will be used to change the direction of the data stream to the host. As shown in Figure 3-2, the choices are ETX, CR, EOT, and XOFF. (IBM host systems use CR or XOFF as the line turnaround character.) The selected turnaround character is automatically generated and sent at the end of the data stream when a Send key (SEND, SEND MSG, or SEND LINE) is pressed. (See "Keyboard Key Functions" later in this chapter for descriptions of the Send keys.)

Note: In character mode, if CR is selected, the CR is always sent as the turnaround character when the New Line key is pressed, regardless of the CR/CR•LF switch setting.

3.3.1.7 DUAL/MONO Switch

The 3101 can be set for either uppercase or lowercase characters, or for uppercase characters only. When the DUAL/MONO switch 18 is set to DUAL, the 3101 displays, transfers, or receives any graphic characters entered from the keyboard or received from the host, without any character code change. When MONO is selected, lowercase characters entered from the keyboard or received from the host are converted to their corresponding uppercase characters before they are displayed or transferred.

A character that is already displayed is not affected by a change in the DUAL/MONO switch setting; therefore, both lowercase and uppercase characters could be displayed, even if the switch setting were set to MONO.

If any of the following five national character keys is pressed when the switch is set to MONO, the keyboard locks, and the message LOCK-MODE/SETUP CHECK appears in the Operator Information Area:

U.S. English, Bilingual English/Canadian French	\, {, , }, ~
U.K. English	\, {, , }, -
German	`, ä, ö, ü, ß
Italian	ù, à, ò, è, ì
French	µ, é, ù, è, ..

For Bilingual English/Canadian French, accented lowercase characters from the host can be received even if the DUAL/MONO switch is set to MONO.

For Japanese Katakana, the DUAL/MONO switch is always disregarded. The alphabetic lowercase characters (see code points, hex 61 through 7A, in Appendix B) cannot be transferred to the host, but can be accepted from the host.

The DEL character is transferred regardless of the switch setting.

See Appendix B for corresponding dual and mono character set display images.

3.3.1.8 STOP 1/STOP 2 Switch

The 3101 uses an 8-bit data length, which includes a parity bit. A total length of 10 or 11 bits used in start-stop line protocol consists of 1 start bit, 8 data bits, including a parity bit, and 1 or 2 stop bits that are switch selectable.

When the STOP 1/STOP 2 switch 21 is set to STOP 1, one stop bit is selected. In the STOP 2 position, two stop bits are selected. The stop bit selection depends, primarily, on the transmission line speed. The 110-bps rate generally uses two stop bits, and the 150-bps or higher rate uses one stop bit.

The bits selected by this switch are also used to transfer data from the 3101 to the device attached to the auxiliary interface.

3.3.1.9 Parity Bit Selection Switches

Two setup switches 22 and 23 make it possible to select the type of parity bit. As shown in Figure 3-2, the choices are ODD, EVEN, MARK, and SPACE.

If either ODD or EVEN parity is selected, the 3101 generates the correct bit parity for the data being transferred, and checks for the parity of all received data. When the 3101 detects a parity error or space-hold condition in a received character, that character is replaced on the display surface with the error symbol (?). When either MARK or SPACE is selected, the parity bit of each character being transferred is forced to 1 for MARK, or 0 for SPACE; the 3101 does not check the parity of received data for MARK and SPACE parity.

3.3.1.10 Send Line Option Switch

This switch 24 operates only in block mode (Model 2X).

When in the On position, this switch changes the function of the Send key on the keyboard. Instead of causing the entire contents of the display buffer to be

transferred to the host, the Send key causes a single line to be transferred; that is, the Send key functions as the Send Line key. The Send Line key will then function as the Send key.

When the switch is in the Off position, the Send key functions as the Send Page key; the Send Line key functions as usual.

3.3.1.11 NULL SUPP Switch

The NULL SUPP switch **26** operates with the Model 2X only.

When this switch is in the On position, trailing nulls are suppressed during block data transfer or buffer printing. When the switch is in the NULL SUPP Off position, a null character is converted to a space character and transferred.

Note: Trailing nulls are null characters between the last significant character in a field and the end-of-line (EOL), end-of-field (EOF), end-of-screen (EOS), or the cursor in a line. The following table shows how null suppression is performed. For example, in a Send Page formatted operation, null characters between the last significant character and EOF or EOS, whichever comes first, are suppressed in each field.

	Unformatted Operation	Formatted Operation
Send Page	EOL	EOF or EOS*
Send Message	EOL or Cursor*	EOF or Cursor*
Send Line	EOL	EOL or EOF*

EOL: End of Line

EOF: End of Field

EOS: End of Screen

* : Whichever comes first

Null suppression is also effective for print operations with the Model 2X in character mode.

In an unformatted display, if data that appears on two lines has null characters on the first line, the null characters are suppressed. In a formatted display, if a null character follows the data in a field, the null character is suppressed.

When the 3101 operates in transparent or program mode, a null character is always transferred to the host without suppression.

When the 3101 performs the Send Page or Send Message operation in an unformatted display, with null suppression enabled, CR or CR•LF is automatically inserted at the end of each line if the line turnaround character switch is set to ETX, EOT, or XOFF; if CR is selected as the turnaround character, a control-character record separator (RS) is automatically inserted at the end of each line, except for the last line.

Note: When the AUTO LF switch is on, a CR character is inserted at the end of each line. When the AUTO LF switch is off, the CR•LF characters are generated.

3.3.1.12 Time-Fill Switches

These two switches 27 and 28 operate only with the Model 2X. They select the number of time-fill characters (DELs) to be used in the print data stream during a buffer-print operation. As shown in Figure 3-2, the choices are 0, 1, 2, and 3.

3.3.1.13 AUTO NL Switch

The AUTO NL (automatic new line) switch 31, when on, causes the cursor to automatically move to the first character position of the next line, after it reaches the last character position of the current line (position 80). If the SCROLL switch 34 also is On, when the cursor reaches the last character position of the bottom line (position 80 of line 24), the display image will scroll up, and the cursor will move to the first character position of the new bottom line. If the SCROLL switch is Off, the cursor stops when it reaches the last character position of the bottom line.

When AUTO NL is Off, the cursor does not advance to the first character position of the next line, regardless of the setting of the SCROLL switch. Instead, it stays at the last character position. If additional characters are entered, they are transferred to the host, and the displayed character in the last character position changes as each character is entered. An audible alarm also sounds as each character is entered.

If the 3101 is in block data-transfer mode, AUTO NL is forced on.

3.3.1.14 AUTO LF Switch

The AUTO LF (automatic line feed) switch 32, when on, causes the cursor to move to the first character position of the next line when the operator presses the carriage return key or when the CR character is received from the host. When the switch is off, the cursor moves to the first character position of the current line. Therefore, if the new-line function is desired, the host must send (or an operator must enter) the CR and LF characters.

3.3.1.15 CR/CR•LF Switch

The CR/CR•LF switch 33 determines the characters generated when the New Line key is pressed. When CR is selected, the New Line key generates CR (carriage return). When CR•LF is selected, the New Line key generates CR and LF (line feed).

In character mode, if CR has been selected as the line turnaround character, and the CR/CR•LF switch is set to CR•LF, pressing the New Line key causes CR and LF functions to be performed, but only the CR character is sent to the host.

3.3.1.16 SCROLL Switch

If the SCROLL switch 34 is on with the display unformatted and the cursor in the bottom line, the display image scrolls up when:

- A new-line character (CR with AUTO LF on, CR•VT (vertical tab), or CR•LF) is received from the host or entered from the keyboard.

- AUTO NL is on, the cursor is in the last character position of the last line (position 80, line 24), and an additional character is received from the host or entered from the keyboard.
- An LF or VT character is received from the host or entered from the keyboard.
- An FF (form-feed) character is received from the host or entered from the keyboard.

When the display image scrolls up, the top line disappears and a new bottom line appears. Data can then be entered in this new bottom line.

Setting the switch off removes the scrolling function.

When the display is formatted, SCROLL off is assumed.

3.3.1.17 REVERSE VIDEO Switch

If the REVERSE VIDEO switch (37) is on, the 3101 displays dark characters on a green background. If the switch is off, the 3101 displays green characters on a dark background.

3.3.1.18 Blink Cursor Switch

When this switch (38) is on, the cursor blinks. When the switch is off, the cursor remains steady.

3.3.1.19 Line Speed Switches for Telecommunication Interface

Four switches (41 to 44) are used in combination to select the line speed for the telecommunication interface. As shown in Figure 3-2, the speeds that can be selected are 110, 150, 200, 300, 600, 1200, 1800, 2400, 4800, and 9600 bps.

3.3.1.20 Line Speed Switches for Auxiliary Interface

These four switches (45 to 48) select the line speed for the auxiliary interface for buffer-print operations.

Data that is to be printed is transferred from the 3101 through the auxiliary interface at 110, 150, 200, 300, 600, 1200, 1800, 2400, 4800, or 9600 bps. The speed selected depends on the print capability of the attached printer.

In the monitor-print operation (described in Chapter 2), the line speed is the same as that selected for the telecommunication interface, regardless of the speed selected by this switch.

3.3.2 Keyboard Key Functions

The 3101 keyboard has 87 keys, including a 12-key numeric keypad. The keyboard can generate all 128 ASCII or 128 ISO character codes (159 character codes for Bilingual English/Canadian French, 191 character codes for Japanese Katakana). For Japanese Katakana, an 88-key keyboard, which has a clustered 12-key numeric pad, is available (see Appendix B).

The 12-key keypad permits easier and faster entry of numbers, and the keys are not affected by shift states as are the regular numeric keys. In addition, eight program function keys (PF1 through PF8) can be activated by holding the ALT key down and then pressing the appropriate numeric key on the keypad.

Figure 3-3 shows the keyboard layout for U.S. English. The keyboard layouts for other languages are shown in Appendix B.

Some of the keys are typematic; that is, they repeat their function as long as they are held down. The rate at which the function is repeated (typematic rate) depends on the line speed in effect, as follows:

Line Speed (bps)	Typematic Rate (Characters per Second)
110 through 200	4
300	10.5
600 through 9600	15

Although the keyboard layout is the same for both Models 1X and 2X, some of the keys work only with Model 2X, and only in block mode. Other keys that are unique to Model 2X work in either character or block mode. If any of the keys unique to Model 2X are pressed on the Model-1X keyboard, the audible alarm sounds.

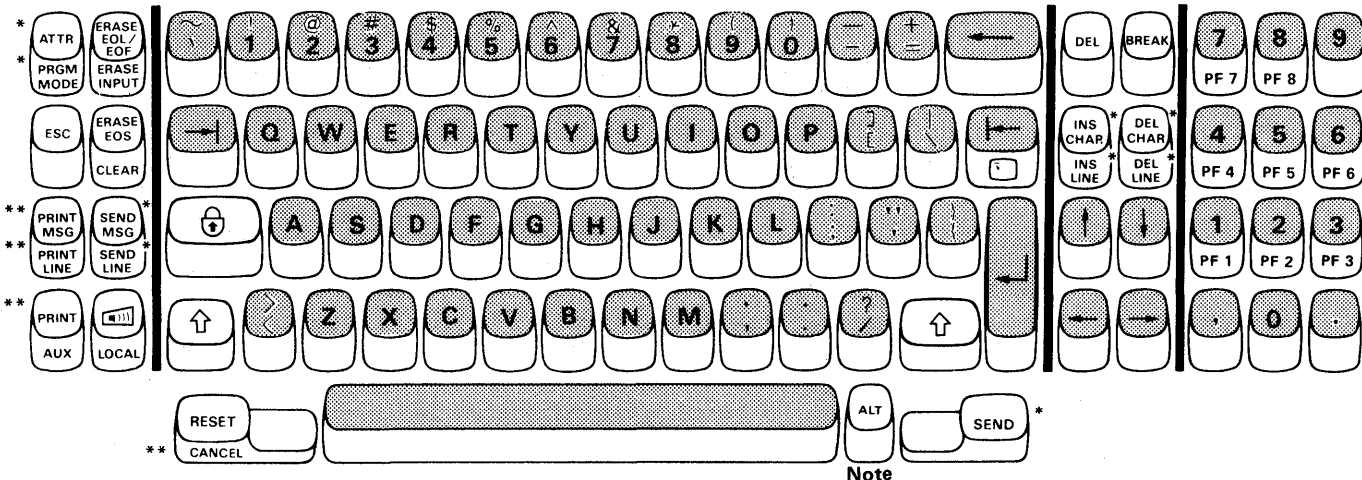

Legend:

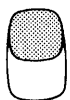

Typamatic Keys



Non-Typamatic Keys

* : Functional in block mode (Model 2X) only

** : Functional in block or character mode on Model 2X

Note: The ALT key must be pressed and held to activate functions shown on the front of the keys.

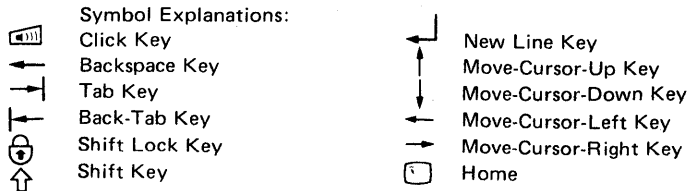

Figure 3-3. IBM 3101 Keyboard Layout (U.S.)

3.3.2.1 ATTR Key

The ATTR key works only with Model 2X and only in block mode.

When the 3101 is in program mode (see “PRGM MODE Key” in this chapter), the ATTR key is used to enter an attribute character. (IN ATTR) appears in the Operator Information Area when the key is pressed.

After the ATTR key is pressed, the desired graphic key must be pressed to enter an attribute character at the cursor position. Figure 3-4 shows what happens when the ATTR key and a graphic character key are pressed.

If the RESET key is pressed instead of a graphic key, (IN ATTR) is replaced by (PROGRAM) in the Operator Information Area.

If the ATTR key is pressed in any mode other than program, the keyboard becomes disabled and LOCK-MODE/SETUP CHECK appears in the Operator Information Area.

Notes:

1. When the operator presses the ATTR key and a valid graphic key, the attribute character should be entered. If not, the operator should press RESET to release the keyboard lock and then retry the ATTR-graphic key sequence.
2. When (IN ATTR) is displayed in the Operator Information Area, the MONO/DUAL switch is assumed to be in the DUAL position; therefore, the correct ATTR-graphic sequence is:
 - a. Press the ATTR key.
 - b. Press an appropriate graphic key (@, A through O) while pressing the Shift key.
3. Figure 3-4 shows the ATTR-graphic sequence, ATTR+@. This sequence is not the same in all countries, however, as shown in the following table:

ATTR key plus graphic key	Language
ATTR + @	<ul style="list-style-type: none"> ● U.S. English ● Bilingual English/Canadian French ● U.K. English
ATTR + à	<ul style="list-style-type: none"> ● French
ATTR + §	<ul style="list-style-type: none"> ● German ● Italian
ATTR + ㇰ through ㇱ (Character code points at position, hexadecimal 40 through 4F. Refer to the Table 2 of Figure B-3.)	<ul style="list-style-type: none"> ● Japanese Katakana (in Kana shift mode)

ATTR Key or ESC+3 Plus Graphic Key	ASCII Bits 3 and 4 Display	ASCII Bit 2 Protected/ Unprotected	ASCII Bit 1 MDT	Character Name	Character Displayed
@	Normal	Unprotected	Off	NUL	⋮⋮
A	Normal	Unprotected	On	SOH	S _H
B	Normal	Protected	Off	STX	S _X
C	Normal	Protected	On	ETX	E _X
D	Highlighted	Unprotected	Off	EOT	E _T
E	Highlighted	Unprotected	On	ENQ	E _Q
F	Highlighted	Protected	Off	ACK	A _K
G	Highlighted	Protected	On	BEL	B _L
H	Blinking	Unprotected	Off	BS	B _S
I	Blinking	Unprotected	On	HT	H _T
J	Blinking	Protected	Off	LF	L _F
K	Blinking	Protected	On	VT	V _T
L	Nondisplay	Unprotected	Off	FF	F _F
M	Nondisplay	Unprotected	On	CR	C _R
N	Nondisplay	Protected	Off	SO	S _O
O	Nondisplay	Protected	On	SI	S _I

Figure 3-4. Definition of Attribute Characters

3.3.2.2 PRGM MODE Key

The PRGM MODE key functions only on Model 2X, and only in block mode. Pressing this key (with the ALT key held down) places the 3101 in the program mode, in which the operator can enter an attribute character at the cursor position. (PROGRAM) appears in the Operator Information Area. The attribute character is entered by using the ATTR key (see preceding description).

To leave this mode, the operator presses the PRGM MODE key again.

The attribute character entered in the program mode does not become active until the 3101 leaves the program mode (after the PRGM MODE key is pressed the second time).

3.3.2.3 ESC Key

The ESC (escape) key generates an ASCII or ISO escape code, which is the first character of an escape sequence (ESC key plus appropriate graphic key). The ESC sequences are commands other than the standard ASCII control functions and perform the specific functions shown in Figure 2-12.

3.3.2.4 PRINT MSG Key

The PRINT MSG key works only on Model 2X. When pressed, it transfers characters to an attached auxiliary device through the auxiliary interface. The characters transferred are those from the first character position of the line below the line identified by the send mark to the cursor position. The symbol for the send mark is the same as that for the control character, Device Control 2 (DC2) (see Figure 3-5).

To set the send mark, move the cursor to the position desired, and enter the ESC•E sequence (ESC key plus graphic E). Then move the cursor to the character following the last character to be transferred. The character at the cursor position is not transferred.

Upon completion of the transfer, the send mark moves to the current cursor position, and the cursor moves to the first character position of the next lower line.

If no send mark is found between the home position and the cursor position, or if the send mark and the cursor are on the same line, the data transferred is from the home position (line 1, column 1) to the cursor position.

If the cursor is at an attribute character position or within a protected field, the print operation is inhibited, and LOCK- FORMAT CHECK appears in the Operator Information Area.

Note: An ESC•E sequence issued by either the host or the operator will replace the old send mark with a null character.

3.3.2.5 PRINT LINE Key

The PRINT LINE key is activated by the ALT key, and works only on Model 2X. When pressed, it transfers the contents of the line indicated by the cursor to an auxiliary device. The cursor then moves to the first character position of the next line. See "Data Stream" in Chapter 2 for detailed information about the format.

3.3.2.6 PRINT Key

The PRINT key is unique to Model 2X. When pressed, it causes the entire display image to be transferred to an attached auxiliary device. The cursor then moves to the home position. See "Data Stream" in Chapter 2 for information about the format.

3.3.2.7 AUX Key

Pressing the AUX key, with the ALT key held down, enables the 3101 to transfer data to an attached auxiliary device, where it is printed or recorded (monitor-print operation). Pressing this key a second time ends the monitor-print operation.

If this key is pressed during a local-mode operation (described in Chapter 2), the keyboard locks, and LOCK-MODE/SETUP CHECK, which is described later, appears in the Operator Information Area.

Note: In the half-duplex operation, the auxiliary device receives data over both the transmit-data and receive-data lines of the telecommunication interface. In the duplex operation, the auxiliary device receives data over the receive-data line only.

The auxiliary interface is EIA RS-232C, and the data-transfer rate is at the line speed of the telecommunication interface.

3.3.2.8 ERASE EOL/EOF Key

When the display is unformatted, pressing the ERASE EOL/EOF (end-of-line/end-of-field) key changes all characters, from the cursor position to the end of the line, to nulls. Tab stops are not cleared, and the cursor does not move.

When the display is formatted, and the cursor is in an unprotected field, pressing the key changes to nulls, all characters from the cursor position to the end of the line or to the end of the field, whichever occurs first.

The cursor does not move, and the modified data tag (MDT) bit is set to 1.

If the cursor is at an attribute character position or within a protected data field when this key is pressed, no change occurs, and LOCK- FORMAT CHECK appears in the Operator Information Area.

3.3.2.9 ERASE INPUT Key

The ERASE INPUT key is activated by the ALT key.

When the display is unformatted, pressing the ERASE INPUT key changes all characters (except tab stops) to nulls, and the cursor moves to the home position (line 1, column 1). If the display is formatted, all *unprotected* character positions are changed to nulls, the MDT bit is reset to 0 in all unprotected fields, and the cursor moves to the first character position of the first unprotected field.

If there are no unprotected fields, this key does not change any characters, and the cursor moves to the home position.

3.3.2.10 ERASE EOS Key

When the display is unformatted, pressing the ERASE EOS (end of screen) key changes to nulls all characters (except tab stops) from the cursor position to the end of the display image. The cursor does not move.

When the display is formatted, the key changes to nulls all *unprotected* data from the cursor position to the end of the display image. The MDT bit is not affected.

3.3.2.11 CLEAR Key

The CLEAR key is activated by the ALT key and, when pressed, changes all characters, including attribute characters, to nulls. All tab stops are also cleared. The cursor moves to the home position.

3.3.2.12 SEND MSG Key

The SEND MSG key is unique to the Model 2X and operates only in block mode.

When pressed, the SEND MSG key transfers to the host the characters from the first character position of the line below the line indicated by the send mark to the cursor position. (See "PRINT MSG Key" for instructions regarding the placement of the send mark.) The data transferred does not include the character at the cursor position.

When the data transfer is complete, the send mark moves to the current cursor position, and the cursor moves to the first character position of the next line.

If the first column of the next line identified by the send mark includes the cursor, only the turnaround character is sent to the host. If no send mark is found between the home position and the cursor position, or if the send mark and cursor are on the same line, the data transferred is from the home position to the cursor position.

If the display is formatted, the data transferred by the SEND MSG key is as specified by the Set Control command from the host. (See description of Set Control command under "Commands" in Chapter 2.)

If the cursor is at an attribute character position, or within a protected field, the send operation does not occur and LOCK- FORMAT CHECK appears in the Operator Information Area. See "Data Stream" in Chapter 2 for more information about the send operation.

If the host reissues a Write Send Mark (ESC•E) command, which is used to generate a send mark, or if the operator rekeys the ESC•E sequence from the keyboard, that send mark overrides the current send mark. (See "Commands" in Chapter 2.)

3.3.2.13 SEND LINE Key

The SEND LINE key is activated by the ALT key, and operates only with the Model 2X in block mode.

The SEND LINE key transfers to the host the contents of the line identified by the cursor. The cursor then moves to the first character position of the next line or the same line, depending on whether the CR•LF switch is on or off.

If the display is formatted, the data transferred is as specified by the Set Control command (ESC•9) from the host (all data, unprotected data only, or modified data only). See Chapter 2 for more information about the send operation.

Note: When the Send Line Option setup switch is on, the SEND key functions as the SEND LINE key, and the SEND LINE key functions as the SEND key.

3.3.2.14 Click Key

The 3101 keyboard has a clicker that is activated when power is first applied, and it produces a clicking sound as keyboard keys are pressed. The absence of the clicking sound indicates a problem.

If the Click key is pressed while the clicker is activated, the clicker becomes deactivated, and no sound will be heard as keys are pressed, unless a problem exists.

3.3.2.15 LOCAL Key

When the LOCAL key is pressed, communications between the 3101 and host are ended, and LOCAL appears in the Operator Information Area. The 3101 can perform any keyboard-display operation but cannot transfer or receive data, except to receive and respond to the Read Status command from the host. The local mode can be used for operator training, format creation, or text or data editing. The display image created and edited in the local mode can be transferred to the host after the local mode is left.

Pressing the LOCAL key a second time returns the 3101 to its previous state.

Note: In duplex operation, the 3101 cannot perform any keyboard-display operations, because keyed-in data cannot be echoed back.

3.3.2.16 Tab Key

The Tab key () moves the cursor to the next tab stop position for an unformatted display, or to the first data character position of the next unprotected field for a formatted display.

If AUTO NL is off when the 3101 is in character mode, the tab stop positions are always set at the first and last character positions of each line. Pressing the Tab key after the cursor reaches the end of the current line causes the cursor to wrap to the first character position of the same line.

If AUTO NL is on, the tab stop positions are at the home position and last character position of the bottom line.

In block mode, the AUTO NL switch is assumed to be on. If the Tab key is pressed after the cursor passes the last tab stop position of the current line, the cursor wraps to the first tab position of the next lower line. If the current line is also the bottom line, the cursor wraps to the home position.

If the display is formatted, the tab stops are assumed to be set at the first character position of unprotected fields, at the home position, and at the last character position of the bottom line. All other normal tab stops are ignored.

If the display has no unprotected fields, the cursor is at the home position or at the end of the display image.

Note: The 3101 uses the column-tab setting in character mode, which means each of the 24 lines has the tab stops at the same character columns.

3.3.2.17 Shift Lock Key

The Shift Lock key () locks the keyboard in uppercase character selection. The "UP SHIFT" indicator appears in the Operator Information Area.

3.3.2.18 Shift Key

The Shift key () allows uppercase characters to be entered. When the Shift key is pressed and held, characters shown on the top position of the keytops can be entered. The "UP SHIFT" indicator appears in the Operator Information Area while this key is pressed.

Pressing the Shift key resets the Shift Lock key, causing the "UP SHIFT" indicator to disappear from the Operator Information Area.

Note: The Katakana keyboard has the following four shift keys:

- Alpha Sign (uppercase)
- Alpha (lowercase)
- Kana Sign (uppercase)
- Kana (lowercase)

The characters associated with each shift case are shown in the corresponding position of the keytops. (See Appendix B for the Japanese Katakana keyboard layouts.) In normal operation, the appropriate shift key is pressed and released to enter the required shift case; the keyboard stays in that shift case until another is selected. The shift case is indicated in the Operator Information Area, so the operator can see the shift case in effect.

The numeric keypad on the Katakana keyboard is always active, regardless of the shift case the keyboard is in.

When the 3101 Power switch is set to off and then on, the shift case of the keyboard starts in Alpha shift.

3.3.2.19 RESET Key

The RESET key is pressed when an error condition has caused the keyboard to lock. Pressing the key unlocks the keyboard, clears LOCK- messages from the Operator Information Area, and resets the error status. If some lock conditions still exist, the status of the highest priority condition is displayed (without LOCK-) in the Operator Information Area as a reminder. See "System and Status Messages" in Chapter 2 for details about error indications.

When (IN ATTR) is displayed in the Operator Information Area, it changes to (PROGRAM) when RESET is pressed.

3.3.2.20 CANCEL Key

The CANCEL key works only on Model 2X.

Pressing this key immediately ends data transfer to the host or an auxiliary device, if the transfer was started by:

- The pressing of a Send key (SEND, SEND MSG, or SEND LINE) or Print key (PRINT, PRINT MSG, or PRINT LINE)
- The receipt of a Read Buffer command (ESC•8) from the host, or a Print command (ESC•U, ESC•V, ESC•W) from the host or keyboard (see Figure 2-12 for a description of the commands).

The cursor then returns to the position before data transfer. When data transfer is ended by the CANCEL key, the 3101 does not send a turnaround character (EOT, CR, DC3, or ETX).

Pressing the CANCEL key after data transfer is complete or is ended, has no effect.

3.3.2.21 Backspace Key

The Backspace key (←) moves the cursor to the left, one character position at a time. If the cursor is at the first character position of a line, and AUTO NL is on, pressing the Backspace key causes the cursor to move to the last character position of the preceding line. If the cursor is at the home position when the Backspace key is pressed, the cursor wraps to the last character position of the bottom line (column 80, line 24).

If **AUTO NL** is off when the Backspace key is pressed, cursor movement will be on the current line only. Wrapping will be from character position 1 to position 80.

Note: The **AUTO NL** switch is always assumed to be on in block mode.

3.3.2.22 Back-Tab Key

The Back-Tab key () operates only on Model 2X in block mode. It moves the cursor one tab position to the left, for an unformatted display, or to the first data character position of an unprotected field for a formatted display.

When the Back-Tab key is held down, the cursor, after reaching the leftmost tab-stop position, moves to the end of the preceding line. If the leftmost tab-stop position is also the home position, the cursor wraps to the end of the display image.

If the display has no unprotected fields, the cursor stays at the home position or at the end of the display.

3.3.2.23 New Line Key

If the New Line key () is pressed when **AUTO LF** is on, the cursor moves to:

- The first character position of the next line, when the **CR/CR•LF** switch is set to **CR**
- The first character position of the line after the next line, when the **CR/CR•LF** switch is set to **CR•LF**

If the **AUTO LF** switch is off, the cursor moves to:

- The first character position of the current line, when the **CR/CR•LF** switch is set to **CR**
- The first character position of the next line, when the **CR/CR•LF** switch is set to **CR•LF**

If **SCROLL** is off, and the cursor is in the bottom line when the New Line key is pressed, the cursor moves to the following position:

- The home position, if the **AUTO LF** is on and the **CR/CR•LF** switch is set to **CR**
- The first character position of the second line, if the **AUTO LF** is on and the **CR/CR•LF** switch is set to **CR•LF**
- The first character position of the bottom line, if the **AUTO LF** is off and the **CR/CR•LF** switch is set to **CR**
- The home position, if the **AUTO LF** is off and the **CR/CR•LF** switch is set to **CR•LF**

If **SCROLL** is on, the display image scrolls as follows:

- One line, if **AUTO LF** is on and **CR/CR•LF** is set to **CR**
- Two lines, if **AUTO LF** is on and **CR/CR•LF** is **CR•LF**
- No lines, if **AUTO LF** is off and **CR/CR•LF** is **CR**

- One line, if AUTO LF is off and CR/CR•LF is CR•LF

The cursor moves to the first character position of the new bottom line.

If the display is formatted, scrolling is suppressed.

When the 3101 is in character mode, the New Line key generates CR or CR•LF characters, depending on the setting of the CR/CR•LF setup switch.

Note: When CR is selected as the line turnaround character, and the CR/CR•LF setup switch is set to CR•LF, the New Line key performs carriage-return and line-feed functions, but only the CR character is sent to the host.

3.3.2.24 ALT Key

The ALT (alternate) shift key is used in conjunction with other graphic keys to generate ASCII or ISO control characters. Figure 3-5 shows the control characters generated, and their functions, when a graphic key is pressed while the ALT key is held down. The ALT key also activates the ERASE INPUT, Home, Program Function, LOCAL, CLEAR, AUX, PRGM MODE, PRINT LINE, SEND LINE, INS LINE, DEL LINE, and CANCEL keys, and must be held down when these keys are pressed.

The following keyboard layout shows the position of each keyboard key that generates an ASCII control character (Figure 3-5) with the ALT key. The symbol shown in each key position is not engraved on the actual key surface. For example, if you want to generate the ASCII control character SOH, you must press the A key while pressing the ALT key.

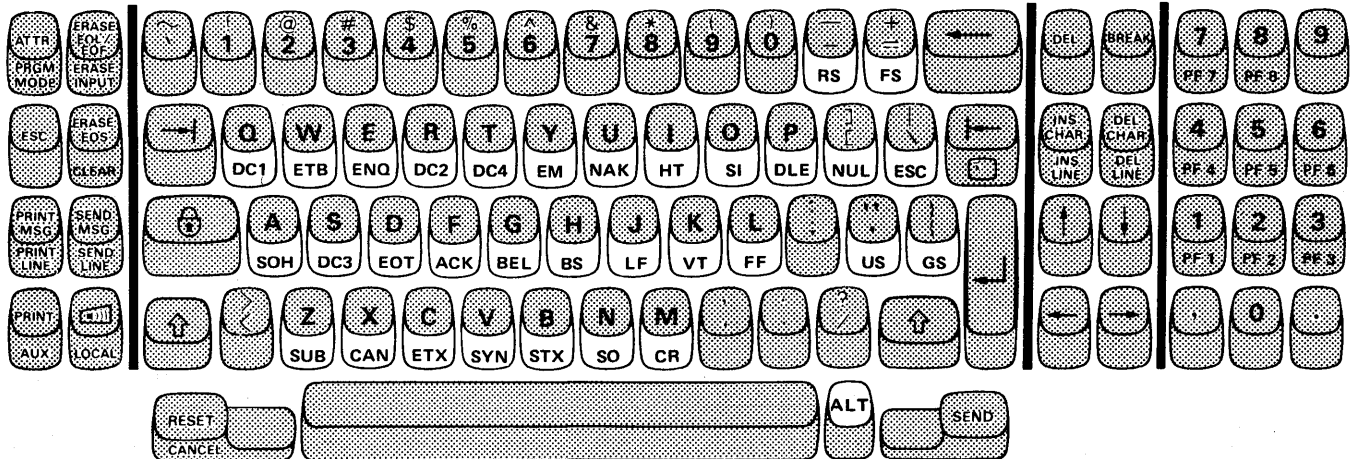

ALT plus ASCII Graphic Character	ASCII Control Characters	Category ⁵	Character ⁴ Displayed	Function in 3101
[²	NUL ³ (Null)	a	⋮ ⋮ ⋮	Causes logical keyboard lock condition when more than 7 contiguous NULs received from the host.
A	SOH (Start of Header)		S H	
B	STX ³ (Start of Text)	a	S X	Enter the transparent mode (DLE sequence).
C	ETX ³ (End of Text) ⁶	a	E X	Exit the transparent mode (DLE Sequence) or terminate a message transmission.
D	EOT ³ (End of Transmission) ⁶	a	E T	Indicates the end of message transmission or disconnect (DLE Sequence).
E	ENQ (Enquiry)		E Q	
F	ACK (Acknowledge)		A K	
G	BEL ³ (Bell)	c	B L	Causes audible alarm to sound.
H	BS ³ (Backspace)	b	B S	Causes the cursor to move left one position.
I	HT ³ (Horizontal Tab)	b	H T (Note)	Causes the cursor to move to next tab stop position.
J	LF ³ (Line Feed)	b	L F	Causes cursor to move to next lowerline. For details on the cursor movement, see Appendix I.
K	VT ³ (Vertical Tab)	b	V T	Causes cursor to move to next lowerline. For details on the cursor movement, see Appendix I.
L	FF ³ (Form Feed)	b	F F	Causes Erase input function to be performed if SCROLL is Off. and moves the cursor to the next lower line if SCROLL is On. For details on the cursor movement, see Appendix I.
M	CR ³ (Carriage Return)	b a ⁶	C R	Causes cursor to move to the first character position of current line or next lower line. For details on the cursor movement, see Appendix I.
N	SO		S O	To specify the extended ISO 7-bit characters for Bilingual English/ Canadian French, and Japanese Katakana. In transmission operation, those characters will be sandwiched with SO (Shift-out) and SI (Shift-in).
O	SI		S I	

Note: When the cursor is positioned at the attribute character location in unprotected field, HT character entered from the keyboard or received from a system/processor moves the cursor one character position to the right.

Figure 3-5 (Part 1 of 3). Control Characters and Their Functions

ALT plus ASCII Graphic Character	ASCII Control Characters	Category ⁵	Character ⁴ Displayed	Function in 3101
P	DLE ³ (Data Link Escape)	a	D L	Changes the meaning of following characters (first character of DLE sequence).
Q	DC1 ³ (Device control 1)	a	⠠	Causes logical keyboard lock. (More than 7 contiguous DC1 characters received from the host)
R	DC2 ³ (Device control 2)	c	⠠	Displays the same symbol as that for the send mark.
S	DC3 ³ (Device control 3)	a ⁶	⠠	Causes logical keyboard lock (More than 7 contiguous DC3 characters received from the host)
T	DC4 (Device control 4)		⠠	
U	NAK (Negative acknowledge)		N K	
V	SYN (Synchronous)		S Y	
W	ETB (End of block)		E B	
X	CAN (Cancel)		C N	
Y ¹	EM (End of medium)		E M	
Z ¹	SUB ³	c	⠠	Displays error symbol, which indicates parity error or stop bit missing.
\ ²	ESC ³ (Escape)	c	E C	Used with other keys to perform specific functions.
= ²	FS (File separator)		F S	
²	GS (Group separator)		G S	
- ²	RS ³ (Record separator)		R S	Indicates the end of line when CR is selected for turnaround character.
, ²	US (Unit separator)		U S	

Legend:

1. In the German keyboard arrangement, key positions "Y" and "Z" are reversed. However, the combination of key positions to generate an appropriate control character is unchanged. This means, to generate the control character "EM," you press the "Z" key on the German keyboard ("Y" key position on U.S. ASCII keyboard) while pressing the ALT key.
2. Graphic symbol varies among countries. The graphic character and symbol engraved on the key positions shown in the following table differ by language.

Figure 3-5 (Part 2 of 3). Control Characters and Their Functions

LANGUAGE	Graphic Keys					
U.S. English	[\	=	{	-	~
Canadian French	[\	=	{	-	~
Canadian English	[\	=	{	-	~
German	ü	+	~	#	?	ä
French	à	&	^	u	?	ù
Italian	è	+	i	ù	?	à
English	@	[↑]	=	:
Japanese Katakana	@	[¥]	-	:

3. Used for 3101 function.
4. Displayed in transparent mode only.
 ? and  can be displayed in non-transparent and transparent modes.
5. Some of the control characters are categorized as follows:
 - a. Indicates telecommunication control character.
 - b. Indicates format effector character.
 - c. Indicates other control character or special symbol/signal information.
6. Used as line turnaround character for IBM System/370 host.

Figure 3-5 (Part 3 of 3). Control Characters and Their Functions

3.3.2.25 SEND Key

The SEND key is functional only on Model 2X in block mode.

Pressing the SEND key when the display is unformatted causes the entire display image to be transferred to the host. If the display is formatted, the amount and type of data transferred (all data, unprotected data only, or modified data only) depend on the Set Control command (ESC•9) from the host. See Chapter 2 for more details about the send operation.

Upon completion of the transfer, the cursor moves to the home position.

Note: When the Send Line Option setup switch is on, the SEND key functions as the SEND LINE key, and the SEND LINE key functions as the SEND key.

3.3.2.26 DEL Key

When the 3101 is in character mode, pressing the DEL key causes the 3101 to send the ASCII or ISO-code delete character (DEL) to the host. In general, DEL characters are used as time-fill characters when the 3101 needs delay time to execute host commands or to perform terminal functions.

Pressing this key in block mode locks the keyboard, and LOCK-MODE/SETUP CHECK appears in the Operator Information Area, when the 3101 is in any operational mode other than transparent. In transparent mode, the 3101 displays the DEL character () when the DEL key is pressed.

3.3.2.27 BREAK Key

When the 3101 is in the receive state, and the PRTS/CRTS setup switch is set to PRTS or to CRTS with the REVERSE CH switch on, pressing the BREAK key causes the 3101 to send a break (space) signal to the host for 500 milliseconds. The break signal allows the operator to interrupt the host while the 3101 is receiving data, and to start a send operation (dependent on the application program).

This key is effective only when a duplex telecommunication facility, or a half-duplex telecommunication facility with reverse channel is used. The operator can press this key at any time in a duplex operation, but when the 3101 is in a half-duplex operation, the key can be pressed only while the 3101 is receiving data from the host.

Pressing this key continually may disconnect the link between the 3101 and host.

If, during a data-transfer operation, the BREAK key is pressed on a 3101 that is attached to a half-duplex telecommunication facility without reverse channel, or to a half-duplex telecommunication facility with reverse channel, the keyboard locks and LOCK- MODE/SETUP CHECK appears in the Operator Information Area.

3.3.2.28 Home Key

The Home key () moves the cursor to the home position (line 1, column 1).

3.3.2.29 INS CHAR Key

The INS CHAR key functions only on Model 2X in block mode.

When the INS CHAR key is pressed, INSERT appears in the Operator Information Area.

If the cursor is in an unprotected field, or the display is unformatted with a null character either at the cursor position or at any character position in the field beyond the cursor, pressing a graphic character key causes that graphic character to be entered at the cursor position. The MDT bit is set to 1. The character formerly at the cursor position, and all remaining characters within the field (except for null characters or characters to the right of null characters), shift one character position to the right. If the position identified by the cursor at the time of the insert operation is a null, no character shifting occurs.

Attribute characters remain in their fixed character positions and are not shifted.

After all null characters have been overwritten, or if no null characters were present, pressing a graphic character key causes the keyboard to lock, and LOCK-FORMAT CHECK appears in the Operator Information Area.

If the field has more than one line of characters, the character in the last position of the line is shifted into the first character position of the next line.

If a graphic character key is pressed when the cursor is at an attribute character position or within a protected field, the keyboard locks, and LOCK- FORMAT CHECK appears in the Operator Information Area. In this case, no character positions are cleared, the cursor does not move, and the MDT bit is not set.

To leave the insert-character mode, the operator must press the INS CHAR key again.

3.3.2.30 INS LINE Key

The INS LINE key is functional only on Model 2X in block mode. The ALT key must be held down when this key is pressed.

The INS LINE key causes the line identified by the cursor to be replaced with a line of null characters. The data in the current line and in the remaining lower lines moves down one line. If the current line and the next lower line have all null characters, no data line is moved.

If the display is unformatted, data in the bottom line is lost. If the display is formatted, the insert-line operation is limited to the current unprotected field; no data line moves down in the other fields. The current unprotected field must have at least one line of null characters. If not, the operation causes the keyboard to lock, and LOCK- FORMAT CHECK appears in the Operator Information Area. The result will be the same as if an attribute character is in the current line, or as if the current field is protected.

If, in a formatted display, an unprotected field has more than one null line, the last null line in the field is lost, and a new null line is created on the current cursor line.

After an insert-line operation, the MDT bit of the current unprotected field is set to 1, and the cursor moves to the first character position of the newly created null line.

3.3.2.31 DEL CHAR Key

The DEL CHAR key is functional only on Model 2X in block mode.

The DEL CHAR key deletes the graphic character identified by the cursor in an unprotected field or unformatted display. The cursor does not move, and the MDT bit is set to 1. All remaining characters to the right of the cursor in the same line move one character position to the left. The last character position of the line is filled with a null. If the unprotected field or unformatted display has more than one line, characters in lines other than the one identified by the cursor are not affected.

When the cursor is at an attribute character position or in a protected field, this key causes the keyboard to lock, and LOCK- FORMAT CHECK appears in the Operator Information Area; no characters are deleted, the cursor does not move, and the MDT bit is not set.

3.3.2.32 DEL LINE Key

The DEL LINE key is activated by the ALT key and is functional in block mode only.

This key deletes the line identified by the cursor. All lower lines within an unprotected field of a formatted display, or within an unformatted display, move up one line.

If the display is unformatteded, a new null line is created on the bottom line. If the display is formatted, the last 80 characters of the unprotected field are cleared to nulls. If an attribute character is in the current line, or if the current field is protected, the keyboard locks and LOCK-FORMAT CHECK appears in the Operator Information Area.

After a delete-line operation, the cursor moves to the first character position of the current line, and the MDT bit in the unprotected field is set to 1.

3.3.2.33 Move-Cursor Keys

A cluster of four keys moves the cursor one location at a time into any character position: ↑ (Up), ↓ (Down), → (Right), and ← (Left). The cursor may be moved into any character location, including unprotected and protected alphameric character and attribute character locations. Operating these keys does not affect the MDT bit.

All these keys can cause the cursor to wrap. Horizontal wrap always involves a vertical movement; the cursor moves to the next or preceding line of characters. Horizontal wrapping is affected by the setting of the AUTO NL setup switch. If the ← (Left) key is pressed while the AUTO NL switch is on, the cursor moves to the last column of the bottom line (line 24) after it reaches the home position. If the → (Right) key is pressed while the AUTO NL switch is off, the cursor moves to the first position of the bottom line after it reaches the last column of the bottom line.

Vertical wrap caused by the ↑ (Up) or ↓ (Down) keys involves no horizontal movement; the cursor stays in the same character column.

Note: The AUTO NL switch is always assumed to be on in block mode (Model 2X).

3.3.2.34 Program Function Keys

The eight program function (PF) keys are activated with the ALT key. When a PF key is pressed, an ESC sequence and the turnaround character are sent to the host. (See Figure A-1 for the ESC sequences of PF keys.) The operation to be performed when an ESC sequence is received can be defined by the user in the application program.

Note: The turnaround character is EOT, ETX, CR, or XOFF, and is selected by the setup switches 16 shown in Figure 3-2.

3.3.2.35 Inoperative Keys

Several keys on the keyboard are unlabeled because they have no assigned function or character. If these keys are pressed, the audible alarm sounds. The audible alarm also sounds if the operator presses an ALT key/graphic key combination for which no function is assigned (for example, ALT plus 9).

Notes:

1. Pressing one of the Model-2X-unique keys on a Model-1X keyboard also causes the alarm to sound.
2. If a block-mode-unique key is pressed when the 3101 is in character mode, LOCK-MODE/SETUP CHECK appears in the Operator Information Area.

3.3.2.36 Dead Keys

The five accent keys on the Bilingual English/Canadian French keyboard (‘, ` , ^ , ¨ , ~) are referred to as *dead keys*. If one of these is pressed, the relevant accent mark appears. The character that is to receive the accent must be entered next. If the character is valid, a unique composite character is formed. (See Figure B-2 in Appendix B for the keyboard layouts and identification of valid accent characters.) If the second character is invalid, the keyboard locks and a LOCK- message appears in the Operator Information Area. The accent mark remains displayed, but the operator must press the RESET key to unlock the keyboard, and then reenter the accent key and the correct character to form the composite character.

When only one stand-alone accent mark is needed, the operator must press the space bar after pressing the appropriate accent mark key.

Chapter 4. Programming Considerations

This chapter describes IBM host-system support and provides some general programming information for the 3101.

4.1 IBM Host Systems

The following IBM host systems support the 3101:

- S/370 (including 3031, 3032, 3033, and 3081 Processors)
- IBM 4300 Processors
- IBM 8100 (DPPX for character mode operations)
- Series/1

The 3101 is designed for asynchronous telecommunication with:

- CCITT V.24/V.28 or EIA RS-232C
- 20-mA current loop
- CCITT V.11 or EIA RS-422

If attachment is planned to a host other than one previously listed, the attachment capabilities of both the host and the 3101 must be examined carefully.

4.1.1 Levels of IBM Host Programming Support

IBM host programming support for the 3101 can be categorized as consisting of three levels:

- CPT-TWX 33/35 type terminal support in character mode
- Editing function support in block mode
- IBM 3101 function support

Figure 4-1 is a summary of functions supported by these levels.

	Character Mode		Block Mode	
	CPT-TWX 33/35 Type Terminal	3101 Function	Line Editing Function	3101 Function
Character Set	64 (4)	95 (4)	64 (4)	95 (4)
Printer Control Characters (CR, LF, HT, BS, BEL)	X	X	X	X
Buffer Edit — Character	—	—	X	X
Buffer Edit — Line	—	—	—	X
Cursor Move	— (1)	X	—	X
Erase/Clear	— (1)	X	—	X
Insert Cursor	—	X	—	X
Set Buffer Address	—	X	—	X
Field Attribute	—	—	—	X
Tab Set/Reset	X	X	X	X
Keyboard Lock/Unlock	—	X	—	X
Program Function Keys	—	X	—	X
Print Control	— (2)	— (2)	— (2)	X
Transparent Mode	— (3)	X (3)	— (3)	X (3)
Program Mode	—	—	—	X
Read Commands	—	X	—	X

X: Supported
- : Not Supported

Notes:

1. No ASCII or ISO code is transferred when invoked by the operator.
2. The printer on the auxiliary port is controlled by the operator.
3. The terminal is placed in or removed from transparent mode by the operator with DLE•STX and DLE•ETX sequences.
4. The 64-graphic character set is 63 graphics plus a space character.
The 95-graphic character set is 94 graphics plus a space character.

Figure 4-1. Summary of Functions Supported by IBM Programming Support Levels

4.1.1.1 CPT-TWX 33/35 Type Terminal Support - Character Mode

The 3101 can be supported as a substitute for CPT-TWX 33/35 devices, in character-mode operation. Such support is possible because a subset of the 3101 functions simulates CPT-TWX 33/35 keyboard/printer operation in response to printer control characters, such as HT (Horizontal Tab), LF (Line Feed), CR (Carriage Return), BS (Backspace), and BEL. Operation of the 3101 at this level, therefore, is line by line, as though it were a CPT-TWX 33/35 device.

The character set at this support level is usually limited by programming to a 64-graphic character set. Some programming support, however, allows the use of the 95-graphic character set. (A monospace/dual-case setup switch is provided for use with programs that support only the 64-graphic character set or that support up to 95 graphic characters.)

This level of support is hereafter referred to as *SUB*.

4.1.1.2 Editing Function Support - Block Mode

The line-editing function allows one line of an input message to be edited before it is sent. Characters can be replaced simply by overstriking or by using the Insert and Delete keys. Data also can be corrected by using the backspace key or logical delete characters. Except for line editing and block transmission, the operational characteristics of this level of support are the same as those of the SUB level.

This level of support is hereafter referred to as *EDIT*.

4.1.1.3 3101 Function Support - Character and Block Modes

In addition to providing a 95-graphic character set, this level of support provides display-surface control functions and advanced functions. The advanced functions increase programmer productivity and enable the terminal to be used more effectively in various operating environments. Following are the functions provided.

DISPLAY-SURFACE CONTROL: Cursor Move (up, down, left, right), Erase (end of line, end of field¹, end of screen, input), Clear, Insert Cursor, Set Buffer Address, Start Field (for attribute handling)¹.

TAB CONTROL: Set and Reset Horizontal Tab, Back Tab Operation¹.

KEYBOARD CONTROL: Lock and Unlock Keyboard

PROGRAM COMMUNICATION: Program Function Keys (8)

PRINT CONTROL²: Print Line, Print Message, Print Page

BUFFER EDIT¹: Insert/Delete Line, Insert/Delete Character

PROGRAMMER PRODUCTIVITY AID: Transparent Mode, Program Mode Control¹

WRITE SEND MARK²

READ COMMANDS: Read Setup Switch, Read Cursor Position, Read Status, Read Buffer¹

TERMINAL CONTROL: Set Control

SWITCHED NETWORK CONTROL: Disconnect

The functions that compose the 3101 function support level are controlled by Data Link Escape (DLE) sequences or Escape (ESC) sequences embedded in the messages.

This level of support is hereafter referred to as *FULL*.

4.1.2 Line Speeds and Telecommunication Facilities Supported

The following line speeds and telecommunication facilities are supported when the 3101 is attached to the 2701, 3704/3705, or 8100:

- 2701 via Start/Stop Interface (U.S. only): 110 bits per second (bps) only; switched network, duplex telecommunication facility; terminal-operator-initiated call.

Programming Note: The graphic left brace (ASCII code point position hex 7B) is lost when the 3101 is attached to a 2701.

¹ Available only in block mode.

² Available in both character and block modes on the 3101 Models 20, 22, and 23 (Americas and Far East countries)

- 3704/3705 via Start/Stop Interface: 110, 150, 200, 300, 600, and 1200 bps, depending on 3704/3705 hardware configuration and programming system capability; switched and nonswitched network, duplex telecommunication facility; terminal-operator-initiated call (switched network only). Operation of the terminal is half-duplex when supported by IBM programming.
- 8100 (via EIA RS-232C or CCITT V.24/V.28 interface with external modem or without modem, and remotely or directly attached): nonswitched, point-to-point, duplex facility; for 8130 attachment, 110, 150, or 300 bps (aggregate line speed must not exceed 330 bps); for 8140 attachment, 110, 150, 300, or 600 bps (aggregate line speed must not exceed 660 bps).

4.1.3 Scope of Support and Operating Environment Restrictions

The following sections provide information for system program support and operating environment restrictions for the 3101 terminal.

4.1.3.1 3704/3705 System Support

This section describes support programs and related Program Temporary Fixes (PTFs) for the 3704/3705 communication controller.

- Support Programs: EP 3.0; NCP/VS 5.0; ACF/NCP/VS R2; ACF/NCP/VS R3; NTO R1, NTO R2 on 3705. (If the MTA option is used on ACF/NCP, the line speed is 110 or 300 bps.)
- The installation of the following PTFs must be evaluated:
 - PTF 517 for NCP VS 5.0 to allow 128-ASCII-character-set or 128-ISO-code-character-set translation by NCP
 - PTF 1005 for ACF/NCP/VS R1 and above to allow 128-ASCII-character-set or 128-ISO-code-character-set translation by ACF/NCP
 - PTF for APAR IR 08564 for ACF/NCP/VS R1 and above to allow read-ahead support for 3101 Read commands for TCAM at FULL level
- ACF/NCP/VS Release 2.1 is required to support a line speed of 1200 bps and a nonswitched line network when the 3101 is operated as a CPT-TWX 33/35 type terminal.

Notes:

1. Restriction - EP 3.0 support for character set:

If the 3101 is attached through a 3704/3705 that is running EP 3.0, the 3101 must be operated in even-parity mode for the 95-graphic character-set support. If operated in any other parity mode, the left brace character (hex 7B) or the language-dependent graphic character at position 7/11 in the ISO code table is lost in the outgoing data stream.

2. NCP Limited Read Command:

Use of the 3101 Read command at 110 bps is not supported.

4.1.3.2 System/370 Support

Figure 4-2 shows System/370 (including 303X and 3081) support for the 3101.

Subsystem	Operating System	Telecommunication Access Method	Communication Controller				3101 Support	
			2701 or EP	NCP	ACF/NCP	ACF/NCP/NTO	CHAR MODE	BLOCK MODE
TSO	MVS	TCAM 10	X	X			SUB	EDIT
		ACF/TCAM V1	X	X	X			
		ACF/TCAM V2/R1	X	X	X			
		ACF/TCAM V2/R2	X	X	X			
		ACF/TCAM V2/R3	X	X	X	X		
		ACF/VTAM V1/R2				X		
		ACF/VTAM V1/R3				X		
		ACF/VTAM V2/R1				X		
CICS	MVS or OS/VS1	BTAM	X				SUB	-
		ACF/TCAM V2/R3				X		
		ACF/VTAM V1/R2				X		
		ACF/VTAM V1/R3				X		
		ACF/VTAM V2/R1				X		
	VSE	BTAM-ES**	X				SUB	-
		ACF/VTAM V1/R2				X		
		ACF/VTAM V1/R3				X		
VSPC	MVS	VTAM 2.0		X	X		FULL	FULL
		ACF/VTAM V1/R2				X		
		ACF/VTAM V1/R3				X		
		ACF/VTAM V2/R1				X		
IMS/VS	MVS or OS/VS1	BTAM	X				SUB	-
User Program	MVS or MVS/SP or OS/VS1	BTAM	X				FULL	FULL
		TCAM 10	X	X			SUB	-
		VTAM 2.0*		X	X			
		ACF/TCAM V1	X	X	X			
		ACF/TCAM V2/R1	X	X	X		FULL	FULL
		ACF/TCAM V2/R2	X	X	X			
		ACF/TCAM V2/R3	X	X	X	X		
ACF/TCAM V2/R4	X	X	X	X				

Legend:

X = Supported

- = Not supported

SUB = CPT-TWX 33/35 type support

EDIT = CPT-TWX 33/35 type plus line-editing support

FULL = CPT-TWX 33/35 type plus 3101 function support

* = Under MVS only.

** = BTAM-ES also supports the 3101 via the Integrated Communication Adapters (ICAs) or 4331 processor communications adapter.

Figure 4-2 (Part 1 of 2). System/370 Support

Subsystem	Operating System	Telecommunication Access Method	Communication Controller				3101 Support	
			2701 or EP	NCP	ACF/NCP	ACF/NCP/NTO	CHAR MODE	BLOCK MODE
User Program	MVS or MVS/SP or OS/VS1	ACF/VTAM V1/R2				X		
		ACF/VTAM V1/R3				X		
		ACF/VTAM V2/R1				X		
	VSE	BTAM-ES**	X				FULL	FULL
		ACF/VTAM V1/R2				X		
		ACF/VTAM V1/R3				X		
		ACF/VTAM V2/R1				X		
CMS	VM/370 or VM/SP	None	X				SUB	EDIT
PVM			X				FULL	FULL

Legend:

X = Supported

- = Not supported

SUB = CPT-TWX 33/35 type support

EDIT = CPT-TWX 33/35 type plus line-editing support

FULL = CPT-TWX 33/35 type plus 3101 function support

* = Under MVS only.

** = BTAM-ES also supports the 3101 via the Integrated Communication Adapters (ICAs) or 4331 processor communications adapter.

Figure 4-2 (Part 2 of 2). System/370 Support

BTAM and BTAM-ES: BTAM supports the 3101 as a CPT-TWX 33/35 type terminal. The FULL level may also be attained with an appropriate user-supplied translation table that allows full ASCII code points or full ISO code points to flow to and from the terminal. The following restrictions apply:

- The left brace character (ASCII code point or ISO code point position 7/11, EBCDIC hexadecimal C0, Reversed PDF Code hexadecimal DF) does not flow to the terminal from a 2701. The previously-noted EP restriction (Note 1 under "3704/3705 System Support") applies.
- The Read Conversational macro is used with IDLIST to support the 3101 Read commands.

VTAM 2.0: VTAM 2.0 Basic Interface supports CPT-TWX 33/35, through which the 3101 is supported at the SUB level.

ACF/VTAM V1/R2, ACF/VTAM V1/R3, and ACF/VTAM V2/R1: These, with the network terminal option, support CPT-TWX 33/35 as a SNA terminal, through which the 3101 is supported by customer-written programs at the FULL level for LU-LU sessions.

For the SSCP-LU session, the 3101 is supported at the SUB or EDIT level, with limited ASCII graphics or ISO graphics and control code points acceptable to SSCP.

The 3101 Read commands may require you to provide a retry recovery program if the service of the response from the terminal for the 3101 Read command cannot be started within 100 milliseconds.

TCAM 10 and ACF/TCAM V1: Support CPT-TWX 33/35, through which the 3101 is supported at the SUB level. The previously-noted EP restriction (Note 1 under "3704/3705 System Support") applies.

ACF/TCAM V2/R1, ACF/TCAM V2/R2, ACF/TCAM V2/R3 and ACF/TCAM V2/R4:
Support CPT-TWX 33/35, through which the 3101 is supported at the FULL level.

IBM 3101 Read commands require PTF installation on ACF/NCP. However, the size of a response from the terminal is restricted to the buffer size defined for ACF/NCP (a maximum of 248 characters, regardless of character and block modes). For block mode, Send-key operations rather than the Read Buffer command are recommended if input data is greater than the buffer size defined for ACF/NCP.

If the 2701 (U.S. only) or EP is used, 3101 read commands are not supported. The EP restriction previously-noted applies.

If NCP is used, 3101 Read Cursor Position, Read Setup Switch, and Read Status commands are supported, but Read Buffer is not, unless the previously-noted restriction is evaluated for impact on an application program.

Note: For information about PTFs, contact your IBM representative.

TSO: TSO supports the CPT-WX 33/35 terminal, through which the 3101 is supported at the SUB level for character mode, and at the EDIT level for block mode.

ASCII graphics or ISO graphics and control code points are limited to the subset acceptable to TSO.

TSO may not support the graphic support of WT-unique characters in a particular user's environment. WT-unique characters must be analyzed by a programmer to determine applicability.

For a TSO/VTAM SSCP-LU session, support is limited to ASCII graphic characters or ISO-code graphic characters and control code points acceptable to the SSCP.

For a TSO operation, ASCII graphic characters or ISO-code graphic characters and control code points are limited to the subset acceptable to TSO. The previously-noted EP restriction (Note 1 under "3704/3705 System Support") applies.

CICS/OS/VS, CCICS/VSE: CICS/VS supports CPT-TWX 33/35, through which the 3101 is supported at the SUB level. Operating with CICS/VS on BTAM with 2701 (U.S. only) or EP, and ACF/VTAM R2 with NTO or ACF/TCAM V2/R2 with NTO, allows the user to define and execute transactions that are consistent with CPT-TWX 33/35 support. ASCII graphic characters or ISO-code graphic characters and control code points are limited to those supported by CICS/VS for CPT-TWX 33/35 support. The EP restriction mentioned in Note 1 under "3704/3705 System Support" applies.

CICS may not support the graphic support of WT-unique characters in a particular user's environment. WT-unique characters must be analyzed by a programmer to determine applicability.

VSPC: VSPC/MVS using VTAM Basic Mode on VTAM 2.0, and VSPC using VTAM Record Mode on ACF/VTAM V1/R2, ACF/VTAM V1/R3, or ACF/VTAM V2/R1 (which requires installation of NTO) support the 3101 at the FULL level. The following restrictions apply:

- The support level for VSPC commands is restricted to the SUB support level for character mode, or to the EDIT level for block mode. The 95-graphic character set is supported.

- Processing of the 3101 Read command and positioning of the cursor at the end of the application message vary, depending on the language being used. Maximum input data is restricted to 1012 characters.

CMS: Under CMS, user-written programs support the 3101 for both character and block mode, except for composite functions that require a Read operation to follow a Write operation within a specific time, such as READ Cursor Address, READ CSU, READ Status, and READ Buffer.

IMS/VS: IMS/VS supports the 3101 on switched lines via BTAM when the 3101 is operating at the SUB level; ASCII graphic characters or ISO code graphic characters and control code points are limited to those supported by IMS/VS for CPT-TWX 33/35 support. The previously-noted EP restriction (Note 1 under “3704/3705 System Support”) applies.

VM/370: SCP, and any of the telecommunication access methods (EP, NCP, or ACF/NCP) on 370X, and subsystems listed as available under SCP, can run on a virtual machine under VM/370 or VM/SP.

VM/370 with or without VM/BSE, VM/SE, or VM/SP supports the 3101 as a CPT-TWX 33/35 type terminal with the following restrictions:

- CP and CMS commands support the 3101 at the SUB level in character mode, or at the EDIT level in block mode. CMS commands support customer-written programs at the FULL level.

Full ASCII code points or full ISO code points, except for the language-unique code points at positions hexadecimal 60 and 7B to 7E, are supported. In addition, the code point at position hexadecimal 5C is translated to a logical NOT.

VM/370 uses only Mark parity to send data to the 3101. The code point position hexadecimal 7B is not supported because of the EP 3.0 restriction specified in Note 1 under “3704/3705 System Support.”

- PLC 4 of VM/370 Release 6, or PLC 13 of VM/370 Release 5, supports the preceding language-unique code points. Under either program level, the code point at position hexadecimal 5C is correctly translated to the reverse slash (\).
- 3101 Read commands, such as Read Cursor Address, Read Setup Switch, Read Buffer, and Read Status, are not supported under VM/370.

4.1.3.3 4300 Support

EXTENDED CONTROL PROGRAM SUPPORT FOR VIRTUAL STORAGE

EXTENDED MODE: VSE with BTAM-ES supports 3101 attachment through the 2701 (U.S. only), 370X with EP, the ICAs or 4331 processor communications adapter. ACF/VTAM V1/R2, ACF/VTAM V1/R3, and ACF/VTAM V2/R1 with NTO on VSE support 3101 attachment through the 3705 with ACF/NCP/VS.

SYSTEM/370 COMPATIBILITY MODE: The same level of support is provided for the 3101 as is already available on System/370, 303X, and 3081. See “System/370 Support” for the scope of support provided (BTAM-ES, ACF/VTAM R2, and ACF/VTAM R3), and “VM/370 Support” for VM/370.

4.1.3.4 8100 Support

DPPX provides EXCP macro level support and SEND/RECEIVE macro level support for the CPT-TWX 33/35 attachment. Through the EXCP or SEND/RECEIVE macro levels, the 3101 Model 10, 12, or 13 (character mode and EIA RS-232C or CCITT V.24/V.28 only) is supported at the FULL level and can log on to the DPPX command facility and to the Data Base and Transaction Management System (DTMS). Performance characteristics of the 8100 with the 3101 attached should be evaluated with respect to the 8100's aggregate start/stop line-speed limitation. The maximum number of 3101s supported for concurrent operation at 110 bps under DPPX is three on the 8130, and six on the 8140.

4.1.3.5 Series/1 Support

IBM Series/1 programming support is provided under the Realtime Programming System (RPS), the Event Driven Executive (EDX), and the Control Program Support (CPS), and other related program products.

Series/1 Feature	Operating System			
	3101 Models Supported	Realtime Programming System	Event Driven Executive	Control Program Support
Teletypewriter Adapter (Feature Number 7850) Current Loop Attach RS-232C (or CCITT V.24/V.28) Attach	12, 22 ALL	X X	X X	X X
Asynchronous Communications Single Line Control (Feature Number 1610) RS-232C (or CCITT V.24/V.28) Attach	ALL	X	X	—
Asynchronous Communications 4 Line Adapter (Feature Number 2092/2091) RS-232C (or CCITT V.24/V.28) Attach	ALL	X	X	—
Feature-Programmable 4 line Communication Adapter (Feature Number 2095/2096) Current Loop Attach RS-232C (or CCITT V.24/V.28) Attach	12, 22 ALL	X X	X X	— —
3101 Direct 8 Line Attachment (Feature Number 2095/D02350) RS-422 Attach	13, 23	X	X	—

X : Supported

— : Not supported

ALL : Includes Models 10, 12, 13, 20, 22, and 23.

Note: See *IBM Series/1 System Summary*, GA34-0035, and *IBM Series/1 Programming System Summary*, GC34-0285, for additional information.

Series/1 Feature	Operating System			
	3101 Models Supported	Realtime Programming System	Event Driven Executive	Control Program Support
Multifunction Adapter (Feature Number 1310) RS-232C Attach RS-422 Attach	ALL 13, 23	X X	X X	— —
HDX DCE Attachment (Feature Number 4730*) RS-232C (or CCITT V.24/V.28)	ALL	X	—	—
FDX DCE Attachment (Feature Number 4731*) RS-232C (or CCITT V.24/V.28)	ALL	X	—	—
TTY Current Attachment (Feature Number 4734*) Current Loop	12, 22	X	—	—
Asynchronous Local Attachment (Feature Number 4739*) RS-232C (or CCITT V.24/V.28)	ALL	X	—	—

*Features available on 4987 programmable communication subsystem.

X : Supported

— : Not supported

ALL : Includes Models 10, 12, 13, 20, 22, and 23.

Note: See *IBM Series/1 System Summary*, GA34-0035, and *IBM Series/1 Programming System Summary*, GC34-0285, for additional information.

4.2 General Programming Considerations

The following sections describe the commonality and differences between the 3101 and the CPT-TWX 33/35 terminal, from a functional compatibility point of view.

4.2.1 ENQ Character

ENQ is a communication control character that a host sends to a CPT-TWX 33/35 terminal to start an automatic identification answer-back. The 3101 ignores the character.

4.2.2 Generating ASCII or ISO Code Control Characters

Both the CPT-TWX 33/35 and 3101 terminals can generate any of 33 ASCII or ISO-code control characters, including DEL, through the keyboard. However, the operational sequences for generating certain characters are different with the two keyboards. The characters and differences are as follows:

Control Characters	CPT-TWX 33/35 Key Operation	3101 Key Operation	
		ASCII	ISO Code
NUL	Shift CTRL P	ALT [See Note
ESC	Shift CTRL K	ALT \	
FS	Shift CTRL L	ALT =	
GS	Shift CTRL M	ALT {	
RS	Shift CTRL N	ALT - (Minus)	
US	Shift CTRL O	ALT ` (Quotation)	

Note: Graphic symbol vary among countries, but each key position is the same as that of the ASCII keyboard (see Appendix B).

4.2.3 Logical Keyboard Lock

Because the 3101 has keyboard lock and unlock functions, its send and receive operations can be controlled automatically through the keyboard lock/unlock status. The operator does not have to know if the host is ready to receive data from the terminal.

IBM programming support, such as TSO/TCAM, uses a concept of logical keyboard lock. TSO/TCAM sends continuous XON/XOFF (DC1/DC3) characters to a CPT-TWX 33/35 terminal to indicate when the operator cannot send data. VTAM/NCP uses the NUL character as the logical keyboard lock. VSPC issues CR then LF to indicate that input can be received.

In the duplex or half-duplex operation with the duplex telecommunication facility, when the 3101 receives eight or more continuous characters of NUL, XON (DC1), or XOFF (DC3) from a host, a logical keyboard lock occurs, the audible alarm sounds, and the following happen:

- If the Blink Cursor setup switch is set to the Off position, the cursor starts blinking and continues until the 3101 receives any character except NUL, XON, and XOFF, or until 640 milliseconds elapse without any character being received from the host.

- If the Blink Cursor setup switch is set to the On position, the cursor stops blinking. It starts blinking after the 3101 receives any character except NUL, XON, and XOFF, or when 640 milliseconds elapse without any character being received from the host.

4.2.4 Invalid Parameters for ESC Sequence

An invalid parameter for an ESC sequence results in a command error; the ESC sequence is not generated, and the command error bit of the status byte (ASCII bit 4 of status 0) is set. The Read Status command (ESC•6) is available for host programming to indicate to the host that a command error occurred.

4.2.5 Timing Considerations for ESC Sequence

The 3101 provides at least 128 bytes of line buffer, which is enough for operations under practical programming. The shortest possible character time interval is 1.04 milliseconds for 9600 bps. Some of the operations listed below however, require 50 to 100 milliseconds to execute block-mode operations, which means that some timing consideration is required to prevent line buffer overrun.

CLEAR
ERASE INPUT
ERASE EOF/EOL
ERASE EOS
WRITE SEND MARK
INSERT LINE
DELETE LINE
INSERT CHAR
DELETE CHAR
TABBING ON FORMATTED DISPLAY

4.2.6 Read Command Considerations

Read commands, such as Read Cursor Address (ESC•5), Read Status (ESC•6), or Read Setup Switch (ESC•7) make the host aware of 3101 status. Upon receipt of a Read command, the 3101 immediately sends a response to the host.

Notes:

1. When the Read, Clear, or Erase command is continuously sent to the 3101, communication buffer overrun may occur. If so, ASCII bit 6 of status 0 is set to 1.
2. IBM host programming requires ASCII-to-EBCDIC code translation to process 3101 data. Application programs may require EBCDIC-to-ASCII code retranslation to process the bit-significant data, such as the 3101 status byte and setup-switch status byte. An ASCII-EBCDIC code conversion table is given in Appendix F.

4.2.6.1 Duplex Telecommunication Facility

When the 3101 communicates with a host over a duplex telecommunication facility, the 3101 can respond immediately to the host's Read commands. If a Read command is received at the same time a key is pressed, the 3101 responds to the Read command first, then processes the keyed-in character.

4.2.6.2 Half-Duplex Telecommunication Facility

Because simultaneous, two-way communications is normally not available through the half-duplex telecommunication facility, a host must give the 3101 an opportunity to reply to a Read command before sending more Read commands. If the 3101 receives more than one Read command while in the receive state, it will respond only to the last command received, after leaving the receive state. All other Read commands will be ignored.

When the 3101 receives a Read command from the host, it waits until the message from the host is complete, then sends its response.

Because the 3101 stores the last-received Read command until the host is ready to receive a response, the host can insert a Read command into any location in a message by giving the 3101 a turnaround condition. When the 3101 tries to send a response to a Read command, an abnormal condition, such as a modem-signal time out, causes the 3101 to stop processing the Read command. The 3101 then exits from the transmit state without an automatic retry.

Chapter 5. Planning and Site Preparation

The 3101 Display Terminal can be set up in an office or computer room with very few special arrangements, and without the help of an IBM service representative. This chapter describes the planning and preparation required for setting up the 3101.

The user is responsible for all site preparation, including:

- Performing the tasks listed in the Planning Checklist (Figure 5-1)
- Obtaining, installing, and maintaining the following cables:
 - Current loop cable, modem cable, or direct-connection cable
 - Auxiliary interface cable for a monitor printer, if required
- Keeping the wrap socket (P/N 5640724), which is provided with the 3101, attached to the communication cable (P/N 5640728) in countries other than the U.S. and Canada
- Arranging to install any required telecommunication facilities and connecting IBM cabling to these facilities

In addition, the user must perform the setup and checkout of the 3101.

5.1 Planning

Figure 5-1 is a planning checklist. Determine the schedule dates for the events listed, and enter them in the "Date" column.

Date	Event in Setup Planning
	Identify the leader who will be responsible for all phases of the planning and preparation.
	Decide who will set up the 3101, the power receptacle, wiring, etc.
	Review specifications for cables that may not be ordered from IBM and begin to gather procurement source information if cables are not to be ordered from IBM. Refer to a host system for cabling to a host.
	Review all electrical requirements of the 3101 in this chapter.
	Plan the configuration of the 3101 and the host system.
	Determine the schedule dates. Fill in the dates in the Date column of this planning checklist.
	Identify and schedule data communication needs. Identify the source for the communication line (contact PTT or common carrier company). Verify that PTT or common carrier facilities can be installed and operational by the planned setup date.
	Make a plan for site preparation. Prepare the floor plan. Show locations of modem and 3101 ("Floor Planning"), considering the length of cables and power cord.
	Order cables from IBM or a contractor if needed. Order modem if needed. IMPORTANT For Japan only. If the NTT-provided modem is ordered and used, a physical inspection of the 3101 will be performed by an NTT inspector at the machine installation location before the modem cable is connected to the modem. The person responsible for the 3101 setup should attend the physical inspection test. See <i>IBM 3101 Display Terminal-Operating Procedures at NTT Physical Inspection Time</i> (N: GA 18-0112).

Figure 5-1 (Part 1 of 2). Planning Checklist

Date	Event in Setup Planning
	Arrange for the installation of the cables and the power receptacles, wiring, etc.
	Determine if changes are required to the existing programs (system control programs, network control programs, program products, and application programs). If so, schedule the required changes.
	Determine if changes are required to existing units (processor, transmission control unit, etc.). If so, schedule the required changes.
	Define a training program for employees, if necessary.
	Order the required manuals for a training program or the terminal familiarization, if necessary.
	Review the progress of the setup plan. Identify and resolve any schedule conflicts.
	Review the configuration to ensure it meets your requirements. Make any necessary changes to your order.
	Start the site preparation work according to the plan previously prepared.
	Review the setup plan to define any exposure to the schedule.
	Confirm the arrival of cables.
	Start installing cables and power receptacles.
	Start employee training if necessary.
	Complete the installation of cables and power receptacles.
	Complete the checkout of the cables and power (continuity test and safety considerations). Check jumpers for the current-loop or EIA RS-422 or CCITT V.11 requirements, if necessary.
	Complete the required changes to the existing programs and data processing units.
	Install communication facilities including communication interface cable.
	Complete the site preparation.
	Make sure all the necessary information is available for the 3101 setup (switch settings, configuration information, etc). Prepare Setup Switch Checklist (Figure 5-7) at this time. IMPORTANT Setup Switch Checklist must be provided at setup time.
	Make sure the site preparation for system/processor end connector and wiring is completed.

Figure 5-1 (Part 2 of 2). Planning Checklist

5.1.1 Telecommunication Service Preparation

Arrangements must be made for installing the telecommunication facilities between the 3101 and host. The 3101, modems, telecommunication line, and host system must be compatible with regard to line speed, duplex or half-duplex facilities, interface used, etc.

Schedules should be established to ensure the modems, telecommunication line, and telecommunication unit/adaptor are installed and tested before delivery of the 3101.

Figure 5-2 is a diagram of the telecommunication and auxiliary interfaces.

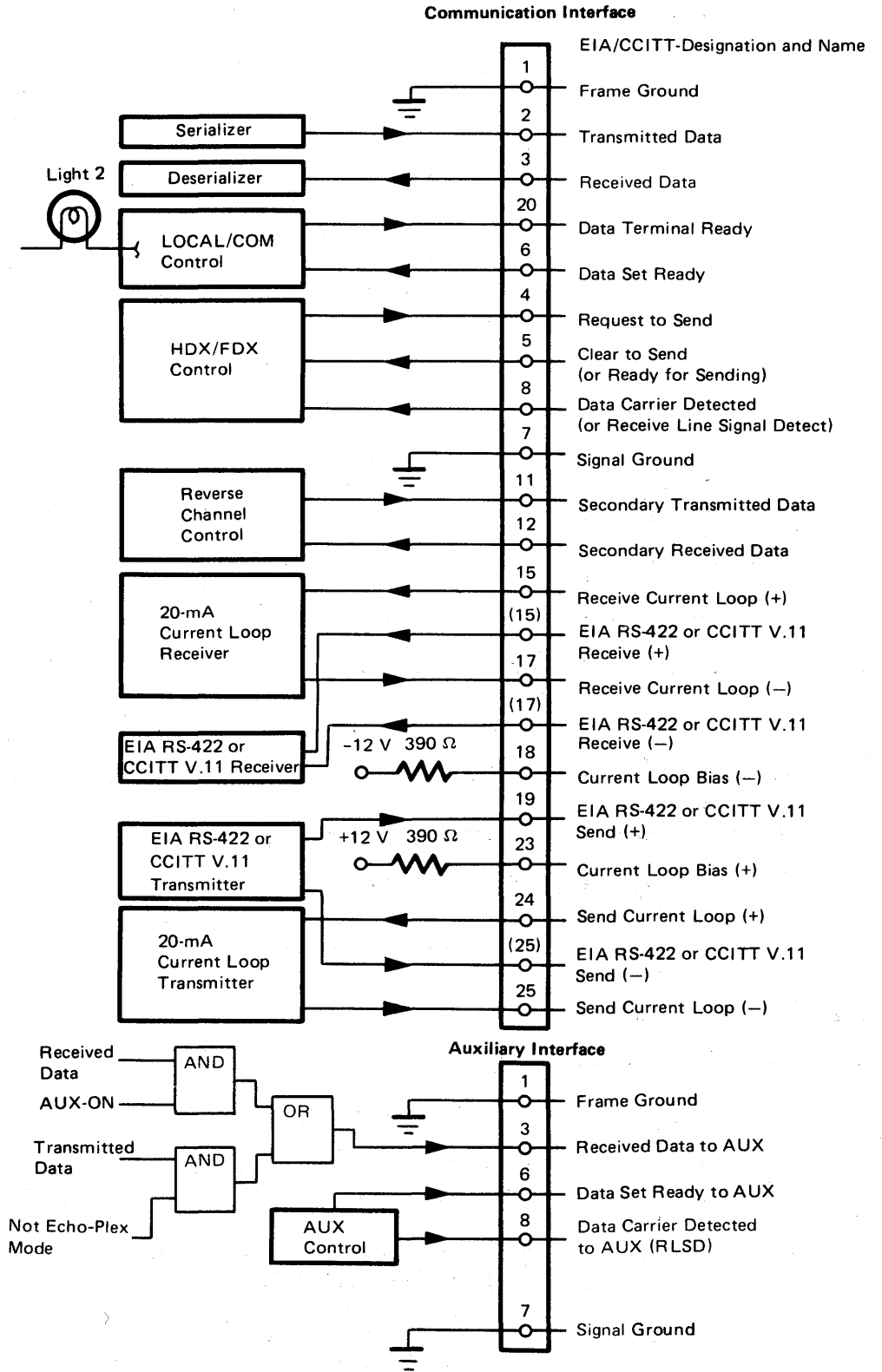

Figure 5-2. IBM 3101 Telecommunication and Auxiliary Interface Diagram

5.1.1.1 Modem Cables

The 3101 can attach to AT&T 202-type (or CCITT V.23), AT&T 103-type (or CCITT V.21), or AT&T 113-type modems.

The 202-type modem, when used without the reverse channel, should have the RTS-CTS delay at the host side set to 180 milliseconds.

The 113A-type modem is only for the U.S. and Canada, and needs special hardware jumpers (see Figure 5-3), because this type of modem does not provide a Data Carrier Detect signal, and originates calling but does not receive calling from other modems.

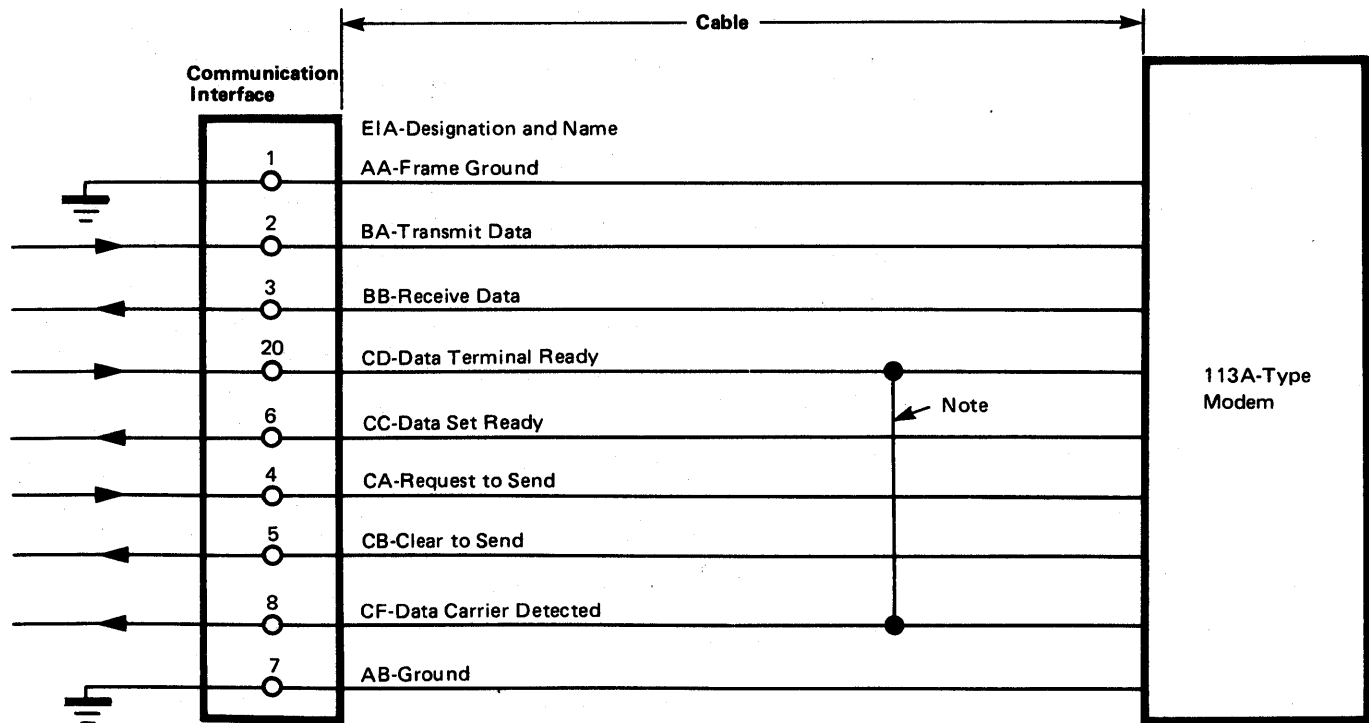

Note: Wiring is required when the 113A-type modem is used.

Figure 5-3. Special Wiring for 113-A Type Modem

IBM modems that support the 3101 are:

- IBM 3976 Model 1, for nonswitched networks at line speeds of from 110 bps to 300 bps
- IBM 3976 Model 2 (CCITT V.21 type modem), for switched networks at line speeds of from 110 bps to 300 bps
- IBM 3976 Model 3 (CCITT V.23 type modem), for point-to-point operation on duplex, PTT-supplied, nonswitched network facilities, or equivalent privately-owned facilities at line speeds of from 110 bps to 1200 bps

Notes:

1. These modems are not available in the U.S. and Canada.
2. For detailed information about 3101 modem cable connections, see Appendix G.

5.1.1.2 Telecommunication Interface Considerations

CURRENT LOOP INTERFACE WIRING CONSIDERATION: For a 20-mA current supply, you can select either:

- 3101-supplied 20-mA current, or
- The user's device-supplied 20-mA current

It is recommended that the current-loop cable be shielded. If the 3101 supplies the current, the 3101 power supply provides +12 Vdc for the current-loop interface. If the user's device is used, the maximum open voltage measured at the side connector of the current-loop-cable (pins 17, 15, 24, and 25) should not exceed +30 Vdc. The minimum required current for the current-flow (MARK) level is 15 mA, and the maximum allowable current is 30 mA. Figure 5-9 shows examples of current-loop wiring for each current supply. Installing the jumpers in the cable is mandatory if the 3101 supplies the current.

Although the 3101 supports line-speeds of up to 9600 bps for EIA RS-232C or CCITT V.24/V.28, EIA RS-422 or CCITT V.11, and current-loop interfaces, the actual maximum line speed operable through the current-loop interface will vary with the type of cable used and the distance between the 3101 and a remote device (see Figure 5-4). The 3101 attaches to the four-wire current-loop interface of the duplex telecommunication facility if the current-loop features are selected.

The 3101 current-loop interface converts the standard EIA RS-232C or CCITT V.24/V.28 voltage-level interface to the 20-mA current switching interface. The switching states are MARK, for the presence of the current flow, and SPACE for the absence of the current flow.

ACTIVE

Connections for Current Loop When 3101 Supplies Current to Drive Loops

The following diagram is an example of the 3101-to-Series/1 connection.

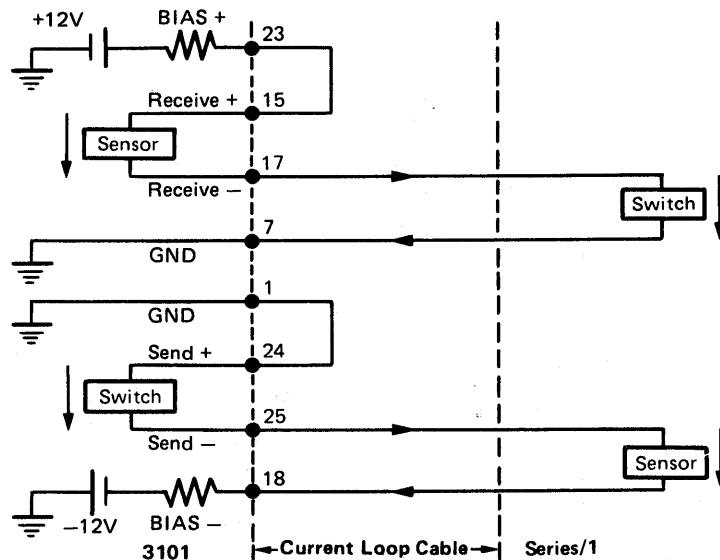

Note: It is recommended that a shielded cable be used for current-loop operation. Connect either side of the cable shield to the frame ground of either the 3101 or Series/1.

Figure 5-4 (Part 1 of 2). Current-Loop Wiring

PASSIVE

Connections for Current Loop When User's Power Supply Supplies Current to Drive Loop

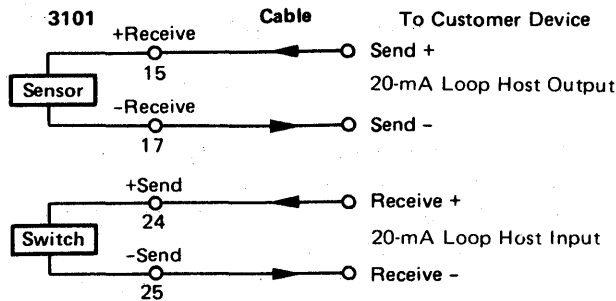

Figure 5-4 (Part 2 of 2). Current-Loop Wiring

DIRECT ATTACHMENT CONSIDERATION FOR EIA RS-422 OR CCITT V.11:

The EIA RS-422 or CCITT V.11 interface is a voltage-digital interface balanced on the signal lines. The EIA RS-422 or CCITT V.11 interface can be used to connect the 3101 directly to a host. The maximum length of the interface cable is 1219 meters (4000 feet). It is recommended that the interface cable be shielded.

The interface cable should not be installed outdoors.

RS-232C DIRECT CONNECTION WIRING CONSIDERATIONS: If the 3101 is connected directly to a host through an EIA interface cable, installing jumpers in the cable is mandatory (see Figure 5-5).

For direct connection to the 8100 or Series/1, two IBM-provided cables must be used. One cable (P/N 5640728, 5640850, 5640883, or 6327885) is provided with the 3101, and the other cable is provided with the 8100 or Series/1. The cable provided with the 8100 or Series/1 has the necessary jumpers installed (see Figure 5-10).

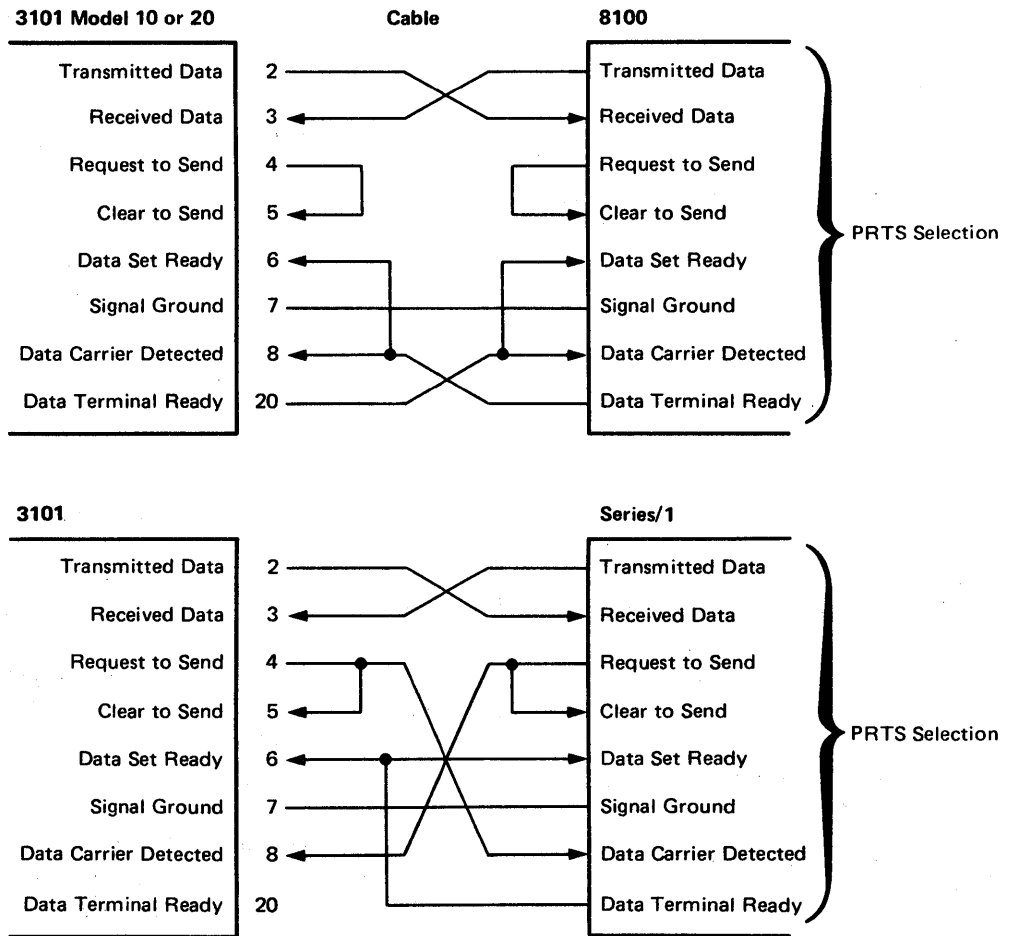

Figure 5-5. Wiring Examples for Direct Connection to Host (EIA)

If CRTS (Controlled Request-to-Send) without the reverse channel is selected, the 3101 assumes the host will need at least 160 milliseconds to turn around and start to send, in order to keep from losing any 3101 data.

5.1.1.3 Telecommunication Facilities

The major elements of each telecommunication line between separated sites are as follows:

1. A telecommunication channel is usually supplied by a communication common carrier or PTT. A telecommunication channel can consist of wire, radio waves, or both. At each site, the communication common carrier provides the connector that terminates the channel.
2. A modem is installed at each end of each telecommunication channel. The modem is the interface between the telecommunication channel and the data terminal equipment.
3. Cables connect the following equipment:
 - The system unit that acts as the interface with the telecommunication channel

- The modem
- The connector that terminates the telecommunication channel

The user must arrange for the installation of telecommunication equipment and services. These facilities should be available at the time IBM equipment is scheduled to be set up.

When using the EIA RS-232C interface, the 3101 operates in a point-to-point mode on the half-duplex or duplex facility at transmission speeds of 110, 150, 200, 300, 600, and 1200/600 bps on the nonswitched or switched facilities.

Although the 3101 performs at speeds of 110 to 9600 bps, its unique capabilities are best used at speeds greater than 300 bps.

When using the CCITT V.24/V.28 interface, the 3101 operates in point-to-point mode only. The line transmission speed is dependent on the type of facilities to be used, such as half-duplex or duplex, and on the using country.

5.1.2 Programming Support Preparation

The user must determine if present host programming will be compatible with the 3101. See Chapter 4 for details about programming support.

5.1.3 Setup Switch Setting Preparation

The user is responsible for preparing the Setup Switch Setting Checklist before 3101 setup. Setting the setup switches selects the desired functions and operations that satisfy individual user needs. Some setup switches have higher priorities than others and affect the functions of other setup switches. For details about priorities, see Chapter 2.

Figure 5-6 shows the setup switches, and can be used as a checklist. Figure 5-7 has a copy of the setup switch setting label, which is on the inside of the setup-switch cover, an example of a completed switch setting checklist, and some blank checklists that you can use to set up your 3101. Enter a check mark in the On or Off box for each setup switch. The binary representation of the setting can also be entered (1 for On, 0 for Off). The binary representations of the actual settings of the switches are displayed on line 10 when the 3101 is in the Test mode, and the operator can compare the display with the checklist.

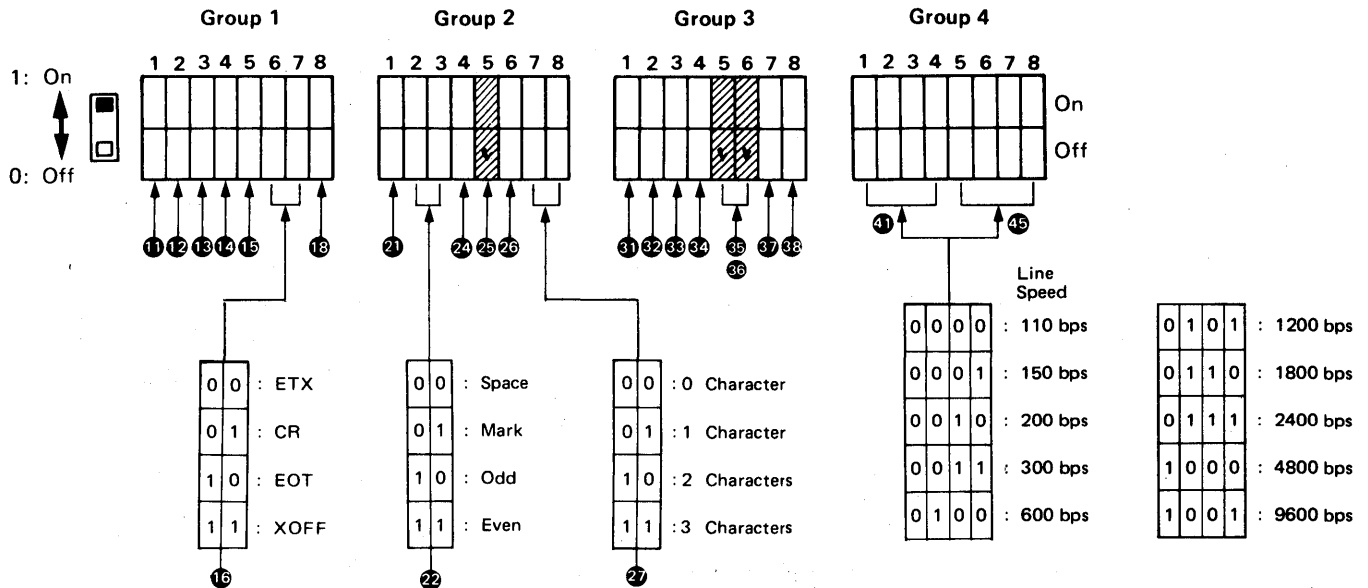
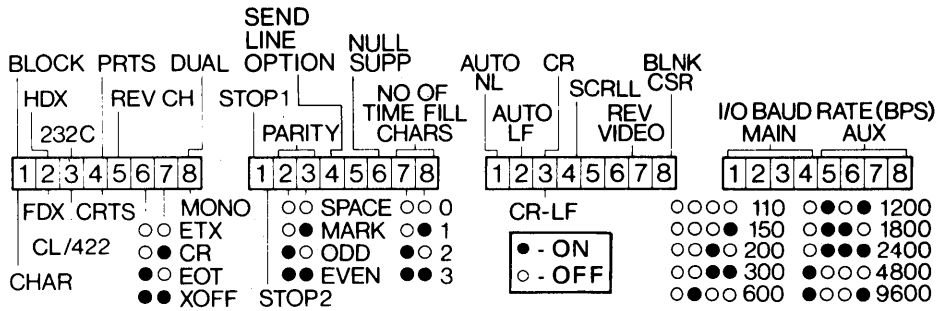

- 11 Transmission Mode (Model 2X only)
On=Block Mode
Off=Character Mode
- 12 HDX/FDX Operating Mode:
On=HDX=Character Not Echoed
Off=FDX=Character Echoed
- 13 Communication Interface:
On=232C=EIA RS-232C
Off=CL/422=20mA Current Loop or EIA RS-422
- 14 Modem Control:
On=PRTS=Permanent Request to Send
Off=CRTS=Controlled Request to Send
- 15 Reverse Channel Control:
On=REV CH=Operation with Reverse Channel
Off=Operation without Reverse channel
- 16 Line Turnaround Character
- 18 Character Set:
On=DUAL=Dual Case
Off=MONO=Uppercase only

- 21 Character Framing
On=STOP 1=One Stop Bit
Off=STOP 2=Two Stop Bits
- 22 Parity
- 24 Send Line Option (Model 2X only)
On: Send Key=Sends one line
Off: Send Key=Sends full screen
- 25 Not Used
- 26 Null Suppression (Model 2X only)
On=NULL SUPP=Trailing Null Suppressed
Off=Not Suppressed
- 27 Number of DEL Time Fill Characters (Model 2X only)
- 31 Automatic New Line:
On=NL after pos. 80
Off=Stops at pos. 80
- 32 Automatic Line Feed:
On=Host CR—CR and LF
Off=Host CR—CR only

- 33 CR or CR•LF Character:
On=CR=Carriage Return
Off=CR•LF=Carriage Return and Line Feed
- 34 Scrolling:
On=SCROLL=Scroll On
Off=Scroll Off
- 35 36 Not Used
- 37 Reverse Video:
On=Black on green
Off=Green on black
- 38 Blinking Cursor:
On=Blinking
Off=Steady
- 41 Communication Interface
- 45 Auxiliary Interface (Model 2X only)

Figure 5-6. 3101 Setup Switches

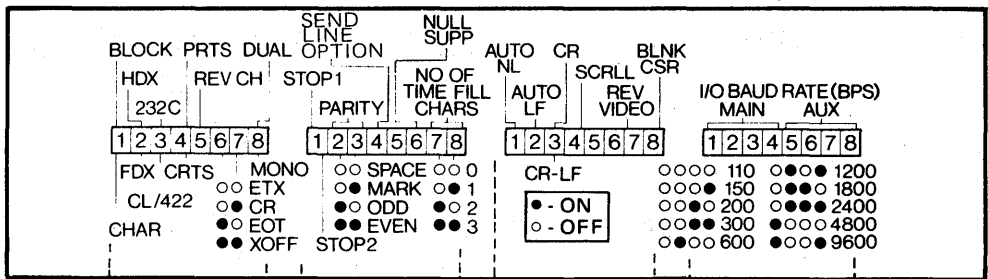

(EXAMPLE)

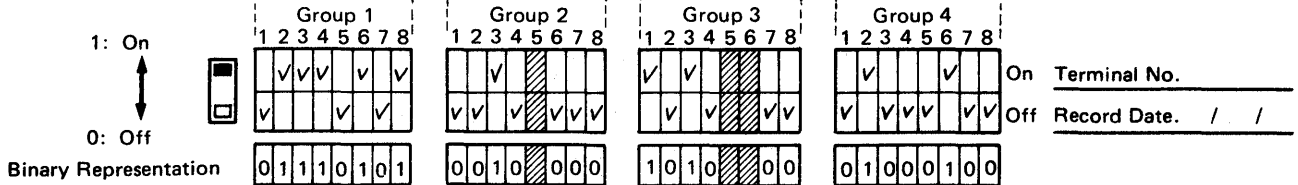

1

1: On
0: Off

Binary Representation

Group 1: [] [] [] [] [] [] [] []
Group 2: [] [] [] [] [] [] [] []
Group 3: [] [] [] [] [] [] [] []
Group 4: [] [] [] [] [] [] [] []

On Terminal No. _____
Off Record Date. / /

2

1: On
0: Off

Binary Representation

Group 1: [] [] [] [] [] [] [] []
Group 2: [] [] [] [] [] [] [] []
Group 3: [] [] [] [] [] [] [] []
Group 4: [] [] [] [] [] [] [] []

On Terminal No. _____
Off Record Date. / /

3

1: On
0: Off

Binary Representation

Group 1: [] [] [] [] [] [] [] []
Group 2: [] [] [] [] [] [] [] []
Group 3: [] [] [] [] [] [] [] []
Group 4: [] [] [] [] [] [] [] []

On Terminal No. _____
Off Record Date. / /

Figure 5-7. 3101 Setup Switch Checklists

5.2 Site Preparation

When preparing your site for 3101 installation, consider the following:

- Floor plan
- Viewing distance
- Ambient lighting
- Cable requirements and installation
- Product and environmental safety

Figure 5-8 shows the dimensions of the 3101.

Note: The metric units used for the 3101 are converted to English units, which are then rounded to the nearest decimal place or whole number.

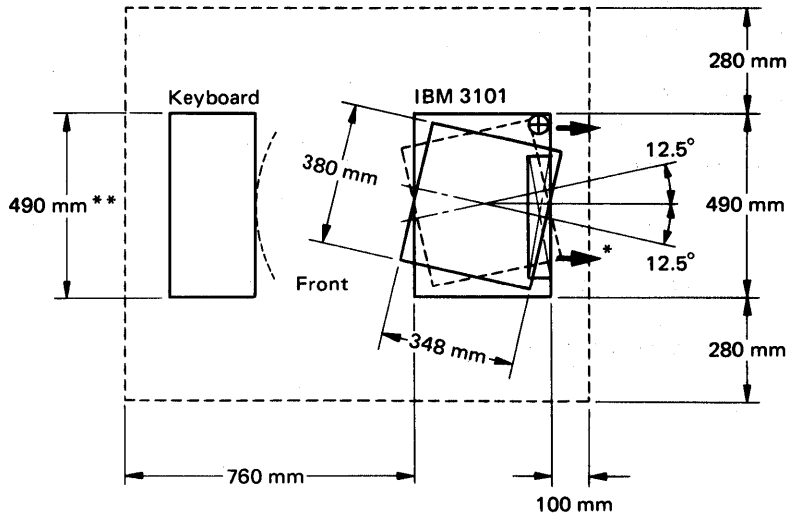

Millimeters (Meters)	Inches (Feet)
90 mm	3.5 in
100 mm	4.0 in
120 mm	4.7 in
225 mm	8.8 in
280 mm	11.0 in
286 mm	11.3 in
348 mm	13.7 in
355 mm	14.0 in
380 mm	15.0 in
490 mm	19.3 in
760 mm	29.9 in
1 meter	3.3 ft

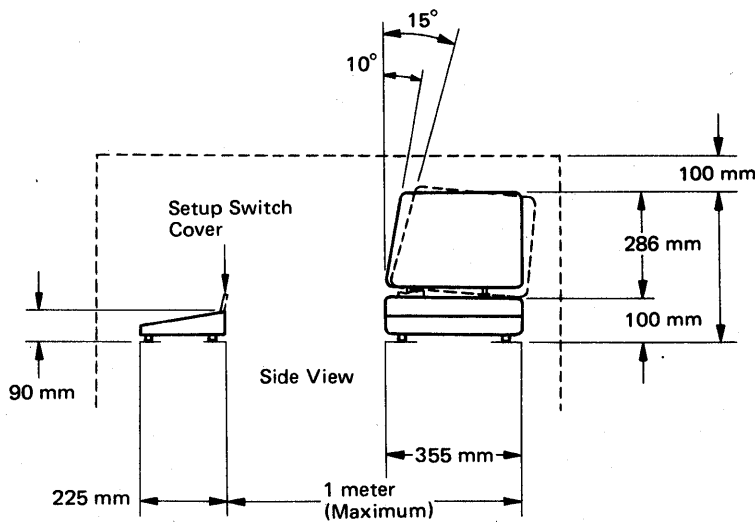

In European countries, the depth of the keyboard can be extended by 60 mm if a Keyboard Palm Rest is attached to the keyboard.

*: Connector area

** : The width of the Japanese Katakana keyboard (88-keys) is 508 mm (20 in.)

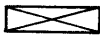
 Cable Entry and Exit Area in Base of Unit

 Power Cord Exit

For routing the power cord or signal cable, a cutout in the table or countertop is not necessary.

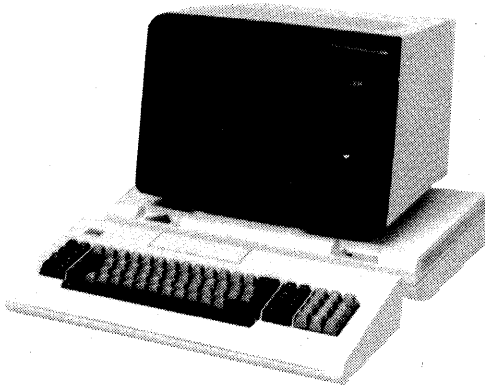

Figure 5-8. IBM 3101 Dimensions

Service Clearances:

Front: 760 mm (29.9 in.)
 Rear: 100 mm (3.9 in.)
 Top: 100 mm (3.9 in.)
 Right: 280 mm (11.0 in.)(See Note)
 Left: 280 mm (11.0 in.)(See Note)

Note: Right and left service clearances can be reduced to the minimum clearances required for 3101 cooling and operating (100 mm (3.9 in.) for each side).

Weight:

Video element: 7.0 kg (15.4 lb)
 Keyboard element: 5.5 kg (12.2 lb)
 Logic element: 4.8 kg (10.7 lb)

Heat Output: 50 watts (170 BTU/hr)

Airflow: Natural convection

Electrical Requirements:

	U.S. and Canada	Japan	European Countries Middle East & Africa
KVA	0.12 max.	0.12 max.	0.12 max.
Phase	1	1	1
Frequency	60 ±0.5 Hz	50 ±0.5 Hz or 60 ±0.5 Hz	50 ±0.5 Hz
Amperage	1.2 A max.	1.2 A max.	0.6 A max.
Voltage	100 - 127 Vac	100 - 127 Vac	200 - 240 Vac
Power Cord Length	1.8 m (6 ft)	3.0 m (10ft)	3.0 m (10 ft)
AC Primary Fuse	Part No. 1176668 or 5640718: 1.5 A, 250 V (slow-blow)		Part No. 5640719 or 111264: 0.75A, 250 V (slow-blow)
Plug Type	See Appendix D		

Environments:

	Environment		
	Operating	Non-Operating	Storage
Temperature	10 - 40.6° C (50 - 105° F)	5 - 52° C (50 - 125° F)	0.6 - 60° C (33 - 140° F)
Relative Humidity	8 - 80%	8 - 80%	5 - 80%
Max Wet Bulb	27° C (80° F)	27° C (80° F)	29.4° C (85° F)
Max Elevation	2133 m (7000 ft)	—	—

5.2.1 Floor Plan

For each location, a detailed floor plan that shows terminal placement should be prepared. In the preparation of the floor plan, efficient work flow and operator comfort and safety must be considered. The floor plan should be reviewed by management before any cabling is ordered.

To assist in the preparation of the floor plan, IBM provides templates of the 3101. Appendix E shows the printed physical planning templates. For the U.S. and Canada, these templates are drawn to a scale of 1/4 inch = 1 foot (2 cm = 1 m).

5.2.1.1 Operator Workspace Considerations

The following are recommended dimensions or positions for planning work-station layouts:

Distance between operators:

- 122 cm to 152 cm (48 in. to 60 in.) preferred

Leg clearance while seated, minimum:

- Width: 61 cm (24 in.)
- Depth: 46 cm (18 in.)
- Height: 64 cm (25 in.)

Toe clearance for standing:

- 12 cm (4.7 in.) minimum

See-over height (top of display unit to floor):

- Standing operator: 140 cm (55 in.) maximum
- Seated operator: 100 cm to 110 cm (40 in. to 43 in.) maximum

Writing surface:

- 41 cm (16 in.) deep by 30 cm (12 in.) wide, minimum
- Allow 2.5 cm (1 in.) spacing between multiple sets of documents

5.2.1.2 Electrostatic Discharge Considerations

High electrostatic charges can build up on people and furniture as a result of contact with floor and furniture coverings. Discharge of these static charges to the metal of the terminal, or to furniture on which the terminal is situated, may cause interference with the operation of electronic equipment. It may also cause personal discomfort if the electrostatic discharge is to or from personnel.

Some major factors that contribute to electrostatic problems are:

- Surface material of a high-resistance floor

- Carpeting without anti-static properties
- Plastic seat coverings
- Very low humidity
- Metal-frame furniture

5.2.1.3 Electromagnetic Interference

In some instances, the site chosen for a 3101 installation may have ambient electromagnetic fields. These fields can result from nearby radio-frequency sources, such as transmitting antennas (AM, FM, television, and two-way radios), radar installations, and industrial equipment (radio-frequency induction heaters, arc welders, and insulation testers). Three-phase power distribution lines can generate magnetic fields that may cause display problems.

Other magnetic sources are transformers, distribution panels, rotating machinery, and electric floor heaters. To identify the location of such magnetic sources, check with your building engineer. As a precautionary measure, the 3101s should be kept as far as possible from such magnetic sources.

A planning review may be appropriate to assess the environment and to determine if any special installation or product considerations are needed to ensure normal system operation and maintenance.

5.2.2 Viewing Distance

Most operators will find that they can view the display surface comfortably at a distance of 33 to 51 cm (13 to 20 in.). This distance will depend, of course, on the individual's eyesight, on the visual environment, on the work-station layout, and on features of the reference or source material.

5.2.3 Ambient Lighting

Moderate lighting of only 540 to 810 lumens/meter² (50 to 75 footcandles) is recommended for most tasks requiring displays, and should be evenly distributed over the work area. The intensity of the light can be measured by a conventional luminance meter.

A display-screen filter is provided to reduce reflections from ambient lighting.

5.2.4 Cable Requirements and Installation

5.2.4.1 3101 Cables

Figure 5-9 shows examples of cabling for the IBM 3101 Display Terminal.

The 3.0-meter (10-foot) modem cable **1**, with a male plug on both ends, can be purchased from IBM.

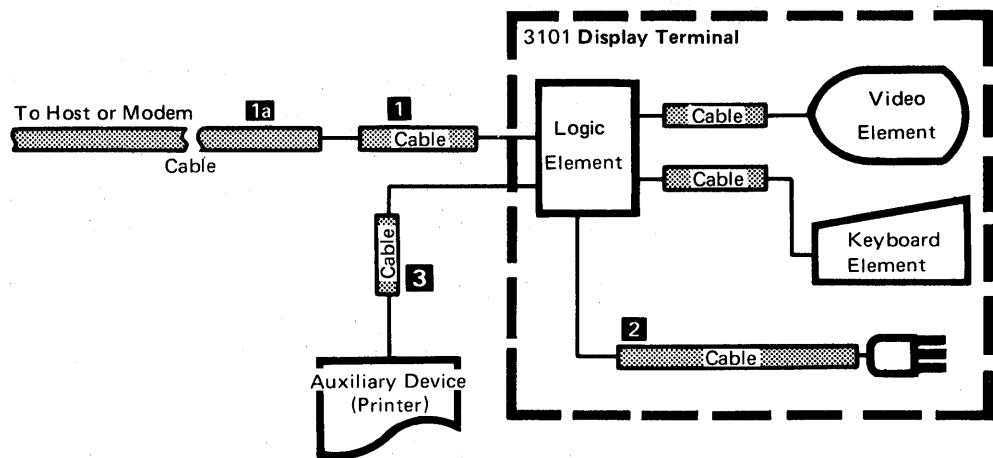

Figure 5-9 (Part 1 of 2). IBM 3101 Cabling

Callout	Cable Part No.	From	To	Cable Length	Description
1 ¹	5640736	Host, Modem, or Cable 1a	3101	Fixed ³ 3.0 m (10 ft)	Interface cable for EIA RS-232C. For direct connect to the IBM 8100 system, this cable or equivalent must be used.
	5640728 ²	Host, Modem, or Cable 1a	3101	3.0 m (10 ft)	Interface cable for CCITT V.24/V.28. For direct connect to the IBM 8100 system or PTT modem, this cable or equivalent must be used.
	6827885 ⁵	Host, Modem, or Cable 1a	3101	3.0 m (10 ft)	Interface cable used in Japan. For direct connect to the IBM 8100 system or modem, this cable must be used.
1a	1743584	Modem	3101 Cable 1	0.3 m (12 in)	U.K. Post Office adapter cable. This cable is used in conjunction with the modem cable P/N 5640728. See 3101 Modem Cable Connection Instruction, 6.4.9.3
	Note 1	Host	3101 Cable 1	Variable ³	IBM- or customer-supplied cable depending on host or modem used.
2 ⁴				Fixed 1.8 m (6 ft)	IBM-provided cord for power supply (for U.S. and Canada)
				Pluggable 3.0 m (10 ft)	IBM-provided cord for power supply (for South and Central America, the Far East, Europe, Middle East, and Africa). See "Caution" below.
3	Note 2	3101	Auxiliary Device	Variable	IBM- or customer-supplied cable depending on device used.

¹ IBM-supplied modem cables can be purchased by part number.

² This cable consists of the modem cable (P/N 5640728) and wrap socket (P/N 5640724). The wrap socket can be ordered by its part number. For connection to a U.K. Post Office modem, the cable, P/N 1743584, must be ordered separately.

³ Line speed and cable length (**1** plus **1a**): EIA RS-232C or CCITT V.24/V.28 interface over 1200 bps is not used for remote operation. The maximum distance for direct connection is 12.2 meters (40 feet) for an EIA RS-232C or CCITT V.24/V.28 shielded cable at 110 through 9600 bps, and 1219 meters (4000 feet) for an EIA RS-422 or CCITT V.11 shielded cable at 110 through 9600 bps. Line speeds of 110 through 9600 bps for a 20-mA current loop are supported up to 12.2 meters (40 feet) with shielded cable; the transmission speed for a cable longer than 12.2 meters (40 feet) will vary according to the supplied cable type and electrical environment.

⁴ Provided with the 3101

Caution: The power attachment cable plug (when supplied) is approved for use with this product and meets the relevant testing laboratory or country/test-house standards. For the user's safety, the plug must be connected to a properly wired and grounded receptacle. An improperly wired receptacle could place a hazardous voltage on accessible metal parts of the product. The customer is responsible for receptacle wiring.

⁵ This part number consists of a modem cable with a wrap-switch connector that has metric thumbscrews (P/N 5640729) and English-unit threaded thumbscrews (P/N 1743514) for various types of modem.

Notes:

- If the 3101 is attached to the Series/1 or 8100 System, the cable **1a** supplied with the host system is:
 - P/N 4411827 for Series/1 Asynchronous Direct Attachment
 - P/N 4946680 for 8100 System
- If the 3102 Printer is attached to the 3101 as an auxiliary device, the auxiliary cable **3** P/N 5642347, is supplied with the 3102.

Figure 5-9 (Part 2 of 2). IBM 3101 Cabling

5.2.4.2 Connector and Cable Specifications

Figure 5-10 gives the communication cable specifications for the 3101.

25-Pin Female Connector

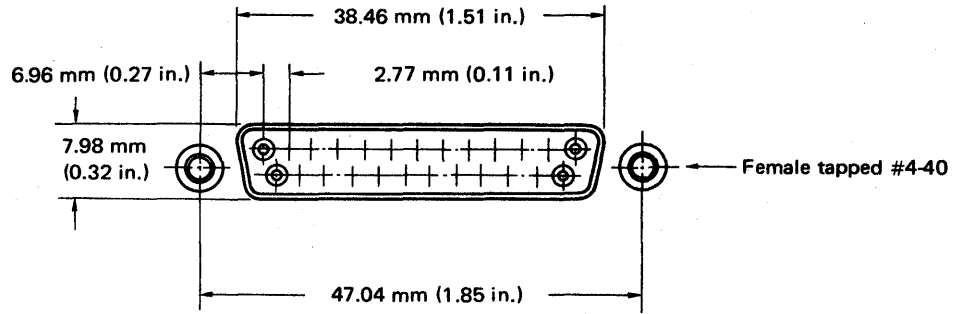

Communication Cable Specifications

Interface	Cable Length (Maximum)	Conductor		Other Specification	Commercially Available
		Wire size (AWG)	Material		
EIA RS-232C	12.2m (40 ft)	22-24	Copper	Shielded Cable Capacitance 40pF/ft	Yes
20 mA Current Loop	12.2 m (40 ft)	22-24	Copper	Twisted Pair	Yes
EIA RS-422	1219 m (4000 ft)	22-24	Copper	Shielded Twisted Pair Telephone Cable	Yes

Figure 5-10. Connector and Cable Specifications

5.2.5 Product and Environmental Safety

Safety is a major consideration in the design of IBM products. Environmental safety is the responsibility of the user, who should consider the following safety factors:

- Emergency disconnection of power to the branch circuits serving the equipment.
- Clearances for both operating and service personnel (see Figure 5-4 for recommended clearances). Access clearance for each unit must also be considered.
- Grounding of branch circuits.
- Lightning protection for power lines and signal lines.

The installation must meet local and national code requirements.

5.2.5.1 Branch Circuits and Grounding

The power cord has a green, or green and yellow, grounding wire. This grounding wire must be routed to earth or to another suitable building ground. A dedicated, insulated, wire conductor is recommended for this purpose; however, a continuous metal conductor may be used, if it has a permanent and continuous low-impedance path to ground to ensure electrical continuity.

5.2.5.2 Lightning Protection

Lightning protection for your secondary power source should be planned when:

- Primary power is supplied by an overhead power service.
- The utility company installs lightning protectors on the primary power source.
- The area is subject to electrical storms or equivalent type power surges.

Appendix A. Summary of Send and Receive Operations

Figures A-1 and A-2 summarize the send and receive operations. Figure A-3 summarizes character conversion in the send-print data stream.

Key Pressed	Operation Mode			Transmitted Code	Performed Function
	FDX Character Mode	HDX Character Mode	Block Mode		
Graphics (labeled)	T	F/T	F	Graphics	Graphic character displayed
VT (ALT+K)	T	F/T	F	VT	Line Feed
LF (ALT+J)	T	F/T	F	LF	Line Feed
CR (ALT+M)	T	F/T	F	CR	Carrier Return or New Line or Turnaround (see Note)
BS (ALT+H)	T	F/T	F	BS	Backspace
HT (ALT+I)	T	F/T	F	HT	Tab
FF (ALT+L)	T	F/T	F	FF	LF or Erase Input
ESC·Graphic Assigned	T	F/T	F	ESC·Graphic	Perform ESC sequence (See Figure 2-12)
ESC·Graphic Unassigned	T	T	—	ESC·Graphic	No function performed
EOT/DC3/ETX	T	F/T	—	EOT/DC3/ETX	Turnaround if specified.
DLE·STX	T	F/T	F	DLE·STX	Enter Transparent Mode
DLE·ETX	T	F/T	F	DLE·ETX	Exit from Transparent Mode
DLE·EOT	T	F/T	F/T	DLE·EOT	Disconnect
DEL	T	T	—	DEL	No function performed. Alarm sounds when in block mode
BEL (ALT+G)	T	F/T	F	BEL	Alarm sounds
SO	F/T	F/T	F	SO	Shift Change (for Japanese Katakana only)
SI	F/T	F/T	F	SI	
Other Control Characters	T	T	—	Corresponding Control Characters	No function performed. Alarm sounds when in block mode
Cursor Move					Cursor Move:
↑	T	F	F	ESC·A	Up
↓	T	F	F	ESC·B	Down
→	T	F	F	ESC·C	Right
←	T	F	F	ESC·D	Left
Home	T	F	F	ESC·H	Home
Backspace	T	F/T	F	BS	Backspace
Space	T	F/T	F	SPACE	Space
New Line	T	F/T	F	CR/CR·LF	New Line (see Note)
Tab	T	F/T	F	HT	Tab
Back Tab	—*	—*	F		Back Tab (Block Mode only)

T: The ASCII or ISO code characters are sent to the host.

F: The function is performed.

—: No character is sent or no function is performed.

LOCK—MODE/SETUP CHECK will appear except for DLE, STX, ETX, and EOT.

For DLE, STX, ETX, and EOT, no LOCK—condition occurs.

*: On a Model 1X, these keys cause the audible alarm to sound, and no function is performed.

Note: Line turnaround occurs in character mode if the setup switch for line turnaround character selection is set to CR.

Figure A-1 (Part 1 of 3). Send Operation

Key Presed	Operation Mode			Transmitted Code	Performed Function
	FDX Character Mode	HDX Character Mode	Block Mode		
CLEAR	T	F	F	ESC·L	Clear
ERASE INPUT	T	F	F	ESC·K	Erase Input
ERASE EOL/EOF	T	F	F	ESC·I	Erase EOL/EOF
ERASE EOS	T	F	F	ESC·J	Erase EOS
Shift Lock	F	F	F	ESC·S	Shift Lock/Unlock
Click	F	F	F		Click On/Off
Shift/ALT	F	F	F		Shift/ALT
RESET	F	F	F		Reset Keyboard Lock
CANCEL	T*	F*	F		Cancel send/print operation (Model 2X only)
PRINT LINE	T*	F*	F	ESC·U	Print Line (Model 2X only)
PRINT MSG	T*	F*	F	ESC·V	Print Message (Model 2X only)
PRINT	T*	F*	F	ESC·W	Print Page (Model 2X only)
AUX	F	F	F		Activate Auxiliary Interface
INS LINE	—*	—*	F	... EOT/CR/DC3/ETX	Insert Line (Block Mode only)
DEL LINE	—*	—*	F		Delete Line (Block Mode only)
INS CHAR	—*	—*	F		Insert Character (Block Mode only)
DEL CHAR	—*	—*	F		Delete Character (Block Mode only)
SEND LINE	—*	—*	F/T		Send Line (Block Mode only)
SEND MSG	—*	—*	F/T		Send Message (Block Mode only)
SEND	—*	—*	F/T		Send Page (Block Mode only)
ATTR	—*	—*	F		Store Attribute (Block Mode only)
PRGM MODE	—*	—*	F		Enter Program Mode (Block Mode only)

T: The ASCII or ISO code characters are sent to the host.

F: The function is performed.

—: No character is sent or no function is performed.

LOCK—MODE/SETUP CHECK will appear except for DLE, STX, ETX, and EOT.

For DLE, STX, ETX, and EOT, no LOCK— condition occurs.

*: On a Model 1X, these keys cause the audible alarm to sound, and no function is performed.

Note: Line turnaround occurs in character mode if the setup switch for line turnaround character selection is set to CR.

Figure A-1 (Part 2 of 3). Send Operation

Key Presed	Operation Mode			Transmitted Code	Performed Function
	FDX Character Mode	HDX Character Mode	Block Mode		
BREAK	F/T	F/T	F/T	Space	Space held for 500 ms (FDX) or STD off (HDX with Reverse) Local Mode Operation Entry/Exit
LOCAL	F	F	F		
PF1	T	T	T	ESC·a	Transmits ESC sequence
PF2	T	T	T	ESC·b	
PF3	T	T	T	ESC·c	
PF4	T	T	T	ESC·d	
PF5	T	T	T	ESC·e	
PF6	T	T	T	ESC·f	
PF7	T	T	T	ESC·g	
PF8	T	T	T	ESC·h (plus EOT/CR/DC3/ETX)	

T: The ASCII or ISO code characters are sent to the host.

F: The function is performed.

—: No character is sent or no function is performed.

LOCK—MODE/SETUP CHECK will appear except for DLE, STX, ETX, and EOT.

For DLE, STX, ETX, and EOT, no LOCK— condition occurs.

*: On a Model 1X, these keys cause the audible alarm to sound, and no function is performed.

Note: Line turnaround occurs in character mode if the setup switch for line turnaround character selection is set to CR.

Figure A-1 (Part 3 of 3). Send Operation

Character Received	Function Performed	Description
• Graphics	Stored & Displayed	
• Control Characters LF** CR** BS HT BEL FF** VT** NUL DC1 (XON) DC3 (XOFF) DEL SI, SO DLE·STX DLE·ETX DLE·EOT Break Signal Other Control Characters	Line Feed Carriage Return/New Line Backspace Horizontal Tab Sound Alarm Form Feed Vertical Tab Logical Keyboard Lock Logical Keyboard Lock Logical Keyboard Lock Time-Fill Character Shift Change Enter Transparent Mode Exit Transparent Mode Mandatory Disconnect Display Error Symbol* (Ignored)	Equivalent to LF if SCROLL on. Equivalent to ERASE INPUT, if SCROLL off. Equivalent to LF. } See "Logical Keyboard Lock" in Chapter 4. Ignored and not stored in the communication buffer. For Japanese Katakana DTR off for 500 ms. See Note.
• ESC·Graphic ESC·A ESC·B ESC·C ESC·D ESC·H ESC·Y·x·y	Cursor Move Up Cursor Move Down Cursor Move Right Cursor Move Left Cursor Move Home Set Cursor Address	Host only x: Row y: Column
ESC·0 ESC·1 ESC·2 ESC·3·x ESC·I ESC·J ESC·K ESC·L	Tab Set Tab Clear Back Tab Start Field Erase EOL/EOF Erase EOS Erase Input (EAU) Clear	Block Mode only Block Mode and Host only x: Attribute
ESC·U ESC·V ESC·W	Print Line Print Message Print Page	Model 2X only Model 2X only Model 2X only
ESC·N ESC·O ESC·P·x ESC·Q	Insert Line Delete Line Insert Character Delete Character	Block Mode only Block Mode only Block Mode only x: Character to be inserted Block Mode only
ESC·: ESC·;	Keyboard Lock Keyboard Unlock	Host only Host only

* The number of error symbols displayed is dependent upon the host used. If current-loop configuration is selected with no current supplied or no cable connected, error symbols appear. In case of EIA RS-422 interface, error symbols appear if no signal exists.

** For cursor movement for these control characters, see Appendix I.

Figure A-2 (Part 1 of 2). Receive Operation

Character Received	Function Performed	Description
ESC-5	Read Cursor Position	Host only
ESC-6	Read Status	Host only
ESC-7	Read Setup Switch	Host only
ESC-8	Read Buffer	Block Mode and Host only
ESC-E	Write Send Mark	Model 2X only
ESC-X·x·y	Set Buffer Address	Host only x: Row y: Column
ESC-Z	Insert Cursor At Buffer Address	Host only
ESC-9·x	Set Control	Host only x: Control parameter
ESC-S	Cancel	Model 2X and Host only

Note: See "Commands" in Chapter 2 for details about the command description (ESC sequence).

Figure A-2 (Part 2 of 2). Receive Operation

Data Stream	MODE	Null Character	31 ASCII Control Characters plus DEL	95 Graphic Characters	E Attribute S·3 C
SEND	Normal Mode	Suppress or Space	As is	As is	SF
	Transparent Mode	As is	As is	As is	None
	Program Mode	Space	As is	As is	SF
PRINT	Normal Mode	Suppress or Space	As is	As is	None
	Transparent Mode	As is	As is	As is	None
	Program Mode	Space	As is	As is	None

Data Stream	MODE	Attribute Character	Send Mark	Error Symbol	Nondisplay Field Characters
SEND	Normal Mode	Graphic	Suppress or Space	Space	Data As is
	Transparent Mode	ASCII Control Character	As is = DC2	As is = SUB	Data As is
	Program Mode	Graphic	Space	Space	Data As is
PRINT	Normal Mode	Space	Suppress or Space	Space	Space
	Transparent Mode	Space	As is = DC2	As is = SUB	Space
	Program Mode	ASCII Control Character	Space	Space	Data As is

Figure A-3. Character Conversion in Send-Print Data Stream

Appendix B. Character Set Information

The IBM 3101 Display Terminal is designed to comply with the specifications of the ISO 7-Bit Coded Character Set for Information Processing Interface (ISO 646), and with the specifications of the following industry and federal standards, as understood and interpreted by IBM as of May 1979:

ANSI	FIPS Pub	Name of Standard
X3.4 - 1977	1	ASCII
	15	Subsets of ASCII
X3.15 - 1976	16 - 1	Bit Sequencing of ASCII
X3.16 - 1976	17 - 1	Character Structure and Character Parity Sense for Serial-by-bit Data Communication in ASCII
X3.32 - 1973	36	Graphic Representation of the Control Characters of ASCII
X3.41 - 1974	35	Code Extension Techniques

Notes:

ANSI : American National Standards Institute

FIPS Pub: Federal Information Processing Standard Publication

ISO : International Organization for Standardization

B.1 U.S. ASCII Character Set

Figure B-1 shows the U.S. ASCII character set.

Bits					b7	0	0	0	0	1	1	1	1
					b6	0	0	1	1	0	0	1	1
Hex0 Hex 1					b5	0	1	0	1	0	1	0	1
					b4	b3	b2	b1	0	1	2	3	4
0	0	0	0	0	NUL	DLE	SP	0	@	P	'	p	
0	0	0	1	1	SOH	DC1	!	1	A	Q	a	q	
0	0	1	0	2	STX	DC2	"	2	B	R	b	r	
0	0	1	1	3	ETX	DC3	#	3	C	S	c	s	
0	1	0	0	4	EOT	DC4	\$	4	D	T	d	t	
0	1	0	1	5	ENQ	NAK	%	5	E	U	e	u	
0	1	1	0	6	ACK	SYN	&	6	F	V	f	v	
0	1	1	1	7	BEL	ETB	'	7	G	W	g	w	
1	0	0	0	8	BS	CAN	(8	H	X	h	x	
1	0	0	1	9	HT	EM)	9	I	Y	i	y	
1	0	1	0	A	LF	SUB	*	:	J	Z	j	z	
1	0	1	1	B	VT	ESC	+	;	K	[k	{	
1	1	0	0	C	FF	FS	,	<	L	\	l		
1	1	0	1	D	CR	GS	-	=	M]	m	}	
1	1	1	0	E	SO	RS	.	>	N	^	n	~	
1	1	1	1	F	SI	US	/	?	O	-	o	DEL	

Note 1

Note 2

Note 3 (Enclosed with bold line)

Notes:

1. Control Character Codes: In transparent mode, all control codes are displayed; in normal display mode, they, and the DEL character, are not displayed.
2. 64-character ASCII set: Uppercase is enabled or DUAL/MONO switch is in MONO.
3. Standard 95-character ASCII Set (excluding DEL): Uppercase and lowercase are enabled, or DUAL/MONO switch is set to DUAL.

Figure B-1. U.S. ASCII Character Set (87 Keys)

B.2 Character Sets for Canada

Figure B-2 shows the Bilingual English/Canadian French character set and keyboards.

Bilingual English/Canadian French Character Set (Table 1)

Bits					b7	0	0	0	0	1	1	1	1
					b6	0	0	1	1	0	0	1	1
					b5	0	1	0	1	0	1	0	1
b4	b3	b2	b1	Hex0	0	1	2	3	4	5	6	7	
				Hex1									
0	0	0	0	0	NUL	DLE	SP	0	@	P	.	p	
0	0	0	1	1	SOH	DC1	!	1	A	Q	a	q	
0	0	1	0	2	STX	DC2	"	2	B	R	b	r	
0	0	1	1	3	ETX	DC3	#	3	C	S	c	s	
0	1	0	0	4	EOT	DC4	\$	4	D	T	d	t	
0	1	0	1	5	ENQ	NAK	%	5	E	U	e	u	
0	1	1	0	6	ACK	SYN	&	6	F	V	f	v	
0	1	1	1	7	BEL	ETB	'	7	G	W	g	w	
1	0	0	0	8	BS	CAN	(8	H	X	h	x	
1	0	0	1	9	HT	EM)	9	I	Y	i	y	
1	0	1	0	A	LF	SUB	*	:	J	Z	j	z	
1	0	1	1	B	VT	ESC	+	;	K	[k	{	
1	1	0	0	C	FF	FS	,	<	L	\	l		
1	1	0	1	D	CR	GS	-	=	M]	m	}	
1	1	1	0	E	SO	RS	.	>	N	^	n	~	
1	1	1	1	F	SI	US	/	?	O	.	o	DEL	

Bilingual English/Canadian French Character Set (Table 2)

Bits					b7	0	0	0	0	1	1	1	1
					b6	0	0	1	1	0	0	1	1
					b5	0	1	0	1	0	1	0	1
b4	b3	b2	b1	Hex0	0	1	2	3	4	5	6	7	
				Hex1									
0	0	0	0	0						ï		ï	
0	0	0	1	1					À		à		
0	0	1	0	2					Â		â		
0	0	1	1	3									
0	1	0	0	4						Ô		ô	
0	1	0	1	5									
0	1	1	0	6									
0	1	1	1	7					Ç		ç		
1	0	0	0	8									
1	0	0	1	9					É	Û	é	ù	
1	0	1	0	A					È	Û	è	û	
1	0	1	1	B					Ê	Û	ê	ü	
1	1	0	0	C					Ë		ë		
1	1	0	1	D									
1	1	1	0	E									
1	1	1	1	F					Û		Û		

Note: When in transmission mode, those characters that appear in the Table 2 will be sandwiched between Shift-Out (SO) and Shift-In (SI) characters.

Figure B-2 (Part 1 of 2). Bilingual English/Canadian French Character Set and Keyboards

Bilingual English/Canadian French Keyboard with Canadian French Function Keys (87 Keys)

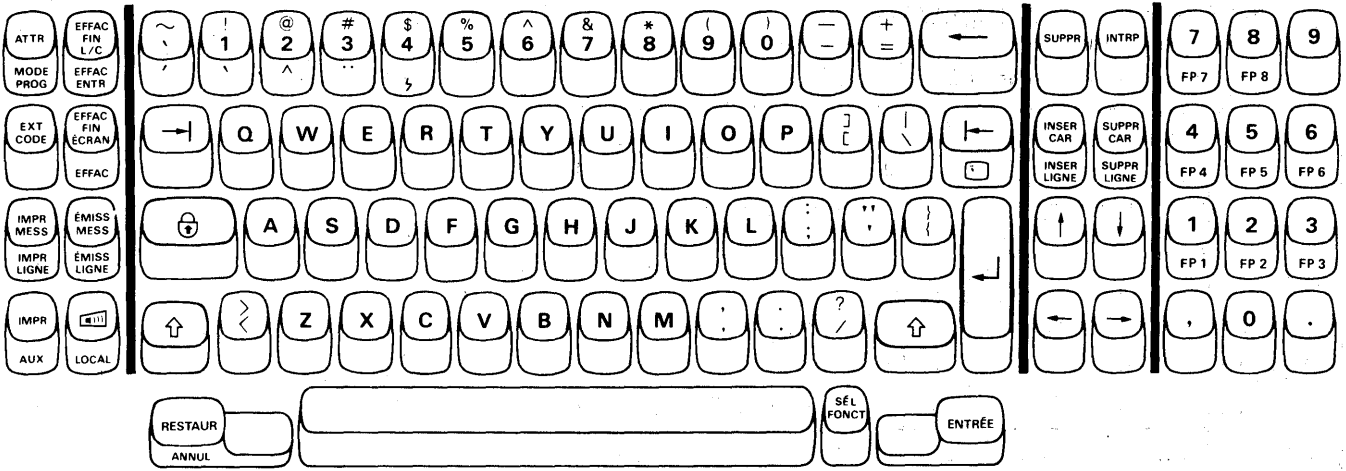

Bilingual English/Canadian French Keyboard with English Function Keys (87 Keys)

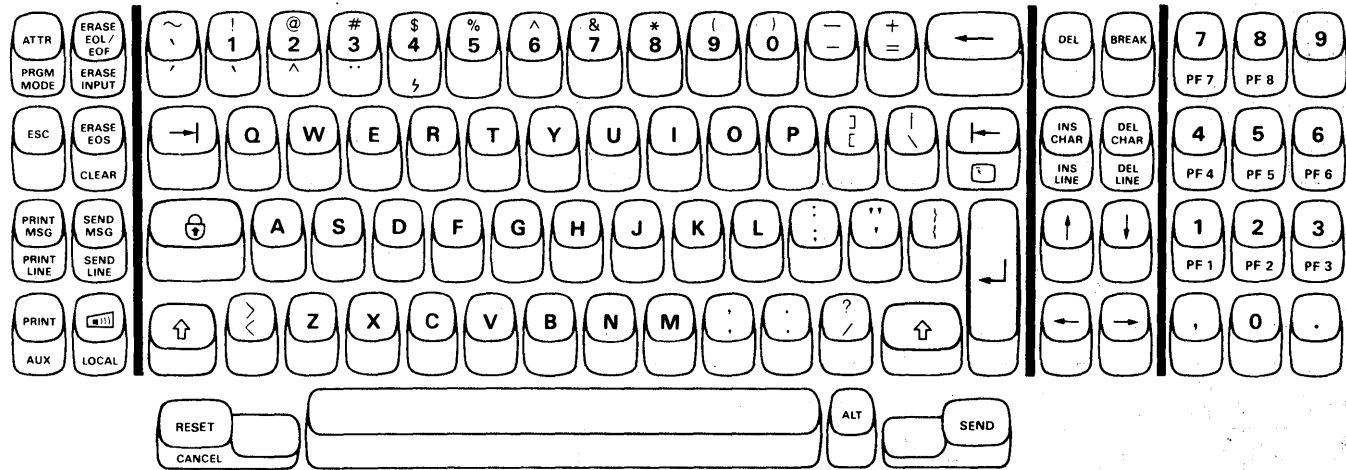

Figure B-2 (Part 2 of 2). Bilingual English/Canadian French Character Set and Keyboards

B.3 Character Set for Japan

Figure B-3 shows the Japanese Katakana character set and keyboard.

Japanese Katakana Character Set (Table 1)

Bits					b7	0	0	0	0	1	1	1	1
					b6	0	0	1	1	0	0	1	1
b4 b3 b2 b1					Hex 0								
					Hex 1	0	1	2	3	4	5	6	7
0	0	0	0	0	0	NUL	DLE	SP	0	(a	P	`	p
0	0	0	0	1	1	SOH	DC1	!	1	A	Q	a	q
0	0	1	0	0	2	STX	DC2	"	2	B	R	b	r
0	0	1	1	0	3	ETX	DC3	#	3	C	S	c	s
0	1	0	0	0	4	EOT	DC4	\$	4	D	T	d	t
0	1	0	1	0	5	ENQ	NAK	!	5	E	U	e	u
0	1	1	0	0	6	ACK	SYN	&	6	F	V	f	v
0	1	1	1	0	7	BEL	ETB	'	7	G	W	g	w
1	0	0	0	0	8	BS	CAN	(8	H	X	h	x
1	0	0	0	1	9	HT	EM)	9	I	Y	i	y
1	0	1	0	0	A	LF	SUB	*	:	J	Z	j	z
1	0	1	1	0	B	VT	ESC	i	;	K	[k	{
1	1	0	0	0	C	FF	FS	,	<	L	¥	l	l
1	1	0	1	0	D	CR	GS	-	=	M]	m	}
1	1	1	0	0	E	SO	RS	.	>	N	^	n	—
1	1	1	1	0	F	SI	US	/	?	O	-	o	DEL

Japanese Katakana Character Set (Table 2)

Bits					b7	0	0	0	1	1	1	1	1	
					b6	0	0	1	1	0	0	1	1	
b4 b3 b2 b1					Hex 0									
					Hex 1	0	1	2	3	4	5	6	7	
0	0	0	0	0	0	NUL	TC ₇ (DLE)	(SP)(3)	-	タ	ミ	↑	↑	
0	0	0	0	1	1	TC ₁ (SOH)	DC ₁	.	ア	チ	ム			
0	0	1	0	0	2	TC ₂ (STX)	DC ₂	「	イ	ツ	メ			
0	0	1	1	0	3	TC ₃ (ETX)	DC ₃	」	ウ	テ	モ			
0	1	0	0	0	4	TC ₄ (EOT)	DC ₄	,	エ	ト	ヤ			
0	1	0	1	0	5	TC ₅ (ENQ)	TC ₈ (NAK)	.	オ	ナ	ユ			
0	1	1	0	0	6	TC ₆ (ACK)	TC ₉ (SYN)	ヲ	カ	ニ	ヨ			
0	1	1	1	0	7	BEL	TC ₁₀ (ETB)	ア	キ	ヌ	ラ	} unde- fined		
1	0	0	0	0	8	FE ₀ (BS)	CAN	イ	ク	ネ	リ			
1	0	0	0	1	9	FE ₁ (HT)	EM	ウ	ケ	ノ	ル			
1	0	1	0	0	A	FE ₂ (LF)	SUB	エ	コ	ハ	レ			
1	0	1	1	0	B	FE ₃ (VT)	ESC	オ	サ	ヒ	ロ			
1	1	0	0	0	C	FE ₄ (FF)	IS ₄ (FS)	ヤ	シ	フ	ワ			
1	1	0	1	0	D	FE ₅ (CR)	IS ₃ (GS)	ユ	ス	ヘ	ン			
1	1	1	0	0	E	SO	IS ₂ (RS)	ヨ	セ	ホ	.			
1	1	1	1	0	F	SI	IS ₁ (US)	ツ	ソ	マ	°		DEL	

Note: When in transmission mode, those characters that appear in Table 2 will be sandwiched between Shift-Out (SO) and Shift-In (SI) characters.

Figure B-3 (Part 1 of 2). Japanese Katakana Character Set and Keyboard

Japanese Katakana Keyboard (88 Keys)

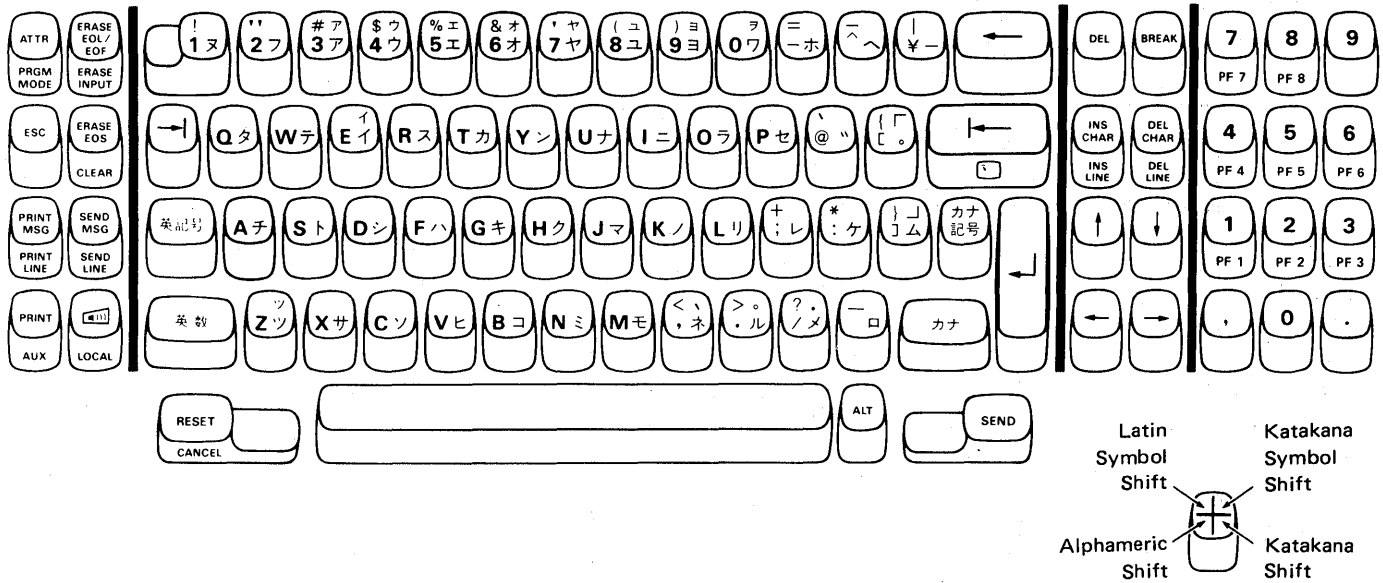

Figure B-3 (Part 2 of 2). Japanese Katakana Character Set and Keyboard.

B.4 Character Set for France

Figure B-4 shows the French character set and keyboard.

French Character Set

Bits				b7	0	0	0	0	1	1	1	1
b4	b3	b2	b1	Hex 0	0	1	2	3	4	5	6	7
				Hex 1								
0	0	0	0	0	NUL	DLE	SP	0	à	P	μ	p
0	0	0	1	1	SOH	DC1	!	1	A	Q	a	q
0	0	1	0	2	STX	DC2	"	2	B	R	b	r
0	0	1	1	3	ETX	DC3	£	3	C	S	c	s
0	1	0	0	4	EOT	DC4	\$	4	D	T	d	t
0	1	0	1	5	ENQ	NAK	%	5	E	U	e	u
0	1	1	0	6	ACK	SYN	&	6	F	V	f	v
0	1	1	1	7	BEL	ETB	'	7	G	W	g	w
1	0	0	0	8	BS	CAN	(8	H	X	h	x
1	0	0	1	9	HT	EM)	9	I	Y	i	y
1	0	1	0	A	LF	SUB	*	:	J	Z	j	z
1	0	1	1	B	VT	ESC	+	;	K	o	k	é
1	1	0	0	C	FF	ES	,	<	L	ç	l	ù
1	1	0	1	D	CR	GS	-	=	M	§	m	è
1	1	1	0	E	SO	RS	.	>	N	^	n	..
1	1	1	1	F	SI	US	/	?	0	-	o	DEL

French Keyboard (87 Keys)

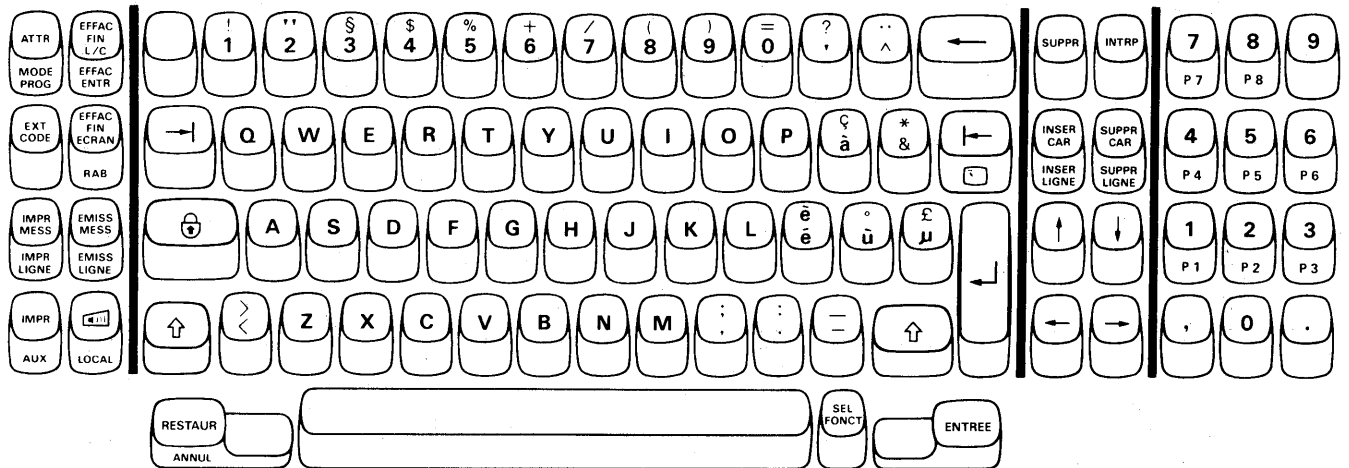

Figure B-4. French Character Set and Keyboard

B.5 Character Set for Germany

Figure B-5 shows the German character set and keyboard.

German Character Set

Bits				b7	0	0	0	0	1	1	1	1
				b6	0	0	1	1	0	0	1	1
				b5	0	1	0	1	0	1	0	1
b4	b3	b2	b1	Hex 0								
				Hex 1	0	1	2	3	4	5	6	7
0	0	0	0	0	NUL	DLE	SP	0	§	P		p
0	0	0	1	1	SOH	DC1	!	1	A	Q	a	q
0	0	1	0	2	STX	DC2	"	2	B	R	b	r
0	0	1	1	3	ETX	DC3	#	3	C	S	c	s
0	1	0	0	4	EOT	DC4	\$	4	D	T	d	t
0	1	0	1	5	ENQ	NAK	%	5	E	U	e	u
0	1	1	0	6	ACK	SYN	&	6	F	V	f	v
0	1	1	1	7	BEL	ETB	'	7	G	W	g	w
1	0	0	0	8	BS	CAN	(8	H	X	h	x
1	0	0	1	9	HT	EM)	9	I	Y	i	y
1	0	1	0	A	LF	SUB	*	:	J	Z	j	z
1	0	1	1	B	VT	ESC	+	;	K	Ä	k	ä
1	1	0	0	C	FF	FS	,	<	L	Ö	l	ö
1	1	0	1	D	CR	GS	-	=	M	Ü	m	ü
1	1	1	0	E	SO	RS	.	>	N	^	n	β
1	1	1	1	F	SI	US	/	?	O	-	o	DEL

German Keyboard (87 Keys)

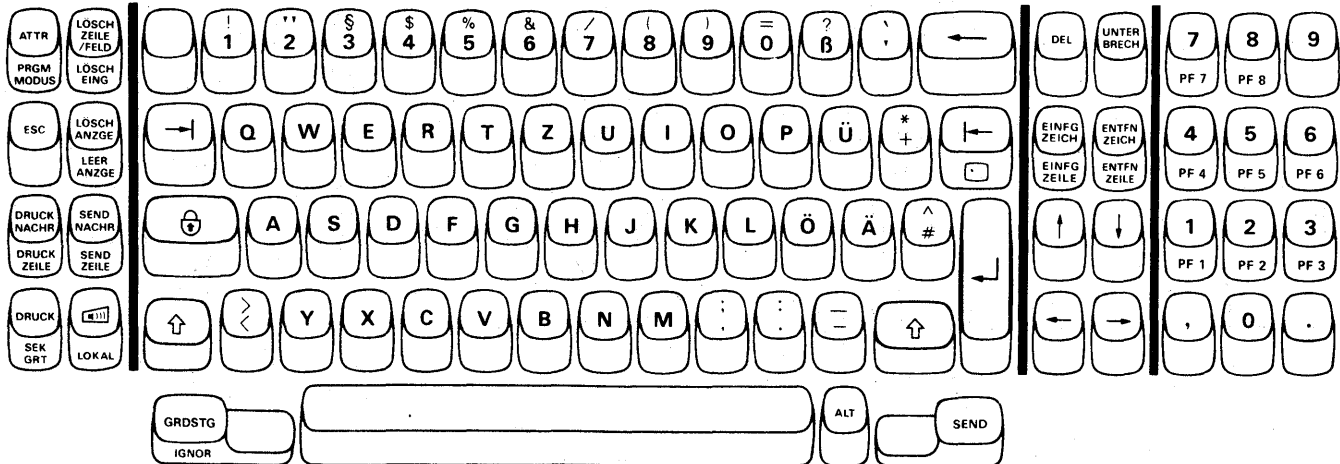

Figure B-5. German Character Set and Keyboard

B.6 Character Set for Italy

Figure B-6 shows the Italian character set and keyboard.

Italian Character Set

Bits				b7	0	0	0	0	1	1	1	1
				b6	0	0	1	1	0	0	1	1
				b5	0	1	0	1	0	1	0	1
b4	b3	b2	b1	Hex 0								
				Hex 1	0	1	2	3	4	5	6	7
0	0	0	0	0	NUL	DLE	SP	0	§	P	ù	p
0	0	0	1	1	SOH	DC1	!	1	A	Q	a	q
0	0	1	0	2	STX	DC2	"	2	B	R	b	r
0	0	1	1	3	ETX	DC3	£	3	C	S	c	s
0	1	0	0	4	EOT	DC4	\$	4	D	T	d	t
0	1	0	1	5	ENQ	NAK	%	5	E	U	e	u
0	1	1	0	6	ACK	SYN	&	6	F	V	f	v
0	1	1	1	7	BEL	ETB	'	7	G	W	g	w
1	0	0	0	8	BS	CAN	(8	H	X	h	x
1	0	0	1	9	HT	EM)	9	I	Y	i	y
1	0	1	0	A	LF	SUB	*	:	J	Z	j	z
1	0	1	1	B	VT	ESC	+	;	K	°	k	à
1	1	0	0	C	FF	FS	,	<	L	Ç	l	ò
1	1	0	1	D	CR	GS	-	=	M	ē	m	è
1	1	1	0	E	SO	RS	.	>	N	^	n	ì
1	1	1	1	F	SI	US	/	?	O	-	o	DEL

Italian Keyboard (87 Keys)

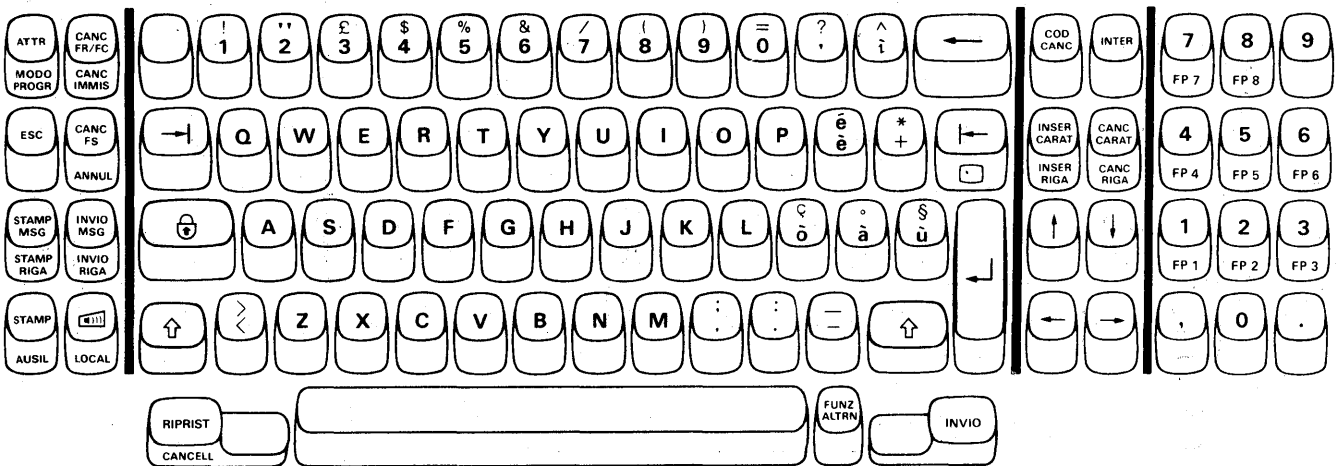

Figure B-6. Italian Character Set and Keyboard

B.7 Character Set for the U.K.

Figure B-7 shows the U.K. English character set and keyboard.

U.K. English Character Set

Bits				b7	0	0	0	0	1	1	1	1
				b6	0	0	1	1	0	0	1	1
b4	b3	b2	b1	b5	0	1	0	1	0	1	0	1
				Hex 0	0	1	2	3	4	5	6	7
				Hex 1	0	1	2	3	4	5	6	7
0	0	0	0	0	NUL	DLE	SP	0	@	P		p
0	0	0	1	1	SOH	DC1	!	1	A	Q	a	q
0	0	1	0	2	STX	DC2	"	2	B	R	b	r
0	0	1	1	3	ETX	DC3	£	3	C	S	c	s
0	1	0	0	4	EOT	DC4	\$	4	D	T	d	t
0	1	0	1	5	ENQ	NAK	%	5	E	U	e	u
0	1	1	0	6	ACK	SYN	&	6	F	V	f	v
0	1	1	1	7	BEL	ETB	'	7	G	W	g	w
1	0	0	0	8	BS	CAN	(8	H	X	h	x
1	0	0	1	9	HT	EM)	9	I	Y	i	y
1	0	1	0	A	LF	SUB	*	:	J	Z	j	z
1	0	1	1	B	VT	ESC	+	;	K	[k	{
1	1	0	0	C	FF	FS	,	<	L	\	l	
1	1	0	1	D	CR	GS	.	=	M]	m	}
1	1	1	0	E	SO	RS	.	>	N	↑	n	—
1	1	1	1	F	SI	US	/	?	O	_	o	DEL

U.K. English Keyboard (87 Keys)

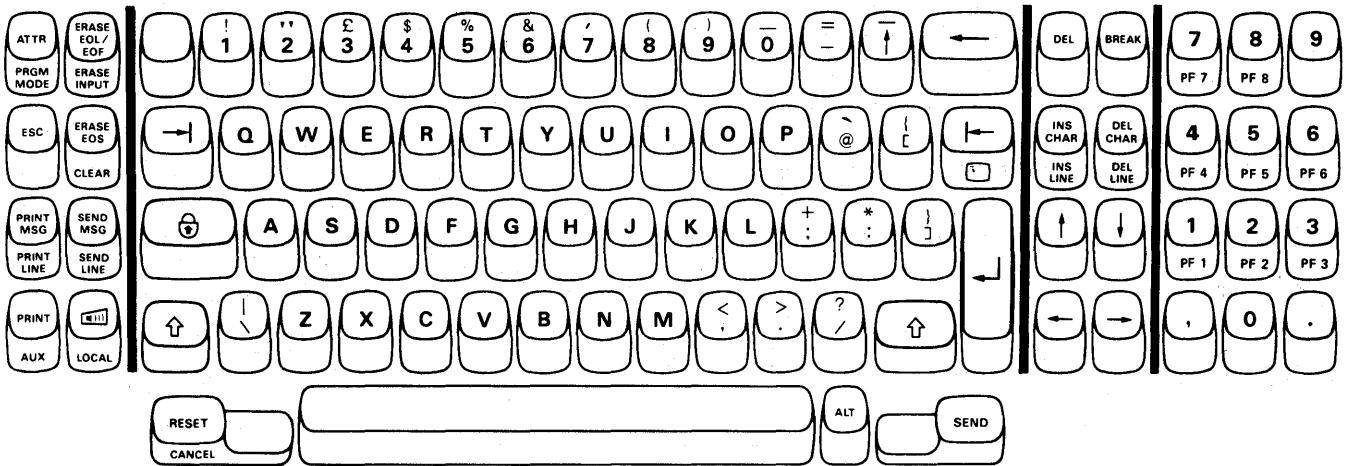

Figure B-7. U.K. English Character Set and Keyboard

Appendix C. Messages in Operator Information Area

The messages that appear in the Operator Information Area (line 25) of the 3101 display surface vary, depending on the language of each keyboard. This appendix shows the messages for each language.

U.S. English

1. CHAR MODE
2. BLOCK MODE
3. (XPARENT)
4. (PROGRAM)
5. (IN ATTR)
6. LOCK-SYSTEM COMMAND
7. LOCK-SENDING
8. LOCK-PRINTING
9. LOCK-LINE CHECK 1
10. LOCK-LINE CHECK 2
11. LOCK-SYSTEM NOT READY
12. LOCK-RE-KEY
13. LOCK-MODE/SETUP CHECK
14. LOCK-DISABLED KEY
15. LOCK-FORMAT CHECK
16. INSERT
17. UP SHIFT
18. S
19. R
20. LOCAL
21. AUX ON
22. MACHINE CHECK-LOGIC. SEE PROBLEM GUIDE
23. MACHINE CHECK-LOGIC OR KEYBOARD. SEE PROBLEM GUIDE
24. MACHINE CHECK-KEYBOARD. SEE PROBLEM GUIDE
25. TEST MODE

Bilingual English/Canadian French with English Messages

1. CHAR MODE
2. BLOCK MODE
3. (XPARENT)
4. (PROGRAM)
5. (IN ATTR)
6. LOCK-SYSTEM COMMAND
7. LOCK-SENDING
8. LOCK-PRINTING
9. LOCK-LINE CHECK 1
10. LOCK-LINE CHECK 2
11. LOCK-SYSTEM NOT READY
12. LOCK-RE-KEY
13. LOCK-MODE/SETUP CHECK
14. LOCK-DISABLED KEY
15. LOCK-FORMAT CHECK
16. INSERT
17. UP SHIFT
18. S
19. R
20. LOCAL
21. AUX ON
22. MACHINE CHECK-LOGIC. SEE PROBLEM GUIDE
23. MACHINE CHECK-LOGIC OR KEYBOARD. SEE PROBLEM GUIDE
24. MACHINE CHECK-KEYBOARD. SEE PROBLEM GUIDE
25. TEST MODE
26. LOCK-INVALID SEQUENCE (Canadian-unique)

Bilingual English/Canadian French with Canadian French Messages

1. MODE CAR
 2. MODE BLOC
 3. (TRANSP)
 4. (PROGRAM)
 5. (ATTR)*
 6. VERROU-COMM DU SYST
 7. VERROU-ÉMISSION
 8. VERROU-IMPRESSION
 9. VERROU-ERREUR LIGNE 1
 10. VERROU-ERREUR LIGNE 2
 11. VERROU-SYST PAS PRÊT
 12. VERROU-RÉ-ENTRER
 13. VERROU-CTL MODE/ARR
 14. VERROU-TCHE INACTIVE
 15. VERROU-ERREUR STRUCT
 16. INSER
 17. MAJUSC
 18. É
 19. R
 20. LOCAL
 21. AUX ST
 22. ERREUR MACHINE-LOGIQUE VOIR GUIDE INCIDENTS
 23. ERREUR MACHINE-LOGIQUE OU CLAVIER VOIR GUIDE INCIDENTS
 24. ERREUR MACHINE-CLAVIER VOIR GUIDE INCIDENTS
 25. MODE TEST
 26. VERROU-SÉQUENCE INVAL (Canadian-unique)
- * Some machines may display (IN ATTR) instead of (ATTR)

Japanese Katakana

1. モジ モード
 2. ブロック モード
 3. (トウカ)
 4. (プログラム)
 5. (ソクセイ)
 6. ロックシステム コマンド
 7. ロックソウシン チュウ
 8. ロックプリント チュウ
 9. ロックカイセン チェック1
 10. ロックカイセン チェック2
 11. ロックシステム ショウ フカ
 12. ロックサイニューリョク
 13. ロックモード セットアップ チェック
 14. ロックショウフカ キー
 15. ロックフォーマット チェック
 16. ソウニユウ
 17. カナキゴウ
 18. S
 19. R
 20. ローカル
 21. ホジョ
 22. マシンチェック - ロジック
 23. マシンチェック - ロジック マタハ キーボード
 24. マシンチェック - キーボード
 25. テスト モード
 26. カナ
 27. エイキゴウ
 28. エイスウ
- モンダイ ノ テビキ ラ ミヨ
モンダイ ノ テビキ ラ ミヨ
モンダイ ノ テビキ ラ ミヨ

U.K. English

1. CHAR MODE
2. BLOCK MODE
3. (XPARENT)
4. (PROGRAM)
5. (IN ATTR)
6. LOCK-SYSTEM COMMAND
7. LOCK-SENDING
8. LOCK-PRINTING
9. LOCK-LINE CHECK 1
10. LOCK-LINE CHECK 2
11. LOCK-SYSTEM NOT READY
12. LOCK-RE-KEY
13. LOCK-MODE/SETUP CHECK
14. LOCK-DISABLED KEY
15. LOCK-FORMAT CHECK
16. INSERT
17. UP SHIFT
18. S
19. R
20. LOCAL
21. AUX ON
22. MACHINE CHECK-LOGIC. SEE PROBLEM GUIDE
23. MACHINE CHECK-LOGIC OR KEYBOARD. SEE PROBLEM GUIDE
24. MACHINE CHECK-KEYBOARD. SEE PROBLEM GUIDE
25. TEST MODE

French

1. MODE CAR
2. MODE BLOC
3. (TRANSP)
4. (PROGRAM)
5. (ATTR)
6. VERR-PAR CDE SYST
7. VERR-EMISSION
8. VERR-IMPRESSION
9. VERR-ERR TRANSM 1
10. VERR-ERR TRANSM 2
11. VERR-SYST NON PRET
12. VERR-REFRAPPER
13. VERR-ERREUR MODE
14. VERR-TOUCHE HF
15. VERR-OPER INVALIDE
16. INSER
17. MAJUSC
18. E
19. R
20. LOCAL
21. AUX
22. ERREUR CONTROLEUR VOIR GUIDE INCIDENTS
23. ERREUR CONTROLEUR OU CLAVIER VOIR GUIDE INCIDENTS
24. ERREUR CLAVIER VOIR GUIDE INCIDENTS
25. MODE TEST

German

1. ZEICHENMOD
2. BLOCKMODUS
3. (TRNSPAR)
4. (PROGRAM)
5. (EIN ATT)
6. VERR.-SYSTEMBEFHL
7. VERR.-SENDEN
8. VERR.-DRUCKEN
9. VERR.-LEITGSPRÜFG 1
10. VERR.-LEITGSPRÜFG 2
11. VERR.-SYST. N. BEREIT
12. VERR.-EINGABE WDHOLG
13. VERR.-MOD/INST PRÜFG
14. VERR.-UNGÜLT TASTE
15. VERR.-FORMATPRÜFUNG
16. EINFÜG
17. UMSCHALT
18. S
19. E
20. LOKAL
21. SEK AN
22. MASCHINENPRÜFUNG-LOGIK SIEHE LEITFADEN
23. MASCHINENPRÜFUNG-LOGIK ODER TASTATUR SIEHE LEITFADEN
24. MASCHINENPRÜFUNG-TASTATUR SIEHE LEITFADEN
25. TESTMODUS

Italian

1. MODO CARAT
2. MODO BLOCC
3. (TRASPAR)
4. (PROGRAM)
5. (IN ATTR)
6. BLOCCO-COMANDO SISTEM
7. BLOCCO-INVIO
8. BLOCCO-STAMPA
9. BLOCCO-ERRORE LINEA-1*
10. BLOCCO-ERRORE LINEA-2*
11. BLOCCO-SIST NON PRONT
12. BLOCCO-RIBATTI
13. BLOCCO-ERR MODO/ATTIV
14. BLOCCO-TASTO DISABIL
15. BLOCCO-ERRORE TRACC
16. INSER
17. MAIUSC
18. I
19. R
20. LOCAL
21. AUS AB
22. ERRORE MACCHINA-LOGICO VEDI GUIDA PRP
23. ERRORE MACCHINA-LOGICO O TASTIERA VEDI GUIDA PRP
24. ERRORE MACCHINA-TASTIERA VEDI GUIDA PRP
25. MODO PROVA

* Some machines may display ERRORE RIGA-1 or 2 instead of LINEA-1 or 2.

Appendix D. Power Plug Requirements

The power plug for the 3101 Display Terminal varies in countries where the terminal is used. (See Figures D-1 through D-10.) The following table is a quick index to help you find the appropriate plug type.

Country	Figure
Austria	D-1
Belgium	D-4
Denmark	D-7
France	D-4
Germany	D-1
Israel	D-9
Italy	D-8
Japan	D-10
Netherlands	D-1

Country	Figure
Norway	D-1
Portugal	D-1
South Africa	D-6
Spain	D-1
Sweden	D-1
Switzerland	D-2
United Kingdom	D-5
U.S.A.	D-3

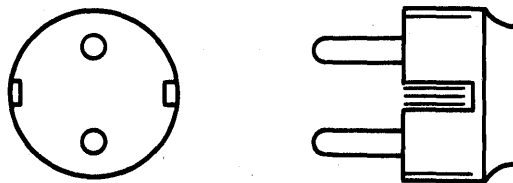

Figure D-1. Plug with Side Earthing (Ground) Pin – 16-A Max, 250V
(Austria, Germany, Netherlands, Norway, Portugal, Spain, and Sweden)

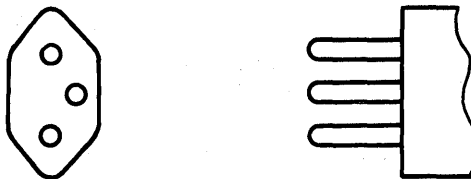

Figure D-2. Plug with Earthing (Ground) Pin – 10-A Max, 250V (Switzerland)



Figure D-3. Plug with Earthing (Ground) Pin – 15-A Max, 125V (Canada and U.S.A.)

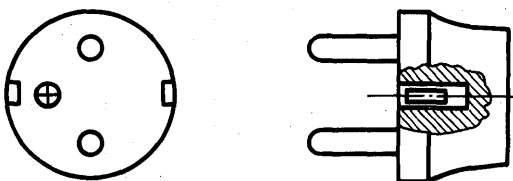

Figure D-4. Plug with Contact Tube and Side Earthing (Ground) Pin – 16-A Max, 250V
(Belgium and France)

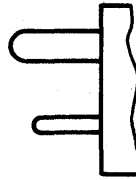
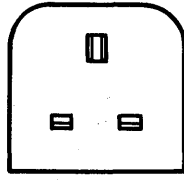

Figure D-5. Plug with Earthing (Ground) Pin – 13-A Max, 250V (U.K.)

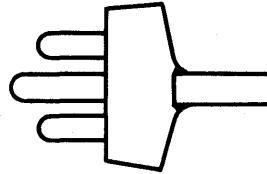
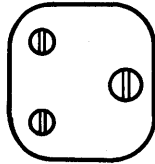

Figure D-6. Plug with Earthing (Ground) Pin – 15-A Max, 250V (South Africa)

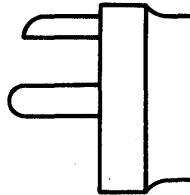
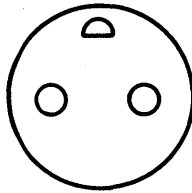

Figure D-7. Plug with Earthing (Ground) Pin – 10-A Max, 250V (Denmark)

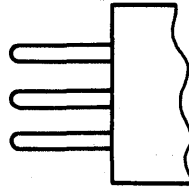
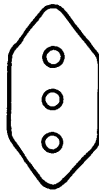

Figure D-8. Plug with Earthing (Ground) Pin – 16-A Max, 250V (Italy)

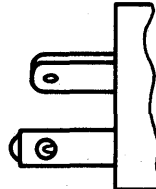
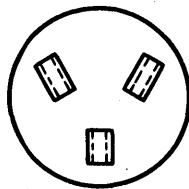

Figure D-9. Plug with Earthing (Ground) Pin – 10-A Max, 250V (Israel)

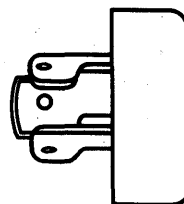
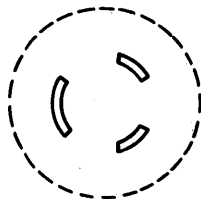
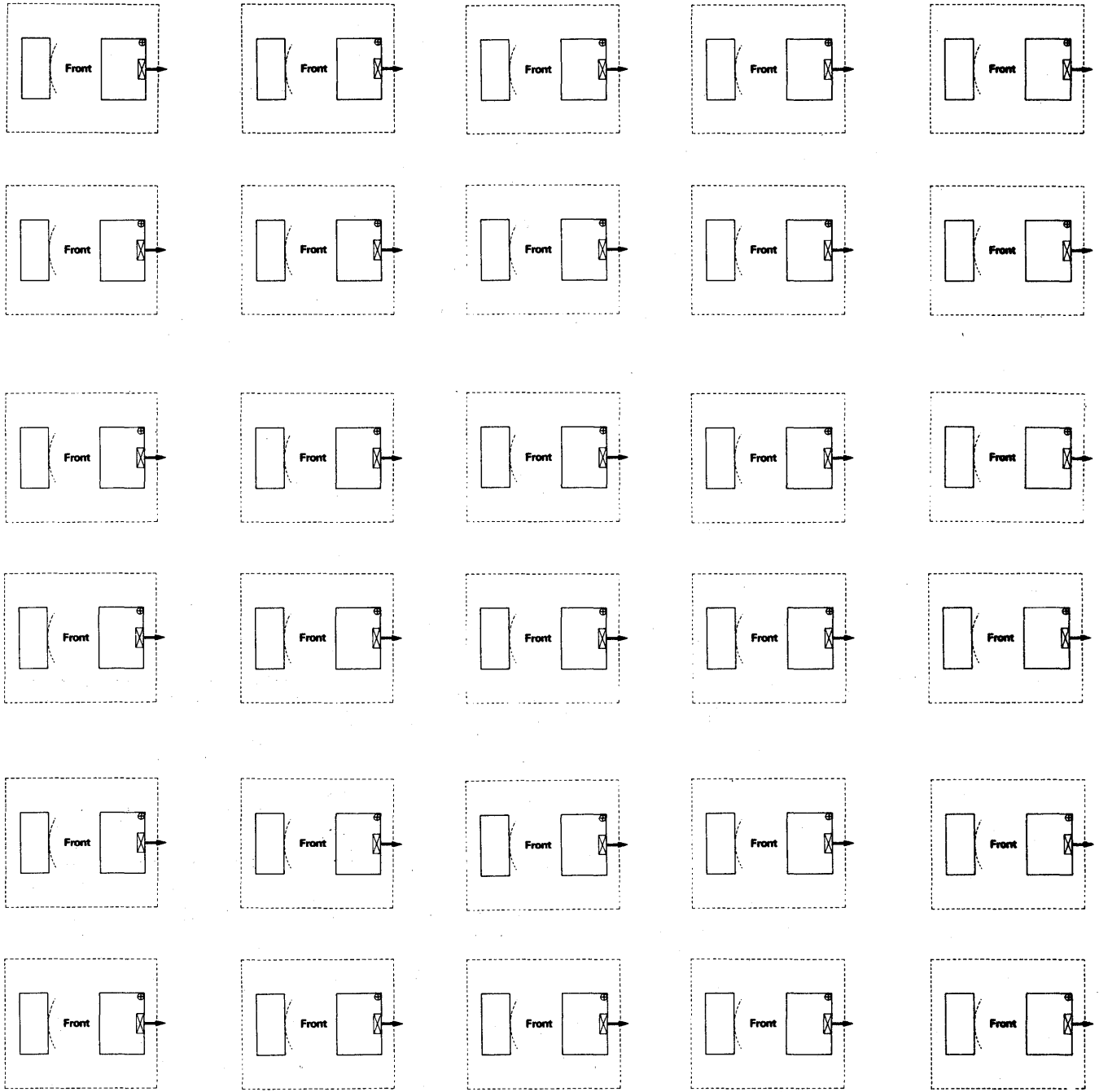



Figure D-10. Locking Plug with Earthing (Ground) Pin – 15-A Max, 125V (Japan)

Appendix E. Physical Planning Template



Scale: 2 cm = 1 meter

-  : Cable Exit Area
-  : Power Cord Exit

Appendix F. Code Translation Table

The following table shows the conversion of ASCII codes to EBCDIC codes. Among the ASCII codes, four characters (!, left bracket, right bracket, and caret) do not have standard EBCDIC codes. They are system- or installation-dependent.

DEC	HEX	ASCII		EBCDIC CODE (HEX)	KEY SEQUENCE	BINARY P765 4321
		GRAPHIC	CONTROL			
00	00	□	(NUL)	00	ALT [000 0000
01	01	S	(SOH)	01	ALT A	000 0001
02	02	X	(STX)	02	ALT B	000 0010
03	03	E	(ETX)	03	ALT C	000 0011
04	04	T	(EOT)	37	ALT D	000 0100
05	05	Q	(ENQ)	2D	ALT E	000 0101
06	06	A	(ACK)	2E	ALT F	000 0110
07	07	B	(BEL)	2F	ALT G	000 0111
08	08	B	(BS)	16	ALT H, ←	000 1000
09	09	S	(HT)	05	ALT I, →	000 1001
10	0A	L	(LF)	25	ALT J	000 1010
11	0B	V	(VT)	0B	ALT K	000 1011
12	0C	F	(FF)	0C	ALT L	000 1100
13	0D	R	(CR)	0D	ALT M, ←	000 1101
14	0E	S	(SQ)	0E	ALT N	000 1110
15	0F	S	(SI)	0F	ALT O	000 1111
16	10	D	(DLE)	10	ALT P	001 0000
17	11	□	(DC1)	11	ALT Q	001 0001
18	12	□	(DC2)	12	ALT R	001 0010
19	13	□	(DC3)	13	ALT S	001 0011
20	14	□	(DC4)	3C	ALT T	001 0100
21	15	N	(NAK)	3D	ALT U	001 0101
22	16	S	(SYN)	32	ALT V	001 0110
23	17	E	(ETB)	26	ALT W	001 0111
24	18	C	(CAN)	18	ALT X	001 1000
25	19	M	(EM)	19	ALT Y	001 1001
26	1A	S	(SUB)	3F	ALT Z	001 1010
27	1B	E	(ESC)	27	ALT , ESC	001 1011
28	1C	F	(FS)	1C	ALT =	001 1100
29	1D	G	(GS)	1D	ALT {	001 1101
30	1E	R	(RS)	1E	ALT -	001 1110
31	1F	S	(US)	1F	ALT '	001 1111
32	20		space	40	1/ 1	010 0000
33	21	!		--	2/ 2	010 0001
34	22	"		7F	3/ 3	010 0010
35	23	#		7B	4/ 4	010 0011

DEC	HEX	ASCII		EBCDIC CODE (HEX)	ROW/COL (DEC)	BINARY P765 4321
		GRAPHIC	CONTROL			
36	24	\$		5B	5/5	010 0100
37	25	%		6C	6/6	010 0101
38	26	&		50	7/7	010 0110
39	27	'		7D	8/8	010 0111
40	28	(4D	9/9	010 1000
41	29)		5D	10/10	010 1001
42	2A	*		5C	11/11	010 1010
43	2B	+		4E	12/12	010 1011
44	2C	,		6B	13/13	010 1100
45	2D	-		60	14/14	010 1101
46	2E	.		4B	15/15	010 1110
47	2F	/		61	16/16	010 1111
48	30	0		F0	17/17	011 0000
49	31	1		F1	18/18	011 0001
50	32	2		F2	19/19	011 0010
51	33	3		F3	20/20	011 0011
52	34	4		F4	21/21	011 0100
53	35	5		F5	22/22	011 0101
54	36	6		F6	23/23	011 0110
55	37	7		F7	24/24	011 0111
56	38	8		F8	/25	011 1000
57	39	9		F9	/26	011 1001
58	3A	:		7A	/27	011 1010
59	3B	;		5E	/28	011 1011
60	3C	<		4C	/29	011 1100
61	3D	=		7E	/30	011 1101
62	3E	>		6E	/31	011 1110
63	3F	?		6F	/32	011 1111
64	40	@		7C	/33	100 0000
65	41	A		C1	/34	100 0001
66	42	B		C2	/35	100 0010
67	43	C		C3	/36	100 0011
68	44	D		C4	/37	100 0100
69	45	E		C5	/38	100 0101
70	46	F		C6	/39	100 0110
71	47	G		C7	/40	100 0111
72	48	H		C8	/41	100 1000
73	49	I		C9	/42	100 1001
74	4A	J		D1	/43	100 1010
75	4B	K		D2	/44	100 1011

DEC	HEX	ASCII		EBCDIC CODE (HEX)	ROW/COL (DEC)	BINARY P765 4321
		GRAPHIC	CONTROL			
76	4C	L		D3	/45	100 1100
77	4D	M		D4	/46	100 1101
78	4E	N		D5	/47	100 1110
79	4F	O		D6	/48	100 1111
80	50	P		D7	/49	101 0000
81	51	Q		D8	/50	101 0001
82	52	R		D9	/51	101 0010
83	53	S		E2	/52	101 0011
84	54	T		E3	/53	101 0100
85	55	U		E4	/54	101 0101
86	56	V		E5	/55	101 0110
87	57	W		E6	/56	101 0111
88	58	X		E7	/57	101 1000
89	59	Y		E8	/58	101 1001
90	5A	Z		E9	/59	101 1010
91	5B	[--	/60	101 1011
92	5C	\		E0	/61	101 1100
93	5D]		--	/62	101 1101
94	5E	^		--	/63	101 1110
95	5F	_		6D	/64	101 1111
96	60	`		79	/65	110 0000
97	61	a		81	/66	110 0001
98	62	b		82	/67	110 0010
99	63	c		83	/68	110 0011
100	64	d		84	/69	110 0100
101	65	e		85	/70	110 0101
102	66	f		86	/71	110 0110
103	67	g		87	/72	110 0111
104	68	h		88	/73	110 1000
105	69	i		89	/74	110 1001
106	6A	j		91	/75	110 1010
107	6B	k		92	/76	110 1011
108	6C	l		93	/77	110 1100
109	6D	m		94	/78	110 1101
110	6E	n		95	/79	110 1110
111	6F	o		96	/80	110 1111
112	70	p		97		111 0000
113	71	q		98		111 0001
114	72	r		99		111 0010
115	73	s		A2		111 0011

DEC	HEX	ASCII		EBCDIC CODE (HEX)	ROW/COL (DEC)	BINARY P765 4321
		GRAPHIC	CONTROL			
116	74	t		A3		111 0100
117	75	u		A4		111 0101
118	76	v		A5		111 0110
119	77	w		A6		111 0111
120	78	x		A7		111 1000
121	79	y		A8		111 1001
122	7A	z		A9		111 1010
123	7B	{		C0		111 1011
124	7C			6A		111 1100
125	7D	}		D0		111 1101
126	7E	~		A1		111 1110
127	7F	█	(DEL)	07		111 1111

Appendix G. Summary of 3101 Functions

The 3101 is available in six models to meet various application requirements. The following table shows the functions available for each model.

Function Name	Model					
	10	12	13	20	22	23
Mode of Operation						
Data Transfer Mode						
–Character Mode	X	X	X	X*	X*	X*
–Block Mode (Page/Message/Line)				X*	X*	X*
Telecommunication Operation						
–Duplex	X*	X*	X*	X*	X*	X*
–Half-Duplex	X*	X*	X*	X*	X*	X*
Line Turnaround (EOT/ETX/CR/XOFF)	X*	X*	X*	X*	X*	X*
Local Mode Operation	X	X	X	X	X	X
Line Protocol						
–Start-Stop using ASCII or ISO code	X	X	X	X	X	X
–8/10 or 8/11 Character Framing	X*	X*	X*	X*	X*	X*
–Point-to-Point	X	X	X	X	X	X
Interface						
–EIA RS-232C or CCITT V.24/V.28	X	X*	X*	X	X*	X*
–EIA RS-422 or CCITT V.11 Interface			X*			X*
–20-mA Current Loop Interface (Passive/Active: see Chapter 5 for current-supply)		X*			X*	
Auxiliary Interface						
–EIA RS-232C or CCITT V.24/V.28 Interface (see Chapter 5)	X	X	X	X	X	X
–Receive Only Device Support				X	X	X
–Send/Receive Line Monitoring (AUX Key-see Chapter 3)	X	X	X	X	X	X
–Buffer Print Operation (Print Keys: Page/Message/Line)				X	X	X
–10 Data Transfer Rates (110, 150, 200, 300, 600, 1200, 1800, 2400, 4800, and 9600 bps)	X	X	X	X*	X*	X*
–8/10 or 8/11 Character Framing	X	X	X	X	X	X
–Start-Stop Protocol	X	X	X	X	X	X
–Parity (Odd, Even, Mark, or Space)	X	X	X	X	X	X
–ASCII or ISO code Character Set (see Appendix B)	X	X	X	X	X	X
–Character Conversion in Print Data Stream (Appendix A-3)				X	X	X
Communication Line Speed						
–110, 150, 200, 300, 600, 1200, 1800, 2400, 4800, or 9600 bps	X*	X*	X*	X*	X*	X*
Parity Selection						
–ODD, EVEN, MARK, or SPACE	X*	X*	X*	X*	X*	X*
Modem Control						
–Asynchronous Modem	X	X	X	X	X	X
–Reverse Channel Support	X*	X*	X*	X*	X*	X*
Break Signal (to a system/processor)	X	X	X	X	X	X

X : Function Provided

* : Setup Switch Selectable

Function Name	Model					
	10	12	13	20	22	23
Display Screen Format						
1920 character screen capacity (24 rows x 80 columns)	X	X	X	X	X	X
Operator Information Area	X	X	X	X	X	X
Displayable Graphic Set						
In non-transparent mode						
– 95 characters for U.S. and EMEA	X	X	X	X	X	X
– 158 characters for Japanese Katakana	X	X	X	X	X	X
– 126 characters for Bilingual English/ Canadian French	X	X	X	X	X	X
In transparent mode						
– 128 characters for U.S. and EMEA	X	X	X	X	X	X
– 191 characters for Japanese Katakana	X	X	X	X	X	X
– 159 characters for Bilingual English/ Canadian French	X	X	X	X	X	X
Control Character Display (Transparent Mode)	X	X	X	X	X	X
Character Box/Dot Matrix – 9 x 16/7 x 14 Dots	X	X	X	X	X	X
Reverse Video	X*	X*	X*	X*	X*	X*
Mono/Dual Case	X*	X*	X*	X*	X*	X*
Keyboard Feature						
ASCII or ISO code Keyboard	X	X	X	X	X	X
A Clustered 12-key numeric keypad	X	X	X	X	X	X
PF Keys	X	X	X	X	X	X
Keyboard Lock/Unlock	X	X	X	X	X	X
Keyboard Clicker	X	X	X	X	X	X
Typamatic Operation	X	X	X	X	X	X
Model 2X Unique Function Keys (14)				X	X	X
Setup Switches						
Model 2X Unique Setup Switches (5)	X	X	X	X	X	X
Edit Function						
Cursor Control						
– Up, Down, Left, Right, Home, New Line and Backspace	X	X	X	X	X	X
– Cursor Address Read/Write	X	X	X	X	X	X
– Block-shaped Cursor	X	X	X	X	X	X
– Blinking Cursor	X*	X*	X*	X*	X*	X*
Erase Function						
– Erase EOL/EOF (EOF = Model 2X only), EOS, Input	X	X	X	X	X	X
– Clear	X	X	X	X	X	X
Tab Operation						
– Forward Tab	X	X	X	X	X	X
– Back Tab				X	X	X

X : Function Provided

* : Setup Switch Selectable

Function Name	Model					
	10	12	13	20	22	23
Edit Function						
Format Operation						
– Protect/Unprotect				X	X	X
– Modified Data Tag (MDT)				X	X	X
– Field Highlighting						
– Highlighted Field				X	X	X
– Blinking Field				X	X	X
– Non-displayed Field				X	X	X
– Format Creation via Keyboard (Program Mode)				X	X	X
– Insert/Delete Function						
– Character Insert/Delete				X	X	X
– Line Insert/Delete				X	X	X
Auto New Line	X*	X*	X*	X*	X*	X*
Scroll On/Off	X*	X*	X*	X*	X*	X*
CR/CR-LF (Carriage Return and Line Feed)	X*	X*	X*	X*	X*	X*
Auto Line Feed	X*	X*	X*	X*	X*	X*
Audible Alarm	X	X	X	X	X	X
Operator's Controls/Indicator Lights						
Power On/Off (I/O) Switch	X	X	X	X	X	X
Normal/Test Switch	X	X	X	X	X	X
Brightness and Contrast Controls	X	X	X	X	X	X
Power-on Light	X	X	X	X	X	X
Light 1 (CRT Control Circuit)	X	X	X	X	X	X
Light 2 (DSR Signal/Current Flow)	X	X	X	X	X	X
Display Screen Filter	X	X	X	X	X	X
Power Supply						
Input Voltage } (See Section 5.2)	X	X	X	X	X	X
AC Primary Fuse }	X	X	X	X	X	X
Cables						
3.0 m (10 ft) Modem (See Section 5.2.4.1)	**	**	**	**	**	**
Power Cord (See Section 5.2)	X	X	X	X	X	X
Character Set						
U.S. ASCII or ISO code	X	X	X	X	X	X
Character Conversion in Send Data Stream (Appendix A-3.)				X	X	X

X : Function provided

* : Setup Switch Selectable

** : 3.0-meter (10-foot) modem cable for the 3101 can be ordered by the following part number from IBM as an accessory, if required.

U.S. modem Cable: P/N 5640736

WT modem Cable: P/N 5640850

U.K. Post Office modem cable: P/N 5640850 and 1743584 (adapter cable)

Appendix H. 3101 Modem Cable Connection Instructions

The modem cable for the 3101 terminal varies, depending on the type of modem used. For each type of modem, an appropriate modem cable and adapter cable, as shown below, are available as accessories. The IBM-supplied cable can be ordered by part number.

For EIA Modem (U.S. and Canada)

1. Connect the communication cable plug **1** to the connector #4 at the rear of the logic element.
2. Connect the other end of the communication cable to the EIA modem.

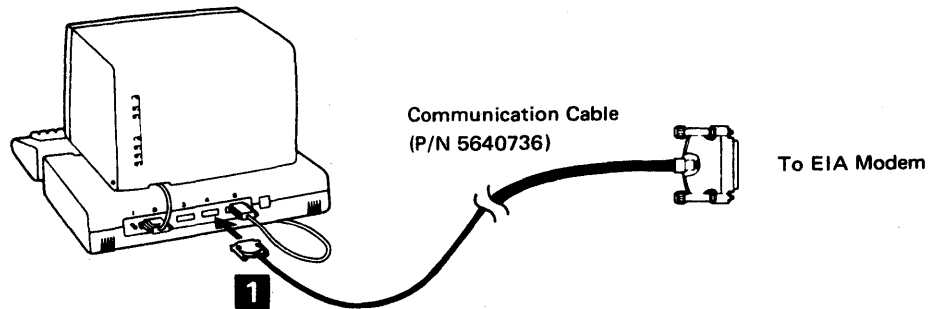

Cable Pin Assignment

Interface pins 11 and 12 are supplied, because 202-type modems use these pins as the reverse-channel interface.

EIA Modem Cable - 3.0 m

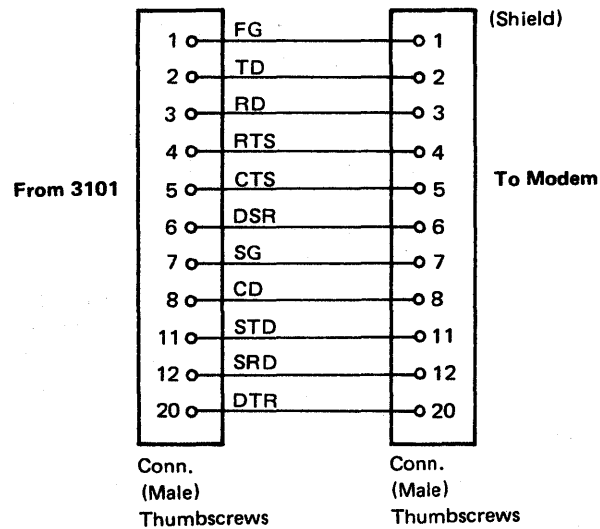

Note: For direct connection to the 8100 System, this cable must be used.

For CCITT Modem (All countries except U.K. and Japan)

1. Connect the communication cable plug **1** to the connector #4 at the rear of the logic element.
2. Disconnect the wrap socket **3** from the cable plug **2** of the communication cable.
3. Connect the cable plug **2** to the CCITT modem.

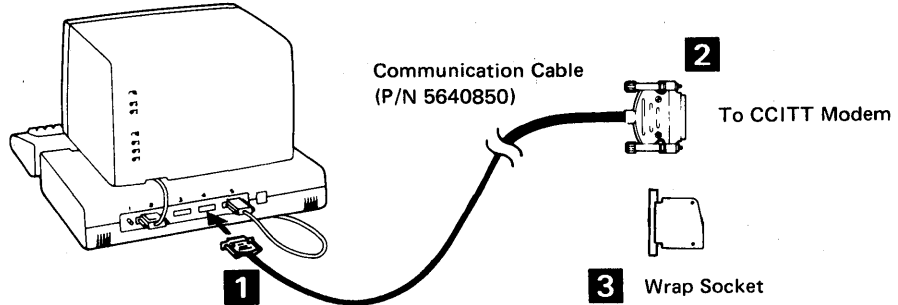

Cable Pin Assignment

For connection to IBM or PTT modems, the cable, P/N 5640850 (or equivalent), must be used.

CCITT Modem Cable - 3.0 m

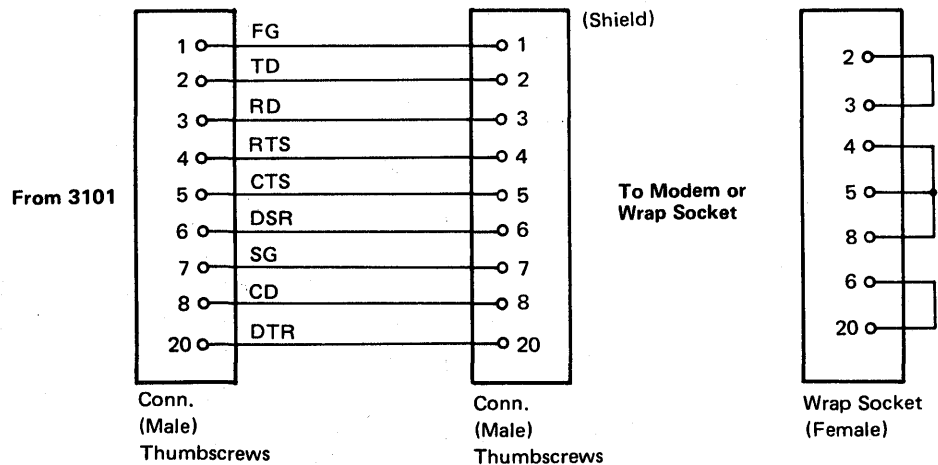

Note: The operator uses the wrap socket to determine if a problem exists in the terminal and cables by connecting the socket to the communication cable plug (see CPAR).

For U.K. Post Office Modem

1. Connect the communication cable plug **1** to the connector #4 at the rear of the logic element.
2. Disconnect the wrap socket **4** from the cable plug **2** of the communication cable.
3. Connect the cable plug **2** of the communication cable to the socket **3** of the 0.3-meter (12-inch) cable. Tighten the thumbscrews of the cable plug **2** securely with your fingers.
4. Connect the cable plug **5** on the other end of the 0.3-meter (12-inch) cable to the modem.

Note: In the U.K., an angled hood should be provided at the modem end for the post-office mandatory modem (switched network only).

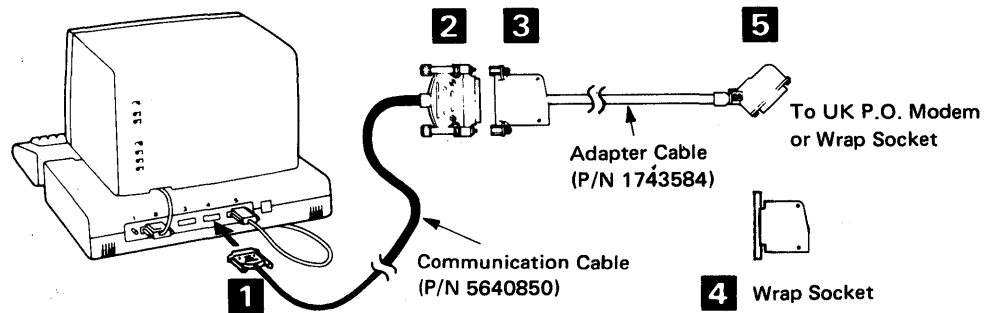

Cable Pin Assignment

For connection to the Post Office modem, the adapter cable (P/N 1743584) should be used.

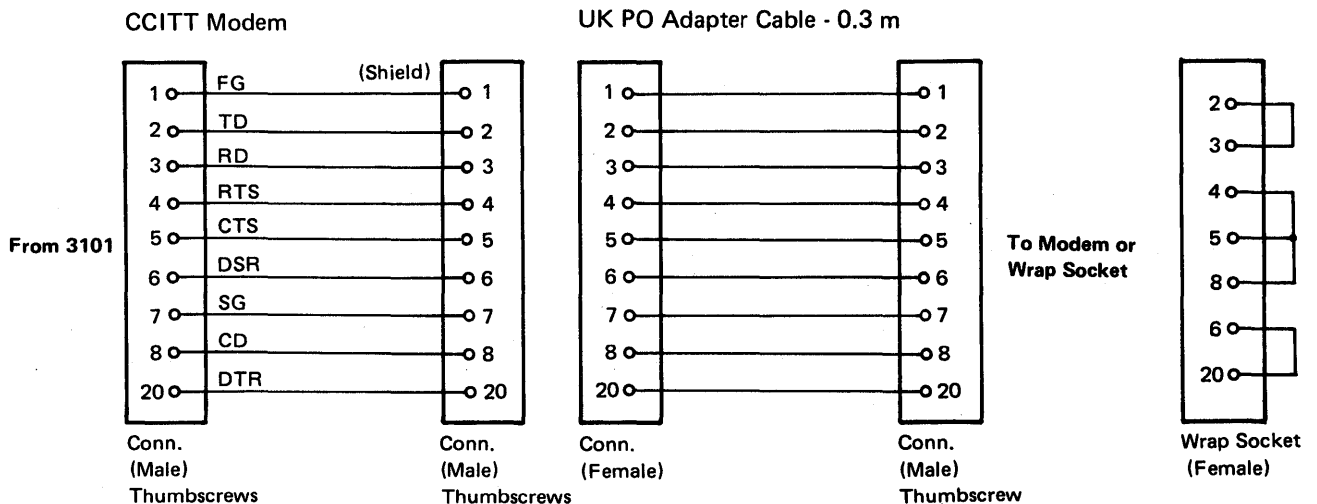

Note: The operator uses the wrap socket to determine if a problem exists in the terminal and cables by connecting the socket to the communication cable plug (see CPAR).

For Japan

The modem cable for Japan has a unique hood that allows the user to perform self-diagnostic tests without using any tools or disconnecting any cables.

The cable connecting procedure is:

1. Connect the communication cable plug **1** to the connector #4 at the rear of the logic element.
2. Set the Test/Oper switch **2** to the Oper position.
3. Connect the cable plug **3** to the modem. Tighten the thumbscrews of the cable plug securely with your fingers.

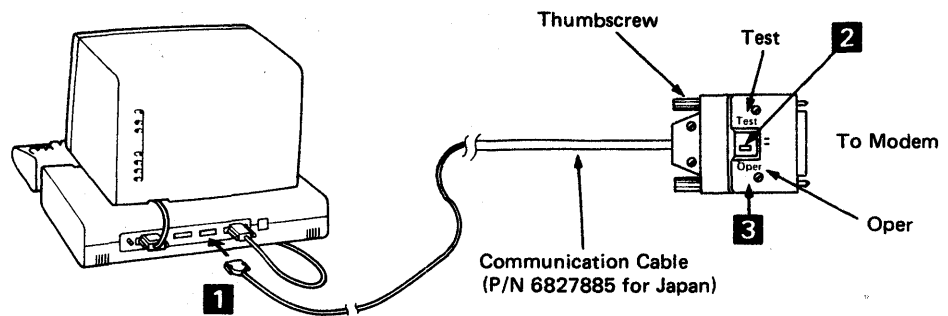

Note: The black thumbscrews on the communication cable shipped to you are made with metric threads and are attached to NTT modems or their equivalents. If your modem is an IBM 3976 Model 1 or 3, or any other modem using an English-unit connector, the black thumbscrews must be exchanged with the silver thumbscrews (made with English threads) in the customer envelope, as described in the following procedure.

Thumbscrew Replacement Instructions:

1. Remove the black thumbscrews **A** by pulling them in the direction of the arrows. (Do not be afraid to use force.)

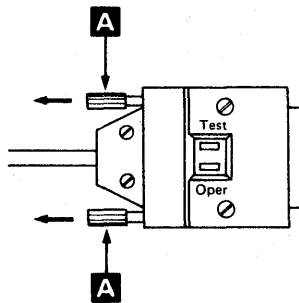

2. Insert the silver thumbscrews by pushing them in the reverse direction of the arrows until the end of each thumbscrew appears outside the hood.

Note: You should keep the removed thumbscrews in the customer envelope for later use; the modem may be changed or the terminal may be moved.

Cable Pin Assignment

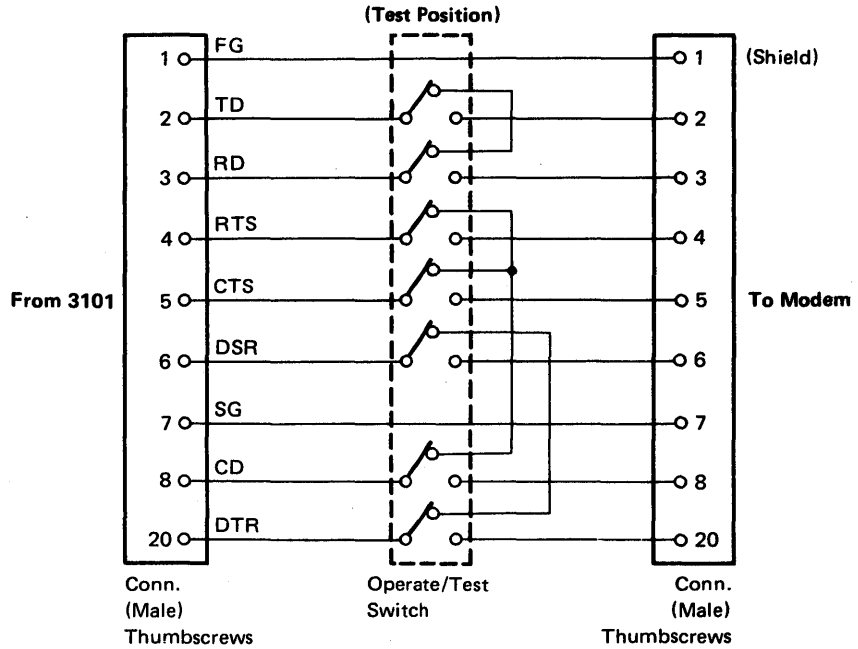

Modem Cable for Japan

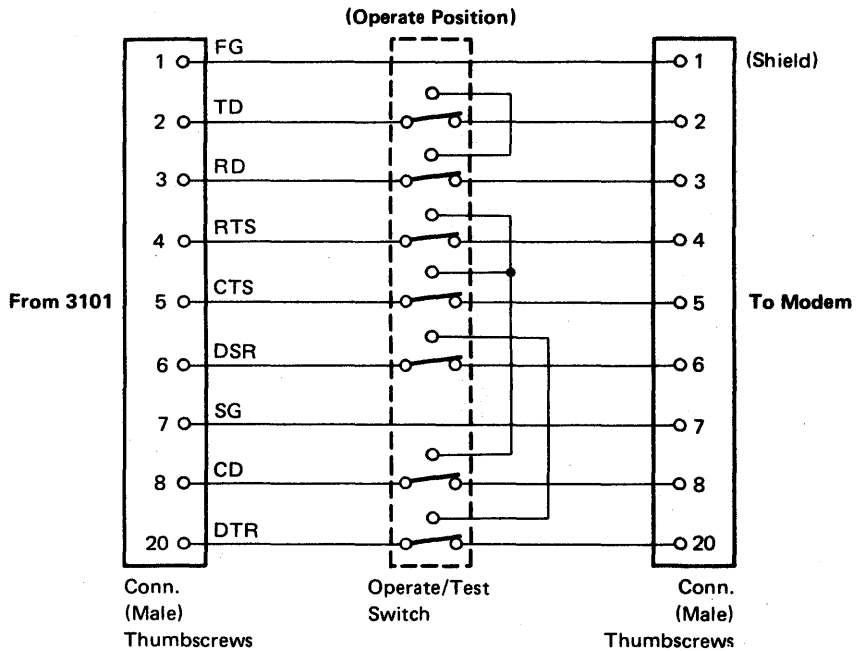

Appendix I. Summary of Cursor Movement

The following tables summarize the cursor movement caused by the various setup switch settings and the related key or receive operation.

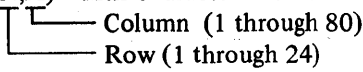
Legend: (N,M) = Mth Character Position of Nth Line

When the cursor is positioned at any character position (column M) of the Nth line, except the 24th line, the cursor moves as follows:

Setup Switch Setting			Cursor Moved by Pressing:				Cursor Moved by Receiving:			
AUTO LF	CR/CR-LF	SCROLL	New line Key	FF Key	CR Key	LF or VT Key	FF from Host	CR from Host	LF or VT from Host	CR-LF or CR-VT from Host
OFF	CR	OFF	(N, 1)	Same as ERASE INPUT	(N, 1)	(N+1,M)	Same as ERASE INPUT	(N, 1)	(N+1,M)	(N+1, 1)
OFF	CR	ON	(N, 1)	(N+1,M)	(N, 1)	(N+1,M)	(N+1, M)	(N, 1)	(N+1,M)	(N+1, 1)
OFF	CR-LF	OFF	(N+1, 1)	Same as ERASE INPUT	(N, 1)	(N+1,M)	Same as ERASE INPUT	(N, 1)	(N+1,M)	(N+1, 1)
OFF	CR-LF	ON	(N+1, 1)	(N+1,M)	(N, 1)	(N+1,M)	(N+1,M)	(N, 1)	(N+1,M)	(N+1, 1)
ON	CR	OFF	(N+1, 1)	Same as ERASE INPUT	(N+1, 1)	(N+1,M)	Same as ERASE INPUT	(N+1, 1)	(N+1,M)	(N+2, 1)*
ON	CR	ON	(N+1, 1)	(N+1,M)	(N+1, 1)	(N+1,M)	(N+1,M)	(N+1, 1)	(N+1,M)	(N+2, 1)**
ON	CR-LF	OFF	(N+2, 1)*	Same as ERASE INPUT	(N+1, 1)	(N+1,M)	Same as ERASE INPUT	(N+1, 1)	(N+1,M)	(N+2, 1)*
ON	CR-LF	ON	(N+2, 1)**	(N+1,M)	(N+1, 1)	(N+1,M)	(N+1,M)	(N+1, 1)	(N+1,M)	(N+2, 1)**

The switch setting of AUTO NL does not affect the above functions.

SCROLL is always assumed to be Off in formatted mode.

* When the cursor is positioned at line 23, the cursor moves to position (1, 1) after the operation.

** When the cursor is positioned at line 23, the display is scrolled up one line, and the cursor moves to position (24, 1) after the operation.

When the cursor is positioned at any character position (column M) of the bottom (24th) line, the cursor moves as follows:

Setup Switch Setting			Cursor Moved by Pressing:				Cursor Moved by Receiving:			
AUTO LF	CR/CR-LF	SCROLL	New line Key	FF Key	CR Key	LF or VT Key	FF from Host	CR from Host	LF or VT from Host	CR-LF or CR-VT from Host
OFF	CR	OFF	(24, 1) No Scroll	Same as ERASE INPUT	(24, 1) No Scroll	(1, M) No Scroll	Same as ERASE INPUT	(24, 1) No Scroll	(1, M) No Scroll	(1,1) No Scroll
OFF	CR	ON	(24, 1) No Scroll	(24, M) Scroll	(24, 1) No Scroll	(24, M) Scroll	(24, M) Scroll	(24, 1) No Scroll	(24, M) Scroll	(24, 1) Scroll
OFF	CR-LF	OFF	(1, 1) No Scroll	Same as ERASE INPUT	(24, 1) No Scroll	(1, M) No Scroll	Same as ERASE INPUT	(24, 1) No Scroll	(1, M) No Scroll	(1, 1) No Scroll
OFF	CR-LF	ON	(24, 1) Scroll	(24, M) Scroll	(24, 1) No Scroll	(24, M) Scroll	(24, M) Scroll	(24, 1) No Scroll	(24, M) Scroll	(24, 1) Scroll
ON	CR	OFF	(1, 1) No Scroll	Same as ERASE INPUT	(1, 1) No Scroll	(1, M) No Scroll	Same as ERASE INPUT	(1, 1) No Scroll	(1, M) No Scroll	(2, 1) No Scroll
ON	CR	ON	(24, 1) Scroll	(24, M) Scroll	(24, 1) Scroll	(24, M) Scroll	(24, M) Scroll	(24, 1) Scroll	(24, M) Scroll	(24, 1) 2 Scrolls
ON	CR-LF	OFF	(2, 1) No Scroll	Same as ERASE INPUT	(1, 1) No Scroll	(1, M) No Scroll	Same as ERASE INPUT	(1, 1) No Scroll	(1, M) No Scroll	(2, 1) No Scroll
ON	CR-LF	ON	(24, 1) 2 Scrolls	(24, M) Scroll	(24, 1) Scroll	(24, M) Scroll	(24, M) Scroll	(24, 1) Scroll	(24, M) Scroll	(24, 1) 2 Scrolls

The switch setting of AUTO NL does not affect the above function.

SCROLL is always assumed to be Off in formatted mode.

Abbreviations

- ADR.** Address.
A/FE. IBM World Trade Americas/Far East Corporation.
ALT. Alternate.
ANSI. American National Standards Institute.
ASCII. American National Standard Code for Information Interchange.
AT&T. American Telephone and Telegraph.
ATTR. Attribute.
AUTO NL. Automatic new line.
AUTO LF. Automatic line feed.
AUX. Auxiliary interface.
- BAT.** Basic assurance test.
BEL. The bell character.
BS. The backspace character.
BTAM. Basic telecommunications access method.
BTU. British thermal unit.
- C.** Celsius.
CAN. The cancel character.
CCITT. International Telegraph and Telephone Consultative Committee.
CD. Data-carrier-detected.
CHAR. Character.
CICS. Customer Information Control System.
CL/422. 20-mA current loop/EIA RS-422.
cm. Centimeter.
CR. The carriage return character.
CR • LF. Carriage return-line feed.
CRT. Cathode ray tube.
CRTS. Controlled request-to-send.
CTS. Clear to send.
- DEL.** The delete character.
DLE. The data link escape character.
DPPX. Distributed Processing Programming Executive.
DSR. Data set ready.
DUAL. Dual case character set.
- EBCDIC.** Extended binary-coded-decimal interchange code.
EIA. Electronic Industries Association.
EM. The end-of-medium character.
E/ME/A. IBM World Trade Europe/Middle East/Africa Corporation.
ENQ. The enquiry character.
EOF. end-of-field.
EOL. end-of-line.
EOS. end-of-screen.
EOT. The end-of-transmission character.
EP. Emulation program.
ESC. The escape character.
ETB. The end-of-transmission-block character.
ETX. The end-of-text character.
- F.** Fahrenheit.
FDX. Full-duplex (duplex).
FF. The form-feed character.
FS. The file-separator character.
ft. Foot (feet).
- GS.** The group-separator character.
HDX. Half-duplex
- HT.** The horizontal tabulation character.
- in.** Inch.
INS. The insert character.
ISO. International Organization for Standardization.
- kg.** Kilogram.
- LF.** The line-feed character.
- m.** Meter.
mA. Milliampere.
MDT. Modified data tag.
mm. Millimeter.
MONO. Monocase character set.
ms. Millisecond.
- NAK.** The negative acknowledge character.
NCP. Network control program.
NTO. Network Terminal Option.
NULL SUPP. Null suppression.
- OS.** Operating System.
- PF.** Program function.
P/N. Part number.
PRGM. Program.
PROT. Protected.
PRTS. Permanent request-to-send.
PTF. Program temporary fix.
PTT. Post Telephone and Telegraph Administration.
- REV CH.** Reverse channel.
RFS. Ready for sending.
RLSD. Received-line-signal detector.
RS. The record separator character.
RTS. Request to send.
- SBA.** Set buffer address.
SCP. System control programming.
SF. start-field.
SI. The shift-in character.
SO. The shift-out character.
SOH. The start-of-heading character.
SRD. Secondary received data.
STD. Secondary transmitted data.
STX. The start-of-text character.
SUB. The substitution character.
- TCAM.** Telecommunication access method.
TSO. Time sharing option.
- UNP.** Unprotected.
US. The unit-separator character.
- VM/370.** IBM Virtual Machine Facility/370.
VSPC. Virtual Storage Personal Computing.
VT. The vertical tabulation character.
VTAM. Virtual telecommunications access method.
- XOFF.** Transmission off.
XON. Transmission on.
XPARENT. Transparent.

Glossary

This glossary includes terms and definitions from the *IBM Vocabulary for Data Processing, Telecommunications, and Office Systems*, GC20-1699. If you do not find the term you are looking for, see the Index or the *IBM Vocabulary*.

A

access method. A technique for moving data between main storage and input/output devices.

adapter. (1) A mechanism for attaching parts, for example, parts having different diameters. (2) An 8100 Information System hardware connection provided on the 8130, 8140, and 8101 for attaching displays, printer devices, magnetic tape units, or another 8101 unit.

alphanumeric. Synonym for alphanumeric.

alphanumeric character set. A character set that contains both letters and digits and may contain control characters, special characters, and the space character.

application program. A program written for or by a user that applies to the user's work. (2) A program used to connect and communicate with stations in a network, enabling users to perform application-oriented activities.

ASCII. American National Standard Code for Information Interchange. The standard code, using a coded character set consisting of 7-bit coded characters (8 bits including parity check), used for information interchange among data processing systems, data communication systems, and associated equipment. The ASCII set consists of control characters and graphic characters.

attribute character. A code that defines the display attributes of the display field that follows. An attribute character is the first character in a display field, but it is not a displayable character.

audible alarm. An alarm that is activated when predetermined events occur that require operator attention or intervention for system operation.

B

block. (1) A string of records, a string of words, or a character string formed for technical or logic reasons to be treated as an entity. (2) A set of things, such as words, characters, or digits, handled as a unit.

block transfer. The process, initiated by a single action, of transferring one or more blocks of data.

buffer. An area of storage that is temporarily reserved for use in performing an input/output operation, into which data is read, or from which data is written. Synonymous with I/O area.

buffer address. The address of a location in the buffer at which one character can be stored.

buffer-print operation. An operation that prints the contents of the buffer from the 3101 to an attached printer.

C

cathode ray tube (CRT). A vacuum tube display in which a beam of electrons can be controlled to form alphanumeric characters or symbols on a luminescent screen, for example, by use of a dot matrix.

character. (1) A member of a set of elements upon which agreement has been reached and that is used for the organization, control, or representation of data. Characters may be letters, digits, punctuation marks, or other symbols often represented in the form of a spatial arrangement of adjacent or connected strokes, or in the form of other physical conditions in data media. (2) A letter, digit, or other symbol that is used as part of the organization, control, or representation of data.

character mode. An operating mode of the 3101 in which data is transferred character by character in either half-duplex or duplex.

character position. Synonym for display position.

communication common carrier. In the U.S.A. and Canada, a public data transmission service that provides the general public with transmission service facilities; for example, a telephone or telegraph company.

communication controller. A type of communication control unit whose operations are controlled by one or more programs stored and executed in the unit; for example, the IBM 3704 and 3705 Communication Controllers.

control character. A character whose occurrence in a particular context initiates, modifies, or stops a control operation. A control character may be recorded for use in a subsequent action, and it may have a graphic representation in some circumstances.

cursor. In computer graphics, a movable marker that is used to indicate a position on a display space.

D

data set. The major unit of data storage and retrieval, consisting of a collection of data in one of several prescribed arrangements and described by control information to which the system has access.

data stream. For the 3101, all data transferred to the 3101 or printer through a telecommunication or auxiliary interface in a single read, write, or buffer-print operation.

direct connection. The attachment of a terminal or similar device directly to a host computer; that is, not through an interface, such as a modem.

display attribute. In computer graphics, a particular property that is assigned to all or part of a display; for example, low intensity, green color, blinking status.

display field. In computer graphics, an area in a display buffer or on a display space that contains a set of characters that can be manipulated or operated upon as a unit.

display position. In computer graphics, any position in a display space that can be occupied by a picture element or a display element.

duplex. In data communication, pertaining to a simultaneous two-way independent transmission in both directions. Contrast with half-duplex.

E

escape command sequence. A two-character sequence that consists of ESC (hexadecimal code 1B in ASCII) and the command character that follows; specifies the 3101 command.

F

field. (1) In a record, a specified area used for a particular category of data, for example, a group of card columns in which a wage rate is recorded. (2) In a data base, the smallest unit of data that can be referred to. (3) See display field.

formatted display. On a display device, a display in which the attributes of one or more display fields have been defined by the user. Contrast with unformatted display.

G

graphic character. A character, other than a control character, that is normally represented by a graphic.

H

half-duplex. In data communication, pertaining to an alternate, one way at a time, independent transmission. Contrast with duplex.

hardware. Physical equipment used in data processing, as opposed to computer programs, procedures, rules, and associated documentation. Contrast with software.

highlighted display. An attribute of a display field that causes data in that field to be displayed at a brighter level than other data displayed on the display surface.

host computer. (1) In a network, a computer that primarily provides services such as computation, data base access, or special programs or programming languages. (2) The primary or controlling computer in a multiple computer installation.

I

input field. In computer graphics, an unprotected field on a display surface in which data can be entered, modified, or erased.

inquiry. A request for information from storage, or a machine statement to initiate a search of library documents.

interface. A shared boundary. An interface might be a hardware component to link two devices, or it might be a portion of storage or registers accessed by two or more computer programs.

L

local mode. In a telecommunication system, the operation of a terminal without interaction with the host program.

M

modem (modulator-demodulator). A device that modulates and demodulates signals transmitted over telecommunication facilities.

modified data tag (MDT). A bit in the attribute character of a display field that, when set, causes that field to be transferred to the channel during a read-modified operation. The MDT may be set by a keyboard input to the field, or by program control. It may be reset by program control or by the ERASE INPUT key.

N

nonswitched line. A telecommunication line on which connections do not have to be established by dialing.

null character (NUL). A control character that is used to accomplish media-fill or time-fill, and that may be inserted into or removed from a sequence of characters without affecting the meaning of the sequence; however, the control of equipment or the format may be affected by this character.

null suppression. The bypassing of all null characters to reduce the amount of data to be transferred.

O

operator information area. For the 3101, the 25th row of data on the display surface in which the operator is supplied information concerning system status.

P

parity bit. A binary digit appended to a group of binary digits to make the sum of all the digits either always odd (odd parity) or always even (even parity).

parity check. (1) A redundancy check that uses a parity bit. (2) For the 3101, occurs when 3101 circuitry detects one or more characters with bad parity in a buffer.

program function (PF) key. On a display device keyboard, a key that passes a signal to a program to call for a particular display operation.

protected field. On a display device, a display field in which the user cannot enter, modify, or erase data. Contrast with unprotected field.

R

remote attachment. The attachment of a terminal or other similar device to a host computer by means of a data link; for example, a modem.

repeat-action key. A key that, when held fully pressed, causes an action (such as typing of a character) to be repeated until the key is released.

reverse channel. In conjunction with Bell System data sets, a means of simultaneous communication from the receiver to the transmitter over half-duplex data transmission systems. The reverse channel is generally used only for the transmission of control information.

reverse video. A form of highlighting a character, field, or cursor by reversing the color of the character, field, or cursor with its background; for example, changing a red character on a black background to a black character on a red background.

S

scrolling. In computer graphics, moving, vertically or horizontally, a display image in a manner such that new data appears at one edge as old data disappears at the opposite edge. For the 3101, only vertical scrolling is available.

software. Programs, procedures, rules, and any associated documentation pertaining to the operation of a computer system. Contrast with hardware.

start-stop transmission. Asynchronous transmission such that a group of signals representing a character is preceded by a start element and followed by a stop element.

switched line. A telecommunication line in which the connection is established by dialing. Contrast with nonswitched line.

T

telecommunication administration. Any governmental department or service responsible for implementing the obligations undertaken in the International Telecommunication Convention and the Regulations annexed thereto.

telecommunication facility. (1) Transmission capabilities, or the means for providing such capabilities, made available by a communication common carrier or by a telecommunication administration. (2) For the 3101, any medium that connects the 3101 with a computer.

typematic key. A repeat-action key.

U

unformatted display. A display screen on which no display field has been defined by the user. See also protected field.

unprotected field. On a display device, a display field in which the user can enter, modify, or erase data. Contrast with protected field.

W

work-station element. A functional element to which the user can isolate a fault and replace for maintenance purposes.

wrap. Synonym for wraparound.

wraparound. The continuation of an operation from the maximum addressable location in storage to the first addressable location.

INDEX

- abbreviations Abbrev-1
- ac primary fuse 3-2, 5-13
- action field message 2-31
- address, cursor 2-6
- air flow, specifications 5-13
- alarm, audible, volume control 3-2
- Alpha Sign, Katakana Shift key 3-18
- Alpha, Katakana Shift key 3-18
- ALT key 3-21
- ambient lighting, site preparation 5-15
- ASCII (American National Standard Code for Information Interchange) 1-1
- ASCII code 2-7
 - character sets B-2
 - translation table F-1
- assistance, on-site 1-3
- attachment 1-2
 - direct 1-3
 - remote 1-3
 - line speed 1-3
- ATTR key 3-12
 - definition of attribute characters 3-14
- attribute character 2-5
 - definition 3-14
 - buffer print operation 2-26
- audible alarm volume control 3-2
- AUTO LF setup switch 3-9
- AUTO NL setup switch 3-9
- AUX key 3-15
 - monitor print operation 2-26
- auxiliary port 5-3

- back tab command 2-20
- Back-Tab key 3-20
- Backspace key 3-19
- Bilingual English/Canadian French character set B-3
- bit assignment, field attribute character 2-6
- blink cursor, setup switch 3-10
- BLOCK/CHAR, setup switch 3-5
- block mode 2-1
- BREAK key 3-25
- brightness control 3-3
- buffer address 2-6
 - parameters, display screen 2-24
 - Set Buffer Address (SBA) 2-23
- buffer print operation 2-11, 2-26
 - attribute character 2-26
 - non-display field characters 2-26

- cable pin assignment
 - CCITT modem H-2
 - EIA modem H-1
 - modems in Japan H-4
 - U.K. Post Office modem H-3
- cable connections, modem H-1, H-2, H-3, H-4
- cable length 5-17
- cable requirements, site preparation 5-16
- cable specifications, telecommunication 5-18
- Canadian English messages in Operator Information Area C-2
- Canadian French messages in Operator Information Area C-3
- Canadian French, shift control codes 2-11

- cancel command 2-22
 - buffer print operation 2-26
- cancel key 3-19
 - buffer print operation 2-26
- cathode ray tube (CRT) 1-1
- CCITT modem H-2
 - cable pin assignment H-2
 - cable connection H-2
- CCITT V.23 type, modems 2-19
- CCITT V.11, direct attachment 5-6
- character conversion
 - print data stream A-5
 - send data stream A-5
- character mode 2-1
- character set
 - bilingual English/Canadian French B-3
 - English B-10
 - French B-7
 - German B-8
 - Italian B-9
 - Japanese Katakana B-5
 - U.S. English B-2
- checklist, setup switch 5-10
- clear all command 2-22
- CLEAR key 3-16
- clear tab command 2-20
- Click key 3-17
- code translation table (ASCII to EBCDIC) F-1
- commands 2-19
 - characteristics 2-19
 - descriptions 2-20
 - back tab 2-20
 - cancel 2-22
 - clear all 2-22
 - clear tab 2-20
 - cursor down 2-21
 - cursor home 2-22
 - cursor left 2-21
 - cursor right 2-21
 - cursor up 2-21
 - delete character 2-22
 - delete line 2-22
 - enter transparent mode 2-3
 - erase EOF/EOL 2-22
 - erase EOS 2-22
 - erase input 2-22
 - exit transparent mode 2-3
 - insert character 2-22
 - insert cursor 2-23
 - insert line 2-22
 - lock keyboard 2-23
 - print line 2-23
 - print message 2-23
 - print page 2-23
 - read buffer 2-21
 - read cursor address 2-20
 - read setup switch 2-21
 - read status 2-20
 - set buffer address 2-23
 - set control 2-21
 - set cursor address 2-23
 - set tab 2-20
 - start field 2-20

- unlock keyboard 2-23
- write send mark 2-22
- escape sequences 2-19
- communication mode 2-2
- connector, 25 pin 5-18
- contrast control 3-3
- control, brightness 3-3
- control characters 3-22
 - data stream 2-7
- control, contrast 3-3
- CPAR (Customer Problem Analysis and Resolution Guide) 1-3
- CPT-TWX 33/35 type terminal support (SUB) 4-2
- CR/CR•LF, setup switch 3-9
- CR, turnaround character switch 3-6
- CRT (cathode ray tube) 1-1
- CTS(RFS) time out 2-18
- current loop interface wiring 5-5
- current loop, power supply 5-5
- cursor address 2-6
 - cursor move command 2-6
 - cursor movement table 1-1
 - insert cursor command 2-7
 - parameters 2-24
 - set cursor address command 2-7
- cursor down command 2-21
- cursor home command 2-22
- cursor left command 2-21
- cursor right command 2-21
- cursor up command 2-21
- customer problem analysis and resolution (CPAR) guide 1-3

- data character, data stream 2-7
- data flow 2-13
- data stream 2-7
 - control characters 2-7
 - data character 2-7
 - from the host, example 2-10
 - to the host, example 2-9
 - print A-5
 - send A-5
- data stream format
 - block mode 2-8
 - character mode 2-8
 - to printer 2-11
- data transfer mode
 - block 1-1, 2-1
 - character 1-1, 2-1
- data-bit format 2-7
- dead keys (see also lock field messages) 3-28
- default attribute, formatted display 2-4
- DEL CHAR key 3-26
- DEL key 3-24
- DEL LINE key 3-26
- delete character command 2-22
- delete line command 2-22
- dimensions, IBM 3101 5-12
- direct attachment
 - CCITT V.11 5-6
 - EIA RS-422 5-6
 - wiring examples 5-7
- DISABLED KEY, lock field messages 2-29
- display buffer 2-4
 - address 2-6
 - buffer location 2-4
 - character position 2-4

- display field 2-5
- display image 2-4
 - formatted display 2-4
 - default attribute 2-4
 - example 2-5
 - unformatted display 2-4
- display screen buffer address
 - parameters 2-24
- DUAL/MONO setup switch 3-6
 - bilingual English/Canadian French 3-7
 - Japanese Katakana 3-7
 - national character keys 3-7
- duplex operating state - character mode 2-14
- duplex operation 2-14
- duplex telecommunication facility 2-17, 4-16, 5-7
 - CTS(RFS) time out 2-18

- EDIT, function support 4-2
- editing function support (EDIT) 4-2
- EIA modem
 - cable pin assignment H-1
 - cable connection H-1
- EIA RS-422, direct attachment 5-6
- electrical requirements 5-13
- electromagnetic interference, site preparation 5-15
- electrostatic discharge, site preparation 5-14
- English messages in Operator Information Area C-5
- English character set B-10
- ENQ characters 4-11
- enter transparent mode command 2-3
- environmental safety 5-18
 - Lightning protection 5-19
- environment, specifications 5-13
- EOT, turnaround character switch 3-6
- ERASE EOL/EOF key 2-22, 3-16
- erase EOL/EOF command 2-22
- erase EOS command 2-22
- ERASE EOS key 3-16
- erase input command 2-22
- ERASE INPUT key 3-16
- error symbol 2-10
 - conversion 2-10
 - print data stream 2-10
- ESC key (see also escape sequence) 3-14
- ESC sequence
 - invalid parameters 4-12
 - timing 4-12
- escape sequences 2-19
- ETX, turnaround character switch 3-6
- EVEN, parity bit selection switch 3-7
- exit transparent mode command 2-3

- facilities, telecommunication service preparation 5-7
- field attribute character 2-5
 - bit assignment 2-6
 - characteristics 2-5
 - character display 2-6
 - protected/unprotected 2-6
 - tab stop positions 2-6
 - Modified data tag (MDT) 2-5
- filter, video element screen 1-2
- floor planning, site preparation 5-14
- FORMAT CHECK, lock field messages 2-30
- formatted display 2-4

French messages in Operator Information Area C-5
 French character set B-7
 FULL function support 4-3

German messages in Operator Information Area C-6
 German character set B-8
 glossary Gloss-1
 grounding 5-19

half-duplex operating state - block mode 2-16
 character mode 2-15
 half-duplex operation 2-14
 half-duplex telecommunication facility 2-17, 4-17, 5-7
 with reverse channel
 CTS(RFS) time out 2-18
 transmit pending state 2-18
 without reverse channel
 CTS(RFS) time out 2-18
 transmit-pending state 2-18
 HDX/FDX, setup switches 3-5
 heat output, specifications 5-13
 Home key 3-25
 host system support 4-1
 host programming support 4-1

IBM host programming support 4-1
 CPT-TWX 33/35 type terminal support 4-2
 editing function support 4-2
 3101 function support 4-3
 IBM host system support 4-1
 line speeds 4-3
 telecommunication facilities 4-3
 IBM modems 2-19, 5-4
 IBM repair center 1-3
 IBM 3101 dimensions 5-12
 indicators
 light 1 3-2
 light 2 3-2
 locations 3-1
 power-on light 3-2
 inoperative keys (see also lock field messages) 3-27
 INS CHAR key 3-25
 INS LINE key 3-26
 insert character command 2-22
 insert cursor command 2-23
 insert field message 2-30
 insert line command 2-22
 interface diagram
 auxiliary port 5-3
 telecommunication port 5-3
 interface switch, setup switches 3-5
 interface wiring, current loop 5-5
 invalid parameters, ESC sequence 4-12
 INVALID SEQUENCE, lock field message 2-30
 ISO (International Organization for Standardization Code) 1-1
 Italian messages in Operator Information Area C-6
 Italian character set B-9

Japanese Katakana messages in Operator Information Area C-4
 Japanese Katakana character set B-5

Kana Sign, Katakana Shift key 3-18
 Kana, Katakana Shift key 3-18
 Katakana keyboard shift control codes 2-11
 Katakana Shift key 3-18
 Alpha 3-18
 Alpha Sign 3-18
 Kana 3-18
 Kana Sign 3-18
 keyboard element 1-1
 keyboard key functions
 ALT key 3-21
 ATTR key 3-12
 definition of attribute characters 3-14
 AUX key 3-15
 Back-Tab key 3-20
 Backspace key 3-19
 BREAK key 3-25
 CANCEL key 3-19
 CLEAR key 3-16
 Click key 3-17
 dead keys 3-28
 DEL CHAR key 3-26
 DEL key 3-24
 DEL LINE key 3-26
 ERASE EOL/EOF key 3-16
 ERASE EOS key 3-16
 ERASE INPUT key 3-16
 ESC key 3-14
 Home key 3-25
 inoperative keys 3-27
 INS CHAR key 3-25
 INS LINE key 3-26
 Katakana Shift key 3-18
 LOCAL key 3-17
 Move Cursor keys 3-27
 New Line key 3-20
 numeric keypad 3-11
 PRGM MODE key 3-14
 PRINT key 3-15
 PRINT LINE key 3-15
 PRINT MSG key 3-15
 Program Function keys 3-27
 RESET key 3-19
 SEND key 3-24
 SEND LINE key 3-17
 SEND MSG key 3-16
 Shift key 3-18
 Shift Lock key 3-18
 Tab key 3-18
 typematic rates 3-11
 keyboard layouts B-1
 keypad, numeric 3-11

length, cable 5-17
 light 1 3-2
 light 2 3-2
 lightning protection 5-19
 LINE CHECK 1, lock field messages 2-28
 LINE CHECK 2, lock field messages 2-28
 line speed switches auxiliary interface 3-10
 telecommunication interface 3-10
 line speeds auxiliary interface 3-10
 telecommunication interface 3-10

- IBM host system support 4-1
- line speed, remote attachment 1-3
- line transmission code
 - ASCII 1-1
 - ISO 1-1
- LOCAL key 3-17
- local mode 2-2
- lock field messages 2-27
 - DISABLED KEY 2-29
 - FORMAT CHECK 2-30
 - INVALID SEQUENCE 2-30
 - LINE CHECK 1 2-28
 - LINE CHECK 2 2-28
 - MODE/SETUP CHECK 2-29
 - PRINTING 2-29
 - priorities 2-28
 - RE-KEY 2-29
 - SENDING 2-29
 - SYSTEM COMMAND 2-29
 - SYSTEM NOT READY 2-28
- lock keyboard command 2-23
- logic element 1-1
- logical keyboard lock 4-11

- Machine Element Replacement Service, On-Site 1-3
- machine status field messages 2-31
- maintenance 1-3
- MARK, parity bit selection switches 3-7
- MDT (modified data tag) 2-6
- messages
 - normal mode 2-27
 - insert field 2-30
 - lock field 2-27
 - miscellaneous status field 2-31
 - mode field 2-27
 - send/receive field 2-30
 - shift field 2-30
 - sub-mode 2-27
 - test mode 2-31
 - action field 2-31
 - machine status field 2-31
 - mode field 2-31
- messages in Operator Information Area
 - Canadian English C-2
 - Canadian French C-3
 - English C-5
 - French C-5
 - German C-6
 - Italian C-6
 - Japanese Katakana C-4
 - U.S. English C-1
- miscellaneous status field messages 2-31
- mode
 - block 1-1, 2-1
 - character 1-1, 2-1
 - data transfer 2-1
- MODE/SETUP CHECK, lock field messages 2-29
- mode field messages 2-27
- mode transition
 - block mode 2-2
 - character mode 2-1
- model
 - 1X 1-1
 - 2X 1-1
- modem cable connection
 - CCITT modem H-2
 - EIA modem H-1
 - U.K. Post Office modem H-3
 - Japan H-4
- modem cables 5-4
- modems 2-19, 5-4
 - CCITT V.23 type 2-19
 - 103A type 2-19
 - 113A type 2-19
 - 202 type 2-19
- modified data tag (MDT) 2-6
- modified data, send operation 2-8
- monitor print operation 2-26
 - AUX key 2-26
- Move Cursor keys 3-27

- national character keys 2-30, 3-7
- New Line key 3-20
- non-display field characters, buffer print operation 2-26
- NORMAL/TEST switch 3-2
- normal mode 2-2
- normal mode messages 2-27
 - insert field message 2-30
 - lock field messages 2-27
 - miscellaneous status field messages 2-31
 - mode field messages 2-27
 - send/receive field messages 2-30
 - shift field message 2-30
 - sub-mode messages 2-27
- null characters 2-11, 3-8
- NULL SUPP, setup switch 3-8
- null suppression 3-8
 - formatted operation 3-8
 - unformatted operation 3-8
- numeric keypad 3-11

- ODD, parity bit selection switches 3-7
- on-site assistance 1-3
- On-Site Machine Element Replacement Service 1-3
- operational modes
 - normal 2-2
 - program 2-3
 - transparent 2-3
- operator controls
 - audible alarm volume control 3-2
 - brightness control 3-3
 - contrast control 3-3
 - locations 3-1
 - NORMAL/TEST switch 3-2
 - power switch 3-2
- operator information area, messages C-1
- operator workspace 5-14

- parameters, display buffer address 2-24
- parameters, cursor address 2-24
- parity bit 2-7, 3-7
- parity bit selection switches
 - EVEN 3-7
 - MARK 3-7
 - ODD 3-7
 - SPACE 3-7
- physical planning template E-1

- planning
 - programming support preparation 5-8
 - setup switch setting preparation 5-8
 - telecommunication service preparation 5-2
- planning checklist 5-1
- Post Telephone and Telegraph Administration (PTT) 1-1
- power plug requirements D-1
- power supply
 - air flow 5-13
 - current loop 5-5
 - heat output 5-13
 - power plug D-1
- power switch 3-2
- power-on light 3-2
- PRGM MODE key 3-14
- print data stream, character conversion A-5
- print key 3-15
 - buffer print operation 2-26
- print line command 2-23
- print line key 3-15
 - buffer print operation 2-26
- print message command 2-23
- print MSG key 3-15
 - buffer print operation 2-26
 - send mark 3-15
- print operation
 - buffer 2-26
 - monitor 2-26
- print page command 2-23
- PRINTING, lock field messages 2-29
- priorities, setup switches 3-4
- priorities, lock field messages 2-28
- product safety
 - grounding 5-19
- Program Function keys 3-27
- program mode 2-3
- programming considerations 4-11
 - ENQ characters 4-11
 - logical keyboard lock 4-11
 - read commands 4-11
- programming support preparation 5-8
- protected field attribute 2-6
- PRTS/CRTS, setup switches 3-6
- PTT (Post Telephone and Telegraph Administration) 1-2

- RE-KEY, lock field messages 2-29
- read buffer command 2-21, 4-12
- read cursor address command 2-20, 4-12
- read setup command 2-21, 4-12
- read setup switch command 2-21
- read status command 2-20
- receive operation A-4
- record separator 3-8
- remote attachment 1-3
 - line speed 1-3
- repair center 1-3
- Replacement Service, On-Site Machine Element 1-3
- requirements, cable 5-16
- RESET key 3-19
- REVERSE CH, setup switch 3-6
- REVERSE VIDEO, setup switch 3-10

- SBA (set buffer address) 2-6, 2-23
- screen filter, video element 1-2
- scroll, setup switches 3-9
- send/receive field messages 2-30
- send all data 2-8
- send data stream, character conversion A-5
- send key (see also send line option switch) 3-7, 3-24
- send line key 3-17
- send line option setup switch 3-7
- send mark 2-10, 3-15
 - treatment 2-10
- print data stream 2-10
- send modified data 2-8
- send MSG key (see also commands) 3-15
- send operation A-1
 - send all data 2-8
 - send modified data 2-8
 - send unprotected data 2-8
- SENDING, Lock field messages 2-29
- send/receive field message 2-30
- Series/1 support 4-9
- service clearances, specifications 5-13
- set buffer address command 2-23
- set control command 2-21
 - control byte graphic representation 2-25
- set cursor address command 2-23
- set tab command 2-20
- setup switch layout 3-4
- setup switch setting preparation 5-8
- setup switches 3-3, 5-9
 - AUTO LF 3-9
 - AUTO NL 3-9
 - blink cursor 3-10
 - BLOCK/CHAR 3-5
 - CR/CR•LF 3-9
 - DUAL/MONO 3-6
 - HDX/FDX 3-5
 - interface switch 3-5
 - line speed switches auxiliary interface 3-10
 - telecommunication interface 3-10
 - NULL SUPP 3-8
 - parity bit selection switches 3-7
 - priorities 3-4
 - PRTS/CRTS 3-6
 - REVERSE CH 3-6
 - REVERSE VIDEO 3-10
 - scroll 3-9
 - send line option switch 3-7
 - STOP 1/STOP 2 3-7
 - time-fill switches 3-9
 - turnaround character switches
 - CR 3-6
 - EOT 3-6
 - ETX 3-6
 - XOFF 3-6
- setup switch checklist 3-10
- shift control codes
 - Canadian French 2-11
 - Katakana keyboard 2-11
- shift field message 2-30
- Shift key 3-18
- Shift Lock key 3-18
- site preparation 5-11
 - ambient lighting 5-15
 - cable requirements 5-16
 - environmental safety 5-18
 - electromagnetic interference 5-15
 - electrostatic discharge 5-14
 - floor planning 5-14

- product safety 5-18
- viewing distance 5-15
- SPACE, parity bit selection switch 3-7
- specifications
 - air flow 5-13
 - electrical requirements 5-13
 - environment 5-13
 - heat output 5-13
 - service clearances 5-13
 - telecommunication cable 5-18
 - weight 5-13
- start field command 2-20
- STOP 1/STOP 2, setup switches 3-7
- SUB terminal support 4-2
- sub-mode messages 2-27
- support
 - editing function 4-2
 - host programming 4-1
 - CPT-TWX 33/35 terminal 4-2
 - 3101 function 4-3
 - 4300 4-8
 - 8100 4-9
 - Series/1 4-9
 - System/370 4-5
- SYSTEM COMMAND, lock field messages 2-29
- system configuration 1-4
- SYSTEM NOT READY, lock field messages 2-28
- system/370 4-5

- Tab key 3-18
- tab stop positions, field attribute 2-6
- telecommunication cable specifications 5-18
- telecommunication facilities 2-17, 4-3
 - duplex 2-17
 - half-duplex
 - with reverse channel 2-18
 - without reverse channel 2-17
- telecommunication modes
 - communication 2-2
 - local 2-2
- telecommunication operating states 2-14
 - duplex operating state - character mode 2-14
 - half-duplex operating state - block mode 2-15
 - half-duplex operating state - character mode 2-16
- telecommunication operations 2-14
 - duplex 2-14
 - half-duplex 2-14
- telecommunication port 5-3
- telecommunication service preparation 5-2
 - facilities 5-7
 - IBM modems 5-4
 - modem cables 5-4
- template, physical planning E-1
- test mode messages
 - action field 2-31
 - machine status field 2-31
 - mode field 2-31
- tilting capability, video element 1-2
- time-fill characters 3-9
- time-fill setup switches 3-9

- timeout
 - CTS(RFS) 2-18
- timing, ESC sequence 4-12
- trailing nulls 2-11
- transition, mode
 - block 2-2
 - character 2-1
- transmission bit format 2-7
- transmission code, line 1-1
- transmit pending state 2-18
- transparent mode 2-3
- turnaround character switches 3-6
 - CR 3-6
 - EOT 3-6
 - ETX 3-6
 - XOFF 3-6
- turnaround characters 3-6
 - record separator 3-8
- typematic rates 3-11

- U.K. Post Office modem
 - cable pin assignment H-3
 - cable connection H-3
- U.S. English messages in Operator Information Area C-1
- U.S. English character set B-2
- unformatted display 2-4
- unlock keyboard command 2-23
- unprotected field attribute 2-6

- video element 1-1
 - screen filter 1-2
 - tilting capability 1-2
- viewing distance, site preparation 5-15
- volume control, audible alarm 3-2

- weight, specifications 5-13
- wiring examples, (EIA) 5-7
- work station element 1-1
- write send mark command 2-22

- XOFF, turnaround character switches 3-6

- 103A type modems 2-19
- 113A type modems 2-19

- 25-pin connector 5-18
- 202 type modems 2-19

- 3101 function support (FULL) 4-3
- 3101 functions G-1
- 3101 setup switch checklists 5-10
- 3704/3705 system support 4-4

- 4300 support 4-8
- 8100 support 4-9

IBM 3101 Display Terminal Description

**READER'S
COMMENT
FORM**

GA18-2033-2

This manual is part of a library that serves as a reference source for systems analysts, programmers, and operators of IBM systems. This form may be used to communicate your views about this publication. They will be sent to the author's department for whatever review and action, if any, is deemed appropriate. Comments may be written in your own language; use of English is not required.

IBM may use or distribute any of the information you supply in any way it believes appropriate without incurring any obligation whatever. You may, of course, continue to use the information you supply.

Note: *Copies of IBM publications are not stocked at the location to which this form is addressed.*

Please direct any requests for copies of publications, or for assistance in using your IBM system, to your IBM representative or to the IBM branch office serving your locality.

Possible topics for comment are:

Clarity Accuracy Completeness Organization Coding Retrieval Legibility

If you wish a reply, give your name and mailing address:

Please use pressure sensitive or other gummed tape to seal this form.

Cut or Fold Along Line

What is your occupation? _____

Number of latest Technical Newsletter (if any) concerning this publication: _____

Thank you for your cooperation. No postage stamp necessary if mailed in the U.S.A. (Elsewhere, an IBM office or representative will be happy to forward your comments.)

Cut or Fold Along Line

Reader's Comment Form

Fold and tape

Please Do Not Staple

Fold and tape



NO POSTAGE
NECESSARY
IF MAILED
IN THE
UNITED STATES



BUSINESS REPLY MAIL
FIRST CLASS PERMIT NO. 40 ARMONK, N.Y. U.S.A.
POSTAGE WILL BE PAID BY ADDRESSEE

INTERNATIONAL BUSINESS MACHINES CORPORATION
DEPARTMENT 812J
1133 WESTCHESTER AVENUE
WHITE PLAINS, NEW YORK 10604

IBM 3101 Display Terminal Description (File No. S370/4300/8100/S1 - 09) Printed in U.S.A. GA18-2033-2

Fold and tape

Please Do Not Staple

Fold and tape

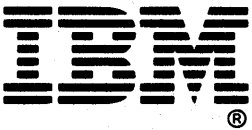

IBM 3101 Display Terminal Description (File No. S370/4300/8100/S1 - 09) Printed in U.S.A. GA18-2033-2

