

*A guide to
buying an
IKEA kitchen*

IKEA KITCHENS

Whether you're looking for a complete kitchen system like SEKTION or one of our other kitchens, this buying guide includes the products, prices and helpful information you need to choose the kitchen of your dreams.





Sinks and faucets.
See pages 54-65



Working in your kitchen is safer, easier and a lot more enjoyable with good lighting on the countertop, behind glass-doors and in drawers. See page 30



You can do everything yourself, but you don't have to. With our broad service offer we can assist you with everything from measuring and planning to complete kitchen installation. See page 04



Table of contents

- Services.....04**
- IKEA Kitchens.....06**
- SEKTION kitchen system.....08**
 - Doors and drawer fronts 10
 - Cover panels, decorative moldings, Toekicks and legs.....20
 - Lighting..... 30
 - Countertops 36
 - Sinks 54
 - Kitchen faucets 60
 - SEKTION cabinets..... 66
 - SEKTION interior fittings and organizers76
 - Kitchen accessories..... 84
 - Knobs and handles..... 90
- KNOXHULT kitchen.....94**
- SUNNERSTA mini-kitchen98**
- J.D. Powers Award100**
- Limited Warranty.....100**
- Steps to buying an IKEA kitchen 102**



Ranked "Highest in Customer Satisfaction with Kitchen Cabinets" in 2019 by J.D. Power. See page 100 for details.



A kitchen island is a great social hub, while giving you extra counter space. The countertop of VADHOLMA kitchen island has a durable top layer of oak and can handle everything from baking muffins to playing family games. See page 89

Life in the kitchen goes a lot smoother when your drawers open up fully to help you reach everything. With interior fittings and organizers inside cabinets and drawers, finding what you're looking for will be easy-peasy. See page 76

Services

You can do it yourself, but you don't have to

Our service offer gives you the freedom to design your own price tag by choosing not only the products that suit your budget but also by deciding how much you want to do yourself and how much you want us to do for you. On this page you'll find the different services that are available to help and support you. For more details about our services, talk to a co-worker at your local IKEA store or visit us at [IKEA-USA.com/kitchenservices](https://www.ikea.com/us/en/kitchenservices)



Kitchen Measurement Service

It's important to have your kitchen accurately measured before planning begins. An experienced IKEA Measurement Technician will come to your home, take all of the essential measurements, and enter the data in the IKEA Home Planner. Your Measurement Service fee is refunded when you have IKEA install your kitchen. Available for customers living within our service area.



IKEA Home Planner

You can plan your kitchen on your computer with our online 3D IKEA Home Planner at [IKEA-USA.com/kitchenplanner](https://www.ikea.com/us/en/kitchenplanner). It's free, it's fun and it calculates your price as you click along. You can PRINT, SAVE and CHANGE your kitchen plan as many times as you want. Then come to the store and get advice - you can access the same plan you've been working on - and share it with our IKEA Kitchen Specialists.



Free Kitchen Planning Service

We offer two **no cost** options to have your kitchen professionally planned. You will receive a detailed layout of your kitchen including cabinets, appliances, and countertops, and a parts list to make it easy to order.

Most Convenient & available to everyone in the continental US:

Planning from Your Home Make a 90-minute appointment, online or in your local IKEA store. Allow time for you to measure your kitchen and select products before your appointment. A professional IKEA Kitchen Planner will work with you interactively online to plan your dream kitchen. You will be able to discuss every detail and view your plan being created. Your planner will follow-up with a second session to make any changes.

Visit an IKEA store:

Planning from the Store You can make an appointment online or at your local IKEA store for a two-hour in-store appointment with one of our professional IKEA Kitchen Planners. Allow time for measuring your kitchen and selecting products before your planning appointment.

Prior to your appointment, you will need to:

- **Measure your space** - The first step is getting your kitchen measurements. Instructions will be provided if you want to do this yourself. But if you live in an IKEA service area, a professional IKEA measurement technician can visit your home to measure your kitchen for you.
- **Choose your products** - Start browsing our kitchen products now to get a better understanding of what you want. You must know this before your planning session to make it productive.



IKEA Kitchen Installation Service

Professional IKEA kitchen installation makes your dream kitchen come true. Check with your local store to see if installation is available in your area. Professional kitchen installers will handle assembling and installing your IKEA cabinets, doors, drawers, interior fittings, handles and knobs. Your kitchen will be installed to the highest industry standards.

Kitchen installation includes:

- Assemble cabinets, drawers, doors and interior fittings
- Install IKEA cabinets, toekicks and side cover panels (excludes 26x36" and 36x96" panels)
- Adjust all IKEA cabinet doors and drawer fronts for appearance
- Clean-up of your kitchen job site, which includes:
 - Daily broom cleaning of job site
 - Vacuum inside of cabinets, floors, and other surfaces upon completion of installation
- Attach IKEA knobs and/or handles to cabinet doors and drawers

Installation Price Quote

Upon completion of your Kitchen Plan on our IKEA Home Planner, we can schedule your Installation Price Quote. An experienced professional from IKEA will contact you and provide an itemized installation price quotation.

Installation Price Quote

- Confirmation of the scope of kitchen installation.
- Confirmation of the time schedule of kitchen installation.
- Confirmation of the price of kitchen installation.

Services and prices may vary. For more information about our services, visit [IKEA-USA.com/services](https://www.ikea.com/us/en/services) or your local store.

5-Year Warranty

Professional Kitchen Installers are professional, licensed, insured and warranty their work for 5 years post completion on IKEA supplied kitchen products.*

*Installation warranty is for the installation of IKEA kitchen products only. In the event of defects in workmanship, the IKEA product or materials will be repaired or replaced; provided, that the defect was not due to a product defect, normal wear and tear, accidents, alteration by the customer, misuse, abuse, or neglect.



Delivery

Whether you're shopping in the store or online, and no matter how big the purchase, we can help do the heavy lifting and arrange delivery, by an Independent Service Provider, to your home or business.



IKEA Projekt Credit Card

Your dream home is now within reach. With the special financing options on our IKEA Projekt credit card*, you don't have to put off loving every room in your home.

*Subject to credit approval. IKEA Projekt Credit Card Accounts are issued by Comenity Capital Bank. To learn more visit [IKEA-USA.com/creditcard](https://www.ikea.com/us/en/creditcard) or drop by your local store.



What type of kitchen are you looking for?

Whether you're looking for a complete kitchen system like SEKTION that you can personalize any way you want, or a simpler kitchen that you can install in a day, we have what you're looking for. Here you have three different types of IKEA kitchens to suit different needs and wishes.



SEKTION Kitchen system

Our SEKTION kitchen system includes cabinets in several different sizes to fit your room layout as well as your kitchen routines. The flexibility of the system offers endless choices, giving you the freedom to build a kitchen that's ideal for you and your space. We've also developed an extensive range of kitchen organizers and interior fittings allowing you to quickly see and reach even the things furthest back in the corner cabinets. In addition you have a vast choice in front expressions, countertops, lighting, sinks, faucets, knobs, handles and much more to personalize every inch of your kitchen. **See pages 08-93**



KNOXHULT Kitchen

KNOXHULT comes in pre-packaged modules that you can arrange the way you prefer. Together with our kitchen appliances you can get a complete kitchen with all the basic functions you need at a very low price. The countertop is included, so just add sink, faucet, knobs and handles of your choice to complete the look. The simplicity of the pre-packaged modules makes the installation so easy that you can have a fully functional kitchen up and running the same day you bring it home from the IKEA store. **See pages 94-97**



SUNNERSTA Mini-kitchen

If you like to keep it simple and don't need an elaborate kitchen, SUNNERSTA might be a perfect fit for you. This flexible mini-kitchen is easy to buy, get home, install and take with you if you move somewhere else. Add the TILLREDA portable induction cooktop and TILLREDA compact fridge, and you'll have the basic functions you need for a small space apartment, guest house, dorm room or wherever you might cook your next meal. **See page 98-99**

SEKTION KITCHEN SYSTEM

Endless possibilities

The modular design of SEKTION kitchen system is easy to install and gives you endless possibilities when designing your kitchen. Whether you have a taste for the traditional, love the minimalism in modern style or land somewhere in between, you'll surely find something that fits you.

To become truly beautiful, the kitchen has to be functional and take care of all your kitchen needs, too. With SEKTION you have the freedom to get the look you want on the outside and keep everything

in perfect order on the inside. Start by deciding the style of your dream kitchen by choosing the doors and drawer fronts, lighting, countertop, sink, faucet, knobs, handles and accessories that you like.



Ranked "Highest in Customer Satisfaction with Kitchen Cabinets" in 2019 by J.D. Power. See [page 100](#) for details.



Doors and drawer fronts

Choose your style!

No matter what your personal style and preference is, make sure to choose a kitchen front you will love for years to come. It is the face of your kitchen, and most likely you will spend many hours there.

We have a wide range of materials and finishes to choose from to suit your style — no matter what you like! Everything from traditional doors and drawer fronts that are rich in details, to high-gloss and modern doors and drawer fronts with integrated handles to give you that open, clean look — we have it!

The process of choosing the style of your kitchen is all up to you, go for whatever you like — it is your kitchen! We have made sure that all our fronts are durable and of high quality. They all come with a free 25-year limited warranty to ensure that whatever you choose, it will last for years to come.

25
Year Limited
Warranty
Included

SEKTION kitchen has a free 25-year limited warranty. Find out more on [page 100](#).



Ranked "Highest in Customer Satisfaction with Kitchen Cabinets" in 2019 by J.D. Power. See [page 100](#) for details.



Door and drawer front styles



Sleek doors and drawer fronts

Sleek doors offers you straight lines and smooth, easy-to-clean surfaces, simplicity in its truest form. Choose from a wide variety of finishes, colors and materials.



Doors and drawer fronts with integrated handles

You might not notice them at first glance — and that's the idea! Integrated handles lend a minimalistic and modern feeling to your kitchen.



High-gloss doors and drawer fronts

Glossy surfaces suit everyone from the minimalist to the wild family with kids. Stains are no problem as they are just as easy to wipe clean as they were to make.



Frame doors and drawer fronts

Frame doors and drawer fronts are rich in detail, with a crafted look and feel — they create a kitchen with a rustic and traditional look. All our frame door families have a matching glass door.

WHAT'S INCLUDED IN THE 10'×10' PRICE?

The 10'×10' price includes cabinets, door and drawer fronts, drawers, shelves, hinges, cover panels, toekicks, and legs. Your choice of countertops, knobs/handles, sinks, faucets, lighting, and appliances are sold separately.

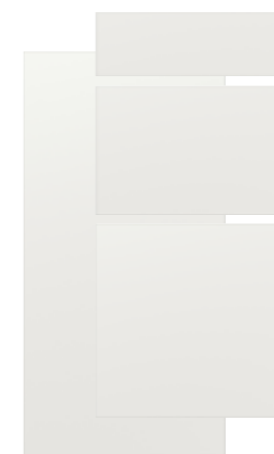
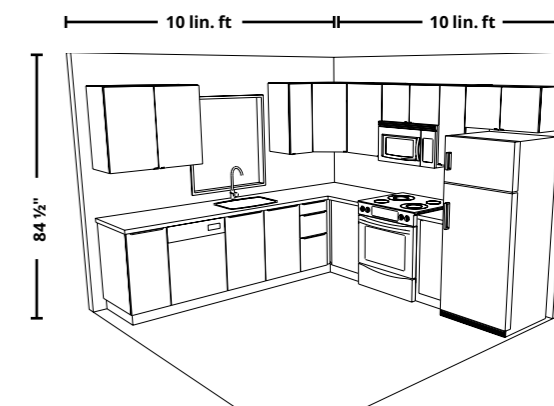

HÄGGEBY White Melamine foil.

Simple, high quality, low price doors that create clean, crisp lines in your kitchen. Complement with JUTIS accent door.

10'×10' kitchen **\$1149**



TINGSRYD Wood-effect black Melamine foil.

These dark wood doors with a natural grain effect create an inviting and warm space. Complement with JUTIS accent door.

10'×10' kitchen **\$1599**



VEDDINGE White Painted finish.

Keep your kitchen space light and bright with these simple and straightforward doors and fronts. Complement with JUTIS accent door.

10'×10' kitchen **\$1599**



ASKERSUND Light ash effect
Melamine foil.

ASKERSUND is a blonde ash wood effect door, with a grain pattern that you can see and feel. It creates a light, modern kitchen. Complement with JUTIS accent door.

10'x10' kitchen **\$1799**



KUNGSBACKA Anthracite
Recycled PET-plastic foil finish.

KUNGSBACKA is a door with a striking matte black finish and two chamfered edges. It's made from recycled wood and PET bottles and brings a modern, streamlined look to your kitchen. Complement with JUTIS accent door.

10'x10' kitchen **\$1799**



BODARP Gray-green
Foil finish.

Produced in factories using renewable electricity and featuring a foil made of recycled PET bottles, BODARP doors in matte gray-green creates an open and welcoming kitchen with a modern twist.

10'x10' kitchen **\$1799**



GRIMSLÖV Off-white
Foil finish.

The bold frames on these fronts create a geometric design, giving your kitchen a clean, modern feel. Tempered glass doors.

10'x10' kitchen **\$2199**



HITTARP Off-white
Painted finish.

Infuse your kitchen with a charming country feel with these doors and fronts. Tempered glass doors.

10'x10' kitchen **\$2199**



AXSTAD Matte white
Foil finish.

AXSTAD door has a matte, white surface with soft lines and an inset mirror. The design allows you to use it to create both a modern and traditional kitchen. Complement with AXSTAD tempered glass doors.

10'x10' kitchen **\$2199**



BODBYN Gray
Painted finish.

Bevelled details and cross-bars on tempered glass accentuate the classic character of these doors.

10'x10' kitchen **\$2299**



BODBYN Dark green
Painted finish.

Bevelled details and cross-bars on tempered glass accentuate the classic character of these doors.

10'x10' kitchen **\$2299**



BOBBYN Off-white
Painted finish.
Bevelled details and cross-bars on tempered glass accentuate the classic character of these doors.

10'x10' kitchen **\$2299**



LERHYTTAN Black stain
Stained, clear lacquered solid ash/ash veneer.

Dark doors with bevelled frames set a warm and traditional tone in the kitchen. Tempered glass doors.

10'x10' kitchen **\$2499**



NEW

LERHYTTAN Light gray
Tinted, clear lacquered solid birch.

LERHYTTAN door has a distinct traditional character, with a solid wood frame with bevelled edges and an inset veneer panel. LERHYTTAN creates a cozy kitchen with rustic charm. Tempered glass doors.

Available Spring 2020.

10'x10' kitchen **\$2499**



GRIMSLÖV Brown
Stained, clear lacquered birch veneer/solid birch.

The frame in solid wood creates a natural and durable look to your kitchen. Tempered glass doors.

10'x10' kitchen **\$2499**

What's included in 10'x10' price? See page 13.



EKESTAD Brown
Stained, clear lacquered oak veneer/solid ash.

The simple design of these fronts lets the woodgrain pattern steal the show, setting a warm tone in the kitchen. Tempered glass doors.

10'x10' kitchen **\$2899**



RINGHULT High-gloss white
High-gloss foil finish.

Get a sleek and streamlined look with high-gloss doors in a modern design. Complement with JUTIS accent door.

10'x10' kitchen **\$2899**



TORHAMN Natural ash
Clear lacquered ash veneer/solid ash.

Each TORHAMN door is unique, with varying grain patterns and shifts in color that highlight the natural charm of wood. It brings the feeling of tradition, quality and handmade craftsmanship to your kitchen. Tempered glass doors.

10'x10' kitchen **\$2899**



VOXTORP Matte white
Melamine foil.

VOXTORP is a smooth, matte door with integrated handles. It brings clean lines and an open, modern look to your kitchen. Complement with JUTIS accent door.

10'x10' kitchen **\$3199**

What's included in 10'x10' price? See page 13.

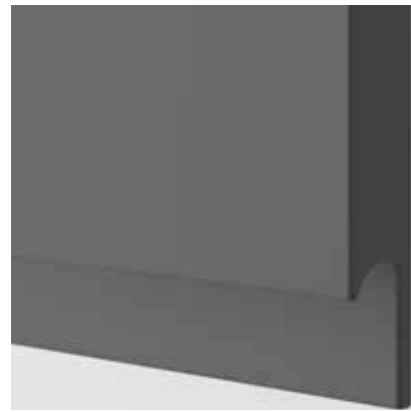

VOXTORP Dark gray
Melamine foil.

VOXTORP is a smooth, matte door with integrated handles. It brings clean lines and an open, modern look to your kitchen. Complement with JUTIS accent door.

10'x10' kitchen **\$3199**



VOXTORP Walnut effect
Foil finish.

VOXTORP is a smooth door with integrated handles. It brings clean lines and an open, modern look to your kitchen. Complement with JUTIS accent door.

10'x10' kitchen **\$3599**



VOXTORP High-gloss
light beige
High-gloss foil finish.

VOXTORP is a smooth door with integrated handles. It brings clean lines and an open, modern look to your kitchen. Complement with JUTIS accent door.

10'x10' kitchen **\$3599**

ACCENT DOORS AND DRAWER FRONTS

Accent doors are a great way to personalize your new kitchen. Available in several different sizes, they let you add big, bold blocks of color or splashes here and there. It's up to you.



JÄRSTA High-gloss black-blue \$79
High-gloss foil finish.
W15xH30".



JUTIS Glass door \$59
Aluminum and frosted tempered glass.
W15xH30".



JUTIS Glass door \$59
Black powder-coated aluminum and smoked-tempered glass.
W15xH30".



UDEVELLA Anthracite \$49
Foil finish, can be used as chalkboard.
W15xH30".



VÄRSTA Drawer front \$39
Stainless steel and melamine foil. W30xH15".

Cover panels, decorative moldings, toekicks and legs

Add the finishing touches

Whether you've decided to go for a more traditional style with lots of drawers and decorative elements, or a sleek modern, more minimalistic style, there are still finishing touches for you to add to make your kitchen stunning.

Enhance your style with uniform cover panels, decorative moldings, legs and toekicks. Or, you can be a bit bold and go for a finish that contrasts with your doors and drawers. It's all up to you.



Decorative molding



Cover panel



Decorative toekick

Cover panels

Choose a cover panel in the same finish as your door for a uniform expression, or mix and match to suit your taste.

ASKERSUND Cover panel Ash wood effect



W15×H32½"	403.483.48	\$27
W15×H42½"	203.483.49	\$37
W15×H90"	003.483.50	\$74
W25×H30"	803.483.51	\$36
W25×H80"	603.483.52	\$99
W25×H90"	403.483.53	\$119
W26×H36"	203.483.54	\$49
W36×H96"	803.483.94	\$159

BOBBYN Cover panel Gray

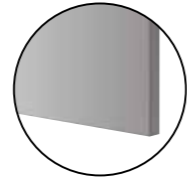

W15×H32½"	402.660.26	\$25
W15×H42½"	002.660.28	\$37
W15×H90"	202.660.27	\$74
W25×H30"	802.660.53	\$35
W25×H80"	102.660.23	\$99
W25×H90"	602.660.54	\$119
W26×H36"	902.660.24	\$49
W36×H96"	602.660.25	\$159

TORHAMN Cover panel Natural ash



W15×H30"	803.134.79	\$49
W15×H40"	603.134.80	\$57
W15×H90"	403.134.81	\$105
W25×H30"	203.134.82	\$67
W25×H80"	003.134.83	\$139
W25×H90"	803.134.84	\$159
W26×H36"	503.134.85	\$72
W36×H96"	403.137.73	\$199

VOXTORP Cover panel High-gloss light beige



W15×H32½"	403.212.64	\$83
W15×H42½"	103.212.65	\$94
W15×H90"	903.212.66	\$149
W25×H30"	703.212.67	\$92
W25×H80"	503.212.68	\$149
W25×H90"	303.212.69	\$169
W26×H36"	103.212.70	\$94
W36×H96"	903.212.71	\$249

EKESTAD Cover panel Oak veneer brown



W15×H32½"	902.943.81	\$49
W15×H42½"	702.943.82	\$57
W15×H90"	502.943.83	\$105
W25×H30"	302.943.84	\$67
W25×H80"	802.943.86	\$139
W25×H90"	602.943.87	\$159
W26×H36"	002.943.85	\$72
W36×H96"	402.943.88	\$199

BOBBYN Cover panel Dark green



W15×H32½"	004.451.72	\$25
W15×H42½"	804.451.73	\$37
W15×H90"	604.451.74	\$74
W25×H30"	304.451.75	\$35
W25×H80"	104.451.76	\$99
W25×H90"	904.451.77	\$119
W26×H36"	704.451.78	\$49
W36×H96"	504.451.79	\$159

VOXTORP Cover panel Walnut effect

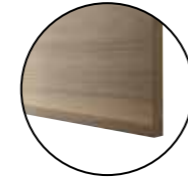

W15×H32½"	103.281.01	\$83
W15×H42½"	903.281.02	\$94
W15×H90"	703.281.03	\$149
W25×H30"	503.281.04	\$92
W25×H80"	203.281.05	\$149
W25×H90"	003.281.06	\$169
W26×H36"	803.281.07	\$94
W36×H96"	603.281.08	\$249

UDDEVALLA Cover panel with blackboard surface Anthracite

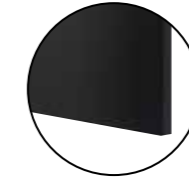

W25×H90"	903.493.31	\$129
----------	------------	-------

GRIMSLÖV Cover panel Brown

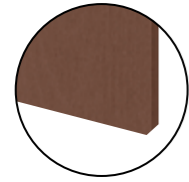

W15×H32½"	204.051.70	\$49
W15×H42½"	904.039.45	\$57
W15×H90"	604.051.68	\$105
W25×H30"	404.051.69	\$67
W25×H80"	804.051.67	\$139
W25×H90"	204.051.65	\$159
W26×H36"	704.039.08	\$72
W36×H96"	004.051.66	\$199

VÄRSTA Cover panel Stainless steel



W15×H30"	204.191.67	\$39
W25×H30"	404.191.52	\$49
W24×H30" with legs	604.192.07	\$69
W15×H30" with legs	804.192.06	\$59

FÖRBÄTTRA Cover panels

Our FÖRBÄTTRA cover panels are developed to fit all our various white doors and drawer fronts. Choose a cover panel in the same color and finish as your door for a perfect match.

BODARP Cover panel Gray-green



W15×H32½"	104.355.92	\$27
W15×H42½"	904.355.93	\$37
W15×H90"	704.355.94	\$74
W25×H30"	404.355.95	\$35
W25×H80"	204.355.96	\$99
W25×H90"	004.355.97	\$119
W26×H36"	804.355.98	\$49
W36×H96"	604.355.99	\$159

HITTARP Cover panel Off-white



W15×H31¼"	502.664.17	\$27
W15×H41¼"	302.664.18	\$37
W15×H90"	102.664.19	\$74
W25×H30"	902.664.20	\$36
W25×H80"	502.664.22	\$99
W25×H90"	302.664.23	\$119
W26×H36"	702.664.21	\$49
W36×H96"	102.664.24	\$159

FÖRBÄTTRA Cover panel Off-white



W15×H32½"	602.664.07	\$25
W15×H42½"	402.664.08	\$37
W15×H90"	202.664.09	\$74
W25×H30"	802.664.11	\$35
W25×H80"	402.664.13	\$99
W25×H90"	202.664.14	\$119
W26×H36"	602.664.12	\$49
W36×H96"	902.664.15	\$159

FÖRBÄTTRA Cover panel Matte white

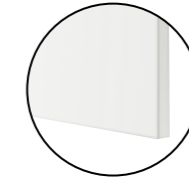

W15×H32½"	504.177.46	\$25
W15×H42½"	304.177.47	\$37
W15×H90"	104.177.48	\$74
W25×H30"	904.177.49	\$35
W25×H80"	704.177.50	\$99
W25×H90"	504.177.51	\$119
W26×H36"	304.177.52	\$49
W36×H96"	104.177.53	\$159

LERHYTTAN Cover panel Black stained



W15×H31¼"	803.559.21	\$49
W15×H41¼"	603.559.22	\$57
W15×H90"	403.559.23	\$105
W25×H30"	203.559.24	\$67
W25×H80"	903.559.25	\$139
W25×H90"	703.559.26	\$159
W26×H36"	503.559.27	\$72
W36×H96"	303.559.28	\$199

KUNGSBACKA Cover panel Anthracite



W15×H31"	603.379.09	\$27
W15×H41"	203.379.11	\$37
W15×H90"	003.379.12	\$74
W25×H30"	803.379.13	\$36
W25×H80"	603.379.14	\$99
W25×H90"	303.379.15	\$119
W26×H36"	103.379.16	\$49
W36×H96"	903.379.17	\$159

FÖRBÄTTRA Cover panel White



W15×H32½"	302.664.37	\$25
W15×H42½"	102.664.38	\$37
W15×H90"	902.664.39	\$74
W25×H30"	702.664.40	\$35
W25×H80"	302.664.42	\$99
W25×H90"	102.664.43	\$119
W26×H36"	502.664.41	\$49
W36×H96"	902.664.44	\$159

FÖRBÄTTRA Cover panel Dark gray

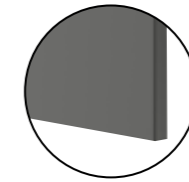

W15×H32½"	804.561.28	\$25
W15×H42½"	604.561.29	\$37
W15×H90"	404.561.30	\$74
W25×H30"	204.561.31	\$35
W25×H80"	004.561.32	\$99
W25×H90"	804.561.33	\$119
W26×H36"	604.561.34	\$49
W36×H96"	304.561.35	\$159

TINGSRYD Cover panel Wood-effect black



W15×H32½"	902.668.30	\$25
W15×H42½"	302.668.28	\$37
W15×H90"	102.668.29	\$74
W25×H30"	302.668.33	\$35
W25×H80"	702.668.31	\$99
W25×H90"	502.668.32	\$119
W26×H36"	202.668.57	\$49
W36×H96"	402.668.56	\$159

LERHYTTAN Cover panel Light gray Available Spring 2020



W15×H31¼"	803.532.34	\$49
W15×H41¼"	503.532.35	\$57
W15×H90"	303.532.36	\$105
W25×H30"	103.532.37	\$67
W25×H80"	903.532.38	\$139
W25×H90"	703.532.39	\$159
W26×H36"	503.532.40	\$72
W36×H96"	303.532.41	\$199

FÖRBÄTTRA Cover panel High-gloss white

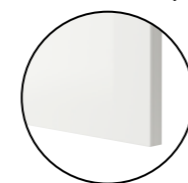

W15×H32½"	904.002.87	\$49
W15×H42½"	704.002.88	\$57
W15×H90"	504.002.89	\$105
W25×H30"	304.002.90	\$67
W25×H80"	104.002.91	\$139
W25×H90"	904.002.92	\$159
W26×H36"	704.002.93	\$72
W36×H96"	504.002.94	\$199

Decorative moldings

Decorative moldings provide the finishing touch to your kitchen. They come in many different styles, but we have something for all of our door and drawer families. Use them to tie your style together, hide lighting or just as a decorative element.

You can choose how to mount them on your cabinets. Below we show the entire range and some different ways of mounting them, both above as moldings and below your cabinet, wrapped around the whole cabinet or just between your cover panels.

ASKERSUND Decorative molding rounded
Ash wood effect

L87×H2¾" 803.318.50 **\$29**



BODBYN Decorative molding contoured
Gray

L87×H2¾" 602.210.65 **\$49**



BODBYN Decorative molding contoured
Dark green

L87×H2¾" 40444514 **\$49**



BODBYN Decorative molding contoured
Off-white

L87×H2¾" 804.177.59 **\$49**



LERHYTTAN Decorative molding contoured
Light gray Available Spring 2020

L87×H1¾" 903.523.71 **\$49**



EKESTAD Decorative molding rounded
Oak veneer brown

L87×H2¾" 202.997.49 **\$39**



GRIMSLÖV Decorative molding rounded
Brown

L87×H2¾" 604.103.44 **\$32**



Decorative moldings

HITTARP Decorative molding contoured
Off-white

L87×H1¾" 204.177.62 **\$49**



BODARP Decorative molding rounded
Gray-green

L87×H2¾" 704.355.27 **\$29**



KUNGSBACKA Decorative molding chamfered
Anthracite

L87×H1¾" 903.373.28 **\$39**



LERHYTTAN Decorative molding rounded
Stained black

L87×H1¾" 903.560.91 **\$49**



TINGSRYD Decorative molding rounded
Wood-effect black

L87×H2¾" 702.082.71 **\$29**



TORHAMN Decorative molding chamfered
Natural ash

L87×H1¾" 903.134.07 **\$49**



VOXTORP Decorative molding rounded
Walnut effect

L87×H2¾" 303.104.59 **\$59**



VOXTORP Decorative molding rounded
High-gloss light beige

L87×H2¾" 803.211.44 **\$59**



FÖRBÄTTRA Decorative moldings

Our FÖRBÄTTRA decorative moldings are developed to fit all our various white doors and drawer fronts. Choose a decorative molding in the same color and finish as your door for a perfect match.

FÖRBÄTTRA Decorative molding rounded
Off-white

L87×H2¾" 702.069.60 **\$29**



FÖRBÄTTRA Decorative molding rounded
White

L87×H2¾" 202.978.87 **\$29**



FÖRBÄTTRA Decorative molding rounded
High-gloss white

L87×H2¾" 503.974.80 **\$60**



FÖRBÄTTRA Decorative molding rounded
Matte white

L87×H2¾" 704.176.65 **\$29**



FÖRBÄTTRA Decorative molding rounded
Dark gray

L87×H2¾" 504.540.84 **\$29**



Toekicks and legs

Choose between a regular or a decorative toekick to cover the gap between your cabinet and the floor. As an alternative to a toekick you can also choose to put legs on your base and high cabinets.

BODBYN Gray



Standard toekick L84×H4½"

002.660.52 **\$24**

Decorative toekick L87×H4½"

202.786.76 **\$44**
Decorative toekick for dishwasher
L26×H4"
402.930.82 **\$29**

Legs H4½"

802.786.78 **\$29/2pk**

BODBYN Dark green



Standard toekick L84×H4½"

20445227 **\$24**

Decorative toekick L87×H4½"

30445180 **\$44**
Decorative toekick for dishwasher
L26×H4"
10445181 **\$29**

Legs H4½"

40445226 **\$29/2pk**

LERHYTTAN Stained black



Standard toekick L84×H4½"

303.559.71 **\$24**

Leg for decorative toekick
L2½×D1½×H4¼"

703.978.13 **\$30/2pk**

Corner legs for decorative toekick
L3×D3×H4¼"

804.032.29 **\$35/2pk**

LERHYTTAN Light gray Available Spring 2020



Standard toekick L84×H4½"

604.825.43 **\$000**

Leg for decorative toekick
L2½×D1½×H4¼"

503.978.14 **\$30/2pk**

Corner legs for decorative toekick
L3×D3×H4¼"

004.032.33 **\$35/2pk**

Toekicks and legs

Standard toekicks

ASKERSUND Ash wood effect



Toekick L84×H4½"
003.483.93 **\$24**

EKESTAD Oak veneer brown



Toekick L84×H4½"
402.997.48 **\$24**

VÄRSTA Stainless steel color



Toekick L84×H4½"
604.351.51 **\$24**

GRIMSLÖV Brown



Toekick L84×H4½"
804.053.32 **\$24**

KUNGSBACKA Anthracite



Toekick L84×H4½"
503.379.57 **\$24**

BODARP Gray-green



Toekick L84×H4½"
204.356.38 **\$24**

TINGSRYD Wood-effect black



Toekick L84×H4½"
602.668.55 **\$24**

TORHAMN Natural ash



Toekick L84×H4½"
003.135.29 **\$24**

VOXTORP Walnut effect



Toekick L84×H4½"
303.281.43 **\$29**

VOXTORP High-gloss light beige



Toekick L84×H4½"
703.213.09 **\$29**

VÄRSTA Stainless steel



Cover panel with legs 15×30"
804.192.06 **\$59**
Cover panel with legs 24×30"
604.192.07 **\$69**

FÖRBÄTTRA Toekicks and legs

Our FÖRBÄTTRA toekicks and legs are developed to fit all our various white doors and drawer fronts. Choose a toekick or legs in the same white color and finish as your door for a perfect match.

FÖRBÄTTRA Off-white



Standard toekick L84×H4½"
402.875.90 **\$24**



Decorative toekick L87×H4½"
002.786.77 **\$44**
Decorative toekick for dishwasher
L26×H4"
702.930.85 **\$29**



Legs H4½"
402.786.75 **\$29/2pk**

FÖRBÄTTRA white



Standard toekick L84×H4½"
602.668.17 **\$24**

FÖRBÄTTRA high-gloss white



Standard toekick L84×H4½"
204.002.95 **\$24**

FÖRBÄTTRA matte white



Standard toekick L84×H4½"
904.177.54 **\$24**

FÖRBÄTTRA dark gray



Standard toekick L84×H4½"
704.561.81 **\$24**

Toekicks and legs



SEKTION Legs H3½-5½"
May be completed with toekick
102.655.18 **\$7/4pk**



CAPITA Legs H4-5"
Stainless steel 602.635.74 **\$13/4pk**
White 302.635.75 **\$13/4pk**



CAPITA Legs
Stainless steel
602.635.74
\$13/4pk

Lighting

A brighter kitchen life

Good lighting is an essential part of any kitchen. That's why we offer integrated lighting series perfectly dimensioned to fit our kitchen cabinets. And they all contain long-lasting built-in LEDs which consume up to 85% less energy and last up to 20 times longer than incandescent bulbs. Having integrated lighting in your kitchen is a great way to show off your favorite dinnerware, behind glass doors or in drawers. And, good lighting brings your cabinet doors and countertop to life too.

Get an even better kitchen life with the ability to dim, turn off and turn on lights wirelessly. All you need is TRÅDFRI LED driver and remote control. Or, use the TRÅDFRI gateway and IKEA Home Smart app to control every beam of light with your smart phone. We call it IKEA Smart Lighting.

All the IKEA Smart lighting products are now compatible with Apple HomeKit, Google Assistant and Amazon Alexa. With our devices, it's possible to voice control the lighting and adjust the lights using Amazon Alexa, Google Assistant, Apple's Home app and Siri voice commands.



Drawer lighting simplifies finding what you need even during those midnight kitchen raids. Opening and closing the drawer turns the light on and off automatically.



Countertop lighting should give you a clean, clear view of all the work you're doing in the kitchen.



Spotlights provide a focused light that is good for lighting smaller areas and behind glass doors.



Cabinet lighting illuminates your favorite kitchen doors and creates a cozy mood light in the entire kitchen.

OMLOPP Series



OMLOPP has a compact design and is easy to install as each element has its own cable which connects to the LED driver.



OMLOPP LED countertop lighting Matches your cabinet sizes and features a compact design. To be completed with TRÅDFRI LED driver and ANSLUTA power cord, sold separately. Dimmable using the TRÅDFRI LED remote control and TRÅDFRI App/gateway, sold separately.

White	L15", 3.4W, 190 lm	804.303.60	\$15.99
	L18", 4.2W, 230 lm	404.303.62	\$19.99
	L24", 5.7W, 300 lm	004.303.64	\$29.99



OMLOPP LED lighting strip for drawers In an IKEA kitchen you can get lighting for all your drawers, that way you'll always be able to find what you need even during those midnight kitchen raids. The light switches on and off automatically when you open or close the drawer. To be completed with TRÅDFRI LED driver and ANSLUTA power cord, sold separately.

Aluminum-color	L14" 1.5W, 60 lm	304.357.32	\$17.99
	L17" 1.5W, 60 lm	504.357.31	\$19.99
	L23" 1.5W, 60 lm	704.357.30	\$24.99
	L29" 3W, 60 lm	904.357.29	\$26.99
	L34" 3W, 60 lm	104.357.28	\$29.99



OMLOPP LED spotlight Provides a focused light that is good for lighting smaller areas. To be completed with TRÅDFRI LED driver and ANSLUTA power cord, sold separately. Dimmable using the TRÅDFRI LED remote control and TRÅDFRI gateway, sold separately. Can be installed in its housing or integrated into coving. Ø2 5/8".

Black	1.4W, 65 lm	004.357.19	\$8.99
White	1.4W, 65 lm	604.357.21	\$8.99

STRÖMLINJE Series



STRÖMLINJE has a slim design and uses only one installation cable per row of lights as each element connects to the next one. STRÖMLINJE also has more light output to give extra bright light over the countertop.



STRÖMLINJE LED countertop lighting Matches your cabinet sizes in a slim design with more lumen output and easy installation. Contains built-in LED light source. To be completed with a TRÅDFRI LED driver and ANSLUTA power cord, sold separately. Dimmable with TRÅDFRI remote control and TRÅDFRI gateway, sold separately. White

L6"	2W, 110 lm	303.936.52	\$19.99
L12"	4W, 220 lm	903.517.05	\$29.99
L15"	5W, 280 lm	103.517.09	\$39.99
L18"	6W, 330 lm	203.517.18	\$49.99

IRSTA Series



IRSTA is a modern and very thin LED lighting, which covers the entire underside of the wall cabinet to illuminate an even light over the entire countertop.



IRSTA LED countertop lighting A modern and very thin LED lighting which covers the entire underside of the wall cabinet and therefore provides an even lighting spread over the entire countertop. Contains built-in LED light source. To be completed with a TRÅDFRI LED driver and ANSLUTA power cord, sold separately. Dimmable with TRÅDFRI LED driver, gateway, and dimmer, sold separately.

L15"	3.8W, 280 lm	504.069.55	\$39.99
L18"	5W, 400 lm	304.069.56	\$59.99
L24"	7W, 580 lm	104.069.57	\$79.99

Cabinet lighting

Cabinet lighting illuminates your favorite kitchen doors and creates a cozy mood light in the entire kitchen. URSHULT, LINDSHULT, and SLAGSIDA cabinet lighting all include energy saving LED and can be dimmed with TRÅDFRI LED driver, gateway and dimmer.



URSHULT LED cabinet lighting Provides a focused light that is good for lighting smaller areas. To be completed with a TRÅDFRI LED driver and ANSLUTA power cord, sold separately. Dimmable with TRÅDFRI remote control and TRÅDFRI App/gateway, sold separately.

Nickel-plated	2W, 100 lm	602.604.05	\$24.99
---------------	------------	------------	----------------



STÖTTA LED cabinet lighting strip with sensor The simplest way to light up your wardrobe without waking your partner in the morning. A soft light switches on as you open the door. It's battery-operated, so you don't have to deal with cords. Batteries are sold separately; 2 pcs AA required. IKEA recommends LADDA rechargeable batteries. Do not mix batteries of different types, capacities or date stamps.

13"	50 lm	103.600.87	\$8.99
20"	70 lm	503.600.90	\$12.99
28"	80 lm	903.600.93	\$14.99



LADDA Rechargeable batteries

HR6 AA 1.2V	2450 mAh	703.038.76	\$6.99/4pk
HR03 AAA 1.2V	900 mAh	903.038.80	\$6.99/4pk



KVARTS Battery charger You can charge any combination and amount of AA and AAA, up to 4 at the time. IKEA recommends LADDA rechargeable batteries. The battery is fully charged after 5-8 hours. The charger will stop charging when the batteries are fully charged.

L3xW2xH5"		004.466.71	\$8.99
-----------	--	------------	---------------



LINDSHULT LED cabinet lighting Provides a focused light that is good for lighting smaller areas. To be completed with a TRÅDFRI LED driver and ANSLUTA power cord, sold separately. Dimmable with TRÅDFRI LED driver, gateway, and dimmer, sold separately.

Nickel-plated	2W, 80 lm	302.604.40	\$24.99
---------------	-----------	------------	----------------



SLAGSIDA LED countertop light This worktop lighting is designed for KNOXHULT kitchen and helps you create a functional workspace. Easy to install on your own with a connected power plug and dimmable in two steps with a touch sensor. This countertop lighting has a power plug so you can easily install it yourself and don't need a certified electrician. White

L16"	5.3W, 320 lm	604.000.62	\$16.99
L23½"	6.6W, 480 lm	303.556.50	\$19.99



KOPPLA series. Equipped with auto-detect function - the USB charger detects the connected device and adjusts the power output accordingly. Comes with built-in over-current protection, short-circuit protection and overheating protection.

3-port USB charger	3.4A, 17W. 2.4A.	604.150.30	\$7.99
1-port USB charger	2.0A, 10W. 5Vdc.	904.122.85	\$4.99

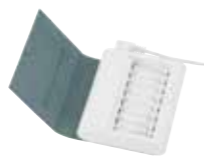

TJUGO Battery charger with storage 8 separate charging channels make it possible to charge 1-8 rechargeable batteries at the same time, and to mix AA and AAA batteries. This battery charger can also be used as practical storage for your batteries when you are not using them. When batteries are fully charged, this battery charger switches to stand-by charging so that you can store your batteries in the charger if not using immediately. The charging time varies depending on your batteries. IKEA recommends LADDA rechargeable batteries.

L5xW1xH5"		10435177	\$17.99
-----------	--	----------	----------------

TRÅDFRI and ANSLUTA Series



With the TRÅDFRI gateway you can control all your TRÅDFRI driver connected lighting via the free IKEA Home Smart app or your voice assistant. Create moods and set scenes together with other IKEA Smart lighting.

All the IKEA Smart lighting products are now compatible with Apple HomeKit, Google Assistant and Amazon Alexa. With our devices, it's possible to voice control the lighting and adjust the lights using Amazon Alexa, Google Assistant, Apple's Home app and Siri voice commands.



TRÅDFRI Remote control With the remote you can control your light sources. Turn on, turn off, choose colors and warm or cold light – and dim for the right mood.

White	004.431.30	\$15.99
-------	------------	----------------



TRÅDFRI Gateway With TRÅDFRI gateway and IKEA Home Smart app you can control each light source individually, create different types of lighting settings - and control them by the IKEA Home Smart app or personal assistant via Google Assistant, Apple HomeKit or Amazon Alexa.

White	003.378.13	\$35
-------	------------	-------------



ANSLUTA Power supply cord For connection to the main's supply of one or up to 10 series connected lamps. Press the cord switch to turn them all on and off simultaneously. White

L11'6"		301.214.11	\$7
--------	--	------------	------------

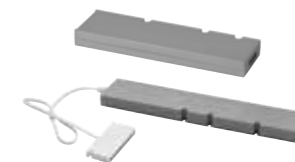

TRÅDFRI LED driver To be completed with ANSLUTA power supply cord, sold separately. Can be used with TRÅDFRI wireless dimmer and TRÅDFRI gateway.

Connect up to 3 units, not to exceed 10W total.	103.561.89	\$27
Connect up to 9 units, not to exceed 30W total.	603.426.61	\$37



ANSLUTA Intermediate connection cord Allows you to connect several LED drivers with only one connection to the main's supply. White

L28"		401.199.26	\$6
L6'7"		601.199.25	\$7

Countertops

Your kitchen is the heart of your home, it's a room for everyone! How it performs and how it looks are two important factors. Even though doors and drawer fronts are the main style decision you make when updating your kitchen, your countertop can have a big impact on the overall look. However, the perfect countertop is not just about completing the look of your kitchen, it has an impact on its functionality too. When picking the right countertop there are many factors to consider, including your style, durability, maintenance, lifestyle and cost. Our countertops are available in pre-cut and custom-made options as well as in durable materials, finishes and thicknesses. Each surface has unique properties, with differing levels of water, wear and heat resistance.

How to choose your countertop:

01

What's your budget?
A stylish look does not have to cost a fortune, our countertops are available in a wide range of materials and expressions, pre-cut as well as custom-made to perfectly fit your style, needs and wallet.

02

What kind of material do you prefer? When deciding on material, consider how robust you need your countertop to be, how much you are prepared to look after it, and how you want it to look in your kitchen scheme.

03

Custom-made countertops are made to fit your kitchen layout, you can order the exact size you need, including cut-outs for your sink, faucet and cooktop. Pre-cut countertops are available in different sizes, and you can cut them to the desired length.

Built to last

When we test our countertops, we put them up against everything they'll face in your kitchen: liquids, oil, steam, heat, thumps, bumps and scratches. Once we're done, we're sure our countertops will last for many years to come.

25
Year Limited
Warranty
Included

Countertops have a free 25-year limited warranty. See page 100 or IKEA-USA.com/warranty for details.



Materials

Laminate

Laminate countertops are durable, affordable and easy to maintain, with lots of colors and expressions to choose from. Spills and grease are easy to wipe clean and the countertop keeps its beauty over time, making it a practical solution.

Wood

Worktops with a top layer of wood have all the qualities of solid wood, enhanced by modern technology. They are made with 1/8" layer of solid wood wrapped on particleboard. This increases the stability and makes them less likely to split or crack. They can be sanded down to remove minor scratches, and will keep their natural beauty over the years.

Quartz

Quartz is one of the hardest materials in nature, making the surface extremely durable and scratch resistant. Plus, the surface is smooth, non-porous and easy to keep clean.

Color overview

We offer pre-cut laminate countertops in two lengths. Choose between the many colors and expressions to find the perfect look. The laminate countertops can be cut into the length you need and finished with the edge strip included in the package.



White

White marble effect

White with metal effect edge

White stone effect

Light gray with white edge

Gray with metal effect edge

Light gray stone effect

Light gray concrete effect

Concrete effect

Black stone effect

Black mineral effect

Ash effect

Light gray mineral effect

Aluminum effect with metal effect edge

Black marble effect

Dark gray/marble effect

Matte anthracite

NEW

Matte beige

Laminate countertops 1 1/8" thick x D25 5/8"



1 1/8" countertops create a light, contemporary feel and are often used in modern-style kitchens. These countertops are 25 5/8" deep.



LILLTRÅSK Countertop White

L74"	502.808.28	\$49
L98"	302.808.29	\$59



EKBACKEN Countertop Double-sided, white with white edge

L74"	002.913.39	\$79
L98"	602.913.41	\$99



EKBACKEN Countertop White marble effect

L74"	403.356.28	\$79
L98"	203.356.29	\$99



EKBACKEN Countertop Light gray concrete effect

L74"	803.954.46	\$79
L98"	603.954.47	\$99



EKBACKEN Countertop Double-sided, light gray with white edge

L74"	002.913.39	\$79
L98"	602.913.41	\$99



EKBACKEN Countertop Dark gray/marble effect

L74"	703.971.77	\$79
L98"	503.971.78	\$99



EKBACKEN Countertop Concrete effect

L74"	003.356.54	\$79
L98"	703.356.55	\$99



EKBACKEN Countertop Black stone effect

L74"	202.748.62	\$79
L98"	802.748.64	\$99



EKBACKEN Countertop Ash effect

L74"	303.376.23	\$79
L98"	103.376.24	\$99



EKBACKEN Countertop Matte anthracite

L74"	304.090.21	\$79
L98"	104.090.22	\$99

NEW



EKBACKEN Countertop Matte beige

L74"	403.971.93	\$79
L98"	203.971.94	\$99

Laminate countertops 1½" thick×D25⅝"



A 1½" countertop creates a robust impression and can often be found in a traditional-style kitchen. These countertops are 25⅝" deep.



SÄLJAN Countertop White stone effect

L74"	102.766.11	\$59
L98"	902.766.12	\$69



HÄLLESTAD Countertop Double-sided white/aluminum effect with metal effect edge

L74"	702.643.61	\$99
L98"	602.643.66	\$119



SÄLJAN Countertop Black marble effect

L74"	803.356.93	\$59
L98"	603.356.94	\$69



SÄLJAN Countertop Light gray mineral effect

L74"	803.972.09	\$59
L98"	403.972.11	\$69



SÄLJAN Countertop Black mineral effect

L74"	602.749.83	\$59
L98"	102.749.85	\$69



Small island/workbench

Create a simple island from a couple of open cabinets with a durable laminate countertop that can withstand all the baking and preparing you need.





Natural and durable, wood brings a warm feeling to your kitchen and makes each countertop unique. It ages beautifully and you just sand and treat it to keep it looking great.

Material overview



OAK is a hardwood, making it a popular choice for countertops and interiors. Its color ranges from light brown to a rich reddish-brown and it darkens with age.



BIRCH is fine-grained and pale in color with a satin-like sheen that darkens with age. It often has knots or heartwood in cream or light brown which will give your countertop a unique and distinct natural look.



WALNUT The natural color and grain of wood adds warmth to your kitchen decor. Walnut gets lighter in color with age. It has a rich variation in color and a decorative, curved grain pattern.



ASH is a blonde hardwood with a beautiful grain pattern. The variations in the color make each countertop unique and give it a distinctive natural look. It gets gradually darker with age.



STOCKARYD Wood treatment oil \$7.99
For indoor use. 17 oz. 202.404.62

Thick veneer wood countertops Walnut



The natural color and grain of wood adds warmth to your kitchen decor. Walnut gets lighter in color with age. It has a rich variation in color and a decorative, curved grain pattern.



BARKABODA Countertop

L74×W25%×H1½"	103.314.72	\$249
L98×W25%×H1½"	903.314.73	\$289



KARLBY Countertop

L74×W25%×H1½"	503.352.08	\$189
L98×W25%×H1½"	703.352.12	\$249
L74×W42×H1½"	302.976.41	\$279



PINNARP Countertop

L74×W25%×H1½"	004.674.75	\$169
L98×W25%×H1½"	204.674.79	\$219

Thick veneer wood countertops Oak



Oak is a hardwood, making it a popular choice for countertops and interiors. Its color ranges from light brown to a rich reddish-brown and it darkens with age.



KARLBY Countertop
Thick veneer oak

L74×W25%×H1½"	703.352.07	\$149
L98×W25%×H1½"	903.352.11	\$189
L74×W42×H1½"	502.976.40	\$229



MÖLLEKULLA Countertop
Thick veneer oak

L74×W25%×H1½"	003.011.35	\$159
L98×W25%×H1½"	803.011.36	\$209



SKOGSÅ Countertop
Thick veneer oak

L74×W25%×H1½"	203.829.94	\$249
L98×W25%×H1½"	903.829.95	\$289

Thick veneer wood countertops Birch



Birch is fine-grained and pale in color with a satin-like sheen that darkens with age. It often has knots or heartwood in cream or light brown which will give your countertop a unique and distinct natural look.



KARLBY Countertop Thick veneer birch

L74×W25%×H1½"	903.352.06	\$149
L98×W25%×H1½"	103.352.10	\$189

Thick veneer wood countertops Ash



Ash is a blonde hardwood with a beautiful grain pattern. The variations in the color make each countertop unique and give it a distinctive natural look. It gets gradually darker with age.



PINNARP Countertop Thick veneer ash

L74×W25%×H1½"	703.723.13	\$169
L98×W25%×H1½"	503.723.14	\$219

Take home today wall panels



Our LYSEKIL wall panels are available to take home today and easy to install. You simply cut them to the right size and put them up on the wall. Follow the included assembly instructions and it can't go wrong.

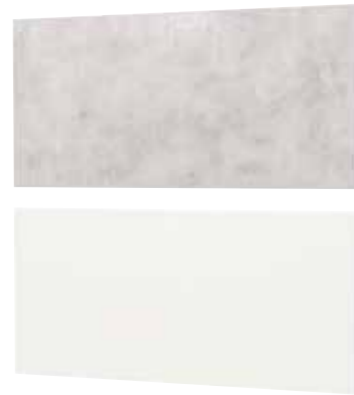

LYSEKIL Wall panel High-pressure melamine laminate. Requires assembly. Double-sided white/light gray concrete effect

L48xW19" 704.287.01 **\$39.99**



LYSEKIL Wall panel High-pressure melamine laminate. Requires assembly. Double-sided, white marble effect/pattern

L48xW19" 304.286.99 **\$39.99**



LYSEKIL Wall panel High-pressure melamine laminate and aluminum foil. Requires assembly. Double-sided brass-color/stainless steel color

L48xW19" 904.287.00 **\$49.99**

Custom-made countertops

Big advantages of a custom-made countertop

Your custom-made countertop is made to fit your kitchen layout perfectly, with the least number of seams. You can order the exact length and depth you need for your kitchen island or bar solution as well as cut-outs for your sink, faucet and cooktop.



How to buy a custom-made countertop

01

Material and color

Choose a color that makes the kitchen your own.

02

The countertop profiles

Choose the desired profile for the edges. Depending on the material you've chosen for your countertop, you have different options.

03

Choose your sink

Choose the sink you want and if you want it top mounted or undermounted.

04

Take measurements

Then start to measure to see what size and shape of countertop you need. If you would like help with this, or with anything to do with the measuring of your kitchen, we can arrange for the measuring service to come to your home.

05

We're here to help

To design your custom-made countertop get help from an IKEA co-worker in the kitchen department at your local IKEA store.

06

Order

To order your custom-made countertop, please contact an IKEA co-worker in the kitchen department at your local IKEA store.

How to measure your countertop

Start by measuring your countertop from the corner where it attaches to the wall. Make sure to make your measurements alongside the wall and always start from the same point. When measuring the depth, start from the wall and measure out. Don't forget to add 1" for an overhang too.

If you need to measure for a freestanding countertop (for a kitchen island for example), simply start from one end and add 1" extra for an overhang.

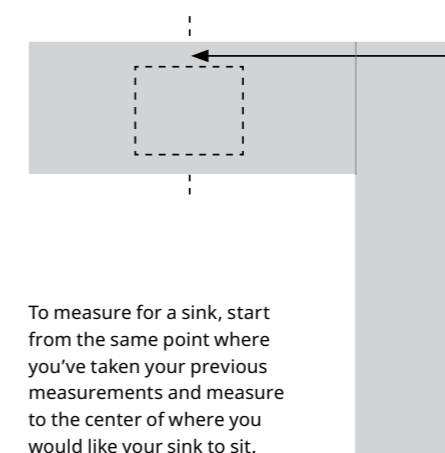
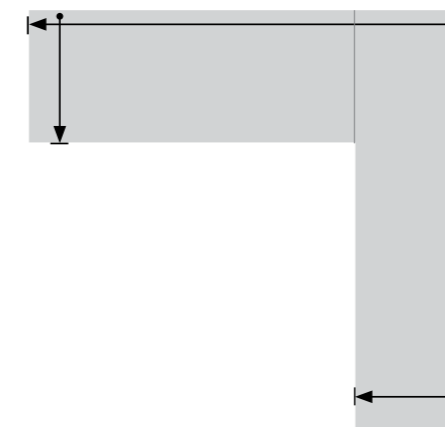

To measure for a sink, start from the same point where you've taken your previous measurements and measure to the center of where you would like your sink to sit.

KASKER quartz custom-made countertops



Price Level 0: **\$45/ft²**
 ¾" thickness

Available color:

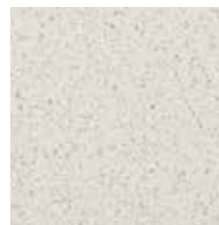

KASKER White stone-effect
 Eggshell

This color is available
 in one edge style:



Straight

When you choose a quartz countertop you get a work surface that's extremely durable. It's scratch resistant and can withstand heavy impact. We construct our quartz countertops with natural quartz crystals (one of the hardest materials in nature) and high-quality polymer resins which make the surface smooth, non-porous and easy to keep clean. That means red wine and beetroot stains are a worry of the past. You can also order quartz backsplashes to complement your countertop.

Good to know

Clean using a soft cloth or sponge and warm water with a mild, non-abrasive detergent. Avoid using scouring products.

How to estimate the cost of your KASKER quartz countertop

$$(A \times D) + (B \times D) + (C \times D) = X \text{ square inches}$$

$$(X \text{ square inches}) / 144 \times \$X / \text{ft}^2 = \text{total price}$$

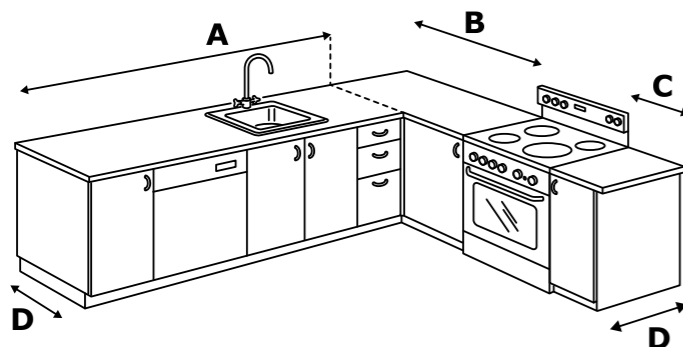

What's included in the price?
 Template/Fabrication/Installation.
 Three faucet cutouts.
 Delivery (see local store for details).
 Additional option charges may apply.
 Lifetime limited warranty.

KASKER quartz custom-made countertops

Price Level 1: **\$53/ft²**
 1¼" thickness

Available colors:



KASKER Light gray/
 beige marble-effect
 Clamshell



KASKER Gray stone-
 effect Pebble/Stone
 Gray

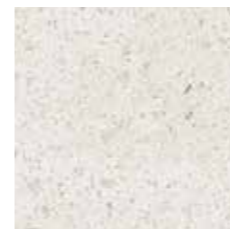

KASKER White
 mineral-effect Ocean
 Foam

Price Level 2: **\$61/ft²**
 1¼" thickness

Available colors:



KASKER Light gray/
 stone-effect
 Raw Concrete



KASKER Light gray/
 beige/glitter/
 marble-effect
 Himalayan Moon



KASKER Black
 mineral/glitter-effect
 Black Noir



KASKER Matte light
 gray/concrete-effect
 Sleek Concrete

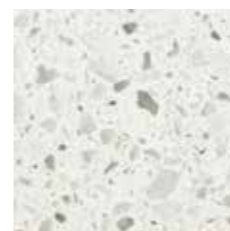

KASKER White
 mineral/glitter-effect
 Nougat

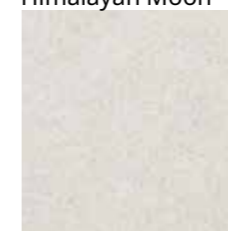

KASKER Off-white
 marble-effect
 Organic White

KASKER quartz custom-made countertops

Price Level 3: **\$69/ft²**
1¼" thickness

Available colors:



KASKER Brown stone/marble-effect Wild Rice

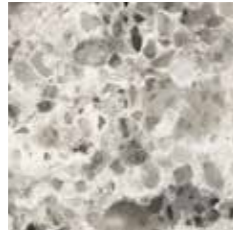

KASKER Light gray/dark gray mineral-effect Atlantic Salt



KASKER White Pure White

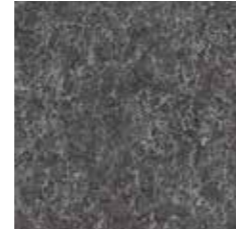

KASKER Gray marble-effect Coastal Gray



KASKER White stone marble-effect Cosmopolitan White



KASKER Gray stone marble-effect Symphony Gray

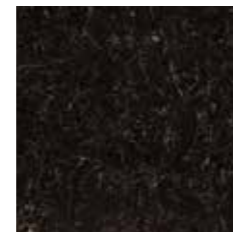

KASKER Dark brown/marble-effect Woodlands

Price Level 4: **\$77/ft²**
1¼" thickness

Available colors:



KASKER Light gray/marble-effect Noble Gray

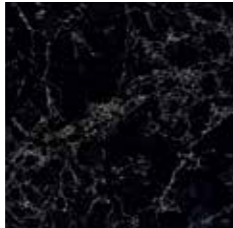

KASKER Black marble-effect Vanilla Noir



KASKER Dark gray marble-effect Piatra Gray



KASKER White marble-effect Frosty Carrina

KASKER Quartz custom-made countertops

Available edge styles:



Straight
\$5/linear foot



Half round
\$10/linear foot



Beveled
\$10/linear foot



Chamfered
\$10/linear foot



Full round
\$10/linear foot

Support fitting for KASKER quartz countertops

To use KASKER in your kitchen you also need a support fitting that lifts the countertop up from the base cabinet frame, so that the countertop slides in place easily. Talk to a co-worker in the kitchen department to find out how many are needed for your countertop.



FIXA Countertop support fitting
Galvanized steel 702.746.28 **\$3.99/ea**



Sinks

A busy place in the kitchen

The sink and the area around it is one of the busiest places in the kitchen. You use it for everything from preparing food and rinsing vegetables, to storing dirty dishes and cleaning up. To make these activities as easy as possible, choose a sink and sink accessories that match your needs and the way you work in the kitchen.

How to choose your sink

01

How much space have you allocated for the sink? Our sink cabinets are 24, 30 or 36" wide.

02

Think about how you prepare food, but also how you clean up. Do you have a dishwasher or do you wash the dishes by hand? Do you need one bowl, two bowls or a sink with drainboard?

03

Complete your sink with sink accessories that help you organize the area in and around the sink, both when you prepare food and when you clean up (**see page 88**).

25
Year Limited
Warranty
Included

We test our sinks to ensure they can withstand the demand of everyday life in the kitchen. That's why all our sinks come with a free 25-year limited warranty (except FYNDIG). Find out more on **pages 100-101**.



Our range of sinks

Single bowl sinks

If space is an issue, one single bowl is a good option. Plus, in a big single bowl you can easily wash large pots and pans. Combine with sink accessories to make the bowl as functional as possible (**see page 88**).

Double bowl sinks

Having two bowls is ideal if you have a lot going on at the same time. For example, if one of the bowls is piling up with dirty dishes, you can still rinse off vegetables and the like in the other.

1½ bowl sinks

A one and a half bowl sink gives you the same advantages as a double bowl sink, but in a smaller area.

Sinks with drainboard

A sink with a drainboard is ideal for drying dishes, as the sloping surface makes excess water flow back into the bowl. Our sink with drainboard is reversible, so you can choose if you want the drainboard to the left or to the right.

24"

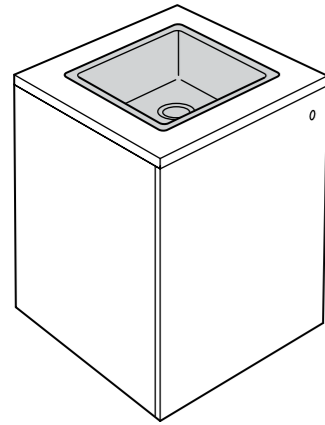

30"

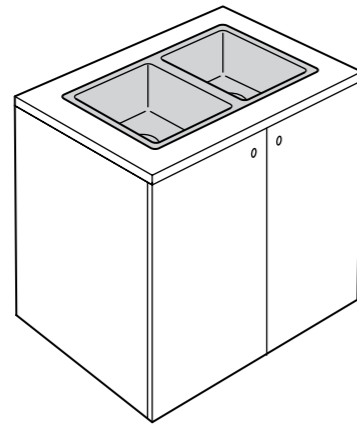

36"

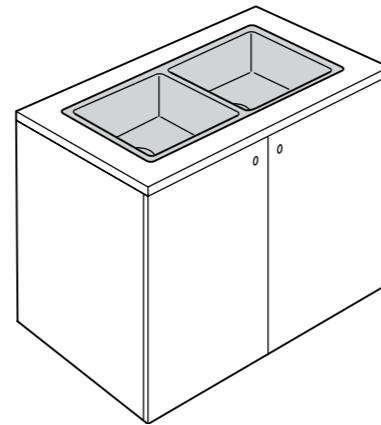

Fits 24" cabinets



FYNDIG Inset sink one bowl

May be completed with GRUNDTVATTNET sink accessories for effective use of space of the sink. LILLVIKEN strainer is included, but packaged separately. Requires installation. W17¼×D15½×H5¾".

Stainless steel 691.580.07 **\$37.99**



BOHOLMEN Inset sink one bowl

Can be undermounted. May be completed with GRUNDTVATTNET sink accessories for effective use of space of the sink. LILLVIKEN strainer is included, but packaged separately. Requires installation. Ø17¾".

Stainless steel 891.574.98 **\$52.99**



VATTUDALEN Inset sink one bowl with drainboard

Reversible; can be used with the drainboard to the right or left. May be completed with GRUNDTVATTNET sink accessories for effective use of space of the sink. LILLVIKEN strainer is included, but packaged separately. Requires installation. W27½×D18½×H7¼".

Stainless steel 891.581.72 **\$97**



LÅNGUDDEN Inset sink one bowl

Has a pre-drilled hole for a kitchen faucet. May be completed with GRUNDTVATTNET sink accessories for effective use of space of the sink. LILLVIKEN strainer is included, but packaged separately. Requires installation. W22×D20¾×H7¼".

Stainless steel 891.574.84 **\$97**



NORRSJÖN Inset sink one bowl

Can be undermounted. Perfect size for an additional sink in the kitchen. Requires installation. W8×D17×H5¾". LILLVIKEN strainer and LILLVIKEN lid are included, but packaged separately.

Stainless steel 192.505.22 **\$181.50**



NORRSJÖN Inset sink one bowl

Can be undermounted. May be completed with NORRSJÖN sink accessories for effective use of space of the sink. Requires installation. W14½×D17¼×H7¾". LILLVIKEN strainer and LILLVIKEN lid are included, but packaged separately.

Stainless steel 691.576.49 **\$171.50**

Fits 24" cabinets



NORRSJÖN Inset sink one bowl

Can be undermounted. May be completed with NORRSJÖN sink accessories for effective use of space of the sink. Requires installation. W21¼×D17¼×H7¾". LILLVIKEN strainer and LILLVIKEN lid are included, but packaged separately.

Stainless steel 691.579.08 **\$211.50**



HAVSEN Inset sink one bowl

Ceramic sinks are kiln-fired which makes each one unique, therefore the size may vary slightly from the measurements given. LILLVIKEN strainer is included, but packaged separately. Requires installation. W21×D19×H7¾".

White 192.537.28 **\$127**



HAVSEN Apron front sink one bowl

Ceramic sinks are kiln-fired which makes each one unique, therefore the size may vary slightly from the measurements given. Fits countertop with a minimum thickness of 1". LILLVIKEN strainer is included, but packaged separately. Requires installation. W25×D18¾×H7¾".

White 792.537.25 **\$187**



BREDSJÖN Apron front single bowl sink

Undermount installation only. Installation must be carried out by a qualified installer. May be completed with GRUNDTVATTNET sink accessories for effective use of space of the sink. LILLVIKEN strainer and LILLVIKEN lid are included, but packaged separately. Requires installation. W19¾×D18×H7¼".

Stainless steel 092.895.63 **\$261.50**

Fits 30" cabinets



HILLESJÖN Inset sink one and a half bowl

Can be undermounted. May be completed with GRUNDTVATTNET sink accessories for effective use of space of the sink. LILLVIKEN strainer is included, but packaged separately. Requires installation. W22¾×D18¾×H7¾".

Stainless steel 991.407.04 **\$105**



HÅLLVIKEN Inset sink one bowl

Has a pre-drilled hole for a kitchen faucet. May be completed with GRUNDTVATTNET sink accessories for effective use of space of the sink. Requires installation. W22×D19¾×H7¾". LILLVIKEN strainer and LILLVIKEN lid are included, but packaged separately.

White 791.576.44 **\$211.50**



HÅLLVIKEN Inset sink one bowl

Has a pre-drilled hole for a kitchen faucet. May be completed with GRUNDTVATTNET sink accessories for effective use of space of the sink. Requires installation. W22×D19¾×H7¾". LILLVIKEN strainer and LILLVIKEN lid are included, but packaged separately.

Black 391.576.41 **\$211.50**

Fits 30" cabinets

**LÅNGUDDEN Inset sink two bowls**

Has a pre-drilled hole for a kitchen faucet. May be completed with GRUNDTVATTNET sink accessories for effective use of space of the sink. LILLVIKEN strainer is included, but packaged separately. Requires installation. W29½×D20½×H7½".

Stainless steel 991.574.88 **\$145**

**HILLESJÖN Inset sink one and a half bowls**

Can be undermounted. May be completed with GRUNDTVATTNET sink accessories for effective use of space of the sink. LILLVIKEN strainer is included, but packaged separately. Requires installation. W29½×D18½×H7½".

Stainless steel 091.407.08 **\$145**

**HILLESJÖN Inset sink two bowls**

Can be undermounted. May be completed with GRUNDTVATTNET sink accessories for effective use of space of the sink. LILLVIKEN strainer is included, but packaged separately. Requires installation. W29½×D18½×H7½".

Stainless steel 391.574.91 **\$125**

**BREDSJÖN Apron front double bowl sink**

Undermount installation only. Installation must be carried out by a qualified installer. May be completed with GRUNDTVATTNET sink accessories for effective use of space of the sink. LILLVIKEN strainer and LILLVIKEN lid are included, but packaged separately. Requires installation. W30×D18×H7½".

Stainless steel 992.895.68 **\$324**

Fits 36" cabinets

**NORRSJÖN Inset sink one bowl**

Can be undermounted. May be completed with NORRSJÖN sink accessories for effective use of space of the sink. Requires installation. W28¾×D17¼×H7½". LILLVIKEN strainer and LILLVIKEN lid are included, but packaged separately.

Stainless steel 491.579.14 **\$261.50**

**NORRSJÖN Inset sink two bowls**

Can be undermounted. May be completed with NORRSJÖN sink accessories for effective use of space of the sink. Requires installation. W28¾×D17¼×H7½". LILLVIKEN strainer and LILLVIKEN lid are included, but packaged separately.

Stainless steel 591.579.23 **\$324**

**HAVSEN Apron front sink two bowls**

Ceramic sinks are kiln-fired, which makes each one unique, therefore the size may vary slightly from measurements given. Fits countertop with a minimum thickness of 1". LILLVIKEN strainer is included, but packaged separately. Requires installation. W37×D18¾×H7½".

White 592.537.26 **\$215**

Strainer, lid and tools for sinks

**LILLVIKEN Sink strainer**

Strainer with stopper. Requires assembly. Ø4¾".

Stainless steel 503.254.26 **\$8**

**LILLVIKEN Lid**

Fits LILLVIKEN sink strainer. On top of the water trap the lid connects through a magnet which can be used as a handle to pick up the basket and throw away scraps. Requires assembly. Ø3".

Stainless steel 203.178.52 **\$4.50**

Strainer, lid and tools for sinks

**KNIPEN Detergent dispenser**

Can be installed in a hole Ø1¼-1¾". Dispenser can be filled from above. Requires assembly. 17 oz.

Stainless steel color 703.417.22 **\$16.99**

Kitchen faucets

Saving water at every step

Earth may be covered in a lot of water, but very little of it is drinkable and even less is accessible. No organism can survive without it, and no new water is created. It's constantly recycled, but our freshwater supply is overused; not evenly distributed; and impacted by pollution, contamination and climate change. That's why we equip all our kitchen faucets with a water-saving aerator that reduces water use up to 40% — while maintaining the same pressure. We didn't invent aerators, but think they are an important example of how we can work together to save water for everyone's benefit.

10
Year Limited
Warranty
Included

All our kitchen faucets are tested and third party-certified to meet, or exceed, the demands of the relevant national and international mechanical, quality, safety and hygienic standards. All IKEA kitchen faucets come with a free 10-year limited warranty. Find out more on [pages 100-101](#).



Functions



Kitchen faucets with low spout

Kitchen faucets with low spouts always have the handle on top, and are ideal for small single bowl sinks.

YTTRAN Kitchen faucet*



Kitchen faucets with high spout

The high spout makes it easier to wash dishes, including large pots.

INSJÖN Kitchen faucet*



Kitchen faucets with pull-out spout

Rinsing dishes is easier with the pull-out spout. A counterweight makes the hose easily retract back into the kitchen faucet.

ÄLMAREN Kitchen faucet with pull-out spout*



Kitchen faucet with sensor technology

Turn this faucet on and off with a slight hand movement, without touching it. The sensor is placed on the side, so it's less visible and more practical.

INSJÖN Kitchen faucet with sensor*

Kitchen faucets with high spout



NYVATTNET Kitchen faucet

Swivel spout is preset to 360° but can be changed to 120°. Requires installation. H15¾".

Polished brass-color 103.416.64 **\$99**



ÄLMAREN Kitchen faucet

Swivel spout is preset to 360° but can be changed to 120°. Also available with pull-out spout. Requires installation. H14¾".

Stainless steel-color 503.416.43 **\$99**



GAMESJÖN Dual-control kitchen faucet

Swivel spout 360°. Requires installation. H14¾".

Brushed black metal 903.416.79 **\$119**



INSJÖN Kitchen faucet

Swivel spout is preset to 360° but can be changed to 120°. Also available with pull-out spout. Requires installation. H15¾".

Brass-color 303.701.32 **\$149**
 Chrome-plated 203.701.23 **\$149**

Kitchen faucets with low spout



LAGAN Kitchen faucet

Swivel spout 360°. Requires installation. H6¼".

Chrome-plated 700.850.29 **\$19.99**



SUNDSVIK Kitchen faucet

Swivel spout 360°. Requires installation. H6".

Chrome-plated 702.705.07 **\$39.99**



YTTRAN Kitchen faucet

Swivel spout is preset to 360° but can be changed to 120°. Also available with pull-out spout. Requires installation. H7½".

Chrome-plated 603.059.46 **\$49.99**



VATTNET Kitchen faucet

Swivel spout is preset to 360° but can be changed to 90° or 120°. Requires installation. H7½".

Chrome-plated 403.416.86 **\$69**



BOSJÖN Kitchen faucet

Swivel spout 120°. Requires installation. H12½".

Stainless steel-color 904.574.05 **\$169**

KITCHEN FAUCETS

Kitchen faucets with pull-out spout



YTRAN Kitchen faucet with pull-out spout
Swivel spout 120°. Also available without pull-out spout. Requires installation. H7".

Chrome-plated 603.059.51 **\$79.99**



ÄLMAREN Kitchen faucet with pull-out spout
Swivel spout 120°. Also available without pull-out spout. Requires installation. H14¼".

Stainless steel-color 803.416.51 **\$119**



INSJÖN Kitchen faucet with pull-out spout
Swivel spout 120°. Also available without pull-out spout. Requires installation. H16¾".

Chrome-plated 703.418.78 **\$159**

Kitchen faucets with handspray



VITHAVET Kitchen faucet with separate handspray
Swivel spout is preset to 360° but can be changed to 120°. Requires installation. H15¾".

Chrome-plated 003.419.28 **\$199**



VIMMERN Kitchen faucet with handspray
Swivel spout 360°. Requires installation. H18½".

Stainless steel-color 103.052.89 **\$169**

Kitchen faucets with sensor technology



TÄMNAREN Kitchen faucet with sensor
You turn this kitchen faucet with sensor function on and off with a slight hand movement, without touching it. The sensor is placed on the faucet's side so it's less visible – and more practical. Requires installation. H12¼".

Stainless steel color 303.595.06 **\$199**



INSJÖN Kitchen faucet with sensor
The water flow turns off automatically after 10 seconds if the sensor does not detect any movement. You can make a hand movement if you want to turn the water off quicker. Requires installation. H18½".

Chrome-plated 203.419.08 **\$199**



SEKTION Cabinets

Modular cabinets that fit your space

What does your dream kitchen look like? How much time will you spend in it and how will you use it? When it comes to kitchens, we're all different. We have different dreams, different needs and different preconditions. To meet this diversity, what could be better than a highly flexible kitchen system with cabinets that can suit everyone, and be planned in everywhere? Whatever the size of your home or family, with cabinets in different sizes, drawers with endless possibilities and interior organizers made to match, you can turn the kitchen of your dreams into the kitchen in your home.

25
Year Limited
Warranty
Included

SEKTION kitchens have a free 25-year limited warranty. Find out more on [pages 100-101](#).



Ranked "Highest in Customer Satisfaction with Kitchen Cabinets" in 2019 by J.D. Power



Here are all available SEKTION cabinets and their sizes.
Choose and mix them to fit the architecture of you room as well as your own needs.

SEKTION Base cabinets

	SEKTION Base cabinet frame W12xD14¼xH30". White 902.653.93 \$30
	SEKTION Base cabinet frame W12xD24xH30". White 102.653.92 \$40
	SEKTION Base cabinet frame W15xD14¼xH30". White 302.653.91 \$35
	SEKTION Base cabinet frame W15xD24xH30". White 002.653.97 \$45
	SEKTION Base cabinet frame W18xD14¼xH30". White 702.653.94 \$40
	SEKTION Base cabinet frame W18xD24xH30". White 202.653.96 \$50
	SEKTION Base cabinet frame W21xD14¼xH30". White 602.653.99 \$45
	SEKTION Base cabinet frame W21xD24xH30". White 302.654.14 \$55
	SEKTION Base cabinet frame W24xD14¼xH30". White 402.653.95 \$50
	SEKTION Base cabinet frame W24xD24xH30". White 902.653.88 \$60
	SEKTION Base cabinet frame W30xD14¼xH30". White 502.653.90 \$55
	SEKTION Base cabinet frame W30xD24xH30". White 302.653.86 \$65
	SEKTION Base cabinet frame W36xD14¼xH30". White 702.653.89 \$60
	SEKTION Base cabinet frame W36xD24xH30". White 802.653.98 \$70

SEKTION Base cabinet for built-in oven

	SEKTION Base cabinet for oven W30xD24xH30". White 502.986.49 \$72
--	--

SEKTION Base cabinet adapted for wheelchairs

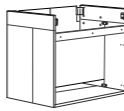

SEKTION Base cabinet frame adapted for wheelchairs
This cabinet can be converted to a wheelchair accessible sink cabinet. Suspension rail sold separately. Hinges are sold separately. Legs are sold separately. W36xD24xH30".

White	304.508.45	\$90
-------	------------	-------------

SEKTION Top cabinets

	SEKTION Fridge/freezer top cabinet frame W30xD24xH15". Whites 602.655.11 \$50
	SEKTION Fridge/freezer top cabinet frame W30xD24xH20". White 402.655.12 \$55
	SEKTION Fridge/freezer top cabinet frame W36xD24xH15". White 002.655.09 \$55
	SEKTION Fridge/freezer top cabinet frame W36xD24xH20". White 202.655.13 \$60

SEKTION Wall cabinets

	SEKTION Wall cabinet frame W12xD14¼xH30". White 102.654.72 \$25
	SEKTION Wall cabinet frame W12xD14¼xH40". White 902.654.73 \$30
	SEKTION Wall cabinet frame W15xD14¼xH15". White 102.654.67 \$25
	SEKTION Wall cabinet frame W15xD14¼xH20". White 802.654.59 \$25
	SEKTION Wall cabinet frame W15xD14¼xH30". White 902.654.54 \$30
	SEKTION Wall cabinet frame W15xD14¼xH40". White 002.654.63 \$35

SEKTION Wall cabinets

	SEKTION Wall cabinet frame W18xD14¼xH15". White 602.654.55 \$30
	SEKTION Wall cabinet frame W18xD14¼xH20". White 502.654.65 \$30
	SEKTION Wall cabinet frame W18xD14¼xH30". White 802.654.64 \$35
	SEKTION Wall cabinet frame W18xD14¼xH40". White 002.654.58 \$40
	SEKTION Wall cabinet frame W21xD14¼xH20". White 402.654.61 \$35
	SEKTION Wall cabinet frame W21xD14¼xH30". White 502.654.51 \$40
	SEKTION Wall cabinet frame W21xD14¼xH40". White 302.654.52 \$45
	SEKTION Wall cabinet frame W24xD14¼xH15". White 302.654.66 \$35
	SEKTION Wall cabinet frame W24xD14¼xH20". White 202.654.57 \$40
	SEKTION Wall cabinet frame W24xD14¼xH30". White 702.654.50 \$45
	SEKTION Wall cabinet frame W24xD14¼xH40". White 502.654.70 \$50
	SEKTION Wall cabinet frame W30xD14¼xH15". White 202.654.62 \$40
	SEKTION Wall cabinet frame W30xD14¼xH20". White 102.654.53 \$45
	SEKTION Wall cabinet frame W30xD14¼xH30". White 702.654.69 \$50
	SEKTION Wall cabinet frame W30xD14¼xH40". White 902.654.68 \$55
	SEKTION Wall cabinet frame W36xD14¼xH15". White 402.654.56 \$45
	SEKTION Wall cabinet frame W36xD14¼xH20". White 302.654.71 \$55

	SEKTION Wall cabinet frame W36xD14¼xH30". White 902.654.49 \$60
--	--

	SEKTION Wall cabinet frame W36xD14¼xH40". White 602.654.60 \$65
--	--

SEKTION High cabinets

	SEKTION High cabinet frame W15xD14¼xH80". White 202.654.43 \$75
	SEKTION High cabinet frame W15xD14¼xH90". White 602.654.41 \$85
	SEKTION High cabinet frame W15xD24xH80". White 802.654.40 \$85
	SEKTION High cabinet frame W15xD24xH90". White 102.654.48 \$95
	SEKTION High cabinet frame W18xD14¼xH80". White 402.654.42 \$80
	SEKTION High cabinet frame W18xD14¼xH90". White 602.654.36 \$90
	SEKTION High cabinet frame W18xD24xH80". White 002.654.44 \$90
	SEKTION High cabinet frame W18xD24xH90". White 002.654.39 \$110
	SEKTION High cabinet frame W24xD14¼xH80". White 402.654.37 \$90
	SEKTION High cabinet frame W24xD14¼xH90". White 302.654.47 \$110
	SEKTION High cabinet frame W24xD24xH80". White 202.654.38 \$110
	SEKTION High cabinet frame W24xD24xH90". White 702.654.45 \$120
	SEKTION High cabinet frame W30xD24xH80". White 502.654.46 \$120
	SEKTION High cabinet frame W30xD24xH90". White 802.654.35 \$130

SEKTION Corner cabinets

	SEKTION Base corner cabinet frame W38xH30".
White	702.655.01 \$80

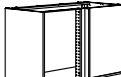
	SEKTION Base corner cabinet frame W47xH30".
White	502.655.02 \$90

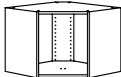
	SEKTION Corner wall cabinet frame W26xH20".
White	802.655.05 \$55

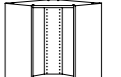
	SEKTION Corner wall cabinet frame W26xH30".
White	102.655.04 \$60

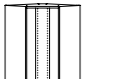
	SEKTION Corner wall cabinet frame W26xH40".
White	302.655.03 \$65

SEKTION Top rail

	SEKTION Reinforced ventilated top rail Galvanized. Use for sink and cooktop base cabinet solutions.
L24"	002.845.79 \$8
L30"	802.845.80 \$9
L36"	602.845.81 \$10

NYTTIG Fillers and separators

	NYTTIG Fillerpiece for hood fan used as filler to the wall when installing a hood fan.
	302.822.39 \$7

	NYTTIG Fillerpiece for microwave hood used as filler to the wall when installing a microwave hood.
	102.822.40 \$19

	NYTTIG Cooktop/drawer separator used for cooktop and drawer combination.
30"	602.906.76 \$7
36"	802.906.75 \$9

Open storage

Create a nice break in a row of cabinets with doors using open cabinets. Your kitchen becomes more personal and you can have often used items like cookbooks within arm's reach.

	TUTEMO Open cabinet
W9xD14xH15".	
Anthracite	203.498.29 \$34.99
Ash	003.498.30 \$34.99
W15xD14xH15".	
Anthracite	303.498.19 \$39.99
Ash	103.498.20 \$39.99

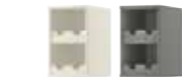
	TORNVIKEN Open cabinet
W9xD14xH15".	
Gray	803.590.28 \$55
Off-white	003.590.32 \$55
W9xD14xH30".	
Gray	203.590.26 \$69
Off-white	103.590.36 \$69
W9xD14xH40".	
Gray	003.590.27 \$79
Off-white	303.590.35 \$79

	TORNVIKEN Box W7xH5".
	A flexible box that you can place in TORNVIKEN open cabinet and also lift out and place somewhere—like on the countertop or the dining table.
Gray	603.590.29 \$17
White	803.590.33 \$17

	VADHOLMA Open storage
Brown/stained ash	
W9xD14xH15"	203.743.43 \$59
W9xD14xH30"	003.743.44 \$69
W9xD14xH40"	703.743.45 \$79

	VADHOLMA Drawer unit W15xD14xH15".
	Smooth-running drawers with stop, self-closing the last inches. You can view and access what's inside, as the drawers fully extends.
Brown/stained ash	403.743.42 \$89

	VADHOLMA Wine shelf W15xD14xH15".
Brown/stained ash	503.743.46 \$69

Wall storage

	BOTKYRKA Wall shelf W31xH7".
White	402.797.31 \$34.99

	TORNVIKEN Plate shelf W31xD7xH39".
Off-white	603.916.56 \$59.99

	TORNVIKEN Wall shelf W47xD11xH9".
Off-white	603.916.61 \$49.99

	TORNVIKEN Wall shelf W19xD11xH9".
Gray	803.592.12 \$39.99
Off-white	803.935.17 \$39.99

	TORNVIKEN Wall shelf L23xD11xH39".
Off-white	203.980.99 \$59.99

	VADHOLMA Wall shelf W15xD7xH39".
Black	203.591.92 \$59.99

MAXIMERA Drawers and drawer accessories

MAXIMERA drawers fully extend, and thanks to a built-in damper they always close softly and quietly. You have complete overview and you can easily reach the smallest of utensils even at the back of the drawer. MAXIMERA drawers are available in different sizes to give you plenty of options depending on your storage needs. You can also add inner drawers to fully utilize the cabinet space.

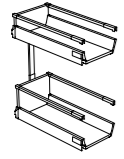

MAXIMERA Pull-out interior fittings		
W12×D24×H23½"	302.972.74	\$75

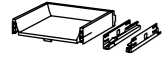

MAXIMERA Drawer, low White		
W15×D14¼×H3½"	302.656.59	\$24
W18×D14¼×H3½"	502.656.58	\$28
W24×D14¼×H3½"	402.656.54	\$34
W30×D14¼×H3½"	102.656.60	\$38
W36×D14¼×H3½"	102.656.55	\$42
W15×D24×H3½"	502.656.63	\$30
W18×D24×H3½"	702.656.57	\$36
W24×D24×H3½"	702.656.62	\$42
W30×D24×H3½"	902.656.56	\$54
W36×D24×H3½"	902.656.61	\$66

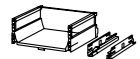

MAXIMERA Drawer, medium White		
W15×D14¼×H5½"	402.656.73	\$28
W18×D14¼×H5½"	202.656.74	\$32
W24×D14¼×H5½"	402.656.68	\$38
W30×D14¼×H5½"	802.656.71	\$44
W36×D14¼×H5½"	202.656.69	\$50
W15×D24×H5½"	002.656.70	\$36
W18×D24×H5½"	002.656.65	\$41
W21×D24×H5½"	602.656.72	\$45
W24×D24×H5½"	802.656.66	\$49
W30×D24×H5½"	302.656.64	\$61
W36×D24×H5½"	602.656.67	\$73

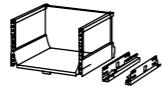

MAXIMERA Drawer, high White		
W24×D17¼×H8¾"	402.766.95	\$47
W30×D17¼×H8¾"	202.766.96	\$55
W36×D17¼×H8¾"	002.766.97	\$63
W15×D24×H8¾"	302.656.78	\$39
W18×D24×H8¾"	502.656.82	\$45
W24×D24×H8¾"	102.656.79	\$57
W30×D24×H8¾"	702.656.76	\$69
W36×D24×H8¾"	102.656.84	\$81



UTRUSTA Drawer front, low White		
W15×H3½"	402.656.25	\$9
W18×H3½"	602.656.29	\$11
W24×H3½"	802.656.28	\$15
W30×H3½"	202.656.26	\$18
W36×H3½"	002.656.27	\$21



UTRUSTA Drawer front, medium White		
W15×H6½"	602.656.34	\$11
W18×H6½"	102.656.36	\$13
W21×H6½"	302.656.35	\$15
W24×H6½"	202.656.31	\$17
W30×H6½"	002.656.32	\$20
W36×H6½"	802.656.33	\$23



UTRUSTA Drawer front, high White		
W15×H8¾"	902.656.37	\$13
W18×H8¾"	702.656.38	\$15
W24×H8¾"	502.656.39	\$19
W30×H8¾"	302.656.40	\$22
W36×H8¾"	902.656.42	\$25

FÖRVARA Drawers

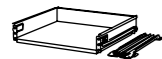

FÖRVARA Drawer, low White		
W15×D24×H3½"	902.620.59	\$13
W18×D24×H3½"	902.620.64	\$20
W24×D24×H3½"	102.620.63	\$24
W30×D24×H3½"	602.620.65	\$28
W36×D24×H3½"	402.620.66	\$32

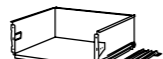

FÖRVARA Drawer, medium White		
W15×D24×H6"	102.620.82	\$16
W18×D24×H6"	402.620.47	\$24
W21×D24×H6"	702.620.60	\$29
W24×D24×H6"	602.656.53	\$33
W30×D24×H6"	702.620.84	\$36
W36×D24×H6"	902.620.40	\$40

Shelves



UTRUSTA Shelves W12×D14¼"		
White	402.655.31	\$6/2pk



UTRUSTA Shelves W12×D24"		
White	902.655.24	\$9/2pk



UTRUSTA Shelves W15×D14¼"		
Glass	202.656.07	\$14/2pk
White	802.655.48	\$10/2pk



UTRUSTA Shelves W15×D24"		
White	602.655.25	\$11/2pk



UTRUSTA Shelves W18×D14¼"		
Glass	002.656.13	\$16/2pk
White	802.655.29	\$12/2pk



UTRUSTA Shelves W18×D24"		
White	202.655.32	\$16/2pk



UTRUSTA Shelves W21×D14¼"		
White	602.655.30	\$12/2pk



UTRUSTA Shelves W21×D24"		
White	202.655.27	\$18/2pk



UTRUSTA Shelves W24×D14¼"		
Glass	002.656.08	\$20/2pk
White	102.655.23	\$16/2pk



UTRUSTA Shelves W24×D24"		
White	002.655.33	\$20/2pk



UTRUSTA Shelves W30×D14¼"		
Glass	802.656.09	\$24/2pk
White	502.655.35	\$16/2pk



UTRUSTA Shelves W30×D24"		
White	002.655.28	\$22/2pk



UTRUSTA Shelves W36×D14¼"		
Glass	402.656.11	\$26/2pk
White	402.655.26	\$22/2pk



UTRUSTA Shelves W36×D24"		
White	802.655.34	\$26/2pk



UTRUSTA Shelf for corner base cabinet W47"		
White	102.656.22	\$24



UTRUSTA Shelf for corner wall cabinet W26"		
Glass	802.656.14	\$26
White	702.656.19	\$22



UTRUSTA Reinforced ventilated shelf W30×D24"		
White	902.656.23	\$30

Corner interior



UTRUSTA Wall corner cabinet carousel		
W24"	802.656.47	\$75

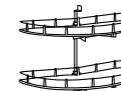

UTRUSTA Corner base cabinet pull-out fitting		
W47"	402.656.49	\$139



UTRUSTA Corner base cabinet carousel		
W34½"	602.152.91	\$99

UTRUSTA Wire basket



UTRUSTA Wire basket		
W15×D24"	802.656.52	\$18
W18×D24"	202.656.50	\$20
W24×D24"	002.656.51	\$24

SEKTION System fittings and hinges

Even the smaller details are important when you are planning a complete kitchen. It all depends on your needs and wishes—but maybe it's just this small part that will make a big difference.



SEKTION Suspension rail L84".

Galvanized 602.615.27 **\$14**

SEKTION Ventilation grille L16 7/8 x H3 3/4".

Stainless steel 702.561.77 **\$9**

UTRUSTA Push opener, electrical You can open the recycling bin with the push of a finger – or use your hip, knee or foot if your hands are busy.

302.387.03 **\$139**

UTRUSTA Push openers Push to open; no handles needed.

802.302.24 **\$8/2pk**

UTRUSTA Large hinges for horizontal door Door lift with catch for gentle closing included.

White 402.794.77 **\$89/2pk**

UTRUSTA Small hinges for horizontal door Door lift with catch for gentle closing included.

White 902.657.36 **\$49/2pk**

UTRUSTA Hinges 45° These hinges are only for use with a corner wall cabinet and is only needed when you want to mount two doors on the cabinet.

202.619.92 **\$12/2pk**

UTRUSTA Hinge with built-in damper 110° This hinge has an integrated damper, so that the door closes slowly, softly and silently.

404.017.84 **\$14**

UTRUSTA Hinges with built-in damper 153° This hinge has an integrated damper, so that the door closes slowly, softly and silently. The extra wide opening angle of 153° makes it possible to have a drawer behind a door.

104.272.62 **\$24/2pk**

SEKTION System fittings and hinges



UTRUSTA Connection hardware for doors UTRUSTA connection fitting for doors is used to connect two doors to one, so you get a uniform look for e.g. a high cabinet.

303.669.17 **\$2.99**

UTRUSTA Connecting rail for fronts You can easily align the drawer front with the other doors and drawer fronts in your kitchen and create a smooth, streamlined look with the help of UTRUSTA connection rail.

202.774.36 **\$19**

UTRUSTA Fitting for mounting drawer on door

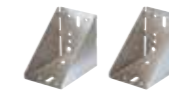
002.807.55 **\$9**

UTRUSTA Corner hardware By using the corner hardware, you can build a corner wall-cabinet solution at a 90° angle.

Galvanized 103.436.44 **\$23/2pk**

SEKTION Assembly kit for kitchen island The assembly kit makes it easy for you to mount cabinets back to back, or to attach a cover panel to the back of the base cabinets.

002.984.11 **\$16**

SEKTION Support bracket for kitchen island The support bracket keeps the island steady on uneven floors.

002.984.06 **\$16**

VARIERA Cover plates Covers drill holes in the glass door cabinet or open shelf. Suitable for all products with 3/16" holes.

White 002.263.15 **\$1.29/100pk**

VAGLIG Connection rail for panel-ready dishwasher

904.247.02 **\$25**

SEKTION interior fittings and organizers

Hidden helpers

With SEKTION interior fittings and organizers, you can get the look you want on the outside without revealing what's inside. The cabinets can be hiding all sorts of kitchen surprises. Behind a door you can find pull-out organizers for your cleaning equipment, organizers keeping all your pots, pans and lids in perfect order, or a great bunch of fully extendable drawers making everything easy to reach. Not to mention drawers inside drawers allowing you to utilize the cabinet space to a maximum. It's really up to you what goes inside your kitchen cabinets.

On the following pages you'll find numerous handy helpers making your daily work in the kitchen so much easier.



Create the perfect combination for your drawers

Less time searching, more time for cooking. Clever inside trays for your drawers keep flatware and kitchen utensils organized and in place. To really make sure you can see everything in the drawer, complete with drawer lighting. See all kitchen lighting on **page 30**.

15" drawer	18" drawer	24" drawer	30" drawer	36" drawer
<p>Inner dimensions 12"</p> <p>Outer dimensions 15"</p>	<p>Inner dimensions 15"</p> <p>Outer dimensions 18"</p>	<p>Inner dimensions 21"</p> <p>Outer dimensions 24"</p>	<p>Inner dimensions 27"</p> <p>Outer dimensions 30"</p>	<p>Inner dimensions 33"</p> <p>Outer dimensions 36"</p>

VARIERA Interior fittings

Choose interior fittings that suit your size of drawer and your flatware and utensils. A helpful tip is to keep things close to where they are used as this enables a smooth workflow.

Interior for 21" deep drawers, width 6"

	<p>VARIERA Utensil tray White W6xD20" 602.797.49 \$5.99</p>		<p>VARIERA Insert for spice jars White W3 7/8xD19" 001.772.49 \$3.99</p>
	<p>VARIERA Knife tray White W6xD20" 302.635.23 \$9.99</p>		<p>VARIERA Utensil tray Bamboo W6xD20" 202.635.66 \$11.99</p>
	<p>VARIERA Box W6xD5" Green/Gray 903.320.95 \$3.99/2pk White 203.351.15 \$1.99/ea</p>		<p>VARIERA Knife tray Bamboo W6xD20" 402.635.65 \$14.99</p>

Interior for 21" deep drawers, width 12"

	<p>VARIERA Flatware tray White W12xD20" 202.802.69 \$9.99</p>		<p>VARIERA Flatware tray Bamboo W12xD20" 702.635.64 \$16.99</p>
--	---	--	---

Interior for 21" deep drawers, width 15"

	<p>4. VARIERA Flatware tray White W15xD20" 802.635.25 \$9.99</p>		<p>11. VARIERA Flatware tray Bamboo W15xD20" 202.774.41 \$17.99</p>
	<p>5. VARIERA Utensil tray White W15xD20" 402.635.27 \$9.99</p>		<p>12. VARIERA Utensil/knife tray Bamboo W15xD20" 002.635.67 \$21.99</p>

Interior for 13" deep drawers, width 6 and 15"

	<p>VARIERA Flatware tray White W14 7/8xD12" 903.158.64 \$6.99</p>		<p>VARIERA Utensil tray White W5 7/8xD12" 603.158.65 \$6.49</p>
--	---	--	---

Additional interior fittings and organizers

Box organizers

Keep things separated and easy-to-access with boxes you can lift out and carry. They're great for dry goods and loose items, like all your take-out menus.



Shelf inserts

Make the most out of your space by adding a few shelf inserts, utilizing all the space between the shelves in your upper cabinets.



Pot lid organizer

Less time searching for the right lid. Keep your lids organized and handy with an extendable rack.



SEKTION System fittings and hinges



1. UTRUSTA Towel rail 6 1/4". It's easy to access towels because it pulls out.
White 502.472.16 **\$12.99**



2. VARIERA Box White
L9 1/2 x W6 3/4 x H4 1/8" 301.550.19 **\$2.79**



3. VARIERA Box L9 1/2 x W6 3/4 x H4 1/8".
Black 503.320.16 **\$2.79**
Gray 103.351.06 **\$2.79**
Green 003.320.14 **\$2.79**



4. VARIERA Box White
L13 1/4 x W9 1/2 x H5 3/4" 701.772.55 **\$4.50**



5. VARIERA Box with handle Bamboo
L9 1/2 x W6 3/4 x H6" 902.260.52 **\$13.99**
L13 x W9 1/2 x H6" 702.260.53 **\$19.99**



6. VARIERA Storage box White high-gloss
L19 3/8 x W4 3/4 x H8 5/8" 903.031.49 **\$11.99**



7. VARIERA Utensil holder White
L7 1/8 x W4 3/4 x H8 5/8" 103.031.48 **\$5.99**



8. MAXIMERA Add-on sides for medium drawer Glass
14 3/4" 702.388.62 **\$10.99/2pk**
24" 302.388.59 **\$12.99/2pk**

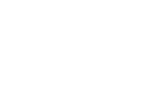

9. MAXIMERA Add-on sides for high drawer Glass
24" 502.388.58 **\$14.99/2pk**



10. MAXIMERA Divider for medium drawer White/transparent
24" 202.784.07 **\$13.99**
30" 002.784.08 **\$15.99**



11. MAXIMERA Divider for high drawer White/transparent
15" 702.784.00 **\$9.99**
24" 102.784.03 **\$15.99**
30" 502.784.01 **\$17.99**



12. VARIERA Plate holder Bamboo/stainless steel
W4 3/4 - 7 1/2" 003.846.92 **\$8.99**
W7 1/2 - 12 3/4" 303.846.95 **\$9.99**

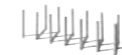

13. VARIERA Pot lid organizer Stainless steel
L3 3/4 - 19 3/4 x W5 3/4 x H4" 701.548.00 **\$7.99**



14. VARIERA Plastic bag dispenser
Ideal for storing things like plastic bags, toilet paper, paper towels, gloves and socks.
White 800.102.22 **\$2.99**



15. VARIERA Drawer mat L59 1/4 x W19 7/8".
Transparent 800.128.53 **\$3.99**



16. PASSARP Drawer mat L31 x W20".
Gray 103.200.01 **\$8.99**



17. VARIERA Shelf insert White
W12 3/8 x D5 1/8 x H6 1/4" 801.366.22 **\$5.99**
W12 3/8 x D11 x H6 1/4" 601.366.23 **\$6.99**



18. UTRUSTA Cleaning interior W14 x D22 3/8 x H53". Pull-out organizers make it easy for you to see and reach your cleaning supplies. Fits in SEKTION cabinets 18" or wider.
803.258.92 **\$99**



RISATORP series
19. RISATORP Basket L9 3/4 x W10 1/4 x H7".
Blue 703.504.86 **\$12.99**
White 902.816.18 **\$12.99**
Red 204.108.12 **\$12.99**



Recycling combinations

Are you curious about how your waste can become new resources? HÅLLBAR series helps you sort different materials into different bins – a simple action and the first step towards giving waste a new life.



A ring on the top edge of the bin hides the trash bag and keeps it in place. It's removable either for easy cleaning or if not being used

HÅLLBAR recycling management series is a waste management solution for any room of your home and can be built-in or freestanding, whichever you prefer.



The folding handle makes it easy to carry the bin with you to the recycling station.



Mount this pull-out frame inside your cabinet to hide your recycling behind a door. Easy to mount and use in cabinets throughout the home. Pull-out to sort and push it back when you are done.







HÅLLBAR bins are stackable to save space. Place same-size bins on top of each other or place smaller bins on top of the larger ones.

HÅLLBAR Freestanding recycling solutions

The bins can be placed freestanding anywhere in your home or integrated in a cabinet or drawer.

HÅLLBAR bins are stackable to save space. Place same-size bins on top of each other or place smaller bins on top of the larger ones.

A lid is included to hide your waste. It's removable for easy cleaning or if you prefer to keep your bin open.

- NEW**  **HÅLLBAR Bin** This bin is perfect for sorting used batteries and light bulbs, or to store smaller items like sponges, cloths, tea lights and crayons. Light gray
101 oz. W7%×D6%×H6% 904.321.94 **\$4.99**
- NEW**  **HÅLLBAR Bin** This bin is perfect for sorting tin cans, small packages such as hygiene products or store paper rolls or shopping bags. Light gray
3 gal. W10%×D8%×H12% 803.980.58 **\$7.99**
- NEW**  **HÅLLBAR Bin** This bin is perfect for sorting things like cardboard, plastic, paper, bottles, glass, tin cans, envelopes and advertising mail. Light gray
6 gal. W10%×D15%×H12% 204.202.03 **\$9.99**
- NEW**  **HÅLLBAR Bin** This bin is perfect for sorting things like cartons, bottles and newspapers or to give bulkier items their own space. Light gray
9 gal. W9%×D15%×H21% 504.202.06 **\$14.99**

Different-colored stickers are included so you can mark each bin according to what you are sorting. You can also draw or write on the stickers to make it even more clear what goes in each bin. The bin is designed with rounded corners to make it easier to clean. The folding handle makes it easy to carry the bin with you to the recycling station. A ring on the top edge of the bin hides the trash bag and keeps it in place. It's removable either for easy cleaning or if not being used.

- NEW**  **HÅLLBAR Pull-out frame for recycling**
Mount this pull-out frame inside your cabinet to hide your recycling behind a door. Easy to mount and use in cabinets throughout the home. The pull-out frame gives you quick access and a good overview of your recycling and keeps your bin stable. Pull it out to sort and push it back when you are done. Light gray
L10%×W17%×H12% 204.228.53 **\$34.99**
- VARIERA Trash can White**
3 gal. L10%×W18%×H6% 801.822.37 **\$3.99**
- UTRUSTA Push opener electrical**
302.387.03 **\$139**

HÅLLBAR Pull-out solutions

HÅLLBAR bins are designed to meet different recycling needs. This narrow combination is suitable if you have limited space and choose to sort your waste at the recycling station.

- NEW**  **HÅLLBAR Recycling solution with pull-out \$50.97**
A combination with two bins that is perfect for sorting your tin cans and smaller packages. Light gray 793.088.03

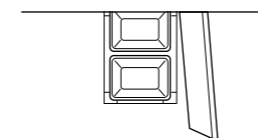

Parts included in this solution

HÅLLBAR Bin 3 gal. Light gray	803.980.58	2 pcs
HÅLLBAR Pull-out frame for recycling		
Light gray	204.228.53	1 pc

- NEW**  **HÅLLBAR Recycling solution with pull-out \$44.98**
HÅLLBAR bins are designed to meet different recycling needs. This bin is perfect for sorting things like cardboard, plastic, paper, bottles, glass, tin cans, envelopes and advertising mail. Light gray 093.088.25

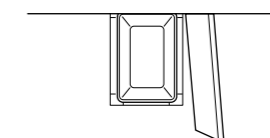

Parts included in this solution

HÅLLBAR Bin 6 gal. Light gray	204.202.03	1 pc
HÅLLBAR Pull-out frame recycling		
Light gray	204.228.53	1 pc

Kitchen accessories, carts and islands

A kitchen easy to live in

Your kitchen isn't fully in function until everything in it has found a place of its own. With smart organizers and accessories, you'll find what you need, when you need it.

Utilize the full area in the kitchen, even the walls. With smart wall storage often used items can be close at hand, at the same time you free up workspace.

Your best kitchen friends

Our carts and islands boost your storage space and kitchen functionality while adding a social focal point in your kitchen at the same time.

The sink area is a busy place. We have accessories with multiple purposes that can help you utilize the area in and around the sink, supporting the workflow both when preparing food and cleaning up.



Rails and accessories

Our selection of kitchen helpers gives you more work and storage space without the expense of a remodel.

SUNNERSTA Series

	SUNNERSTA Container W4¼×D4¾×H5½".		
White	503.037.35	99c	
Pale green	904.405.23	99c	

	SUNNERSTA Hooks	403.037.26	99c/5pk
---	------------------------	------------	----------------

	SUNNERSTA Rail		
L23½"	303.037.22	\$1.99	

	SUNNERSTA Shelf		
W14¾×D6¾"	603.926.51	\$4.99	

FINTORP Series

	FINTORP Condiment stand W14¾×D5½×H4¾".		
White/black	602.020.81	\$16.99	

	FINTORP Dish drainer W14¾×D11½×H5¼".		
Black/galvanized	802.131.73	\$14.99	
Nickel-plated	402.256.15	\$14.99	

	FINTORP Utensil holder Ø5½", H5½".		
White/black	002.020.79	\$6.99	

	FINTORP Hooks		
Black H4¼"	602.018.97	\$3.99/2pk	
Black H2¾"	402.019.02	\$3.99/5pk	
Nickel-plated H2¾"	002.138.55	\$3.99/5pk	

	FINTORP Paper towel holder Black		
H13"	402.477.97	\$10.99	

	FINTORP Magnetic knife rack Black		
L15"	202.020.83	\$13.99	

	FINTORP Rail		
Black L22½"	502.019.06	\$8.99	
Nickel-plated L22½"	402.138.39	\$8.99	
Black L31"	002.019.04	\$9.99	
Nickel-plated L31"	002.138.41	\$9.99	

SEKTION System fittings and hinges

RIMFORSA Series

	RIMFORSA Basket Bamboo		
W12½×D6×H4¼"	402.820.69	\$19.99	

	RIMFORSA Chopping board Bamboo		
L14¼×W11¾"	602.820.68	\$15.99	

	RIMFORSA Containers Tube-shaped.		
Glass/bamboo			
Ø1¾, H8½"	802.820.67	\$16.99/4pk	

	RIMFORSA Holder for containers Bamboo		
W7¾×D2¾×H6"	802.962.67	\$10.99	

KUNGSFORS Series

	KUNGSFORS Mesh bags		
Natural	203.728.34	\$5.99/	set of 2

	KUNGSFORS Rail Stainless steel		
W15¾"	004.424.99	\$4.99	
W22"	403.349.16	\$5.99	

	KUNGSFORS S-hooks Stainless steel		
H2¼"	203.349.22	\$2.99/5pk	

	KUNGSFORS Tablet stand Stainless steel		
W10¼×D5½×H4¾"	203.349.17	\$9.99	

	KUNGSFORS Hooks Stainless steel		
H3¾×D4"	703.796.92	\$2.99/3pk	

	KUNGSFORS Magnetic knife rack Stainless steel		
W22"	403.349.21	\$16.99	

	KUNGSFORS Magnetic clips Stainless steel		
H3¾"	003.349.23	\$4.99/3pk	

	KUNGSFORS Wall grid Stainless steel		
W22×H10½"	803.349.19	\$18.99	

	KUNGSFORS Shelf W23¾×D11¾".		
Ash veneer	903.712.23	\$19.99	
Stainless steel	503.349.25	\$21.99	
Bamboo	004.017.81	\$19.99	

	KUNGSFORS Suspension rail Stainless steel		
L31½"	803.348.58	\$9.99	

	RIMFORSA Holder with containers		
Bamboo/glass			
W8×D5×H8¾"	802.820.72	\$29.99	

	RIMFORSA Hook Stainless steel		
H2¼"	702.820.77	\$2.99/4pk	

	RIMFORSA Rail Stainless steel		
L23½"	002.820.71	\$8.99	
L31½"	902.820.76	\$10.99	

	VIVALLA Tablet stand Bamboo		
W10¼×D6¼×H6¾"	104.014.84	\$12.99	

	KUNGSFORS Dish drainer Stainless steel		
W23½×D11¾×H4"	403.712.25	\$39.99	

	KUNGSFORS Container Stainless steel		
Ø4¾, H10¾"	003.349.18	\$9.99	

	KUNGSFORS Container Stainless steel		
W9½×D4¾×H10¾"	603.349.20	\$17.99	

KUNGSFORS Combinations

	KUNGSFORS Suspension rail with shelf/wall grid		
W72½×D12¾×H63".			
This full wall solution in ash and stainless steel is created to give you plenty of storage space, so you can store for example your cookware and tableware in the same place, while providing a mixture of materials that feel both warm and professional.			
Stainless steel/ash veneer	292.543.41	\$454.74	

	KUNGSFORS Suspension rail with shelf/wall grid		
W25¼×D12¾×H31½".			
A stainless steel combination which comprises of two shelves that allows you to see what is on the shelf from underneath. On the wall grid you can create more storage space by hanging utensils using the S-hooks or containers in this series.			
Stainless steel	192.543.32	\$82.95	

	KUNGSFORS Suspension rail with shelf/magnet knife rack		
W25¼×D12¾×H31½".			
This combination comprises of three shelves in ash that help you store what you need, while providing a mixture of materials that feel warm and professional in the kitchen. The magnetic knife rack makes it easy to see and reach all your different knives when cooking.			
Ash veneer/stainless steel	392.543.26	\$96.94	



Sink accessories

Our sink accessories support all activities in and around the sink, helping you when preparing food and washing up. Plus, they help you to save both water and space, too.



GRUNDVATTNET Box L7×W5". Can be placed in GRUNDVATTNET colander and used to separate different ingredients when preparing food. Polypropylene plastic. Gray
 103.142.98 **\$3.99**



GRUNDVATTNET Colander L18×D6×H4". You can use it as a colander to rinse vegetables and salad or drain pasta. The colander's flat bottom can be used as a dish drainer for e.g. glasses to free up space on the countertop. Polypropylene plastic. Gray
 903.142.80 **\$5.99**



GRUNDVATTNET Mat L12×W10¼". The mat can be placed in the bottom of the sink to easily collect food waste when preparing food, or protect the surface against wear. Polypropylene plastic. Gray
 103.142.84 **\$3.99**



GRUNDVATTNET Rinsing tub L15¼×D9×H6¼". You can use the washing bowl as a divider in a sink with one bowl to create two bowls. You can save water by doing your dishes in the washing bowl instead of washing dishes under running water. Polypropylene plastic. Gray
 803.142.85 **\$8.99**



NORRSJÖN Colander L16½×W7½×H3½". The colander is designed to rest steadily on the edges of the bowl. You can use it as a colander to rinse vegetables and salad or drain pasta. Fits NORRSJÖN sinks.
 003.397.13 **\$25.99**

Step stools

Sometimes all you need is a little boost. Our step stools put the top shelves within reach.



BEKVÅM Step stool H19".
 Birch 301.788.79 **\$19.99**
 Black 603.637.19 **\$19.99**
 White 401.788.88 **\$19.99**



BEKVÅM 3-step stepladder H24¾".
 Beech 901.904.11 **\$39.99**
 Black 902.198.29 **\$39.99**

Kitchen islands and sideboards

Boost your storage space and kitchen functionality while adding a social focal point in your kitchen at the same time. A kitchen island or sideboard is great for many things.



TORNVIKEN Kitchen island W28×D20½×H35¾".
 Off-white/oak 003.933.71 **\$249**
 Gray/oak 203.916.58 **\$249**



VADHOLMA Island W49×D31×H35¾".
 Black/oak 203.591.54 **\$449**



TORNVIKEN Kitchen island L49×W30×H35¾".
 Off-white/oak 403.916.57 **\$399**
 Gray/oak 803.933.72 **\$399**



VADHOLMA rack for kitchen island W56¼×D12×H57½".
 Black 804.023.81 **\$99**



RIMFORSA Work bench L47¼×W25×H36¼".
 Stainless steel/bamboo 603.994.12 **\$499**



VADHOLMA Island with rack W49×D31×H88".
 Black/oak 592.762.28 **\$548**



VADHOLMA Island L31×W24×H35¾".
 Black/oak 403.661.15 **\$299**

Carts

A cart is a quick, easy and affordable solution giving you more flexible storage space.



RÅSKOG Cart L13×W17¼×H30¾".
 White 203.829.32 **\$29.99**
 Gray-green 904.431.35 **\$29.99**
 Black 903.339.76 **\$29.99**



FÖRHÖJA Cart W39×W16×H35".
 Birch 800.359.20 **\$109**



BEKVÅM Cart L22×W19×H33½".
 Birch 302.403.48 **\$59.99**



NISSAFORS Cart L19×W11¼×H32".
 Black 203.997.77 **\$24.99**



FLYTTA Cart L38×W22½×H33¾".
 Stainless steel 000.584.87 **\$179**



STENSTORP Cart W16×D17½×H35¾".
 White/oak 402.019.16 **\$129**



RISATORP Cart L22½×W15×H33¾".
 White 202.816.31 **\$59.99**



SUNNERSTA Cart L22×W13×H38¾".
 White 703.037.20 **\$29.99**



KUNGSFORS Cart L23×W15×H35¾".
 Stainless steel 803.349.24 **\$149**

Knobs and handles

Small details that make a difference!

Knobs and handles are like icing on the cake. Enhance the style you like, refresh the look of doors and drawers, co-ordinate with the rest of your home – or simply change because it's fun.

Knobs and handles may seem small but they can help you to really personalize your kitchen. You can enhance a style to make your kitchen look more traditional or more modern. Mix them or match them perfectly and play with placements to create the finishing touches to the look you want in your dream kitchen.



FIXA Drill template \$2.49
This simple tool helps you easily and accurately mark where you want to place your knobs and handles. Available online and at your local IKEA store. High impact polystyrene. W2½×L20¼". Orange 903.233.93

KNOBS AND HANDLES



TYDA Handles Stainless steel
L5 3/8" 701.169.31 **\$9.99/2pk**



VINNA Handles Stainless steel
L6" 201.166.98 **\$9.99/2pk**



EDVALLA Drop pulls L1 9/16".
Brass-color 403.478.86 **\$6.99/2pk**
Black 003.478.88 **\$6.99/2pk**



BILLSBRO Handles L1 9/16".
Stainless steel-color 603.235.92 **\$4.99/2pk**
White 203.343.14 **\$4.99/2pk**



BILLSBRO Handles L11 15/16".
Stainless steel-color 803.236.28 **\$9.99/2pk**
White 903.343.15 **\$9.99/2pk**



BILLSBRO Handles L15".
Stainless steel-color 603.236.29 **\$10.99/2pk**
White 903.343.01 **\$10.99/2pk**



BILLSBRO Handles L18".
Stainless steel-color 403.236.30 **\$11.99/2pk**
White 603.343.07 **\$11.99/2pk**



BILLSBRO Handles L21".
Stainless steel-color 203.236.31 **\$13.99/2pk**
White 003.343.10 **\$13.99/2pk**



BILLSBRO Handles L27".
Stainless steel-color 003.236.32 **\$17.99/2pk**
White 903.343.20 **\$17.99/2pk**



BILLSBRO Handles L33".
Stainless steel-color 803.236.33 **\$19.99/2pk**
White 703.343.21 **\$19.99/2pk**



BILLSBRO Handles L74".
Stainless steel-color 303.235.98 **\$24.99/2pk**

BILLSBRO Handles L87 3/8".
Stainless steel-color 103.235.99 **\$29.99/2pk**
White 203.343.09 **\$29.99/2pk**





BAGGANÄS Knobs Black

W1/2"	303.384.15	\$4.99/2pk
W13/16"	103.384.16	\$4.99/2pk
W13/16"	903.384.17	\$4.99/2pk

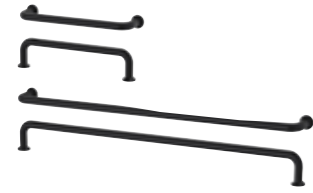

BAGGANÄS Handles Black

L5 5/8"	803.384.13	\$6.99/2pk
L13 3/16"	603.384.14	\$10.99/2pk



GUBBARP Handles White

L4 9/16"	003.364.32	79c/2pk
----------	------------	----------------

GUBBARP Knobs White

D1 1/16"	803.364.33	59c/2pk
----------	------------	----------------



KALLRÖR Handles Stainless steel

L8 3/8"	503.570.02	\$7.99/2pk
L15 15/16"	103.570.04	\$9.99/2pk
L23 1/2"	303.570.03	\$12.99/2pk

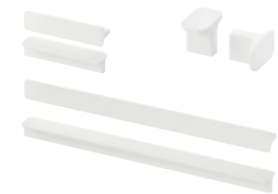

HACKÅS Handles White

L3 15/16"	304.086.82	\$6.99/2pk
L11 13/16"	104.086.83	\$10.99/2pk

HACKÅS Knobs White

L9/16"	604.086.85	\$4.99/2pk
--------	------------	-------------------



BAGGANÄS Knobs Brass-color

W1/2"	603.384.09	\$4.99/2pk
W13/16"	803.384.08	\$4.99/2pk
W13/16"	003.384.12	\$4.99/2pk



BAGGANÄS Handles Brass-color

L5 5/8"	003.384.07	\$6.99/2pk
L13 3/16"	203.384.11	\$10.99/2pk



BJÄRRED Handles Stainless steel/black leather

L6 7/8"	703.488.94	\$16.99/2pk
---------	------------	--------------------

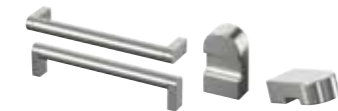

ORRNÄS Handles Stainless steel-color

L6 11/16"	702.361.51	\$10.99/2pk
L9 3/16"	802.254.11	\$11.99/2pk
L13"	402.254.13	\$13.99/2pk

ORRNÄS Knobs Stainless steel-color

W11/16"	302.361.53	\$4.99/2pk
---------	------------	-------------------

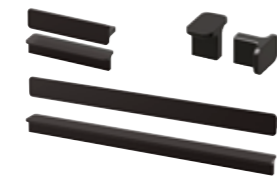

HACKÅS Handles Anthracite

L3 15/16"	303.424.79	\$6.99/2pk
L11 13/16"	503.424.78	\$10.99/2pk

HACKÅS Knobs Anthracite

L9/16"	803.397.90	\$4.99/2pk
--------	------------	-------------------



BAGGANÄS Knobs Stainless steel

W1/2"	303.384.20	\$4.99/2pk
W13/16"	103.384.21	\$4.99/2pk
W13/16"	903.384.22	\$4.99/2pk



BAGGANÄS Handles Stainless steel

L5 5/8"	703.384.18	\$6.99/2pk
L13 3/16"	503.384.19	\$10.99/2pk



KLACKBERG Knobs Silver-color

W1 3/8"	303.731.64	\$8.99/2pk
---------	------------	-------------------



BERGHALLA Handles

Gray		
L2 3/16"	603.228.56	\$8.99/2pk
White		
L2 3/16"	803.228.55	\$8.99/2pk



ENERYDA Cup handles Black

L3 1/2"	503.475.17	\$8.99/2pk
---------	------------	-------------------



ENERYDA Handles Black

L4 7/16"	703.475.16	\$8.99/2pk
----------	------------	-------------------



ENERYDA Knobs Black

L13/16"	303.475.04	\$4.99/2pk
L1 1/16"	803.475.06	\$5.99/2pk
L1 3/8"	003.475.05	\$6.99/2pk



SKÄRHAMN Handles Black/chrome-plated

L5 13/16"	503.487.86	\$15.99/2pk
-----------	------------	--------------------



HISHULT Handles Porcelain white

L5 1/2"	902.652.46	\$7.99/2pk
---------	------------	-------------------

HISHULT Knobs Porcelain white

W7/8"	202.731.41	\$4.99/2pk
W1 3/16"	502.652.48	\$4.99/2pk



ÖSTERNÄS Handles Tanned leather

L6"	403.488.95	\$14.99/2pk
L2 9/16"	203.488.96	\$10.99/2pk



ENERYDA Cup handles Brass-color

L3 1/2"	903.475.15	\$8.99/2pk
---------	------------	-------------------



ENERYDA Handles Brass-color

L4 7/16"	203.475.14	\$8.99/2pk
----------	------------	-------------------



ENERYDA Knobs Brass-color

L13/16"	203.475.09	\$4.99/2pk
L1 1/16"	403.475.08	\$5.99/2pk
L1 3/8"	603.475.07	\$6.99/2pk



SKÄRHAMN Knobs Black/chrome-plated

D7/8"	703.487.85	\$8.99/2pk
D1 3/16"	303.710.56	\$10.99/2pk



MÖLLARP Handles Black

L4 3/16"	702.652.47	\$8.99/2pk
----------	------------	-------------------

MÖLLARP Knobs Black

W9/16"	102.730.90	\$5.99/2pk
--------	------------	-------------------

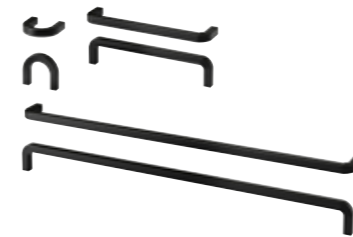

BORGHAMN Handles Steel

L1 5/8"	003.160.47	\$6.99/2pk
L6 3/4"	203.160.46	\$12.99/2pk
L16 3/4"	403.189.78	\$18.99/2pk



ENERYDA Cup handles Chrome-plated

L3 1/2"	403.475.13	\$8.99/2pk
---------	------------	-------------------



ENERYDA Handles Chrome-plated

L4 7/16"	603.475.12	\$8.99/2pk
----------	------------	-------------------



ENERYDA Knobs Chrome-plated

L13/16"	503.475.03	\$4.99/2pk
L1 1/16"	003.475.10	\$5.99/2pk
L1 3/8"	803.475.11	\$6.99/2pk



SKÄRHAMN Drop handles Black/chrome-plated

L2 9/16"	103.694.36	\$12.99/2pk
----------	------------	--------------------



MOSSARYD Drop handles Black

L1 15/16"	503.703.53	\$8.99/2pk
-----------	------------	-------------------

MOSSARYD Drop handles Stainless steel-color

L1 15/16"	703.703.52	\$8.99/2pk
-----------	------------	-------------------



HEDRA Knobs Anthracite

D1 1/4"	500.461.52	\$4.99/2pk
---------	------------	-------------------

KNOXHULT KITCHEN

When basic functions and low price matters

To make it easy for you, we've already combined ready cabinets with doors, countertops, shelves and drawers. All you have to do is to pick the finishing touches, like knobs, handles and appliances. If you

bring it home from your local IKEA store in the morning, you can have it installed and ready for cooking a late dinner in the evening. On the next pages you'll see what choices you have.



KNOXHULT is functional and easy to plan. Pick the combinations you like, then choose appliances, sink, faucet, knobs and handles. Done!

Base cabinets



KNOXHULT Base cabinet with doors and drawer

You can install a sink and also adjust the space in the cabinet to your needs with two adjustable shelves. The frame and fronts are coated with foil which gives a scratch-resistant surface that is easy to keep clean. You can easily mount the door front in the right position, because the hinges are adjustable in height, depth and width. Stands steady on uneven floors because it has small adjustable feet. The countertop is 3/8" wider than the cabinet. W72xD24xL36".

White	003.722.60	\$189
Gray	203.722.59	\$219



KNOXHULT Base cabinet with doors and drawer

You can install a sink and also adjust the space in the cabinet to your needs with two adjustable shelves. The frame and fronts are coated with foil which gives a scratch-resistant surface that is easy to keep clean. You can easily mount the door front in the right position, because the hinges are adjustable in height, depth and width. Stands steady on uneven floors because it has small adjustable feet. Drawer with stop. The countertop is 3/8" wider than the cabinet. W48xD24xH36".

White	603.722.62	\$129
Gray	803.722.61	\$159



KNOXHULT Base cabinet with drawers

Drawer with stop. Drawer fronts are covered with foil, which gives a scratch-resistant finish. Stands steady on uneven floors because it has small adjustable feet. The countertop is 3/8" wider than the cabinet. W15xD24xH36".

White	403.722.63	\$119
Gray	203.722.64	\$139



KNOXHULT Corner base cabinet

The frame and fronts are coated with foil which gives a scratch-resistant surface that is easy to keep clean. The corner cabinet can be used in a left or right position. Stands steady on uneven floors because it has small adjustable feet. The countertop is 3/8" wider than the cabinet. W44xD24xH36".

White	703.722.71	\$119
Gray	503.722.72	\$139

Wall cabinets



KNOXHULT Wall cabinet with door

You can adjust the space in the cabinet to your need with the adjustable shelf. The door is covered with foil, which provides a scratch-resistant surface. The door can be mounted to open from the left or right. W24xD12xH30".

White	503.722.67	\$49
Gray	303.722.68	\$64



KNOXHULT Wall cabinet with door

You can adjust the space in the cabinet to your need with the adjustable shelf. The door is covered with foil, which provides a scratch-resistant surface. The door can be mounted to open from the left or right. W15xD12xH30".

White	903.722.65	\$39
Gray	703.722.66	\$49



KNOXHULT Wall cabinet with doors

The doors are covered with foil, which provides a scratch-resistant surface. W30xD12xH12 1/2".

White	103.722.69	\$34
Gray	903.722.70	\$39



Accessories



STÖDJA Flatware tray W11 3/4 x D19 3/8".

White	101.772.20	\$2.99
-------	------------	---------------



STÖDJA Utensil tray W6 x D20".

White	601.772.27	\$1.79
-------	------------	---------------



LAGAN Kitchen faucet Single lever.

Swivel sprout 360°. H6 1/4".

Chrome-plated	700.850.29	\$19.99
---------------	------------	----------------



STÖDJA Flatware tray W14 1/4 x D19 3/8".

White	701.772.22	\$3.99
-------	------------	---------------



SMÄCKER Flatware tray W12 x D10".

Gray	902.417.88	\$1.29
------	------------	---------------



FYNDIG Single sink with strainer Sink in stainless steel, a hygienic, strong and durable material that's easy to keep clean. Fits cabinet frames min. 19 3/8" wide. L18 1/8 x D15 3/8". Bowl depth 5 3/8".

Stainless steel	691.580.07	\$37.99
-----------------	------------	----------------

SUNNERSTA MINI-KITCHEN

Flexible and affordable

With SUNNERSTA mini-kitchen you can create an open and welcoming kitchen even if space is limited. It's also great for dorm rooms and guest houses. Use the hooks and containers to keep track of utensils, and use the cart as a utility

surface when there's a lot going on in the kitchen. By adding our TILLREDA compact refrigerator, you'll have everything you need. This affordable and flexible kitchen is easy to buy, get home, install and move to new places.



SUNNERSTA Mini-kitchen
W44½×D22×H54¾".

403.133.63 **\$121.01**



SUNNERSTA Cart
L22×W13×H38¾". White

703.037.20 **\$29.99**



SUNNERSTA Hooks

403.037.26 **99¢/5pk**



LAGAN Kitchen faucet
Single lever. Swivel sprout 360°. H6¼". Chrome-plated

700.850.29 **\$19.99**



SUNNERSTA Shelf
W14½×D6¾×H2".
Fits SUNNERSTA rail and mini-kitchen. White

603.926.51 **\$4.99**



SUNNERSTA Container
W4¾×D4¾×H5½". Fits SUNNERSTA rail, cart and mini-kitchen.

White 503.037.35 **99¢**
Pale green 904.405.23 **99¢**



SUNNERSTA Rail
L23½". White

303.037.22 **\$1.99**



TILLREDA Compact refrigerator 2 cu.ft.
W18¾×D17¾×H19¾". White

103.432.34 **\$99**

SUNNERSTA
Mini-kitchen

\$149

SUNNERSTA Mini-kitchen \$149 Includes five hooks, LILLVIKEN strainer and LAGAN kitchen faucet. The shelf is reversible, so you can choose if you want it to the right or left. Must be secured to the wall according to product assembly instructions. Stainless steel and powder-coated steel. Designer: Henrik Preutz. RA. W44½×D22×H54¾". 591.396.89
Accessories sold separately.





**Highest in Customer Satisfaction
with Kitchen Cabinets**

IKEA SEKTION Kitchen cabinets were ranked “Highest in Customer Satisfaction with Kitchen Cabinets” for 2019 by J.D. Power. IKEA was among eight brands included in the study, and ranked highest in each of the three factors the brands were evaluated on:

- Operational Performance
- Price Satisfaction
- Warranty Satisfaction

For J.D. Power 2019 award information, visit jdpower.com/awards

LIMITED WARRANTY

GENERAL CONDITIONS

What is limited warrantied?

The extent of the limited warranty given for each product is described alongside each product.

Duration of limited warranty

Each limited warranty lasts for the number of years stated against each product starting from the date of purchase.

What will IKEA do to correct the problem?

IKEA will examine the product and decide if it's covered under this limited warranty. IKEA will then, at its choice, either repair the defective product or replace it with the same or a comparable product. In these cases, IKEA will be responsible for the costs of repairs, spare parts, labor and travel for repair staff that IKEA incurs, provided that the product is accessible for repair without IKEA incurring additional expenditure to gain access. This will not apply in cases where repair work has not been authorized by IKEA. Any defected parts removed in the course of repair works will become the property of IKEA. If the item is no longer sold by IKEA, IKEA will provide an appropriate replacement. IKEA will decide at its discretion, what will constitute an appropriate replacement.

Conditions for the limited warranties

The limited warranties are valid from the date of purchase at IKEA. The original purchase receipt is required as proof of purchase.

Exclusions

The limited warranties do not apply to products that have been stored or assembled incorrectly, used inappropriately, abused, misused, altered or cleaned with wrong cleaning methods or wrong cleaning products. The limited warranties do not cover normal wear and tear, cuts or scratches or damage caused by impacts or accidents. The limited warranties do not apply if products have been placed outdoors or in a humid environment or if the products have been used for non-residential purposes (unless otherwise stated). The limited warranties do not cover consequential or incidental damages. Some states do not allow the limitation or exclusion of incidental or consequential damage, so this limitation or exclusion may not apply to you. For details see the limited warranty conditions and description for every product.

Care instructions

To be able to rely on this limited warranty you need to follow the specific care instructions for every product.

► You will find all care instructions in the IKEA stores and on the IKEA website: IKEA-USA.com

General legal rights

This limited warranty gives you specific legal rights. This limited warranty does not, in any way, affect the rights given to you by law.

How to reach us if you need service:

Contact your local IKEA store.

► You will find the address and phone number in the IKEA catalog or at IKEA-USA.com. Save your sales receipt as proof of purchase. Proof of purchase is required for the limited warranties to be valid.

► To find out more, pick up the limited warranty folders in your local store.

25 Year Limited Warranty Included SEKTION KITCHEN SYSTEM

What products are covered under this limited warranty?

This limited warranty applies to residential kitchen use only. It covers defects in material and workmanship in the SEKTION kitchen system. This limited warranty covers all of the following parts of the

SEKTION kitchen system: • Cabinet frames • Fronts • Wall rail • UTRUSTA hinges • MAXIMERA fully-extending drawers • UTRUSTA shelves of tempered glass and melamine • Toe-kicks • Legs • Door dampers • Push opener for doors • Cover panels • Deco strips/moldings • Pre-cut countertops • Sinks except FYNDIG and VÄGLIG connecting rail.

Products not covered under this limited warranty:

• Knobs and handles

10 Year Limited Warranty Included
FÖRVARA drawers • UTRUSTA wire baskets • UTRUSTA push opener electrical • TUTEMO, VADHOLMA and TORNVIKEN open cabinet have a 10-year limited warranty.

KNOXHULT Kitchen system

KNOXHULT is not covered by this limited warranty.

KITCHEN FAUCETS

10 Year Limited Warranty Included

What is covered under this warranty?

The 10-year limited warranty is valid for all kitchen faucets at IKEA. This limited warranty applies to residential use only and covers defects in material and workmanship in all kitchen faucets. Our kitchen faucets are tested well beyond all relevant international standards and we use only top brand components to secure our 10-year limited warranty

promise.

What is not covered under this warranty?

This limited warranty does not cover normal wear and tear, cuts or scratches, or damage caused by impacts, accidents or waterborne debris.

What will IKEA do to correct the problem?

IKEA will examine the product and decide, at its sole discretion, if it is covered under this warranty. If considered covered, IKEA through its own service operations, will then, at its sole discretion, replace it with the same or a comparable product. If the item is no longer sold by IKEA, IKEA will provide an appropriate replacement. It is IKEA that determines, at its sole discretion, what constitutes an appropriate replacement.

Exclusions

The limited warranties do not apply to products that have been stored or assembled incorrectly, used inappropriately, abused, misused, altered, or cleaned with wrong cleaning methods or wrong cleaning products. This warranty does not cover normal wear and tear, cuts or scratches, or damage caused by impacts, accidents or waterborne debris. It also does not apply to the filter/aerator which should be cleaned regularly or replaced when worn out. Follow our assembly instructions and care instructions carefully.

This limited warranty does not apply to products that have been stored, assembled or installed incorrectly, used inappropriately, abused, misused, altered, or cleaned with wrong cleaning methods or wrong cleaning products. This limited warranty does not apply if the products have been used for public use, outdoors or in a corrosive environment. It also does not cover accidental damage.

KASKER QUARTZ COUNTERTOPS

LIFETIME Limited Warranty Included

Limited residential lifetime warranty

• The thickness of Caesarstone quartz slabs are ¾" or 1¼" with an allowable variance of +/- 1.5mm.
• Color may vary slightly from in-store samples.
• Quartz is not perfectly smooth, minor pitting is common and does not affect the performance or constitute a material defect.

Conditions for the limited warranty

• Owner must register warranty on or before 30 days of installation at www.Caesarstoneus.com.
• Original proof of purchase receipt is required.

What is covered under this limited warranty?

• Warranty against any manufacturing performed by the supplier, as well as the correct installation of the product.
• The warranty is effective only if the owner of the countertop is the occupant of an indoor single-family residence.

What is not covered under this limited warranty?

• The warranty does not protect against natural causes (ie: fire, flood, tornado, etc).
• Does not cover wear and tear such as stains, scratches, water spots and burns.
• Does not cover failure to comply with care instructions.
• Does not cover chips or damage from abuse or excessive impact.
• Does not cover any products moved from their original place of installation.
• Does not cover repair to electrical, tile or wall surfaces and plumbing modifications possibly required to install the custom countertop.
• Does not cover damages from alterations performed after initial installation.

Care instructions

• Clean with soap and water on a regular basis. For tougher dirt, use warm water and a damp cloth or a Scotch Brite delicate sponge pad with a small amount of non-abrasive cleaner that does not contain bleach.
• Trivets and hot pads must be used when placing hot skillets, pans, crock-pots or other heat generating kitchenware on the surface.
• Using cutting boards and taking care not to drop or move heavy objects on the surface will help to ensure long-lasting beauty.

Planning needs

• For KASKER custom quartz countertop planning needs and term and conditions, please see a co-worker at your local IKEA store.



IKEA Home Planner

Design the SEKTION kitchen of your dreams in a 3D environment and get a price on every detail as well as the total kitchen. Print out your drawings and product list at home, or save to the IKEA website. At the IKEA store you can discuss your design and get lots of advice and guidance from our kitchen experts. Learn more at [IKEA-USA.com/kitchenplanner](https://www.ikea.com/us/en/kitchenplanner)



Kitchen brochure

A brochure full of inspirational pictures of kitchens in all styles and sizes. Here you'll find everything from full-sized kitchens to all those little extras that make everyday life in the kitchen easier and more fun.

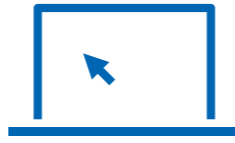

IKEA-USA.com/kitchens

On our webpage you'll find lots of inspiration and ideas to get the most out of your SEKTION kitchen, whether it's a new one or an old that you want to freshen up. Plus, here you'll find all products that you can imagine to personalise and create the kitchen of your dreams.



IKEA Kitchens and Appliances

In these buying guides you'll find all the products, details and prices to choose exactly what you need to make your dream kitchen a reality. [IKEA-USA.com/buyingguide](https://www.ikea.com/us/en/buyingguide)



SEKTION Kitchen cabinets

This buying guide offers all you need to know to plan the position of your cabinets as well as the inside in the most efficient way. [IKEA-USA.com/buyingguide](https://www.ikea.com/us/en/buyingguide)



Installation guide

This guide provides you with tips and step-by-step instructions on how to install your kitchen on your own. [IKEA-USA.com/buyingguide](https://www.ikea.com/us/en/buyingguide)

More information and guidance

You can pick up all brochures and guides at your local IKEA store, or flip through them on [IKEA-USA.com/buyingguide](https://www.ikea.com/us/en/buyingguide)

NEED HELP?

You can contact us in different ways:

IN PERSON

You can always find knowledgeable staff in our stores, ready to help whenever you need it.

EMAIL

You can send us a message via the online form at [IKEA-USA.com/contactus](https://www.IKEA-USA.com/contactus)

FAQ

Find answers to some of the most commonly asked questions at [IKEA-USA.com/FAQ](https://www.IKEA-USA.com/FAQ)

Installation Services: Save time and effort with professional installation. For full details visit [IKEA-USA.com/kitchenservices](https://www.IKEA-USA.com/kitchenservices)

Special Information

This buying guide has been prepared by IKEA to better assist customers when purchasing products. Sources of supply and specifications are subject to change. Every reasonable effort will be made to ensure that all advertised merchandise is available in adequate supply. A high standard of accuracy has been sought in the preparation of this buying guide. Errors and omissions are always a possibility. Although IKEA cannot be held responsible, upon discovery of any error or omission, all reasonable steps will be taken to inform IKEA customers.

Country of origin

For all our products, we choose specialized manufacturers who can produce our components at the lowest price. A single item may consist of several components from different countries. Country of origin information is available on each component when you pick it up.

NEW

This symbol appears on products that are new in the buying guide this year. New items continue to arrive all the time, so visit the store often.

NEW LOWER PRICE

Good quality function and even better prices. We're constantly striving to cut costs without compromising quality. Wherever you see "New Lower Price", it means we've found a way to offer your favorite products for even less. The new lower prices in the buying guide are in effect now, so hurry in to your local IKEA store today.

Stock Availability

Not all products may be available in all stores. See what is available in your local store by visiting [IKEA-USA.com/stockavailability](https://www.IKEA-USA.com/stockavailability)

Prices valid as of February 1, 2020 posting. Prices are subject to change. Please see [IKEA-USA.com](https://www.IKEA-USA.com) or your local IKEA store for the most up-to-date pricing.

