

Filing
Indexing
Labeling
Experts



tabbies®

Filing, Indexing & Labeling Products Catalog

simple solutions @ work®

table of contents

FOLDERS

Expansion Pockets	6
File Folders.....	4 - 5
File Pocket Handles	6
Outguides	13

FILING ACCESSORIES

CD Saver™ Sleeve Protectors.....	11
Conversion Products.....	12
Digi-Strip® Flash Drive	11
Dividers	5
Expanding Divider Pocket.....	10
Fasteners	7
Protectors.....	9
Reinforcing Strips.....	11
Self-Adhesive Pockets.....	10

INDEX TABS

Computer Printout Index Tabs	16
Copier Indexes.....	14
Custom Indexes	15
Erasable Write-on Index Tabs	17
Printed Index Tabs	16
Road Atlas Index Tabs.....	16
Tabs-u-Create	17

LABELS

Alpha Color Code Labels	25 - 37
Blank Strip Labels	18
Billing Collection Labels.....	39
Color Code Filing Labels on Demand	18
Custom Labels	20
Designator Labels	37, 38
Double Digit Color Code Labels.....	27
File Folder Labels.....	8
Labels-u-Create	17
Laser/Inkjet Blank Labels	19
Month Labels	36
Numeric Color Code Labels	25 - 37
Removable remind'r' labels	39
Specialty Labels.....	39
Year Code Labels	22 - 24

COLOR CODE LABELS

Acme Visible® Compatible	22, 29
Alpha.....	29
Numeric	29
Year Code.....	22
Ames® Compatible.....	22, 37
Numeric	37
Year Code.....	22
Barkley® Compatible	23, 30
Alpha.....	30
Numeric	30
Year Code.....	23
Original Col'rTab®	22 - 28, 38
Alpha.....	25 - 28
Designator	38
Double Digit.....	27
Month	36
Numeric	25 - 28
Year Code.....	22, 23
Colwell® Compatible	23, 31
Alpha.....	31
Numeric	31
Year Code.....	23
GBS/VRE® Compatible	23, 31, 32
Alpha.....	31, 32
Numeric	31, 32
Year Code.....	23
Jeter® Compatible	23, 28, 32, 33, 37
Alpha.....	28, 32, 33
Designator	37
Numeric	32, 33
Year Code.....	23
Kardex® Compatible	29, 30, 38
Alpha.....	29
Numeric	30
Designator	38
Medical Arts Press® Compatible.....	23
Year Code.....	23
POS® Compatible.....	33
Alpha.....	33
Safeguard® Compatible	28
Alpha.....	28
SFI® Compatible	22, 37
Numeric	37
Year Code.....	22
Smead® Compatible	24, 34, 35
Alpha.....	34, 35
Numeric	34, 35
Year Code.....	24
Tab Products® Compatible.....	24, 32, 35, 36
Alpha.....	32, 35, 36
Numeric	32, 35, 36
Year Code.....	24
Original Tabbies®	22, 24, 36, 37
Alpha.....	36
Designator	37
Month	36
Numeric	36
Year Code.....	22

numerical stock index

138-0 - 138-9.....	30	40539.....	39	66000 - 66026.....	14	91321 - 91347.....	31
139-A - 139-Z.....	29	40554.....	39	67999.....	14	91400 - 91409.....	31
140-0 - 140-9.....	30	40570.....	39	68001 - 68025.....	14	91410.....	31
144-A - 144-Z.....	29	40572.....	39	68305.....	14	91420.....	31
142.....	29	40574.....	39	68386 - 68387.....	9	91421 - 91447.....	31
143.....	29	41000.....	25	68801 - 68860.....	6	91500 - 91509.....	33
11000 - 11009.....	25	41020.....	35	70213 - 70223.....	22	91520.....	33
11015.....	25, 26, 28, 29, 32, 37	41800.....	34	70231 - 70242.....	36	91521 - 91547.....	33
11050 - 11059.....	26	41820.....	34	70513 - 70523.....	22	91600 - 91609.....	30
11100 - 11113.....	38	42000.....	25	70521 - 70533.....	37	91621 - 91647.....	30
11190 - 11199.....	27	42030.....	25	70813 - 70823.....	24	91721 - 91747.....	28
11200.....	27	42100.....	26	71000 - 71009.....	35	91800 - 91809.....	34
11500 - 11509.....	26	49401 - 49406.....	8	71010.....	35	91821 - 91846.....	34
11600 - 11613.....	38	49430 - 49437.....	8, 19	71020.....	35	91921 - 91933.....	34
11713 - 11723.....	22	49441 - 49443.....	8	71021 - 71047.....	35	91981 - 91993.....	37
11830 - 11842.....	27	51713 - 51723.....	22	71100 - 71109.....	32	92013 - 92023.....	24
11850 - 11862.....	27	53110.....	38	71110.....	32	93021 - 93047.....	28
11881 - 11892.....	24	53300 - 53310.....	38	71120.....	32	94613 - 94623.....	23
12000.....	25, 28, 32, 35	53500 - 53510.....	38	71121 - 71147.....	32	94900 - 94909.....	37
12001 - 12027.....	25	54460.....	10	71200 - 71209.....	36	97115 - 97120.....	24
12030 - 12042.....	25	54470 - 54471.....	10	71221 - 71246.....	36	97215 - 97220.....	24
12101 - 12127.....	26	54492 - 54499.....	10	71520.....	33	97315 - 97320.....	24
12500 - 12509.....	29	55990 - 55996.....	12	71521 - 71547.....	33	97415 - 97420.....	24
12613 - 12623.....	22	56012 - 5601213.....	4	71600 - 71609.....	30	97515 - 97520.....	24
12701 - 12714.....	29	56015 - 5601513.....	4	71620.....	30	97615 - 97620.....	24
12800 - 12809.....	37	56018 - 5601813.....	4	71621 - 71647.....	30	DTK BK.....	25
12913 - 12923.....	22	56019 - 5601913.....	4	71713 - 71723.....	22	DTK GDA.....	25
14000 - 14009.....	35	56022 - 56024.....	4	71821 - 71846.....	34	DTK GDN.....	25
14101 - 14127.....	35	56025 - 5602513.....	4	74500 - 74504.....	13	MAP1320.....	39
14413 - 14423.....	23	56055 - 5605513.....	4	74520.....	13	MAP1350.....	39
14560 - 14569.....	28	56058 - 5605813.....	4	74530 - 74534.....	13	MAP1400.....	39
14600 - 14609.....	32	56222 - 5622213.....	4	74540 - 74544.....	13	MAP2370.....	39
14611 - 14637.....	32	56600 - 566001.....	4	74559.....	13	MAP2500.....	39
14715 - 14723.....	23	56760 - 567601.....	4	74580 - 74585.....	13	MAP4220.....	39
14914 - 14923.....	22	56804.....	7	74590 - 74591.....	13	MAP4300.....	39
1524 - 1536.....	6	56805.....	7	81000 - 81009.....	25	MAP4710.....	39
21813 - 21823.....	24	56807.....	7	81500 - 81509.....	26	MAP4790.....	39
25100 - 25101.....	11	56809.....	7	81713 - 81723.....	22	MAP5790.....	39
26330 - 2633013.....	5	56811 - 56812.....	7	81951 - 81976.....	27	RT1056ELP.....	6
26360.....	5	56820.....	7	82001 - 82027.....	25	RT1076GLP.....	6
26370.....	5	58301 - 58311.....	16	82030 - 82042.....	25	T1524EP.....	6
26372.....	5	58314.....	16	82051 - 82077.....	26	T1526EP.....	6
26808.....	7	58320 - 58322.....	16	82101 - 82127.....	26	T1526T.....	6
30010 - 30011.....	18	58385.....	9	84101 - 84127.....	35	T1534GP.....	6
31000.....	25	58385B.....	9	88385.....	9	T1534S.....	6
31100.....	32	58390.....	11	88485.....	9	T1536GP.....	6
31120.....	32	58392.....	11	90100 - 90109.....	36	T1536S.....	6
31600.....	30	58485.....	9	90110.....	30 - 36	TE1524EP.....	6
31620.....	30	58530.....	17	90121 - 90146.....	36	TE1526EP.....	6
31920.....	34	58600 - 58610.....	17	90150.....	28, 30 - 34, 36	TE1534GP.....	6
31950.....	27	58700 - 58710.....	17	90413 - 90423.....	23	TE1536GP.....	6
32000.....	25	58727.....	16, 17	90513 - 90523.....	23	TP240-A - TP240-MC.....	35
32030.....	25	58800 - 58810.....	17	90613 - 90623.....	23		
32100.....	26	58900 - 58910.....	17	90813 - 90823.....	24		
40100 - 40103.....	17	59430 - 59437.....	8	90913 - 90923.....	24		
40120 - 40123.....	17	59441 - 59443.....	8	91000 - 91009.....	35		
40140 - 40143.....	17	61021 - 61047.....	35	91010.....	35		
40150 - 40154.....	19	61321 - 61347.....	31	91021 - 91047.....	35		
40156 - 40165.....	19	61421 - 61447.....	31	91100 - 91109.....	32		
40200 - 40202.....	17	61521 - 61547.....	33	91121 - 91147.....	32		
40502.....	39	61721 - 61747.....	28	91213 - 91223.....	24		
40506.....	39	62231 - 62240.....	33	91300 - 91309.....	31		
40508.....	39	62241 - 62267.....	33	91310.....	31		
40531.....	39	63021 - 63047.....	28	91320.....	31		

file folders

CUSTOM PRINTED FOLDERS
Call for quote

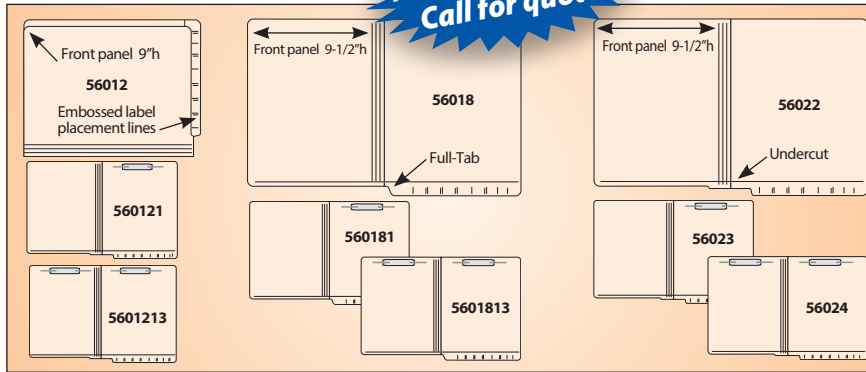

11 pt. 2-Ply (Reinforced) Letter

stock no.	size	folders/case
56012	12-1/4" w x 9-1/2" h	500
560121*	12-1/4" w x 9-1/2" h	250
5601213**	12-1/4" w x 9-1/2" h	250
56018	12-1/4" w x 9-1/2" h	500
560181*	12-1/4" w x 9-1/2" h	250
5601813**	12-1/4" w x 9-1/2" h	250
56022	12-1/4" w x 9-1/2" h	500
56023*	12-1/4" w x 9-1/2" h	250
56024**	12-1/4" w x 9-1/2" h	250

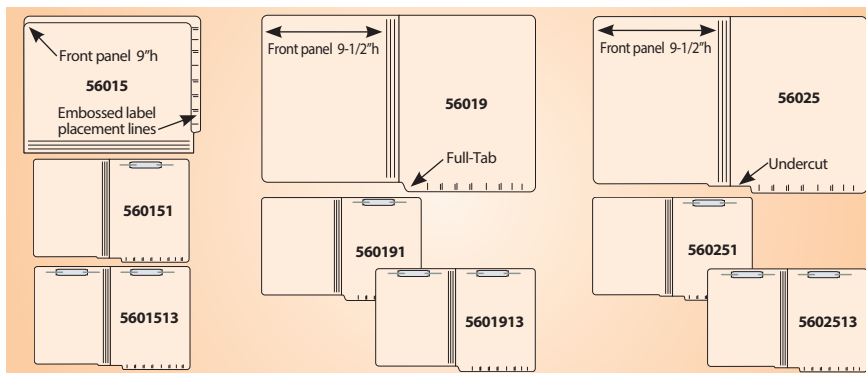

14 pt. 1-Ply Letter

stock no.	size	folders/case
56015	12-1/4" w x 9-1/2" h	500
560151*	12-1/4" w x 9-1/2" h	250
5601513**	12-1/4" w x 9-1/2" h	250
56019	12-1/4" w x 9-1/2" h	500
560191*	12-1/4" w x 9-1/2" h	250
5601913**	12-1/4" w x 9-1/2" h	250
56025	12-1/4" w x 9-1/2" h	500
560251*	12-1/4" w x 9-1/2" h	250
5602513**	12-1/4" w x 9-1/2" h	250

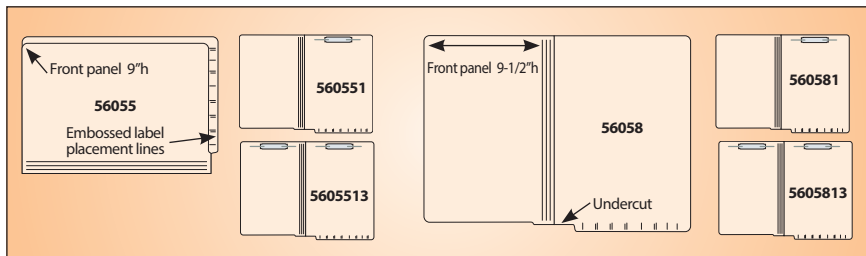

14 pt. 1-Ply Legal

stock no.	size	folders/case
56055	15-1/4" w x 9-1/2" h	500
560551*	15-1/4" w x 9-1/2" h	250
5605513**	15-1/4" w x 9-1/2" h	250
56058	15-1/4" w x 9-1/2" h	500
560581*	15-1/4" w x 9-1/2" h	250
5605813**	15-1/4" w x 9-1/2" h	250

combo drawer/shelf file folder

combination drawer / shelf folder design can be used as top tab in a drawer or as an end tab in an open shelf. Large tab area on top and side allows plenty of room for all your labeling needs.

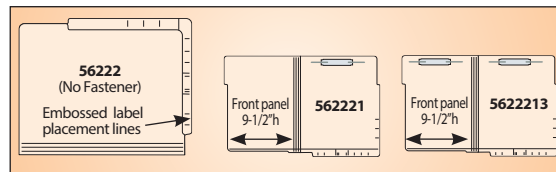

11 pt. 2-Ply (Reinforced) Letter

stock no.	size	folders/case
56222	12" w x 9-1/2" h	500
562221*	12" w x 9-1/2" h	250
5622213**	12" w x 9-1/2" h	250

top straight cut file folder

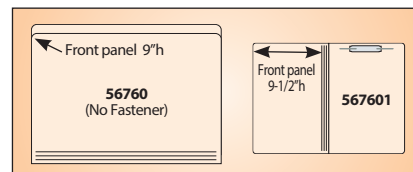
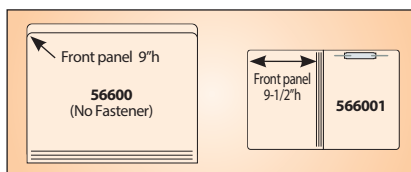

11 pt. 1-Ply Letter

stock no.	size	folders/case
56600	11-3/4" w x 9-1/2" h	500
566001*	11-3/4" w x 9-1/2" h	250

14 pt. 1-Ply Legal

stock no.	size	folders/case
56760	14-3/4" w x 9-1/2" h	500
567601*	14-3/4" w x 9-1/2" h	250

* 1 Fastener applied, POSITION 1 ** 2 Fasteners applied, POSITIONS 1 & 3. Printed label placement lines except where noted. **FASTENER POSITION GUIDE** on page 7.

self-adhesive divider sheets

Quickly convert your standard folders to classification folders. Just fold on the score line to create a flap, then remove protective strip and apply to folder—it's that easy! Sturdy **divider sheets** are 11 pt. manila stock. Die-cuts on flap allow for easy positioning around fasteners. **Divider sheets** comes in several options: no fastener, 1 fastener on front of divider, or 2 fasteners on both sides of divider. 8-1/2" w x 11" h (not including flap) – 100 dividers per package.

stock no.	fastener(s)
26330	None
263301	1-Fastener Front Top – Pos. #1
263305	1-Fastener Front Side – Pos. #5
2633013	2-Fasteners Top of both sides – Pos. #1 & #3

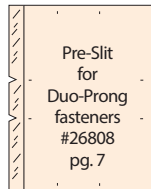

Fold on score line, peel away backing sheet and apply to folder

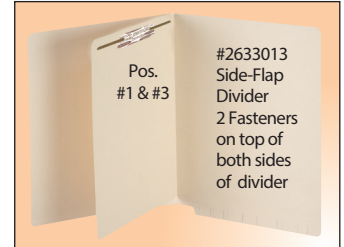
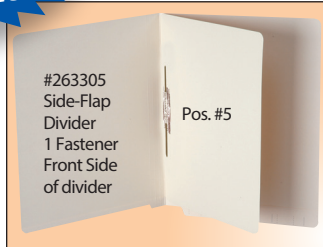
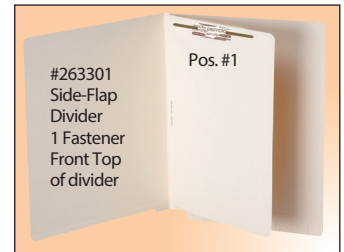

fileback dividers

fileback dividers allow immediate access to each section without removing the top sections from the folder. Each **fileback divider** is scored for easy folding and comes with an installed 2" capacity fastener. Fold score line to form flap and slip divider over existing fastener in folder. The next divider is attached to the fastener or the first divider, and so on. Sturdy 11 pt. manila stock. Available with or without (bottom) end tab cut. 100 dividers per pkg.

stock no.	description
26360	Letter 8-1/2" x 11
26370*	Letter 8-1/2" x 11-3/4"; Left End Tab 1/2 cut
26372*	Letter 8-1/2" x 11-3/4"; Right End Tab 1/2 cut

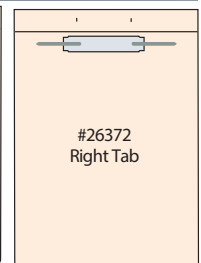
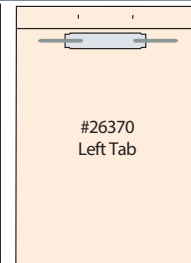
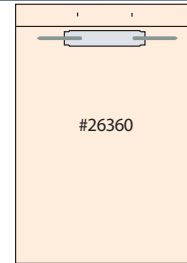

* Includes tab length

custom installation solutions

Save time and money... choose any of our stock or custom products to fit your filing needs and let us do the **custom installation** work.

Tabs/Labels

Pockets

Fasteners

Indexes

Filebacks

u-file-m Strips

Conversion Strips

Dividers

Index Tab Divider Positions

CALL FOR QUOTE

Folder Fastener Positions Pg. 7

Right End Tab Folder

Top Tab Folder

file pocket handles

Retrieve file pockets with ease from any shelf. **file pocket handles** by **tabbies** are made with tear resistant Tyvek® and prevent tearing of gussets. **file pocket handles** come with a suggested placement guideline for the 3 most popular expansions for file pockets: 1-3/4", 3-1/2" and 5-1/4". 6 colors available. Handle dimensions: 9-5/8" w x 2" h.

stock no.	color	handles/pkg.	pkgs./box
68801	Yellow	48	5
68805	Red	48	5
68806	Lt Blue	48	5
68807	Dk Blue	48	5
68809	Green	48	5
68815	White	48	5
68860	Assorted	288	6

clear label protectors

clear label protectors cover printed area to keep **file pocket handles** clean and protected from smudges. 4-1/2" w x 1-1/2" h.

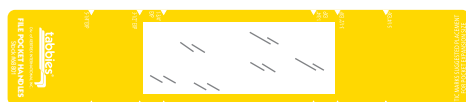

stock no.	color	labels/pkg.	pkgs./box
68850	Clear	48	5



expansion pockets



- ◆ 14 pt. Manila back with 3/4" reinforced full side tab
- ◆ 18 pt. Manila front & back linings
- ◆ 11 pt. Red wallet front cover
- ◆ 6-1/2" High reinforced gusset
- ◆ Drop front is 1/2" lower than back

stock no.	size	expansion	pockets/case
TE1524EP	9-1/2"h X 12-1/2"w	3-1/2"	100
TE1526EP	9-1/2"h X 15-1/2"w	3-1/2"	100
TE1534GP	9-1/2"h X 12-1/2"w	5-1/4"	100
TE1536GP	9-1/2"h X 15-1/2"w	5-1/4"	100

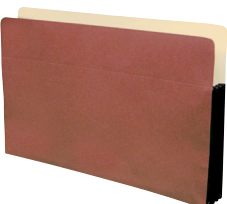

- ◆ 11 pt. Red wallet front & back covers
- ◆ 18 pt. Manila front & back linings
- ◆ 6-1/2" High reinforced gusset
- ◆ Drop front is 1/2" lower than back

stock no.	size	expansion	pockets/case
T1524EP	9-1/2"h X 11-3/4"w	3-1/2"	100
T1526EP	9-1/2"h X 14-3/4"w	3-1/2"	100
T1534GP	9-1/2"h X 11-3/4"w	5-1/4"	100
T1536GP	9-1/2"h X 14-3/4"w	5-1/4"	100



- ◆ 11 pt. Red wallet front & back covers
- ◆ 11 pt. Manila back lining
- ◆ 11 pt. Red wallet front lining
- ◆ 6-1/2" High reinforced gusset
- ◆ Drop front is 1/2" lower than back

stock no.	size	expansion	pockets/case
T1526T	9-1/2"h X 14-3/4"w	3-1/2"	100
T1534S	9-1/2"h X 11-3/4"w	5-1/4"	100
T1536S	9-1/2"h X 14-3/4"w	5-1/4"	100



- ◆ 17 pt. Red wallet front & back covers including flap
- ◆ 11 pt. Red wallet front & back linings
- ◆ Full height reinforced gusset; elastic cord standard

stock no.	size	expansion	pockets/case
RT1056ELP	10"h X 15"w	3-1/2"	100
RT1076GLP	10"h X 15"w	5-1/4"	100



- ◆ 11 pt. Red wallet front & back covers
- ◆ 11 pt. Manila back linings
- ◆ 11 pt. Red wallet front lining
- ◆ 6-1/2" High reinforced gusset
- ◆ Drop front is 1/2" lower than back

stock no.	size	expansion	pockets/case
1524	9-1/2"h X 11-3/4"w	3-1/2"	50
1526	9-1/2"h X 14-3/4"w	3-1/2"	50
1534	9-1/2"h X 11-3/4"w	5-1/4"	50
1536	9-1/2"h X 14-3/4"w	5-1/4"	50

modifications available

- ◆ Colored Backs
- ◆ Colored Body
- ◆ Colored Gussets
- ◆ Full Color Products
- ◆ Eyelets
- ◆ Pull Loops



sup'r'grip fasteners



Self-adhesive **sup'r'grip fasteners** are an ideal space-saving solution for large files. Long 2" prongs accommodate 2-hole punched material, while the ultra-thin design saves valuable filing space. Fasteners are heat bonded onto pressure-sensitive, 60 lb. manila-colored paper to hold even the bulkiest files without tearing. Printed aligning guides on each strip ensure accurate placement. 4 fasteners per sheet; 25 sheets per box.

stock no.	description	fasteners/box
56805	sup'r'grip fasteners	100

duo-prong fasteners

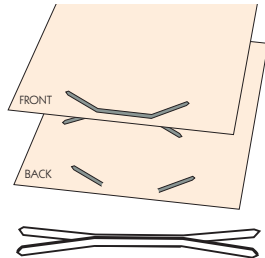

duo-prong fasteners are used when fasteners are required on both the front and back of a divider sheet for 2-hole punched documents. Fastener capacity is 1" on one side and 5/8" on the other. Simply insert 1" prongs thru slits in divider sheet, and bend prongs back. No adhesive required.

stock no.	description	fasteners/box
26808	duo-prong fasteners	100

earflap™ fasteners

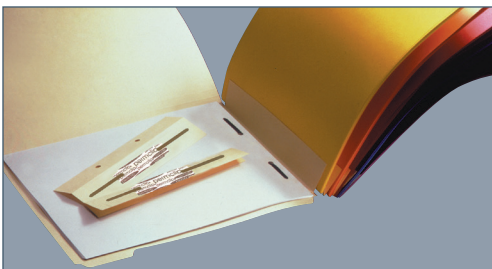

Turn existing file folders into classification folders easily and inexpensively. Section files by date, subject or other criteria that fit your needs.

Slip the punched flap over an existing fastener and close the prongs. Fold flap forward and add filing material to the bonded fastener on top of the manila strip. **earflap™ fasteners** work with any two-prong fastener in all folder positions.

stock no.	description	fasteners/box
56809	earflap fasteners	50

foamclip® fasteners



Self-adhesive **foamclip® fasteners** are a perfect choice for organizing any 2-hole punched papers. These fasteners bond permanently to file folders, pressboard, plastic, wood, glass, even metal. With their superior strength, **foamclip® fasteners** can't be pulled off like other brands! The 2-3/4" center-to-center, 1-1/2" capacity fastener is easy to use; just peel off backing paper and press fastener into place.

stock no.	description	fasteners/box
56807	foamclip fasteners	100

jalemaclip fasteners

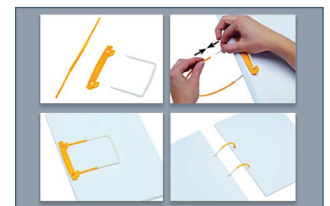
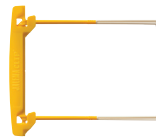

jalemaclip fasteners are 5" capacity fasteners that allow you to access any part of the file without having to remove the file contents. Make notes, copy or review the pages within the file quickly and easily. For use with 2-hole punched documents. Holes are positioned 2-3/4", center-to-center. Sets consist of self-adhesive bases, compressor bars and u-shaped extensions.

stock no.	description	fasteners/box
56804	jalemaclip fasteners	100

u-file-m binder strips

u-file-m binder strips make each folder read like a book. Documents are affixed to a strip of tabs in either ascending or descending order. File by either older information first, or by newer information on top. Instructions included.

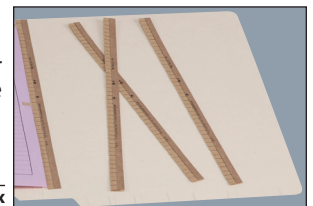

stock no.	description	strips/box
56820	u-file-m binder strip	100

Strip holds up to 22 sheets.

factory installed fasteners

permclip® fasteners are heat-bonded for permanent adhesion to the file folder. **permclip® fasteners** are factory installed in any position to fit your filing needs. Prongs are 2" in length and 2-3/4" center to center. Please specify fastener position from the position guide at the time of order.

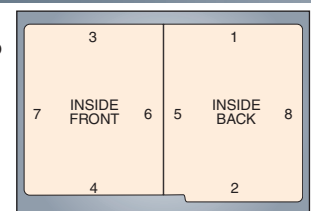

Fastener Position Guide

stock no.	description
56811	one bonded fastener per folder
56812	two bonded fasteners per folder

Any of the above stock fasteners can be factory installed to fit your filing needs. Choose your fastener position from the position guide above.

laser / inkjet file folder labels

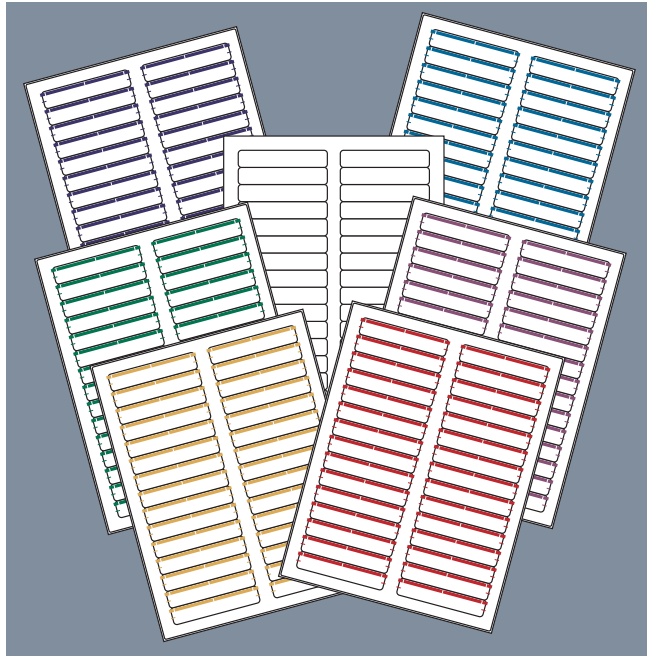

laser / inkjet file folder labels are easy to use with most label software. The paper and adhesive are formulated specifically for use in laser or inkjet printers. 750 labels per package. Labels are 2-up per page. Overall sheet size: 8-1/2" w x 11" h

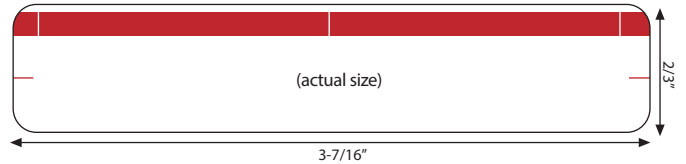

Avery #5366 Laser/Inkjet File Folder Labels compatible series

stock no.	color	labels/sheet	sheets/pkg.
49430	White	30	25
49431	Light Blue	30	25
49432	Red	30	25
49436	Green	30	25
49437	Dark Blue	30	25
49441	Tan	30	25
49443	Purple	30	25

file folder labels

Self-adhesive **file folder labels** attach permanently to file folders, cards, etc. Color coded for easy identification and smudge proof for legibility. Available in convenient sheets, in white and 6 colors ready for writing or typing. Labels are 3-7/16" w x 9/16" h in size. Labels are 1-up per page.

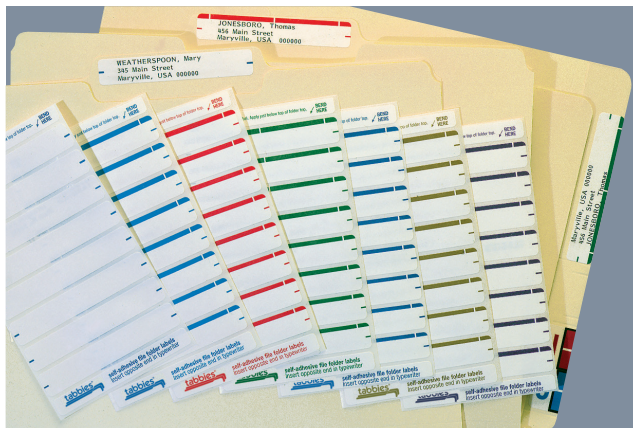

Writable only. This product is not intended for use with printer.

stock no.	color	labels/pkg.
59430	White	248
59431	Light Blue	248
59432	Red	248
59436	Green	248
59437	Dark Blue	248
59441	Tan	248
59443	Purple	248

wrap-around file folder labels

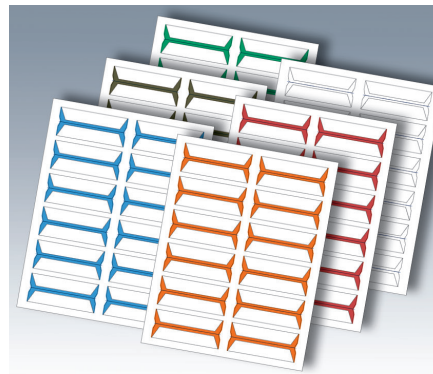

Use Microsoft Word® and any laser/inkjet printer to create **wrap-around file folder labels** for file folders, pockets, jackets, etc. Easy set-up instructions for both drawer and shelf filing applications in each package. 8-1/2" w x 11" h sheets.

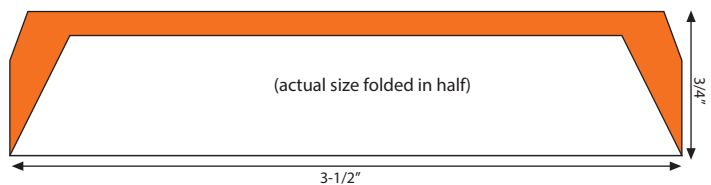

Acme® Abgor File Folder Labels compatible series

stock no.	color	labels/sheet	labels/pkg.
49401	Azure Blue	12	240
49402	Brown	12	240
49403	Green	12	240
49404	Orange	12	240
49405	Red	12	240
49406	White	12	240

name label protectors

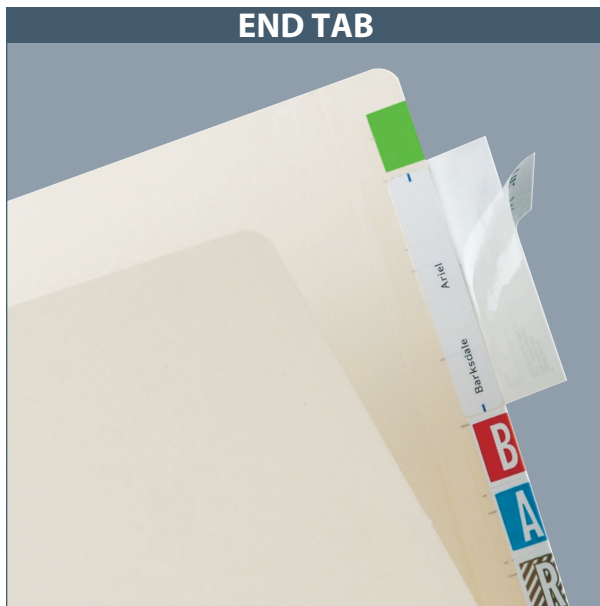

name label protectors eliminate dirty, worn, dog-eared file folders and file folder labels. Clear, wrap-around, self-adhesive protectors keep file folders and labels clean and prevent them from falling off, extending the life of the folder. **name label protectors** can also be used "flat" to attach miscellaneous materials to any surface.

stock no.	protectors/ size	pkgs./ pkg.	protectors/ box	roll
58385	3-1/2"w x 2"h	100	5	–
58485	4"w x 2"h	100	5	–
58385B	3-1/2"w x 1-3/4"h	–	500*	–
88385	3-1/2"w x 2"h	–	–	500
88485	4"w x 2"h	–	–	500

*500 single protectors per box



full end tab protectors



end tab protectors are an ideal solution for extending the life of shelf file folders. Clear protectors wrap around folder end tabs, preventing labels from cracking or popping off, and protect against wear and tear. Self-adhesive, 8" x 2" protectors can be easily applied to all types of end tab file folders to keep them looking neat and clean longer.

stock no.	size	protectors/pkg.
68386	8"h x 2"w	100

spine edge protectors



edge protectors keep heavily used file folders looking good longer by protecting edges from cracking or splitting. The 11" x 2" clear, wrap-around protector is easily applied to the bottom edge of a file folder, where the most wear and tear occurs as the folder is moved in and out of shelf file cabinets.

stock no.	size	protectors/pkg.
68387	11"w x 2"h	100

lock-it pockets

Durable, clear polyethylene ziplock style secures small documents, including photos, flash drives, CD's, x-rays and much more. Peel off self-adhesive 5 mil poly pocket. Permanently apply to your folders or wherever it is most convenient. Clear front keeps important information at full view without opening the pocket.



stock no.	inside	outside	pockets/box
54470	5" w x 5-1/4" h	5-1/2" w x 6-1/4" h	100
54471	6" w x 9" h	6-1/2" w x 10" h	100

First dimension is the pocket opening

poly & vinyl pockets

Clear see-thru pockets are available in several sizes to fit all your needs. It's easy to add a pocket to your file or binder; simply peel off the protective backing and apply the self-adhesive side to your folder. Pockets are sealed on three sides. Store x-rays, forms, immunization records, flash drives, CD's and more.

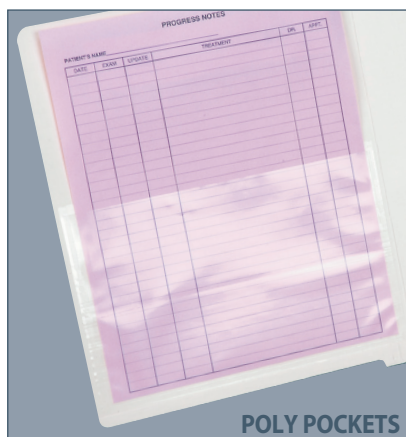

POLY POCKETS

Poly pockets provide easy access to information.

Poly Pockets

stock no.	inside	outside	pockets/box
54495	2-1/2" w x 3-1/4" h	3" w x 3-3/4" h	100
54496	10-1/2" w x 8-1/2" h	11" w x 9" h	100
54497	5" w x 3" h	5-3/4" w x 3-3/4" h	100
54498	6-1/2" w x 4-1/4" h	7" w x 4-3/4" h	100
54499	8-3/4" w x 5-1/2" h	9-1/4" w x 6" h	100

Vinyl Pockets

stock no.	inside	outside	pockets/box
54492	8-3/4" w x 11-1/4" h	9" w x 11-1/2" h	100
54493	5-1/4" w x 3-1/4" h	5-1/2" w x 3-1/2" h	100
54494	8-3/4" w x 5-1/2" h	9" w x 5-3/4" h	100

First dimension is the pocket opening

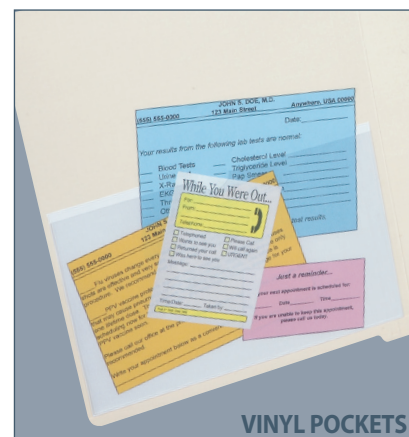

VINYL POCKETS

Vinyl pockets are textured and heavy-duty.

expanding divider pocket

Strong 40 lb. Kraft pocket has a thumbcut opening for easy access. Reinforced binding holes are pre-punched to be used with fastener folder. Letter or legal size application. Pocket has a 1" expansion.

stock no.	description	pockets/box
54460	divider pockets	100



2-hole reinforcing strips

Add durability and longevity to your documents with our **2-hole reinforcing strips**. Strips are self-adhesive for easy use. Material is tear resistant and clear so it will not hide printed information.

stock no.	description	strips/box
58392	3-1/2" 2-hole punched	500 strips (bulk)

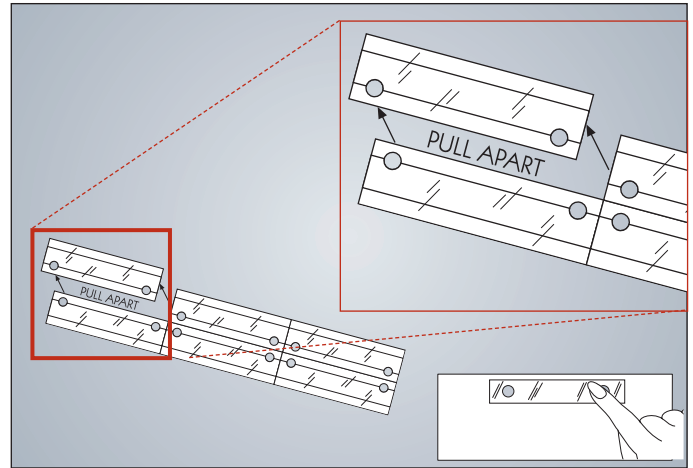

5-hole reinforcing strips

5-hole reinforcing strips are made of tear resistant material, pre-punched and ready to use. Clear strips will not hide printed information. The **5-hole reinforcing strips** can be used in one of three ways:

stock no.	description	strips/pkg.	pkgs./box
58390	11" 5-hole punched 2" overall (1" pulled apart)	20	10

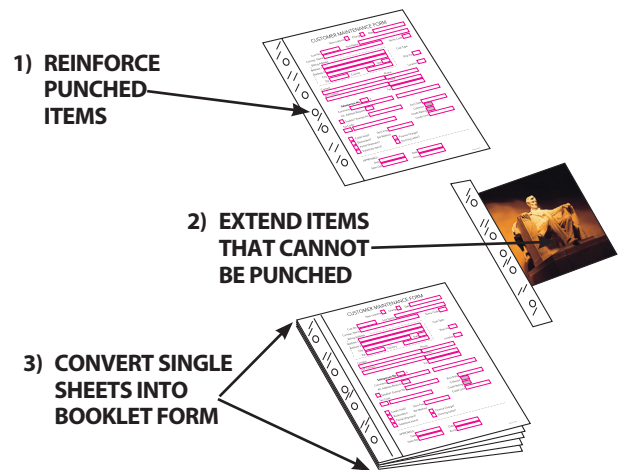

cd saver™ sleeve protectors



Protect compact disks in these smooth, durable polypropylene sleeves in stylish, translucent colors. Disks stay clean and organized, and a tuck-in flap holds CDs more securely than an open pocket. **cd saver sleeve protectors** come with self-adhesive labels for built-in index tabs.

stock no.	description	sleeves/pkg.	pkgs./carton
25100	Assorted	10	12
25101	Clear	25	10

conversion products

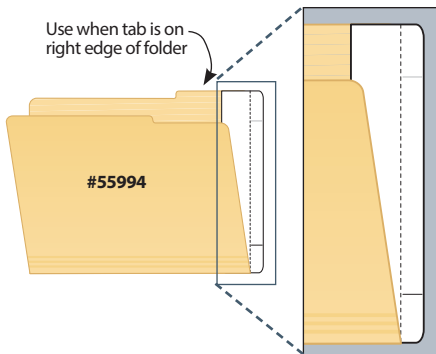

- ◆ 9-1/2" h can be used for any top tab cut folders.
- ◆ Strip is applied inside of the back folder panel.
- ◆ Labels can be pre-applied before installation of strip.
- ◆ White stock, 3/4" tab extension, 9-1/2" h.

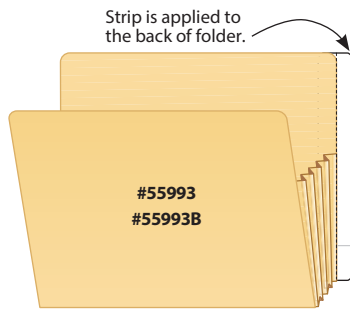

- ◆ Specifically made for pressboard or gusset folders.
- ◆ Labels can be pre-applied before installation of strip.
- ◆ White stock, 3/4" tab extension, 9-1/2" h.

extenda-folder strips

Convert any top tab pocket folders, pressboard folders, or expanding file jackets into end tab file folders. Save the trouble and expense of transferring materials and throwing away good file folders, pockets, and jackets. All conversion strips are self-adhesive and easy to install. Choose from 6 styles to fit your needs.

stock no.	size	tab extension	strips/box
55991	3-1/4" w x 9-1/4" h	1/2"	100
55991B	3-1/4" w x 9-1/4" h	1/2"	1,000
55992	4-3/4" w x 9-1/2" h	3/4"	100
55993	3-1/4" w x 9-1/2" h	3/4"	100
55993B	3-1/4" w x 9-1/2" h	3/4"	1,000
55994	2" w x 9-1/2" h	3/4"	100
55995	3-3/4" w x 9" h	3/4"	100
55996	3-3/4" w x 9-1/2" h	1"	100

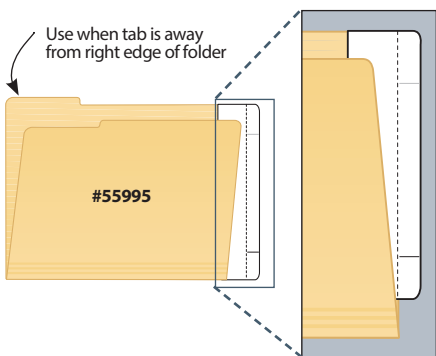

- ◆ 9" h can be used for any top tab cut folders.
- ◆ Strip is applied inside of the back folder panel.
- ◆ Labels can be pre-applied before installation of strip.
- ◆ White stock, 3/4" tab extension, 9" h.



- ◆ Wrap-around design is easy to apply to any top tab folder.
- ◆ Attaches to inside and outside back of folder panel.
- ◆ Manila stock to match your folder.

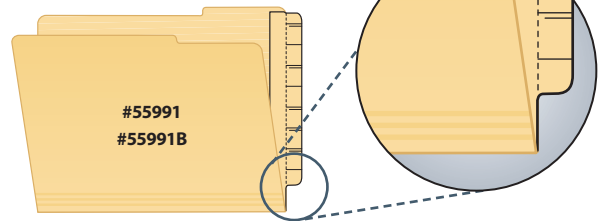

1" wide end tab is an ideal solution for conversions that include computer generated strip labels.

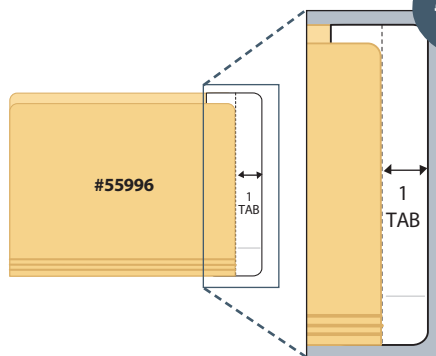

- ◆ Use with any straight cut folder.
- ◆ Strip is applied inside of the back folder panel.
- ◆ Strip-label can be pre-applied before installation of strip.
- ◆ White stock, 1" tab extension, 9-1/2" h.

cov'r'tabs

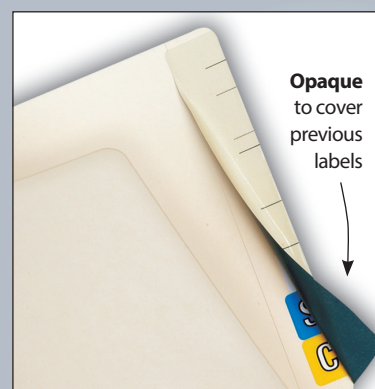

- ◆ Easy way to re-use old folders.
- ◆ Self-adhesive and wrap-around design adds reinforcement to tab.
- ◆ Printed score marks for even positioning of new labels.
- ◆ 60 lb. in manila color finish.
- ◆ Strip must be applied to folder *before* application of new labels.

stock no.	size	cov'r'tabs/pkg.
55990	2-1/2" w x 8" h	50

outguides

vinyl outguides are flexible enough for easy handling, yet resist cracking and tearing. Double sided "OUT" tab extends beyond folder for easy access. Clear vinyl pocket holds charge-out slips. Heavy duty outguides feature large tabs, a rigid vinyl back and stress contours on pockets to provide added strength and durability for frequent handling.

Call to inquire about other available colors.

charge-out slips

charge-out slips keep track of removed folder, when used with outguide. 100 sheets/pkg.

stock no.	size	pads/box
74559	5" w x 3" h	10

FILE NAME/NUMBER _____
DATE OUT _____ DATE RETURN _____
NAME (PRINT) _____ DEPT. _____
SIGNATURE _____
<small>INSERT THIS CHARGE-OUT FORM INTO THE POCKET ON THE OUTGUIDE AND REPLACE CHARGED-OUT FOLDER WITH OUTGUIDE. NOTE: DUPLICATE CHARGE-OUT FORMS CAN BE USED FOR FOLLOW-UP PURPOSES. IN "FILE NAME/NUMBER" ORDER OR "DATE TO RETURN" ORDER.</small>
<small>TABBIES STOCK NO. 74559</small>

center tab

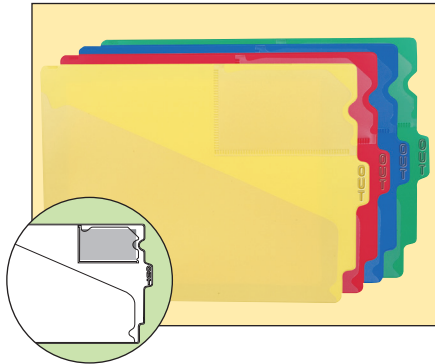

- ◆ "OUT" is embossed on both sides of tab
- ◆ Overall size: 9-1/2"h x 12-7/8"w
- ◆ Body size: 9-1/2"h x 12-3/8"w

stock no.	color	size	guides/pkg.
74500	Red	Letter	10
74501	Blue	Letter	10
74502	Green	Letter	10
74504	Yellow	Letter	10
74520*	Red	Legal	10

*Legal size: Overall size: 9-1/2" x 15-3/4"
Body size: 9-1/2" x 15-1/4"

bottom tab

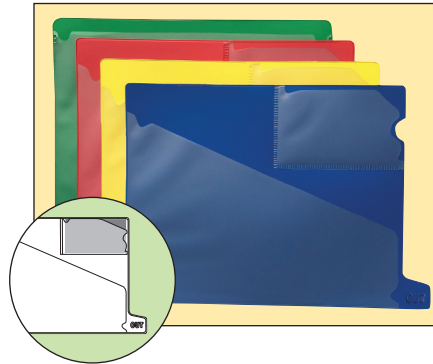

- ◆ "OUT" is embossed on the tab
- ◆ Overall size: 9-1/2"h x 13-1/4"w
- ◆ Body size: 9-1/2"h x 11-7/8"w

stock no.	color	guides/pkg.
74530	Red	10
74531	Blue	10
74532	Green	10
74534	Yellow	10

large tab

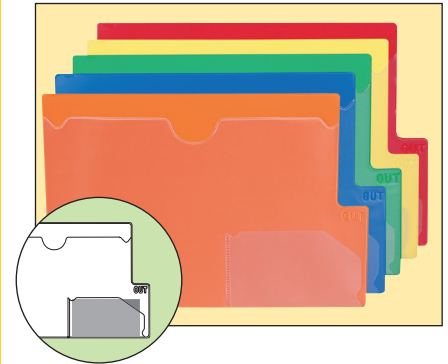

- ◆ "OUT" is embossed on the tab
- ◆ Overall size: 9"h x 13-1/4"w
- ◆ Body size: 9"h x 12"w

stock no.	color	guides/pkg.
74580	Red	10
74581	Blue	10
74583	Orange	10
74584	Yellow	10
74585	Green	10

economical

A cost-efficient choice when a full pocket is not necessary. Easy to read "OUT" is embossed on both sides of the rigid vinyl guides. 3" x 5-1/2" pocket for charge-out forms. Letter size 13"w x 4"h.



stock no.	color	guides/pkg.
74540	Red	10
74541	Blue	10
74542	Green	10
74543	Orange	10
74544	Yellow	10

alphabetical & blank

Quickly locate information filed by name. 24-gauge yellow vinyl guides. Black print on both sides A-W, plus one Mc and XYZ. Letter size 14-1/2"w x 4"h.

Blank guides have clear pockets on both sides and include insert cards.



stock no.	description	guides/box
74590	Alphabetical	25
74591	Blank	25

printed index dividers

Keep your documents, exhibits, briefs and more, neatly organized with our **printed index dividers**.

Standard Specifications: (Avery® match)

- ◆ 80 lb. white stock
- ◆ 1/2" tab extension
- ◆ Clear Mylar® on tab extension for reinforcement
- ◆ 8-1/2"w x 11"h
- ◆ Tabs printed both sides
- ◆ Accommodate any binding style - dividers are not hole punched

Call for pricing and lead times on the following:

- ◆ Hole punching
- ◆ Custom titles
- ◆ High numbered tabs and bulk pricing
- ◆ All-State® and Blumberg® styles

Month Side Indexing

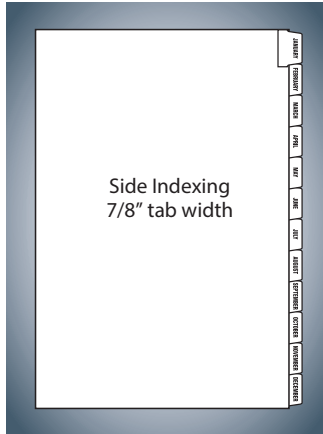

12 tabs per set

stock no.	sets/ description	qty./ pkg.	box
68305	JANUARY-DECEMBER	2	10

Alpha Side Indexing

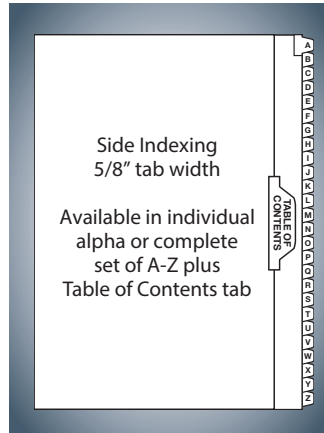

stock no.	sets/ description	qty./ pkg.	box
66001	A	25	10
66002	B	25	10
66003	C	25	10
66004	D	25	10
66005	E	25	10
66006	F	25	10
66007	G	25	10
66008	H	25	10
66009	I	25	10
66010	J	25	10
66011	K	25	10
66012	L	25	10
66013	M	25	10
66014	N	25	10
66015	O	25	10
66016	P	25	10
66017	Q	25	10
66018	R	25	10
66019	S	25	10
66020	T	25	10
66021	U	25	10
66022	V	25	10
66023	W	25	10
66024	X	25	10
66025	Y	25	10
66026	Z	25	10

Complete Set A-Z plus TABLE OF CONTENTS

stock no.	sets/ description	qty./ pkg.	box
66000	A-Z	25	10

Numerical Side Indexing

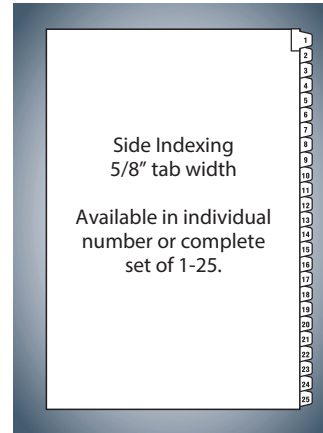

stock no.	sets/ description	qty./ pkg.	box
68001	1	25	10
68002	2	25	10
68003	3	25	10
68004	4	25	10
68005	5	25	10
68006	6	25	10
68007	7	25	10
68008	8	25	10
68009	9	25	10
68010	10	25	10
68011	11	25	10
68012	12	25	10
68013	13	25	10
68014	14	25	10
68015	15	25	10
68016	16	25	10
68017	17	25	10
68018	18	25	10
68019	19	25	10
68020	20	25	10
68021	21	25	10
68022	22	25	10
68023	23	25	10
68024	24	25	10
68025	25	25	10

Complete Set 1-25

stock no.	sets/ description	qty./ pkg.	box
67999	1-25	25	10

numbers up to 5,000 available

CUSTOM VARIETIES are always available. Special colors, collation sequences, paper types and different tab cuts can be quickly and easily manufactured to your specifications. **Just Ask!**

Go to www.tabbies.com for a complete list of compatible copiers

custom index tab filebacks & dividers

Custom Index Tab Dividers

custom index tab dividers are the cost-effective choice for organizing important papers within your file folder or binder. From medical charts to legal folders or overall general filing, using **custom index tab dividers** allows for quick access to information in a wide range of applications. Choose your own tab titles, color selection, and style that will fit your budget and filing needs.

CUSTOM INDEX

Easy Ordering Instructions:

- Specify paper weight and divider color:
 - 90 lb. or 110 lb.
 - White or ivory (manila) stock
- Choose tab print style and punch hole positions:
 - Side or bottom tabs
 - 5, 3, or 2 hole punch
- Specify tab cut size and tab extension
- List tab titles, positions, and colors
- Choose packaging options:
 - Collated / titles boxed together in sets
 - Non-Collated / each title boxed individually

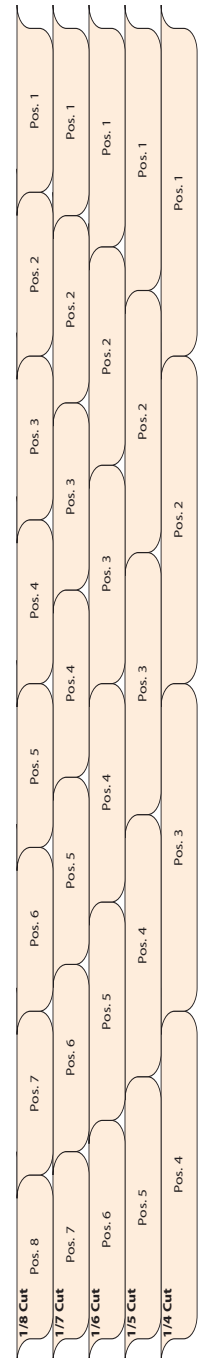
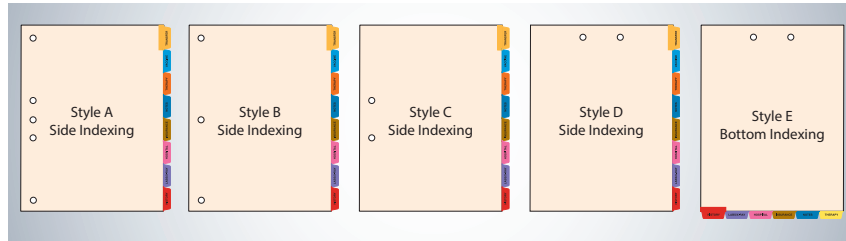

Custom Fileback Dividers

custom fileback dividers take file organization one step further. Each section is self-contained and information can be easily removed without disturbing other sections. Each **custom fileback divider** has a permanent heat-bonded fastener applied to the top or side of the divider allowing for easy and quick retrieval of information.

CUSTOM FILEBACK

Easy Ordering Instructions:

- Specify side or bottom tabs
- Choose fastener: top or side
- Specify style:
 - hinge or self-adhesive
- List tab positions, titles, and colors
- Choose packaging options:
 - Collated / titles boxed together in sets
 - Non-Collated / each title boxed individually

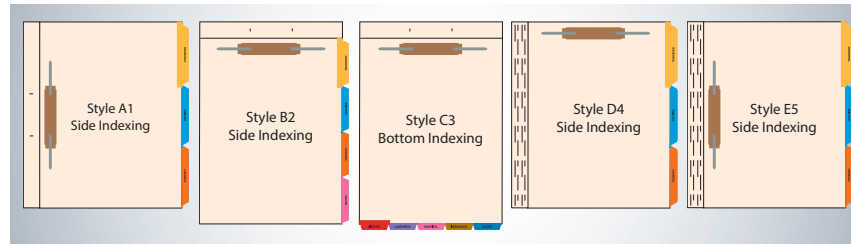

TAB TIP: Plan ahead! Allow for expansion and add a write-on erasable tab to use for your specific office needs.

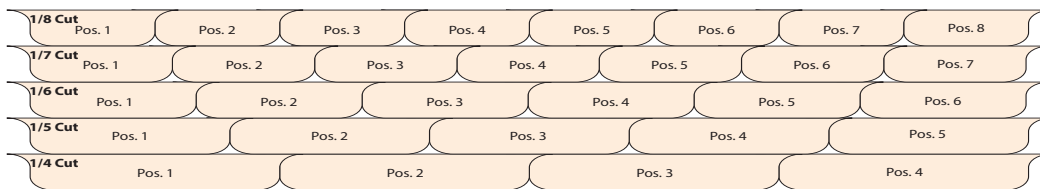
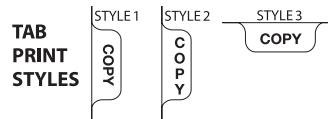

AVAILABLE COLORS:

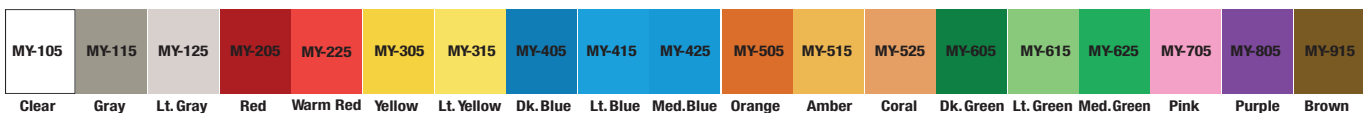

Custom Divider Applications Include:

- ◆ Banking and Financial Records
- ◆ Medical Records
- ◆ Insurance Offices
- ◆ Hospital Patient Charts
- ◆ Spiral Bound Books
- ◆ Employee Handbooks
- ◆ Mortgage Loan Files
- ◆ Product Catalogs
- ◆ Manuals
- ◆ Price Books/Lists
- ◆ Telephone Directories
- ◆ Instruction Manuals
- ◆ Legal Briefs
- ◆ Sales Presentations

Save Time & Money
by letting us install
dividers to your file folders

computer printout index tabs

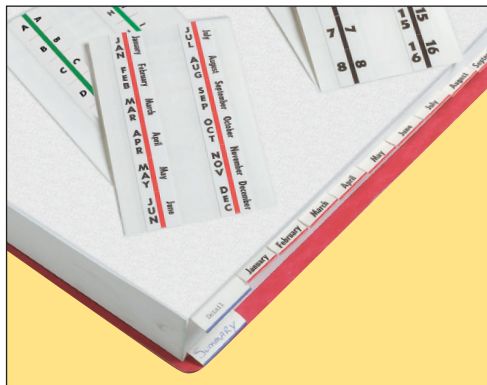

computer printout index tabs turn any computer report into an easy to read format. Tabs have transparent gripping edges that attach to both sides of the page. Available in several options, including erasable write-on index tabs.

stock no.	description	size	color edge	tabs/pkg.	sets/box
58320	A-Z	1"	Green	24	10
58321	Months	1"	Red	12	10
58322	1-31	1"	Black	31	10
58727	Erasable write-on	1-1/2"	Blue	16	10

printed index tabs

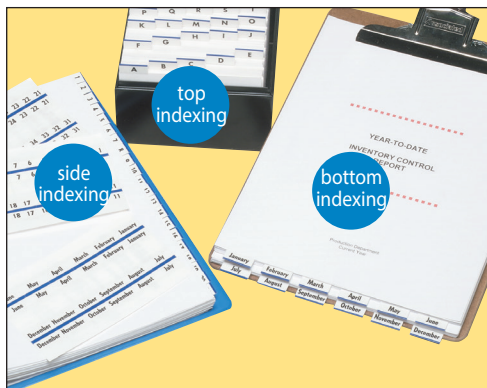

printed index tabs are ready to use and can be attached quickly and easily to most material. Choose alphabetical, monthly or numerical index tabs with new, improved styling for top, side or bottom indexing. Transparent gripping edges adhere to both sides of paper for a secure, lasting hold. Tabs are plastic laminated to remain clean and tear-proof and are printed in bold black ink with colored edges.

stock no.	description	size	color edge	tabs/pkg.	sets/box
58301	A-Z (24 divisions)	1/2"	Red	24	10
58302	A-Z (24 divisions)	1"	Blue	24	10
58305	Months, Jan. - Dec.	1"	Blue	12	10
58307	Numbers, 1-31 (daily)	1/2"	Blue	31	10
58309	Numbers, 1-50	1/2"	Blue	50	10
58311	Numbers, 1-100	1/2"	Blue	100	10

road atlas index tabs



road atlas index tabs make it easy to index and identify states for quick reference. Pre-cut, self-adhesive tabs attach securely to both sides of page for a permanent bond. State abbreviations are printed on one side with name of the state spelled out on the reverse side. Each set includes 53 1" tabs – 50 states plus District of Columbia, Canada and Mexico.

stock no.	description	size	color edge	tabs/pkg.	sets/box
58314	Road Atlas	1"	Green	53	10

tabbies has a variety of **index divider sheets** in stock or we can customize to accommodate any tab size for your filing needs.

erasable write-on index tabs



erasable write-on index tabs can be used over and over again. Write with pencil or any erasable ink pen – then just erase and reuse. Tabs have 1/2" tab extension with colored edges or solid color fluorescent tabs. Ideal for any filing, flagging or indexing situation.

color edge	1" 24 tabs/pkg.	1-1/2" 16 tabs/pkg.	2" 12 tabs/pkg.	3" 8 tabs/pkg.	pkgs./box
Yellow	58600	58700	58800	58900	10
Red	58602	58702	58802	58902	10
Green	58606	58706	58806	58906	10
Blue	58607	58707/58727	58807	58907	10
Black	58609	58709	58809	58909	10
White	58610	58710	58810	58910	10

Assorted Solid Colors

stock no.	color	size	tabs/pkg.	pkgs./box
58530	Fluorescent	1-1/2"	24	10

tabs-u-create & divider sheets



Use your laser printer and Microsoft Word® with **tabs-u-create** to make custom title indexes in seconds. Self-adhesive tabs are 1-1/4" in length and grip both sides of the page for added strength. Easy set-up instructions come inside each package of index tabs. Use **tabs-u-create divider sheets** to make full index dividers. Tabs have 1/2" tab extension in white or assorted colors. For bottom or side indexing.

stock no.	color	tab size	tabs/sheet	tabs/pkg.
40201	White	1-1/4"	12	60
40202	Assorted	1-1/4"	12	60

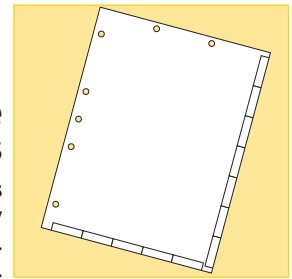

tabs-u-create divider sheets

tabs-u-create divider sheets have position marks for easy placement of index tabs. For bottom or side indexing.

stock no.	sheet size	sheets/pkg.
40200	8-1/2" w x 11" h	50

Create Indexes In Seconds!

labels-u-create



Create bright, eye-catching communication labels in seconds, using your PC and laser printer with **labels-u-create** to make custom labels for any application. Permanent labels can be applied to folders, documents, drawers, even shelving. Make an entire sheet of the same label or just a few at a time. Easy set-up instructions inside. Works with Microsoft Word®. No additional software is needed. 10 (8-1/2" x 11") sheets per package. Available in 3 colors plus white.

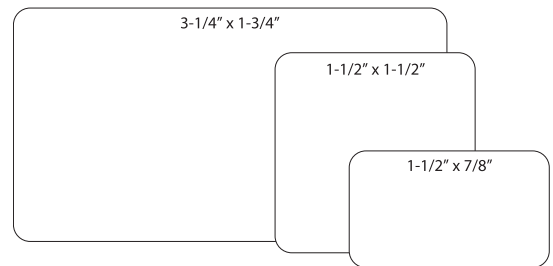

stock no.	label size	color	labels/sheet	labels/pkg.
40100	1-1/2" X 7/8"	White	32	320
40101	1-1/2" X 7/8"	Fl. Red	32	320
40102	1-1/2" X 7/8"	Fl. Green	32	320
40103	1-1/2" X 7/8"	Fl. Yellow	32	320
40120	1-1/2" X 1-1/2"	White	20	200
40121	1-1/2" X 1-1/2"	Fl. Red	20	200

stock no.	label size	color	labels/sheet	labels/pkg.
40122	1-1/2" X 1-1/2"	Fl. Green	20	200
40123	1-1/2" X 1-1/2"	Fl. Yellow	20	200
40140	3-1/4" X 1-3/4"	White	10	100
40141	3-1/4" X 1-3/4"	Fl. Red	10	100
40142	3-1/4" X 1-3/4"	Fl. Green	10	100
40143	3-1/4" X 1-3/4"	Fl. Yellow	10	100

COL'RTAB® II

label refill packages

Color code filing labels on demand

30010 End Tab File Folder Name Labels

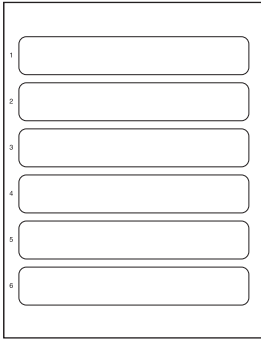

stock no.	description	label size	labels/pkg.
30010	end tab file folder name labels	1-1/4"W X 7-1/2"H	300
30011	top tab file folder name labels	3-1/2"W X 1"H	700

Up to six 1/2" alpha or numeric characters, with two line name label option, year code and 1/2" solid color designator options

(6 labels per sheet, 50 sheets per pack)
(for use with COL'RTAB® II label software)

30011 Top Tab File Folder Name Labels

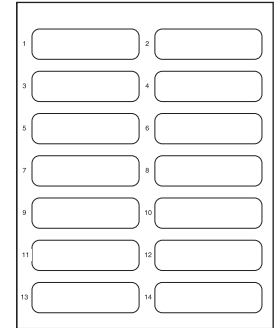

Standard 1/3 cut top tab name label with color stripe option

(14 labels per sheet, 50 sheets per pack)
(for use with COL'RTAB® II label software)

blank strip labels

Let **TABBIES** quote you on manufacturing any 8-1/2" x 11" strip label sheets. We can match any computer generated blank label configuration for use with any color coded label on demand system in the marketplace today. Call **TABBIES** Customer Service for further information and a quote.

integrated label forms

Combine both **Labels & Forms** in one sheet with Integrated **Label Forms** from TABBIES®!

stock no.	size	uom
59816	6" X 4" / 2" X 4"	1500/CASE
59918	6" X 4"	1500/CASE
59919	6" X 4"	1500/CASE
59920	6" X 4"	1500/CASE
59921	6" X 4"	1500/CASE
59923	6" X 4"	1500/CASE

*SOLD IN CASE QUANTITIES ONLY

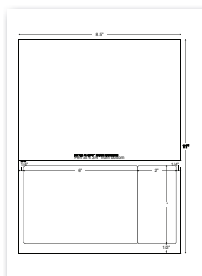

59816, 2-Up, 6"x 4" / 2"x 4" with perf.

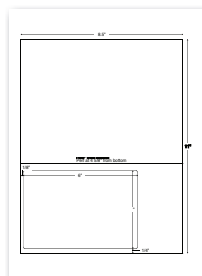

59918, 1-Up, 6"x 4" with perf. bottom left

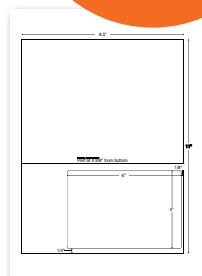

59919, 1-Up, 6"x 4" with perf. bottom right

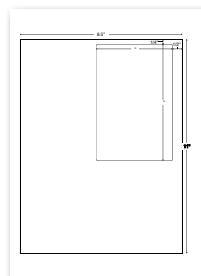

59920, 1-Up, 4"x 6" upper right MOM

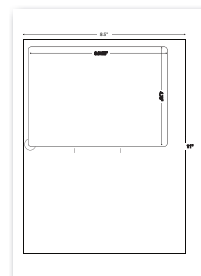

59921, USPS Clip-n-Ship, 6 3/16" x 4 3/4"

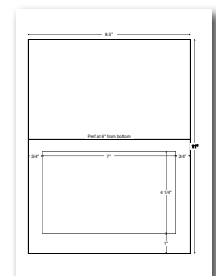

59923, PayPal 1-Up, 7" x 4 1/4"

laser/inkjet label sheets

Multi-use **laser/inkjet label sheets** are useful for mailings, announcements, getting organized, tracking or recalling documents and more. Labels are easy to apply for convenient, personalized labels anytime. Sheets are shrink-wrapped in packages and are fully compatible with both laser and inkjet printers. Labels feed automatically from paper tray and are centered on sheets so they can be fed using either the top or bottom as the lead edge. *See your printer manual for additional feeding instructions.*

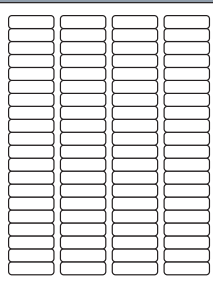
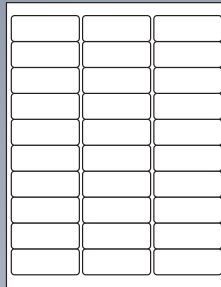
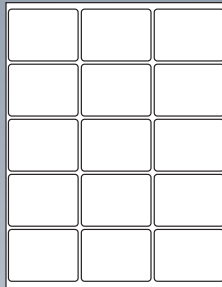
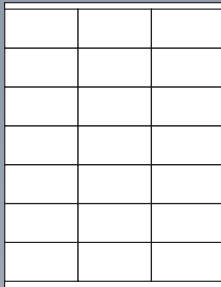
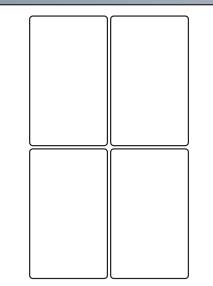
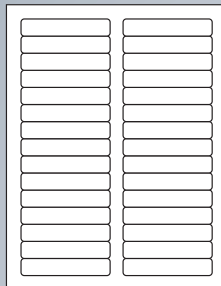
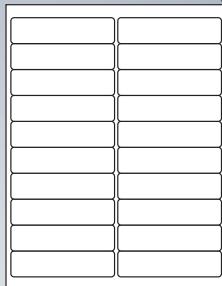
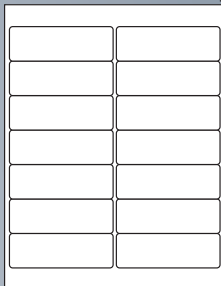
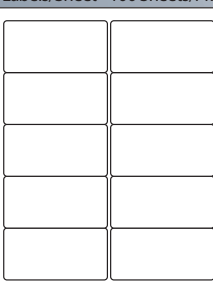
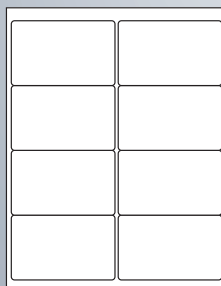
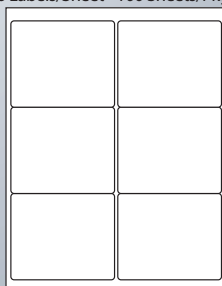
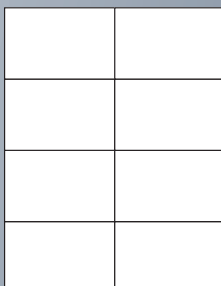
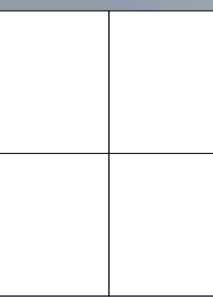
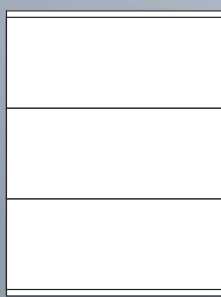
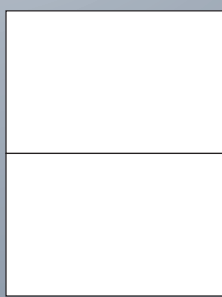
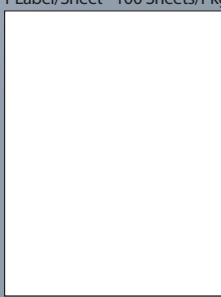
<p>Stock No. 40150 Matches Avery® No. 5167 1-3/4" x 1/2" 80 Labels/Sheet - 100 Sheets/Pkg</p> 	<p>Stock No. 40151 Matches Avery® No. 5160 2-5/8" x 1" 30 Labels/Sheet - 100 Sheets/Pkg</p> 	<p>Stock No. 40152 Matches Avery® No. 6490 2-11/16" x 2" 15 Labels/Sheet - 100 Sheets/Pkg</p> 	<p>Stock No. 40153 2-13/16" x 1-1/2" 21 Labels/Sheet - 100 Sheets/Pkg</p> 
<p>Stock No. 40154 3" x 5" 4 Labels/Sheet - 100 Sheets/Pkg</p> 	<p>Stock No. 49430 Matches Avery® No. 5366 3-7/16" x 2/3" 30 Labels/Sheet - 25 Sheets/Pkg</p> 	<p>Stock No. 40156 Matches Avery® No. 5161 4" x 1" 20 Labels/Sheet - 100 Sheets/Pkg</p> 	<p>Stock No. 40157 Matches Avery® No. 5162 4" x 1-1/3" 14 Labels/Sheet - 100 Sheets/Pkg</p> 
<p>Stock No. 40158 Matches Avery® No. 5163 4" x 2" 10 Labels/Sheet - 100 Sheets/Pkg</p> 	<p>Stock No. 40159 4" x 2-1/2" 8 Labels/Sheet - 100 Sheets/Pkg</p> 	<p>Stock No. 40160 Matches Avery® No. 5164 4" x 3-1/3" 6 Labels/Sheet - 100 Sheets/Pkg</p> 	<p>Stock No. 40161 4-1/4" x 2-3/4" 8 Labels/Sheet - 100 Sheets/Pkg</p> 
<p>Stock No. 40162 4-1/4" x 5-1/2" 4 Labels/Sheet - 100 Sheets/Pkg</p> 	<p>Stock No. 40163 8-1/2" x 3-1/2" 3 Labels/Sheet - 100 Sheets/Pkg</p> 	<p>Stock No. 40164 8-1/2" x 5-1/2" 2 Labels/Sheet - 100 Sheets/Pkg</p> 	<p>Stock No. 40165 Matches Avery® No. 5165 8-1/2" x 11" 1 Label/Sheet - 100 Sheets/Pkg</p> 

custom labels

TABBIES has been printing and converting high quality labels and films for packaging and industrial products since 1985. We stock a wide variety of materials, dies and adhesives. We provide paper and film solutions that help your customers create compelling graphics that project strong shelf presence, increase brand recognition and capture the consumer's attention.



A few of the industries we serve are:

Personal Care Labels

- Moisturizers
- Lotions
- Shampoos



- Sea Salts
- Conditioners

Packaging Labels

- Corrugated Labels
- Coffee Cups
- Dairy & Water Caps
- Flexible Packaging



- Tamper Evident

Retail Labels

- Candle Labels
- Counter Mats
- Garment Labels
- Shelf Talkers



- Shelf Tape
- POS
- Static Cling

Food & Beverage Labels

- Water
- Micro Brew
- Beef Jerky



- Coffee & Tea
- Energy Drinks

Agricultural Chemical Labels

- Weed Prevention
- Pesticides
- Insect Repellent



- Lawn & Garden
- Drum Labels

Manufacturing Labels

- Safety Cans
- Model Products
- Industrial Tools



- Heavy Equipment
- Oral Bonding Products



color code filing made easy

Color coding is the assignment of color to a number, letter or particular item that shows meaning. In filing, we assign a color for each number 0 through 9, and a color for each letter A through Z, to aid in filing and retrieval of all types of hard copy files. By putting these colors (letters, numbers and designators) in a particular position on a file folder, file pocket, etc., a color/block pattern is formed. When these patterns of color are broken, a misfile has occurred. In retrieving a file, color recognition reduces look-up time. It also saves presorting time and reduces filing time. In fact, color coded filing can reduce filing and retrieval time by up to 50%. Approximately 75% of every dollar spent in filing areas is people time; therefore, color coding can save as much or more than 33% of the money that is now spent on your present non-color coded files. Misfiles are virtually non-existent in color coded files because of the ease of spotting a file when it is out of order. Memorization of colors is not necessary; the color works as a flag which identifies position or meaning in a file sequence. A good color code system can work for your files, and in most cases pays for itself in less than a year due to the time saved in filing and retrieval without misfiles. Since most files are filed in one of the demonstrated examples, you can easily adapt your file situation to color coding.

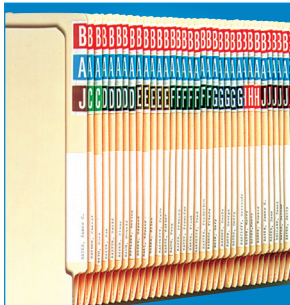

alphabetical filing

alphabetical color coded name files are easy to maintain without requiring a cross reference file. Color coding alphabetical breakdowns of initials with color can direct you to the proper file area and help eliminate misfiles, which are most common in non-color coded alphabetical files. Filing of common names is accomplished by coding the first two letters of the last name; for example, James C. Bayer would be coded "BA". In larger alphabetical files, the additional coding of the first name initial will further break up the large name groupings in the file. Using "J" for James, we now can go immediately to the "BA" section and then to the "J" section in the "BA" group to retrieve or refile. When filing corporate or company names, it is suggested to use the first two or three letters of the first full proper name; for example, "Ajax Tool Works" would be coded "AJA".



Note that AZ 124 is a misfile.

alpha-numeric filing

alpha-numeric filing is simply the filing of letters and numbers in a format that suits the file situation. Many times, files have alphabetical indicators which have a particular meaning in a numeric file, or vice versa. When filing alpha-numeric files, a decision must be made as to whether the number or the letter is more important for locating or segregating the file, since the file can be set up either way. An example of alpha-numeric filing (at left) shows a construction company using the alpha prefix of the state in which the construction site is located. In the illustration, IL (postal abbreviation) is for the state of Illinois, job number 123. Job number 124 has the indicator AZ, showing that the construction site is in Arizona, which is a misfile. The files are kept in alphabetical order by state, then in numerical order by job numbers which are assigned in sequence as construction sites become available. Alpha-numeric files need not be complicated; numbers or letters used in an alpha-numeric file can give added dimension for presorting, filing and retrieval.

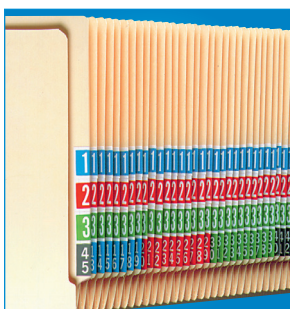

straight numeric filing

straight numeric filing is the filing of numbered documents in a numerical sequence order starting from the first number and proceeding to the highest numbered file (last or most recent). Color coding a straight numeric file is somewhat dependent upon the total number of files. In the example, we have color coded all five digits. In straight numeric filing, time-saving and cost-saving advantages can be gained by coding the last two digits (tens and units) of the number with one double-digit color block. (Note - the units and tens digit must be color coded separately if you are considering converting to terminal digit filing at a later date.) The major advantages of straight numeric filing are (1) no training of file personnel, since most people know how to find files if they are numbered from the lowest through the highest number in the files, (2) ease of retiring old files. In most cases of straight numeric files, the oldest files are the ones with the lowest numbers.

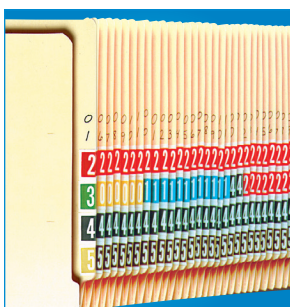

terminal digit filing

terminal digit filing is the filing of all files ending in the same last two digits in one section, forming 100 distinct file groups (00 through 99) in any given file number situation. The use of terminal digit filing is usually seen in large file areas: hospitals, insurance companies, government, banking, etc. It speeds up retrieval time and reduces refile time by segregating files into groups of 00 through 99 (example #12345) terminal digits (45), middle digits (23 within the 45 section) and tertiary digits (01 within the 23 section). For example, file 12345 (01-23-45) would be filed in the 45 section next to file 2345 (00-23-45). File 12346 (01-23-46) which would normally be put next to 12345, would be filed in the 46 section (then in the 23 section, then 01 within 23 section). Note the misfile - two files in the 45 section between subsections 21 and 22 that should be in the middle digit section 24 (file numbers larger than six digits can also be filed in terminal digit order). The major advantage of terminal digit filing is that the file grows equally in 100 places and reduces itself in 100 places with the retirement of older files, forming an equal growth pattern in the file.

yearcode labels

11700 / 51700 / 81700 series Original Col'R'Tab®

3/4"H x 1-1/2"W – Label size
1,000 labels per roll • 500 labels per roll • 250 labels per pkg.

stock no. 1,000/roll	stock no. 500/roll	stock no. 250/pkg	item	color
11713	51713	81713	13	Lt. Green
11714	51714	81714	14	Gray
11715	51715	81715	15	Gold
11716	51716	81716	16	Green
11717	51717	81717	17	Blue
11718	51718	81718	18	Orange
11719	51719	81719	19	Black
11720	51720	81720	20	Yellow
11721	51721	81721	21	Lt. Blue
11722	51722	81722	22	Red
11723	51723	81723	23	Lt. Green



11718 – Roll • 51718 – Roll • 81718 – Pkg.



11719 – Roll • 51719 – Roll • 81719 – Pkg.



11720 – Roll • 51720 – Roll • 81720 – Pkg.

71700 series Original Col'R'Tab®

1-1/2"H x 3/4"W (Top Tab) – Label size
1,000 labels per roll

stock no.	item	color
71713	13	Lt. Green
71714	14	Gray
71715	15	Gold
71716	16	Green
71717	17	Blue
71718	18	Orange
71719	19	Black
71720	20	Yellow
71721	21	Lt. Blue
71722	22	Red
71723	23	Lt. Green



71718 – Roll



71719 – Roll



71720 – Roll

70200 series Original Tabbies®

3/4"H x 1-1/2"W – Label size
500 labels per roll

stock no.	item	color
70213	13	Dk. Green
70214	14	Gold
70215	15	Gray
70216	16	Lt. Green
70217	17	Red
70218	18	Lt. Blue
70219	19	Pink
70220	20	Black
70221	21	Orange
70222	22	Blue
70223	23	Dk. Green



70218 – Roll



70219 – Roll



70220 – Roll

70500 series Original Tabbies®

1"H x 1/2"W (Top Tab) – Label size
250 labels per pkg.

stock no.	item	color
70513	13	Dk. Green
70514	14	Gold
70515	15	Gray
70516	16	Lt. Green
70517	17	Red
70518	18	Lt. Blue
70519	19	Pink
70520	20	Black
72521	21	Orange
72522	22	Blue
72523	23	Dk. Green



70518 – Pkg.



70519 – Pkg.



70520 – Pkg.

12600 series Acme Visible® compatible series

3/4"H x 1-1/2"W – Label size
1,000 labels per roll
Original Col'R'Tab® construction

stock no.	item	color
12613	13	Yellow
12614	14	Purple
12615	15	Red
12616	16	Gray
12617	17	Brown
12618	18	Blue
12619	19	Orange
12620	20	Green
12621	21	Pink
12622	22	Black
12623	23	Yellow



12618 – Roll



12619 – Roll



12620 – Roll

14900 series Ames® compatible series

1-7/8"H x 1-7/8"W – Label size
500 labels per roll

stock no.	item	color
14914	14	Purple
14915	15	Black
14916	16	Yellow
14917	17	Brown
14918	18	Pink
14919	19	Green
14920	20	Red
14921	21	Gray
14922	22	Blue
14923	23	Orange

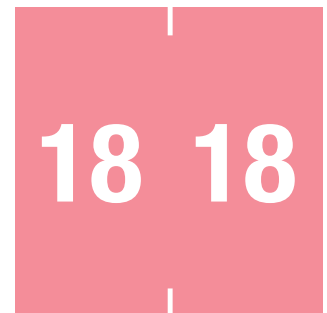

14918 – Roll



14919 – Roll



14920 – Roll

12900 series SFI® compatible series

3/4"H x 1-1/2"W – Label size
1,000 labels per roll
Original Col'R'Tab® construction



12918 – Roll

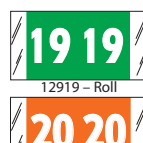

12919 – Roll

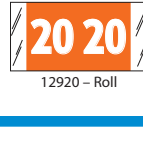

12920 – Roll

stock no.	item	color
12913	13	Gray
12914	14	Red
12915	15	Purple
12916	16	Org./Yel.
12917	17	Black
12918	18	Pink

stock no.	item	color
12919	19	Green
12920	20	Orange
12921	21	Blue
12922	22	Brown
12923	23	Gray

yearcode labels

90600 series

Barkley® compatible series

3/4"H x 1-1/2"W – Label size
500 labels per roll

stock no.	item	color
90613	13	Orange
90614	14	Lt. Green
90615	15	Blue
90616	16	Lilac
90617	17	Brown
90618	18	Gray
90619	19	Gold
90620	20	Red
90621	21	Pink
90622	22	Yellow
90623	23	Orange



90618 – Roll



90619 – Roll



90620 – Roll



14418 – Roll



14419 – Roll



14420 – Roll

14400 series

Colwell® compatible series

3/4"H x 1-1/2"W – Label size
500 labels per roll

stock no.	item	color
14413	13	Brown
14414	14	Blue
14415	15	Pink
14416	16	Orange
14417	17	Green
14418	18	Purple
14419	19	Lt. Orange
14420	20	Yellow
14421	21	Red
14422	22	Dk. Green
14423	23	Brown

14700 Digi-Kolor® series

Original Col'R'Tab®

3/4"H x 1-1/2"W – Label size
1,000 labels per roll
Original Col'R'Tab® construction

stock no.	item	color
14715	15	Gold
14716	16	Dk. Green
14717	17	Gray
14718	18	Orange
14719	19	Brown
14720	20	Yellow
14721	21	Blue
14722	22	Red
14723	23	Lt. Green



14718 – Roll



14719 – Roll



14720 – Roll



94618 – Roll



94619 – Roll



94620 – Roll

94600 series

GBS®/VRE® compatible series

3/4"H x 1-1/2"W – Label size
500 labels per roll

stock no.	item	color
94613	13	Purple
94614	14	Orange
94615	15	Brown
94616	16	Green
94617	17	Gray
94618	18	Red
94619	19	Black
94620	20	Yellow
94621	21	Blue
94622	22	Pink
94623	23	Purple

90500 series

Jeter® compatible series

3/4"H x 1-1/2"W – Label size
500 labels per roll

stock no.	item	color
90513	13	Purple
90514	14	Gold
90515	15	Black
90516	16	Orange
90517	17	White/Black
90518	18	Aqua
90519	19	Gray
90520	20	Blue
90521	21	Yellow
90522	22	Red
90523	23	Purple



90518 – Roll

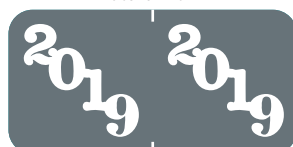

90519 – Roll



90520 – Roll

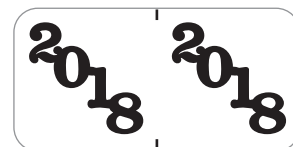

90418 – Roll



90419 – Roll



90420 – Roll

90400 series

Jeter® compatible series

3/4"H x 1-1/2"W – Label size
500 labels per roll

stock no.	item	color
90413	13	Blue
90414	14	Red
90415	15	Green
90416	16	Gray
90417	17	Fushcia
90418	18	Black/White
90419	19	Orange
90420	20	Yellow
90421	21	Black
90422	22	Pink
90423	23	Blue

yearcode labels

21800 / 90800 series Smead® compatible series

1/2"H x 1"W – Label size
500 labels per roll • 250 labels per pkg.

stock no.	stock no.	item	color
500/roll	250/pkg		
90813	21813	13	Purple
90814	21814	14	Orange
90815	21815	15	Brown
90816	21816	16	Green
90817	21817	17	Gray
90818	21818	18	Red
90819	21819	19	Black
90820	21820	20	Yellow
90821	21821	21	Lt. Blue
90822	21822	22	Pink
90823	21823	23	Purple



21818-Pkg • 90818-Roll



21819-Pkg • 90819-Roll



21820-Pkg • 90820-Roll



92018 – Roll



92019 – Roll



92020 – Roll

92000 series Tab Products® compatible series

3/4"H x 1-1/2"W – Label size
500 labels per roll • Laminated

stock no.	item	color
92013	13	Dk. Orange
92014	14	Lt. Green
92015	15	Dk. Green
92016	16	Blue
92017	17	Purple
92018	18	Lilac
92019	19	Brown
92020	20	Pink
92021	21	Red
92022	22	Lt. Orange
92023	23	Dk. Orange

70800 series Smead® compatible series

1"H x 1/2"W (Top Tab) – Label size
500 labels per roll

stock no.	item	color
70813	13	Purple
70814	14	Orange
70815	15	Brown
70816	16	Green
70817	17	Gray
70818	18	Red
70819	19	Black
70820	20	Yellow
70821	21	Lt. Blue
70822	22	Pink
70823	23	Purple



70818 – Roll



70819 – Roll



70820 – Roll



91218 – Roll



91219 – Roll



91220 – Roll

91200 series Tab Products® compatible series

1/2"H x 1-1/8"W – Label size
500 labels per roll • Kimdura

stock no.	item	color
91213	13	Dk. Orange
91214	14	Lt. Green
91215	15	Dk. Green
91216	16	Blue
91217	17	Purple
91218	18	Lilac
91219	19	Brown
91220	20	Pink
91221	21	Red
91222	22	Lt. Orange
91223	23	Dk. Orange

90900 series Smead® compatible series

3/4"H x 1-1/2"W – Label size
500 labels per roll



90918 – Roll



90919 – Roll



90920 – Roll

stock no.	item	color
90913	13	Purple
90914	14	Gold
90915	15	Black
90916	16	Orange
90917	17	White/Black
90918	18	Aqua

stock no.	item	color
90919	19	Gray
90920	20	Blue
90921	21	Yellow
90922	22	Red
90923	23	Purple

97100 series PMA compatible series

3/4"H x 1-1/2"W – Label size
500 labels per roll



97118 – Roll



97119 – Roll



97120 – Roll

stock no.	item	stock no.	item	stock no.	item	stock no.	item	stock no.	item	stock no.	item	color
97115	15	97116	16	97117	17	97118	18	97119	19	97120	20	Aqua-Holographic
97215	15	97216	16	97217	17	97218	18	97219	19	97220	20	Blue-Holographic
97315	15	97316	16	97317	17	97318	18	97319	19	97320	20	Green-Holographic
97415	15	97416	16	97417	17	97418	18	97419	19	97420	20	Orange-Holographic
97515	15	97516	16	97517	17	97518	18	97519	19	97520	20	Red-Holographic
97615	15	97616	16	97617	17	97618	18	97619	19	97620	20	Purple-Holographic



col'r'tab® color code labels

Original Col'RTab® color code labels provide the best value of any label system in the industry. The unique hinged construction allows for consistent and quick application to file folders, pockets, or even pressboard folders. The clear, outside skirt offsets any tendency for the labels to "hook" onto one another when pulled from the shelf. Made with heavy duty paper and fade-resistant inks. Do not settle for inexpensive color matches – realize the value and savings by using only original Col'RTab products!

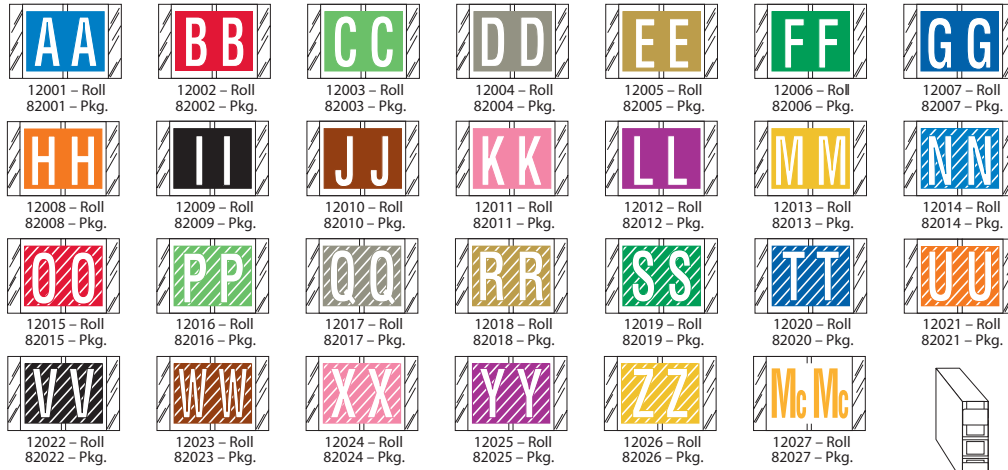

12000 / 82000 series
Original Col'RTab®

1"H x 1-1/2"W – Label size

ROLL / 500 labels per roll
Roll Unit – 42000 (28 rolls)

PACK / 100 labels per pkg.
10 labels per strip
Sheet size: 10" x 1-1/2"

Desktop Kit – 32000 (3,200 labels)

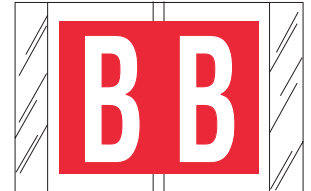

Dispenser Container only – 12000
(Holds 30 Rolls)

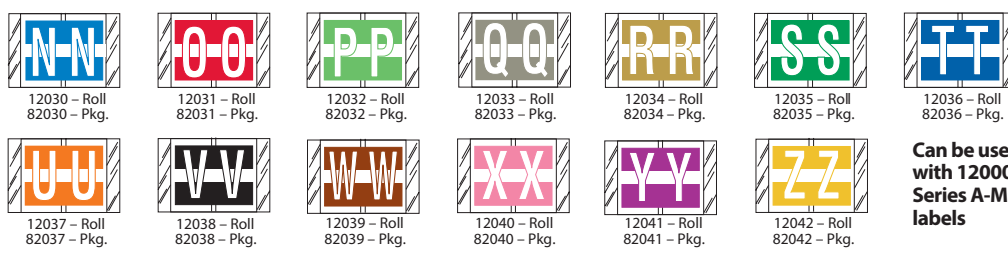

12030 / 82030 series
Original Col'RTab®

1"H x 1-1/2"W – Label size

ROLL / 500 labels per roll
Roll Unit – 42030 (28 rolls)

PACK / 100 labels per pkg.
10 labels per strip
Sheet size: 10" x 1-1/2"

Desktop Kit – 32030 (3,200 labels)

Can be used
with 12000
Series A-M
labels

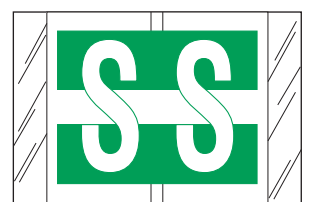

11000 / 81000 series
Original Col'RTab®

1"H x 1-1/2"W – Label size

ROLL / 500 labels per roll
Roll Unit – 41000 (10 rolls)

PACK / 100 labels per pkg.
10 labels per strip
Sheet size: 10" x 1-1/2"

Desktop Kit – 31000 (4,000 labels)

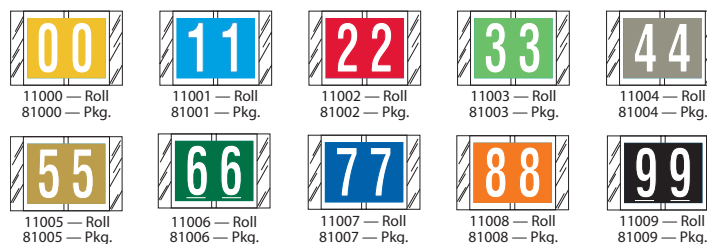

Dispenser Container only – 12000
(Holds 30 Rolls)

Dispenser Container only – 11015
(Holds 10 Rolls)

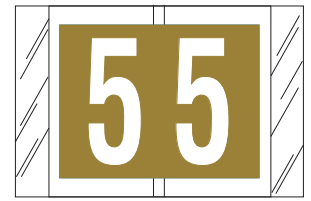

col'r'tab® color code labels

12100 / 82100 series Original Col'R'Tab®

1-1/2"H x 1-1/2"W – Label size

ROLL / 500 labels per roll

Roll Unit – 42100 (28 rolls)

PACK / 100 labels per pkg.

8 labels per strip

Sheet size: 12" x 1-1/2"

Desktop Kit – 32100 (3,200 labels)

Dispenser Container only – 12000
(Holds 30 Rolls)

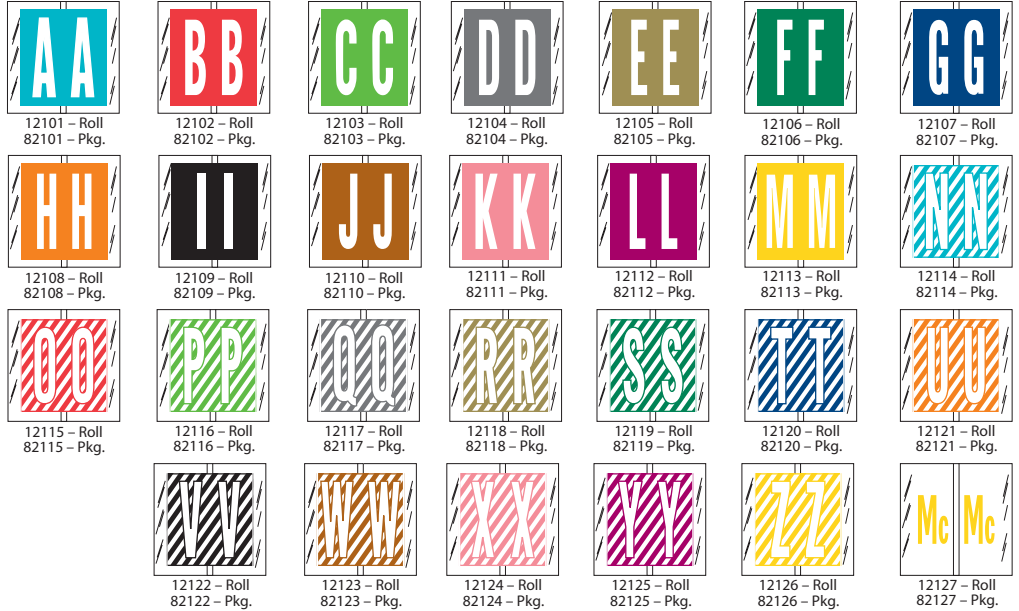
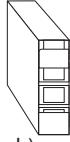

11500 / 81500 series Original Col'R'Tab®

1-1/2"H x 1-1/2"W – Label size

ROLL / 500 labels per roll

PACK / 100 labels per pkg.

8 labels per strip

Sheet size: 12" x 1-1/2"

Dispenser Container only – 11015
(Holds 10 Rolls)

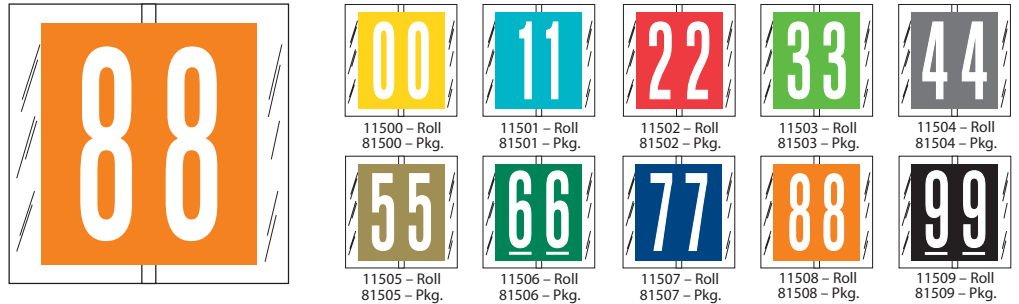
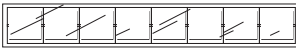

82050 series Original Col'R'Tab®

1-1/2"H x 1"W (Top Tab) – Label size

PACK / 100 labels per pkg.

10 labels per strip

Sheet size: 10" x 1-1/2"

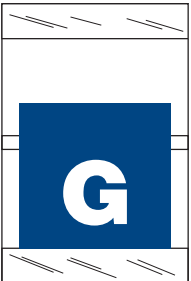

11050 series Original Col'R'Tab®

1-1/2"H x 1"W (Top Tab) – Label size

ROLL / 500 labels per roll

Dispenser Container only – 11015
(Holds 10 Rolls)

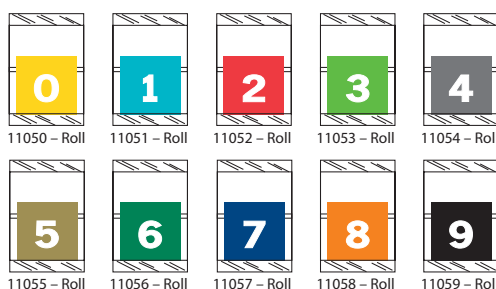
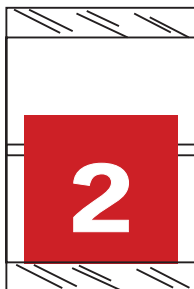
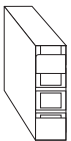

original col'r'tab® color code labels

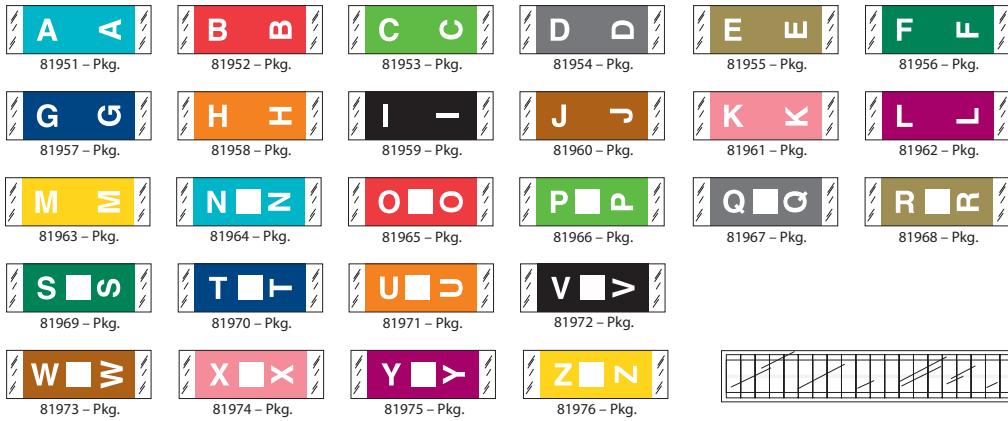

81950 series
Original Col'R'Tab®
 1/2"H x 1-1/2"W - Label size
PACK / 100 labels per pkg.
 20 labels per strip
 Sheet size: 10" x 1-1/2"
Desktop Kit - 31950 (3,100 labels)

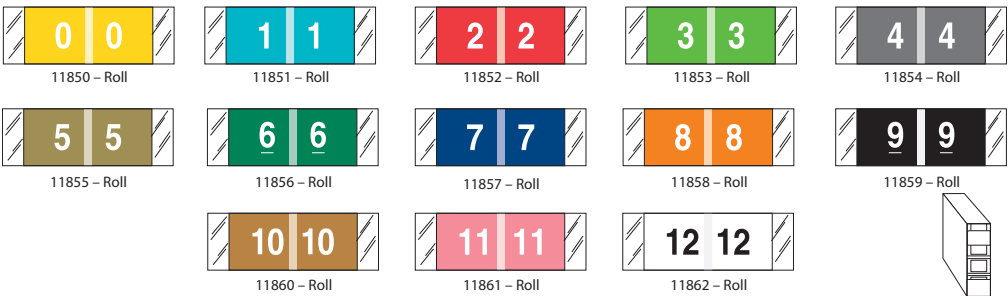
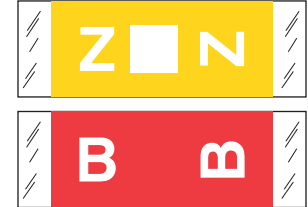

11850 series
Original Col'R'Tab®
 1/2"H x 1-1/2"W - Label size
ROLL / 500 labels per roll

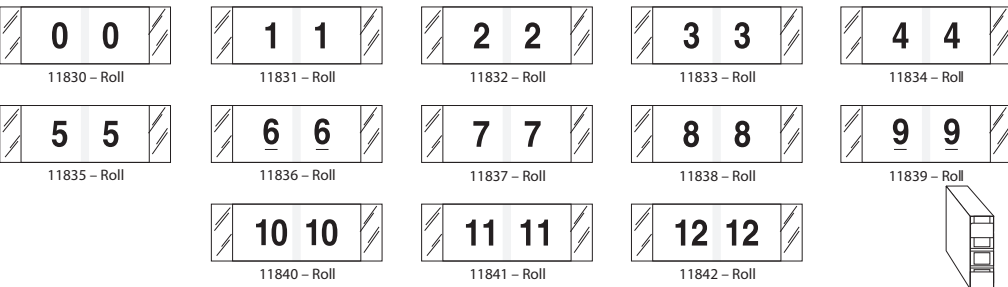

11830 series
Original Col'R'Tab®
 1/2"H x 1-1/2"W - Label size
ROLL / 500 labels per roll

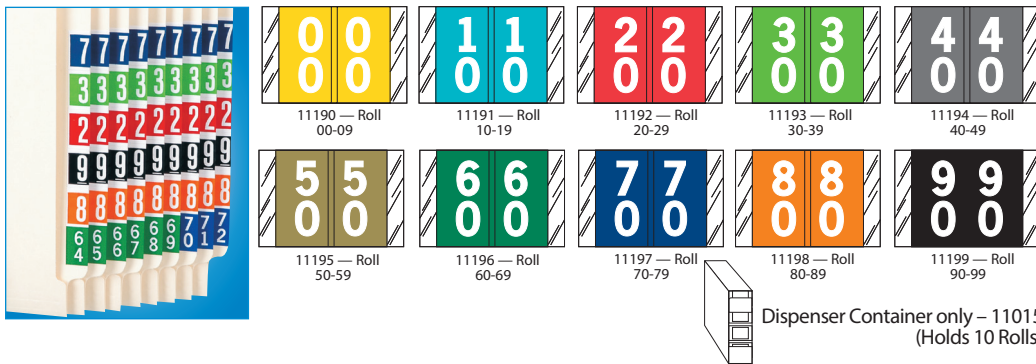

11200 series
Original Col'R'Tab®
 1"H x 1-1/2"W - Label size
ROLL / 500 labels per roll
Roll Unit - 11200 (10 rolls)

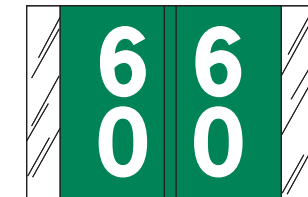

Dispenser Container only - 11015
 (Holds 10 Rolls)

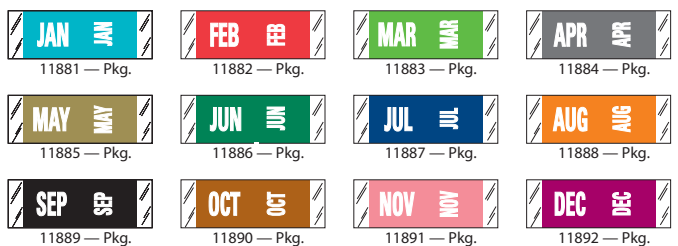

11880 series
Original Col'R'Tab®
 1/2"H x 1-1/2"W - Label size
PACK / 100 labels per pkg.
 20 labels per strip
 Sheet size: 10" x 1-1/2"



original col'r'tab® color code labels

14560 Digi-Kolor™ series Original Col'R Tab®

1"H x 1-1/2"W – Label size

ROLL / 500 labels per roll
Original Col'R Tab® construction

Dispenser Container only – 11015
(Holds 10 Rolls)

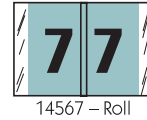
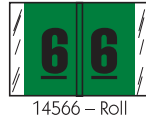
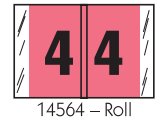
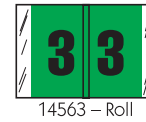
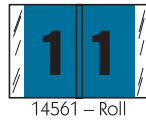
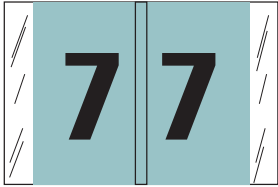

compatible color code labels

91720 / 61720 series

Jeter® 0200 compatible series

15/16"H x 1-5/8"W – Label size

ROLL / 500 labels per roll

Dispenser Container only – 90150
(Holds 28 Rolls)

RINGBOOK / 240 labels per pkg.
10 labels per sheet – 7 drill holes
Sheet size: 8-1/2" x 5-3/4"

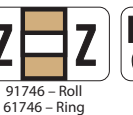
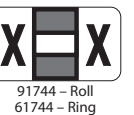
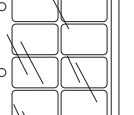
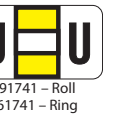
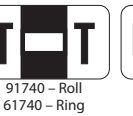
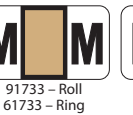
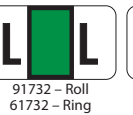
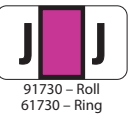
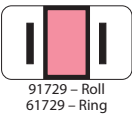
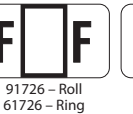
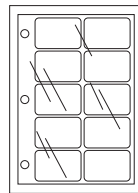

93020 / 63020 series

Safeguard® compatible series

15/16"H x 1-5/8"W – Label size

ROLL / 500 labels per roll

Dispenser Container only – 90150
(Holds 28 Rolls)

RINGBOOK / 240 labels per pkg.
10 labels per sheet – 7 drill holes
Sheet size: 8-1/2" x 6"

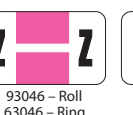
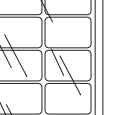
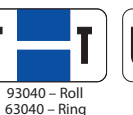
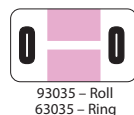
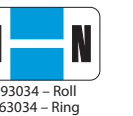
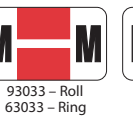
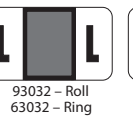
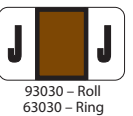
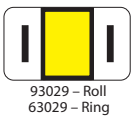
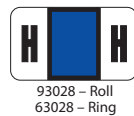
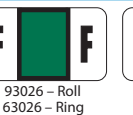
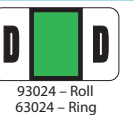
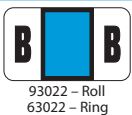
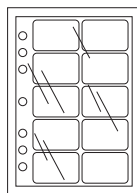
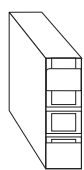

compatible color code labels

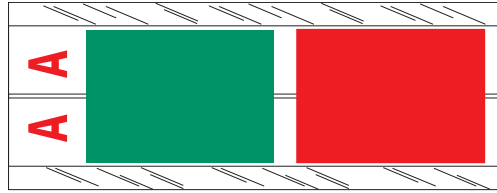
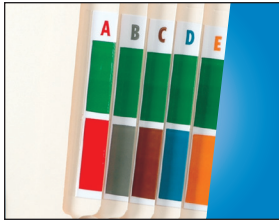

12700 series Acme Visible® compatible series

4"H x 1-1/2"W – Label size

PACK / 102 labels per pkg.
3 labels per strip

Sheet size: 12" x 1-1/2"
Original Col'RTab® construction

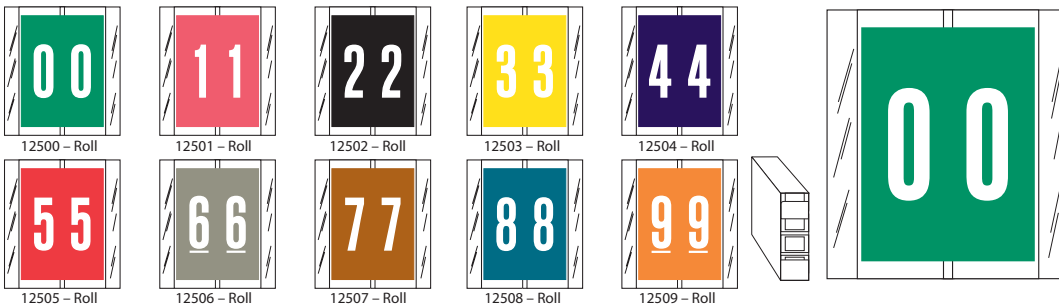

12500 series Acme Visible® compatible series

1-2/3"H x 1-1/2"W – Label size
Original Col'RTab® construction

ROLL / 500 labels per roll

Dispenser Container only – 11015
(Holds 10 Rolls)

**Call for availability on
double digit labels.**

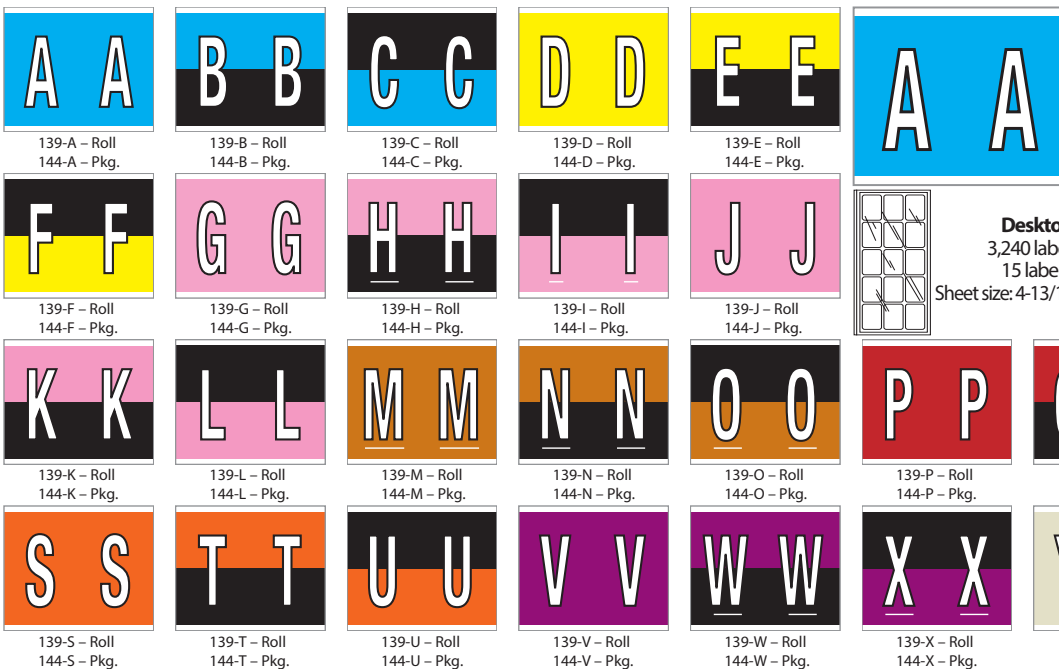

139 & 144 series Kardex® compatible series

1-1/4"H x 1-1/2"W – Label size

ROLL / 500 labels per roll

PACK / 210 labels per pkg.
15 labels per sheet
Sheet size: 4-13/16" x 6-7/8"

Desktop Kit – 142
3,240 labels per pkg.
15 labels per sheet
Sheet size: 4-13/16" x 6-7/8"

Pack Set – 143
1,725 labels per pkg.
15 labels per sheet
Sheet size: 4-13/16" x 6-7/8"

compatible color code labels

138 series Kardex® compatible series

1-1/4"H x 1-1/2"W – Label size
ROLL / 500 labels per roll

140 series
1/2"H x 1"W – Label size
ROLL / 1500 labels per roll
Stock #'s 140-0 thru 140-9

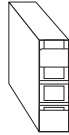

138-0 – Roll
140-0 – Roll

138-1 – Roll
140-1 – Roll

138-2 – Roll
140-2 – Roll

138-3 – Roll
140-3 – Roll

138-4 – Roll
140-4 – Roll

138-5 – Roll
140-5 – Roll

138-6 – Roll
140-6 – Roll

138-7 – Roll
140-7 – Roll

138-8 – Roll
140-8 – Roll

138-9 – Roll
140-9 – Roll

91620 / 71620 series Barkley® ABKM compatible series

1"H x 1-1/2"W – Label size
ROLL / 500 labels per roll
Roll Unit – 31620 (28 rolls)
Dispenser Container only – 90150
(Holds 28 Rolls)
PACK / 252 labels per pkg.
9 labels per sheet
Sheet size: 5" x 3-3/8"
Desktop Kit – 71620 (2,016 labels)

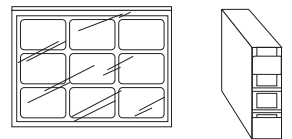
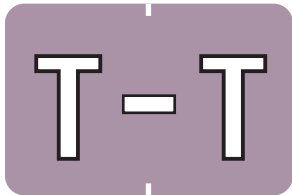

91621 – Roll
71621 – Pkg.



91622 – Roll
71622 – Pkg.



91623 – Roll
71623 – Pkg.



91624 – Roll
71624 – Pkg.



91625 – Roll
71625 – Pkg.



91626 – Roll
71626 – Pkg.



91627 – Roll
71627 – Pkg.



91628 – Roll
71628 – Pkg.



91629 – Roll
71629 – Pkg.



91630 – Roll
71630 – Pkg.



91631 – Roll
71631 – Pkg.



91632 – Roll
71632 – Pkg.



91633 – Roll
71633 – Pkg.



91634 – Roll
71634 – Pkg.



91635 – Roll
71635 – Pkg.



91636 – Roll
71636 – Pkg.



91637 – Roll
71637 – Pkg.



91638 – Roll
71638 – Pkg.



91639 – Roll
71639 – Pkg.



91640 – Roll
71640 – Pkg.



91641 – Roll
71641 – Pkg.



91642 – Roll
71642 – Pkg.



91643 – Roll
71643 – Pkg.



91644 – Roll
71644 – Pkg.



91645 – Roll
71645 – Pkg.



91646 – Roll
71646 – Pkg.



91647 – Roll
71647 – Pkg.



91600 / 71600 series Barkley® NBKM compatible series

1"H x 1-1/2"W – Label size
ROLL / 500 labels per roll
Roll Unit – 31600 (10 rolls)
Dispenser Container only – 90110
(Holds 10 Rolls)
PACK / 252 labels per pkg.
9 labels per sheet
Sheet size: 5" x 3-3/8"

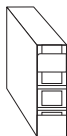

91600 – Roll
71600 – Pkg.

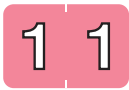

91601 – Roll
71601 – Pkg.



91602 – Roll
71602 – Pkg.



91603 – Roll
71603 – Pkg.



91604 – Roll
71604 – Pkg.



91605 – Roll
71605 – Pkg.

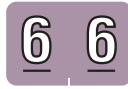

91606 – Roll
71606 – Pkg.



91607 – Roll
71607 – Pkg.

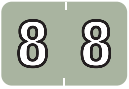

91608 – Roll
71608 – Pkg.



91609 – Roll
71609 – Pkg.



compatible color code labels



91420 / 61420 series
Colwell® Jewel-Tone compatible series

1"H x 1-1/2"W – Label size

ROLL / 500 labels per roll
Roll Unit – 91420 (28 rolls)

Dispenser Container only – 90150
(Holds 28 Rolls)

RINGBOOK / 240 labels per pkg.
24 labels per sheet / 3 drill holes
Sheet size: 5-1/2" x 9"

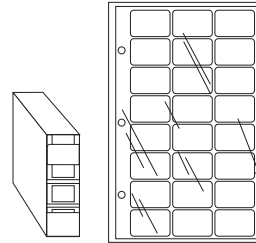

91400 series
Colwell® Jewel-Tone compatible series

1"H x 1-1/2"W – Label size

ROLL / 500 labels per roll
Roll Unit – 91410 (10 rolls)

Dispenser Container only – 90110
(Holds 10 Rolls)

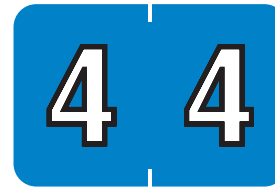

91320 / 61320 series
GBS® / VRE® 8848/8850 compatible series

1-5/16"H x 1-1/4"W – Label size

ROLL / 550 labels per roll
Roll Unit – 91320 (27 rolls)

RINGBOOK / 200 labels per pkg.
10 labels per sheet / 6 drill holes
Sheet size: 3-1/4" x 6-3/4"

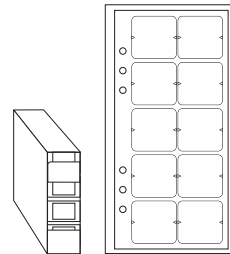

91300 series
GBS® / VRE® compatible series

1-5/16"H x 1-1/4"W – Label size

ROLL / 550 labels per roll
Roll Unit – 91310 (10 rolls)



compatible color code labels

14610 series GBS® / VRE® compatible series

1-5/16"H x 1-1/2"W – Label size
Original Col'R'Tab® construction

ROLL / 500 labels per roll

Dispenser Container only – 12000
(Holds 30 Rolls)

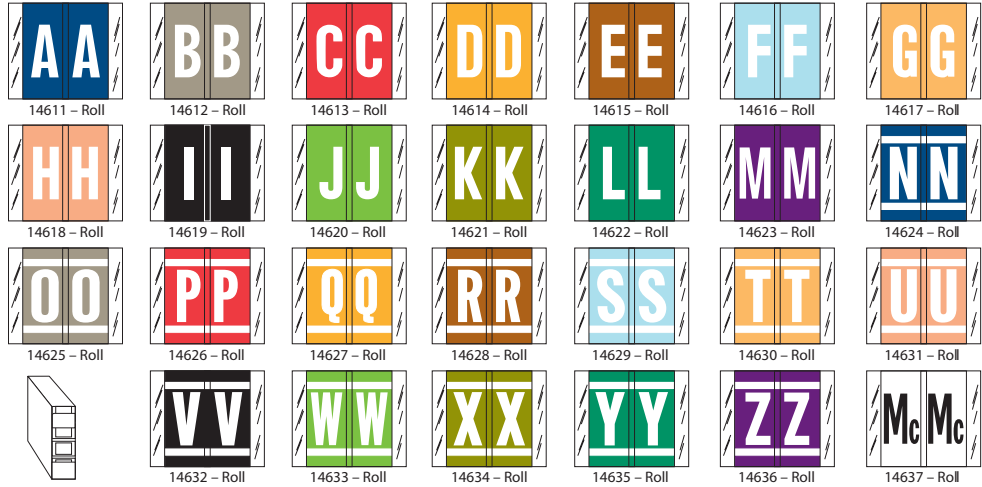

14600 series GBS® / VRE® compatible series

1-5/16"H x 1-1/2"W – Label size
Original Col'R'Tab® construction

ROLL / 500 labels per roll

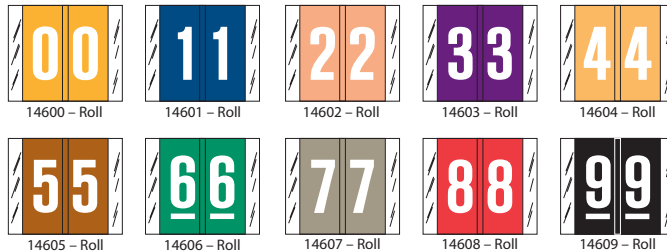
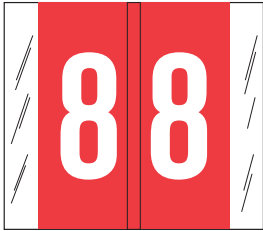

call for availability on double digit labels

Dispenser Container only – 11015
(Holds 10 Rolls)



91120 / 71120 series Tab Products® & Jeter® 5100 compatible series

15/16"H x 1-1/2"W – Label size
Laminated finish

ROLL / 500 labels per roll
Roll Unit – 31120 (28 rolls)

PACK / 252 labels per pkg.
9 labels per sheet
Sheet size: 5" x 3-1/2"

Desktop Kit – 71120 (2,016 labels)

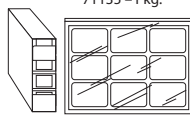

Dispenser Container only – 90150
(Holds 28 Rolls)

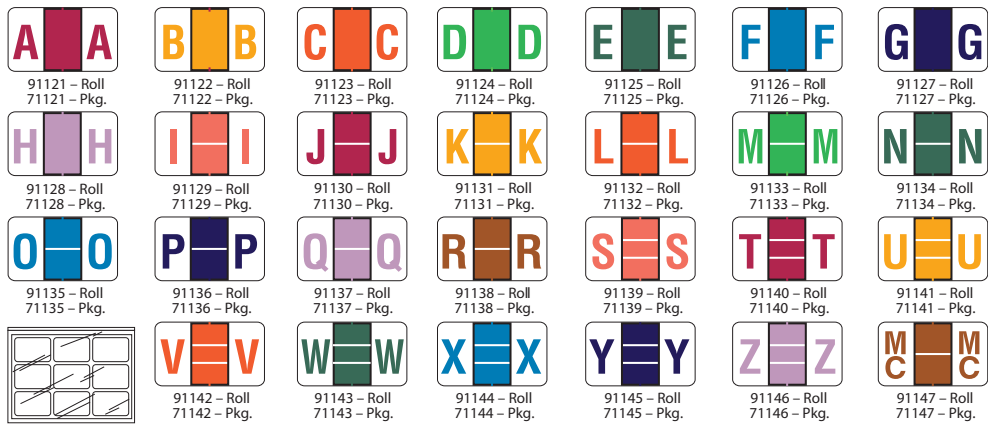

91100 / 71100 series Tab Products® & Jeter® 6100 compatible series

15/16"H x 1-1/2"W – Label size
Laminated finish

ROLL / 500 labels per roll
Roll Unit – 31100 (10 rolls)

PACK / 252 labels per pkg.
9 labels per sheet
Sheet size: 5" x 3-1/2"

Desktop Kit – 71110 (2,016 labels)

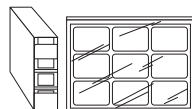
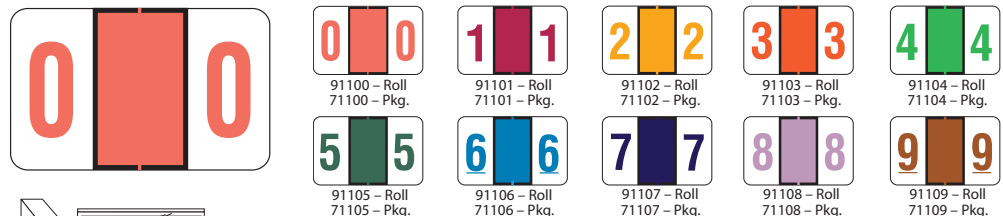

Dispenser Container only – 90110
(Holds 10 Rolls)

compatible color code labels

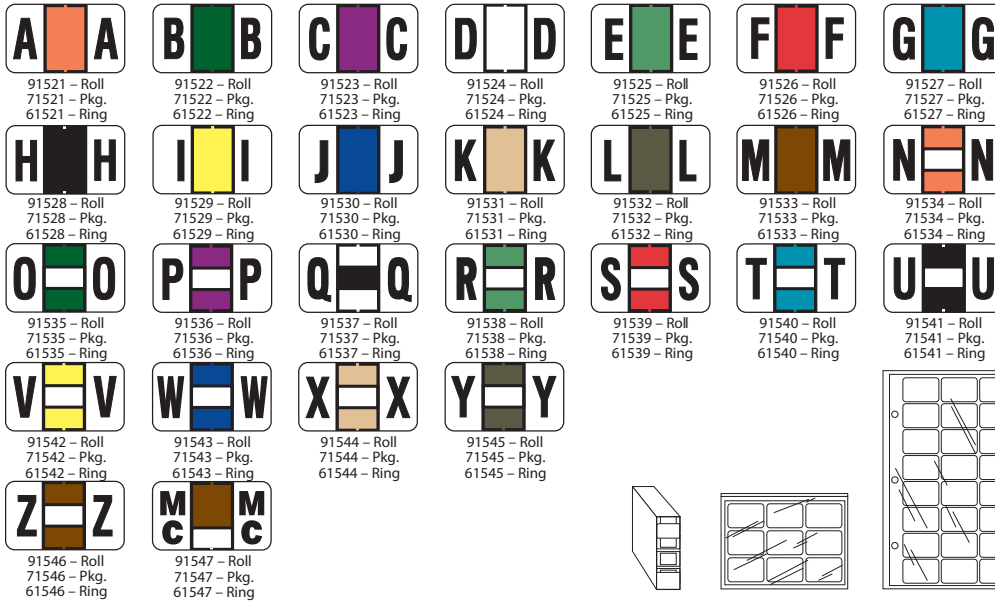

91520 / 71520 / 61520 series
Jeter® 5800, 7100, 7200
compatible series

15/16"H x 1-5/8"W - Label size

ROLL / 500 labels per roll
Roll Unit - 91520 (28 rolls)

Dispenser Container only - 90150
(Holds 28 Rolls)

PACK / 252 labels per pkg.
9 labels per sheet
Sheet size: 5-1/4" x 3-1/4"
Desktop Kit - 71520 (2,016 labels)

RINGBOOK / 240 labels per pkg.
24 labels per sheet / 3 drill holes
Sheet size: 5-3/4" x 8-1/2"

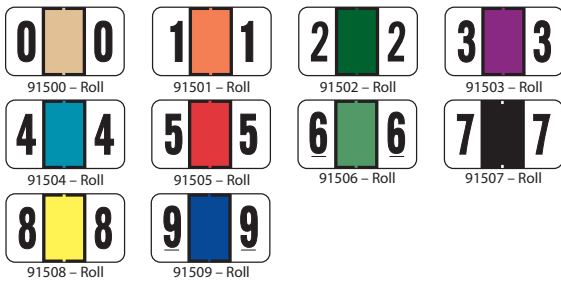

91500 series
Jeter® 7300 compatible series

15/16"H x 1-5/8"W - Label size

ROLL / 500 labels per roll

Dispenser Container only - 90110
(Holds 10 Rolls)

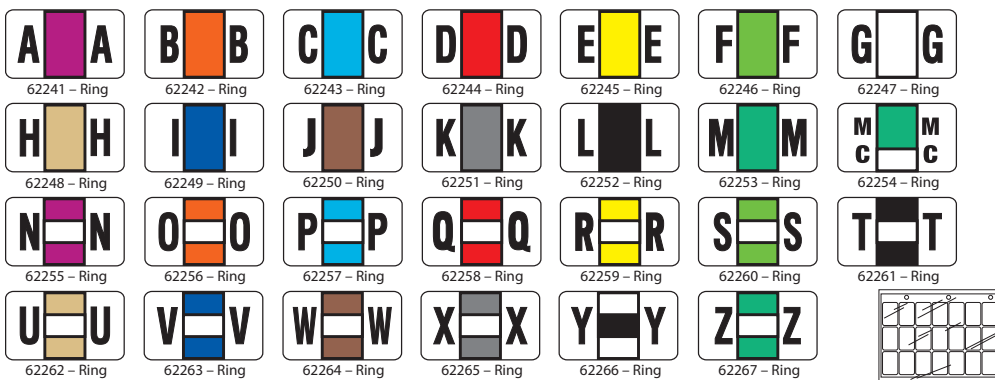

62240 series
POS® 2000 compatible series

15/16"H x 1-5/8"W - Label size

RINGBOOK / 240 labels per pkg.
24 labels per sheet / 3 drill holes
Sheet size: 5-3/4" x 8-1/2"

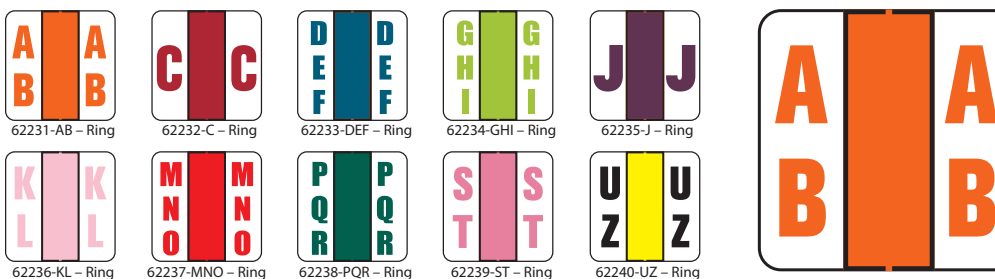

62230 multi-letter series
POS® 3700 compatible series

1-1/2"H x 1-1/2"W - Label size

RINGBOOK / 150 labels per pkg.
15 labels per sheet / 3 drill holes
Sheet size: 5-1/2" x 8-1/2"

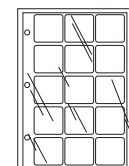

compatible color code labels

91920 series Smead® NCC compatible series

1-5/32"H x 3-5/8"W – Label size

PACK / 100 labels per pkg.

5 labels per sheet

Sheet size: 3-3/4" x 5-7/8"

Desktop Kit – 31920 (1,500 labels)

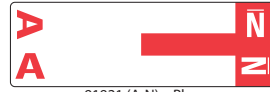
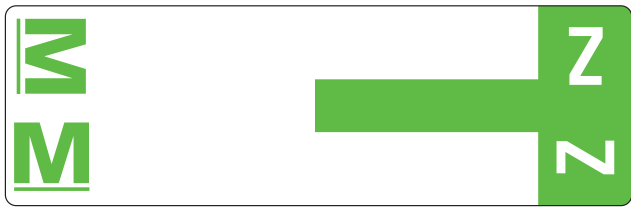
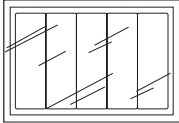

91921 (A-N) – Pkg.



91924 (D-Q) – Pkg.

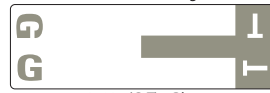

91927 (G-T) – Pkg.

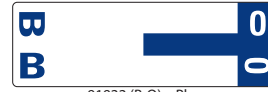

91922 (B-O) – Pkg.



91925 (E-R) – Pkg.

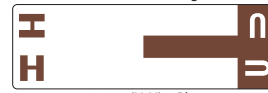

91928 (H-U) – Pkg.



91930 (J-W) – Pkg.

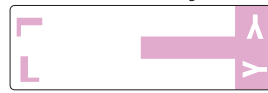

91932 (L-Y) – Pkg.

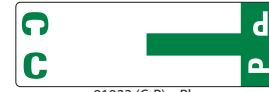

91923 (C-P) – Pkg.



91926 (F-S) – Pkg.

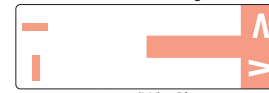

91929 (I-V) – Pkg.



91931 (K-X) – Pkg.



91933 (M-Z) – Pkg.

91820 / 71820 series Smead® ACC & ACCS compatible series

1-5/8"H x 1"W – Label size

ROLL / 250 labels per roll

Roll Unit – 41820 (26 rolls)

Dispenser Container only – 90150
(Holds 26 Rolls)

PACK / 108 labels per pkg.

9 labels per sheet

Sheet size: 5-1/4" x 3-3/8"

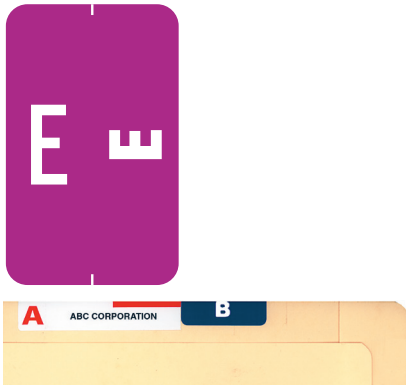

91821 – Roll
71821 – Pkg.



91822 – Roll
71822 – Pkg.



91823 – Roll
71823 – Pkg.



91824 – Roll
71824 – Pkg.



91825 – Roll
71825 – Pkg.



91826 – Roll
71826 – Pkg.



91827 – Roll
71827 – Pkg.



91828 – Roll
71828 – Pkg.



91829 – Roll
71829 – Pkg.



91830 – Roll
71830 – Pkg.



91831 – Roll
71831 – Pkg.



91832 – Roll
71832 – Pkg.



91833 – Roll
71833 – Pkg.



91834 – Roll
71834 – Pkg.



91835 – Roll
71835 – Pkg.



91836 – Roll
71836 – Pkg.



91837 – Roll
71837 – Pkg.



91838 – Roll
71838 – Pkg.



91839 – Roll
71839 – Pkg.



91840 – Roll
71840 – Pkg.



91841 – Roll
71841 – Pkg.

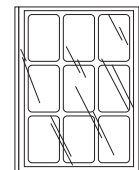

91842 – Roll
71842 – Pkg.



91843 – Roll
71843 – Pkg.



91844 – Roll
71844 – Pkg.



91845 – Roll
71845 – Pkg.



91846 – Roll
71846 – Pkg.

91800 series Smead® LCC compatible series

2"H x 1"W – Label size

ROLL / 250 labels per roll

Roll Unit – 41800 (10 rolls)

Dispenser Container only – 90110
(Holds 10 Rolls)



91800 – Roll



91801 – Roll



91802 – Roll



91803 – Roll



91804 – Roll



91805 – Roll



91806 – Roll



91807 – Roll



91808 – Roll



91809 – Roll

compatible color code labels

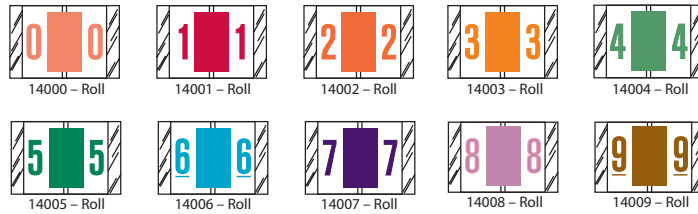
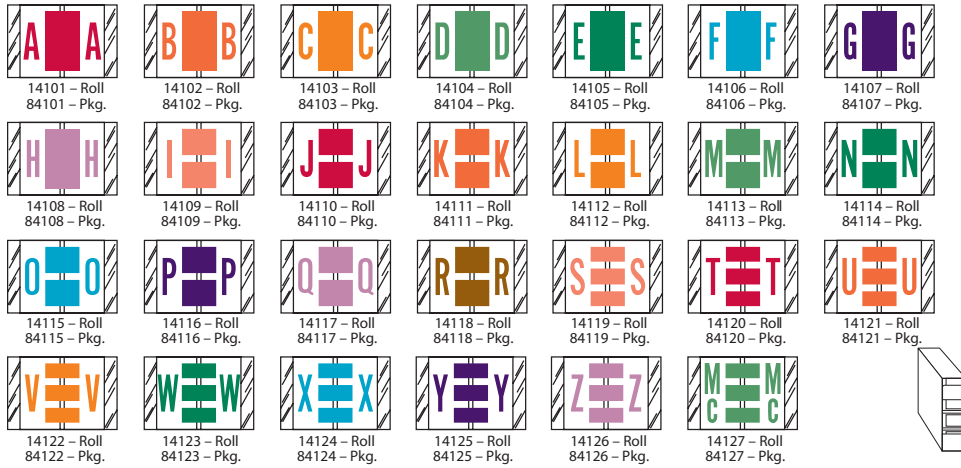

Dispenser Container only - 11015 (Holds 10 Rolls)

14100 / 84100 series Tab Products® compatible series

1"H x 1-1/2"W - Label size
Original Col'RTab® construction
ROLL / 500 labels per roll
Dispenser Container only - 12000 (Holds 30 Rolls)
PACK / 100 labels per pkg.
10 labels per strip
Sheet size: 10" x 1-1/2"

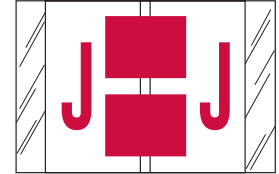
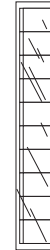

14000 series Tab Products® compatible series

1"H x 1-1/2"W - Label size
Original Col'RTab® construction
ROLL / 500 labels per roll

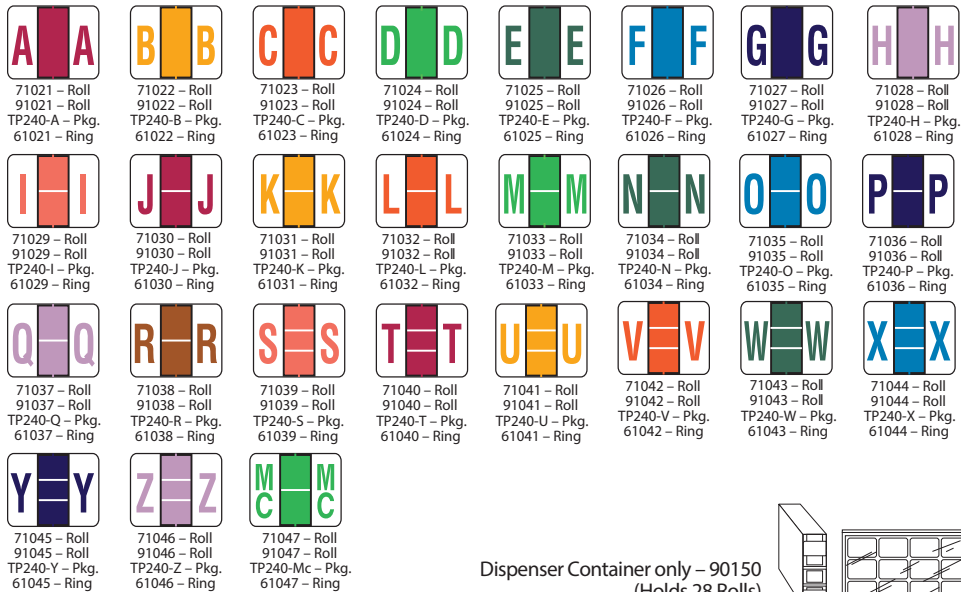

Dispenser Container only - 90150 (Holds 28 Rolls)

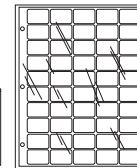
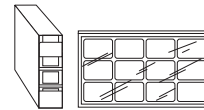

71020 series (Kimdura) rolls 91020 series (Paper laminated) rolls TP240 series (Paper laminated) pack Tab Products® 1283, 1286 & Smead® BCCS & BCCR compatible series 61020 series (Kimdura) ringbook sheets

1"H x 1-1/4"W - Label size
ROLL / 71020 Series - 500 labels per roll
Roll Unit - 71020 - Kimdura (28 rolls)
ROLL / 91020 Series - 500 labels per roll
Roll Unit - 41020 - Laminated (28 rolls)
PACK / 240 labels per pkg.
12 labels per sheet
Sheet size: 5-1/2" x 3-3/8"
RINGBOOK / 250 labels per pkg.
50 labels per sheet / 3 drill holes
Sheet size: 7-1/4" x 11-1/4"

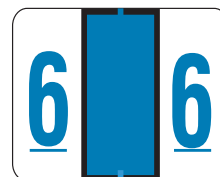
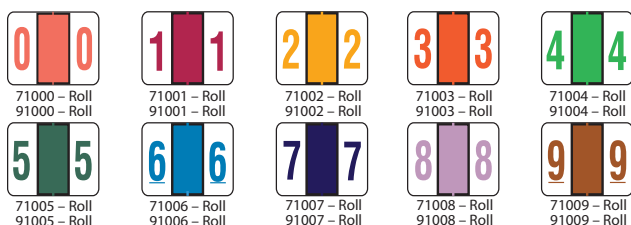

71000 series (Kimdura) 91000 series (Paper laminated) Tab Products® 1282 & Smead® BCCRN compatible series

1"H x 1-1/4"W - Label size
ROLL / 71000 Series - 500 labels per roll
Roll Unit - 71010 - Kimdura (10 rolls)
ROLL / 91000 Series - 500 labels per roll
Roll Unit - 91010 - Laminated (10 rolls)
Dispenser Container only - 90110 (Holds 10 Rolls)

compatible color code labels

71220 series Tab Products® compatible series

1/2"H x 1"W – Label size
(Laminated)
ROLL / 500 labels per roll
Dispenser Container only – 90150
(Holds 28 Rolls)

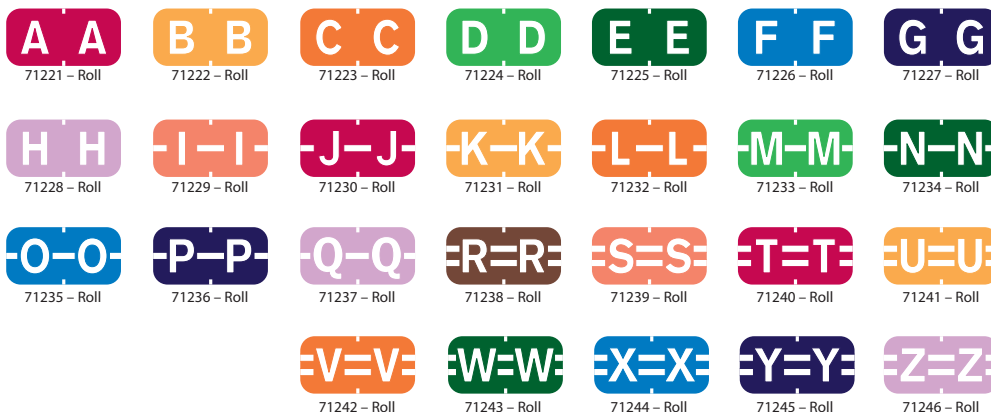

71200 series Tab Products® compatible series

1/2"H x 1"W – Label size
(Laminated)
ROLL / 500 labels per roll
Dispenser Container only – 90110
(Holds 10 Rolls)

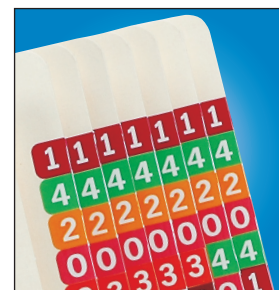
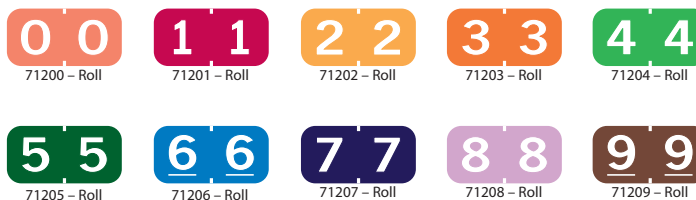

90120 series Original Tabbies®

15/16"H x 1-1/2"W – Label size
ROLL / 500 labels per roll



Dispenser Container only – 90150
(Holds 28 Rolls)

90100 series Original Tabbies®

15/16"H x 1-1/2"W – Label size
ROLL / 500 labels per roll

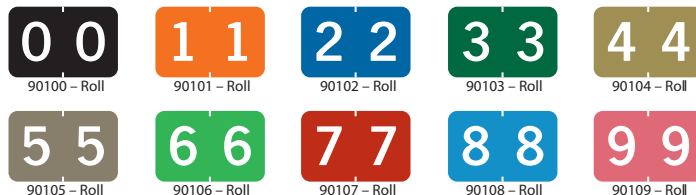

Dispenser Container only – 90110
(Holds 10 Rolls)

70230 series Original Tabbies®

1/2"H x 1"W – Label size
PACK / 100 labels per pkg.
25 labels per sheet
Sheet size: 5-5/8" x 3-1/8"

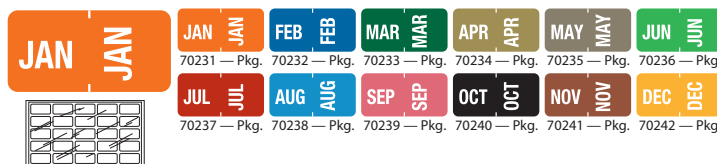

compatible color code labels



94900 series
Ames® compatible series
1-7/8"H x 1-7/8"W – Label size
ROLL / 500 labels per roll

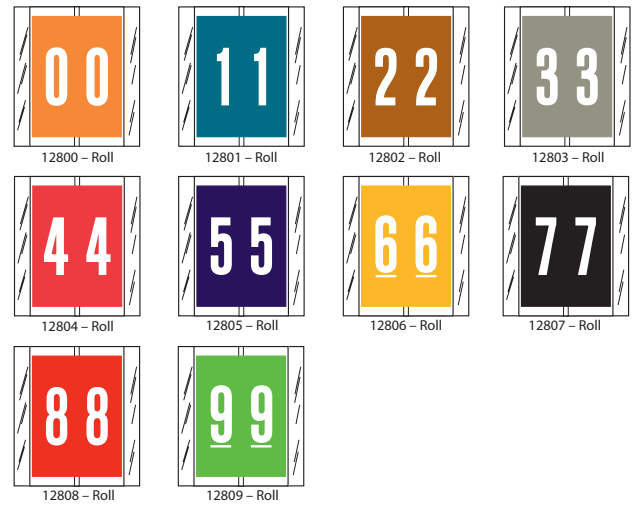
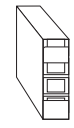

12800 series
SFI® compatible series
1-2/3"H x 1-1/2"W – Label size
Original Col'RTab® construction
ROLL / 500 labels per roll

Dispenser Container only – 11015
(Holds 10 Rolls)

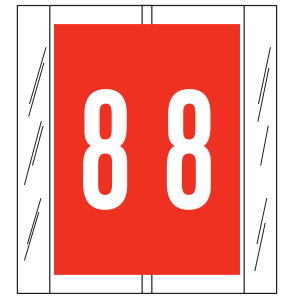

70520 series
Original Tabbies®

1"H x 1-1/2"W – Label size
PACK / 252 labels per pkg.
9 labels per sheet
Sheet size: 5" x 3-1/4"

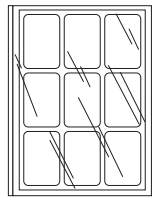

91980 series
Jeter® 9500 compatible series

3/4"H x 1-1/2"W – Label size
ROLL / 500 labels per roll

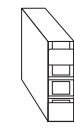

compatible color code labels

11600 series Original Col'RTab®

1-1/2"H x 1-1/2"W – Label size

ROLL / 500 labels per roll

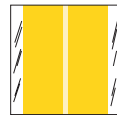
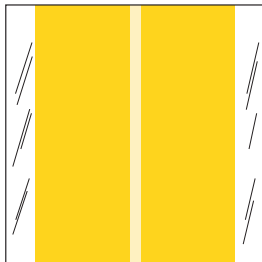

11600 – Roll

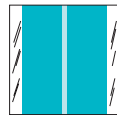

11601 – Roll

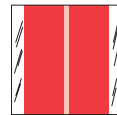

11602 – Roll



11603 – Roll



11604 – Roll



11605 – Roll



11606 – Roll

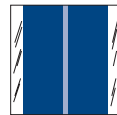

11607 – Roll

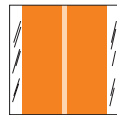

11608 – Roll



11609 – Roll

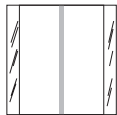

11610 – Roll

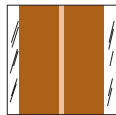

11611 – Roll

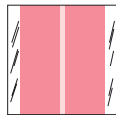

11612 – Roll

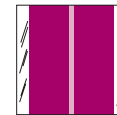

11613 – Roll

11100 series Original Col'RTab®

1"H x 1-1/2"W – Label size

ROLL / 500 labels per roll

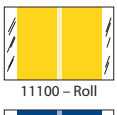
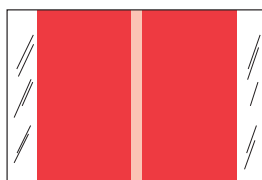

11100 – Roll

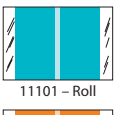

11101 – Roll

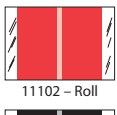

11102 – Roll

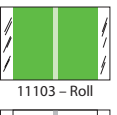

11103 – Roll

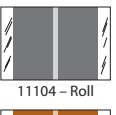

11104 – Roll

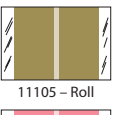

11105 – Roll

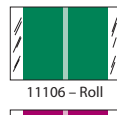

11106 – Roll

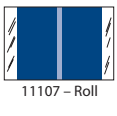

11107 – Roll

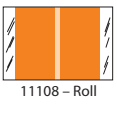

11108 – Roll

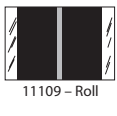

11109 – Roll

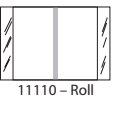

11110 – Roll

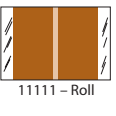

11111 – Roll

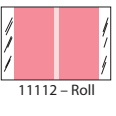

11112 – Roll

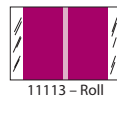

11113 – Roll

53300 series Kardex® compatible series

3/8"H x 1-7/16"W – Label size
Original Col'RTab® construction

ROLL / 1,000 labels per roll

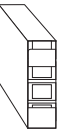

53300 – Roll



53301 – Roll



53302 – Roll

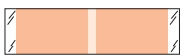

53303 – Roll



53304 – Roll



53305 – Roll



53306 – Roll



53307 – Roll



53308 – Roll



53309 – Roll



53310 – Roll

53500 series Kardex® compatible series

1/2"H x 1-7/16"W – Label size
Original Col'RTab® construction

ROLL / 1,000 labels per roll



53500 – Roll



53501 – Roll



53502 – Roll



53503 – Roll



53504 – Roll



53505 – Roll



53506 – Roll



53507 – Roll



53508 – Roll



53509 – Roll



53510 – Roll

53110 series Kardex® compatible series

5/16"H x 1-7/16"W – Label size
Original Col'RTab® construction

ROLL / 2,000 labels per roll



53110 – Roll

specialty labels

CONFIDENTIAL
For Authorized Personnel Only

40572

Thank You!

40506

FINAL NOTICE!

40508

CONFIDENTIAL

40531

stock no.	color	size	labels/roll
40506	Fl. Red	1-1/2"w x 3/4"h	250
40508	Fl. Red	1-1/2"w x 3/4"h	250
40531	Fl. Red	1-1/2"w x 3/4"h	250
40570	Red	2"w x 2"h	500
40572	Red	6-1/2"w x 1"h	100
40574	Red	4"w x 2-1/2"h	100
MAP6880	Red	3-1/4"w x 1-3/4"h	250

CONFIDENTIAL
For Authorized Personnel Only

40570

CONFIDENTIAL
For Authorized Personnel Only

40574

removable remind'r labels

removable remind 'r labels convey vital information and instructions quickly and easily. Perfect for invoices, letters, files and more! The fluorescent red background color attracts immediate attention, while the brief messages are easy to read and understand. Perfect for use in busy legal offices. Labels are packaged in dispenser boxes for fast, convenient use. Easy to remove.

BILLS ARE DUE IN 30 DAYS

40502

Sign Here

40539

RUSH

40554

stock no.	color	size	labels/roll
40502	Fl. Red	1-1/2"w x 3/4"h	250
40539	Fl. Red	1-1/2"w x 3/4"h	250
40554	Fl. Red	1-1/2"w x 3/4"h	250

billing/collection labels

FINAL NOTICE

If we do not hear from you within 10 days, this account will be turned over to our collection agency.

MAP4790

WE ACCEPT MAJOR CREDIT CARDS

To pay with your credit card please complete:

Acct. No. _____
VISA _____ MasterCard _____ American Ex _____ Discover _____
Exp. Date _____ Signature _____

MAP5790

We accept VISA and MasterCard. If you wish to pay your account with your credit card, please complete the following lines:

Acct. No. _____
Exp. Date _____ VISA MasterCard
Signature _____

MAP2500

SELF PAY

MAP1320

PAST DUE

Please remit TODAY!

MAP1350

ACCOUNT SERIOUSLY OVERDUE

Remit payment in full to prevent collections

MAP1400

stock no.	color	size	labels/roll
MAP1320	Fl. Green	1-1/2"w x 7/8"h	250
MAP1350	Fl. Red	1-1/2"w x 7/8"h	250
MAP1400	Fl. Red	1-1/2"w x 7/8"h	250
MAP2370	Fl. Pink	1-1/2"w x 7/8"h	250
MAP2500	Fl. Chartreuse	3-1/4"w x 1-3/4"h	250
MAP4220	Fl. Green	1-1/2"w x 7/8"h	250
MAP4300	Fl. Chartreuse	1-1/2"w x 7/8"h	250
MAP4710	Fl. Chartreuse	1-1/2"w x 7/8"h	250
MAP4790	Fl. Red	3-1/4"w x 1-3/4"h	250
MAP5790	Fl. Chartreuse	3"w x 1"h	250

MISSED APPOINTMENT

ON

MAP2370

Just a friendly reminder
that your account is overdue. Won't you please mail your remittance?

MAP4220

Thank You!

MAP4300

AMOUNT DUE

\$ _____

MAP4710

tabbies®



www.tabbies.com

www.tabbiestcustomlabels.com



*Family owned & operated
since 1955*

Manufacturer #084371

OTHER CATALOGS AVAILABLE:

- Custom Label and Print Guide**
- Legal Filing, Indexing & Labeling Products**
- Healthcare Filing, Indexing & Labeling Products**
- Veterinary Filing, Indexing & Labeling Products**
 - Religious Products**
- Shipping & Handling Products**