



TS6000 series Online Manual

Overview
Printing
Copying
Scanning
Frequently Asked Questions

Contents

Using This Online Manual.	9
Trademarks and Licenses.	10
Basic Operation.	19
Printing Photos from a Computer.	20
Copying.	25
Handling Paper, Originals, Ink Tanks, etc..	30
Loading Paper.	31
Paper Sources.	32
Loading Paper in the Rear Tray.	33
Loading Paper in the Cassette.	38
Loading Envelopes.	43
Loading Originals.	47
Loading Originals on the Platen Glass.	48
Loading Based on Use.	50
Supported Originals.	53
How to Detach / Attach the Document Cover.	54
Replacing Ink Tanks.	56
Replacing Ink Tanks.	57
Checking Ink Status on the Touch Screen.	62
Checking the Ink Status with the Ink Lamps.	63
Maintenance.	65
If Printing Is Faint or Uneven.	66
Maintenance Procedure.	67
Printing the Nozzle Check Pattern.	70
Examining the Nozzle Check Pattern.	72
Cleaning the Print Head.	74
Deep Print Head Cleaning.	76
Aligning the Print Head.	78
Cleaning.	81
Cleaning Paper Feed Rollers.	82
Cleaning Inside the Printer (Bottom Plate Cleaning).	84

Overview.	87
Safety.	89
Safety Precautions.	90
Regulatory Information.	91
WEEE (EU&EEA).	93
Main Components and Their Use.	103
Main Components.	104
Front View.	105
Rear View.	107
Inside View.	108
Operation Panel.	109
Power Supply.	110
Confirming that the Power Is On.	111
Turning the Printer On and Off.	112
Checking the Power Plug/Power Cord.	114
Unplugging the Printer.	115
Using the Operation Panel.	116
Changing Settings.	120
Changing Printer Settings from Your Computer (Windows).	121
Changing the Print Options.	122
Registering a Frequently Used Printing Profile.	124
Managing the Printer Power.	126
Changing the Printer Operation Mode.	128
Changing Settings from Operation Panel.	130
Changing Settings from Operation Panel.	131
Setting Items on Operation Panel.	133
Print settings.	134
LAN settings.	135
Device user settings.	140
Language selection.	141
Firmware update.	142
Feed settings.	143
Reset setting.	144
System information.	145

ECO settings.	146
Network Connection.	148
Network Connection Tips.	149
Default Network Settings.	150
Another Printer Found with Same Name.	152
Connecting to Another Computer via LAN/Changing from USB to LAN Connection.	153
Printing Network Settings.	154
Changing Wireless LAN Connection Method.	158
Ensuring Optimal Printing Results.	159
Transporting Your Printer.	160
Legal Restrictions on Scanning/Copying.	161
Specifications.	162
Information about Paper.	166
Supported Media Types.	167
Paper Load Limit.	169
Unsupported Media Types.	171
Handling Paper.	172
Printing from Computer.	173
Printing from Application Software (Windows Printer Driver).	174
Basic Printing Setup.	175
Paper Settings on the Printer Driver and the Printer (Media Type).	179
Paper Settings on the Printer Driver and the Printer (Paper Size).	180
Various Printing Methods.	181
Setting a Page Size and Orientation.	182
Setting the Number of Copies and Printing Order.	183
Execute Borderless Printing.	185
Scaled Printing.	188
Page Layout Printing.	191
Tiling/Poster Printing.	193
Duplex Printing.	196
Setting Up Envelope Printing.	200
Printing on Postcards.	202
Setting the Print Quality Level (Custom).	204

Overview of the Printer Driver.	206
Canon IJ Printer Driver.	207
Instructions for Use (Printer Driver).	210
Printer Driver Description.	212
Quick Setup tab Description.	213
Main tab Description.	220
Page Setup tab Description.	227
Maintenance tab Description.	240
Canon IJ Status Monitor Screen.	246
Installing the MP Drivers.	249
Printing Directly from Smartphone/Tablet.	250
Using Printer with Wireless Direct.	251
Paper Settings.	256
Making Copies.	261
Setting Items for Copying.	264
Scanning from Computer (Windows).	267
Using IJ Scan Utility.	268
What Is IJ Scan Utility (Scanner Software)?.	269
Starting IJ Scan Utility.	271
Using Auto Scan Function.	272
IJ Scan Utility Screens.	273
IJ Scan Utility Main Screen.	274
Settings Dialog Box.	276
Scanning Using Application Software (ScanGear).	293
What Is ScanGear (Scanner Driver)?.	294
Starting ScanGear (Scanner Driver).	296
Scanning in Basic Mode.	297
ScanGear (Scanner Driver) Screens.	300
Basic Mode Tab.	301
Advanced Mode Tab.	309
General Notes (Scanner Driver).	315
Positioning Originals (Scanning from Computer).	317
Network Scan Settings.	319
Scanning from Operation Panel.	323

Forwarding Scanned Data to Computer Using Operation Panel.	324
Setting Items for Scanning Using Operation Panel.	329
Frequently Asked Questions.	331
Network Settings and Common Problems.	333
Connecting the Printer to a Network.	335
Restrictions.	337
Network Communication Problems.	339
Cannot Find Printer on Network.	340
Cannot Find Printer on Check Printer Settings Screen During Setup (Windows).	341
Cannot Find Printer on Check Printer Settings Screen During Wireless LAN Setup (Windows)- Checking Power Status.	342
Cannot Find Printer on Check Printer Settings Screen During Wireless LAN Setup (Windows)- Checking PC Network Connection.	343
Cannot Find Printer on Check Printer Settings Screen During Wireless LAN Setup (Windows)- Checking Printer's Wireless LAN Settings.	344
Cannot Find Printer on Check Printer Settings Screen During Wireless LAN Setup (Windows)- Checking Wireless LAN Environment.	345
Cannot Find Printer on Check Printer Settings Screen During Wireless LAN Setup (Windows)- Checking Printer's IP Address.	347
Cannot Find Printer on Check Printer Settings Screen During Wireless LAN Setup (Windows)- Checking Security Software Settings.	348
Cannot Find Printer on Check Printer Settings Screen During Wireless LAN Setup (Windows)- Checking Wireless Router Settings.	349
Cannot Proceed beyond Printer Connection Screen/Connect Cable Screen.	350
Cannot Find Printer while Using Wireless LAN.	352
Network Connection Problems.	354
Printer Suddenly Cannot Be Used.	355
Network Key Unknown.	359
Printer Cannot Be Used After Replacing Wireless Router or Changing Its Settings.	361
Other Network Problems.	363
Checking Network Information.	364
Restoring to Factory Defaults.	367
Printing Problems.	368
Printing Does Not Start.	369
No Ink Comes Out.	371
Paper Does Not Feed Properly/"No Paper" Error.	372

Print Results Are Unsatisfactory.	374
Paper Is Blank/Printing Is Blurry/Colors Are Wrong/White Streaks Appear.	376
Lines Are Misaligned.	379
Paper Is Smudged / Printed Surface Is Scratched.	380
Vertical Line Next to Image.	384
Scanning Problems (Windows).	385
Scanning Problems.	386
Scanner Does Not Work.	387
ScanGear (Scanner Driver) Does Not Start.	388
Mechanical Problems.	389
Power Does Not Come On.	390
Power Shuts Off By Itself.	391
USB Connection Problems.	392
Cannot Communicate with Printer via USB.	393
Installation and Download Problems.	394
Cannot Install MP Drivers.	395
Updating MP Drivers in Network Environment (Windows).	397
Errors and Messages.	398
An Error Occurs.	399
Message Appears.	401
List of Support Code for Error.	408
List of Support Code for Error (Paper Jams).	410
1300.	411
1303.	413
1304.	417
1313.	420
Paper Is Jammed inside Printer.	423
1000.	426
1003.	427
1200.	428
1401.	429
1600.	430
1660.	431

1688.....	432
1689.....	433
1700.....	434
1890.....	435
2110.....	436
2900.....	439
2901.....	440
4103.....	441
5011.....	442
5012.....	443
5100.....	444
5200.....	445
5B00.....	446
6000.....	447
C000.....	448

Using This Online Manual

- [Symbols Used in This Document](#)
- [Touch-enabled Device Users \(Windows\)](#)

Symbols Used in This Document

Warning

Instructions that, if ignored, could result in death or serious personal injury caused by incorrect operation of the equipment. These must be observed for safe operation.

Caution

Instructions that, if ignored, could result in personal injury or material damage caused by incorrect operation of the equipment. These must be observed for safe operation.

Important

Instructions including important information. To avoid damage and injury or improper use of the product, be sure to read these indications.

Note

Instructions including notes for operation and additional explanations.

Basics

Instructions explaining basic operations of your product.

Note

-
- Icons may vary depending on your product.
-

Touch-enabled Device Users (Windows)

For touch actions, you need to replace "right-click" in this document with the action set on the operating system. For example, if the action is set to "press and hold" on your operating system, replace "right-click" with "press and hold."

Trademarks and Licenses

- Microsoft is a registered trademark of Microsoft Corporation.
- Windows is a trademark or registered trademark of Microsoft Corporation in the U.S. and/or other countries.
- Windows Vista is a trademark or registered trademark of Microsoft Corporation in the U.S. and/or other countries.
- Internet Explorer is a trademark or registered trademark of Microsoft Corporation in the U.S. and/or other countries.
- Mac, Mac OS, AirPort, Safari, Bonjour, iPad, iPhone and iPod touch are trademarks of Apple Inc., registered in the U.S. and other countries. macOS, App Store, AirPrint and the AirPrint logo are trademarks of Apple Inc.
- IOS is a trademark or registered trademark of Cisco in the U.S. and other countries and is used under license.
- Google Cloud Print, Google Chrome, Chrome OS, Chromebook, Android, Google Play, Google Drive, Google Apps and Google Analytics are either registered trademarks or trademarks of Google Inc.
- Adobe, Flash, Photoshop, Photoshop Elements, Lightroom, Adobe RGB and Adobe RGB (1998) are either registered trademarks or trademarks of Adobe Systems Incorporated in the United States and/or other countries.
- Bluetooth is a trademark of Bluetooth SIG, Inc., U.S.A. and licensed to Canon Inc.
- Autodesk and AutoCAD are registered trademarks or trademarks of Autodesk, Inc., and/or its subsidiaries and/or affiliates in the USA and/or other countries.

»» Note

- The formal name of Windows Vista is Microsoft Windows Vista operating system.

Copyright (c) 2003-2004, Apple Computer, Inc. All rights reserved.

Redistribution and use in source and binary forms, with or without modification, are permitted provided that the following conditions are met:

1. Redistributions of source code must retain the above copyright notice, this list of conditions and the following disclaimer.
2. Redistributions in binary form must reproduce the above copyright notice, this list of conditions and the following disclaimer in the documentation and/or other materials provided with the distribution.
3. Neither the name of Apple Computer, Inc. ("Apple") nor the names of its contributors may be used to endorse or promote products derived from this software without specific prior written permission.

THIS SOFTWARE IS PROVIDED BY APPLE AND ITS CONTRIBUTORS "AS IS" AND ANY EXPRESS OR IMPLIED WARRANTIES, INCLUDING, BUT NOT LIMITED TO, THE IMPLIED WARRANTIES OF MERCHANTABILITY AND FITNESS FOR A PARTICULAR PURPOSE ARE DISCLAIMED. IN NO EVENT SHALL APPLE OR ITS CONTRIBUTORS BE LIABLE FOR ANY DIRECT, INDIRECT, INCIDENTAL, SPECIAL, EXEMPLARY, OR CONSEQUENTIAL DAMAGES (INCLUDING, BUT NOT LIMITED TO, PROCUREMENT OF SUBSTITUTE GOODS OR SERVICES; LOSS OF USE, DATA, OR PROFITS; OR BUSINESS INTERRUPTION) HOWEVER CAUSED AND ON ANY THEORY OF LIABILITY, WHETHER IN CONTRACT, STRICT LIABILITY, OR TORT (INCLUDING NEGLIGENCE OR OTHERWISE) ARISING IN ANY WAY OUT OF THE USE OF THIS SOFTWARE, EVEN IF ADVISED OF THE POSSIBILITY OF SUCH DAMAGE.

Apache License

Version 2.0, January 2004

<http://www.apache.org/licenses/>

TERMS AND CONDITIONS FOR USE, REPRODUCTION, AND DISTRIBUTION

1. Definitions.

"License" shall mean the terms and conditions for use, reproduction, and distribution as defined by Sections 1 through 9 of this document.

"Licensor" shall mean the copyright owner or entity authorized by the copyright owner that is granting the License.

"Legal Entity" shall mean the union of the acting entity and all other entities that control, are controlled by, or are under common control with that entity. For the purposes of this definition, "control" means (i) the power, direct or indirect, to cause the direction or management of such entity, whether by contract or otherwise, or (ii) ownership of fifty percent (50%) or more of the outstanding shares, or (iii) beneficial ownership of such entity.

"You" (or "Your") shall mean an individual or Legal Entity exercising permissions granted by this License.

"Source" form shall mean the preferred form for making modifications, including but not limited to software source code, documentation source, and configuration files.

"Object" form shall mean any form resulting from mechanical transformation or translation of a Source form, including but not limited to compiled object code, generated documentation, and conversions to other media types.

"Work" shall mean the work of authorship, whether in Source or Object form, made available under the License, as indicated by a copyright notice that is included in or attached to the work (an example is provided in the Appendix below).

"Derivative Works" shall mean any work, whether in Source or Object form, that is based on (or derived from) the Work and for which the editorial revisions, annotations, elaborations, or other modifications represent, as a whole, an original work of authorship. For the purposes of this License, Derivative Works shall not include works that remain separable from, or merely link (or bind by name) to the interfaces of, the Work and Derivative Works thereof.

"Contribution" shall mean any work of authorship, including the original version of the Work and any modifications or additions to that Work or Derivative Works thereof, that is intentionally submitted to Licensor for inclusion in the Work by the copyright owner or by an individual or Legal Entity authorized to submit on behalf of the copyright owner. For the purposes of this definition, "submitted" means any form of electronic, verbal, or written communication sent to the Licensor or its representatives, including but not limited to communication on electronic mailing lists, source code control systems, and issue tracking systems that are managed by, or on behalf of, the Licensor for the purpose of discussing and improving the Work, but excluding communication that is conspicuously marked or otherwise designated in writing by the copyright owner as "Not a Contribution."

"Contributor" shall mean Licensor and any individual or Legal Entity on behalf of whom a Contribution has been received by Licensor and subsequently incorporated within the Work.

2. Grant of Copyright License. Subject to the terms and conditions of this License, each Contributor hereby grants to You a perpetual, worldwide, non-exclusive, no-charge, royalty-free, irrevocable

copyright license to reproduce, prepare Derivative Works of, publicly display, publicly perform, sublicense, and distribute the Work and such Derivative Works in Source or Object form.

3. Grant of Patent License. Subject to the terms and conditions of this License, each Contributor hereby grants to You a perpetual, worldwide, non-exclusive, no-charge, royalty-free, irrevocable (except as stated in this section) patent license to make, have made, use, offer to sell, sell, import, and otherwise transfer the Work, where such license applies only to those patent claims licensable by such Contributor that are necessarily infringed by their Contribution(s) alone or by combination of their Contribution(s) with the Work to which such Contribution(s) was submitted. If You institute patent litigation against any entity (including a cross-claim or counterclaim in a lawsuit) alleging that the Work or a Contribution incorporated within the Work constitutes direct or contributory patent infringement, then any patent licenses granted to You under this License for that Work shall terminate as of the date such litigation is filed.
4. Redistribution. You may reproduce and distribute copies of the Work or Derivative Works thereof in any medium, with or without modifications, and in Source or Object form, provided that You meet the following conditions:
 1. You must give any other recipients of the Work or Derivative Works a copy of this License; and
 2. You must cause any modified files to carry prominent notices stating that You changed the files; and
 3. You must retain, in the Source form of any Derivative Works that You distribute, all copyright, patent, trademark, and attribution notices from the Source form of the Work, excluding those notices that do not pertain to any part of the Derivative Works; and
 4. If the Work includes a "NOTICE" text file as part of its distribution, then any Derivative Works that You distribute must include a readable copy of the attribution notices contained within such NOTICE file, excluding those notices that do not pertain to any part of the Derivative Works, in at least one of the following places: within a NOTICE text file distributed as part of the Derivative Works; within the Source form or documentation, if provided along with the Derivative Works; or, within a display generated by the Derivative Works, if and wherever such third-party notices normally appear. The contents of the NOTICE file are for informational purposes only and do not modify the License. You may add Your own attribution notices within Derivative Works that You distribute, alongside or as an addendum to the NOTICE text from the Work, provided that such additional attribution notices cannot be construed as modifying the License.

You may add Your own copyright statement to Your modifications and may provide additional or different license terms and conditions for use, reproduction, or distribution of Your modifications, or for any such Derivative Works as a whole, provided Your use, reproduction, and distribution of the Work otherwise complies with the conditions stated in this License.

5. Submission of Contributions. Unless You explicitly state otherwise, any Contribution intentionally submitted for inclusion in the Work by You to the Licensor shall be under the terms and conditions of this License, without any additional terms or conditions. Notwithstanding the above, nothing herein shall supersede or modify the terms of any separate license agreement you may have executed with Licensor regarding such Contributions.
6. Trademarks. This License does not grant permission to use the trade names, trademarks, service marks, or product names of the Licensor, except as required for reasonable and customary use in describing the origin of the Work and reproducing the content of the NOTICE file.
7. Disclaimer of Warranty. Unless required by applicable law or agreed to in writing, Licensor provides the Work (and each Contributor provides its Contributions) on an "AS IS" BASIS, WITHOUT WARRANTIES OR CONDITIONS OF ANY KIND, either express or implied, including, without

limitation, any warranties or conditions of TITLE, NON-INFRINGEMENT, MERCHANTABILITY, or FITNESS FOR A PARTICULAR PURPOSE. You are solely responsible for determining the appropriateness of using or redistributing the Work and assume any risks associated with Your exercise of permissions under this License.

8. Limitation of Liability. In no event and under no legal theory, whether in tort (including negligence), contract, or otherwise, unless required by applicable law (such as deliberate and grossly negligent acts) or agreed to in writing, shall any Contributor be liable to You for damages, including any direct, indirect, special, incidental, or consequential damages of any character arising as a result of this License or out of the use or inability to use the Work (including but not limited to damages for loss of goodwill, work stoppage, computer failure or malfunction, or any and all other commercial damages or losses), even if such Contributor has been advised of the possibility of such damages.
9. Accepting Warranty or Additional Liability. While redistributing the Work or Derivative Works thereof, You may choose to offer, and charge a fee for, acceptance of support, warranty, indemnity, or other liability obligations and/or rights consistent with this License. However, in accepting such obligations, You may act only on Your own behalf and on Your sole responsibility, not on behalf of any other Contributor, and only if You agree to indemnify, defend, and hold each Contributor harmless for any liability incurred by, or claims asserted against, such Contributor by reason of your accepting any such warranty or additional liability.

END OF TERMS AND CONDITIONS

---- Part 1: CMU/UCD copyright notice: (BSD like) ----

Copyright 1989, 1991, 1992 by Carnegie Mellon University

Derivative Work - 1996, 1998-2000

Copyright 1996, 1998-2000 The Regents of the University of California

All Rights Reserved

Permission to use, copy, modify and distribute this software and its documentation for any purpose and without fee is hereby granted, provided that the above copyright notice appears in all copies and that both that copyright notice and this permission notice appear in supporting documentation, and that the name of CMU and The Regents of the University of California not be used in advertising or publicity pertaining to distribution of the software without specific written permission.

CMU AND THE REGENTS OF THE UNIVERSITY OF CALIFORNIA DISCLAIM ALL WARRANTIES WITH REGARD TO THIS SOFTWARE, INCLUDING ALL IMPLIED WARRANTIES OF MERCHANTABILITY AND FITNESS. IN NO EVENT SHALL CMU OR THE REGENTS OF THE UNIVERSITY OF CALIFORNIA BE LIABLE FOR ANY SPECIAL, INDIRECT OR CONSEQUENTIAL DAMAGES OR ANY DAMAGES WHATSOEVER RESULTING FROM THE LOSS OF USE, DATA OR PROFITS, WHETHER IN AN ACTION OF CONTRACT, NEGLIGENCE OR OTHER TORTIOUS ACTION, ARISING OUT OF OR IN CONNECTION WITH THE USE OR PERFORMANCE OF THIS SOFTWARE.

---- Part 2: Networks Associates Technology, Inc copyright notice (BSD) ----

Copyright (c) 2001-2003, Networks Associates Technology, Inc

All rights reserved.

Redistribution and use in source and binary forms, with or without modification, are permitted provided that the following conditions are met:

* Redistributions of source code must retain the above copyright notice, this list of conditions and the following disclaimer.

* Redistributions in binary form must reproduce the above copyright notice, this list of conditions and the following disclaimer in the documentation and/or other materials provided with the distribution.

* Neither the name of the Networks Associates Technology, Inc nor the names of its contributors may be used to endorse or promote products derived from this software without specific prior written permission.

THIS SOFTWARE IS PROVIDED BY THE COPYRIGHT HOLDERS AND CONTRIBUTORS ``AS IS'' AND ANY EXPRESS OR IMPLIED WARRANTIES, INCLUDING, BUT NOT LIMITED TO, THE IMPLIED WARRANTIES OF MERCHANTABILITY AND FITNESS FOR A PARTICULAR PURPOSE ARE DISCLAIMED. IN NO EVENT SHALL THE COPYRIGHT HOLDERS OR CONTRIBUTORS BE LIABLE FOR ANY DIRECT, INDIRECT, INCIDENTAL, SPECIAL, EXEMPLARY, OR CONSEQUENTIAL DAMAGES (INCLUDING, BUT NOT LIMITED TO, PROCUREMENT OF SUBSTITUTE GOODS OR SERVICES; LOSS OF USE, DATA, OR PROFITS; OR BUSINESS INTERRUPTION) HOWEVER CAUSED AND ON ANY THEORY OF LIABILITY, WHETHER IN CONTRACT, STRICT LIABILITY, OR TORT (INCLUDING NEGLIGENCE OR OTHERWISE) ARISING IN ANY WAY OUT OF THE USE OF THIS SOFTWARE, EVEN IF ADVISED OF THE POSSIBILITY OF SUCH DAMAGE.

---- Part 3: Cambridge Broadband Ltd. copyright notice (BSD) ----

Portions of this code are copyright (c) 2001-2003, Cambridge Broadband Ltd.

All rights reserved.

Redistribution and use in source and binary forms, with or without modification, are permitted provided that the following conditions are met:

* Redistributions of source code must retain the above copyright notice, this list of conditions and the following disclaimer.

* Redistributions in binary form must reproduce the above copyright notice, this list of conditions and the following disclaimer in the documentation and/or other materials provided with the distribution.

* The name of Cambridge Broadband Ltd. may not be used to endorse or promote products derived from this software without specific prior written permission.

THIS SOFTWARE IS PROVIDED BY THE COPYRIGHT HOLDER ``AS IS'' AND ANY EXPRESS OR IMPLIED WARRANTIES, INCLUDING, BUT NOT LIMITED TO, THE IMPLIED WARRANTIES OF MERCHANTABILITY AND FITNESS FOR A PARTICULAR PURPOSE ARE DISCLAIMED. IN NO EVENT SHALL THE COPYRIGHT HOLDER BE LIABLE FOR ANY DIRECT, INDIRECT, INCIDENTAL, SPECIAL, EXEMPLARY, OR CONSEQUENTIAL DAMAGES (INCLUDING, BUT NOT LIMITED TO, PROCUREMENT OF SUBSTITUTE GOODS OR SERVICES; LOSS OF USE, DATA, OR PROFITS; OR BUSINESS INTERRUPTION) HOWEVER CAUSED AND ON ANY THEORY OF LIABILITY, WHETHER IN CONTRACT, STRICT LIABILITY, OR TORT (INCLUDING NEGLIGENCE OR OTHERWISE) ARISING IN ANY WAY OUT OF THE USE OF THIS SOFTWARE, EVEN IF ADVISED OF THE POSSIBILITY OF SUCH DAMAGE.

---- Part 4: Sun Microsystems, Inc. copyright notice (BSD) ----

Copyright c 2003 Sun Microsystems, Inc., 4150 Network Circle, Santa Clara, California 95054, U.S.A. All rights reserved.

Use is subject to license terms below.

This distribution may include materials developed by third parties.

Sun, Sun Microsystems, the Sun logo and Solaris are trademarks or registered trademarks of Sun Microsystems, Inc. in the U.S. and other countries.

Redistribution and use in source and binary forms, with or without modification, are permitted provided that the following conditions are met:

- * Redistributions of source code must retain the above copyright notice, this list of conditions and the following disclaimer.
- * Redistributions in binary form must reproduce the above copyright notice, this list of conditions and the following disclaimer in the documentation and/or other materials provided with the distribution.
- * Neither the name of the Sun Microsystems, Inc. nor the names of its contributors may be used to endorse or promote products derived from this software without specific prior written permission.

THIS SOFTWARE IS PROVIDED BY THE COPYRIGHT HOLDERS AND CONTRIBUTORS ``AS IS'' AND ANY EXPRESS OR IMPLIED WARRANTIES, INCLUDING, BUT NOT LIMITED TO, THE IMPLIED WARRANTIES OF MERCHANTABILITY AND FITNESS FOR A PARTICULAR PURPOSE ARE DISCLAIMED. IN NO EVENT SHALL THE COPYRIGHT HOLDERS OR CONTRIBUTORS BE LIABLE FOR ANY DIRECT, INDIRECT, INCIDENTAL, SPECIAL, EXEMPLARY, OR CONSEQUENTIAL DAMAGES (INCLUDING, BUT NOT LIMITED TO, PROCUREMENT OF SUBSTITUTE GOODS OR SERVICES; LOSS OF USE, DATA, OR PROFITS; OR BUSINESS INTERRUPTION) HOWEVER CAUSED AND ON ANY THEORY OF LIABILITY, WHETHER IN CONTRACT, STRICT LIABILITY, OR TORT (INCLUDING NEGLIGENCE OR OTHERWISE) ARISING IN ANY WAY OUT OF THE USE OF THIS SOFTWARE, EVEN IF ADVISED OF THE POSSIBILITY OF SUCH DAMAGE.

---- Part 5: Sparta, Inc copyright notice (BSD) ----

Copyright (c) 2003-2009, Sparta, Inc

All rights reserved.

Redistribution and use in source and binary forms, with or without modification, are permitted provided that the following conditions are met:

- * Redistributions of source code must retain the above copyright notice, this list of conditions and the following disclaimer.
- * Redistributions in binary form must reproduce the above copyright notice, this list of conditions and the following disclaimer in the documentation and/or other materials provided with the distribution.
- * Neither the name of Sparta, Inc nor the names of its contributors may be used to endorse or promote products derived from this software without specific prior written permission.

THIS SOFTWARE IS PROVIDED BY THE COPYRIGHT HOLDERS AND CONTRIBUTORS ``AS IS'' AND ANY EXPRESS OR IMPLIED WARRANTIES, INCLUDING, BUT NOT LIMITED TO, THE IMPLIED WARRANTIES OF MERCHANTABILITY AND FITNESS FOR A PARTICULAR PURPOSE ARE DISCLAIMED. IN NO EVENT SHALL THE COPYRIGHT HOLDERS OR CONTRIBUTORS BE LIABLE FOR ANY DIRECT, INDIRECT, INCIDENTAL, SPECIAL, EXEMPLARY, OR CONSEQUENTIAL DAMAGES (INCLUDING, BUT NOT LIMITED TO, PROCUREMENT OF SUBSTITUTE GOODS OR SERVICES; LOSS OF USE, DATA, OR PROFITS; OR BUSINESS INTERRUPTION) HOWEVER CAUSED AND ON ANY THEORY OF LIABILITY, WHETHER IN CONTRACT, STRICT LIABILITY, OR TORT (INCLUDING NEGLIGENCE OR OTHERWISE) ARISING IN ANY WAY OUT OF THE USE OF THIS SOFTWARE, EVEN IF ADVISED OF THE POSSIBILITY OF SUCH DAMAGE.

---- Part 6: Cisco/BUPTNIC copyright notice (BSD) ----

Copyright (c) 2004, Cisco, Inc and Information Network Center of Beijing University of Posts and Telecommunications.

All rights reserved.

Redistribution and use in source and binary forms, with or without modification, are permitted provided that the following conditions are met:

- * Redistributions of source code must retain the above copyright notice, this list of conditions and the following disclaimer.
- * Redistributions in binary form must reproduce the above copyright notice, this list of conditions and the following disclaimer in the documentation and/or other materials provided with the distribution.
- * Neither the name of Cisco, Inc, Beijing University of Posts and Telecommunications, nor the names of their contributors may be used to endorse or promote products derived from this software without specific prior written permission.

THIS SOFTWARE IS PROVIDED BY THE COPYRIGHT HOLDERS AND CONTRIBUTORS ``AS IS" AND ANY EXPRESS OR IMPLIED WARRANTIES, INCLUDING, BUT NOT LIMITED TO, THE IMPLIED WARRANTIES OF MERCHANTABILITY AND FITNESS FOR A PARTICULAR PURPOSE ARE DISCLAIMED. IN NO EVENT SHALL THE COPYRIGHT HOLDERS OR CONTRIBUTORS BE LIABLE FOR ANY DIRECT, INDIRECT, INCIDENTAL, SPECIAL, EXEMPLARY, OR CONSEQUENTIAL DAMAGES (INCLUDING, BUT NOT LIMITED TO, PROCUREMENT OF SUBSTITUTE GOODS OR SERVICES; LOSS OF USE, DATA, OR PROFITS; OR BUSINESS INTERRUPTION) HOWEVER CAUSED AND ON ANY THEORY OF LIABILITY, WHETHER IN CONTRACT, STRICT LIABILITY, OR TORT (INCLUDING NEGLIGENCE OR OTHERWISE) ARISING IN ANY WAY OUT OF THE USE OF THIS SOFTWARE, EVEN IF ADVISED OF THE POSSIBILITY OF SUCH DAMAGE.

---- Part 7: Fabasoft R&D Software GmbH & Co KG copyright notice (BSD) ----

Copyright (c) Fabasoft R&D Software GmbH & Co KG, 2003 oss@fabasoft.com

Author: Bernhard Penz

Redistribution and use in source and binary forms, with or without modification, are permitted provided that the following conditions are met:

- * Redistributions of source code must retain the above copyright notice, this list of conditions and the following disclaimer.
- * Redistributions in binary form must reproduce the above copyright notice, this list of conditions and the following disclaimer in the documentation and/or other materials provided with the distribution.
- * The name of Fabasoft R&D Software GmbH & Co KG or any of its subsidiaries, brand or product names may not be used to endorse or promote products derived from this software without specific prior written permission.

THIS SOFTWARE IS PROVIDED BY THE COPYRIGHT HOLDER ``AS IS" AND ANY EXPRESS OR IMPLIED WARRANTIES, INCLUDING, BUT NOT LIMITED TO, THE IMPLIED WARRANTIES OF MERCHANTABILITY AND FITNESS FOR A PARTICULAR PURPOSE ARE DISCLAIMED. IN NO EVENT SHALL THE COPYRIGHT HOLDER BE LIABLE FOR ANY DIRECT, INDIRECT, INCIDENTAL, SPECIAL, EXEMPLARY, OR CONSEQUENTIAL DAMAGES (INCLUDING, BUT NOT LIMITED TO, PROCUREMENT OF SUBSTITUTE GOODS OR SERVICES; LOSS OF USE, DATA, OR PROFITS; OR BUSINESS INTERRUPTION) HOWEVER CAUSED AND ON ANY THEORY OF LIABILITY, WHETHER

IN CONTRACT, STRICT LIABILITY, OR TORT (INCLUDING NEGLIGENCE OR OTHERWISE) ARISING IN ANY WAY OUT OF THE USE OF THIS SOFTWARE, EVEN IF ADVISED OF THE POSSIBILITY OF SUCH DAMAGE.

LEADTOOLS

Copyright (C) 1991-2009 LEAD Technologies, Inc.

CMap Resources

Copyright 1990-2009 Adobe Systems Incorporated.
All rights reserved.

Copyright 1990-2010 Adobe Systems Incorporated.
All rights reserved.

Redistribution and use in source and binary forms, with or without modification, are permitted provided that the following conditions are met:

Redistributions of source code must retain the above copyright notice, this list of conditions and the following disclaimer.

Redistributions in binary form must reproduce the above copyright notice, this list of conditions and the following disclaimer in the documentation and/or other materials provided with the distribution.

Neither the name of Adobe Systems Incorporated nor the names of its contributors may be used to endorse or promote products derived from this software without specific prior written permission.

THIS SOFTWARE IS PROVIDED BY THE COPYRIGHT HOLDERS AND CONTRIBUTORS "AS IS" AND ANY EXPRESS OR IMPLIED WARRANTIES, INCLUDING, BUT NOT LIMITED TO, THE IMPLIED WARRANTIES OF MERCHANTABILITY AND FITNESS FOR A PARTICULAR PURPOSE ARE DISCLAIMED. IN NO EVENT SHALL THE COPYRIGHT HOLDER OR CONTRIBUTORS BE LIABLE FOR ANY DIRECT, INDIRECT, INCIDENTAL, SPECIAL, EXEMPLARY, OR CONSEQUENTIAL DAMAGES (INCLUDING, BUT NOT LIMITED TO, PROCUREMENT OF SUBSTITUTE GOODS OR SERVICES; LOSS OF USE, DATA, OR PROFITS; OR BUSINESS INTERRUPTION) HOWEVER CAUSED AND ON ANY THEORY OF LIABILITY, WHETHER IN CONTRACT, STRICT LIABILITY, OR TORT (INCLUDING NEGLIGENCE OR OTHERWISE) ARISING IN ANY WAY OUT OF THE USE OF THIS SOFTWARE, EVEN IF ADVISED OF THE POSSIBILITY OF SUCH DAMAGE.

MIT License

Copyright (c) 1998, 1999, 2000 Thai Open Source Software Center Ltd

Permission is hereby granted, free of charge, to any person obtaining a copy of this software and associated documentation files (the "Software"), to deal in the Software without restriction, including without limitation the rights to use, copy, modify, merge, publish, distribute, sublicense, and/or sell copies of the Software, and to permit persons to whom the Software is furnished to do so, subject to the following conditions:

The above copyright notice and this permission notice shall be included in all copies or substantial portions of the Software.

THE SOFTWARE IS PROVIDED "AS IS", WITHOUT WARRANTY OF ANY KIND, EXPRESS OR IMPLIED, INCLUDING BUT NOT LIMITED TO THE WARRANTIES OF MERCHANTABILITY, FITNESS FOR A PARTICULAR PURPOSE AND NONINFRINGEMENT. IN NO EVENT SHALL THE AUTHORS OR COPYRIGHT HOLDERS BE LIABLE FOR ANY CLAIM, DAMAGES OR OTHER LIABILITY, WHETHER IN AN ACTION OF CONTRACT, TORT OR OTHERWISE, ARISING FROM, OUT OF OR IN CONNECTION WITH THE SOFTWARE OR THE USE OR OTHER DEALINGS IN THE SOFTWARE.

The following applies only to products supporting Wi-Fi.

(c) 2009-2013 by Jeff Mott. All rights reserved.

Redistribution and use in source and binary forms, with or without modification, are permitted provided that the following conditions are met:

- * Redistributions of source code must retain the above copyright notice, this list of conditions, and the following disclaimer.
- * Redistributions in binary form must reproduce the above copyright notice, this list of conditions, and the following disclaimer in the documentation or other materials provided with the distribution.
- * Neither the name CryptoJS nor the names of its contributors may be used to endorse or promote products derived from this software without specific prior written permission.

THIS SOFTWARE IS PROVIDED BY THE COPYRIGHT HOLDERS AND CONTRIBUTORS "AS IS," AND ANY EXPRESS OR IMPLIED WARRANTIES, INCLUDING, BUT NOT LIMITED TO, THE IMPLIED WARRANTIES OF MERCHANTABILITY AND FITNESS FOR A PARTICULAR PURPOSE, ARE DISCLAIMED. IN NO EVENT SHALL THE COPYRIGHT HOLDER OR CONTRIBUTORS BE LIABLE FOR ANY DIRECT, INDIRECT, INCIDENTAL, SPECIAL, EXEMPLARY, OR CONSEQUENTIAL DAMAGES (INCLUDING, BUT NOT LIMITED TO, PROCUREMENT OF SUBSTITUTE GOODS OR SERVICES; LOSS OF USE, DATA, OR PROFITS; OR BUSINESS INTERRUPTION) HOWEVER CAUSED AND ON ANY THEORY OF LIABILITY, WHETHER IN CONTRACT, STRICT LIABILITY, OR TORT (INCLUDING NEGLIGENCE OR OTHERWISE) ARISING IN ANY WAY OUT OF THE USE OF THIS SOFTWARE, EVEN IF ADVISED OF THE POSSIBILITY OF SUCH DAMAGE.

Basic Operation

- ▶ **Printing Photos from a Computer**
- ▶ **Copying**

Printing Photos from a Computer

This section describes how to print photos with My Image Garden.

1. Open the rear tray cover (A) and then pull up the paper support (B).

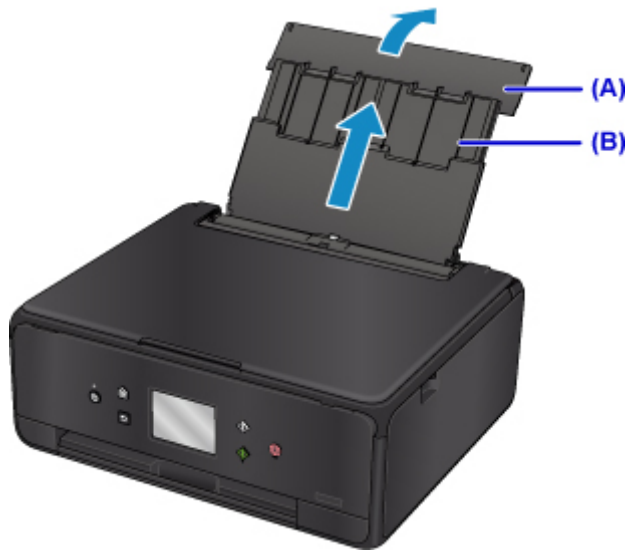

2. Open the feed slot cover (C).

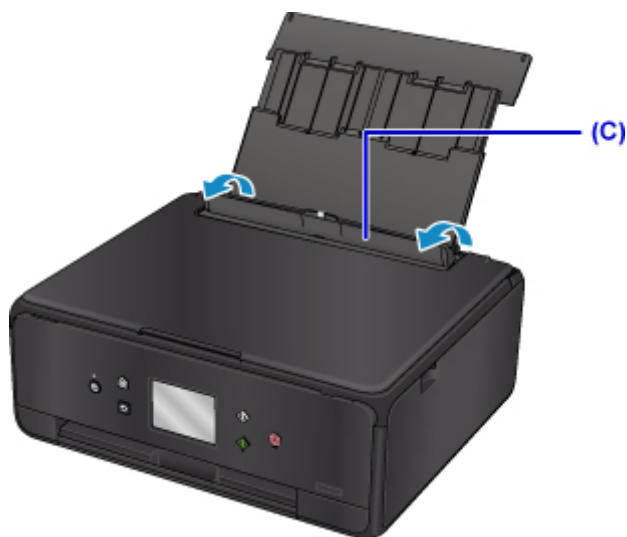

3. Load paper vertically WITH THE PRINT SIDE FACING UP.
4. Align the paper guides (D) with the paper width.

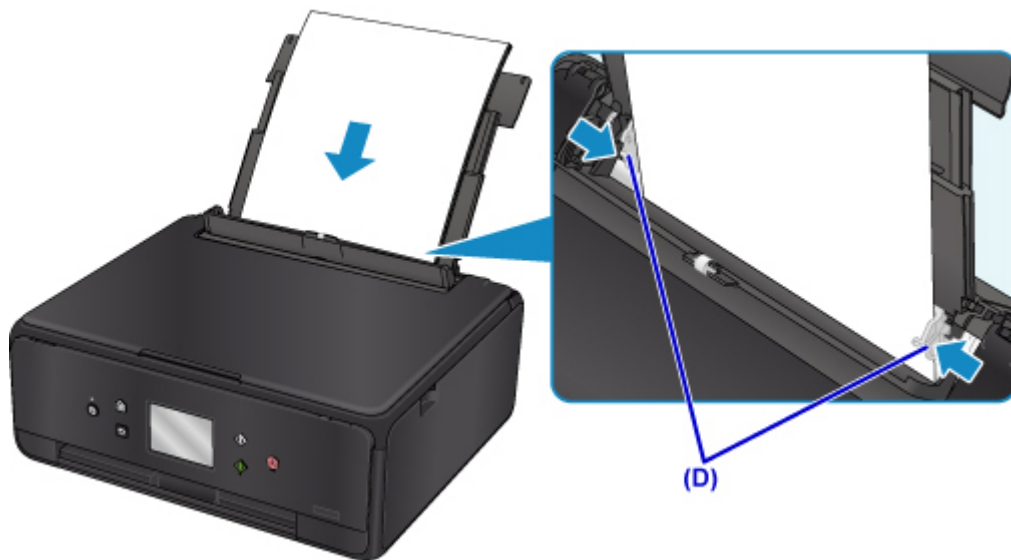

5. Close the feed slot cover (E) gently.



After closing the feed slot cover, the paper information registration screen for the rear tray is displayed on the touch screen.

6. Select the size and type of the loaded paper in the rear tray at **Page size** and **Type**, and then select **Register**.

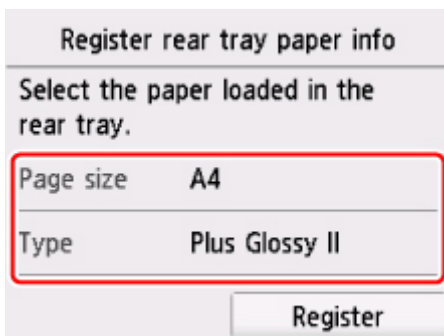

7. Open the operation panel (F), pull out the paper output tray (G) and paper output support (H), and open the output tray extension (I).

Be sure to open the operation panel before printing. If the operation panel is close, the printer does not start printing.

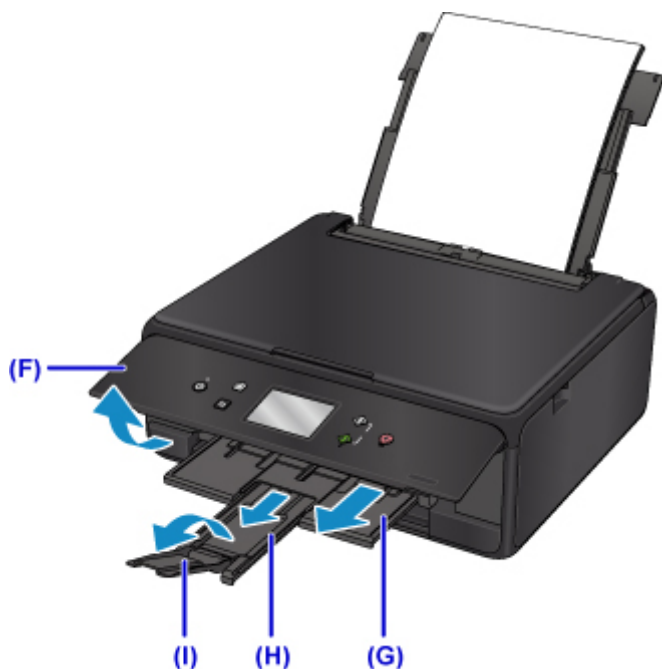

8. Click the My Image Garden icon (J) in Quick Menu.

The **Guide Menu** screen is displayed.

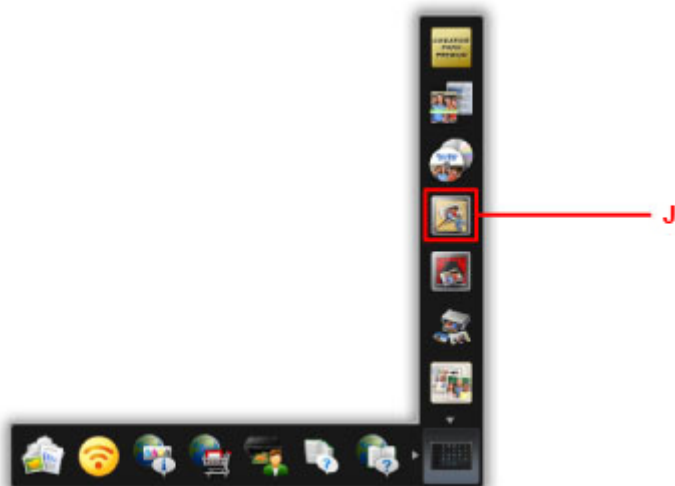

▶▶▶ Note

- The number and types of icons displayed vary depending on your region, the registered printer/ scanner and the installed applications.

9. Click the **Photo Print** icon (K).

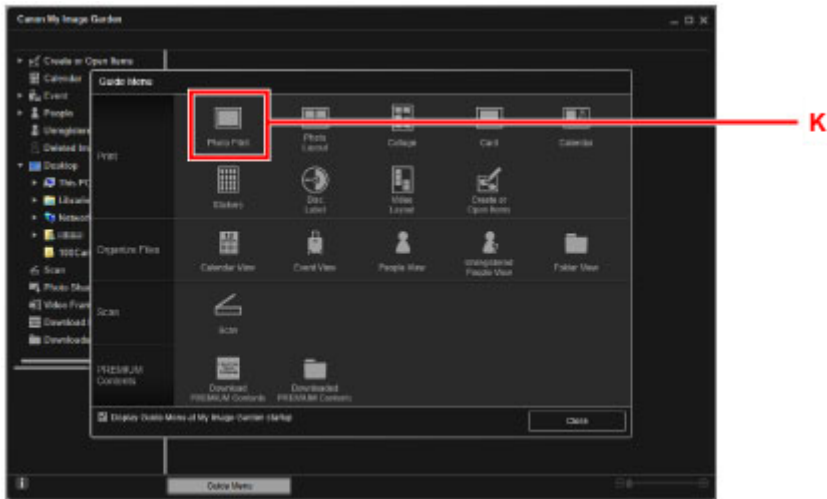

10. Click the folder (L) with photos you want to print.

11. Click the photos (M) you want to print.

For Windows:

To select two or more photos at a time, click photos while pressing the Ctrl key.

For Mac OS:

To select two or more photos at a time, click photos while pressing the command key.

12. Click **Print** (N).

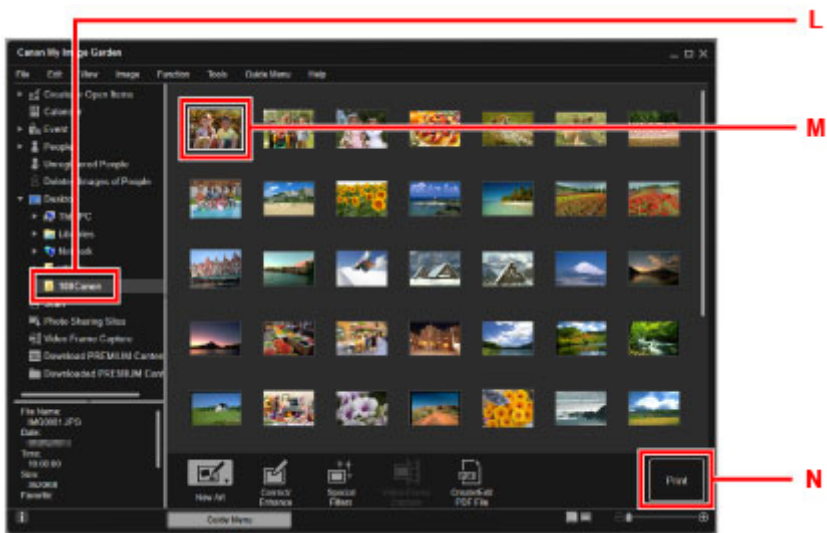

13. Specify the number of copies, your printer name, media type, etc. (O).

14. Click **Print** (P).

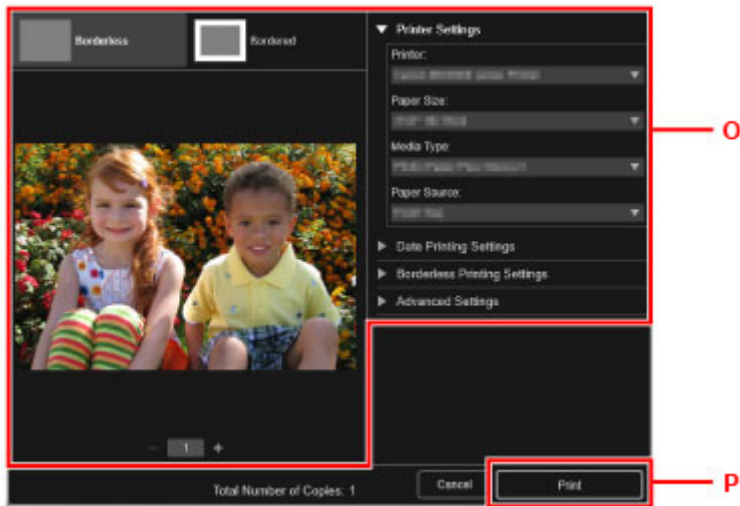

For Mac OS:

Click **OK** when the confirmation message appears, then click **Print**.

►►► Note

- My Image Garden lets you use images on your computer, such as photos taken with a digital camera, in a number of ways.
 - For Windows:
 - My Image Garden Guide
 - For Mac OS:
 - My Image Garden Guide

Copying

This section describes how to load originals and copy them to plain paper loaded in the cassette.

1. Pull out the cassette (A) from the printer.

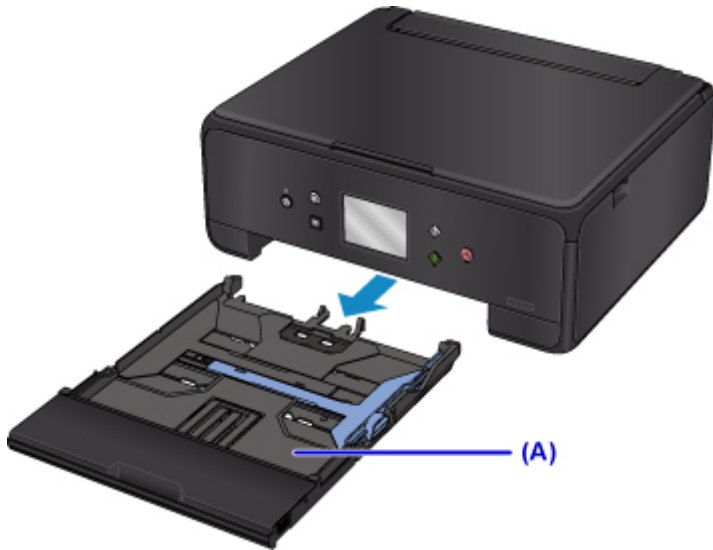

2. Remove the cassette cover (B).

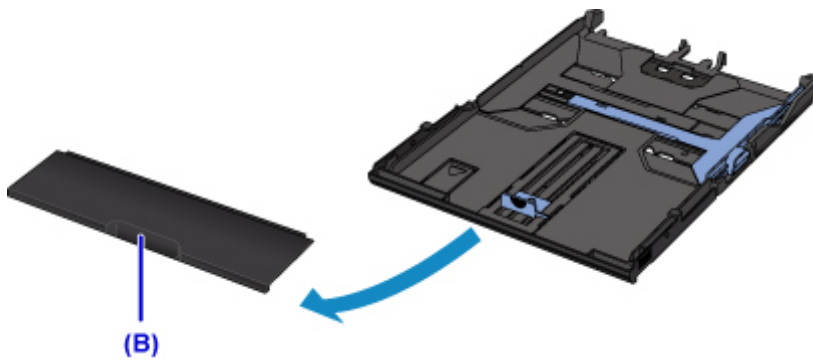

3. Load the paper stack WITH THE PRINT SIDE FACING DOWN.

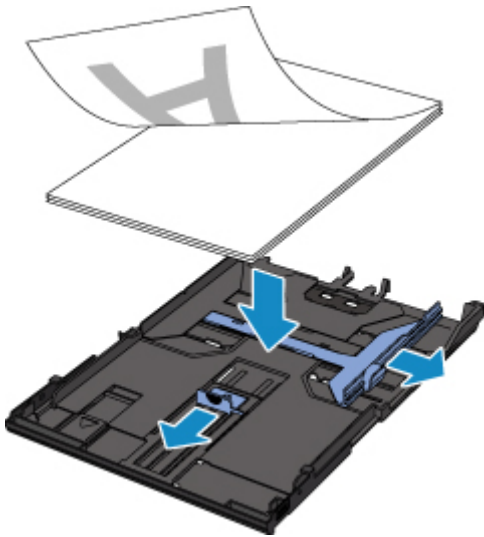

▶▶▶ **Note**

- To load A4 or Letter-sized paper in the cassette, extend the cassette.

4. Align the paper guides (C) with the paper length and width.

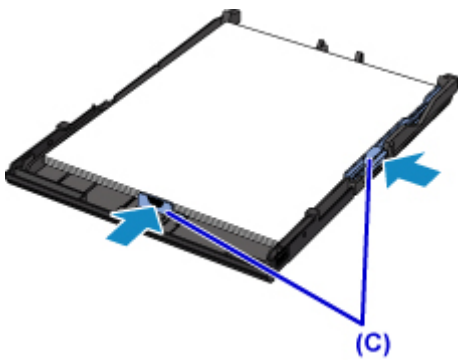

5. Mount the cassette cover, and then insert the cassette into the printer.



After inserting the cassette into the printer, the paper information registration screen for the cassette is displayed on the touch screen.

6. Select the size of the loaded paper in the cassette at **Page size**, and then select **Register**.

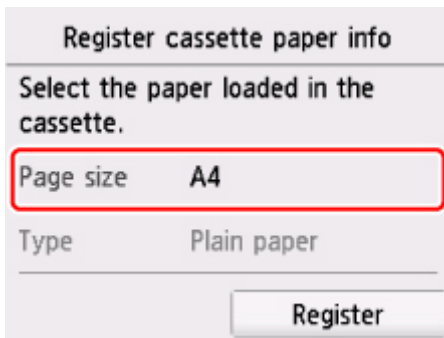

7. Open the operation panel (D), pull out the paper output tray (E) and paper output support (F), and open the output tray extension (G).

Be sure to open the operation panel before printing. If the operation panel is close, the printer does not start printing.

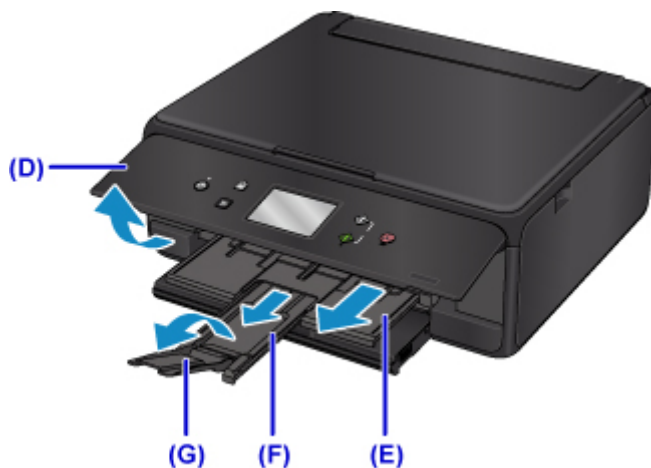

8. Press the **HOME** button (H).

9. Select  **Copy** (I).

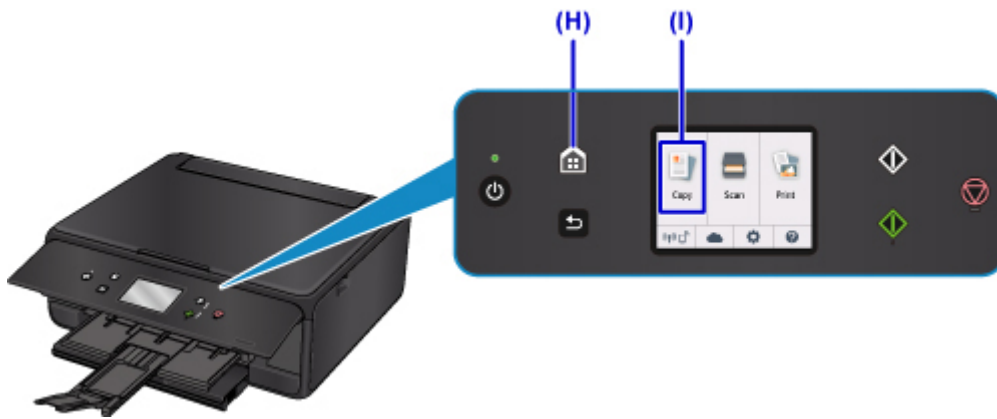

10. Select  **Standard copy**.

11. Open the document cover (J).

12. Load the original WITH THE SIDE TO COPY FACING DOWN and align it with the alignment mark (K).

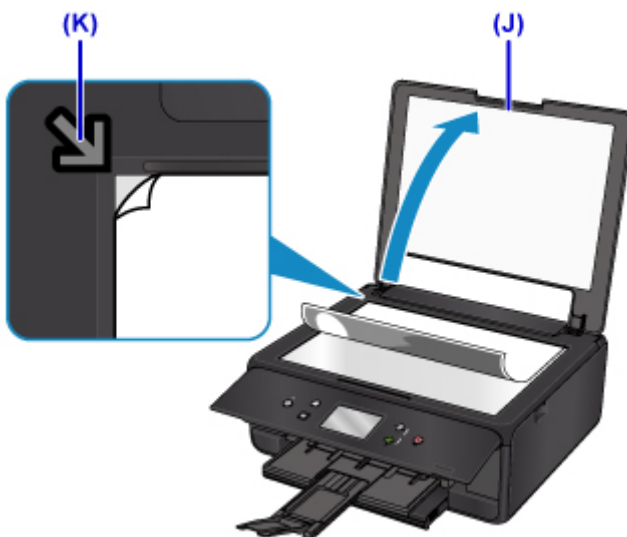

13. Close the document cover.

14. Confirm the paper settings, then press the **Black** button or **Color** button (L).



»» Important

- Do not open the document cover until copying is complete.

»» Note

- Your printer is equipped with many other convenient copy features.

■ Copying

Handling Paper, Originals, Ink Tanks, etc.

- ▶ **Loading Paper**
- ▶ **Loading Originals**
- ▶ **Replacing Ink Tanks**

Loading Paper

- ▶ **Paper Sources**
- ▶ **Loading Paper in the Rear Tray**
- ▶ **Loading Paper in the Cassette**
- ▶ **Loading Envelopes**

Paper Sources

The printer has two paper sources for feeding paper, the rear tray (A) and cassette (B).

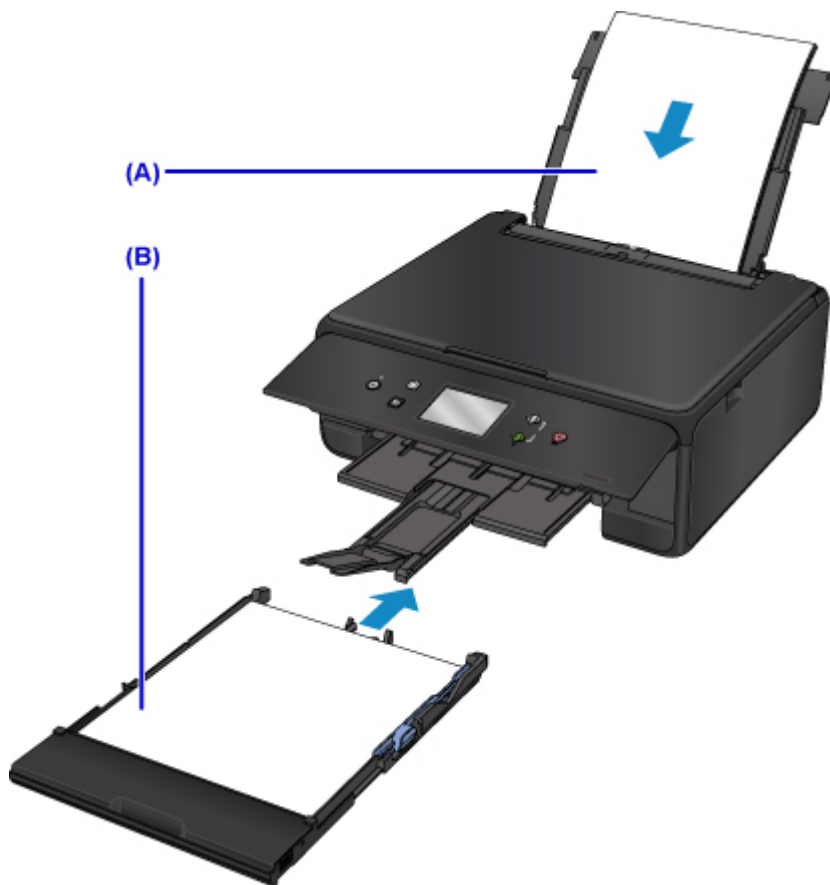

The paper source used depends on the page size and media type.

■ [Supported Media Types](#)

▶▶▶ **Note**

- When printing, select the correct page size and media type. If you select the wrong page size or media type, the printer may feed paper from the wrong paper source or may not print with the proper print quality.

For details on how to load paper in each paper source, see below.

■ [Loading Paper in the Rear Tray](#)

■ [Loading Paper in the Cassette](#)

■ [Loading Envelopes](#)

Loading Paper in the Rear Tray

You can load plain paper or photo paper.

You can also load envelopes on the rear tray.

■ [Loading Envelopes](#)

▶▶▶ Important

- If you cut plain paper into small size such as 4" x 6" (10 x 15 cm) or 5" x 7" (13 x 18 cm) to perform trial print, it can cause paper jams.

▶▶▶ Note

- We recommend Canon genuine photo paper for printing photos.
For details on the Canon genuine paper, see [Supported Media Types](#).
- You can use general copy paper or Canon Red Label Superior WOP111/Canon Océ Office Colour Paper SAT213.
For the page size and paper weight you can use for this printer, see [Supported Media Types](#).

1. Prepare paper.

Align the edges of paper. If paper is curled, flatten it.

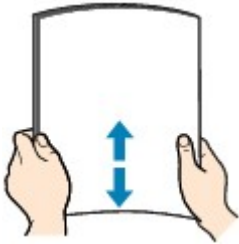

▶▶▶ Note

- Align the edges of paper neatly before loading. Loading paper without aligning the edges may cause paper jams.
- If paper is curled, hold the curled corners and gently bend them in the opposite direction until the paper becomes completely flat.

For details on how to flatten curled paper, see [Is the paper curled?](#)

2. Load paper.

1. Open the rear tray cover (A) and then pull up the paper support (B).



2. Open the feed slot cover (C).

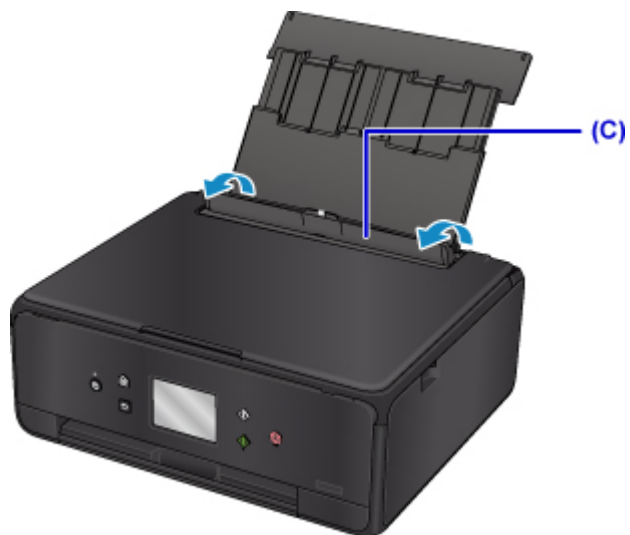

3. Slide the paper guides to open them, and load the paper in the center of the rear tray WITH THE PRINT SIDE FACING UP.

4. Slide the paper guides (D) to align them with both sides of the paper stack.

Do not slide the paper guides too hard against the paper. The paper may not be fed properly.

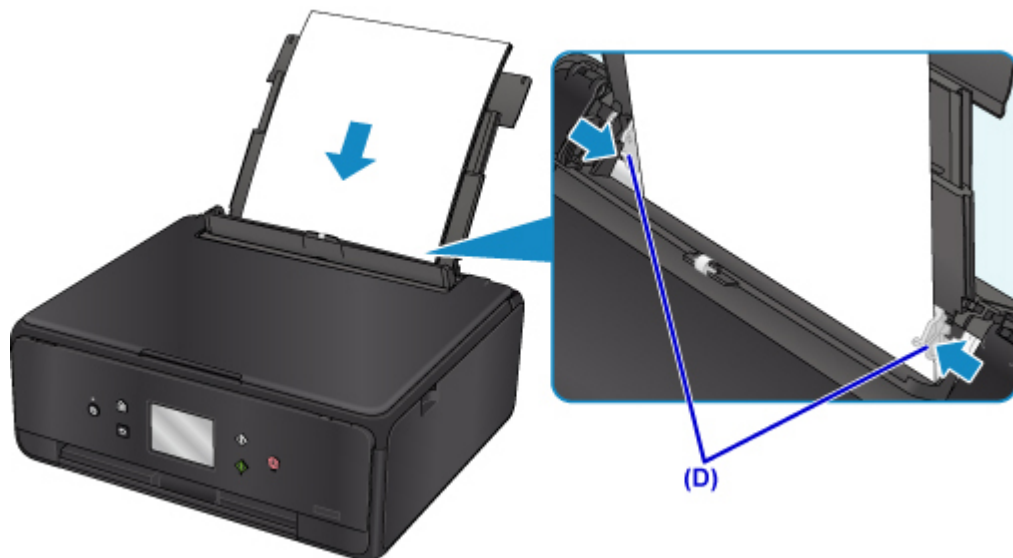

▶▶▶ Important

- Always load paper in the portrait orientation (E). Loading paper in the landscape orientation (F) can cause paper jams.

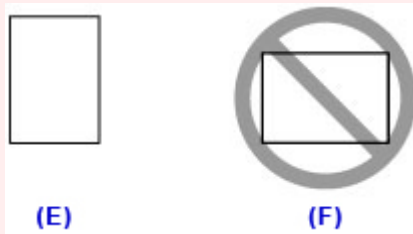

▶▶▶ Note

- Do not load sheets of paper higher than the load limit mark (G).

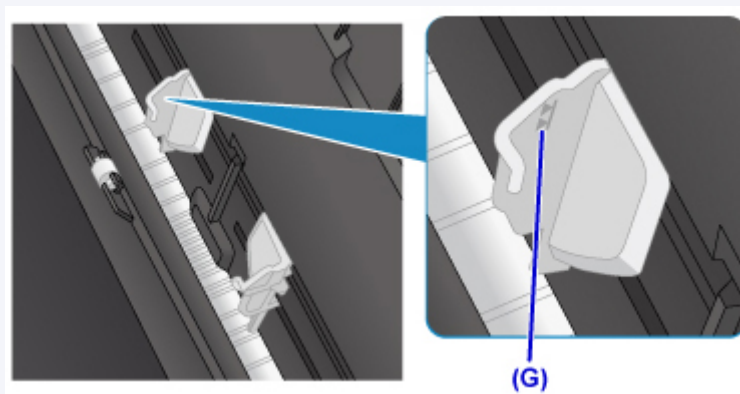

5. Close the feed slot cover (H) gently.

▶▶▶ Important

- If the feed slot cover is open, paper cannot be fed. Be sure to close the feed slot cover.



After closing the feed slot cover, the paper information registration screen for the rear tray is displayed on the touch screen.

6. Select the size and type of the loaded paper in the rear tray at **Page size** and **Type**, and then select **Register**.

Register rear tray paper info	
Select the paper loaded in the rear tray.	
Page size	A4
Type	Plus Glossy II
Register	

7. Open the operation panel (I), pull out the paper output tray (J) and paper output support (K), and open the output tray extension (L).

Be sure to open the operation panel before printing. If the operation panel is close, the printer does not start printing.

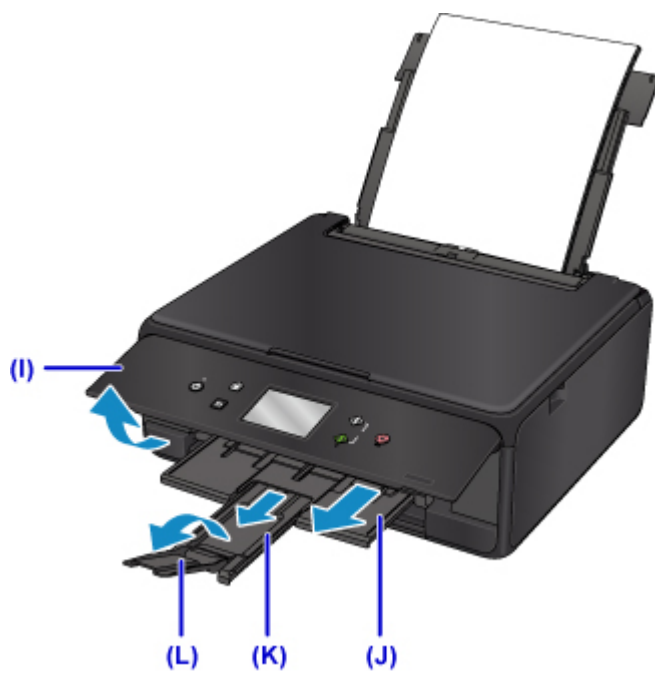

▶▶▶ Note

- When printing, select the size and type of the loaded paper on the print settings screen of the operation panel or printer driver.

Loading Paper in the Cassette

You can load A4, B5, A5, or Letter-sized plain paper in the cassette.

▶▶▶ Note

- In the cassette, be sure to load only plain paper.
- You can use general copy paper or Canon Red Label Superior WOP111/Canon Océ Office Colour Paper SAT213.

For the page size and paper weight you can use for this printer, see [Supported Media Types](#).

1. Prepare paper.

Align the edges of paper. If paper is curled, flatten it.

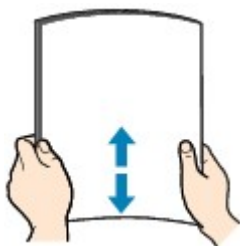

▶▶▶ Note

- Align the edges of paper neatly before loading. Loading paper without aligning the edges may cause paper jams.
- If paper is curled, hold the curled corners and gently bend them in the opposite direction until the paper becomes completely flat.

For details on how to flatten curled paper, see [Is the paper curled?](#)

2. Pull out the cassette (A) from the printer.

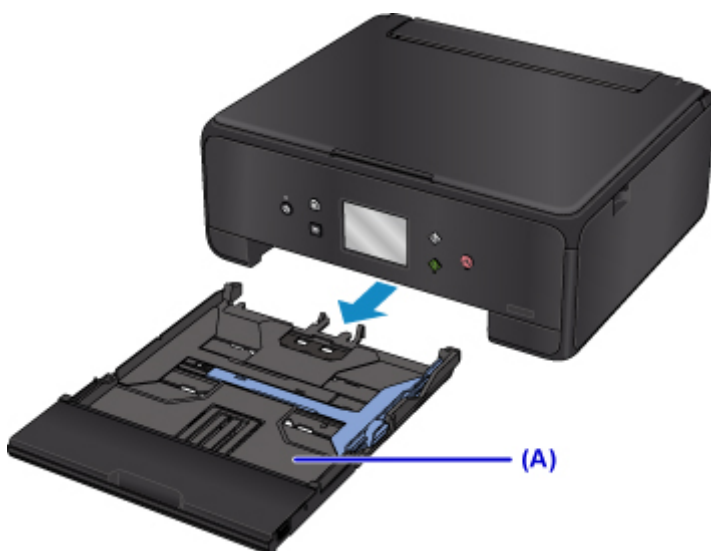

3. Remove the cassette cover (B).

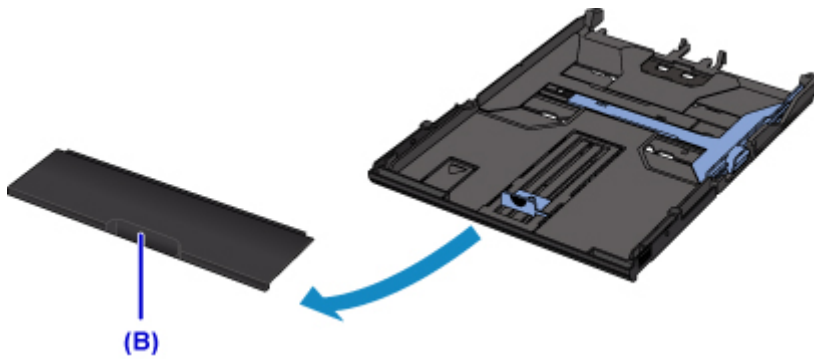

4. Slide the paper guide (C) in front and (D) on the right to open the guides.

5. Load the paper stack WITH THE PRINT SIDE FACING DOWN, and place it in the center of the cassette.

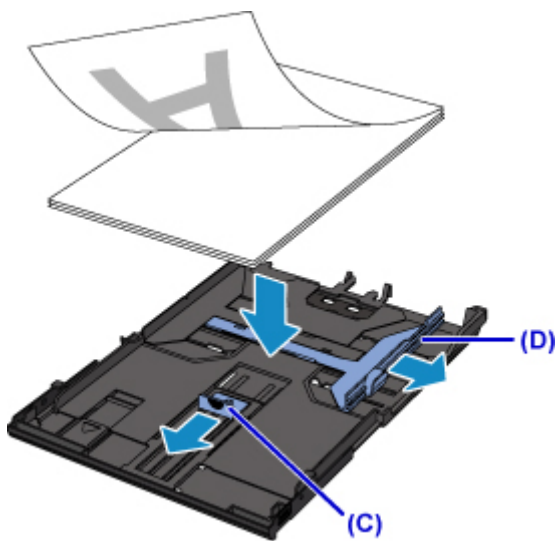

»» Important

- Always load paper in the portrait orientation (E). Loading paper in the landscape orientation (F) can cause paper jams.

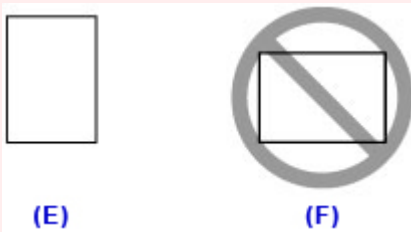

»» Note

- Align the paper stack with the edge of the cassette as shown in the figure below.
If the paper stack is in contact with the protrusion (G), the paper may not be fed properly.



- To load A4 or Letter-sized paper in the cassette, press down the lock (H) on the cassette, then extend the cassette.

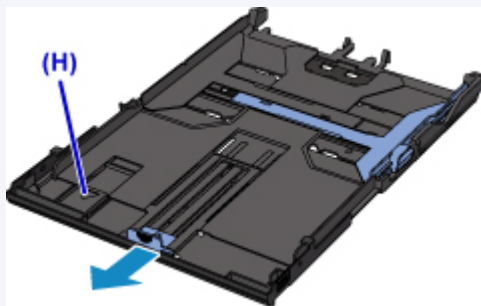

6. Align the paper guide (I) in front with the paper stack.

Align the paper guide (I) with where it clicks into place.

7. Slide the paper guide (J) on the right to align the right and left guides with both sides of the paper stack.

Do not slide the paper guides too hard against the paper. The paper may not be fed properly.

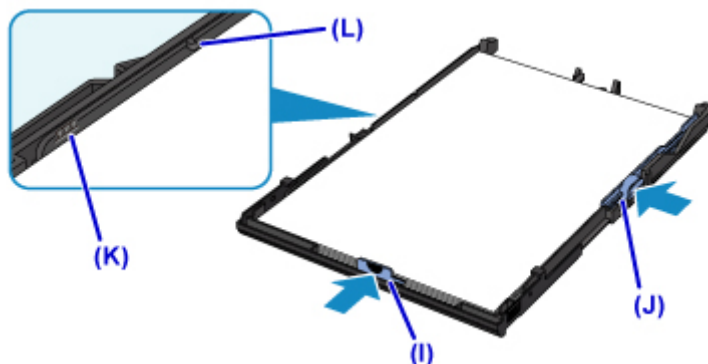

▶▶▶ Note

- Do not load sheets of paper higher than the load limit mark (K).
- Keep the paper stack height below the tabs (L) of the paper guides.

8. Mount the cassette cover, and then insert the cassette into the printer.

Push the cassette into the printer until it stops.

After inserting the cassette into the printer, the paper information registration screen for the cassette is displayed on the touch screen.



9. Select the size and type of the loaded paper in the cassette at **Page size**, then select **Register**.

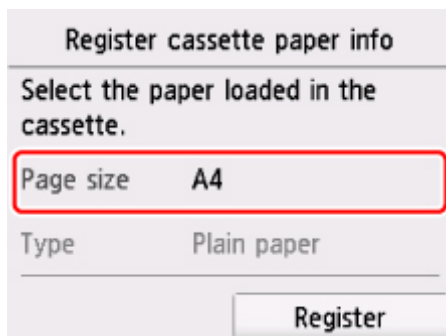

10. Open the operation panel (M), pull out the paper output tray (N) and paper output support (O), and open the output tray extension (P).

Be sure to open the operation panel before printing. If the operation panel is close, the printer does not start printing.

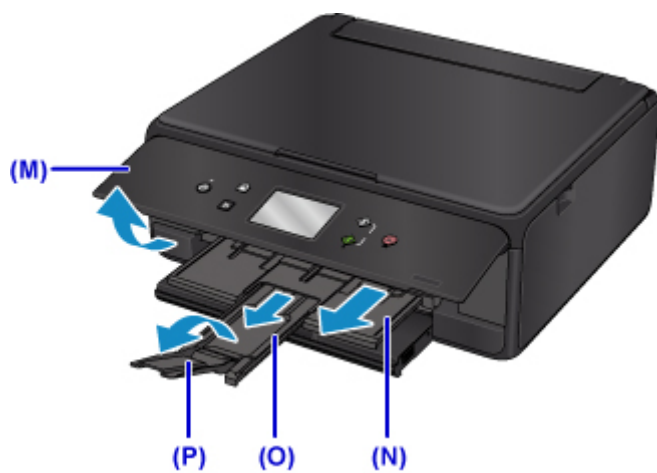

▶▶ Note

- When printing, select the size and type of the loaded paper on the print settings screen of the operation panel or printer driver.

Loading Envelopes

You can load Envelope DL and Envelope Com 10 on the rear tray.

The address is automatically rotated and printed according to the envelope's direction by specifying with the printer driver properly.

▶▶▶ Important

- Printing of envelopes from the operation panel or from a PictBridge (Wireless LAN) compliant device is not supported.
- Do not use the following envelopes. They could jam in the printer or cause the printer to malfunction.
 - Envelopes with an embossed or treated surface
 - Envelopes with a double flap
 - Envelopes whose gummed flaps are already moistened and adhesive

1. Prepare envelopes.

- Press down on all four corners and edges of the envelopes to flatten them.

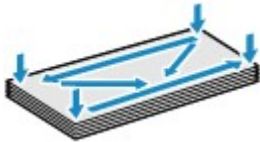

- If the envelopes are curled, hold the opposite corners and gently twist them in the opposite direction.



- If the corner of the envelope flap is folded, flatten it.
- Use a pen to press the leading edge in the inserting direction flat and sharpen the crease.

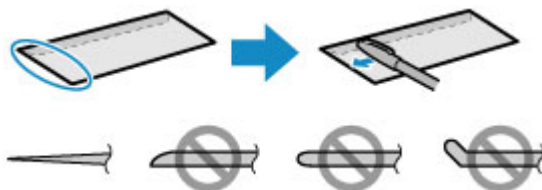

The figures above show a side view of the leading edge of the envelope.

▶▶▶ Important

- The envelopes may jam in the printer if they are not flat or the edges are not aligned. Make sure that no curl or puff exceeds 0.12 inch (3 mm).

2. Load envelopes.

1. Open the rear tray cover (A) and then pull up the paper support (B).

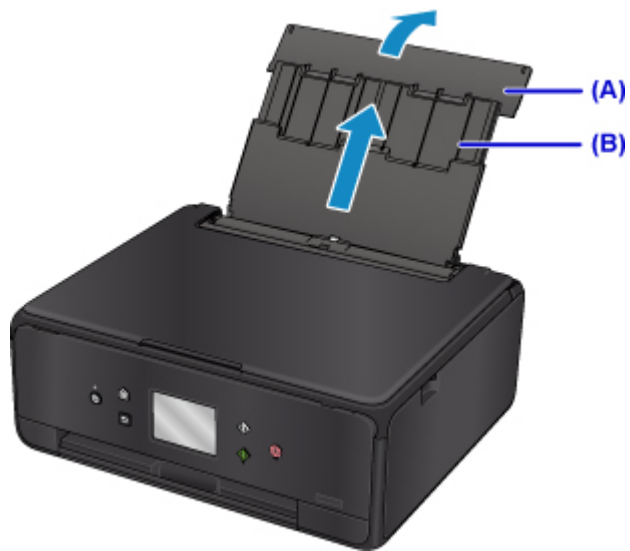

2. Open the feed slot cover (C).

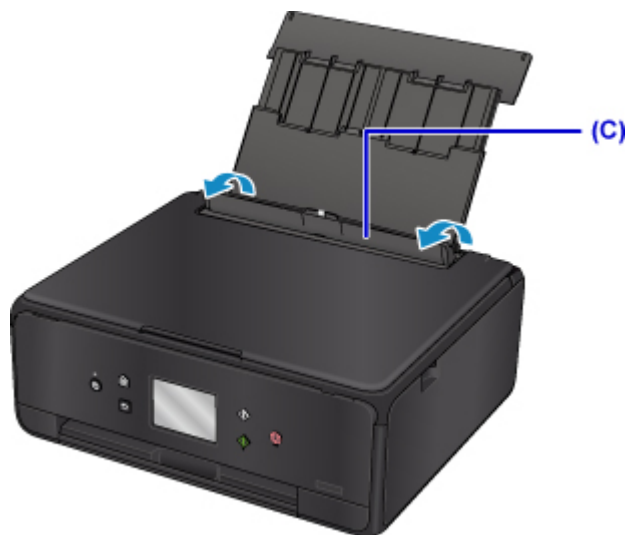

3. Slide the paper guides (D) to open them, and load the envelopes in the center of the rear tray WITH THE PRINT SIDE FACING UP.

Fold flap of the envelope and load the envelope in the portrait orientation with the address side facing up.

Up to 10 envelopes can be loaded at once.

4. Slide the paper guides (D) to align them with both sides of the envelopes.

Do not slide the paper guides too hard against the envelopes. The envelopes may not be fed properly.

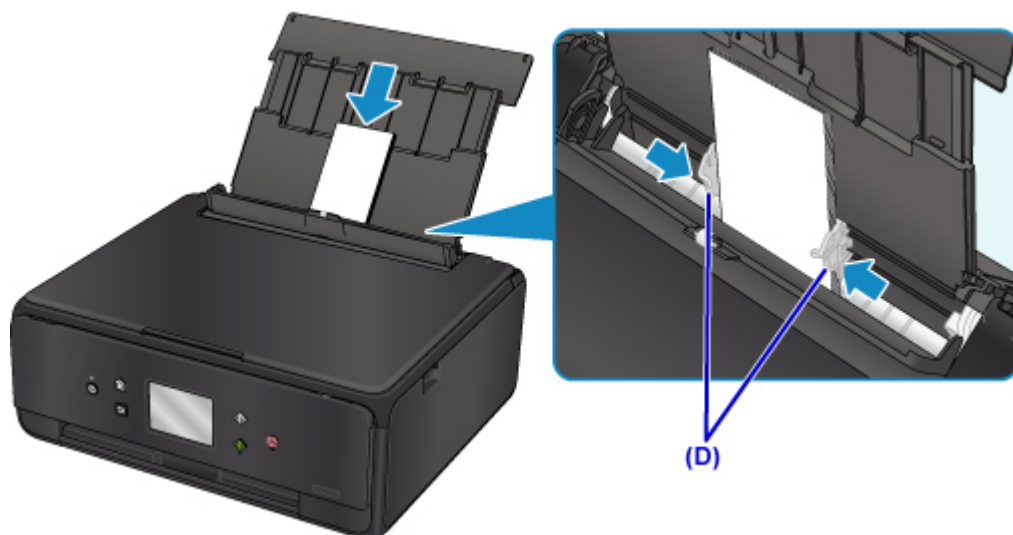

Note

- Do not load envelopes higher than the load limit mark (E).

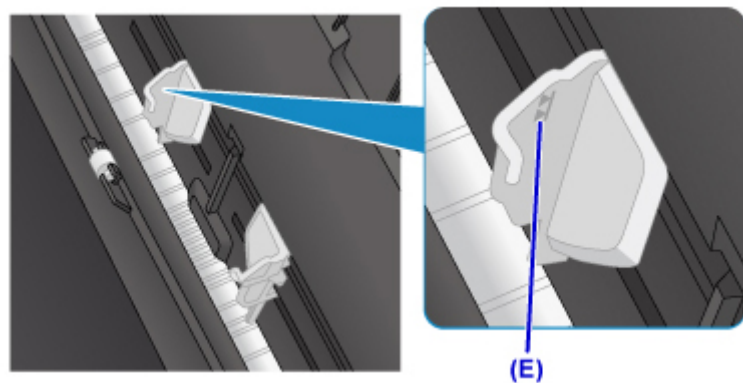

5. Close the feed slot cover (F) gently.

Important

- If the feed slot cover is open, paper cannot be fed. Be sure to close the feed slot cover.

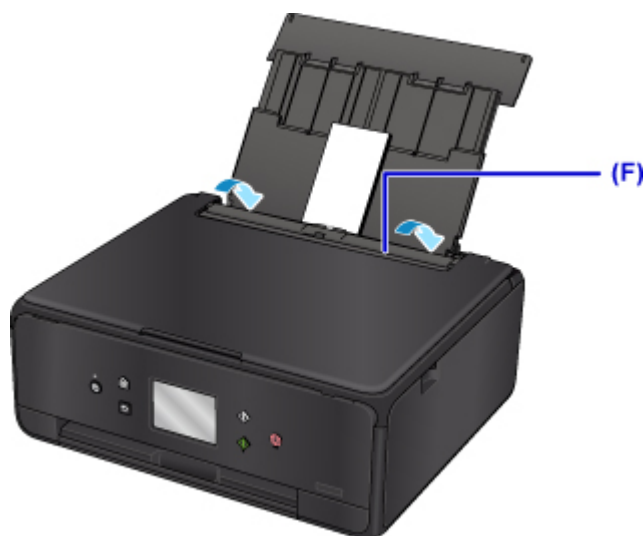

After closing the feed slot cover, the paper information registration screen for the rear tray is displayed on the touch screen.

6. Select the size and type of the loaded envelopes in the rear tray at **Page size** and **Type**, and then select **Register**.

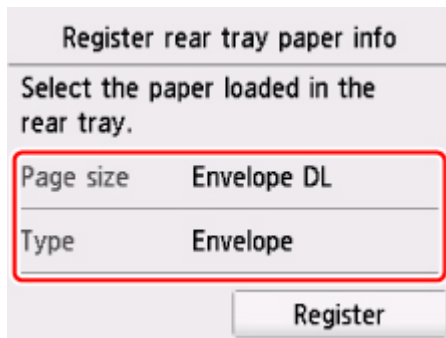

7. Open the operation panel (G), pull out the paper output tray (H) and paper output support (I), and open the output tray extension (J).

Be sure to open the operation panel before printing. If the operation panel is close, the printer does not start printing.

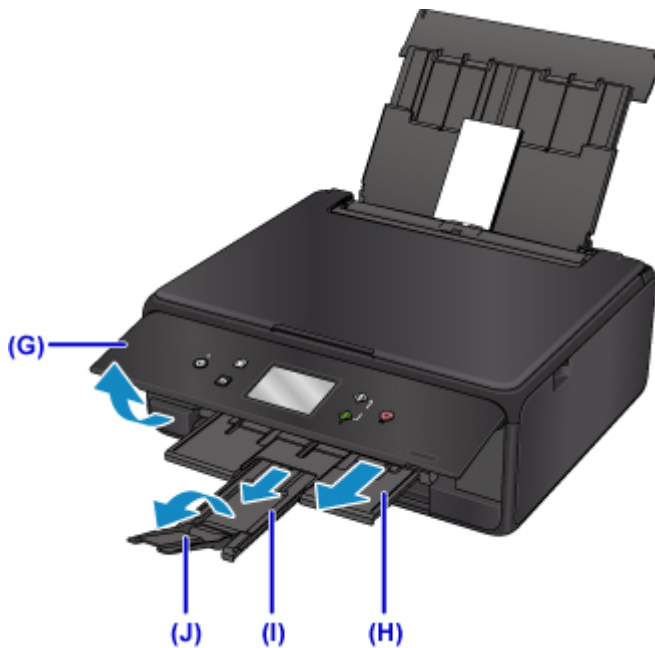

▶▶▶ Note

- The printer may make operating noise when feeding envelopes.
- After loading envelopes, select the size and type of the loaded envelopes on the print settings screen of the printer driver.

Loading Originals

- ▶ **Loading Originals on the Platen Glass**
- ▶ **Loading Based on Use**
- ▶ **Supported Originals**
- ▶ **How to Detach / Attach the Document Cover**

Loading Originals on the Platen Glass

1. Open the document cover.
2. Load the original WITH THE SIDE TO SCAN FACING DOWN on the platen glass.

■ [Loading Based on Use](#)

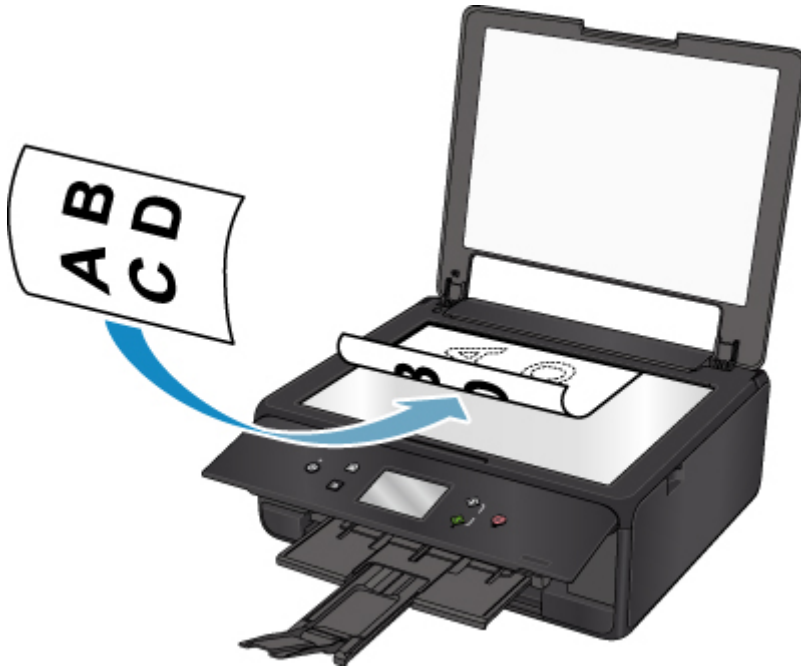

▶▶▶ Important

- Be sure to observe the following when loading the original on the platen glass.
 - Do not place any objects weighing 4.4 lb (2.0 kg) or more on the platen glass.
 - Do not put any pressure of 4.4 lb (2.0 kg) or more on the platen glass, such as pressing down the original.

Failure to observe the above may cause the scanner to malfunction or the platen glass to break.

3. Close the document cover gently.



»» Important

- After loading the original on the platen glass, be sure to close the document cover before starting to copy or scan.

Loading Based on Use

Load the original in the correct position according to the function to use. If you do not load the original correctly, it may not be scanned properly.

Loading the Original to Be Aligned with the alignment mark

- Load originals to copy
- In **Scan**,
 - select **Auto scan** for **Doc.type** to scan text documents, magazines, or newspapers
 - select **Document** or **Photo** for **Doc.type** and specify a standard size (A4, Letter, etc.) for **Scan size** to scan originals
- With a software application on a computer,
 - scan text documents, magazines, or newspapers
 - select a standard size (A4, Letter, etc.) to scan originals

Place the original WITH THE SIDE TO SCAN FACING DOWN on the platen glass and align it with the alignment mark . Portions placed on the diagonally striped area cannot be scanned.

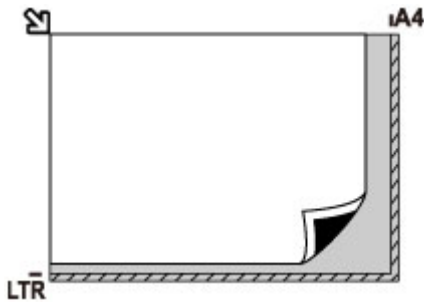

Important

- The printer cannot scan the striped area (A) (0.04 inch (1 mm) from the edges of the platen glass).

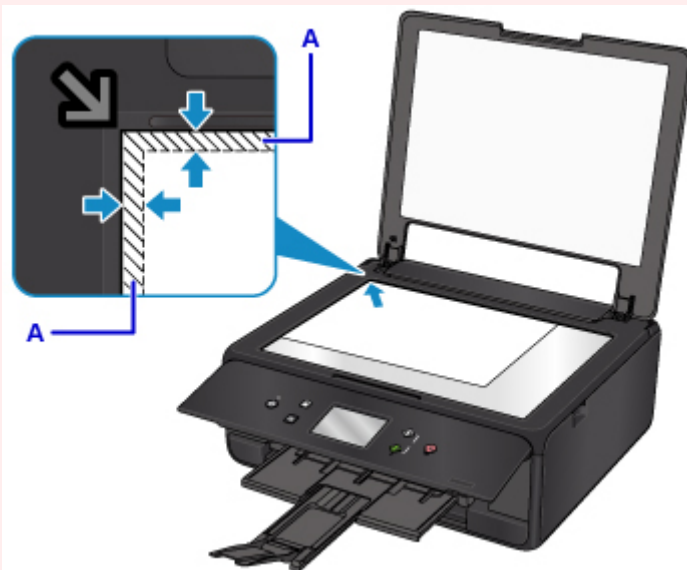

Loading Only One Original in the Center of the platen glass

- Scan only one printed photo in **Photo copy**
- In **Scan**,
 - select **Auto scan** for **Doc.type** to scan one printed photo, postcard, business card, or disc (BD/DVD/CD)
 - select **Photo** for **Doc.type** and specify **Auto scan** for **Scan size** to scan one original

Place the original WITH THE SIDE TO SCAN FACING DOWN, with 0.4 inch (1 cm) or more space between the edges (diagonally striped area) of the platen glass. Portions placed on the diagonally striped area cannot be scanned.

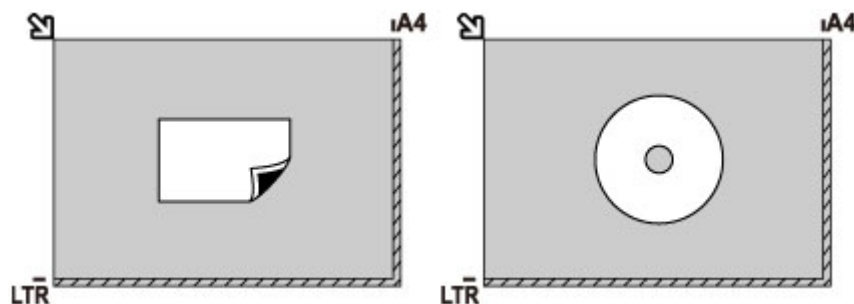

Loading Two or More Originals on the platen glass

- Scan two or more printed photos in **Photo copy**
- In **Scan**,
 - select **Auto scan** for **Doc.type** to scan two or more printed photos, postcards, or business cards
 - select **Photo** for **Doc.type** and specify **Auto multi scan** for **Scan size** to scan two or more originals
- Scan two or more printed photos, postcards, or business cards with a software application on a computer

Place the originals WITH THE SIDE TO SCAN FACING DOWN. Allow 0.4 inch (1 cm) or more space between the edges (diagonally striped area) of the platen glass and the originals, and between the originals. Portions placed on the diagonally striped area cannot be scanned.

You can place up to 12 items.

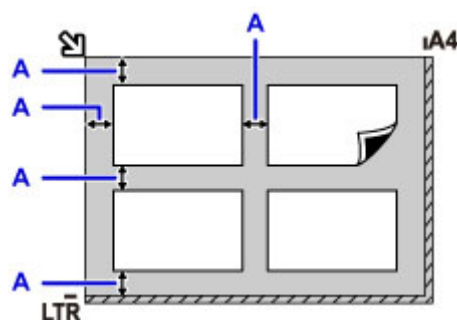

A: More than 0.4 inch (1 cm)

▶▶ Note

- The Skew Correction function automatically compensates for the originals placed at an angle of up to approximately 10 degrees. Slanted photos with a long edge of 7.1 inches (180 mm) or more cannot be corrected.
- Non-rectangular or irregular shaped photos (such as cut out photos) may not be scanned properly.

Supported Originals

Item	Details
Types of originals	- Text document, magazine, or newspaper - Printed photo, postcard, business card, or disc (BD/DVD/CD, etc.)
Size (width x height)	Max. 8.5 x 11.7 inches (216 x 297 mm)

▶▶ Note

- When loading a thick original such as a book on the platen glass, you can load it by removing the document cover from the printer.

■ [How to Detach / Attach the Document Cover](#)

How to Detach / Attach the Document Cover

Detaching the document cover:

Hold up the document cover vertically and then tip it back.



Attaching the document cover:

Fit both hinges (A) of the document cover into the holder (B) and insert both hinges of the document cover vertically as illustrated below.

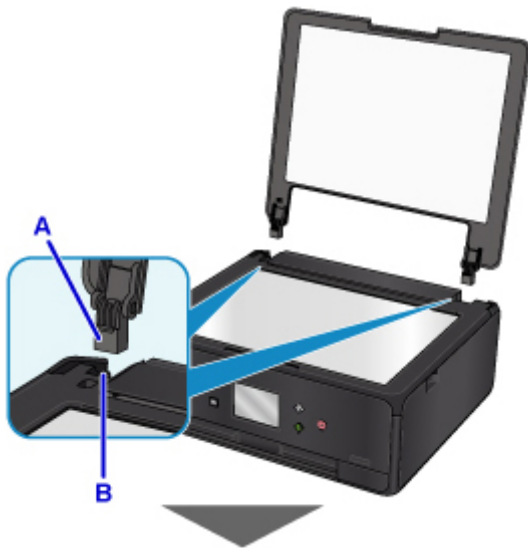



Replacing Ink Tanks

- ▶ **Replacing Ink Tanks**
- ▶ **Checking Ink Status on the Touch Screen**
- ▶ **Checking the Ink Status with the Ink Lamps**

Replacing Ink Tanks

When remaining ink cautions or errors occur, the message will appear on the touch screen to inform you of the error. In this state, the printer cannot print or scan. Take appropriate action according to the message.

■ [An Error Occurs](#)

▶▶▶ Note

- If print results become faint or white streaks appear despite sufficient ink levels, see [Maintenance Procedure](#).
- For precautionary notes on handling ink tanks, see [Notes on ink tanks](#).

Replacing Procedure

When you need to replace an ink tank, follow the procedure below.

1. Make sure that the power is turned on.
2. Open the scanning unit / cover.

The print head holder moves to the replacement position.

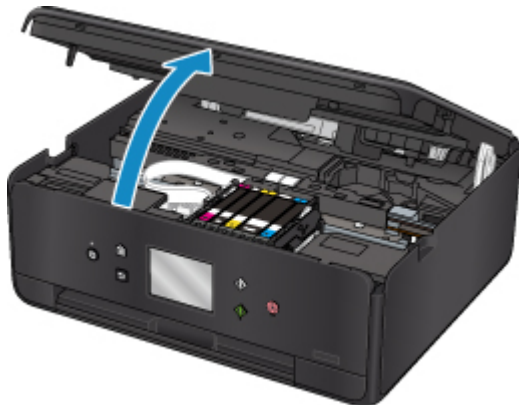

⚠ Caution

- Do not hold the print head holder to stop or move it forcibly. Do not touch the print head holder until it stops completely.

▶▶▶ Important

- Do not touch the metallic parts or other parts inside the printer.
- If the scanning unit / cover is left open for more than 10 minutes, the print head holder moves to the right. In this case, close and reopen the scanning unit / cover.

3. Remove the ink tank with the lamp flashing fast.

Push the tab (A) and lift the ink tank to remove.

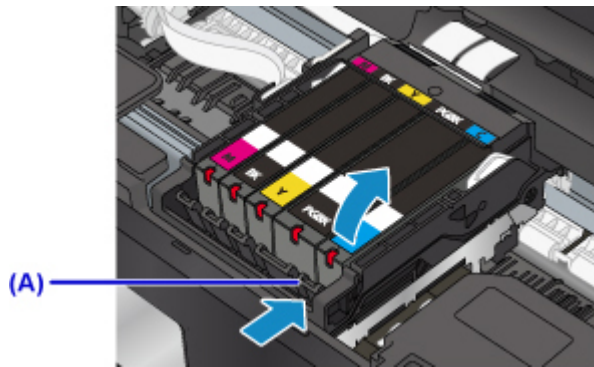

»» Important

- Do not touch other parts besides the ink tanks.
- Handle the ink tank carefully to avoid staining of clothing or the surrounding area.
- Discard the empty ink tank according to the local laws and regulations regarding disposal of consumables.

»» Note

- Do not remove two or more ink tanks at the same time. Be sure to replace ink tanks one by one when replacing two or more ink tanks.
- For details on ink lamp flashing speed, see [Checking the Ink Status with the Ink Lamps](#).

4. Take a new ink tank out of its package, remove the orange tape (B) completely, then remove the protective film (C) completely.

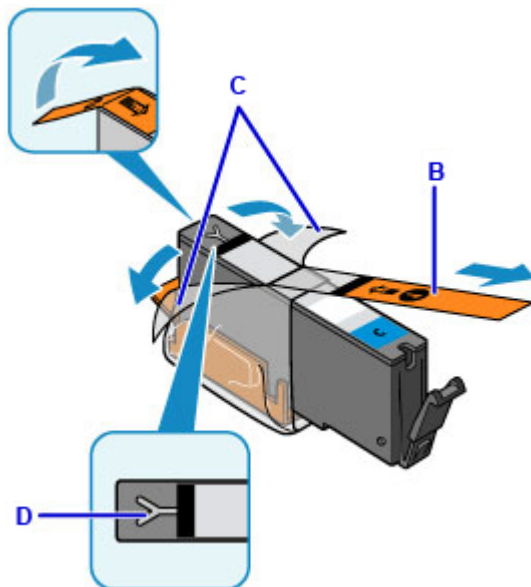

»» Important

- Handle an ink tank carefully. Do not drop or apply excessive pressure to it.
- If the orange tape remains on the Y-shape air hole (D), ink may splash or the printer may not print properly.

5. Hold the ink tank with the orange protective cap (E) pointing up while being careful not to block the Y-shape air hole (D).

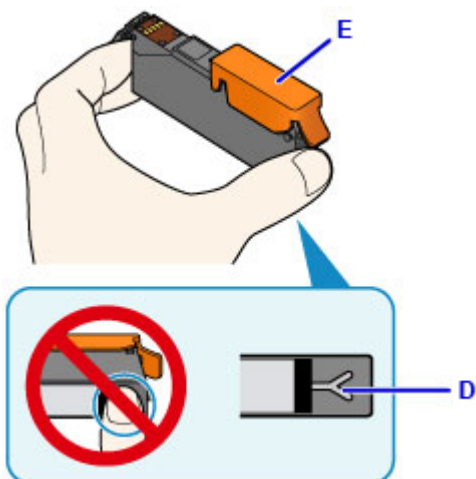

6. Lift up the tab on the orange protective cap (E) to remove it off GENTLY.

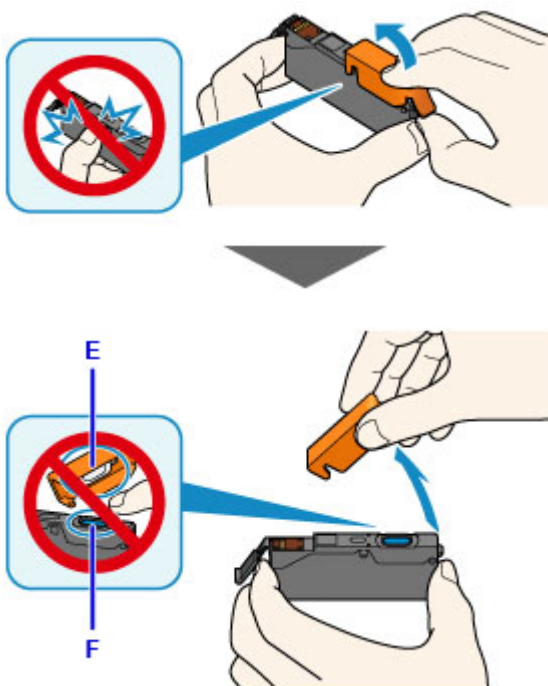

»» Important

- Do not push the sides of the ink tank. If you push the sides of the ink tank with the Y-shape air hole (D) blocked, ink may splash.
- Do not touch the inside of the orange protective cap (E) or the open ink port (F). The ink may stain your hands if you touch them.
- Do not reattach the protective cap (E) once you have removed it. Discard it according to the local laws and regulations regarding disposal of consumables.

7. Insert the front end of the ink tank into the print head at a slant.

Make sure that the position of the ink tank matches the label.

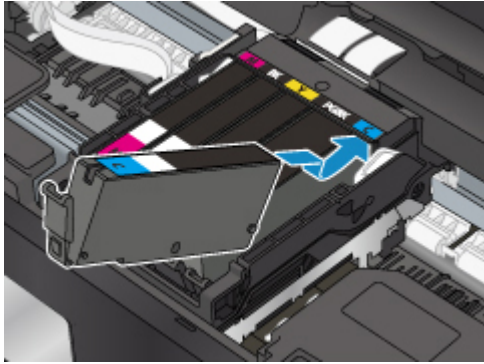

8. Press on the top of the ink tank until the ink tank snaps firmly into place.

Make sure that the ink lamp lights up.

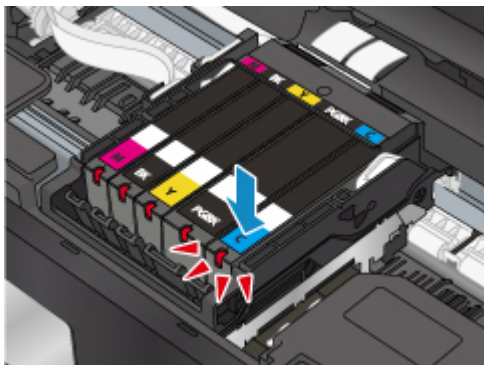

►► Important

- You cannot print if the ink tank is installed in the wrong position. Be sure to install the ink tank in the correct position according to the label on the print head holder.
- You cannot print unless all the ink tanks are installed. Be sure to install all the ink tanks.

9. Close the scanning unit / cover.

To close the scanning unit / cover, hold it up once, then take it down gently.

If a message is displayed on the screen, select **OK**.

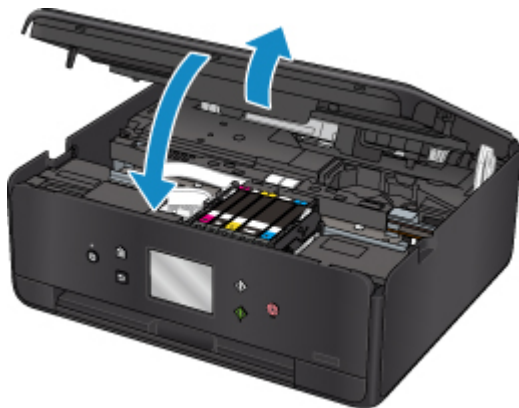

⚠ Caution

- When closing the scanning unit / cover, be careful not to get your fingers caught.

►► Note

- If the error message appears after the scanning unit / cover is closed, take appropriate action.
 - [An Error Occurs](#)
- When you start printing after replacing the ink tank, the printer starts cleaning the print head automatically. Do not perform any other operations until the printer completes the cleaning of the print head.
- If the print head is out of alignment, as indicated by misaligned printed ruled lines or similar symptoms, [align the print head](#).
- The printer may make a noise during these operations, but this does not indicate a problem.

Notes on ink tanks

►► Important

- If you remove an ink tank, replace it immediately. Do not leave the printer with the ink tank removed.
- Use a new ink tank for replacement. Installing a used ink tank may cause the nozzles to clog. Furthermore, with such an ink tank, the printer will not be able to inform you when to replace the ink tank properly.
- Once an ink tank has been installed, do not remove it from the printer and leave it out in the open. This will cause the ink tank to dry out, and the printer may not operate properly when it is reinstalled. To maintain optimal printing quality, use an ink tank within six months of first use.

►► Note

- Color ink may be consumed even when printing a black-and-white document or when black-and-white printing is specified. Every ink is also consumed in the standard cleaning and deep cleaning of the print head, which may be necessary to maintain the performance of the printer.

When an ink tank is out of ink, replace it immediately with a new one.

■ Ink Tips

Checking Ink Status on the Touch Screen

1. Make sure that the power is turned on, and display the HOME screen.

If the HOME screen is not displayed, press the **HOME** button to display it.

2. Select  **Setup** on the HOME screen.

■ [Using the Operation Panel](#)

The setup menu screen will appear.

3. Select  **Estimated ink levels**.

A symbol appears in the area (A) if there is any information about the remaining ink level.

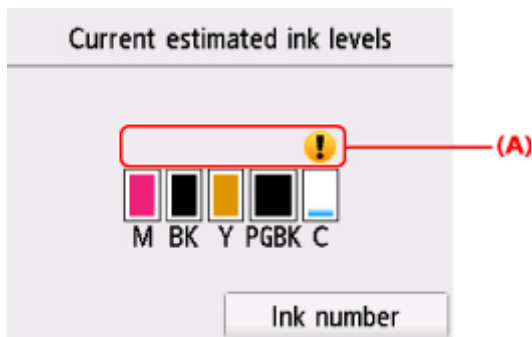

Example: 

The ink is running low. Prepare a new ink tank.

The resulting print quality may not be satisfactory, if printing is continued under this condition.

▶▶▶ Note

- The above screen shows estimated ink levels.
- Tapping **Ink number** displays the **Ink number** screen for checking ink numbers. Tapping **Print no.** on this screen enables you to print ink numbers. Tapping **Order ink now** displays the QR code for accessing the ink purchasing site. Cost of connecting to Internet is to be born by the customer.
- You can also check the ink status on a screen of the touch screen displayed while printing.
- You can also check the ink status on the computer screen.
 - For Windows:
 - [Checking Ink Status from Your Computer](#)
 - For Mac OS:
 - [Checking Ink Status from Your Computer](#)

Checking the Ink Status with the Ink Lamps

1. Make sure that the power is turned on.
2. Open the scanning unit / cover.

■ [Replacing Procedure](#)

3. Check the ink lamp.

Close the scanning unit / cover after checking the ink lamp status.

■ [Replacing Procedure](#)

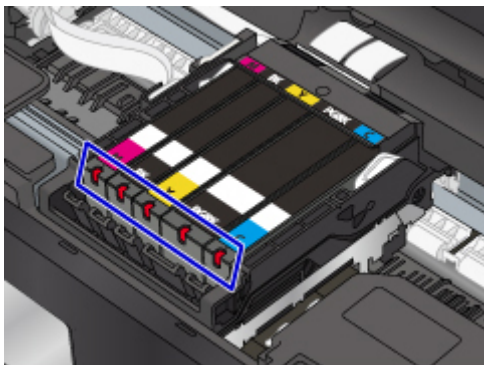

- The ink lamp is on.
The ink tank is correctly installed.
- The ink lamp is flashing.

Flashing slowly (at around 3-second intervals)



Lighting for 3 seconds (A) repeats

The ink is running low. Prepare a new ink tank.

The resulting print quality may not be satisfactory, if printing is continued under this condition.

Flashing fast (at around 1-second intervals)



Lighting for 1 second (B) repeats

- The ink tank is installed in the wrong position.

Or

- The ink has run out.

Make sure that the ink tank is installed in the correct position as indicated by the label on the print head holder. If the position is correct but the lamp flashes, there has been an error and the printer cannot print. Check the error message displayed on the touch screen.

■ [An Error Occurs](#)

- The ink lamp is off.

The ink tank is not installed properly or the function for detecting the remaining ink level is disabled. If the ink tank is not firmly in place, make sure that the orange protective cap has been removed from the bottom of the ink tank, then press on the top of the ink tank until the ink tank clicks into place.

If the ink lamp is still off after reinstalling the ink tank, there has been an error and the printer cannot print. Check the error message displayed on the touch screen.

■ [An Error Occurs](#)

▶▶ Note

- You can also check the ink status on the computer screen.
 - For Windows:
 - [Checking Ink Status from Your Computer](#)
 - For Mac OS:
 - [Checking Ink Status from Your Computer](#)

Maintenance

- ▶ **If Printing Is Faint or Uneven**
- ▶ **Performing Maintenance Functions from Your Computer (Windows)**
- ▶ **Performing Maintenance Functions from Your Computer (Mac OS)**
- ▶ **Cleaning**

If Printing Is Faint or Uneven

- **Maintenance Procedure**
- **Printing the Nozzle Check Pattern**
- **Examining the Nozzle Check Pattern**
- **Cleaning the Print Head**
- **Deep Print Head Cleaning**
- **Aligning the Print Head**

Maintenance Procedure

If print results are blurred, colors are not printed correctly, or print results are unsatisfactory (e.g. misaligned printed ruled lines), perform the maintenance procedure below.

▶▶▶ Important

- Do not rinse or wipe the print head and ink tank. This can cause trouble with the print head and ink tank.

▶▶▶ Note

- Make sure that the orange protective tape does not remain on the ink tank.

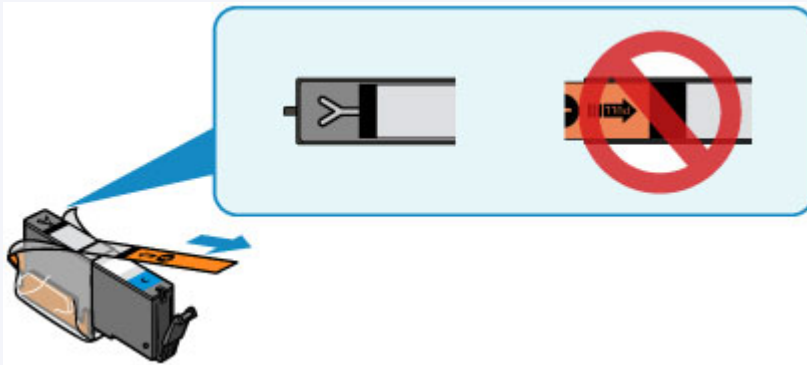

- Open the scanning unit / cover and make sure that the lamp on the ink tank is lit. If the lamp is flashing or off, take appropriate action.

■ [Checking the Ink Status with the Ink Lamps](#)

- Increasing the print quality setting in the printer driver may improve the print result.
 - For Windows:
 - [Changing the Print Quality and Correcting Image Data](#)
 - For Mac OS:
 - [Changing the Print Quality and Correcting Image Data](#)

When the Print Results Are Blurred or Uneven:

Step1 Print the nozzle check pattern.

From the printer

■ [Printing the Nozzle Check Pattern](#)

From the computer

- For Windows:
 - [Printing a Nozzle Check Pattern](#)
- For Mac OS:
 - [Printing a Nozzle Check Pattern](#)

Step2 [Examine the nozzle check pattern.](#)

If there are missing lines or horizontal white streaks in the pattern:



Step 3 Clean the print head.

From the printer

- [Cleaning the Print Head](#)

From the computer

- For Windows:
 - [Cleaning the Print Heads](#)
- For Mac OS:
 - [Cleaning the Print Heads](#)

After cleaning the print head, print and examine the nozzle check pattern: ➔ [Step 1](#)

If the problem is not resolved after performing from step 1 to step 3 twice:



Step 4 Clean the print head deeply.

From the printer

- [Deep Print Head Cleaning](#)

From the computer

- For Windows:
 - [Cleaning the Print Heads](#)
- For Mac OS:
 - [Cleaning the Print Heads](#)

➤➤➤ Note

- When you have performed the procedure until step 4 and the problem has not been resolved, turn off the power and clean the print head deeply again after 24 hours.
If the problem is still not resolved, the print head may be damaged. Contact the service center.

When the Print Results Are Not Even such as the Ruled Lines Are Misaligned:

Step Align the print head.

From the printer

- [Aligning the Print Head](#)

From the computer

- For Windows:
 - [Adjusting Print Head Position](#)

- For Mac OS:

- Adjusting Print Head Position

Printing the Nozzle Check Pattern

Print the nozzle check pattern to determine whether the ink ejects properly from the print head nozzle.

▶▶▶ Note

- If the remaining ink level is low, the nozzle check pattern will not be printed correctly. [Replace the ink tank](#) whose ink is low.

You need to prepare: a sheet of A4 or Letter-sized plain paper

1. Make sure that the power is turned on.
2. Load a sheet of A4 or Letter-sized plain paper in the cassette.

After pushing the cassette back, the paper information registration screen is displayed on the touch screen. Select **A4** or **Letter** for **Page size**, then select **Register**.

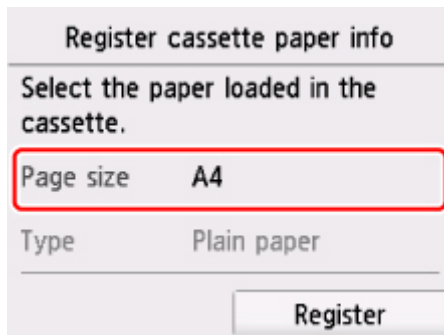

Register cassette paper info

Select the paper loaded in the cassette.

Page size A4

Type Plain paper

Register

If a message is displayed on the screen, follow the directions in the message to complete registration.

▶▶▶ Note

- Be sure to load paper in the cassette. Even if you load paper on the rear tray, the nozzle check pattern is not be printed.

3. Open the operation panel, then pull out the paper output tray.

4. Select  **Setup** on the HOME screen.

■ [Using the Operation Panel](#)

The setup menu screen will appear.

5. Select  **Maintenance**.

The **Maintenance** screen will appear.

6. Select **Print nozzle check pattern**.

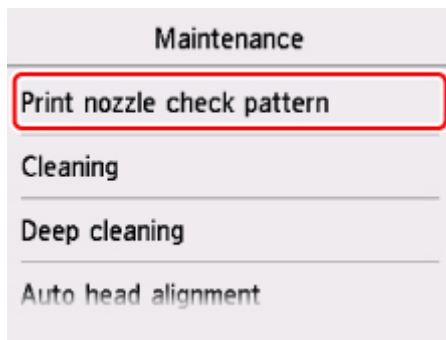

The confirmation screen will appear.

7. Select **Yes**.

The nozzle check pattern will be printed and two pattern confirmation screens will appear on the touch screen.

8. [Examine the nozzle check pattern.](#)

Examining the Nozzle Check Pattern

Examine the nozzle check pattern, and clean the print head if necessary.

1. Check if there are missing lines in the pattern C or horizontal white streaks in the pattern D.

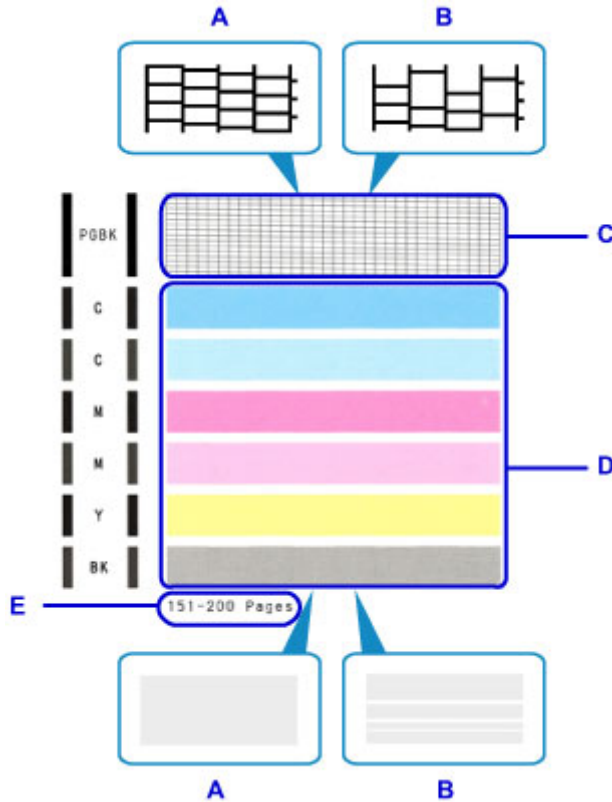

- A: No missing lines/No horizontal white streaks
- B: Lines are missing/Horizontal white streaks are present
- E: Number of sheets printed so far

2. Select the pattern that is closer to the printed nozzle check pattern on the confirmation screen.

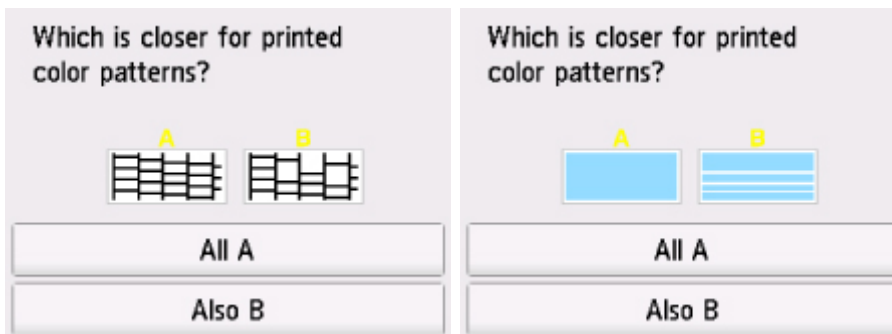

For A (no missing lines or no horizontal white streaks) in both the pattern C and pattern D:

The cleaning is not required. Select **All A**, confirm the message, then select **OK**.

The screen will return to the **Maintenance** screen.

For B (lines are missing or horizontal white streaks are present) in the pattern C or pattern D, or in both patterns:

The cleaning is required. Select **Also B**, then select **Yes** on the cleaning confirmation screen.

The printer starts cleaning the print head.

■ [Cleaning the Print Head](#)

If the pattern D or any color in the pattern C is not printed:



(Example: Magenta pattern is not printed)

The cleaning is required. Select **Also B**, then select **Yes** on the cleaning confirmation screen.

The printer starts cleaning the print head.

■ [Cleaning the Print Head](#)

▶▶▶ Note

- The total number of sheets printed so far is shown in increments of 50 sheets on the printout of the nozzle check pattern.

Cleaning the Print Head

Clean the print head if lines are missing or if horizontal white streaks are present in the printed nozzle check pattern. Cleaning unclogs the nozzles and restores the print head condition. Cleaning the print head consumes ink, so clean the print head only when necessary.

You need to prepare: a sheet of A4 or Letter-sized plain paper

1. Make sure that the power is turned on.
2. Load a sheet of A4 or Letter-sized plain paper in the cassette.

After pushing the cassette back, the paper information registration screen is displayed on the touch screen. Select **A4** or **Letter** for **Page size**, then select **Register**.

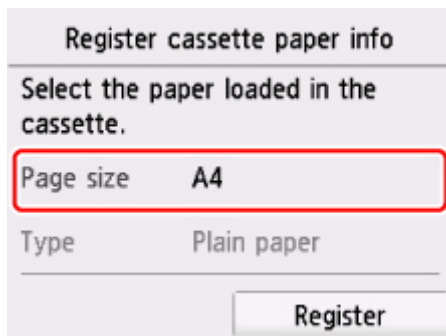

If a message is displayed on the screen, follow the directions in the message to complete registration.

▶▶▶ Note

- Be sure to load paper in the cassette. Even if you load paper on the rear tray, the nozzle check pattern is not be printed.

3. Open the operation panel, then pull out the paper output tray.

4. Select  **Setup** on the HOME screen.

■ [Using the Operation Panel](#)

The setup menu screen will appear.

5. Select  **Maintenance**.

The **Maintenance** screen will appear.

6. Select **Cleaning**.

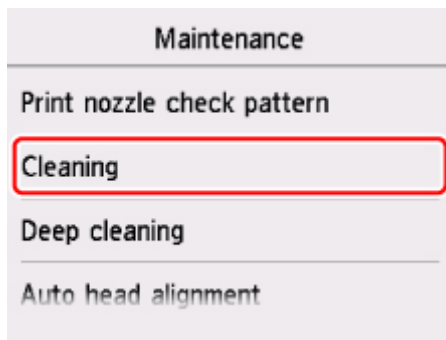

The confirmation screen will appear.

7. Select **Yes**.

The printer starts cleaning the print head.

Do not perform any other operations until the printer completes the cleaning of the print head. This takes about 1 minute.

The pattern print confirmation screen will appear.

8. Select **Yes**.

The nozzle check pattern will be printed.

9. [Examine the nozzle check pattern](#).

▶▶ Note

- If the problem is not resolved after cleaning the print head twice, [clean the print head deeply](#).

Deep Print Head Cleaning

If print quality does not improve by the standard cleaning of the print head, clean the print head deeply. Cleaning the print head deeply consumes more ink than the standard cleaning of the print head, so clean the print head deeply only when necessary.

You need to prepare: a sheet of A4 or Letter-sized plain paper

1. Make sure that the power is turned on.
2. Load a sheet of A4 or Letter-sized plain paper in the cassette.

After pushing the cassette back, the paper information registration screen is displayed on the touch screen. Select **A4** or **Letter** for **Page size**, then select **Register**.

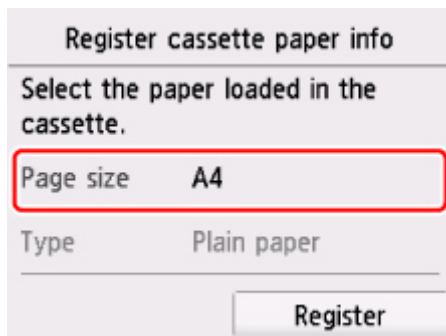

If a message is displayed on the screen, follow the directions in the message to complete registration.

▶▶▶ Note

- Be sure to load paper in the cassette. Even if you load paper on the rear tray, the nozzle check pattern is not be printed.

3. Open the operation panel, then pull out the paper output tray.



4. Select **Setup** on the HOME screen.

■ [Using the Operation Panel](#)

The setup menu screen will appear.



5. Select **Maintenance**.

The **Maintenance** screen will appear.

6. Select **Deep cleaning**.

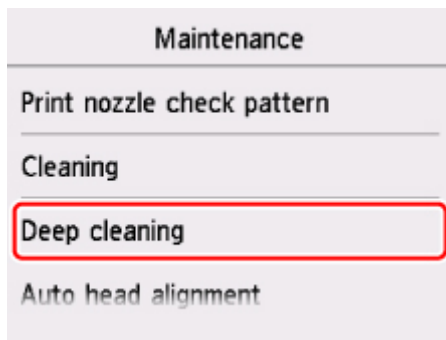

The confirmation screen will appear.

7. Select **Yes**.

The printer starts cleaning the print head deeply.

Do not perform any other operations until the printer completes the deep cleaning of the print head. This takes about 1 to 2 minutes.

The pattern print confirmation screen will appear.

8. Select **Yes**.

The nozzle check pattern will be printed.

9. When the completion message appears, select **OK**.

10. [Examine the nozzle check pattern](#).

If a particular color is not printed properly, [replace the ink tank](#) of that color.

If the problem is not resolved, turn off the power and clean the print head deeply again after 24 hours.

If the problem is still not resolved, the print head may be damaged. Contact the service center.

Aligning the Print Head

If printed ruled lines are misaligned or print results are otherwise unsatisfactory, adjust the print head position.

▶▶▶ Note

- If the remaining ink level is low, the print head alignment sheet will not be printed correctly.

[Replace the ink tank](#) whose ink is low.

You need to prepare: a sheet of A4 or Letter-sized plain paper (including recycled paper)*

* Be sure to use paper that is white and clean on both sides.

1. Make sure that the power is turned on.
2. Load a sheet of A4 or Letter-sized plain paper in the cassette.

After pushing the cassette back, the paper information registration screen is displayed on the touch screen. Select **A4** or **Letter** for **Page size**, then select **Register**.

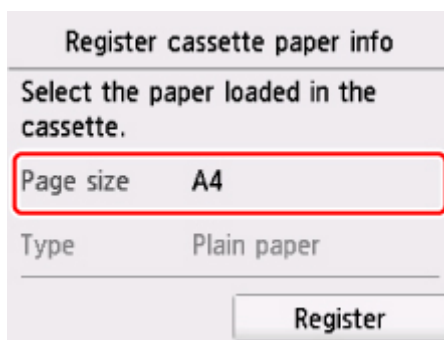

Register cassette paper info	
Select the paper loaded in the cassette.	
Page size	A4
Type	Plain paper
<input type="button" value="Register"/>	

If a message is displayed on the screen, follow the directions in the message to complete registration.

▶▶▶ Note

- Be sure to load paper in the cassette. Even if you load paper on the rear tray, the print head alignment sheet is not be printed.

3. Open the operation panel, then pull out the paper output tray.

4. Select  **Setup** on the HOME screen.

■ [Using the Operation Panel](#)

The setup menu screen will appear.

5. Select  **Maintenance**.

The **Maintenance** screen will appear.

6. Select **Auto head alignment**.

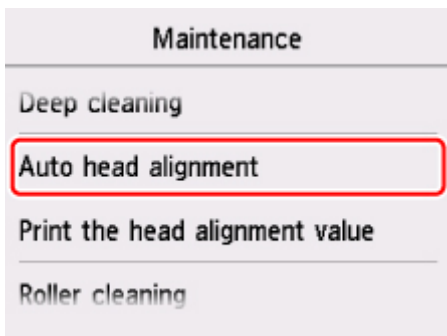

The confirmation screen will appear.

7. Confirm the message, then select **Yes**.

The print head alignment sheet will be printed.

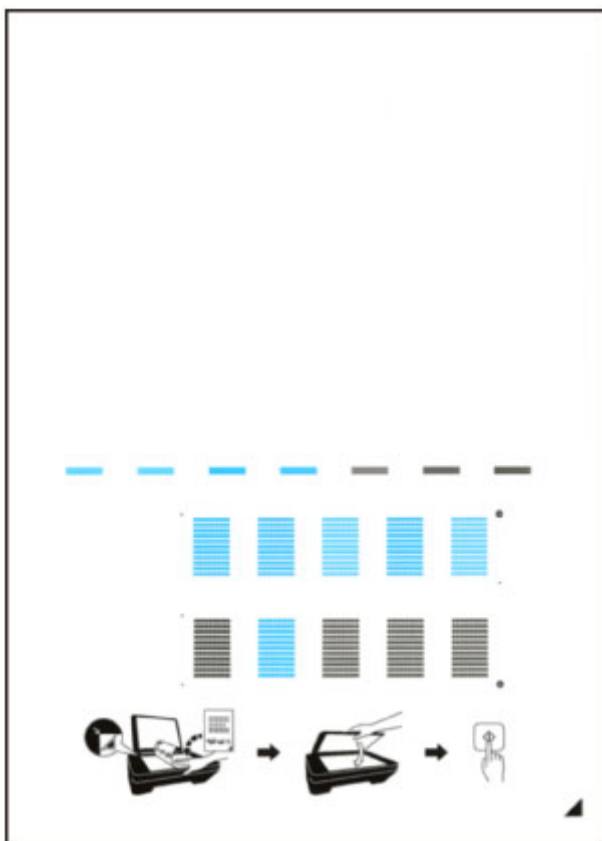

Important

- Do not touch any printed part on the print head alignment sheet. If the sheet is stained or wrinkled, it may not be scanned properly.

8. When the message "**Did the patterns print correctly?**" appears, confirm that the pattern is printed correctly, then select **Yes**.

9. Confirm the message, then load the print head alignment sheet on the platen glass.

Load the print head alignment sheet WITH THE PRINTED SIDE FACING DOWN and align the mark ▲ on the bottom right corner of the sheet with the alignment mark ▼.



10. Close the document cover gently, then select **OK**.

The printer starts scanning the print head alignment sheet, and the print head position will be adjusted automatically.

►► Important

- Do not open the document cover or move the print head alignment sheet on the platen glass until adjusting the print head position is complete.
- If the error message appears on the touch screen, select **OK** to release the error, then take appropriate action.

■ [An Error Occurs](#)

11. When the completion message appears, select **OK**.

Remove the print head alignment sheet on the platen glass.

►► Note

- If the print results are still not satisfactory after adjusting the print head position as described above, adjust the print head position manually from the computer.
 - For Windows:
 - [Adjusting Print Head Position](#)
 - For Mac OS:
 - [Adjusting Print Head Position](#)
- To print and check the current head position adjustment values, select **Print the head alignment value** on the **Maintenance** screen.

Cleaning

- ▶ **Cleaning Exterior Surfaces**
- ▶ **Cleaning the Platen Glass and Document Cover**
- ▶ **Cleaning Paper Feed Rollers**
- ▶ **Cleaning Inside the Printer (Bottom Plate Cleaning)**
- ▶ **Cleaning Cassette Pads**

Cleaning Paper Feed Rollers

If the paper feed roller is dirty or paper powder is attached to it, paper may not be fed properly.

In this case, clean the paper feed roller. Cleaning will wear out the paper feed roller, so perform this only when necessary.

You need to prepare: three sheets of A4 or Letter-sized plain paper

1. Make sure that the power is turned on.

2. Select  **Setup** on the HOME screen.

■ [Using the Operation Panel](#)

The setup menu screen will appear.

3. Select  **Maintenance**.

The **Maintenance** screen will appear.

4. Select **Roller cleaning**.

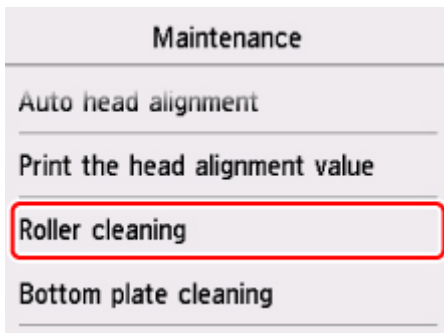

The confirmation screen will appear.

5. Select **Yes**.
6. Select **Rear tray** or **Cassette** to clean the paper feed roller.
7. Follow the message to remove any paper from the paper source.

If you clean the paper feed roller of cassette, remove any paper from the cassette, then push it back.

8. Select **OK**.

The paper feed roller will rotate as it is cleaned without paper.

9. Make sure that the paper feed roller has stopped rotating, then follow the message to load the three sheets of A4 or Letter-sized plain paper.

10. Open the operation panel, then pull out the paper output tray.

11. Select **OK**.

The printer starts cleaning. The cleaning will be complete when the paper is ejected.

12. When the completion message appears, select **OK**.

If the problem is not resolved after cleaning the paper feed roller, contact the service center.

Cleaning Inside the Printer (Bottom Plate Cleaning)

Remove stains from the inside of the printer. If the inside of the printer becomes dirty, printed paper may get dirty, so we recommend performing cleaning regularly.

You need to prepare: a sheet of A4 or Letter-sized plain paper*

* Be sure to use a new piece of paper.

1. Make sure that the power is turned on.
2. Open the operation panel, then pull out the paper output tray.

3. Select  **Setup** on the HOME screen.

 [Using the Operation Panel](#)

The setup menu screen will appear.

4. Select  **Maintenance**.

The **Maintenance** screen will appear.

5. Select **Bottom plate cleaning**.

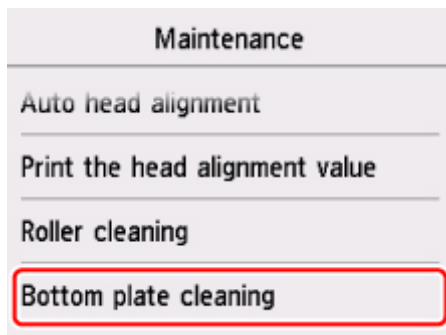

The confirmation screen will appear.

6. Select **Yes**.
7. Follow the message to remove any paper from the cassette, then tap **OK**.
8. Fold a single sheet of A4 or Letter-sized plain paper in half widthwise, then unfold the paper.
9. Fold one side of the opened paper in another half, aligning the edge with the center crease, unfold the paper, then tap **OK**.

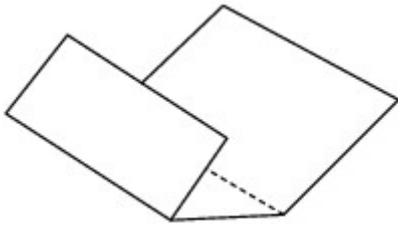

10. Load only this sheet of paper in the cassette with the ridges of the creases facing up and the edge of the half with no crease facing to the far side.



11. Select **OK**.

The paper cleans the inside of the printer as it feeds through the printer.

Check the folded parts of the ejected paper. If they are smudged with ink, perform Bottom Plate Cleaning again.

12. When the completion message appears, select **OK**.

▶▶▶ Note

- When performing Bottom Plate Cleaning again, be sure to use a new piece of paper.

If the problem is not resolved after performing cleaning again, the protrusions inside the printer may be stained. Wipe off any ink from the protrusions using a cotton swab or the like.

▶▶▶ Important

- Be sure to turn off the power and unplug the power cord before cleaning the printer.

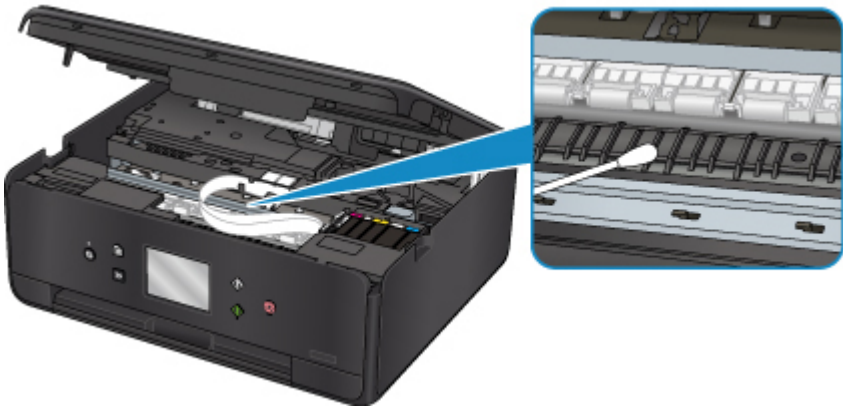

Overview

▶ **Safety**

- Safety Precautions
- Regulatory Information
- WEEE (EU & EEA)

▶ **Main Components and Their Use**

- Main Components
- Power Supply
- Using the Operation Panel

▶ **Changing Settings**

- Changing Printer Settings from Your Computer (Windows)
- Changing Printer Settings from Your Computer (Mac OS)
- Changing Settings from Operation Panel
- Changing Printer's Setting Using Web Browser

▶ **Network Connection**

- Network Connection Tips

▶ **Network Settings (IJ Network Device Setup Utility) (Windows)**

- IJ Network Device Setup Utility
- Starting Up IJ Network Device Setup Utility

▶ **Ensuring Optimal Printing Results**

- Ink Tips
- Printing Tips
- Check Paper Settings Before Printing
- Set Rear Tray/Cassette Paper Information After Loading Paper
- Canceling Print Jobs
- Printer Handling Precautions
- Keeping Print Quality High

- Transporting Your Printer
- ▶ **Legal Restrictions on Scanning/Copying**
- ▶ **Specifications**

Safety

- ▶ **Safety Precautions**
- ▶ **Regulatory Information**
- ▶ **WEEE (EU&EEA)**

Safety Precautions

Choosing a location

- Do not install the printer in a location that is unstable or subject to excessive vibration.
- Do not install the printer in locations that are very humid or dusty, in direct sunlight, outdoors, or close to a heating source.
To avoid the risk of fire or electric shocks, use the printer under the operating environment specified in the [Specifications](#).
- Do not place the printer on a thick rug or carpet.
- Do not place the printer with its back attached to the wall.

Power Supply

- Ensure that the area around the power outlet is kept clear at all times so you can easily unplug the power cord if necessary.
- Never remove the plug by pulling on the cord.
Pulling the cord may damage the power cord, leading to possible fire or electrical shock.
- Do not use an extension lead/cord.

Working Around the Printer

- Never put your hands or fingers in the printer while it is printing.
- When moving the printer, carry the printer at both ends. In case the printer weighs more than 14 kg, it is recommended to have two people lifting the printer. Accidental dropping of the printer causes injury. For the printer's weight, refer to the [Specifications](#).
- Do not place any object on the printer. Especially do not place metal objects (paper clips, staples, etc.) or containers of flammable solvents (alcohol, thinners, etc.) on top of the printer.
- Do not transport or use the printer on a slant, vertically or upside-down, as the ink may leak and damage the printer.
- When loading a thick book on the platen glass, do not press hard on the Document Cover. The platen glass may break and cause injury.

Print Heads/Ink Tanks/FINE Cartridges

- Keep ink tanks out of the reach of children. In case ink is accidentally licked or swallowed, rinse out mouth or give one or two glasses of water to drink. If irritation or discomfort occurs, obtain medical advice immediately.
- In case ink gets in contact with eyes, rinse with water immediately. In case ink gets in contact with skin, wash with soap and water immediately. If irritation to eyes or skin persists, obtain medical advice immediately.
- Never touch the electrical contacts on a print head or FINE cartridges after printing.
The metal parts may be very hot and could cause burns.
- Do not throw ink tanks and FINE cartridges into fire.
- Do not attempt to disassemble or modify the print head, ink tanks, and FINE cartridges.

Regulatory Information

Users in the U.S.A.

FCC Notice (U.S.A. Only)

For 120V, 60Hz model

Model Number: K10444 (Contains FCC Approved WLAN Module K30365)

This device complies with Part 15 of the FCC Rules. Operation is subject to the following two conditions: (1) This device may not cause harmful interference, and (2) this device must accept any interference received, including interference that may cause undesired operation.

Note: This equipment has been tested and found to comply with the limits for a Class B digital device, pursuant to Part 15 of the FCC Rules. These limits are designed to provide reasonable protection against harmful interference in a residential installation. This equipment generates, uses and can radiate radio frequency energy and, if not installed and used in accordance with the instructions, may cause harmful interference to radio communications.

However, there is no guarantee that interference will not occur in a particular installation. If this equipment does cause harmful interference to radio or television reception, which can be determined by turning the equipment off and on, the user is encouraged to try to correct the interference by one or more of the following measures:

- Reorient or relocate the receiving antenna.
- Increase the separation between the equipment and receiver.
- Connect the equipment into an outlet on a circuit different from that to which the receiver is connected.
- Consult the dealer or an experienced radio/TV technician for help.

Use of a shielded cable is required to comply with Class B limits in Subpart B of Part 15 of the FCC Rules.

Do not make any changes or modifications to the equipment unless otherwise specified in the manual. If such changes or modifications should be made, you could be required to stop operation of the equipment.

FCC ID:AZDK30365

Changes or modifications not expressly approved by the party responsible for compliance could void the user's authority to operate equipment.

This transmitter must not be co-located or operating in conjunction with any other antenna or transmitter.

The equipment complies with FCC radiation exposure limits for uncontrolled equipment. This equipment should be installed and operated with minimum distance at least 20cm between the radiator and persons body (excluding extremities: hands, wrists, feet and ankles) and must not be colocated or operated with any other antenna or transmitter.

Canon U.S.A., Inc.

One Canon Park

Melville, New York 11747

1-800-652-2666

Users in Canada

This device complies with Industry Canada license-exempt RSS standard(s). Operation is subject to the following two conditions:

(1) this device may not cause interference, and (2) this device must accept any interference, including interference that may cause undesired operation of the device.

This equipment complies with IC radiation exposure limits set forth for an uncontrolled environment and meets RSS-102 of the IC radio frequency (RF) Exposure rules. This equipment should be installed and operated keeping the radiator at least 20cm or more away from person's body (excluding extremities: hands, wrists, feet and ankles).

Pour les usagers résidant au Canada

Le présent appareil est conforme aux CNR d'Industrie Canada applicables aux appareils radio exempts de licence. L'exploitation est autorisée aux deux conditions suivantes :

(1) l'appareil ne doit pas produire de brouillage, et (2) l'utilisateur de l'appareil doit accepter tout brouillage radioélectrique subi, même si le brouillage est susceptible d'en compromettre le fonctionnement.

Cet équipement est conforme aux limites d'exposition aux rayonnements énoncées pour un environnement non contrôlé et respecte les règles d'exposition aux fréquences radioélectriques (RF) CNR-102 de l'IC. Cet équipement doit être installé et utilisé en gardant une distance de 20 cm ou plus entre le dispositif rayonnant et le corps (à l'exception des extrémités : mains, poignets, pieds et chevilles).

Environmental Information

Reducing your environmental impact

Power Consumption and Operational Modes

The amount of electricity a device consumes depends on the way the device is used. This product is designed and set in a way to allow you to reduce the power consumption. After the last print it switches to Ready Mode. In this mode it can print again immediately if required. If the product is not used for a time, the device switches to its Sleep Mode. The devices consume less power (Watt) in these modes.

Energy Star®

The Energy Star® programme is a voluntary scheme to promote the development and purchase of energy efficient models, which help to minimise environmental impact.

Products which meet the stringent requirements of the Energy Star® programme for both environmental benefits and the amount of energy consumption will carry the Energy Star® logo accordingly.

Paper types

This product can be used to print on both recycled and virgin paper (certified to an environmental stewardship scheme), which complies with EN12281 or a similar quality standard. In addition it can support printing on media down to a weight of 64g/m², lighter paper means less resources used and a lower environmental footprint for your printing needs.



WEEE (EU&EEA)

Only for European Union and EEA (Norway, Iceland and Liechtenstein)



This symbol indicates that this product is not to be disposed of with your household waste, according to the WEEE Directive (2012/19/EU) and national legislation. This product should be handed over to a designated collection point, e.g., on an authorized one-for-one basis when you buy a new similar product or to an authorized collection site for recycling waste electrical and electronic equipment (EEE). Improper handling of this type of waste could have a possible negative impact on the environment and human health due to potentially hazardous substances that are generally associated with EEE. At the same time, your cooperation in the correct disposal of this product will contribute to the effective usage of natural resources. For more information about where you can drop off your waste equipment for recycling, please contact your local city office, waste authority, approved WEEE scheme or your household waste disposal service. For more information regarding return and recycling of WEEE products, please visit www.canon-europe.com/weee.

Nur für Europäische Union und EWR (Norwegen, Island und Liechtenstein)



Dieses Symbol weist darauf hin, dass dieses Produkt gemäß der EU-Richtlinie über Elektro- und Elektronik-Altgeräte (2012/19/EU) und nationalen Gesetzen nicht über den Hausmüll entsorgt werden darf. Dieses Produkt muss bei einer dafür vorgesehenen Sammelstelle abgegeben werden. Dies kann z. B. durch Rückgabe beim Kauf eines ähnlichen Produkts oder durch Abgabe bei einer autorisierten Sammelstelle für die Wiederaufbereitung von Elektro- und Elektronik-Altgeräten geschehen. Der unsachgemäße Umgang mit Altgeräten kann aufgrund potentiell gefährlicher Stoffe, die generell mit Elektro- und Elektronik-Altgeräten in Verbindung stehen, negative Auswirkungen auf die Umwelt und die menschliche Gesundheit haben. Durch die umweltgerechte Entsorgung dieses Produkts tragen Sie außerdem zu einer effektiven Nutzung natürlicher Ressourcen bei. Informationen zu Sammelstellen für Altgeräte erhalten Sie bei Ihrer Stadtverwaltung, dem öffentlich-rechtlichen Entsorgungsträger, einer autorisierten Stelle für die Entsorgung von Elektro- und Elektronik-Altgeräten oder Ihrem örtlichen Entsorgungsunternehmen. Weitere Informationen zur Rückgabe und Entsorgung von Elektro- und Elektronik-Altgeräten finden Sie unter www.canon-europe.com/weee.

Union Européenne, Norvège, Islande et Liechtenstein uniquement.



Ce symbole indique que ce produit ne doit pas être jeté avec les ordures ménagères, conformément à la directive DEEE (2012/19/UE) et à la réglementation de votre pays. Ce produit doit être confié au distributeur à chaque fois que vous achetez un produit neuf similaire, ou à un point de collecte mis en

place par les collectivités locales pour le recyclage des Déchets des Équipements Électriques et Électroniques (DEEE). Le traitement inapproprié de ce type de déchet risque d'avoir des répercussions sur l'environnement et la santé humaine, du fait de la présence de substances potentiellement dangereuses généralement associées aux équipements électriques et électroniques. Parallèlement, votre entière coopération dans le cadre de la mise au rebut correcte de ce produit favorisera une meilleure utilisation des ressources naturelles. Pour plus d'informations sur les points de collecte des équipements à recycler, contactez vos services municipaux, les autorités locales compétentes, le plan DEEE approuvé ou le service d'enlèvement des ordures ménagères. Pour plus d'informations sur le retour et le recyclage des produits DEEE, consultez le site: www.canon-europe.com/weee.

Uitsluitend bestemd voor de Europese Unie en EER (Noorwegen, IJsland en Liechtenstein)



Dit symbool geeft aan dat dit product in overeenstemming met de AEEA-richtlijn (2012/19/EU) en de nationale wetgeving niet mag worden afgevoerd met het huishoudelijk afval. Dit product moet worden ingeleverd bij een aangewezen, geautoriseerd inzamelpunt, bijvoorbeeld wanneer u een nieuw gelijksoortig product aanschaft, of bij een geautoriseerd inzamelpunt voor hergebruik van elektrische en elektronische apparatuur (EEA). Een onjuiste afvoer van dit type afval kan leiden tot negatieve effecten op het milieu en de volksgezondheid als gevolg van potentieel gevaarlijke stoffen die veel voorkomen in elektrische en elektronische apparatuur (EEA). Bovendien werkt u door een juiste afvoer van dit product mee aan het effectieve gebruik van natuurlijke hulpbronnen. Voor meer informatie over waar u uw afgedankte apparatuur kunt inleveren voor recycling kunt u contact opnemen met het gemeentehuis in uw woonplaats, de reinigingsdienst, of het afvalverwerkingsbedrijf. U kunt ook het schema voor de afvoer van afgedankte elektrische en elektronische apparatuur (AEEA) raadplegen. Ga voor meer informatie over het inzamelen en recyclen van afgedankte elektrische en elektronische apparatuur naar www.canon-europe.com/weee.

Sólo para la Unión Europea y el Área Económica Europea (Noruega, Islandia y Liechtenstein)



Este símbolo indica que este producto no debe desecharse con los desperdicios domésticos, de acuerdo con la directiva RAEE (2012/19/UE) y con la legislación nacional. Este producto debe entregarse en uno de los puntos de recogida designados, como por ejemplo, entregándolo en el lugar de venta al comprar un producto similar o depositándolo en un lugar de recogida autorizado para el reciclado de residuos de aparatos eléctricos y electrónicos (RAEE). La manipulación inapropiada de este tipo de desechos podría tener un impacto negativo en el entorno y la salud humana, debido a las sustancias potencialmente peligrosas que normalmente están asociadas con los RAEE. Al mismo tiempo, su cooperación a la hora de desechar correctamente este producto contribuirá a la utilización eficaz de los recursos naturales. Para más información sobre cómo puede eliminar el equipo para su reciclado, póngase en contacto con las autoridades locales, con las autoridades encargadas de los desechos, con un sistema de gestión RAEE

autorizado o con el servicio de recogida de basuras doméstico. Si desea más información acerca de la devolución y reciclado de RAEE, visite la web www.canon-europe.com/weee.

Només per a la Unió Europea i a l'Espai Econòmic Europeu (Noruega, Islàndia i Liechtenstein)



Aquest símbol indica que aquest producte no s'ha de llençar a les escombraries de la llar, d'acord amb la Directiva RAEE (2012/19/UE) i la legislació nacional. Aquest producte s'hauria de lliurar en un dels punts de recollida designats, com per exemple, intercanviant-lo un per un en comprar un producte similar o lliurant-lo en un lloc de recollida autoritzat per al reciclatge de residus d'aparells elèctrics i electrònics (AEE). La manipulació inadequada d'aquest tipus de residus podria tenir un impacte negatiu en l'entorn i en la salut humana, a causa de les substàncies potencialment perilloses que normalment estan associades als AEE. Així mateix, la vostra cooperació a l'hora de llençar correctament aquest producte contribuirà a la utilització efectiva dels recursos naturals. Per a més informació sobre els punts on podeu lliurar aquest producte per procedir al seu reciclatge, adreceu-vos a la vostra oficina municipal, a les autoritats encarregades dels residus, al pla de residus homologat per la RAEE o al servei de recollida de deixalles domèstiques de la vostra localitat. Per a més informació sobre la devolució i el reciclatge de productes RAEE, visiteu www.canon-europe.com/weee.

Solo per Unione Europea e SEE (Norvegia, Islanda e Liechtenstein)



Questo simbolo indica che il prodotto deve essere oggetto di raccolta separata in conformità alla Direttiva RAEE (2012/19/UE) e alla normativa locale vigente. Il prodotto deve essere smaltito presso un centro di raccolta differenziata, un distributore autorizzato che applichi il principio dell'"uno contro uno", ovvero del ritiro della vecchia apparecchiatura elettrica al momento dell'acquisto di una nuova, o un impianto autorizzato al riciclaggio dei rifiuti di apparecchiature elettriche ed elettroniche. La gestione impropria di questo tipo di rifiuti può avere un impatto negativo sull'ambiente e sulla salute umana causato dalle sostanze potenzialmente pericolose che potrebbero essere contenute nelle apparecchiature elettriche ed elettroniche. Un corretto smaltimento di tali prodotti contribuirà inoltre a un uso efficace delle risorse naturali ed eviterà di incorrere nelle sanzioni amministrative di cui all'art. 255 e successivi del Decreto Legislativo n. 152/06. Per ulteriori informazioni sullo smaltimento e il recupero dei Rifiuti di Apparecchiature Elettriche ed Elettroniche, consultare la Direttiva RAEE, rivolgersi alle autorità competenti, oppure visitare il sito www.canon-europe.com/weee.

Apenas para a União Europeia e AEE (Noruega, Islândia e Liechtenstein)



Este símbolo indica que o produto não deve ser colocado no lixo doméstico, de acordo com a Directiva REEE (2012/19/UE) e a legislação nacional. Este produto deverá ser colocado num ponto de recolha designado, por exemplo, num local próprio autorizado quando adquirir um produto semelhante novo ou num local de recolha autorizado para reciclar resíduos de equipamentos eléctricos e electrónicos (EEE). O tratamento inadequado deste tipo de resíduo poderá causar um impacto negativo no ambiente e na saúde humana devido às substâncias potencialmente perigosas normalmente associadas aos equipamentos eléctricos e electrónicos. Simultaneamente, a sua cooperação no tratamento correcto deste produto contribuirá para a utilização eficaz dos recursos naturais. Para mais informações sobre os locais onde o equipamento poderá ser reciclado, contacte os serviços locais, a autoridade responsável pelos resíduos, o esquema REEE aprovado ou o serviço de tratamento de lixo doméstico. Para mais informações sobre a devolução e reciclagem de produtos REEE, vá a www.canon-europe.com/weee.

Gælder kun i Europæiske Union og EØS (Norge, Island og Liechtenstein)



Dette symbol angiver, at det pågældende produkt ikke må bortskaffes sammen med dagrenovation jf. direktivet om affald af elektrisk og elektronisk udstyr (WEEE) (2012/19/EU) og gældende national lovgivning. Det pågældende produkt skal afleveres på et nærmere specificeret indsamlingssted, f.eks. i overensstemmelse med en godkendt én-til-én-procedure, når du indkøber et nyt tilsvarende produkt, eller produktet skal afleveres på et godkendt indsamlingssted for elektronikaffald. Forkert håndtering af denne type affald kan medføre negative konsekvenser for miljøet og menneskers helbred på grund af de potentielt sundhedsskadelige stoffer, der generelt kan forefindes i elektrisk og elektronisk udstyr. Når du foretager korrekt bortskaffelse af det pågældende produkt, bidrager du til effektiv brug af naturressourcerne. Yderligere oplysninger om, hvor du kan bortskaffe dit elektronikaffald med henblik på genanvendelse, får du hos de kommunale renovationsmyndigheder. Yderligere oplysninger om returnering og genanvendelse af affald af elektrisk og elektronisk udstyr får du ved at besøge www.canon-europe.com/weee.

Μόνο για την Ευρωπαϊκή Ένωση και τον ΕΟΧ (Νορβηγία, Ισλανδία και Λιχτενστάιν)



Αυτό το σύμβολο υποδηλώνει ότι αυτό το προϊόν δεν πρέπει να απορρίπτεται μαζί με τα οικιακά απορρίμματα, σύμφωνα με την Οδηγία σχετικά με τα Απόβλητα Ηλεκτρικού και Ηλεκτρονικού Εξοπλισμού (ΑΗΗΕ) (2012/19/ΕΕ) και την εθνική σας νομοθεσία. Αυτό το προϊόν πρέπει να παραδίδεται σε καθορισμένο σημείο συλλογής, π.χ. σε μια εξουσιοδοτημένη βάση ανταλλαγής όταν αγοράζετε ένα νέο παρόμοιο προϊόν ή σε μια εξουσιοδοτημένη θέση συλλογής για την ανακύκλωση των αποβλήτων Ηλεκτρικού και Ηλεκτρονικού Εξοπλισμού (ΗΗΕ). Ο ακατάλληλος χειρισμός αυτού του τύπου αποβλήτων μπορεί να έχει αρνητικό αντίκτυπο στο περιβάλλον και την υγεία του ανθρώπου, λόγω δυνητικώς επικίνδυνων ουσιών που γενικά συνδέονται με τον ΗΗΕ. Ταυτόχρονα, η συνεργασία σας όσον αφορά τη σωστή απόρριψη αυτού του προϊόντος θα συμβάλει στην αποτελεσματική χρήση των φυσικών πόρων. Για περισσότερες πληροφορίες σχετικά με τα σημεία όπου μπορείτε να απορρίψετε τον εξοπλισμό σας για

ανακύκλωση, επικοινωνήστε με το τοπικό γραφείο της πόλης σας, την υπηρεσία απορριμμάτων, το εγκεκριμένο σχήμα ΑΗΗΕ ή την υπηρεσία απόρριψης οικιακών αποβλήτων. Για περισσότερες πληροφορίες σχετικά με την επιστροφή και την ανακύκλωση των προϊόντων ΑΗΗΕ, επισκεφθείτε την τοποθεσία www.canon-europe.com/weee.

Gjelder kun den europeiske union og EØS (Norge, Island og Liechtenstein)



Dette symbolet indikerer at dette produktet ikke skal kastes sammen med husholdningsavfall, i henhold til WEEE-direktiv (2012/19/EU) og nasjonal lov. Produktet må leveres til et dertil egnet innsamlingspunkt, det vil si på en autorisert en-til-en-basis når du kjøper et nytt lignende produkt, eller til et autorisert innsamlingssted for resirkulering av avfall fra elektrisk og elektronisk utstyr (EE-utstyr). Feil håndtering av denne typen avfall kan være miljø- og helseskadelig på grunn av potensielt skadelige stoffer som ofte brukes i EE-utstyr. Samtidig bidrar din innsats for korrekt avhending av produktet til effektiv bruk av naturressurser. Du kan få mer informasjon om hvor du kan avhende utrangert utstyr til resirkulering ved å kontakte lokale myndigheter, et godkjent WEEE-program eller husholdningens renovasjonsselskap. Du finner mer informasjon om retur og resirkulering av WEEE-produkter på www.canon-europe.com/weee.

Vain Euroopan unionin sekä ETA:n (Norja, Islanti ja Liechtenstein) alueelle.



Tämä tunnus osoittaa, että sähkö- ja elektroniikkalaiteromua koskeva direktiivi (SER-direktiivi, 2012/19/EU) sekä kansallinen lainsäädäntö kieltävät tuotteen hävittämisen talousjätteen mukana. Tuote on vietävä asianmukaiseen keräyspisteeseen, esimerkiksi kodinkoneliikkeeseen uutta vastaavaa tuotetta ostettaessa tai viralliseen sähkö- ja elektroniikkalaiteromun keräyspisteeseen. Sähkö- ja elektroniikkalaiteromun virheellinen käsittely voi vahingoittaa ympäristöä ja ihmisten terveyttä, koska laitteet saattavat sisältää ympäristölle ja terveydelle haitallisia aineita. Lisäksi tuotteen asianmukainen hävittäminen säästää luonnonvaroja. Lisätietoja sähkö- ja elektroniikkalaiteromun keräyspisteistä saat kaupunkien ja kuntien tiedotuksesta, jätehuoltoviranomaisilta, sähkö- ja elektroniikkalaiteromun kierrätysjärjestelmän ylläpitäjältä ja jätehuoltoyhtiöltä. Lisätietoja sähkö- ja elektroniikkalaiteromun keräyksestä ja kierrätyksestä on osoitteessa www.canon-europe.com/weee.

Endast för Europeiska unionen och EES (Norge, Island och Liechtenstein)



Den här symbolen visar att produkten enligt WEEE-direktivet (2012/19/EU) och nationell lagstiftning inte får sorteras och slängas som hushållsavfall. Den här produkten ska lämnas in på en därför avsedd insamlingsplats, t.ex. på en återvinningsstation auktoriserad att hantera elektrisk och elektronisk utrustning (EE-utrustning) eller hos handlare som är auktoriserade att byta in varor då nya, motsvarande

köps (en mot en). Olämplig hantering av avfall av den här typen kan ha en negativ inverkan på miljön och människors hälsa på grund av de potentiellt farliga ämnen som kan återfinnas i elektrisk och elektronisk utrustning. Din medverkan till en korrekt avfallshantering av den här produkten bidrar dessutom till en effektiv användning av naturresurserna. Kontakta ditt lokala kommunkontor, berörd myndighet, företag för avfallshantering eller ta del av en godkänd WEEE-organisation om du vill ha mer information om var du kan lämna den kasserade produkten för återvinning. För mer information om inlämning och återvinning av WEEE-produkter, se www.canon-europe.com/weee.

Pouze Evropská unie a EHP (Norsko, Island a Lichtenštejsko)



Tento symbol znamená, že podle směrnice o OEEZ (2012/19/EU) a podle vnitrostátních právních předpisů nemá být tento výrobek likvidován s odpadem z domácností. Tento výrobek má být vrácen do sběrného místa, např. v rámci autorizovaného systému odběru jednoho výrobku za jeden nově prodaný podobný výrobek nebo v autorizovaném sběrném místě pro recyklaci odpadních elektrických a elektronických zařízení (OEEZ). Nevhodné nakládání s tímto druhem odpadu by mohlo mít negativní dopad na životní prostředí a lidské zdraví, protože elektrická a elektronická zařízení zpravidla obsahují potenciálně nebezpečné látky. Vaše spolupráce na správné likvidaci tohoto výrobku současně napomůže efektivnímu využívání přírodních zdrojů. Další informace o místech sběru vašeho odpadního zařízení k recyklaci vám sdělí místní úřad vaší obce, správní orgán vykonávající dozor nad likvidací odpadu, sběrný OEEZ nebo služba pro odvoz komunálního odpadu. Další informace týkající se vracení a recyklace OEEZ naleznete na adrese www.canon-europe.com/weee.

Csak az Európai Unió és az EGT (Norvégia, Izland és Liechtenstein) országában



Ez a szimbólum azt jelzi, hogy a helyi törvények és a WEEE-irányelv (2012/19/EU) szerint a termék nem kezelhető háztartási hulladékként. A terméket a kijelölt nyilvános gyűjtőpontokon kell leadni, például hasonló cserekészülék vásárlásakor, illetve bármelyik, elektromos és elektronikai berendezésekből származó hulladék (WEEE) átvételére feljogosított gyűjtőponton. Az ilyen jellegű hulladékok a nem megfelelő kezelés esetén a bennük található veszélyes anyagok révén ártalmasak lehetnek a környezetre és az emberek egészségére. Továbbá, a termékből származó hulladék megfelelő kezelésével hozzájárulhat a természetes nyersanyagok hatékonyabb hasznosításához. A berendezésekből származó, újrahasznosítható hulladékok elhelyezésére vonatkozó további tudnivalóért forduljon a helyi önkormányzathoz, a közterület-fenntartó vállalathoz, a háztartási hulladék begyűjtését végző vállalathoz, illetve a hivatalos WEEE-képviselőhöz. További tudnivalókat a WEEE-termékek visszajuttatásáról és újrahasznosításáról a www.canon-europe.com/weee.

Tylko dla krajów Unii Europejskiej oraz EOG (Norwegia, Islandia i Liechtenstein)



Ten symbol oznacza, że zgodnie z dyrektywą WEEE dotyczącą zużytego sprzętu elektrycznego i elektronicznego (2012/19/UE) oraz przepisami lokalnymi nie należy wyrzucać tego produktu razem z odpadami gospodarstwa domowego. Produkt należy przekazać do wyznaczonego punktu gromadzenia odpadów, np. firmie, od której kupowany jest nowy, podobny produkt lub do autoryzowanego punktu gromadzenia zużytego sprzętu elektrycznego i elektronicznego w celu poddania go recyklingowi. Usuwanie tego typu odpadów w nieodpowiedni sposób może mieć negatywny wpływ na otoczenie i zdrowie innych osób ze względu na niebezpieczne substancje stosowane w takim sprzęcie. Jednocześnie pozbycie się zużytego sprzętu w zalecany sposób przyczynia się do właściwego wykorzystania zasobów naturalnych. Aby uzyskać więcej informacji na temat punktów, do których można dostarczyć sprzęt do recyklingu, prosimy skontaktować się z lokalnym urzędem miasta, zakładem utylizacji odpadów, skorzystać z instrukcji zatwierdzonej dyrektywą WEEE lub skontaktować się z przedsiębiorstwem zajmującym się wywozem odpadów domowych. Więcej informacji o zwracaniu i recyklingu zużytego sprzętu elektrycznego i elektronicznego znajduje się w witrynie www.canon-europe.com/weee.

Plati len pre štáty Európskej únie a EHP (Nórsko, Island a Lichtenštajnsko)



Tento symbol znamená, že podľa Smernice 2012/19/EÚ o odpade z elektrických a elektronických zariadení (OEEZ) a podľa platnej legislatívy Slovenskej republiky sa tento produkt nesmie likvidovať spolu s komunálnym odpadom. Produkt je potrebné odovzdať do určenej zberne, napr. prostredníctvom výmeny za kúpu nového podobného produktu, alebo na autorizované zberné miesto, ktoré spracúva odpad z elektrických a elektronických zariadení (EEZ). Nesprávna manipulácia s takýmto typom odpadu môže mať negatívny vplyv na životné prostredie a ľudské zdravie, pretože elektrické a elektronické zariadenia obsahujú potenciálne nebezpečné látky. Spoluprácou na správnej likvidácii produktu prispejete k účinnému využívaniu prírodných zdrojov. Ďalšie informácie o mieste recyklácie opotrebovaných zariadení získate od miestneho úradu, úradu životného prostredia, zo schváleného plánu OEEZ alebo od spoločnosti, ktorá zaisťuje likvidáciu komunálneho odpadu. Viac informácií nájdete aj na webovej stránke: www.canon-europe.com/weee.

Üksnes Euroopa Liit ja EMP (Norra, Island ja Liechtenstein)



See sümbol näitab, et antud toodet ei tohi vastavalt elektri- ja elektroonikaseadmete jäätmeid käsitlevale direktiivile (2012/19/EL) ning teie riigis kehtivatele õigusaktidele utiliseerida koos olmejäätmetega. Antud toode tuleb anda selleks määratud kogumispunkti, nt müügipunkt, mis on volitatud üks ühe vastu vahetama, kui ostate uue sarnase toote, või elektri- ja elektroonikaseadmete jäätmete ümbertöötlemiseks

mõeldud kogumispunkti. Täiendava teabe saamiseks elektri- ja elektroonikaseadmetest tekkinud jäätmete tagastamise ja ümbertöötlemise kohta võtke ühendust kohaliku omavalitsusega, asjakohase valitsusasutusega, asjakohase tootjavastutusorganisatsiooniga või olmejäätmete käitlejaga. Lisateavet leitate ka Interneti-leheküljelt www.canon-europe.com/weee.

Tikai Eiropas Savienībai un EEZ (Norvēģijai, Islandei un Lihtenšteinai)



Šis simbols norāda, ka atbilstoši ES Direktīvai (2012/19/ES) par elektrisko un elektronisko iekārtu atkritumiem (EEIA) un vietējiem tiesību aktiem no šī izstrādājuma nedrīkst atbrīvoties, izmetot to kopā ar sadzīves atkritumiem. Šis izstrādājums ir jānodod piemērotā savākšanas vietā, piemēram, apstiprinātā veikalā, kur iegādājaties līdzīgu jaunu produktu un atstājat veco, vai apstiprinātā vietā izlietotu elektrisko un elektronisko iekārtu pārstrādei. Nepareiza šāda veida atkritumu apsaimniekošana var apdraudēt vidi un cilvēka veselību tādu iespējami bīstamu vielu dēļ, kas parasti ir elektriskajās un elektroniskajās iekārtās. Turklāt jūsu atbalsts pareizā šāda veida atkritumu apsaimniekošanā sekmēs efektīvu dabas resursu izmantošanu. Lai saņemtu pilnīgāku informāciju par vietām, kur izlietoto iekārtu var nodot pārstrādei, sazinieties ar vietējo pašvaldību, atkritumu savākšanas atbildīgo dienestu, pilnvarotu EEIA struktūru vai sadzīves atkritumu apsaimniekošanas iestādi. Lai saņemtu plašāku informāciju par elektrisko un elektronisko iekārtu nodošanu pārstrādei, apmeklējiet tīmekļa vietni www.canon-europe.com/weee.

Tik Europos Sąjungai ir EEE (Norvegijai, Islandijai ir Lichtenšteinai)



Šis ženkla reiškia, kad gaminio negalima išmesti su buitiniemis atliekomis, kaip yra nustatyta Direktyvoje (2012/19/ES) ir nacionaliniuose teisė aktuose dėl EEJ atliekų tvarkymo. Šį gaminį reikia atiduoti į tam skirtą surinkimo punktą, pvz., pagal patvirtintą keitimo sistemą, kai perkamas panašus gaminys, arba į elektros ir elektroninės įrangos (EEJ) atliekų perdirbimo punktą. Netinkamas tokios rūšies atliekų tvarkymas dėl elektros ir elektroninėje įrangoje esančių pavojingų medžiagų gali pakenkti aplinkai ir žmonių sveikatai. Padėdami užtikrinti tinkamą šio gaminio šalinimo tvarką, kartu prisidėsite prie veiksmingo gamtos išteklių naudojimo. Jei reikia daugiau informacijos, kaip šalinti tokias atliekas, kad jos būtų toliau perdirbamos, kreipkitės į savo miesto valdžios institucijas, atliekų tvarkymo organizacijas, patvirtintų EEJ atliekų sistemų arba jūsų buitinių atliekų tvarkymo įstaigų atstovus. Išsamesnės informacijos apie EEJ atliekų grąžinimo ir perdirbimo tvarką galite rasti apsilankę tinklalapyje www.canon-europe.com/weee.

Samo za Evropsko unijo in EGP (Norveška, Islandija in Lihtenštajn)



Ta simbol pomeni, da tega izdelka v skladu z direktivo OEE0 (2012/19/EU) in državno zakonodajo ne smete odvreči v gospodinjske odpadke. Ta izdelek morate odložiti na ustrezno zbiralno mesto, na primer pri pooblaščenem prodajalcu, ko kupite podoben nov izdelek ali na zbiralno mesto za recikliranje električne in elektronske opreme. Neprimerno ravnanje s takšnimi odpadki lahko negativno vpliva na okolje in človekovo zdravje zaradi nevarnih snovi, ki so povezane z električno in elektronsko opremo. S pravilno odstranitvijo izdelka hkrati prispevate tudi k učinkoviti porabi naravnih virov. Če želite več informacij o tem, kje lahko odložite odpadno opremo za recikliranje, pokličite občinski urad, komunalno podjetje ali službo, ki skrbi za odstranjevanje odpadkov, ali si oglejte načrt OEE0. Če želite več informacij o vračanju in recikliranju izdelkov v skladu z direktivo OEE0, obiščite www.canon-europe.com/weee.

Само за Европейския съюз и ЕИП (Норвегия, Исландия и Лихтенщайн)



Този символ показва, че този продукт не трябва да се изхвърля заедно с битовите отпадъци, съгласно Директивата за ИУЕЕО (2012/19/ЕС) и Вашето национално законодателство. Този продукт трябва да бъде предаден в предназначен за целта пункт за събиране, например на база размяна, когато купувате нов подобен продукт, или в одобрен събирателен пункт за рециклиране на излязло от употреба електрическо и електронно оборудване (ИУЕЕО). Неправилното третиране на този тип отпадъци може да доведе до евентуални отрицателни последици за околната среда и човешкото здраве поради потенциално опасните вещества, които обикновено са свързани с ЕЕО. В същото време Вашето съдействие за правилното изхвърляне на този продукт ще допринесе за ефективното използване на природните ресурси. Повече информация относно местата, където може да предавате излязло от употреба оборудване за рециклиране, може да получите от местните власти, от органа, отговорен за отпадъците и от одобрена система за излязло от употреба ЕЕО или от Вашата местна служба за битови отпадъци. За повече информация относно връщането и рециклирането на продукти от излязло от употреба ЕЕО посетете www.canon-europe.com/weee.

Doar pentru Uniunea Europeană și EEA (Norvegia, Islanda și Liechtenstein)



Acest simbol indică faptul că acest produs nu trebuie aruncat o dată cu reziduurile menajere, în conformitate cu Directiva DEEE (Directiva privind deșeurile de echipamente electrice și electronice) (2012/19/UE) și legile naționale. Acest produs trebuie transportat la un punct de colectare special, de exemplu un centru care preia produsele vechi atunci când achiziționați un produs nou similar, sau la un punct de colectare autorizat pentru reciclarea deșeurilor provenite de la echipamentele electrice și electronice (EEE). Mănuirea necorespunzătoare a acestor tipuri de deșeuri poate avea un impact negativ asupra mediului înconjurător și sănătății indivizilor, din cauza substanțelor potențial nocive care sunt în general asociate cu EEE. În același timp, cooperarea dvs. la reciclarea corectă a acestui produs va contribui la utilizarea efectivă a resurselor naturale. Pentru mai multe informații privind locurile de reciclare a deșeurilor provenite de la echipamente, contactați biroul primăriei locale, autoritatea responsabilă cu colectarea deșeurilor, schema DEEE aprobată sau serviciul de colectare a deșeurilor menajere. Pentru

mai multe informații privind returnarea și reciclarea produselor DEEE, vizitați www.canon-europe.com/weee.

Samo za Europsku uniju i EEZ (Norveška, Island i Lihtenštajn)



Ovaj simbol pokazuje da se ovaj proizvod ne smije odlagati s kućnim otpadom sukladno WEEE Direktivi (2012/19/EC) i vašem nacionalnom zakonu. Ovaj proizvod je potrebno predati na posebno mjesto za sakupljanje otpada, npr. na ovlašteno mjesto gdje možete zamijeniti staro za novo ukoliko kupujete novi sličan proizvod ili na ovlašteno mjesto za sakupljanje rabljene električne i elektroničke opreme (EEE) za recikliranje. Nepropropisno rukovanje ovom vrstom otpada može imati negativan učinak na okolinu i zdravlje ljudi zbog supstanci koje su potencijalno opasne za zdravlje, a općenito se povezuju s EEE. Istovremeno, vaša će suradnja kroz propisno odlaganje ovog proizvoda doprinijeti efektivnoj uporabi prirodnih resursa. Za više informacija o tome gdje možete odložiti svoj otpad za recikliranje obratite se vašem lokalnom gradskom uredu, komunalnoj službi, odobrenom WEEE programu ili službi za odlaganje kućnog otpada. Ostale informacije o vraćanju i recikliranju WEEE proizvoda potražite na www.canon-europe.com/weee.

Korisnici u Srbiji



Ovaj simbol označava da ovaj proizvod ne sme da se odlaže sa ostalim kućnim otpadom, u skladu sa WEEE Direktivom (2012/19/EU) i nacionalnim zakonima. Ovaj proizvod treba predati određenom centru za prikupljanje, npr. na osnovi "jedan-za-jedan" kada kupujete sličan novi proizvod, ili ovlašćenom centru za prikupljanje za reciklažu istrošene električne i elektronske opreme (EEE). Nepravilno rukovanje ovom vrstom otpada može da ima moguće negativne posledice po životnu sredinu i ljudsko zdravlje usled potencijalno opasnih materijala koji se uglavnom vezuju za EEE. U isto vreme, vaša saradnja na ispravnom odlaganju ovog proizvoda će doprineti efikasnom korišćenju prirodnih resursa. Za više informacija o tome gde možete da predate vašu staru opremu radi recikliranja, vas molimo, da kontaktirate lokalne gradske vlasti, komunalne službe, odobreni plan reciklaže ili Gradsku čistoću. Za više informacija o vraćanju i recikliranju WEEE proizvoda, posetite stranicu www.canon-europe.com/weee.

Main Components and Their Use

- ▶ **Main Components**
- ▶ **Power Supply**
- ▶ **Using the Operation Panel**

Main Components

- ▶ **Front View**
- ▶ **Rear View**
- ▶ **Inside View**
- ▶ **Operation Panel**

Front View

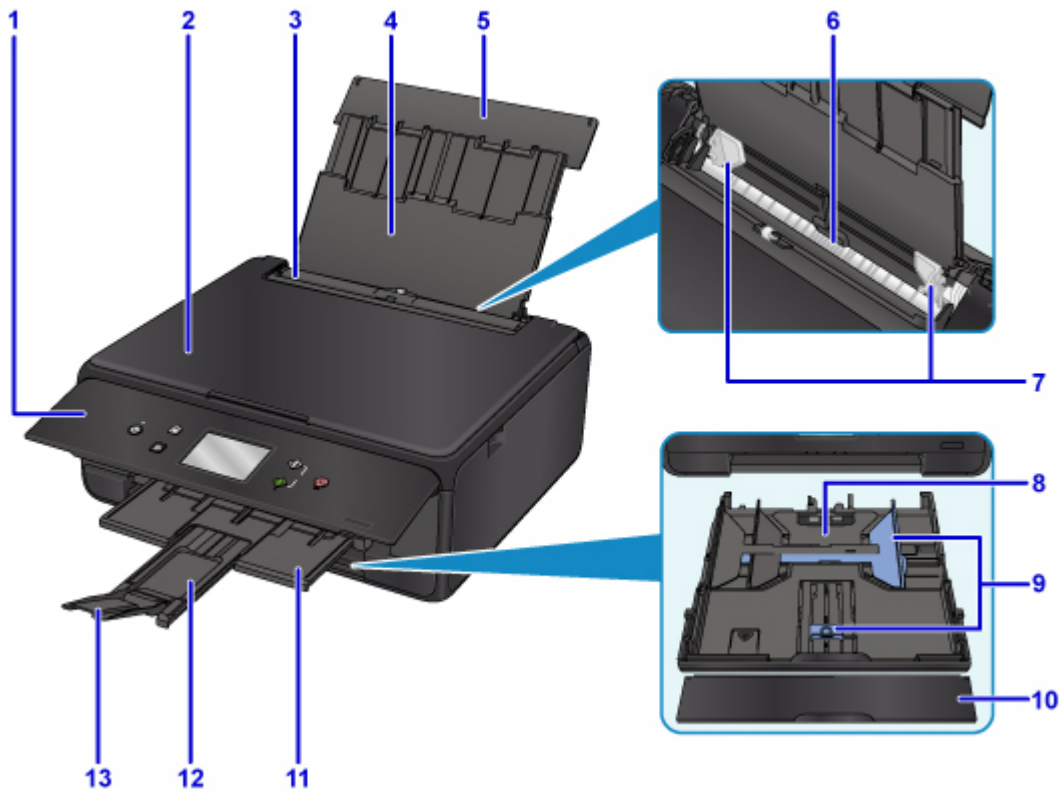

(1) operation panel

Use to change the settings of the printer or to operate it.

■ [Operation Panel](#)

(2) document cover

Open to load an original on the platen glass.

(3) feed slot cover

Prevents anything from falling into the feed slot.

Open it to slide the paper guides, and close it before printing.

(4) paper support

Extend to load paper in the rear tray.

(5) rear tray cover

Open to load paper in the rear tray.

(6) rear tray

Load paper here. Two or more sheets of the same size and type of paper can be loaded at the same time, and fed automatically one sheet at a time.

■ [Loading Paper in the Rear Tray](#)

■ [Loading Envelopes](#)

(7) paper guides

Align with both sides of the paper stack.

(8) cassette

Load A4, B5, A5, or Letter-sized plain paper into the cassette, and insert it into the printer.

■ [Loading Paper in the Cassette](#)

(9) paper guides

Align with right/left/front sides of the paper stack.

(10) cassette cover

Detach to load paper in the cassette.

(11) paper output tray

Printed paper is ejected. Pull out it before printing.

(12) paper output support

Extend to support ejected paper.

(13) output tray extension

Open to support ejected paper.



(14) platen glass

Load an original here.

Rear View

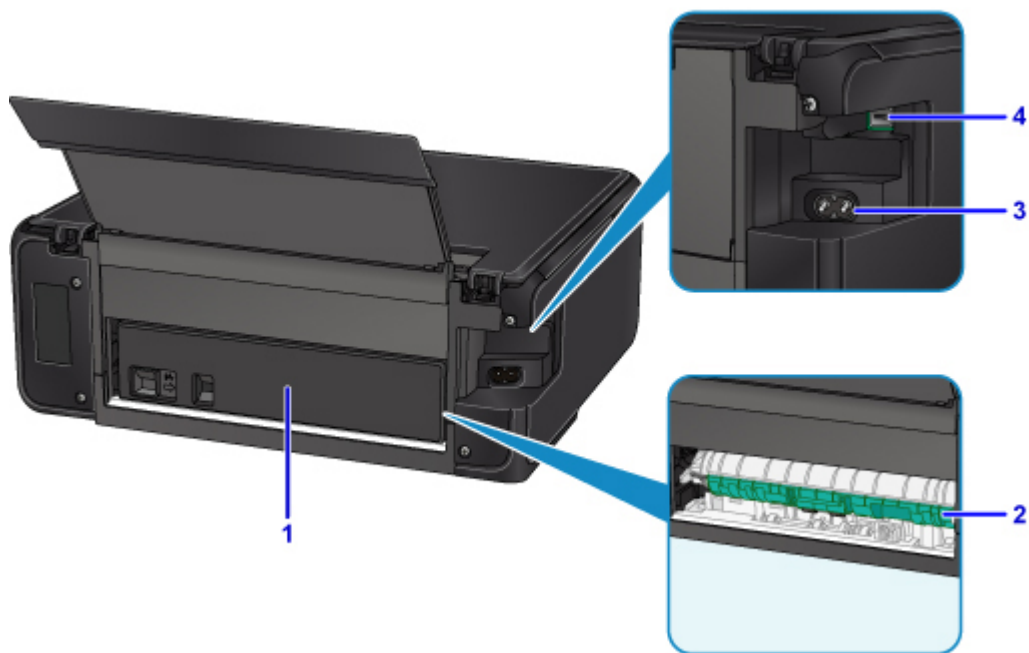

(1) rear cover

Detach when removing jammed paper.

(2) transport unit cover

Open when removing jammed paper.

(3) power cord connector

Plug in the supplied power cord.

(4) USB port

Plug in the USB cable to connect the printer with a computer.

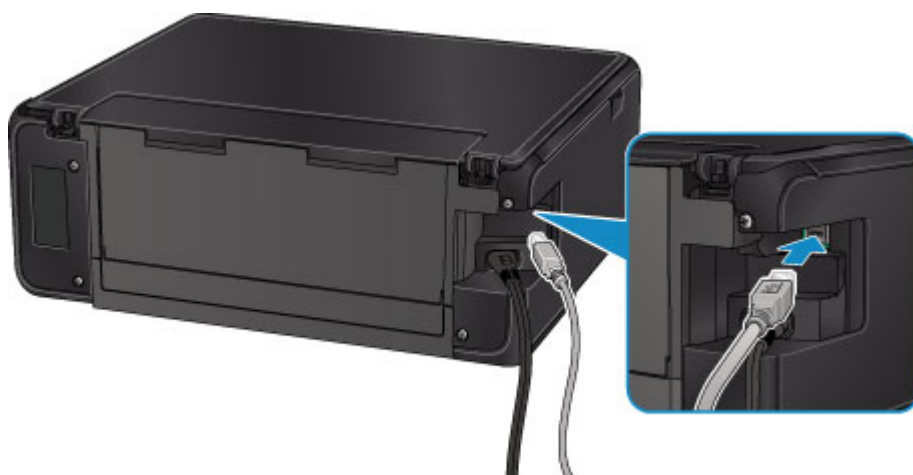

Important

- Do not touch the metal casing.
- Do not plug in or unplug the USB cable while the printer is printing or scanning originals with the computer.

Inside View

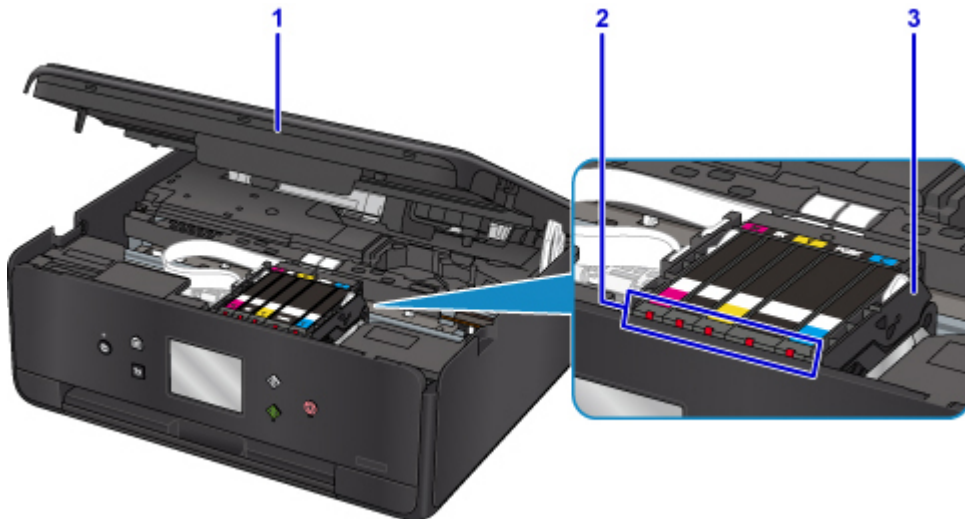

(1) scanning unit / cover

Scans originals. Also, lift and open it to replace an ink tank, to check the ink lamp, or to remove jammed paper inside the printer.

(2) ink lamps

Lights or flashes to indicate the ink tank status.

■ [Checking the Ink Status with the Ink Lamps](#)

(3) print head holder

The print head is pre-installed.

▶▶▶ Note

- For details on replacing an ink tank, see [Replacing Ink Tanks](#).

Operation Panel

* All lamps on the operation panel are shown lit in the figure below for explanatory purposes.

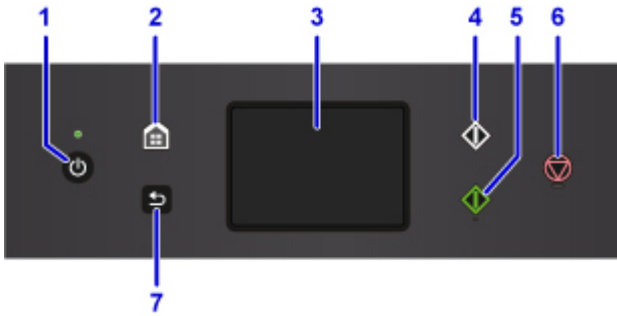

(1) ON button/POWER lamp

Turns the power on or off. Lights after flashing when the power is turned on. Before turning on the power, make sure that the document cover is closed.

(2) HOME button

Used to display the HOME screen.

■ [Using the Operation Panel](#)

(3) touch screen

Displays messages, menu items, and the operational status. Directly touch the screen lightly with your finger tip to select a menu item or displayed button.

■ [Basic Operation of the touch screen](#)

(4) Black button

Starts black & white copying, scanning, etc.

(5) Color button

Starts color copying, scanning, etc.

(6) Stop button

Cancels operation when print, copy, or scan job is in progress.

(7) Back button

Returns the touch screen to the previous screen.

Power Supply

- **Confirming that the Power Is On**
- **Turning the Printer On and Off**
- **Checking the Power Plug/Power Cord**
- **Unplugging the Printer**

Confirming that the Power Is On

The **POWER** lamp is lit when the printer is turned on.

Even if the touch screen is off, if the **POWER** lamp is lit, the printer is on.

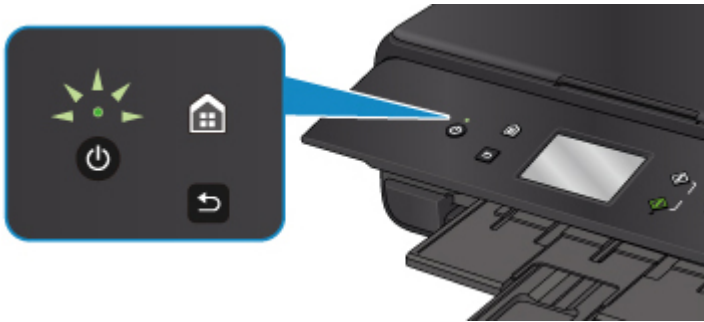

▶▶ Note

- It may take a while for the printer to start printing immediately after you turn on the printer.
- The touch screen display will turn off if the printer is not operated for about 10 minutes. To restore the display, press any button except the **ON** button or touch the touch screen. The print operation from a computer can also restore the display.

Turning the Printer On and Off

Turning on the printer

1. Press the **ON** button to turn on the printer.

The **POWER** lamp flashes and then remains lit.

- [Confirming that the Power Is On](#)

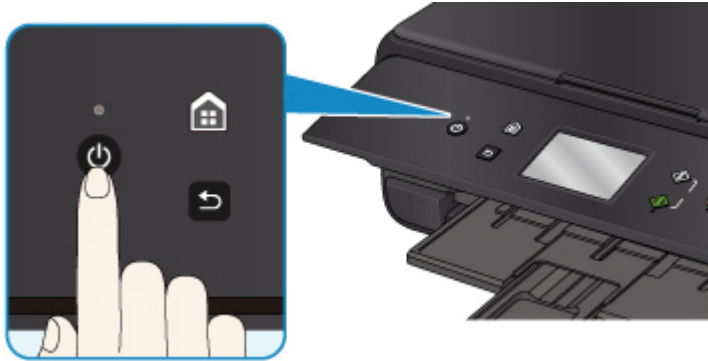

➤➤ Note

- It may take a while for the printer to start printing immediately after you turn on the printer.
- If an error message is displayed on the touch screen, see [An Error Occurs](#).
- You can set the printer to automatically turn on when a print or scan operation is performed from a computer connected by USB cable or wireless network. This feature is set to off by default.

From the printer

- [ECO settings](#)

From the computer

- For Windows:
 - [Managing the Printer Power](#)
- For Mac OS:
 - [Managing the Printer Power](#)

Turning off the printer

1. Press the **ON** button to turn off the printer.

When the **POWER** lamp stops flashing, the printer is turned off.

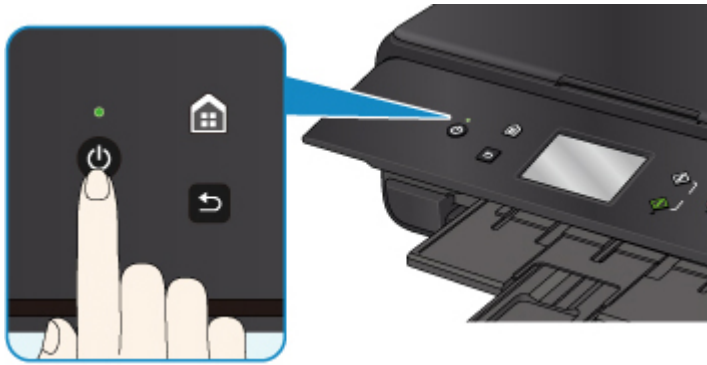

►► Important

- When you [unplug the power cord](#) after turning off the printer, be sure to confirm that the **POWER** lamp is off.

►► Note

- You can set the printer to automatically turn off when no operations are performed or no print jobs are sent to the printer for a certain interval. This feature is set to on by default.

From the printer

- [ECO settings](#)

From the computer

- For Windows:
 - [Managing the Printer Power](#)
- For Mac OS:
 - [Managing the Printer Power](#)

Checking the Power Plug/Power Cord

Unplug the power cord once a month to confirm that the power plug/power cord does not have anything unusual described below.

- The power plug/power cord is hot.
- The power plug/power cord is rusty.
- The power plug/power cord is bent.
- The power plug/power cord is worn.
- The power plug/power cord is split.

Caution

- If you find anything unusual with the power plug/power cord described above, [Unplugging the Printer](#) and call for service. Using the printer with one of the unusual conditions above may cause a fire or an electric shock.

Unplugging the Printer

To unplug the power cord, follow the procedure below.

▶▶▶ Important

- When you unplug the power cord, press the **ON** button, then confirm that the **POWER** lamp is off. Unplugging the power cord while the **POWER** lamp is lit or flashing may cause drying or clogging of the print head and print quality may be reduced.

1. Press the **ON** button to turn the printer off.

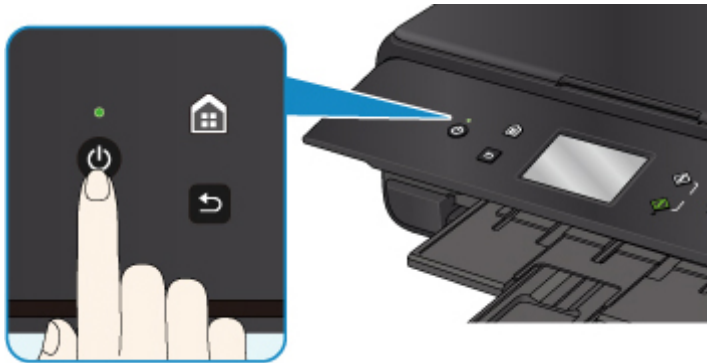

2. Confirm that the **POWER** lamp is off.

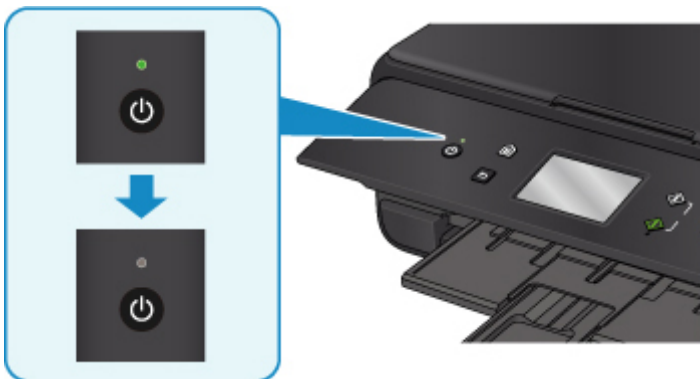

3. Unplug the power cord.

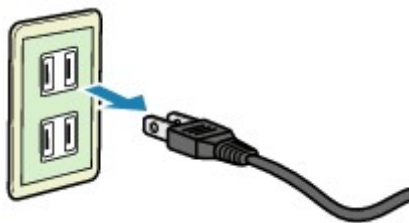

The specification of the power cord differs depending on the country or region of use.

Using the Operation Panel

The operation panel consists of the touch screen (A) and buttons (B).

Touch the HOME screen on the touch screen with your finger tip to select menus for copying, scanning, and other functions.

■ [Operations on the Home Screen](#)

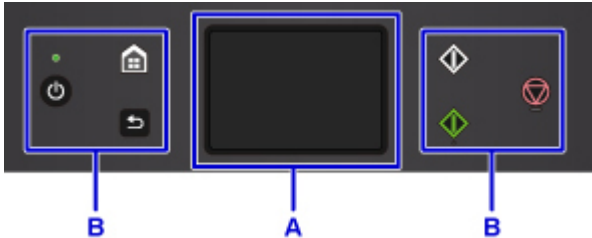

A: touch screen

■ [Basic Operation of the touch screen](#)

B: Buttons on the operation panel

Basic Operation of the touch screen

Touch the touch screen lightly with your finger tip or move your finger to access various functions or settings.

▶▶ Important

- When operating the touch screen, make sure to avoid the followings, which may cause the printer to malfunction or damage the printer.
 - Strongly pressing the touch screen.
 - Pressing the touch screen with other than your finger (especially with sharpened tips, such as on ballpoint pens, pencils, or nails).
 - Touching the touch screen with wet or dirty hands.
 - Placing any objects on the touch screen.
- Do not attach a protective sheet on the touch screen. Removing it may damage the touch screen.

Tap

Touch lightly with your finger tip and immediately release.

Use to select an item or photo on the screen.

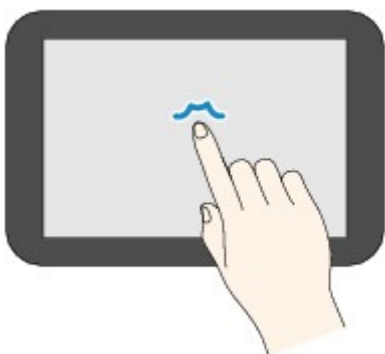

Touch

Touch lightly with your finger tip.

To move forward (or go back) menus or photos continuously, keep touching the forward (or back) mark.

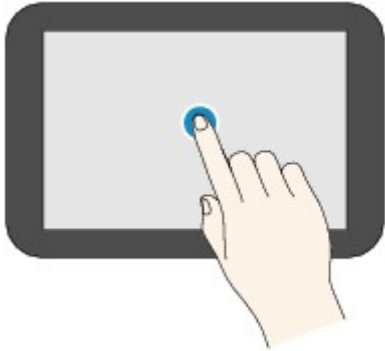

Flick

Flick your finger on the screen up, down, left, or right.

Use to switch menus or move forward or backward through photos.

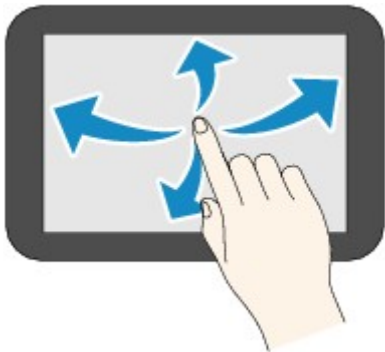

Drag

While lightly touching the screen, move your finger up, down, left, or right.

Use to view lists of items or move sliders.

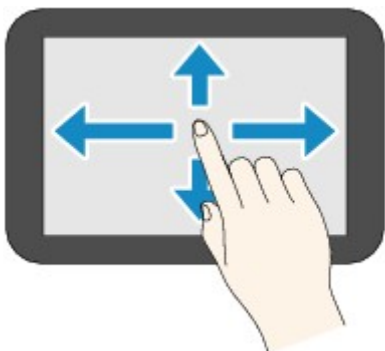

Operations on the Home Screen

Display the menu screen or the settings screen from the Home screen.

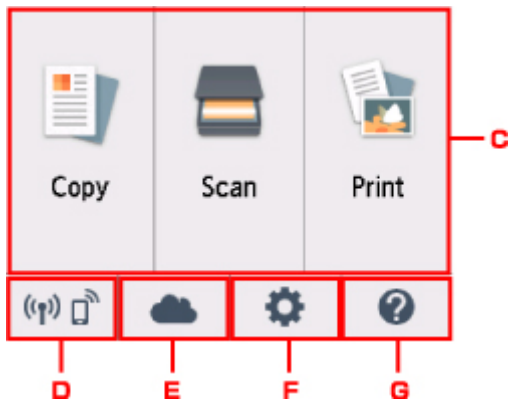

C. Basic menu

Select to copy or scan using the operation panel. After selecting a basic menu, the particular menus are displayed.

D. Network status

Displays the current network status. Select to display the basic network information or to change the network settings.

The icon differs depending on the network of use or the network status.



Wireless LAN is enabled and the printer is connected to the wireless router.

▶▶▶ Note

- Depending on the signal state, the icon will change.



(Signal strength: 81 % or more): You can use the printer over a wireless LAN without any problems.



(Signal strength: 51 % or more): The problem such as the printer cannot print may occur according to the network status. We recommends placing the printer near the wireless router.



(Signal strength: 50 % or less): The problem such as the printer cannot print may occur. Place the printer near the wireless router.



Wireless LAN is enabled but the printer is not connected to the wireless router.



Wireless Direct is enabled.



Wireless LAN is disabled.

E. Cloud

Displays the cloud's Main screen. You can use the services of PIXMA/MAXIFY Cloud Link.

F. Setup

Displays the printer's setting menus or the maintenance menus.

G. Quick guide

Displays the guides how to loading paper or how to replace the ink tank, or the troubleshooting.

Changing Settings

- ▶ **Changing Printer Settings from Your Computer (Windows)**
- ▶ **Changing Printer Settings from Your Computer (Mac OS)**
- ▶ **Changing Settings from Operation Panel**
- ▶ **Changing Printer's Setting Using Web Browser**

Changing Printer Settings from Your Computer (Windows)

- ▶ **Changing the Print Options**
- ▶ **Registering a Frequently Used Printing Profile**
- ▶ **Managing the Printer Power**
- ▶ **Changing the Printer Operation Mode**

Changing the Print Options

You can change the detailed printer driver settings for print data that is sent from an application software. Check this check box if part of the image data is cut off, the paper source during printing differs from the driver settings, or printing fails.

The procedure for changing the print options is as follows:

1. Open the [printer driver setup window](#)
2. Click **Print Options...** on the **Page Setup** tab

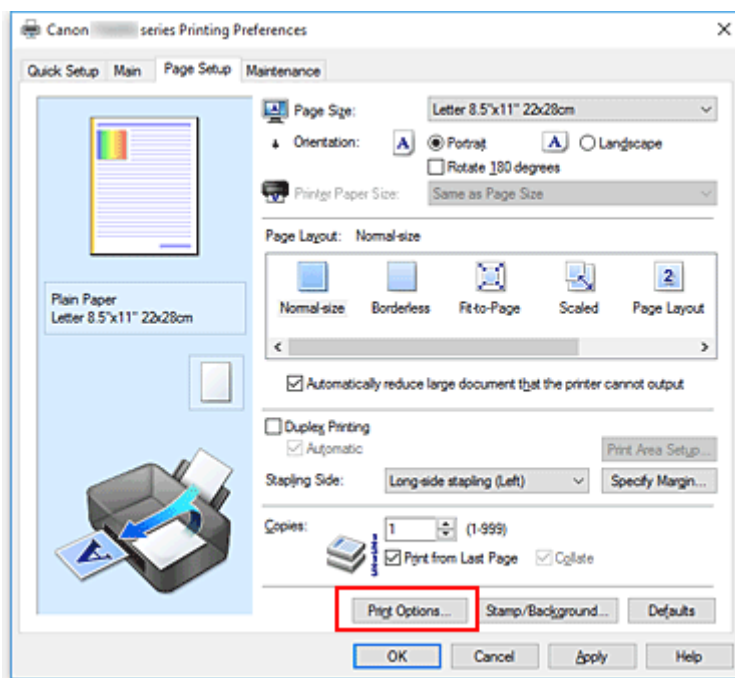

The **Print Options** dialog box opens.

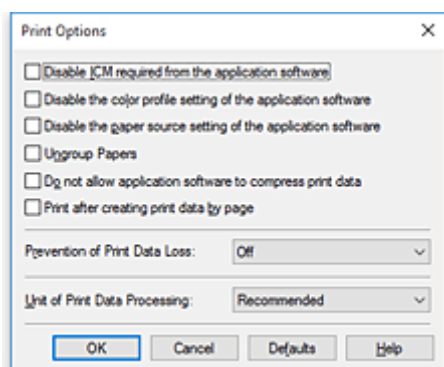

►►► Note

- When you use the XPS printer driver, the functions available to you are different.

3. Change the individual settings

If necessary, change the setting of each item, and then click **OK**.

The **Page Setup** tab is displayed again.

Registering a Frequently Used Printing Profile

You can register the frequently used printing profile to **Commonly Used Settings** on the **Quick Setup** tab. Unnecessary printing profiles can be deleted at any time.

The procedure for registering a printing profile is as follows:

Registering a Printing Profile

1. Open the [printer driver setup window](#)

2. Set the necessary items

From **Commonly Used Settings** on the **Quick Setup** tab, select the printing profile to be used and if necessary, change the settings after **Additional Features**.

You can also register necessary items on the **Main** and **Page Setup** tabs.

3. Click **Save...**

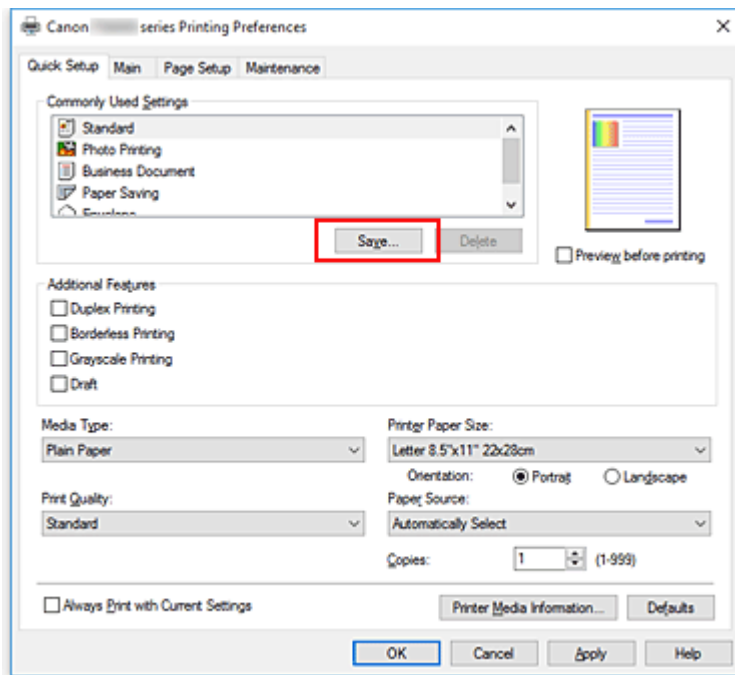

The **Save Commonly Used Settings** dialog box opens.



4. Save the settings

Enter a name in the **Name** field. If necessary, click **Options...**, set the items, and then click **OK**.

In the **Save Commonly Used Settings** dialog box, click **OK** to save the print settings and return to the **Quick Setup** tab.

The name and icon are displayed in **Commonly Used Settings**.

▶▶▶ Important

- To save the page size, orientation, and number of copies that was set in each sheet, click **Options...**, and check each item.

▶▶▶ Note

- When you re-install the printer driver or upgrade the printer driver version, the print settings that are already registered will be deleted from **Commonly Used Settings**. Registered print settings cannot be saved and preserved. If a profile is deleted, register the print settings again.

Deleting Unnecessary Printing Profile

1. Select the printing profile to be deleted

Select the printing profile you want to delete from the **Commonly Used Settings** list on the **Quick Setup** tab.

2. Delete the printing profile

Click **Delete**. When the confirmation message appears, click **OK**.

The selected printing profile is deleted from the **Commonly Used Settings** list.

▶▶▶ Note

- Printing profiles that are registered in the initial settings cannot be deleted.

Managing the Printer Power

This function allows you to manage the printer power from the printer driver.

The procedure for managing the printer power is as follows:



Power Off

The **Power Off** function turns off the printer. When you use this function, you will not be able to turn the printer on from the printer driver.

1. Open the [printer driver setup window](#)
2. Execute power off

Click **Power Off** on the **Maintenance** tab. When the confirmation message appears, click **OK**.

The printer power switches off, and the **Maintenance** tab is displayed again.



Auto Power

Auto Power allows you to set **Auto Power On** and **Auto Power Off**.

The **Auto Power On** function automatically turns on the printer when data is received.

The **Auto Power Off** function automatically turns off the printer when there are no operations from the printer driver or the printer for a specified period of time.

1. Open the [printer driver setup window](#)
2. Make sure that the printer is on and then click **Auto Power** on the **Maintenance** tab

The **Auto Power Settings** dialog box opens.

▶▶▶ Note

- If the printer is off or if communication between the printer and the computer is disabled, an error message may appear because the computer cannot collect the printer status. If this happens, click **OK** to display the most recent settings specified on your computer.

3. If necessary, complete the following settings:

Auto Power On

Specifying **Enable** from the list will turn the printer on upon receipt of print data.

Auto Power Off

Specify the time from the list. When this time lapses without any operations from the printer driver or the printer, the printer is turned off automatically.

4. Apply the settings

Click **OK**. When the confirmation message appears, click **OK**.

The **Maintenance** tab is displayed again.

The setting is enabled after this. When you want to disable this function, select **Disable** from the list according to the same procedure.

▶▶ Note

- When the printer is turned off, the Canon IJ Status Monitor message varies depending on the **Auto Power On** setting.
When the setting is **Enable**, "Printer is standing by" is displayed. When the setting is **Disable**, "Printer is offline" is displayed.

Changing the Printer Operation Mode

If necessary, switch between various modes of printer operation.

The procedure for configuring **Custom Settings** is as follows:



Custom Settings

1. Open the [printer driver setup window](#)
2. Make sure that the printer is on, and then click **Custom Settings** on the **Maintenance** tab

The **Custom Settings** dialog box opens.

▶▶▶ Note

- If the printer is off or if communication between the printer and the computer is disabled, an error message may appear because the computer cannot collect the printer status. If this happens, click **OK** to display the most recent settings specified on your computer.

3. If necessary, complete the following settings:

Prevent paper abrasion

The printer can increase the gap between the print head and the paper during high-density printing to prevent paper abrasion.

Check this check box to prevent paper abrasion.

Align heads manually

Usually, the **Print Head Alignment** function on the **Maintenance** tab is set to automatic head alignment, but you can change it to manual head alignment.

If the printing results of automatic print head alignment are not satisfactory, perform manual head alignment.

Check this check box to perform the manual head alignment. Uncheck this check box to perform the automatic head alignment.

Rotate 90 degrees left when orientation is [Landscape]

On the **Page Setup** tab, you can change the rotation direction of the **Landscape** in the **Orientation**.

To rotate the print data 90 degrees to the left during printing, select this item. To rotate the print data 90 degrees to the right during printing, clear this item.

▶▶▶ Important

- Do not change this setting while the print job is displayed in the print wait list. Otherwise, characters may be omitted or the layout may become corrupt.

Don't detect mismatch of paper settings when printing from computer

When you print documents from your computer and the paper settings in the printer driver and the paper information registered on the printer do not match, this setting disables the message

display and allows you to continue printing.

To disable detection of paper setting mismatches, select this check box.

Ink Drying Wait Time

You can set the length of the printer rest time until printing of the next page begins. Moving the slider to the right increases the pause time, and moving the slider to the left decreases the time.

If the paper gets stained because the next page is ejected before the ink on the printed page dries, increase the ink drying wait time.

Reducing the ink drying wait time speeds up printing.

4. Apply the settings

Click **OK** and when the confirmation message appears, click **OK**.

The printer operates with the modified settings hereafter.

Changing Settings from Operation Panel

- **Changing Settings from Operation Panel**
- **Setting Items on Operation Panel**
- **Print settings**
- **LAN settings**
- **Device user settings**
- **PictBridge print settings**
- **Language selection**
- **Firmware update**
- **Feed settings**
- **Reset setting**
- **Web service setup**
- **System information**
- **ECO settings**
- **Quiet setting**

Changing Settings from Operation Panel

This section describes the procedure to change the settings in the **Device settings** screen, taking the steps to specify **Extended copy amount** as an example.

1. [Make sure printer is turned on.](#)

2. Select  **Setup** on the HOME screen.

■ [Using the Operation Panel](#)

3. Select  **Settings**.

4. Select  **Device settings**.

The **Device settings** screen is displayed.

5. Select a setting item to adjust.

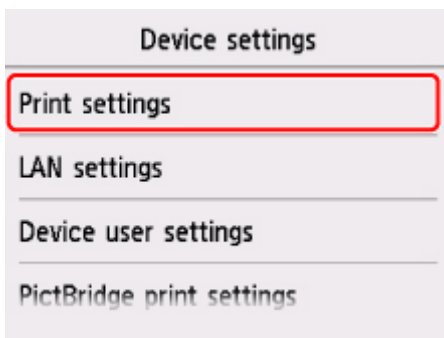

The setting screen for the selected item is displayed.

6. Select a setting item.

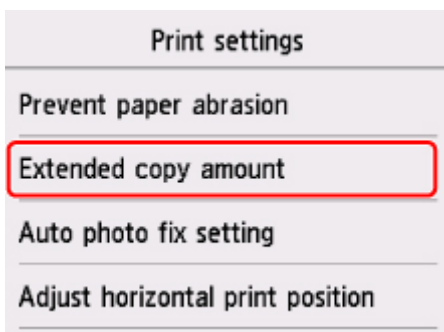

7. Select a setting to specify.

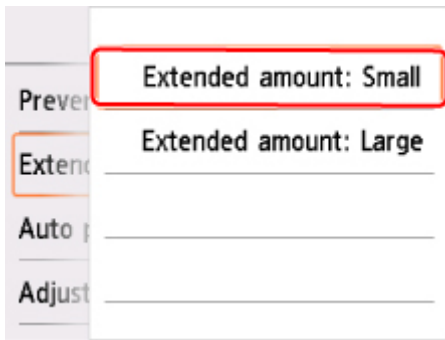

For more on setting items on the operation panel:

- [Setting Items on Operation Panel](#)

Setting Items on Operation Panel

Items for Printer

- [Device user settings](#)
- Web service setup
- [Language selection](#)
- [ECO settings](#)
- Quiet setting

Items for Paper/Printing

- [Print settings](#)
- [Feed settings](#)
- PictBridge print settings

Items for Maintenance/Management

- [System information](#)
- [Firmware update](#)
- [LAN settings](#)
- [Reset setting](#)

Print settings

- **Prevent paper abrasion**

Use this setting only if the print surface becomes smudged.

»»» Important

- Be sure to set this back to **OFF** after printing since it may result in lower printing speed or lower print quality.

- **Extended copy amount**

Selects the amount of image that extends off the paper when printing in borderless (full).

Slight cropping may occur at the edges since the copied image is enlarged to fill the whole page. You can change the width to be cropped from the borders of the original image as needed.

»»» Important

- This setting can be applied under the following conditions:
 - Performing borderless copying
 - Borderless is selected for Border when copying printed photos

»»» Note

- If printouts contain margins even though you are printing in Borderless, specifying **Extended amount: Large** for this setting may help solve the problem.

- **Auto photo fix setting**

When **ON** is selected, you can select whether to print photos using the Exif information recorded in the image files when **Default*** or **On** is selected in printing with a PictBridge (Wireless LAN) compliant device.

* When **Default** is selected for the print setting on the PictBridge (Wireless LAN) compliant device, select **Auto photo fix** for **Photo fix** in **PictBridge print settings**.

- **Adjust horizontal print position**

Adjusts the print position when the left/right margins are not aligned.

You can adjust the left/right margins in increments of 0.01 inch/0.1 mm between -0.12 inch/-3 mm and +0.12 inch/+3 mm centered on the horizontal center of the paper.

»»» Important

- For Letter-sized or Legal-sized paper, you can adjust the left/right margins between -0.06 inch/-1.5 mm and +0.06 inch/+1.5 mm even if you specify the value over 0.06 inch/1.5 mm.

LAN settings

- [Wireless LAN](#)
- [Wireless Direct](#)
- [Common settings](#)

Wireless LAN

- **WLAN active/inactive**

Enables/disables wireless LAN.

- **Wireless LAN setup**

Selects the setup method for wireless LAN connection.

- **Easy wireless connect**

Select if you specify the settings of the access point information to the printer directly from a device (e.g. smartphone, or tablet) without operating the wireless router. Follow the on-screen instructions of the connecting device for the setup procedure.

- **Manual connect**

Select when you perform settings for wireless LAN manually using the operation panel of the printer.

- **WPS (Push button method)**

Select when you perform settings for wireless LAN using a wireless router supporting a Wi-Fi Protected Setup (WPS) push button method. Follow the on-screen instructions during setup.

- **Other setup**

- **Advanced setup**

Select when you perform settings for wireless LAN manually. You can specify multiple WEP keys.

- **WPS (PIN code method)**

Select when you perform settings for wireless LAN using a wireless router supporting a Wi-Fi Protected Setup (WPS) PIN code method. Follow the on-screen instructions during setup.

- **WLAN setting list**

The list of wireless LAN settings of this printer is displayed on the touch screen.

Select **Print details** and then **Yes** to print the list.

- [Printing Network Settings](#)

▶▶▶ Important

- The network settings printout contains important information about your network. Handle it with care.

The following setting items are displayed. (Some setting items are not displayed depending on the printer settings.)

Items	Setting
SSID	XXXXXXXXXXXXXXXXXXXX XXXXXXXXXXXXXXXXXXXX (up to 32 characters)
Wireless LAN security	Inactive/WEP(64bit)/WEP(128bit)/WPA-PSK(TKIP)/WPA-PSK(AES)/WPA2-PSK(TKIP)/WPA2-PSK(AES)
Signal strength (%)	XXX
IPv4 address	XXX. XXX. XXX. XXX (12 characters)
IPv4 subnet mask	XXX. XXX. XXX. XXX (12 characters)
IPv4 default gateway	XXX. XXX. XXX. XXX (12 characters)
IPv6 address	XXXX: XXXX: XXXX: XXXX: XXXX: XXXX: XXXX: XXXX (32 characters)
MAC address of wireless LAN	XX:XX:XX:XX:XX:XX (12 characters)
Printer name	XXXXXXXXXXXXXXXXXXXX (up to 15 characters)
Bonjour service name	XXXXXXXXXXXXXXXXXXXX XXXXXXXXXXXXXXXXXXXX XXXXXXXXXXXXXXXXXXXX XXXXXXXXXXXXXXXXXXXX (up to 52 characters)
Root cert. thumbprint (SHA-1)	XXXXXXXXXX XXXXXXXXXXXX XXXXXXXXXXXX XXXXXXXXXX XXXXXXXXXXXX
Root cert. thumbprint (SHA-256)	XXXXXXXXXX XXXXXXXXXXXX XXXXXXXXXXXX XXXXXXXXXXXX XXXXXXXXXX XXXXXXXXXXXX XXXXXXXXXXXX XXXXXXXXXXXX

("XX" represents alphanumeric characters.)

Wireless Direct

- **Wireless Direct active/inactive**

Enables/disables Wireless Direct.

- **Update SSID/password**

Selecting **Yes** updates the identifier (SSID) and password for Wireless Direct.

- **Change device name**

Changes the printer's name displayed on a Wi-Fi Direct compatible device.

- **Connection request confirmation**

Selecting **Yes** displays the confirmation screen when a Wi-Fi Direct compatible device is connecting the printer.

- **Wireless Direct setting list**

The list of Wireless Direct settings of this printer is displayed on the touch screen.

Select **Print details** and then **Yes** to print the list.

■ [Printing Network Settings](#)

»» **Important**

- The network settings printout contains important information about your network. Handle it with care.

The following setting items are displayed. (Some setting items are not displayed depending on the printer settings.)

Items	Setting
SSID	DIRECT-XXXX-TS6000series
Password	XXXXXXXXXX (10 characters)
Wireless LAN security	WPA2-PSK(AES)
IPv4 address	XXX. XXX. XXX. XXX (12 characters)
IPv4 subnet mask	XXX. XXX. XXX. XXX (12 characters)
IPv4 default gateway	XXX. XXX. XXX. XXX (12 characters)
IPv6 address	XXXX: XXXX: XXXX: XXXX: XXXX: XXXX: XXXX: XXXX (32 characters)
MAC address of wireless LAN	XX:XX:XX:XX:XX:XX (12 characters)
Printer name	XXXXXXXXXXXXXXXXXX (up to 15 characters)
Bonjour service name	XXXXXXXXXXXXXXXX XXXXXXXXXXXXXXXX XXXXXXXXXXXXXXXX XXXXXXXXXXXXXXXX (up to 52 characters)
Wireless Direct device name	XXXXXX-XXXXXXseries
No. of devices connected now	XX/XX
Root cert. thumbprint (SHA-1)	XXXXXXXX XXXXXXXX XXXXXXXX XXXXXXXX XXXXXXXX
Root cert. thumbprint (SHA-256)	XXXXXXXX XXXXXXXX XXXXXXXX XXXXXXXX XXXXXXXX XXXXXXXX XXXXXXXX XXXXXXXX

("XX" represents alphanumeric characters.)

Common settings

- **Set printer name**

Specifies the printer name. You can use up to 15 characters for the name.

►► Note

- You cannot use the same printer name as that already used for other LAN connected devices.
- You cannot use a hyphen for the initial or last character of the printer name.

• TCP/IP settings

Performs IPv4 or IPv6 setting.

• WSD setting

Setting items when you use WSD (one of the network protocols supported in Windows 8.1, Windows 8, Windows 7, and Windows Vista).

◦ Enable/disable WSD

Selects whether WSD is enabled or disabled.

►► Note

- When this setting is enabled, the printer icon is displayed on the Network Explorer in Windows 8.1, Windows 8, Windows 7, and Windows Vista.

◦ Optimize inbound WSD

Selecting **Enable** allows you to receive the WSD printing data faster.

◦ WSD scan from this device

Selecting **Enable** allows you to transfer the scanned data to the computer using WSD.

◦ Timeout setting

Specifies the timeout length.

• Bonjour settings

Setting items for LAN using Bonjour for Mac OS.

◦ Enable/disable Bonjour

Selecting **Enable** allows you to use Bonjour to perform the network settings.

◦ Service name

Specifies the Bonjour service name. You can use up to 48 characters for the name.

►► Note

- You cannot use the same service name as that already used for other LAN connected devices.

• LPR protocol setting

Enables/disables the LPR setting.

• RAW protocol

Enables/disables RAW printing.

• LLMNR

Enables/disables LLMNR (Link-Local Multicast Name Resolution). Selecting **Active** allows the printer to detect printer's IP address from the printer name without a DNS server.

• PictBridge communication

Setting items for printing from a PictBridge (Wireless LAN) compliant device.

- **Enable/disable communication**

Selecting **Enable** allows you to print from a PictBridge (Wireless LAN) compliant device.

- **Timeout setting**

Specifies the timeout length.

- **IPsec settings**

Selecting **Active** allows you to specify the IPsec security.

Device user settings

- **Sound control**

Selects the volume.

- **Keypad volume**

Selects the beep volume when tapping the touch screen or the buttons on the operation panel.

- **Alarm volume**

Selects the alarm volume.

- **Device info sending setting**

Selects whether you will send the printer usage information to Canon server. The information sent to Canon will be utilized to develop better products. Select **Agree** to send the printer usage information to Canon server.

- **Energy saving settings**

Allows you to turn on/off the printer automatically to save electricity.

- **Auto power off**

Specifies the length of time to turn off the printer automatically when no operation is made or no printing data is sent to the printer.

- **Auto power on**

Selecting **ON** enables the printer to turn on automatically when a scanning command from a computer or printing data is sent to the printer.

- You can also enter this setting menu by selecting **ECO settings** and **Energy saving settings** on the HOME screen.

■ [ECO settings](#)

- **Document removal reminder**

Selects whether the printer will display the reminder screen in case you forget to remove the original from the platen glass after scanning.

▶▶▶ Important

- Depending on the type of original or the state of the document cover, forgetting to remove the original may not be detected.

Language selection

Changes the language for the messages and menus on the touch screen.

Firmware update

You can update the firmware of the printer, check the firmware version, or perform settings of a notification screen, a DNS server and a proxy server.

▶▶▶ Note

- Only **Check current version** is available when **Inactive** is selected for **WLAN active/inactive** of **Wireless LAN** in **LAN settings**.

• Install update

Performs the firmware update of the printer. If you select **Yes**, the firmware update starts. Follow the on-screen instructions to perform update.

▶▶▶ Important

- When you use this function, make sure the printer is connected to the Internet.

▶▶▶ Note

- If the firmware update is not complete, check the following and take an appropriate action.
 - Check the network settings such as a wireless router.
 - If **Cannot connect to the server.** is displayed on the touch screen, select **OK** and try again after a while.

• Check current version

You can check the current firmware version.

• Update notification setting

When **Yes** is selected and the firmware update is available, the screen to inform you of the firmware update is displayed on the touch screen.

• DNS server setup

Performs settings for a DNS server. Select **Auto setup** or **Manual setup**. If you select **Manual setup**, follow the display on the touch screen to perform settings.

• Proxy server setup

Performs settings for a proxy server. Follow the display on the touch screen to perform settings.

Feed settings

By registering the paper size and the media type loaded on the rear tray or in the cassette, you can prevent the printer from misprinting by displaying the message before printing starts when the paper size or the media type of the loaded paper differs from the print settings.

For details:

■ [Paper Settings](#)

• Register paper information

Registers the paper size and the media type you load on the rear tray and in the cassette.

▶▶▶ Note

- Plain paper can only be loaded in the cassette.
- When you register the paper size and the media type, the screen to select whether you apply the settings to those for copying is displayed. Select **Yes** to apply the registered settings to copying.
- For more on the combination of paper settings you can specify by the printer driver or on the touch screen:
 - For Windows:
 - [Paper Settings on the Printer Driver and the Printer \(Media Type\)](#)
 - [Paper Settings on the Printer Driver and the Printer \(Paper Size\)](#)
 - For Mac OS:
 - Paper Settings on the Printer Driver and the Printer (Media Type)
 - Paper Settings on the Printer Driver and the Printer (Paper Size)

• Detect paper setting mismatch

If you select **Yes**, the printer detects whether the paper size and the media type are identical with those registered in **Register paper information**. If printing starts with the settings that do not match, an error message is displayed on the touch screen.

▶▶▶ Note

- When **No** is selected, **Register paper information** is disabled.

Reset setting

You can set the settings back to the default.

- **Web service setup only**

Sets the Web service settings back to the default.

- **LAN settings only**

Sets the LAN settings back to the default.

- **Settings only**

Sets the settings such as the paper size or media type back to the default.

- **Device info sending setting only**

Sets only the device information sending settings back to the default.

- **Reset all**

Sets all settings you made to the printer back to the default. The administrator password specified by Remote UI or IJ Network Device Setup Utility reverts to the default setting.

Note

- You cannot set the following setting items back to the default:
 - The language displayed on the touch screen
 - The current position of the print head
 - CSR (Certificate Signing Request) for encryption method (SSL/TLS) setting

System information



To display this menu, select **System information** on



Setup.

- **Current version**

Displays the current firmware version.

- **Printer name**

Displays the printer name currently specified.

- **Serial number**

Displays the printer serial number.

- **MAC address of wireless LAN**

Displays the MAC address for wireless LAN.

ECO settings

This setting allows you to use automatic duplex printing as a default to save paper and to turn on/off the printer automatically to save electricity.

- [Using Duplex Printing](#)
- [Using Power Saving Function](#)

Using Duplex Printing

Follow the procedure below to use duplex printing.

1. [Make sure printer is turned on.](#)

2. Select  **Setup** on the HOME screen.

- [Using the Operation Panel](#)

3. Select  **Settings**.

4. Select  **ECO**.

5. Select **Two-sided printing setting**.

6. Specify settings as necessary.

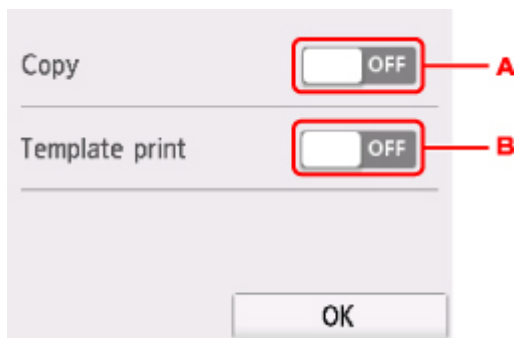

A. Tap to select two-sided copying as a default.

B. Tap to select two-sided printing of template forms on the printer as a default.

▶▶▶ Note

- When duplex printing is selected, the  icon is displayed on the setting items for duplex printing on each print setting screen.

Using Power Saving Function

Follow the procedure below to use power saving function.

1. [Make sure printer is turned on.](#)

2. Select  **Setup** on the HOME screen.

■ [Using the Operation Panel](#)

3. Select  **Settings**.

4. Select  **ECO**.

5. Select **Energy saving settings**.

6. Check on-screen instructions and select **Next**.

7. Specify settings as necessary.

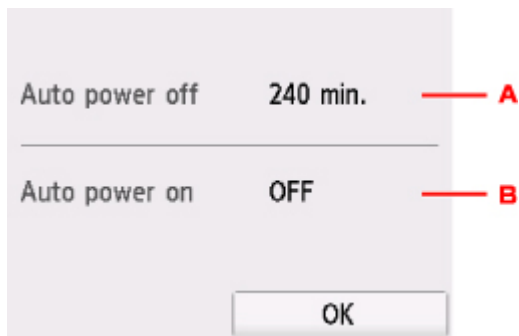

- A. Specify the length of time to turn the printer off automatically when no operation is made or no printing data is sent to the printer.
- B. Selecting **ON** enables the printer to turn on automatically when a scanning command from a computer or printing data is sent to the printer.

Network Connection

- ▶ [Network Connection Tips](#)

Network Connection Tips

- ▶ **Default Network Settings**
- ▶ **Another Printer Found with Same Name**
- ▶ **Connecting to Another Computer via LAN/Changing from USB to LAN Connection**
- ▶ **Printing Network Settings**
- ▶ **Changing Wireless LAN Connection Method**

Default Network Settings

LAN Connection Defaults

Item	Default
Enable/Disable LAN	Disable LAN
SSID	BJNPSETUP
Wireless LAN security	Disable
IP address (IPv4)	Auto setup
IP address (IPv6)	Auto setup
Set printer name*	XXXXXXXXXXXXXX
Enable/disable IPv6	Enable
Enable/disable WSD	Enable
Timeout setting	15 minutes
Enable/disable Bonjour	Enable
Service name	Canon TS6000 series
LPR protocol setting	Enable
RAW protocol	Enable
LLMNR	Active
PictBridge communication	Enable

("XX" represents alphanumeric characters.)

* Default value depends on printer. To check value, use operation panel.

■ [LAN settings](#)

Wireless Direct Defaults

Item	Default
SSID (Identifier for wireless direct)	DIRECT-abXX-TS6000series *1
Password	YYYYYYYYYY *2
Wireless LAN security	WPA2-PSK (AES)
Wireless Direct device name	ZZZZZ-TS6000series *3
Connection request confirmation	Displayed

*1 "ab" is specified at random and "XX" represents last two digits of printer's MAC address. (The value is specified when the printer is turned on for the first time.)

*2 The password is specified automatically when the printer is turned on for the first time.

*3 "ZZZZZZ" represents last six digits of printer's MAC address.

Another Printer Found with Same Name

When the printer is found during setup, other printers with the same name may appear on the results screen.

Select a printer with checking the printer settings against those on detection result screen.

- For Windows:

Check the printer's MAC address or serial to select the correct printer from the results.

- For Mac OS:

The printer names appear with the MAC address added at the end or as the printer name specified by Bonjour.

Check identifiers such as the MAC address, the printer name specified by Bonjour, and the printer's serial number to select the printer from among those that appear.

»» Note

- Serial number may not appear on result screen.

Check the printer's MAC address and the serial number by one of the following methods.

- Display on the touch screen.

MAC address

- [LAN settings](#)

Serial number

- [System information](#)

- Print the network settings.

- [Printing Network Settings](#)

Connecting to Another Computer via LAN/Changing from USB to LAN Connection

■ [For Windows:](#)

■ [For Mac OS:](#)

For Windows:

To add a computer to connect to the printer on a LAN or to change from USB to LAN connection, perform setup using the Setup CD-ROM or follow the instructions on the Canon website.

For Mac OS:

To connect an additional computer to the printer via LAN, or to change from USB to LAN connection, follow the instructions on the Canon website.

Printing Network Settings

Use the operation panel to print the printer's current network settings.

▶▶▶ Important

- The network settings printout contains important information about your network. Handle it with care.

1. [Make sure printer is turned on.](#)

If the HOME screen is not displayed, press the HOME button.

2. [Load two sheets of A4 or Letter-sized plain paper.](#)

3. Tap  (**Network status**) icon.

■ [Using the Operation Panel](#)

The menu screen appears.

4. Check message and tap **Yes**.

5. Tap **Print details**.

6. Tap **Yes**.

The printer starts printing network settings information.

The printed network settings information is as follows: (Some setting values are not displayed depending on the printer settings.)

Item	Description	Setting
Product Information	Product information	–
Product Name	Product name	XXXXXXXX
ROM Version	ROM version	XXXXXXXX
Serial Number	Serial number	XXXXXXXX
Wireless LAN	Wireless LAN	Enable/Disable
MAC Address	MAC address	XX:XX:XX:XX:XX:XX
Infrastructure	Infrastructure	Enable/Disable
Connection	Connection status	Active/Inactive
SSID	SSID	Wireless LAN SSID
Channel	Channel	XX (1 to 11)

Encryption	Encryption method	None/WEP/TKIP/AES
WEP Key Length	WEP key length (bits)	Inactive/128/64
Authentication	Authentication method	None/auto/open/shared/WPA-PSK/WPA2-PSK
Signal Strength	Signal strength	0 to 100 [%]
TCP/IPv4	TCP/IPv4	Enable
IP Address	IP address	XXX.XXX.XXX.XXX
Subnet Mask	Subnet mask	XXX.XXX.XXX.XXX
Default Gateway	Default gateway	XXX.XXX.XXX.XXX
TCP/IPv6	TCP/IPv6	Enable/Disable
Link Local Address	Link local address	XXXX:XXXX:XXXX:XXXX XXXX:XXXX:XXXX:XXXX
Link Local Prefix Length	Link local prefix length	XXX
Stateless Address1	Stateless address 1	XXXX:XXXX:XXXX:XXXX XXXX:XXXX:XXXX:XXXX
Stateless Prefix Length1	Stateless prefix length 1	XXX
Stateless Address2	Stateless address	XXXX:XXXX:XXXX:XXXX XXXX:XXXX:XXXX:XXXX
Stateless Prefix Length2	Stateless prefix length 2	XXX
Stateless Address3	Stateless address 3	XXXX:XXXX:XXXX:XXXX XXXX:XXXX:XXXX:XXXX
Stateless Prefix Length3	Stateless prefix length 3	XXX
Stateless Address4	Stateless address 4	XXXX:XXXX:XXXX:XXXX XXXX:XXXX:XXXX:XXXX
Stateless Prefix Length4	Stateless prefix length 4	XXX
Default Gateway1	Default gateway 1	XXXX:XXXX:XXXX:XXXX XXXX:XXXX:XXXX:XXXX
Default Gateway2	Default gateway 2	XXXX:XXXX:XXXX:XXXX XXXX:XXXX:XXXX:XXXX
Default Gateway3	Default gateway 3	XXXX:XXXX:XXXX:XXXX XXXX:XXXX:XXXX:XXXX
Default Gateway4	Default gateway 4	XXXX:XXXX:XXXX:XXXX XXXX:XXXX:XXXX:XXXX

IPsec	IPsec setting	Active
Security Protocol	Security method	ESP/ESP & AH/AH
Wireless Direct	Wireless direct	Enable/Disable
Connection	Connection status	Active/Inactive
SSID	SSID	Wireless Direct SSID
Password	Password	Wireless Direct password (10 alphanumeric characters)
Channel	Channel	3
Encryption	Encryption method	AES
Authentication	Authentication method	WPA2-PSK
TCP/IPv4	TCP/IPv4	Enable
IP Address	IP address	XXX.XXX.XXX.XXX
Subnet Mask	Subnet mask	XXX.XXX.XXX.XXX
Default Gateway	Default gateway	XXX.XXX.XXX.XXX
TCP/IPv6	TCP/IPv6	Enable/Disable
Link Local Address	Link local address	XXXX:XXXX:XXXX:XXXX XXXX:XXXX:XXXX:XXXX
Link Local Prefix Length	Link local prefix length	XXX
IPsec	IPsec setting	Active
Security Protocol	Security method	–
Other Settings	Other settings	–
Printer Name	Printer name	Printer name (Up to 15 alphanumeric characters)
Direct Conn. DevName	Device name for wireless direct (Up to 32 characters)	Device name for wireless direct
WSD Printing	WSD printing setting	Enable/Disable
WSD Timeout	Timeout	1/5/10/15/20 [min]
LPD Printing	LPD printing setting	Enable/Disable
RAW Printing	RAW printing setting	Enable/Disable
Bonjour	Bonjour setting	Enable/Disable

Bonjour Service Name	Bonjour service name	Bonjour service name (Up to 52 alphanumeric characters)
LLMNR	LLMNR setting	Enable/Disable
SNMP	SNMP setting	Enable/Disable
PictBridge Commun.	PictBridge communication	Enable/Disable
DNS Server	Obtain DNS server address automatically	Auto/Manual
Primary Server	Primary server address	XXX.XXX.XXX.XXX
Secondary Server	Secondary server address	XXX.XXX.XXX.XXX
Proxy Server	Proxy server setting	Enable/Disable
Proxy Address	Proxy address	XXXXXXXXXXXXXXXXXXXX
Proxy Port	Proxy port specification	1 to 65535
Cert. Fingerprt(SHA-1)	Certificate fingerprint(SHA-1)	XXXXXXXXXX XXXXXXXXXXX XXXXXXXXXXX XXXXXXXXXX XXXXXXXXXXX
Cert. Fingerprt(SHA-256)	Certificate fingerprint(SHA-256)	XXXXXXXXXX XXXXXXXXXXX XXXXXXXXXXX XXXXXXXXXX XXXXXXXXXX XXXXXXXXXXX XXXXXXXXXXX XXXXXXXXXX

("XX" represents alphanumeric characters.)

Changing Wireless LAN Connection Method

Follow either procedure below to change wireless LAN connection method (infrastructure or wireless direct).

- **For Windows:**

- Use the Setup CD-ROM or follow the instructions on the Canon website to redo setup.
- Perform settings on the **Network Settings** screen on IJ Network Device Setup Utility.

▶▶▶ Important

- Before you perform settings using IJ Network Device Setup Utility, turn on Easy wireless connect mode on the printer following the procedure below.

1. [Make sure printer is turned on.](#)

If the HOME screen is not displayed, press the HOME button.

2. Tap  (**Network status**) icon.

■ [Using the Operation Panel](#)

3. Check message and tap **Yes**.
4. Tap **LAN settings**.
5. Tap **Wireless LAN**.
6. Tap **Wireless LAN setup**.
7. Tap **Easy wireless connect**.
8. Check message and tap **Yes**.

Follow instructions on your smartphone or tablet.

9. If message saying setup is completed appears, tap **OK**.

- **For Mac OS:**

Follow the instructions on the Canon website to redo setup.

Ensuring Optimal Printing Results

- ▶ Ink Tips
- ▶ Printing Tips
- ▶ Check Paper Settings Before Printing
- ▶ Set Rear Tray/Cassette Paper Information After Loading Paper
- ▶ Canceling Print Jobs
- ▶ Printer Handling Precautions
- ▶ Keeping Print Quality High
- ▶ [Transporting Your Printer](#)

Transporting Your Printer

When relocating the printer, make sure of the following.

▶▶▶ Important

- Pack the printer in a sturdy box so that it is placed with its bottom facing down, using sufficient protective material to ensure safe transport.
- With the print head and ink tank left installed in the printer, press the **ON** button to turn off the power. This allows the printer to automatically cap the print head, thus preventing it from drying.
- After packing, do not tilt the box containing the printer or turn it on its side or upside down. Doing so may cause the ink to leak during transport and cause damage to the printer.
- When a shipping agent is handling transport of the printer, have its box marked "THIS SIDE UP" to keep the printer with its bottom facing down. Mark also with "FRAGILE" or "HANDLE WITH CARE".

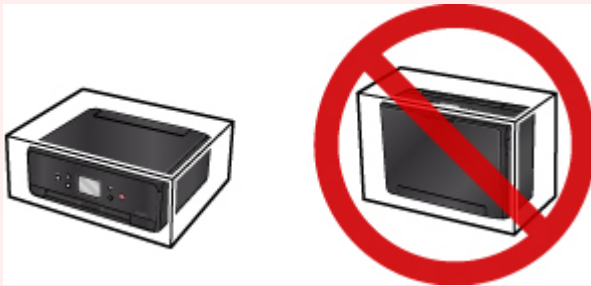

1. Turn the printer off.
2. Confirm that the **POWER** lamp is off and [unplugging the power cord](#).

▶▶▶ Important

- Do not unplug the printer while the **POWER** lamp is lit or flashing, as it may cause malfunction or damage to the printer, making the printer unable to print.

3. Retract the paper output tray and the output tray extension.
4. Close the operation panel and the rear tray.
5. If the cassette is extended, contract it.
6. Unplug the printer cable from the computer and from the printer, then unplug the power cord from the printer.
7. Use adhesive tape to secure all the covers on the printer to keep them from opening during transportation. Then pack the printer in the plastic bag.
8. Attach the protective material to the printer when packing the printer in the box.

Legal Restrictions on Scanning/Copying

Scanning, printing, copying, or modifying copies of the following may be punishable under law.

This list is non-exhaustive. When in doubt, check with a local legal representative.

- Paper money
- Money orders
- Certificates of deposit
- Postage stamps (canceled or uncanceled)
- Identification badges or insignia
- Selective service or draft papers
- Checks or drafts issued by governmental agencies
- Motor vehicle licenses and certificates of title
- Traveler's checks
- Food stamps
- Passports
- Immigration papers
- Internal revenue stamps (canceled or uncanceled)
- Bonds or other certificates of indebtedness
- Stock certificates
- Copyrighted works or works of art, without the owner's consent

Specifications

General Specifications

Printing resolution (dpi)	4800* (horizontal) x 1200 (vertical) * Ink droplets can be placed with a pitch of 1/4800 inch at minimum.
Interface	<p>USB Port: Hi-Speed USB *1</p> <p>LAN Port: Wireless LAN: IEEE802.11n / IEEE802.11g / IEEE802.11b *2</p> <p>*1 A computer that complies with Hi-Speed USB standard is required. Since the Hi-Speed USB interface is fully upwardly compatible with USB 1.1, it can be used at USB 1.1.</p> <p>*2 Setup possible through Standard setup, WPS (Wi-Fi Protected Setup), WCN (Windows Connect Now) or Easy wireless connect.</p> <p>USB and LAN can be used at the same time.</p>
Print width	8 inches/203.2 mm (for Borderless Printing: 8.5 inches/216 mm)
Printable area	<p>Borderless printing: Top/Bottom/Left/Right margin: 0.00 inch (0.0 mm)</p> <p>Standard printing:</p> <p>-Top margin: 0.12 inch (3.0 mm)</p> <p>-Bottom margin: 0.20 inch (5.0 mm)</p> <p>-Left margin:</p> <ul style="list-style-type: none"> • Letter/Legal: 0.26 inch (6.4 mm) • Other sizes: 0.14 inch (3.4 mm) <p>-Right margin:</p> <ul style="list-style-type: none"> • Letter/Legal: 0.25 inch (6.3 mm) • Other sizes: 0.14 inch (3.4 mm) <p>Auto duplex printing:</p> <p>-Top margin: 0.20 inch (5.0 mm)</p> <p>-Bottom margin: 0.20 inch (5.0 mm)</p> <p>-Left margin:</p> <ul style="list-style-type: none"> • Letter/Legal: 0.26 inch (6.4 mm) • Other sizes: 0.14 inch (3.4 mm) <p>-Right margin:</p> <ul style="list-style-type: none"> • Letter/Legal: 0.25 inch (6.3 mm) • Other sizes: 0.14 inch (3.4 mm)
Operating environment	<p>Temperature: 41 to 95 °F (5 to 35 °C)</p> <p>Humidity: 10 to 90 % RH (no condensation)</p> <p>* The performance of the printer may be reduced under certain temperature and humidity conditions.</p>

	<p>Recommended conditions:</p> <p>Temperature: 59 to 86 °F (15 to 30 °C)</p> <p>Humidity: 10 to 80 % RH (no condensation)</p> <p>* For the temperature and humidity conditions of papers such as photo paper, refer to the paper's packaging or the supplied instructions.</p>
Storage environment	<p>Temperature: 32 to 104 °F (0 to 40 °C)</p> <p>Humidity: 5 to 95 % RH (no condensation)</p>
Power supply	AC 100-240 V, 50/60 Hz
Power consumption	<p>Printing (Copy): Approx. 13 W</p> <p>Standby (minimum): Approx. 0.7 W *1*2</p> <p>OFF: Approx. 0.2 W *1</p> <p>*1 USB connection to PC</p> <p>*2 The wait time for standby cannot be changed.</p>
External dimensions	<p>Approx. 14.7 (W) x 12.5 (D) x 5.5 (H) inches</p> <p>Approx. 372 (W) x 315 (D) x 139 (H) mm</p> <p>* With the Paper Support and Paper Output Tray retracted.</p>
Weight	<p>Approx. 13.6 lb (Approx. 6.2 kg)</p> <p>* With the Print Head and ink tanks installed.</p>
Print Head/Ink	Total 4096 nozzles (PGBK 1024 nozzles, Y/DyeBK each 512 nozzles, C/M each 1024 nozzles)

Copy Specifications

Multiple copy	max. 99 pages
Intensity adjustment	9 positions, Auto intensity (AE copy)
Reduction / Enlargement	25 % - 400 % (1 % unit)

Scan Specifications

Scanner driver	<p>Windows: TWAIN 1.9 Specification, WIA</p> <p>Mac OS: ICA</p>
Maximum scanning size	A4/Letter, 8.5" x 11.7"/216 x 297 mm
Scanning resolution	<p>Optical resolution (horizontal x vertical) max: 1200 x 2400 dpi *1</p> <p>Interpolated resolution max: 19200 x 19200 dpi *2</p> <p>*1 Optical Resolution represents the maximum sampling rate based on ISO 14473.</p> <p>*2 Increasing the scanning resolution will limit the maximum possible scanning area.</p>

Gradation (Input / Output)	Gray: 16 bit/8 bit Color: 48 bit/24 bit (RGB each 16 bit/8 bit)
-----------------------------------	--

Network Specifications

Communication protocol	TCP/IP
Wireless LAN	<p>Supported Standards: IEEE802.11n / IEEE802.11g / IEEE802.11b</p> <p>Frequency bandwidth: 2.4 GHz</p> <p>Channel: 1-11 or 1-13</p> <p>* Frequency bandwidth and available channels differ depending on country or region.</p> <p>Communication distance: Indoors 164 feet/50 m</p> <p>* Effective range varies depending on the installation environment and location.</p> <p>Security:</p> <p>WEP (64/128 bits)</p> <p>WPA-PSK (TKIP/AES)</p> <p>WPA2-PSK (TKIP/AES)</p> <p>Setup:</p> <p>WPS (Push button configuration/PIN code method)</p> <p>WCN (WCN-NET)</p> <p>Easy wireless connect</p> <p>Other Features: Administration password</p>

Minimum System Requirements

Conform to the operating system's requirements when higher than those given here.

Windows

Operating System	Windows 10, Windows 8.1*, Windows 8 Windows 7 SP1 Windows Vista SP2 * Windows 8.1 includes Windows 8.1 Update.
Hard Disk Space	3.1 GB Note: For bundled software installation. The necessary amount of hard disk space may be changed without notice.
Display	XGA 1024 x 768

Mac OS

Operating System	OS X v10.8.5 - OS X v10.11
-------------------------	----------------------------

Hard Disk Space	1.5 GB Note: For bundled software installation. The necessary amount of hard disk space may be changed without notice.
Display	XGA 1024 x 768

Other Supported OS

Some functions may not be available with each OS. Refer to the Canon web site for details on operation with iOS, Android, Windows RT, and Windows 10 Mobile.

Mobile Printing Capability

Apple AirPrint
Google Cloud Print
PIXMA Cloud Link

- An internet connection is required to use Easy-WebPrint EX and all the Online Manual.
- Windows: Operation can only be guaranteed on a PC with pre-installed Windows Vista or later.
- Windows: A CD-ROM Drive or internet connection is required during software installation.
- Windows: Internet Explorer 8, 9, 10 or 11 is required to install Easy-WebPrint EX.
- Windows: Some functions may not be available with Windows Media Center.
- Windows: .NET Framework 4.5.2 or 4.6 must be installed to use the Windows software.
- Windows: The TWAIN driver (ScanGear) is based on the TWAIN 1.9 Specification and requires the Data Source Manager bundled with the operating system.
- Mac OS: For Mac OS, an internet connection is required during software installation.
- In an in-house network environment, the 5222 port must be open. Contact the network administrator for details.

Information in this guide is subject to change without notice.

Information about Paper

- ▶ **Supported Media Types**
 - Paper Load Limit
- ▶ **Unsupported Media Types**
- ▶ **Handling Paper**
- ▶ **Print Area**

Supported Media Types

For best results, choose paper designed for how you are printing. A variety of paper for documents as well as photos or illustrations is available from Canon. Use genuine Canon paper to print important photos, when possible.

Media Types

Genuine Canon paper

▶▶▶ Note

- For warnings on use of the non-printable side, see each product's usage information.
- For details on page sizes and media types, access the Canon website.
- Genuine Canon paper is not available in some countries or regions. Note that in the United States, Canon paper is not sold by model number. Instead, purchase paper by name.

Paper for printing documents:

- Canon Red Label Superior <WOP111>
- Canon Océ Office Colour Paper <SAT213>
- High Resolution Paper <HR-101N>^{*1}

Paper for printing photos:

- Photo Paper Pro Platinum <PT-101>
- Glossy Photo Paper "Everyday Use" <GP-501>
- Photo Paper Glossy <GP-701>
- Photo Paper Plus Glossy II <PP-201>
- Photo Paper Plus Glossy II <PP-301>
- Photo Paper Pro Luster <LU-101>
- Photo Paper Plus Semi-gloss <SG-201>
- Matte Photo Paper <MP-101>

Paper other than genuine Canon paper

- Plain Paper (including recycled paper)
- Envelopes^{*1}
- T-Shirt Transfers^{*1}

*1 Printing to this paper from the operation panel or from a PictBridge (Wireless LAN) compliant device is not supported.

■ [Paper Load Limit](#)

■ [Paper Settings on the Printer Driver and the Printer \(Media Type\)](#) (Windows)

■ [Paper Settings on the Printer Driver and the Printer \(Media Type\)](#) (Mac OS)

▶▶▶ Note

- When printing photos saved on a PictBridge (Wireless LAN) compliant device, you must specify the page size and media type.

■ Printing from Digital Camera

Page Sizes

You can use the following page sizes.

►► Note

- Page sizes and media types the printer supports differ depending on the OS you are using.

Standard sizes:

- Letter
- Legal
- A4
- B5
- A5
- L(89x127mm)
- KG/4"x6"(10x15)
- 2L/5"x7"(13x18)
- Hagaki
- Hagaki 2
- 8"x10"(20x25cm)
- Card 2.17"x3.58" 55x91mm
- Square 5"x5" 127x127mm
- Envelope Com 10
- Envelope DL
- Nagagata 3
- Nagagata 4
- Yougata 4
- Yougata 6

Special sizes

Special page sizes must be within the following limits:

- rear tray
 - Minimum size: 2.17 x 3.50 inches (55.0 x 89.0 mm)
 - Maximum size: 8.50 x 26.61 inches (215.9 x 676.0 mm)
- cassette
 - Minimum size: 5.83 x 8.27 inches (148.0 x 210.0 mm)
 - Maximum size: 8.50 x 11.69 inches (215.9 x 297.0 mm)

Paper Weight

You can use paper in the following weight range.

- 17 to 28 lb (64 to 105 g /m²) (plain paper other than genuine Canon paper)

Paper Load Limit

Genuine Canon Paper

Paper for printing documents:

Media Name <Model No.>	Rear Tray	Cassette	Paper Output Tray
Canon Red Label Superior <WOP111>	Approx. 100 sheets	Approx. 100 sheets	Approx. 50 sheets
Canon Océ Office Colour Paper <SAT213>	Approx. 80 sheets	Approx. 80 sheets	Approx. 50 sheets
High Resolution Paper <HR-101N> *1	Approx. 80 sheets	N/A	Approx. 50 sheets

Paper for printing photos:

Media Name <Model No.>	Rear Tray	Paper Output Tray
Photo Paper Pro Platinum <PT-101> *2	10 sheets: A4, Letter, and 8" x 10" (20 x 25 cm) 20 sheets: 4" x 6" (10 x 15 cm)	*3
Glossy Photo Paper "Everyday Use" <GP-501> *2	A4, Letter: 10 sheets 4" x 6" (10 x 15 cm): 20 sheets	*3
Photo Paper Glossy <GP-701> *2	A4, Letter: 10 sheets 4" x 6" (10 x 15 cm): 20 sheets	*3
Photo Paper Plus Glossy II <PP-201> *2	A4, Letter, 5" x 7" (13 x 18 cm), 8" x 10" (20 x 25 cm): 10 sheets 4" x 6" (10 x 15 cm), Square 5" x 5" (127 x 127 mm): 20 sheets	*3
Photo Paper Plus Glossy II <PP-301> *2	A4, Letter, 5" x 7" (13 x 18 cm), 8" x 10" (20 x 25 cm): 10 sheets 4" x 6" (10 x 15 cm), Square 5" x 5" (127 x 127 mm): 20 sheets	*3
Photo Paper Pro Luster <LU-101> *2	A4, Letter: 10 sheets	*3
Photo Paper Plus Semi-gloss <SG-201> *2	A4, Letter, 5" x 7" (13 x 18 cm), 8" x 10" (20 x 25 cm): 10 sheets 4" x 6" (10 x 15 cm): 20 sheets	*3
Matte Photo Paper <MP-101>	A4, Letter: 10 sheets 4" x 6" (10 x 15 cm): 20 sheets	*3

Paper other than Genuine Canon Paper

Common Name	Rear Tray	Cassette	Paper Output Tray
Plain Paper (including recycled paper)* 1	Approx. 100 sheets (10 sheets: Legal)	Approx. 100 sheets	Approx. 50 sheets (10 sheets: Legal)
Envelopes	10 envelopes	N/A	*3
T-Shirt Transfers	1 sheet : A4	N/A	*3

*1 Normal feeding at maximum capacity may not be possible with some types of paper, or under very high or low temperature or humidity. In this case, load half the amount of paper or less.

*2 Feeding from a loaded stack of paper may leave marks on the printed side or prevent efficient feeding. In this case, load one sheet at a time.

*3 For best results in continuous printing, remove printed paper or envelopes from the paper output tray to avoid smearing or discoloration.

Unsupported Media Types

Do not use the following types of paper. Using such paper will cause not only unsatisfactory results, but also the printer to jam or malfunction.

- Folded, curled, or wrinkled paper
- Damp paper
- Paper that is too thin (weighing less than 17 lb (64 g /m²))
- Paper that is too thick (plain paper weighing more than 28 lb (105 g /m²), except for Canon genuine paper)
- Paper thinner than a postcard, including plain paper or notepad paper cut to a small size (when printing on paper smaller than A5)
- Picture postcards
- Postcards
- Envelopes with a double flap
- Envelopes with an embossed or treated surface
- Envelopes whose gummed flaps are already moistened and adhesive
- Any type of paper with holes
- Paper that is not rectangular
- Paper bound with staples or glue
- Paper with an adhesive surface on the back such as label seal
- Paper decorated with glitter, etc.

Handling Paper

- Be careful not to rub or scratch the surfaces of any types of paper when handling.
- Hold the paper as closely as possible to its edges and try not to touch the printing surface. The print quality may be degraded if the printing surface is smudged with sweat or oil that comes from your hands.
- Do not touch the printed surface until the ink is dried. Even when the ink is dried, be careful not to touch the printed surface as much as possible when handling. Due to the nature of the pigment ink, the ink on the printed surface may be removed when being rubbed or scratched.
- Take out only the necessary number of paper from the package, just before printing.
- To avoid curling, when you do not print, put unused paper back into the package and keep it on a level surface. And also, store it avoiding heat, humidity, and direct sunlight.

Printing from Computer

- ▶ [Printing from Application Software \(Windows Printer Driver\)](#)
- ▶ [Printing from Application Software \(Mac OS Printer Driver\)](#)
- ▶ [Printing Using Canon Application Software](#)
- ▶ [Printing Using a Web Service](#)
- ▶ [Printing from an AirPrint-enabled Printer with Mac](#)

Printing from Application Software (Windows Printer Driver)

- ▶ **Basic Printing Setup** 📌 **Basic**
- ▶ **Various Printing Methods**
- ▶ **Changing the Print Quality and Correcting Image Data**
- ▶ **Overview of the Printer Driver**
- ▶ **Printer Driver Description**
- ▶ **Updating the MP Drivers**

Basic Printing Setup

This section describes settings on the [Quick Setup tab](#) used for basic printing.

Basic Printing Setup

1. [Check that printer power is on](#)
2. [Load paper](#) in printer
3. Open [printer driver's setup screen](#)
4. Select frequently used settings

On the **Quick Setup** tab, use **Commonly Used Settings** to select from predefined print settings.

When you select a print setting, the settings for **Additional Features**, **Media Type**, and **Printer Paper Size** automatically switch to the predefined values.

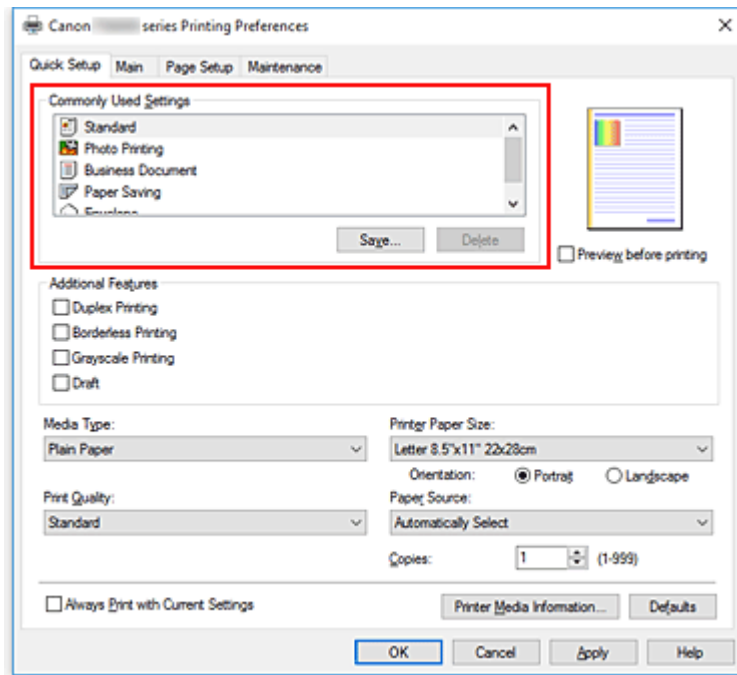

5. Select print quality

For **Print Quality**, select from **High**, **Standard**, or **Draft**.

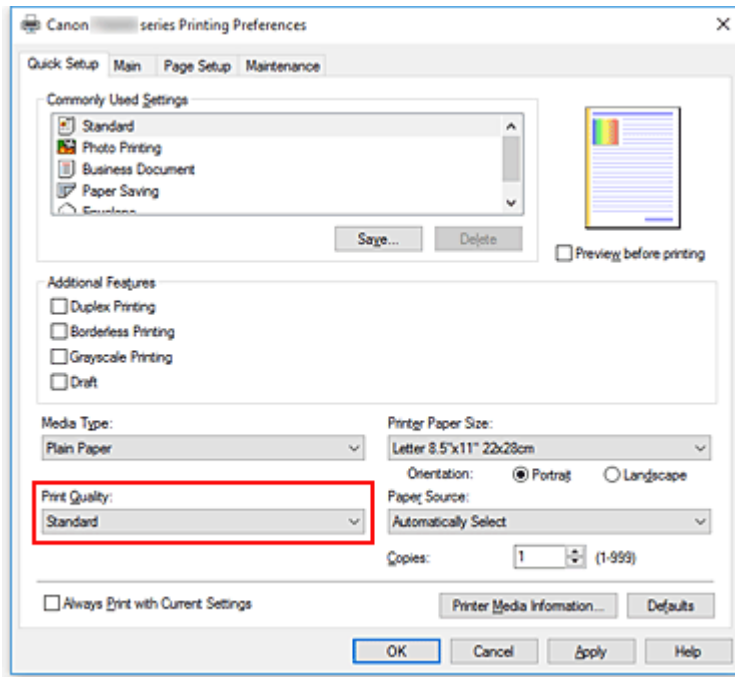

»»» Important

- The print quality selections will differ depending on which print setting you select.

6. Select paper source

For **Paper Source**, select **Automatically Select**, **Rear Tray**, or **Cassette**, whichever matches your purpose.

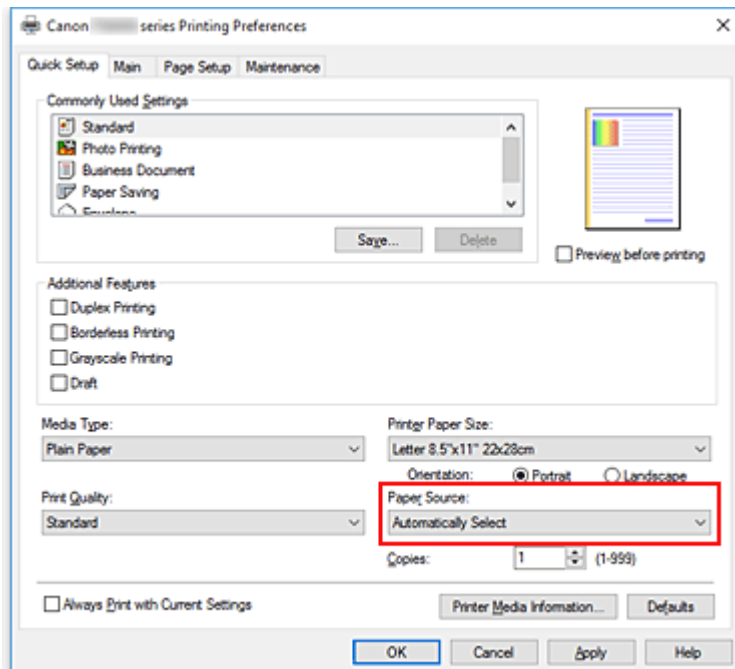

»»» Important

- The paper source settings that can be selected may differ depending on the paper type and size.

7. Click **OK**

The printer will now print using these settings.

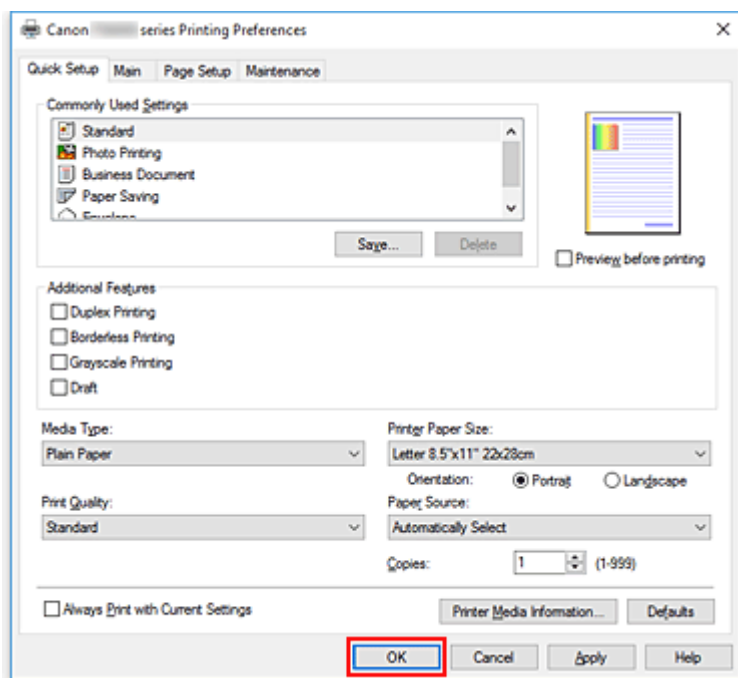

►►► Important

- When you select **Always Print with Current Settings**, the settings on the **Quick Setup**, **Main**, and **Page Setup** tabs are saved, and those settings are used in subsequent printings.
- To [register the current settings](#) as a new preset, click **Save...** under **Commonly Used Settings**.

►►► Note

- If the paper settings in the printer driver differ from the paper information registered on the printer, an error may occur. For instructions on what to do if an error occurs, see "[Paper Settings](#)."
To check the current printer settings or to apply the printer settings to the printer driver, display the **Quick Setup** tab, click **Printer Media Information...**, and specify the settings in the dialog box that appears.
For details about the paper information to be registered on the printer, see the following:
 - [Paper Settings on the Printer Driver and the Printer \(Media Type\)](#)
 - [Paper Settings on the Printer Driver and the Printer \(Paper Size\)](#)

Checking Printer Settings and Applying Settings to Printer Driver

1. Open printer driver setup window
2. On **Quick Setup** tab, click **Printer Media Information...**
The **Printer Media Information** dialog box appears.
3. Select **Paper Source**

From **Paper Source**, check the setting or select a new paper source.
The current printer settings appear in **Media Type** and **Page Size**.

4. Apply settings

To apply the printer settings to the printer driver, click **Set**.

»» Note

- If the media type on the printer is set to Hagaki, Ink Jet Hagaki, or Hagaki K, or if the output paper size on the printer is set to 2L/5"x7"(13x18), click **Set** to display the dialog box. Select the media type and paper size that match your purpose, and then click **OK**.
- If the media type and the output paper size are not set on the printer, **Set** will be grayed out and cannot be clicked.
- If communication with the printer is disabled, the **Printer Media Information...** dialog box will not appear or the printer driver will not be able to obtain printer media information.

Paper Settings on the Printer Driver and the Printer (Media Type)

When you use this printer, selecting a media type and [paper size](#) that matches the print purpose will help you achieve the best print results.

You can use the following media types on this printer.

Canon genuine papers (Document Printing)

Media name <Model No.>	Media Type in the printer driver	Paper information registered on the printer
Canon Red Label Superior <WOP111>	Plain Paper	Plain paper
Canon Océ Office Colour Paper <SAT213>	Plain Paper	Plain paper

Canon genuine papers (Photo Printing)

Media name <Model No.>	Media Type in the printer driver	Paper information registered on the printer
Photo Paper Plus Glossy II <PP-201/PP-301>	Photo Paper Plus Glossy II	Plus Glossy II
Photo Paper Pro Platinum <PT-101>	Photo Paper Pro Platinum	Pro Platinum
Photo Paper Pro Luster <LU-101>	Photo Paper Pro Luster	Pro Luster
Photo Paper Plus Semi-gloss <SG-201>	Photo Paper Plus Semi-gloss	Plus Semi-gloss
Glossy Photo Paper "Everyday Use" <GP-501>	Glossy Photo Paper	Glossy
Photo Paper Glossy <GP-701>	Glossy Photo Paper	Glossy
Matte Photo Paper <MP-101>	Matte Photo Paper	Matte

Canon genuine papers (Business Letter Printing)

Media name <Model No.>	Media Type in the printer driver	Paper information registered on the printer
High Resolution Paper <HR-101N>	High Resolution Paper	High-Res Paper

Commercially available papers

Media name	Media Type in the printer driver	Paper information registered on the printer
Plain Paper (including recycled paper)	Plain Paper	Plain paper
Envelopes	Envelope	Envelope
Other Photo Paper	Other Photo Paper	Other Photo Paper
T-Shirt Transfers	T-Shirt Transfers	Others

Paper Settings on the Printer Driver and the Printer (Paper Size)

When you use this printer, selecting a paper size that matches the print purpose will help you achieve the best print results.

You can use the following paper sizes on this printer.

Printer Paper Size in the printer driver	Paper information registered on the printer
Letter 8.5"x11" 22x28cm	Letter
Legal 8.5"x14" 22x36cm	Legal
A5	A5
A4	A4
B5	B5
4"x6" 10x15cm	KG/4"x6"(10x15)
5"x7" 13x18cm	2L/5"x7"(13x18)
8"x10" 20x25cm	8"x10"(20x25cm)
L 89x127mm	L(89x127mm)
2L 127x178mm	2L/5"x7"(13x18)
Square 5"x5" 13x13cm	Square 5"x5"
Envelope Com 10	Envelope Com 10
Envelope DL	Envelope DL
Yougata 4 4.13"x9.25"	Yougata 4
Yougata 6 3.86"x7.48"	Yougata 6
Card 2.17"x3.58" 55x91mm	Card 2.17"x3.58"
Custom Size	Others

Various Printing Methods

- ▶ **Setting a Page Size and Orientation**
- ▶ **Setting the Number of Copies and Printing Order**
- ▶ **Execute Borderless Printing**
- ▶ **Scaled Printing**
- ▶ **Page Layout Printing**
- ▶ **Tiling/Poster Printing**
- ▶ **Duplex Printing**
- ▶ **Setting Up Envelope Printing**
- ▶ **Printing on Postcards**
- ▶ **Setting Paper Dimensions (Custom Size)**

Setting a Page Size and Orientation

The paper size and orientation are essentially determined by the application software. When the page size and orientation set for **Page Size** and **Orientation** on the **Page Setup** tab are same as those set with the application software, you do not need to select them on the **Page Setup** tab.

When you are not able to specify them with the application software, the procedure for selecting a page size and orientation is as follows:

You can also set page size and orientation on the **Quick Setup** tab.

1. Open the [printer driver setup window](#)

2. Select the paper size

Select a page size from the **Page Size** list on the **Page Setup** tab.

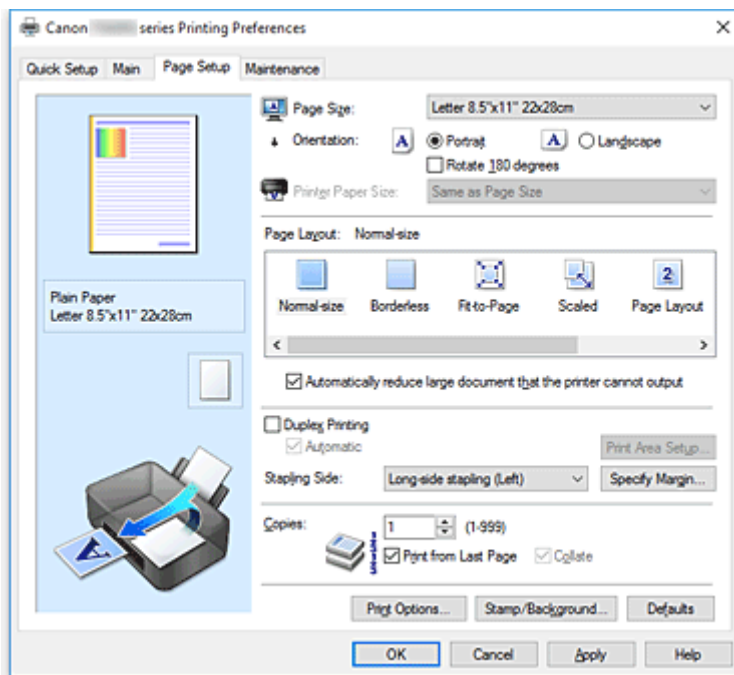

3. Set **Orientation**

Select **Portrait** or **Landscape** for **Orientation**. Check **Rotate 180 degrees** check box when you want to perform printing with the original being rotated 180 degrees.

4. Click **OK**

When you execute print, the document will be printed with the selected page size and the orientation.

▶▶▶ Note

- If **Normal-size** is selected for **Page Layout**, then **Automatically reduce large document that the printer cannot output** is displayed.

Normally, you can leave the check box checked. During printing, if you do not want to reduce large documents that cannot be printed on the printer, uncheck the check box.

Setting the Number of Copies and Printing Order

The procedure for specifying the number of copies and printing order is as follows:
You can also set the number of copies on the **Quick Setup** tab.

1. Open the [printer driver setup window](#)
2. Specify the number of copies to be printed

For **Copies** on the **Page Setup** tab, specify the number of copies to be printed.

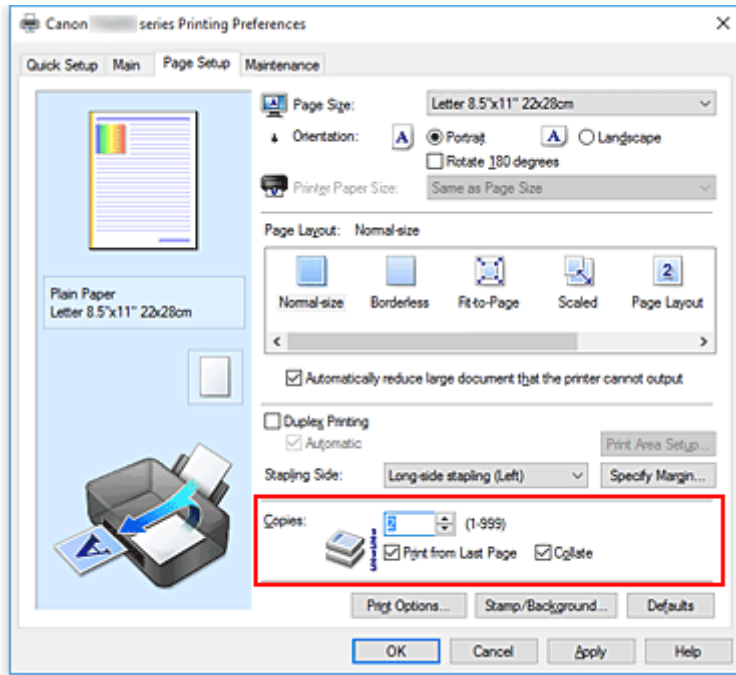

3. Specify the print order

Check the **Print from Last Page** check box when you want to print from the last page in order, and uncheck the check box when you want to print from the first page.

Check the **Collate** check box when you are printing multiple copies of a document and want to print out all pages in each copy together. Uncheck this check box when you want to print all pages with the same page number together.

- **Print from Last Page:** / **Collate:**

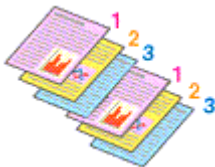

- **Print from Last Page:** / **Collate:**

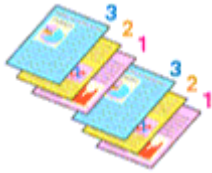

- **Print from Last Page:** / **Collate:**

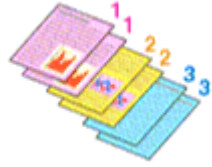

- **Print from Last Page:** / **Collate:**



4. Click **OK**

When you execute print, the specified number of copies will be printed with the specified printing order.

»» Important

- When the application software that you used to create the document has the same function, specify the settings on the printer driver. However, if the print results are not acceptable, specify the function settings on the application software. When you specify the number of copies and the printing order with both the application software and this printer driver, the number of copies may be multiplied numbers of the two settings or the specified printing order may not be enabled.
- **Print from Last Page** appears grayed out and is unavailable when **Tiling/Poster** is selected for **Page Layout**.
- When **Booklet** is selected for **Page Layout**, **Print from Last Page** and **Collate** appear grayed out and cannot be set.
- When **Duplex Printing** is selected, **Print from Last Page** appears grayed out and cannot be set.

»» Note

- By setting both **Print from Last Page** and **Collate**, you can perform printing so that papers are collated one by one starting from the last page.
These settings can be used in combination with **Normal-size**, **Borderless**, **Fit-to-Page**, **Scaled**, and **Page Layout**.

Execute Borderless Printing

The borderless printing function allows you to print data without any margin by enlarging the data so that it extends slightly off the paper. In standard printing, margins are created around the document area. However, in borderless printing function, these margins are not created. When you want to print data such as a photo without providing any margin around it, set borderless printing.

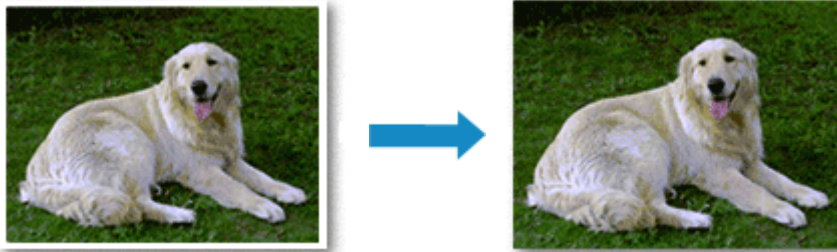

The procedure for performing borderless printing is as follows:

You can also set borderless printing in **Additional Features** on the **Quick Setup** tab.

Setting Borderless Printing

1. Open the [printer driver setup window](#)
2. Set borderless printing

Select **Borderless** from the **Page Layout** list on the **Page Setup** tab.

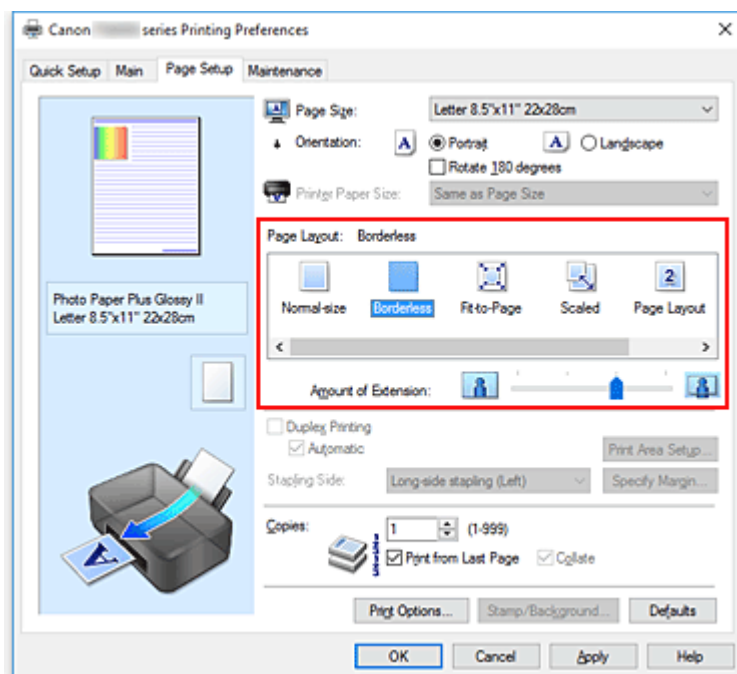

Click **OK** when the confirmation message appears.

When a message prompting you to change the media type appears, select a media type from the list and click **OK**.

3. Check the paper size

Check the **Page Size** list. When you want to change it, select another page size from the list. The list displays only sizes that can be used for borderless printing.

4. Adjust the amount of extension from the paper

If necessary, adjust the amount of extension using the **Amount of Extension** slider.

Moving the slider to the right increases the amount extending off the paper, and moving the slider to the left decreases the amount.

It is recommended to set the slider at the second position from the right for most cases.



►► Important

- When the **Amount of Extension** slider is set to the rightmost position, the back side of the paper may become smudged.

5. Click **OK**

When you execute print, the data is printed without any margins on the paper.

►► Important

- When a page size that cannot be used for borderless printing is selected, the size is automatically changed to the valid page sizes for borderless printing.
- When **Borderless** is selected, the **Printer Paper Size**, **Duplex Printing**, **Stapling Side** settings, and the **Stamp/Background... (Stamp...)** button on the **Page Setup** tab appear grayed out and are unavailable.
- When **Envelope**, **High Resolution Paper**, or **T-Shirt Transfers** is selected from the **Media Type** list on the **Main** tab, you cannot perform borderless printing.
- Depending on the type of the media used during borderless printing, the print quality may deteriorate at the top and bottom of the sheet or stains may form.
- When the ratio of the height to the width differs from the image data, a portion of the image may not be printed depending on the size of the media used.
In this case, crop the image data with an application software according to the paper size.

►► Note

- When **Plain Paper** is selected for **Media Type** on the **Main** tab, borderless printing is not recommended. Therefore, the message for media selection appears.
When you are using plain paper for test printing, select **Plain Paper**, and click **OK**.

Expanding the Range of the Document to Print

Setting a large amount of extension allows you to perform borderless printing with no problems. However, the portion of the document extending off the paper range will not be printed and for this reason, the subjects around the perimeter of a photo may not be printed.

When you are not satisfied with the result of borderless printing, reduce the amount of extension. The extension amount decreases as the **Amount of Extension** slider is moved to the left.

▶▶ Important

- When the amount of extension is decreased, an unexpected margin may be produced on the print, depending on the size of the paper.

▶▶ Note

- When the **Amount of Extension** slider is set to the leftmost position, image data will be printed in the full size. If you set this when printing the address side of a postcard, the postal code of the sender is printed in the correct position.
- When **Preview before printing** is checked on the **Main** tab, you can confirm whether there will be no margin before printing.

Scaled Printing



The procedure for printing a document with pages enlarged or reduced is as follows:

1. Open the [printer driver setup window](#)
2. Set scaled printing

Select **Scaled** from the **Page Layout** list on the **Page Setup** tab.

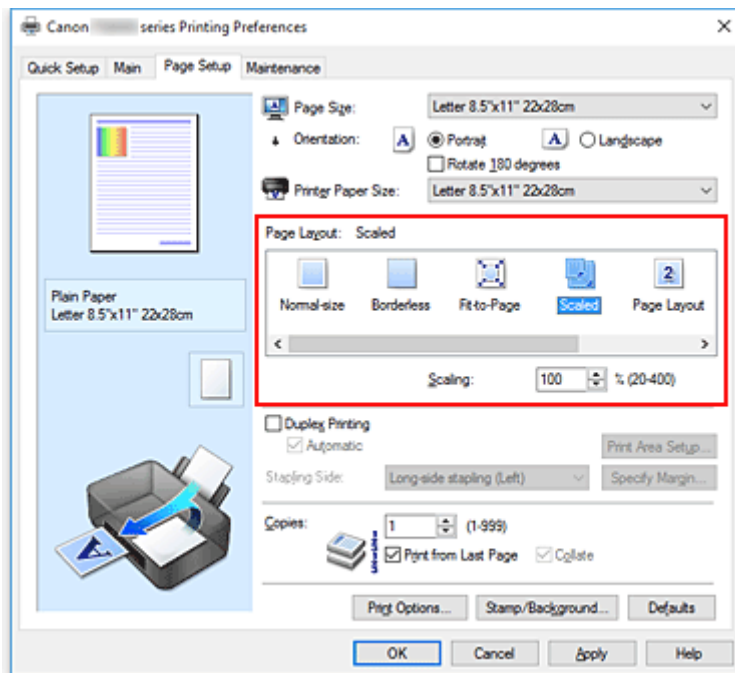

3. Select the paper size of the document

Using **Page Size**, select the page size that is set with your application software.

4. Set the scaling rate by using one of the following methods:

- Select a **Printer Paper Size**

When the printer paper size is smaller than the **Page Size**, the page image will be reduced. When the printer paper size is larger than the **Page Size**, the page image will be enlarged.

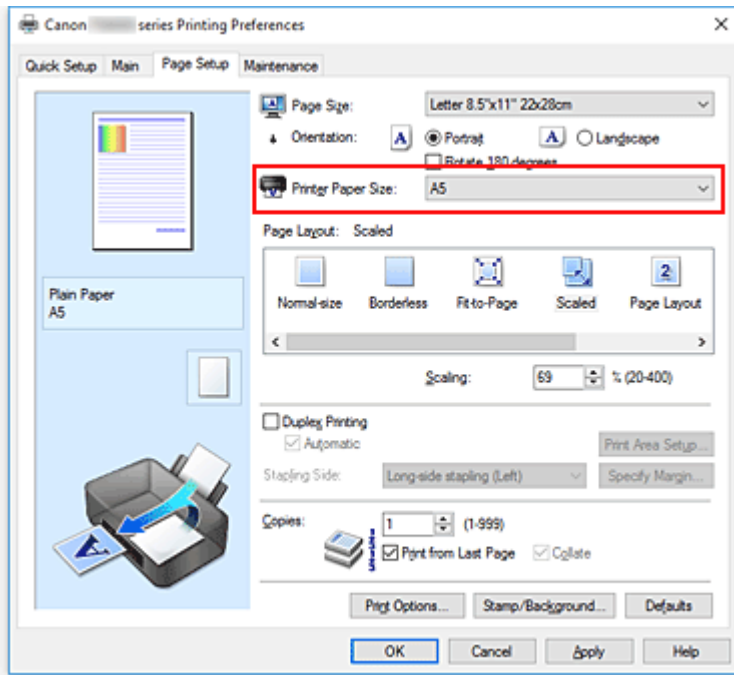

- Specify a scaling factor

Directly type in a value into the **Scaling** box.

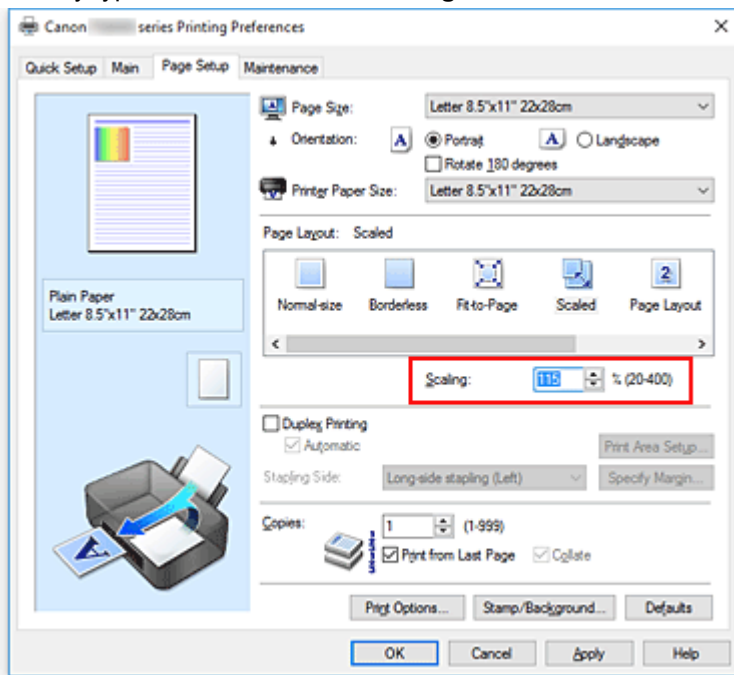

The current settings are displayed in the settings preview on the left side of the printer driver.

5. Click **OK**

When you execute print, the document will be printed with the specified scale.

►►► Important

- When the application software which you used to create the original has the scaled printing function, configure the settings on your application software. You do not need to configure the same setting in the printer driver.

»» Note

- Selecting **Scaled** changes the printable area of the document.

Page Layout Printing

The page layout printing function allows you to print more than one page image on a single sheet of paper.



The procedure for performing page layout printing is as follows:

1. Open the [printer driver setup window](#)

2. Set page layout printing

Select **Page Layout** from the **Page Layout** list on the **Page Setup** tab.

The current settings are displayed in the settings preview on the left side of the printer driver.

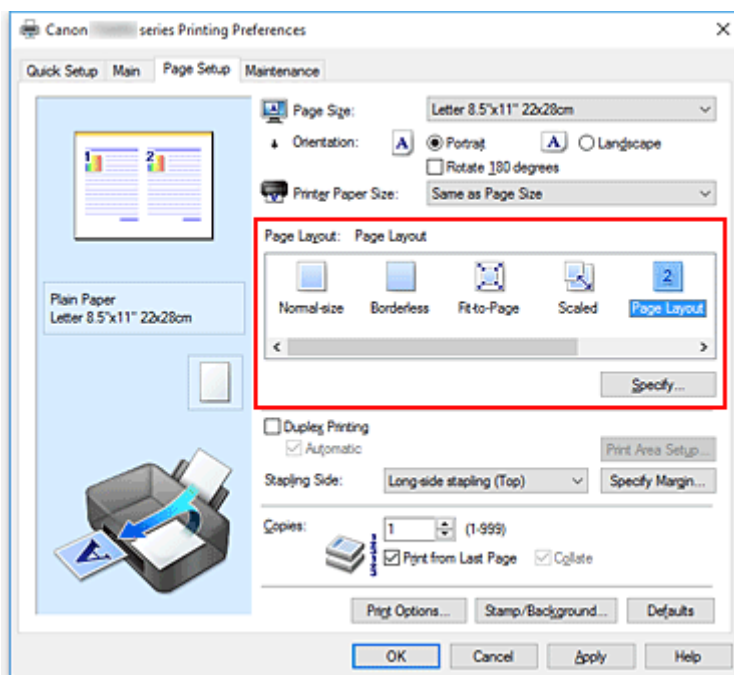

3. Select the print paper size

Select the size of the paper loaded in the printer from the **Printer Paper Size** list.

4. Set the number of pages to be printed on one sheet and the page order

If necessary, click **Specify...**, specify the following settings in the **Page Layout Printing** dialog box, and click **OK**.

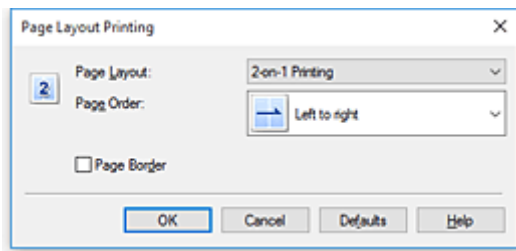

Page Layout

To change the number of pages to be printed on a single sheet of paper, select the number of pages from the list.

Page Order

To change the page arrangement order, select a placement method from the list.

Page Border

To print a page border around each document page, check this check box.

5. Complete the setup

Click **OK** on the **Page Setup** tab.

When you execute print, the specified number of pages will be arranged on each sheet of paper in the specified order.

Tiling/Poster Printing

The tiling/poster printing function allows you to enlarge image data, divide it into several pages, and print these pages on separate sheets of paper. You can also paste the pages together to create a large print like a poster.

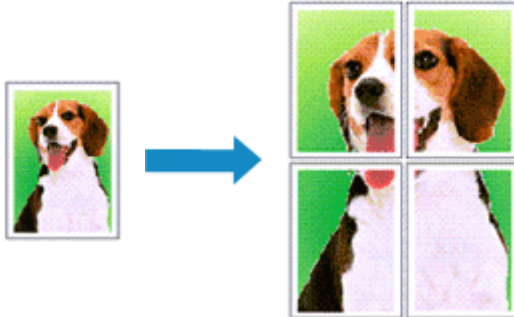

The procedure for performing tiling/poster printing is as follows:

Setting Tiling/Poster Printing

1. Open the [printer driver setup window](#)
2. Set tiling/poster printing

Select **Tiling/Poster** from the **Page Layout** list on the **Page Setup** tab.

The current settings are displayed in the settings preview on the left side of the printer driver.

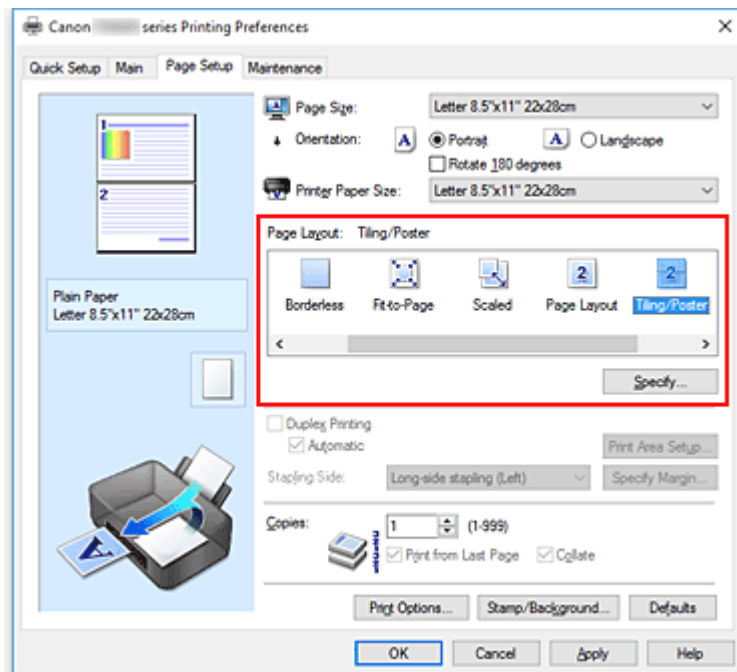

3. Select the print paper size

Select the size of the paper loaded in the printer from the **Printer Paper Size** list.

4. Set the number of image divisions and the pages to be printed

If necessary, click **Specify...**, specify the following settings in the **Tiling/Poster Printing** dialog box, and then click **OK**.

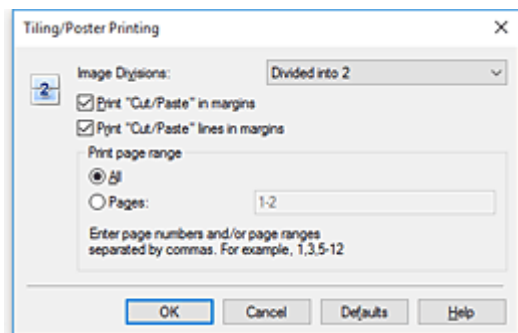

Image Divisions

Select the number of divisions (vertical x horizontal).

As the number of divisions increases, the number of sheets used for printing increases. If you are pasting pages together to create a poster, increasing the number of divisions allows you to create a larger poster.

Print "Cut/Paste" in margins

To leave out words "Cut" and "Paste", uncheck this check box.

»»» Note

- This feature may be unavailable when certain printer drivers or operating environments are used.

Print "Cut/Paste" lines in margins

To leave out cut lines, uncheck this check box.

Print page range

Specifies the printing range. Select **All** under normal circumstances.

To reprint only a specific page, select **Pages** and enter the page number you want to print. To specify multiple pages, enter the page numbers by separating them with commas or by entering a hyphen between the page numbers.

»»» Note

- You can also specify the print range by clicking the pages in the settings preview.

5. Complete the setup

Click **OK** on the **Page Setup** tab.

When you execute print, the document will be divided into several pages during printing.

Printing Only Specific Pages

If ink becomes faint or runs out during printing, you can reprint only the specific pages by following the procedure below:

1. Set the print range

In the settings preview on the left of the **Page Setup** tab, click the pages that do not need to be printed.

The pages that were clicked are deleted, and only the pages to be printed are displayed.

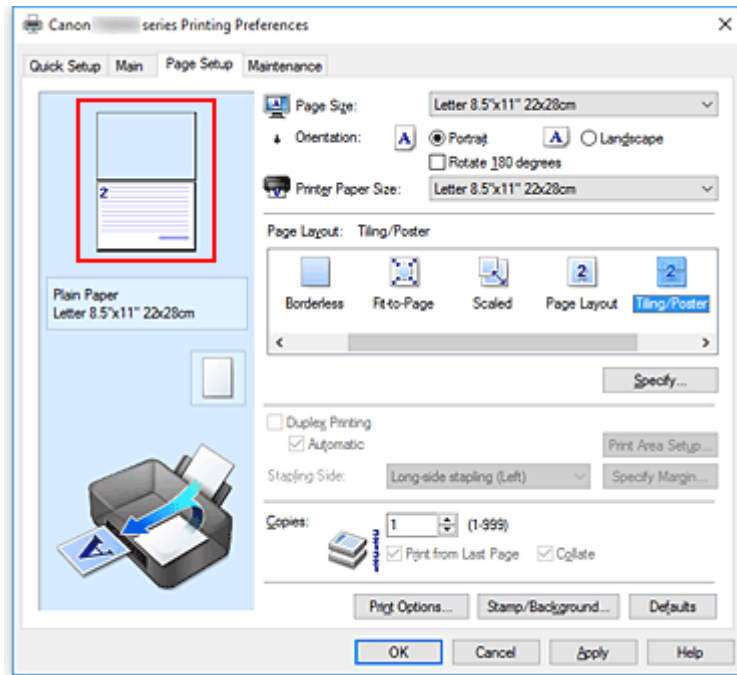

➤➤➤ Note

- Click the deleted pages to display them again.
- Right-click the settings preview to select **Print all pages** or **Delete all pages**.

2. Complete the setup

After completing the page selection, click **OK**.

When you execute print, only specified pages will be printed.

➤➤➤ Important

- Since tiling/poster printing enlarges the document when printing it, the print results may become coarse.

Duplex Printing



The procedure for printing data on both sides of a sheet of paper is as follows:
You can also set duplex printing in **Additional Features** on the **Quick Setup** tab.

Performing Automatic Duplex Printing

You can perform the duplex printing without having to turn over the paper.

1. Open the [printer driver setup window](#)
2. Set automatic duplex printing

Check the **Duplex Printing** check box on the **Page Setup** tab and confirm that **Automatic** is checked.

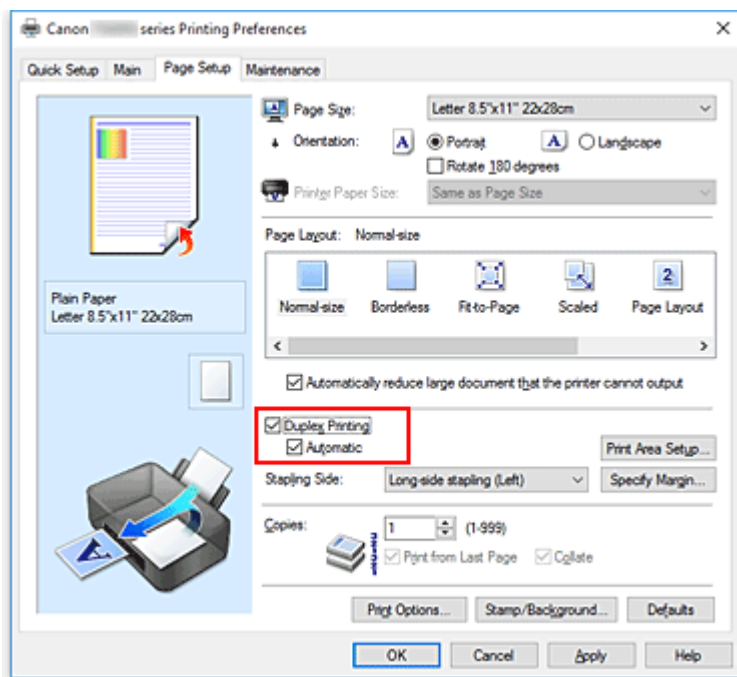

3. Select the layout
Select **Normal-size**, **Fit-to-Page**, **Scaled**, or **Page Layout** from the **Page Layout** list.
4. Set the print area

When you perform duplex printing, the print area of the document becomes slightly narrower than usual and the document may not fit on one page.

Click **Print Area Setup...**, select one of the following process methods, and then click **OK**.

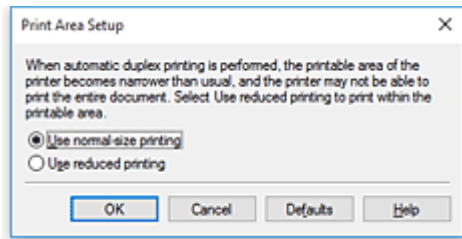

Use normal-size printing

Print without reducing the page.

Use reduced printing

Reduce the page slightly during printing.

5. Specify the side to be stapled

The best **Stapling Side** is selected automatically from the **Orientation** and **Page Layout** settings. To change the setting, select another stapling side from the list.

6. Set the margin width

If necessary, click **Specify Margin...** and set the margin width, and then click **OK**.

7. Complete the setup

Click **OK** on the **Page Setup** tab.

When you execute print, duplex printing will be started.

Performing Duplex Printing Manually

You can perform the duplex printing manually.

1. Open the [printer driver setup window](#)

2. Set duplex printing

Check the **Duplex Printing** check box and uncheck the **Automatic** check box on the **Page Setup** tab.

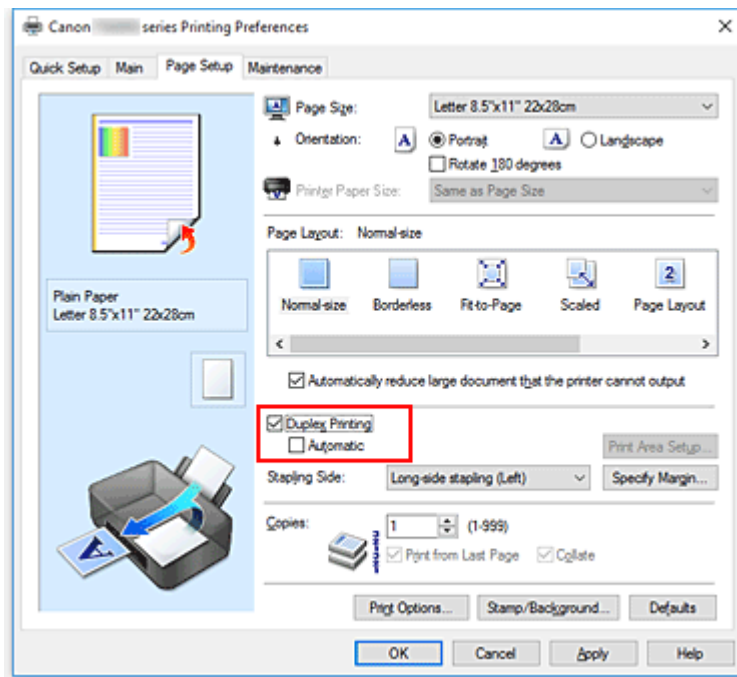

3. Select the layout

Select **Normal-size**, **Fit-to-Page**, **Scaled**, or **Page Layout** from the **Page Layout** list.

4. Specify the side to be stapled

The best **Stapling Side** is selected automatically from the **Orientation** and **Page Layout** settings. To change the setting, select another stapling side from the list.

5. Set the margin width

If necessary, click **Specify Margin...** and set the margin width, and then click **OK**.

6. Complete the setup

Click **OK** on the **Page Setup** tab.

When you execute print, the document is first printed on one side of a sheet of paper. After one side is printed, reload the paper correctly according to the message.

Then click **Start Printing** to print the opposite side.

▶▶▶ Important

- When a media type other than **Plain Paper** is selected from the **Media Type** list on the **Main** tab, **Duplex Printing** appears grayed out and is unavailable.
- When **Borderless**, **Tiling/Poster**, or **Booklet** is selected from the **Page Layout** list, **Duplex Printing** and **Stapling Side** appear grayed out and are unavailable.
- **Duplex Printing** can be performed only when one of the following paper sizes is selected from **Page Size** on the **Page Setup** tab.
 - **Letter 8.5"x11" 22x28cm, A4**

- After printing the front page, there is an ink drying wait time before starting to print the back page (Operation stops temporarily). Do not touch the paper during this time. You can change the ink drying wait time at **Custom Settings** on the **Maintenance** tab.

Related Topic

- [Changing the Printer Operation Mode](#)

Setting Up Envelope Printing

The procedure for performing envelope printing is as follows:

1. [Load envelope](#) on the printer
2. Open the [printer driver setup window](#)
3. Select the media type

Select **Envelope** from **Commonly Used Settings** on the **Quick Setup** tab.

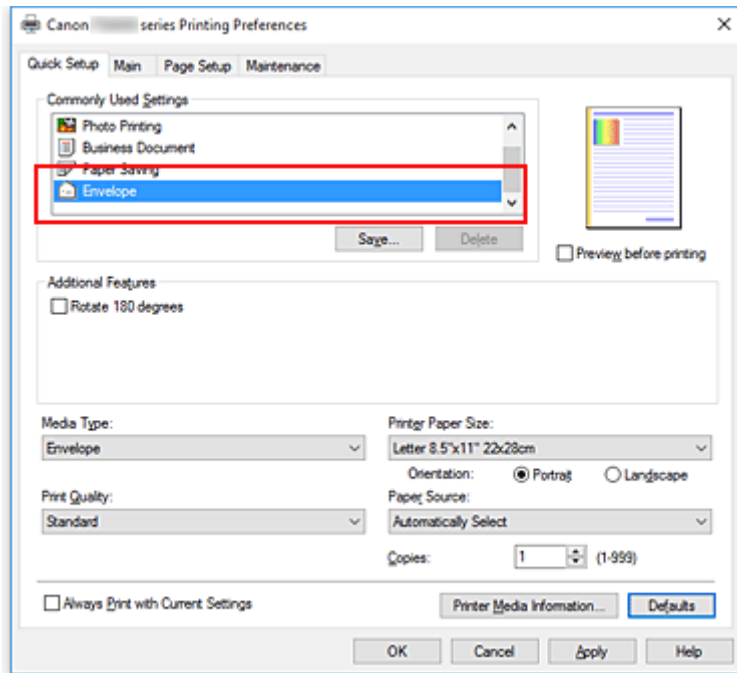

4. Select the paper size

When the **Envelope Size Setting** dialog box is displayed, select **Envelope Com 10**, **Envelope DL**, **Yougata 4 4.13"x9.25"**, or **Yougata 6 3.86"x7.48"**, and then click **OK**.

5. Set the orientation

To print the addressee horizontally, select **Landscape** for **Orientation**.

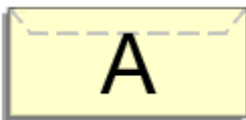

▶▶▶ Note

- If **Yougata 4 4.13"x9.25"**, **Yougata 6 3.86"x7.48"**, **Envelope Com 10**, or **Envelope DL** is selected for **Printer Paper Size**, the printer rotates the paper 90 degrees to the left to print, regardless of the **Rotate 90 degrees left when orientation is [Landscape]** setting for **Custom Settings** on the **Maintenance** tab.

6. Select the print quality

Select **High** or **Standard** that matches your purpose for **Print Quality**.

7. Click **OK**

When you execute print, the information is printed on the envelope.

▶▶▶ Important

- When you execute envelope printing, guide messages are displayed.
To hide the guide messages, check the **Do not show this message again** check box.
To show the guide again, click the **View Printer Status** button on the **Maintenance** tab, and start the Canon IJ Status Monitor.
Then click **Envelope Printing** from **Display Guide Message** of the **Option** menu to enable the setting.

▶▶▶ Note

- If the paper settings in the printer driver differ from the paper information registered on the printer, an error may occur. For instructions on what to do if an error occurs, see "[Paper Settings](#)."
To check the current printer settings or to apply the printer settings to the printer driver, click **Printer Media Information...** from the **Quick Setup** tab, and specify the settings in the dialog box that appears.
For details about the paper information to be registered on the printer, see the following:
 - [Paper Settings on the Printer Driver and the Printer \(Media Type\)](#)
 - [Paper Settings on the Printer Driver and the Printer \(Paper Size\)](#)

Printing on Postcards

This section describes the procedure for postcard printing.

1. [Load postcard](#) on the printer
2. Open the [printer driver setup window](#)
3. Select commonly used settings

Display the **Quick Setup** tab, and for **Commonly Used Settings**, select **Standard**.

4. Select the media type

For **Media Type**, select **Ink Jet Hagaki (A)**, **Ink Jet Hagaki**, **Hagaki K (A)**, **Hagaki K**, **Hagaki (A)**, or **Hagaki**.

▶▶▶ Important

- This printer cannot print on postcards that have photos or stickers attached.
- When printing on each side of a postcard separately, you will get cleaner printing if you print the message side first and then print the address side.
- The paper settings on the printer driver are different, depending on whether you are printing on the address side or the message side.

To check the current printer settings or to apply the printer settings to the printer driver, click **Printer Media Information...** from the **Quick Setup** tab, and specify the settings in the dialog box that appears.

For details about the paper information to be registered to the printer driver and on the printer, see the following:

- [Paper Settings on the Printer Driver and the Printer \(Media Type\)](#)
- [Paper Settings on the Printer Driver and the Printer \(Paper Size\)](#)

5. Select the paper size

For **Printer Paper Size**, select **Hagaki 100x148mm** or **Hagaki 2 200x148mm**.

▶▶▶ Important

- Return postcards can be used only when you print them from the computer.
- When printing a return postcard, always set the paper size to **Hagaki 2 200x148mm** from your application software or the printer driver.
- Do not fold the return postcard. If a crease is formed, the printer will not be able to feed the postcard properly, and this condition will cause line shifts or a paper jam.
- With return postcards, borderless printing cannot be used.

6. Set the print orientation

To print the address horizontally, set **Orientation** to **Landscape**.

7. Select the print quality

For **Print Quality**, select **High** or **Standard**, according to your purpose.

8. Click **OK**

When you execute printing, the data will be printed onto the postcard.

▶▶ Important

- When you execute postcard printing, a guide message is displayed.
When the guide message is displayed, select **Do not show this message again** if you do not want any guide messages to be displayed.
To display guide messages again, open the **Maintenance** tab and click **View Printer Status** to start the Canon IJ Status Monitor.
On the **Option** menu, choose **Display Guide Message** and click **Hagaki Printing** to enable the setting.
- When printing on media other than postcards, load the media according to usage method of that media, and click **Start Printing**.

Setting the Print Quality Level (Custom)

The print quality level can be set in the **Custom**.

The procedure for setting the print quality level is as follows:

1. Open the [printer driver setup window](#)
2. Select the print quality

On the **Main** tab, select **Custom** for **Print Quality**, and click **Set...**

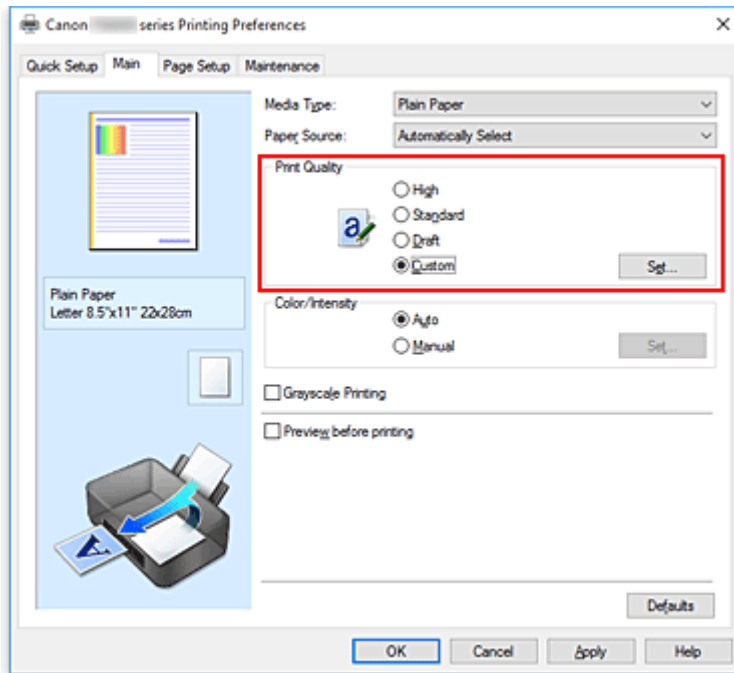

The **Custom** dialog box opens.

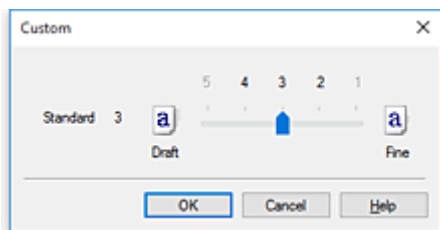

3. Setting the print quality level

Drag the slider bar to select the print quality level and click **OK**.

4. Complete the setup

Click **OK** on the **Main** tab.

When you execute print, the image data is printed with the selected print quality level.

►►► Important

- Certain print quality levels cannot be selected depending on the settings of **Media Type**.

Related Topics

- [Specifying Color Correction](#)
- [Adjusting Color Balance](#)
- [Adjusting Brightness](#)
- [Adjusting Intensity](#)
- [Adjusting Contrast](#)

Overview of the Printer Driver

- ▶ [Canon IJ Printer Driver](#)
- ▶ [Opening Printer Driver's Setup Screen](#)
- ▶ [Canon IJ Status Monitor](#)
- ▶ [Checking the Ink Status from Your Computer](#)
- ▶ [Canon IJ Preview](#)
- ▶ [Deleting the Undesired Print Job](#)
- ▶ [Instructions for Use \(Printer Driver\)](#)

Canon IJ Printer Driver

The Canon IJ printer driver (simply called printer driver below) is software that you install onto your computer so that it can communicate with the printer.

The printer driver converts the print data created by your application software into data that your printer can understand, and sends the converted data to the printer.

Because different printers support different data formats, you need a printer driver that supports your printer.

Printer Driver Types

If your computer is running Windows Vista SP1 or a later version, you can install the XPS printer driver in addition to the normal printer driver.

The XPS printer driver is suited to printing from application software that supports XPS printing.

►►► Important

- Note that if you want to use the XPS printer driver, the normal printer driver must also be installed.

Installing the Printer Driver

- To install the normal printer driver, install the driver from **Start Setup Again** on the setup CD-ROM that came with your printer.
- To install the XPS printer driver, load the setup CD-ROM that comes with the printer, and then select **XPS Driver** from **Add Software**.

Specifying the Printer Driver

To specify the printer driver, open the **Print** dialog box of the application software you are using, and select "Canon XXX" (where "XXX" is your model name) to specify the regular printer driver or select "Canon XXX XPS" (where "XXX" is your model name) to specify the XPS printer driver.

Displaying the Manual from the Printer Driver

To display the description of a setup tab from the printer driver's setup screen, click **Help** on that tab.

Related Topic

- [Opening Printer Driver's Setup Screen](#)

Opening Printer Driver's Setup Screen

You can display the printer driver's setup screen from your application software or by clicking the printer icon.

Displaying the Printer Driver's Setup Screen from Your Application Software

Perform this procedure to set up the print settings during printing.

1. Select print command from application software

The **Print** command can generally be found in the **File** menu.

2. Select your printer model, and click **Preferences** (or **Properties**)

The printer driver's setup screen appears.

▶▶▶ Note

- Depending on the application software you are using, the command and menu names, and the number of steps may vary. For details, refer to the operating instructions of your application software.

Displaying the Printer Driver's Setup Screen by Clicking the Printer Icon

From the setup screen you can perform printer maintenance operations such as print head cleaning, or set print settings to be shared by all application software.

1. To open the setup screen:

- If you are using Windows 10, Windows 8.1, or Windows 8, select **Control Panel** -> **Hardware and Sound** -> **Devices and Printers**.
- If you are using Windows 7, from the **Start** menu, select **Devices and Printers**.
- If you are using Windows Vista, select the **Control Panel** -> **Hardware and Sound** -> **Printers**.

2. Right-click the icon of your model. When the menu appears, select **Printing preferences**

The printer driver's setup screen appears.

▶▶▶ Important

- Opening the printer driver setup window through **Printer properties** (Windows 10, Windows 8.1, Windows 8, Windows 7) or **Properties** (Windows Vista) displays such tabs regarding the Windows functions as the **Ports** (or **Advanced**) tab. Those tabs do not appear when opening through **Printing preferences** or application software. For tabs regarding Windows functions, refer to the user's manual for the Windows.

Checking the Ink Status from Your Computer

You can check the remaining ink level and the ink tank types for your model.

1. Open the [printer driver setup window](#)

2. Launching the Canon IJ Status Monitor

On the **Maintenance** tab, click **View Printer Status**.

The Canon IJ Status Monitor opens and displays an image of the ink status.



3. Display **Estimated ink levels**

For **Estimated ink levels**, click  (the disclosure triangle) to display an image representation of the ink status.

Instructions for Use (Printer Driver)

This printer driver is subject to the following restrictions. Keep the following points in mind when using the printer driver.

Restrictions on the Printer Driver

- Depending on the document type to be printed, the paper feed method specified in the printer driver may not operate correctly.

If this happens, open the [printer driver setup window](#) from the **Print** dialog box of the application software, and check the setting in the **Paper Source** field on the **Main** tab.

- With some applications, the **Copies** setting in the **Page Setup** tab of the printer driver may not be enabled.

In this case, use the copies setting in the **Print** dialog box of the application software.

- If the selected **Language** in the **About** dialog box of the **Maintenance** tab does not match the operating system interface language, the printer driver setup window may not be displayed properly.
- Do not change the **Advanced** tab items of the printer properties. If you change any of the items, you will not be able to use the following functions correctly.

Also, if **Print to file** is selected in the **Print** dialog box of the application software and with applications that prohibit EMF spooling, such as Adobe Photoshop LE and MS Photo Editor, the following functions will not operate.

- **Preview before printing** on the **Main** tab
 - **Prevention of Print Data Loss** in the **Print Options** dialog box on the **Page Setup** tab
 - **Page Layout, Tiling/Poster, Booklet, Duplex Printing, Specify Margin..., Print from Last Page, Collate, and Stamp/Background... (Stamp...)** on the **Page Setup** tab
 - **Print a pattern for color adjustment** on the **Color Adjustment** tab in the **Manual Color Adjustment** dialog box
- Since the resolution in the preview display differs from the printing resolution, text and lines in the preview display may appear different from the actual print result.
 - With some applications, the printing is divided into multiple print jobs.
To cancel printing, delete all divided print jobs.
 - If image data is not printed correctly, display the **Print Options** dialog box from the **Page Setup** tab and change the setting of **Disable ICM required from the application software**. This may solve the problem.

▶▶▶ Note

- **Disable ICM required from the application software** cannot be used when the XPS printer driver is used.

Points to Note About Applications with Restrictions

- There are following restrictions in Microsoft Word (Microsoft Corporation).
 - When Microsoft Word has the same printing functions as the printer driver, use Word to specify them.
 - When **Fit-to-Page, Scaled, or Page Layout** is used for **Page Layout** on the **Page Setup** tab of the printer driver, the document may not print normally in certain versions of Word.

- When **Page Size** in Word is set to "XXX Enlarge/Reduce", the document may not print normally in certain versions of Word.

If this happens, follow the procedure below.

1. Open Word's **Print** dialog box.
 2. Open the [printer driver setup window](#), and on the **Page Setup** tab, set **Page Size** to the same paper size that you specified in Word.
 3. Set the **Page Layout** that you want, and then click **OK** to close the window.
 4. Without starting printing, close the **Print** dialog box.
 5. Open Word's **Print** dialog box again.
 6. Open the printer driver setup window and click **OK**.
 7. Start printing.
- If bitmap printing is enabled in Adobe Illustrator (Adobe Systems Incorporated), printing may take time or some data may not be printed. Print after unchecking the **Bitmap Printing** check box in the **Print** dialog box.

Printer Driver Description

- ▶ **Quick Setup tab Description**
- ▶ **Main tab Description**
- ▶ **Page Setup tab Description**
- ▶ **Maintenance tab Description**
- ▶ **Canon IJ Preview Description**
- ▶ **Canon IJ Status Monitor Screen**

Quick Setup tab Description

The **Quick Setup** tab is for registering commonly used print settings. When you select a registered setting, the printer automatically switches to the preset items.

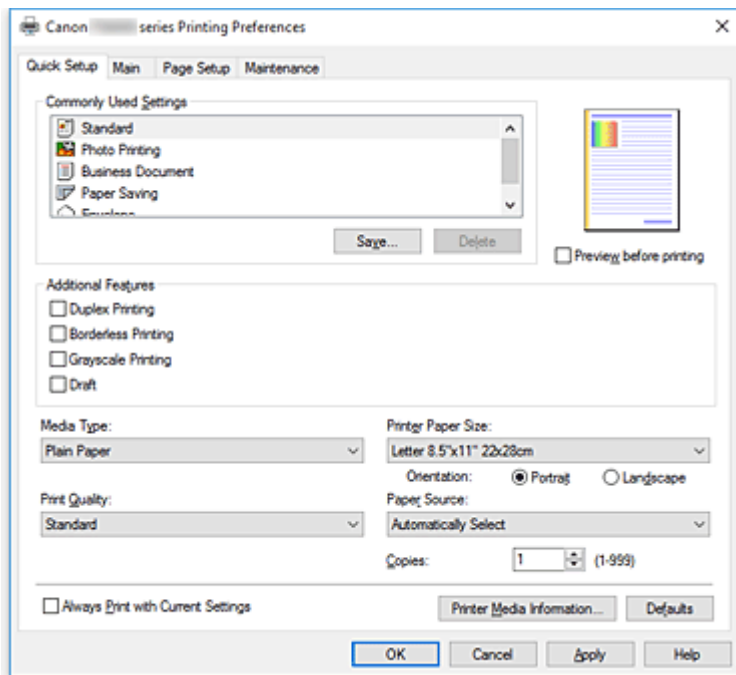

Commonly Used Settings

The names and icons of frequently used printing profiles are registered. When you select a printing profile according to the purpose of the document, settings that match the purpose are applied.

In addition, functions that are thought to be useful for the selected printing profile are displayed in **Additional Features**.

You can also change a printing profile and register it under a new name. You can delete the registered printing profile.

You can rearrange the profiles either by dragging the individual profiles or by holding down the Ctrl key and pressing the up or down arrow keys.

Standard

These are the factory settings.

If **Page Size**, **Orientation**, and **Copies** were set from the application software, those settings have priority.

Photo Printing

If you select this setting when printing a photo, the photo paper and photo size generally used are set. The **Borderless Printing** check box is checked automatically.

If **Orientation** and **Copies** were set from the application software, those settings have priority.

Business Document

Select this setting when printing a general document.

If **Page Size**, **Orientation**, and **Copies** were set from the application software, those settings have priority.

Paper Saving

Select this setting to save paper when printing a general document. The **2-on-1 Printing** and **Duplex Printing** check boxes are checked automatically.

If **Page Size**, **Orientation**, and **Copies** were set from the application software, those settings have priority.

Envelope

If you select this setting for printing an envelope, **Media Type** is set automatically to **Envelope**. In the **Envelope Size Setting** dialog box, select the size of the envelope to be used.

▶▶▶ Note

- The combination of the **Additional Features** that was displayed for the printing profile that had been selected when the added printing profile was saved is also displayed when that added printing profile is selected.

Save...

Displays the [Save Commonly Used Settings dialog box](#).

Click this button when you want to save the information that you set on the **Quick Setup**, **Main**, and **Page Setup** tabs to **Commonly Used Settings**.

Delete

Deletes a registered printing profile.

Select the name of the setting to be deleted from **Commonly Used Settings**, and click **Delete**. When a confirmation message is displayed, click **OK** to delete the specified printing profile.

▶▶▶ Note

- Printing profiles that are registered in the initial settings cannot be deleted.

Settings Preview

The paper illustration shows how the original will be laid out on a sheet of paper. You can check an overall image of the layout.

Preview before printing

Shows what the print result will look like before you actually print the data.

Check this check box to display a preview before printing.

Uncheck this check box if you do not want to display a preview.

▶▶▶ Important

- To use the Canon IJ XPS Preview, you must have Microsoft .NET Framework 4.5.2 or later installed on your computer.

Additional Features

Displays the frequently used, convenient functions for the printing profile that you selected for **Commonly Used Settings** on the **Quick Setup** tab.

When you move the mouse pointer near a function that can be changed, a description of that function is displayed.

To enable a function, check the corresponding check box.

For some functions, you can set detailed settings from the **Main** and **Page Setup** tabs.

▶▶▶ Important

- Depending on the printing profiles, certain function may be grayed out and you will not be able to change them.

2-on-1 Printing

Prints two pages of the document, side by side, on one sheet of paper.

To change the page sequence, click the **Page Setup** tab, select **Page Layout** for **Page Layout**, and click **Specify...** Then in the [Page Layout Printing dialog box](#) that appears, specify the **Page Order**.

4-on-1 Printing

Prints four pages of the document, side by side, on one sheet of paper.

To change the page sequence, click the **Page Setup** tab, select **Page Layout** for **Page Layout**, and click **Specify...** Then in the [Page Layout Printing dialog box](#) that appears, specify the **Page Order**.

Duplex Printing

Selects whether to print the document on both sides or one side of a sheet of paper.

To change the staple side or the margins, set the new values from the **Page Setup** tab.

Borderless Printing

Performs borderless printing without any margins on the paper.

With the borderless printing function, the document to be printed is enlarged, so that it extends slightly off the paper. In other words, the document is printed without any margin.

To adjust the amount that the document extends beyond the paper, click the **Page Setup** tab, choose **Borderless**, and enter the value in **Amount of Extension**.

Grayscale Printing

This function converts the data to monochrome data when printing your document.

Draft

This setting is appropriate for test printing.

Rotate 180 degrees

Prints the document by rotating it 180 degrees against the paper feed direction.

The width of print area and the amount of extension that are configured in other application software will be reversed vertically and horizontally.

Color/Intensity Manual Adjustment

Select when you set the **Color Correction** method and individual settings such as **Cyan**, **Magenta**, **Yellow**, **Brightness**, **Intensity**, and **Contrast**, etc.

Media Type

Selects a type of printing paper.

Select a media type that matches the paper that is loaded in the printer. This ensures that printing is carried out properly for the specified paper.

Printer Paper Size

Selects the size of paper actually loaded into the printer.

Normally, the paper size is set automatically according to the output paper size setting, and the document is printed with no scaling.

When you set **2-on-1 Printing** or **4-on-1 Printing** in **Additional Features**, you can manually set the paper size with **Page Size** on the **Page Setup** tab.

If you select a paper size that is smaller than the **Page Size**, the document size will be reduced. If you select a paper size that is larger, the document size will be enlarged.

Also if you select **Custom...**, the [Custom Paper Size dialog box](#) opens and allows you to specify any vertical and horizontal dimensions for the paper size.

Orientation

Selects the printing orientation.

If the application used to create your document has a similar function, select the same orientation that you selected in that application.

Portrait

Prints the document so that its top and bottom positions are unchanged relative to the paper feed direction. This is the default setting.

Landscape

Prints the document by rotating it 90 degrees relative to the paper feed direction.

You can change the rotation direction by going to the **Maintenance** tab, opening the **Custom Settings** dialog box, and then using **Rotate 90 degrees left when orientation is [Landscape]** check box.

To rotate the document 90 degrees to the left when printing, select the **Rotate 90 degrees left when orientation is [Landscape]** check box.

Print Quality

Selects your desired printing quality.

Select one of the following to set the print quality level that is appropriate for the purpose.

To set the print quality level individually, click the **Main** tab, and for **Print Quality**, select **Custom**. The **Set...** becomes enabled. Click **Set...** to open the [Custom dialog box](#), and then specify the desired settings.

High

Gives priority to print quality over printing speed.

Standard

Prints with average speed and quality.

Draft

This setting is appropriate for test printing.

Paper Source

Select the source from which paper is supplied.

Automatically Select

Based on the paper settings in the printer driver and the paper information registered on the printer, the printer automatically determines the paper source and feeds paper.

Rear Tray

Paper is always supplied from the rear tray.

Cassette

Paper is always supplied from the cassette.

►►► Important

- Depending on the media type and size, the **Paper Source** settings that can be selected may differ.

Copies

Specifies the number of copies you want to print. You can specify a value from 1 to 999.

►►► Important

- When the application software that you used to create the document has the same function, specify the settings on the printer driver. However, if the print results are not acceptable, specify the function settings on the application software.

Always Print with Current Settings

Prints documents with the current settings starting from the next print execution.

When you select this function and then close the [printer driver setup window](#), the information that you set on the **Quick Setup**, **Main**, and **Page Setup** tabs are saved and printing with the same settings is possible starting from the next print execution.

»» Important

- If you log on with a different user name, the settings that were set when this function was enabled are not reflected in the print settings.
- If a setting was specified on the application software, it has priority.

Printer Media Information...

Displays [Printer Media Information dialog box](#).

You can check the printer settings and apply the checked settings to the printer driver.

Defaults

Restores all the settings you have changed to their default values.

Click this button to return all settings on the **Quick Setup**, **Main**, and **Page Setup** tabs to their default values (factory settings).

Save Commonly Used Settings dialog box

This dialog box allows you to save the information that you set on the **Quick Setup**, **Main**, and **Page Setup** tabs and add the information to the **Commonly Used Settings** list on the **Quick Setup** tab.

Name

Enter the name for the printing profile you wish to save.

Up to 255 characters can be entered.

The name appears, with its associated icon, in the **Commonly Used Settings** list on the **Quick Setup** tab.

Options...

Opens the [Save Commonly Used Settings dialog box](#).

Changes the details of printing profile to be saved.

Save Commonly Used Settings dialog box

Select the icons of the printing profiles to be registered to **Commonly Used Settings**, and change the items to be saved in the printing profiles.

Icon

Select the icon for the printing profile you wish to save.

The selected icon appears, with its name, in the **Commonly Used Settings** list on the **Quick Setup** tab.

Save the paper size setting

Saves the paper size to the printing profile in **Commonly Used Settings**.

To apply the saved paper size when the printing profile is selected, check this check box.

If this check box is unchecked, the paper size is not saved, and consequently the paper size setting is not applied when the printing profile is selected. Instead the printer prints with the paper size specified with the application software.

Save the orientation setting

Saves the **Orientation** to the printing profile in **Commonly Used Settings**.

To apply the saved print orientation when the printing profile is selected, check this check box.

If this check box is unchecked, the print orientation is not saved, and consequently the **Orientation** setting is not applied when the printing profile is selected. Instead the printer prints with the print orientation specified with the application software.

Save the copies setting

Saves the **Copies** setting to the printing profile in **Commonly Used Settings**.

To apply the saved copies setting when the printing profile is selected, check this check box.

If this check box is unchecked, the copies setting is not saved, and consequently the **Copies** setting is not applied when the printing profile is selected. Instead the printer prints with the copies setting specified with the application software.

Custom Paper Size dialog box

This dialog box allows you to specify the size (width and height) of the custom paper.

Units

Select the unit for entering a user-defined paper size.

Paper Size

Specifies the **Width** and the **Height** of the custom paper. Measurement is shown according to the units specified in **Units**.

Printer Media Information dialog box

This dialog box allows you to check the printer settings and apply the checked settings to the printer driver.

Paper Source

Check the setting or select a new paper source.

Media Type

Displays the **Media Type** that is currently set on the printer.

To apply the displayed setting to the printer driver, click **Set**.

Page Size

Displays the **Page Size** that is currently set on the printer.

To apply the displayed setting to the printer driver, click **Set**.

Related Topics

- [Basic Printing Setup](#)
- [Setting a Page Size and Orientation](#)
- [Setting the Number of Copies and Printing Order](#)
- [Execute Borderless Printing](#)
- [Duplex Printing](#)
- [Setting Up Envelope Printing](#)
- [Printing on Postcards](#)
- [Switching the Paper Source to Match the Purpose](#)

- **Displaying the Print Results before Printing**
- **Setting Paper Dimensions (Custom Size)**
- **Printing a Color Document in Monochrome**
- **Specifying Color Correction**
- **Adjusting Color Balance**
- **Adjusting Color Balance Using Sample Patterns (Printer Driver)**
- **Adjusting Brightness**
- **Adjusting Intensity**
- **Adjusting Contrast**
- **Adjusting Intensity/Contrast Using Sample Patterns (Printer Driver)**
- **[Registering a Frequently Used Printing Profile](#)**

Main tab Description

The **Main** tab allows you to create a basic print setup in accordance with the media type. Unless special printing is required, normal printing can be performed just by setting the items on this tab.

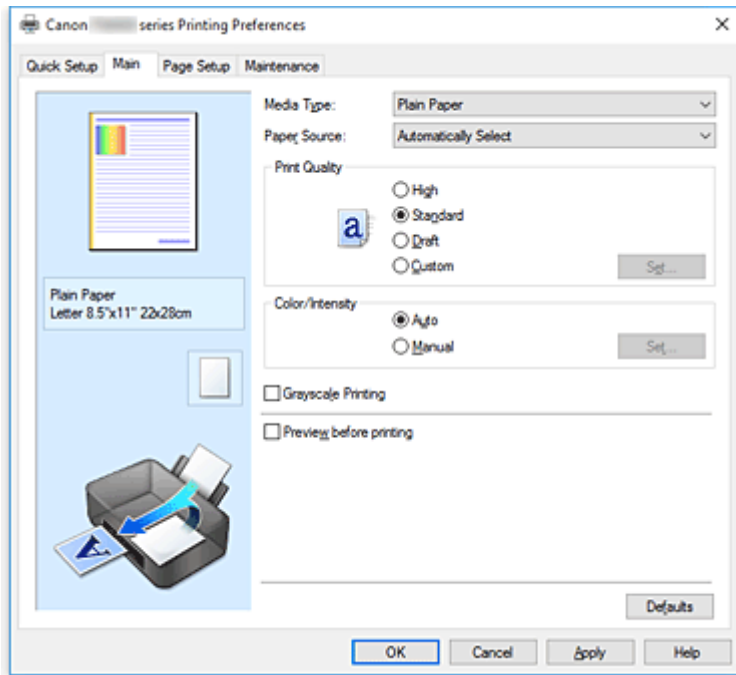

Settings Preview

The paper illustration shows how the original will be laid out on a sheet of paper.

You can check an overall image of the layout.

The printer illustration shows how to load paper to match the printer driver settings.

Check whether the printer is set up correctly by looking at the illustration before you start printing.

Media Type

Selects a type of printing paper.

Select a media type that matches the paper that is loaded in the printer. This ensures that printing is carried out properly for the specified paper.

Paper Source

Shows the source from which paper is supplied.

You may be able to switch the paper source with the printer driver.

Automatically Select

Based on the paper settings in the printer driver and the paper information registered on the printer, the printer automatically determines the paper source and feeds paper.

Rear Tray

Paper is always supplied from the rear tray.

Cassette

Paper is always supplied from the cassette.

►►► Important

- Depending on the media type and size, the **Paper Source** settings that can be selected may differ.

Print Quality

Selects your desired printing quality.

Select one of the following to set the print quality level that is appropriate for the purpose.

»» Important

- Depending on the **Media Type** settings, the same print results may be produced even if the **Print Quality** is changed.

High

Gives priority to print quality over printing speed.

Standard

Prints with average speed and quality.

Draft

This setting is appropriate for test printing.

Custom

Select this when you want to set the printing quality level individually.

Set...

Select **Custom** for **Print Quality** to enable this button.

Open the [Custom dialog box](#). You can then individually set the print quality level.

Color/Intensity

Selects color adjustment method.

Auto

Cyan, Magenta, Yellow, Brightness, Intensity, and Contrast, and so on are adjusted automatically.

Manual

Select when you set the individual settings such as **Cyan, Magenta, Yellow, Brightness, Intensity, and Contrast**, etc. and **Color Correction** method.

Set...

Select **Manual** for **Color/Intensity** to enable this button.

In the **Manual Color Adjustment** dialog box, you can adjust individual color settings such as **Cyan, Magenta, Yellow, Brightness, Intensity, and Contrast** on the [Color Adjustment tab](#), and select the **Color Correction** method on the [Matching tab](#).

»» Note

- If you want to use an ICC profile to adjust colors, use the **Manual Color Adjustment** dialog box to set the profile.

Grayscale Printing

This function converts the data to monochrome data when printing your document.

Check this check box to print a color document in monochrome.

Preview before printing

Shows what the print result will look like before you actually print the data.

Check this check box to display a preview before printing.

▶▶▶ Important

- To use the Canon IJ XPS Preview, you must have Microsoft .NET Framework 4.5.2 or later installed on your computer.

Defaults

Restores all the settings you have changed to their default values.

Clicking this button restores all the settings on the current screen to their default values (factory settings).

Custom dialog box

Set the quality level, and select the desired print quality.

Quality

You can use the slider bar to adjust the print quality level.

▶▶▶ Important

- Certain print quality levels cannot be selected depending on the settings of **Media Type**.

▶▶▶ Note

- The **High**, **Standard**, or **Draft** print quality modes are linked with the slider bar. Therefore when the slider bar is moved, the corresponding quality and value are displayed on the left. This is the same as when the corresponding radio button is selected for **Print Quality** on the **Main** tab.

Color Adjustment Tab

This tab allows you to adjust the color balance by changing the settings of the **Cyan**, **Magenta**, **Yellow**, **Brightness**, **Intensity**, and **Contrast** options.

Preview

Shows the effect of color adjustment.

The color and brightness change when each item is adjusted.

▶▶▶ Note

- The graphic is in monochrome when the **Grayscale Printing** check box is checked.

View Color Pattern

Displays a pattern for checking color changes produced by color adjustment.

If you want to display the preview image with a color pattern, check this check box.

Cyan / Magenta / Yellow

Adjusts the strengths of **Cyan**, **Magenta**, and **Yellow**.

Moving the slider to the right makes a color stronger, and moving the slider to the left makes a color weaker.

You can also directly enter a value linked to the slider. Enter a value in the range from -50 to 50.

This adjustment changes the relative amount of ink of each color used, which alters the total color balance of the document. Use your application if you want to change the total color balance significantly. Use the printer driver only if you want to adjust the color balance slightly.

»» Important

- When **Grayscale Printing** is checked on the **Main** tab, **Cyan**, **Magenta**, and **Yellow** appear grayed out and are unavailable.

Brightness

Selects the brightness of your print.

You cannot change the levels of pure white and black. However, the brightness of the colors between white and black can be changed.

Intensity

Adjusts the overall intensity of your print.

Moving the slider to the right increases the intensity, and moving the slider to the left decreases the intensity.

You can also directly enter a value linked to the slider. Enter a value in the range from -50 to 50.

Contrast

Adjusts the contrast between light and dark in the image to be printed.

Moving the slider to the right increases the contrast, moving the slider to the left decreases the contrast.

You can also directly enter a value linked to the slider. Enter a value in the range from -50 to 50.

Print a pattern for color adjustment

When the color balance or intensity/contrast is changed, the pattern printing function prints a list of the adjustment results along with the adjustment values.

Select this function when printing a pattern for color adjustment.

Pattern Print preferences...

Check **Print a pattern for color adjustment** to enable this button.

The [Pattern Print dialog box](#) opens and allows you to set pattern printing settings.

Pattern Print dialog box

Performs the setup for printing of patterns that allow you to check the color balance and intensity/contrast of documents.

Parameters to Adjust

Select the item to be checked by pattern printing.

Cyan/Magenta/Yellow

Prints a pattern that allows you to check the cyan/magenta/yellow balance.

»» Important

- When **Grayscale Printing** is checked on the **Main** tab, **Cyan/Magenta/Yellow** appear grayed out and are unavailable.

Intensity/Contrast

Prints a pattern that allows you to check the intensity/contrast balance.

Printer Paper Size

Selects the paper size to be used for pattern printing.

This setting is linked to **Printer Paper Size** on the **Page Setup** tab.

►► Note

- Depending on the paper size selected on the **Page Setup** tab, there may be sizes that cannot be selected.

Amount of Pattern Instances

Sets the number of patterns to be printed.

You can select from **Largest**, **Large**, and **Small**. When you select a pattern size, the number of patterns that can be printed is as follows:

►► Note

- **Largest** and **Large** cannot be selected when certain paper sizes or output paper sizes are selected.
- The setting preview on the **Main** tab displays an image that allows you to check the overall layout.

Largest

Cyan/Magenta/Yellow 37
Intensity/Contrast 49

Large

Cyan/Magenta/Yellow 19
Intensity/Contrast 25

Small

Cyan/Magenta/Yellow 7
Intensity/Contrast 9

Color Variation Between Instances

Sets the amount of color change between neighboring patterns.

Select from **Large**, **Medium**, and **Small**. **Large** produces a large amount of change, and **Small** produces a small amount of change.

►► Note

- **Large** is about double the size of **Medium**, and **Small** is about half the size of **Medium**.

Matching Tab

Allows you to select the method for adjusting colors to match the type of document to be printed.

Color Correction

Allows you to select **Driver Matching**, **ICM (ICC Profile Matching)**, or **None** to match the purpose of the print operation.

►► Important

- When **Grayscale Printing** is checked on the **Main** tab, **Color Correction** appears grayed out and is unavailable.

Driver Matching

With Canon Digital Photo Color, you can print sRGB data with color tints that most people prefer.

ICM (ICC Profile Matching)

Adjusts the colors by using an ICC profile when printing.

»» Important

- If the application software is set so that ICM is disabled, **ICM (ICC Profile Matching)** is unavailable for **Color Correction** and the printer may not be able to print the image data properly.

None

Disables color adjustment with the printer driver.

Rendering Intent

Specifies the matching method to be used when you select **ICM (ICC Profile Matching)** for **Color Correction**.

Saturation

This method reproduces images even more vividly than the **Perceptual** method.

Perceptual

This method reproduces images by focusing on colors that most people find desirable. Select this method to print photos.

Relative Colorimetric

When image data is converted to the color space of the printer, this method converts the image data so the color reproduction approximates the shared color regions. Select this method to print image data with colors that are close to the original colors.

The white spots are reproduced as white spots (background color) on the paper.

Absolute Colorimetric

This method uses the white spot definitions in the input and output ICC profiles to convert the image data.

Although the color and color balance of the white spots change, you may not be able to get the desired output results because of the profile combination.

»» Important

- Depending on the media type, you may obtain the same print results even when you change the **Rendering Intent** setting.

»» Note

- In the XPS printer driver, **ICM** has become **ICC Profile Matching**.

Related Topics

- [Setting the Print Quality Level \(Custom\)](#)
- Adjusting Color Balance
- Adjusting Brightness
- Adjusting Intensity
- Adjusting Contrast
- Adjusting Color Balance Using Sample Patterns (Printer Driver)
- Adjusting Intensity/Contrast Using Sample Patterns (Printer Driver)
- Specifying Color Correction
- Adjusting Colors with the Printer Driver
- Printing with ICC Profiles
- Printing a Color Document in Monochrome

■ Displaying the Print Results before Printing

Page Setup tab Description

The **Page Setup** tab allows you to determine how a document is to be arranged on the paper. Also, this tab allows you to set the number of copies and the order of printing. If the application which created the document has a similar function, set them with the application.

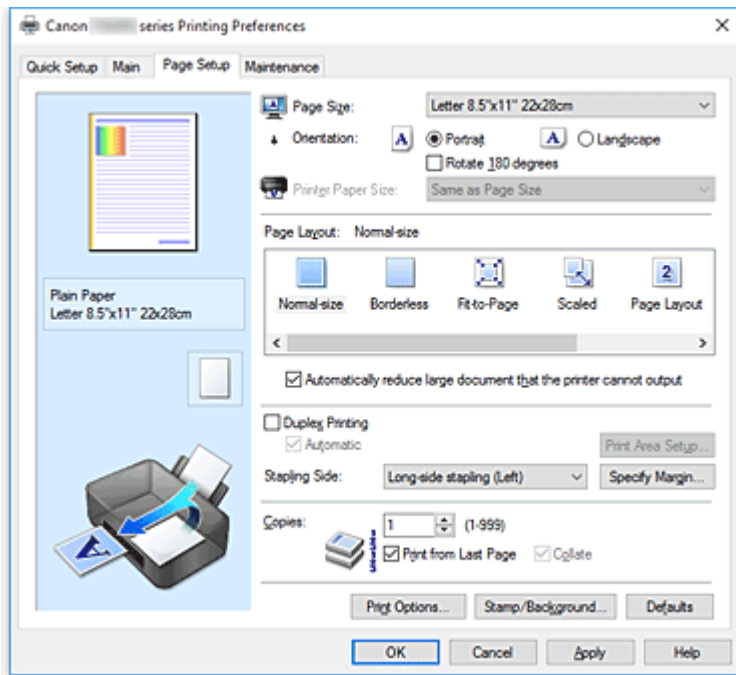

Settings Preview

The paper illustration shows how the original will be laid out on a sheet of paper.

You can check an overall image of the layout.

The printer illustration shows how to load paper to match the printer driver settings.

Check whether the printer is set up correctly by looking at the illustration before you start printing.

Page Size

Selects a page size.

Ensure that you select the same page size as you selected within the application.

If you select **Custom...**, the [Custom Paper Size dialog box](#) opens and allows you to specify any vertical and horizontal dimensions for the paper size.

Orientation

Selects the printing orientation.

If the application used to create your document has a similar function, select the same orientation that you selected in that application.

Portrait

Prints the document so that its top and bottom positions are unchanged relative to the paper feed direction. This is the default setting.

Landscape

Prints the document by rotating it 90 degrees relative to the paper feed direction.

You can change the rotation direction by going to the **Maintenance** tab, opening the **Custom Settings** dialog box, and then using **Rotate 90 degrees left when orientation is [Landscape]** check box.

To rotate the document 90 degrees to the left when printing, select the **Rotate 90 degrees left when orientation is [Landscape]** check box.

Rotate 180 degrees

Prints the document by rotating it 180 degrees against the paper feed direction.

The width of print area and the amount of extension that are configured in other application software will be reversed vertically and horizontally.

Printer Paper Size

Selects the size of paper actually loaded into the printer.

The default setting is **Same as Page Size** to perform normal-sized printing.

You can select a printer paper size when you select **Fit-to-Page**, **Scaled**, **Page Layout**, **Tiling/Poster**, or **Booklet** for **Page Layout**.

If you select a paper size that is smaller than the **Page Size**, the document size will be reduced. If you select a paper size that is larger, the document size will be enlarged.

Also if you select **Custom...**, the [Custom Paper Size dialog box](#) opens and allows you to specify any vertical and horizontal dimensions for the paper size.

Page Layout

Selects the size of the document you want to print and the type of printing.

Normal-size

This is the normal printing method. Select this when you do not specify any page layout.

Automatically reduce large document that the printer cannot output

If the printer cannot print the paper size of a document, the printer can automatically reduce the size when it prints the document.

Check this check box to reduce the size when printing the document.

Borderless

Chooses whether you are printing on a full page without any page margins or printing with page margins.

In borderless printing, originals are enlarged to extend slightly off the paper. Thus, printing can be performed without any margins (border).

Use **Amount of Extension** to adjust how much of the document extends off the paper during borderless printing.

Amount of Extension

Adjusts how much of the document extends off the paper during borderless printing.

Moving the slider to the right increases the amount of extension and allows you to perform borderless printing with no problems.

Moving the slider to the left reduces the amount of extension and expands the range of the document to print.

Fit-to-Page

This function enables you to automatically enlarge or reduce documents to fit to the paper size loaded in the printer without changing the paper size you specified in your application software.

Scaled

Documents can be enlarged or reduced to be printed.

Specify the size in **Printer Paper Size**, or enter the scaling ratio in the **Scaling** box.

Scaling

Specifies an enlargement or reduction ratio for the document you want to print.

Page Layout

Multiple pages of document can be printed on one sheet of paper.

Specify...

Opens the [Page Layout Printing dialog box](#).

Click this button to set details on page layout printing.

Tiling/Poster

This function enables you to enlarge the image data and divide the enlarged data into several pages to be printed. You can also glue together these sheets of paper to create large printed matter, such as a poster.

Specify...

Opens the [Tiling/Poster Printing dialog box](#).

Click this button to set details on tiling/poster printing.

Booklet

The booklet printing function allows you to print data for a booklet. Data is printed on both sides of the paper. This type of printing ensures that pages can be collated properly, in page number order, when the printed sheets are folded and stapled at the center.

Specify...

Opens the [Booklet Printing dialog box](#).

Click this button to set details on booklet printing.

Duplex Printing

Selects whether to print the document automatically on both sides or one side of a sheet of paper.

Check this check box to print the document on both sides.

This function can be used only when **Plain Paper** is selected for **Media Type** and one of **Normal-size**, **Fit-to-Page**, **Scaled**, or **Page Layout** is selected.

Automatic

Selects whether duplex printing is to be performed automatically or manually.

This check box will be enabled if **Booklet** is selected from the **Page Layout** list or the **Duplex Printing** check box is checked.

To perform duplex printing automatically, check this check box.

To perform duplex printing manually, uncheck this check box.

Print Area Setup...

Opens the [Print Area Setup dialog box](#) in which you can configure the print area for automatic duplex printing.

This button will be enabled if automatic duplex printing is set when **Borderless** is not selected.

Stapling Side

Selects the stapling margin position.

The printer analyzes the **Orientation** and **Page Layout** settings, and automatically selects the best stapling margin position. Check **Stapling Side**, and select from the list to change it.

Specify Margin...

Opens the [Specify Margin dialog box](#).

You can specify the width of the margin.

Copies

Specifies the number of copies you want to print. You can specify a value from 1 to 999.

»» Important

- If the application used to create your document has a similar function, specify the number of copies with the application without specifying it here.

Print from Last Page

Check this check box when you want to print from the last page in order. If you do this, you do not need to sort the pages into their correct order after printing.

Uncheck this check box to print your document in normal order, starting from the first page.

Collate

Check this check box to group together the pages of each copy when you want to print multiple copies.

Uncheck this check box when you want to print with all pages of the same page number grouped together.

»» Important

- When the application software that you used to create the document has the same function, give priority to the printer driver settings. However, if the print results are not acceptable, specify the function settings on the application software. When you specify the number of copies and the printing order with both the application and this printer driver, the number of copies may be multiplied numbers of the two settings or the specified printing order may not be enabled.

Print Options...

Opens the [Print Options dialog box](#).

Changes detailed printer driver settings for print data that is sent from applications.

Stamp/Background... (Stamp...)

Opens the [Stamp/Background \(Stamp\) dialog box](#).

The **Stamp** function allows you to print a stamp text or a bitmap over or behind document data. It also allows you to print date, time and user name. The **Background** function allows you to print a light illustration behind the document data.

»» Note

- With the XPS printer driver, the **Stamp/Background...** button has become the **Stamp...** button and only the stamp function can be used.

Depending on the type of printer driver you are using and the environment, **Stamp** and **Background** may not be available.

Custom Paper Size dialog box

This dialog box allows you to specify the size (width and height) of the custom paper.

Units

Select the unit for entering a user-defined paper size.

Paper Size

Specifies the **Width** and the **Height** of the custom paper. Measurement is shown according to the units specified in **Units**.

Page Layout Printing dialog box

This dialog box allows you to select the number of document pages to be placed on one sheet of paper, the page order, and whether a page border line is to be printed around each document page. The settings specified in this dialog box can be confirmed in the settings preview on the printer driver.

Preview Icon

Shows the settings made on the **Page Layout Printing** dialog box.
You can check what the print result will look like before you actually print the data.

Pages

Specifies the number of document pages to fit on one sheet.

Page Order

Specifies the document orientation to be printed on a sheet of paper.

Page Border

Prints a page border line around each document page.
Check this check box to print the page border line.

Tiling/Poster Printing dialog box

This dialog box allows you to select the size of the image to be printed. You can also make settings for cut lines and paste markers which are convenient for pasting together the pages into a poster. The settings specified in this dialog box can be confirmed in the settings preview on the printer driver.

Preview Icon

Shows the settings of the **Tiling/Poster Printing** dialog box.
You can check what the print result will look like.

Image Divisions

Select the number of divisions (vertical x horizontal).
As the number of divisions increases, the number of sheets used for printing increases. If you are pasting pages together to create a poster, increasing the number of divisions allows you to create a larger poster.

Print "Cut/Paste" in margins

Specifies whether to print the words "Cut" and "Paste" in the margins. These words serve as guidelines for pasting together the pages into a poster.
Check this check box to print the words.

▶▶▶ Note

- Depending on the type of printer driver you are using and the environment, this function may not be available.

Print "Cut/Paste" lines in margins

Specifies whether to print cut lines that serve as guidelines for pasting together the pages into a poster.
Check this check box to print the cut lines.

Print page range

Specifies the printing range. Select **All** under normal circumstances.
Select **Pages** to specify a specific page or range.

»» Note

- If some of the pages have not been printed well, specify the pages that do not need to be printed by clicking them in the settings preview of the **Page Setup** tab. Only the pages shown on the screen will be printed this time.

Booklet Printing dialog box

This dialog box allows you to set how to bind the document as a booklet. Printing only on one side and printing a page border, can also be set in this dialog box.

The settings specified in this dialog box can be confirmed in the settings preview on the printer driver.

Preview Icon

Shows the settings made on the **Booklet Printing** dialog box.

You can check what the document will look like when printed as a booklet.

Margin for stapling

Specifies which side of the booklet is to be stapled.

Insert blank page

Selects whether to print the document on one side or both sides of the booklet.

Check this check box to print the document on one side of the booklet and select the side to be left blank from the list.

Margin

Specifies the width of the stapling margin.

The specified width becomes the stapling margin from the center of the sheet.

Page Border

Prints a page border line around each document page.

Check this check box to print the page border line.

Print Area Setup dialog box

When you perform duplex printing, the print area of the document becomes slightly narrower than usual. Therefore when a document that has small margins is printed, the document may not fit on one page. This dialog box allows you to set whether the page is to be reduced when printed so that the document fits in one page.

Use normal-size printing

Prints the document pages without reducing them. This is the default setting.

Use reduced printing

Slightly reduces each document page so that it fits on one sheet of paper during printing.

Select this setting when using automatic duplex printing to print a document with small margins.

Specify Margin dialog box

This dialog box allows you to specify the margin width for the side to be stapled. If a document does not fit on one page, the document is reduced when printed.

Margin

Specifies the width of the stapling margin.

The width of the side specified by **Stapling Side** becomes the stapling margin.

Print Options dialog box

Makes changes to print data that is sent to the printer.

Depending on the type of printer driver you are using and the environment, this function may not be available.

Disable ICM required from the application software

Disables the ICM function required from the application software.

When an application software uses Windows ICM to print data, unexpected colors may be produced or the printing speed may decrease. If these problems occur, checking this check box may resolve the problems.

►►► Important

- Uncheck this check box under normal circumstances.
- This function does not work when **ICM** is selected for **Color Correction** on the **Matching** tab of the **Manual Color Adjustment** dialog box.

►►► Note

- **Disable ICM required from the application software** tab cannot be used with the XPS printer driver.

Disable the color profile setting of the application software

Checking this check box disables information in the color profile that was set on the application software.

When the information in the color profile set on the application software is output to the printer driver, the print result may contain unexpected colors. If this happens, checking this check box may resolve the problem.

►►► Important

- Even when this check box is checked, only some of the information in the color profile is disabled, and the color profile can still be used for printing.
- Uncheck this check box under normal circumstances.

Disable the paper source setting of the application software

Disables the paper feeding method that is set by the application.

With some applications such as Microsoft Word, the data may be printed with a feeding method that differs from the printer driver setting. In this case, check this function.

►►► Important

- When this function is enabled, normally the paper feeding method cannot be changed from the Canon IJ Preview.
However, if you are using the XPS printer driver, you will be able to change the paper feeding method from the Canon IJ XPS Preview.

Ungroup Papers

Sets the display method of **Media Type**, **Page Size**, and **Printer Paper Size**.

To display the items separately, select the check box.

To display the items as a group, clear the check box.

Do not allow application software to compress print data

Compression of the application software print data is prohibited.

If the print result has missing image data or unintended colors, selecting this check box may improve the condition.

▶▶▶ Important

- Uncheck this check box under normal circumstances.

▶▶▶ Note

- **Do not allow application software to compress print data** tab cannot be used with the XPS printer driver.

Print after creating print data by page

The print data is created in page units, and printing starts after the processing of one page of print data is complete.

If a printed document contains unintended results such as streaks, selecting this check box may improve the results.

▶▶▶ Important

- Uncheck this check box under normal circumstances.

Scale images using nearest-neighbor interpolation

When an image is to be enlarged or reduced when printed, the printer uses a simple interpolation process to enlarge or reduce the image.

If the image data in a printed document is not printed clearly, selecting this check box may improve the results.

▶▶▶ Important

- Uncheck this check box under normal circumstances.

▶▶▶ Note

- **Scale images using nearest-neighbor interpolation** can be used only with the XPS printer driver.

Prevention of Print Data Loss

You can reduce the size of the print data that was created with the application software and then print the data.

Depending on the application software being used, the image data may be cut off or may not be printed properly. In such cases, select **On**. If you will not be using this function, select **Off**.

▶▶▶ Important

- When using this function, the print quality may drop depending on the print data.

Unit of Print Data Processing

Selects the processing unit of the print data to be sent to the printer.

Select **Recommended** under normal circumstances.

►► Important

- A large amount of memory may be used for certain settings.
Do not change the setting if your computer has a small amount of memory.

►► Note

- **Unit of Print Data Processing** tab cannot be used with the XPS printer driver.

Stamp/Background (Stamp...) dialog box

The **Stamp/Background (Stamp...)** dialog box allows you to print a stamp and/or background over or behind the document pages. In addition to the pre-registered ones, you can register and use your original stamp or background.

►► Note

- With the XPS printer driver, the **Stamp/Background...** button has become the **Stamp...** button and only the stamp function can be used.

Stamp

Stamp printing is a function that prints a stamp over a document.
Check this check box and select a title from the list to print a stamp.

Define Stamp...

Opens the [Stamp Settings dialog box](#).
You can check the details of a selected stamp or save a new stamp.

Place stamp over text

Sets how the stamp is to be printed over the document.
Check the **Stamp** check box to enable this.
Check this check box to print a stamp over the printed document page. The printed data may be hidden behind the stamp.
Uncheck this check box to print the document data over the stamp. The printed data will not be hidden behind the stamp. However, the sections of the stamp that are overlapped by the document may be hidden.

Print semitransparent stamp

Sets how the stamp is to be printed over the document.
Check the **Stamp** check box to enable this.
Check this check box to print a semi-transparent stamp over the printed document page.
Uncheck this check box to print the stamp over the document data. The printed data may be hidden behind the stamp.

►► Note

- You can use **Print semitransparent stamp** only with the XPS printer driver.

Stamp first page only

Selects whether the stamp is to be printed on the first page only or on all pages when the document has two or more pages.
Check the **Stamp** check box to enable this.
Check this check box to print a stamp on the first page only.

Background

Background printing is a function that allows you to print an illustration or a similar object (bitmap) behind the document.

Check this check box to print a background and select a title from the list.

Select Background...

Opens the [Background Settings dialog box](#).

You can register a bitmap as a background, and change layout method and intensity of the selected background.

Background first page only

Selects whether to print the background on the first page only or print on all pages when the document has two or more pages.

Check the **Background** check box to enable this.

Check this check box to print a background on the first page only.

Stamp Tab

The Stamp tab allows you to set the text and bitmap file (.bmp) to be used for a stamp.

Preview Window

Shows the status of the stamp configured in each tab.

Stamp Type

Specifies the stamp type.

Select **Text** to create a stamp with characters. Select **Bitmap** to create with a bitmap file. Select **Date/Time/User Name** to display the creation date/time and user name of the printed document.

The setting items in the **Stamp** tab change depending on the selected type.

When Stamp Type is Text or Date/Time/User Name

Stamp Text

Specifies the stamp text string.

Up to 64 characters can be entered.

For **Date/Time/User Name**, the creation date/time and user name of the printed object are displayed in **Stamp Text**.

▶▶ Important

- **Stamp Text** appears grayed out and is unavailable if **Date/Time/User Name** is selected.

TrueType Font

Selects the font for the stamp text string.

Style

Selects the font style for the stamp text string.

Size

Selects the font size for the stamp text string.

Outline

Selects a frame that encloses the stamp text string.

If a large font size is selected for **Size**, characters may extend outside of the stamp border.

Color/Select Color...

Shows the current color for the stamp.

To select a different color, click **Select Color...** to open the **Color** dialog box, and select or create a color you wish to use as a stamp.

When Stamp Type is Bitmap

File

Specifies the name of the bitmap file to be used as the stamp.

Select File...

Opens the dialog box to open a file.

Click this button to select a bitmap file to be used as a stamp.

Size

Adjusts the size of the bitmap file to be used as a stamp.

Moving the slider to the right increases the size, moving the slider to the left decreases the size.

Transparent white area

Specifies whether to make white-filled areas of the bitmap transparent.

Check this check box to make white-filled areas of the bitmap transparent.

►►► Note

- Click **Defaults** to set **Stamp Type** to text, **Stamp Text** to blank, **TrueType Font** to Arial, **Style** to Regular, **Size** to 36 points, **Outline** unchecked, and **Color** to gray with the RGB values (192, 192, 192).

Placement Tab

The Placement tab allows you to set the position where the stamp is to be printed.

Preview Window

Shows the status of the stamp configured in each tab.

Position

Specifies the stamp position on the page.

Selecting **Custom** from the list allows you to enter values for the **X-Position** and **Y-Position** coordinates directly.

Orientation

Specifies the angle of rotation for the stamp. The angle can be set by entering the number of degrees.

Negative values rotate the stamp clockwise.

►►► Note

- **Orientation** is enabled only when **Text** or **Date/Time/User Name** is selected for **Stamp Type** on the **Stamp** tab.

►►► Note

- Click **Defaults** to set the stamp position to **Center** and the orientation to 0.

Save settings Tab

The **Save settings** tab allows you to register a new stamp or delete an unnecessary stamp.

Title

Enter the title to save the stamp you created.

Up to 64 characters can be entered.

▶▶▶ Note

- Spaces, tabs, and returns cannot be entered at the beginning or end of a title.

Stamps

Shows a list of saved stamp titles.

Specify a title to display the corresponding stamp in **Title**.

Save/Save overwrite

Saves the stamp.

Enter a title in **Title**, and then click this button.

Delete

Deletes an unnecessary stamp.

Specify the title of an unnecessary stamp from the **Stamps** list, and click this button.

Background Tab

The Background tab allows you to select a bitmap file (.bmp) to be used as a background or determine how to print the selected background.

Preview Window

Shows the status of the bitmap set on the **Background** tab.

File

Specifies the name of the bitmap file to be used as the background.

Select File...

Opens the dialog box to open a file.

Click this button to select a bitmap file (.bmp) to be used as the background.

Layout Method

Specifies how the background image is to be placed on the paper.

When **Custom** is selected, you can set coordinates for **X-Position** and **Y-Position**.

Intensity

Adjusts the intensity of the bitmap to be used as a background.

Moving the slider to the right increases the intensity, and moving the slider to the left decreases the intensity. To print the background at the original bitmap intensity, move the slider to the rightmost position.

▶▶▶ Note

- Depending on the type of printer driver you are using and the environment, this function may not be available.
- Click **Defaults** to set **File** to blank, **Layout Method** to **Fill page**, and the **Intensity** slider to the middle.

Save settings Tab

The **Save settings** tab allows you to register a new background or delete an unnecessary background.

Title

Enter the title to save the background image you specified.

Up to 64 characters can be entered.

▶▶ Note

- Spaces, tabs, and returns cannot be entered at the beginning or end of a title.

Backgrounds

Shows a list of registered background titles.

Specify a title to display the corresponding background in **Title**.

Save/Save overwrite

Saves the image data as a background.

After inserting the **Title**, click this button.

Delete

Deletes an unnecessary background.

Specify the title of an unnecessary background from the **Backgrounds** list, and then click this button.

Maintenance tab Description

The **Maintenance** tab allows you to perform printer maintenance or change the settings of the printer.

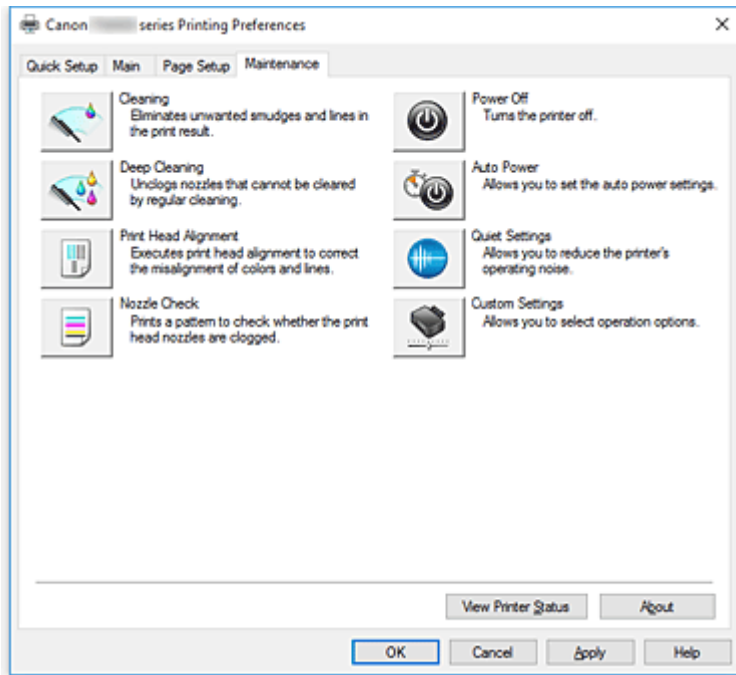

Cleaning

Performs print head cleaning.

Print head cleaning removes any blockage in the print head nozzles.

Perform cleaning when printing becomes faint, or a specific color fails to print, even though all ink levels are sufficiently high.



Deep Cleaning

Performs deep cleaning.

Perform deep cleaning when two cleaning attempts do not resolve the print head problem.

►►► Note

- **Deep Cleaning** consumes a larger amount of ink than **Cleaning**.
Cleaning the print heads frequently will rapidly deplete your printer's ink supply. Therefore, perform cleaning only when necessary.

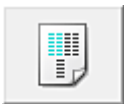

Print Head Alignment

Print head alignment corrects the installation positions of the print head and improves deviated colors and lines.

Align the print head immediately after installing the print head.

When you click **Print Head Alignment**, the [Start Print Head Alignment dialog box](#) is displayed.



Nozzle Check

Prints a nozzle check pattern.

Perform this function if printing becomes faint or a specific color fails to print. Print a nozzle check pattern, and check whether the print head is working properly.

If the print result for a specific color is faded, or if there are any unprinted sections, click **Cleaning** to clean the print head.

To display a list of items that you should check before printing the nozzle check pattern, click [Initial Check Items](#).

Print Check Pattern

This function prints a pattern that allows you to check whether the any of the ink nozzles are clogged.

Click **Print Check Pattern**. When the confirmation message is displayed, click **OK**. The **Pattern Check** dialog box is then displayed.

Left-side bitmap (good)

The print head nozzles are not clogged.

Right-side bitmap (bad)

The print head nozzles may be clogged.

Exit

Closes the **Pattern Check** dialog box, and returns to the **Maintenance** tab.

Cleaning

Performs print head cleaning.

Print head cleaning removes any blockage in the print head nozzles.

Perform cleaning when printing becomes faint, or if a specific color fails to print, even though all ink levels are sufficiently high.



Power Off

Turns off the printer from the printer driver.

Perform this function to turn off the printer when you cannot press the ON button (POWER button) on the printer because the printer is out of your reach.

You must press the ON button (POWER button) on the printer to turn the printer on again after clicking this button. When you use this function, you will not be able to turn the printer on from the printer driver.



Auto Power

Opens the [Auto Power Settings dialog box](#).

Specify settings for operating the printer power automatically. Perform this function if you want to change the auto power settings.

►► Note

- If the printer is off or if communication between the printer and the computer is disabled, an error message may appear because the computer cannot collect the printer status.
If this happens, click **OK** to display the most recent settings specified on your computer.



Quiet Settings

Opens the [Quiet Settings dialog box](#).

Quiet Settings dialog box allows you to specify a setting that reduces the operating noise of the printer. This mode comes in handy when the operating noise of the printer becomes a concern, such when printing at night. Perform this operation when you want to change the quiet mode setting.

▶▶▶ Note

- If the printer is off or if communication between the printer and the computer is disabled, an error message may appear because the computer cannot collect the printer status.



Custom Settings

Opens the [Custom Settings dialog box](#).

Perform this function to change the settings of this printer.

▶▶▶ Note

- If the printer is off or if communication between the printer and the computer is disabled, an error message may appear because the computer cannot collect the printer status. If this happens, click **OK** to display the most recent settings specified on your computer.

View Print History

This function starts the Canon IJ XPS preview, and displays the print history.

▶▶▶ Note

- You can use this function only with the XPS printer driver.

View Printer Status

Starts the Canon IJ Status Monitor.

Perform this function when you want to check the printer status and how a print job is proceeding.

▶▶▶ Note

- If you are using the XPS printer driver, the "Canon IJ Status Monitor" becomes the "Canon IJ XPS Status Monitor".

About

Opens the [About dialog box](#).

The version of the printer driver, plus a copyright notice, can be checked.

In addition, the language to be used can be switched.

Initial Check Items (Cleaning / Deep Cleaning)

Before running **Cleaning** or **Deep Cleaning**, check that the printer power is on, and open the cover of the printer.

Check the following items for each ink.

- [Check the amount of ink](#) remaining in the tank.
- Make sure that you push in the ink tank completely until you hear a clicking sound.
- If an orange tape is adhered to the ink tank, peel it off completely. Any remaining tape will hinder ink output.

- Check that the ink tanks are installed in their correct positions.

Start Print Head Alignment dialog box

This dialog box allows you to adjust the attachment position for the print head, or to print the current setting value for the print head position.

Align Print Head

Aligns the print head.

Print head alignment corrects the installation positions of the print head and improves deviated colors and lines.

Align the print head immediately after installing the print head.

Print Alignment Value

Click this button to check the current setting value of the print head position.

Prints the current setting value for the print head position.

Print Head Alignment dialog box

To adjust the print head position manually, click **Align Print Head** in the **Start Print Head Alignment** dialog box, and perform the operations instructed in the messages. The **Print Head Alignment** dialog box is then displayed.

This dialog box allows you to check the printed pattern and adjust the print head position.

Preview Window

Displays the pattern of **Print Head Alignment**, and checks the position of the selected pattern.

You can also change the setting by clicking the pattern on the screen directly.

Select the Pattern Number

Compare the printed adjustment patterns, and enter the pattern number of the pattern with the least visible streaks or horizontal stripes into the corresponding box.

►► Note

- If you do not know how to analyze the printed pattern, see [Adjusting Print Head Position](#).

Initial Check Items (Nozzle Check)

Before running **Nozzle Check**, check that the printer power is on, and open the cover of the printer.

Check the following items for each ink.

- [Check the amount of ink](#) remaining in the tank.
- Make sure that you push in the ink tank completely until you hear a clicking sound.
- If an orange tape is adhered to the ink tank, peel it off completely.
Any remaining tape will hinder ink output.
- Check that the ink tanks are installed in their correct positions.

Auto Power Settings dialog box

When you click **Auto Power**, the **Auto Power Settings** dialog box is displayed.

This dialog box allows you to manage the printer power from the printer driver.

Auto Power On

Selects the auto power-on setting.

Specify **Disable** to prevent the printer from turning on automatically when print data is sent to it.

Make sure the printer is on and then click **OK** to change the printer settings.

Specify **Enable** to turn the printer on automatically when print data is sent to it.

Auto Power Off

Selects the auto power-off setting.

If a printer driver operation or a printer operation is not performed within the specified time, the printer turns off.

Quiet Settings dialog box

When you click **Quiet Settings**, the **Quiet Settings** dialog box is displayed.

Quiet Settings dialog box allows you to specify a setting that reduces the operating noise of the printer.

Select when you wish to reduce the operating noise of the printer at night, etc.

Using this function may lower the print speed.

Do not use quiet mode

Select this option when you wish to use the printer with volume of normal operating noise.

Always use quiet mode

Select this option when you wish to reduce the operating noise of the printer.

Use quiet mode during specified hours

Select this option when you wish to reduce the operating noise of the printer during a specified period of time.

Set the **Start time** and the **End time** of the quiet mode you wish to be activated. If both are set to the same time, the quiet mode will not function.

»» Important

- You can set the quiet mode from the operation panel of the printer, the printer driver, or ScanGear (scanner driver).
No matter how you use to set the quiet mode, the mode is applied when you perform operations from the operation panel of the printer or printing and scanning from the computer.
- If you specify a time for **Use quiet mode during specified hours**, quiet mode is not applied to operations (copy, direct print, etc.) performed directly from the printer.

Custom Settings dialog box

When you click **Custom Settings**, the **Custom Settings** dialog box is displayed.

If necessary, switch between various modes of printer operation.

Prevent paper abrasion

The printer can increase the gap between the print head and the paper during high-density printing to prevent paper abrasion.

Check this check box to enable this function.

Align heads manually

Usually, the **Print Head Alignment** function on the **Maintenance** tab is set to automatic head alignment, but you can change it to manual head alignment.

If the printing results of automatic print head alignment are not satisfactory, perform manual head alignment.

Check this check box to perform the manual head alignment.

Rotate 90 degrees left when orientation is [Landscape]

On the **Page Setup** tab, you can change the rotation direction of the **Landscape** in the **Orientation**. To rotate the document 90 degrees to the left when printing, select the check box.

▶▶▶ Note

- If **Yougata 4 4.13"x9.25"**, **Yougata 6 3.86"x7.48"**, **Envelope Com 10**, or **Envelope DL** is selected for **Page Size** on the **Page Setup** tab, the printer rotates the paper 90 degrees to the left to print, regardless of the **Rotate 90 degrees left when orientation is [Landscape]** setting for **Custom Settings** on the **Maintenance** tab.

Don't detect mismatch of paper settings when printing from computer

When you print documents from your computer and the paper settings in the printer driver and the paper information registered on the printer do not match, this setting disables the message display and allows you to continue printing.

To disable detection of paper setting mismatches, select this check box.

Ink Drying Wait Time

The printer can pause before printing a subsequent page. Moving the slider to the right increases the pause time, and moving the slider to the left decreases the time.

If the paper gets stained because the next page is ejected before the ink on the printed page dries, increase the ink drying wait time.

Reducing the ink drying wait time speeds up printing.

About dialog box

When you click **About**, the **About** dialog box is displayed.

This dialog box displays the version, copyright, and module list of the printer driver. You can select the language to be used and switch the language displayed in the setup window.

Modules

Lists the printer driver modules.

Language

Specifies the language you wish to use in the [printer driver setup window](#).

▶▶▶ Important

- If the font for displaying the language of your choice is not installed in your system, the characters will be garbled.

Related Topics

- [Cleaning the Print Heads](#)
- [Adjusting Print Head Position](#)
- [Printing a Nozzle Check Pattern](#)
- [Managing the Printer Power](#)
- [Reducing the Printer Noise](#)
- [Changing the Printer Operation Mode](#)

Canon IJ Status Monitor Screen

The Canon IJ Status Monitor displays the printer status and the printing progress. The printer status is shown by the images, icons, and messages in the status monitor.

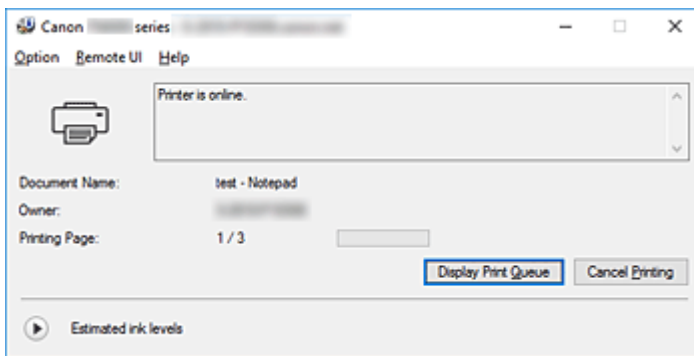

Features of the Canon IJ Status Monitor

The Canon IJ Status Monitor has the following functions:

Onscreen display of printer status

The status monitor displays the printer status in real-time.

You can check the progress of each document to be printed (print job).

Display of error content and correction procedure

The status monitor displays information on any errors that occur on the printer.

You can then immediately check what sort of action to perform.

Ink status display

The status monitor displays ink tank types and estimated ink levels.

When the remaining ink level becomes low, a warning icon and message (low ink level warning) are displayed.

Overview of the Canon IJ Status Monitor

The Canon IJ Status Monitor uses images and messages to display the printer status and the ink status.

During printing, you can check information about the document being printed and the print progress.

If an error occurs, the status monitor displays the error content and instructions on how to correct the error. Follow the message instructions.

Printer

Canon IJ Status Monitor shows an icon when a warning or error occurs to the printer.



: There is a warning.



: There has been an operator error.



: There is a notice about ink levels etc.



: There has been an error which requires a service.

Ink Tank

If a low ink warning or an empty ink tank error occurs, the status monitor displays an icon. The status monitor also uses images to display the estimated ink levels of the ink tanks.

Click the image to display the **Ink Details** dialog box showing detailed information such as the remaining ink levels and the names of ink tanks that the printer can use.

Document Name

Name of the document being printed.

Owner

Owner's name of the document being printed.

Printing Page

Page number of current page and the total page count.

Display Print Queue

The print queue, which controls the current document and documents waiting to be printed.

Cancel Printing

Cancels printing.

Estimated ink levels

Displays icons to report a remaining ink level warning and an ink depletion error.

Click  (the disclosure triangle) to display a pictorial representation of the estimated ink level in the ink tank.

Ink Model Number

You can look up the correct ink tank for your printer.

Option Menu

If a printer message appears, select **Enable Status Monitor** to start the Canon IJ Status Monitor. Select **Enable Status Monitor** to use the following commands:

Always Display Current Job

Displays the Canon IJ Status Monitor whenever a document is being printed.

Always Display on Top

Displays the Canon IJ Status Monitor in front of other windows.

Display Guide Message

Displays guide messages for complicated paper setting operations.

Envelope Printing

Displays guide messages when envelope printing starts.

To hide these guide messages, select the **Do not show this message again** check box.

To display the guide messages again, open the **Option** menu, select **Display Guide Message**, click **Envelope Printing**, and enable this setting.

Hagaki Printing

Displays guide messages before the printer begins hagaki printing.

To hide these guide messages, select the **Do not show this message again** check box.

To display the guide messages again, open the **Option** menu, select **Display Guide Message**, click **Hagaki Printing**, and enable this setting.

Display Warning Automatically**When a Low Ink Warning Occurs**

Starts the Canon IJ Status Monitor window automatically and displays it in front of the other windows when a low ink warning occurs.

Start when Windows is Started

Automatically starts the Canon IJ Status Monitor when Windows is started.

Remote UI menu

You are able to open the printer's Remote User Interface.

You are able to check the printer status and run maintenance functions on the printer when connected to and using it through a network.

»» Note

- When the printer is being used via USB connection **Remote UI** will not display.

Printer Information

Allows you check detailed information, such as the printer status, the print progress, and remaining ink levels.

Maintenance

Allows you to run printer maintenance and change printer settings.

Download Security Certificate

Displays the **For secure communication** window.

This window allows you to download the route certificate, register it to the browser, and disable warning displays.

Help Menu

Select this menu to display Help information for the Canon IJ Status Monitor including version and copyright information.

Installing the MP Drivers

You can access our web site through the Internet and download the latest MP Drivers and XPS printer driver for your model.

The procedure for installing the downloaded MP Drivers is as follows:

1. Turn off the printer

2. Start the installer

Double-click the icon of the downloaded file.

The installation program starts.

▶▶▶ Important

- A confirmation/warning dialog box may appear when starting, installing or uninstalling software. This dialog box appears when administrative rights are required to perform a task. When you are logged on to an administrator account, click **Yes** (or **Continue**, **Allow**) to continue. Some applications require an administrator account to continue. In such cases, switch to an administrator account, and restart the operation from the beginning.

3. Install the MP Drivers

Take the appropriate action as described on the screen.

4. Complete the installation

Click **Complete**.

Depending on the environment you are using, a message prompting you to restart the computer may be displayed. To complete the installation properly, restart the computer.

▶▶▶ Important

- You can install the XPS printer driver with the same procedure for installing the MP Drivers. However, when installing the XPS printer driver, first complete installation of the MP Drivers.
- You can download the MP Drivers and XPS printer driver for free, but any Internet access charges incurred are your responsibility.
- Before installing the latest MP Drivers, delete the previously installed version.

Related Topics

- Obtaining the Latest MP Drivers
- Deleting the Unnecessary MP Drivers
- Before Installing the MP Drivers

Printing Directly from Smartphone/Tablet

- ▶ **Android Print**
- ▶ **Printing from an AirPrint-enabled Printer with iOS Device**
- ▶ **Printing from a Device Equipped with Windows 10 Mobile**
- ▶ **Using Printer with Wireless Direct**

Using Printer with Wireless Direct

You can connect devices (e.g. smartphone, or tablet) to the printer by two methods below.

- Wireless connection (connecting devices via a wireless router)
- Direct wireless connection (connecting devices using Wireless Direct)

This section describes Wireless Direct, which allows you to print or scan by connecting the devices to the printer directly.

Follow the procedure below to use Wireless Direct.

1. [Changing Printer's Settings](#)
2. [Changing Settings of a Device and Connecting It to the Printer](#)
3. [Printing/Scanning with Wireless Direct](#)

This section also describes changing Wireless Direct to wireless LAN.

■ [Changing Printer Setting to Use Wireless LAN](#)

▶▶▶ Important

- You can connect up to 5 devices to the printer at the same time.
- Check the usage restrictions and switch the printer to the Wireless Direct.

■ [Restrictions](#)

Preparing for Wireless Direct

Change settings below to prepare for Wireless Direct.

- Printer's LAN settings
 - [Changing Printer's Settings](#)
- Settings of a device to connect
 - [Changing Settings of a Device and Connecting It to the Printer](#)

Changing Printer's Settings

1. [Make sure printer is turned on.](#)

2. Select  **Setup** on the HOME screen.

■ [Using the Operation Panel](#)

3. Select  **Settings**.

4. Select  **Device settings**.

5. Select **LAN settings**.
6. Select **Wireless Direct**.
7. Select **Wireless Direct active/inactive**.
8. Select **ON**.

The confirmation screen asking if you display the password information appears.

9. Select **Yes** or **No**.

The list of Wireless Direct settings is displayed.

The device detects the printer by the identifier (SSID).

▶▶▶ Note

- You can check the following.

- SSID
- Security setting
- Password
- Printer's name which appears on a Wi-Fi Direct compatible device

The password is required when connecting a device to the printer. Depending on the device you are using, no password is required.

When you connect a Wi-Fi Direct compatible device to the printer, select the device name displayed on the touch screen from your device.

- The identifier (SSID) and the security setting are specified automatically. To update them, see below.

■ [Changing Wireless Direct Setting](#)

10. Select **OK**.

The Wireless Direct is enabled and a device can be connected to the printer wirelessly.

Changing Settings of a Device and Connecting It to the Printer

1. Turn on wireless communication on your device.

Enable "Wi-Fi" on your device's "Setting" menu.

For more on turning on wireless communication, see your device's instruction manual.

2. Select "DIRECT-XXXX-TS6000series" ("X" represents alphanumeric characters) from list displayed on device.

▶▶▶ Note

- If "DIRECT-XXXX-TS6000series" does not appear on the list, Wireless Direct is not enabled.

See [Changing Printer's Settings](#) to enable Wireless Direct.

3. Enter password.

Your device is connected to the printer.

▶▶▶ Note

- Check the password for the Wireless Direct.

Check by one of the following methods.

- Display on the touch screen.

■ [LAN settings](#)

- Print the network settings.

■ [Printing Network Settings](#)

- Depending on the device you are using, entering the password is required to connect a device to the printer via wireless LAN. Enter the password specified for the printer.
- If your Wi-Fi Direct compatible device is set to prioritize using Wi-Fi Direct and it is connecting to the printer, the printer displays a confirmation screen asking if you allow the device to connect to the printer.

Make sure the name on the touch screen is the same as that of your wireless communication device and tap **Yes**.

Printing/Scanning with Wireless Direct

Connect a device and the printer and start printing/scanning.

▶▶▶ Note

- For more on printing or scanning from a device via wireless LAN, refer to the device's or application's instruction manual.
- You can print/scan from your smartphone or tablet by installing Canon PRINT Inkjet/SELPHY. Download it from App Store and Google Play.

■ For iOS

■ For Android

Changing Printer Setting to Use Wireless LAN

Follow the procedure below to change the printer setting to use wireless LAN.



1. Select **Setup** on the HOME screen.

■ [Using the Operation Panel](#)



2. Select **Settings**.

3. Select  **Device settings**.
4. Select **LAN settings**.
5. Select **Wireless LAN**.
6. Select **WLAN active/inactive**.
7. Select **Active**.

If you do not use the printer over wireless LAN, select **Inactive**.

Changing Wireless Direct Setting

Change the settings for the Wireless Direct following the procedure below.

1. [Make sure printer is turned on.](#)

2. Select  **Setup** on the HOME screen.

■ [Using the Operation Panel](#)

3. Select  **Settings**.

4. Select  **Device settings**.

5. Select **LAN settings**.

6. Select **Wireless Direct**.

7. Select a setting item.

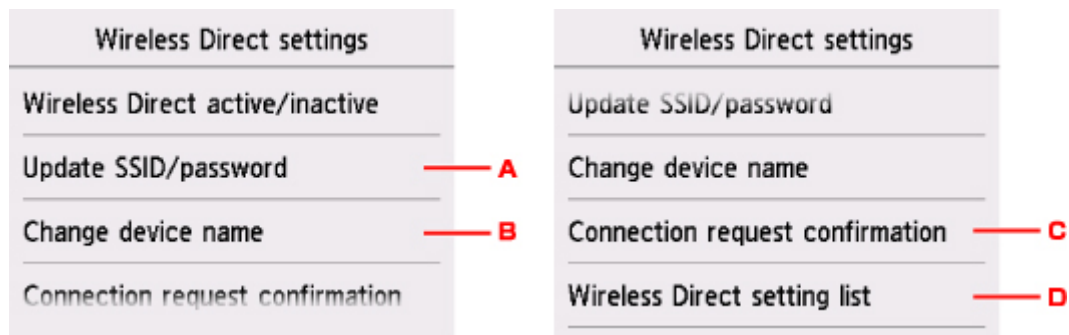

- To update the identifier (SSID) and the password for Wireless Direct

Tap A to display the confirmation screen. To update the identifier (SSID) and the password, tap **Yes**.

To check the security setting and the updated password, tap **Details** and tap **Yes** on the screen displayed next.

- To change the printer's name displayed on the Wi-Fi Direct compatible device

Tap B to display the printer's name (device name) displayed on a Wi-Fi Direct compatible device.

Follow the procedure below to change the name.

1. Tap touch screen.
 2. Enter device name (up to 32 characters).
 3. Tap **OK** to finish entering device name.
 4. Tap **OK** to finish specifying device name.
- To change the confirmation screen setting when a Wi-Fi Direct compatible device is connecting to the printer

Tap C to display the confirmation screen. If you want the printer to display the screen to inform you a Wi-Fi direct compatible device is connecting to the printer, tap **Yes**.

▶▶▶ Important

- To prevent an unauthorized access, we recommend you should not change the setting from the default.

- To check the current Wireless Direct settings

Tap D to display the confirmation screen. To check the current Wireless Direct settings, tap **Yes**.

▶▶▶ Note

- If you select **Print details**, you can print the network settings.

8. Press **HOME** button.

The HOME screen is displayed.

▶▶▶ Note

- If you change the Wireless Direct setting of the printer, also change the wireless router setting of the device.

Paper Settings

By registering the paper size and the media type loaded on the rear tray or in the cassette, you can prevent the printer from misprinting by displaying the message before printing starts when the paper size or the media type of the loaded paper differs from the print settings.

▶▶▶ Note

- The default display setting is different between when you print or copy from the operation panel of the printer and when you print using the printer driver.

■ [Default Setting for Displaying the Message which Prevents Misprinting](#)

After loading paper:

- When you close the feed slot cover:



The screen to register the rear tray paper information is displayed.

Register rear tray paper info	
Select the paper loaded in the rear tray.	
Page size	A4
Type	Plain paper
<input type="button" value="Register"/>	

Register the paper size and the media type according to the loaded paper.

- When you insert the cassette:



The screen to register the cassette paper information is displayed.

Register cassette paper info	
Select the paper loaded in the cassette.	
Page size	A4
Type	Plain paper
<input type="button" value="Register"/>	

Register the paper size and the media type according to the loaded paper.

* You can load only plain paper in the cassette.

»» Important

- For more on the proper combination of paper settings you can specify by the printer driver or on the touch screen:
 - For Windows:
 - [Paper Settings on the Printer Driver and the Printer \(Media Type\)](#)
 - [Paper Settings on the Printer Driver and the Printer \(Paper Size\)](#)
 - For Mac OS:
 - Paper Settings on the Printer Driver and the Printer (Media Type)
 - Paper Settings on the Printer Driver and the Printer (Paper Size)

When the paper settings for printing or copying are different from the paper information registered to the printer:

Ex:

- Paper setting for printing or copying: A5
- Paper information registered to the printer: A4

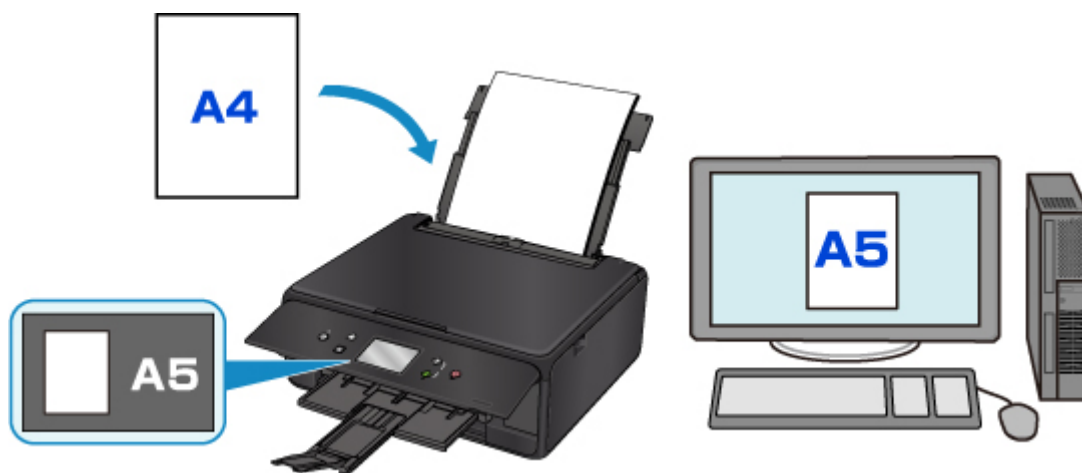

When you start printing or copying, a message is displayed.

Selecting **OK** on the touch screen displays the paper setting specified for printing or copying under the message.

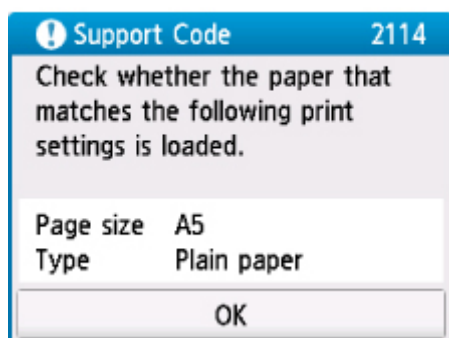
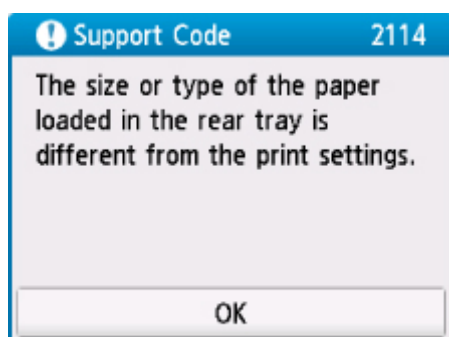

Check the message and select **OK**. When the screen to select the operation is displayed, select one of the operations below.

➤➤➤ Note

- Depending on the setting, the choices below may not be displayed.

Print with the loaded paper.

Select if you want to print on the paper loaded without changing the paper settings.

For example, when the paper setting for printing or copying is A5 and the paper information registered to the printer is A4, the printer starts printing or copying with A5 on the paper loaded.

Replace the paper and print

Select if you want to print after replacing the paper of the rear tray or the cassette.

For example, when the paper setting for printing or copying is A5 and the paper information registered to the printer is A4, you load A5 sized paper before you start printing or copying.

The paper information registration screen is displayed after replacing the paper and closing the feed slot cover or inserting the cassette. Register the paper information according to the paper that you loaded.

▶▶▶ Note

- If you do not know what paper information to register to the printer, press the **Back** button when the screen to select the operation is displayed. When the previous screen is displayed, check the paper size and the media type and register them to the printer.
- For more on the proper combination of paper settings you can specify by the printer driver or on the touch screen:
 - For Windows:
 - [Paper Settings on the Printer Driver and the Printer \(Media Type\)](#)
 - [Paper Settings on the Printer Driver and the Printer \(Paper Size\)](#)
 - For Mac OS:
 - [Paper Settings on the Printer Driver and the Printer \(Media Type\)](#)
 - [Paper Settings on the Printer Driver and the Printer \(Paper Size\)](#)

Cancel

Cancels printing.

Select when you change the paper settings specified for printing or copying. Change the paper settings and try printing again.

Default Setting for Displaying the Message which Prevents Misprinting

• When you print using the operation panel of the printer:

The message which prevents misprinting is enabled by default.

To change the display setting when you copy or print using the operation panel of the printer:

- [Feed settings](#)

• When you print using the printer driver:

The message which prevents misprinting is disabled by default.

To change the display setting when you print using the printer driver:

- For Windows:
 - [Changing the Printer Operation Mode](#)
- For Mac OS:
 - [Changing the Printer Operation Mode](#)

▶▶▶ Important

- When the message which prevents misprinting is disabled:

The printer starts printing or copying even though the paper settings for printing or copying and the paper information registered to the printer are different.

Making Copies

This section describes the procedure to copy with **Standard copy**.

1. [Make sure printer is turned on.](#)

2. [Load paper.](#)



3. Select **Copy** on the HOME screen.

■ [Using the Operation Panel](#)



4. Select **Standard copy**.

The Copy standby screen is displayed.

5. [Load original on platen glass.](#)

6. Specify settings as necessary.

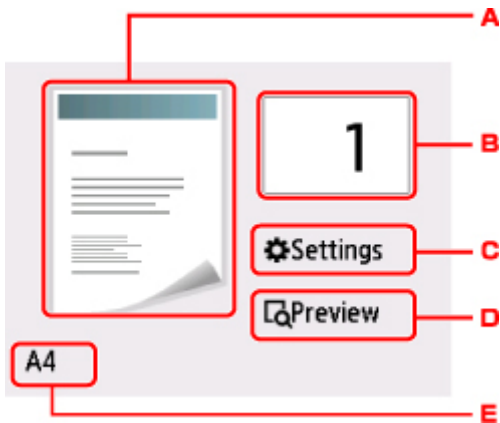

A. The copy layout is displayed.

Switch the layout (single-sided/2-on-1/two-sided).

B. Tap to specify the number of copies.

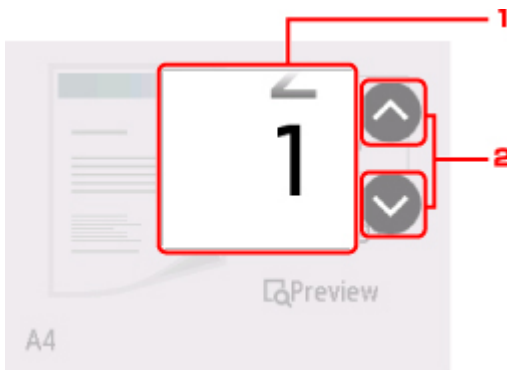

1. Flick to specify the number of copies.

2. Tap to specify the number of copies.

If you keep touching here, the number scrolls by 10.

C. Tap to display the print setting items.



For more on the setting items:

■ [Setting Items for Copying](#)

D. Tap to preview an image of the printout on the preview screen.

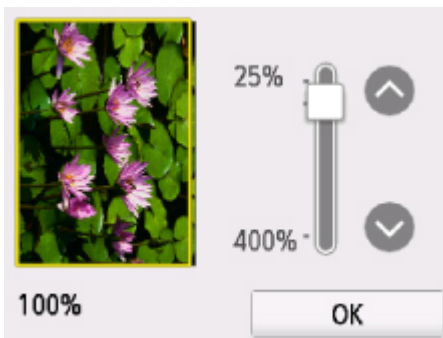

For details:

■ [Displaying Preview Screen](#)

E. Tap to specify the page size.

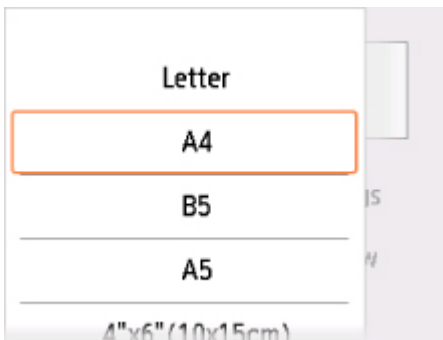

7. Press **Color** button for color copying, or **Black** button for black & white copying.

The printer starts copying.

Remove the original on the platen glass after copying is complete.

▶▶▶ Important

- Do not open the document cover or remove the original from the platen glass until scanning is completed.

▶▶▶ Note

- To cancel copying, press the **Stop** button.

Adding Copying Job (Reserve copy)

You can add the copying job while printing (Reserve copy).

The screen below is displayed when you can add the copying job.

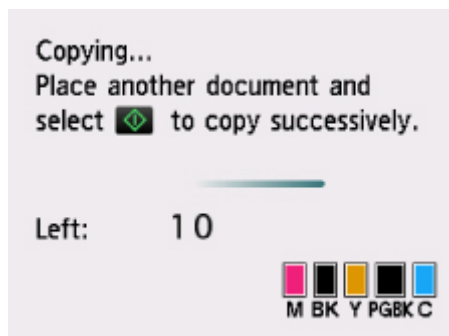

Load the original on the platen glass and press the same button (the **Color** button or the **Black** button) as the one which you previously pressed.

▶▶▶ Important

- When you load the original on the platen glass, move the document cover gently.

▶▶▶ Note

- When **Print qlty** (print quality) is set **High**, you cannot add the copying job.
- When you add the copying job, the number of copies or the settings such as the page size or media type cannot be changed.
- If you press the **Stop** button while reserve copying is in progress, the screen to select the method to cancel copying is displayed. If you tap **Cancel all reservations**, you can cancel copying all scanned data. If you tap **Cancel the last reservation**, you can cancel the last copying job.
- If you set a document of too many pages to add the copying job, **Cannot add more copy jobs. Please wait a while and redo the operation.** may appear on the touch screen. Tap **OK** and wait a while, and then try copying again.
- If **Failed to reserve the copy job. Start over from the beginning.** appears on the touch screen when scanning, tap **OK** and press the **Stop** button to cancel copying. After that, copy the documents that have not been finished copying.

Setting Items for Copying

You can change the copy settings such as magnification and intensity.

Print Settings Screen

▶▶▶ Note

- For more on the print setting screen or the setting item for **Photo copy**, see Copying Photos.

How to display the print setting screen varies with the copy menu.

- In **Standard copy**:

The following screen is displayed by tapping **Settings** on the Copy standby screen.

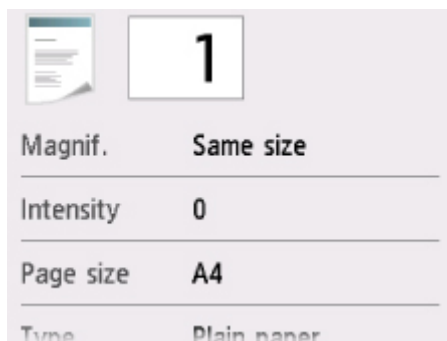

- In **Borderless copy**, **Frame erase copy**, or **ID card copy**:

The following screen is displayed before copying.

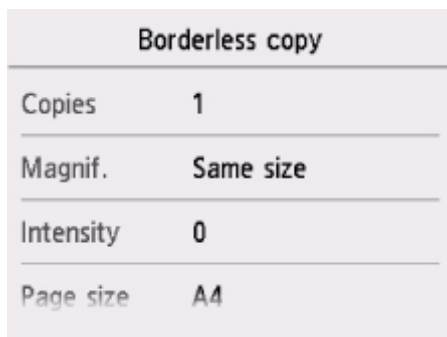

Setting Items

Flick to display setting items and tap the setting item to display the settings. Tap to specify the setting.

▶▶▶ Note

- Depending on the copy menu, some setting items cannot be selected. This section describes the setting items in **Copy**.

The setting item which cannot be selected is displayed grayed out.

For more on the setting items for **Photo copy**, see Copying Photos.

- Some settings cannot be specified in combination with the setting of other setting item or the copy menu. If the setting which cannot be specified in combination is selected,  and **Error details** are

displayed on the touch screen. In this case, tap  on the upper left on the touch screen to check the message and change the setting.

- The settings of the page size, media type, etc. are retained even if the printer is turned off.
- When copying starts in the copy menu that is not available with the specified setting, **The specified function is not available with current settings.** is displayed on the touch screen. Change the setting, following the on-screen instructions.

Following setting items can be changed.

- **Magnif.** (Magnification)

Specify the reduction/enlargement method.

Reducing/Enlarging Copies

- **Intensity**

Specify the intensity.



A. Tap to activate/deactivate automatic intensity adjustment.

When **ON** is selected, the intensity is adjusted automatically according to the originals loaded on the platen glass.

B. Drag to specify the intensity.

- **Page size**

Select the page size of the loaded paper.

- **Type** (Media type)

Select the media type of the loaded paper.

- **Paper src**

Select a paper source (**Rear tray/Cassette/Auto**) where paper is loaded.

Note

- When **Auto** is selected, paper is fed from the paper source where the paper that matches the paper settings (page size and media type) is loaded.

- **Print qlty** (Print quality)

Adjust print quality according to the original.

Important

- If you use **Draft** with **Type** set to **Plain paper** and the quality is not as good as expected, select **Standard** or **High** for **Print qlty** and try copying again.
- Select **High** for **Print qlty** to copy in grayscale. Grayscale renders tones in a range of grays instead of black or white.

• **Layout**

Select the layout.

- Copying Two Pages onto Single Page
- Copying Four Pages onto Single Page

• **2-sidedPrintSetting**

Select whether to perform two-sided copying.

- Two-Sided Copying

Scanning from Computer (Windows)

- ▶ [Using IJ Scan Utility](#)
- ▶ [Scanning Using Application Software \(ScanGear\)](#)
- ▶ **Other Scanning Methods**
- ▶ **IJ Network Scanner Selector EX2 Menu and Setting Screen**
- ▶ **Scanning Tips**
 - [Positioning Originals \(Scanning from Computer\)](#)
 - [Network Scan Settings](#)

Using IJ Scan Utility

- ▶ **What Is IJ Scan Utility (Scanner Software)?**
- ▶ **Starting IJ Scan Utility**
- ▶ **Using Auto Scan Function** 📄 **Basics**
- ▶ **Scanning Documents**
- ▶ **Scanning Photos**
- ▶ **Scanning with Favorite Settings**
- ▶ **Scanning Originals Larger than the Platen (Image Stitch)**
 - Adjusting Cropping Frames in the Image Stitch Window
- ▶ **Scanning Multiple Originals at One Time**
- ▶ **Saving after Checking Scan Results**
- ▶ **Sending Scanned Images via E-mail**
- ▶ **Extracting Text from Scanned Images (OCR)**
- ▶ **IJ Scan Utility Screens**

What Is IJ Scan Utility (Scanner Software)?

IJ Scan Utility is an application for scanning documents, photos, and other items.

Access all scanning functions to scan and save directly, from the icons in the IJ Scan Utility main screen.

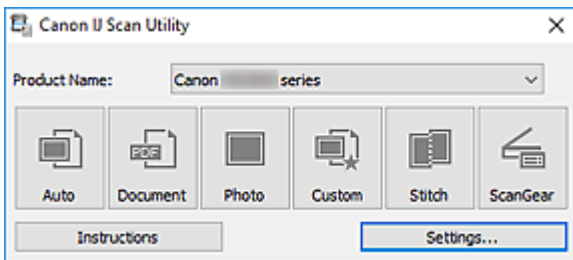

IJ Scan Utility Features

Multiple Scanning Modes

Auto allows for one click scanning with default settings for various items. **Document** will sharpen text in a document or magazine for better readability, and **Photo** is best suited for scanning photos.

►►► Note

- For details on the IJ Scan Utility main screen, see [IJ Scan Utility Main Screen](#).

Save Scanned Images Automatically

Scanned images are automatically saved to a preset folder. The folder can be changed as needed.

►►► Note

- The default save folders are as follows.
 - **Windows 10/Windows 8.1/Windows Vista:**
Documents folder
 - **Windows 8/Windows 7:**
My Documents folder
- To change folder, see [Settings Dialog Box](#).

Application Integration

Scanned images can be sent to other applications. For example, display scanned images in your favorite graphics application, attach them to e-mails, or extract text from images.

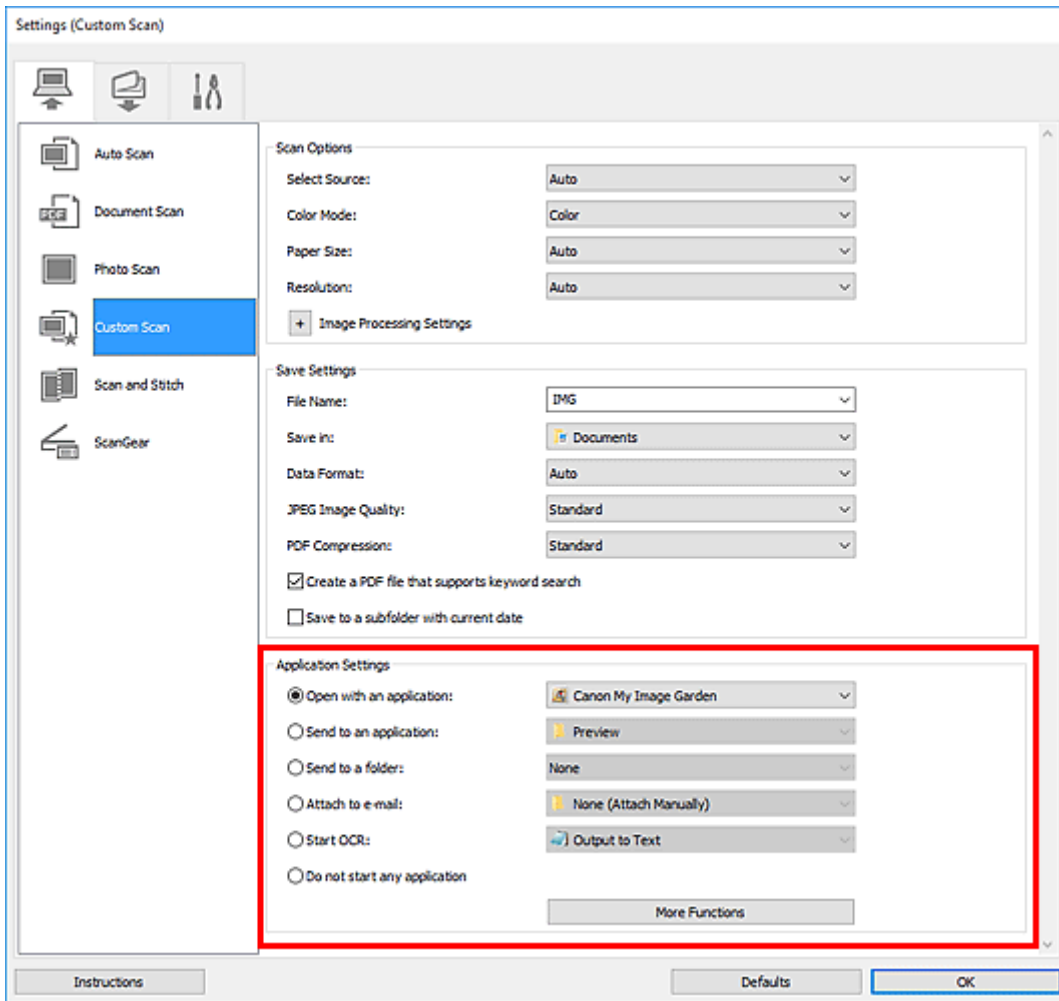

»»» Important

- Some functions are available only when My Image Garden is installed.

»»» Note

- To set the applications to integrate with, see [Settings Dialog Box](#).

Starting IJ Scan Utility

▶▶▶ Note

- If you have more than one scanner or have changed from USB to network connection, set up the network environment from IJ Scan Utility.

■ [Network Scan Settings](#)

Follow the steps below to start IJ Scan Utility.

Windows 10:

From **Start** menu, select **All apps** > **Canon Utilities** > **IJ Scan Utility**.

Windows 8.1/Windows 8:

Select **IJ Scan Utility** on the Start screen.

If **IJ Scan Utility** is not displayed on the Start screen, select the **Search** charm, and then search for "IJ Scan Utility".

Windows 7/Windows Vista:

From **Start** menu, select **All Programs** > **Canon Utilities** > **IJ Scan Utility** > **IJ Scan Utility**.

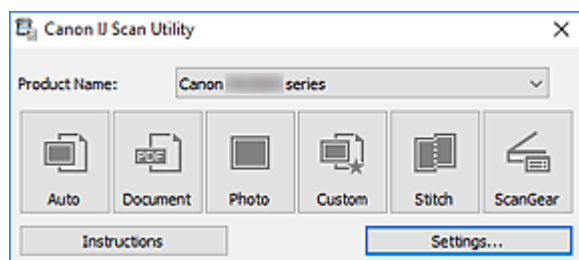

Using Auto Scan Function

Auto Scan allows for automatic detection of the item type.

▶▶▶ Important

- The following types of items may not be scanned correctly. In that case, adjust the cropping frames (scan areas) in whole image view of ScanGear (scanner driver), and then scan again.
 - Photos with a whitish background
 - Items printed on white paper, hand-written text, business cards, and other unclear items
 - Thin items
 - Thick items

1. Make sure scanner or printer is turned on.

2. Place items on platen.

■ [Positioning Originals \(Scanning from Computer\)](#)

3. [Start IJ Scan Utility.](#)

4. Click **Auto**.

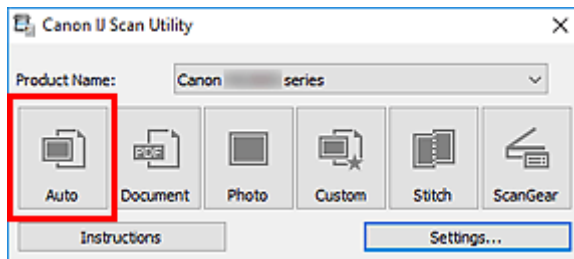

Scanning starts.

▶▶▶ Note

- To cancel the scan, click **Cancel**.
- To apply suitable corrections based on the item type, click **Settings...**, and then select the **Apply recommended image correction** checkbox in the **Settings (Auto Scan)** dialog box.
- Scanned images are saved in the folder set for **Save in** in the [Settings \(Auto Scan\) dialog box](#) displayed by clicking **Settings...**. In the **Settings (Auto Scan)** dialog box, advanced scan settings can also be made.
- To scan a specific item type, see the following pages.
 - Scanning Photos
 - Scanning Documents
 - Scanning with Favorite Settings

IJ Scan Utility Screens

- ▶ **IJ Scan Utility Main Screen**
- ▶ **Settings Dialog Box**
 - **Settings (Auto Scan) Dialog Box**
 - **Settings (Document Scan) Dialog Box**
 - Settings (Photo Scan) Dialog Box
 - **Settings (Save to PC (Auto)) Dialog Box**
 - **Settings (General Settings) Dialog Box**

IJ Scan Utility Main Screen

Follow the steps below to start IJ Scan Utility.

Windows 10:

From **Start** menu, select **All apps > Canon Utilities > IJ Scan Utility** to start IJ Scan Utility.

Windows 8.1/Windows 8:

Select **IJ Scan Utility** on Start screen to start IJ Scan Utility.

If **IJ Scan Utility** is not displayed on the Start screen, select the **Search** charm, and then search for "IJ Scan Utility".

Windows 7/Windows Vista:

From **Start** menu, select **All Programs > Canon Utilities > IJ Scan Utility > IJ Scan Utility** to start IJ Scan Utility.

You can complete from scanning to saving at one time by simply clicking the corresponding icon.

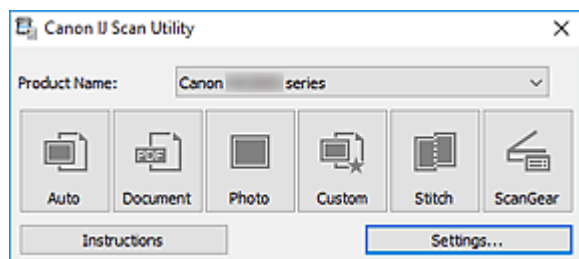

Product Name

Displays the name of the product that IJ Scan Utility is currently set to use.

If the displayed product is not the one you want to use, select the desired product from the list.

In addition, for network connection, select one with "Network" after the product name.

►►► Note

- Refer to "[Network Scan Settings](#)" for how to set up a network environment.

Auto

Detects the item type automatically and saves them to a computer. The data format for saving will also be set automatically.

Save settings and the response after scanning can be specified in the [Settings \(Auto Scan\) dialog box](#).

Document

Scans items as documents and saves them to a computer.

Scan/save settings and the response after scanning can be specified in the [Settings \(Document Scan\) dialog box](#).

Photo

Scans items as photos and saves them to a computer.

Scan/save settings and the response after scanning can be specified in the Settings (Photo Scan) dialog box.

Custom

Scans items with your favorite settings and saves the images to a computer. The item type can be automatically detected.

Scan/save settings and the response after scanning can be specified in the Settings (Custom Scan) dialog box.

Stitch

Displays the **Image Stitch** window in which you can scan the left and right halves of an item larger than the platen and combine the scanned images back into one image.

Scan/save settings and the response after scanning can be specified in the Settings (Scan and Stitch) dialog box.

ScanGear

Starts ScanGear (scanner driver) in which you can make image corrections and color adjustments when scanning.

Scan/save settings and applications can be specified in the Settings (ScanGear) dialog box.



Instructions

Opens this guide.

Settings...

Displays the [Settings dialog box](#) in which you can specify the scan/save settings and the response after scanning.

Settings Dialog Box

The Settings dialog box has three tabs:  (Scanning from a Computer),  (Scanning from the Operation Panel), and  (General Settings). When you click a tab, the options available in the red frame switches; set the details of each function on each tab as needed.

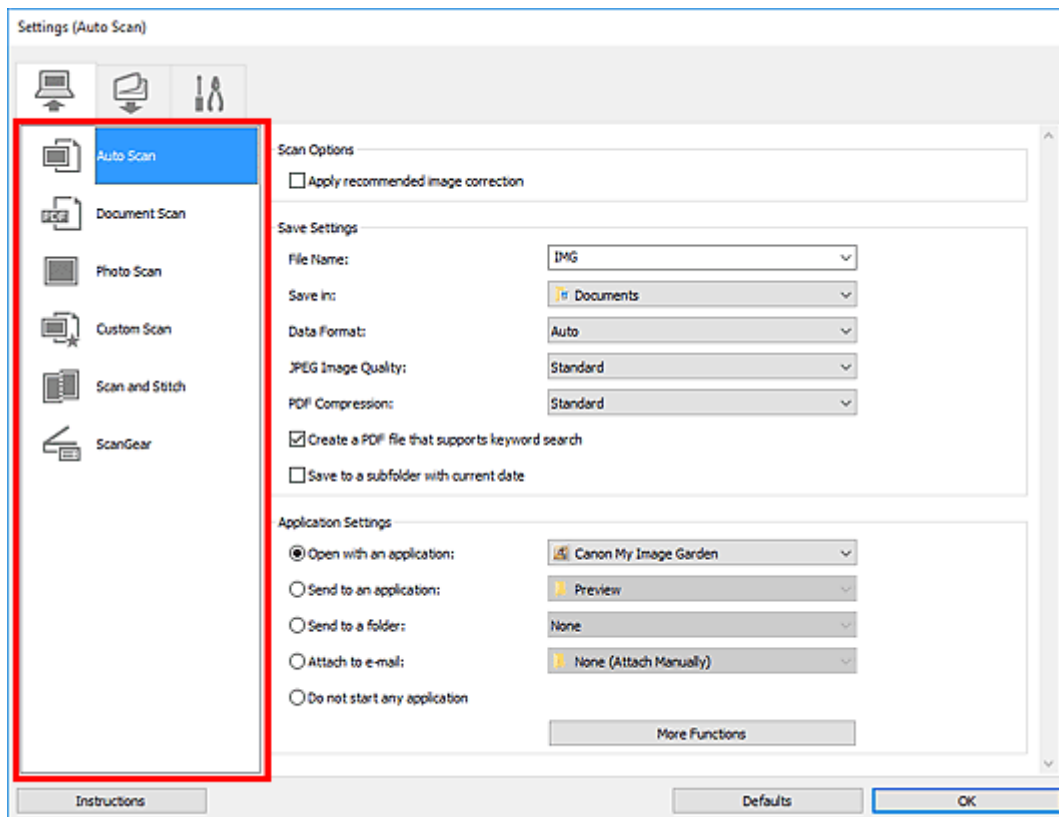

(Scanning from a Computer) Tab

Set the default actions when scanning from IJ Scan Utility or My Image Garden.

- [Settings \(Auto Scan\) Dialog Box](#)
- [Settings \(Document Scan\) Dialog Box](#)
- Settings (Photo Scan) Dialog Box
- Settings (Custom Scan) Dialog Box
- Settings (Scan and Stitch) Dialog Box
- Settings (ScanGear) Dialog Box

(Scanning from the Operation Panel) Tab

Set the default actions when scanning from the operation panel.

- [Settings \(Save to PC \(Auto\)\) Dialog Box](#)
- Settings (Save to PC (Document)) Dialog Box

- Settings (Save to PC (Photo)) Dialog Box
- Settings (Attach to E-mail (Auto)) Dialog Box
- Settings (Attach to E-mail (Document)) Dialog Box
- Settings (Attach to E-mail (Photo)) Dialog Box

▶▶ Important

- When the Settings dialog box is displayed from My Image Garden, the  (Scanning from the Operation Panel) tab does not appear.



(General Settings) Tab

Set the model to use, file size restriction on e-mail attachment, language for detecting text in images, and the folder in which to save images temporarily.

- [Settings \(General Settings\) Dialog Box](#)

Settings (Auto Scan) Dialog Box

Click **Auto Scan** on the  (Scanning from a Computer) tab to display the **Settings (Auto Scan)** dialog box.

In the **Settings (Auto Scan)** dialog box, you can make advanced scan settings to scan by automatically detecting the item type.

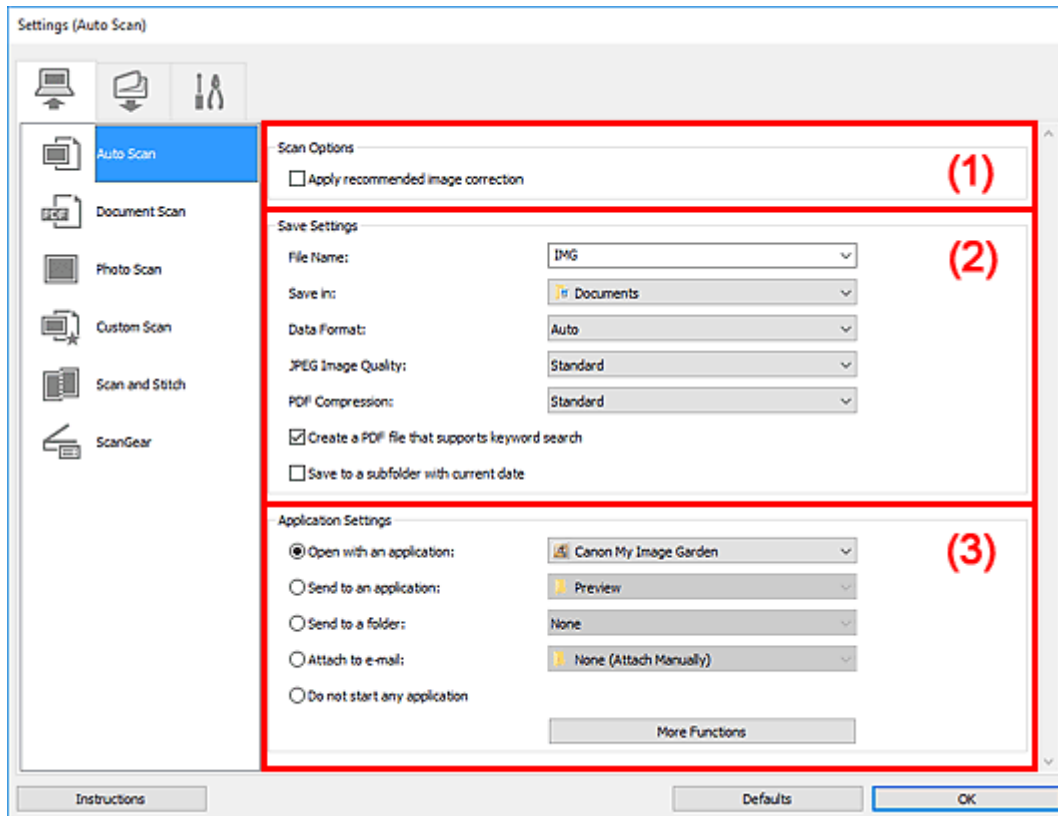

- [\(1\) Scan Options Area](#)
- [\(2\) Save Settings Area](#)
- [\(3\) Application Settings Area](#)

»»» Important

- When the Settings dialog box is displayed from My Image Garden, the setting items for **Application Settings** do not appear.

Supported Items

Photos, postcards, business cards, magazines, newspapers, documents, and BD/DVD/CD.

»»» Important

- To scan the following types of items, specify the item type and size in the **Settings (Document Scan)** dialog box, **Settings (Photo Scan)** dialog box, or **Settings (Custom Scan)** dialog box, then click **Photo**, **Document**, or **Custom** in the IJ Scan Utility main screen. You cannot scan correctly with **Auto**.
 - A4 size photos
 - Text documents smaller than 2L (5 inches x 7 inches) (127 mm x 178 mm), such as paperback pages with the spine cut off

- Items printed on thin white paper
 - Long narrow items such as panoramic photos
 - Reflective disc labels may not be scanned as expected.
 - Place items to be scanned on the platen correctly. Otherwise, items may not be scanned correctly.
- Refer to "[Positioning Originals \(Scanning from Computer\)](#)" for how to place items.

»» Note

- To reduce moire in scans, set **Select Source** to **Magazine** in the **Settings (Document Scan)** dialog box or **Settings (Custom Scan)** dialog box, then click **Document** or **Custom** in the IJ Scan Utility main screen.

(1) Scan Options Area

Apply recommended image correction

Applies suitable corrections automatically based on the item type.

»» Important

- The color tone may differ from the source image due to corrections. In that case, deselect the checkbox and scan.

»» Note

- Scanning takes longer than usual when you enable this function.

(2) Save Settings Area

File Name

Enter the file name of the image to be saved. When you save a file, the date and four digits are appended to the set file name in the "_20XX0101_0001" format.

»» Note

- When you select the **Save to a subfolder with current date** checkbox, the date and four digits are appended to the set file name.

Save in

Displays the folder in which to save the scanned images. To add a folder, select **Add...** from the pull-down menu, then click **Add** in the displayed **Select Destination Folder** dialog box and specify the destination folder.

The default save folders are as follows.

- **Windows 10/Windows 8.1/Windows Vista:**
Documents folder
- **Windows 8/Windows 7:**
My Documents folder

»» Important

- When the Settings dialog box is displayed from My Image Garden, this option does not appear.

Data Format

Auto is selected. The following data formats are automatically applied according to the item type when saving.

- Photos, postcards, BD/DVD/CD, and business cards: JPEG
- Magazines, newspapers, and documents: PDF

»» Important

- The save format may differ depending on how you place the item.

■ [Positioning Originals \(Scanning from Computer\)](#)

JPEG Image Quality

You can specify the image quality of JPEG files.

PDF Compression

Select the compression type for saving PDF files.

Standard

It is recommended that you normally select this setting.

High

Compresses the file size when saving, allowing you to reduce the load on your network/server.

Create a PDF file that supports keyword search

Select this checkbox to convert text in images into text data and create PDF files that support keyword search.

»» Note

- PDF files that are searchable in the language selected in **Document Language** on the (General Settings) tab of the Settings dialog box are created.



Save to a subfolder with current date

Select this checkbox to create a current date folder in the folder specified in **Save in** and save scanned images in it. The folder will be created with a name such as "20XX_01_01" (Year_Month_Date).

If this checkbox is not selected, files are saved directly in the folder specified in **Save in**.

(3) Application Settings Area

Open with an application

Select this when you want to enhance or correct the scanned images.

You can specify the application from the pull-down menu.

Send to an application

Select this when you want to use the scanned images as they are in an application that allows you to browse or organize images.

You can specify the application from the pull-down menu.

Send to a folder

Select this when you also want to save the scanned images to a folder other than the one specified in **Save in**.

You can specify the folder from the pull-down menu.

Attach to e-mail

Select this when you want to send e-mails with the scanned images attached.

You can specify the e-mail client you want to start from the pull-down menu.

Do not start any application

Saves to the folder specified in **Save in**.

»» Note

- To add an application or folder to the pull-down menu, select **Add...** from the pull-down menu, then click **Add** in the displayed **Select Application** or **Select Destination Folder** dialog box and specify the application or folder.

Instructions

Opens this guide.

Defaults

You can restore the settings in the displayed screen to the default settings.

Settings (Document Scan) Dialog Box

Click **Document Scan** on the  (Scanning from a Computer) tab to display the **Settings (Document Scan)** dialog box.

In the **Settings (Document Scan)** dialog box, you can make advanced scan settings to scan items as documents.

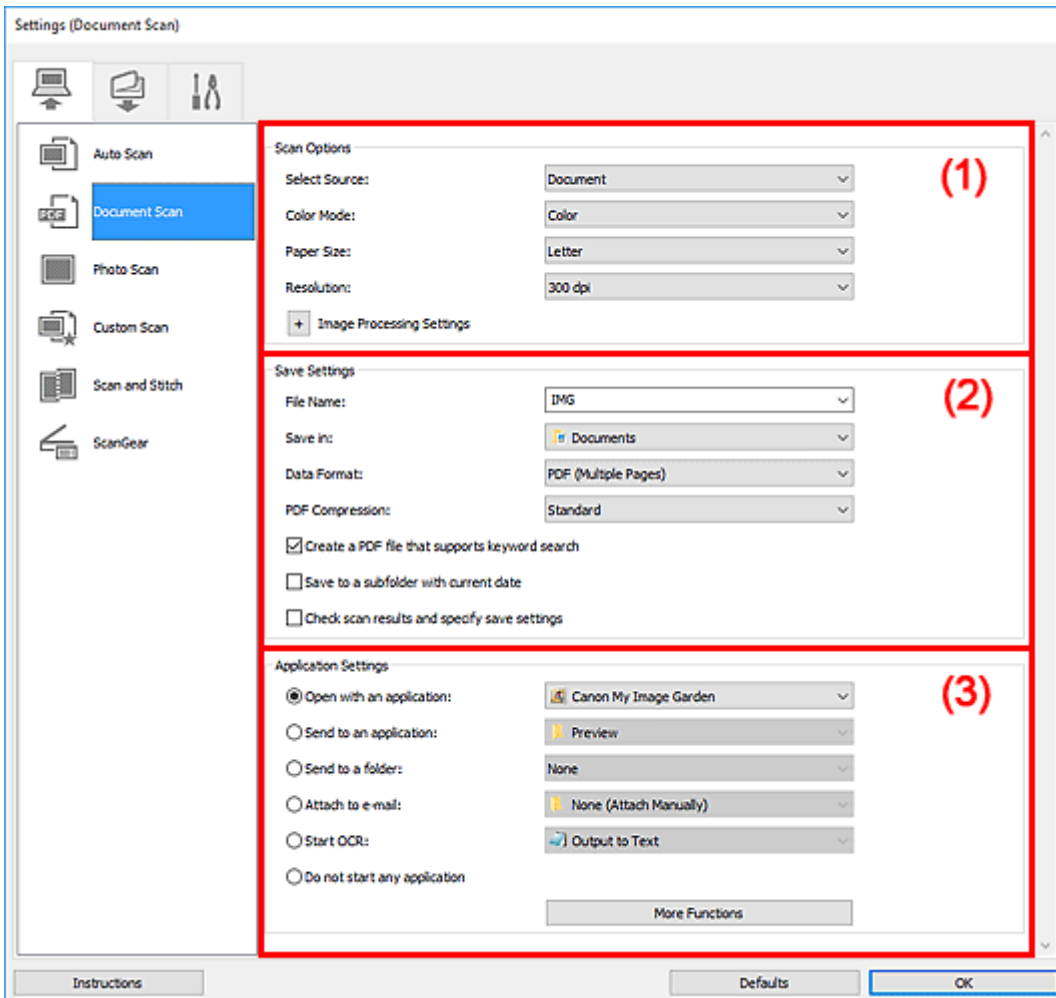

- [\(1\) Scan Options Area](#)
- [\(2\) Save Settings Area](#)
- [\(3\) Application Settings Area](#)

▶▶▶ Important

- When the Settings dialog box is displayed from the Scan screen of My Image Garden, the setting items for **Application Settings** do not appear.

(1) Scan Options Area

Select Source

Select the type of item to be scanned.

- Scanning documents: **Document**
- Scanning magazines: **Magazine**

Color Mode

Select the color mode in which to scan the item.

Paper Size

Select the size of the item to be scanned.

When you select **Custom**, a screen in which you can specify the paper size appears. Select a **Unit**, then enter the **Width** and **Height**, and then click **OK**.

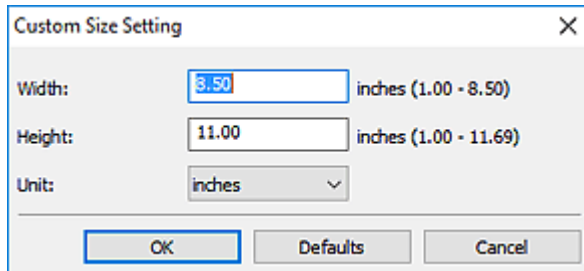

»»» Note

- Click **Defaults** to restore the specified settings to the default settings.

Resolution

Select the resolution of the item to be scanned.

The higher the resolution (value), the more detail in your image.

- Resolution

»»» Note

- Only **300 dpi** or **400 dpi** can be set when **Start OCR** is selected in **Application Settings**.

Image Processing Settings

Click (Plus) to set the following.

»»» Note

- When **Color Mode** is **Black and White**, only **Reduce gutter shadow**, **Correct slanted text document**, and **Detect the orientation of text document and rotate image** appear.

Apply Auto Document Fix

Select this checkbox to sharpen text in a document or magazine for better readability.

»»» Important

- The color tone may differ from the source image due to corrections. In that case, deselect the checkbox and scan.

»»» Note

- Scanning takes longer than usual when you enable this function.

Sharpen outline

Emphasizes the outline of the subjects to sharpen the image.

Reduce show-through

Sharpens text in an item or reduces show-through in newspapers, etc.

Reduce moire

Reduces moire patterns.

Printed materials are displayed as a collection of fine dots. "Moire" is a phenomenon where uneven gradation or a stripe pattern appears when such photos or pictures printed with fine dots are scanned.

▶▶▶ Note

- Scanning takes longer than usual when you enable **Reduce moire**.

Reduce gutter shadow

Reduces gutter shadows that appear between pages when scanning open booklets.

▶▶▶ Note

- Use ScanGear (scanner driver)'s **Advanced Mode** tab to correct gutter shadows when scanning non-standard size items or specified areas.
Refer to "Gutter Shadow Correction" for your model from Home of the Online Manual for details.
- When you enable this function, scanning may take longer than usual with network connection.

Correct slanted text document

Detects the scanned text and corrects the angle (within -0.1 to -10 degrees or +0.1 to +10 degrees) of the document.

▶▶▶ Important

- The following types of documents may not be corrected properly since the text cannot be detected correctly.
 - Documents in which the text lines are inclined more than 10 degrees or the angles vary by line
 - Documents containing both vertical and horizontal text
 - Documents with extremely large or small fonts
 - Documents with small amount of text
 - Documents containing figures/images
 - Hand-written text
 - Documents containing both vertical and horizontal lines (tables)

▶▶▶ Note

- Scanning takes longer than usual when you enable **Correct slanted text document**.

Detect the orientation of text document and rotate image

Automatically rotates the image to the correct orientation by detecting the orientation of text in the scanned document.

▶▶▶ Important

- Only text documents written in the language selected from **Document Language** in the [Settings \(General Settings\) dialog box](#) are supported.
- The orientation may not be detected for the following types of settings or documents since the text cannot be detected correctly.

- Resolution is outside the range of 300 dpi to 600 dpi
- Font size is outside the range of 8 points to 48 points
- Documents containing special fonts, effects, italics, or hand-written text
- Documents with patterned backgrounds

In that case, select the **Check scan results and specify save settings** checkbox, and then rotate the image in the Save Settings dialog box.

(2) Save Settings Area

File Name

Enter the file name of the image to be saved. When you save a file, the date and four digits are appended to the set file name in the "_20XX0101_0001" format.

▶▶▶ Note

- When you select the **Save to a subfolder with current date** checkbox, the date and four digits are appended to the set file name.

Save in

Displays the folder in which to save the scanned images. To add a folder, select **Add...** from the pull-down menu, then click **Add** in the displayed **Select Destination Folder** dialog box and specify the destination folder.

The default save folders are as follows.

- **Windows 10/Windows 8.1/Windows Vista:**
Documents folder
- **Windows 8/Windows 7:**
My Documents folder

▶▶▶ Important

- When the Settings dialog box is displayed from My Image Garden, this option does not appear.

Data Format

Select the data format in which to save the scanned images.

You can select **JPEG/Exif**, **TIFF**, **PNG**, **PDF**, or **PDF (Multiple Pages)**.

▶▶▶ Important

- You cannot select **JPEG/Exif** when **Color Mode** is **Black and White**.
- When **Start OCR** is selected in **Application Settings**, you cannot select **PDF** or **PDF (Multiple Pages)**.

▶▶▶ Note

- With network connection, scanning may take longer than usual when you set **TIFF** or **PNG** in **Data Format**.

PDF Compression

Select the compression type for saving PDF files.

Standard

It is recommended that you normally select this setting.

High

Compresses the file size when saving, allowing you to reduce the load on your network/server.

»»» Important

- This appears only when **PDF** or **PDF (Multiple Pages)** is selected in **Data Format**.
- When **Black and White** is selected in **Color Mode**, this option does not appear.

JPEG Image Quality

You can specify the image quality of JPEG files.

»»» Important

- This appears only when **JPEG/Exif** is selected in **Data Format**.

Create a PDF file that supports keyword search

Select this checkbox to convert text in images into text data and create PDF files that support keyword search.

»»» Important

- This appears only when **PDF** or **PDF (Multiple Pages)** is selected in **Data Format**.

»»» Note

- If text cannot be searched correctly, we recommend that you select 300 dpi or higher for **Resolution**.
- PDF files that are searchable in the language selected in **Document Language** on the (General Settings) tab of the Settings dialog box are created.



Save to a subfolder with current date

Select this checkbox to create a current date folder in the folder specified in **Save in** and save scanned images in it. The folder will be created with a name such as "20XX_01_01" (Year_Month_Date).

If this checkbox is not selected, files are saved directly in the folder specified in **Save in**.

Check scan results and specify save settings

Displays the Save Settings dialog box after scanning.

»»» Important

- When the Settings dialog box is displayed from My Image Garden, this option does not appear.

(3) Application Settings Area

Open with an application

Select this when you want to enhance or correct the scanned images.

You can specify the application from the pull-down menu.

Send to an application

Select this when you want to use the scanned images as they are in an application that allows you to browse or organize images.

You can specify the application from the pull-down menu.

Send to a folder

Select this when you also want to save the scanned images to a folder other than the one specified in **Save in**.

You can specify the folder from the pull-down menu.

Attach to e-mail

Select this when you want to send e-mails with the scanned images attached.

You can specify the e-mail client you want to start from the pull-down menu.

Start OCR

Select this when you want to convert text in the scanned image into text data.

You can specify the application from the pull-down menu.

Do not start any application

Saves to the folder specified in **Save in**.

►► Note

- To add an application or folder to the pull-down menu, select **Add...** from the pull-down menu, then click **Add** in the displayed **Select Application** or **Select Destination Folder** dialog box and specify the application or folder.

Instructions

Opens this guide.

Defaults

You can restore the settings in the displayed screen to the default settings.

Settings (Save to PC (Auto)) Dialog Box



Click **Save to PC (Auto)** on the (Scanning from the Operation Panel) tab to display the **Settings (Save to PC (Auto))** dialog box.

In the **Settings (Save to PC (Auto))** dialog box, you can specify how to respond when saving images to a computer after scanning them from the operation panel by automatically detecting the item type.

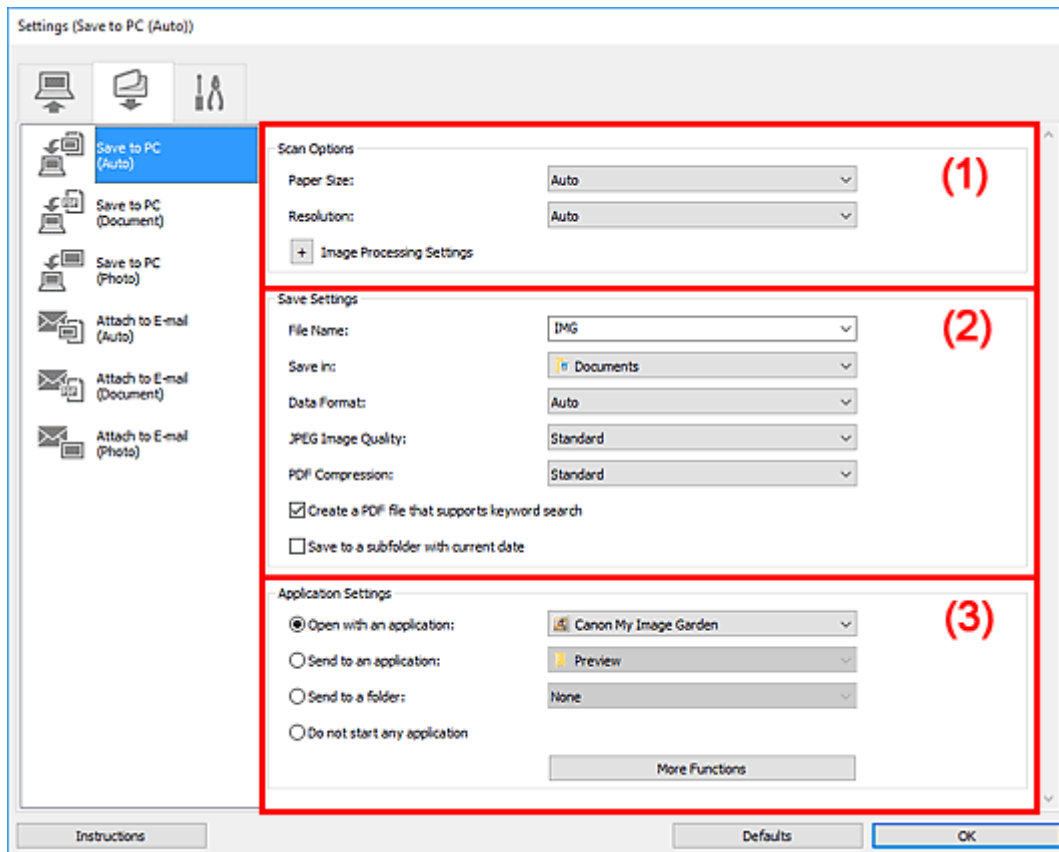

- (1) [Scan Options Area](#)
- (2) [Save Settings Area](#)
- (3) [Application Settings Area](#)

(1) Scan Options Area

Paper Size

Auto is selected.

Resolution

Auto is selected.

Image Processing Settings

Click (Plus) to set the following.

Apply recommended image correction

Applies suitable corrections automatically based on the item type.

»»» Important

- The color tone may differ from the source image due to corrections. In that case, deselect the checkbox and scan.

»»» Note

- Scanning takes longer than usual when you enable this function.

(2) Save Settings Area

File Name

Enter the file name of the image to be saved. When you save a file, the date and four digits are appended to the set file name in the "_20XX0101_0001" format.

»»» Note

- When you select the **Save to a subfolder with current date** checkbox, the date and four digits are appended to the set file name.

Save in

Displays the folder in which to save the scanned images. To add a folder, select **Add...** from the pull-down menu, then click **Add** in the displayed **Select Destination Folder** dialog box and specify the destination folder.

The default save folders are as follows.

- **Windows 10/Windows 8.1/Windows Vista:**
Documents folder
- **Windows 8/Windows 7:**
My Documents folder

Data Format

Auto is selected. The following data formats are automatically applied according to the item type when saving.

- Photos, postcards, BD/DVD/CD, and business cards: JPEG
- Magazines, newspapers, and documents: PDF

»»» Important

- The save format may differ depending on how you place the item.
Refer to "[Positioning Originals \(Scanning from Computer\)](#)" for how to place items.

JPEG Image Quality

You can specify the image quality of JPEG files.

PDF Compression

Select the compression type for saving PDF files.

Standard

It is recommended that you normally select this setting.

High

Compresses the file size when saving, allowing you to reduce the load on your network/server.

Create a PDF file that supports keyword search

Select this checkbox to convert text in images into text data and create PDF files that support keyword search.

▶▶▶ Note

- PDF files that are searchable in the language selected in **Document Language** on the (General Settings) tab of the Settings dialog box are created.



Save to a subfolder with current date

Select this checkbox to create a current date folder in the folder specified in **Save in** and save scanned images in it. The folder will be created with a name such as "20XX_01_01" (Year_Month_Date).

If this checkbox is not selected, files are saved directly in the folder specified in **Save in**.

(3) Application Settings Area

Open with an application

Select this when you want to enhance or correct the scanned images.

You can specify the application from the pull-down menu.

Send to an application

Select this when you want to use the scanned images as they are in an application that allows you to browse or organize images.

You can specify the application from the pull-down menu.

Send to a folder

Select this when you also want to save the scanned images to a folder other than the one specified in **Save in**.

You can specify the folder from the pull-down menu.

Do not start any application

Saves to the folder specified in **Save in**.

▶▶▶ Note

- To add an application or folder to the pull-down menu, select **Add...** from the pull-down menu, then click **Add** in the displayed **Select Application** or **Select Destination Folder** dialog box and specify the application or folder.

Instructions

Opens this guide.

Defaults

You can restore the settings in the displayed screen to the default settings.

Settings (General Settings) Dialog Box



Click the  (General Settings) tab to display the **Settings (General Settings)** dialog box.

In the **Settings (General Settings)** dialog box, you can set the product to use, file size restriction on e-mail attachment, language to detect text in images, and folder in which to save images temporarily.

►►► Important

- When the Settings dialog box is displayed from My Image Garden, some options may not appear.

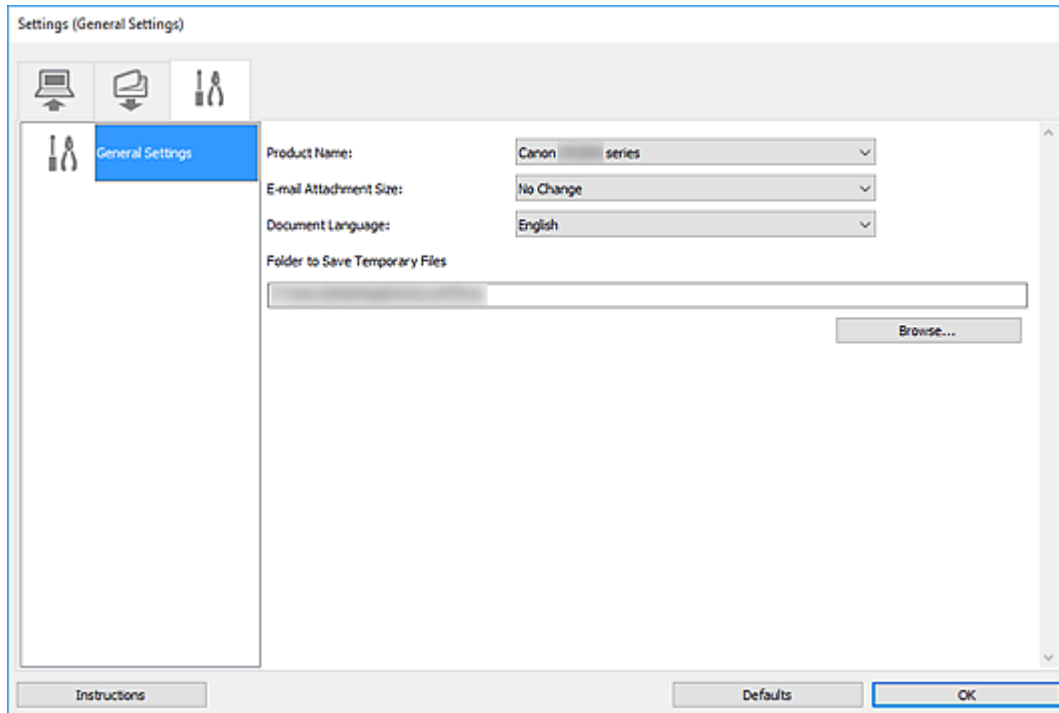

Product Name

Displays the name of the product that IJ Scan Utility is currently set to use.

If the displayed product is not the one you want to use, select the desired product from the list.

In addition, for network connection, select one with "Network" after the product name.

►►► Note

- With network connection, **Select** appears on the right side of the product name. Click **Select** to display IJ Network Scanner Selector EX from which you can change the scanner to use. Refer to "[Network Scan Settings](#)" for the setting procedure.

E-mail Attachment Size

You can restrict the size of scanned images to be attached to an e-mail.

You can select **Small (Suitable for 640 x 480 Windows)**, **Medium (Suitable for 800 x 600 Windows)**, **Large (Suitable for 1024 x 768 Windows)**, or **No Change**.

Document Language

You can select the language for detecting text in images and for use with search when a PDF file that supports keyword search is created.

Folder to Save Temporary Files

Displays the folder in which to save images temporarily. Click **Browse...** to specify the destination folder.

Instructions

Opens this guide.

Defaults

You can restore the settings in the displayed screen to the default settings.

Scanning Using Application Software (ScanGear)

- ▶ [What Is ScanGear \(Scanner Driver\)?](#)
- ▶ [Starting ScanGear \(Scanner Driver\)](#)
- ▶ [Scanning in Basic Mode](#)
- ▶ [Scanning in Advanced Mode](#)
- ▶ [Scanning Multiple Documents from the ADF \(Auto Document Feeder\) in Advanced Mode](#)
- ▶ [Scanning Multiple Documents at One Time with ScanGear \(Scanner Driver\)](#)
- ▶ [ScanGear \(Scanner Driver\) Screens](#)
- ▶ [Positioning Originals \(Scanning from Computer\)](#)
- ▶ [General Notes \(Scanner Driver\)](#)

▶▶ Important

- Available functions and settings vary depending on your scanner or printer.

What Is ScanGear (Scanner Driver)?

ScanGear (scanner driver) is software required for scanning documents. Use the software to specify the output size, image corrections, and other settings.

ScanGear can be started from IJ Scan Utility or applications that are compatible with the standard TWAIN interface. (ScanGear is a TWAIN-compatible driver.)

Features

Specify the document type, output size, and other settings when scanning documents and preview scan results. Make various correction settings or finely adjust the brightness, contrast, and other parameters to scan in a specific color tone.

Screens

There are two modes: Basic Mode and Advanced Mode.

Switch modes with the tabs on the upper right of the screen.



➤➤➤ Note

- ScanGear starts in the last used mode.
- Settings are not retained when you switch modes.

Basic Mode

Use the **Basic Mode** tab to scan easily by following three simple on-screen steps (**1** , **2** , and **3**).

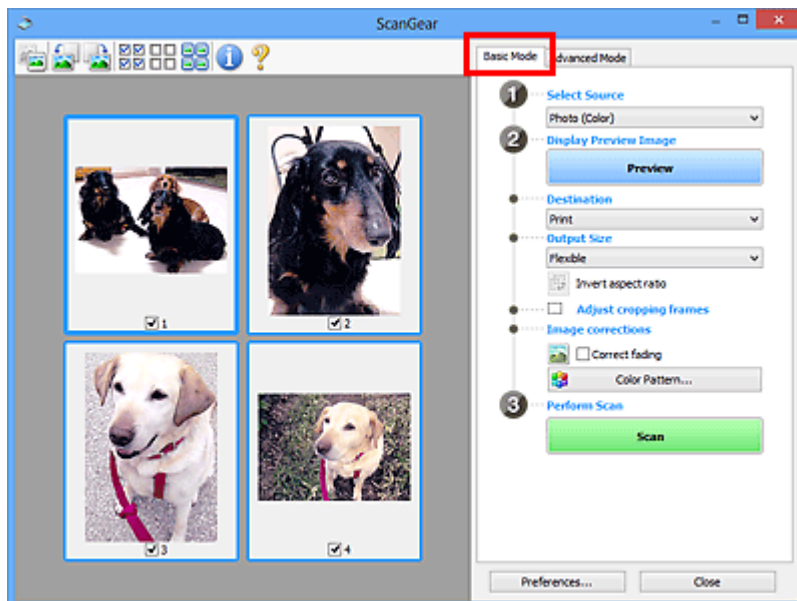

Advanced Mode

Use the **Advanced Mode** tab to scan by specifying the color mode, output resolution, image brightness, color tone, and other settings.

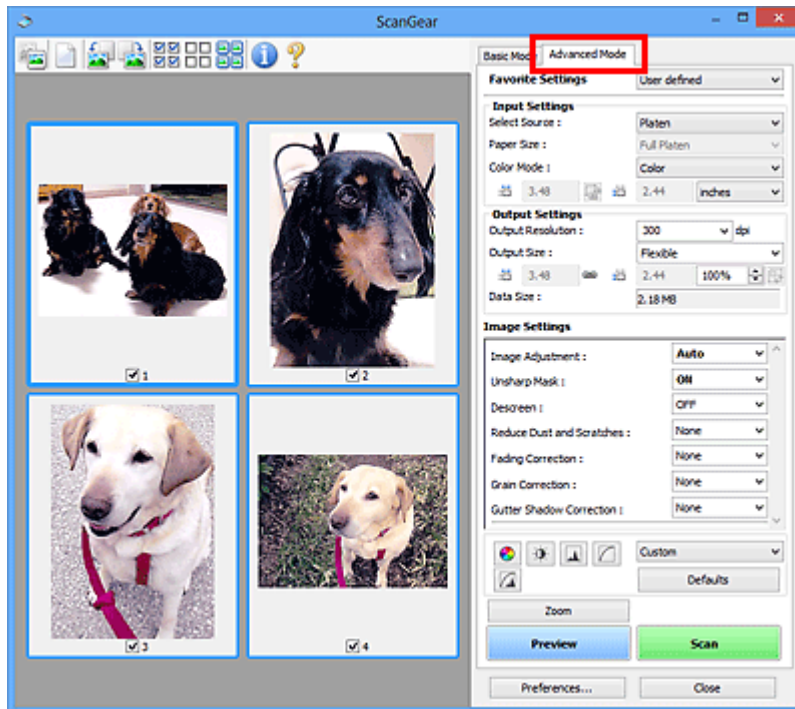

Starting ScanGear (Scanner Driver)

Use ScanGear (scanner driver) to make image corrections and color adjustments when scanning. Start ScanGear from IJ Scan Utility or other applications.

▶▶▶ Note

- If you have more than one scanner or have a network compatible model and changed the connection from USB connection to network connection, set up the network environment.

Starting from IJ Scan Utility

1. Start IJ Scan Utility.

For details search for "Starting IJ Scan Utility" from the top page of the Online Manual for your model.

2. In IJ Scan Utility main screen, click ScanGear.

The ScanGear screen appears.

Starting from Application

The procedure varies depending on the application. For details, see the application's manual.

1. Start application.
2. On application's menu, select machine.

▶▶▶ Note

- A machine connected over a network, will have "Network" displayed after the product name.

3. Scan document.

The ScanGear screen appears.

Scanning in Basic Mode

Use the **Basic Mode** tab to scan easily by following these simple on-screen steps.

To scan multiple documents at one time from the Platen, see [Scanning Multiple Documents at One Time with ScanGear \(Scanner Driver\)](#).

When scanning from the ADF (Auto Document Feeder), preview is not available.

▶▶ Important

- The following types of documents may not be scanned correctly. In that case, click  (Thumbnail) on the Toolbar to switch to whole image view and scan.
 - Photos with a whitish background
 - Documents printed on white paper, hand-written text, business cards, and other unclear documents
 - Thin documents
 - Thick documents
- The following types of documents cannot be scanned correctly.
 - Documents smaller than 1.2 inches (3 cm) square
 - Photos that have been cut to irregular shapes

▶▶ Note

- Both sides of a two sided document can be scanned simultaneously on models with ADF duplex scanning support.

1. Place document on machine's Platen or ADF, and then start ScanGear (scanner driver).

- [Positioning Originals \(Scanning from Computer\)](#)
- [Starting ScanGear \(Scanner Driver\)](#)

2. Set **Select Source** to match your document.

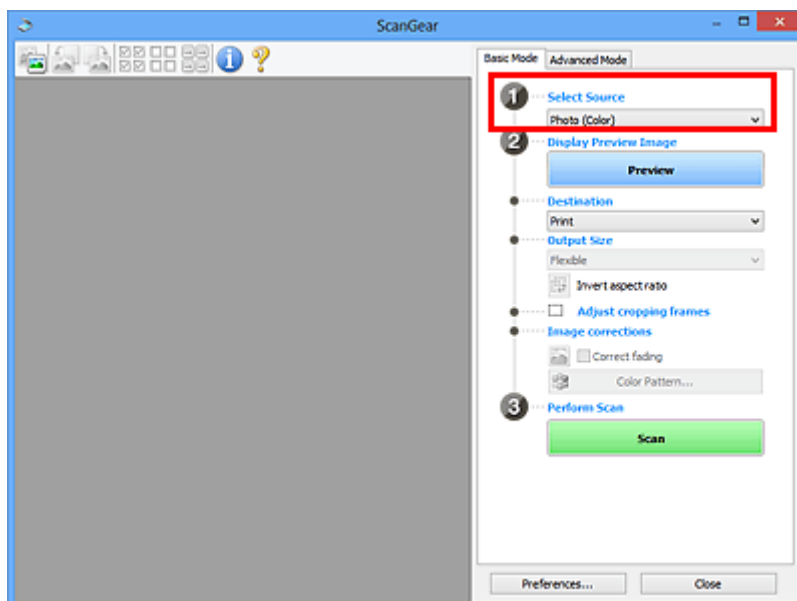

▶▶▶ Important

- Some applications do not support continuous scanning from the ADF. For details, see the application's manual.

▶▶▶ Note

- To scan magazines containing many color photos, select **Magazine (Color)**.

3. Click **Preview**.

Preview image appears in the Preview area.

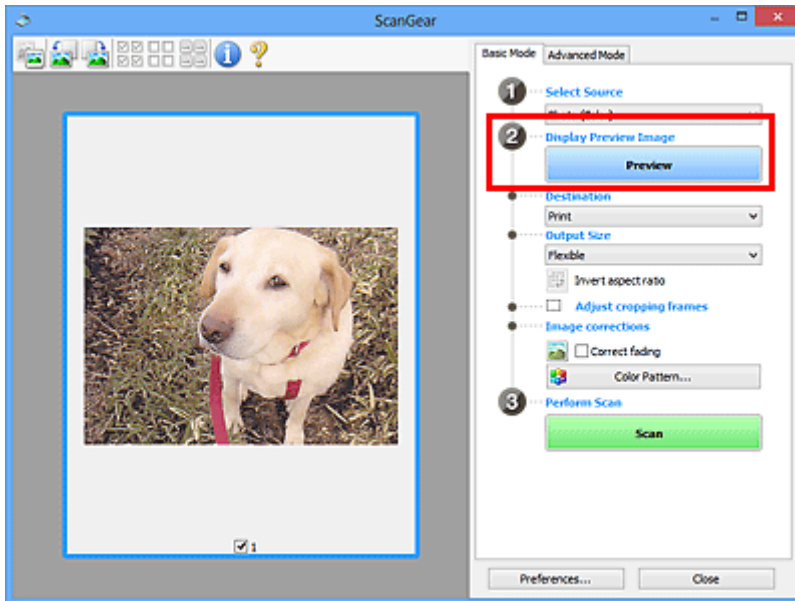

▶▶▶ Important

- **Preview** is not available when scanning from the ADF.

▶▶▶ Note

- Colors are adjusted based on the document type selected in **Select Source**.

4. Set **Destination**.

▶▶▶ Note

- Skip ahead to Step 7 if an ADF option is selected in **Select Source**.

5. Set **Output Size**.

Output size options vary with the selected **Destination**.

6. Adjust cropping frames (scan areas) as needed.

Adjust the size and position of the cropping frames on the preview image.

- Adjusting Cropping Frames (ScanGear)

7. Set **Image corrections** as needed.

8. Click **Scan**.

Scanning starts.

▶▶▶ **Note**

- Click  (Information) to display a dialog box showing the document type and other details of the current scan settings.
- How ScanGear behaves after scanning is complete can be set from **Status of ScanGear dialog after scanning** on the Scan tab of the **Preferences** dialog box.

Related Topic

- [Basic Mode Tab](#)

ScanGear (Scanner Driver) Screens

- ▶ [Basic Mode Tab](#)
- ▶ [Advanced Mode Tab](#)

Basic Mode Tab

Use the **Basic Mode** tab to scan easily by following these simple on-screen steps.

This section describes the settings and functions available on the **Basic Mode** tab.

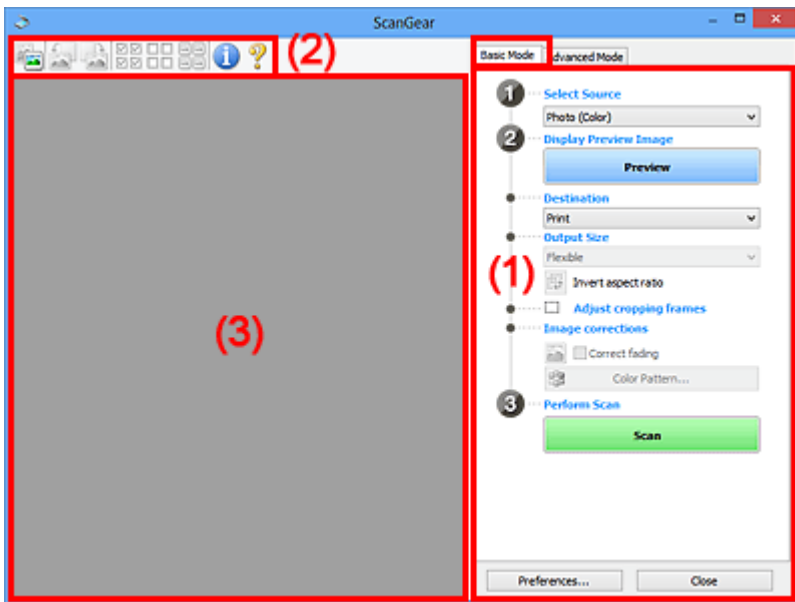

- [\(1\) Settings and Operation Buttons](#)
- [\(2\) Toolbar](#)
- [\(3\) Preview Area](#)

▶▶▶ Note

- The displayed items vary by document type and view.
- Preview is not available when scanning from the ADF (Auto Document Feeder).

(1) Settings and Operation Buttons

Select Source

Photo (Color)

Scan color photos.

Magazine (Color)

Scan color magazines.

Document (Color)

Scan documents in color.

Document (Grayscale)

Scan documents in black and white.

Document (Color) ADF Simplex

Scan documents from the ADF in color.

Document (Grayscale) ADF Simplex

Scan documents from the ADF in black and white.

Document (Color) ADF Duplex (only for models supporting ADF duplex scanning)

Scan both sides of documents from the ADF in color.

Document (Grayscale) ADF Duplex (only for models supporting ADF duplex scanning)

Scan both sides of documents from the ADF in black and white.

►►► Important

- Some applications do not support continuous scanning from the ADF. For details, see the application's manual.

►►► Note

- When you select a document type, the unsharp mask function will be active.
- When you select an option other than the ADF types, the image adjustment function which adjusts images based on the document type will also be active.
- When you select **Magazine (Color)**, the descreen function will be active.

Display Preview Image

Preview

Performs a trial scan.

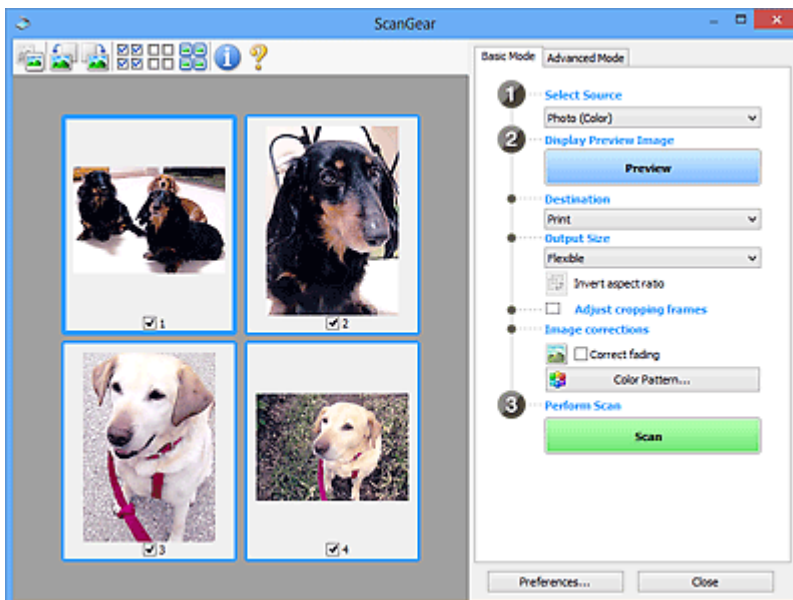

►►► Note

- When using the machine for the first time, scanner calibration starts automatically. Wait a while until the preview image appears.

Destination

Select what you want to do with the scanned image.

Print

Select this to print the scanned image on a printer.

Image display

Select this to view the scanned image on a monitor.

OCR

Select this to use the scanned image with OCR software.

"OCR software" is software that converts text scanned as an image into text data that can be edited in word processors and other programs.

Output Size

Select an output size.

Output size options vary by the item selected in **Destination**.

Flexible

Adjust the cropping frames (scan areas) freely.

In thumbnail view:

Drag the mouse over a thumbnail to display a cropping frame. When a cropping frame is displayed, the portion within the cropping frame will be scanned. When no cropping frame is displayed, each frame is scanned individually.

In whole image view:

When no cropping frame is displayed, the entire Preview area will be scanned. When a cropping frame is displayed, the portion within the cropping frame will be scanned.

Paper Size (such as L or A4)

Select an output paper size. The portion within the cropping frame will be scanned at the size of the selected paper size. Drag the cropping frame to enlarge/reduce it while maintaining the aspect ratio.

Monitor Size (such as 1024 x 768 pixels)

Select an output size in pixels. A cropping frame of the selected monitor size will appear and the portion within the cropping frame will be scanned. Drag the cropping frame to enlarge/reduce it while maintaining the aspect ratio.

Add/Delete...

Displays the **Add/Delete the Output Size** dialog box for specifying custom output sizes. This option can be selected when **Destination** is **Print** or **Image display**.

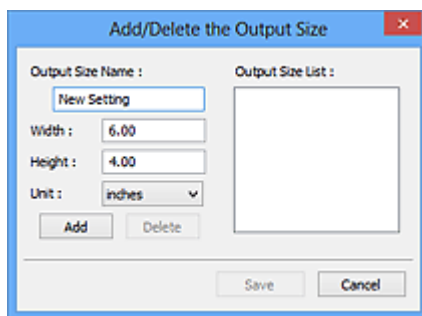

In the **Add/Delete the Output Size** dialog box, multiple output sizes can be specified and then saved at one time. Saved items will be registered to the **Output Size** list and can be selected, along with the predefined items.

Adding:

Enter **Output Size Name**, **Width**, and **Height**, and then click **Add**. For **Unit**, select **inches** or **mm** if **Destination** is **Print**; if it is **Image display**, only **pixels** can be selected. The name of the added size appears in **Output Size List**. Click **Save** to save the items listed in **Output Size List**.

Deleting:

Select the output size you want to delete in **Output Size List**, and then click **Delete**. Click **Save** to save the items listed in **Output Size List**.

»»» Important

- Predefined output sizes such as **A4** and **1024 x 768 pixels** cannot be deleted.

»»» Note

- Save up to 10 items.
- An error message appears when you enter a value outside the setting range. Enter a value within the setting range.

»»» Note

- For details on whether or how the cropping frame initially appears on a preview image, see **Cropping Frame on Previewed Images** in Preview Tab of the **Preferences** dialog box.



Invert aspect ratio

Available when **Output Size** is set to anything but **Flexible**.

Click this button to rotate the cropping frame. Click again to return it to the original orientation.

Adjust cropping frames

Adjust the scan area within the Preview area.

If an area is not specified, the document will be scanned at the document size (Auto Crop). If an area is specified, only the portion in the cropping frame will be scanned.

- Adjusting Cropping Frames (ScanGear)

Image corrections

Correct the image to be scanned.

»»» Important

- **Apply Auto Document Fix** and **Correct fading** are available when **Recommended** is selected on the **Color Settings** tab of the **Preferences** dialog box.

»»» Note

- Available functions vary by the document type selected in **Select Source**.

Apply Auto Document Fix

Sharpens text in a document or magazine for better readability.

»»» Important

- Scanning may take longer than usual when this checkbox is selected.
- The color tone may change from the source image due to corrections. In that case, deselect the checkbox and scan.
- Correction may not be applied properly if the scan area is too small.

Correct fading

Corrects photos that have faded with time or have a colorcast.

Reduce gutter shadow

Corrects shadows that appear between pages when scanning open booklets.

»» Important

- Be sure to see Gutter Shadow Correction for precautions and other information on using this function.

Color Pattern...

Adjust the image's overall color. Correct colors that have faded due to colorcast or other reasons and reproduce natural colors while previewing color changes.

- Adjusting Colors Using a Color Pattern

»» Important

- This setting is not available when **Color Matching** is selected on the **Color Settings** tab of the **Preferences** dialog box.

Perform Scan

Scan

Starts scanning.

»» Note

- When scanning starts, the progress appears. To cancel the scan, click **Cancel**.

Preferences...

Displays the Preferences dialog box for making scan/preview settings.

Close

Closes ScanGear (scanner driver).

(2) Toolbar

Adjust or rotate preview images. The buttons displayed on the Toolbar vary by view.

In thumbnail view:



In whole image view:

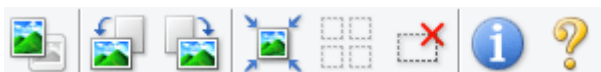

Switches the view in the Preview area.

- [\(3\) Preview Area](#)



(Rotate Left)

Rotates the preview image 90 degrees counter-clockwise.

- The result will be reflected in the scanned image.
- The image returns to its original state when you preview again.



(Rotate Right)

Rotates the preview image 90 degrees clockwise.

- The result will be reflected in the scanned image.
- The image returns to its original state when you preview again.



(Auto Crop)

Displays and adjusts the cropping frame automatically to the size of the document displayed in the Preview area. The scan area is reduced every time you click this button if there are croppable areas within the cropping frame.



(Check All Frames)

Available when two or more frames are displayed.

Selects the checkboxes of the images in thumbnail view.



(Uncheck All Frames)

Available when two or more frames are displayed.

Deselects the checkboxes of the images in thumbnail view.



(Select All Frames)

Available when two or more frames are displayed.

Selects the images in thumbnail view and outlines them in blue.



(Select All Cropping Frames)

Available when two or more cropping frames are specified.

Turns the cropping frames into thick broken lines and applies the settings to all of them.



(Remove Cropping Frame)

Removes the selected cropping frame.



(Information)

Displays the version of ScanGear, along with the document type and other details of the current scan settings.



(Open Guide)

Opens this page.

(3) Preview Area



This is where a trial image appears after you click **Preview**. The results of image corrections, color adjustments, and other settings made in [\(1\) Settings and Operation Buttons](#) are also reflected.

When  (Thumbnail) is displayed on Toolbar:

Cropping frames are specified according to the document size, and thumbnails of scanned images appear. Only the images with the checkbox selected will be scanned.



►► Note

- When multiple images are previewed, different outlines indicate different selection status.
 - Focus Frame (thick blue outline): The displayed settings will be applied.
 - Selected Frame (thin blue outline): The settings will be applied to the Focus Frame and Selected Frames simultaneously. To select multiple images, click them while pressing the Ctrl key.
 - Unselected (no outline): The settings will not be applied.
- Double-click a frame to enlarge the image. Click   (Frame Advance) at the bottom of the screen to display the previous or next frame. Double-click the enlarged frame again to return it to its original state.

When  (Whole Image) is displayed on Toolbar:

Items on the Platen are scanned and appear as a single image. All portions in the cropping frames will be scanned.



▶▶ Note

- Create cropping frame(s) on the displayed image. In thumbnail view, one cropping frame can be created per image. In whole image view, multiple cropping frames can be created.

- Adjusting Cropping Frames (ScanGear)

Related Topic

- [Scanning in Basic Mode](#)

Advanced Mode Tab

This mode allows you to make advanced scan settings such as the color mode, output resolution, image brightness, and color tone.

This section describes the settings and functions available on the **Advanced Mode** tab.

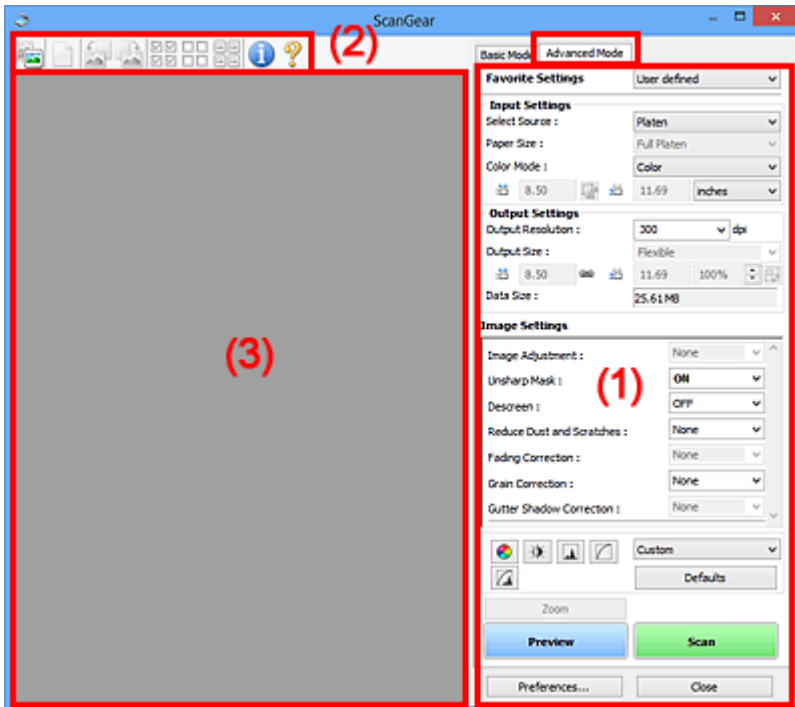

- [\(1\) Settings and Operation Buttons](#)
- [\(2\) Toolbar](#)
- [\(3\) Preview Area](#)

▶▶▶ Note

- The displayed items vary by document type and view.
- The preview function is not available when scanning from the ADF (Auto Document Feeder).

(1) Settings and Operation Buttons

Favorite Settings

You can name and save a group of settings (Input Settings, Output Settings, Image Settings, and Color Adjustment Buttons) on the **Advanced Mode** tab, and load it as required. It is convenient to save a group of settings if you will be using it repeatedly. You can also use this to reload the default settings.

Select **Add/Delete...** from the pull-down menu to open the **Add/Delete Favorite Settings** dialog box.

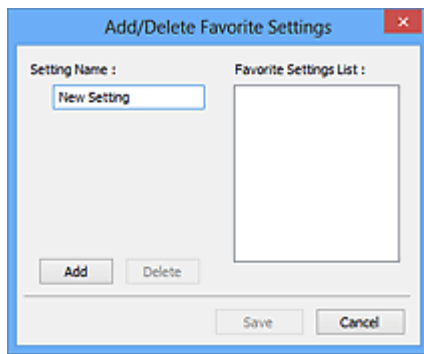

Enter **Setting Name** and click **Add**; the name appears in **Favorite Settings List**.

When you click **Save**, the item appears in the **Favorite Settings** list and can be selected, along with the predefined items.

To delete an item, select it in **Favorite Settings List** and click **Delete**. Click **Save** to save the settings displayed in **Favorite Settings List**.

►►► Note

- You can set **Add/Delete...** in **Favorite Settings** after preview.
- Save up to 10 items.

Input Settings

Specify the input settings such as the document type and size.

Output Settings

Specify the output settings such as the output resolution and size.

Image Settings

Enable/disable various image correction functions.

Color Adjustment Buttons

Fine corrections to the image brightness and color tones can be made including adjustments to the image's overall brightness or contrast and adjustments to its highlight and shadow values (histogram) or balance (tone curve).

Zoom

Zooms in on a frame, or zooms in on the image in the area specified with a cropping frame (scan area). When zoomed in, **Zoom** changes to **Undo**. Click **Undo** to return the display to its non-magnified state.

In thumbnail view:

When multiple images are displayed in thumbnail view, clicking this button zooms in on the selected frame. Click  (Frame Advance) at the bottom of the screen to display the previous or next frame.

►►► Note

- You can also zoom in on an image by double-clicking the frame. Double-click the enlarged frame again to return it to its original state.

In whole image view:

Rescans the image in the area specified with a cropping frame at higher magnification.

►►► Note

- **Zoom** rescans the document and displays high-resolution image in Preview.
-  (Enlarge/Reduce) on the Toolbar zooms in on the preview image quickly. However, the resolution of the displayed image will be low.

Preview

Performs a trial scan.

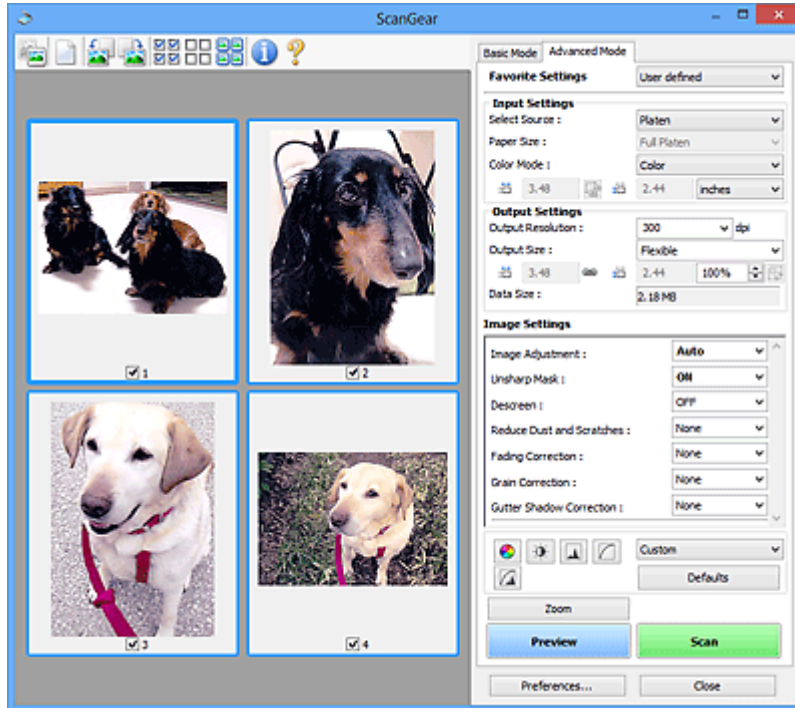

Scan

Starts scanning.

►►► Note

- When scanning starts, the progress appears. To cancel the scan, click **Cancel**.
- When scanning is completed, a dialog box prompting you to select the next action may appear. Follow the prompt to complete. For details, refer to **Status of ScanGear dialog after scanning** in Scan Tab (**Preferences** dialog box).
- It will take time to process the images if the total size of the scanned images exceeds a certain size. In that case, a warning message appears; it is recommended that you reduce the total size. To continue, scan in whole image view.

Preferences...

Displays the Preferences dialog box for making scan/preview settings.

Close

Closes ScanGear (scanner driver).

(2) Toolbar

Adjust or rotate preview images. The buttons displayed on the Toolbar vary by view.

In thumbnail view:



In whole image view:



(Thumbnail) / (Whole Image)
Switches the view in the Preview area.

■ [\(3\) Preview Area](#)



(Clear)
Deletes the preview image from the Preview area.
It also resets the Toolbar and color adjustment settings.



(Crop)
Allows you to specify the scan area by dragging the mouse.



(Move Image)
Allows you to drag the image until the part you want to see is displayed when an image enlarged in the Preview area does not fit in the screen. You can also move the image using the scroll bars.



(Enlarge/Reduce)
Allows you to zoom in on the Preview area by clicking the image. Right-click the image to zoom out.



(Rotate Left)
Rotates the preview image 90 degrees counter-clockwise.

- The result will be reflected in the scanned image.
- The image returns to its original state when you preview again.



(Rotate Right)
Rotates the preview image 90 degrees clockwise.

- The result will be reflected in the scanned image.
- The image returns to its original state when you preview again.



(Auto Crop)
Displays and adjusts the cropping frame automatically to the size of the document displayed in the Preview area. The scan area is reduced every time you click this button if there are croppable areas within the cropping frame.



(Check All Frames)
Available when two or more frames are displayed.
Selects the checkboxes of the images in thumbnail view.



(Uncheck All Frames)

Available when two or more frames are displayed.

Deselects the checkboxes of the images in thumbnail view.



(Select All Frames)

Available when two or more frames are displayed.

Selects the images in thumbnail view and outlines them in blue.



(Select All Cropping Frames)

Available when two or more cropping frames are specified.

Turns the cropping frames into thick broken lines and applies the settings to all of them.



(Remove Cropping Frame)

Removes the selected cropping frame.



(Information)

Displays the version of ScanGear, along with the document type and other details of the current scan settings.



(Open Guide)

Opens this page.

(3) Preview Area

This is where a trial image appears after you click **Preview**. The results of image corrections, color adjustments, and other settings made in [\(1\) Settings and Operation Buttons](#) are also reflected.



When **(Thumbnail)** is displayed on Toolbar:

Cropping frames are specified according to the document size, and thumbnails of scanned images appear. Only the images with the checkbox selected will be scanned.



►► Note

- When multiple images are previewed, different outlines indicate different selection status.
 - Focus Frame (thick blue outline): The displayed settings will be applied.
 - Selected Frame (thin blue outline): The settings will be applied to the Focus Frame and Selected Frames simultaneously. To select multiple images, click them while pressing the Ctrl key.
 - Unselected (no outline): The settings will not be applied.



When (Whole Image) is displayed on Toolbar:

Items on the Platen are scanned and appear as a single image. All portions in the cropping frames will be scanned.



►► Note

- Create cropping frame(s) on the displayed image. In thumbnail view, one cropping frame can be created per image. In whole image view, multiple cropping frames can be created.
 - Adjusting Cropping Frames (ScanGear)

Related Topic

- Scanning in Advanced Mode
- Scanning Multiple Documents from the ADF (Auto Document Feeder) in Advanced Mode

General Notes (Scanner Driver)

ScanGear (scanner driver) is subject to the following restrictions. Keep these points in mind when using it.

Scanner Driver Restrictions

- When using the NTFS file system, the TWAIN data source may not be invoked. This is because the TWAIN module cannot be written to the winnt folder for security reasons. Contact the computer's administrator for help.
- Some computers (including laptops) connected to the machine may not resume correctly from standby mode. In that case, restart the computer.
- Do not connect two or more scanners or multifunction printers with scanner function to the same computer simultaneously. If multiple scanning devices are connected, you cannot scan from the operation panel of the machine and also may experience errors while accessing the devices.
- Scanning may fail if the computer has resumed from sleep or standby mode. In that case, follow these steps and scan again.
 1. Turn off the machine.
 2. Exit ScanGear, then disconnect the USB cable from the computer and reconnect it.
 3. Turn on the machine.
- ScanGear cannot be opened in multiple applications at the same time. Within an application, ScanGear cannot be opened for the second time when it is already open.
- Be sure to close the ScanGear window before closing the application.
- When using a network compatible model by connecting to a network, the machine cannot be accessed from multiple computers at the same time.
- When using a network compatible model by connecting to a network, scanning takes longer than usual.
- Make sure that you have adequate disk space available when scanning large images at high resolutions. For example, at least 300 MB of free space is required to scan an A4 document at 600 dpi in full-color.
- ScanGear and WIA driver cannot be used at the same time.
- Do not enter the computer into sleep or hibernate state during scanning.

Applications with Restrictions on Use

- Some applications may not display the TWAIN user interface. In that case, refer to the application's manual and change the settings accordingly.
- Some applications do not support continuous scanning of multiple documents. In some cases, only the first scanned image is accepted, or multiple images are scanned as one image. For such applications, do not scan multiple documents from the ADF (Auto Document Feeder).
- To import scanned images into Microsoft Office 2000, first save them using IJ Scan Utility, then import the saved files from the **Insert** menu.
- When scanning Platen size images into Microsoft Office 2003 (Word, Excel, PowerPoint, etc.), click **Custom Insert** in the **Insert Picture from Scanner or Camera** screen. Otherwise, images may not be scanned correctly.
- When scanning images into Microsoft Office 2007/Microsoft Office 2010 (Word, Excel, PowerPoint, etc.), use Microsoft Clip Organizer.

- Images may not be scanned correctly in some applications. In that case, increase the operating system's virtual memory and retry.
- When image size is too large (such as when scanning large images at high resolution), your computer may not respond or the progress bar may remain at 0 % depending on the application. In that case, cancel the action (for example by clicking **Cancel** on the progress bar), then increase the operating system's virtual memory or reduce the image size/resolution and retry. Alternatively, scan the image via IJ Scan Utility first, then save and import it into the application.

Positioning Originals (Scanning from Computer)

This section describes how to load originals on the platen for scanning. If items are not placed correctly they may not be scanned correctly.

▶▶▶ Important

- Do not place objects on the document cover. When you open the document cover, the objects may fall into your scanner or printer, resulting in malfunction.
- Close the document cover when scanning.

Placing Items

Place items as described below to scan by detecting the item type and size automatically.

▶▶▶ Important

- When scanning by specifying the paper size in IJ Scan Utility or ScanGear (scanner driver), align an upper corner of the item with the corner at the arrow (alignment mark) of the platen.
- Photos that have been cut to irregular shapes and items smaller than 1.2 inches (3 cm) square cannot be cropped accurately when scanning.
- Reflective disc labels may not be scanned as expected.

Photos, Postcards, Business Cards, and BD/DVD/CD	Magazines, Newspapers, and Documents
<div data-bbox="220 1055 726 1182" data-label="Image"> </div> <p data-bbox="188 1234 327 1261">Single item:</p> <p data-bbox="188 1283 847 1417">Place the item face-down on the platen, with 0.4 inch (1 cm) or more space between the edges (diagonally striped area) of the platen and the item. Portions placed on the diagonally striped area cannot be scanned.</p> <div data-bbox="188 1435 699 1800" data-label="Diagram"> </div> <p data-bbox="188 1827 399 1861">▶▶▶ Important</p> <ul data-bbox="212 1877 831 2011" style="list-style-type: none"> • Large items (such as A4 size photos) that cannot be placed away from the edges/arrow (alignment mark) of the platen may be saved as PDF files. To save in a format other than PDF, scan by specifying the data format. 	<div data-bbox="949 1055 1332 1182" data-label="Image"> </div> <p data-bbox="863 1223 1422 1357">Place the item face-down on the platen and align an upper corner of the item with the corner at the arrow (alignment mark) of the platen. Portions placed on the diagonally striped area cannot be scanned.</p> <div data-bbox="863 1375 1369 1740" data-label="Diagram"> </div> <p data-bbox="863 1767 1074 1800">▶▶▶ Important</p> <ul data-bbox="887 1816 1417 1883" style="list-style-type: none"> • For the portions in which items cannot be scanned, see Loading Originals.

Multiple items:

Allow 0.4 inch (1 cm) or more space between the edges (diagonally striped area) of the platen and items, and between items. Portions placed on the diagonally striped area cannot be scanned.

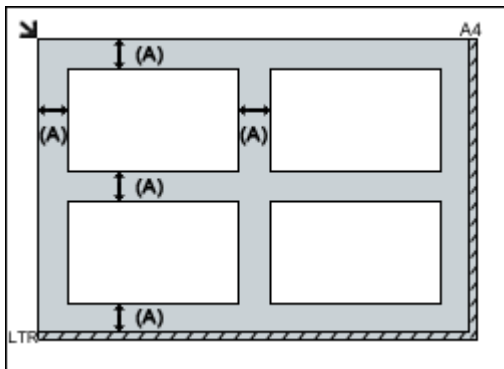

(A) 0.4 inch (1 cm) or more

▶▶▶ Note

- Place up to 12 items.
- Positions of slanted items (10 degrees or less) are corrected automatically.

Network Scan Settings

You can connect your scanner or printer to a network to share it among multiple computers or scan images into a specified computer.

»» Important

- Multiple users cannot scan at the same time.

»» Note

- Complete the network settings of your scanner or printer beforehand from the Setup CD-ROM or by following the instructions our website.
- With network connection, scanning takes longer than USB connection.

Complete the following settings to enable scanning over a network.

Specifying Your Scanner or Printer

Use IJ Network Scanner Selector EX to specify the scanner you want to use. By specifying the scanner, you can scan over a network from your computer or the operation panel.

»» Important



- If the product you want to use is changed with IJ Network Scanner Selector EX, the product used for scanning with IJ Scan Utility changes as well. The product for scanning from the operation panel also changes.

If your scanner or printer is not selected in IJ Scan Utility, check that it is selected with IJ Network Scanner Selector EX.

Refer to "IJ Network Scanner Selector EX2 Menu and Setting Screen" for your model from Home of the Online Manual for details.

- To scan from the operation panel, specify your scanner or printer with IJ Network Scanner Selector EX beforehand.

1. Check that IJ Network Scanner Selector EX is running.

If IJ Network Scanner Selector EX is running,  (IJ Network Scanner Selector EX2) appears in the notification area on the desktop. Click  to check the hidden icons as well.

»» Note

- If the icon is not displayed in the notification area on the desktop, follow the procedure below to start.

- **Windows 10:**

- From the **Start** menu, click **All apps > Canon Utilities > IJ Network Scanner Selector EX2**.

- **Windows 8.1/Windows 8:**

- Click **IJ Network Scanner Selector EX2** on the Start screen.

If **IJ Network Scanner Selector EX2** is not displayed on the Start screen, select the **Search** charm, then search for "IJ Network Scanner Selector EX".

- **Windows 7/Windows Vista:**

From the **Start** menu, click **All Programs > Canon Utilities > IJ Network Scanner Selector EX2 > IJ Network Scanner Selector EX2**.

The icon appears in the notification area on the desktop, and the Scan-from-PC Settings screen appears. In that case, skip ahead to Step 3.

2. In the notification area on the desktop, right-click  (IJ Network Scanner Selector EX2), then select **Settings....**

The Scan-from-PC Settings screen appears.

3. Select your scanner or printer from **Scanners**.

Normally, the MAC address of your scanner or printer is already selected after the network setup. In that case, you do not need to select it again.

Important

- If multiple scanners exist on the network, multiple model names appear. In that case, you can select one scanner per model.

4. Click **OK**.

Note

- The scanner selected in the Scan-from-PC Settings screen will be automatically selected in the Scan-from-Operation-Panel Settings screen as well.

Setting for Scanning with IJ Scan Utility

To scan from IJ Scan Utility using a scanner or printer connected to a network, specify your scanner or printer with IJ Network Scanner Selector EX, then follow the steps below to change the connection status between it and the computer.

1. [Start IJ Scan Utility](#).
2. Select "Canon XXX series Network" (where "XXX" is the model name) for **Product Name**.
3. Click **Settings...** to use another scanner connected to a network.
4. Click  (General Settings), then click **Select** in **Product Name**.

The Scan-from-PC Settings screen of IJ Network Scanner Selector EX appears.

Select the scanner you want to use and click **OK**.

5. In the **Settings (General Settings)** dialog box, click **OK**.

The IJ Scan Utility main screen reappears. You can scan via a network connection.

Setting for Scanning from the Operation Panel



You can make the setting for scanning from the operation panel.

►► Important

- Set IJ Scan Utility to use your scanner or printer via a network connection beforehand.

■ [Setting for Scanning with IJ Scan Utility](#)

1. Check that IJ Network Scanner Selector EX is running.

If IJ Network Scanner Selector EX is running,  (IJ Network Scanner Selector EX2) appears in the notification area on the desktop. Click  to check the hidden icons as well.

►► Note

- If the icon is not displayed in the notification area on the desktop, follow the procedure below to start.

- **Windows 10:**

From the **Start** menu, click **All apps > Canon Utilities > IJ Network Scanner Selector EX2**.

- **Windows 8.1/Windows 8:**

Click **IJ Network Scanner Selector EX2** on the Start screen.

If **IJ Network Scanner Selector EX2** is not displayed on the Start screen, select the **Search** charm, then search for "IJ Network Scanner Selector EX".

- **Windows 7/Windows Vista:**

From the **Start** menu, click **All Programs > Canon Utilities > IJ Network Scanner Selector EX2 > IJ Network Scanner Selector EX2**.

The icon appears in the notification area on the desktop, and the Scan-from-PC Settings screen appears. In that case, skip ahead to Step 3.

2. In the notification area on the desktop, right-click  (IJ Network Scanner Selector EX2), then select **Settings....**

The Scan-from-PC Settings screen appears.

3. Click **Scan-from-Operation-Panel Settings**.

The Scan-from-Operation-Panel Settings screen appears.

4. Select your scanner or printer from **Scanners** and click **OK**.

Select the MAC address of your scanner or printer.

▶▶▶ Note

- When multiple scanners are connected via a network, you can select up to three scanners.

5. In the Scan-from-PC Settings screen, click **OK**.

▶▶▶ Note

- If your scanner or printer does not appear, check the following, click **OK** to close the screen, then reopen it and try selecting again.
 - MP Drivers is installed
 - Network settings of your scanner or printer is completed after installing the MP Drivers
 - Network communication between your scanner or printer and computer is enabled

If the problem is still not solved, see [Network Communication Problems](#).

Scanning from Operation Panel

- ▶ **Forwarding Scanned Data to Computer Using Operation Panel**  **Basics**
- ▶ **Sending Scanned Data as E-Mail from Computer**
- ▶ **Setting Items for Scanning Using Operation Panel**
- ▶ **Setting Up Operation Panel with IJ Scan Utility (Windows)**
- ▶ **Setting Up Operation Panel with IJ Scan Utility (Mac OS)**

Forwarding Scanned Data to Computer Using Operation Panel

Before forwarding scanned data to the computer, check the following:

- **MP Drivers are installed. (Windows)**

If MP Drivers are not yet installed, install MP Drivers with the Setup CD-ROM or install them from the Canon website.

- **The scanner driver is installed. (Mac OS)**

If the scanner driver is not yet installed, install the scanner driver from the Canon website.

- **The printer is connected to a computer correctly.**

Make sure the printer is connected to the computer correctly.

Do not plug in or unplug the USB cable while the printer is in operation, or when the computer is in the sleep or standby mode.

If you perform scanning via a network connection, make sure all the required settings have been specified.

- For Windows:

- [Network Scan Settings](#)

- For Mac OS:

- Network Scan Settings

- **The destination and the file name are specified in Canon IJ Scan Utility.**

You can specify the destination and the file name in Canon IJ Scan Utility. For more on settings of Canon IJ Scan Utility:

- For Windows:

- [Settings Dialog Box](#)

- For Mac OS:

- Settings Dialog

For Mac OS X 10.11, starting Canon IJ Scan Utility is required to forward the scanned data to your computer.

Follow the procedure below to forward scanned data to the computer.

1. [Make sure printer is turned on.](#)



2. Select **Scan** on the HOME screen.

- [Using the Operation Panel](#)

The screen for selecting to which you save the data is displayed.

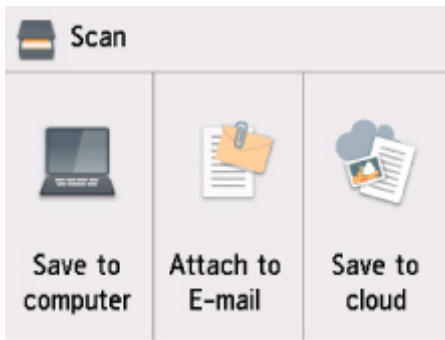

3. Select  **Save to computer.**

4. Select a computer to forward scanned data.

Select **Local (USB)** for a USB-connected computer, or select the computer to forward the scanned data for a network-connected computer.

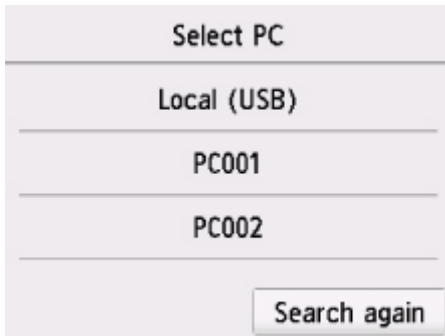

The Scan standby screen is displayed.

▶▶▶ Note

- When you forward the scanned data to the computer using WSD (one of the network protocols supported in Windows), select **Enable** for **WSD scan from this device** on **WSD setting** on **Common settings** in **LAN settings** under **Device settings**.

■ [WSD setting](#)

If you select **Search again**, the printer starts searching for the connected computers again.

- The destination and the file name are specified in Canon IJ Scan Utility in advance.
 - For Windows:
 - [Settings Dialog Box](#)
 - For Mac OS:
 - Settings Dialog

5. Specify settings as necessary.

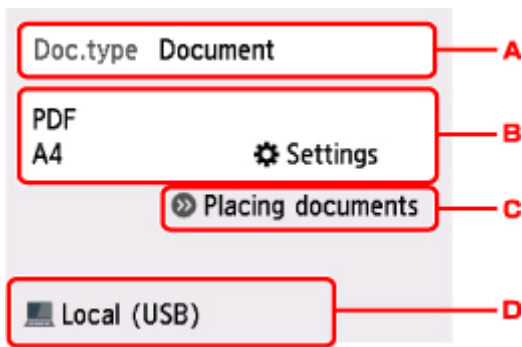

A. Select the document type.

»» Note

- When you forward the scanned data to the computer searched using WSD, you cannot select the document type.

Auto scan

The printer detects the type of the originals automatically and the image is forwarded in the optimized size, resolution and data format.

»» Important

- Load originals properly according to their type; otherwise, some originals may not be scanned properly.

For more on loading the original:

■ [Loading Originals](#)

- The following items can be scanned:

Photos, postcards, visiting cards, magazines, newspapers, documents, BD/DVD/CDs

- The following items cannot be scanned properly.

- A4 sized photos
- Documents smaller than 5 inches x 7 inches (127 mm x 178 mm) such as a paperback with its backbone cut off
- Originals on thin white paper
- Long and narrow originals such as panoramic photographs

Document

Scans the original on the platen glass as a document data applying the settings specified in **Scan settings**.

Photo

Scans the original on the platen glass as a photo data applying the settings specified in **Scan settings**.

B. Displays **Scan settings** screen.

For more on the setting items:

■ [Setting Items for Scanning Using Operation Panel](#)

C. Displays how to load the original.

D. Displays the screen to select the destination.

6. [Load original on platen glass.](#)

7. Press **Color** button for color scanning, or **Black** button for black & white scanning.

▶▶▶ Note

• When you forward the scanned data to the computer using WSD, press the **Color** button.

• If you select **JPEG** or **TIFF** for **Format** on the scan setting screen:

The printer starts scanning and scanned data is forwarded to the computer.

• When you select **PDF** or **Compact PDF** for **Format** on the scan setting screen:

The confirmation screen asking you if you continue scanning is displayed after scanning is complete.

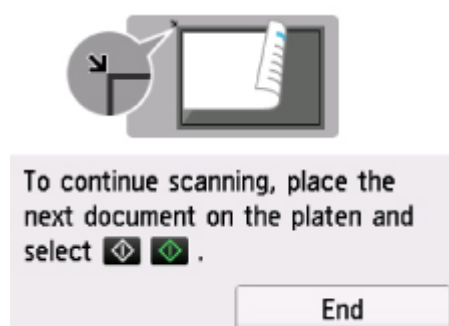

If you continue scanning, load the original on the platen glass and start scanning.

If you do not continue scanning, tap **End**. The scanned data is forwarded to the computer.

Scanned data is forwarded to the computer according to the settings specified in Canon IJ Scan Utility.

Remove the original on the platen glass after scanning is complete.

▶▶▶ Important

• If the scanning result with **Auto scan** is not satisfactory, select the document type or size according to the original in step 5.

If program selection screen appears (Windows):

The program selection screen may be displayed after pressing the **Color** or **Black** button. In this case, select **Canon IJ Scan Utility** and click **OK**.

If you want to scan originals with advanced settings, or if you want to edit or print scanned images:

If you scan originals from a computer using My Image Garden, My Image Garden enables you to edit the scanned images, such as optimizing or trimming.

In addition, you can edit or print the scanned images using the compatible application software to make better use of them.

- For Windows:
 - Scanning Photos and Documents
- For Mac OS:
 - Scanning Photos and Documents

►► Note



- For Windows:
 - You can use a WIA-compliant application software to scan originals with this printer.
For details:
 - Other Scanning Methods
 - If you want to convert a scanned document to text:
 - Extracting Text from Scanned Images (OCR)

Setting Items for Scanning Using Operation Panel

You can change the scan settings such as the scan size, resolution, or data format.

When the Scan standby screen is displayed, tap **Settings** to select the setting item. Flick to display setting items and tap the setting item to display the settings. Tap to specify the setting.

▶▶▶ Note

- The scan setting cannot be specified under the following conditions:
 - When **Auto scan** is selected for **Doc.type** to forward the scanned data to the computer
 - When you forward the scanned data to the computer using WSD (one of the network protocols supported in Windows)
- Some settings cannot be specified in combination with the setting of other setting item, the document type selected for **Doc.type**, or the scan menu on the screen for selecting to which you save the data. If the setting which cannot be specified in combination is selected,  and **Error details** are displayed on the touch screen. In this case, tap  on the upper left on the touch screen to check the message and change the setting.
- The specified scan settings such as the scan size, resolution, and data format are retained even if the printer is turned off.
- When scanning starts in the scan menu that is not available with the specified setting, **The specified function is not available with current settings.** is displayed on the touch screen. Change the setting, following the on-screen instructions.
- When you forward the scanned data to the computer or attach the data to an e-mail, you can specify the destination and file name using Canon IJ Scan Utility.
 - For Windows:
 - [Settings Dialog Box](#)
 - For Mac OS:
 - Settings Dialog
- If you scan originals from the computer, you can scan with advanced settings. For more on scanning from the computer:
 - For Windows:
 - Scanning Photos and Documents
 - For Mac OS:
 - Scanning Photos and Documents

Scan settings		
Scan size	A4	1
Format	PDF	2
Scan res	300 dpi	3
Reduce show-thru	OFF	

Scan settings		
Scan res	300 dpi	
Reduce show-thru	OFF	4
Descreen	OFF	5
Unsharp mask	ON	6

1. Scan size

Select the size of the original.

2. Format

Select the data format of the scanned data.

3. Scan res (Scan resolution)

Select the resolution for scanning.

4. Reduce show-thru (Reducing show-through)

Characters on the back may show through when scanning a thin document such as a newspaper. Select **ON** if characters seem to show through on the scanned document.

This setting item is not available when **Photo** is selected for **Doc.type**.

5. Descreen

A printout consists of minute dots to make characters or graphs. Interfering with each dot may result in uneven shades or a striped pattern. Select **ON** if you notice any uneven shades or a striped pattern on the scanned image.

This setting item is not available when **Photo** is selected for **Doc.type**.

▶▶▶ Note

- Even if **ON** is selected for this setting, some moire effects may remain if **Unsharp mask** is set to **ON**. In that case, select **OFF** for **Unsharp mask**.

6. Unsharp mask

The outline of small characters or thin objects such as a hair or leaves on a photo can be accentuated. Select **ON** if you want to accentuate the outline of the scanned data.

Frequently Asked Questions



Network

- [Cannot Find Printer on Network](#)
- [Cannot Find Printer while Using Wireless LAN](#)
- [Network Key Unknown](#)

For other questions about network, [click here](#).



Print

- [Printing Does Not Start](#)
- [Paper Is Blank/Printing Is Blurry/Colors Are Wrong/White Streaks Appear](#)
- [Print Results Are Unsatisfactory](#)
- [Paper Jams](#)



Installation

- [Cannot Install MP Drivers](#)



Error

- [An Error Occurs](#)
- [Message Appears](#)

Examples of Problems

Printer Does Not Move

- [Power Does Not Come On](#)
- [Power Shuts Off By Itself](#)
- Display on Touch Screen Is Off
- Touch Screen Shows Wrong Language
- [USB Connection Problems](#)
- [Cannot Communicate with Printer via USB](#)

-
- [Printing Does Not Start](#)
 - Copying/Printing Stops
 - Cannot Print Using AirPrint
 - Printing Is Slow
 - [No Ink Comes Out](#)
 - [Paper Jams](#)
 - [Paper Does Not Feed Properly/"No Paper" Error](#)
 - Automatic Duplex Printing Problems
 - [Print Results Are Unsatisfactory](#)

-
- [Scanning Problems \(Windows\)](#)
 - Scanning Problems (Mac OS)

- [Scan Results Are Unsatisfactory \(Windows\)](#)
 - [Scan Results Are Unsatisfactory \(Mac OS\)](#)
-

- [Cannot Print/Scan from Smartphone/Tablet](#)

Cannot Set Correctly (Network)

- [Cannot Find Printer on Check Printer Settings Screen](#)
 - [Cannot Find Printer while Using Wireless LAN](#)
-

- [Printer Suddenly Cannot Be Used](#)
 - [Network Key Unknown](#)
 - Administrator Password Set for Printer Unknown
 - [Printer Cannot Be Used After Replacing Wireless Router or Changing Its Settings](#)
-

- Message Appears on Computer During Setup
- [Checking Network Information](#)
- [Restoring to Factory Defaults](#)

Cannot Set Correctly (Installation)

- [Cannot Install MP Drivers](#)
- Easy-WebPrint EX Does Not Start or Easy-WebPrint EX Menu Does Not Appear (Windows)
- [Updating Printer Driver in Network Environment \(Windows\)](#)

Error or Message Appears

- [An Error Occurs](#)
 - [Message Appears](#)
-

- [List of Support Code for Error](#)
- Error Message Appears on PictBridge (Wireless LAN) Compliant Device
- IJ Scan Utility Error Messages (Windows)
- ScanGear (Scanner Driver) Error Messages
- IJ Scan Utility Error Messages (Mac OS)
- Scanner Driver (ICA Driver) Error Messages (Mac OS)

Operation Problems

- [Network Communication Problems](#)
- [Printing Problems](#)
- Problems while Printing/Scanning from Smartphone/Tablet
- [Scanning Problems \(Windows\)](#)
- Scanning Problems (Mac OS)
- [Mechanical Problems](#)
- [Installation and Download Problems](#)
- [Errors and Messages](#)
- If You Cannot Solve a Problem

Network Settings and Common Problems

Here are frequently asked questions on network. Select a connection method you are using, or you want to use.



Wireless LAN

Cannot Find Printer

- [Cannot Find Printer while Using Wireless LAN](#)
- [Cannot Find Printer on Check Printer Settings Screen](#)
- [Cannot Proceed beyond Printer Connection Screen/Connect Cable Screen](#)
- Cannot Find Printer after Searching it on Printer Detection Screen During Setup
- Searching Printer by IP Address or Host Name During Setup
- Error Occurs During Wireless LAN Setup
- [Another Printer Found with Same Name](#)
- [Changing Wireless LAN Connection Method](#)

Cannot Print or Connect

- [Printer Suddenly Cannot Be Used](#)
- [Printer Cannot Be Used After Replacing Wireless Router or Changing Its Settings](#)
- Cannot Access to Internet on Wireless LAN from Communication Device
- Connecting Printer and Wireless Router Using Easy wireless connect
- Cannot Connect Smartphone/Tablet to Wireless Router
- Error Occurs During Wireless LAN Setup
- [Connecting to Another Computer via LAN/Changing from USB to LAN Connection](#)

LAN Setting Tips/Changing LAN Settings

- [Network Key Unknown](#)
- Administrator Password Set for Printer Unknown
- [Checking Network Information](#)
- [Restoring to Factory Defaults](#)
- Checking Wireless Router SSID/Key
- Checking Wireless Router SSID for Smartphone/Tablet
- Privacy Separator/SSID Separator/Network Separation function
- [Default Network Settings](#)
- [Connecting to Another Computer via LAN/Changing from USB to LAN Connection](#)
- [Printing Network Settings](#)
- [Changing Wireless LAN Connection Method](#)

Printing/Scanning from Smartphone/Tablet

- Connecting Printer and Wireless Router Using Easy wireless connect
- Cannot Connect Smartphone/Tablet to Wireless Router

- [Checking Wireless Router SSID for Smartphone/Tablet](#)
- [Setting Up Using Smartphone/Tablet](#)
- [Cannot Print/Scan from Smartphone/Tablet](#)
- [Downloading Canon PRINT Inkjet/SELPHY](#)

Problems while Using Printer

- [Message Appears on Computer During Setup](#)
- [Printing Is Slow](#)
- [Ink Level Not Shown on Printer Status Monitor \(Windows\)](#)
- [Packets Are Sent Constantly \(Windows\)](#)

Wireless Direct

Cannot Print or Connect

- [Printer Suddenly Cannot Be Used](#)
- [Cannot Access to Internet on Wireless LAN from Communication Device](#)

LAN Setting Tips/Changing LAN Settings

- [Network Key Unknown](#)
- [Administrator Password Set for Printer Unknown](#)
- [Checking Network Information](#)
- [Restoring to Factory Defaults](#)
- [Printing Network Settings](#)
- [Default Network Settings](#)
- [Changing Wireless LAN Connection Method](#)

Printing/Scanning from Smartphone/Tablet

- [Cannot Print/Scan from Smartphone/Tablet](#)
- [Downloading Canon PRINT Inkjet/SELPHY](#)

Problems while Using Printer

- [Message Appears on Computer During Setup](#)
- [Printing Is Slow](#)
- [Ink Level Not Shown on Printer Status Monitor \(Windows\)](#)

Connecting the Printer to a Network

Available Connection Methods

The following connection methods are available on the printer.

- **Wireless Connection** 
Connect the printer and computer/smartphone/tablet using a wireless router.
If you have a wireless router, we recommend you use one for wireless connection.



- **Wireless Direct**
Connect the printer and computer/smartphone/tablet without using a wireless router.



For more on connection method, see Available Connection Methods.

»» Note

- You can connect the printer and computer using a USB cable (USB connection). Prepare a USB cable. For details, see [Connecting to Another Computer via LAN/Changing from USB to LAN Connection](#).

Network Connection Settings/Setup

Perform connection setup for the printer and computer/smartphone/tablet.

For more on setup procedure, click [here](#).

Changing Network Settings

See below for changing connection settings for the printer and computer/smartphone/tablet.

- To change network connection method:
 - [Changing Wireless LAN Connection Method](#)
 - Changing the Connection Mode
- To add computer/smartphone/tablet to the printer:
 - [Connecting to Another Computer via LAN/Changing from USB to LAN Connection](#)
- To use wireless direct temporarily:
 - [Using Printer with Wireless Direct](#)

Application Software for Network (Windows)

For Windows, you can use IJ Network Device Setup Utility to perform network settings. It allows a network/printer administrator to manage printers on network.

- Network Settings (IJ Network Device Setup Utility) (Windows)

Troubleshooting

See [Network Settings and Common Problems](#) for troubleshooting on network connection.

Notice/Restriction

See below for details.

- Restrictions on network settings:
 - [Restrictions](#)
- Notices when printing using web service:
 - Notice for Web Service Printing

Restrictions

When connecting another device while a device (such as a smartphone) is already connected to the printer, connect it using the same connection method as the connected device.

If you connect using a different connection method, the connection to the device in use will be disabled.

Connect via wireless router

- Make sure your device and the wireless router are connected. For details on checking these settings, see the manual supplied with the wireless router or contact its manufacturer.
As for a device already connected to the printer without using a wireless router, reconnect it via a wireless router.
- Configuration, router functions, setup procedures and security settings of network devices vary depending on the system environment. For details, see the manual for your network device or contact its manufacturer.
- This printer does not support IEEE802.11ac, IEEE802.11a, or IEEE802.11n (5 GHz). Check if your device supports IEEE802.11n (2.4 GHz), IEEE802.11g or IEEE802.11b.
- If your device is set to the "IEEE802.11n only" mode, WEP or TKIP cannot be used as a security protocol. Change the security protocol for your device to something other than WEP and TKIP or change the setting to something other than "IEEE802.11n only."
The connection between your device and the wireless router will be temporarily disabled while the setting is changed. Do not proceed to the next screen of this guide until setup is complete.
- For office use, consult your network administrator.
- Note that if you connect to a network with no security protection, your personal information could be disclosed to a third party.

Wireless Direct

▶▶ Important

- If a device is connected to the Internet via a wireless router, and you then connect it to a printer in Wireless Direct mode, the existing connection between the device and wireless router will be disabled. In that case, the connection of the device may switch to a mobile data connection automatically depending on your device. When you connect to the Internet using a mobile data connection, charges may apply depending on your contract.
 - When you connect a device and the printer using Wireless Direct, the connection information will be saved to Wi-Fi settings. The device may be connected to the printer automatically even after disconnecting it or connecting it to another wireless router.
 - To prevent automatic connection to the printer in Wireless Direct mode, change the connection mode after using the printer, or set not to connect automatically in the Wi-Fi settings of the device.
For details on checking or changing wireless router settings, see the router manual or contact its manufacturer.
- If you connect a device and the printer using Wireless Direct, Internet connection may become unavailable depending on your environment. In that case, web services for the printer cannot be used.

- In Wireless Direct mode, you can connect up to five devices at the same time. If you try to connect a sixth device while five devices are already connected, an error will appear.
If an error appears, disconnect a device that does not use the printer, then configure settings again.
- Devices connected to the printer using Wireless Direct cannot communicate with each other.
- Firmware updates for the printer are not available while using Wireless Direct.
- When a device has been connected to the printer without using a wireless router and you want to set it up again using the same connection method, disconnect it first. Disable the connection between the device and printer in the Wi-Fi setting screen.

Network Communication Problems

- ▶ **Cannot Find Printer on Network**
- ▶ **Network Connection Problems**
- ▶ **Other Network Problems**

Cannot Find Printer on Network

While performing printer setup:

- ▶ **Cannot Find Printer on Check Printer Settings Screen During Setup (Windows)**
- ▶ **Cannot Proceed beyond Printer Connection Screen/Connect Cable Screen**

While using printer:

- ▶ **Cannot Find Printer while Using Wireless LAN**

Cannot Find Printer on Check Printer Settings Screen During Setup (Windows)

If the printer cannot be found and the **Check Printer Settings** screen appears after searching the printer by **Automatic search** on the **Search for Printers** screen, click **Redetect** and search for the printer again by the IP address on the **Search for Printers** screen.

If the printer has not been found after searching it by the IP address, check network settings.

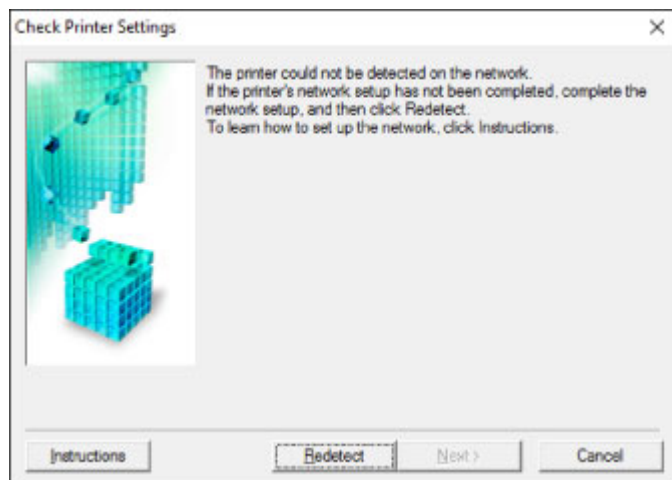

- [Cannot Find Printer on Check Printer Settings Screen During Wireless LAN Setup \(Windows\)-
Checking Power Status](#)
- [Cannot Find Printer on Check Printer Settings Screen During Wireless LAN Setup \(Windows\)-
Checking PC Network Connection](#)
- [Cannot Find Printer on Check Printer Settings Screen During Wireless LAN Setup \(Windows\)-
Checking Printer's Wireless LAN Settings](#)
- [Cannot Find Printer on Check Printer Settings Screen During Wireless LAN Setup \(Windows\)-
Checking Wireless LAN Environment](#)
- [Cannot Find Printer on Check Printer Settings Screen During Wireless LAN Setup \(Windows\)-
Checking Printer's IP Address](#)
- [Cannot Find Printer on Check Printer Settings Screen During Wireless LAN Setup \(Windows\)-
Checking Security Software Settings](#)
- [Cannot Find Printer on Check Printer Settings Screen During Wireless LAN Setup \(Windows\)-
Checking Wireless Router Settings](#)



Cannot Find Printer on Check Printer Settings Screen During Wireless LAN Setup (Windows)-Checking Power Status



Are printer and network device (router, etc.) turned on?

Make sure the printer is turned on.

- [Confirming that the Power Is On](#)

Make sure network device (router, etc.) is turned on.

If printer or network device is off:

Turn on printer or network device.

It may take a while for the printer and network device to become ready for use once they are turned on.

Wait a while after turning on the printer or network device, and then click **Redetect** on the **Check Printer Settings** screen to redetect the printer.

If the printer is found, follow the instructions on the screen to continue to set up network communication.

If printer and network device are on:

If the network devices are on, turn them off and on again.

If above does not solve the problem:

- [Cannot Find Printer on Check Printer Settings Screen During Wireless LAN Setup \(Windows\)-Checking PC Network Connection](#)



Cannot Find Printer on Check Printer Settings Screen During Wireless LAN Setup (Windows)-Checking PC Network Connection



Can you view any web pages on your computer?

Make sure the computer and network device (router, etc.) are configured and the computer is connected to the network.

If you cannot view any web pages:

Click **Cancel** on the **Check Printer Settings** screen to cancel to set up the network communication.

After that, configure the computer and network device.

For the procedures, refer to the instruction manuals supplied with the computer and network device, or contact their manufacturers.

If you can view web pages after configuring the computer and network device, try to set up the network communication from the beginning.

If above does not solve the problem:



- [Cannot Find Printer on Check Printer Settings Screen During Wireless LAN Setup \(Windows\)-Checking Wireless LAN Environment](#)



Cannot Find Printer on Check Printer Settings Screen During Wireless LAN Setup (Windows)-Checking Printer's Wireless LAN Settings



Is printer set to allow wireless communication?

Make sure the  or  icon is displayed on the touch screen.

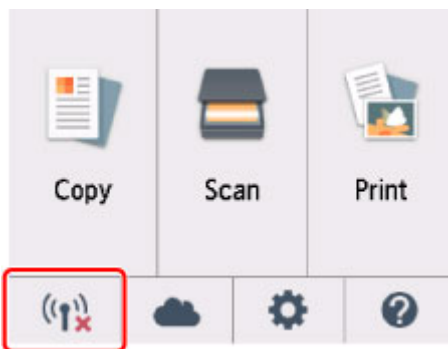

If icon is not displayed:

The printer is not set to allow wireless communication. Click **Wireless LAN Setup Information** on the **Check Printer Settings** screen to check the status and turn on wireless communication on the printer.

If icon is displayed:

- [Cannot Find Printer on Check Printer Settings Screen During Wireless LAN Setup \(Windows\)-Checking Wireless LAN Environment](#)



Cannot Find Printer on Check Printer Settings Screen During Wireless LAN Setup (Windows)-Checking Wireless LAN Environment



Is printer connected to wireless router?

Use the icon on the touch screen to make sure the printer is connected to the wireless router.

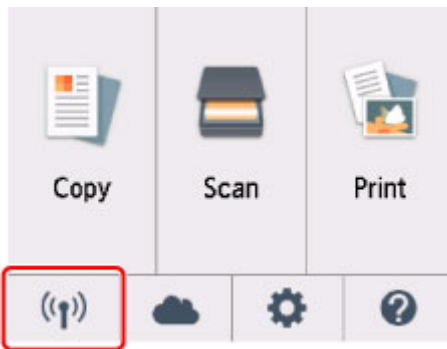

If icon is displayed:

- Checking wireless router location

After checking the wireless router setting, make sure the printer is not placed far away from the wireless router.

The printer can be up to 50 m (164 ft) from the wireless router indoors. Make sure the printer is close enough to the wireless router to be used.

Place the wireless router and printer where there are no obstacles between them. Wireless communication between different rooms or floors is generally poor. Wireless communication can be impeded by building materials containing metal or concrete. If the printer cannot communicate with the computer over a wireless LAN due to a wall, place the printer and the computer in the same room.

In addition, if a device like a microwave oven that emits radio waves of the same frequency bandwidth as a wireless router is nearby, it may cause interference. Place the wireless router as far away from interference sources as possible.

▶▶▶ Note

- Though an antenna is attached to most wireless routers, note that some of them have it inside.

- Checking wireless router settings

The printer and wireless router should be connected using 2.4 GHz bandwidth. Make sure the wireless router for the printer's destination is configured to use 2.4 GHz bandwidth.

»» Important

- Depending on the wireless router, note that different SSID is assigned for a bandwidth (2.4 GHz or 5 GHz) or its usage (for PC or game machine) using alphanumeric characters at the end of SSID.

Check the SSID of the wireless router for the printer on the touch screen.

Tap the icon on the lower left, tap **Yes**, and then check **SSID**.

For more on the wireless router, refer to the instruction manual supplied with the wireless router or contact its manufacturer.

After taking measures above, click **Redetect** on the **Check Printer Settings** screen to redetect the printer.

If the printer is found, follow the instructions on the screen to continue to set up network communication.

If the printer cannot be detected, the printer is not connected to the wireless router. Connect the printer to the wireless router.

After connecting the printer to the wireless router, set up the network communication from the beginning.



If  icon is displayed:

- [Cannot Find Printer on Check Printer Settings Screen During Wireless LAN Setup \(Windows\)-Checking Printer's IP Address](#)



Cannot Find Printer on Check Printer Settings Screen During Wireless LAN Setup (Windows)-Checking Printer's IP Address



Is printer's IP address specified correctly?

If printer's IP address is not specified correctly, the printer may not be found. Make sure whether printer's IP address is not used for another device.

To check the printer's IP address, print out the network settings information or use the operation panel to display it.

- Display on the touch screen.

- [LAN settings](#)

- Print the network settings.

- [Printing Network Settings](#)

If the IP address is not specified correctly:

See If an error screen appears: and specify the IP address.

If the IP address is specified correctly:

- [Cannot Find Printer on Check Printer Settings Screen During Wireless LAN Setup \(Windows\)-Checking Security Software Settings](#)



Cannot Find Printer on Check Printer Settings Screen During Wireless LAN Setup (Windows)-Checking Security Software Settings



Disable block in firewall function temporarily.

The firewall of your security software or operation system for computer may limit communication between the printer and your computer. Check the firewall setting of your security software or operation system or the message shown on your computer and disable block temporarily.

If firewall interferes with setup:

- **If message appears:**

If a message appears warning that Canon software is attempting to access the network, set the security software to allow access.

After allowing the software to access, click **Redetect** on the **Check Printer Settings** screen to redetect the printer.

If the printer is found, follow the instructions on the screen to continue to set up network communication.

- **If no message appears:**

Cancel the setup, and then set the security software to allow Canon software to access the network.

The file **Setup.exe** or **Setup64.exe** in the **win > Driver > DrvSetup** folder on the Setup CD-ROM

After setting the security software, redo the network communication setup from the beginning.

After setup is completed, enable firewall.

▶▶▶ Note

- For more on firewall settings of your operating system or security software, see instruction manual or contact its manufacturer.

If above does not solve the problem:

- [Cannot Find Printer on Check Printer Settings Screen During Wireless LAN Setup \(Windows\)-Checking Wireless Router Settings](#)



Cannot Find Printer on Check Printer Settings Screen During Wireless LAN Setup (Windows)-Checking Wireless Router Settings



Check wireless router settings.

Check wireless router network connection settings, such as IP address filtering, MAC address filtering, encryption key, and DHCP function.

Make sure the same radio channel is assigned to the wireless router and the printer.

To check the settings of the wireless router, see the instruction manual supplied with the wireless router or contact the manufacturer.

After checking the wireless router settings, click **Redetect** on the **Check Printer Settings** screen to redetect the printer.

If the printer is found, follow the instructions on the screen to continue to set up network communication.



Cannot Proceed beyond Printer Connection Screen/Connect Cable Screen



If you cannot proceed beyond the **Printer Connection** screen or the **Connect Cable** screen, check the following.

Check1 Make sure USB cable is securely plugged in to printer and computer.

Connect the printer and the computer using a USB cable as the illustration below. The USB port is located at the back of the printer.

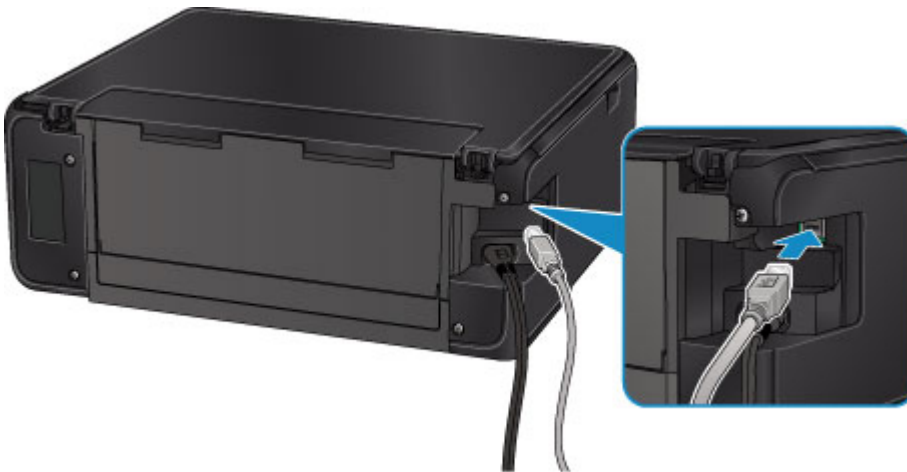

Check the items below only if you cannot proceed beyond the **Printer Connection** screen.

Check2 Follow procedure below to connect printer and computer again.

▶▶▶ Important

- For Mac OS, make sure the lock icon is on the lower left of the **Printers & Scanners** screen (**Print & Scan** screen in Mac OS X v10.8).

If the  icon (locked) is displayed, click the icon to unlock. (The administrator name and the password are necessary to unlock.)

1. Turn off printer.
2. Unplug USB cable from printer and computer and connect it again.
3. Turn on printer.

Check3 If you cannot resolve problem, follow procedure below to reinstall MP Drivers.

- For Windows:
 1. Click **Cancel**.

- If the **Installation Failure** screen appears:
 1. Click **Start Over**.
 2. Click **Exit** on **Start Setup** screen and finish setup.
- If the **Connection failed.** screen appears:
 1. Click **Next**.
 2. Click **Next** on displayed screen.
 3. Click **Back to Top** on **Select Printer** screen.
 4. Click **Exit** on **Start Setup** screen and finish setup.
- 3. Turn off printer.
- 4. Restart computer.
- 5. Make sure you have no application software running.
- 6. Redo setup according to instructions on Canon website.

▶▶▶ Note

- You can use the Setup CD-ROM to redo setup.

- For Mac OS:
 1. Click **Next**.
 - If the **Installation Failure** screen appears, click **Exit** on displayed screen and finish setup.
 - If the **Connection failed.** screen appears:
 1. Click **Next**.
 2. Click **Next** on displayed screen.
 3. Click **Back to Top** on **Select Printer** screen.
 4. Click **Exit** on **Start Setup** screen and finish setup.
 3. Turn off printer.
 4. Restart computer.
 5. Make sure you have no application software running.
 6. Redo setup according to instructions on Canon website.



Cannot Find Printer while Using Wireless LAN

▶▶▶ Note

- This section describes the troubleshooting when using the computer.
For the troubleshooting when using the smartphone or the tablet:
 - Cannot Print/Scan from Smartphone/Tablet



Check1 Make sure the printer is turned on.

Check2 Is  icon displayed on the touch screen?

If the icon is not displayed, select **Active** on **WLAN active/inactive** in **Wireless LAN** under **LAN settings**.

Check3 Make sure printer setup is complete.

If it is not, perform setup.

- For Windows:
Use the Setup CD-ROM or follow the instructions on the Canon website.
- For Mac OS:
Follow the instructions on the Canon website.

Check4 If you can use IJ Network Device Setup Utility, look for printer again. (Windows)

- IJ Network Device Setup Utility Screen

Check5 Make sure printer and wireless router network settings match.

Make sure the network settings of the printer (e.g. wireless router name, SSID, network key, etc.) are identical with those of the wireless router.

To check the settings of the wireless router, refer to the instruction manual provided with it or contact its manufacturer.

To check the current network settings of the printer, print out the network setting information.

- [Printing Network Settings](#)

Check6 Make sure the printer is not placed too far away from the wireless router.

Place the wireless router and printer where there are no obstacles between them. Wireless communication between different rooms or floors is generally poor. Wireless communication can be impeded by building materials containing metal or concrete. If the printer cannot communicate with the computer over a wireless LAN due to a wall, place the printer and the computer in the same room.

In addition, if a device like a microwave oven that emits radio waves of the same frequency bandwidth as a wireless router is nearby, it may cause interference. Place the wireless router as far away from interference sources as possible.

▶▶▶ Note

- Though an antenna is attached to most wireless routers, note that some of them have it inside.

Check7 Make sure wireless signal is strong. Monitor signal status and move printer and wireless router as necessary.

To check the signal strength:

- Checking Wireless Network Status

Check8 Make sure the computer is connected to the wireless router.

For more on how to check the computer settings or connection status, see your computer instruction manual or contact its manufacturer.

▶▶▶ Note

- If you use the smartphone/tablet, make sure that its Wi-Fi setting is enabled.

Check9 Make sure **Enable bidirectional support** is selected in the **Ports** sheet of the properties dialog box of the printer driver. (Windows)

Check10 Make sure security software's firewall is off.

If your security software's firewall is on, a message may appear warning you that Canon software is attempting to access the network. If this warning message appears, set security software to always allow access.

If you are using any programs that switch between network environments, check their settings. Some programs use a firewall by default.

Check11 If printer is connected to an AirPort Base Station via LAN, use alphanumeric characters for network identifier (SSID). (Mac OS)

If the problem is not resolved, redo setup.

- For Windows:
Use the Setup CD-ROM or follow the instructions on the Canon website.
- For Mac OS:
Follow the instructions on the Canon website.

Network Connection Problems

- ▶ **Printer Suddenly Cannot Be Used**
- ▶ **Network Key Unknown**
- ▶ **Printer Cannot Be Used After Replacing Wireless Router or Changing Its Settings**

Printer Suddenly Cannot Be Used

- [Cannot Communicate with Printer Following Network Settings Change](#)
- [Cannot Communicate with Printer via Wireless LAN](#)
- [Cannot Communicate with Printer Using Wireless Direct](#)
- [Cannot Print or Scan from a Computer Connected to the Network](#)



Cannot Communicate with Printer Following Network Settings Change



It may take a while for the computer to obtain an IP address, or you may need to restart your computer. Make sure the computer has obtained a valid IP address, and try again to find the printer.



Cannot Communicate with Printer via Wireless LAN



Check1 Check the power status of printer, network devices (e.g. wireless router), and smartphone/tablet.

Turn on the printer or devices.

If the power is already turned on, turn it off and on again.

It may be necessary to resolve wireless router problems (e.g. update interval of a key, problems of DHCP update interval, energy saving mode, etc.) or to update the wireless router firmware.

For details, contact the manufacturer of your wireless router.

Check2 Can you view any web pages on your computer?

Make sure your computer is connected to the wireless router properly.

For more on checking computer settings or connection status, see the instruction manual supplied with the wireless router or contact the manufacturer.

Check3 Is the printer connected to the wireless router?

Check the connection status between the printer and wireless router by the icon on the touch screen. If the



is not displayed, wireless LAN is disabled, enable wireless LAN.

Check4 Make sure the printer and wireless router network settings match.

Make sure the network settings of the printer (e.g. wireless router name, SSID, network key, etc.) are identical with those of the wireless router.

To check the settings of the wireless router, refer to the instruction manual provided with it or contact its manufacturer.

To check the current network settings of the printer, print out the network setting information.

■ [Printing Network Settings](#)

If the printer network settings do not match with those of the wireless router, change the network settings of the printer to match with those of the wireless router.

■ Network Settings (IJ Network Device Setup Utility) (Windows)

Check5 Make sure the printer is not placed too far away from the wireless router.

Place the wireless router and printer where there are no obstacles between them. Wireless communication between different rooms or floors is generally poor. Wireless communication can be impeded by building materials containing metal or concrete. If the printer cannot communicate with the computer over a wireless LAN due to a wall, place the printer and the computer in the same room.

In addition, if a device like a microwave oven that emits radio waves of the same frequency bandwidth as a wireless router is nearby, it may cause interference. Place the wireless router as far away from interference sources as possible.

▶▶▶ Note

- Though an antenna is attached to most wireless routers, note that some of them have it inside.

Check6 Make sure wireless signal is strong. Monitor signal status and move printer and wireless router as necessary. (Windows)

■ Checking Wireless Network Status

Check7 Make sure you are using a valid channel.

Usable wireless channels may be limited depending on wireless network device used by your computer. See the instruction manual provided with your computer or wireless network device to check usable wireless channels.

Check8 Make sure channel set on wireless router is a usable channel as confirmed in Check 7.

If it is not, change the channel set on the wireless router.

Check9 Make sure security software's firewall is off.

If your security software's firewall is on, a message may appear warning you that Canon software is attempting to access the network. If this warning message appears, set security software to always allow access.

If you are using any programs that switch between network environments, check their settings. Some programs use a firewall by default.

Check10 If printer is connected to an AirPort Base Station via LAN, use alphanumeric characters for network identifier (SSID). (Mac OS)

If the problem is not resolved, redo setup.

- For Windows:
Use the Setup CD-ROM or follow the instructions on the Canon website.
- For Mac OS:
Follow the instructions on the Canon website.
- **Positioning:**
Make sure there are no obstacles between the wireless router and the printer.

Cannot Communicate with Printer Using Wireless Direct

A

Check1 Check the power status of printer and other devices (smartphone or tablet).

Turn on the printer or devices.

If the power is already turned on, turn it off and on again.

Check2 Is the  icon displayed on the touch screen?

If the icon is not displayed, Wireless Direct is disabled, enable Wireless Direct.

Check3 Check the settings of your device (smartphone/tablet).

Make sure wireless LAN is enabled on your device.

For details, refer to your device's instruction manual.

Check4 Make sure printer is selected as connection for device (e.g. smartphone or tablet).

Select the identifier for wireless direct (SSID) specified for the printer as the connection destination for devices.

Check the destination on your device.

For details, refer to your device's instruction manual or visit the manufacturer's website.

To check the identifier for wireless direct (SSID) specified for the printer, display it using the operation panel of the printer or print out the network setting information of the printer.

- Display on the touch screen.

■ [LAN settings](#)

- Print the network settings.

■ [Printing Network Settings](#)

Check5 Have you entered the proper password specified for the wireless direct?

To check the password specified for the printer, display it using the operation panel of the printer or print out the network setting information of the printer.

- Display on the touch screen.

- [LAN settings](#)

- Print the network settings.

- [Printing Network Settings](#)

Check6 Make sure the printer is not placed too far away from the device.

Place the device and printer where there are no obstacles between them. Wireless communication between different rooms or floors is generally poor. Wireless communication can be impeded by building materials containing metal or concrete. If the printer cannot communicate with the computer over a wireless LAN due to a wall, place the printer and the computer in the same room.

In addition, if a device like a microwave oven that emits radio waves of the same frequency bandwidth as a wireless router is nearby, it may cause interference. Place the wireless router as far away from interference sources as possible.

Place devices a suitable distance from the printer.

Check7 Make sure 5 devices are already connected.

Wireless Direct does not allow more than 5 devices to be connected.

Cannot Print or Scan from a Computer Connected to the Network

A

Check1 Make sure the computer is connected to the wireless router.

For more on how to check the computer settings or connection status, see your computer instruction manual or contact its manufacturer.

Check2 If MP Drivers are not installed, install them.

- For Windows:

Install the MP Drivers using the Setup CD-ROM or install them from the Canon website.

- For Mac OS:

Install the MP Drivers from the Canon website.

Check3 Make sure wireless router does not restrict which computers can access it.

For more on connecting to and setting up your wireless router, see the wireless router instruction manual or contact its manufacturer.

Note

- To check the MAC address or IP address of your computer, see [Checking Computer IP Address or MAC Address](#).

Network Key Unknown

- [WPA/WPA2 or WEP Key Set for Wireless Router Unknown, Cannot Connect](#)
- [Setting an Encryption Key](#)

WPA/WPA2 or WEP Key Set for Wireless Router Unknown, Cannot Connect

For more on setting up a wireless router, see the instruction manual provided with the wireless router or contact its manufacturer. Make sure your computer can communicate with the wireless router.

Note

- For Windows, set up the printer to match the wireless router settings using IJ Network Device Setup Utility.

Setting an Encryption Key

For more on setting up a wireless router, see the instruction manual provided with the wireless router or contact its manufacturer. Make sure your computer can communicate with the wireless router.

Note

- For Windows, set up the printer to match the wireless router settings using IJ Network Device Setup Utility.

Selecting WPA, WPA2, or WPA/WPA2 is recommended for security reason. If your wireless router is compatible with WPA/WPA2, you can also use WPA2 or WPA.

- **Using WPA/WPA2**

The authentication method, passphrase, and dynamic encryption type must be the same for the wireless router, the printer, and your computer.

Enter the passphrase configured on the wireless router (a sequence of between 8 and 63 alphanumeric characters, or a 64-character hexadecimal number).

Either TKIP (basic encryption) or AES (secure encryption) is selected automatically as the dynamic encryption method.

For details, see If WPA/WPA2 Details Screen Appears.

Note

- This printer supports WPA/WPA2-PSK (WPA/WPA2-Personal) and WPA2-PSK (WPA2-Personal).

- **Using WEP**

The key length, key format, key to use (one of 1 to 4), and authentication method must be the same for the wireless router, the printer, and your computer.

To communicate with a wireless router that uses automatically generated WEP keys, you must set the printer to use the key generated by the wireless router, entering it in hexadecimal format.

- For Windows:

When the **WEP Details** screen appears after you click **Search...** on the **Network Settings (Wireless LAN)** screen in IJ Network Device Setup Utility, follow the on-screen instructions to set the WEP key length, format, and the number.

For details, see *If WEP Details Screen Appears*.

Note

- If the printer is connected to an AirPort Base Station via LAN:

If the printer is connected to an AirPort Base Station via a LAN, check the settings in **Wireless Security of AirPort Utility**.

- Select **64 bit** if **WEP 40 bit** is selected for key length in AirPort Base Station.
- Select **1** for **Key ID**. Otherwise, computer will not be able to communicate with printer via the wireless router.



Printer Cannot Be Used After Replacing Wireless Router or Changing Its Settings



When you replace a wireless router, redo the network setup for the printer.

- For Windows:
Use the Setup CD-ROM or follow the instructions on the Canon website.
- For Mac OS:
Follow the instructions on the Canon website.

If this does not solve the problem, see below.

- [Cannot Communicate with Printer After Enabling MAC/IP Address Filtering or Encryption Key on Wireless Router](#)
- [With Encryption On, Cannot Communicate with Printer After Changing Encryption Type at Wireless Router](#)



Cannot Communicate with Printer After Enabling MAC/IP Address Filtering or Encryption Key on Wireless Router



Check1 Check wireless router setting.

To check the wireless router setting, see the instruction manual provided with the wireless router or contact its manufacturer. Make sure the computer and the wireless router can communicate with each other under this setting.

Check2 If filtering MAC addresses or IP addresses at wireless router, check that MAC addresses or IP addresses for computer, network device, and printer are registered.

Check3 If using WPA/WPA2 or WEP key, make sure encryption key for computer, network device, and printer matches key set for wireless router.

Not only the WEP key itself, but also the key length, key format, the key ID to use, and the authentication method must be the same for the printer, the wireless router, and the computer.

For details, see [Setting an Encryption Key](#).

Q With Encryption On, Cannot Communicate with Printer After Changing Encryption Type at Wireless Router

A

If you change the encryption type for the printer and it subsequently cannot communicate with the computer, make sure the encryption type for the computer and the wireless router matches the type set for the printer.

- [Cannot Communicate with Printer After Enabling MAC/IP Address Filtering or Encryption Key on Wireless Router](#)

Other Network Problems

- ▶ **Checking Network Information**
- ▶ **Restoring to Factory Defaults**
- ▶ **Message Appears on Computer During Setup**
- ▶ **Packets Are Sent Constantly (Windows)**

Checking Network Information

- [Checking Printer IP Address or MAC Address](#)
- [Checking Computer IP Address or MAC Address](#)
- [Checking Communication Between the Computer, the Printer, and the Wireless Router](#)
- [Checking Network Setting Information](#)

Checking Printer IP Address or MAC Address

A

To check the printer's IP Address or MAC address, print out the network settings information or use the operation panel to display it.

- Display on the touch screen.

- [LAN settings](#)

- Print the network settings.

- [Printing Network Settings](#)

For Windows, you can check the network setting information on the computer screen.

- [IJ Network Device Setup Utility Screen](#)

You can display the printer's MAC address on the touch screen.

- [System information](#)

Checking Computer IP Address or MAC Address

A

To check the IP Address or MAC address of your computer, follow the instructions below.

- For Windows:

1. Select **Command Prompt** as shown below.

In Windows 10, right-click **Start** button and select **Command Prompt**.

In Windows 8.1 or Windows 8, select **Command Prompt** from the **Start** screen. If **Command Prompt** is not displayed on the **Start** screen, select the **Search** charm and search for "**Command Prompt**".

In Windows 7 or Windows Vista, click **Start** > **All Programs** > **Accessories** > **Command Prompt**.

2. Enter "ipconfig/all" and press **Enter**.

The IP address and MAC address of your computer appear. If your computer is not connected to a network, the IP address does not appear.

- For Mac OS:

1. Select **System Preferences** from Apple menu, and then click **Network**.
2. Make sure network interface used by computer is selected, and then click **Advanced**.
Make sure **Wi-Fi** is selected as network interface.
3. Check the IP address or MAC address.
Click **TCP/IP** to check the IP address.
Click **Hardware** to check the MAC address.

Checking Communication Between the Computer, the Printer, and the Wireless Router

A

Perform a ping test to check if communication is taking place.

- For Windows:

1. Select **Command Prompt** as shown below.

In Windows 10, right-click **Start** button and select **Command Prompt**.

In Windows 8.1 or Windows 8, select **Command Prompt** from the **Start** screen. If **Command Prompt** is not displayed on the **Start** screen, select the **Search** charm and search for "**Command Prompt**".

In Windows 7 or Windows Vista, click **Start** > **All Programs** > **Accessories** > **Command Prompt**.

2. Type the ping command and press **Enter**.

The ping command is as follows: ping XXX.XXX.XXX.XXX

"XXX.XXX.XXX.XXX" is the IP address of the target device.

If communication is taking place, a message like the one shown below appears.

Reply from XXX.XXX.XXX.XXX: bytes=32 time=10ms TTL=255

If **Request timed out** appears, communication is not taking place.

- For Mac OS:

1. Start **Network Utility** as shown below.

In Mac OS X v10.11, Mac OS X v10.10 or Mac OS X v10.9, select **Computer** from **Go** menu of Finder, double-click **Macintosh HD** > **System** > **Library** > **CoreServices** > **Applications** > **Network Utility**.

In Mac OS X v10.8, open **Utilities** folder in **Applications** folder, then double-click **Network Utility**.

2. Click **Ping**.
3. Make sure **Send only XX pings** (XX are numbers) is selected.
4. Enter IP address of target printer or target wireless router in **Enter the network address to ping**.
5. Click **Ping**.

"XXX.XXX.XXX.XXX" is the IP address of the target device.

A message such as the following appears.

64 bytes from XXX.XXX.XXX.XXX: icmp_seq=0 ttl=64 time=3.394 ms

64 bytes from XXX.XXX.XXX.XXX: icmp_seq=1 ttl=64 time=1.786 ms

64 bytes from XXX.XXX.XXX.XXX: icmp_seq=2 ttl=64 time=1.739 ms

--- XXX.XXX.XXX.XXX ping statistics ---

3 packets transmitted, 3 packets received, 0% packet loss

If packet loss is 100%, communication is not taking place. Otherwise, computer is communicating with target device.

Checking Network Setting Information

A

To check the printer's network settings information, print out the network settings information or use the operation panel to display it.

- Display on the touch screen.

- [LAN settings](#)

- Print the network settings.

- [Printing Network Settings](#)



Restoring to Factory Defaults



»» Important

- For Windows:

Initialization erases all network settings on the printer, making printing or scanning operation from a computer over a network impossible. To use the printer over a network again after restoring it to the factory defaults, use the Setup CD-ROM or follow the instructions on the Canon website to redo setup.

- For Mac OS:

Initialization erases all network settings on the printer, making printing or scanning operation from a computer over a network impossible. To use the printer over a network again after restoring it to the factory defaults, follow the instructions on the Canon website to redo setup.

Initialize the network setting using the printer's operation panel.

■ [Reset setting](#)

Printing Problems

- **Printing Does Not Start**
- **No Ink Comes Out**
- **Print Results Are Unsatisfactory**
- **Paper Does Not Feed Properly/"No Paper" Error**



Printing Does Not Start



Check1 Make sure printer is securely plugged in and press **ON** button to turn it on.

The **POWER** lamp flashes while the printer is initializing. Wait until the **POWER** lamp stops flashing and remains lit.

▶▶▶ Note

- If you are printing large data such as photos or other graphics, printing may take longer to start. The **POWER** lamp flashes while the computer is processing data and sending it to the printer. Wait until printing starts.

Check2 Make sure printer is properly connected to computer.

If you are using a USB cable, make sure it is securely connected to both the printer and the computer. When the USB cable is securely plugged in, check the following:

- If you are using a relay device such as a USB hub, disconnect it, connect the printer directly to the computer, and retry the printing. If printing starts normally, there is a problem with the relay device. Contact the vendor of the relay device.
- There could also be a problem with the USB cable. Replace the USB cable and retry the printing.

If you use the printer over a LAN, make sure the printer is correctly set up for network use.

▶▶▶ Note

- For Windows: If you can use IJ Network Device Setup Utility, check the network connection status.

Check3 Make sure paper settings match information set for rear tray or cassette.

If the paper settings do not match the information set for the rear tray or the cassette, an error message appears on the touch screen. Follow the instructions on the touch screen to solve the problem.

▶▶▶ Note

- You can select whether the message which prevents misprinting is displayed.
 - To change the message view setting when printing or copying using the printer's operation panel:
 - [Device user settings](#)
 - To change the message view setting when printing using the printer driver:
 - [Changing the Printer Operation Mode](#) (Windows)
 - [Changing the Printer Operation Mode](#) (Mac OS)

Check4 If printing from a computer, delete unnecessary print jobs.

- For Windows:

■ Deleting the Undesired Print Job

- For Mac OS:

■ Deleting the Undesired Print Job

Check5 Is your printer's printer driver is selected when printing?

The printer will not print properly if you are using a printer driver for a different printer.

- For Windows:

Make sure "Canon XXX series" (where "XXX" is your printer's name) is selected in the Print dialog box.

▶▶▶ Note

- To make the printer the one selected by default, select **Set as Default Printer**.

- For Mac OS:

Make sure your printer's name is selected in **Printer** in the Print dialog.

▶▶▶ Note

- To make the printer the one selected by default, select the printer for **Default printer**.

Check6 Is print data extremely large? (Windows)

Click **Print Options** on **Page Setup** sheet of the printer driver. Then set **Prevention of Print Data Loss** to **On** in the dialog that appears.

* This may reduce print quality.

Check7 If printing from your computer, restart computer.



No Ink Comes Out



Check1 Has ink run out?

Open the scanning unit / cover and check the ink lamp.

■ [Checking the Ink Status with the Ink Lamps](#)

Check2 Is orange tape or protective film still on ink tank?

Make sure all the protective film is peeled off to expose the Y-shaped air hole, as shown below (A).

If the orange tape remains on the ink tank (B), peel it off.

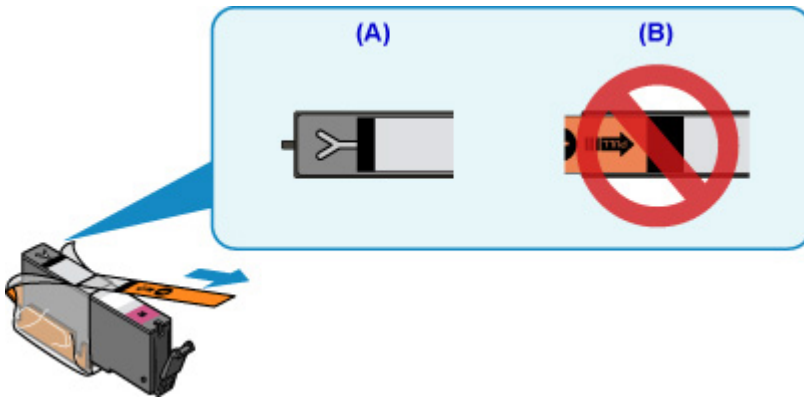

Check3 Are the print head nozzles clogged?

Print the nozzle check pattern to determine whether the ink ejects properly from the print head nozzles.

For details on printing the nozzle check pattern, print head cleaning, and print head deep cleaning, see [If Printing Is Faint or Uneven](#).

- If nozzle check pattern is not printed correctly:
 - Check if the ink tank for the problem color is empty.
 - If the ink tank is not empty, perform print head cleaning and try printing the nozzle check pattern again.
- If problem is not resolved after performing print head cleaning twice:
 - Perform print head deep cleaning.
 - If the problem is not resolved after performing print head deep cleaning, turn off the printer and perform print head deep cleaning again 24 hours later.
- If problem is not resolved after performing print head deep cleaning twice:
 - If print head deep cleaning does not resolve the problem, the print head may be damaged. Contact your nearest Canon service center to request a repair.



Paper Does Not Feed Properly/"No Paper" Error



Check1 Make sure paper is loaded.

■ [Loading Paper](#)

Check2 When loading paper, consider the following.

- When loading two or more sheets of paper, align the edges of the sheets before loading the paper.
- When loading two or more sheets of paper, make sure the paper stack does not exceed the paper load limit.

However, paper may not feed correctly at the maximum capacity, depending on the type of paper or environmental conditions (very high or low temperature and humidity). In such cases, reduce the amount of paper you load at a time to less than half of the paper load limit.

- Always load the paper in portrait orientation, regardless of the printing orientation.
- When you load the paper on the rear tray, place the print side facing UP and align the right and left paper guides with the paper stack.

■ [Loading Paper](#)

- In the cassette, be sure to load only plain paper.
- When you load the paper on the cassette, place the print side facing DOWN and align the right/left/front paper guides with the paper stack.

■ [Loading Paper](#)

Check3 Is paper too thick or curled?

■ [Unsupported Media Types](#)

Check4 When loading postcards or envelopes, consider the following:

- If a postcard is curled, it may not feed properly even though the paper stack does not exceed the paper load limit.

Load Japanese postcards with their postcode column downward on the rear tray.

- When printing on envelopes, see [Loading Paper](#), and prepare the envelopes before printing.

Once you have prepared the envelopes, load them in portrait orientation. If the envelopes are placed in landscape orientation, they will not feed properly.

Check5 Make sure media type and paper size settings match with loaded paper.

Check6 Make sure that there are not any foreign objects in the rear tray.



If the paper tears in the rear tray, see [List of Support Code for Error \(Paper Jams\)](#) to remove it.

If there are any foreign objects in the rear tray, be sure to turn off the printer, unplug it from the power supply, then remove the foreign object.

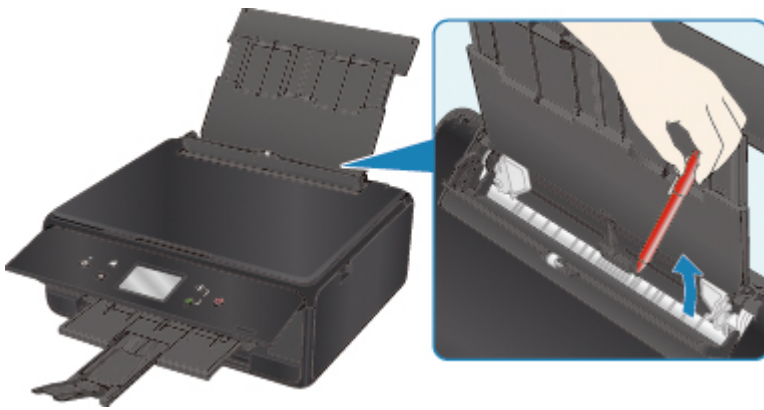

▶▶▶ Note

- If the feed slot cover is opened, close it slowly.

Check7 Clean paper feed roller.

■ [Cleaning Paper Feed Rollers](#)

▶▶▶ Note

- Cleaning the paper feed roller abrades it, so do this only when necessary.

Check8 If two or more sheets of paper feed from cassette at once, clean inside of cassette.

■ [Cleaning Cassette Pads](#)

Check9 Are transport unit cover and rear cover attached properly?

See [Rear View](#) for the positions of the transport unit cover and the rear cover.

If the measures above do not solve the problem, contact your nearest Canon service center to request a repair.



Print Results Are Unsatisfactory

If the print results are unsatisfactory due to white streaks, misaligned lines, or uneven colors, check the paper and print quality settings first.



Check1 Do page size and media type settings match size and type of loaded paper?

If these settings do not match, it is not possible to obtain the proper result.

If you are printing a photograph or an illustration, an incorrect paper type setting may reduce the quality of the printout color.

Also, if you print with an incorrect paper type setting, the printed surface may be scratched.

In borderless printing, uneven coloring may occur depending on the combination of the paper type setting and the loaded paper.

The method for checking the paper and print quality settings differs depending on what you are using your printer for.

Copying	Check the settings using the operation panel. ■ Setting Items for Copying
Copying a photo	Check the settings using the operation panel. ■ Copying Photos
Printing from a PictBridge (Wireless LAN) compliant device	Check the settings on your PictBridge (Wireless LAN) compliant device. ■ PictBridge (Wireless LAN) Print Settings Check the settings using the operation panel. ■ PictBridge print settings
Printing from your computer	Check the settings using the printer driver. • For Windows: ■ Printing with Easy Setup • For Mac OS: ■ Printing with Easy Setup

Check2 Make sure appropriate print quality is selected (see table above).

Select a print quality suited to the paper and to what you are printing. If you notice blurs or uneven colors, increase the print quality setting and retry the printing.

▶▶▶ Note

- When printing from a PictBridge (Wireless LAN) compliant device, set the print quality setting using the operation panel.

This setting cannot be made on the PictBridge (Wireless LAN) compliant device.

Check3 If problem is not resolved, check other causes.

See also the sections below:

- [Paper Is Blank/Printing Is Blurry/Colors Are Wrong/White Streaks Appear](#)
- [Lines Are Misaligned](#)
- [Paper Is Smudged / Printed Surface Is Scratched](#)
- [Vertical Line Next to Image](#)
- Cannot Complete Printing
- Part of Page Is Not Printed (Windows)
- Lines Incomplete or Missing (Windows)
- Images Incomplete or Missing (Windows)
- Ink Blots / Paper Curl
- Back of Paper Is Smudged
- Uneven or Streaked Colors



Paper Is Blank/Printing Is Blurry/Colors Are Wrong/White Streaks Appear



Printing Is Blurry

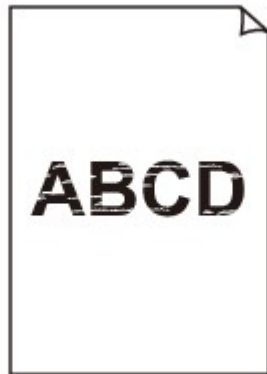

Colors Are Wrong



White Streaks Appear



A

Check1 Check paper and print quality settings.

■ [Print Results Are Unsatisfactory](#)

Check2 Check status of ink tanks. Replace ink tank if ink has run out.

■ [Replacing Ink Tanks](#)

Check3 Is orange tape or protective film still on ink tank?

Make sure all the protective film is peeled off to expose the Y-shaped air hole, as shown below (A).

If the orange tape remains on the ink tank (B), peel it off.

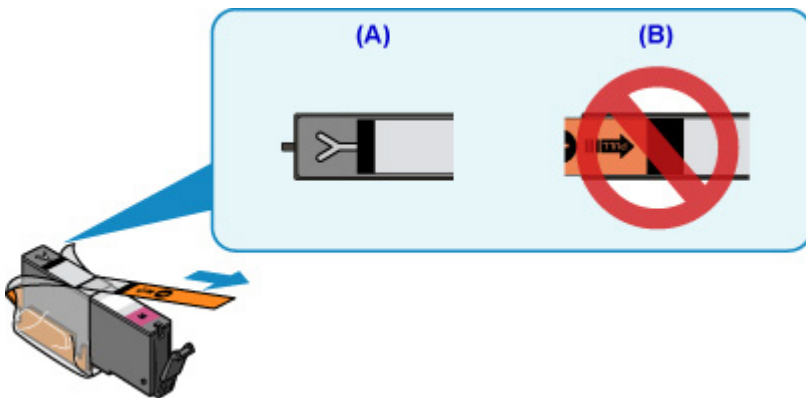

Check4 Are the print head nozzles clogged?

Print the nozzle check pattern to determine whether the ink ejects properly from the print head nozzles.

For details on printing the nozzle check pattern, print head cleaning, and print head deep cleaning, see [If Printing Is Faint or Uneven](#).

- If nozzle check pattern is not printed correctly:
 - Check if the ink tank for the problem color is empty.
 - If the ink tank is not empty, perform print head cleaning and try printing the nozzle check pattern again.
- If problem is not resolved after performing print head cleaning twice:

Perform print head deep cleaning.

If the problem is not resolved after performing print head deep cleaning, turn off the printer and perform print head deep cleaning again 24 hours later.

- If problem is not resolved after performing print head deep cleaning twice:

If print head deep cleaning does not resolve the problem, the print head may be damaged. Contact your nearest Canon service center to request a repair.

Check5 When using paper with one printable surface, check the correct printable side of the paper.

Printing on the wrong side of such paper may cause unclear prints or prints with reduced quality.

When you load paper on the rear tray, load paper with the printable side facing up. When you load paper in the cassette, load paper with the printable side facing down.

Refer to the instruction manual supplied with the paper for detailed information on the printable side.

- **When copying, see also the sections below:**

Check6 Is platen glass dirty?

Clean the platen glass.

- [Cleaning the Platen Glass and Document Cover](#)

Check7 Make sure original is properly loaded on platen glass.

- [Loading Originals](#)

Check8 Is original loaded with side to be copied facing down on platen glass?

Check9 Did you copy a printout done by this printer?

If you use a printout done by this printer as the original, print quality may be reduced depending on the condition of the original.

Print from the printer directly, or reprint from the computer if you can reprint from it.



Lines Are Misaligned



Check1 Check paper and print quality settings.

■ [Print Results Are Unsatisfactory](#)

Check2 Perform print head alignment.

If printed lines are misaligned or print results are otherwise unsatisfactory, adjust the print head position.

■ [Aligning the Print Head](#)

▶▶▶ Note

- If the problem is not resolved after performing the print head alignment, perform print head alignment manually from your computer.
 - For Windows:
 - [Aligning the Print Head Position](#)
 - For Mac OS:
 - [Aligning the Print Head Position](#)

Check3 Increase print quality and try printing again.

Increasing the print quality using the operation panel or the printer driver may improve the print result.



Paper Is Smudged / Printed Surface Is Scratched

Paper Is Smudged

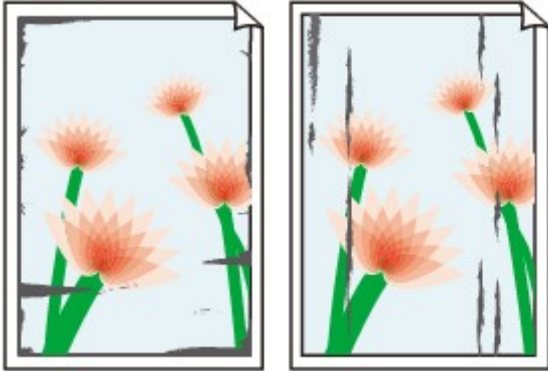

Smudged Edges

Smudged Surface



Printed Surface Is Scratched



Check1 Check paper and print quality settings.

 [Print Results Are Unsatisfactory](#)

Check2 Check paper type.

Make sure you are using the right paper for what you are printing.

 [Supported Media Types](#)

Check3 Correct curl before loading paper.

When using Photo Paper Plus Semi-gloss, even if the sheet is curled, load one sheet at a time as it is. Rolling this paper in the opposite direction to flatten it may crack the paper surface and reduce the print quality.

We recommend putting unused paper back into the package and storing it flat.

- Plain Paper

Turn the paper over and reload it to print on the other side.

- Other Paper

If the paper corners curl more than 0.1 inch / 3 mm (A) in height, the paper may smudge or may not feed properly. Follow the instructions below to correct the paper curl.



1. Roll up paper in opposite direction to paper curl as shown below.



2. Check that paper is now flat.

We recommend printing curl-corrected paper one sheet at a time.

►►► Note

- Depending on paper type, the paper may smudge or may not feed properly even if it is not curled inward. Follow the instructions below to curl the paper outward up to 0.1 inch / 3 mm (B) in height before printing. This may improve the print result.

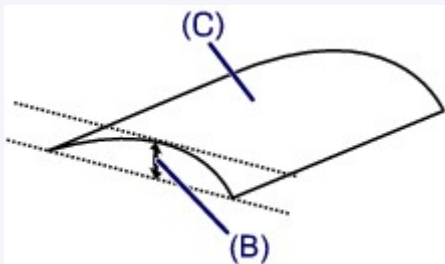

(C) Print side

We recommend feeding paper that has been curled outward one sheet at a time.

Check4 Set printer to prevent paper abrasion.

Adjusting the setting to prevent paper abrasion will widen the clearance between the print head and the paper. If you notice abrasion even with the media type set correctly to match the paper, set the printer to prevent paper abrasion using the operation panel or the computer.

This may reduce the print speed.

* Once you have finished printing, undo this setting. Otherwise, it will apply to subsequent print jobs.

- From operation panel



Press the **HOME** button, select **(Setup)** icon, **Settings**, **Device settings**, and **Print settings**, and then set **Prevent paper abrasion** to **ON**.

■ [Changing Settings from Operation Panel](#)

- From computer

- For Windows:

Open the printer driver setup window, select **Custom Settings** in **Maintenance** sheet, select **Prevent paper abrasion** check box, and then click **OK**.

To open the printer driver setup window, see [How to Open the Printer Driver Setup Window](#).

- For Mac OS:

In the Canon IJ Printer Utility2, select **Custom Settings** in the pop-up menu, select **Prevent paper abrasion** check box, and then click **Apply**.

To open the Canon IJ Printer Utility2, see [Opening the Canon IJ Printer Utility2](#).

Check5 If intensity is set high, reduce intensity setting and try printing again.

If you are printing with a high intensity setting on plain paper, the paper may absorb too much ink and become wavy, causing paper abrasion.

- Printing from your computer

Check the intensity setting in the printer driver.

- For Windows:

■ [Adjusting Intensity](#)

- For Mac OS:

■ [Adjusting Intensity](#)

- Copying

■ [Setting Items for Copying](#)

Check6 Do not print outside recommended printing area.

If you print outside the recommended printing area of your paper, ink may stain the lower edge of the paper.

Resize the document using application software.

■ [Print Area](#)

Check7 Is platen glass dirty?

Clean the platen glass.

■ [Cleaning the Platen Glass and Document Cover](#)

Check8 Is paper feed roller dirty?

Clean the paper feed roller.

■ [Cleaning Paper Feed Rollers](#)

▶▶▶ Note

- Cleaning the paper feed roller abrades it, so do this only when necessary.

Check9 Is inside of printer dirty?

During duplex printing, ink may stain the inside of the printer, smudging the printout.

Perform the bottom plate cleaning to clean the inside of the printer.

■ [Cleaning Inside the Printer \(Bottom Plate Cleaning\)](#)

▶▶▶ Note

- To prevent staining inside the printer, be sure to set the correct paper size.

Check10 Set longer ink drying time.

This allows the printed surface to dry, preventing smudges and scratches.

- For Windows:
 1. Make sure printer is turned on.
 2. Open printer driver setup window.
 - [How to Open the Printer Driver Setup Window](#)
 3. Click **Maintenance** tab and **Custom Settings**.
 4. Drag **Ink Drying Wait Time** slide bar to set wait time and click **OK**.
 5. Check message and click **OK**.
- For Mac OS:
 1. Make sure printer is turned on.
 2. Open Canon IJ Printer Utility2.
 - Opening the Canon IJ Printer Utility2
 3. Select **Custom Settings** in pop-up menu.
 4. Drag **Ink Drying Wait Time**: slide bar to set wait time and click **Apply**.
 5. Check message and click **OK**.



Vertical Line Next to Image



Check Is loaded paper size correct?

If the loaded paper is larger than the size you specified, a vertical line may appear in the margin.

Set the paper size to match the loaded paper.

Print Results Are Unsatisfactory

▶▶ Note

- The direction of the vertical line pattern may vary depending on the image data or the print setting.
- This printer performs automatic cleaning when necessary to keep printouts clean. A small amount of ink is ejected for cleaning.

Although the ink is normally ejected onto the ink absorber at the outer edge of the paper, it may get onto the paper if the loaded paper is larger than the set size.

Scanning Problems (Windows)

- ▶ **Scanning Problems**
- ▶ **IJ Scan Utility Error Messages**
- ▶ **ScanGear (Scanner Driver) Error Messages**

Scanning Problems

- ▶ **Scanner Does Not Work**
- ▶ **ScanGear (Scanner Driver) Does Not Start**



Scanner Does Not Work



Check 1 Make sure that your scanner or printer is turned on.

Check 2 Connect the USB cable to a different USB port on the computer.

Check 3 If the USB cable is connected to a USB hub, remove it from the USB hub and connect it to a USB port on the computer.

Check 4 With network connection, check the connection status and reconnect as needed.

Check 5 Restart the computer.



ScanGear (Scanner Driver) Does Not Start



Check 1 Make sure MP Drivers is installed.

If not installed, install MP Drivers from the Setup CD-ROM or our website.

Check 2 Select your scanner or printer on the application's menu.

▶▶ Important

- If your scanner or printer name is displayed multiple times, select the one that does not include WIA.

▶▶ Note

- The operation may differ depending on the application.
- Use the WIA driver when scanning from a WIA-compliant application.
 - Scanning with WIA Driver

Check 3 Make sure that the application supports TWAIN.

You cannot start ScanGear (scanner driver) from applications not supporting TWAIN.

Check 4 Scan and save images with IJ Scan Utility and open the files in your application.

Mechanical Problems

- ▶ **Power Does Not Come On**
- ▶ **Power Shuts Off By Itself**
- ▶ **USB Connection Problems**
- ▶ **Cannot Communicate with Printer via USB**
- ▶ **Touch Screen Shows Wrong Language**



Power Does Not Come On



Check1 Press **ON** button.

Check2 Make sure power plug is securely connected to printer, and then turn it back on.

Check3 Unplug printer, leave it for at least 2 minutes, and then plug it back in and turn it on again.

If this does not solve the problem, contact your nearest Canon service center to request a repair.



Power Shuts Off By Itself



Check If printer is set to turn off automatically after a certain time, disable this setting.

If you have set the printer to turn off automatically after a specified time, the power will shut off by itself once that time has elapsed.

- If you are using a Windows and if you do not want the printer to turn off automatically:
Open the printer driver setup window and in **Auto Power** in **Maintenance** sheet, select **Disable** for **Auto Power Off**.
- If you are using a Mac OS and if you do not want the printer to turn off automatically:
Open Canon IJ Printer Utility2, select **Power Settings** in the pop-up menu, and then select **Disable** for **Auto Power Off** on **Auto Power**.

▶▶▶ Note

- You can also enable the printer to turn on/off automatically from the operation panel.
 - [ECO settings](#)
- If you are using a Windows, you can also enable the printer to turn on/off automatically from ScanGear (scanner driver).
 - [Scanner Tab](#)

USB Connection Problems

Q Printing or Scanning Is Slow/Hi-Speed USB Connection Does Not Work/"This device can perform faster" Message Appears (Windows)

A

If your system environment does not support Hi-Speed USB, the printer operates at the slower speed of USB 1.1. In this case, the printer works properly but printing or scanning speed may slow down due to the communication speed.

Check Check following to make sure your system environment supports Hi-Speed USB connection.

- Does the USB port on your computer support Hi-Speed USB connection?
- Does the USB cable or the USB hub support Hi-Speed USB connection?

Be sure to use a certified Hi-Speed USB cable. We recommend that the USB cable be no longer than 10 feet / 3 meters or so.

- Does the operating system of your computer support Hi-Speed USB connection?

Install the latest update for your computer.

- Is the Hi-Speed USB driver working properly?

If necessary, obtain and install the latest version of the Hi-Speed USB driver for your computer.

»» Important

- For more information, contact the manufacturer of your computer, USB cable, or USB hub.



Cannot Communicate with Printer via USB



Check1 Make sure printer is turned on.

Check2 Connect USB cable properly.

As the illustration below, the USB port is at the back of the printer.

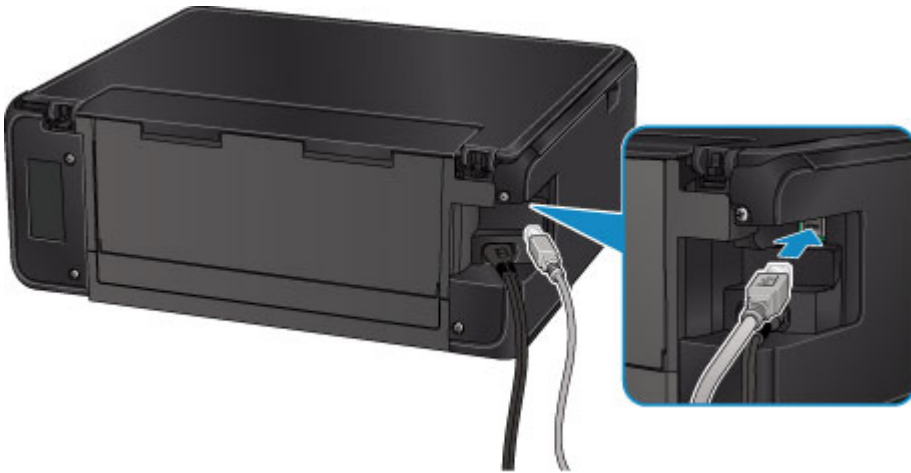

Check3 Make sure **Enable bidirectional support** is selected in **Ports** sheet of properties dialog box of printer driver. (Windows)

■ [How to Open the Printer Driver Setup Window](#)

Installation and Download Problems

- ▶ **Cannot Install MP Drivers**
- ▶ **Easy-WebPrint EX Does Not Start or Easy-WebPrint EX Menu Does Not Appear (Windows)**



Cannot Install MP Drivers



■ [For Windows:](#)

■ [For Mac OS:](#)

For Windows:

- **If installation does not start when you insert Setup CD-ROM:**

Follow the instructions below to start the installation.

1. Make the following settings.

- In Windows 10, click **Start** button > **File Explorer**, and then click **This PC** from list on left.
- In Windows 8.1 or Windows 8, select **Explorer** icon in **Taskbar** on **Desktop**, and then select **This PC (Computer for Windows 8)** from list on left.
- In Windows 7 or Windows Vista, click **Start**, and then click **Computer**.

2. Double-click the  CD-ROM icon in the window that appears.

If the contents of the CD-ROM appear, double-click **MSETUP4.EXE**.

If you cannot install the MP Drivers with the Setup CD-ROM, install them from the Canon website.

▶▶▶ Note

- If the CD-ROM icon does not appear, try the following:
 - Remove the CD-ROM from your computer and reinsert it.
 - Restart your computer.

If the icon still does not appear, try a different disc and see if it appears. If it does, there is a problem with the Setup CD-ROM. Contact your nearest Canon service center to request a repair.

- If you cannot get past the Printer Connection screen:

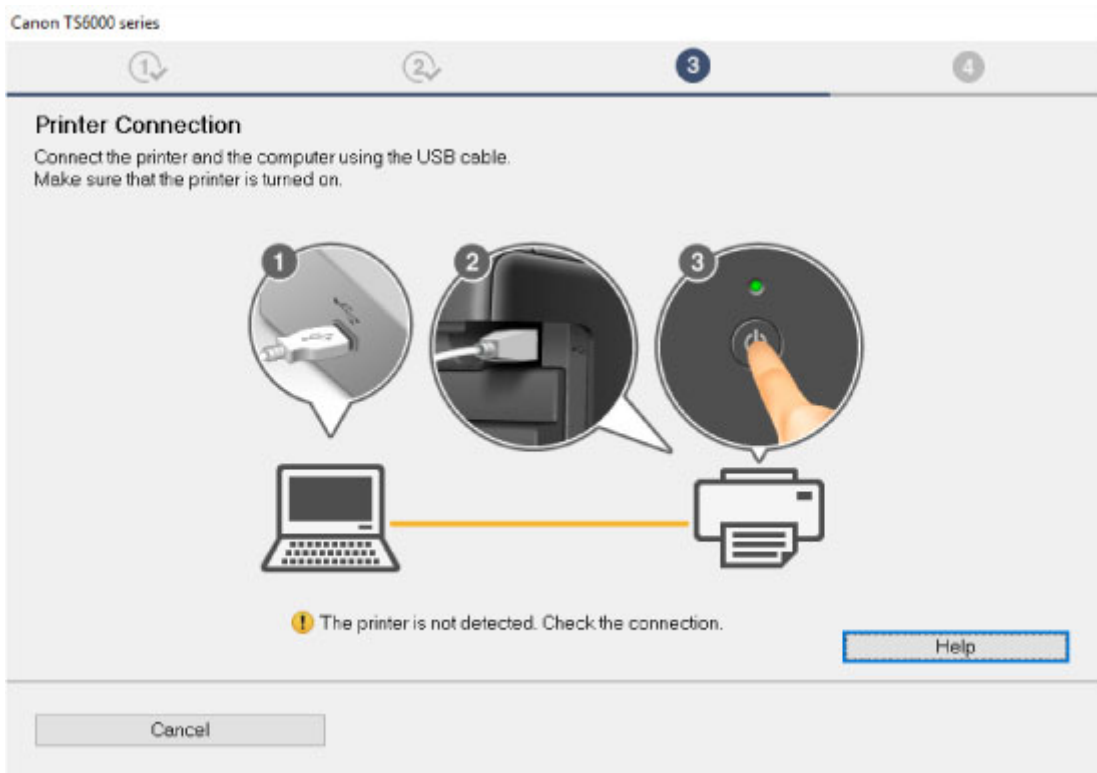

■ [Cannot Proceed beyond Printer Connection Screen/Connect Cable Screen](#)

- Other cases:

Reinstall the MP Drivers.

If the MP Drivers were not installed correctly, uninstall the MP Drivers, restart your computer, and then reinstall the MP Drivers.

■ Deleting the Unnecessary MP Drivers

Reinstall the MP Drivers with the Setup CD-ROM or install them from the Canon website.

▶▶▶ Note

- If the installer was stopped due to a Windows error, Windows operation may be unstable, and you may not be able to install the drivers. Restart your computer and then reinstall the drivers.

For Mac OS:

Download the driver from the support page of Canon website and reinstall it.



Updating MP Drivers in Network Environment (Windows)



Download the latest MP Drivers.

The latest MP Drivers for your model are available for download on the Canon website.

Uninstall the existing MP Drivers and follow the installation instructions to install the latest MP Drivers that you downloaded. In the connection method selection screen, select **Use the printer with wireless LAN connection**. The printer is detected automatically in the network.

Make sure the printer was found, and install the MP Drivers following the on-screen instructions.

Note

- The network settings on the printer are not affected, so the printer can be used on the network without redoing settings.

Errors and Messages

- ▶ **An Error Occurs**
- ▶ **Message Appears**

An Error Occurs

If an error occurs in printing, for example if the paper runs out or jams, a troubleshooting message appears automatically. Take the appropriate action described in the message.

When an error occurs, a message is displayed on the computer screen or the touch screen. Depending on the error, a Support Code (error number) is displayed on the computer screen or the touch screen.

When a Support Code and a message are displayed on the computer screen:

- For Windows:

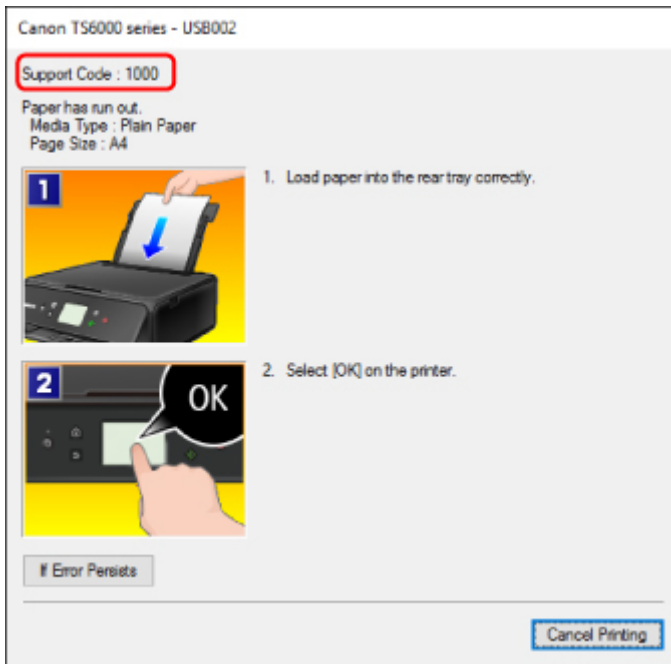

- For Mac OS:

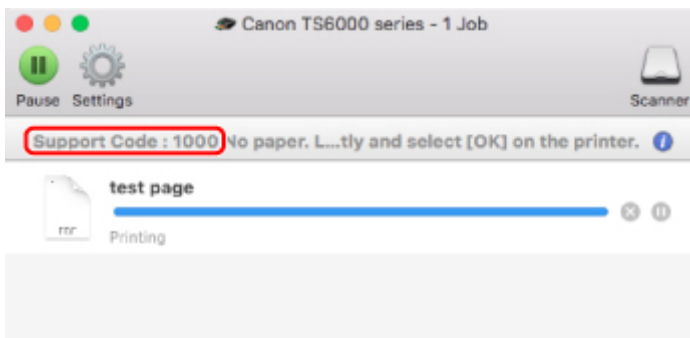

* The screen differs depending on the OS you are using.

When a Support Code and a message are displayed on the touch screen:

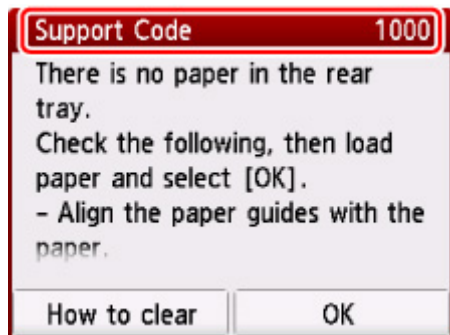

For details on how to resolve errors, see [List of Support Code for Error](#).

▶▶▶ Note

- For details on how to resolve errors without Support Codes, see [Message Appears](#).

Message Appears

This section describes some of the errors and messages that may appear.

►► Note

- A support code (error number) is displayed on the computer or on the touch screen for some errors. For details on errors that have support code, see [List of Support Code for Error](#).

If a message appears on the touch screen, see below.

■ [Message Appears on Touch Screen](#)

If a message appears on the computer, see below.

- [Error Regarding Automatic Duplex Printing Is Displayed](#)
- [Error Regarding Power Cord Being Unplugged Is Displayed \(Windows\)](#)
- [Writing Error/Output Error/Communication Error \(Windows\)](#)
- [Other Error Messages \(Windows\)](#)
- [Inkjet Printer/Scanner/Fax Extended Survey Program Screen Is Displayed \(Windows\)](#)
- [Inkjet Printer/Scanner/Fax Extended Survey Program Icon Appears \(Mac OS\)](#)

Message Appears on Touch Screen

Check the message and take an appropriate action.

- **Power was not turned off correctly the last time. Press the  button when turning power off.**

The printer may have been unplugged while the power was still on.

Tap **OK** on the touch screen.

►► Note

- See [Unplugging the Printer](#) to unplug the printer correctly.

- **Cannot connect to the server. Please wait a while and try again.**

The printer cannot connect to the server due to a communication error.

Tap **OK** on the touch screen and try again after a while.

Error Regarding Automatic Duplex Printing Is Displayed

Check See Automatic Duplex Printing Problems and take the appropriate action.

Error Regarding Power Cord Being Unplugged Is Displayed (Windows)

The printer may have been unplugged while it was on.

Check the error message that appears on the computer and click **OK**.

The printer starts printing.

See [Unplugging the Printer](#) for unplugging the power cord.

Writing Error/Output Error/Communication Error (Windows)

Check1 If **POWER** lamp is off, make sure printer is plugged in and turn it on.

The **POWER** lamp flashes while the printer is initializing. Wait until the **POWER** lamp stops flashing and remains lit.

Check2 Make sure printer is properly connected to computer.

If you are using a USB cable, make sure it is securely connected to both the printer and the computer. When the USB cable is securely plugged in, check the following:

- If you are using a relay device such as a USB hub, disconnect it, connect the printer directly to the computer, and retry the printing. If printing starts normally, there is a problem with the relay device. Contact the vendor of the relay device.
- There could also be a problem with the USB cable. Replace the USB cable and retry the printing.

If you use the printer over a LAN, make sure the printer is connected to the network with a LAN cable or is correctly set up for network use.

Check3 Make sure MP Drivers are installed correctly.

Uninstall the MP Drivers following the procedure described in [Deleting the Unnecessary MP Drivers](#) and reinstall them from the Setup CD-ROM or the Canon website.

Check4 When printer is connected to your computer with a USB cable, check device status from your computer.

Follow the procedure below to check the device status.

1. Open the Device Manager on your computer as shown below.

If the **User Account Control** screen appears, follow the on-screen instructions.

- In Windows 10, right-click **Start** button and select **Device Manager**.
- In Windows 8.1 or Windows 8, select **Control Panel** from **Settings** charm on **Desktop > Hardware and Sound > Device Manager**.

- In Windows 7 or Windows Vista, click **Control Panel, Hardware and Sound, and Device Manager.**
2. Double-click **Universal Serial Bus controllers** and **USB Printing Support.**

If the **USB Printing Support Properties** screen does not appear, make sure the printer is correctly connected to the computer.

 **Check2** [Make sure printer is properly connected to computer.](#)

3. Click **General** tab and check for a device problem.

If a device error is shown, see Windows Help to resolve it.

Other Error Messages (Windows)

 **Check** If an error message appears outside printer status monitor, check the following:

- **"Could not spool successfully due to insufficient disk space"**
Delete any unnecessary files to increase the amount of free space on the disk.
- **"Could not spool successfully due to insufficient memory"**
Close other applications to increase the available memory.
If you still cannot print, restart your computer and retry the printing.
- **"Printer driver could not be found"**
Uninstall the MP Drivers following the procedure described in *Deleting the Unnecessary MP Drivers* and reinstall them from the Setup CD-ROM or the Canon website.
- **"Could not print Application name - File name"**
Try printing again once the current job is complete.

Inkjet Printer/Scanner/Fax Extended Survey Program Screen Is Displayed (Windows)

If the Inkjet Printer/Scanner/Fax Extended Survey Program is installed, a screen appears asking for permission to send the printer and application usage information every month for about ten years.

Read the information on the screen and follow the instructions below.

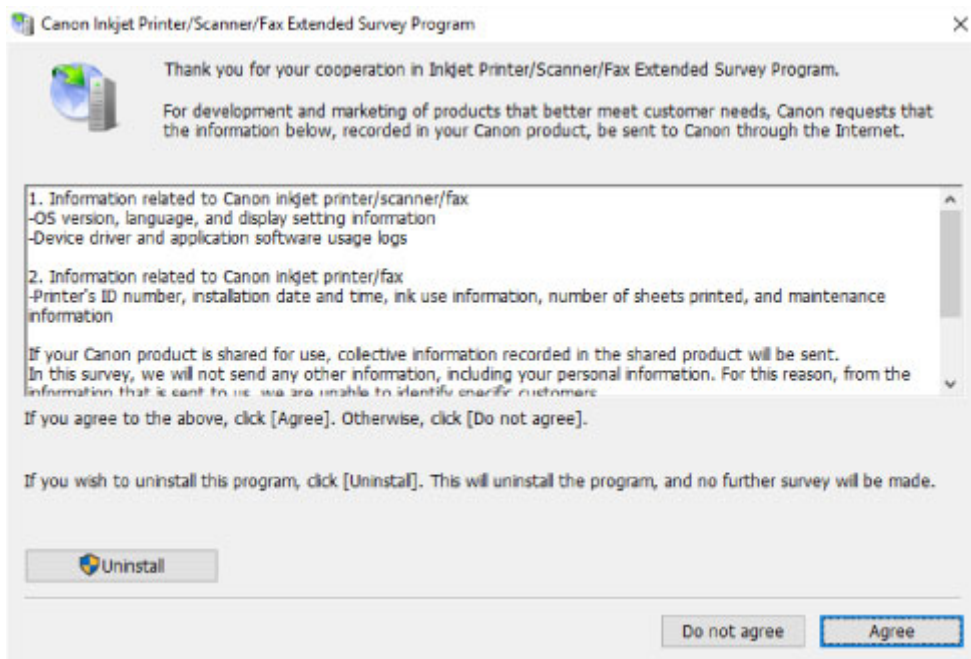

- **If you agree to participate in survey program:**

Click **Agree** and follow the on-screen instructions. The printer usage information is sent via the Internet. Once you have completed the procedure, the information is subsequently sent automatically and the confirmation screen does not reappear.

►►► **Note**

- When the information is being sent, a warning such as an Internet security message may appear. Make sure the program name is "IJPLMUI.exe" and allow it.
- If you clear **Send automatically from the next time** check box, the information will not be sent automatically from next time and a confirmation screen will appear at the time of the next survey. To send the information automatically, see [Changing confirmation screen setting:](#).

- **If you do not agree to participate in survey program:**

Click **Do not agree**. The confirmation screen closes and the survey is skipped. The confirmation screen will reappear one month later.

- **To uninstall Inkjet Printer/Scanner/Fax Extended Survey Program:**

To uninstall the Inkjet Printer/Scanner/Fax Extended Survey Program, click **Uninstall** and follow the on-screen instructions.

- **Changing confirmation screen setting:**

1. Make the following settings.
 - In Windows 10, right-click **Start** button and select **Programs and Features**.
 - In Windows 8.1 or Windows 8, select **Control Panel** from **Settings** charm on **Desktop** > **Programs** > **Programs and Features**.
 - In Windows 7, or Windows Vista, select **Start** menu > **Control Panel** > **Programs** > **Programs and Features**.

»» Note

- A confirmation/warning dialog box may appear when installing, uninstalling or starting up software.

This dialog box appears when administrative rights are required to perform a task.

If you are logged in on an account with administrator privileges, follow the on-screen instructions.

2. Select **Canon Inkjet Printer/Scanner/Fax Extended Survey Program**.
3. Select **Change**.

If you select **Yes** after you have followed the on-screen instructions, the confirmation screen will appear at the time of the next survey.

If you select **No**, the information will be sent automatically.

»» Note

- If you select **Uninstall**, the Inkjet Printer/Scanner/Fax Extended Survey Program is uninstalled. Follow the on-screen instructions.

Inkjet Printer/Scanner/Fax Extended Survey Program Icon Appears (Mac OS)

A

If the Inkjet Printer/Scanner/Fax Extended Survey Program is installed, the printer and application software usage information is sent every month for about ten years. The **Inkjet Printer/Scanner/Fax Extended Survey Program** icon appears in the Dock when it is time to send the printer usage information.

Click the icon, read the information that appears, and then follow the instructions below.

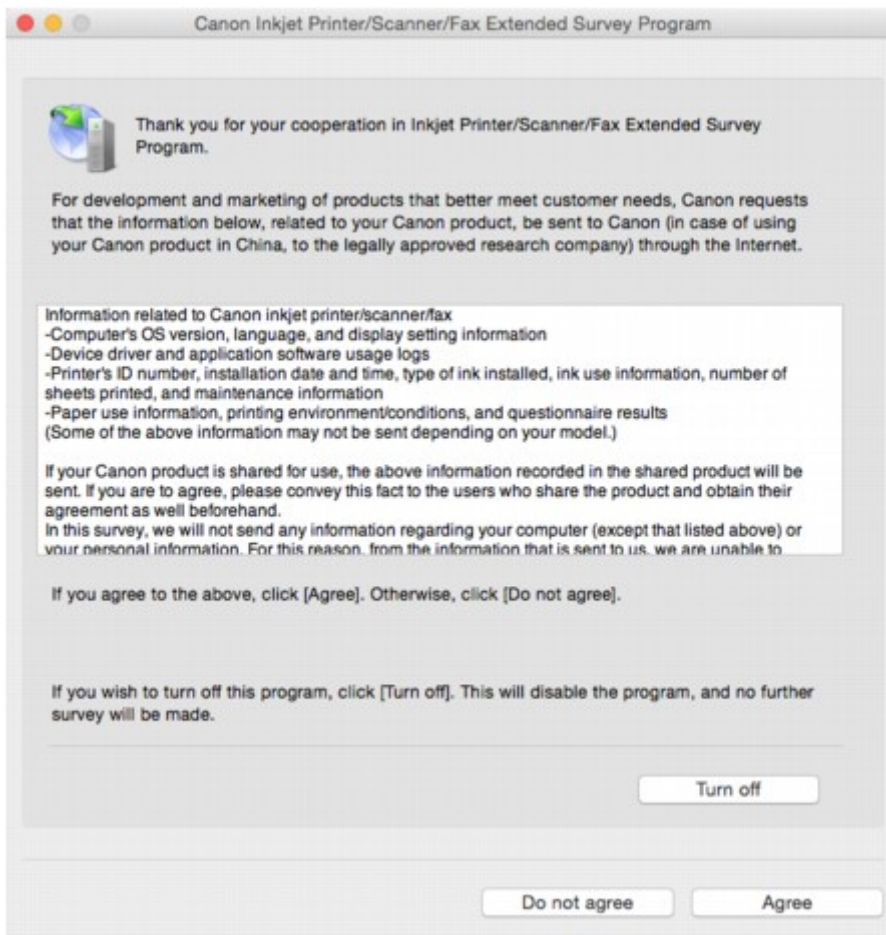

- **If you agree to participate in survey program:**

Click **Agree** and follow the on-screen instructions. The printer usage information is sent via the Internet. Once you have completed the procedure, the information is subsequently sent automatically and the confirmation screen does not reappear.

▶▶▶ **Note**

- If you clear **Send automatically from the next time** check box, the information will not be sent automatically the next time and the **Inkjet Printer/Scanner/Fax Extended Survey Program** icon will appear in the dock at the time of the next survey.

- **If you do not agree to participate in survey program:**

Click **Do not agree**. The confirmation screen closes and the survey is skipped. The confirmation screen will reappear one month later.

- **To stop sending information:**

Click **Turn off**. This stops the Inkjet Printer/Scanner/Fax Extended Survey Program, and information is not sent. To resume the survey, see [Changing setting](#).

- **To uninstall Inkjet Printer/Scanner/Fax Extended Survey Program:**

1. Stop Inkjet Printer/Scanner/Fax Extended Survey Program.

■ [Changing setting](#):

2. Select **Applications** from **Go** menu of Finder, double-click **Canon Utilities** folder and **Inkjet Extended Survey Program** folder.
3. Move **Canon Inkjet Printer/Scanner/Fax Extended Survey Program.app** file to **Trash**.
4. Restart computer.
Empty **Trash** and restart your computer.

- **Changing setting:**

To display the confirmation screen every time the printer usage information is sent or to resume surveying, follow the procedure below.

1. Select **Applications** from **Go** menu of Finder, double-click **Canon Utilities** folder and **Inkjet Extended Survey Program** folder.
2. Double-click **Canon Inkjet Printer/Scanner/Fax Extended Survey Program** icon.

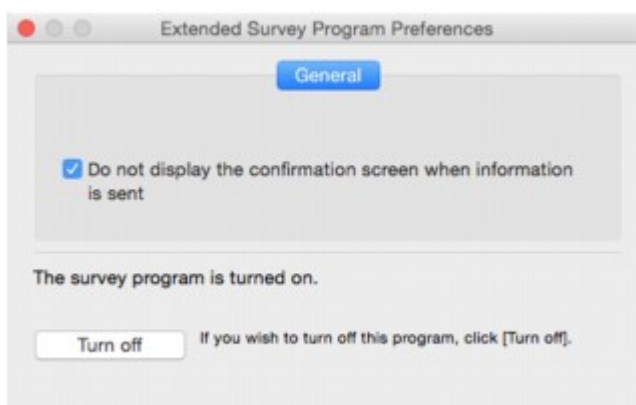

- **Do not display the confirmation screen when information is sent:**

If the check box is selected, the information will be sent automatically.

If the check box is not selected, **Inkjet Printer/Scanner/Fax Extended Survey Program** icon will appear in the Dock at the time of the next survey. Click the icon and follow the on-screen instructions.

- **Turn off/Turn on** button:

Click the **Turn off** button to stop the Inkjet Printer/Scanner/Fax Extended Survey Program.

Click the **Turn on** button to restart the Inkjet Printer/Scanner/Fax Extended Survey Program.

List of Support Code for Error

Support code appears on the touch screen and your computer screen when errors occur.

A "support code" is an error number, and appears along with an error message.

When an error occurs, check the support code displayed on the touch screen and computer screen and take the appropriate action in response.

Support Code Appears on Touch Screen and Computer Screen

- **1000 to 1ZZZ**

[1000](#) [1003](#) [1200](#) 1240 1270 [1300](#)

[1303](#) [1304](#) 1309 1310 [1313](#) [1401](#)

1403 1405 140B 1410 1411 1412

1413 1414 1551 1552 [1600](#) [1660](#)

1680 1681 1684 [1688](#) [1689](#) [1700](#)

1701 1730 1731 1750 1871 1874

[1890](#)

- **2000 to 2ZZZ**

[2110](#) 2113 2114 2120 2123 2700

[2900](#) [2901](#)

- **3000 to 3ZZZ**

3402 3403 3405 3407 3408 3410

3411 3412 3413 3438 3439 3440

3441 3442 3443 3444 3445 3446

3447

- **4000 to 4ZZZ**

4100 [4103](#) 4104

- **5000 to 5ZZZ**

[5011](#) [5012](#) 5050 [5100](#) [5200](#) 5400

5700 [5B00](#) 5B01 5C02

- **6000 to 6ZZZ**

[6000](#) 6001 6004 6500 6502 6800

6801 6900 6901 6902 6910 6911

6930 6931 6932 6933 6936 6937

6938 6940 6941 6942 6943 6944

6945 6946 6A80 6A81 6A82

- **A000 to ZZZZ**

B202 B203 B204 B205 [C000](#)

For paper jam support codes, see also [List of Support Code for Error \(Paper Jams\)](#).

List of Support Code for Error (Paper Jams)

If paper jams, remove it following the appropriate procedure as shown below.

- If you can see the jammed paper at the paper output slot or the rear tray:
 - If the paper fed from the rear tray is jammed:
 - [1300](#)
- If you cannot see the jammed paper at the paper output slot or the rear tray:
 - If the paper fed from the cassette is jammed:
 - [1303](#)
 - If the paper is jammed when performing automatic duplex printing:
 - [1304](#)
 - If the paper is jammed as the printer pulled in the printed paper:
 - [1313](#)
 - If the paper tears and you cannot remove it from the paper output slot or from the transport unit:
 - [Paper Is Jammed inside Printer](#)
- Cases other than above:
 - Other Cases

1300

Cause

Paper is jammed when feeding paper from rear tray.

What to Do

If the paper fed from the rear tray is jammed, remove the jammed paper from the paper output slot or from the rear tray following the instructions below.

1. Slowly pull out paper, either from paper output slot or from rear tray, whichever is easier.

Hold the paper with both hands, and pull it out slowly so as not to tear it.



▶▶ Note

- If you cannot pull out the paper, turn the printer back on without pulling forcibly. The paper may be ejected automatically.
- If paper becomes jammed during printing and you need to turn off the printer to remove it, press the **Stop** button to stop the printing before you turn off the printer.
- If the paper tears and you cannot remove the jammed paper from the paper output slot or the rear tray, remove the paper from inside the printer.

■ [Paper Is Jammed inside Printer](#)

- If you cannot pull the paper out from the paper output slot or from the rear tray, try to pull the paper out from the rear side of the printer.

■ [Removing Jammed Paper from Rear Side](#)

2. Reload paper and select **OK** on printer's touch screen.

The printer resumes printing. Reprint the page you were printing if it was not printed properly due to the paper jam.

If you turned off the printer in step 1, the print data that was sent to the printer is erased. Redo the printing.

»» Note

- When reloading the paper, make sure you are using suitable paper and loading it correctly.
- We recommend using paper sizes other than A5 to print documents with photos or graphics. A5 paper may curl and jam as it leaves the printer.

If the measures above do not solve the problem, contact your nearest Canon service center to request a repair.

1303

Cause

Paper is jammed when feeding paper from cassette.

What to Do

If the paper fed from the cassette is jammed, try to remove the paper from the following locations.

- Paper output slot
 - [1300](#)
- Inside of the printer
 - [Paper Is Jammed inside Printer](#)
- Feeder at the cassette

Pull out the cassette, and then remove the paper slowly with both hands.



If the measures above do not solve the problem, see [Removing Jammed Paper from Rear Side](#) to open the rear cover and to remove the paper.

Removing Jammed Paper from Rear Side

▶▶▶ Note

- If paper becomes jammed during printing and you need to turn off the printer to remove it, press the **Stop** button to stop the printing before you turn off the printer.

1. Rotate printer so that rear side of printer faces toward you.



2. Open rear tray cover and then pull up paper support.

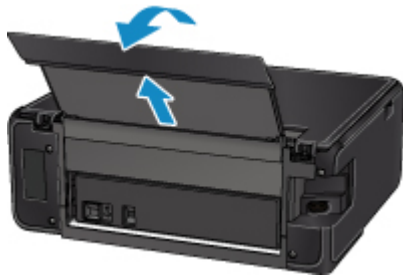

3. Detach rear cover.

Pull out the rear cover.

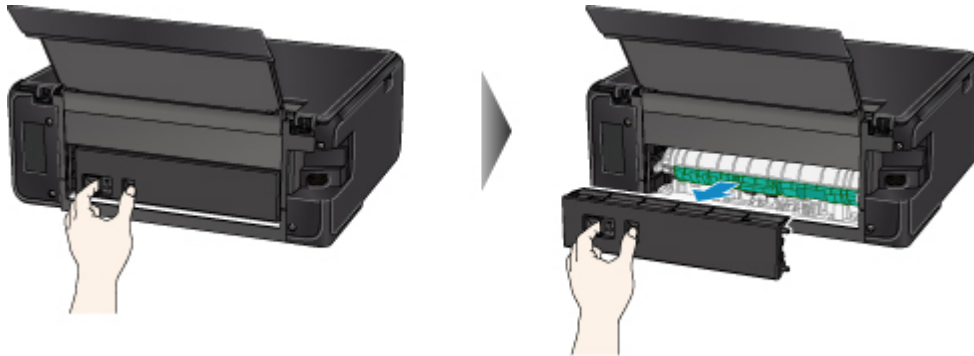

4. Slowly pull out paper.

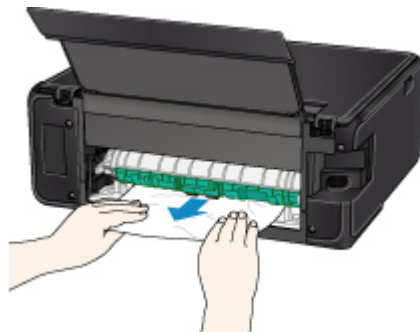

▶▶▶ **Note**

- Do not touch the inner parts of the printer.

If you were not able to remove the paper in this step, detach the transport unit cover and remove the paper by following these steps.

1. Detach transport unit cover.

Lift up the transport unit cover and pull out it.

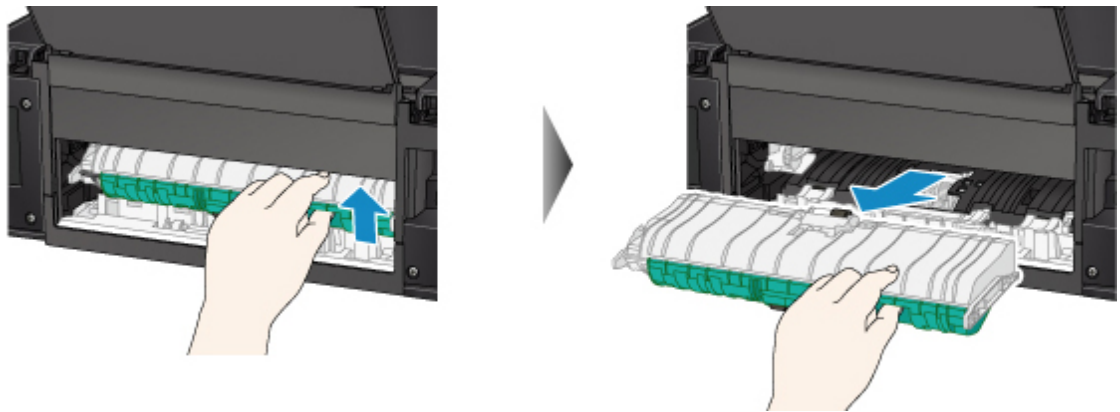

2. Slowly pull out paper.

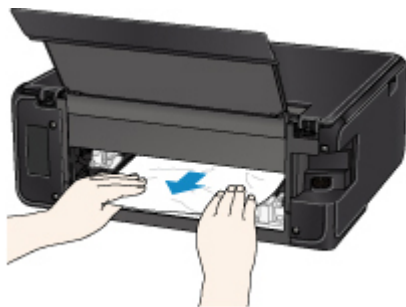

▶▶▶ Note

- Do not touch the inner parts of the printer.

3. Make sure all jammed paper is removed.
4. Attach transport unit cover.

Insert the transport unit cover slowly all the way into printer and take down the transport unit cover.

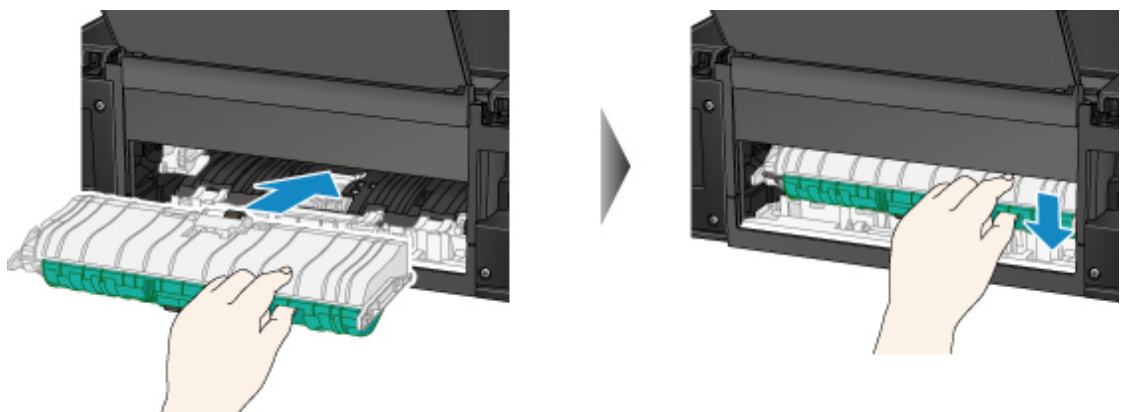

5. Attach rear cover.

Insert the projections of the right side of the rear cover into the printer, and then push the left side of the rear cover until it is closed completely.



If the measures above do not solve the problem, contact your nearest Canon service center to request a repair.

1304

Cause

Paper is jammed when performing automatic duplex printing.

What to Do

If the paper is jammed when performing automatic duplex printing, try to remove the paper from the following locations.

- Paper output slot
 - [1300](#)
- Inside of the printer
 - [Paper Is Jammed inside Printer](#)

If the measures above do not solve the problem, see [Removing Jammed Paper from Rear Side](#) to open the rear cover and to remove the paper.

Removing Jammed Paper from Rear Side

►► Note

- If paper becomes jammed during printing and you need to turn off the printer to remove it, press the **Stop** button to stop the printing before you turn off the printer.

1. Rotate printer so that rear side of printer faces toward you.



2. Open rear tray cover and then pull up paper support.

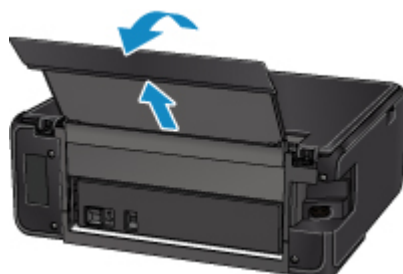

3. Detach rear cover.

Pull out the rear cover.

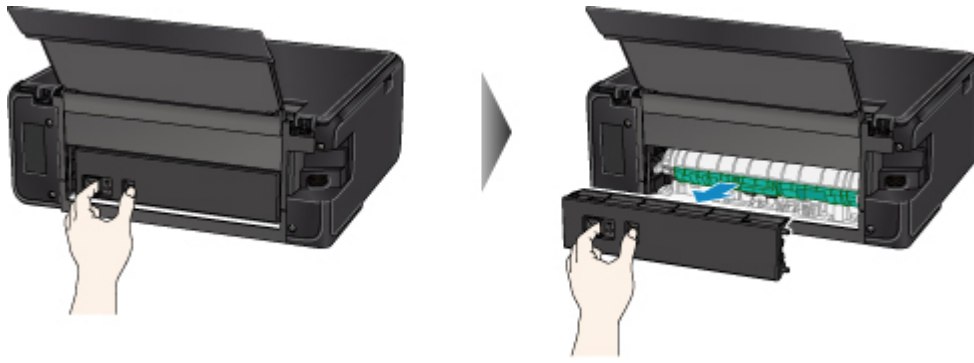

4. Slowly pull out paper.

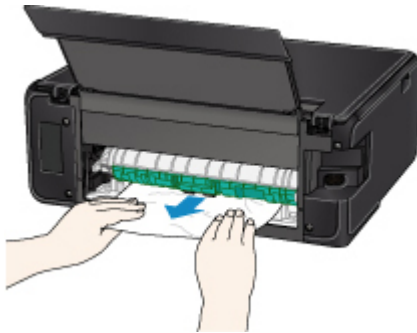

▶▶ Note

- Do not touch the inner parts of the printer.

If you were not able to remove the paper in this step, detach the transport unit cover and remove the paper by following these steps.

1. Detach transport unit cover.

Lift up the transport unit cover and pull out it.

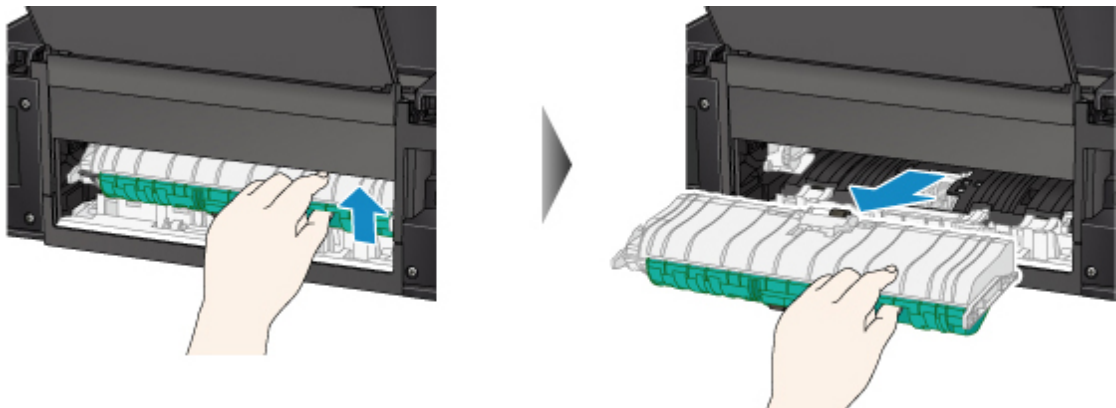

2. Slowly pull out paper.

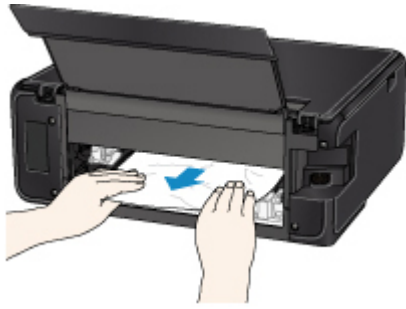

▶▶▶ Note

- Do not touch the inner parts of the printer.

3. Make sure all jammed paper is removed.
4. Attach transport unit cover.

Insert the transport unit cover slowly all the way into printer and take down the transport unit cover.

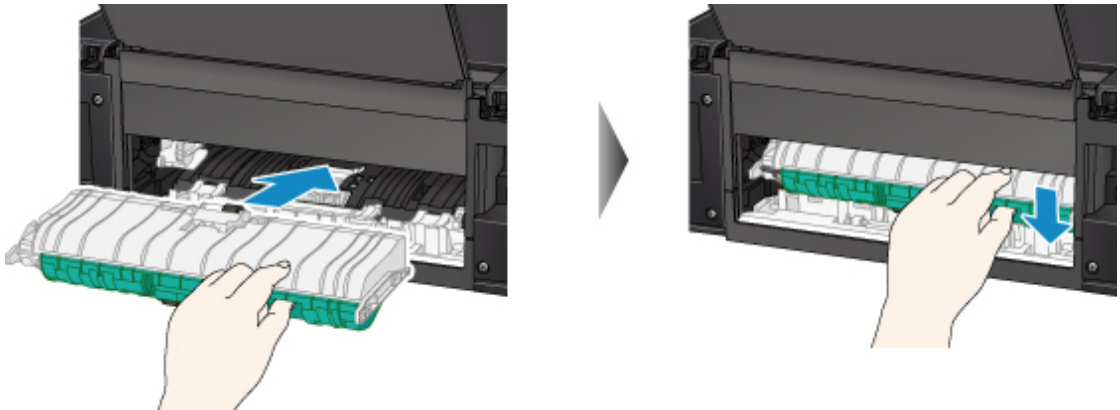

5. Attach rear cover.

Insert the projections of the right side of the rear cover into the printer, and then push the left side of the rear cover until it is closed completely.



If the measures above do not solve the problem, contact your nearest Canon service center to request a repair.

1313

Cause

Paper is jammed as printer pulled in printed paper.

What to Do

If the paper is jammed as the printer pulled in the printed paper, try to remove the paper from the following locations.

- Paper output slot
 - [1300](#)
- Inside of the printer
 - [Paper Is Jammed inside Printer](#)

If the measures above do not solve the problem, see [Removing Jammed Paper from Rear Side](#) to open the rear cover and to remove the paper.

Removing Jammed Paper from Rear Side

►► Note

- If paper becomes jammed during printing and you need to turn off the printer to remove it, press the **Stop** button to stop the printing before you turn off the printer.

1. Rotate printer so that rear side of printer faces toward you.



2. Open rear tray cover and then pull up paper support.



3. Detach rear cover.

Pull out the rear cover.

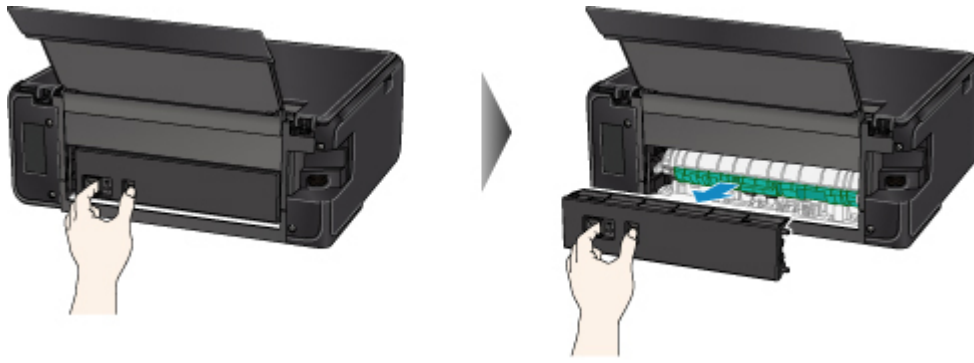

4. Slowly pull out paper.

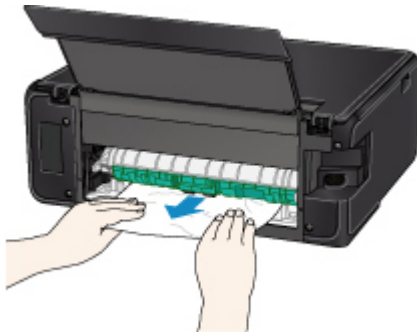

▶▶ Note

- Do not touch the inner parts of the printer.

If you were not able to remove the paper in this step, detach the transport unit cover and remove the paper by following these steps.

1. Detach transport unit cover.

Lift up the transport unit cover and pull out it.

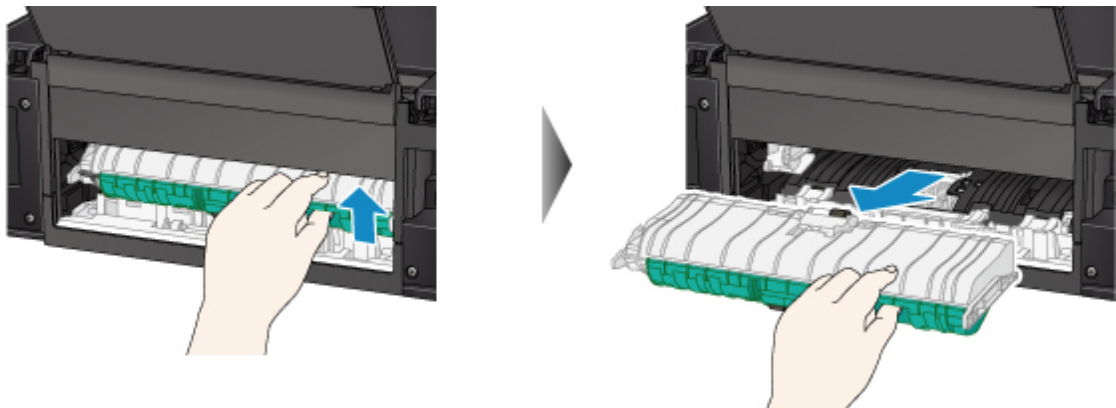

2. Slowly pull out paper.

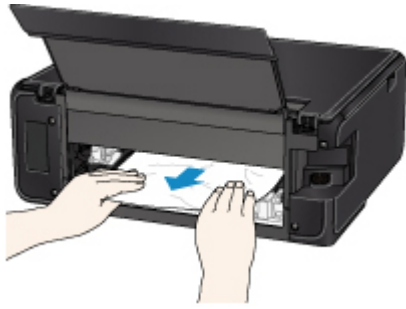

▶▶▶ **Note**

- Do not touch the inner parts of the printer.

3. Make sure all jammed paper is removed.
4. Attach transport unit cover.

Insert the transport unit cover slowly all the way into printer and take down the transport unit cover.

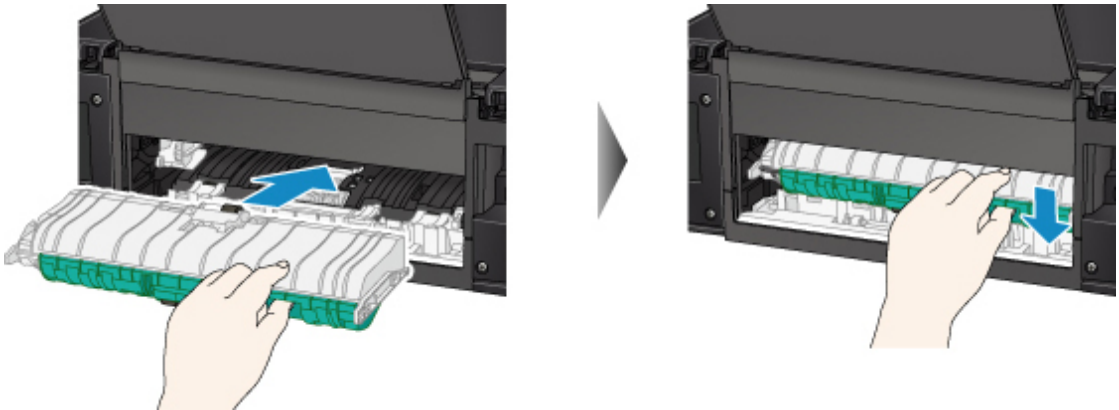

5. Attach rear cover.

Insert the projections of the right side of the rear cover into the printer, and then push the left side of the rear cover until it is closed completely.



If the measures above do not solve the problem, contact your nearest Canon service center to request a repair.

Paper Is Jammed inside Printer

If the jammed paper tears and you cannot remove the paper either from the paper output slot or from the transport unit, or if the jammed paper remains inside the printer, remove the paper following the instructions below.

▶▶▶ Note

- If paper becomes jammed during printing and you need to turn off the printer to remove it, press the **Stop** button to stop the printing before you turn off the printer.

1. Turn off printer and unplug it.
2. Open scanning unit / cover.

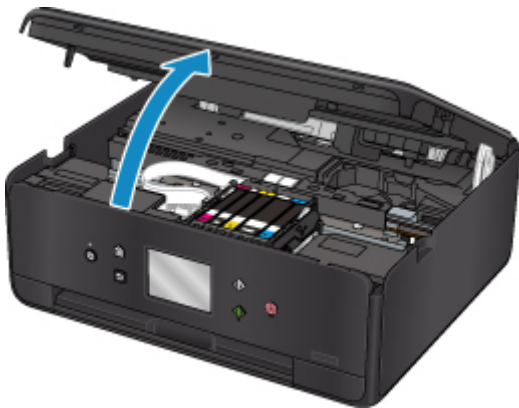

▶▶▶ Important

- Do not touch white belt (A).



If you soil or scratch this part by touching it with paper or your hand, it could damage the printer.

3. Check if jammed paper is under print head holder.

If the jammed paper is under the print head holder, move the print head holder to the far right or left, whichever makes it easier to remove the paper.

When moving the print head holder, hold the top of the print head holder and slide it slowly to the far right or left.

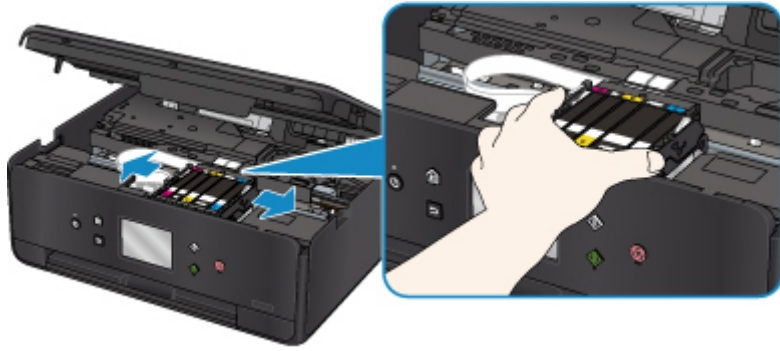

4. Hold jammed paper firmly in both hands.



If the paper is rolled up, pull out it.



5. Slowly pull out paper, so as not to tear it.

Pull out the paper at an angle of about 45 degrees.

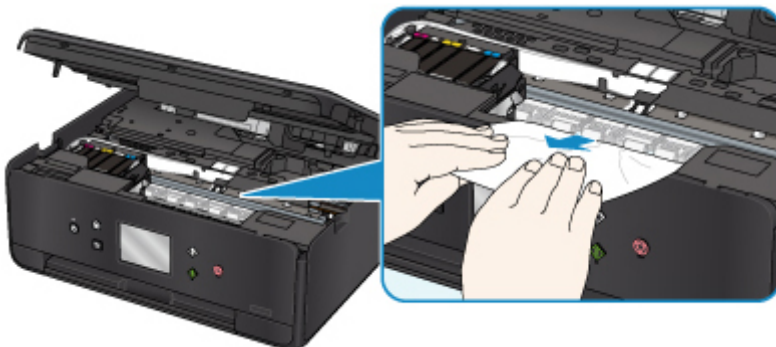

6. Make sure all jammed paper is removed.

If the paper tears when you pull out it, a bit of paper may remain in the printer. Check the following and remove any remaining paper.

- Any paper left under the print head holder?
- Any small bits of paper left in the printer?
- Any paper left in the left and right empty spaces (B) in the printer?

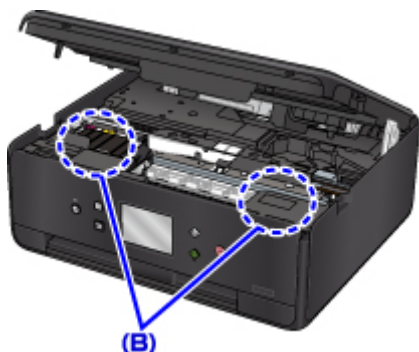

7. Close scanning unit / cover.

To close the scanning unit / cover, hold it up once, and then take it down gently.

All jobs in the print queue are canceled. Redo the printing.

▶▶▶ Note

- When reloading the paper, make sure you are using suitable paper and loading it correctly. If a paper jam message appears on the touch screen or on your computer screen when you resume printing after removing all the jammed paper, there may be some paper still inside the printer. Check the printer again for any remaining bits of paper.

If the measures above do not solve the problem, contact your nearest Canon service center to request a repair.

1000

Cause

Possible causes include the following.

- There is no paper in the rear tray.
- Paper is not loaded in the rear tray properly.

What to Do

Take the corresponding actions below.

- Load paper in the rear tray.
- Align the paper guides with the both edges of the paper when you load paper in the rear tray.
- Set paper information for the paper in the rear tray.

After carrying out the above measures, select **OK** on the touch screen.

▶▶▶ Important

- Be sure to close the feed slot cover after loading paper in the rear tray. If the feed slot cover is open, paper cannot be fed.

▶▶▶ Note

- After loading paper in the rear tray, the screen for setting rear tray paper information appears. Set paper information for the paper in the rear tray.
- To cancel printing, press the printer's **Stop** button.

1003

Cause

Possible causes include the following.

- There is no paper in the cassette.
- Paper is not loaded in the cassette properly.

What to Do

Take the corresponding actions below.

- Load paper in the cassette.
- Align the paper guides with the both edges of the paper when you load paper in the cassette.
- Set paper information for the paper in the cassette.

After carrying out the above measures, select **OK** on the touch screen.

▶▶▶ Note

- Once the cassette is inserted, the screen for setting cassette paper information appears. Set paper information for the paper in the cassette.
- The loadable paper differs depending on the paper source.
The loadable paper in the cassette is A4, Letter, A5, or B5 size plain paper.
- To cancel printing, press the printer's **Stop** button.

1200

Cause

Scanning unit/cover is open.

What to Do

Close the scanning unit / cover and wait for a while.

Do not close it while you are replacing an ink tank.

1401

Cause

Print head may be damaged.

What to Do

Contact your nearest Canon service center to request a repair.

1600

Cause

If the lamp on the ink tank is flashing, ink may have run out.

What to Do

Replacing the ink tank is recommended.

If printing is in progress and you want to continue printing, select **OK** on the printer with the ink tank installed. Then printing can continue. Replacing the ink tank is recommended after the printing. The printer may be damaged if printing is continued under the ink out condition.

▶▶ Note

- If multiple ink lamps are flashing, check the status of each ink tank.

1660

Cause

An ink tank is not installed.

What to Do

Install the ink tank.

1688

Cause

The ink has run out. (The lamp on the ink tank flashes.)

What to Do

Replace the ink tank and close the scanning unit (cover).

Printing under the current condition may damage the printer.

If you want to continue printing in this condition, you need to disable the function for detecting the remaining ink level. Press and hold the printer's **Stop** button for at least 5 seconds, and then release it.

With this operation, disabling the function for detecting the remaining ink level is memorized. Please be advised that Canon shall not be liable for any malfunction or trouble which may be caused by continuation of printing under the ink out condition.

▶▶▶ Note

- If the function for detecting the remaining ink level is disabled, the ink tank in gray is displayed on the touch screen when checking the current estimated ink level.

1689

Cause

Printer detected ink out condition (The lamp on the ink tank flashes).

What to Do

Replace the ink tank and close the scanning unit (cover).

An ink tank that was once empty is installed.

Printing under the ink out condition may damage the printer.

If you want to continue printing, you need to disable the function for detecting the remaining ink level. To disable this function, press and hold the printer's **Stop** button for at least 5 seconds, and then release it.

With this operation, disabling the function for detecting the remaining ink level is memorized. Please be advised that Canon shall not be liable for any malfunction or trouble caused by continuation of printing under the ink out condition or by using refilled ink tanks.

▶▶ Note

- If the function for detecting the remaining ink level is disabled, the ink tank in gray is displayed on the touch screen when checking the current estimated ink level.

1700

Cause

Ink absorber is almost full.

What to Do

Select **OK** on the touch screen to continue printing. Contact your nearest Canon service center to request a repair.

▶▶ Note

- In the case of warnings or errors caused by remaining ink levels, the printer cannot print or scan.

1890

Cause

Tape for securing print head holder during transportation may still be attached.

What to Do

Open the scanning unit / cover and make sure the tape for securing the print head holder during transportation has been removed.

If the tape is still there, remove it and close the scanning unit / cover.



If this does not solve the problem, contact your nearest Canon service center to request a repair.

2110

Cause

Paper settings for printing or copying do not match cassette paper information set on printer.

▶▶▶ Note

- See below for the correct correspondence between paper settings made on the printer driver or on the touch screen.
 - [Paper Settings on the Printer Driver and the Printer \(Media Type\) \(Windows\)](#)
 - Paper Settings on the Printer Driver and the Printer (Media Type) (Mac OS)
 - [Paper Settings on the Printer Driver and the Printer \(Paper Size\) \(Windows\)](#)
 - Paper Settings on the Printer Driver and the Printer (Paper Size) (Mac OS)
- For copying, make the copy paper settings to match cassette paper information set on the printer.
- See below for details on cassette paper information set on the printer.
 - [Paper Settings](#)

If the print or copy paper settings do not match cassette paper information set on the printer, as shown below, a message appears on the touch screen.

- Print settings specified on the printer driver:
 - Paper size: A5
 - Media type: Plain paper
- Cassette paper information set on the printer:
 - Paper size: A4
 - Media type: Plain paper

After selecting **OK** on the touch screen, the print or copy paper settings appear below the message.

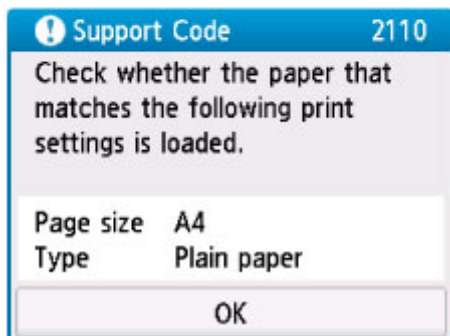
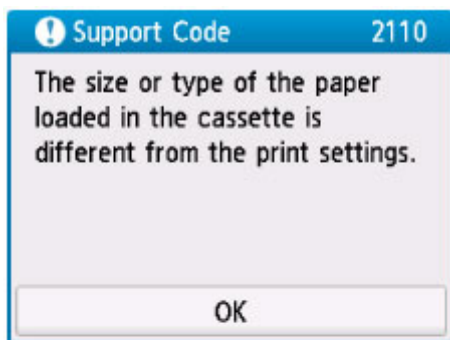

What to Do

Select **OK** on the touch screen again to display the screen below.

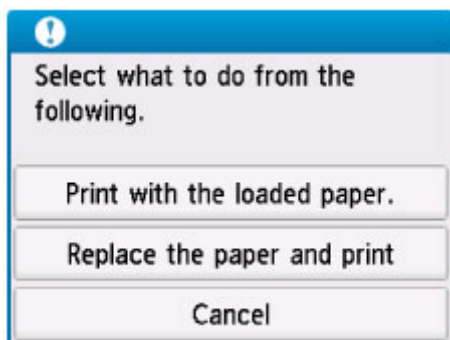

Select the appropriate action.

»» Note

- Depending on settings, some of the options below may not appear.

Print with the loaded paper.

Select this option to print or copy onto the paper in the cassette without changing the paper settings.

For example, if the print or copy paper setting is A5, and cassette paper information is set to A4, the A5 size setting is used to print or copy onto the paper in the cassette.

Replace the paper and print

Select this option to print after changing the paper in the cassette.

For example, if the print or copy paper setting is A5, and cassette paper information is set to A4, change the paper in the cassette to A5 paper and proceed with printing or copying.

Once you have inserted the cassette after changing the paper, the screen for setting cassette paper information appears. Set paper information for the paper in the cassette.

▶▶▶ Note

- If you do not know what paper information to set, press the **Back** button. The previous screen appears, showing the paper size and media type. Check the paper settings and set them as cassette paper information.
- See below for the correct correspondence between paper settings made on the printer driver or on the touch screen.
 - [Paper Settings on the Printer Driver and the Printer \(Media Type\)](#) (Windows)
 - Paper Settings on the Printer Driver and the Printer (Media Type) (Mac OS)
 - [Paper Settings on the Printer Driver and the Printer \(Paper Size\)](#) (Windows)
 - Paper Settings on the Printer Driver and the Printer (Paper Size) (Mac OS)

Cancel

Cancels printing.

Select this option when you want to change the print or copy paper settings. Change the paper settings and retry printing.

▶▶▶ Note

- To suppress the misprint prevention message, change the setting as described below. When you suppress the message, the printer uses the paper settings for printing or copying onto the paper in the cassette regardless of whether or not the paper matches these settings.
 - To change the message view setting when printing or copying using the operation panel of the printer:
 - [Feed settings](#)
 - To change the message view setting when printing using the printer driver:
 - [Changing the Printer Operation Mode](#) (Windows)
 - Changing the Printer Operation Mode (Mac OS)

2900

Cause

Scanning print head alignment sheet failed.

What to Do

Select **OK** on the touch screen and follow the instructions below.

- Make sure the print head alignment sheet is set in the correct position and orientation on the platen glass.
- Make sure the platen glass and the print head alignment sheet are not dirty.
- Make sure the loaded paper is correct.

For automatic print head alignment, load A4 or Letter-sized plain paper.

- Make sure the print head nozzle is not clogged.

Check the print head condition by printing the nozzle check pattern.

If the error is still not resolved, try manual print head alignment.

2901



Cause

Print head alignment pattern has been printed and printer is waiting to scan sheet.

What to Do

Scan the printed alignment pattern.

1. Load print head alignment sheet on platen glass.

Place the printed side down and align the mark  in the upper left corner of the sheet with the alignment mark .



2. Slowly close the document cover and select **OK** on printer's touch screen.

The printer starts scanning the print head alignment sheet, and automatically adjusts the print head position.

4103

Cause

Cannot perform printing with current print settings.

What to Do

Press the printer's **Stop** button to cancel printing.

Then change the print settings and retry printing.

5011

Cause

Printer error has occurred.

What to Do

Turn off printer and unplug it.

Plug in the printer again and turn it back on.

If this does not solve the problem, contact your nearest Canon service center to request a repair.

5012

Cause

Printer error has occurred.

What to Do

Turn off printer and unplug it.

Plug in the printer again and turn it back on.

If this does not solve the problem, contact your nearest Canon service center to request a repair.

5100

Cause

Printer error has occurred.

What to Do

Cancel printing and turn off the printer.

Check the following:

- Make sure print head holder motion is not impeded by tapes for securing the print head holder during transportation, jammed paper, etc.

Remove any impediment.

- Make sure the ink tanks are properly installed.

Press ink tanks until they click into place.

Turn the printer back on.

If this does not solve the problem, contact your nearest Canon service center to request a repair.

▶▶ Important

- When clearing an impediment to print head holder motion, be careful not to touch white belt (A).



If you soil or scratch this part by touching it with paper or your hand, it could damage the printer.

5200

Cause

Printer error has occurred.

What to Do

Turn off printer and unplug it.

Plug in the printer again and turn it back on.

If this does not solve the problem, contact your nearest Canon service center to request a repair.

5B00

Cause

Printer error has occurred.

What to Do

Contact your nearest Canon service center to request a repair.

▶▶ Note

- In the case of warnings or errors caused by remaining ink levels, the printer cannot print or scan.

6000

Cause

Printer error has occurred.

What to Do

If the paper is jammed, remove it depending on the jammed location and cause.

■ [List of Support Code for Error \(Paper Jams\)](#)

Turn off printer and unplug it.

Plug in the printer again and turn it back on.

If this does not solve the problem, contact your nearest Canon service center to request a repair.

C000

Cause

Printer error has occurred.

What to Do

Cancel printing and turn off the printer.

Check the following:

- Make sure print head holder motion is not impeded by tapes for securing the print head holder during transportation, jammed paper, etc.

Remove any impediment.

- Make sure the ink tanks are properly installed.

Press ink tanks until they click into place.

Turn the printer back on.

If this does not solve the problem, contact your nearest Canon service center to request a repair.

▶▶ Important

- When clearing an impediment to print head holder motion, be careful not to touch white belt (A).



If you soil or scratch this part by touching it with paper or your hand, it could damage the printer.