

November, 1977

**Getting Small: Microcomputers**  
**Can Core Survive? - Choosing a Microprocessor**

# Digital Design

The Magazine of Digital Systems

## Making Microcomputer Programming Easier

THE GEORGE E. FREEMAN LIBRARY  
STATE TECHNICAL INSTITUTE AT MEMPHIS  
5983 Macon Cove at Interstate 40  
Memphis, Tennessee 38134



# is to take it apart piece by piece.

Compare the features of our S-100 bus system, the industry standard, to anyone else. After you've taken them apart piece by piece, you'll know why IMSAI is the system you can grow with. At a price you can live with.

## **IMSAI 80/30 Integrated Video Computer (with Intelligent Keyboard—IKB-1)** **Standard Features:**

- **Price assembled \$1499.** IMSAI is the only S-100 bus manufacturer that offers a micro-processor driven keyboard with "N" key roll over, 2¼K of RAM, 8 expansion slots, choice of 4K, 16K, 32K and 64K RAM expansion boards, 3K ROM monitor, synch/asynch serial interfaces, parallel and serial ports, high resolution CRT monitor, 24 x 80 display with graphic editing and data entry features, and 28 amp power supply for the incredibly low price of \$1499.
- **mpu Speed.** IMSAI is the only S-100 bus manufacturer that offers true 8080 compatibility, operating at 3 MHz.
- **RAM Included.** 2¼K.
- **Expansion Slots.** Eight expansion slots are provided in a new terminated and regulated motherboard (10 slots total).
- **RAM Board Sizes.** IMSAI is the only S-100 bus manufacturer to supply 4K, 16K, 32K, and 64K RAM memory expansion boards.
- **ROM Monitor.** IMSAI is the only S-100 bus manufacturer to provide 3K of ROM.
- **Asynch/Synch.** Only one other S-100 bus manufacturer provides both methods of data communication.
- **PIO/SIO.** IMSAI is the only S-100 bus manufacturer that provides two serial ports and one fully implemented parallel port at no extra charge.
- **Video I/O.** IMSAI is the only S-100 bus manufacturer to include a high resolution (14 MHz) monitor as an integrated part of the computer.
- **CRT Format.** IMSAI is the only S-100 bus manufacturer to provide a full 24 x 80 screen, which is two times the capacity of the common 16 x 64 screen.
- **Graphic/Edit.** IMSAI is the only S-100 bus manufacturer that provides graphics and text editing features with character and line insert/delete for your CRT display.

□ **Keyboard Included.** IMSAI is the only S-100 bus manufacturer to supply a micro-processor driven keyboard with "N" key roll over and tiered construction for a true typewriter keyboard touch.

□ **28 amp Power Supply.** The world famous IMSAI power supply assures stability and reliability of performance.

□ **Options:** IMSAI is the only S-100 bus manufacturer to provide a comprehensive array of fully integrated options including: line and character printers, CRT terminals, intelligent keyboard, ACR storage, standard and mini floppies, TTY BASIC with OS, 4K, 8K and 12K BASIC, audio cassette BASIC with OS, 8K disk operating system (DOS) based upon CP/M,\* scientifically and commercially oriented disc BASIC and level 2 FORTRAN IV compiler.

□ **Printers.** Only one other S-100 bus manufacturer can supply both line and character printers.

□ **CRT/Keyboard.** IMSAI is the only S-100 bus manufacturer to provide both CRT terminal and intelligent keyboard as separate options.

□ **ACR Storage.** Available.

□ **Floppies.** IMSAI is one of the few S-100 bus manufacturers to provide both standard and mini floppies and the only S-100 bus manufacturer that supplies double density standard floppies.

□ **TTY BASIC.** IMSAI is one of the few S-100 bus manufacturers that provides self-contained operating systems with 4K, 8K and 12K BASIC.

□ **ACR BASIC.** IMSAI supports ACR BASIC with an 8K version.

□ **DOS.** IMSAI is the only S-100 bus manufacturer to provide an enhanced version of the control program monitor (CP/M\*) that can support up to 18 disk drives.

□ **Disc BASIC.** IMSAI is the only S-100 bus manufacturer that provides both scientific and commercial versions of compiler oriented BASIC.

□ **FORTRAN IV.** IMSAI is the only S-100 bus manufacturer that offers a level 2 FORTRAN IV compiler that operates under an enhanced version of CP/M\*

Prices and specifications subject to change without notice.  
\*CP/M is a trademark of Digital Research Corporation.

# Price/Performance no one else has put together.

**IMSAI**<sup>®</sup>

The Standard of Excellence  
in Microcomputer Systems

# The \$6,000\* DP Center.



## IMSAI Introduces the VDP-80

Until now, owning real computing power meant paying unreal prices. Announcing the IMSAI VDP-80 Video Data Processor, a complete computer, intelligent terminal and megabyte floppy disk mass storage system. All in one compact cabinet. All for just \$5995\*. A complete desk top DP center.

For small business applications, the VDP-80 places a stand-alone computer at your fingertips. And, our full line of add-on peripherals, assures that the system can be expanded as your needs do.

For the large business user, with an existing central mainframe, the VDP-80 is the ultimate remote processor. You have the advantage of powerful local processing capability, plus the epitome in cost-effectiveness for implementing a distributed data communications network.

Take a close look at the following features. Then you'll know why we call our VDP-80 the desk top DP center.

□ **Powerful, High-Speed, Central Processor.** 3 mHz Intel 8085 microprocessor. 32K RAM memory (expandable to 196K). Parallel and serial I/O. Asynch, synch and bisynch communications. Programmable baud rates (.05-56 KB).

□ **Megabyte Mass Storage.** PerSci dual floppy, double density disk drive standard. One million byte storage capacity. Three floppy disk drives can be added-on, providing 4 million bytes of on-line storage.

□ **Drives Printers, Plotters, Terminals, Modems and Tape Drives.** Supports up to six terminals or modems, and four tape drives. Drives plotters, serial printers and line printers (up to 300 lpm).

□ **12" CRT, 24x80 Field, User Programmable Font.** Character and line insert/delete allows fast program correction and text editing. Inverse video and programmable field allows highlighting or enlarging graphics of information display. Titled fields protect information blocks from being written over accidentally. Programmable font (up to 256 different characters) allows foreign language and special purpose character forms.

□ **Alphanumeric Intelligent Keyboard.** 62-pad main keyboard. Programmable 12-pad numeric keyboard. 12-pad control keyboard. Standard typewriter and calculator keyboard layouts. "N" key roll over reduces operator error during high-speed data entry.

□ **Commercial BASIC, FORTRAN IV, DOS Software.** Built-in ROM monitor allows extensive debugging and diagnostics. BASIC, interactive or compiler version. FORTRAN IV level 2 ANSI compiler. DOS-enhanced CP/M.\*\*

Distributed processing, financial reporting and analysis, word processing, whatever your application, the VDP-80 is your answer.

**Dial (415) 483-2093, and we'll tell you how you can put our \$5995\* DP Center on your desk top. When it comes to small business computers, Just Ask IMSAI.**

\*Base price VDP-80/1000, \$5995, with 32K RAM memory and dual double density floppy disk drive. U.S. Domestic Price Only. Features and prices subject to change without notice.  
\*\*CP/M is a trademark of Digital Research Corporation.

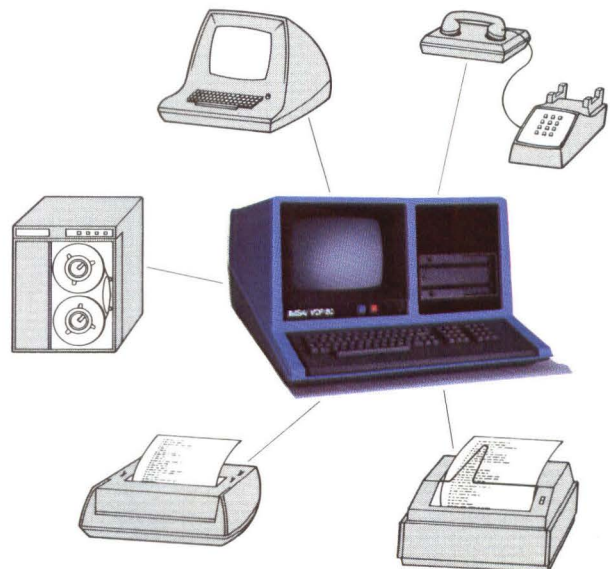

**IMSAI®**  
The Standard of Excellence  
in Microcomputer Systems

IMSAI Manufacturing Corporation  
14860 Wicks Blvd.  
San Leandro, CA 94577  
(415) 483-2093 TWX 910-366-7287

# the best way to build your system...



PCS-80 / 30 Integrated Video Computer



PCS-80 / 15 (w/IKB-1)



PCS-80 / 30: 80-25A, DHMO



PCS-80 / Components

## IMSAI introduces the PCS-80 component system...

# Introducing push-button microprocessor system debugging.

HP's 1611A Logic State Analyzer ... Dedicated to all 8080 or 6800 based systems.\*

View program flow in mnemonics. With CRT data and addresses selectable in either hexadecimal or octal formats and external lines in 1's and 0's.

Maintain testing control. LED indicators show status at all times. You can monitor system operation at normal speed or stop the microprocessor and give control to the 1611A for single or multiple keyed steps.

Enter data quickly and easily. The hexadecimal keyboard makes trigger and qualifier data entry as easy as operating a calculator. And the CRT display gives you a quick visual check on your entries.



Choose your display. Either mnemonic or absolute (op codes). Roll the display to view any 16-line slice of the 64-byte memory.

Pinpoint virtually any specific event. Trigger on address, data, or external signals... or on any combination of the three. You can also qualify the trigger by bracketing the address and opting to trigger on the nth occurrence of the trigger word. TRIGGER ENABLE and DISABLE keys act as arm and disarm circuits providing unparalleled pinpointing flexibility.

Move the display window. Delay up to 65,472 qualified clocks or memory transactions from the trigger word. Or, pre-trigger to see up to 63 bytes leading up to the trigger word (negative time).

Obtain program and timing data. Qualify the display with TRACE TRIGGER and see only those bytes that match your trigger inputs... all write instructions, for example. Press COUNT TRIGGERS and the 1611A displays the number of trigger occurrences between the TRIGGER ENABLE and TRIGGER DISABLE entries. Push TIME INTERVAL and you get a display of actual elapsed time between selected points in your program on your hardware.

The 1611A should be on hand when you start up your microprocessor-based system. Imagine the time you'll save with push-button operation and an unparalleled view of your system's operation; viewing things dynamically that you never could see before. And there's more... self test; trigger outputs to drive external equipment; error messages to warn of improper operation or setup; and the choice of two initial "μP personality modules" that let you tailor the 1611A to either 8080 or 6800 based systems.



Let HP's 1611A, priced at \$5,000\*\*, help you speed development, production-line testing or service. Ask your local HP field engineer for all the details. Ask him about HP's digital seminars too. He can tell you when one will be held in your area and how you can attend.

\*and more modules for other microprocessors to come.  
\*\*Domestic U.S.A. price only

HEWLETT  PACKARD

Sales and service from 172 offices in 65 countries.

1507 Page Mill Road, Palo Alto, California 94304  
For assistance call: Washington (301) 948-6370, Chicago (312) 877-0400,  
Atlanta (404) 434-4000, Los Angeles (213) 877-1262

Managing  
the data domain.

# At only \$1088, you can't offer your customers a better buy.



Our quantity-50 OEM price for the *Silent 700*\* Model 743 KSR Terminal is now just \$1088†. In larger quantities, the price goes below \$1000.

And it keeps on costing less because the real payoff is in the cost of ownership. In the long run, it costs less than any other printer terminal with comparable performance.

The reason is easy. Superior design. The 743 KSR is built around a TI microprocessor. So, there are fewer components and circuit boards than in other printer terminals. That means less maintenance and more uptime performance. Plus standard EIA and current loop interfaces in a lighter, desk-top package.

The 743 features the speed, reliability and quietness that made the *Silent 700* terminal family so popular. Incoming data is buffered, so you get true 30 characters-per-second throughput.

Data entry. Interactive remote computing. Or as a message terminal network. And it's now available with APL. The 743 is backed by TI's worldwide maintenance and support services.

Find out more about TI's 743 KSR printer terminal. Fill out and mail the coupon today. Or call your nearest TI sales office, or Terminal Marketing, (713) 494-5115, extension 2126.



## TI's Model 743 KSR

Disturbing noises associated with impact printers are eliminated with the 743's non-impact electronic printing.

Use it as a console I/O for software development. Keyboard terminal for inquiry/response.

**TEXAS INSTRUMENTS**  
INCORPORATED

Yes! I am interested in the 743 KSR Printer Terminal.

- Please have your representative call me.  
 Please send me more information.

**SILENT 700**  
electronic data terminals

Name \_\_\_\_\_

Title \_\_\_\_\_

Company \_\_\_\_\_

Phone \_\_\_\_\_

Address \_\_\_\_\_

City \_\_\_\_\_ State \_\_\_\_\_ Zip \_\_\_\_\_

Mail to: Texas Instruments Incorporated, P.O. Box 1444, M/S 784,  
Houston, Texas 77001

2-11-DD

\*Trademark of Texas Instruments

Copyright© 1977, Texas Instruments Incorporated  
†U.S. Domestic Price

# TEXAS INSTRUMENTS.

# Sperry Univac's new mainframe-on-a-board: What you do with it is your business.

Whether your systems business is scientific, instrument control, or data communications, know this:

Our new V77-200 delivers more computing power than any other computer-on-a-board you can buy. Handling up to 32K/16-bit words of 660ns MOS memory.

Reason enough to call it the world's first mainframe-on-a-board. But there's more.

Because our new V77-200 comes loaded with "big machine" features. Like 8 programmable registers with byte, word and double word manipulation. Up to 32-bits of arithmetic precision. A powerful set of 187 instructions. Hardware multiply/divide. Direct memory access. Programed I/O. Multi-device automatic program loaders. A real-time clock. And a teletype/CRT controller. All standard. And all on a single 10.8" x 17" board.

There's even Virtual Console Logic that eliminates the need for a programmer's console by allowing you to control the V77-200 from a teletype or CRT keyboard.

You get "big machine" performance, too. Example: a microinstruction cycle time of 165ns that allows multiplication functions to be handled in just 4.9 microseconds — divide in just 8.

Plus your choice of OEM-tailored options. Like a variety of connector planes and general purpose interface boards for custom I/O designs. Three different 660ns memory boards (in 8K, 16K, and 32K-word modules). An operator's console. Power-fail detect and data save. Memory parity. Hardware for up to 64 priority vectored interrupts. An integral or modular power supply. And a system chassis. All the "unbundled" pieces you need for quick and easy system integrations.

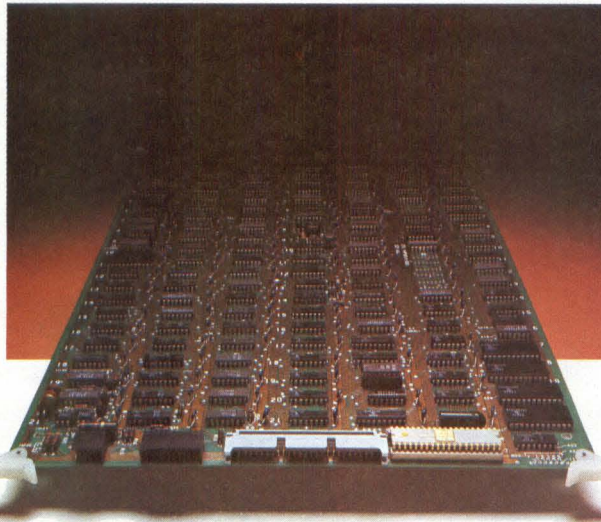

The new V77-200 also saves you time and money by allowing you to use Sperry Univac's well-established floppy or disk-based VORTEX real-time operating system. In effect, allowing you to concentrate on the development of your application software.

And giving you access to Sperry Univac's extensive library of software subsystems, language processors, and system utilities.

Best of all, the world's first mainframe-on-a-board has a base price of just \$1200. Plus a discount plan designed to give even modest-volume OEM buyers a big break. And you can take delivery in a matter of days — not months.

No matter how you configure it, the new V77-200 is the most economical Sperry Univac yet. Delivering the kind of price/performance value that just makes good sense. No matter what business your systems are in.

For more information on the world's first mainframe-on-a-board, please contact: Sperry Univac Mini-Computer Operations, 2722 Michelson Drive, P.O. Box C-19504, Irvine, California 92713, Telephone (714) 833-2400.

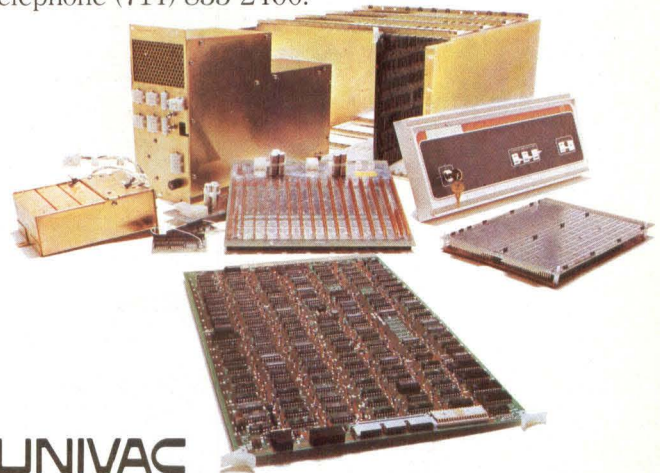

**SPERRY UNIVAC**  
SPERRY UNIVAC IS A DIVISION OF SPERRY RAND CORPORATION

CIRCLE 6

# The 8080 "Ice Breaker"

Portable, Flexible and Rugged for  
Production Test and Field Service

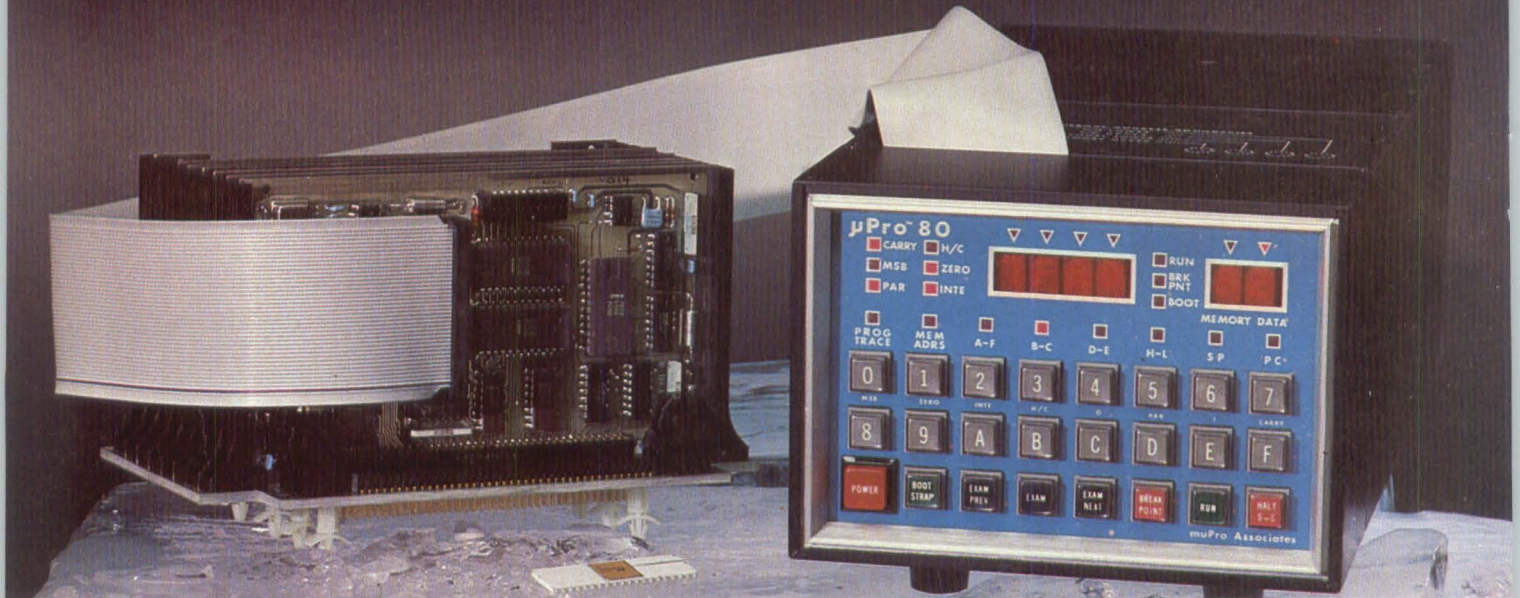

## MUPRO 80E Emulator

### MUPRO FEATURES

Real-Time Execution from emulator or user's system memory (no restrictions, no wait states)

Transparent Control/Display Console (terminal is not required)

Debug system totally implemented in emulator hardware

Hardware breakpoint, pass count and 64-instruction program trace

No overhead memory requirements

Optional plug-in Prom programmer card

Compact and ruggedized system packaging (4.6"H x 6.6"W x 15"L, 18 lbs)

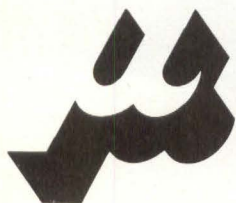

MANUFACTURERS OF  
INNOVATIVE MICROCOMPUTER  
SUPPORT SYSTEMS

Circle 4 for demo and technical data

## The complete solution

### YOUR BENEFITS

More thorough and flexible system test capability

Provides total use of microprocessor. No memory, I/O or interrupt restrictions.

No costly peripherals are required e.g. keyboard display, printer, etc.

Efficient control of program execution for hardware and software testing

All emulator memory available to user's program (up to 64K bytes)

Programs up to eight Proms simultaneously with same or different data

Single system provides total solution to production test and field service needs

## MUPRO

424 Oakmead Pkwy. Sunnyvale, Ca. 94086  
(408) 737-0500 TWX 910-339-9251

Circle 100 for technical data



# THIS MONTH

## Features

### 18

#### Choosing Microprocessors for Reduced Parts Counts

Whenever you need to move and interpret data at high speeds, correct microprocessor choice can provide significant savings by reducing the parts count.

### 31

#### Can Core Survive?

Semiconductor memory changed the data storage scene, but core will remain a viable technology.

### 43

#### Getting Small: Microcomputers

Our state-of-the-art survey of microcomputers covers representative products of each microcomputer type.

### 66

#### Making Microcomputer Programming Easier

Diskette operating systems for microcomputer-based equipment can reduce development time by making programming easier and faster.

### 78

#### Microprocessor Control of a Bridge Crane

Two 8080-based systems replace five miles of gravity conveyor with a computer-controlled bridge crane system.

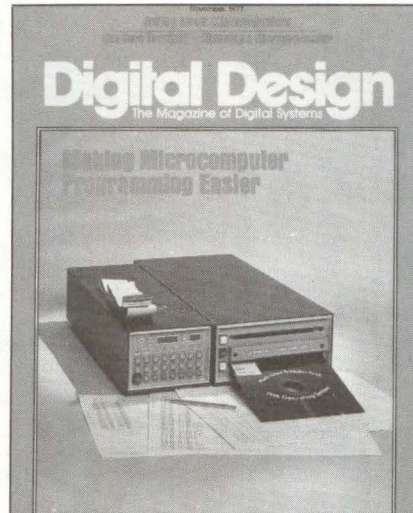

November, 1977

Vol. 7 No. 11

Diskette operating systems can enhance microcomputer capabilities; MuPro's MUTE system gives additional power and flexibility that reduce debug time. Cover design by Mike Barisano.

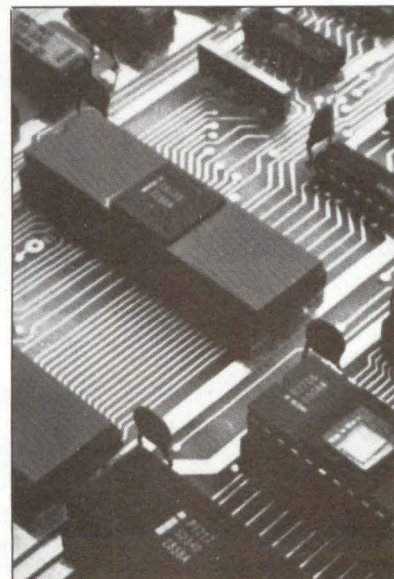
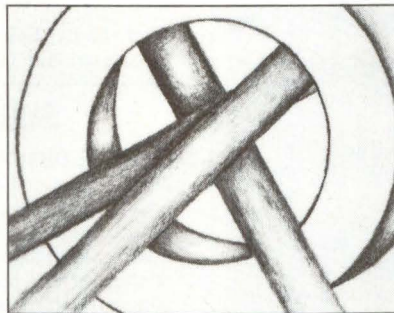

## Departments

### 8

#### Technology Trends

Floppy Drive Innovations: Challenging Hard Disks.

Development System Bus-Connects to Prototypes.

Magnetic Circuit Protector Doubles as Power Switch.

Computer to Speed Production of Braille Literature.

### 86

#### Product News

### 99

#### Advertiser's Index

### 100

#### Alpha Bits

Detecting Digital Signals.

Questions Answered.

How to Store Your Data.

Learn About Emulation.

Shopping for Computers, Peripherals.

Published monthly by Benwill Publishing Corp., 1050 Commonwealth Ave., Boston, MA 02215. Application to mail at controlled circulation rates is pending at Waseca, MN 56093. Copyright © Benwill Publishing Corp. 1977.

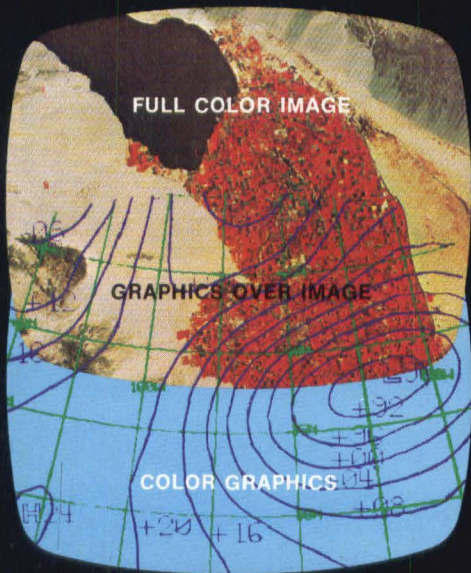

There's only one thing  
about Genisco's full  
color display systems  
that isn't on the high side.

Their low price.\*

High in performance, versatility, reliability, processing speed and data display density. These are just some of the highpoints that put Genisco's fully programmable GCT-3000 Series a whole generation ahead of stroke-writer and storage tube display systems. And they're expandable, so you can get "on-line" now at minimal cost, and make additions as the need arises. Check these feature highlights:

**Fully Programmable Microprocessor  
with 150 ns Cycle Time**

**Fast Access MOS/RAM Refresh Memory**

**Automatic Color Circumfill**

**Selective Erase and Zoom/Scroll**

**256 to 640 Elements per Scan Line**

**Up to 16 Bits per Pixel**

**Automatic DMA Access**

**High-Resolution Grey Scale Versions Too**

\*All these highs, yet the basic GCT-3000 is priced on the low-profile pocketbook side — \$6,000 in OEM quantities; \$7,500 singly.

So contact Genisco, a name that has stood for technological leadership over the past 30 years, and get the whole story.



**GENISCO COMPUTERS**

A DIV. OF GENISCO TECHNOLOGY CORPORATION

17805-D SKY PARK CIRCLE DRIVE, IRVINE, CA 92714 • (714) 556-4916

# Digital Design

The Magazine of Digital Systems

**Publisher** Yuri R. Spiro  
**Editorial Director** Harold G. Buchbinder  
**Editor** George King

**Associate Editors** William Belt  
Jeff Spiner  
**West Coast Editor** Henry K. Simpson, Jr.

**Assistant Editor** Carol Baran  
**Staff Artists** Mike Barisano  
Jane Higgins  
Rene Stawicki

**Production** E. Storm  
Sarah Jewler  
Joe Gillis  
Joe T. Ingram

**Composition** Nancy Aldrich  
Paul Cioto

**Circulation** Regina Harrington

**General Administration** Esther Shershow  
Sarah Binder  
Margie Morse  
Marion Pearlman  
Charles Vigilante  
Joy Wallens  
Merrie Buchbinder

**Marketing Programs Director:** George Palken, 1050 Commonwealth Ave., Boston, MA 02215. (617) 232-5470.

**West Coast Editorial Office:** George King, 442 Begonia, Corona del Mar, CA 92625. (714) 675-7123, (213) 454-0624.

## SUBSCRIPTION POLICY

DIGITAL DESIGN is circulated only to qualified research, development and design engineers in all branches of industry, government institutions and universities. To obtain a complimentary subscription, request (on company letterhead) a qualification card from Circulation Director. For change of address; attach old address label from recent issue to new company letterhead or note telling us what your old address was; send this plus request for new qualification card to:

Circulation Director  
DIGITAL DESIGN

1050 Commonwealth Ave.,  
Boston, MA 02215

Subscription rates: Domestic subscriptions for non-qualified subscribers, groups, libraries or companies, \$25.00 per year. Foreign subscriptions, \$35.00 per year.

DIGITAL DESIGN solicits editorial material and articles from engineers and scientists. Contributors should submit their manuscripts in duplicate and typed with two spaces between lines. All illustrations should be clear; components on all schematics and line drawings should be labeled. The editors assume no responsibility for the safety or return of any unsolicited manuscripts.

**BPA**

PRINT RUN  
OVER 51,000

Published monthly by Benwill Publishing Corporation, Harold G. Buchbinder, Chairman of the Board; George Palken, President; Esther Shershow, Treasurer, Executive, Editorial and Subscription Offices, 1050 Commonwealth Ave., Boston, MA 02215. Telephone: (617) 232-5470.

THE TELETYPE MODEL 43:  
IT'S SO GOOD YOU HAVE TO SEE IT TO BELIEVE IT.



The Teletype model 43 teleprinter doesn't just look good. It works even better.

Delivering true 30-character per second throughput, upper and lower case printing in a 132-column format, the model 43 has an exclusive, Teletype-developed 9-wire matrix impact printhead mechanism. This unique feature provides superior service life as well as exceptional print quality, even on multiple copies.

Under the cover, we kept hardware and moving parts to a minimum for maximum reliability. Solid-state circuitry and only five modular components—plus a built-in test capability—mean service is not

only fast, but also simple.

What a lot of people have trouble believing, however, is the model 43's low price. Because whatever your application—time-sharing, data inquiry/response,

or communicating point-to-point over private line or the dialed switched network—the model 43 delivers printing quality, reliability and serviceability at an unsurpassed price/performance value. Plus it's compatible with systems incorporating model 33 terminals.

The Teletype model 43. No matter how you look at it, nothing even comes close.



# TECHNOLOGY TRENDS

## Floppy Drive Innovations: Challenging Hard Disks

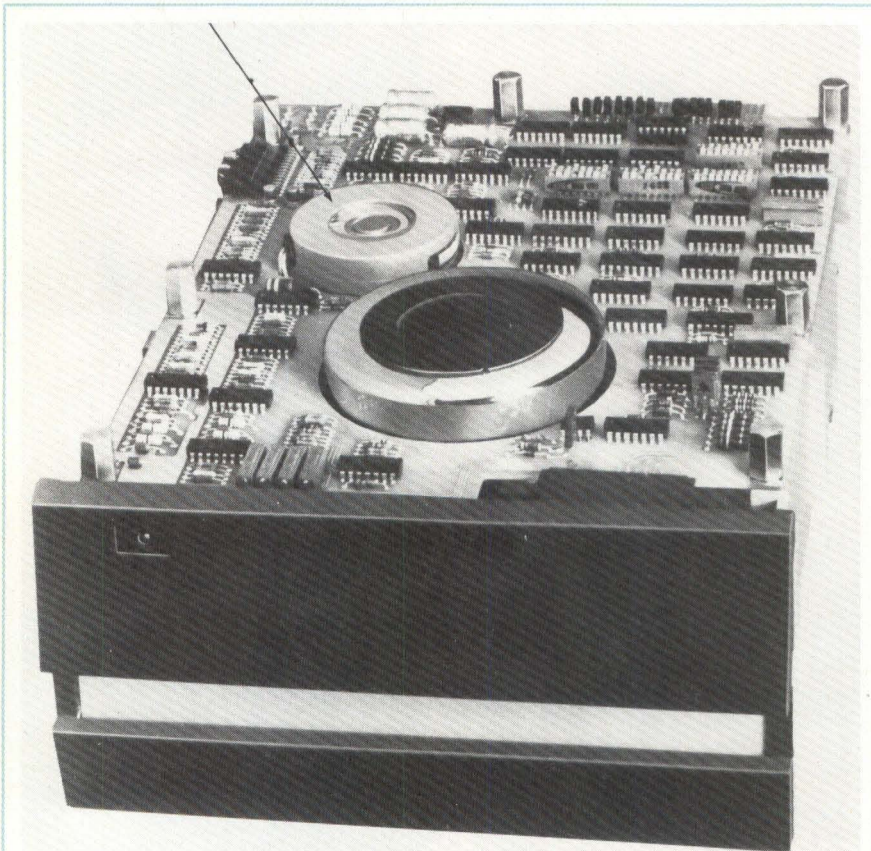

Fig 1 Top view of the 800 diskette drive shows central location of the stepper motor.

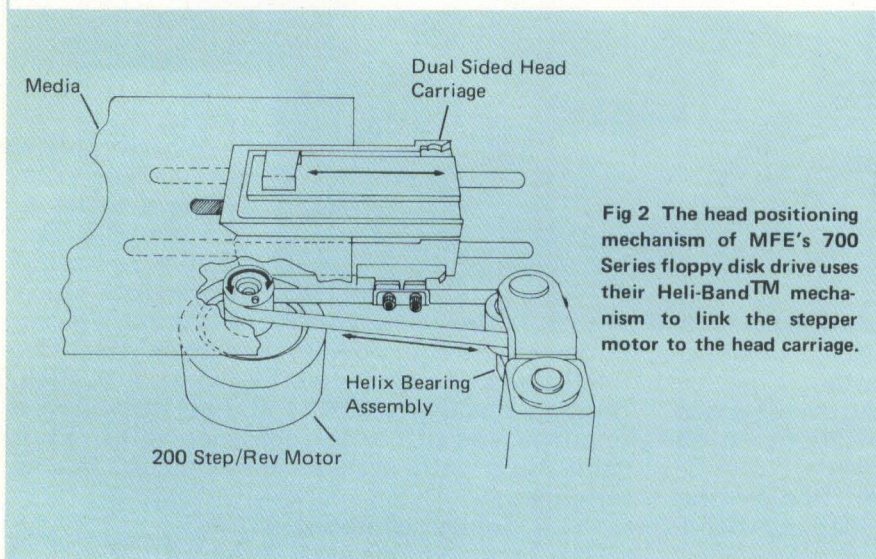

Fig 2 The head positioning mechanism of MFE's 700 Series floppy disk drive uses their Heli-Band™ mechanism to link the stepper motor to the head carriage.

Advances in the state-of-the-art in digital systems components — often thought of only in terms of *electronic* progress — frequently come as a result of *mechanical* innovation. This mechanical innovation does not necessarily mean new technologies or new devices; it can just as easily be the result of a new parts orientation or substitution of one component for another. These types of changes are responsible for much of the progress in peripheral device technology, particularly for printers, plotters, CRT terminals and disk and flexible disk drives.

Flexible disk, or floppy, drives typically house a spindle motor for spinning the disk and a stepper motor-based system that positions the read/write head. MFE Corporation of Salem, New Hampshire, claims that their recently introduced 700 Series double-sided flexible disk drive runs at low power with greater head positioning accuracy and higher MTBF because of mechanical changes they introduced in both the spindle motor and the positioning system.

Most floppy drives use an AC synchronous induction motor that typically consumes about 80 to 100 watts. MFE designers replaced the AC motor with a DC brushless motor that, according to Jim Bartley, Sales Manager for MFE's OEM digital products, operates at higher efficiency than AC motors, thus reducing power consumption. In addition, an electronic circuit automatically drops the voltage supplied to the stepper motor whenever it is not stepping. The resulting power consumption averages 30 watts in typical random operation.

Most floppy drive designers put the stepper motor at the rear of the unit. To increase thermal stability, and to allow the unit to fit in a smaller space, MFE engineers located the stepper motor at the center. Because of this motor relocation, the 700 Series measures 8.7" x 4.35" x 12", making it the

**If you wait until 1978, you'll see some new 150 and 300 lpm band printers.**

**If you order a field-proven Printronix impact matrix line printer today, you'll get unbeatable print quality plus full plotting capability for the same price...or less.**

**And we'll ship it tomorrow.**

Read about the new 150 and 300 lpm band printers scheduled for delivery sometime next year? Supposedly, they'll be in the same low price range as Printronix 150 and 300 lpm impact matrix line printers. But good as they might be, they'll never be able to match the utility and value of Printronix Printer/Plotters.

In the first place, you can't plot with a band printer. A Printronix can plot anything that can be displayed on a CRT. You get this extra capability at no extra cost. Printing and plotting for the same price as a band printer.

What's more, a Printronix gives you a 160 character capacity with no slowdown in print speed. A standard 96 character ASCII set plus your choice of an optional 64 character computer selectable set. No time lost changing bands to print different languages or character styles. And since a Printronix has fewer parts than a band printer, you can count on higher reliability.

Since mid 1975, we have shipped more than 3,000 units. They're field proven. And we are tripling our production capacity. So you won't have to wait 6 to 9 months to get the best buy in printers. Order one today and we'll ship it tomorrow!

Printronix, Inc., 17421 Derian, Irvine, California 92714  
Call us at (714) 549-8272



**PRINTRONIX...**  
**Your chance to beat the band.**



smallest currently available double-sided flexible disk drive, according to Bartley. This size savings permits rack-mounting four units vertically in the space that two units take up horizontally. The entire package can even fit comfortably in the base of a CRT terminal, thus becoming the mass storage device for an intelligent terminal or desktop computer.

Another mechanical change MFE designers introduced with the 700 Series is what they call the Heli-Band mechanism for head positioning. Flexible disk drives typically use a stepper motor with a lead screw for their positioning system, a method that suffers from high error rates and initial alignment problems. According to MFE, the Heli-Band, which gives a track-to-track access time of 3 ms, has greater accuracy than other band designs. Dave Dunn, Engineering Manager for the 700

Series, says that this accuracy improvement results from locating the stepper motor in the center of the unit, near the spindle itself. Dunn points out that the consequent compression of the positioner reduces expansion, thereby improving thermal stability. He also emphasized that the Heli-Band design offers a significant maintenance advantage: you can easily replace the entire head/carriage mechanism or the band in minutes, whereas in some other designs, to replace the carriage or the band, you must also replace the entire positioning mechanism.

The 700 Series allows double-density, double-sided recording, permitting storage of up to 12.8 megabits per flexible disk. Using double ceramic read/write heads and ceramic load pads in the carriage mechanism eliminates trouble-prone felt pads, and, according to Bartley, extends head life beyond

$4 \times 10^7$  wear revolutions.

Bartley points out that the 700 drive provides a wide range of factory-installed options, including separated data and separated clock for single density applications, activity lights to indicate unit selected or head loaded, write protect sensor. Among the options that the design allows you to install: daisy chain interface, radial ready allowing each drive to have ready monitor simultaneously, and a power saver for the DC spindle drive.

Can flexible disks challenge hard disks in most applications? Dunn foresees the higher reliability and increased storage capability of newer units like MFE's 700 Series giving "the hard disk a run for the money."

For further information, contact MFE Corporation, Keewaydin Drive, Salem, NH 03079. (603) 893-1921.

**Circle 169**

## Development System Bus-Connects To Prototypes

In the September issue of *Digital Design*, Greg Miller of Tektronix Corp. explored the role of microprocessor development systems in the testing and debugging of prototypes of microprocessor-based products. One such system, developed by Arthur D. Little (ADL) of Cambridge, Massachusetts, was originally conceived and developed to meet the needs of the company's staff. However, the growing use of microprocessors in industrial and consumer products has created a growing need for development systems; because of this, ADL welcomes inquiries about this system and customized versions.

A primary design goal for the system, according to Dr. David Curtis, Manager of ADL's Electronic Systems Section, was to allow testing and debugging of systems that did not have I/O ports. These systems, once designed using the 'random logic' approach, include such special-purpose devices as controllers for washing machines. This type of product poses unique problems for the microprocessor system designer; because there are no ports for peripherals, problems exist in loading applications software, running it, and diagnosing and correcting hardware and software faults.

Also important in the design of

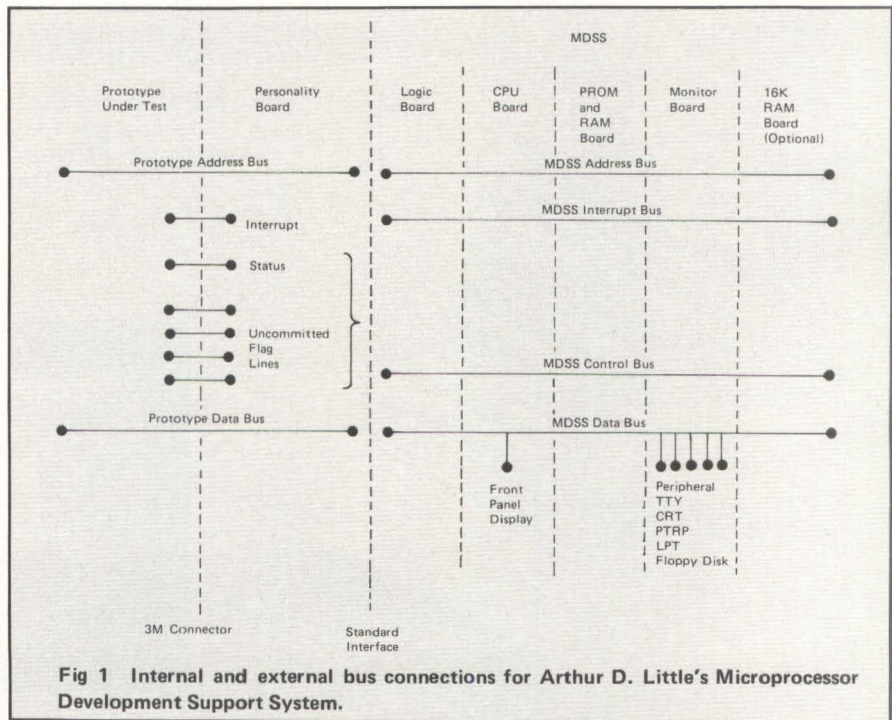

ADL's Microprocessor Development Support System (MDSS) is the capability to monitor and control the prototype in real-time. Curtis points out that many development systems that use emulation techniques cannot run in realtime; they incorporate an external

processor that may replace a single prototype microprocessor instruction with several emulator instructions. Because the MDSS does not replace the microprocessor, but instead hooks directly into the prototype bus, the test unit does not generate timing problems.

# Why settle for less when nothing costs less?

At \$750\*, the Soroc IQ 120 is now priced lower than any OEM terminal on the market.

Yet it provides **standard** features that others offer as options. For example:

- lower case
- numeric pad
- protect mode
- tabbing
- 15 baud rates (75 to 19,200)
- cursor addressing
- controllable auxiliary port
- auto repeat
- dual intensity

The smart money is on IQ 120. Call us toll free now for other quantity discounts and delivery dates.

Soroc Technology, Inc.,  
165 Freedom Ave., Anaheim,  
CA 92801, (800) 854-0147,  
In California call (714)  
992-2860.

\* 50 - 99 unit price (1 - 5 unit \$995)

 **SOROC**  
TECHNOLOGY, INC.

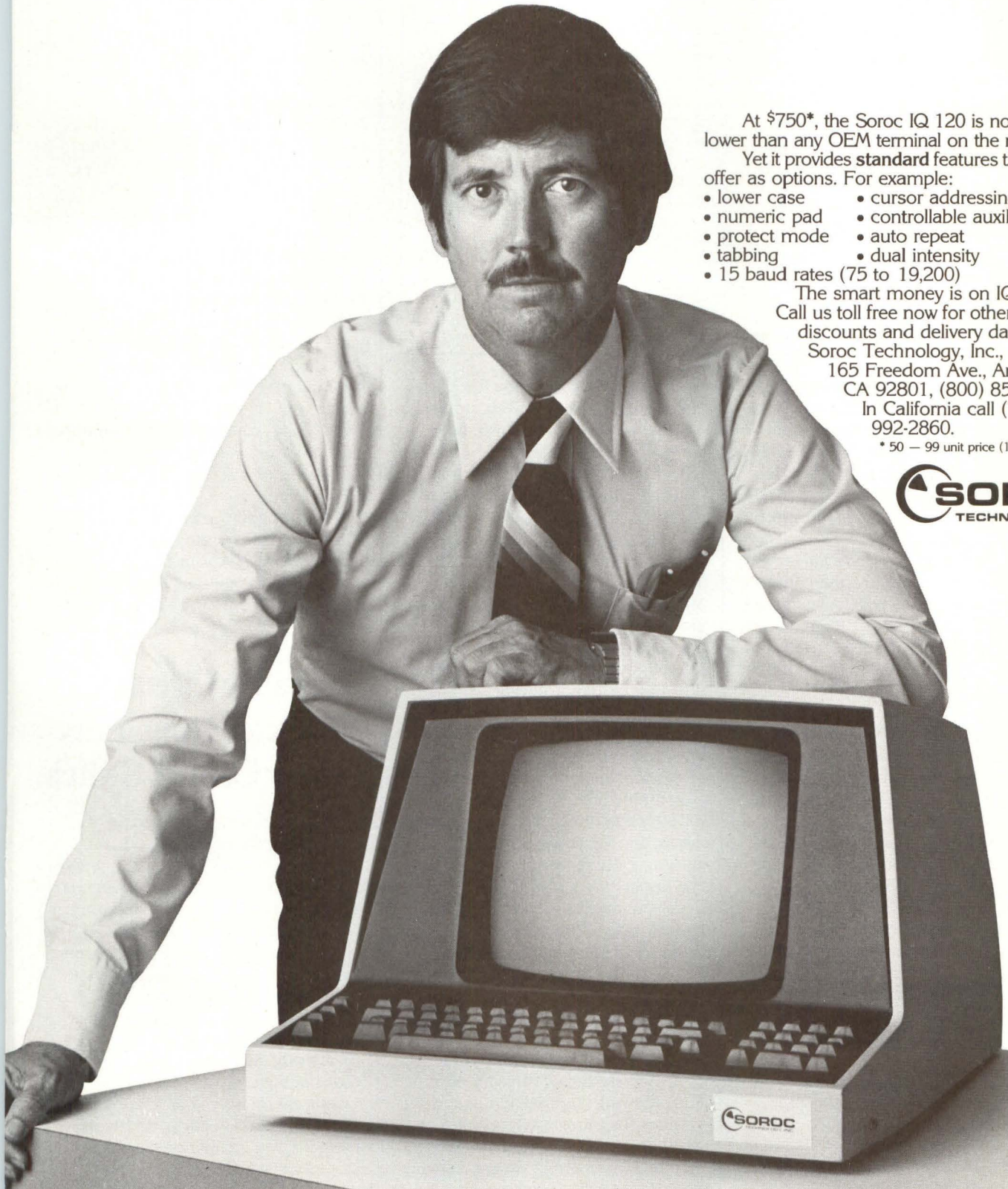

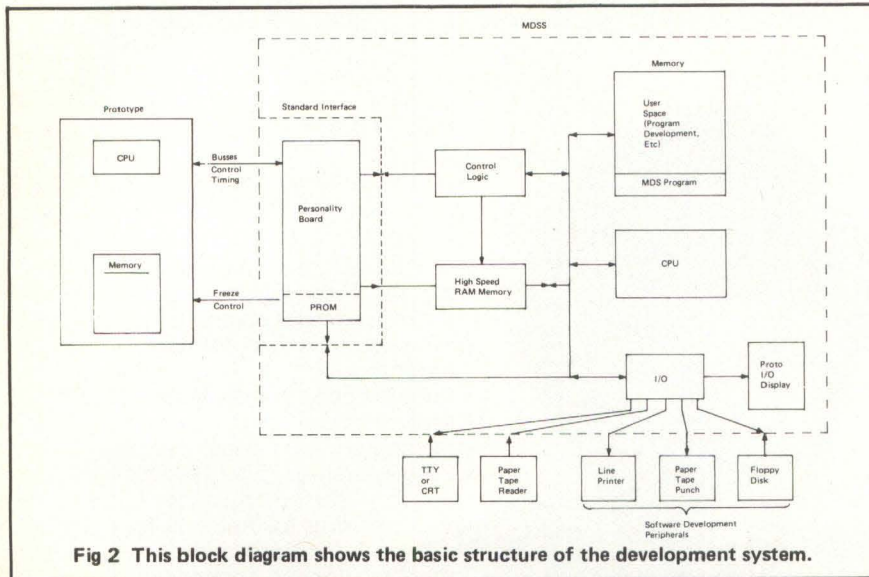

**Fig 2 This block diagram shows the basic structure of the development system.**

Through the use of personality boards, the MDSS can easily adapt to any microprocessor; boards currently available serve the Intel 8080, National Semiconductor's Pace and the Motorola M6800 series. ADL plans to add additional interface boards to handle other microprocessors.

The MDSS features interactive operation; you can monitor and control the operation of the prototype in real-time using a teletype or CRT terminal connected to the MDSS. Curtis says that this allows rapid determination of the running conditions of the prototype under test. You can alter these conditions via prototype program changes (using MDSS commands) and then reexecute the modified program.

Two types of commands assist you when using the development system. Monitor commands allow you to examine the operation of the prototype in real-time under control of the prototype's internal software. Intercommunication commands, also known as Buswatcher commands, allow you to examine or modify data in the prototype memory and registers.

**Typical Operation.** The prototype links to the MDSS via a flat cable, connecting the prototype's address bus and data bus to the personality board. Loading the assembled software into the prototype's RAM activates the prototype hardware. The use of RAM rather than PROM permits immediate corrections to the data or program. Loading can most easily be accomplished

by reading the object code file, existing on paper tape or in mass storage, into the prototype microprocessor memory through peripherals associated with MDSS.

The PUT command loads the program into prototype RAM; you can then use the EXECUTE command to run the actual applications program. The TRACE command causes the MDSS to store each operation of the prototype in high-speed RAM for later retrieval by the MDSS processor, thus allowing uninterrupted real-time operation of the prototype while providing information on as many as 63 sequential prototype microprocessor bus operations. You can review the program in operation after the fact, even if only one run has taken place.

After recording a desired prototype instruction sequence, the MDSS can automatically print out the data, or else display it on a CRT. The print-out or display operation can be controlled by four variations of the TRACE command. A STEP command, following a FREEZE-at-address command, forces the prototype to execute one instruction at a time, thus providing more detailed analysis. The GET command gives you the capability to examine the prototype memory following execution, allowing you to determine whether the correct program is installed and whether the instructions have been modified by incorrect program operation or which data is present in the prototype. You can investigate I/O prob-

lems with the aid of the I/O DISPLAY command; this command causes continuous display of input or output data.

By incorporating suitable electronics, you can also test the prototype while the input ports are exercised, allowing system debugging in a working environment.

Curtis points out the utility of the MDSS: he comments that "with the inevitable proliferation of microprocessor-based products, the MDSS is especially significant and timely. Not only are no two microprocessors of different manufacture alike, but even the same model produced from different sources can diverge in software and hardware performance. For this reason, a universal testing and debugging instrument that accommodates itself to the differences and idiosyncracies of diverse microprocessor systems is a necessity to avoid chaos and the waste of literally thousands of hours of plant and laboratory work. The MDSS was designed, and is offered, with these factors in mind."

For further information about the Microprocessor Development Support System, contact Arthur D. Little, 25 Acorn Park, Cambridge, MA 02140, (617) 864-5770.

## **Magnetic Circuit Protector Doubles as Power Control Switch**

Designers and manufacturers of control and distribution panels for marine and medical equipment, power supplies, data processing, instrumentation and many other systems continually search for smaller, less expensive components that help simplify circuit design, increase packaging density and reduce manufacturing costs, while providing better product life cycle economies for the end user.

With the needs of these manufacturers in mind, Airpax Electronics of Cambridge, Maryland developed the T11, a snap-action magnetic circuit protector that combines overcurrent protection and OFF/ON power switching into one unit. The patented device eliminates three conventional com-



# SUPERSUB.

Substitute high cost disk memory units with our new cartridge disk subsystem and save substantially.

But savings aren't everything.

Even the considerable savings this subsystem offers the OEM, systems house or end user.

We also made sure it's totally compatible.

Plug compatible with DEC's PDP-11 and Data General's NOVA computer systems.

Software and media compatible to prevent loss of

investments in time, effort.

We made sure it meets your needs.

With 5 and 10 megabyte storage capacities. 1500 and 2400 rpm models for tailoring to your applications. Front and top loading models to match current configuration.

And we made sure it's quickly and easily available. No long lead times.

Ready to save?

Call for Supersub!

Our new Data 100 cartridge disk subsystem.

**DATA 100**  
CORPORATION

**Data 100 knows what you want in a cartridge disk subsystem.**



NEWPORT BEACH CA (714) 549-0982 • SANTA CLARA CA (408) 732-1530 • BRAintree MA (617) 848-6100 • SOUTHFIELD MI (313) 358-3984 • EDINA MN (612) 941-6500 • CHERRY HILL NJ (609) 665-5141 • WOODBRIDGE NJ (201) 634-7800 • HOUSTON TX (713) 777-4413 • McLEAN VA (703) 790-5560 • TORONTO CANADA (distributor) (416) 495-0222 • HEMEL HEMPSTEAD ENGLAND (0442) 66511 • BRUSSELS BELGIUM 251•69•72 • FRANKFURT GERMANY 72•04•71 • PARIS FRANCE 630•2144 • MILAN ITALY (02) 659•52•32

CIRCLE 18

# Making power supplies in-house?

## Compare Adtech quality and prices with your honest bottom-line costs.

## You might be happier at our house.

OVER 50,000 HOUR MTBF / U.L. RECOGNIZED AS NOTED.

UNIVERSAL INPUT: 115/230 Vac  $\pm 10\%$ , 47-440 Hz  
No derating for operation at 50 Hz.

AUTOMATIC FOLDBACK CURRENT LIMITING  
AND SHORT CIRCUIT PROTECTION.

IC IS ZENER PROTECTED AGAINST OVERVOLTAGE

CHASSIS DESIGN PROVIDES  
UP TO 40% MORE HEAT TRANSFER  
AREA THAN OTHER MAKES.

INSULATED SHAFT  
POTENTIOMETERS . . .  
(No Humdingers!)  
prevent shorting  
during adjustment.

ELECTROSTATICALLY  
SHIELDED TRANSFORMERS  
reduce noise better than 4 to 1.

Transformers are larger than  
on other makes . . .  
for added reliability.

COMPUTER GRADE CAPACITORS  
rated for 10-year life.

ALL TRANSISTORS AND IC's  
ARE HERMETICALLY SEALED  
(No Plastic types)

INTEGRATED CIRCUIT REGULATION  
AND INTEGRATED DARLINGTON TO-3 OUTPUT STAGE  
simplify circuitry . . . increase reliability.

### 3 Day Delivery . . . 6 Year Guarantee!

# Single Output Microcomputer Power Supplies.

REQUEST BULLETIN APS-277

## 15 TO 24 WATT "RED BARON" SERIES. \*U.L. Recognized (File No. E58512)

MODEL NUMBER	RATING		REGULATION		RIPPLE (PK/PK)	OVP MODEL SUFFIX	PRICES-ALL MODELS		
	Vdc	Amps	Line	Load			QTY	POWER SUPPLY	OVP UNIT
APS 5-3*	5	3	+0.05%	+0.1%	3mV	OV1-53	1-9	34.00	7.00
APS 6-2.5	6	2.5	+0.05%	+0.1%	3mV	OV1-63	10-24	32.20	6.70
APS 12-1.6*	12	1.6	+0.05%	+0.1%	3mV	OV1-122	25-49	30.70	6.40
APS 15-1.5*	15	1.5	+0.05%	+0.1%	3mV	OV1-152	50-99	29.20	6.05
APS 20-1	20	1.0	+0.05%	+0.1%	5mV	OV1-201	100-249	27.00	5.70
APS 24-1*	24	1.0	+0.05%	+0.1%	5mV	OV1-241	250-499	25.20	5.25
APS 28-0.8*	28	0.8	+0.05%	+0.1%	5mV	OV1-281			

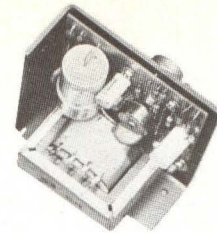

DIMENSIONS: 4"x2.75"x4.87"

## 30 TO 60 WATT "GREEN HORNET" SERIES. †U.L. Recognized (File No. E58512)

MODEL NUMBER	RATING		REGULATION		OVP MODEL SUFFIX	POWER SUPPLY PRICES			OVP PRICES
	Vdc	Amps	Line	Load		QTY	APS 48-1	ALL OTHERS	
APS 5-6†	5	6.0	+0.05%	+0.1%	OV2-56	1-9	68.00	55.00	15.00
APS 6-5	6	5.0	+0.05%	+0.1%	OV2-65	10-24	64.75	52.10	14.40
APS 12-4†	12	4.0	+0.05%	+0.1%	OV2-124	25-49	61.75	49.65	13.75
APS 15-3†	15	3.0	+0.05%	+0.1%	OV2-153	50-99	58.75	47.25	13.05
APS 20-2.4*	20	2.4	+0.05%	+0.1%	OV2-203	100-249	55.75	44.35	12.25
APS 24-2.2†	24	2.2	+0.05%	+0.1%	OV2-245	250-499	50.75	42.00	11.30
APS 28-2†	28	2.0	+0.05%	+0.1%	OV2-284	500-999	49.60	40.00	11.05
APS 48-1*	48	1.0	+0.05%	+0.1%	OV2-481				

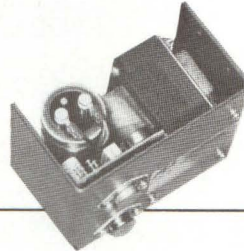

DIMENSIONS: 5.62"x3.40"x4.87"

\* RIPPLE: (PK/PK) 5mV. All others 3mV.

## 50 TO 120 WATT "BLACK BEAUTY" SERIES. \*U.L. Recognized (File No. E58512)

MODEL NUMBER	RATING		OVP MODEL SUFFIX	POWER SUPPLY PRICES				OVP PRICES	
	Vdc	Amps		QTY	APS 5-9	APS 5-12	APS 5-18		ALL OTHERS
APS 5-9	5	9	OV2-510	1-9	71.00	85.00	108.00	75.20	15.00
APS 5-10*	5	10	OV2-510	10-24	66.74	80.55	101.45	71.30	14.40
APS 5-12	5	12	OV2-512	25-49	63.90	76.80	96.70	67.95	13.75
APS 5-18	5	18	OV2-518	50-99	61.05	73.00	91.95	64.60	13.05
APS 12-7*	12	7	OV2-127	100-249	57.30	68.55	86.35	60.65	12.25
APS 15-6*	15	6	OV2-156	250-499	52.75	65.00	79.45	55.80	11.30
APS 24-5*	24	5	OV2-245	500-999	51.60	57.90	77.70	54.60	11.05

REGULATION: LINE +0.05% Load +0.1% RIPPLE (PK/PK): 3mV on 5, 12, 15V models. 5mV on 24, 28V.

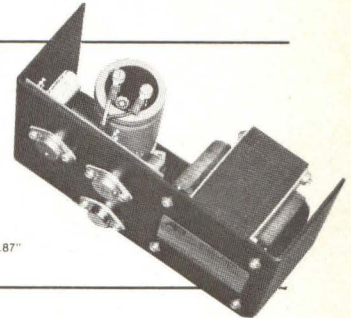

DIMENSIONS: 9"x3.65"x4.87"  
APS 5-18 DIMENSIONS: 14"x3.65"x4.87"

## 125 TO 250 WATT "BLUE MAX" SERIES.

MODEL NUMBER	RATING		REGULATION		OVP MODEL SUFFIX	POWER SUPPLY PRICES			OVP PRICES
	Vdc	Amps	Line	Load		QTY	APS 5-30	ALL OTHERS	
APS 5-25	5	25	+0.05%	+0.0.1%	OV3-525	1-9	163.00	158.00	25.00
APS 5-30	5	30	+0.05%	+0.0.1%	OV3-530	10-24	154.65	149.95	24.25
APS 6-22	6	22	+0.05%	+0.0.1%	OV3-622	25-49	147.45	142.95	23.15
APS 12-17	12	17	+0.05%	+0.0.1%	OV3-1217	50-99	140.20	135.90	22.00
APS 15-15	15	15	+0.05%	+0.0.1%	OV3-1515	100-249	131.65	127.60	20.65
APS 20-11	20	11	+0.05%	+0.0.1%	OV3-2011	250-499	121.10	117.40	19.00
APS 24-10	24	10	+0.05%	+0.0.1%	OV3-2410	500-999	118.50	114.85	18.60
APS 28-9	28	9	+0.05%	+0.0.1%	OV3-289				

RIPPLE (PK/PK): 3mV on 5.6.12.15V models. 5mV on 20.24.28V models.

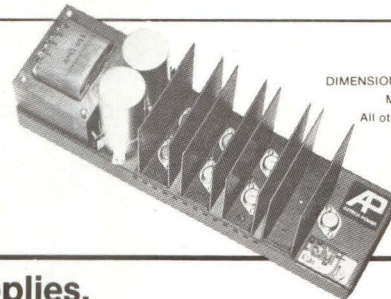

DIMENSIONS: 16.72"x4.87"x6.60"  
Max. APS 5-30 only  
All others 16.72"x4.87"x5.75"

# New Multiple Output Microprocessor Power Supplies.

## DUAL OUTPUT MICROPROCESSOR SERIES U.L. Recognized (File No. E58512)

MODEL NUMBER	RATING		QUANTITY PRICES					
	Vdc	Amps	1-9	10-24	25-49	50-99	100-249	250-499
DAPS 5.8	+5	0.8	43.00	40.70	39.80	38.00	36.80	33.00
DAPS 9-12.5	+9-12	0.5	43.00	40.70	39.80	38.00	35.80	33.00
DAPS 12-7.5	+12	0.75	43.00	40.70	39.80	38.00	35.80	33.00
DAPS 15-6.0	+15	0.66	43.00	40.70	39.80	38.00	35.80	33.00
DAPS 512.5	+5	1.0	43.00	40.70	39.80	38.00	35.80	33.00
DAPS 12-1.5	+12	1.5	59.00	55.90	53.30	50.65	47.60	43.80
DAPS 15-1.3	+15	1.3	59.00	55.90	53.30	50.65	47.60	43.80
DAPS 5312.5	+5	3.0	59.00	55.90	53.30	50.65	47.60	43.80

REGULATION: +0.05% Line, +0.1% Load. RIPPLE (PK/PK) 3mV.

DIMENSIONS: (Small unit) 4"x2.75"x4.87" (Large Unit) 7"x3.40"x4.87"

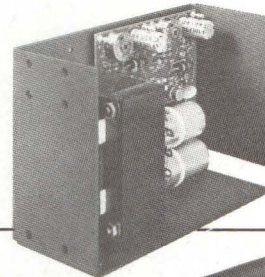

REQUEST BULLETIN DAPS - 976

## TRIPLE OUTPUT "TAPS" MICROPROCESSOR/GENERAL PURPOSE SERIES

MODEL NUMBER	RATING		QUANTITY PRICES					
	Vdc	Amps	1-9	10-24	25-49	50-99	100-249	250-499
TAPS 1	+5V	4.0	94.15	89.20	85.05	80.85	75.90	71.00
TAPS 2	+9-12*	0.5	107.00	101.60	96.85	92.10	89.00	87.50
TAPS 3	+5V	9.0	137.00	129.80	127.80	125.00	123.75	113.85
TAPS 4	+9-12*	1.5	168.00	159.00	151.50	149.00	148.00	147.00

\* Also available with +12-15V output. Specify if desired. REGULATION: +0.1% Line, +0.1% Load. RIPPLE (PK/PK): 5mV

REQUEST BULLETIN TAPS - 377

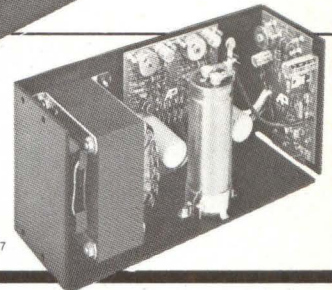

DIMENSIONS: 8.62"x3.65"x4.87" to 15"x4.5"x4.87"

## CALL OUR ENGINEERING SALES OFFICE IN YOUR AREA FOR APPLICATION ASSISTANCE

Arizona, Phoenix (602) 946-9860  
California, Long Beach (213) 426-7375  
San Diego (714) 292-0636  
San Francisco (408) 733-6690  
Colorado, Denver (303) 773-2830  
Connecticut, Meriden (203) 237-9232  
Hawaii, Honolulu (808) 941-1574  
Illinois, Chicago (312) 298-4830  
Kansas, Kansas City (913) 381-0004  
Wichita (316) 264-2662

Massachusetts, Boston (617) 245-0250  
Michigan, Detroit (313) 576-4705  
Minnesota, Minneapolis (612) 854-4270  
Missouri, St. Louis (314) 569-1220  
New Mexico, Albuquerque (505) 294-8408  
Las Cruces (505) 524-0126  
New York, Albany (518) 456-6667  
Buffalo (716) 632-7880  
New York (516) 487-3966  
Rochester (716) 482-3000

New York, Syracuse (315) 637-9383  
Ohio, Dayton (513) 434-8808  
Pennsylvania, Philadelphia (215) 825-9515  
Pittsburgh (412) 961-0414  
Texas, Dallas (214) 387-2489  
Houston (713) 665-0991  
Washington, Seattle (206) 641-3535  
Washington D.C., (202) 363-9417  
Wisconsin, Milwaukee (414) 421-2300

Canada: Montreal (514) 363-5120, Ottawa (613) 745-0541, Toronto (416) 787-0991, Winnipeg (204) 338-5050, Vancouver (614) 748-2392  
In Europe: SOPHIA, Wholly Owned Subsidiary of Adtech Power, 46 BD. Roger Salengro, 78200 Mantes La Ville, France. Tel: 4775301+

Adtech Power Inc., 1621 South Sinclair Street, Anaheim, California 92806, Telephone: (714) 634-9211

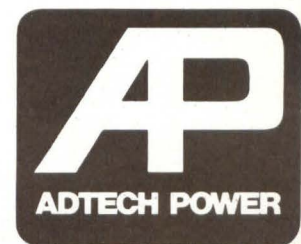

# MICRO or MINI . . . We've Got the Best A/D "Front-End" Module for your computer or system.

**Guaranteed 12-bit accuracy and  
linearity, ultra-stable,  
16-256 channels, throughputs to 100 kHz.  
. . . and the price is right!**

This is the "first family" of multi-channel modular front ends — enthusiastically imitated, but never equaled.

Sure, they're all superficially similar. 16 channels of MUX, buffer, sample-hold, 12-bit A/D converter . . . but after that, it's no contest.

Our microprocessor design (MP6812) gives you relative *and* absolute accuracies better than 0.025%, at a full 30 kHz throughput (faster when short-cycled). And it makes those accuracies *meaningful* with T.C.'s of 3 to 15 ppm/°C. Tri-state output buffers for ease of interfacing. Ultra-flexible: pin-selectable output codes (3), output formats (3), input ranges (4). Cool-running (<1.5 Watts, <8°C rise), EMI/RFI-shielded metal case, low-profile, only 3"x 4.6" x 0.375". Tack on one or more MUX expanders for up to 64 channels. Price? Are you ready? The lowest in the field!

Our minicomputer design (MP6912) is even more impressive. 12-bit throughput, 100 kHz (faster if short-cycled), even lower T.C.'s, 3-Sigma noise <0.01% FSR. Even *greater flexibility: four* output codes, *eight* input ranges,

expansion to 256 channels. Pin-selectable input configurations; single-ended pseudo-differential or true differential. And now there's an *especially* low-priced 75 kHz version that gives you premium performance for less than you'd pay for a pale imitation.

Is it any wonder that Analogic is the leading supplier of A/D and D/A interface hardware to the microcomputer/microprocessor community?

## Get All The Facts.



We'll send you a complete engineering file on the MP6812/6912/expander family, to prove that you can travel first class, with the first family . . . at coach prices.

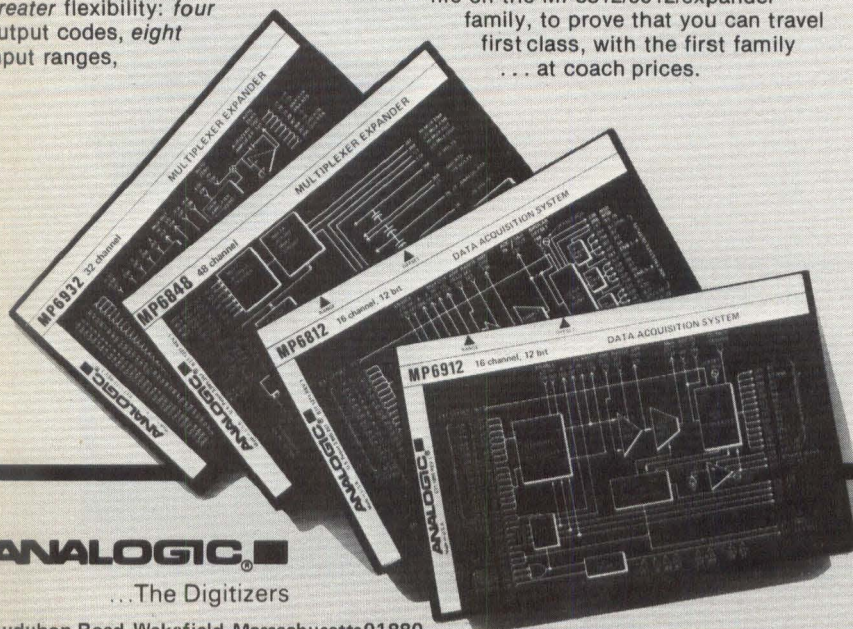

**ANALOGIC**  
...The Digitizers

Audubon Road, Wakefield, Massachusetts 01880  
Tel. (617) 246-0300 / TWX (710) 348-0425 / Telex 94-9307

## TECHNOLOGY TRENDS

ponents: a fuse, a fuse holder and a separate power control switch, plus the necessary wiring to complete the circuit. According to the firm, T11 has the benefits of magnetic circuit protectors — long life, positive resettable operation, high current switching and tailorable delay-to-operate features.

T11 configuration — single pole, single throw series trip with the load being protected, comes with a choice of paddle handle colors. According to Airpax, it's the smallest magnetic protector available, being about one half the size of devices that handle comparable loads.

### How the T11 Works

Through linkage, the paddle handle positions a carrier to initiate both the opening and closing of the switch contacts. In either case, carrier position causes an over center spring to control a movable contact bar.

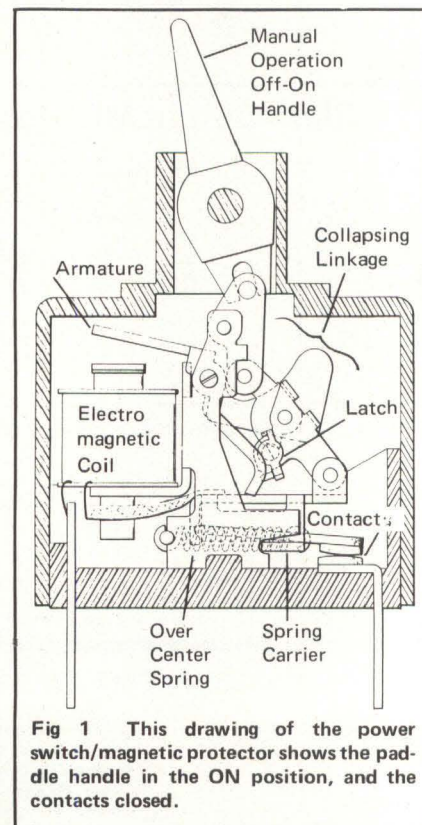

**Fig 1** This drawing of the power switch/magnetic protector shows the paddle handle in the ON position, and the contacts closed.

When opening the contacts manually, the paddle handle position causes rotation of the carrier until the over center spring passes through the horizontal line of the contact bar. Instantaneously, the spring opens the contacts

with a snapping action. Positioning the paddle handle in the ON position reverses the contact snap action.

In the event of overcurrent, the circuit protector responds to open the contacts. An electromagnetic coil senses overcurrent, and attracts an armature; the movement of the armature trips a latch that unlocks the collapsible linkage. Unlatching the collapsible linkage cancels out the ON position of the paddle handle. A spring initiates carrier movement to duplicate contact opening action as previously described.

To reset, after removing the overcurrent situation, you return the paddle handle to the ON position, and the contacts close. Because of the snap action, the T11 contacts can't be "teased" or "kissed." This helps eliminate the problems of arcing and contact wear and erosion to further increase contact life.

An added benefit, useful where loads are dc or inductive, is the quick, wide opening of the contacts. Normally, open switch contact gap is

about 0.010 to 0.015 inch, according to the firm. The T11's open contact gap is 0.280 inch — 20 times as much, permitting the contacts to handle higher currents and increasing contact life.

By selecting specific delays, you can get a choice of trip responses and inrush tolerances. Time delays and therefore the time to trip the latch, brought about by the movement of an iron core in viscous oil, depend on the speed of the iron core movement, which in turn depends on the amount of overcurrent and the oil viscosity (usually silicone oil).

Current rating and trip curves easily adapt for close correlation with the needs of mixed loads, matching them to wiring, PC boards, motors, transformers, lights and other components. The switch/protectors cost under \$5.00 each in quantities of one to twenty-four. Similar savings apply for higher quantity purchases. Airpax Electronics, Cambridge Division, Cambridge, MD 21613.

## Computer to Speed Production of Braille Literature

A GEC 4070 computer and related equipment for use in the production of braille literature will be installed by the Royal National Institute for the Blind in London. Part of a plan that will make RNIB's work in this field the most advanced in the world, the computer equipment will be used in a new printing center to speed publication of a greatly increased range of braille books and periodicals for educational, vocational and recreational purposes, according to the firm.

Operators at 16 text-entry visual display terminals will key in text from English originals. The computer system will directly accept these inputs and translate the data into braille output coded onto magnetic tape cassettes. These are used to control embossing machines which automatically punch the braille characters (called cells) onto zinc plates suitable for use on a printing press. Alternatively, for single copies of a document, the computer can itself drive a paper embosser, thus eliminating the need to manufac-

ture a metal printing plate. The use of visual display units as input terminals gives the operators the facility to edit text on entry. Separate purpose-built refresh graphics display terminals are used to edit the braille cells prior to committing the output to embossed paper or zinc.

The GEC system will replace an existing system which uses punched cards as the text input medium. Contained in the GEC configuration are two GEC 4070 central processors, each with 192 Kbytes of core store, four 4.8/4.8 Mbyte fixed/exchangeable cartridge disks, two 300 lpm line-printers, two 9-track 800 bpi magnetic tape units, four digital input/output devices, two control thermal printers, paper tape station, four cassette decks for braille coded tapes and two cassette decks for maintenance and diagnostic programs.

The GEC system will bring to the RNIB benefits in speed gained through improved editing, economy and throughput.

# Now! Adtech Power Supplies are built in France for fast delivery anywhere in Europe!

The standard OEM power supplies that are the best buy in the United States are now manufactured and sold in Europe by SOPHIA, the wholly-owned subsidiary of Adtech Power, Inc., Anaheim, California, U.S.A.

For product literature, prices and application, contact:  
SOPHIA, 46 BD. Roger Salengro  
78200 Mantes La Ville, France,  
Telephone: 4775301 +

See the Adtech Product listing on the preceding two pages.



WHOLLY OWNED SUBSIDIARY OF  
ADTECH POWER, INC., ANAHEIM,  
CALIFORNIA 92806, USA.

CIRCLE 14

# Choosing Microprocessors For Reduced Parts Counts

by  
Frank Lunch  
and  
Clay Showen

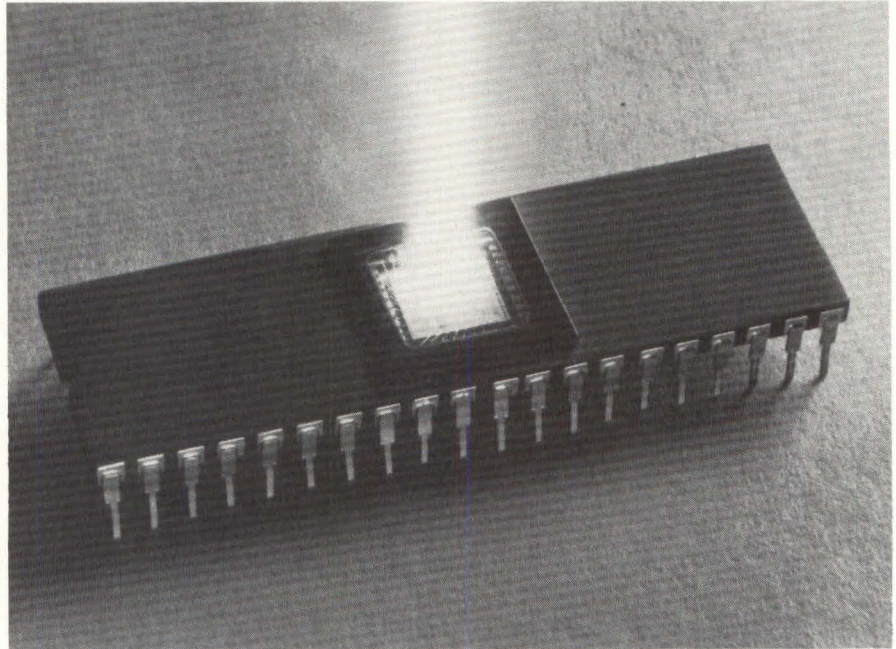

Faced with selecting a microprocessor for a control application, today's designers choose between three alternative devices: a fixed-instruction MOS chip, a bipolar bit-slice chip or a fixed-instruction bipolar chip.

The first alternative, a fixed-instruction MOS microprocessor such as the 8080, was originally developed for low-level applications that do not require high-speed operation. Systems designers have used these chips in controllers, but not without paying the penalty of adding components to overcome the inherent MOS speed limitation.

The second alternative, a bipolar bit-slice microprocessor such as the 2901, was designed to emulate minicomputers. Well suited to preserving existing software, this high-level emulation does little to simplify circuitry for lower-level control applications. To implement the bit-slice device, the designer must not only define a microprocessor architecture, but create an instruction set.

When it comes to high-speed control applications, no microprocessor can match the combination of high-speed performance and ease of implementation offered by the third alternative, the fixed-instruction bipolar chip. While designers recognize more and more the attributes of this single-chip bipolar Schottky device in the controller market, little has

been said about the hidden savings its exceptional operation speed (4 million operations/second) brings to overall system development cost.

Significantly, the operating speed allows several critical functions, which might otherwise be handled with external components, to be performed on-chip. Although the need for fewer parts may save money, the lower parts count during the manufacturing stage provides the major cost savings. Fewer components mean less handling and inventory, reduced assembly and testing, low power consumption and improved reliability.

This microprocessor is ideally suited for numerous control applications, including tape/disk controllers, CRT keyboard terminals and communications concentrators/demultiplexers. Whenever the device satisfies the need to move and interpret data at high speeds, it usually provides savings resulting from reduced parts count.

For example, consider a communications controller. In this case, a fixed-instruction bipolar Schottky device, such as the Signetic 8x300, provides an order of magnitude greater throughput over that possible with a typical MOS microprocessor. The higher baud rates achievable with the 8x300 often allow you to completely eliminate the need for UART's

# Boschert is the new leader in low cost, OEM Switching Power Supplies

—in fact we're price-competitive with linears!

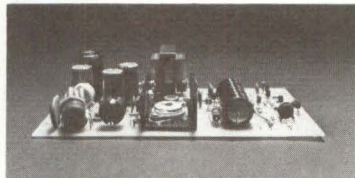

*For example: our 50 watt has 4 outputs, weighs only 14 oz. and costs less than \$100.\* —just right for microprocessors.*

*Our standard switchers produce 50 to 300 watts with 4 to 6 outputs, and protection against short circuit, reverse-polarity and over-voltage is built in.*

*Our state-of-the-art experience with the F-14 and four satellite programs coupled with volume production for corporations like Diablo and Qume insures high quality at low cost.*

*So, if you're in the middle of designing a printer, display, data storage or microprocessor system and you want to save not only heat, weight and space but dollars, then call us collect for the name of the Boschert Sales Engineer nearest you.*

*We're the new leader.*

**boschert**

384 Santa Trinita Ave. ■ Sunnyvale, CA 94086 ■ 408 732-2440

*\*in quantities of 100 or more.*

and baud-rate generators — while substantially reducing the number of interface circuits required.

A similar savings results from implementing a CRT controller with the 8x300; in this case the microprocessor eliminates the UART and keyboard encoder because it handles these functions on-chip.

Let's now examine more closely the hidden economics of microprocessor speed by taking a specific example, such as a double-density floppy disk controller. And let's compare an 8x300 implementation with three alternate approaches.

### Double-Density Floppy Disk Controller

To evaluate the benefits derived from microprocessor speed, compare an actual 8x300 design of a double-density Floppy Disk Controller (FDC) with three other microprocessor implementations, namely: MOS, bi-polar bit slice and standard bipolar TTL.

As the electronic link between a minicomputer and floppy disk drive, the FDC manages disk mechanics, formats data and frees the minicomputer (host processor) from many tasks, such as copy, search and autoretry. Since the introduction of the IBM 3740, the first industry standard, the FDC has become considerably more powerful — both in control features and recording formats. For example, the Shugart

3800 uses a M<sup>2</sup>FM encoding format to double the recording density of the IBM 3740. An advance such as this one places heavy time constraints on FDC design, particularly when you consider that a double-density FDC needs to transfer data at 500 kbits/s, while handling the other routine tasks related to disk subsystem management.

**Design Guidelines.** There are several major time-critical functions that double-density FDC must perform. The response/resolution times dictate the boundaries of our design implementations.

To create a common base for design comparison, first partition the time-critical functions into blocks of minimum complexity. If a general-purpose LSI device can handle the speed/resolution time requirements, then it is likely to provide the least complicated implementation. And if the LSI device is programmable, it probably offers the greatest design flexibility for subsequent product changes without PC board work. Accordingly, we will use discrete components only for those tasks for which speed requires dedicated hardware. Let's now analyze four implementations of double-density FDC with these common guidelines in mind.

As the central controlling element, the 8x300 provides a 250ns instruction execution time that encompasses accessing data and storing the result. Besides handling logical and arithmetic operations, the chip can rotate, mask, shift and merge data during a single instruction cycle. This capability to quickly move data at the bit level minimizes the number of FDC functions (Fig 1) requiring special-purpose hardware.

The processor contains a 8x300 CPU, a RAM for working store, a ROM for the control program and I/O bus control circuitry. Commands received from the host computer and status sent to the host are first buffered in the processor's RAM. The arithmetic necessary to map addresses between the host memory and the sector buffer takes place in the processor. Counters are maintained in RAM for bytes-per-sector, index marks, track position and autoretries. The processor also performs address mark comparison and generates the timing and control signals for the drive mechanics.

The host interface consists of dedicated hardware elements for each of the functions identified. Two Direct Memory Access (DMA) registers contain the address data for transfer to or from the host computer's memory. The address decoder and time control circuits permit the host computer to access the command and status buffers while occupying the bus for only one processor cycle. The 250ns required for a "cycle-steal" greatly simplifies meeting this requirement.

The drive interface demands the most critical timing in the double-density FDC, because the 500 kbit/s disk transfer rate results in a 2μs bit time and a 16μs byte time. These speed parameters determine the sophistication and amount of hardware needed for the drive interface. Whenever the software loop time exceeds the time allowed for a given function, it limits placing the maximum number of functions in software. For example, the command, clock-shift and data-shift registers are double-buffered. To eliminate this second set of buffers, the loop time must not exceed the byte time, and the response must be handled in a one-bit time. Bit detection for the read function and encoding and pre-compensation for the write function operate at a speed substantially less than the bit cell time of 2μs, because the mechanical drive

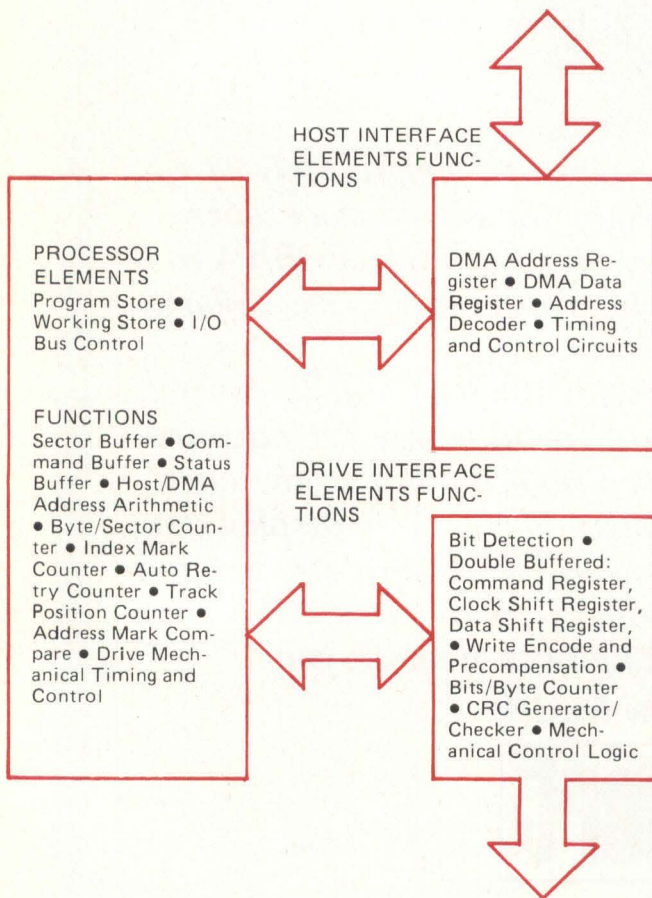

Fig 1 Block diagram of the floppy disk controller shows how the elements and functions for the 8X300 microprocessor are partitioned.



SAFER THAN SEMICONDUCTORS-- MORE POWERFUL  
THAN CCD! --- **FASTER** THAN DISKS!!!

THINK  
OF IT AS  
**SUPER-  
MEMORY!**



**MEGASTORE**  
INSTALL IT ONCE--  
USE IT FOREVER!

**MEGASTORE**  
MEMORY FROM

IS THE DISK-REPLACEMENT  
AMPEX THAT DOESN'T SPIN.

A COMPACT ARRAY OF RELIABLE CORE ELEMENTS,  
MEGASTORE WON'T WEAR OUT, BURN OUT OR LOSE  
DATA WHEN THE POWER FAILS!

AVAILABLE NOW AS DIRECT REPLACEMENT FOR DEC'S RJS0 3/4  
AND DATA GENERAL'S NOVA DISK PRODUCTS.

AVAILABLE WITHOUT CONTROLLER FOR CUSTOM OEM APPLICATIONS.

**AMPEX**

AMPEX MEMORY PRODUCTS DIVISION 200 NORTH NASH STREET  
EL SEGUNDO, CALIFORNIA 90245 213-640-0150

Get a free "Megastore Person" poster by writing us on your letterhead.

CIRCLE 70 FOR NOVA; 71 FOR PDP-11; 72 FOR CUSTOM APPLICATIONS.

does not maintain absolutely constant speed; the transitions which read relative to the bit cell move as a result of the recorded ones and zeros pattern. Moreover, special hardware is provided for the bits-per-byte counter and the Cyclic Redundancy Check (CRC) generator and checker. Logic also interfaces the mechanical control of the drive to the timing and control signals from the processor.

Implementing the double-density FDC with an 8x300 satisfies the design criteria. The arrangement accommodates double-density transfer rate and the host computer transfers its data under DMA control. The FDC performs all the system housekeeping functions, such as autoretry on CRC failure, disk formatting, search and seek commands.

This implementation uses only components currently available from production and requires a single +5V power supply. Support for the microcontroller includes an assembler (MCCAP) and a simulator (MCSIM) for simplifying the design process, while maintaining FDC design flexibility.

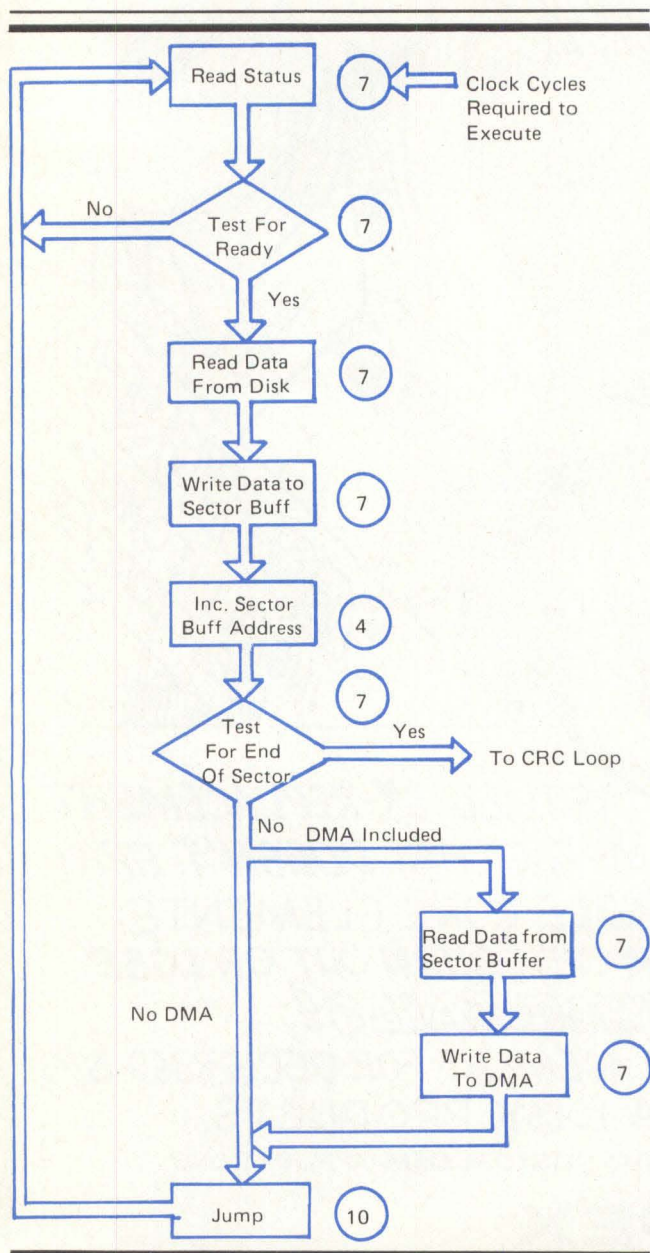

Fig 2 Program loop shows the steps taken by a MOS microprocessor-based FDC in reading data from a disk.

**MOS Microprocessor.** When designing a double-density FDC with an MOS microprocessor, you must begin by carefully choosing the microprocessor for speed and then using some additional MSI devices. The flow chart in Fig 2 shows some of the difficulty in choosing a MOS microprocessor. In transferring data from the disk to the sector buffer, the basic steps include reading and testing the status, reading the data from the disk, writing the data into the sector buffer, incrementing the address preparatory to the next sector buffer access, and testing the address for the end of the sector. If the sector is incomplete, the next byte is read from the disk.

The flow chart shows the simplest possible DMA transfer at this point. Data is read from the sector buffer and written into DMA logic; successive jumps back to the beginning of the loop repeat the process until completion of the sector. At that time, the test for end-of-sector results in a jump to the CRC loop.

The circled figures indicate the number of clock cycles required for a Z-80A, the fastest currently available MOS microprocessor, to go through the loop. With the DMA operation included, the clock-cycle count totals 63. Allowing for the  $\pm 2.5\%$  drive speed variation, the amount of time available to write a byte is  $15.2\mu\text{s}$ . This total requires a 240ns clock period which is lower than the minimum for the Z-80A microprocessor 4 MHz or 250ns clock cycle. Eliminating the 14 clock cycles required for DMA allows the Z-80A to complete the 49 clock-cycle loop.

To implement the DMA function, you must add two address counters for host memory address and internal RAM address, plus some miscellaneous logic to the host interface. The drive interface also requires additional parts to perform the address mark comparison. Other portions of this section are the same as the 8x300 implementation.

For the processor, higher density ROMs and RAMs of the MOS type provide some parts-count economy. In all, the MOS processor implementation requires more dedicated special-purpose logic and therefore results in a higher parts count with reduced flexibility of design. Moreover, a MOS-implemented FDC generally needs additional power supplies beyond the +5V.

**Bipolar Bit-Slice Microprocessor.** In the bipolar Schottky and MOS microprocessor FDCs, the most important single design parameter is instruction execution speed. A bit-slice microprocessor could solve this problem, since its execution time is extremely fast and we could add microprogramming tailored to make the processor perform the functions desired.

Referring back to the elements and functions listed in Fig 1, we find that the speed of a bit-slice processor can reduce special-purpose hardware. In the drive interface, for instance, the two preceding implementations require double buffering of the command, clock and data registers. The bit-slice system requires only single buffering. And while it operates on information at the byte rate, it can respond within a one-bit time. It is not, however, fast enough to operate on all of the information at the bit rate. Consequently, we can eliminate only three of the six registers. This parts count reduction, however, is offset by the complex nature of implementing a multi-chip CPU; the support hardware and software for bit-slice systems are far less available than for single



## HOLD DOWN PROM SOFTWARE DEVELOPMENT COSTS WITH DATA I/O SYSTEMS.

With Data I/O PROM programming systems you can develop and test PROM programs before committing a single PROM.

You simply load your program into the system using the Data I/O PROM Programmer keyboard or remote interface. The programmer system can emulate any commercially available PROM—including MOS.

You can then review the program as many times as you need to check against truth tables, edit or make changes. Once the program is perfect, you can begin programming with the assurance that the first PROM you program will work.

Data I/O Universal Programmers interface with all microprocessor developmental systems.



**HOW TO SELECT  
THE RIGHT PROM  
PROGRAMMER  
FOR YOUR NEEDS.**

### We'd like to tell you more.

This fact filled tabloid gives you valuable information about PROM programming technology. To get your copy, circle reader service number or contact Data I/O Corporation, P.O. Box 308, Issaquah, WA 98027. Phone 206/455-3990.

# DATA I/O

**THE PROM PROGRAMMER PEOPLE.**

chip microprocessors like the 8x300. Programming, or more accurately, microprogramming of a bit-slice system is done frequently at the bit level. Accordingly, the system designer must not only program the bit-slice, but must design the opcode structure to be programmed.

**Standard Bipolar TTL.** An analysis of using standard TTL to implement an FDC leads very quickly to several simple conclusions. First, you can design a very high-speed, special-purpose controller for the floppy disk with TTL, provided that the controller is functionally restricted to simply writing into and reading from the disk drive. It performs functions essential to handling the disk medium — bit detection, serialization/deserialization, address mark comparison, CRC generation/checking and write precompensation/encoding in a manner almost equivalent to that shown in Fig 1.

When the system-oriented functions of DMA transfer begin the task of seeking and searching for data on the disk, disk formatting and autoretry after CRC failure are added to the basic control functions. As a result, the amount of special purpose hardware required to handle these functions approaches some 250 to 300 integrated circuit packages.

The second line of reasoning follows directly from the first. If this mostly special-purpose hardware is unacceptable, then why shouldn't you implement a general-purpose processor using standard TTL to handle all these control functions? Today's available devices can implement these functions most efficiently by using the bit-slice approach just described. And we have already seen that the bit-slice microprocessor is more difficult to implement than the 8x300, because it's a multi-chip CPU that lacks design support.

## The Bottom Line

In comparing the four implementations of the double density FDC, the bipolar Schottky microprocessor becomes a clear choice, because its high-operating speed allows several critical control functions to be handled on-chip. Faster than MOS, and far easier to implement than a bipolar bit-slice device, the 8x300 requires fewer parts to implement a typical control task. From these advantages, you could conclude that the 8x300 suits those applications in which the control processor must function in the data path.

Summarizing the parts count for the basic functions of the four implementations just discussed, we find that the 8X300 approach requires 101 parts; the MOS system requires 116 parts; the bit-slice method requires 105 parts; and discrete TTL requires 160 parts. These parts counts, with the exception of the 8X300, arise from paper designs never implemented. The counts represent minimum estimates likely to go higher when they reach the hardware stage. The major savings in reduced parts count reside more in the manufacturing stage than in the parts cost.

Strictly on a parts count basis, a bit-slice approach may appear to be closely competitive with the 8x300. However, a fixed instruction set 8x300 offers complete design support (MCCAP and MCSIM) for a single-chip processor at a power consumption of only 1.5W. The equivalent bit-slice design, by comparison, spreads over three to four chips, consumes 5W.

*Frank Lunch and Clay Showen are with Signetics, 811 East Arques Ave., Sunnyvale, CA 94086*

## Two New Refreshing Alternatives MEGRAPHIC 5000 & 7000 SERIES

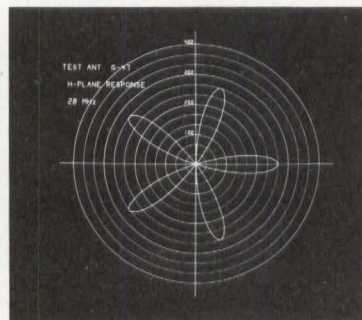
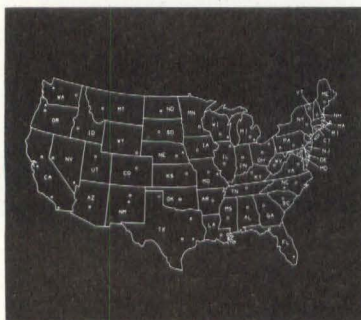
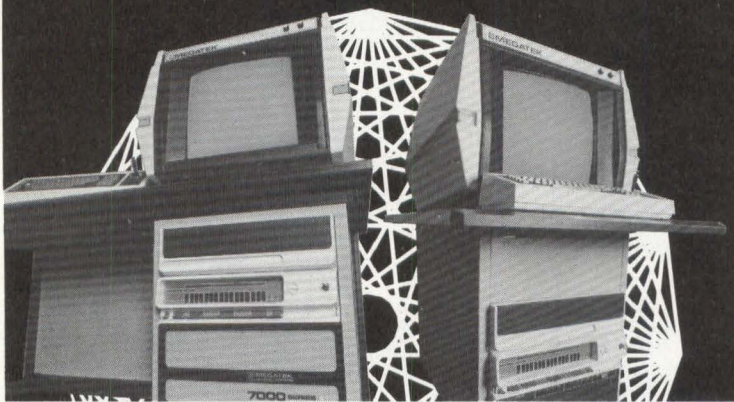

## Dollar For Dollar, The Best Performing, Most Powerful, Intelligent Graphics Systems

### DYNAMIC REFRESH

All MEGAPHIC Systems feature 100% vector refresh. Sharp, bright lines with 12 bits of screen resolution. Individual vectors or symbols can be erased, translated, rotated, or scaled in real-time. No need to blank the entire screen to change one, one hundred, one thousand, ten thousand, or more points!

Local minicomputer power eliminates the host or minimizes its support requirements.

### TEKTRONIX®\* COMPATIBLE

Our 5014 emulates all Tektronix® 4010/4014™ Series storage terminals. MEGATEK's EDS™ adds powerful local edit capabilities, not available on a storage tube.

Easy to use, easy to pay for. Flexible, cost effective systems, backed by MEGATEK engineering and software support. PDP-11, DATA GENERAL, and OEM interfaces available. We listen to your problems and solve them with quality products.



**MEGATEK CORPORATION**  
The Refreshing Alternative™

1055 Shafter Street  
San Diego, California 92106 (714) 224-2721

\*"TEKTRONIX" is a registered trademark of Tektronix, Inc., use of which in no way constitutes endorsement.

CIRCLE 19

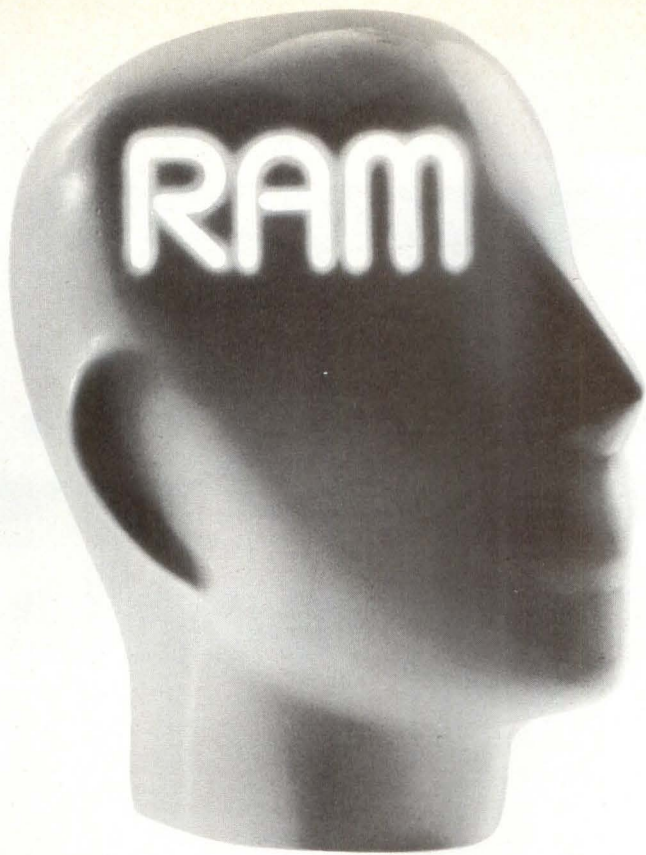

**LOOK!!**  
 we've added to the family  
 fold here

# There are only 2 types of memory. yours and ours.

Ours is the **16K SPACE BYTE**

A fully static, state of the art RAM

**\$599.** Fully assembled, burned in and tested

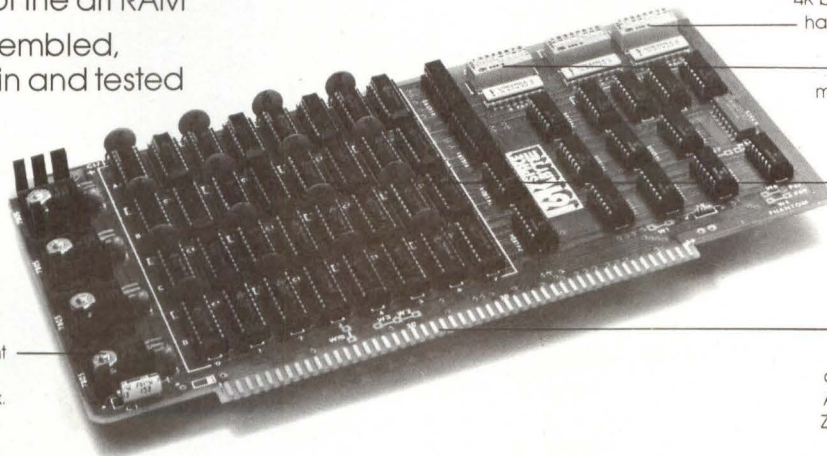

Addressable in 4K blocks at any 4K border by dip switch... as if you had 4 individual 4K static boards

Memory write protect and memory disable (phantom) are controllable in 4K blocks by dip switch

The state of the art TMS-4044 (4K by 1 bit) fully static RAM by Texas Instruments

The all popular S100 bus... The 16K SPACE BYTE is fully compatible with the VECTOR 1, ALTAIR, SOL-20, IMSAI, POLY-88, Z-80, COMPAL-80, and AM-100 (DMA DISK)

Single +8 volt power requirement  
 4 independent 7805 voltage regulators, one for each 4K block.  
 Typical worst case power dissipation is less than 2 amps

CIRCLE 20

# Introducing the SPACE 808 BYTE 808 A self-contained

Two RS-232C serial I/O ports —  
a CRT in one and a printer in the  
other with software selectable  
baud rates

Fully buffered parallel I/O ports  
interface directly with the ICOM®  
FD 3700 or Frugal Floppy disk  
systems

The state of the art INTEL®  
8085 CPU is 50% faster than the  
8080A. It operates at 3MHz, using  
450 ns memory and is fully  
compatible with all existing 8080  
software

Complete 3K system monitor with  
2708\* EPROMs including  
extensive de-bugging, fdos,  
tarbell and video driver routines.  
\*Jumper selectable for use with  
2716 EPROMs for up to 6K of on  
board system monitor

The all popular S100 bus...

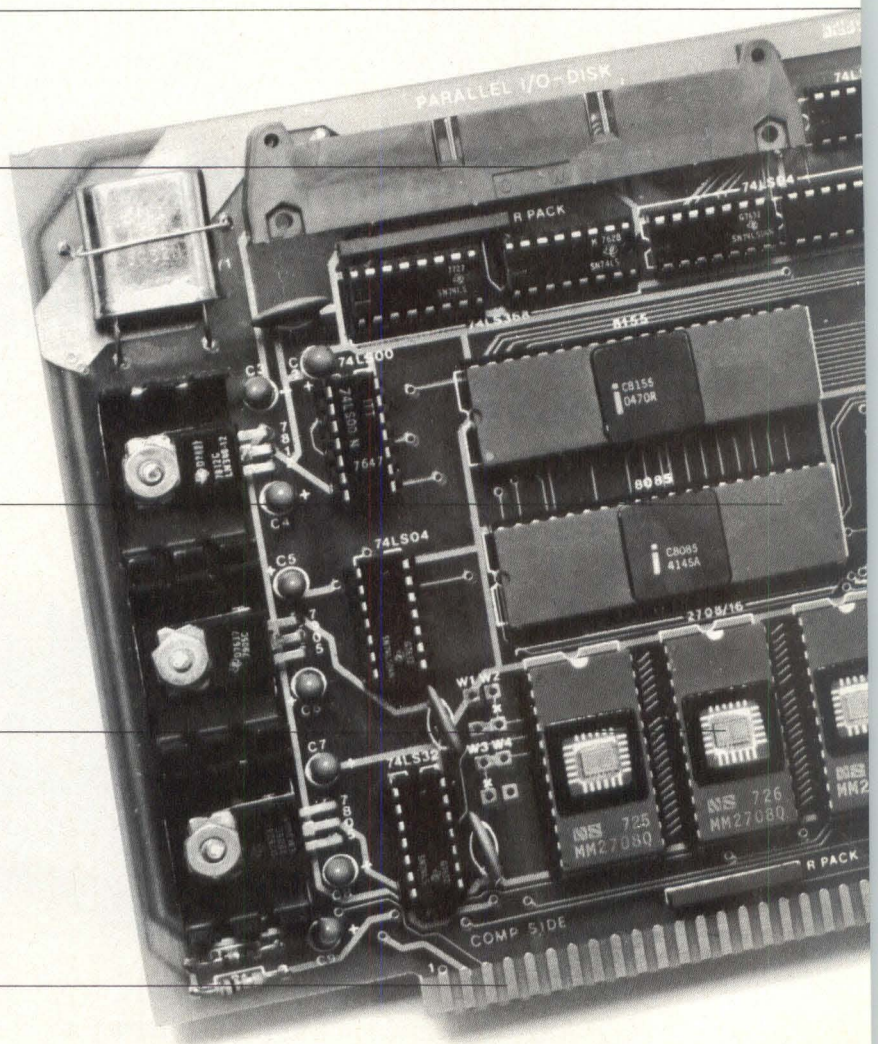

# the CPU ed computer

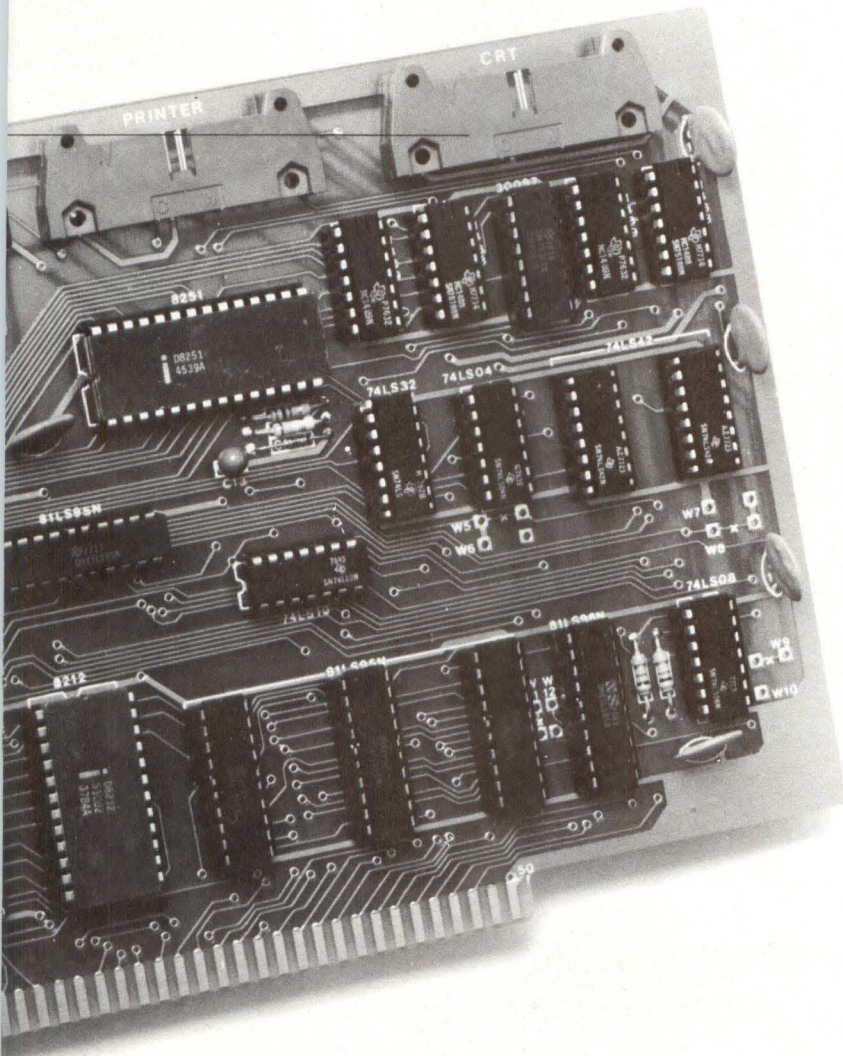
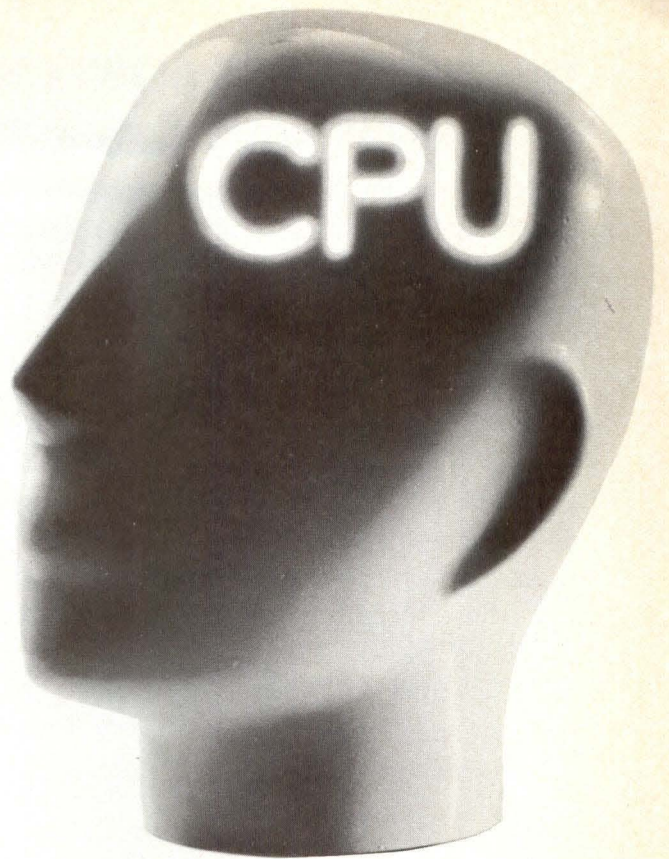

Other features include:  
256 bytes of RAM  
4 vectored interrupts  
programmable 14 bit binary timer/counter  
optional 2708/2716 EPROM PROGRAMMER  
complete dedicated system controller capability  
(see back page)

## \$499.

end user quantity one.  
fully assembled, burned in and tested.  
OEM, retailer and distribution margins available

CIRCLE 21

## The SPACE BYTE 8085 CPU- As the dedicated controller with its own software development system\*

Applications for dedicated system controllers are virtually limitless. The SPACE BYTE 8085 CPU is a complete dedicated system controller because it has full I/O capability, 256 bytes of RAM, 14 bit binary interval timer/counter, 3MHz operational speed and the capacity for 3K or 6K of on board application firmware.

Additionally, the SPACE BYTE 8085 CPU will serve as the heart of its own software development system when installed in a S-100 type mainframe. With the optional SPACE BYTE 2708/2716 EPROM PROGRAMMER, application firmware can be developed and tested on the very device for which it was conceived.

By inserting programmed EPROMS in the sockets on board the SPACE BYTE 8085 CPU, the dedicated controller can now be tested "as itself," while still installed in the S-100 mainframe.

The SPACE BYTE 8085 CPU and increments of 16K SPACE BYTE fully static memory offer perhaps the most innovative, versatile and cost effective software development system in the industry.

**The SPACE BYTE 8085 is:  
a self contained computer  
a software development system  
a dedicated controller**

\*A complete software development system requires in addition to the SPACE BYTE 8085 CPU; RAM (such as the 16K SPACE BYTE); an EPROM programmer (such as the SPACE BYTE 2708 2716 EPROM PROGRAMMER); floppy disk system; CRT; line printer; and mainframe.



THE SPACE BYTE CORPORATION

1720 Pontius Ave. Suite 201 Los Angeles, California 90025 (213) 468-8080

SPACE BYTE microcomputer products are now available at computer retailers everywhere.



# CAN CORE SURVIVE ?

by Alton C. Shimp

The core versus semiconductor debate continues. Despite the introduction of a variety of new technologies for semiconductor memory, core still appears in most minicomputer, and some microcomputer systems. Will core stay with us in the

Many comparisons between core and semiconductor memories have skewed performance, reliability and even pricing data. Fortunately, valid comparisons between the two technologies are possible. This article highlights the principal characteristics of core and semiconductor memories as they affect system performance by presenting 'hard' data drawn from the test laboratory and actual field reports. This data demonstrates that when price, performance and reliability comparisons are made between equivalent core and semiconductor memory systems, the competitive edge goes to core. Core memories will remain a viable technology into the 1980's because of continued reductions in cost, improved performance, proven reliability and its established production capability.

Semiconductor memories are inherently volatile. Following a power interrupt, it is often inconvenient and sometimes impossible to reload the information lost from memory. A similar situation would not affect data stored in a core memory because it can be powered down either catastrophically or routinely for an indefinite period without loss of data. In contrast, semiconductor memories must overcome the volatility disadvantage by using internal batteries to back up the primary power source. While operating on back-up power, data protection is limited and the battery power cannot be disconnected for system maintenance purposes.

Battery back-up for a small memory system can add considerable expense. Commonly used low cost lead-acid or high cost nickel-cadmium rechargeable batteries require battery charging circuits; both battery types have high failure rates when compared to other electronic components. Batteries also tend to demonstrate 'charging history' effects.

future? We present one perspective in this article: that core memory will remain a viable technology into the 1980's because of improved performance, proven reliability, established production capability and continued cost reductions.

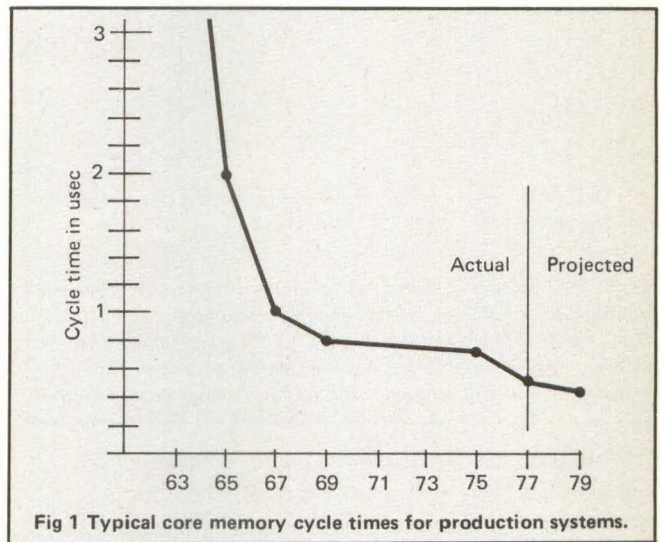

Fig 1 Typical core memory cycle times for production systems.

The cost of a battery back-up option to a user of a typical 16K x 18 memory can range from \$200 to \$250, providing back-up power over a period of a few hours to a day. However, frequent intermittent power failures can still cause a memory failure by not allowing sufficient time for batteries to recharge. Memories requiring long storage times need larger, more costly, remotely mounted batteries. One alternative to a battery back-up system would be the use of a core memory system to store key data from the semiconductor memory system while it is powered down.

Dynamic semiconductor memories store ones and zeros as a charge or absence of a charge in the cell capacitor. Even when MOS devices with low leakage currents are used, the capacitors must be frequently refreshed, thus requiring addi-

tional refresh circuitry. Typically, each cell in a 4K RAM is refreshed every two milliseconds simultaneously at 64 addresses; thus refresh circuitry must perform 64 refresh cycles every two msec. At a cycle time of 470 nsec, 30.08  $\mu$ sec out of every two msec are required just for the refresh function. For a different ratio of addresses to the refresh rate, the efficiency loss of larger memory chips may be greater. Extra refresh circuitry usually consists of a counter, refresh address register and OR gating to the input address lines of the memory chip.

Leakage current approximately doubles for every 10°C. Most dynamic semiconductor memories have their maximum refresh rates specified at 70°C; at 90°C the refresh rate required for a dynamic RAM is four times the rate of 70°C. Thus, for the typical 4K RAM described above, the refresh rate would be 500  $\mu$ sec at 90°C instead of two msec. This further reduces the over-all efficiency and greatly limits the use of dynamic semiconductor RAMs in military environment temperature ranges.

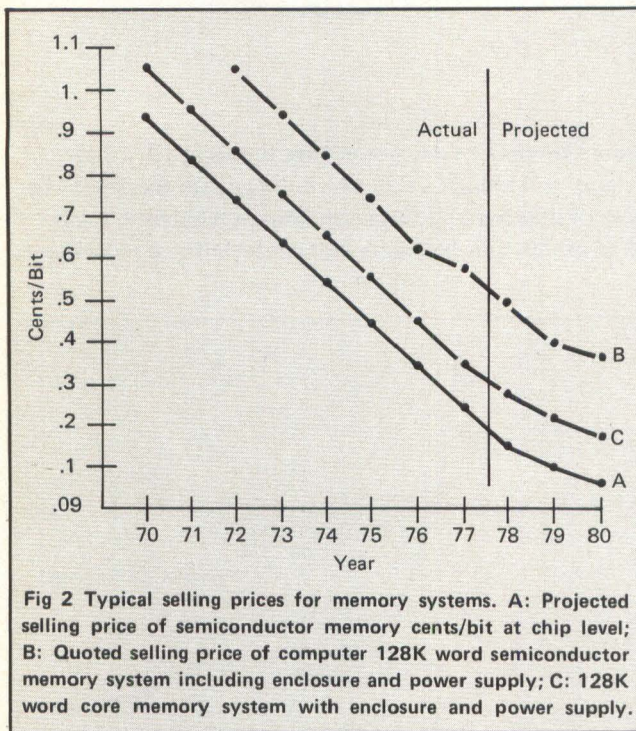

Fig 2 Typical selling prices for memory systems. A: Projected selling price of semiconductor memory cents/bit at chip level; B: Quoted selling price of computer 128K word semiconductor memory system including enclosure and power supply; C: 128K word core memory system with enclosure and power supply.

**Reliability.** A significant problem with semiconductor memories has been their relative lack of reliability in comparison to core memories. This can best be illustrated by using the data given in MIL-HDBK-217B. For integrated circuits MIL-HDBK-217B takes into consideration such factors as system environment, manufacturing learning factors, junction temperatures, chip complexity, packaging factors and quality factors.

According to MIL-HDBK-217B, the failure rate for integrated circuits is:

$$\lambda = \pi_P \pi_L \pi_Q (C_1 \pi_T + C_2 \pi_E)$$

where  $\pi_P$  is the packaging factor and depends on the number of pins,

$\pi_L$  is the learning factor,

$\pi_Q$  is the quality factor,

$\pi_T$  is the junction temperature factor,

$\pi_E$  is the system environment factor,

and  $C_1$  and  $C_2$  are the chip complexity factors.

A typical specification for a semiconductor memory might be: operation at 55°C junction temperatures, commercial grade, hermetic packages, system environment of fixed ground equipment (GF), 24-pin dual-in-line packages and an established chip design (i.e. one which has been in continuous production for more than six months). For this example the failure rate calculation is shown below:

$$\lambda = \pi_P \pi_L \pi_Q (C_1 \pi_T + C_2 \pi_E)$$

$$\pi_P = 1.1$$

$$\pi_L = 1.0 \text{ (for the chip designs } \pi_L = 10)$$

$$\pi_Q = 150$$

$$C_1 = .3$$

$$\pi_T = 1.2$$

$$C_2 = .12$$

$$\pi_E = 1.0$$

$$\lambda = 79.2 \text{ failures / } 10^6 \text{ hours}$$

For a typical 16K x 18 dynamic RAM system requiring 72 4K RAMs, the MTBF would be 175.36 hours for the RAM chips alone. (This calculation excludes the refresh circuits, timing, battery back-up, power regulators, and the circuits required to drive the memory chips.) In comparison, a typical core memory system that includes peripheral interface circuitry and a power supply has a calculated MTBF of approximately 600 hours.

Core memories always have the reliability edge when direct comparisons to semiconductor memories are made because the toroid core storage element retains stored information until it is physically damaged. While screening can enhance the quality factor of 4K semiconductor RAMs, screening can also enhance the reliability of the semiconductors used in core memories. For military applications, the choice of fully qualified RAMs is presently limited to the JM38510/23501, 4K RAM.

Unlike core memories, semiconductor memory pattern sensitivity is not well defined. Core memory worst pattern noise, commonly referenced as delta noise, has been well established and is reliably tested. For semiconductor memory, worst case patterns vary from design to design, and even from vendor to vendor on identical designs. Semiconductor memories often approach obsolescence before complete testing information is derived.

To circumvent the semiconductor memory worst pattern identification problem, checking programs have been established that check all combinations and interactions of addresses and read/write sequences. Examples of some of these so called 'N<sup>2</sup>' patterns include Galloping Pattern, Ping Pong, Walk Pattern and Galloping Write Recovery. These test programs insure that pattern sensitive memories are eliminated no matter what the pattern may be; however, they are very time consuming. The N<sup>2</sup> dependency indicates that test time is proportional to the square of the number of memory bits, which means a 16K RAM takes 16 times longer to test than a 4K RAM. As an example, using typical 4K and 16K RAM chips with a 0.47 microsecond cycle time, it takes approximately 84 seconds for a 4K RAM and 22.4 minutes for a 16K RAM to run one Galloping Write Recovery pattern.

N<sup>2</sup> testing thus becomes impractical for medium/large scale RAMs except on a sample basis, leaving the 'N' patterns — such as Checker Board, Double Checker Board

# Our first SBC 80 compatible systems for 1977!

Visit us in Booth 121-123,  
Mini/Micro 77  
December 6-8, Anaheim, CA

## 4K to 64K RAM Up to 8K EPROM on one board

Now you can have RAM and EPROM on the same board and buy as much or as little memory as you need. And because our memories use 16 pin memory element sockets you can change your memory when you change your mind.

Speaking of changing your mind, when you want to change address locations of either RAM or EPROM, it's done with two, on-board switches—providing 16 possible start locations for each memory.

Compare these features with our much improved read, write and refresh cycle times and you'll choose MSC first.

## 16K RAM Version

Up to 16K × 8 of RAM and up to 8K × 8 of EPROM on the same board.

RAM expandable in 4K × 8 increments and EPROM expandable in 1K × 8 or 2K × 8 increments.

On-board DIP switches to select any of 16 address start locations for RAM and 16 address start locations for EPROM.

Cycle times:  
Read, 350 nsec.  
Write, 500 nsec.  
Refresh, 500 nsec.

Totally SBC 80 and Intellec MDS hardware and software compatible.

Limited one year warranty on parts and labor.

Delivery 30 days ARO.

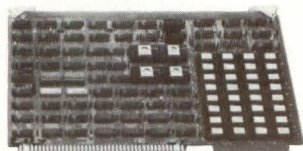

MSC 4602

## 64K RAM Version

Up to 64K × 8 of RAM and up to 8K × 8 of EPROM on the same board.

RAM expandable in 16K × 8 increments and EPROM expandable in 1K × 8 or 2K × 8 increments.

On-board DIP switches to select any of 16 address start locations for RAM and 16 address start locations for EPROM.

Cycle times:  
Read, 350 nsec.  
Write, 500 nsec.  
Refresh, 500 nsec.

Totally SBC 80 and Intellec MDS hardware and software compatible.

Limited one year warranty on parts and labor.

Delivery 30 days ARO.

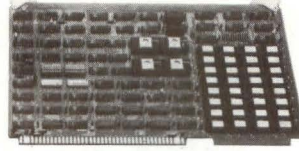

MSC 4502

## Beginning firsts

Beginning with compatible memories, Monolithic Systems will continue to introduce SBC 80 systems with features which are firsts.

First to take advantage of the latest technology. And first in reliability, value and delivery.

You can be among the first, when you call us for SBC 80 compatible systems.

**SBC 80 compatible systems... from the first.**



Monolithic  
Systems corp.

14 Inverness Drive East  
Englewood, CO 80110  
303/770-7400

Intellec is a registered trademark of Intel Corporation.

© 1977, Monolithic Systems Corp.

and Marching — as the only practical production testing modes. Unfortunately, many so called 'soft' errors, i.e. pattern sensitive errors, can pass undetected, yielding an increased failure rate of the basic memory. If you add error correction to the semiconductor memory system to correct these 'soft' errors, the failure rate of the 'hard' errors increases because of the added support electronics required. Hard errors are those catastrophic errors which are detected in all patterns.

As chip size increases, catastrophic defects that cause 'hard' errors become more likely. Current lithographic techniques limit MOS RAM chip size to 40,000 to 50,000 square mils; as design layout features and spacings become smaller, this chip size limit will probably decrease because smaller defects will produce 'hard' errors. The growth of memory size beyond 4K requires new layout techniques, for example, the double poly processing technique used on most 16K RAM designs. Relative reliability comparisons are difficult with these new techniques, although it is unlikely that these new techniques will enhance reliability.

Some defects in semiconductor memories, such as oxide contamination, do not show up immediately, but are time/temperature sensitive. Because latent defects in MOS designs are more prevalent than in bipolar designs, MOS memory has relatively higher failure rates.

**Error Correction.** To reduce the failure rate of semiconductor memory systems, designers have resorted to error detection and correction techniques that add a 'check bit' word to each memory data word. For single bit

memory bits required, error correction requires a parity, or hamming code generator for the check bit word, an error code detector and an error logging memory. Error correction can add 40% or more to the hardware costs of the semiconductor memory system.

Users must also review the error log periodically to determine if errors were non-recurrent pattern susceptible, or catastrophic chip defects. You must identify and remove the problem chip; otherwise the probability of multiple bit errors, which are not correctable, increases. This is not required with core memory; error correction is unnecessary.

Error correction causes some degradation in performance. During a read cycle, the check bits generated during a write cycle are checked, the data bits are checked, and then an error code is generated. If there is an error, the error code identifies the erring bit, automatically complements it using an exclusive OR gate, and logs the error in the error logging memory. Typically, read access time increases by 50 nanoseconds when using error correction.

With error correction techniques, the semiconductor memory failure rate is relatively independent of the storage devices themselves. Failure modes occur in the peripheral memory circuitry, refresh, power supply and in the error correction logic itself. This also holds true for core memory systems except that error correction is not required; in core memories, the failure rate is relatively independent of the storage devices themselves; failure modes again consist of failures in the core memory peripheral circuitry and power supply.

**Table 1 Failure Rates in Core Systems**

Memory Size Customer	2K	4K	16K	32K
A	143,000			
B		192,000		
C			93,000	
D				74,000

A = 12,636,000 unit/hours of field operation.

B = 576,000 unit/hours of field operation.

C = 1,861,200 unit/hours of field operation.

D = 1,109,056 unit/hours of field operation.

**MTBF (Hours)  
CORE MEMORY SYSTEMS**

error correction, a five-bit check word is required for each 16-bit data word, allowing you to check both the data word as well as the check word for single-bit errors. The formula for the number of required check bits is  $2^C - C \geq D + 1$ , where C is the number of check bits, sometimes called hamming parity bits, and D is the number of data bits. You can see that the shorter the data word, the larger the percentage of required check bits: an eight-bit data word requires 50% redundancy for error correction.

By adding another check bit, you can perform double bit error detection with single bit correction. A 16-bit data word thus requires a total of six check bits; the additional bit sums the parity of the check bit plus the odd parities of the data word bits. The state of this error summing parity bit shows whether the error is a single bit correctable or a double bit non-correctable error. In addition to the extra

### Future Trends

According to Electronic Engineering Times, April 4, 1977, present lithographic techniques will not allow RAMs larger than 65K; this may even hold for the 65K RAMs. 'Minor' variations in processing, such as the use of double poly silicon, were employed in making the transition from 4K to 16K to keep chip area within bounds. To go from 16K to 65K and beyond requires major changes.

Electron beam exposing with plasma etch will almost certainly be needed to keep pace with the closer tolerances needed for new smaller cell requirements. The transition to these new techniques will probably take longer than the transition from 1K to 4K. Thus, future price reductions (for the next 3-5 years) in semiconductor RAMs may slow as the learning curve on the 4K and 16K chips flatten, and the 65K RAMs undergo production/engineering problems.

Over the past 25 years, a consistent set of techniques evolved for both the production and the testing of cores and core systems. Nomenclature, test methods, core chemistry and design techniques passed between and among the various core memory suppliers result in industry standardization. Core specification presently allows interchangeability at the stack level and temperature ranges, current compensation, disturb ratios, switching/peaking times and signal outputs are consistent enough to allow the system designer multiple sourcing on the core array. This second sourcing is more independent than that often found in the semiconductor industry with their mask interchanging. If the primary design had faults, the second source will probably have the same faults.

# SAVE 80%

on PDP-11/70 main memory with Dataram

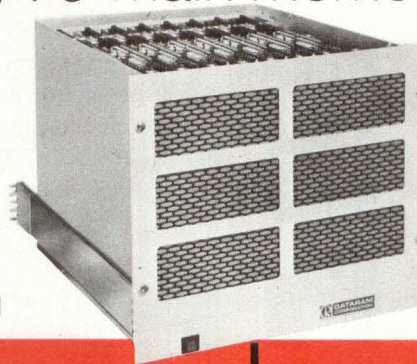

## BULK CORE

1024K x 18  
(one megaword)  
PRICE COMPARISON

DEC				DATARAM			
Qty	Item	Unit Price	Sub-Total	Qty	Item	Unit Price	Sub-Total
1	MJ11-BC 256K word (512KB) system	\$ 55,500	\$ 55,500	1	BC-417 chassis and accessories	\$ 3,400	\$ 3,400
3	MJ11-BG 256K word (512KB) additional	53,240	159,720	8	128K x 18 (256KB) additional	5,140	41,120
			\$215,220				\$ 44,520

Source: Datapro, February 77

$$\text{SAVINGS} = \frac{215,220 - 44,520}{215,220} = \frac{170,700}{215,220} = 79.3\%$$

### You read right!

Dataram's BULK CORE provides a dramatic main memory alternative for PDP-11/70 users. BULK CORE system BC-417 interfaces to DEC's 11/70 Memory Bus, and is completely compatible with DEC's MJ11 series of core systems.

The BULK CORE BC-417 system is offered in a 15 3/4" chassis with a minimum configuration of 256K x 18. It can be expanded in increments of 256K x 18 to a maximum of 1024K x 18 (one megaword).

**BULK CORE. An economical, exciting ... and proven alternative.**



PRINCETON-HIGHTSTOWN ROAD  
CRANBURY, NEW JERSEY 08512  
TEL:609-799-0071 TWX:510-685-2542

I'd like to learn more about BULK CORE for my PDP 11/70

- Please send information  
 Please have a salesman contact me

I'd also like to learn more about BULK CORE for my  PDP-11  Nova

Name \_\_\_\_\_

Title \_\_\_\_\_ Phone \_\_\_\_\_

Company \_\_\_\_\_

Address \_\_\_\_\_

City \_\_\_\_\_ State \_\_\_\_\_ Zip \_\_\_\_\_

Please send me information about Dataram's ADD-ON/ADD-IN memory for minicomputers.

PDP and DEC are registered trademarks of Digital Equipment Corporation

Canada: Tracac Electronics Corporation, Ontario/Quebec/British Columbia • Belgium/Luxembourg/Netherlands: Synelec Information Systems, (02) 647-67-12 • France: YREL, 950-2224 • Italy: Telcom, s.r.l. 422-8646 • Sweden/Finland/Norway: Teleinstrument AB, 08-380370 • Spain: Aupoca, (01) 457-53-12 • Switzerland: Interrest AG, 031-224481 • United Kingdom: Sintrom Ellinor Ltd., (0734) 85464 • West Germany/Austria: O.E.M. Elektronik GmbH, 0711-798047 • India: Industrial Electronic Instruments, 79281 • Israel: K.D.M. Electronics Ltd., (03) 58232 • Japan: Matsushita Electric Trading Co. Ltd., (03) 435-4552 • Australia/New Zealand: Anderson Digital Electronics, (03) 543-2077.

# MASS STORAGE CONTROLLERS FOR INTERDATA® COMPUTERS

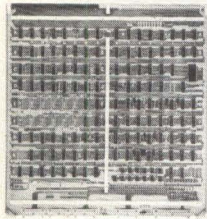

**TDC803  
CALCOMP  
TRIDENT**

1 to 4 drives/controller  
25 to 1200 MB online  
OS/16 and OS/32 support  
Limited one-year warranty

**\$1710**  
(at 10 per year)



MiniComputer  
Technology

2470 Embarcadero Way • Palo Alto CA 94303

\* Reg. TM. PERKIN-ELMER CORP.

**CIRCLE 25**

MiniComputer Technology

Core system testing has evolved to where the worst patterns (i.e. the patterns of 'ones' and 'zeros' in the core array that generate maximum noise or minimum operating margins during interrogation) are clearly defined for virtually all configurations and sense winding schemes. Half select read currents (called x/y currents for 3D designs and word/digit for 2½D designs) generate this pattern noise. When any core is coincidentally selected in a core array, these half select currents disturb a group of cores along either of the two coincident drive lines. Because the patterns that add the most noise to a 'zero' signal and subtract the most noise from a 'one' signal are identified, you can take steps in the design and production phases of the core element to reduce this effect.

In recent years, reductions in the amount of inherent delta noise (half select output of 'one' cores minus the half select output of 'zero' cores) and full select 'zero' noise, along with tightly controlled compacted packaging techniques, have contributed to the wide current margins of

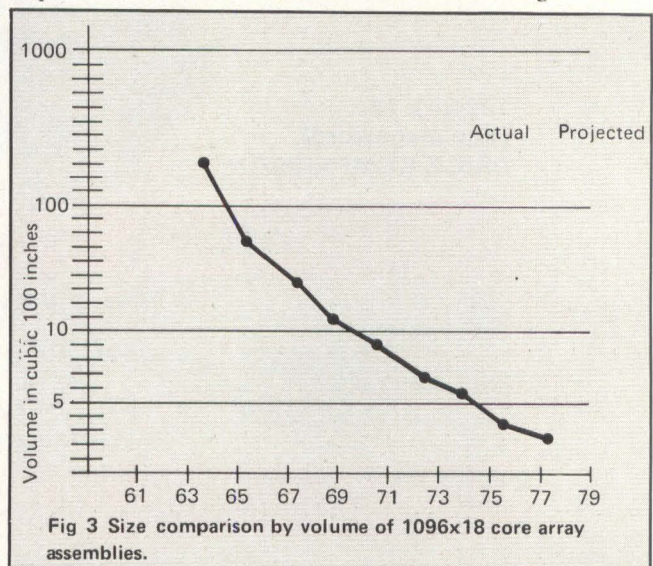

Fig 3 Size comparison by volume of 1096x18 core array assemblies.

present day core memory systems. The reduced delta noise and new packaging techniques make possible the low cost 16K and 32K sense lines in new designs. Development stage testing now includes checking delta noise and minimizing it. A laboratory test that ran nineteen 16K semiconductor memories for 28 days on a 24 hours a day basis, yielded an MTBF of 1160 hours; a concurrent test using eight 16K core memories showed no system failures.

Table 1, based upon documented field data provided by Fabri-Tek customers, shows MTBF's for core memory systems. These systems include core array, sense amps/drives, timing and control circuitry and address and data registers for either 16 or 18-bit memories.

Semiconductor memory selling price projections are easily misinterpreted, unless translated into complete memory system costs to the O.E.M. or user for a specific application. RAM memory pricing, primarily projected at the component or chip level as some fraction of cents per bit, can be misleading until you consider a detailed analysis of associated cost factors at the system level. For example, in a process control application requiring 128K words of memory with an enclosure, power supply and error correction and detection, the projected semiconductor price of .1 cents/bit at the chip level may end up as high as .4 cents/bit. Fig

**Up, up  
and  
away...**

**with SEC  
Hardware and  
the LSI-11**

**PRODUCTS INCLUDE:**  
Computer Packaging,  
E-PROM, CAMAC  
Interfaces, Prototype  
Modules, Multi-port  
Memory, etc.

**MODULE OF THE MONTH:**  
4 Channel Isolated Triac  
Output on Dual size board.

**Write or call (415) 657-7555**

**STANDARD ENGINEERING CORPORATION**

4400 Industrial Drive - Fremont, Calif. 94538 - 415 657-7555

\* Trademark Digital Equipment Corp.



**CIRCLE 26**

Another first for ISS

# THE INDUSTRY'S FIRST "SMART" FIXED MEDIA DRIVE

Announcing another in a long line of industry first's from ISS—the EFF 735—the first disk drive of its kind ever to employ an on-board microprocessor.

The advantages of microprocessor power in a disk drive are impressive. Complete internal drive diagnostics. Simplified circuitry because most analog circuits are eliminated. No field adjustments—ever. And a lot more, including microprocessor controlled routines that ease the load on the controller and the mainframe.

The EFF 735 gives you 353.8 megabytes on a single spindle using a fixed and sealed disk. There's one spindle per drive and each drive has its own internal power supply and air filtration system. Average access time is 23 milliseconds.

With our fixed head option, you get another 1.26 megabytes and zero access time.

Besides the microprocessor, the EFF 735

gives you a sweeping lineup of operating and maintenance features. A single phase motor. Dual port capability. A completely electronic tachometer. Total modularity of subassemblies. And truly outstanding serviceability, with no field adjustments and no requirement for special tools—one of the big reasons why your total cost of ownership is exceptionally low with the EFF.

EFF stands for Expandable File Family. The 735 is the first member of this new ISS family, later versions of which will have even greater capacities and capabilities. And all versions will be field upgradable so you can increase performance as your needs increase.

ISS is an operating unit of Sperry Univac bringing technological leadership for the generations ahead. For more details on the new EFF 735, write or call OEM Marketing, ISS, 10435 N. Tantau Avenue, Cupertino, California 95014, telephone (408) 257-6220.

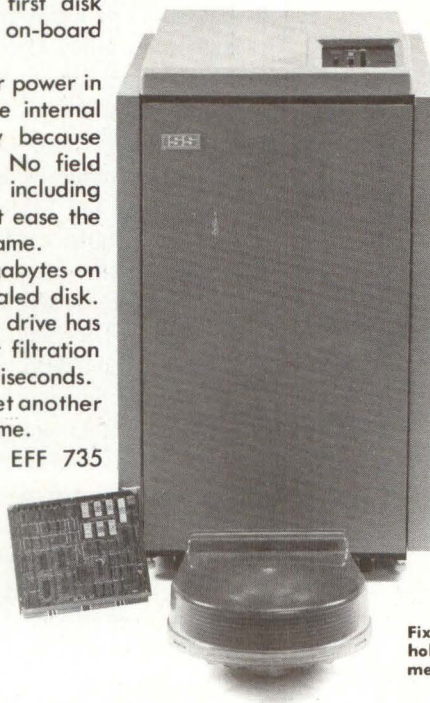

Microprocessor makes it a "smart" drive.

Fixed disk pack holds 353.8 megabytes.

**EFF 735. The first "smart" disk drive.**

**SPERRY  UNIVAC**

Sperry Univac is a Division of Sperry Rand Corporation

CIRCLE 27

## New! Model 640 Low Cost\* Loader Reads 350 Characters per Second

All solid state photo-electronic components.  
Reads all standard 5,6,7 or 8 level tapes.  
Smooth, quiet, AC drive.

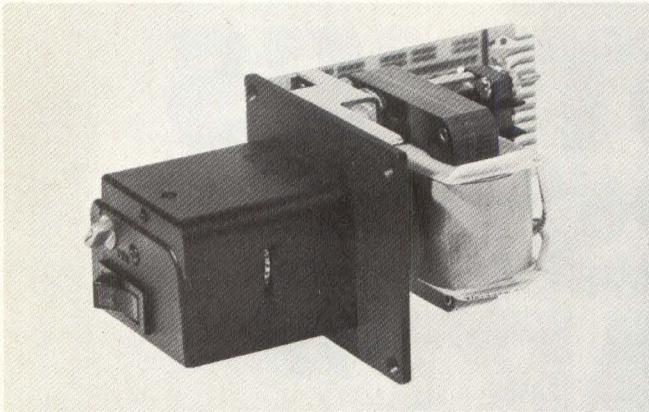

Provides reliable, high speed data entry. Data amplifiers and "character ready" output available for CMOS or TTL interfaces. Fanfold box available.

The Model 640 is the newest addition to the Addmaster line of quality paper tape equipment.

\*Only \$166-189! (1-49 units; substantial quantity discounts available.)

Addmaster Corporation, 416 Junipero Serra Drive, San Gabriel, California 91776. Telephone: (213) 285 1121.

CIRCLE 28

## BJ-4 Desktop Computer

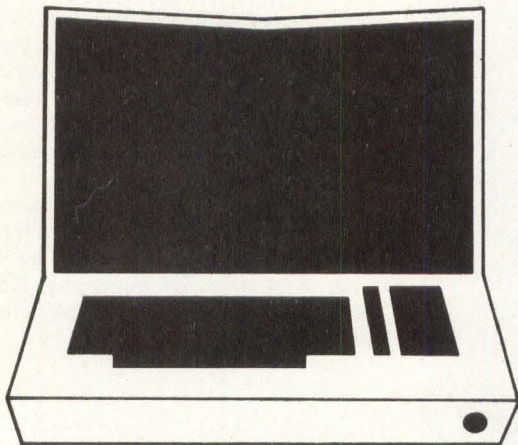

FROM \$3449.00

Intelligent  
Terminals

Turnkey  
Systems

Powerful  
Basic



**MOHR LABS INC.**

Route Four Fish Hatchery Road Madison, WI. 53711  
Phone: (608) 271-5380

CIRCLE 29

3 shows typical semiconductor and core memory prices for 128K word memory systems.

The past twenty years show dramatic improvement in the development of core memory products. The predominant core types in the late 1950's and early 1960's were 80 mil and 50 mil cores. Technological advances and improved manufacturing techniques made during this period laid the groundwork for future core memory designs.

Thirty and 20 mil cores were developed during the mid 1960's; these cores were used primarily in 3D, 4-wire systems. In the late 1960's, the 20 mil core emerged as a predominant core type. System cycle times improved by more than an order of magnitude; 1.0  $\mu$ sec became a common performance characteristic. Planar arrayed core systems were developed in the early 1970's with the 18 mil core predominant. The 3D, 3-wire organization became the standard memory architecture; sub-1.0  $\mu$ sec systems now appear on the horizon.

Today's core memories, best characterized as 16K x 18, and 32K x 18, planar arrayed pluggable modules cycle in 550 to 650 nsec and access 225 to 250 nsec. Containing a single or double sided planar core array, the electronics within these core modules are highly integrated and feature sophisticated multi-layer circuit boards.

Core memories of tomorrow will use cores made from better materials and manufactured by improved processes; 13 and 14 mil cores will enable designers to further increase the packaging densities of systems and improve performance. Work will continue on the development of 10 mil cores and there will be new types of both low drive temperature stable cores. Additional work will realize the development of partial switching techniques along with further investigation of multi-state cores. Core arrays that package 100,000 bits in a fraction of a cubic inch will be developed, memory system electronics will continue to become more integrated as MSI and LSI technologies mature, and higher performance 16K and 32K modules will become available; slower-speed modules of 65K and 128K are also imminent.

Core memories will remain a viable technology into the 1980's because of continued reductions in cost, improved performance, proven reliability and established production capability. They will continue to thrive in applications where high reliability and nonvolatility are major considerations. The process control marketplace, with its harsh environmental conditions and its need for continuous operations, will use core memories to meet its requirements; point-of-sale systems and other on-line applications requiring a permanent data base will continue to use core memories. Core memories will replace drums and disks, thus improving the cost/performance ratios of both large and small computing systems.

As the applications for microprocessors develop, so will new applications for core. Microprocessor memory will not be the exclusive domain of the semiconductor memory because core memories will be used as the microprocessor memory in those applications where high reliability and nonvolatility are required.

Alton C. Shimp is Engineering Manager for OEM Memory Products at Fabri-Tek Inc.



# NATIONAL ANTHEM



A Review of New Products and Literature from

National Semiconductor • No. 4

## 65 K static ROM features high speed, low power

We call it the MAXI-ROM™: 8192 × 8 bits of static, fully decoded, read-only memory with an access time of 800 ns maximum. And because our MAXI-ROM has timing requirements identical to those of static RAMs, you need only one clock for both RAM and ROM store.

Officially called the MM4235/MM5235, this new mask programmable metal-gate MOS ROM is an n-channel device and operates from a single 5-V supply. Its inputs are TTL compatible, as are its Tri-State®, OR-tie-compatible outputs. Further, the MAXI-ROM has three programmable chip-select inputs for easy, wire-OR'd memory expansion.

Right now, all of this comes to you in a 28-lead package; shortly, look for another version of the MAXI-ROM in the 24-lead 2316E pin-out. ☐

## 3½-digit DPM on a single chip

Okay—you've asked for it, now you've got it. We proudly announce our ADD3501/ADD3701 and ADD3511/ADD3711 DPMs-on-a-chip. While the 3501 is intended for instrumentation-type uses, the 3511 is designed to interface with microprocessors. With its addressable BCD outputs, the 3511 is ideal for MPU-based system A/D uses and is the first of its kind available in the industry.

The results of an extensive survey of your DPM needs, the ADD3501 and ADD3511 incorporate just about everything you've told us you want.

To start with, we've put it all on a TTL-compatible, single CMOS chip that runs from a single 5-V supply (45 mW drain) and requires only two external parts—a reference and a digit driver. By switching external resistors you get two scale ranges: ±0.1999 V and ±1.999 V for the ADD3501, or ±0.3999 and ±3.999 for the ADD3701 (ideal for electronic weight scales, azimuth indicators, and so on), and to an accuracy of one count from 0° to +70°C.

And these units are National proprietary designs that use pulse modulation A/D conversion techniques, rather than dual-slope techniques. This method of

conversion eliminates precision external components, and lets you use a single reference voltage of the same polarity as the input signal. The use of a single, isolated power supply for the whole DPM, by the way, allows the conversion of positive and negative voltages. The ADD3501/ADD3701 automatically outputs the proper sign and, also automatically, displays +OFL or -OFL in case of an overrange situation.

You can use either an external RC network or an external signal source to control the DPM's on-chip clock (100-640 kHz), which in turn sets the conversion rate to  $64,256/t_{in}$  conversions per second. The digit multiplexing is synchronized with the A/D conversion timing to eliminate noise from power supply transients.

Other features of the ADD3501/ADD3701 are a FET input circuit, which draws an analog input current of only ±0.5 nA; a Start Conversion input and a Conversion Complete output; and a seven-segment LED drive for jitter-free displays to 0.5 inch. Our NSB5388, described in this issue, is a perfect companion for the 3501; and we've got a 3¾-digit display that's an ideal display-mate for the 3701, too. ☐

## Cutting it fine: a 4-bit bipolar MPU slice



The IDM2901A is a 4-bit microprocessor slice intended to be used either alone or cascaded in central processing units, programmable microprocessors, peripheral controllers—in fact, wherever high-speed applications demand economy, software/hardware flexibility, and easy expansion. Its building-block architecture and microinstruction format permit the IDM2901A to emulate most digital-based systems.

A low-power-Schottky part, the 40-pin IDM2901A features a multiple-address architecture, which improves system speed by providing simultaneous yet independent access to two working registers. Its multifunction ALU performs addition, two subtraction operations, and five logic functions on two source operands; for every ALU function, the IDM2901A selects data from five source ports for a total of 203 source

operand pairs. And because left/right shifts are independent of the ALU, an arithmetic operation and a left or right shift are obtainable on the same machine cycle.

The IDM2901A has four status functions with carry, overflow, zero, and functional sign available as outputs. And it's microprogrammable, too, with three 3-bit groups for source operand, ALU function, and destination control.

The IDM2901A chip carries a 16-word by 4-bit two-port RAM, a high-speed ALU, and all required shifting, decoding, and multiplexing circuits. And it's fast. In fact, our IDM2901A is the fastest 2900-type MPU you can buy. We've proved it, and so can you. Check the IDM2901A's data sheet, then try the part itself. We're sure you'll like it. ☐

A Review of New Products and Literature from National Semiconductor

A

## Voltage regulators —we have 'em

Innovative technology, quality of the highest order, competitive and better-than-competitive pricing, and minimum-lead-time delivery—these have made National the Number One supplier of linear circuits.

Our voltage regulator family is a good example of our leadership position. Already the most complete three-terminal regulator line in the industry, it's still growing, as this chart shows:

### POSITIVE REGULATORS

#### Fixed

LM123	- 3.0A
LM140	- 1.5A
* LM140A	- 1.5A
LM141	- 0.5A
LM142	- 0.25A
LM140L	- 0.1A
LM78XX	- 1.5A
LM78MXX	- 0.5A
LM78LXX	- 0.1A

#### Variable

LM117	- 1.5A
* LM150	- 3.0A

### NEGATIVE REGULATORS

#### Fixed

LM145	- 3.0A
LM120	- 1.5A
LM120M	- 0.5A
* LM120ML	- 0.25A
* LM120L	- 0.1A
LM79XX	- 1.5A
LM79MXX	- 0.5A
* LM79LXX	- 0.1A

#### Variable

* LM137	- 1.5A
---------	--------

The products marked here with an asterisk either have been introduced very recently, or will be available very shortly. Our LM140A/LM340A, for example, has performance unmatched by any other manufacturer, with nearly perfect line (0.06 %/V) and load (0.5 %/A) regulations and is fully spec'd at 1.0 A—not at 0.5 A. The LM340, in fact, has improved specs—right to the military limits—and slips into any 78LXX socket to give superior performance at no increase in cost.

Then there are the LM120ML/LM320ML (0.25 A) and LM120L/LM320L (0.1 A), negative regulators that complement the positive regulator versions, and which offer optimal price performance.

Two other bright new stars in our regulator galaxy are the LM150/LM350—a high power (3 A) version of our LM117/LM317, which was the industry's first adjustable regulator—and the LM137/LM337, which is an adjustable 1.5-A negative regulator that complements the LM117. We've improved reliability by 100 per cent burn-in test-

## New in PACE family: n-channel, 16-bit MPU

Our INS8900 microprocessor is intended for applications which require the efficiency of a 16-bit word length, yet it is priced the same as many 8-bit microprocessors.

Housed in a standard 40-pin ceramic DIP, the INS8900 is built with n-channel silicon-gate technology. It's a true 16-bit CPU with 16-bit instruction words and 16-bit data words, all handled by a powerful, efficient, and flexible set of 45 instructions.

The single-word 16-bit format of the instructions reduces memory accesses and program storage requirements. And because it can operate on both 8-bit and 16-bit data words, the INS8900 extends its efficiency and power to 8-bit applications as well.

Features of the new MPU, for which a full family of peripheral circuits is planned, include multiple addressing modes, four general-purpose accumulators, byte and word processing, common memory and peripheral addressing, six hardware vectored priority interrupts, a ten-word stack, four control flag outputs, three sense inputs, four I/O control strobe signals, a single-phase 2-MHz clock, and low-power-Schottky-compatible outputs. And all of this is yours at a high-volume pricing of less than \$10. 

## TO-92+ dissipation —pinned down

Many of you have been asking to see a comparison of the power dissipation capabilities of three popular packages—the molded TO-92+ and TO-92, and the metal TO-39. In answer to these requests we present the following chart, which shows what you can expect in actual use on a PC board.

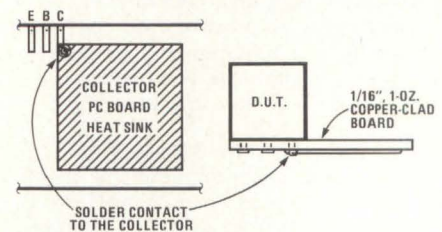
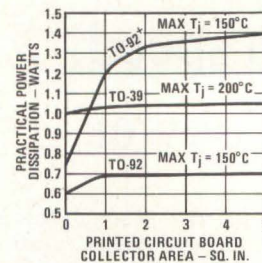

We are pleased to point out that our TO-92+ power devices lead the pack; so pleased, in fact that we're adding these curves to the TO-92+ data sheets to complement the SOA and thermal de-rating curves already present. 

## Our 80/10: alternate source, lower cost

National has entered the microcomputer marketplace with the introduction of our Series/80 BLC 80/10—a self-contained computer-on-a-board. The central processor, system clock, RAM/ROM store, I/O lines, serial communications interface, bus drivers and logic... all on a 6.75 × 12-inch PC board.

Our 80/10 is an alternate source for the Intel product—but at a price lower than Intel's. The lower price results not only from our automated assembly procedures, but also from a major use of our own components—something Intel cannot match.

The CPU, for example, is our own INS8080A; the 1K × 8 static read/write capability, our MM2711 RAMs; up to 4K × 8 read-only memory, our MM2708 PROMs or MM2308 ROMs; two INS8255

programmable interface circuits provide 48 I/O lines; an INS8251 US/ART; Teletypewriter<sup>®</sup> and RS232 interfaces; provision for up to six interrupt request lines; etc., etc.—you get it all.

And supporting the BLC 80/10 card itself is an army of other Series/80 cards: RAM boards, ROM/PROM boards, DMA boards, I/O boards, memory and I/O expansion boards, prototyping boards; and coming very shortly, full Series/80 systems and firmware.

With National as an alternate source, the 80/10 microcomputer emerges as the *de facto* industry standard. So get on the bandwagon today. Ask for our Series/80 literature. See what you've been missing—and how much you'll be able to save. 

ing, so these parts will reduce your inventory requirements and standardize packaging, while improving your system's performance.

Finally, there's our LM79LXX—a new regulator for negative, low-current ap-

plications, which we test to 100 mA (versus only 40 mA for competitive parts); even with only a 0.1-μF output compensation capacitor, this unit retains its excellent transient response, line regulation (0.07 %V<sub>o</sub>/V, max.), and load regulation (0.01 %V<sub>o</sub>/A, max.). 

## Active filters, anyone?

National now has an extensive line of standard active filters. While many of these filters are intended for general purpose use up to 100 kHz, there is also a new family intended specifically for telephone equipment.

In the general purpose line our AF99, for example, is a tunable (60 to 270 Hz) high Q, band pass filter with a user-strappable bandwidth option of 2.5 to 5.0 Hz. Because it is also usable as an oscillator, the AF99 comprises a complete tone generating and receiving system in a single package—excellent for 2-wire tone-activated systems.

Our AF100 is a universal active filter that needs only four external resistors to program it for specific second-order functions. It features simultaneous and separate low pass, band pass, and high pass outputs; and independent Q (to 500), frequency (to 10kHz), and gain adjustments. The AF100 may be cascaded to realize higher-order systems. (In fact, we have a new filter to make that job even easier: our AF151, which combines two AF100s in a single package.) And the AF150—the newest member of our filter family—is a high-frequency version of the AF100, with operation extended to 100 kHz and the  $Q_{fc}$  product increased to 200,000.

Then there's our AF120—a generalized impedance converter. Adding one external capacitor to this device turns it into the gyrator-equivalent of a grounded inductor; paired AF120s form ungrounded inductors or inductor networks. Two external capacitors turn the AF120 into a frequency-dependent negative resistance. In short, with appropriate transformations the AF120 makes it possible to realize any low-frequency ladder filter network.

Finally, we have a group of filters intended specifically for telephone transmission systems. The AF132, for example, combines transmit and receive filters in one package, and is for use in digital PBX equipment. The AF130 (transmit) and AF131 (receive) filters, on the other hand, are high quality, fifth order, elliptic low pass units intended for high-quality PBX and PABX equipment or D3 Channel Bank use. Yet another step up the chain are our premium, central-office quality AF133 (transmit) and AF134 (receive) filters. These allow you to meet all AT&T 2- and 4-wire specifications as well as the CCITT international specs for PCM exchange equipment. All these filters meet the stringent requirements of the telephone industry, and satisfy all considerations of size, environment, life, and cost. ■

# APPLICATIONS CORNER

## Seven-segment to BCD—the easy way

Many popular devices output multiplexed seven-segment information. If you want to analyze such information, or store it, process it or route it, it is more efficient and easier to do if you first convert to a BCD format. Unfortunately, most of the articles that have appeared on this subject in the trade press have presented methods that are expensive, or complicated, or both. Unfortunately, too, the interface problem has aggravated the situation. Thus, the use of calculators, clocks, counters, and A/Ds as number crunchers, real-time clocks, and inexpensive converters has been discouraged. But now, we're pleased to point out, the situation has changed.

It has changed because of our MM74C915—a CMOS seven-segment-to-BCD converter. This part holds, on one chip, all the circuitry you'll need for level shifting, decoding, latching, busing, and even error detection.

The MM74C915 accepts either positive-true or negative-true inputs. It decodes only legitimate seven-

segment characters, allows for variations on the characters one, six, and nine, and gives you an error output when illegitimate characters are present. Its on-chip latch simplifies de-multiplexing a display; the outputs are TTL compatible; and the inputs are MOS compatible without a clamp diode to  $V_{CC}$ . And you can use the Tri-State® data outputs for direct data-bus interfacing; there's even a minus-sign output useful in program branching.

With a single MM74C915 you can interface a nine-volt calculator or a watch chip to a five-volt MPU; you can store data in half the memory space, route it with a mux half as wide, process and analyze it twice as efficiently—all without the loss of the price or low parts count of a MOS seven-segment device.

In fact, it's so easy to use and solves so many problems that whenever you think of the seven-segment LSI world, you should also think about the MM74C915. ■

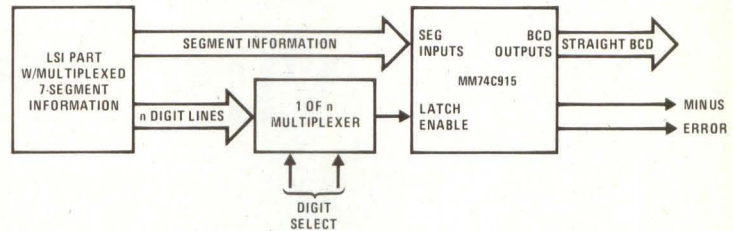

Multiplex 7-Segment to Straight BCD

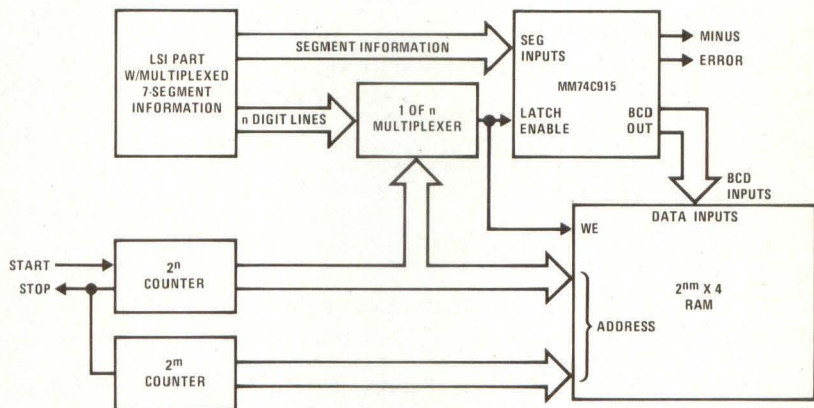

Memory Expansion from 7-Segment Outputs

## 3½-digit, 0.5-in. high LED display

Intended for digital instrumentation applications—power supply readouts, multimeters, panel meters, etc.—the NSB5388 is a common-cathode multiplexed display with separate access to the decimal points and  $\pm$  signs. It is

directly compatible with our ADD3501 DVM chip (story on page 1).

Electrical specifications include a typical light intensity of 1.6 mcd and forward voltage of 1.7 V. ■

## Chip set for processor systems

We have a pair of CMOS/LSI circuits that we've dubbed LPCS—which stands for Low-power Programmable Calculator Set. The pair consists of the MM58101 (a Control ROM Element, or CRE), and the MM58102 (a Memory and Processor Element, or MPE). The two chips form a processor with an eight-bit instruction/four-bit data word architecture.

The LPCS turns out to be ideal for any and all controller/timekeeping applications that demand a low-cost, micro-power processor—electronic door locks and security systems in general, toys and games, telephone interconnect devices, battery operated instruments and control systems.

The LPCS directly drives seven-segment, six-digit liquid-crystal dis-

plays (with decimal points), and interfaces to 40-position keyboards. An on-chip 32.768-kHz oscillator provides not only all clock and control signals required for the LPCS to operate as a processor, but a 1-Hz program-controlled interrupt function as well.

A key feature of the set is its single-mask programmability: the 2048 × 8 ROM is mask-programmable to your own application requirements, and you talk to it via a set of 39 standard instructions.

Other features of the MM58101/MM58102 LPCS include operation from a single -3 V supply, an on-chip doubler to drive liquid-crystal displays, a general purpose output port, and three program-controlled I/O ports. ☐

## Pressure transducers: what you need when you need it—at the right price

When it comes to pressure transduction we have the devices you need. If you're involved with hydraulic controls, medical instrumentation, machine monitoring, flow control, chemical analysis, etc. in the industrial, automotive, medical, or process control fields—among others—remember this: Our unique transduction method, our manufacturing skills, and our *in-touch* application-oriented designs combine to guarantee you production volumes of the most advanced, reliable, and cost-effective true IC pressure transducers you can buy.

Four years ago we published the first transducer catalog of any usefulness to transducer users. Since then, National has become a world leader in the field. Now we've made this experience available to you in an up-to-date new edition of that catalog. The 142-page mix of detailed specifications and charts and tables, and applications-oriented hard-to-come-by practical information—and some blue sky thoughts, too—is so complete and useful that we call it *The Pressure Transducer Handbook*.

Besides completely characterizing our extensive line of pressure transducers and telling how to install them, the *Handbook* has sections on accuracy, auto-referencing, and signal conditioning; on packaging and environmental considerations; fluid flow; accelerometers and load cells; switch control; temperature measurement; and medical, acoustic, and automotive applications.

From theory to practice, from the here-and-now to the avant-garde—it's all between the covers of *The Pressure Transducer Handbook*. A copy is yours for \$3.00; mail your check or money order (no cash) to Marketing Services MS/520, National Semiconductor Corp., 2900 Semiconductor Drive, Santa Clara, CA 95051. (San Francisco Bay Area residents add 6.5% sales tax, please; other California residents, 6%.) ☐

DD 11



## VIP CARD

Complete card and mail to  
National Semiconductor  
Attn: Marketing Services  
2900 Semiconductor Drive  
Santa Clara, CA 95051

Please send me the information that I have checked:

- |   |  |
|---|--|
| <input type="checkbox"/> MAXI-ROM™, Pg. A, Col. 1                                     | <input type="checkbox"/> AF99/100/120/150/151 Active Filters, Pg. C, Col. 1  |
| <input type="checkbox"/> IDM2901A MPU, Pg. A, Col. 1                                  | <input type="checkbox"/> AF130/131/132/133/134 Active Filters, Pg. C, Col. 1 |
| <input type="checkbox"/> ADD3501/ADD3701 DPMs, Pg. A, Col. 2                          | <input type="checkbox"/> MM74C915 7-seg./BCD, Pg. C, Col. 2                  |
| <input type="checkbox"/> ADD3511/ADD3711 DPMs, Pg. A, Col. 2                          | <input type="checkbox"/> NSB5388 LED Display, Pg. C, Col. 2                  |
| <input type="checkbox"/> LM140A/150/120ML/120L/79LXX LM137 Volt. Regs., Pg. B, Col. 1 | <input type="checkbox"/> LPCS Chip Set, Pg. D, Col. 1                        |
| <input type="checkbox"/> INS8900 MPU, Pg. B, Col. 2                                   |  |
| <input type="checkbox"/> Series/80 BLC 80/10, Pg. B, Col. 2                           |  |

Please send me the literature that I have checked:

- |   |   |
|---|---|
| <input type="checkbox"/> AN-178 Applications for an adjustable IC power regulator           | <input type="checkbox"/> AN-183 A cheap and easy dc-dc converter    |
| <input type="checkbox"/> AN-181 Three-terminal regulator is adjustable                      | <input type="checkbox"/> AN-189 A PROM programmer for the SCMP LCDS |
| <input type="checkbox"/> AN-182 Improving power supply reliability with IC power regulators | <input type="checkbox"/> AN-190 Serial data transfers with SCMP-II  |

Your End Product or Application: \_\_\_\_\_

Have Salesman Call  YES  NO

Please print clearly; this information will be used for our mailing list.

NAME \_\_\_\_\_ TITLE \_\_\_\_\_

COMPANY \_\_\_\_\_

ADDRESS \_\_\_\_\_

CITY \_\_\_\_\_ STATE \_\_\_\_\_ ZIP \_\_\_\_\_

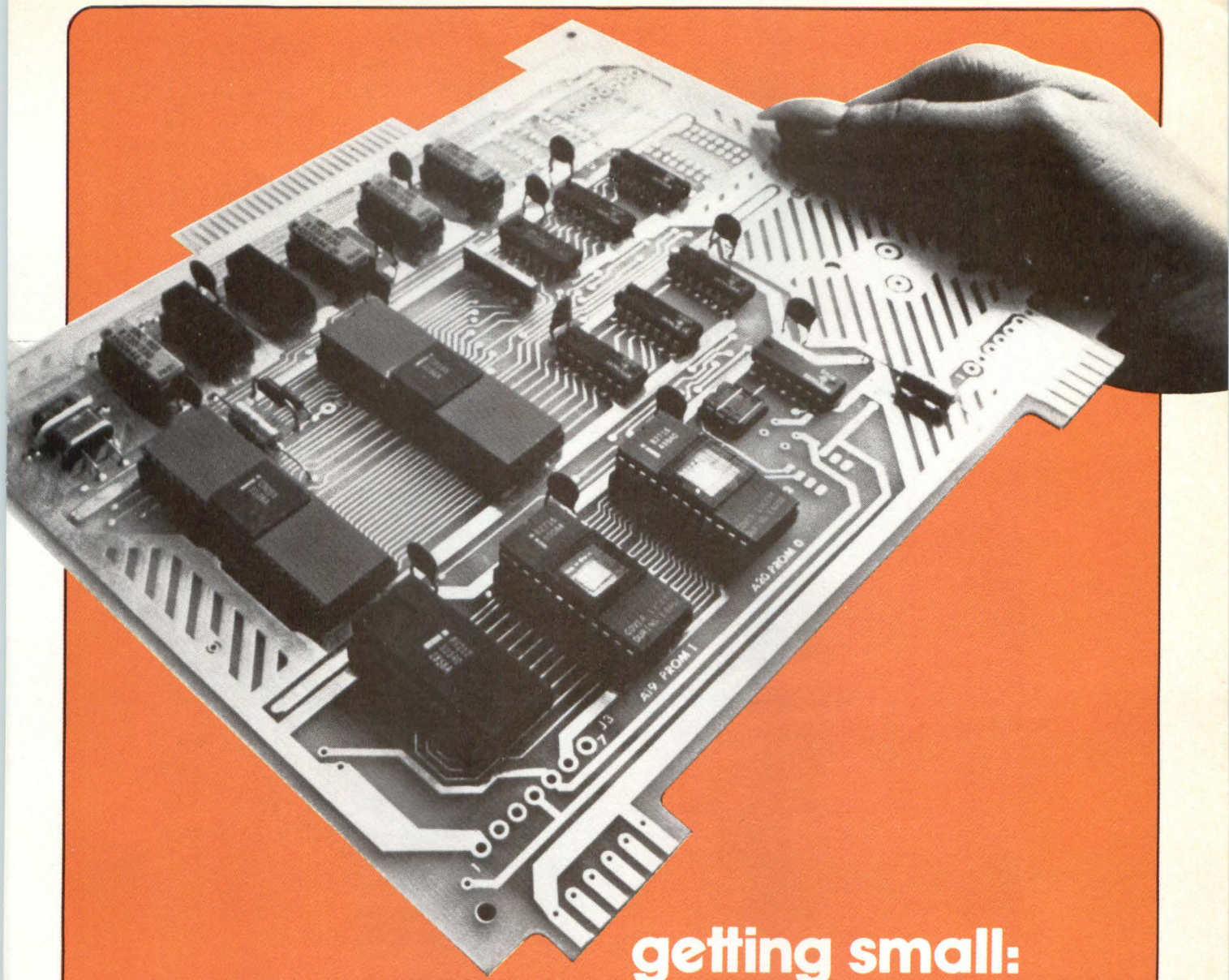

## getting small: microcomputers

by Henry K. Simpson

No one has yet put a microcomputer onto the head of a pin but it would probably not surprise anyone who follows the industry if it happened the day after tomorrow. No question about it — microcomputers can be amazingly small. This small size, extremely important in some of the earliest applications of microcomputers in the aerospace industry, remains important in many current applications. Increasingly, however, microcomputers find places in industry where their compactness is convenient but not the main reason for their selection. Just as minicomputers in their early days began doing things that larger computers could do, microcomputers are now making inroads into the applications of minicomputers (see page 44).

If littleness is no longer the big thing it once was, then cost may well have taken its place as being of primary im-

portance. Compared to minicomputers or hard-wired logic, methods that compete with microcomputers in many control applications, microcomputers, at least on an initial purchase basis, clearly win the race. But initial cost does not tell the whole story; this is as true of microcomputers as of anything else. Dick Anderson, Product Planning Manager of Rockwell's Microelectronic Device Division, observed that "the trend, if projected, suggests that in the future hardware will be free and all the expense will be in software development." Well, prices may never asymptote to zero, but this comment still makes a significant point — that software or, more specifically, the programming aspect of microcomputers, is a very important cost item. Most microcomputers serve in dedicated, special-purpose applications and are programmed in assembly or machine language. Usually these programs are developed by design engineers who, until recently, knew very little about computer programming. In

other words, the advent of microcomputers has changed the design engineer's task and has significantly increased emphasis on programming. We now survey the microcomputer field covering representative products of each major type of microcomputer, and considering how microcomputers affect the designer's task. We will map industrial trends and see what the manufacturers are saying will happen to microcomputers in the next few years.

## What is a Microcomputer?

Industry generally classifies a microcomputer as a microprocessor plus memory, with I/O interface (Fig 1). Two types of memories generally are used: ROM (Read Only Memory), which contains the program; and RAM (Random Access Memory, also sometimes referred to as read/write memory), used to store data temporarily. The I/O interface gets data into and out of the microcomputer. The micro-

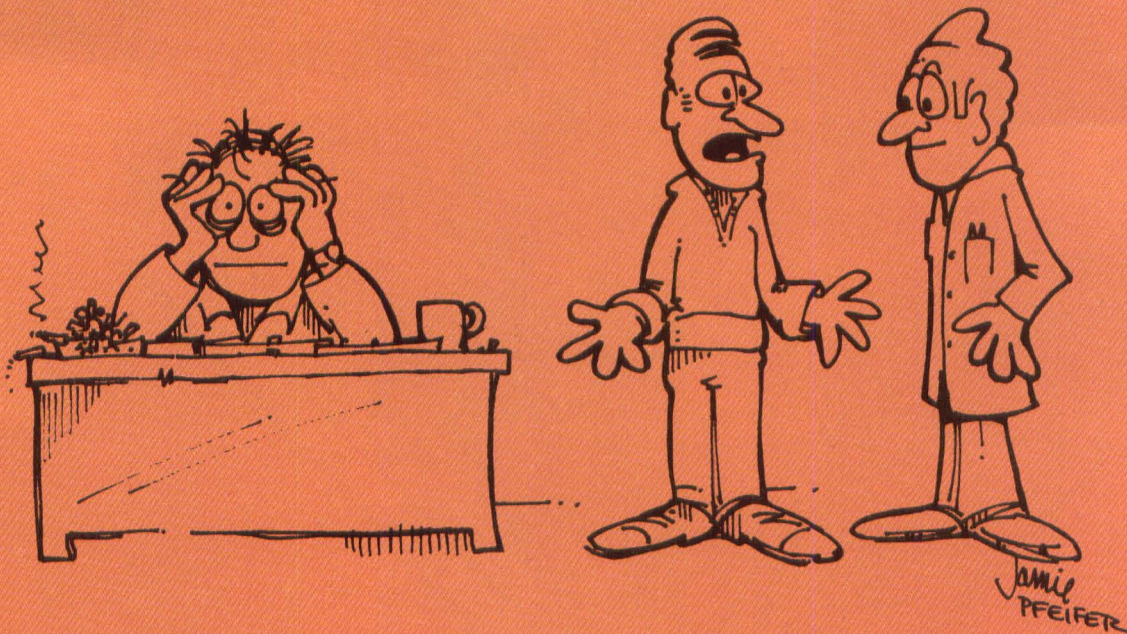

*"It began when somebody told him that only microcomputers use LSI and he discovered a mini that uses LSI. Then he figured that minis had bigger memories. That worked okay until he found a micro with half a megabyte. Then he tried to convince everyone that microcomputers were simple-minded and had to be coded in machine language. What finally blew his mind was our new business microcomputer that can be programmed in FORTRAN, has 16-bit addresses, a CRT and a line printer."*

## Microcomputers and Minicomputers

The distinction between microcomputer and minicomputer becomes increasingly blurred, at least at the boundaries, as time passes. Both got their names because of size — the mini because it was smaller than the larger computers it was compared with, the micro because it was smaller than the mini. At one time you could make a distinction based on technologies employed — micros used large scale integration while minis used discrete components — but many minis now employ LSI also. We used to say that minis were more memory-oriented than micros, but many micros now contain large memories. It used to be true that high-level languages such as BASIC and FORTRAN were available on minis, but not on micros. This is no longer true in many cases, though it is true that such languages are more widely available on minis than on micros. Micros used to be limited to 16-bit or smaller addresses. No longer.

Many of the previous rules still hold, at least in most cases. The problem develops with a class of

microcomputers, designed for general-purpose applications, that possess the appearance and all the capabilities of minicomputers. Manufacturers such as Texas Instruments do not help us solve this dilemma when they design both minicomputers and microcomputers around the same TMS 9900 microprocessor chip. Nor does Pacific Cyber/Metrix do much to clarify the situation by designing its PCM-12 microcomputer with a microprocessor that is "essentially an LSI version of the CPU in the PDP-8/E™," making the PCM-12 "perform like a PDP-8/E in nearly every respect."

You may by now see that we do not take this issue too seriously. Names — whether you call something a minicomputer or a microcomputer — are far less important than performance (or, as Shakespeare once had Romeo put it, in a slightly different context, "... a rose by any other name would smell as sweet ..."). In many cases today, microcomputer performance approaches or equals that of some minicomputers.



# Sooner or later it was bound to get out.

Yes, the Dumb Terminal™ really does have two smarter brothers.

At first, they weren't quite as well known, because their Dumb Brother's smashing success was stealing the show. Although they had been selling quite well all along, even without getting constant headlines, like their Brother.

Now, however, Dumb Brother has pulled them into the limelight. And ADM-1 and -2 have decided, after all, that perhaps it's time you knew a little more about how smart they really are.

ADM-2 is the more intelligent of the two, providing you with flexibility of format, security, editing, interface, and transmission. You'll find, among a variety of other outstanding features, up to 8 screen status indicators and a numeric key pad. And a detachable keyboard with 16 function keys. Which give you the ability to access your special program, or form, or instruction.

The ADM-2 is also available in a model compatible with your Burroughs TD-800 Series. The ADM-2B. The ADM-2B adheres to the standard Burroughs poll and address line discipline.

On top of all that, we've made the ADM-2 micro-programmable. And taken all the mystery out of the procedure. Which makes user-micro-programmable simple, quick, and cost-effective. The ADM-2's versatility is limited only by your imagination.

You could call the other Smarter Brother, ADM-1, the "with-or-without" terminal. Starting with some pretty smart standard features, like a standard 24-line display, a field protection feature with dual-intensity and switch-selectable operating modes — block mode and conversation mode — you build up from there. With options like a hardcopy printer interface, and display editing capabilities (line insert, line delete, line erase, character insert, and character delete). Just add the options you need, and leave the rest of the "bells and whistles" for someone else. That way, it's more systems adaptable. And it's up to you just how smart you want it to be.

The Smarter Brothers have it all. Intelligence, appropriate functions, and sensible cost-per-performance.

So, you might as well get used to seeing more of the ADM-1 and -2 in the future. Because we suspect they're going to be in the spotlight from now on.

After all, there's really nothing wrong with exposing your Smarts.



**The dumb terminal's smarter brothers.**

Lear Siegler, Inc., E.I.D./Data Products, 714 N. Brookhurst St., Anaheim, CA 92803, (800) 854-3805. In California (714) 774-1010.

### F6800 MICROCOMPUTER FAMILY BLOCK DIAGRAM

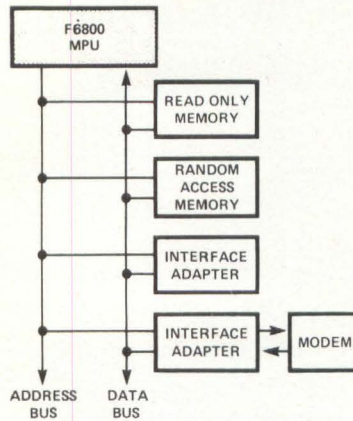

Fig 1 Microcomputer consists of micro-processor (in this case Fairchild 6800), ROM, RAM and I/O.

### F6800 BLOCK DIAGRAM

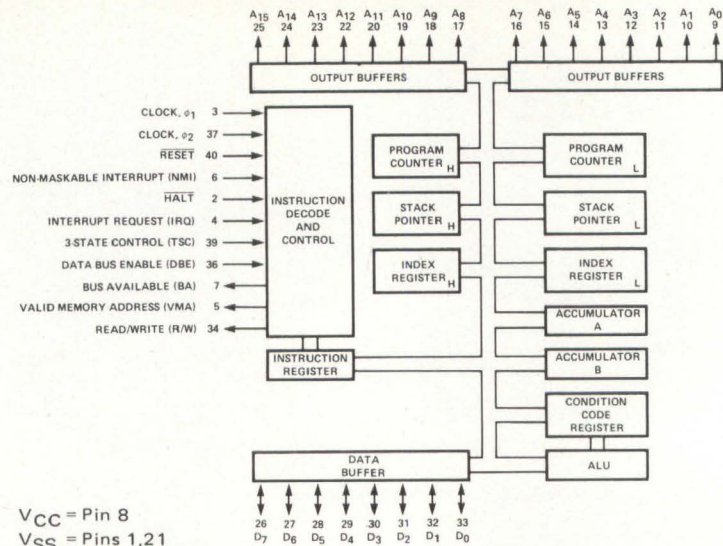

Fig 2 Block diagram of fairly representative 8-bit microprocessor chip, the Fairchild 6800.

processor, heart of the microcomputer, contains an arithmetic logic unit, accumulators, registers, address buffers, instruction decoding and control, and the various other functional entities found in larger computers. Fig 2 shows a block diagram of the F6800 microprocessor.

Microcomputers use a fairly limited set of microprocessors. Most common of the 8-bit processors are the 8080 and its variants, Z-80, 6800 and F-8; the 4040 is a widely used 4-bit processor. Sixteen-bit processors, now becoming quite common, include the IMS 9900 and 1M6100 I. The

*Bailey and Sanderson always get this way after programming in machine language.*

1011 ?  
1001 ?  
1000 ?  
0000!  
0000!  
1111!



### What Programming Language Should You Use?

Programming is easiest with high-level languages, more difficult with assembly-level languages, most difficult with machine languages. [For a more complete discussion of this topic, see page 66 of this issue.] The easier the language, the more rapidly the program can be written and the more money saved in programming time. On the other hand, high-level languages must be compiled and the machine instructions thus constructed are not generally as efficient in terms of number of instructions or memory requirements as

programs originally written in machine language. In other words, you may save yourself time by programming with a high-level language but you will pay for this time-saving by getting a program that has more steps (and runs slower) and that requires more memory.

If you do decide to use a high level or assembly level language for programming, your choice of microcomputers becomes more limited, because cross compilers and assemblers are not available for all microcomputers.



# THE FIRST AFFORDABLE MINICOMPUTER

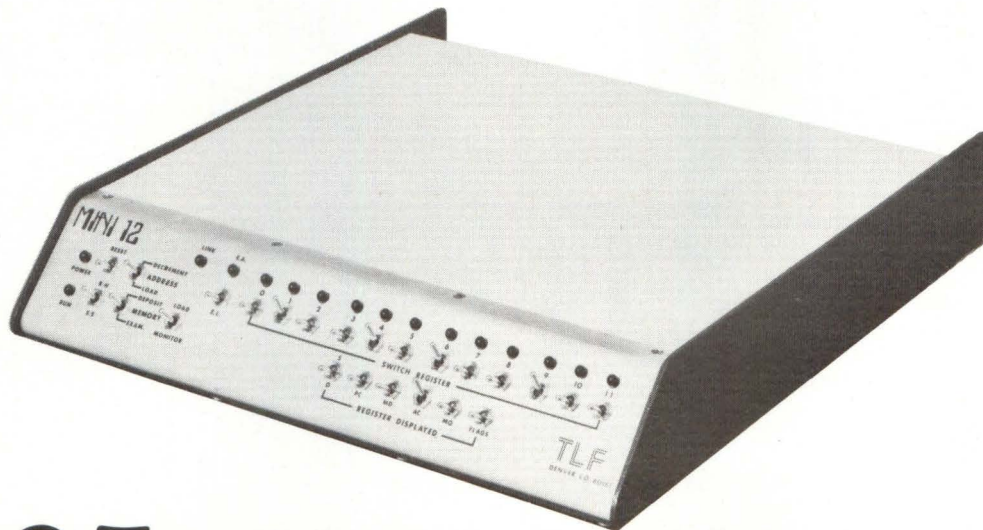

# \$895

ASSEMBLED

READY TO COMPUTE,  
CALCULATE, CONTROL,  
OR . . . . ? . . . . ? . . . .

## STANDARD FEATURES:

Word Length	12 Bits
Instruction Set	PDP-8E Compatible
Memory Size	8K, Expandable to 32K
Extended Memory Control	DEC Compatible
Serial I/O Port	DEC Compatible, current loop
Parallel I/O Port	Compatible with DEC DR-8 - EA
Programmable Real Time Clock	Compatible with DEC DK8 - EP
Full Function Programmer's Front Panel	
Binary Load and Punch Routines in ROM	

**TLF** CORPORATION

P.O. Box 2298, Littleton, Colorado 80161  
303-922-6241 Telex 454541

CIRCLE 31



**Fig 3** Texas Instruments model 990/4 16-bit microcomputer, based on TMS 9900 microprocessor, with 24K x 16 words of memory, floppy-disk ROM loader, video terminal and floppy disk, can be programmed in several high-level languages such as FORTRAN IV, COBOL and Multiuser BASIC.



**Fig 4** Data General microNOVA 16-bit computer, available in board or cabinet configuration, uses mN601 CPU chip, can provide up to 315 K word memory with optional dual diskette.

microprocessor alone is not a microcomputer, because it lacks the requisite memory and I/O. However, single-chip microcomputers do exist and are becoming commonplace.

Given a particular microprocessor, it is difficult to predict all possible applications, because, in the words of one industry spokesman, "we see no clear mapping from microprocessor to end product." Four-bit processors are more commonly used in control applications than 8-bit devices because they perform adequately at lower cost. High speed data processing microcomputers generally use 16-bit processors. A popular processor such as the 8080 turns up in microcomputers designed for such varied applications as dedicated control, data processing and hobby systems.

### Some Typical Microcomputers

Microcomputers come in many shapes and sizes, suitable for an enormous range of applications. They may be general or special-purpose (dedicated) machines, operating in real or non-real time. Since the field is so diverse, one of the problems is to get a handle on the different kinds of microcomputers available. Let's look at some classification schemes.

One way industry commonly classifies microcomputers is by product application. The commonly accepted categories include control, data acquisition, data processing, scientific computing, intelligent terminal, hobby and development systems. Most microcomputer-based products belong to at least one of these categories. The last category, development systems, contains machines used in the process of designing,

testing, prototyping, programming and debugging new microprocessor- or microcomputer-based systems. Development systems are extremely important to the designer who is working with microcomputers and for this reason we are going to treat development systems separately and at length in the January issue.

Another way to classify microcomputers is by how they are physically structured when sold. Industry produces microcomputers in four different basic structural forms: single chip, board, cabinet and modular component system (like a minicomputer). Actually, this classification scheme proves very useful, because it relates directly to what the engineer must do to get a microcomputer to work in the system being designed. Going from chip to board to cabinet and then to component system, the designer's task becomes progressively simpler. At the same time, as microcomputers are acquired in progressively more finished states, the computers generally become more specialized, thereby reducing the designer's options.

**Single-Chip Microcomputers.** Intel introduced the first single-chip microcomputers late in 1976. Three related chips — 8048, 8748, 8035 — contain the same processing and control subsystems, with 8-bit CPU, 64-byte read/write data memory, three programmable 8-bit I/O ports and eight other control and timing lines, programmable interval timer/event counter, priority interrupt controls, system clock generator and a set of system controls and utilities. Various expansion peripherals are available with these microcomputers, as with most other single-chip microcomputers, to increase memory,

# 4-bit, one-chip micro- computers

Brainy enough  
for anything  
from TV games  
to industrial  
controls.



Block diagram of MN1400  
with on-chip, 1024x8-bit ROM.

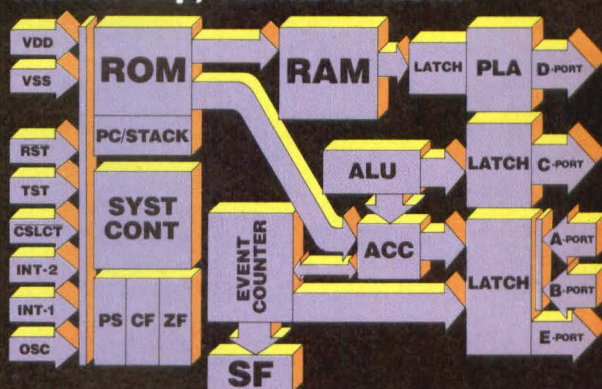

Now Panasonic offers you a whole family of TTL compatible, one-chip microcomputers. So you can choose the combination of features and capabilities that are most cost-effective for your application. From appliances to gas pumps and electronic scales, to copiers, POS and intelligent terminals, tractor controls and countless others.

### Why pay for costly I/O interfacing when Panasonic puts it all on the chip?

Our MN1400 family is ideally suited for control functions with its extensive array of on-chip I/O facilities. There's an 8-bit presetable counter/timer, a clock generator, an arithmetic logic unit, and several input and output ports. Units are available with a self-contained 1024x8-bit ROM and a 64x4-bit RAM memory.

### Still more flexibility and efficiency from Panasonic.

For flexibility, our instruction set contains up to 75 instructions. To give you TTL compatibility, all our family members operate on +5V. And for extra computing speed, we've utilized N-channel E/D MOS construction.

### Panasonic can help you cut development time and costs.

Our Evaluator, the MN1499, can help you design, evaluate and debug programs quickly. In addition, software is available for a number of applications.

### The Panasonic family of one-chip microcomputers.

Package	MN1400 40-Pin Plastic DIP	MN1402 28-Pin Plastic DIP	MN1498 40-Pin Plastic DIP	MN1499 64-Pin Ceramic DIP
Power Supply	+5V	+5V	+5V	+5V
Instruction Cycle Time	10 $\mu$ s	10 $\mu$ s	10 $\mu$ s	10 $\mu$ s
Instruction Set	75	57	68	75
Instruction Memory	Internal 1024 x 8 bits (8192 bits)	Internal 768 x 8 bits (6144 bits)	External 1024 x 8 bits (8192 bits)	External 2048 x 8 bits (16384 bits)
Total on Chip RAM	64 x 4 bits (256 bits)	32 x 4 bits (128 bits)	64 x 4 bits (256 bits)	64 x 4 bits (256 bits)

### 16-bit microprocessors, too.

They're ideally suited for a wide variety of computer peripheral and business machine applications. Designed with minicomputer architecture LOCOS MOS N-channel construction for optimum speed and thruput efficiency.

For complete information and prices, write to Panasonic Electronic Components, One Panasonic Way, Secaucus, N.J. 07094; or call (201) 348-7269.

**Panasonic**<sup>®</sup>  
just slightly ahead of our time

# More

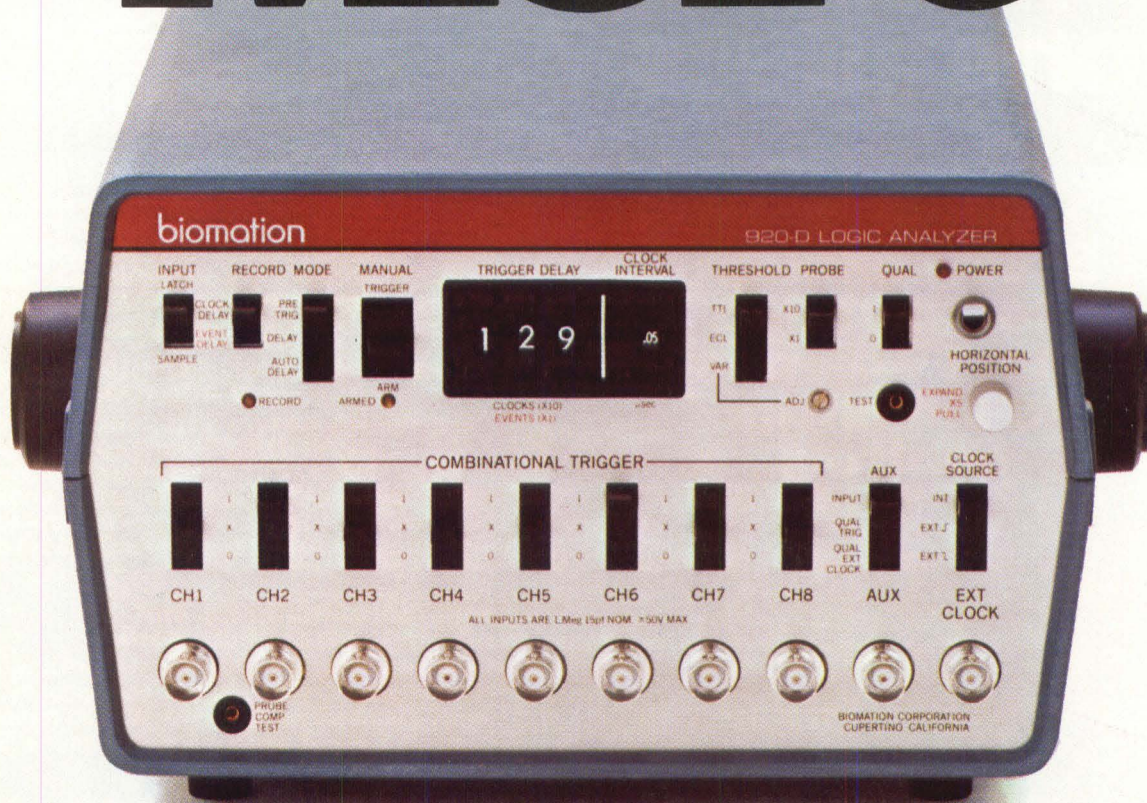

## Introducing the 920-D logic analyzer. Nine channels, 20 MHz and much, much more.

Don't let the low price mislead you. Biomation's new 920-D stands up to logic analyzers costing twice, even three times as much. It includes the functional features design engineers ask for most. And combines them with 9½ pound portability, making the 920-D an ideal field troubleshooting tool.

Nine channels — not just eight — give you added capability for more applications. Use the extra channel for recording data, or to mark a trigger location. And select between trigger or clock qualifier. Attach the optional Biomation 10-TC probe pod and you can select up to a 19-bit combinational trigger word.

The 920-D enables you to set a precise interval between the actual trigger and the start of recording, using either clock periods or number of trigger events. Or the pre-trigger recording mode can be selected to capture data from before the actual trigger. The logic threshold level is selectable — TTL, ECL

or variable. And you can record at rates from DC to 20 MHz.

Captured data, at 256 bits per channel, can then be displayed on any single channel scope or CRT display in timing diagram format.

Compare the 920-D with other logic analyzers, for both price and performance. Then ask yourself if you can afford to settle for less.

Don't let the 920-D's many features and high performance mislead you. It's priced less — far less — than any comparable logic analyzer.

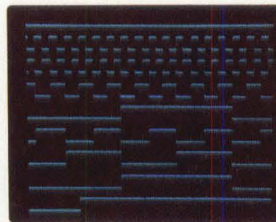

In fact, the 920-D's \$1295\* price tag makes it practical to put its extensive capabilities to work

wherever you design, debug or troubleshoot TTL logic.

The 920-D is a cost-effective first logic analyzer for most applications. Years of experience providing

# Less

\$1295.00

**BIOMATION 920-D  
LOGIC ANALYZER**



thousands of engineers and technicians with the industry's leading family of logic analyzers has helped us design the 920-D with proven real-world features you can put to good use.

Low price makes the 920-D a great choice for your second... or third or fourth logic analyzer. You won't need

to stand in line or share your company's only

logic analyzer when you have a 920-D of your own.

We built the 920-D for lightweight portability. It weighs in at under 10 pounds and connects to

the nearest oscilloscope or CRT. That makes the 920-D the newest tool for field service.

Biomatik has led the way in logic analyzer developments. Today there are seven Biomatik analyzers, offering from 8 to 16 channels, 10 to 200 MHz capture rate, memory lengths from 256 bits to 2048 bits per channel and operating in both time and data domains.

What more can we tell you? Plenty. Ask for the 920-D product sheet. Or give us a call to arrange a demonstration. Ask for Ed Jacklitch (408) 255-9500. Or write Biomatik, 10411 Bubb Road, Cupertino, CA 95014.

## biomatik

\*U.S. price only

Circle No. 42 for information. Circle No. 102 for information and demonstration.

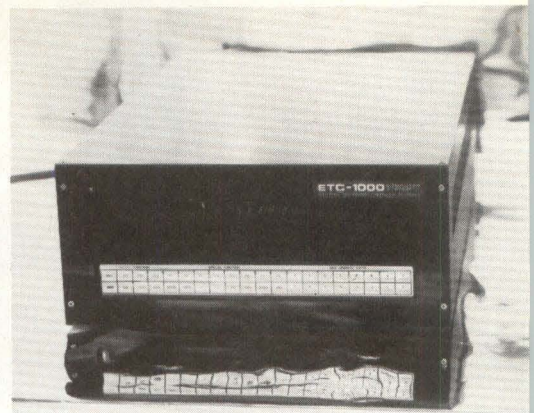

**Fig 5 Tektronix 8001 development system provides software and hardware emulation, software development support and hardware debug capability for 8080, 6800, Z-80, 9900 and 8085 microprocessors.**

I/O and programming capabilities. Intel supports the designer with its Intellec™ development system. Other single-chip microcomputer manufacturers support their product with similar special-purpose development systems. The 8748 contains a 1-Kbyte EPROM (erasable and electrically reprogrammable ROM) which can be programmed in assembly language with the Intellec development system, or in machine language with the less expensive Intellec PROMPT 48 personal programming tool. The CPU in these microcomputers has 96 instructions. Possible applications, according to the manufacturer, include home appliances, electronic games, automotive equipment, small business machines, instruments, data terminals, vending machines and controllers.

Fairchild produces the F3870 MicroMachine™, another 8-bit single-chip microcomputer, with 70 instructions, 2048 bytes of PROM, 64 bytes of RAM, a programmable binary timer and 32 bits of I/O. Software for the F3870 is compatible with the F8, a widely-used microprocessor.

Rockwell produces a line of PPS-4/1 single-chip microcomputers; its most recent addition, the model MM76C, incorporates a programmable high-speed counter-timer. Instruction set size is 53 instructions and it contains a 48x4 RAM and a 640x8 ROM. You can automatically reload the counter with a preset value; serial 8-bit mode with start-pulse detection is possible. The counter functions as a single 16-bit reference or as two independent 8-bit counters. It can count inputs ranging from 2 MHz to days-long frequencies. Two input counting modes are provided: in "event" mode, discrete inputs are counted up or down; in "quadrature sensing" mode, motion and direction can be sensed. PPS-4/1 microcomputers are supported by various design aids, including a PC board development microcomputer, XPO-1, a special MM76C development circuit internally wired to permit real-time operation directed by a program contained in external memory.



**Fig 6 Electronic Tool Company ETC-1000 microcomputer, based on 8-bit 6502 microprocessor, available in several configurations, can have up to 32 K of RAM and dual floppy disks.**

American Microsystems recently introduced the S2000, an 8-bit microcomputer with 1Kx8 ROM, 256 bit RAM and 51 element instruction set. AMI supports development of the S2000 with its microcomputer development center, which enables text editing, assembly, simulation, real-time debugging and PROM programming. Various other support options are available.

### Microcomputers on a Board

Intel makes a wide range of microcomputer boards and recently introduced two low-cost single-board microcomputers, based on the 8085 8-bit microprocessor. The 80/04, selling for under \$100 in OEM quantities, consists of a CPU with system clock generator, system controller and 4-level vectored priority interrupt control, 256 bytes of RAM, up to 4 Kbytes of program storage in ROM or PROM and 22 programmable parallel I/O lines. Selling for under \$200 in OEM quantities, the 80/05 offers more RAM storage than the 80/04 and a system interface bus, which the 80/04 lacks. Intel supports their microcomputers with development systems and extensive documentation.

Zilog builds a series of Z-80 based microcomputer boards that fit together in modules. The basic board, designated Z80-MCB, can operate as a single-board computer and contains 4 Kbytes of dynamic RAM, up to 4 Kbytes of ROM, PROM or EPROM and serial/parallel I/O ports. Z80-MCB can be expanded to include greater I/O or memory.

Motorola produces a series of modular microcomputer boards, referred to as Micromodules™, based on the 6800 microprocessor. The M68MM01 computer board has 1K static RAM, Peripheral Interface Adapters (PIA's) to provide programmable I/O and sockets for installing up to 4 Kbytes of ROM. Motorola also produces modules to increase memory and I/O capabilities of the system being designed. Motorola manufactures a "kit" for use in designing with

# Tandberg's TDC 3000 Digital Cartridge Recorder.

## WHAT'S IN A NAME?



## Communication. With every computer.

Begin with the industry-proven Tandberg TDC 3000 Digital Cartridge Recorder. Add our new RS-232 I/O controller/interface. And you have a highly cost-effective recording system compatible with *every* computer.

There's a complete family of interfaces for the Tandberg TDC 3000. From the original design conceived by Tandberg of Norway, the \$150-million electronics firm that pioneered tape recorders internationally. The company that is to high quality electronic equipment what Rolls Royce is to automobiles. With a tradition of excellence that continues in a wide range of computer peripherals from Tandberg Data in the United States.

With *total* communications compatibility, the microprocessor-based RS-232 controller/interface from Tandberg Data is engineered according to EIA Standard RS-232-C, type D and E, and a "teletype-compatible current loop," recording in ANSI/ECMA/ISO-compatible format.

And from the substantial savings in line charges alone, the TDC 3000 with the RS-232 controller/interface will recoup its modest cost in a matter of months. It's hard to beat that kind of cost-effectiveness.

Conceived in the rugged Norse heritage, the Tandberg TDC 3000 is no wilting lily when it comes

to tough environments. Put it to work in subzero snow country or under a desert sun and don't worry about the bad vibes or emissions from nearby equipment. The TDC 3000 is engineered to roll with environmental punches.

Modular construction of the TDC 3000 enables the user to configure a system to individual needs. Applications include minicomputer input/output, minicomputer peripheral storage, terminal peripheral storage, software distribution, data entry via keyboard, local data collection, data transmission, and text editing. And a few other things yet to be dreamed up.

Besides RS-232, Tandberg Data provides TDC 3000 interfaces for HP 21MX, PDP 11, 8080 Microprocessor, AN/UYK-20 and 8-bit parallel general purpose. All give up to 48K bits transfer rate.

**Tandberg Data Inc.**  
4060 Morena Blvd.  
San Diego, California 92117  
(714) 270-3990

**TANDBERG** 

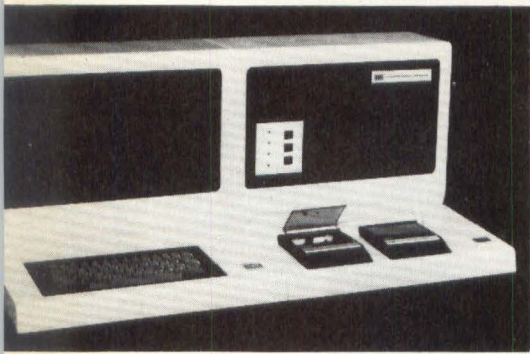

**Fig 7** Information Control Microcommand System™ supports development of 8080 and Z-80 microprocessor-based systems with light pen, editor, assembler, monitor, up to 64K RAM and up to 2 Kbytes ROM, dual floppy disks, EPROM programmer, keyboard, CRT and optional In-Circuit Debugger.™

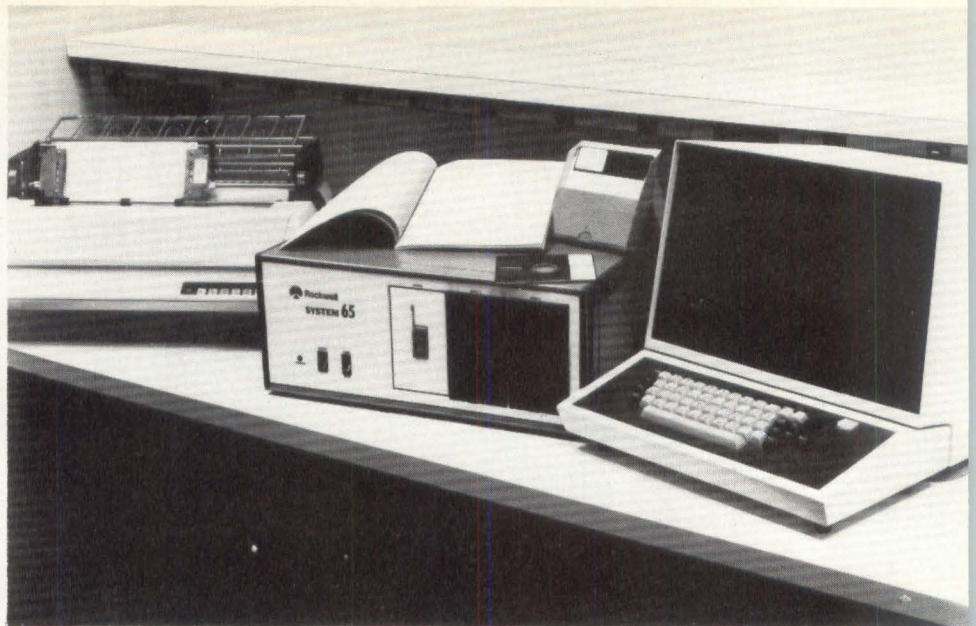

**Fig 8** Rockwell System 65 development system supports R6500 microcomputer system development with dual minifloppy disk drives, 16K bytes of static RAM plus ROM-based resident system software, monitor, text editor and assembler.

6800 series microprocessors that includes documentation and simple hardware for programming and debugging 6800-based systems at relatively low cost.

**Microcomputers in a Cabinet.** Most microcomputers in this category, while packaged, do not come with extensive peripherals. Generally used in industrial control applications, they vary somewhat in the degree in which their manufacturers have tailored them for specialized applications.

Warner & Swasey produces System 4 and RT-4 4-bit microcomputers, both of which use 4040 microprocessors, for special-purpose industrial control applications. The RT-4, with 1Kx8-bit words of PROM and 320x4-bits of RAM, is a modular system in which the CPU and various I/O modules are plugged into a motherboard housed in an oil-tight industrial enclosure. With greater memory capacity than the RT-4, the System 4 suits many of the same applications, such as machine tool control, remote monitoring and control, material handling control, data entry and retrieval, traffic control and energy management. The company also produces a System 8, based on the 8080 microprocessor, suitable for complex industrial measurement and control applications. Warner & Swasey supports its microcomputers with FORTRAN compilers, available on timesharing systems or able to run on the user's computer. A microcode assembler is available for users wanting to define their own micro-coded instruction set. System tester and program analyzer are available, as is a programmer's console to provide on-line control and diagnostic capability.

Wyle produces a series of microcomputer modules, based on the 8080A microprocessor, that you can assemble in various configurations, depending upon user requirements. Wyle provides separate modules for CPU, memory (1K and 4K RAM, 256 word RAM/1K ERPROM, 4K ERPROM), I/O, priority interrupt, timing, operator/programmer's panel, PROM programmer, direct memory access and paper tape reader. Wyle can provide the customer with resident assembler or cross-assembler (using a PDP-11), a relatively simple and inexpensive development system and various software

packages. Primary applications of these microcomputers are process control and monitoring and data collection.

Data Numerics manufactures the DL-8A microcomputer, 8080-based, with 4K RAM, 2K PROM, four 8-bit I/O registers, Universal Asynchronous Receiver-Transmitter (UART) for teletype or any RS-232 terminal operation and an interrupt system with priority resolution and self-identifying vectors. Users can expand memory to 64K. Edit and assembly programs are available resident with the DL-8A and as programs which execute on a PDP-8, PDP-11 or from time-sharing services.

Process Computer Systems offers its PCS SuperPac 180 microcomputer, an 8080A-based machine designed primarily for on-line direct control in industrial automation applications. The 180 comes with a 64 character ASCII keyboard and CRT with character generator capable of presenting 7x9 dot matrix characters. You can customize the system with various modules — memory, keyboard interface, I/O, A/D and D/A conversion. Real-time operating system and FORTRAN compiler are available.

Fabri-Tek manufactures the MP12 microcomputer, a 12-bit modular machine designed for industrial control, laboratory automation, data communications and data acquisition. The MP12 provides a 4Kx12 magnetic core RAM, direct memory access, hardware interrupt capability and a PDP-8-compatible instruction set. Additional modules increase memory and provide I/O and D/A or A/D conversion.

Data General supplies microNOVA 16-bit computers, using the mN601 CPU chip, in board or cabinet configuration, for use in instrumentation, industrial automation, communications and data acquisition system (Fig 4). The cabinet version of the computer, referred to by its manufacturer as a minicomputer, contains a 4K word RAM, optional RAM and PROM to 32 K, single or dual diskette subsystems providing up to 315 K words and I/O and other boards. The manufacturer provides a software library and makes available a disk operating system, assembler and FORTRAN IV compiler. Data General also provides a devel-



# Why Toggle?

(when you can turnkey)

Power-on-start means automatic program execution when computing with the Altair™ Turnkey Models from MITS. Both highly acclaimed Altair mainframes, the 8800b and 680b, are obtainable in easy-to-implement turnkey versions—offering the same capabilities as their full front panel counterparts—and then some.

Our 8800b Turnkey Model incorporates a Module Board complete with serial I/O channel, 1K of RAM, and provisions for 1K of PROM. All 8800 hardware and software are compatible with the 8800b Turnkey Model.

In addition to the 8800b Turnkey, we are introducing these new 8800 system peripherals. The Altair 88-AD/DA converter is our eight channel analog I/O system for applications where analog to digital and digital to analog conversion is necessary. For economical mass storage, the Altair Minidisk System (88-MDS) provides a fast access storage capacity of over 71K bytes per minidiskette.

A big computer in a small package—the Altair 680b Turnkey Model—is a low cost mainframe capable of home, business and process control applications. The 680b CPU module contains all the logic circuitry needed for immediate computing plus 1K of RAM, serial I/O port and provisions for 1K of PROM.

You may expand your 680b Turnkey with these new additions to the 680b line. Load and save programs on audio cassette with the 680b-KCACR. This inexpensive mass storage device is highly reliable under widely varying conditions and requires no circuitry adjustments. Interface your 680b Turnkey to the practical world of process control with the 680b-PCI. Monitor and compensate for changes in any operation, from tracking the sun to watering the lawn.



**mits**

a subsidiary of Perdec Computer Corp.  
2450 Alamo S.E.  
Albuquerque, New Mexico 87106  
(505) 243-7821

opment system for use with mN601-based microcomputers.

Plessey Corp. manufactures the Miproc 16-bit microcomputer, a high-speed machine for special military and commercial applications such as signal processing, multiplexing, weapon control systems and industrial control. Miproc 16 can process up to 4 million instructions per second, with a maximum data throughput of 20 Mbytes per second. The system has 83 basic instructions, expandable to 170, and various memory options — up to 8Kx16 RAM and 8Kx16 PROM. Cross-assemblers are available for various computers and timesharing. Plessey also manufactures a supporting development system.

**Modular Component System Microcomputers.** Microcomputers in this category may remind you of minicomputers — they can be programmed in a high-level language, and some of them were designed for people who don't know very much about computers. A wide range of easily interfaced optional peripherals is usually available.

Texas Instruments manufactures general-purpose 16-bit minicomputers and microcomputers, based on the TMS9900 microprocessor. The microcomputer, designated model 990/4 (Fig 3) consists of 24Kx16 word memory, floppy-disk ROM loader, video display terminal and dual FD 800 floppy disk. Hard copy devices can be interfaced directly. Available high-level languages include FORTRAN IV, COBOL and Multiuser BASIC. Texas Instruments provides software support and a disk-based development system.

The Components Group of Digital Equipment Corp. offers the 16-bit LSI-11 microcomputer system, used mainly in specialized process and control applications such as remittance processing systems, ultrasonic scanning systems, distributed process control, voice input terminals and computer numerical control. The LSI-11, using the same 400-instruction set as the PDP-11 minicomputer (also manufactured by Digital), fits many of the same applications. LSI-11 contains a 4Kx16 RAM, expandable up to 64 Kbytes, and various I/O interfaces and peripherals. Digital claims that over 30,000 PDP-11s are in use and the extensive library of programs for these computers is compatible with the LSI-11.

## Who's Programming?

Increasingly, designers are doing their own programming. In the "old days," with larger computers, the designer would generally assign programming to programmers and stick with hardware. Most designers now feel that they must do their programming to stay on top of the product they are developing. If that product eventually requires changes, then the designer will make them, and more likely than not, the program modifications will land in his lap. An argument can be made in favor of farming programming out to "experts" if the program is a one-time only exercise and the designer is never going to be called upon again to change or update the product.

Also compatible are assembly and higher-level languages available for PDP-11. Digital provides documentation and training services for the user.

General Automation offers 16-bit GA-16/110 and GA-16/220 microcomputers. The GA-16/110 is designed as a "load and go" worker computer for dedicated applications, rather than as a software development system; the more expensive GA-116/220 contains hardware needed for program generation. Both computers are compatible with software and I/O of GA-16 and SPC-16 series computers. Memory can be expanded to 64 Kbytes. Program assembly tools enable using assembly and high-level languages such as FORTRAN, COBOL and BASIC.

Pacific Cyber/Metrix manufactures the PCM-12 microcomputer, using a 12-bit IM6100 microprocessor that is "essentially an LSI version of the PDP-8 CPU," according to PC/M. The PCM-12 is therefore compatible with PDP-8 series minicomputers software. You may purchase PCM-12 as a kit or fully-constructed. A wide range of peripherals is available, as are various memory and I/O options.

Electronic Tool Company offers its ETC-1000 (Fig 6) 8-bit, 6502 microprocessor-based microcomputer in various configurations, depending upon user requirements — from hobby to scientific computing and data processing. Software consists of three levels of operating systems plus language processors and other software aids. The ETC-1000 can be configured with up to 32K of RAM and dual floppy disks. CRT display with integral keyboard and buffered interfaces are standard.

Electronic Memories & Magnetics Corp. manufactures the System 800 microcomputer, which uses a high-speed bipolar 8080 emulator. It is compatible with the 8080 instruction set and widely available software for the 8080, but runs at higher speed. The system offers 32 Kbytes of RAM, expandable to 1 Mbyte and optional nonvolatile core memories. Intending the system to compete with minicomputers, the manufacturer also offers disk drives, CRT display and line printer and delivers System 800 with an operating system and Enhanced BASIC.

MITS Corp., a Pertec subsidiary, manufactures the Altair™ 8800b microcomputer, an 8080A-based general-purpose machine used in home, business, scientific and educational applications. Available software includes Altair BASIC, a disk operating system and an assembly language development system. Memory can be expanded up to 64K of directly addressable memory and up to 256 separate input and output devices can be addressed. The manufacturer provides various peripheral options, including floppy disk, printer and CRT terminals.

Processor Technology Corp. makes the Sol-20, an 8080-based microcomputer that its manufacturer says is the "first small computer designed as a complete system," and which is operable "without any prior computer experience." Sol-20 comes with an 85-key keyboard, video display circuitry (for a TV monitor or standard TV), 1K word RAM, 1K word ROM, cassette interface, parallel and serial I/O interfaces and software including preprogrammed PROM personality module and cassette with BASIC-5 and two "sophisti-

**Quality is known by the company it keeps**



**Quality is known by the company it keeps and here are eight reasons why COMPLLOT® is outstanding in the field:**

- |        |   |              |  |
|--------|---|--------------|--|
| DP-101 | All-new microprocessor-controlled plotter—\$3495                            | PTC-5A       | The new Remote Time Share Plotter Controller—two models—\$1945 & \$2595              |
| DP-1   | Classic 11" wide plotter—\$3550   | BTC-7 Series | Adds inexpensive graphic output to the CDC 734 and Cyber 18-5 Batch Terminals—\$2595 |
| DP-11  | Our newest 11" wide plotter at speeds up to 4000 steps/sec.—\$3995          | MTR-4        | Magnetic Tape Reader/Controller \$15,500<br>1600 CPI Phase Encoded Model—\$19,950    |
| DP-3   | Plotting on a 22" wide surface at 400 steps—\$5150                          |              |  |
| DP-8   | One pen or three, 36" wide, super quiet, three models from—\$7600 to \$9500 |              |  |

**houston  
instrument**

**THE  
RECORDER  
COMPANY**

DIVISION OF BAUSCH & LOMB

ONE HOUSTON SQUARE (at 8500 Cameron Road) AUSTIN, TEXAS 78753

(512) 837-2820

TWX 910-874-2022

cable HOINCO

TELECOPIER

EUROPEAN OFFICE  
Rochesterlaan 6 8240 Gistel Belgium  
Phone 059/277445 Telex Bausch. 81399

® A registered trademark of Houston Instrument

US DOMESTIC PRICES ONLY

Plotters can be driven on-line, offline, time share or remote batch

For demonstration, circle #35; for literature, circle #73.

cated" video games. The computer will find application with hobbyists and in home, office and laboratories, according to Processor Technology.

### Where Microcomputers Are Going

We asked manufacturers who submitted product information to us to predict how microcomputer technology would evolve by 1980. There seems to be a general consensus among them that certain well-established trends in the industry toward lower cost, greater miniaturization and faster speeds will continue. These trends, widely read about and in many cases their results directly experienced by people in the industry such as the readers of this magazine, are not exactly news. A few of the specific comments made by the manufacturers may raise an eyebrow, however. Shay Adams, a marketing executive with Pro-Log, for example, suggests that by 1980 the microprocessor industry will address itself more to "real-world" designs, improve low-end CPU technology, limit attempts to emulate minicomputers and instead advance dedicated control-type architecture. John Staller, manager of marketing services with Warner & Swasey, a manufacturer of industrial control microcom-

puters, foresees that by 1980 the only type of industrial machinery available will be that controlled by microcomputer-based systems.

Dick Anderson and Roger Helmick of Rockwell, addressing the issue of the effect the evolving technology will have on designers, foresee continued change in the engineer's job. Increasingly they see software becoming an off-the-shelf item, just as hardware is now. This idea is echoed by many in the industry and we have already seen changes in this direction. Higher-level languages are becoming increasingly available on microcomputers — it may be that soon the only people who need to worry about machine language will be those who manufacture microprocessors.

**In the January Issue** of *Digital Design*, we will continue our coverage of the microcomputer revolution with a report on the role of the development system.

## BUYER'S GUIDE

This buyer's guide lists manufacturers of microcomputers and of development systems. A word of caution, however: we only indicate what a manufacturer makes if we have first-hand information. In some cases, manufacturers did not respond to our request for information, and in other cases the manufacturer may not have told us about its entire product line. As noted in the text, most microcomputer manufacturers also make development-related products — hardware and software — to assist designers using their systems in the product development process. This means that, even if a particular manufacturer is not in the business of making development systems, it may still provide tools to aid the designer. Contact manufacturers directly for information or circle the appropriate number on the reader service card.

	M	DS
<b>American Microsystems, Inc.</b> 800 Homestead Rd. Santa Clara, CA 95051 (408) 246-0330 <b>Circle 226</b>	•	•
<b>Applied Data Communications</b> 1509 East McFadden Ave. Santa Ana, CA 92705 (714) 547-6954 <b>Circle 227</b>	•	
<b>Applied Systems Corporation</b> 6401 Harper Avenue St. Clair Shores, MI 48081 (313) 779-8700 <b>Circle 228</b>	•	
<b>Automated Computer Systems</b> 361 East Foothill Blvd. Pasadena, CA 91107 (213) 449-0616 <b>Circle 229</b>	•	
<b>Bedford Computer Systems</b> Preston Court Bedford, MA 01730 (617) 275-0870 <b>Circle 230</b>	•	•
<b>Control Logic, Inc.</b> 9 Tech Circle Natick, MA 01760 (617) 655-1170 <b>Circle 231</b>	•	
<b>Cramer Electronics, Inc.</b> 85 Wells Avenue Newton, MA 02159 (617) 969-7700 <b>Circle 232</b>	•	
<b>Data General Corporation</b> Route 9 Southboro, MA 01772 (617) 485-9100 <b>Circle 233</b>	•	•
<b>Data Numerics, Inc.</b> 141-A Central Avenue Farmingdale, NY 11735 (516) 293-6600 <b>Circle 234</b>	•	
<b>Digital Equipment Corporation</b> 146 Main St. Maynard, MA 01754 (617) 897-5111 <b>Circle 235</b>	•	

# While others promise to improve 2901 Bit-Slice performance, Signetics delivers the promise.

**Introducing the Signetics 2901-1. It's 30% faster than the 2901, and distributors have it now.**

When the 2901 microprocessor slice gained wide industry acceptance, Signetics began an intensive program to improve bipolar bit-slice performance. That effort has resulted in the 2901-1, the best 4-bit slice around.

Signetics 2901-1 does everything the 2901 does, but does it better and faster. With a typical cycle time of 65 nsec, the 2901-1 offers the speed and microinstruction flexibility to handle many applications.

It's great for emulating minicomputers—or for designing high-performance controllers for tape/disk systems and communications networks. And it's available today in large production volume.

**Full 2901-1 Product Support.**

There are many good reasons to select the Signetics bit-slice for your high-performance application. Aside from the fact that the part is very reliable, available today and 30% faster than the 2901 — Signetics provides unmatched product support.

Check the table below for some of the key ICs supporting the 2901-1. In it you'll find cost-saving LSI peripherals like our 8X02 Control Store Sequencer. Generating a 10-bit address for microprogram memory sequencing, this single IC greatly simplifies bit-slice implementation. Soon, other exciting ICs will be added to the 8X02 Sequencer family.

**Signetics offers the most complete selection of Bipolar Memory ICs, including 24 PROMs and 22 RAMs. You can also choose from more than 150 standards in Schottky and Low-Power Schottky.**

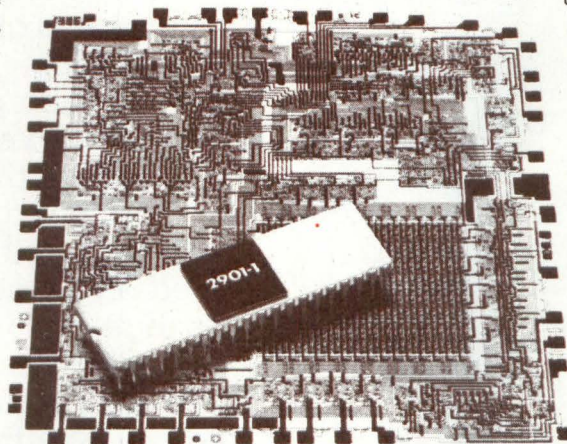

**Microprogramming Made Easier.** With our Microassembler, you get software support which makes it easier to write microprograms. This powerful design tool frees you from the task of hand-coding binary ones and zeroes. Instead, it lets you tailor the Microassembler to the specific needs of your system.

Besides producing PROM programming tapes, our Microassembler also generates listings that can serve as your microprogram's primary documentation.

Of course, the 2901-1 is fully backed by Signetics applications engineers, both at the factory and in the field. Their in-depth microprocessor knowledge can work to extend your design resources.

The Signetics 2901-1 microprocessor slice: reliable—and backed by peripheral circuits, software support and knowledgeable applications engineers. Count on it for complete design flexibility now—and in the future. Available today! For details, use the coupon below, or contact your local Signetics distributor.

## Signetics

a subsidiary of U.S. Philips Corporation

Signetics Corporation  
811 East Arques Avenue  
Sunnyvale, California 94086  
Telephone 408/739-7700

**2901-1 KEY SUPPORT CIRCUITS**

Available Now		Available Now	
8X02*	Control Store Sequencer	82S09*	Bipolar 64x9 RAM
82S115*	Bipolar PROM 512x8	82S16*	Bipolar 256x1 RAM
82S140/141*	Bipolar PROM 512x8	8T26A*	Inverting Bipolar Quad Bus Transceiver
82S146/147*	Bipolar PROM 512x8 (Fast)	8T28*	Non-inverting Bipolar Quad Bus Transceiver
82S136/137*	Bipolar PROM 1024x4	8T97*	Non-inverting Bipolar Hex Tri State Buffers
82S180/181*	Bipolar PROM 1024x8	8T98*	Inverting Bipolar Hex Tri State Buffers
82S184/185*	Bipolar PROM 2048x4	74S182	Look-Ahead Carry Block
82S190/191	Bipolar PROM 2048x8	3001*	Microprogram Control Unit
82S100/101*	Bipolar Field Programmable Logic Array		
82S102/103	Bipolar Field Programmable Gate Array		

\*Second source available

To: Signetics Information Services, 811 E. Arques Ave., P.O. Box 9052, Sunnyvale, CA 94086

Please send 2901-1 data file.  
 My need is urgent: have an applications engineer phone me.

( ) \_\_\_\_\_ ext. \_\_\_\_\_

Name \_\_\_\_\_ Title \_\_\_\_\_

Company \_\_\_\_\_ Division \_\_\_\_\_

Address \_\_\_\_\_ MS \_\_\_\_\_

City \_\_\_\_\_ State \_\_\_\_\_ Zip \_\_\_\_\_

Please also send literature for the following 2901-1 key support circuits:

DD11

# Is your computer smart enough

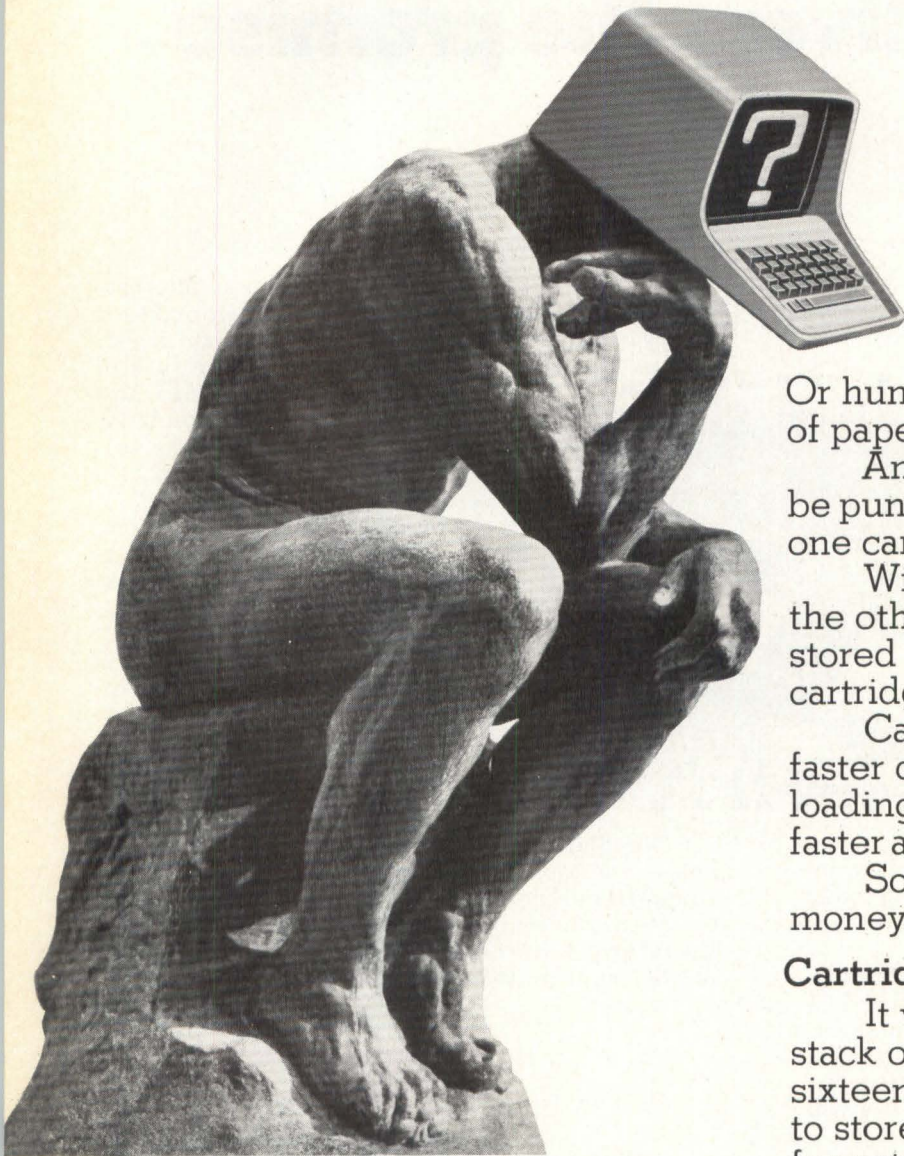

One DC-300A cartridge equals almost 16 feet of cards.

Or hundreds of feet of paper tape.

And each program must be punched, verified and read one card at a time.

With our drive system, on the other hand, programs are stored on a single tape cartridge.

Cartridges offer much faster data storage, program loading, data transfer and faster access to the computer.

So you save time and money.

## Cartridges take less space.

It would take a stack of cards almost sixteen feet high to store all the information you can store on a single 3MDC-300A data cartridge.

With cartridges, you can store all of your programs in a fraction of the space you'd need for cards or paper tape.

Your filing system is simplified and overhead is greatly reduced.

## Cartridges won't fold, spindle or mutilate.

Unlike paper cards, you need never touch the media. It's well

A 3M peripheral drive which uses 3M data cartridges is better than any drive which uses punched cards or paper tape.

And, if you'd take the time to ask it, your computer would probably tell you so.

It's simple logic.

## Cartridges are faster than cards.

Cards and paper tape are slow. It takes hundreds of cards for a single computer program.

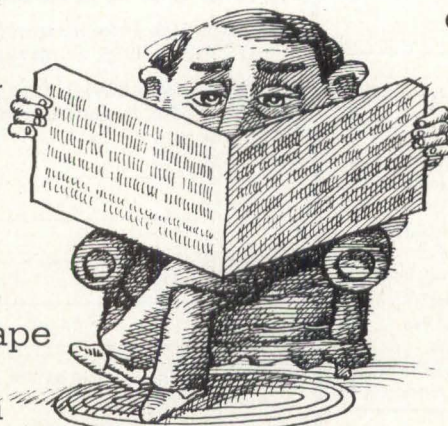

*Cards must be read one at a time.*

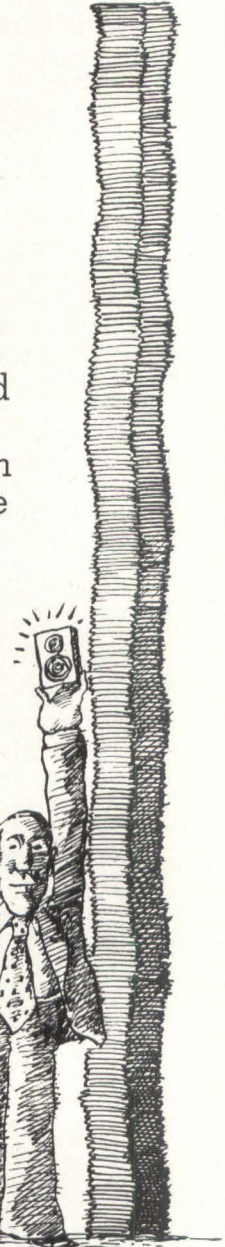

# to choose our cartridge drive?

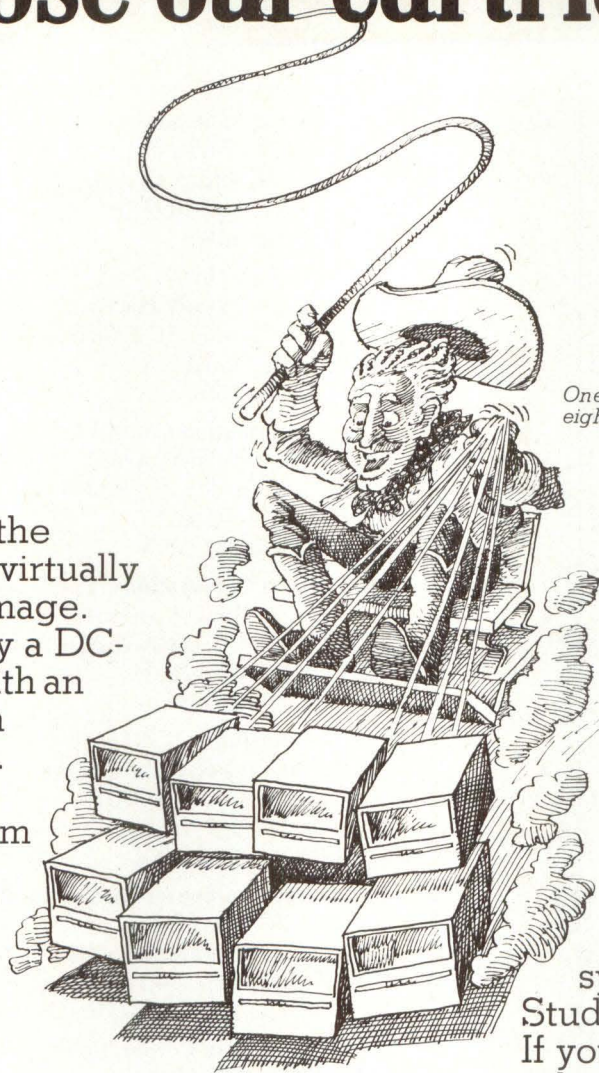

*One formatter can control eight drives at once.*

protected inside the cartridges, so it's virtually impossible to damage.

You can carry a DC-100A cartridge with an entire program in your shirt pocket.

Even if you drop it, the program will survive unscathed.

Remember that the next time you drop a stack of cards.

## **Don't take our word for it. Ask your computer.**

If you'll send us the coupon, we'll send you the specifications for all three of our drive systems.

Ask your computer to compare them with any other type of drive system.

We'll bet your computer will prefer ours.

Maybe it'll choose our famous DCD-3 drive. It's people-proof, jam-proof and wear-resistant.

Or maybe your computer will decide upon our DCS-3000 series, an ANSI-formatted system that allows one formatter to control up to eight drives.

The DCS-3000 is extremely easy to integrate into your system. Only one cable to the user's logic is required.

But if you require compact size, your computer will probably choose our

unique DCD-1. It offers many of the features of our bigger systems, yet it will fit inside a five-inch cube.

The cartridge alone measures just 2.4 x 3.2 x .5 inches.

## **See for yourself.**

Send us the coupon.

There's much more we can tell you about our drive systems.

Study the information carefully.

If your computer isn't smart enough to choose our drive systems, we'll bet you will be.

Send me more information.

Name

Title

Firm

Address

City

State

Zip

Phone

**3M**  
COMPANY

Mail to: 3M Company  
Data Products, Dept. 125  
Mincom Division, Bldg. 223-5F  
3M Center  
St. Paul, Minnesota 55101



	M	DS		M	DS
<b>Educational Data Systems</b> 1682 Langley Avenue Irvine, CA 92707 (714) 556-4242 <b>Circle 236</b>	•			•	
<b>E &amp; L Instruments, Inc.</b> 61 First Street Derby, CT 06418 (203) 735-8774 <b>Circle 237</b>	•			•	
<b>Electronic Memories &amp; Magnetics Corp.</b> 1261 Chadron Avenue Hawthorne, CA 90250 (213) 644-9881 <b>Circle 238</b>	•			•	
<b>Electronic Products Associates</b> 1157 Vega Street San Diego, CA 92110 (714) 276-8911 <b>Circle 239</b>	•	•			
<b>Electronic Tool Co.</b> 4736 El Segundo Blvd. Hawthorne, CA 90250 (213) 644-0113 <b>Circle 240</b>	•	•			
<b>Fabri-Tek, Inc.</b> 5901 South County Road 18 Minneapolis, MN 55436 (612) 935-8811 <b>Circle 241</b>	•			•	
<b>Fairchild Semiconductor Components</b> 1725 Technology Drive San Jose, CA 95110 (408) 998-0123 <b>Circle 242</b>	•			•	
<b>Futuredata Computer, Inc.</b> (formerly Mikrokit) 2180 Colorado Ave. Santa Monica, CA 90404 (213) 328-8539 <b>Circle 243</b>	•	•			
<b>General Automation, Inc.</b> 1055 South East Street Anaheim, CA 92805 (714) 778-4800 <b>Circle 244</b>	•			•	
<b>Gnat Computers, Inc.</b> 7895 Convoy Court, Unit 6 San Diego, CA 92111 (714) 560-0433 <b>Circle 245</b>	•			•	
<b>HAL Communications</b> Box 365 Urbana, IL 61801 (217) 367-7373 <b>Circle 246</b>	•			•	
<b>Heurikon Corporation</b> 700 W. Badger Road Madison, WI 53713 (608) 255-9075 <b>Circle 247</b>	•			•	
			<b>Hewlett-Packard</b> Garden of the Gods Rd. Colorado Springs, CO 80907 (303) 598-1900 <b>Circle 248</b>	•	
			<b>Imesai Associates</b> 14800 Wicks Blvd. San Leandro, CA 94577 (415) 483-2093 <b>Circle 249</b>	•	
			<b>Infinite, Inc.</b> 1924 Waverly Place Melbourne, FL 32901 (305) 724-1588 <b>Circle 250</b>	•	
			<b>Information Control Inc.</b> 9610 Bellanca Ave. Los Angeles, CA 90045 (213) 641-8520 <b>Circle 251</b>		•
			<b>Intel Corporation</b> 3065 Bowers Avenue Santa Clara, CA 95051 (408) 246-7501 <b>Circle 252</b>	•	•
			<b>Intersil, Inc.</b> 10900 North Tantan Avenue Cupertino, CA 95014 (408) 257-5450 <b>Circle 253</b>	•	
			<b>Microcomputer Associates, Inc.</b> 2589 Scott Blvd. Santa Clara, CA 95050 (408) 247-8940 <b>Circle 254</b>	•	
			<b>Microdata Corporation</b> 17481 Red Hill Avenue Irvine, CA 92705 (714) 540-6730 <b>Circle 255</b>	•	
			<b>MITS</b> 2450 Alamo SE Albuquerque, NM 87106 (505) 243-7821 <b>Circle 256</b>	•	
			<b>Monolithic Systems Corp.</b> 14 Inverness Drive East Englewood, CO 80110 (303) 770-7400 <b>Circle 257</b>	•	
			<b>Mostek Corporation</b> 1215 West Crosby Road Carrollton, TX 75006 (214) 242-0444 <b>Circle 258</b>	•	
			<b>Motorola Semiconductor Products, Inc.</b> P.O. Box 20912 Phoenix, AZ 85036 (602) 244-6900 <b>Circle 259</b>	•	





# Miproc 16-AS, micropower to give you high-speed faster.

Internationally acclaimed Miproc-16 with a compute-rate of up to 4 million instructions per second is the fastest 16-bit microcomputer card family available.

Now supplied with an OEM chassis package, Miproc-16 is even more quickly brought into action.

This cost-effective application system, named Miproc-16 AS, has room for one, two or even three Miproc-16 CPU's. Smartly styled and equipped with add-in 13-slot card bay modules, fans and power supply, this new OEM chassis package eases the way into high speed microcomputing.

## Instruction Power

Up to 170 instructions including multiply/divide and bit manipulation give Miproc-16 formidable processing capability.

## 16-bit Power

16-bit program words make programming easy. 16-bit data words maintain high precision in arithmetic operations.

## Addressing Power

16-bit dual memory architecture gives 65k words of directly addressable program memory *and* 65k words of data memory with 8 powerful address modes.

## Interrupt Power

Multilevel, priority vectored interrupt system handles context changes in less than 2 microseconds.

## I/O Power

256 directly addressable I/O channels with data I/O rates of up to 1.7 megabytes/sec. under program control, and up to 20 megabytes/sec. for DMA.

## High Speed Processing Power

The unique dual memory architecture combines with high speed Schottky TTL technology to execute most instructions in a single machine cycle.

## Software Power

Easy to use cross-assemblers for mainframe or minicomputer make programming faster, *and* PL-MIPROC, a super-efficient high level assembly language.

## Hardware Power

Comprehensive range of processor, memory and interface cards backed up by sophisticated hardware development aids.

## Ruggedized Power

Miproc can be configured to meet any known military specification.



**PLESSEY**  
**MICROSYSTEMS**

Phil Burnley,  
Plessey Microsystems,  
1641 Kaiser Avenue,  
Irvine, California 92714, USA.

Tel: (714) 540 9931

CIRCLE 37

David Garrison,  
Plessey Microsystems,  
Suite 408, 11141 Georgia Avenue,  
Wheaton, Maryland 20902, USA.

Tel: (301) 949 1664

654 PP044

	M	DS		M	DS
<p><b>Multisonics, Inc.</b> 3300 Crow Canyon Road, Box 350 San Ramon, CA 94583 (415) 837-8111 <b>Circle 260</b></p>	•		<p><b>Process Computer Systems (PCS)</b> 750 N. Maple Saline, MI 48176 (313) 429-4971 <b>Circle 266</b></p>	•	•
<p><b>Mupro Inc.</b> 424 Oakmead Parkway Sunnyvale, CA 94086 (408) 732-8246 <b>Circle 261</b></p>	•	•	<p><b>Processor Technology Corp.</b> 6200 Hollis Street Emeryville, CA 94608 (415) 652-8080 <b>Circle 267</b></p>	•	•
<p><b>National Semiconductor Corp.</b> 2900 Semiconductor Drive Santa Clara, CA 95051 (408) 732-5000 <b>Circle 262</b></p>	•	•	<p><b>Pro-Log Corp.</b> 2411 Garden Rd. Monterey, CA 93940 (408) 372-4593 <b>Circle 268</b></p>	•	•
<p><b>NEC Microcomputers, Inc.</b> 5 Militia Dr. Lexington, MA 02173 (617) 862-6410 <b>Circle 263</b></p>	•		<p><b>Radio Shack</b> 205 N.W. 7th St. Ft Worth, TX 76101 <b>Circle 269</b></p>	•	
<p><b>PC/M Inc.</b> P.O. Box 215 San Ramon, CA 94583 (415) 837-5400 <b>Circle 264</b></p>	•	•	<p><b>Rockwell International, Inc.</b> Electronic Devices Div. P.O. Box 3669 Anaheim, CA 92803 (714) 632-3860 <b>Circle 270</b></p>	•	•
<p><b>Plessey Microsystems</b> 1674 McGaw Ave. Irvine, CA 92714 (714) 540-9945 <b>Circle 265</b></p>	•	•	<p><b>Signetics Corp.</b> 811 East Arques Ave. Sunnyvale, CA 94086 (408) 739-7700 <b>Circle 271</b></p>	•	•

## NOW! A HIGH SPEED, HIGH QUALITY READER PUNCH FOR JUST \$2395.

Our new model RP 7100 brings you a new 75 CPS punch combined with our 2100 fanfold reader that reads at 300 CPS. All at a price that's hard to beat. Both units are latest state of the art. The 7100 punches and reads 5 through 8 level data on 1", 7/8", 1 1/16" wide tapes. Punching tolerances exceed EIA Standard RS227A requirements. The panel unit is 10 1/2" high, 19" wide with drawer slides. The RP 7100 is also available with a variety of controllers. Write or call for more information.

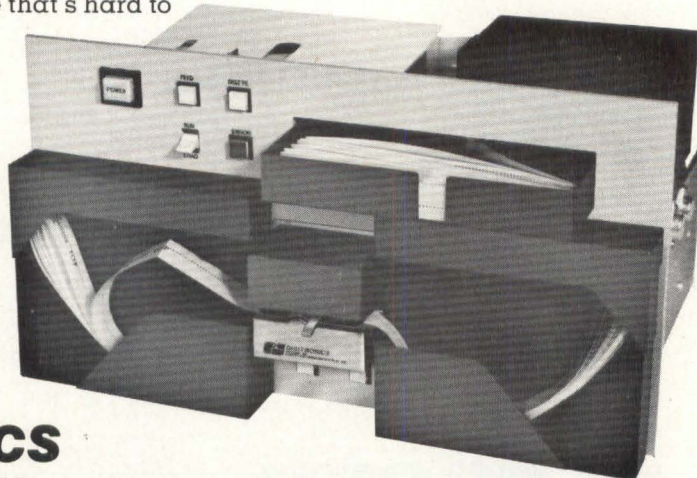

**DIGITRONICS**

Div. of Comtec Information Systems, Inc.  
53 John Street, Cumberland, R. I. 02864. Phone: 401-724-8500 TWX 710-387-1171

	M	DS
<b>Southwest Technical Products Corp.</b> 219 West Rhapsody San Antonio, TX 78284 (512) 344-0241 <b>Circle 272</b>	•	•
<b>The Space Byte Corp.</b> 1720 Pontius Ave. Los Angeles, CA 90025 (213) 468-8080 <b>Circle 273</b>	•	•
<b>System Integration Associates</b> RD. 1, Box 126 Glenmore, PA 19343 (215) 286-5136 <b>Circle 274</b>	•	•
<b>Tektronix, Inc.</b> P.O. Box 500 Beaverton, OR (503) 644-0161 <b>Circle 275</b>	•	•
<b>Teledyne Systems Company</b> 19601 Nordhoff Street Northridge, CA 91324 (213) 886-2211 <b>Circle 276</b>	•	•
<b>Texas Instruments Inc.</b> Components Group P.O. Box 1443 Houston, TX 77001 (713) 494-5115 <b>Circle 277</b>	•	•
<b>Three Phoenix Company</b> 10632 North 21st Ave. Phoenix, AZ 85029 (602) 944-2221 <b>Circle 278</b>	•	•
<b>Warner &amp; Swasey Company</b> 7413 Washington Ave. S. Minneapolis, MN 55435 (612) 941-1300 <b>Circle 279</b>	•	•
<b>Wintex Computer Corp.</b> 544 Lunt Ave. Schaumburg, IL 60172 (312) 529-3080 <b>Circle 280</b>	•	•
<b>Wyle Computer Products</b> 3200 Magruder Blvd. Hampton, VA 23666 (804) 838-0122 <b>Circle 281</b>	•	•
<b>Zilog, Inc.</b> 10460 Bubb Rd. Cupertino, CA 95014 (408) 446-4666 <b>Circle 282</b>	•	•

**WHEN YOUR  
SYSTEM NEEDS  
TO COMMUNICATE—  
IEE • ARGUS  
WILL DO IT!!!**

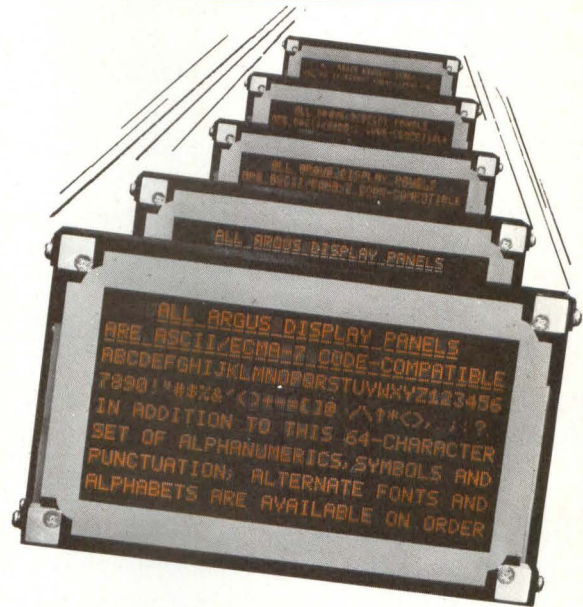

**Alphanumeric Display Subsystems**

The ideal display for process control, word-processing and test equipment. Eighteen different configurations to choose from: 32, 64, 80, 120, 128, 256, 320, 384, 480, 512, or 960-character capacity panels.

Available in either neon-orange (filterable to red) or GREEN!

This space-saving, versatile alternative gives you a choice, not a substitute.

- 120° cone viewing angle with high contrast, high brightness
- Available now with memory, character generation, integral drive electronics
- Simple, versatile interface, easy-to-use
- 5 x 7, 5 x 9, and 7 x 9 dot matrix characters
- Character heights from .2" (5.08mm) to .33" (8.38mm)
- For further information, request Catalogs AG-3 for Complete Electronics, AG-4 for Power Supplies, Filters and Serial Data Converters, and AG-6 for Tube Displays

**Available Now!**



**The Display Maker**

INDUSTRIAL ELECTRONIC ENGINEERS, INC.  
 7740 LEMONA AVE., VAN NUYS, CA 91405  
 TEL. (213) 787-0311 • TWX 910-495-1707

CIRCLE 40

# making microcomputer programming easier

by Carol B. Shaw

When an engineering team designs a microcomputer-based piece of equipment, it can develop the software quicker with a Diskette Operating System (DOS). In addition, software packages for such functions as text editing, compiling and debugging, currently available from many microprocessor/microcomputer suppliers, also make programming easier and faster. Both types of programming tools cut debugging time significantly.

Here's how microcomputer programming evolved. When microcomputers first became available, software development facilities virtually did not exist. Users had to translate programs into machine code by hand and then toggle them into the machine through the front panel. Soon, the industry developed cross-assemblers to run on minicomputers or large computers and produce punched tape or other outputs to be read into the microcomputer memory. When addressable memory sizes increased, assemblers became available to run directly on the microcomputers. Now, a microcomputer with a DOS can provide complete editing, assembling, compiling, linking, loading, debugging and file management facilities, and eliminate the need for costly large computers in micro software development.

What factors should you use to compare microcomputer system software? To help you make your choice we shall provide basic operating system definitions and features, and describe the types of support programs available with microcomputer DOS development systems.

## Know Your Application

When choosing a microcomputer system, you must consider hardware and software. A unit with a sophisticated operating system (OS) and diskette drives costs more than one without, but usually saves money in the long run, because the DOS greatly reduces development and maintenance time.

Since your system must satisfy the requirement of your application, you must consider the following factors:

- Are you going to integrate the operating system into the final product? If you are, can you use it for software development or do you need a separate development system?
- How fast is the operating system? How much memory space does it require?
- If you expect to purchase optional software packages for the system, how much memory do they require?
- Is the application single or multiple task; that is, will several programs run concurrently?
- Will the system have one user or multiple concurrent users?
- Does the system need to operate in real time?
- Which peripheral devices are standard on the system? Will the system require

special interrupt handlers for nonstandard devices? • Does the application require file management capabilities? • Is the system easy to use, well-documented and reliable?

You can answer these questions by defining your application and then comparing your needs with the specifications of currently available operating systems.

## Diskette Operating System Definitions

An OS is a collection of programs that manages the resources of a computer. These resources include allocation of the CPU, main memory (RAM, ROM, PROM) and peripheral devices such as diskettes, lineprinters and terminals. An OS can be thought of as a group of "tasks" or "processes" running concurrently. Fig 1 shows how a task interacts with the rest of the system. When a user program is run, a new task is created. If several user programs can be run simultaneously, then the system is said to be multiprogrammed.

In reality, since only one task can run at a time, a multi-task OS must provide a mechanism for switching from one task to another. Several methods exist for deciding when to switch and which task to run next. One method uses a time-sliced system; that is, each task runs for a small, fixed amount of CPU time, then is suspended and the next task in line is started up. In an event-driven system, such as MuPro's Multi-User/Multi-Task Executive (MUTE) DOS, switching occurs only when a significant event such as a completion interrupt from a peripheral device or a task completion occurs (Fig 2).

In most systems, tasks are assigned different priorities so that the most important things are done first. For example, let's consider a system with a lineprinter. This peripheral is often the bottleneck because it is relatively slow and in high demand. Giving the lineprinter's I/O driver a high priority keeps the printer busy as much of the time as possible. The driver is suspended while it waits for each line to be printed. The ordered-according-to-priority task queue contains information on all of the tasks. The task scheduler starts up the highest priority task which is ready to run.

Interactive capability is a key DOS feature. In an interactive system, a prompting message appears on the user's terminal; the user enters a command and receives a response. The time between the command entry and reply is called the response time and is proportional to the difficulty of the requested task and the load on the system. If this wait time is too long, the user becomes frustrated. An interactive system allows the user to send data to a program from the terminal during execution, whereas a batch system does not.

Some interactive systems allow the user to put several

# Your new Smart Box

## All you do is plug it in

What "point-and-push-the-button" sophistication did for photography, our new Smart Box does for desktop punched tape readers. All you do with the new Decitek Model 262D9 is plug it into your RS232C port.

Then, using the DIP mode selector switch on the rear panel of the Smart Box you can select data transmission rate, word length, parity and number of stop bits. You also have the full range of Baud rates from 110 to 9600 as options.

And our new Smart Box configures to RS232C, current loop or parallel I/O.

Additional program functions all internally programmable by jumpers. You also get patented dual-sprocket drive, 25,000 hour light source with fiber optics, and stepper motor drive — all proven Decitek reader advantages.

That's a lot of desktop tape reader. There's not another one on the market that gives you this kind of flexibility with our Smart Box's plug-in simplicity.

But your biggest surprise will be the reasonable cost of the Smart Box. It would be smart of you to find out about that right now. Call or write. We'll be happy to give you complete facts and figures.

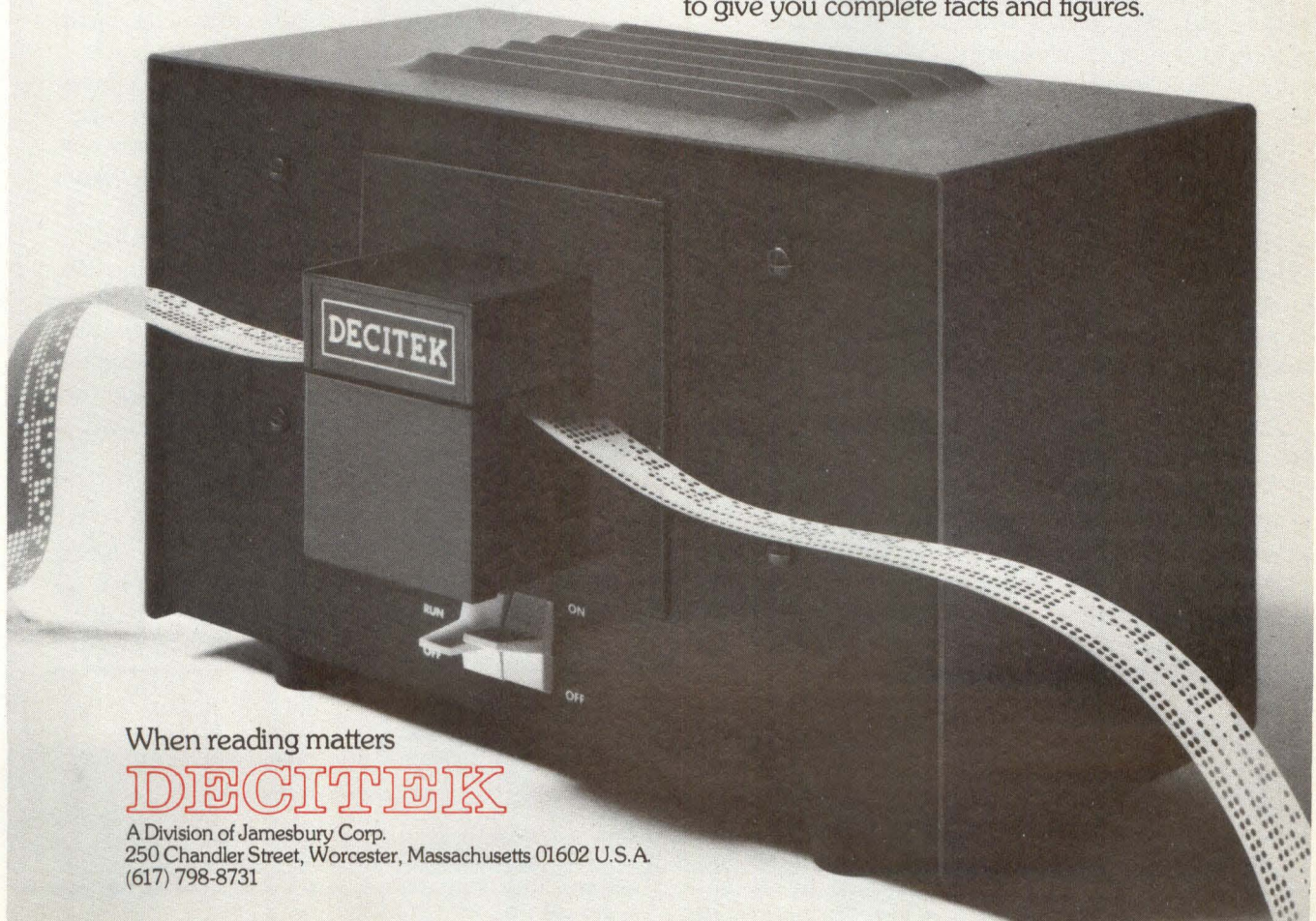

When reading matters

## DECITEK

A Division of Jamesbury Corp.  
250 Chandler Street, Worcester, Massachusetts 01602 U.S.A.  
(617) 798-8731

CIRCLE 41

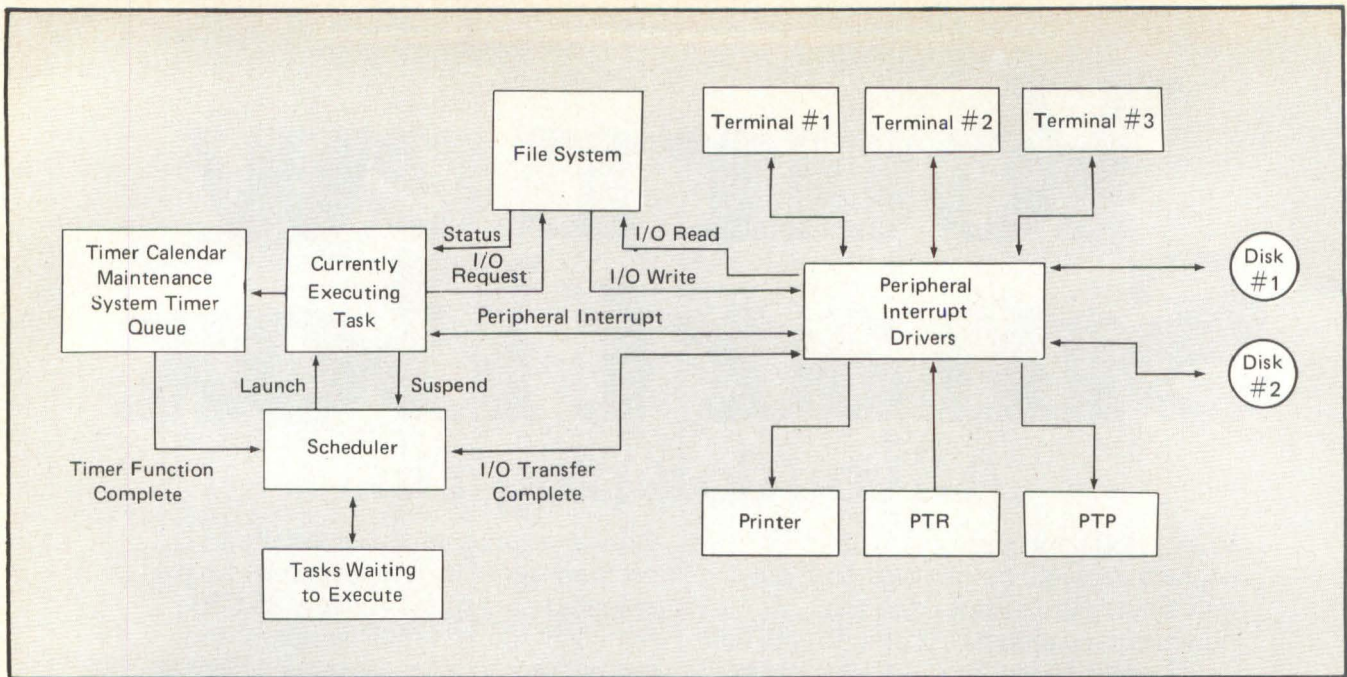

Fig 1 Simplified multitask operating system block diagram shows how the currently executing task interacts with peripherals through the file system: It is launched and suspended by the task scheduler.

commands on the same line to be executed sequentially before the next prompt appears. A few systems have a read-ahead feature which allows the user to enter new commands or program input before the previous input line has been processed. In a multi-user system, several people on separate terminals can use the system at the same time.

Some operating systems are called "executives." Usually these are real-time systems which must be reconfigured for each application. An example is Intel's RMX/80, which is supplied as a collection of relocatable program modules. After the software has been developed on the Intellec Development System, it is linked with the desired system modules and stored in ROM, PROM or RAM. RMX/80 has an optional diskette driver that gives the system a file management capability.

Memory protection, which prevents one user from destroying another user's programs and data, is generally found on large computers. When a user's program tries to access memory outside its allocated area or do I/O, an interrupt is generated which starts up an OS routine. The OS

can terminate the user program with an error message or execute privileged instructions, such as I/O, that are not available to the user.

The average microcomputer, on the other hand, lacks privileged instructions and hardware memory protection. The OS can allocate a different part of memory to each program, but it cannot prevent a program from branching outside its own area. Since an undebugged program may destroy the OS programs, it may force you to reboot the system. Thus, a multi-user microcomputer system without protection features must be a cooperative effort. Several people can edit and assemble at the same time, but they may want to restrict the system to one user at a time when debugging an untested program. Fig 4 shows where each system program resides in memory in one microcomputer system.

The file system, a part of the OS, manages information storage and retrieval. In some systems, all peripheral devices, including lineprinters, readers, punches, terminals and diskette drives are treated as files. This arrangement means that user programs treat all I/O in a similar fashion, without wor-

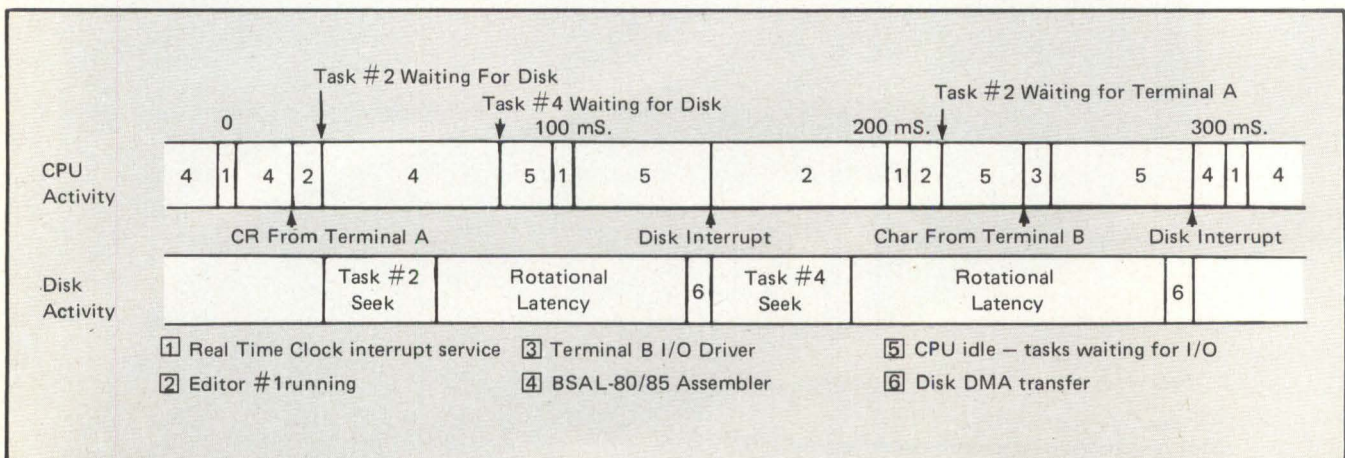

Fig 2 In an execution sequence of an event-driven OS, an editor (task # 2) is interacting with terminal A user. The lower priority

assembler (task # 4) executes while the editor waits for terminal or diskette I/O.

# Have it your way.

## Bit by bit our Standard Modular Memory lets you make every word count.

### **The Standard.**

768K x 16 in one 5¼ x 19 inch chassis.

### **Need more?**

You can address up to *eight* of our MSC 2601 Standard Modular Memory units for up to 6144K x 16.

### **Want it your way?**

Our field-proven MSC 2601 uses dynamic 16K RAM elements. You can organize each card 16K x 1 to 64K x 9. Multiple cards give you almost any word and bit size you want.

### **Any way you like it.**

Up to 14,155,776 bits in one MSC 2601.

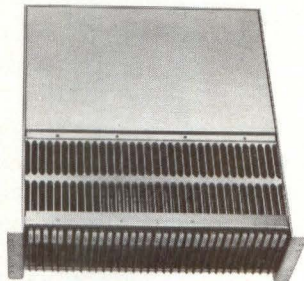

MSC - 2601

### **When you like it.**

Access time up to 350 nsec. Cycle time as fast as 450 nsec.

### **Together in the rack.**

RETMA rackmountable or freestanding. Self-contained with power supplies and forced air cooling. Battery backup available, too, for nonvolatile storage.

### **And for another way.**

If you want 4K RAM our static or dynamic versions will let you have your way with up to 192K words.

### **Our way.**

We use fewer components and low power for high reliability. Multiple source, full specification components tested, assembled and then systems tested under worst case operating conditions.

**The MSC 2601,  
Standard Modular  
Memory...**

**We set the standard.**



Monolithic  
Systems corp

14 Inverness Drive East  
Englewood, CO 80110  
303/770-7400

© 1977 Monolithic Systems Corp.

Visit us in  
Booth 121-123  
Mini-Micro 77  
December 6-8  
Anaheim, CA

rying about the particular characteristics of a peripheral. There are many file management routines that a user program may call. Disk program and data files are accessed with the same system routines.

A good file system allocates diskette space so that the user does not need to know the physical location of his/her file. Files are accessed by specifying the file name and record number. Deleting and creating files can cause diskette fragmentation — the division of available space into many small pieces, none of which is big enough to hold a new file. In some systems, the diskette must be compacted or pushed together periodically to create one large free area.

Some file systems offer techniques for minimizing fragmentation. For example, in MuPro's DOS, a file can be broken up into pieces called "extents". The file can fill in several small holes with extents, instead of occupying one large contiguous set of sectors on the diskette.

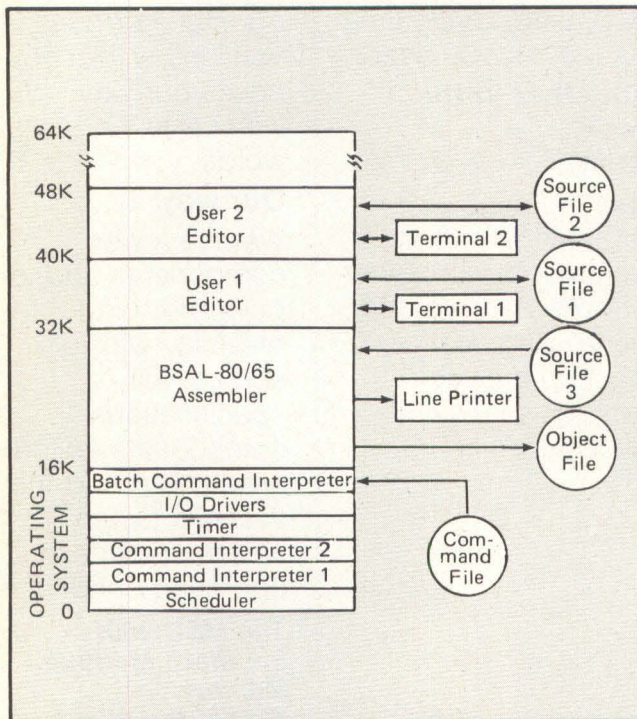

Fig 3 In this two-terminal system, the lower 48K of memory is allocated to the system tasks and the rest of the memory, to user tasks.

Another useful file system feature is the user directory. The file system allows the user to group files on each diskette into several user directories. A separate directory can separate the files for various programming projects. When referring to a file, the user may specify the diskette drive number, directory name and filename. If only the filename is specified, then the OS will use the default directory name which was set up at the time for setting the default disk and user name for searching the files.

### Associated Program Packages

Most microcomputer development systems include a variety of programs that are not technically part of the OS, such as editors, assemblers, compilers, linkers, loaders, debuggers and utilities. Some of these are written as subroutines linked in with user programs. Others are run as separate programs, with user programs as inputs.

**Text Editors.** An interactive text editor can greatly facilitate software development. With the editor, the operator

enters into the system through the terminal keyboard. A diskette file stores them. The user can make changes in a file quickly and easily with such editor commands as ADD, DELETE, COPY, GATHER, FIND, MODIFY, LIST and REPLACE. Usually the commands can be abbreviated (for example, A for ADD) to save keystrokes, once the commands have been learned.

The lines of text in a file are numbered so that individual lines can be identified and accessed. In some editors, all of the lines are renumbered every time new lines are added or deleted, so that the numbers always run consecutively, starting with 1, 2, 3, etc. In other editors, new incremental line numbers are inserted. For example, lines added between lines 100 and 101 could be numbered 100.1, 100.2, 100.3. In this scheme, since text lines retain their original line numbers, it is easy to determine where changes have been made.

**Programming Languages.** Since machine language is no longer used extensively, languages can be divided into two basic categories: assembly (or assembler) and high level. Assembly language is the most efficient in terms of speed and memory use, because each instruction corresponds one for one with a hardware machine instruction. The programmer must manipulate registers and allocate memory space for all variables. Assembler opcode mnemonics are sometimes hard to understand and each computer uses a different set of mnemonics. To make a program intelligible, a comment is needed on nearly every line.

High level languages include ALGOL, FORTRAN, BASIC and many others. When using these languages, the programmer does not have to worry about register or memory allocations, because the compiler or interpreter takes care of such details. Consequently, programs in these languages can be machine-independent. However, the programs usually run slower and less efficiently than they would in assembler, because the code is not optimal. High-level programs require fewer lines of source code and less detailed comments than assembler language programs, and usually require less time to code, debug and maintain.

Some languages, such as ALGOL, contain control structures that make it easier to follow the flow of control within a program. Such constructs as "IF condition THEN BEGIN . . . END ELSE BEGIN . . . END" (Fig 5) and "DO . . . WHILE condition" encourage structured programming. Languages similar to ALGOL are available on some microcomputers. FORTRAN, the first high-level language, lacks such control structures, but benefits from being standardized and widely used.

An interesting compromise between assembler and high level languages, MUPRO's BSAL-80 (Block Structured Assembly Language), uses a statement syntax similar to ALGOL's, but is just as efficient as assembly language, because most statements correspond directly to machine instructions. BSAL-80 has the "IF condition THEN BEGIN . . . END ELSE BEGIN . . . END" construct that makes block structured programs possible.

**Assemblers/Compilers/Interpreters.** Programs for converting source statements into executable object code are called assemblers for assembly language and compilers for high level languages. Interpreters perform source code analysis as a program is being executed, so that no object code is needed.



# CLIFTON PRECISION

More and more O.E.M.'s are changing to Clifton. They know that Clifton offers the finest motor technology, versatility and a responsiveness to customer's needs that is unmatched

in the industry. Clifton designers have demonstrated an ability to solve seemingly impossible problems. Why not put Clifton technology to work for you?

## FRACTIONAL HP DC PM

# motors

### APPLICATIONS

TAPE TRANSPORT DRIVES  
DISK MEMORY DRIVES  
PRINTER CARRIAGE DRIVES  
MACHINE TOOL DRIVES  
CONVEYOR DRIVES

### FEATURES

Torques from 10 to 120 lb-ft  
2 inch to 5.5 inch O.D.  
Advanced magnetic materials  
Cartridge brushes



## MINIATURE DC PM INSTRUMENT

# motors

### APPLICATIONS

DAISY WHEEL DRIVES  
PRINT HEAD DRIVES  
INSTRUMENT RECORDERS  
LABORATORY INSTRUMENTS

### FEATURES

Torques from 2 to 50 oz-in.  
.75 inch cube to 1.25 inch O.D.  
Cartridge brushes  
Alnico or rare earth magnets

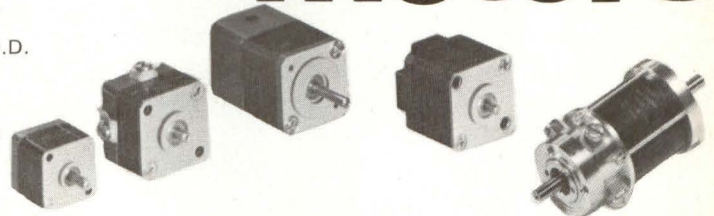

## PM STEPPER

# motors

### APPLICATIONS

PRINTER RIBBON DRIVES  
PRINTER PLATTEN DRIVES  
CARD SORTERS  
OFFICE COPIERS

### FEATURES

Step angles 7.5°, 15°, 30°, 45°, 90°  
1.1 inch to 2.8 inch O.D.  
Ceramic or rare earth magnets



## INTEGRAL ENCODER AND

# motors

## MOTOR-TACHOMETER ASSEMBLIES

### APPLICATIONS

PRINTER CARRIAGE DRIVES  
COPYING MACHINES  
SPEED CONTROLS  
MACHINE TOOL CONTROLS

### FEATURES

Optical encoder resolution to 1000 cycles  
Solid state gallium arsenide light source  
Integral assemblies — no assembly or alignment necessary  
Single source for motor/encoders eliminates costly assembly & simplifies service

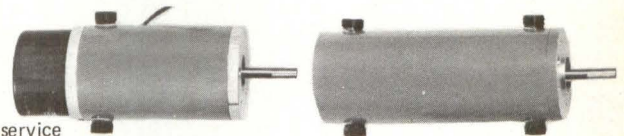

## DC PM HOLLOW SHAFT TORQUE

# motors

### APPLICATIONS

INERTIAL NAVIGATION  
PLATFORMS  
AIRCRAFT INSTRUMENTS  
AIRCRAFT CONTROLS

### FEATURES

Torques from 6 to 500 oz-in.  
1.1 inch to 5.2 inch O.D.  
Precision tolerances  
Gold commutators  
High reliability



CLIFTON PRECISION

for further information, call John Staiber,  
(215) 622-1000

MARPLE & BROADWAY, CLIFTON HEIGHTS, PA. 19018

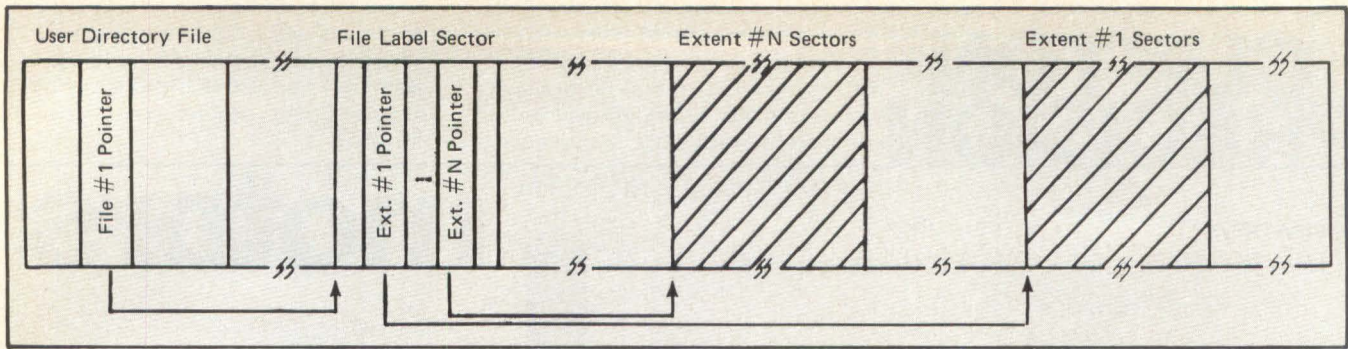

Fig 4 Each disk file in this type of organization can consist of up to 8 separate extents.

Assemblers produce absolute or relocatable code. Absolute code must be loaded into a fixed location in memory, whereas relocatable code can be loaded anywhere. Relocatability is advantageous, because several program modules can be developed independently without worrying about the location of the other modules, then linked together into one program module. Some assemblers possess a macro capability that allows a user to associate an identifier with a block of text which is substituted every time the macro is invoked. Parametric macros allow a different parameter value to be used each time a macro is invoked.

The listing produced by an assembler/compiler should be easy to follow with line numbers, address, source and object code all shown on the same line. Error messages should be easy to find and understand. A symbol table and cross-references are extremely useful in locating vari-

ables and labels and the statements that refer to them (Fig 10). **Linkers/Loaders.** A linker combines relocatable object modules into one absolute or relocatable program module and produces a load map giving the address of each symbol that has been declared as an entry point. MUPRO's linker also provides a cross-reference table telling which modules reference each symbol.

A loader transfers the program file from diskette to main memory so that the program can be executed. Some systems have a single combination linking loader program.

**Debuggers.** A debugger allows one or more breakpoints to be set so that the user program can run until a specific memory location is accessed. The break may occur at memory read and write or just at instruction execution. Memory locations and registers may be examined and changed. The program can be stepped through by executing one instruction at a time. A program trace facility allows the user to follow the order of instruction execution.

In some systems, the debugger must be specified during the linking process and becomes part of the program module. In others, the debugger is run as a separate program. The front panels of some microcomputers have switches, LEDs and hardware debugging circuitry.

**Utilities.** Provided with the system, utilities perform general-purpose functions. Examples include multiplication/division subroutines for computers which do not possess these functions in hardware, and conversion routines such as binary to ASCII and binary to BCD.

### The Bottom Line

Choosing a DOS requires careful consideration of the support it can provide for each application. Today's microcomputers provide features previously found only on larger systems such as multi-user, multi-programming and random access file systems. Program packages are available for text editing, compiling, debugging and other facilities to aid program development.

Microcomputer applications in which recurring production costs or execution speed are important factors demand efficient use of the machine architecture and instruction set. Software design and maintenance costs are also important considerations, and often far exceed the hardware engineering costs. An operating system and its associated editor and programming languages must take these factors into account.

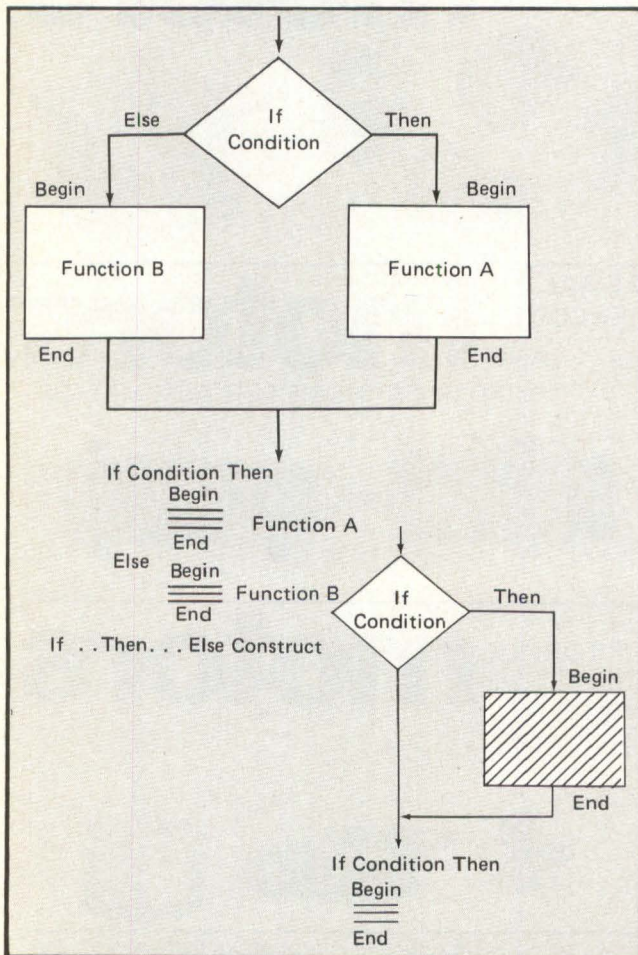

Fig 5 Flowcharts and equivalent program statements are given for ALGOL "If . . . Then" control structures.

Carol B. Shaw is a systems programmer at MuPro, Inc., 424 Oakmead Parkway, Sunnyvale, CA.

MEMO:

TO: *All potential Microprocessor Users*  
Consider the NEW Memodyne 760 Series of high-performance digital cassette recorders with your micro processor (or your mini-computer or terminal)

### HIGH PERFORMANCE DIGITAL CASSETTE RECORDERS

Model 764 (Shown)

#### FEATURES

- HIGH SPEED** Up to 32 kilobits per second. Searches forward and reverse at 100 inches per second.
- FAST RESPONSE** 200 millisecond start-stop-settle time.
- RUGGED AND RELIABLE** Only 2 moving parts. • MTBF > 10,000 hours. Soft error rate of 1 in  $10^7$ .
- LARGE CAPACITY** Up to 1600 flux changes per inch or 5 million bits per standard Philips cassette.
- VERSATILITY** Accurate speed, very low skew and ANSI/ECMA compatibility permits use of all popular encoding schemes.
- STATUS INDICATIONS** BOT/EOT hole and leader sensor, Cassette-In-Place, File Protect and Busy/Ready.



#### DESCRIPTION

The Memodyne 760 Series of cassette recorders are compact, removable medium, storage devices for digital information. Their two track and high density capability provide up to 5 million bits of storage on a single standard Philips cassette. In their standard configuration they are capable of storing or retrieving data at a rate of 16 kilobits per second per track. A patented reel-to-reel constant tape speed servo (U.S. Patent Office #3,733,529) coupled with precision tape guid-

ance allows implementation of any of the popular encoding schemes with low error rates, minimal tape wear, and high tape utilization. The simplicity of the transport mechanism and the use of conservatively rated, high quality parts give high reliability and maintenance-free operation. Three of these compact units can be fit on a single 5" x 19" standard panel. The enclosed cassette chamber holds the cassette firmly, resisting vibration while shielding the cassette from airborne contaminants.

#### SPECIFICATIONS

**Status Signals:**  
Cassette-In-Place, File Protect, B/EOT, Busy/Ready — TTL Compatible.

**Control Signals:**  
Run/Stop, Forward/Reverse, Slow/Fast — TTL Compatible.

#### READ AND WRITE PERFORMANCE (Read-While-Write)

**Gap Spacing:**  
.150,  $\pm$  .005 inch.

**Dynamic Skew:**  
 $\pm$  100 microinches max.

**Recording Density:**  
To 1600 flux reversals per inch nominal.

**Transition Spacing:**  
Down to 625 microinches nominal.

**Read and Write Rate:**  
Up to 32,000 transitions per second.

#### TAPE MOTION

**Tape Speed:**  
20 inches per second,  
100 inches per second.

**Start Time to  $\pm$  5% of 20 Inches Per Second:**  
75 milliseconds.

**Start Distance to  $\pm$  5% of 20 Inches Per Second:**  
1.00 to 1.25 inch.

**Start Distance to  $\pm$  5% of 100 Inches Per Second:**  
500 milliseconds maximum.

**Stop and Settle Time:**  
150 millisecond recommended minimum.

**ERROR RATES**  
Soft errors: 1 in  $10^7$  is easily obtainable in typical applications.

Priced \$300. and up in OEM Quantities F.O.B. Newton, Mass.  
Write for latest Memodyne Product Catalog

**Memodyne**  
CORPORATION

385 ELLIOT STREET, NEWTON UPPER FALLS, MA 02164  
TELEPHONE (617) 527-6600-TELEX 922537

CIRCLE 44

# PPG helps keep things under control.

With glass.

PPG electronic glass with a permanent, transparent, electrically conductive, metallic oxide coating. PPG provides two different coated glasses for two separate custom products: touch control panels and electronic displays.

Touch control for devices and appliances like calculators, ranges, TV receivers, and



dozens of other kinds of electronic equipment.

And for visual displays on digital clocks, wristwatches, calculators, and on any other instrumentation your fertile mind can create.

One brand of PPG electronic glass is Nesatron® glass. Its coating has a hardness and

durability far superior to evaporated coatings. It is applied at relatively low temperatures, so the process has no effect on the flatness of the glass substrate. It can be readily etched to create diagrams, letters, numbers, or any other design that suits your purposes.

The other PPG electronic glass is Nesa® glass. Because of its durability, it is ideally suited for use in electronic controls, and offers you the opportunity to abolish buttons, knobs, dials, and switches.

Design with PPG Nesa® and Nesatron® electronic glass. For beauty, efficiency, reliability.

And we'll help with complete information: Just write Industrial Glass Products, PPG Industries, Inc., One Gateway Center, Pittsburgh, Pa. 15222.

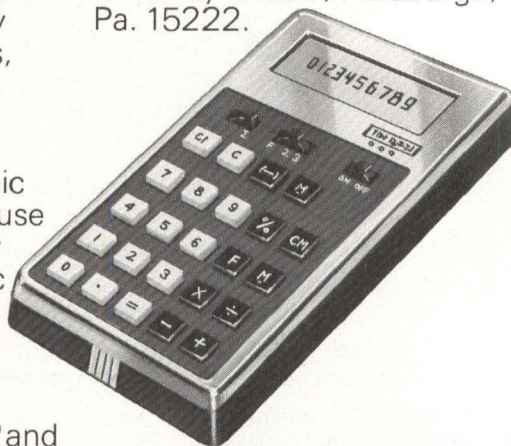

PPG: a Concern for the Future

**PPG**  
INDUSTRIES

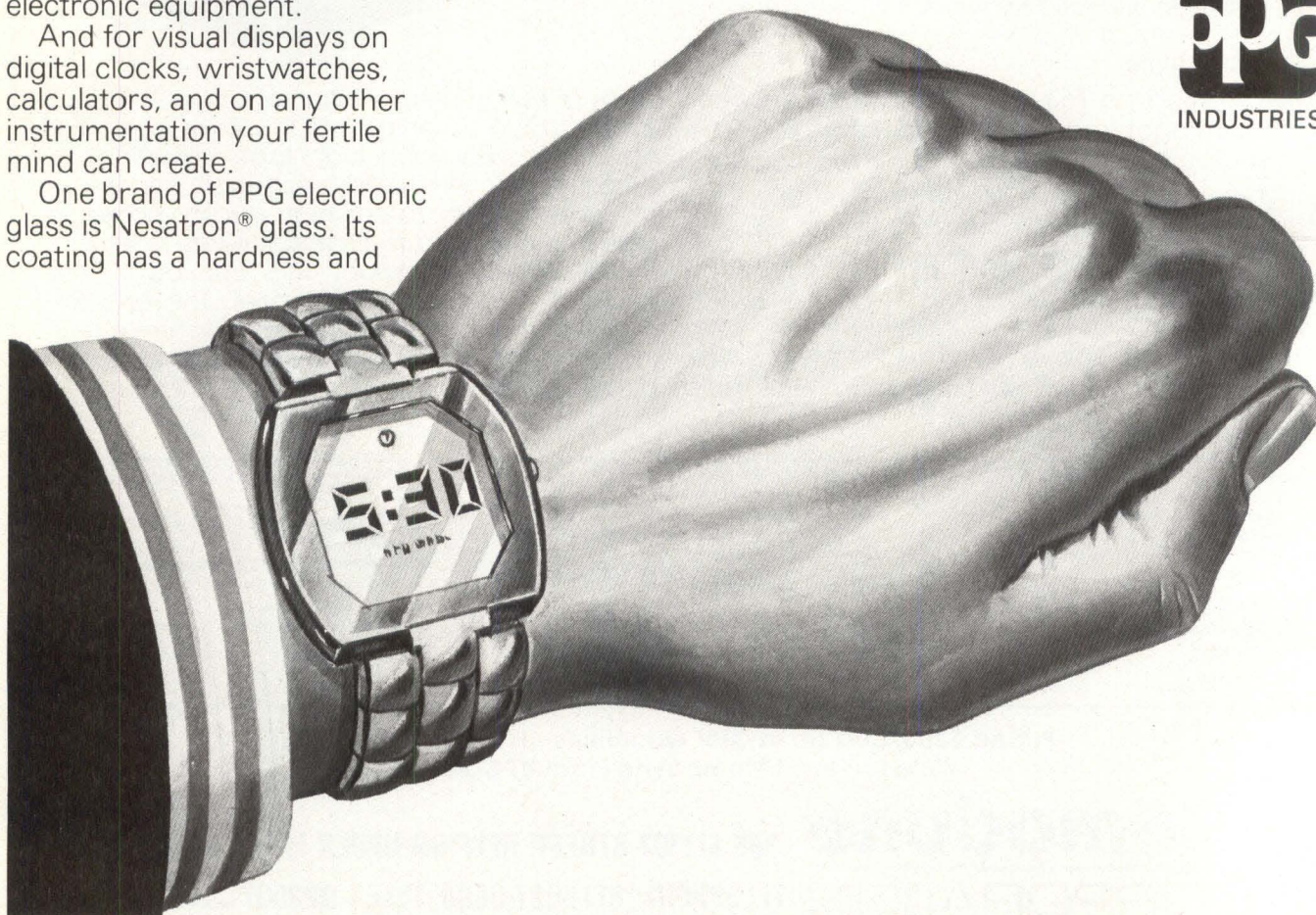

CIRCLE 45

QUIETIZED



MODEL 1560-AS

Combination reader/punch with serial asynchronous RS-232C compatible interface utilizing ASCII-DC codes to control devices.

EXPERIENCE



MODEL 1560-P

Combination reader/punch with parallel TTL level interface.

COMPATIBILITY



MODEL 1060-AS

Punch with serial asynchronous RS-232C compatible interface.

HI-QUALITY



MODEL 1060-P

Punch with parallel TTL level interface.

RELIABILITY

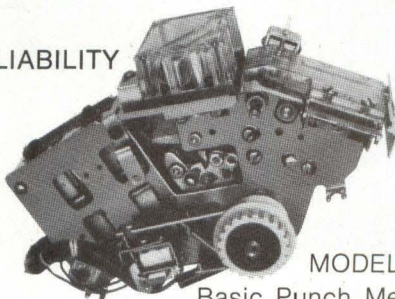

MODEL 500

Basic Punch Mechanism operates at 60 cps. For OEM's who prefer to provide their own circuitry and housing.

if you design or use data processing systems for communications, data collection, instrumentation, etc. here are the best reasons to go with

# ROYTRON™

PROVEN DEPENDABLE

## HI-SPEED SERIES PAPER TAPE UNITS

All Made in U.S.A.

OEM DISCOUNTS

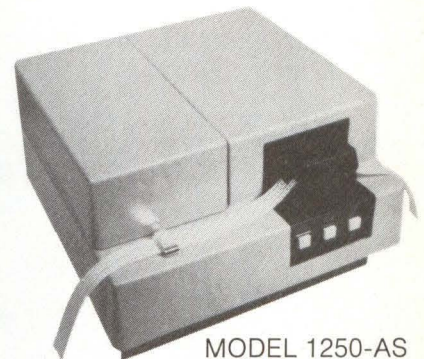

MODEL 1250-AS

Reader with serial asynchronous RS-232C compatible interface.

DESIGNER'S DELIGHT

If you value your skins more than ours, we'll sell you the pieces.

Every unit at OEM quantity discount prices.



For full details, write or call us.

### SWEDA INTERNATIONAL, INC.

Litton OEM Products

34 Maple Avenue, Pine Brook, N.J. 07058/(201) 575-8100

IN U.K. — ADLER BUS. SYSTEMS/OEM PRODS., Airport House, Purley Way, Croyden, Surrey, England

IN FRANCE — SWEDA INTERNATIONAL/OEM, 103-107 Rue de Tocqueville, 75017 Paris, France

CIRCLE 46

# Microprocessor Control Of A Bridge Crane

by Sharon Pellerin

**L**ast winter, after accepting the task to replace five miles of gravity conveyor with a computer-controlled bridge crane system, Control Logic, Natick, MA and their parent company, Harnischfeger Corp., began work. Their customer, a major aluminum manufacturer, requested the crane system for storing carbon blocks. The aluminum maker carries an inventory of as many as 12,528 carbon blocks, each measuring 1.5 by 1 by 3 feet. Half of these blocks, in a green state, occupy the east storage area waiting to be baked. The other half are baked and ready for use.

For discussion purposes, only a portion of the project receives treatment here. Control Logic engineers designed and built the crane system electronics which includes two 8080-based systems. The first system is called the ground console (GC) and the second the on-board controller (OB). Control Logic programmer Ted Knowlton wrote the software to control both systems. The ensuing article delves into Knowlton's six-month development effort in an attempt to shed light on the time and effort involved in programming microprocessors for control applications.

**Fig 1** Pictured here is the crane used by a major aluminum manufacturer to load and unload carbon blocks from a storage area. The crane has its hoist lowered to the bottom point and its twelve grabs closed around the carbon blocks.

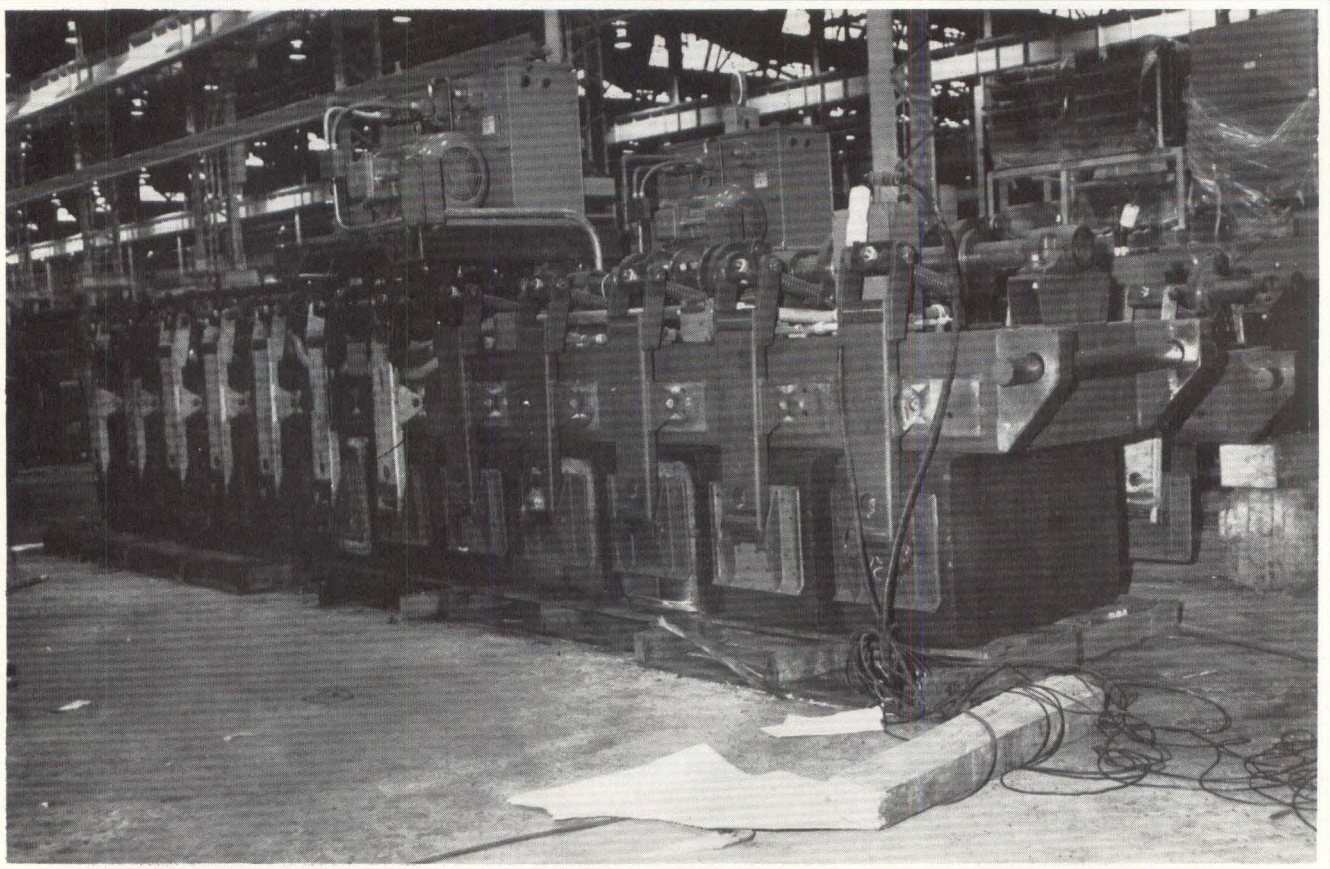

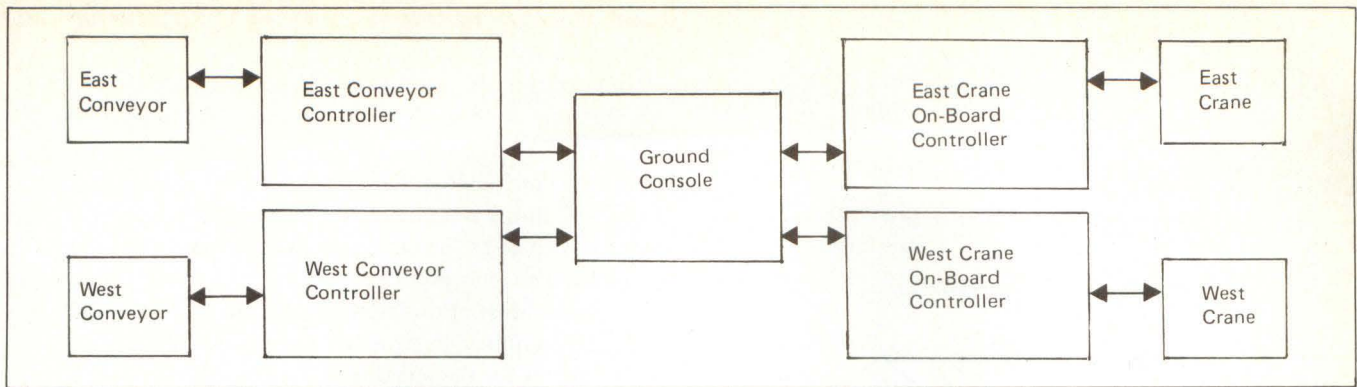

Fig 2 This block diagram shows the overall crane control system.

### system overview

The system specifications are as follows. Each storage area holds 6,264 carbon blocks arranged in 87 rows of 72 blocks each. Within a row, the blocks are stored 12 across and six high. Three conveyors split each storage area into two sections – north and south. The north section contains 27 rows and the south 60 rows. The distance between the first and last rows is 306 feet. Both cranes lift twelve carbons at once with each block weighing up to 710 pounds.

Of the three floor-mounted roller conveyors that feed and drain the storage areas, only the north and south conveyors do both. The center conveyor feeds only. A conveyor controller commands each crane to either load carbon onto a conveyor from storage or to unload carbon from a conveyor into storage. Communication with the cranes occurs via wiring to the ground console which serves as a command multiplexer to the crane controllers. The ground console talks to the crane only when the crane is stationary.

Storage areas fill up either in layers or tiers. Starting from the farthest point, the crane works its way back to the conveyor either a row per command for layers or a row every six commands for tiers. When a section fills, ground console flashes a message on the CRT to alert the operator. Furthermore, on system initialization, the operator can specify any rows to be excluded from the stacking process.

Normally, the crane waits for instructions in an idle state positioned above the conveyor serviced in the last command. When an unload command issues, the crane bridges to the selected conveyor – if required. It then lowers its grab, picks up the carbon blocks and hoists them to a 10'-6" level. The bridge travels to its destination at maximum speed, slows down and stops at the proper stacking position. The hoist then lowers the grab to the proper level and the grab opens to release the twelve carbon blocks. The hoist returns to maximum height and the crane returns to the selected conveyor.

Conversely, receipt of a load command from the ground console reverses the process and the crane brings carbon blocks from the last stacking position to the selected conveyor. The grab opens, releasing the carbon, and the hoist rises to the highest position to await the next command.

The ground console monitors crane operation and uses this information to update the operator display. The operator display includes information on the contents of each storage area (east and west) as well as associated sections

(north and south). Any faults in either the GC or the OB are reported on the display. In addition, the ground console regularly transmits crane status to the conveyor controller.

### ground console

The ground console serves as a command multiplexer between the conveyors and the cranes. It accepts commands from the conveyors' controller and updates them as to crane status. Further, it delivers commands to the cranes as well as requesting and accepting each crane's status. The ground console must also support two-way communications with a CRT terminal which provides an interface for the operator.

The GC program treats both cranes equally. After each pass through the main loop, a turnaround routine forces the program to use variables for the other crane in its next pass. Two 120-byte read/write memory sections

Fig 3 The ground console is shown here with its front panel swung open. This station will sit in the air conditioned room in the aluminum manufacturer's facility.

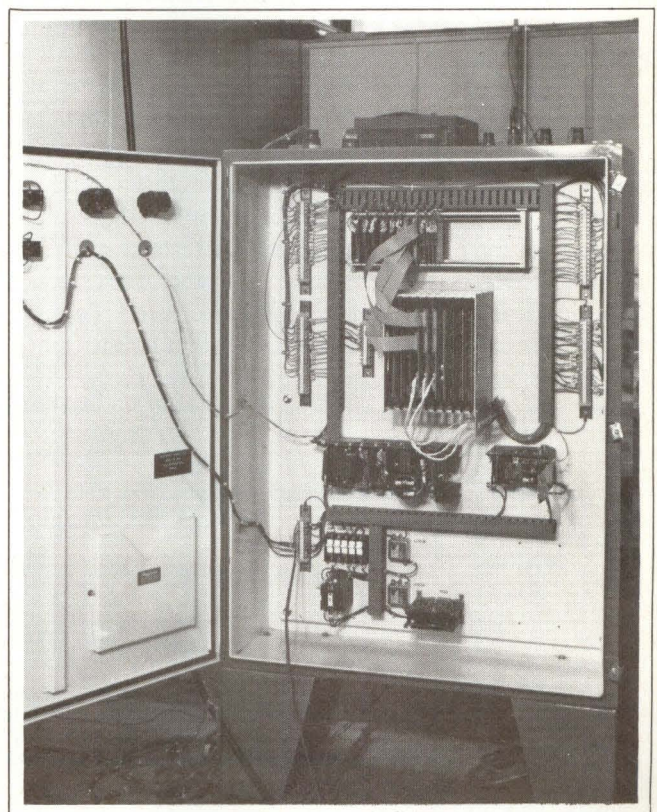

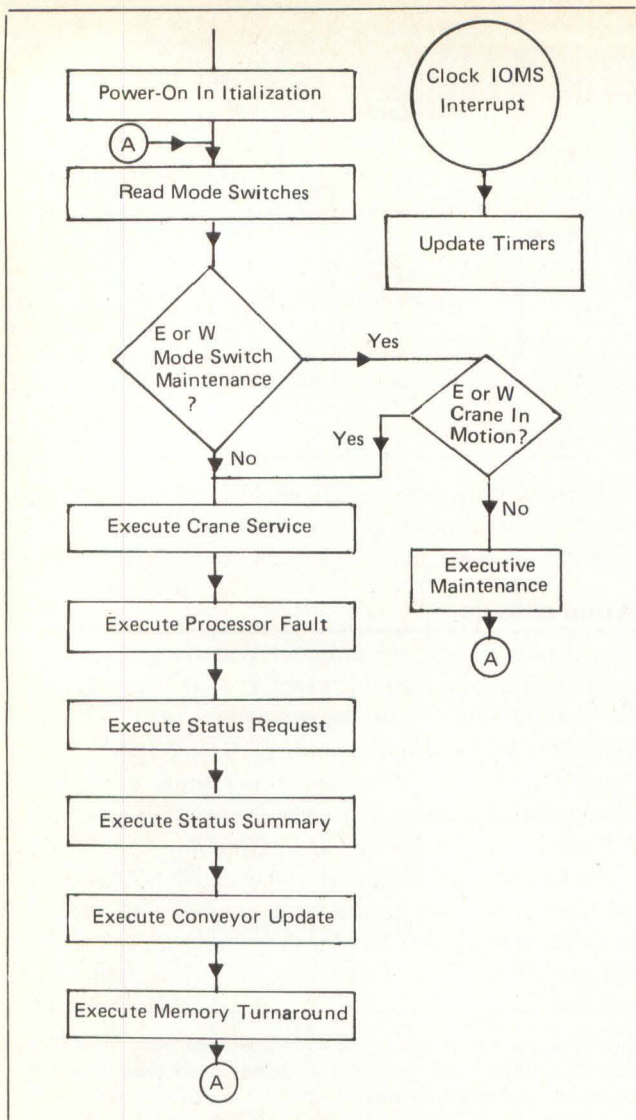

Fig 4 This flow chart shows the operation of the ground console program.

house the variable data for each crane and a third 120-byte workspace section is loaded alternately from the other crane during each execution of the turnaround routine.

The ground console program operates in two modes: maintenance and normal. During the maintenance mode, the operator enters stack limits and exclusions, start stacking positions and stacking method (layers or tiers). To enter the maintenance mode, both manual switches on the front

panel of the ground console station must be positioned in the maintenance state.

In normal mode, the GC first executes crane service. This routine waits for a single character transmission from the OB controller. This character indicates the present activity of the OB controller; either idle and ready, waiting to send status, executing a command or faulty. All exits from crane service go to the fault processor routine – even for no faults. The fault processor routine occupies 2106 bytes of memory. Most of this storage is for text; 75 message segments combined in twos and threes form 68 possible fault displays for the operator.

After processing faults, the ground console program enters the status request routine. Here, the GC obtains the crane's status and displays it on the CRT, if requested. Then, the summary status routine updates the bottom line of the CRT which maintains by section a running tally of the contents of east and west storage areas. This bottom line on the CRT also posts the operation being performed by each crane.

Finally, the GC updates the conveyor controller as to the crane's status and then executes memory turnaround to service the alternate storage area. The GC program, also stored in PROM, requires 10.8K bytes of memory.

When the GC sends commands to the OB controller, it informs the crane of its bridge and hoist destination and the selected conveyor. It also commands either full or half cycle sequences. For half cycle sequences, the crane either picks up or deposits carbon blocks. It does not perform an entire load or unload operation. These half cycle commands are operator initiated and serve manual fault recovery.

On the other hand, when the OB transmits the crane's status to the GC, it informs the GC of its present hoist and bridge address, the condition of the bridge, cable and grab and the status of the twelve carbon blocks within the grab. Thus the GC keeps itself up to date on the crane's activities.

### on-board controller

The on-board controller manages the movements of its associated crane. It accepts as input bridge and hoist positions and sensor readings for cable state (slack or taut). In turn the OB outputs speed and direction signals to the crane's motors. The bridge moves at four speeds – creep, slow, medium and full – and the hoist at three speeds, creep, slow and full. Further, the OB issues commands to open and close the grab.

Fig 5 These message strings command the crane and provide crane status.

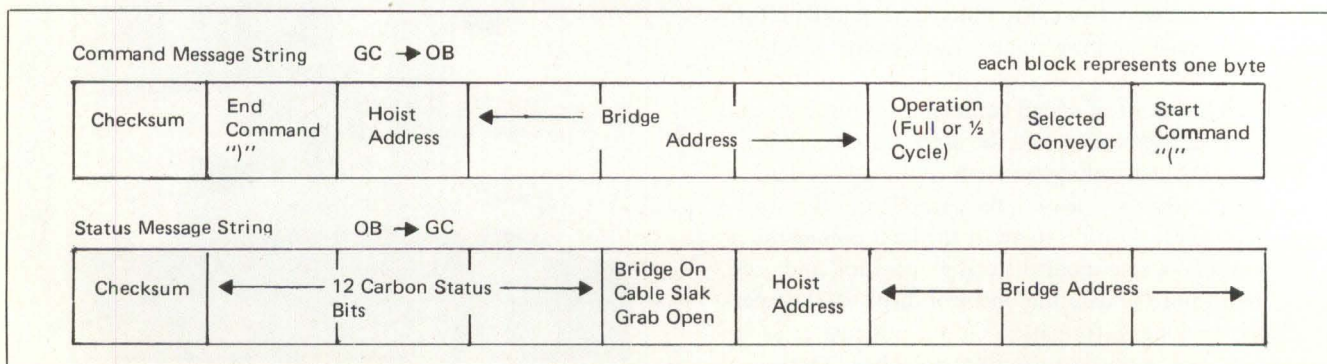



# Start your own revolution



with a personal computer

Dramatic developments in computer technology have made it possible for you to *completely reorganize* and *improve* the ways you manage your personal and business life.

Today, for as little as \$600, you can buy a complete computer system about the size of a typewriter. These new computers are called *personal* computers. They are every bit as powerful as yesterday's room-sized computers that cost millions of dollars.

A personal computer can be your *equalizer* in dealing with our complicated society. You'll have the same organizing, calculating, and information storage **POWER** that was previously only in the hands of large institutions. You can have a computer to deal with *their* computers.

As a reader of **PERSONAL COMPUTING** magazine, you'll be in the heart of the

computer revolution. We'll show you how to use your own computer for business and home management—for education, income tax preparation, research, text editing, environmental control, art, games, recipe files, budgeting, inventory control and hundreds of other applications.

**PERSONAL COMPUTING** is a consumer magazine that makes computers more *understandable* and *useable*. Our readers include businessmen, teachers, accountants, doctors, lawyers, engineers, programmers, and scientists.

Each issue of **PERSONAL COMPUTING** brings you page-upon-page of useful information and colorful, people oriented articles. Subscribe now so you can be a part of this new revolution.

Please start my subscription to **Personal Computing**

Name \_\_\_\_\_

Address \_\_\_\_\_

City \_\_\_\_\_ State \_\_\_\_\_ Zip \_\_\_\_\_

**USA**

1 year (12 issues) \$14     2 years (24 issues) \$26     3 years (36 issues) \$38

Charge my:  Master Charge     Bank Americard

Account # \_\_\_\_\_

Card expiration date \_\_\_\_\_

Bill me

Check enclosed (you'll receive one extra issue for each year!) please allow two months for processing.

**Additional Postage per year:**

Canada & Mexico    \$ 4.00 surface  
                                   \$ 8.00 air  
 Other foreign        \$ 8.00 surface  
                                   \$36.00 air

Please remit in US funds — Thank you

Back Issues \$2.00/copy (check with order)

MAIL TO: **PERSONAL COMPUTING**, 1050 COMMONWEALTH AVE., BOSTON, MA 02215

Once commanded by the GC, the crane performs tasks on its own. After determining both destination and task, the crane executes the task, stops and waits for another command from GC. The GC communicates with the OB in either single characters or message strings.

The two message strings shown in Figure 5 command the crane and provide crane status.

The OB controller program requires 3.8K bytes of memory. Control Logic chose to implement this on PROM. In addition, the program uses 93 bytes of read/write memory for variables and workspace. After power-on initialization, where the program initializes pointers and checks out memory and clocks, the program enters the main loop called the idle loop. Once in the idle loop, the program scans all status bits for any faults. If any errors prevail, the program enters the fault processing loop and reports the fault type to the GC. If no faults exist, the crane controller searches for a status request or a new command from the GC.

Both the OB controller and the GC contain a clock interrupt routine. Every ten milliseconds, the interrupt causes all the status bits to be updated as well as all the critical timers for system operation. Figure 6 shows a flow chart of the OB controller program. According to Knowlton, about half the program or 1703 bytes are used by the crane to perform its tasks. The other half handles GC communications, faults, initialization and clock updates.

### program development

Knowlton spent 26 weeks developing the software for this system. He went through four phases to complete the project — program organization, flow chart, coding, and debug. In the first five weeks, he produced the program organization document. Here, the tasks to be performed by each 8080 were written down in plain language following an

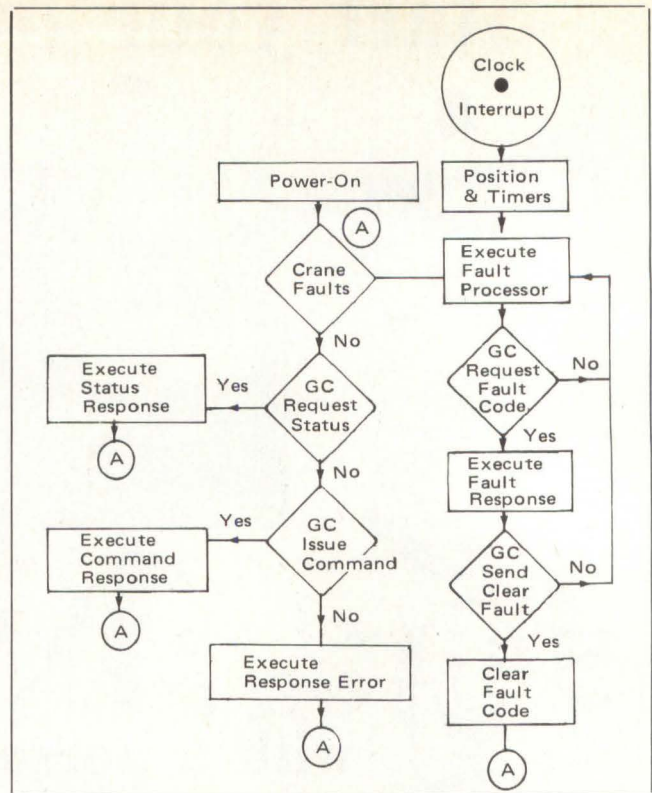
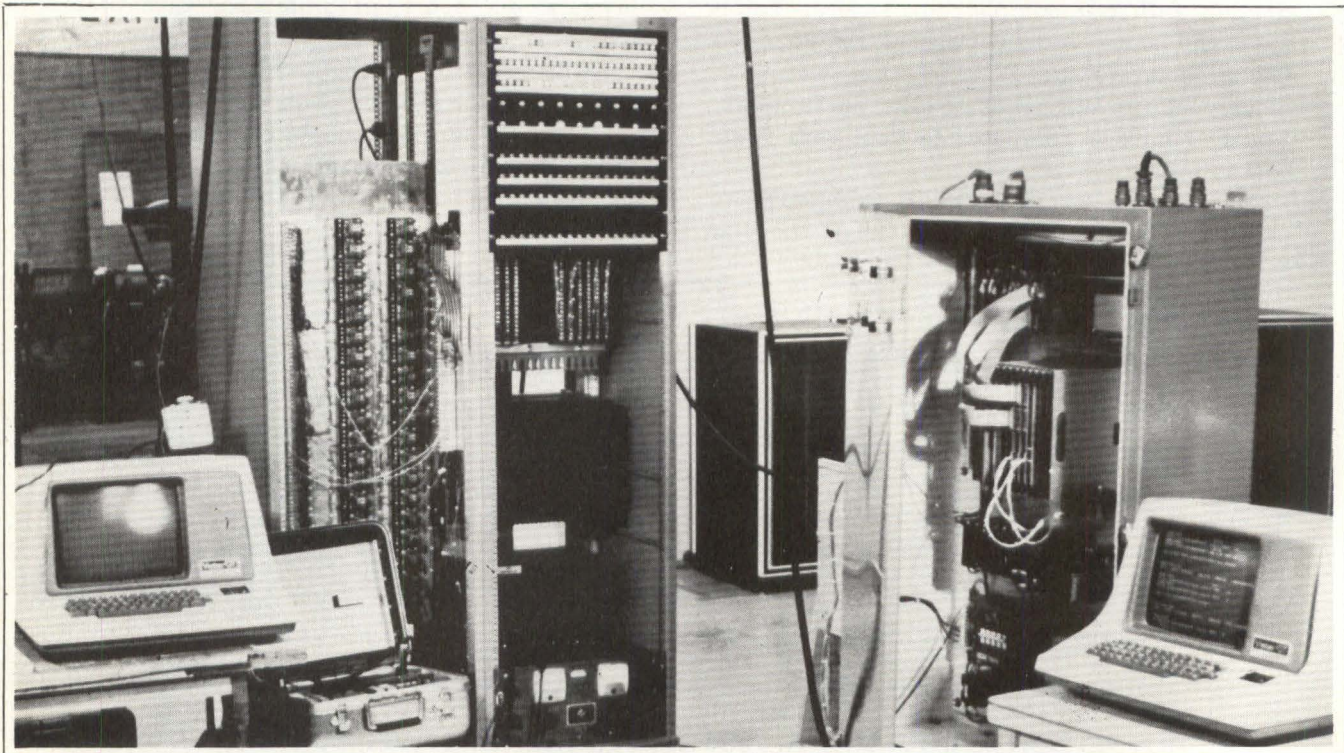

Fig 6 This flow chart shows how the OB controller program operates.

outline format. In total, Knowlton's program organization document required 29 typewritten pages. He used the specifications set down by the negotiating team as input.

The next phase, flow chart, took eight weeks to complete. Here Knowlton developed pages and pages of sequences and branches in an effort to link together all the concep-

Fig 7 Pictured below from left to right are the CRT used to debug the OB controller, the crane simulator, the ground console and the ground console's CRT.



# KERONIX

- ◎ MINI COMPUTERS
- ◎ PERIPHERAL CONTROLLERS
- ◎ ADD-IN MEMORIES
- ◎ ADD-ON MEMORIES
- ◎ TERMINALS
- ◎ SYSTEMS

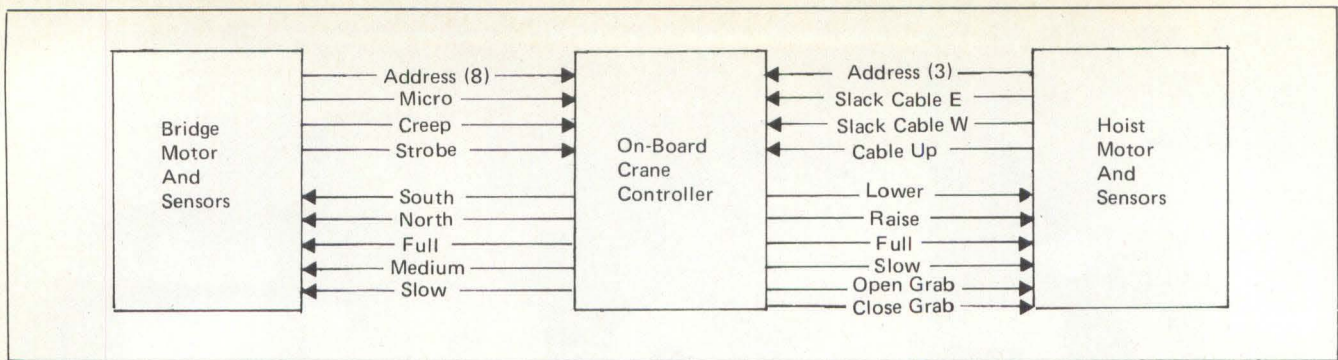

Fig 8 This diagram show signal flow for OB bridge, hoist.

tual tasks set down in the program organization document. Status and control bits were assigned abbreviated symbols and placed in flow chart format. The GC program alone required 46 pages of flow chart information.

After the flow chart, Knowlton dived into coding. Converting the flow charts into 8080 mnemonics took five weeks. According to Knowlton, portions of the program were coded directly from the program organization document, skipping the flow chart phase all together. As a result, time requirements for these two phases may vary slightly from those quoted.

The last phase, debug, went for eight weeks. Knowlton encountered no major problems during this stage and believed the program fairly strong after six weeks. He used the remaining two weeks to develop a maintenance routine which outputs a time chart of the input and output signals

between the OB controller and the bridge and hoist. At 160 millisecond intervals, the status of each crane I/O bit is stored. Then for every active bit (high) the printer outputs a "SPACE" and then an "I". For each inactive bit (low) the printer outputs an "I" and then the SPACE". After a given time limit, the printer paper is removed from the unit, rotated 90 degrees and each "I" connected with a pencil to create a time chart.

For the coding phase, Knowlton used a Control Logic MM1 microcomputer development system. The OB controller, connected to a factory tester to simulate actual crane responses, was debugged first. A CRT played the part of the GC. For GC debug, he used the true ground console with CRT, both OB controllers connected to the simulator and a black box for the conveyor controller with switches for output signals and lights for input signals.

## MDB SYSTEMS presents... The NOVA\* Connection

**GP Interface Modules · Peripheral Controllers · Communications Interfaces · Accessory Hardware**

**New: Four or Eight Channel Multiplexors · Multiple I/O Controller**

MDB Systems products always equal and usually exceed the host manufacturer's specifications and performance for a similar interface. MDB interfaces are software and diagnostic transparent to the host computer. MDB products are competitively priced; delivery is usually within 14 days ARO or sooner.

Here are some MDB Systems connections to Data General NOVA computers:

- General Purpose Interfaces: GPIO similar to Nova 4040, with PC'd interface logic and wire wrap section for 105 wire wrap devices. Full wire wrap board for 215

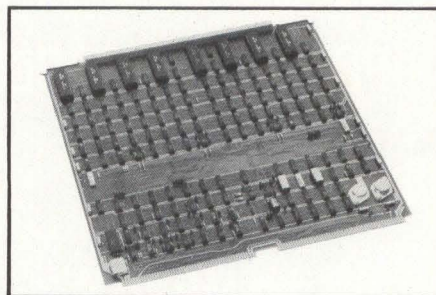

- sockets or DIP devices.
- Device Controllers for most major manufacturer's Printers Card equipment Paper Tape equipment
- Four or eight channel Multiplexors, Nova 4060 compatible, with many additional program controlled features. Full modem control contained on board. Optional panel for multiplexor provides standard 25 pin communications connectors for each channel.

- Multiple I/O board for TTY and/or RS-232 Controllers. Options include Real Time Clock and modem control.
- Accessory Hardware Front loading expansion chassis, optional power supply configurations, chassis may be terminated or daisy chained. Terminator modules. Extender boards. Check first with MDB Systems

for your NOVA computer interface requirements.

MDB also supplies interface modules for DEC PDP-11\* and Interdata computers and for DEC's LSI-11 microprocessor.

**MDB**  
MDB SYSTEMS, INC.

1995 N. Batavia St., Orange, California 92665  
714/998-6900 TWX: 910-593-1339

\*TMs Data General Corp. & Digital Equipment Corp.

CIRCLE 49 FOR NOVA; 50 FOR PDP-11; 51 FOR INTERDATA; 52 FOR LSI-11.

# Technological Leadership for 3 Decades!

Ampex, headquartered on the San Francisco Peninsula, is the company that "invented" the magnetic recording industry.

The technology pioneered by Ampex over three decades has affected many aspects of our modern lifestyles, and has established Ampex as a leader in magnetic recording. Our continued effort in developing new technology has always been the key to our leadership. Right now our Advanced Technology, Data Products and Audio-Video Systems Divisions are embarking on several new programs. To insure the success of these programs we are seeking innovative graduate engineers with experience in the fields listed below.

Opportunities like this don't happen very often. But they're happening at Ampex now.

## Advanced Technology Division

- electron beam and optical recording
- magnetic recording
- tape or film handling
- servos
- high-bit rate digital circuit design
- optics
- signal analysis
- pattern recognition
- high frequency circuit
- communications theory

## Data Products Division

- circuit/systems design of very high-bit rate systems

- disk read/write systems and equalizing systems for tape recorders
- codes for magnetic recording
- precision servo systems for both linear positioners and rotating systems
- mechanical design of high precision systems in disk recorders and in longitudinal, helical and transverse scan tape recorders

## Audio-Video Systems Division

- analog videotape signal systems
- digital video signal processing
- servo systems
- videotape editing
- professional audio recorders
- head technology
- TV cameras

If you think you have something valuable to offer in any of these or closely related areas, and if you would like to join some of America's most talented engineers, please send your resume or a letter outlining your qualifications to: Ampex Corporation, ATTN: J.B. Puckett, Building 2, 2655 Bay Road, Redwood City, CA 94063. Or you can send us this coupon and we'll get back to you. We are an equal opportunity employer m/f.

**Manager Corporate Staffing  
AMPEX Corporation  
Building 2, 2655 Bay Road  
Redwood City, CA 94063**

Dept. 3

Name \_\_\_\_\_  
Address \_\_\_\_\_  
City, State, Zip \_\_\_\_\_  
Phone \_\_\_\_\_

Occupation \_\_\_\_\_  
Years of Experience \_\_\_\_\_  
Employer \_\_\_\_\_



# PRODUCTS



## DIGITIZER INPUT FOR HAND-HELD CALCULATOR

A non-keyboard entry device for Texas Instruments' hand-held programmable calculators, the SAC GP-352 consists of the basic Graf/Pen Model GP-3 sonic digitizer, a Texas Instruments SR-52 hand-held programmable calculator, and the necessary interface, cabling, and plug-in connector. Designed to eliminate the manual input of graphic data to the calculator, hand calculations, and transcription errors, uses for

the GP-352 system include calculating variables such as area, line length and volume in applications including navigation, surveying, statistics, aviation, estimating, mathematics, trend analysis and civil engineering. The basic GP-3 sonic digitizer includes a 14-inch aluminum data tablet, stylus or cursor, and control unit. The TI SR-52 calculator provides the visual display, and comes with a basic program library. Science Accessories Corp., 970 Kings Highway West, Southport, CT 06490. (203) 255-1526. **Circle 154**

## 12-BIT HYBRID DATA ACQUISITION SYSTEM

Model HDAS-16 and HDAS-8 complex hybrid devices, are complete 12-bit data acquisition systems fabricated with thin-film hybrid technology. The systems incorporate a CMOS multiplexer, programmable gain instrumentation amplifier, sample-hold, 10V buffered reference, 12 bit A/D converter, address register and digital control logic into a miniature 62-pin package 2.3 x 1.4 x 0.24 inches. The two models come in 16 channel single-ended (HDAS-16) or 8 channel differential (HDAS-8) forms and include a throughput rate of 50 KHz at 12 bits resolution. The digital output data have three-state outputs to permit interfacing to a microcomputer data bus. The HDAS operate in three different modes: free running sequential addressing, trig-

gered sequential addressing and random addressing. Other specifications include 100 megohm input resistance and 200 pA maximum input bias current. The HDAS-16 or HDAS-8 use  $\pm 15Vdc$  and  $+5Vdc$  for a total consumption of 2.8W. Datel Systems Inc., 1020 Turnpike St., Canton, MA 02021. (617) 828-8000. **Circle 160**

## LARGE FORMAT SCANNER DIGITIZES GRAPHICS

A large format, high-speed scanner, capable of digitizing graphics for COM output, uses a rotating drum system that produces output on 9 track, 800 b.p.i. magnetic tape in a format suitable for direct operation with graphic COM systems. The system can directly convert engineering drawings without the re-tracing with bolder lines that conven-

tional camera reduction techniques require for processing microfiche. Using advanced multihead scanning technology, the Pagitron can scan a "C" size drawing in under ten minutes or any combination of smaller sized drawings that are ganged up. Applications include converting engineering drawings, technical manuals, engineering and design archives to microfiche or microfilm. Optronics International, 7 Stuart Road, Chelmsford, MA 01824. (617) 256-4511. **Circle 173**

## MONITORING SYSTEM ENDS MANUAL CALCULATIONS

This microprocessor-based computational module eliminates manual calculations typically performed by the operator in stack gas monitoring applications. The Model 2000 Stack Gas Monitoring System has applications in power plants, sulfuric and nitric acid plants, chemical refineries, and lead, zinc and copper smelting facilities. Each computational module accepts 16 analog inputs from up to three separate stacks. In addition to calculations and report generation the Model 2000 continuously and automatically performs maintenance routines on the sample handling system, including sample probe back-flush, automatic blowdown of the sample system water trap, audible alarm in the event of a plugged sample probe, and automatic analyzer zero and span corrections at operator selected intervals. The system has a built-in real time clock and comes with a battery back-



up system to prevent memory loss in the event of a power failure. The system interfaces with Beckman analyzers, and includes a flexible standard software package. Beckman Instruments Inc., 2500 Harbor Blvd., P.O. Box 3100, Fullerton, CA 92634. (714) 871-4848. **Circle 143**

# A Total Systems Capability

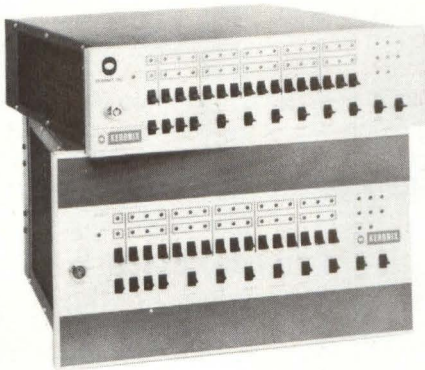

## KERONIX IDS - 16 MINICOMPUTERS A 16-Bit Full Parallel Synchronous, High-Speed General Purpose, Mini Computer

- INSTRUCTION SET, I/O INTERFACE & MEMORY INTERFACE COMPLETELY COMPATIBLE WITH NOVA™ SERIES OF MINI COMPUTERS
- ADDRESS UP TO 65K (Without the Use of Costly Memory Management)
- HINGED FRONT PANEL WITH FRONT LOADING CIRCUIT BOARDS
- POWER FAIL & RESTART—STANDARD
- FOUR 16 BIT ACCUMULATORS
- 800, 1000, or 1200 NANOSECOND MACHINE CYCLE TIME USING ONE BOARD CPU'S
- 4, 8, 10, 13 OR 17 SLOT CAPACITY
- INTEGRATED MSI & LSI CIRCUITS THROUGHOUT. TRI-STATE ELEMENTS ARE USED FOR ALL I/O & MEMORY LINES
- FORCED-AIR COOLING (UP TO 4 COOLING FANS)
- POWER SUPPLY IS MODULAR FOR EASY SERVICING & PROVIDES UP TO 50% MORE POWER THAN COMPARABLE UNITS
- MANY OPTIONAL FEATURES AVAILABLE
- EXTENSIVE SOFTWARE AVAILABLE
- LOANERS AVAILABLE ON OUR ONE-YEAR WARRANTY

**LOOK FOR OUR COMPLETELY INTELLIGENT  
KERONIX MODEL KX-8000, COMING SOON!**

For more extensive information on our IDS-16, please contact us directly.

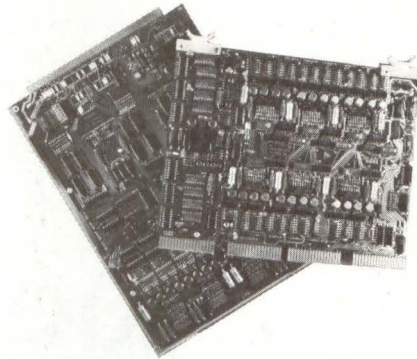

## KERONIX ADD-IN MEMORY PRODUCTS 4K, 8K, And 16K Words PLUG COMPATIBLE CORE MEMORY SYSTEMS

- P-3 SERIES . . . FULLY COMPATIBLE WITH DATA GENERAL NOVA™ 1200 & DCC™-116
- P-4 SERIES . . . FULLY COMPATIBLE WITH DATA GENERAL NOVA™ 800, 820 and 840
- P-5 SERIES . . . FULLY COMPATIBLE WITH DATA GENERAL NOVA™ 2 SYSTEMS
- I SERIES . . . FULLY COMPATIBLE WITH INTERDATA™ 70, 74, 7/16, 7/32 SYSTEMS
- D SERIES . FULLY COMPATIBLE WITH PDP-11™<sub>s</sub>
- J-1 SERIES . . . FULLY COMPATIBLE WITH MICRODATA™ 800 AND CIP™ 2000
- J-2 SERIES . . . FULLY COMPATIBLE WITH MICRODATA™ 1600
- G SERIES . . . FULLY COMPATIBLE WITH PRIME™ 100, 200, & 300
- E SERIES . . . FULLY COMPATIBLE WITH PDP™ 8E, F, M, AND A

IN ADDITION TO THE ABOVE, KERONIX MANUFACTURES ADD-ON MEMORIES, OEM MEMORIES, AND CUSTOM MEMORIES

**ONE-YEAR WARRANTY  
WITH ALL KERONIX MEMORIES**

™ Trademarks registered by Data General Corp., Digital Computer Controls, Inc., Interdata, Digital Equipment Corp., Microdata, Cincinnati Milacron, and Prime. Endorsement of Keronix products not to be implied.

# KERONIX INC.

WE HAVE REPRESENTATIVES AND DISTRIBUTORS WORLDWIDE

George Foldvary

250 E. Emerson St. • Orange, California 92662 • (714) 974-0800

TWX 910-593-1344

## PRODUCTS

### FIELD-PROGRAMMABLE LOGIC ARRAYS AVAILABLE

Two Schottky TTL field programmable logic arrays (FPLA) provide new dimensions in logic design, coupling innovative control options with increased cost effectiveness to produce a practical LSI alternative for random logic designs. Designated the SN54S/74S330 and SN54S/74S331, these FPLAs have a built-in capability

for multidimensional expansion of their basic 12 input X 50 product term X 6 output organization. A special circuit can decode true product terms to automatically enable the FPLA outputs. The S330/S331 can be programmed to stand alone; that is, the outputs are constantly enabled when system power is applied. Time consuming reduction of complicated Boolean functions can be eliminated or reduced significantly by directly

writing compound/multiple gating functions into the S330/S331. Virtually any combination of AND, NAND, OR, NOR logic functions can be programmed to replace random logic gates, reducing design time, PC board area, package count and soldered connections — all of which enhances system cost-effectiveness. Texas Instruments, P.O. Box 5012, Dallas, TX 75222. (713) 494-5115. **Circle 172**

# RESPONSYN<sup>®</sup>

## fine angle stepping motors

- Excellent Position Control
- High Transient Performance
- Low System Cost

**□ Fine Step Angle** — RESPONSYN motors are fine-angle, high-resolution stepping motors. They offer step angles from 0.75° to 0.18° and resolution from 480 to 2000 steps per revolution.

**□ High Accuracy** — RESPONSYN design ensures accurate stepping via a positive spline coupling between stator and rotor. For example, the HDM 155 motor's maximum one-step error is ±4 arc minutes, non-accumulative.

**□ Low Overshoot** — The RESPONSYN motor has a single-step crossover time on the order of one millisecond and an overshoot of approximately 40% of one step. Consequently, the RESPONSYN motor rapidly positions a load in a corridor only a few arc minutes wide.

**□ Excellent Settling Time** — The short settling time of RESPONSYN motors, as little as three or four milliseconds, makes them well suited to critical applications. Fast settling as well as low overshoot are accomplished without elaborate and expensive electronic drives.

**□ High Start/Stop Rate** — RESPONSYN motors handle load inertia at high start/stop rates.

**□ Low System Cost** — RESPONSYN performance and efficient design result in lower total system costs. RESPONSYN motors eliminate the added expense of sophisticated electronic drives, gearing, and damping devices.

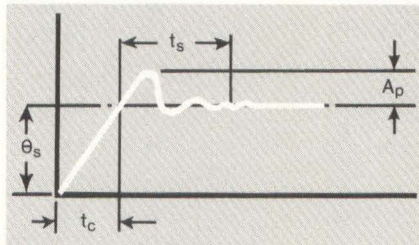

#### Transient Characteristics

Typical values for the HDM-155-800-4 RESPONSYN<sup>®</sup> motor are:

Crossover Time ( $t_c$ )	— 1.2 milliseconds
Settling Time ( $t_s$ )	— 6.3 milliseconds
Overshoot ( $A_p$ )	— 40 percent
Step Angle ( $\theta_s$ )	— .45 degree



Circle Reader Service Number or Write for Free Brochure Today.



**Harmonic Drive Division**

51 Armory Street, Wakefield, Massachusetts 01880  
Tel: (617) 245-7802 TWX 710-348-0586 Telex 94-9442

**USM Corporation**

CIRCLE 58

### EXPANDABLE HOBBY COMPUTER COMES IN A KIT

An expandable, low-cost hobbyist computer kit, called COSMAC VIP — Video Interface Processor, permits the hobbyist to assemble a microcomputer with which he or she can create and play video games, generate graphics and develop microprocessor control functions. The VIP is a computer on a printed circuit card, offering a complete operating system in 4K bits of ROM. VIP's output directly interfaces with a monochrome CRT display or

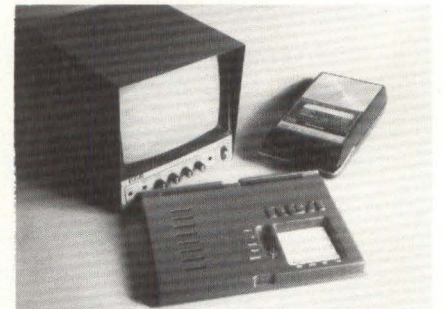

to a TV receiver through a modulator. Programs can be generated and then stored in an audio cassette tape recorder for easy retrieval and use. The VIP incorporates a single 8-1/2 x 11" PC card with the CDP1802 microprocessor, 2,048 byte RAM using 4K-bit static RAMs, single-chip graphic video display interface, built-in hexadecimal keyboard, 100-byte per second audio tape cassette interface, simple wall-plug regulated power supply, and expandability for both memory and I/O interfaces. The included hobbyist's manual contains detailed information on kit assembly, VIP operating procedures, CHIP-8 interpreter programming technique, machine language programming, logic description, test programs and trouble shooting guides and VIP system expansion instructions. Price: \$275.00 in kit form. RCA Solid State Division, Box 3200, Somerville, New Jersey 08876. (201) 685-6423.

**Circle 158**



# A Total Systems Capability



**VIDEO DISPLAY TERMINAL  
KERONIX MODEL K-4000**

- FULL KEYBOARD (Optional 10-Key Pad Available)
- HIGH RESOLUTION, NON-REFLECTING SCREEN; 9" X 7" (12" Diagonal); SWIVEL BASE; EASY VIEWING UP TO 10 FEET; BRIGHTNESS CONTROL; REVERSE VIDEO (Black Characters on White Background, Selectable)
- 80 CHARACTERS PER LINE, 25 LINES, 2000 CHARACTER DISPLAY; STORE UP TO 51 LINES & 4080 CHARACTERS; BLINKING CHARACTERS AT 3Hz RATE
- CURSOR CONTROL (Non-Destructive)
- INTERCHANGEABLE WITH TELETYPE USES STANDARD ASCII CODE
- INTERNAL POWER SUPPLY; RUNS OFF A SINGLE 15" X 15" P.C. BOARD
- VARIABLE BAUD RATE (75 to 9600 Bits Per Second); 10 OR 11 BIT CODE
- ODD OR EVEN OR MARK PARITY
- EITHER EIA OR 20 MA CURRENT LOOP

**LOOK FOR OUR COMPLETELY INTELLIGENT**

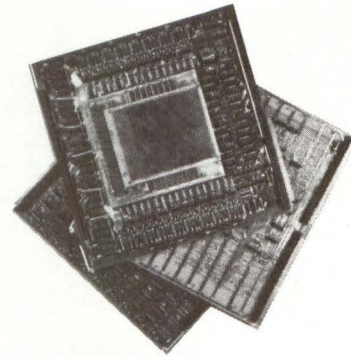

**I/O AND PERIPHERAL CONTROLLERS  
FOR KERONIX IDS 16 COMPUTERS  
AND NOVA™ SERIES OF COMPUTERS**

- 1007 I/O BOARDS
- 1008 REAL TIME CLOCK
- 1010 TTY INTERFACE
- 1011 PAPER TAPE READER CONTROL
- 1012 PAPER TAPE PUNCH CONTROL
- 1016 CARD READER CONTROLLER
- 1023 EIA INTERFACE
- 1034 LINE PRINTER CONTROLLER
- 1038 MULTI-PROCESSOR COMMUNICATIONS ADAPTER
- 1046 DISK CONTROLLER
- 1146 FLEXIBLE DISK CONTROLLER
- 1054 EXTENDER BOARDS
- 1060-4 FOUR LINE ASYNCHRONOUS MULTIPLEXER FOR FOUR EIA STANDARD LEVEL LINES (MUX)
- 1060-8 MUX FOR EIGHT EIA STANDARD LEVEL LINES

IN ADDITION TO THE ABOVE, KERONIX MANUFACTURES ADD-ON MEMORIES, OEM MEMORIES, AND CUSTOM MEMORIES

**ONE YEAR WARRANTY ON ALL KERONIX I/O  
PERIPHERAL CONTROLLERS**

TM Trademarks registered by Data General Corporation  
Endorsement of Keronix products by Data General not to be implied.

# KERONIX INC.

WE HAVE REPRESENTATIVES AND DISTRIBUTORS WORLDWIDE

George Foldvary

250 E. Emerson St. • Orange, California 92662 • (714) 974-0800

TWX 910-593-1344

## PRODUCTS

### SINGLE-BOARD PE/NRZ TAPE CONTROLLER

A single-board magnetic tape controller software compatible with existing Interdata operating systems, the TC-140 is a complete dual density controller with all interface and formatting electronics for both Phase Encoding (PE) and NRZ. Fully embedded, the controller requires no separate chassis or power supply, and operates via the selector channel or multiplexer bus.

The TG 140 handles up to four drives in any combination of seven-track NRZ, nine-track NRZ, nine-track PE or nine-track PE/NRZ, at any two speeds in the range of 12.5 to 125 ips. The TC-140 also includes an extended command register and an enhanced status register allowing higher level of control than previously available. Diagnostic software comes with all TC-140's. Western Peripherals, Inc., 1100 Claudina Place, Anaheim, CA 92805. (714) 991-8700. **Circle 174**

### LSI-11 COMPATIBLE MINIDISK CONTROLLER

An interface board allows up to three Shugart SA-400 minidisk drives (5-1/4" format) to be controlled by an LSI-11 computer system. This multi-function controller, designated the MDC11, also provides a DMA Dynamic Memory Refresh Controller and sockets for up to 4096 sixteen bit words of EPROM. All of the functions are contained on a single dual width card that plugs directly into the LSI-11 Q-Bus and uses the standard voltages +5 & +12. The controller performs several functions automatically, including track seek and verify, 16 bit CRCC generation and checking and drive motor timeout shutoff. The EPROM section of the

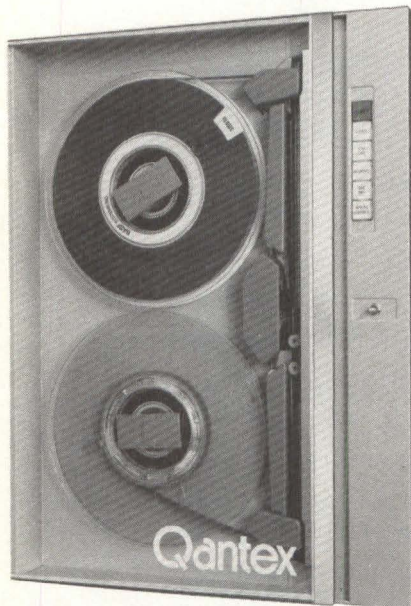

### HIGH RELIABILITY LOW COST

# 75 ips

### 7- & 9-TRACK TAPE DRIVE

### NO VACUUM COLUMNS OR TENSION ARMS

That's right! The Qantex TDX tape drive with 75 ips read/write and 300 ips rewind speeds has no vacuum columns or tensioning arms. How? With a unique patented Floating-Shuttle™ tape buffering technique. This time-proven technique assures through its simplicity, high performance, high reliability, and low cost.

In field use for 2 years, the TDX is available for NRZI (800 bpi) and Phase-Encoded (1600 bpi). It is compatible with IBM and ASCII codes, and has no program restrictions. Of course, the interconnects are industry standard. Call or write today for full data and price information on the TDX, its Formatters and Controllers, and the militarized version meeting MIL-E-16400.

# Qantex

THE PERIPHERALS DIVISION OF NORTH ATLANTIC INDUSTRIES, INC.

200 TERMINAL DRIVE, PLAINVIEW, NEW YORK 11803 • 516-681-8350

SEE US AT MINI MICRO SHOW - BOOTH #113

CIRCLE 56

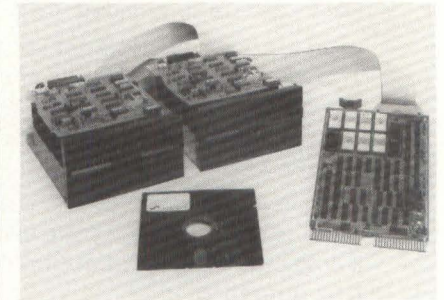

MDC11 permits critical software and data to reside in a non-volatile memory, thus giving the system some 'resident' intelligence. The EPROM area will accommodate up to 4K words of 2708-type memory chips or up to 8K words of 2716-type chips. Andromeda Systems, 14701 Arminta St. #J, Panorama City, CA 91402. (213) 781-6000.

**Circle 201**

### SERIAL PRINTER GENERATES 120 LINES/MINUTE

In the MP 580 serial printer, the mobile head with 7 printing electrodes prints characters from left to right in a dot matrix generated by the control logic. The non-impact recorder prints the characters on metallized, electro-sensitive paper. Input and output are TTL/CMOS compatible, and the printer accepts 6 bit parallel column serial in ASCII code. The MP 580 generates 2 lines per second on paper isolated from the input; the printer has the capability for 63 ASCII characters. Available in 19" rack mount version, in a case or as an OEM version from Gertsch and Brutsch Ag, CH-8304 Wallisellen, Hertistrasse 25, Switzerland. Telefon 01 830 12 55.

# Electronic Engineering Times Announces Three California Conferences

## NEXT GENERATION OF ELECTRONICS

Disneyland Hotel  
Anaheim, CA  
Nov. 28-Dec. 2, 1977

A new concept in product application conferences—talks aimed at updating the engineer in both new products and new instrumentation. The latest advances in integrated circuits, microprocessors and test equipment for the engineer's use are described. The emphasis is on improving the engineer's knowledge of designing techniques as well as his familiarity with recently introduced integrated circuits.

## GAMETRONICS

Airport Hilton  
San Francisco, CA  
Jan. 9-11, 1978

This conference brings together active and prospective participants in electronic game design and production with leading suppliers of components that can be used in electronic games, consumer electronics products and personal computers. Talks range from descriptions of integrated circuits specifically intended for use in electronic games to marketing considerations affecting game sales. Major emphasis is placed on panel discussions of interest to both game designers and suppliers to game manufacturers.

## NEXT GENERATION OF ELECTRONICS

Airport Hilton  
San Francisco, CA  
Jan. 30-Feb. 3, 1978

A new concept in product application conferences—talks aimed at updating the engineer in both new products and new instrumentation. The latest advances in integrated circuits, microprocessors and test equipment for the engineer's use are described. The emphasis is on improving the engineer's knowledge of designing techniques as well as his familiarity with recently introduced integrated circuits.

### HOTEL ACCOMMODATIONS

Fill in below if overnight rooms are needed

Reservations Department  
Disneyland Hotel  
1150 W. Cerritos Avenue  
Anaheim, CA 92802

I am attending "Next Generation of Electronics." Please reserve the following accommodations at the Disneyland Hotel:

- Single at \$32, \$42 (circle preferred rate)
- Double at \$38, \$44, \$48, \$54 (circle preferred rate)

Arrival Date \_\_\_\_\_ Departure Date \_\_\_\_\_

Name \_\_\_\_\_ Title \_\_\_\_\_

Address \_\_\_\_\_

City \_\_\_\_\_ State \_\_\_\_\_ Zip \_\_\_\_\_

Signature \_\_\_\_\_

The Disneyland Hotel requires one night's deposit with reservation. Accommodation request must be received by November 4, 1977.

### HOTEL ACCOMMODATIONS

Fill in below if overnight rooms are needed

ICA Conference  
Electronic Engineering Times  
P.O. Box 1021, Melville, NY 11746

I am attending "Gametronics." Please reserve the following accommodations at the San Francisco Airport Hilton:

- Single at \$32, \$34, \$36, \$38, \$40 (circle preferred rate)
- Double at \$40, \$42, \$44, \$46, \$48 (circle preferred rate)
- Guaranteed payment, hold room for late arrival

Arrival Date \_\_\_\_\_ Departure Date \_\_\_\_\_

Name \_\_\_\_\_ Title \_\_\_\_\_

Address \_\_\_\_\_

City \_\_\_\_\_ State \_\_\_\_\_ Zip \_\_\_\_\_

Signature \_\_\_\_\_

Accommodation requests must be received by December 24, 1977. The San Francisco Airport Hilton is located at the airport. Mailing address is P.O. Box 8355, San Francisco, CA 94128 (415) 589-0770

### HOTEL ACCOMMODATIONS

Fill in below if overnight rooms are needed

ICA Conference  
Electronic Engineering Times  
P.O. Box 1021, Melville, NY 11746

I am attending "Next Generation of Electronics." Please reserve the following accommodations at the San Francisco Airport Hilton:

- Single at \$32, \$34, \$36, \$38, \$40 (circle preferred rate)
- Double at \$40, \$42, \$44, \$46, \$48 (circle preferred rate)
- Guaranteed payment, hold room for the late arrival

Arrival Date \_\_\_\_\_ Departure Date \_\_\_\_\_

Name \_\_\_\_\_ Title \_\_\_\_\_

Address \_\_\_\_\_

City \_\_\_\_\_ State \_\_\_\_\_ Zip \_\_\_\_\_

Signature \_\_\_\_\_

Accommodation requests must be received by January 15, 1978. The San Francisco Airport Hilton is located at the airport. Mailing address is P.O. Box 8355, San Francisco, CA 94128 (415) 589-0770.

### CONFERENCE REGISTRATION/ INFORMATION (516) 829-5880

ICA Conference, Div. of  
ELECTRONIC ENGINEERING TIMES  
P.O. Box 1021, Melville, NY 11746

Please register me for "Next Generation of Electronics," Anaheim, CA, November 28-December 2, 1977. Fee: \$200

Name \_\_\_\_\_ Title \_\_\_\_\_

Company \_\_\_\_\_

Address \_\_\_\_\_

City \_\_\_\_\_ State \_\_\_\_\_ Zip \_\_\_\_\_

Signature \_\_\_\_\_

- Check enclosed
- Purchase order enclosed (pay at door).

Make checks payable to ICA Conference

### CONFERENCE REGISTRATION/ INFORMATION (516) 829-5880

ICA Conference, Div. of  
ELECTRONIC ENGINEERING TIMES  
P.O. Box 1021, Melville, NY 11746

Please register me for "Gametronics," San Francisco Airport Hilton, January 9-11, 1978. Fee: \$90

Name \_\_\_\_\_ Title \_\_\_\_\_

Company \_\_\_\_\_

Address \_\_\_\_\_

City \_\_\_\_\_ State \_\_\_\_\_ Zip \_\_\_\_\_

Signature \_\_\_\_\_

- Check enclosed
- Purchase order enclosed (pay at door).

Make checks payable to ICA Conference

### CONFERENCE REGISTRATION/ INFORMATION (516) 829-5880

ICA Conference, Div. of  
ELECTRONIC ENGINEERING TIMES  
P.O. Box 1021, Melville, NY 11746

Please register me for "Next Generation of Electronics," San Francisco Airport Hilton, January 30-February 3, 1978. Fee: \$200

Name \_\_\_\_\_ Title \_\_\_\_\_

Company \_\_\_\_\_

Address \_\_\_\_\_

City \_\_\_\_\_ State \_\_\_\_\_ Zip \_\_\_\_\_

Signature \_\_\_\_\_

- Check enclosed
- Purchase order enclosed (pay at door).

Make checks payable to ICA Conference

**DOUBLE-SIZE CHARACTERS SEEN ON CRT TERMINAL**

Model 400D Terminals now come with a double-size character option for applications where readability at greater distances is desired. The terminal's refresh memory stores 2000 characters in a 50 line by 40 character format. Twelve lines show on the monitor at one time, with the remaining 38 lines



accessible in either Roll or Scroll modes. On a 15-inch monitor, the characters are approximately one-half inch high. Standard character accents include blink, dim and reverse-video. The cursor appears as a blinking field. An RS232 data interface and RS170 video output for driving auxiliary monitors come as standard equipment. The desk-top version incorporates a 15-inch non-glare screen; the KSR-version has a detachable 72-key keyboard, including cursor control keys, TTY lock, and a separate numeric pad. The user can select baud rate (110-9600), keyboard mode (TTY or full-ASCII), I/O mode (local, full or half-duplex), and display mode (page, roll, or scroll). Ann Arbor Terminals Inc., 6107 Jackson Rd., Ann Arbor, MI 48103. (313) 769-0926.

**Circle 151**

**COMPACT ELECTRONIC DIGITAL PRINTER**

Electro-sensitive Model TCM-101B "Panaprinter" was designed for use in electronic calculators, instrumentation, cash registers and computer equipment. A low level of power consumption in the unit allows battery operation. In addition, its compact size makes it suitable for small printing electronic calculators. Design of the printer eliminates all solenoids providing silent operation. Eliminating the need for inks, ribbons or chemicals, the "Panaprinter" prints both alphanumerals and arithmetic symbols in a permanent dry process. A mechanical horizontal scanning operation of a 7-row-by-one-column head prints characters based on the 7-row-by-

5-column dots matrix structure. The unit prints 20 characters per line, at a rate of 2 lines per second. The "Panaprinter" weighs 11.7 oz. and has a voltage supply of -24Vdc. Panasonic Co., One Panasonic Way, Secaucus, NJ 07094. (201) 348-7000.

**Circle 203**

**DESK-TOP COMPUTER**

A desk-top microcomputer turnkey system, based on the MOS technology 6502 processor, incorporates a 20x64 character CRT and a full-ASCII keyboard with a numeric keypad. The system also includes a 4K RAM (expandable to 64K), 4K system monitor EROM, 16-level priority interrupt, modem and TTY interfaces. Price: \$3449. Mohr Labs Inc., Madison, WI 53711. (608) 271-5380.

**Circle 202**

**LSI-11 COMPATIBLE DATA ACQUISITION SYSTEM**

The System 1000 data acquisition system for industrial and scientific applications, in the stand-alone configuration comes with a DEC LSI-11 microcomputer and a minimum of 4K of RAM memory. Up to 24K of additional memory can be supplied in both ROM and RAM. The LSI-11 can communicate with any of the ADAC library of analog I/O modules for digitizing outputs of thermocouples, strain gages, isolation amplifiers, LVDT, RTD and photomultipliers. With the digital I/O

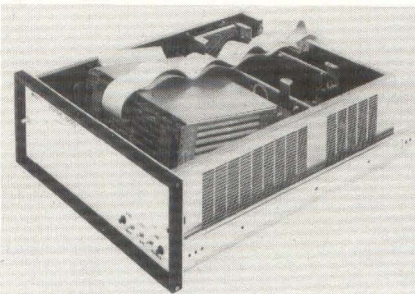

modules, inputs from Digi-switches, shaft encoders, motor controls, and relay contacts can be sensed with outputs to printers, cassettes, lamps, relays and solenoids. The System 1000 enclosure consists of three major components, the rack drawer, card cage/backplane assembly and power supply. The card cage/backplane can accommodate up to eleven 8 1/2"x10" or twenty-two 8 1/2"x5" or any mixture of LSI-11 bus compatible printed circuit cards. Adac Corp., 15 Cummings Park, Woburn, MA 01801. (617) 935-6668.

**Circle 144**

**TI Distributors**

- ALABAMA:** Huntsville, Hall-Mark/Huntsville (205) 837-8700.
- ARIZONA:** Phoenix, Kierulff Electronics (602) 243-4101; R. V. Weatherford (602) 272-7144; Tempe, G. S. Marshall (602) 968-6181.
- CALIFORNIA:** Anaheim, R. V. Weatherford (714) 634-9600; Canoga Park, G. S. Marshall (213) 999-5001; El Monte, G. S. Marshall (213) 686-0141; El Segundo, TI Supply (213) 973-2571; Glendale, R. V. Weatherford (213) 849-3451; Goleta, RPS, Inc. (805) 964-6823; Irvine, Cramer/Los Angeles (714) 979-3000, (213) 771-8300; G. S. Marshall (714) 556-6400; Los Angeles, Kierulff Electronics (213) 685-5511; RPS, Inc. (213) 748-1271; Mountain View, Time Electronics (408) 965-8000; Palo Alto, Kierulff Electronics (415) 968-6292; Pomona, R. V. Weatherford (714) 623-1261; San Diego, Cramer/San Diego (714) 565-1881, Kierulff Electronics (714) 278-2122; G. S. Marshall (714) 278-6350; RPS Inc. (714) 292-5611; R. V. Weatherford (714) 278-7400; Sunnyvale, Cramer/San Francisco (408) 739-3011; G. S. Marshall (408) 732-1100; TI Supply (408) 732-5555; Torrance, Time Electronics (213) 320-0880; Tustin, Kierulff Electronics (714) 731-5711; Woodland Hills, JACO (213) 884-4560.
- COLORADO:** Denver, Cramer/Denver (303) 758-2100; Kierulff Electronics (303) 371-6500; Englewood, R. V. Weatherford (303) 761-5432.
- CONNECTICUT:** Hamden, Arrow Electronics (203) 248-3801; TI Supply (203) 281-4669; North Haven, Cramer/Connecticut (203) 239-5641; Orange, Milgray/Connecticut (203) 795-0714.
- FLORIDA:** Clearwater, Diplomat/Southland (813) 443-4514; Ft. Lauderdale, Arrow Electronics (305) 776-7790; Hall-Mark/Miami (305) 971-9280; Hollywood, Cramer/Hollywood (305) 921-7878; Orlando, Cramer/Orlando (305) 894-1511; Hall-Mark/Orlando (305) 855-4020; Winter Park, Milgray Electronics (305) 647-5747.
- GEORGIA:** Doraville, Arrow Electronics (404) 455-4054; Norcross, Cramer/Atlanta (404) 448-9050.
- ILLINOIS:** Arlington Heights, TI Supply (312) 640-2964; Elk Grove, Hall-Mark/Chicago (312) 437-8800; Kierulff Electronics (312) 640-0200; Chicago, Newark Electronics (312) 638-4411; Mt. Prospect, Cramer/Chicago (312) 593-8230.
- INDIANA:** Ft. Wayne, Ft. Wayne Electronics (219) 423-3422; Indianapolis, Graham Electronics (317) 634-8202.
- IOWA:** Cedar Rapids, Deeco (319) 365-7551.
- KANSAS:** Shawnee Mission, Hall-Mark/Kansas City (913) 888-4747.
- MASSACHUSETTS:** Billerica, Kierulff Electronics (617) 667-8331; Newton, Cramer/Newton (617) 969-7700; Waltham, TI Supply (617) 890-0510; Woburn, Arrow Electronics (617) 933-8130.
- MARYLAND:** Baltimore, Arrow Electronics (202) 737-1700, (301) 247-5200; Hall-Mark/Baltimore (301) 796-9300; Columbia, Technico (301) 461-2200; Gaithersburg, Cramer/Washington (301) 948-0110; Kierulff Electronics (301) 948-0250; Hyattsville, Milgray/Washington (301) 459-2222.
- MICHIGAN:** Ann Arbor, Arrow Electronics (313) 971-8220; Detroit, Newark Electronics (313) 967-0600; Grand Rapids, Newark Electronics (616) 241-6681.
- MINNESOTA:** Bloomington, Arrow Electronics (612) 887-6400; Edina, Cramer/Minnesota (612) 835-7811.
- MISSOURI:** Earth City, Hall-Mark/St. Louis (314) 291-5350; Kansas City, LCOMP-Kansas City (816) 221-2400; St. Louis, LCOMP-St. Louis (314) 291-6200.
- NEW HAMPSHIRE:** Manchester, Arrow Electronics (603) 668-6968.
- NEW JERSEY:** Camden, General Radio Supply (609) 964-8560; Cherry Hill, Cramer/Pennsylvania (215) 923-5950; (609) 424-5993; Milgray/Delaware Valley (609) 424-1300; (215) 228-2000; Clark, TI Supply (201) 382-6400; Clifton, Wilshire Electronics (201) 340-1900; Little Falls, Cramer/New Jersey (201) 785-4300; Moorestown, Arrow Electronics (609) 235-1900; Rutherford, Kierulff Electronics (201) 935-2120; Saddlebrook, Arrow Electronics (201) 797-5800.
- NEW MEXICO:** Albuquerque, Cramer/New Mexico (505) 243-4566; International Electronics (505) 265-6453.
- NEW YORK:** East Syracuse, Cramer/Syracuse (315) 437-6671; Endwell, Wilshire Electronics (607) 754-1570; Farmingdale, Arrow Electronics (516) 694-6800; Hicksville, Kierulff Electronics (516) 433-5530; Fishkill, Arrow Electronics (914) 896-7530; Freeport, Milgray Electronics (516) 546-6000; N.J. (800) 645-3986; Hauppauge, Cramer/Long Island (516) 231-5600; JACO (516) 273-1234; Rochester, Cramer/Rochester (716) 275-0300; Rochester Radio Supply (716) 454-7800; Wilshire Electronics (716) 442-9560.
- NORTH CAROLINA:** Raleigh, Hall-Mark/Raleigh (919) 832-4465; Winston-Salem, Cramer/Winston-Salem (919) 725-8711.
- OHIO:** Cleveland, Arrow Electronics (216) 464-2000; Cramer/Cleveland (216) 248-8400; Columbus, Hall-Mark/Ohio (614) 846-1882; Dayton, ESCO Electronics (513) 226-1133; Kettering, Arrow Electronics (513) 253-9176.
- OKLAHOMA:** Tulsa, Hall-Mark/Tulsa (918) 835-8458; TI Supply (918) 582-8272.
- PENNSYLVANIA:** Huntingdon Valley, Hall-Mark/Philadelphia (215) 355-7300.
- TEXAS:** Austin, Hall-Mark/Austin (512) 837-2814; Dallas, Hall-Mark/Dallas (214) 234-7400; TI Supply (214) 238-6821; El Paso, International Electronics, (915) 778-9761; Houston, Hall-Mark/Houston (713) 781-6100; Harrison Equipment (713) 652-4700; TI Supply (713) 776-6511; R. V. Weatherford (713) 688-7406.
- UTAH:** Salt Lake City, Diplomat/Altalad (801) 486-4134; Standard Supply (801) 486-3371.
- VIRGINIA:** Roanoke, Technico (703) 563-4975.
- WASHINGTON:** Seattle, Almac/Stroum Electronics (206) 763-2300; Cramer/Seattle (206) 575-0907; Kierulff Electronics (206) 575-4420.
- WISCONSIN:** Brookfield, Newark Electronics (414) 781-2450; Oak Creek, Arrow Electronics (414) 764-6600; West Allis, Hall-Mark/Milwaukee (414) 476-1270.
- CANADA:** Calgary, Cam Gard Supply (403) 287-0520; Downsview, CESCO Electronics (416) 661-0220; Zentrionics (416) 635-2822; Edmonton, Cam Gard Supply (403) 426-1805; Halifax, Cam Gard Supply (902) 454-8581; Kamloops, Cam Gard Supply (604) 372-3338; Moncton, Cam Gard Supply (506) 855-2200; Montreal, CESCO Electronics (514) 735-5511; Future Electronics (514) 735-5775; Zentrionics (514) 735-5361; Ottawa, CESCO Electronics (613) 729-6411; Quebec City, CESCO Electronics (418) 524-4641; Regina, Cam Gard Supply (306) 525-1317; Rexdale, Future Electronics (416) 677-7820; Saskatoon, Cam Gard Supply (306) 652-6424; Vancouver, Cam Gard Supply (604) 291-1441; Winnipeg, Cam Gard Supply (204) 786-8481.

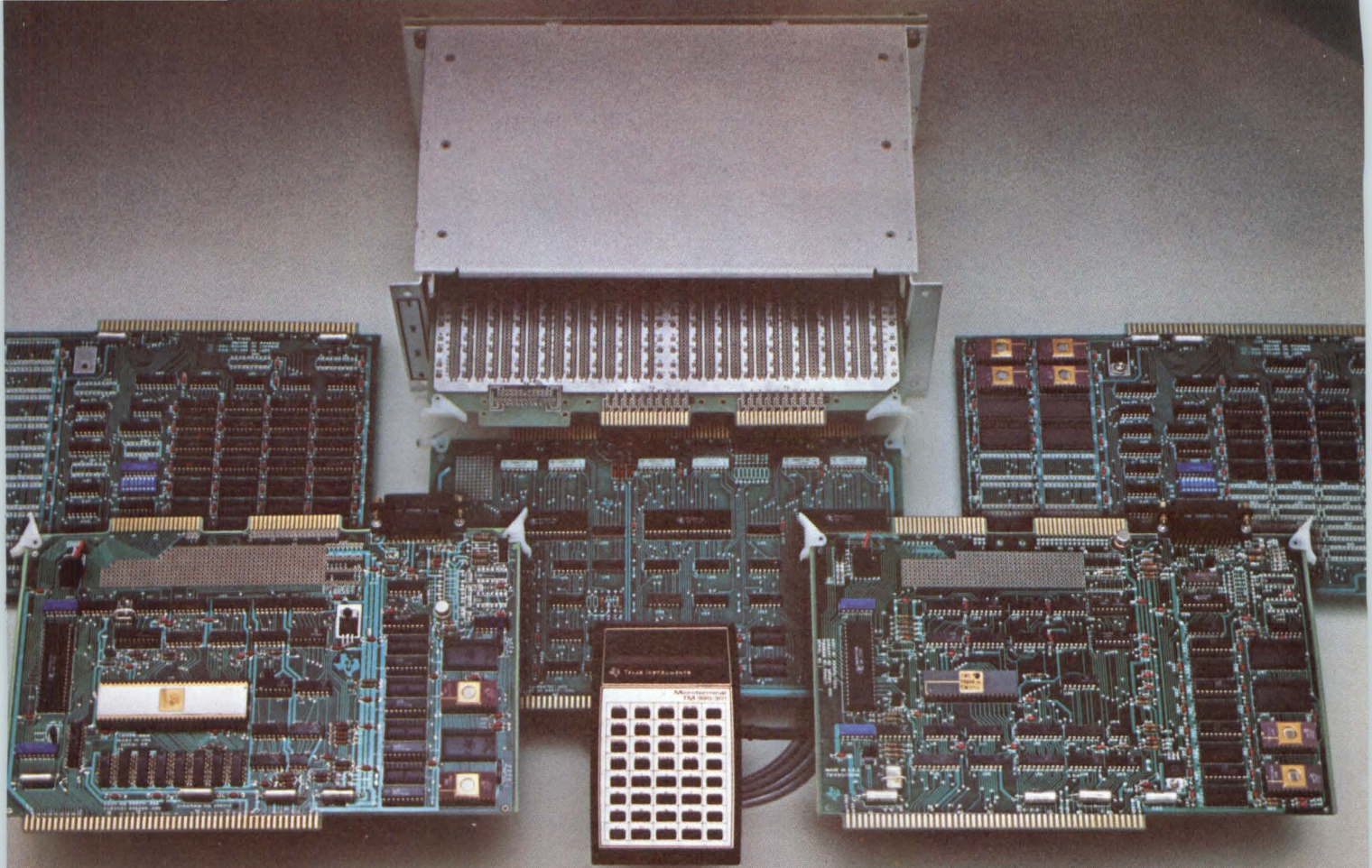

## 9900 FAMILY

# Now—more OEM $\mu$ P modules from TI: 16-bit performance at 8-bit prices.

Compare TI's series of TM 990 microcomputer modules. Here's 16-bit performance at a cost less than 8 bits.

And 16-bit performance means increased throughput. Programming ease. Improved memory efficiency. All leading to greater system savings.

Use these new modules for  $\mu$ P evaluation. And as a production alternative. To speed your microprocessor-based design to market. To minimize design costs.

### Leadership series

Included in the TM 990 Series are:

- TM 990/100M — TI's TMS 9900  $\mu$ P, I/O circuits, and memory — all on a single board. \$450.00\*.
- TM 990/180M — 16-bit TMS 9980  $\mu$ P offers 2 MHz operation with 8-bit data bus. \$435.00\*.
- TM 990/201 — Memory expansion board: 8K bytes of EPROM, 4K bytes of static RAM. Expandable to 32K bytes of EPROM and 16K bytes of RAM. \$595.00\*.
- TM 990/206 — Memory expansion board with 8K bytes of RAM. Expandable to 16K bytes. \$585.00\*.
- TM 990/301 — Microterminal for data entry and display. \$125.00\*.
- TM 990/310 — a 48-bit input/output expansion module. \$295.00\*.
- TM 990/401 — Interactive debug monitor (TIBUG™) preprogrammed into CPU EPROM. \$100.00\*.
- TM 990/402 — Line-by-line assembler preprogrammed into the EPROM. \$100.00\*.
- TM 990/510 — Four-slot OEM chassis on 1" spacing. \$190.00\*.

• Cables, connectors, extender and prototyping boards are also available.

And even more modules will be available soon.

All are preassembled. Pretested. Ready to go. Supported by easy-to-use software.

### 9900 First Family compatibility.

The TM 990 modules are also supported by the advanced AMPL™ software development system. And all are instruction-set compatible with other members of TI's 9900 First Family.

For more details, call your authorized TI distributor. Or write Texas Instruments Incorporated, P. O. Box 1443, M/S 653, Houston, Texas 77001.

\*One to nine quantity



**TEXAS INSTRUMENTS**  
INCORPORATED

## PRODUCTS

### KIT AIDS FIBEROPTIC CONNECTION EVALUATION

A kit for engineering evaluation of fiberoptic interconnections offers a complete interconnect system rather than connectors only. The electro-fiberoptic system operates from DC to 5 MBPS over a temperature range of 0-55°C without drifts or inadvertent comparator switching. The complete fiberoptic kit, Part No. 698-OK-002, consists of emitter assembly, 5-meter fiberoptic cable as-



sembly, temperature-referenced photodetector assembly, TTL-compatible pre-

amplifier and TTL-compatible emitter driver. A second kit, Part No. 698-OK-001, comes without the preamplifier and driver for applications not requiring the electronics package. Price: Kit No. 698-OK-001 \$99.50, and Kit No. 698-OK-002 \$190.00. Augat Inc., 33 Perry Ave., P.O. Box 779, Attleboro, MA 02703. (617) 222-2202.

Circle 145

### BLACK BOX PRINTER USES PRINT CYLINDER

The Black Box Printer, a fully assembled, 80 column, 10 character per second impact printer, uses a print cylinder (not a dot matrix) containing a 64 ASCII character set. It can make up to three copies on tractor (or pressure) fed 8½" wide paper. Shipped ready to connect to (almost) any microprocessor parallel port, the printer has a parallel

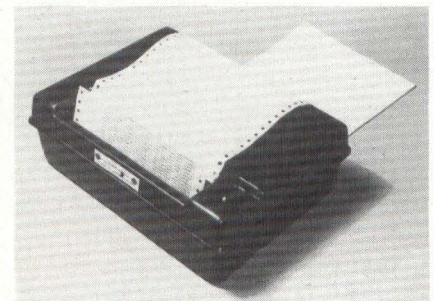

interface requiring 7 data bits, a ready and a strobe. Documentation supplied with the printer includes trouble shooting guides, installation and maintenance instructions, printer and interface schematics, plus instructions on how to wire up to the I-O parallel port. The Black Box Printer measures 4.5"H, 13"W, & 10"D, and weighs 11 lbs. Expander Inc., 612 Beatty Rd., Monroeville, PA 15146. (412) 373-0300.

Circle 147

### DISK CARRYING CASE MAGNETICALLY SHIELDED

Magnetically shielded floppy disk preservers protect your flexible disks from magnetic degradation, erasure or physical damage and also protect 9" diameter tape reels. Cases, designed for storage, shipment and hand carrying, come in a wide choice of models and capacities for standard reels, disks, disk packs and standard cassettes. Perfection Mica Co., 740 North Thomas Dr., Bensenville, IL 60106. (312) 766-7800.

Circle 169

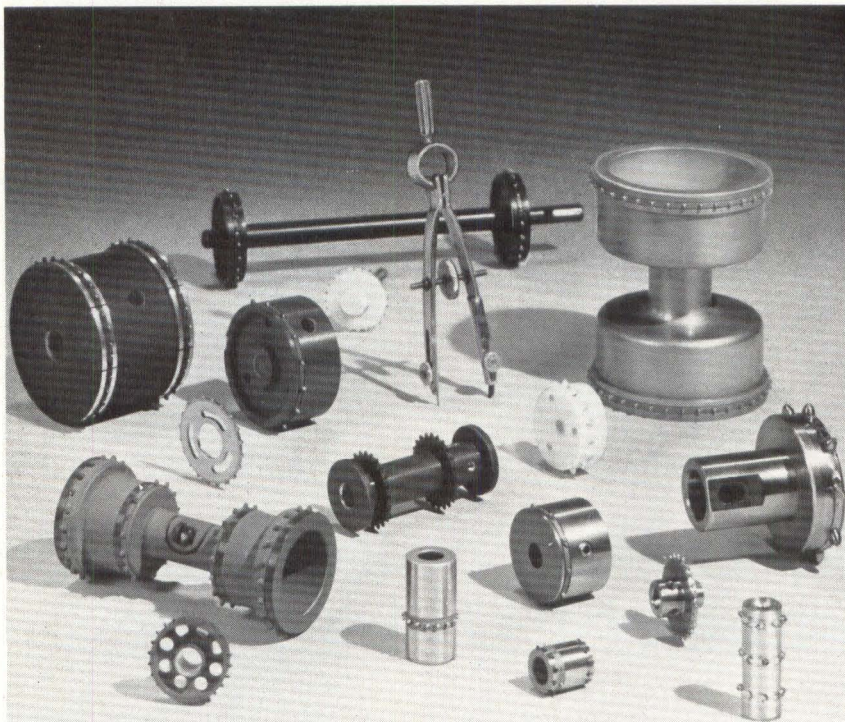

## LA VEZZI SPROCKETS FIT THE SHAPE OF YOUR DRIVE IDEAS

When a requirement calls for moving perforated film, tape or charts, La Vezzi sprockets are specified where precise control of media movement is important.

There are good reasons for it! La Vezzi sprockets are designed for accurate and dependable operation. For example: Minute details are strictly observed in tooth-to-tooth accuracy. Each sprocket tooth is precision formed, exactly

sized and freed of all burrs to maintain media integrity. The diameter is cylindrically ground for good concentricity and abrasion-free contact with the perforated media.

Compare the reliability and accuracy of La Vezzi sprockets. They give drive designs an extra measure of confidence.



Our catalog tells all. Ask for it, or send us your specifications.

*La Vezzi* machine works, inc.

900 N. Larch Ave. • Elmhurst, Ill. 60126 • (312) 832-8990

CIRCLE 60

# /ability.

## It Comes Naturally With The Altair™ 8800b

The Altair 8800b from MITS: the second generation design of the microcomputer that started it all. The mainframe that has the abilities everyone is demanding from microcomputers today:

### Expand-ability:

The Altair 8800b power supply and one-piece, 18-slot motherboard allow efficient and easy expandability for memory and I/O options. All Altair PC boards are designed to give you maximum capability/lowest power usage possible per board. This means that for each slot used you get more features and require less power, than with any of the "off-brand" Altair-bus-compatible boards.

Whether you buy an entire system up front or choose to expand gradually, it's easy to get the configuration you need with the complete family of Altair peripheral equipment, including floppy disk, line printer, audio cassette record interface, A/D converter, PROM programmer, serial and parallel I/O boards.

choice of four different memory boards and many others.

### Reli-ability:

The unique design features of the Altair 8800b, which have set the standard for the microcomputer industry, make it the most reliable unit of its kind. The Altair 100-pin bus, the now-standard design used by many imitators, has been "standard" all along at MITS. The unique Front Panel Interface Board on the Altair 8800b isolates and filters front panel noise before it can be transmitted to the bus. The all-new CPU board utilizes the 8080A microprocessor, Intel 8224 clock generator and 8216 bus drivers.

### Flex-ability:

Meeting the diversified demands of an ever-increasing microprocessor market requires flexibility: not just hardware flexibility but

software flexibility as well. MITS software, including the innovative Altair BASIC language, allows the full potential of the Altair 8800b computer to be realized.

8K ALTair BASIC has facilities for variable length strings with LEFT\$, RIGHT\$, and MID\$ functions, a concatenation operator, and VAL AND STR\$ functions to convert between strings and numbers.

Extended ALTair BASIC allows integer, single and double precision variables, automatic line numbering and renumbering, user-defined string functions, PRINT USING for formatted output and a powerful EDIT command for editing program files during or after entry. Extended statements and commands include IF . . . THEN . . . ELSE, LIST and DELETE program lines, SWAP variables and Trace On and Off for debugging.

Disk ALTair BASIC has all the features of Extended BASIC with the additional capability to maintain sequential and random access disk files. Utilities are provided for formatting disks and printing directories.

In all versions of ALTair BASIC you get the ease and efficiency of BASIC for the solution of real world problems.

Package II, an assembly language development system for the Altair 8800b, includes system monitor, text editor, assembler and debug.

### Afford-ability:

Prices for the Altair 8800b start at \$840.00 for a kit and \$1100.00 for an assembled unit (all documentation included).

For a complete listing of prices on all Altair products and a free brochure, contact:

MITS, Inc.  
2450 Alamo S.E.  
Albuquerque, N.M. 87106  
(505) 243-7821

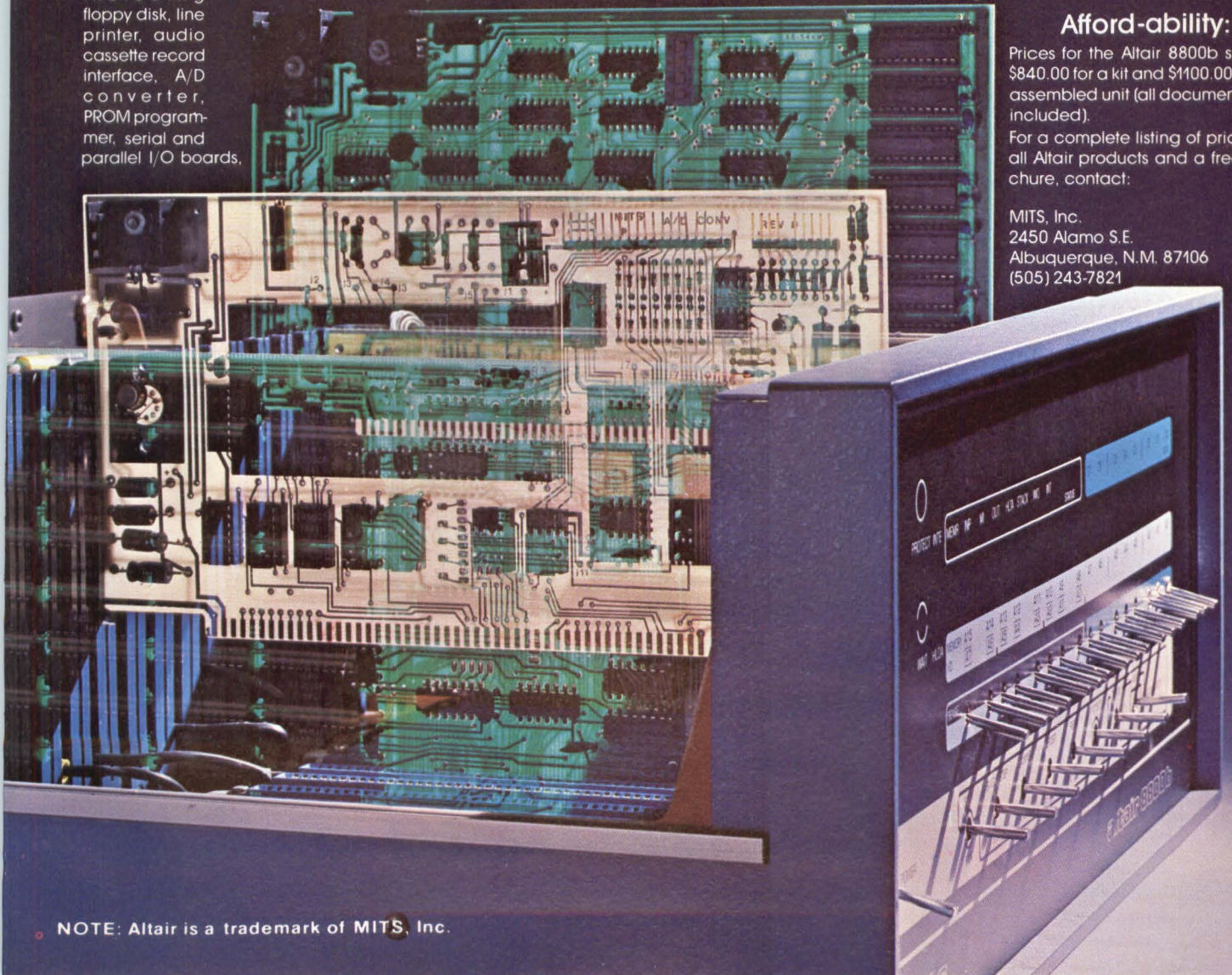

NOTE: Altair is a trademark of MITS, Inc.

# punched tape readers

operating at ANY  
rate from 0 to 1,000  
ch/s are available in  
2 weeks from CHALCO  
for as low as \$250.00 . . . . .

Since 1957 CHALCO has delivered thousands of readers for many applications. Highly reliable, they will read ANY punched tape material . . . and ANY format interchangeably. They have MSI buffer memory, TTL I/O signals, and many other technical features. When you're serious about reading punched tape, read our FREE brochure. Or take advantage of our application and design services. Call or write CHALCO today.



## CHALCO ENGINEERING CORPORATION

15126 SOUTH BROADWAY • GARDENA, CA 90248  
TEL: (213) 321-0121 • TWX (910) 346-7026

CIRCLE 62

# We're Moving Up

As of October 24, 1977, Benwill Publishing's Headquarters and Editorial Offices move from the 1st floor at 167 Corey Rd. to the 2nd floor at 1050 Commonwealth Ave., Boston, MA 02215.

Moving to 1050 Commonwealth not only raises our sights, it also triples our work space. Thus expanded and uplifted, we hope to serve you better. Call us. Come up to visit. Our phone number stays the same: (617) 232-5470.

## PRODUCTS

### MONOLITHIC 8-BIT DAC SETTLES IN 85 ns

Model DAC-08BC DAC comes in a 16 pin plastic DIP and operates over the 0°C to 70°C temperature range; model DAC-08BM DAC, packaged in a 16 pin ceramic DIP, operates over the -55°C to +125°C military temperature range. The DAC-08 consists of 8 fast switching current sources, a diffused R-2R ladder network, a bias circuit and a reference control amplifier. An external reference current programs the scale factor for the DAC-08. This current can be varied resulting in one or two quadrant multiplying operations. Output current has a high voltage compliance of -10 to +18 volts, allowing direct current to voltage conversion with just an output resistor. Power supply requirement: +4.5V to +18V at 3.8 mA and -4.5V to -18V at 7.8 mA. The DAC-08 interfaces directly to a variety of logic families such as TTL, DTL, CMOS and HNIL. Datel Systems, 1020 Turnpike St., Canton, MA 02021. (617) 828-8000.

Circle 166

### EPROM PROGRAMMER WITH HEX DISPLAY

Model 7608, a low cost, self-contained programmer for type 2704 & 2708 EPROMs, has program entry via panel keyboard and true hexadecimal display of addresses and data. Model 7608 may also be used to copy master EPROMs and to read preprogrammed EPROMs, and an accessory emulator unit permits loading from an external keyboard or computer. Type 2716, 2K x 8 EPROMs may be programmed in two passes using the optional adapter board. Extensive editing capabilities in Model 7608 allow insertion and deletion of data with resequencing prior to programming. Provision for operating the internal memory on battery backup is included. SMR Electronics, 3 Haven Rd., Medfield, MA 02052. (617) 359-4043. Circle 204

### EIA INTERFACE MONITOR AND BREAKOUT PANEL

A pocket-size rechargeable version of the Model 60 EIA Interface Monitor and Breakout Panel uses two long-life size AA rechargeable Nickel-Cadmium batteries that allow the unit to operate directly from 110Vac while charging the batteries. Model 60 provides access to all 25 conductors of the EIA RS232



interface; twelve LED's monitor twelve key signals and two LED's sense whether signals meet EIA specs. Twenty-four switches with test points on each side allow all interface conductors except frame ground to be individually interrupted permitting isolated testing and observation of terminal and modem signals. The Model 60 weighs 13 oz including batteries and measures 3-3/4" W x 5" H x 1-3/4"D. International Data Sciences, Inc., 100 Nashua St., Providence, RI 02904. (401) 274-5100. **Circle 177**

## PAGE PRINTER FORMS 100 CPS FROM CRT

This solid state thermal CRT Page Printer can print full 1920-character screens from any CRT terminal in less than 20 seconds using only one moving part. The fully buffered, microprocessor-controlled Model 650 accepts data as fast as it can be transferred from any CRT having the RS232 interface. Normal interactive CRT dialogues can continue while printing the previous screen. The terminal prints noiselessly at 100 cps on a standard size sheet of paper, in a 24-line by 80-column format using a full 96-character ASCII set. The 9 by 12 dot matrix format provides for descenders on lower case characters. Printing heads, fixed in position, consist of thick film thermal dot arrays. The printer has switch-selectable baud rates up to 9600. It measures 4" x 12" x 12" and weighs 15 pounds. Perkin-Elmer Data Systems, Rte. 10 and Emery Ave., Randolph, NJ 07801. (201) 366-5550. **Circle 168**

## 40 COLUMN INTELLIGENT DOT MATRIX PRINTER

Model SP-302 5 x 7 impact dot matrix 40 column intelligent printer uses a microprocessor controller to perform such functions as double width printing and double and triple spacing. Inputs include RS-232; a 20mA current loop as standard and a rear panel EIA connector that handles RS-232 'busy' signals; and TTL 'on-line' signals. Internally programmable jumpers allow selectable print intensity. Input baud rate of 110 is standard; other input rates can be internally set. The unit prints at 50 cps with multiple copy capability. Syntest, 169 Millham St., Marlboro, MA 01752. (617) 481-7827. **Circle 176**

# The Perfect Cover-Up!!!

For The Computer  
Designer and Builder

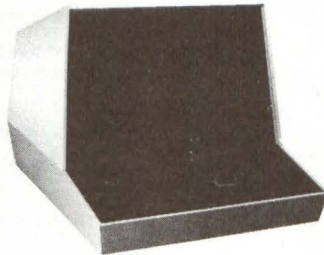

VTE 101  
TERMINAL ENCLOSURE  
\$78.95



KBE 101  
KEYBOARD ENCLOSURE  
\$24.95

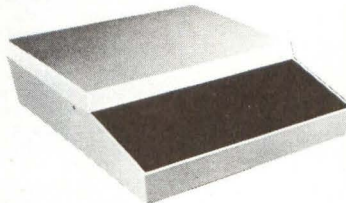

TVT 101  
TYPEWRITER ENCLOSURE  
\$47.95

... AND THESE FEATURES  
ARE STANDARD:

- High Impact Structural Plastic Construction
- Flame Retardant
- Attractive Professional Appearance
- Easily Machinable Using Ordinary Woodworking Tools
- Highly Adaptable to Your Needs
- Ribs & Bosses for Component Mounting
- Molded Ventilation Grills
- Removable Keyboard Mounting Plate
- Available Unfinished or in Three Standard Colors

*Inquire about special designs*

Enclosure Dynamics Products Are  
Distributed Worldwide By:

### CALIFORNIA

Byte Shop Computer  
Store of Diablo Valley  
2989 North Main Street  
Walnut Creek, CA 94596  
415-933-6252

Computer Land  
22634 Foothill Blvd.  
Hayward, CA 94542  
415-538-8080

Computer Land  
of West L.A.  
6840 La Cienega Blvd.  
Englewood, CA 90302  
213-776-8080

Computer Playground  
6789 Westminster Ave.  
Westminster, CA 92683  
714-898-8330

### COLORADO

Byte Shop  
2040 30th Street  
Boulder, CO 80301  
303-449-6233

Byte Shop  
3464 So. Acoma St.  
Englewood, CO 80110  
303-761-6232

Gateway Electronics  
2839 West 44th Ave.  
Denver, CO 80211  
303-458-5444

Miti-Mini Computer Co.  
621 So. Broadway  
Denver, CO 80209

### FLORIDA

Microcomputer Systems  
144 So. Dale Mabry Hwy.  
Tampa, FL 33609  
813-879-4301

### ILLINOIS

American Microprocessors  
Equipment & Supply Corp.  
20 North Milwaukee Ave.  
Prairieview, ILL 60069  
312-634-0076

Bits N Bytes  
Computer Store  
2928 West 147th St.  
Posen, ILL 60469  
312-389-7112

Lillipute Computer Mart  
4446 Oakton St.  
Skokie, ILL 60076  
312-674-1383

### INDIANA

The Computer Mart  
of Indiana  
901 Strong Ave.  
Elkhart, IN 46514  
219-293-7378

### IOWA

Micro Bus, Inc.  
1910 Mt. Vernon Rd. S.E.  
Cedar Rapids, Iowa 52403  
319-364-5075

### KENTUCKY

Computer Land  
of Louisville  
813 B Lyndon Lane  
Louisville, KY 40222  
502-425-8308

### MARYLAND

Computer Land  
of Rockville  
16065 Frederick Rd.  
Rt. # 355  
Rockville, Maryland 20850  
301-948-7676

### MASSACHUSETTS

Computer Mart, Inc.  
1097 Lexington St.  
Waltham, MA 02154  
617-899-4540

Microtec  
23 Hamburg St.  
Springfield, MA 01107  
413-734-3818

### MICHIGAN

Compumart, Inc.  
1250 North Main  
Ann Arbor, MI 48103  
313-994-4445

### MINNESOTA

Microprogramming, Inc.  
12033 Riverwood Drive  
Burnsville, Minn. 55337  
218-894-3510

### MISSOURI

Gateway Electronics  
8123 Page Blvd.  
St. Louis, MO 33130  
314-427-6116

### MONTANA

Computers Made Easy  
415 Morrow  
Bozeman, MT 59715  
406-586-3065

### NEW JERSEY

Computer Land  
of Morristown  
2 De Hard St.  
Morristown, NJ 07960  
201-539-4077

William Electronics Supply  
1863 Woodbridge Ave.  
Edison, NJ 08817  
201-985-3700

### NEW YORK

Computer Land  
of Tonawanda  
1612 Niagara Falls Blvd.  
Tonawanda, NY 14150  
716-836-6511

Computer Mart  
of New York  
118 Madison Ave.  
New York, NY 10016  
212-686-7923

Computer Microsystems  
1309 Northern Blvd.  
Manhasset, NY 11030  
516-627-3640

The Computer Shoppe  
444 Middle Country Rd.  
Middle Island, NY 11953  
516-732-4446

### PENNSYLVANIA

Lectro-Media, Ltd.  
New Market-Front & Pine  
Philadelphia, PA 19105  
215-925-4477  
800-523-2906

### TEXAS

The Micro Store  
634 So. Central Expwy.  
Richardson, TX 75080  
214-231-1096

### UTAH, NEVADA, IDAHO

The Computer Room  
3455 So. West Temple  
Salt Lake City, Utah 84115  
801-486-4311

## FOREIGN DISTRIBUTORS

### ENGLAND

West Hyde  
Developments, Ltd.  
Ryefield Crescent  
Northwood, Middlesex  
England HA6 1NN

### GERMANY

Datameg KG  
D 8011 Putzbrunn  
Munich, Germany  
4-60-49-93

### AUSTRALIA

Digital Electronics  
Pty. Ltd.  
4/29 Hotham PDE  
Artamon, N.S.W.  
Australia  
438-2444

ENCLOSURE DYNAMICS, Inc.  
P.O. Box 6276  
Bridgewater, New Jersey 08807  
201-725-7982

CIRCLE 64

# Mini/Micro77

THE MINICOMPUTER/MICROCOMPUTER CONFERENCE AND EXPOSITION

DECEMBER 6-7-8 • CONVENTION CENTER • ANAHEIM, CALIFORNIA

## CONFERENCE SESSIONS

### TUESDAY

#### MORNING

**Small Business Systems**  
Organizer: Don Schnitter,  
Basic Four Corp.

**Trends in CRT Terminals**  
Organizer: To be announced

#### AFTERNOON

**Small Disk Memory Trends**  
Organizer: Henry T. Meyer,  
CalComp

**Buyer Be Aware: How Reliable  
and Flexible will Future  
Systems Be?**  
Organizer: Edward J. Bride,  
The Conference Co.

**Low Cost Microcomputers in  
Business Applications**  
Organizer: Adam Osborne,  
Osborne & Assoc.

### WEDNESDAY

**Trends in Printer Development**  
Organizer: Neil Kleinman,  
International Data  
Corp.

**Intelligent Applications of Minis  
in the Small Business Environ-  
ment**  
Organizer: John Kirkley,  
Datamation Magazine

**Criteria Used in Selecting & Eval-  
uating a Minicomputer**  
Organizer: Joe Baker,  
Robert W. Baird Co.

**How to Keep an On-Line System  
from Crashing**  
Organizer: Neil Kelley,  
Infosystems Magazine

**Application of Microcomputers to  
Military Avionics**  
Organizer: Joe Genna,  
Delco Electronics

**Trends in Mini/Micro Software**  
Organizer: Joe DeVita,  
Computer Automation

### THURSDAY

**OEM Peripherals in End-User  
Systems: The Current View**  
Organizer: George King,  
Benwill Pub. Co.

**Distributed Data Processing**  
Organizer: Roger Billings,  
Billings Computer

**Getting Into the Microcomputer  
Business**  
Organizer: Robert S. Jones,  
Interface Age Mag.

**Computer Law**  
Organizer: Richard L. Bernocchi,  
Irell & Manella

**Transaction Processing with  
Networks**  
Organizer: Elton Sherman,  
General Automation

- NOTES: 1. Morning Session - 9:30 - 12:00 noon  
Afternoon Session - 1:30 - 4:00 p.m.
2. All Sessions will be held in the Anaheim Convention Center
3. Monday, December 5 is IEEE Career Day. Contact:  
Vincent J. Giardina (201) 981-0060

## LIST OF EXHIBITORS (as of October 1)

E & L Instruments  
MuPRO  
Micro Computer Systems  
Optical Electornics  
AMPEX  
Data I/O  
Applied Computer Systems<sup>®</sup>  
Okidata  
Artec Electronics Corp.  
Qantex  
Cahners Publishers  
Telefile Computer Products  
American Microsystems  
Newman Computer Exchange  
Computer Magazine (IEEE)  
Monolithic Systems Corp.  
Electronic Representatives  
Assoc.  
Anderson Jacobson  
Digital Systems  
Logical Services  
Computerworld  
Micro Communications  
Publishers for Conventions  
Alpha Data  
Shugart Assoc.  
Sola Electric  
Matrix Publishers  
Wyle Distribution Group/  
Liberty Elmar (Intel,  
Motorola, Fairchild, Sig-  
netics, Standard Power,  
Allen Bradley, Corning,  
Sprague, ITT Cannon)

Biomation Corp  
Sord Computer Systems  
Dataflux Corp.  
Hughes Aircraft Co.  
Pro-Log Corp  
Zilog  
Digital Equipment Corp.  
Mini Micro Systems  
Teletype Corp  
Applied Digital Data (ADDS)  
Printronic  
MDB Systems  
Systems Furniture  
Data Systems Design  
Basic/Four Corp.  
Ball Brothers Research Corp.  
Lear Siegler Inc./EID  
Minicomputer Accessories  
Ex-Cell-O Corp/Remex Div.  
Sybex, Inc.  
Memorex  
Avnet Electronics

Terminal Rentals  
Interdyne  
Intermec  
Intel Corp  
Addmaster Corp  
Megatek Corp  
The Digital Group  
Infosystems Magazine  
Calex  
Parsons Mfg. Corp.  
Ai Electronics Corp.  
Triple I  
Hamilton Electro Sales  
(Motorola, National,  
Intel, Burr-Brown,  
Shugart Assoc., Ryan-  
McFarland)

General Robotics Corp.  
Computer Automation  
Tally Corp.  
EECO  
First Data Corp.  
Calcomp  
Microdata Corp.  
Electronic Memories  
& Magnetics (EM&M)

Wangco  
Applied Data Communications  
Tandberg Data  
PCC Pertec  
Datamation  
Computer Roomers  
Computer Decisions  
Interface Magazine  
Elmatex International  
Raymond Engineering  
Trim Enclosure Prod.  
Pfystar Microcomputer  
Products

Diva  
Educational Data Systems  
CMP Publications  
Computer Design  
Tektronix  
Centronics  
Cherry Electrical  
Benwill Publishing Corp.  
Sybex  
Iasis  
Cipher Data Products  
Commodore Bus. Machines  
International Microsystems  
Texas Instruments  
Pacific Telephone Co.  
Newport Data Systems  
Problem Solver Systems

(More companies are being added on a daily basis)

Conference Program Chairman: Dr. L.A. Lotito (Computer Automation)

Exhibits Committee Chairman: William Handel (Nigbert Corporation)



To: MINI/MICRO COMPUTER CONFERENCE AND EXPOSITION  
5528 E. La Palma Avenue, Suite I, Anaheim, CA 92807, Phone: (714) 528-2400

#### My Primary Interest Is:

- Attending.** Please send me a Preview Program listing information on sessions/papers, exhibitors, and hotel reservations.
- Exhibiting.** Please send a copy of the Exhibit Prospectus.

Name \_\_\_\_\_  
Title \_\_\_\_\_  
Company \_\_\_\_\_  
Address \_\_\_\_\_ M/S \_\_\_\_\_  
City \_\_\_\_\_ State \_\_\_\_\_ Zip \_\_\_\_\_

Please type or print

# ADVERTISER'S INDEX

38	ADDMASTER	24	MEGATEK
14,15,17	ADTECH POWER	73	MEMODYNE
21	AMPEX	36	MINICOMPUTER TECHNOLOGY
85	AMPEX/ REDWOOD CITY	98	MINI/MICRO COMPUTER CON- FERENCE AND EXPOSITION
16	ANALOGIC	38	MOHR LABS
50,51	BIOMATION	33,69	MONOLITHIC SYSTEMS
19	BOSCHERT	4	MUPRO
96	CHALCO ENGI- NEERING	39,40,41,42	NATIONAL SEMICONDUCTOR/MICROCIR- CUITS DIV.
71	CLIFTON PRE- CISION	49	PANASONIC/ INDUSTRIAL DIV.
64	COMTEC	55,95	PERTEC MICRO- SYSTEMS
24	DATA I/O	63	PLESSEY SEMI- CONDUCTOR
13	DATA 100	74	PPG INDUSTRIES
35	DATARAM	9	PRINTRONIX
67	DECITEK	90	QANTEX
91	ELECTRONIC ENGINEERING TIMES	59	SIGNETICS
97	ENCLOSURE DYNAMICS	11	SOROC
6	GENISCO TECH- NOLOGY	27-30,P.C.	SPACE BYTE
C-4	GRINNELL SYS- TEMS	3	SPERRY UNIVAC
1	HEWLETT-PACK- ARD/COLORADO	36	STANDARD ENGINEERING
57	HOUSTON INSTRUMENTS	77	SWEDA
65	INDUSTRIAL ELECTRONIC ENGINEERS	81,C-3	SYSTEM IN- DUSTRIES
C-2	IMSAI	53	TANDBERG DATA
37	ISS/SPERRY	7	TELETYPE
83,87,89	KERONIX	92,93	TEXAS INSTRU- MENTS/DALLAS
94	LAVEZZI MA- CHINE WORKS	2	TEXAS INSTRU- MENTS/HOUSTON
45	LEAR SIEGLER	47	TLF
60,61	3M/MINCOM/ DATA PRODUCTS	88	USM
84	MDB SYSTEMS		

## SALES OFFICES

**PUBLISHER** Yuri Spiro **MARKETING PROGRAMS DIRECTOR** George Palken **NEW ENGLAND** George Palken 1050 Commonwealth Ave., Boston, MA 02215 (617) 232-5470 **NEW YORK, WASHINGTON, DC, PHILADELPHIA** Arthur Daks, 299 Madison Ave., New York, NY 10017 (212) 661-0360 **MIDWEST, SOUTH** Ralph Petersen, 1 Wheaton Center No. 1706, Wheaton, IL 60187 (312) 653-2480 **LOS ANGELES, PHOENIX, DALLAS, SAN FRANCISCO** Alan Cazier, 823 Enchanted Way, Pacific Palisades, CA 90272 (213) 454-0624 **WEST GERMANY** Maurice A. Coates Int'l. Media Reps. D-675 Kaiserlautern, Box 1610 **JAPAN** Hiro H. Irie International Business Corp., 11-8 Narita-Higashi 1-Chome, Sugunami-KU, Tokyo 166 Phone (03) 311-1746

# ALPHA BITS

## Detecting Digital Signals

Written primarily for practicing and student engineers involved in the design and development of future data-transmission systems, **Advanced Data-Transmission Systems** by A.P. Clark presents an account of the theory and techniques involved in the generation and detection of digital signals, where these are sampled prior to processing at the receiver. The book concentrates on the application of computer-like techniques to the detection of a sampled digital data signal. First studying the discrete Fourier transform and its application to the analysis of linear distortion in a sampled digital signal, the book proceeds through some theory development and accounts of principles, then presents studies of new detection processes and at the end, an analysis of various parallel systems using code-division multiplexing. 420 pages. \$27.50 from Halsted Press, Division of John Wiley & Sons, 605 Third Avenue, NY 10016.

## Questions Answered

Intended for people new to computing, **Home Computers: 2<sup>10</sup> Questions and Answers, Volume 1: Hardware** supplies hardware related information. Based on fictional conversations between a person who knows little about computers and a person very knowledgeable about the field, author Rich Didday says the book should give people who want to buy a home computer enough of a feel for the hardware so they don't make any purchasing mistakes.

In keeping with the book's dialog format, it is organized by days: Volume 1 includes the first five days of talks and Volume 2 the next five days. As the days progress, the topics become complex.

**Volume 2; Software** deals exclusively with two models, the Intel 8080 and the Motorola 6800. For these, Didday's chapters cover specific microprocessors' organization, memory access instructions and stack handling; machine and assembly-language pro-

gramming; basic language programming, including random number generators, arrays, and games; and generalities on programming. Volume 2 also includes a detailed index of both Volumes 1 and 2. Illustrated, Vol. 1 225 pp., \$7.95 paper; Vol. 2 225 pp., \$6.95 paper. dilithium Press, P.O. Box 92, Forest Grove, OR 97116.

## How to Store Your Data

Describing and examining the available storage devices, their technologies and architectures, **Computer Storage Systems & Technology** gives a modern perspective for making the best decisions. Each type of storage device is examined by author Richard Matick for its speed of access, required size, relative cost, necessary organization, as well as other crucial advantages and

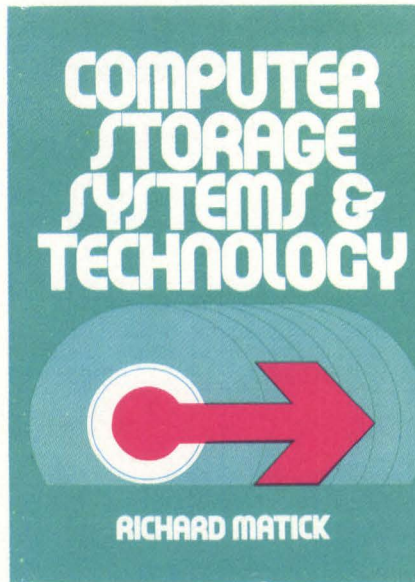

disadvantages. The more sophisticated topics related to memory, such as file structuring, virtual memory systems and hardware restrictions are also considered, and typical application examples are given to show how each type of memory can best be implemented and how it functions within the digital system. This 667 page book can be ordered for \$29.95 from John Wiley & Sons, Inc., One Wiley Drive, Somerset, NJ 08873. (201) 479-4400.

## Learn About Emulation

An introductory "how-to" book that treats microprogramming and emulation topics, **A Microprogramming Primer** by Harry Katzan, Jr., discusses complex relationships between programs, computers and modern methods of implementation. The book presents microprogramming concepts and shows how they relate to the organization of modern computer systems, then discusses the concept of emulation; a microprogramming language; and a microprogrammable computer. The author states the principles of emulation so that students can apply the concepts to the design and development of practical systems. The text uses translator and simulator systems to enable students to write programs that can be executed on any computer system with FORTRAN facilities. Hardcover, 254 pages. \$17.95 from McGraw-Hill Book Company, 1221 Avenue of the Americas, New York, NY 10020. (212) 997-2485.

## Shopping for Computers, Peripherals

Billing itself as "The Affordable Computer Catalog," **Byte Shopper**, created by The Phoenix Group, Inc., represents over 50 manufacturers of microcomputers, video terminals, floppy discs, I/O boards, memory systems, printers, magnetic tape and books. The catalog includes a glossary of terms for the novice computer user/buyer and begins with a basic description of microcomputers and what they can do. After explaining 4 typical microcomputer systems, **Byte Shopper** continues with descriptions of other microcomputer systems, micro training aids, display, storage and printing peripherals and software. The Phoenix Group has included an up-to-date price list and indicates in the catalog which systems or components are the best buys for hobbyists and small businesses. 41 pages in 11" x 14½" format, for \$2.50. Order from Byte Shopper, P.O. Box 28106, Tempe, AZ 85282. (602) 894-1193.

# When we installed our first minicomputer disk system, we talked a lot about **RELIABILITY.**



## 4000 systems later, our customers tell the story.

Reliability. We do more than just talk about it. We deliver it. That's one of the main reasons we're now the world's largest independent supplier of minicomputer disk storage systems.

We've delivered more than 4,000 systems since we installed our first one in 1971. That's strong evidence of hardware reliability and product acceptance.

There's a lot more to the story. Behind our reliable hardware is a reliable company that keeps delivery commitments, provides total software support and responds quickly to customer service requirements. Ask our customers.

We make good disk drives work better through *Extended Emulation*.™ This powerful approach adapts software to emulate the CPU manufacturer's operating systems—while still taking full advantage of the unmatched performance offered by our disk system. Whether you need disk storage for mini or micro, you need to know about the important benefits *Extended Emulation* can provide.

The diverse applications for our disk systems are regularly described in our quarterly newsletter, *The Bit*. If you'd like to be on our complimentary mailing list, use the coupon today. We'll send you the current issue. And if you need product data, or help with a specific application, contact the System Industries sales/service office nearest you.

**System Industries**  
an equal opportunity employer

525 Oakmead Parkway  
P.O. Box 9025  
Sunnyvale, California 94086  
(408) 732-1650, Telex: 346-459

Please add my name to your mailing list for *The Bit*. Send product data on the follow disk systems:

2.5 MBytes       10 MBytes       300 MBytes

Name \_\_\_\_\_ Position \_\_\_\_\_

Company \_\_\_\_\_

Address \_\_\_\_\_

City \_\_\_\_\_ State \_\_\_\_\_ Zip \_\_\_\_\_

My need is urgent. Have an applications specialist phone me today: (\_\_\_\_\_) \_\_\_\_\_ ext. \_\_\_\_\_

#### Sales/Service Offices:

**Boston:** (617) 492-1791. **New York:** (201) 461-3242; (201) 694-3334; (516) 751-8686; (716) 385-3021.

**Washington, D.C.:** (202) 337-1160. **Cincinnati:** (513) 661-9156. **Los Angeles:** (714) 752-8904.

**Houston:** (713) 465-2700. **Atlanta:** (404) 491-0161. **Sunnyvale HQ:** (408) 732-1650.

**Germany, Dusseldorf:** 0211-400606. **Sweden, Stockholm:** 08-236-640.

**United Kingdom, Woking:** (4862) 70725.

THE GEORGE E. FREEMAN LIBRARY  
 STATE TECHNICAL INSTITUTE AT MEMPHIS  
 5983 Macon Cove at Interstate 40  
 Memphis, Tennessee 38134

# GRINNELL DISPLAYS:

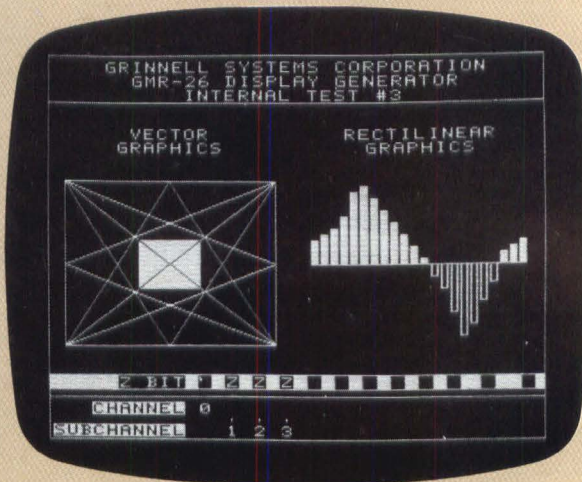
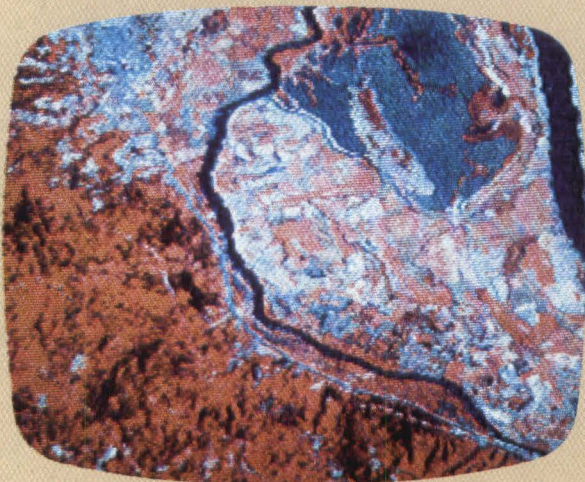
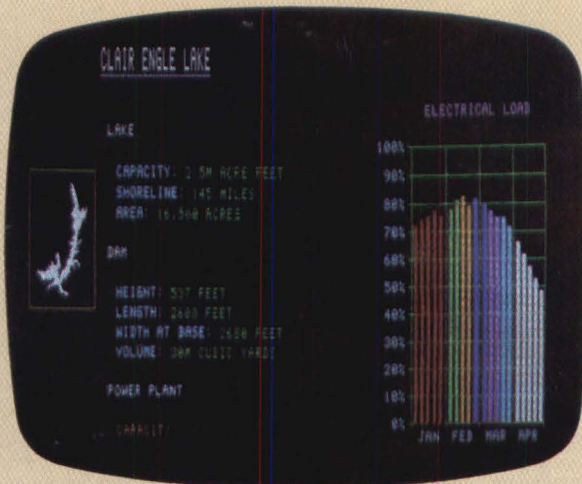
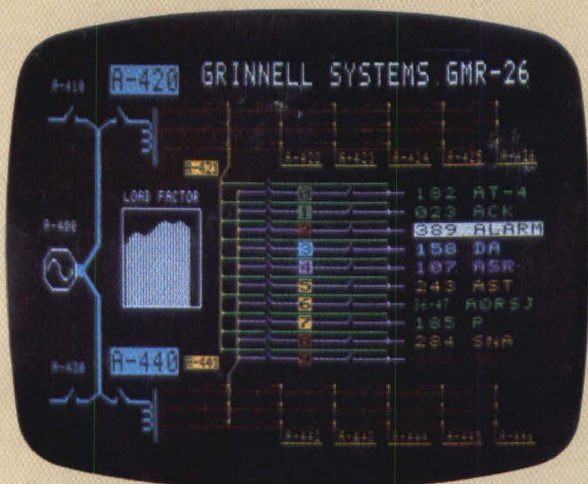

Complex color imaging . . . graphics . . . grey scale . . . basic black and white: our 100% solid state graphic television display systems can be matched to your computer display requirement, easily and economically.

And, they're intelligent. Powerful instruction sets minimize software overhead, simplify programming and eliminate the need for complex macro-instructions and

high order programming languages.

Further, every Grinnell system includes a standard computer interface, full alphanumerics and graphics, 4K MOS random access refresh memories and your choice of standard resolutions: 256 x 256, 256 x 512 or 512 x 512. Plug-compatible interfaces for most minicomputers are available, along with a large number of

operating options. All systems drive standard TV monitors.

So, before you make any decision about computer display systems, talk to the Grinnell experts. Our engineers have been in the display picture longer than most, and their experience shows. Complete operating systems start at \$5,700, and quantity discounts are available. For detailed specs and/or a quotation, call or write.

# GRINNELL SYSTEMS

2986 Scott Boulevard, Santa Clara, California 95050 (408) 988-2100